

Installation instruction of 5-Phase Motor

■ Connection Diagram

5-phase stepper motor from Autonics is equipped with pentagon wiring method.

Therefore, 5-phase stepper motor is suitable for a driver with bipolar constant pentagon drive method.

The relations between each phase (coil) in the stepper motor and the color of the Lead-wire are followings.

● Pentagon wiring (standard)

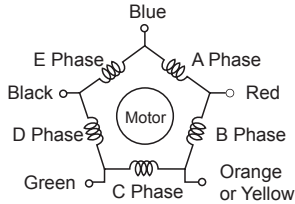

● Standard wiring (option)

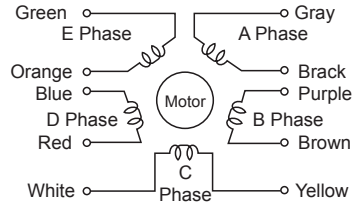

Lead wire color for standard connection type	Lead wire color for pentagon connection type
Gray+Red	Blue
Yellow+Black	Red
Orange+White	Orange
Brown+Green	Green
Blue+Purple	Black

In case of connecting standard connection type models to 5-phase motor drivers, make sure that lead wire of the motor must be connected as specified in the above table.

■ Motor Installation

◎ Shaft type, hollow shaft type, geared type, geared built-in brake type stepper motor

● Mounting direction

Motor can be mounted in any directions-facing up, facing down and side ways. No matter which direction motors to be mounted, be sure not to apply overhung or thrust load on the shaft.

Refer to the table below for allowable shaft overhung load / thrust load.

● Side way

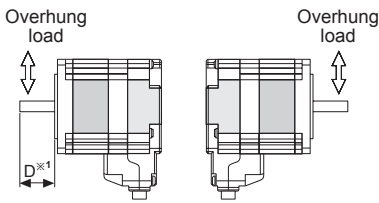

< Shaft type >

※1: The distance from the shaft tip (mm)

● Facing up, down

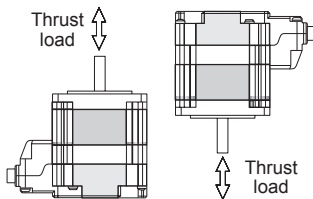

< Shaft type >

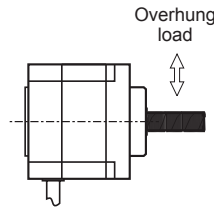

< Hollow shaft type >

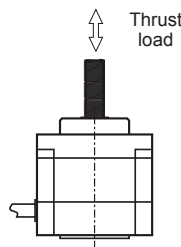

< Hollow shaft type >

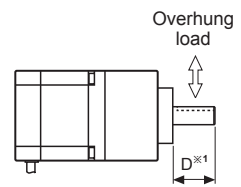

< Geared, Geared built-in brake type >

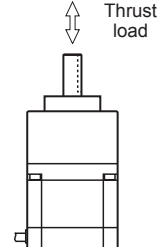

< Geared, Geared built-in brake type >

Refer to the table below for allowable overhung load / thrust load for shaft type stepper motor.

Motor frame size	The distance from the shaft in front (mm), Allowable overhung load [kgf (N)]					Allowable thrust load [kgf (N)]
	D=0	D=5	D=10	D=15	D=20	
24mm	2(20)	2.5(25)	3.4(33)	—	—	Under the load of motor
42mm	2(20)	2.5(25)	3.4(33)	5.2(51)	—	
60mm	6.3(62)	7.5(74)	9.5(93)	13(127)	19(186)	
85mm	26(255)	29(284)	34(333)	39(382)	48(470)	

Refer to the table below for allowable overhung load / thrust load for geared type stepper motor.

Motor frame size	The distance from the shaft in front (mm), Allowable overhung load [kgf (N)]					Allowable thrust load [kgf (N)]
	D=0	D=5	D=10	D=15	D=20	
42mm	7.3(72)	8.4(82)	10(98)	12.3(121)	—	5(49)
60mm	25(245)	27(265)	30(294)	34(333)	39(382)	10(98)
85mm	48(471)	54(530)	60(588)	68(667)	79(775)	30(294)

Installation instruction of 5-Phase Motor

● Motor installation method

When installing the motor, carefully consider heat radiation and vibration resistance. Mount the unit tightly on the surface of a metal with high thermal conductivity. (steel, aluminum, etc.) Use hexagon bolts, spring washers and flat washers when installing the motor. Please refer to the table below for mounting plate thickness and bolt types.

● Through hole type

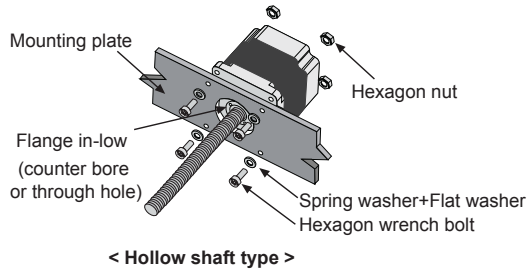
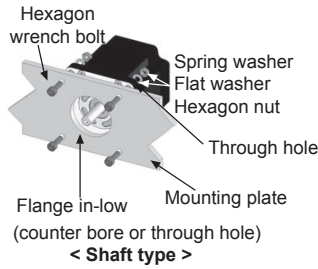

< Hollow shaft type >

● Tap hole type

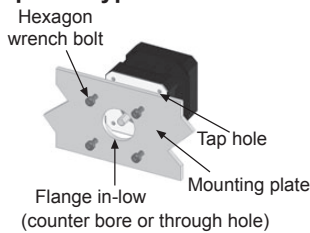

< Shaft type >

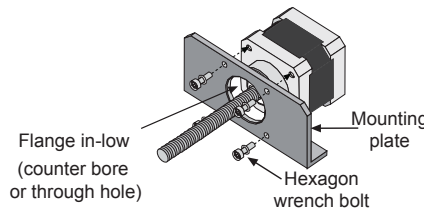

< Hollow shaft type >

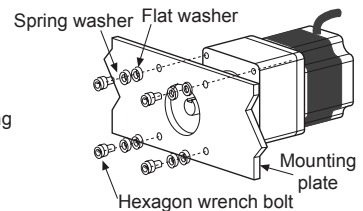

< Geared, Geared built-in brake type >

Motor frame size	Mounting plate thickness	Applied bolt
24mm	Min. 3mm	M2.6
42mm	Min. 4mm	M3
60mm	Min. 5mm	M4
85mm	Min. 8mm	M6

Motor frame size	Mounting plate thickness	Applied bolt
42mm	Min. 4mm	M3
60mm	Min. 5mm	M4
85mm	Min. 8mm	M6

Motor frame size	Mounting plate thickness	Applied bolt
42mm	Min. 5mm	M4
60mm	Min. 8mm	M5
85mm	Min. 12mm	M8

● Connection with load (shaft type, geared type, geared built-in brake type stepper motor)

When connecting the load, be sure of the center, tension of the belt, and parallel of the pulley. When connecting the load such as a pulley, a belt, be sure of the allowable thrust load, radial load, and shock. Tighten the screw for a coupling or a pulley not to be unscrewed. When connecting a coupling or a pulley on the motor shaft, be sure of damage of the motor shaft and the motor shaft bearing. Do not disassemble or modify the motor shaft to connect with the load.

Direct load connection with coupling	Load connection with pulley, belt, and wire	Load connection with gear
<p>※Use Autonics flexible coupling (ERB Series).</p>		
<p>When connecting the load directly (ball screw, TM screw, etc) to the motor shaft, use a flexible coupling as shown in the above figure. If the center of the load is not matched to that of shaft, it may cause severe vibration, shaft damage or shortened life cycle of the shaft bearing.</p>	<p>The motor shaft and the load shaft should be parallel. Connect the motor shaft and the line which connects the center of two pulleys to a right angle.</p>	<p>The motor shaft and the load shaft should be parallel. Connect the motor shaft to the center of gear teeth side to be interlocked.</p>

(A) Photoelectric Sensors

(B) Fiber Optic Sensors

(C) Door/Area Sensors

(D) Proximity Sensors

(E) Pressure Sensors

(F) Rotary Encoders

(G) Connectors/ Connector Cables/ Sensor Distribution Boxes/Sockets

(H) Temperature Controllers

(I) SSRs / Power Controllers

(J) Counters

(K) Timers

(L) Panel Meters

(M) Tacho / Speed / Pulse Meters

(N) Display Units

(O) Sensor Controllers

(P) Switching Mode Power Supplies

(Q) Stepper Motors & Drivers & Controllers

(R) Graphic/ Logic Panels

(S) Field Network Devices

(T) Software

Installation instruction of 5-Phase Motor

● Shaft assembly for hollow shaft type motor

Make sure that external shaft assembly into motors must be made as sturdy as possible. If not, motor's torque might not be thoroughly transmitted to the shaft. In case no additional shaft assembly changes would be made, it is recommended to apply adhesives on bolt fixing part.

1. Tap hollow shaft type motor

Use pliers to fasten lock nut tightly as shown in the figure below.

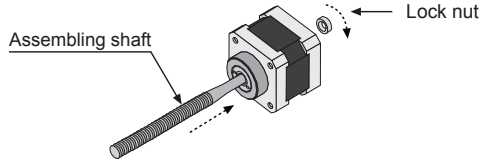

2. Through hole type motor with single shaft

Use hexagon wrench bolt, spring washer, flat washer and lock washer to fasten the shaft tightly as shown in the figure below.

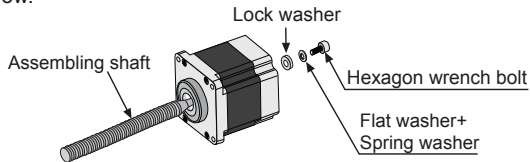

3. Through hole type motor with dual shaft

Use a lock nut to fasten the shaft tightly as shown in the figure below.

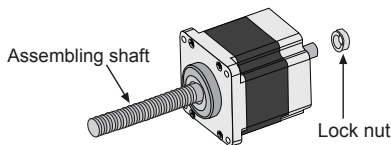

● Caution during install the motor

Do not apply excessive force on motor cable when mounting motors.

Do not forcibly pull or insert the cable. It may cause poor connection or disconnection of the cable.

In case of frequent cable movement required application, proper safety countermeasures must be ensured.

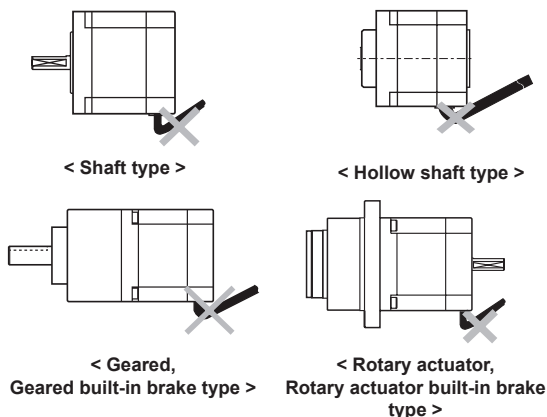

◎ Rotary actuator type stepper motor

● Motor installation method

① With considering heat radiation and vibration isolation, make sure the motor's in-low to be kept as close as possible against a metal panel having high thermal conductivity such as iron or aluminum. Make sure to use mounting plates with thickness more than 8mm.

② As shown in the figure below, total 4 mounting TAP holes on F1 and F2 are used to fix rotary actuator. In case of using M4, screw tightening torque needs to be 2N·m, and in case of M5, 4.4N·m.

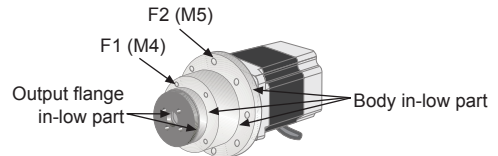

③ Do not apply excessive force on motor cable when installing rotary actuators. Do not forcibly pull or insert the cable. Do not move the motor cable repeatedly with excessive force, or it may cause poor connection or disconnection of the cable. In case when frequent cable movement or excessive force is required, proper safety countermeasures must be ensured.

● Motor operation

Observe the rated product specification.

- ① Do not apply rotational load on the motor while it stops.
- ② Do not apply excessive load on the motor while driving. It may cause motors to miss a step.
- ③ Use a sensor for home searching or division completed position detecting.

● Installation of accessories (index table, arm, etc.)

- ① Mount the accessory (index table or arm) on output axis flange using M4 screw. Note that $\varnothing 13$ in-low part is processed with C0.3. It is necessary to process the accessory under C0.2 to mount. Place a positioning pin on flange's positioning hole and push it in. Make sure not to place the pin on output flange.
- ② Do not use a hammer to mount the accessory (table or arm). It may cause product damage. Mount the accessory with hands in a gentle manner.
- ③ Make sure that accessory mounted on output axis to be fixed as tight as possible. It may cause an accident if an actuator is detached from the motor while driving.

● Application example

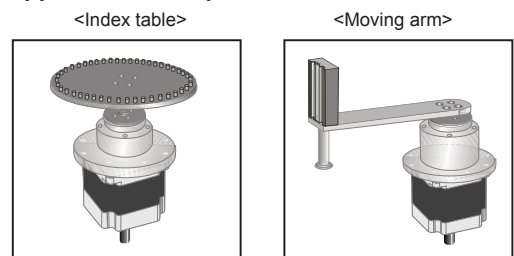

Installation instruction of 5-Phase Motor

● Sensor attachment

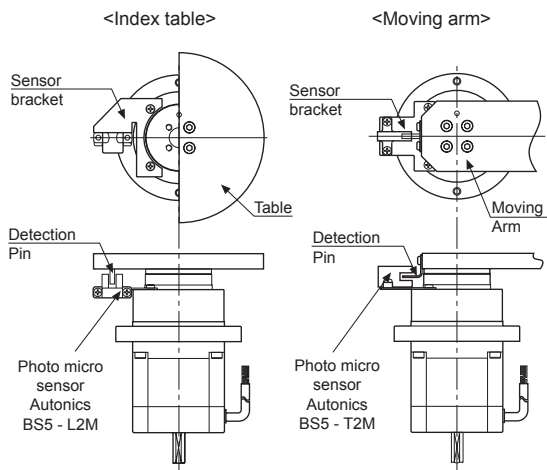

■ Installation Conditions

Install the motor in a place that meets certain conditions specified below. It may cause product damage if instructions are not following.

- ① The inner housing installed indoor
(This unit is manufactured and designed for attaching to equipment. Install a ventilation device.)
- ② Within -10 to 50°C (at non-freezing status) of ambient temperature
- ③ Within 35 to 85%RH (at non-dew status) of ambient humidity
- ④ The place without explosive, flammable and corrosive gas
- ⑤ The place without direct ray of light
- ⑥ The place where dust or metal scrap does not enter into the unit
- ⑦ The place without contact with water, oil, or other liquid
- ⑧ The place without contact with strong alkali or acid material
- ⑨ The place where easy heat dissipation could be made
- ⑩ The place where no continuous vibration or severe shock
- ⑪ The place with less salt content
- ⑫ The place with less electronic noise occurs by welding machine, motor, etc.
- ⑬ The place where radioactive substances and magnetic fields does not exist and is not in the vacuum status

■ Cautions during Use

● Do not disassemble or modify the product.

It may cause malfunction due to small dregs.
Once disassembling the motor, its performance would significantly decline.

● Do not impact the motor.

The air-gap, the distance between rotator and stator is processed as 0.05mm , but if it is impacted, the balance of air-gap can be broken and it may cause a malfunction.

● Using at low temperature.

Using motors at low temperature may cause reducing maximum starting / driving characteristics of the motor with rise of the friction torque, because grease consistency of the ball bearing and Gear Head becomes heavy. Since it is not error of the torque, start the motor in a steady manner.

● Temperature rise

The surface temperature of motor shall be under 100°C . It can be significantly increased by operation conditions (ambient temperature, drive speed, drive duty ratio, etc). In this case, use the cooling fan to lower the temperature forcedly. Or, it may cause damage on motor power cable by fire, shortening the life cycle of the inner ball-bearing, or malfunction of the unit.

● Use the motor within the allowable torque range.

The allowable torque range indicates the maximum value of mechanical strength of gear part and the total of ac/deceleration torque of start/stop and friction torque shall not be exceed the allowable torque range, or it may cause the breakdown of gear.

● Use the motor within the allowable speed range.

The allowable speed range includes the revolution number of gear and pulse speed of motor. Use the motor within the allowable speed range, or it may shorten the life cycle of gear part. (backlash is increased.)

● Be careful of backlash when positioning the motors in both CW/CCW directions.

Backlash refers to the displacement occurred on motor's output shaft while gear's input axis is fixed.
Geared type stepping motors are to realize high accuracy and low backlash. When positioning the motors in both CW/CCW directions, however, backlash may possibly occur. Therefore, make sure that motor positioning will be made in one single direction in case of geared type motors.

● Clack sound of electro-magnetic brake

When operating or releasing electro-magnetic brake, this machine may occur clack sound.
Be assured that it is not the cause of malfunction, and do not hit or disassemble the motor.

● Using of electro-magnetic brake

When drive the motor, supply power to electro-magnetic brake for releasing the brake. If not supply power, it may cause abnormal motor operation, and the brake pad of electro-magnetic brake is worn. It may also cause shorten product life cycle, reducing the rated static friction torque.

(A) Photoelectric Sensors

(B) Fiber Optic Sensors

(C) Door/Area Sensors

(D) Proximity Sensors

(E) Pressure Sensors

(F) Rotary Encoders

(G) Connectors/ Connector Cables/ Sensor Distribution Boxes/Sockets

(H) Temperature Controllers

(I) SSRs / Power Controllers

(J) Counters

(K) Timers

(L) Panel Meters

(M) Tacho / Speed / Pulse Meters

(N) Display Units

(O) Sensor Controllers

(P) Switching Mode Power Supplies

(Q) Stepper Motors & Drivers & Controllers

(R) Graphic/ Logic Panels

(S) Field Network Devices

(T) Software