

SYSMAC

CX-Programmer Ver. 9.□
CXONE-AL□□D-V4

OPERATION MANUAL
**Function Blocks/
Structured Text**

OMRON

NOTE

All rights reserved. No part of this publication may be reproduced, stored in a retrieval system, or transmitted, in any form, or by any means, mechanical, electronic, photocopying, recording, or otherwise, without the prior written permission of OMRON.

No patent liability is assumed with respect to the use of the information contained herein. Moreover, because OMRON is constantly striving to improve its high-quality products, the information contained in this manual is subject to change without notice. Every precaution has been taken in the preparation of this manual. Nevertheless, OMRON assumes no responsibility for errors or omissions. Neither is any liability assumed for damages resulting from the use of the information contained in this publication.

Trademarks

- Microsoft, and Windows are either registered trademarks or trademarks of Microsoft Corporation in the United States and other countries.

Other company names and product names in this document are the trademarks or registered trademarks of their respective companies.

Copyrights

Microsoft product screen shots reprinted with permission from Microsoft Corporation.

SYSMAC

CX-Programmer Ver. 9.□

CXONE-AL□□D-V4

Operation Manual

Function Blocks/Structured Text

Revised April 2016

Notice:

OMRON products are manufactured for use according to proper procedures by a qualified operator and only for the purposes described in this manual.

The following conventions are used to indicate and classify precautions in this manual. Always heed the information provided with them. Failure to heed precautions can result in injury to people or damage to property.

 **DANGER** Indicates an imminently hazardous situation which, if not avoided, will result in death or serious injury. Additionally, there may be severe property damage.

 **WARNING** Indicates a potentially hazardous situation which, if not avoided, could result in death or serious injury. Additionally, there may be severe property damage.

 **Caution** Indicates a potentially hazardous situation which, if not avoided, may result in minor or moderate injury, or property damage.

OMRON Product References

All OMRON products are capitalized in this manual. The word “Unit” is also capitalized when it refers to an OMRON product, regardless of whether or not it appears in the proper name of the product.

The abbreviation “Ch,” which appears in some displays and on some OMRON products, often means “word” and is abbreviated “Wd” in documentation in this sense.

The abbreviation “PLC” means Programmable Controller. “PC” is used, however, in some Programming Device displays to mean Programmable Controller.

Visual Aids

The following headings appear in the left column of the manual to help you locate different types of information.

Note Indicates information of particular interest for efficient and convenient operation of the product.

1,2,3... 1. Indicates lists of one sort or another, such as procedures, checklists, etc.

Part 1: Function Block

SECTION 1 Introduction to Function Blocks

SECTION 2 Function Block Specifications

SECTION 3 Creating Function Blocks

Part 2: Structured Text

SECTION 4 Introduction to Structured Text

SECTION 5 Structured Text (ST) Language Specifications

SECTION 6 Creating ST Programs

Appendices

TABLE OF CONTENTS

PRECAUTIONS	xix
1 Intended Audience	xx
2 General Precautions	xx
3 Safety Precautions	xx
4 Application Precautions	xxi

Part 1: Function Blocks

SECTION 1

Introduction to Function Blocks	3
1-1 Introducing the Function Blocks	4
1-2 Function Blocks	11
1-3 Variables	18
1-4 Converting Function Block Definitions to Library Files	23
1-5 Usage Procedures	23
1-6 Version Upgrade Information	25

SECTION 2

Function Block Specifications	31
2-1 Function Block Specifications	32
2-2 Data Types Supported in Function Blocks	43
2-3 Instance Specifications	44
2-4 Programming Restrictions	53
2-5 Function Block Applications Guidelines	58
2-6 Precautions for Instructions with Operands Specifying the First or Last of Multiple Words	67
2-7 Instruction Support and Operand Restrictions	70
2-8 CPU Unit Function Block Specifications	71
2-9 Number of Function Block Program Steps and Instance Execution Time	78

SECTION 3

Creating Function Blocks	81
3-1 Procedural Flow	82
3-2 Procedures	84

TABLE OF CONTENTS

Part 2: Structured Text (ST)

SECTION 4

Introduction to Structured Text 133

4-1 ST Language 134

4-2 CX-Programmer Specifications 135

SECTION 5

Structured Text (ST) Language Specifications 137

5-1 Structured Text Language Specifications 138

5-2 Data Types Used in ST Programs 139

5-3 Inputting ST Programs 140

5-4 ST Language Configuration 144

5-5 Statement Descriptions 155

5-6 ST-language Program Example 173

5-7 Restrictions 174

SECTION 6

Creating ST Programs 177

6-1 Procedures 178

Appendices

A System-defined external variables supported in function blocks 191

B Structured Text Errors 193

C Function Descriptions 197

Index 223

Revision History 225

About this Manual:

This manual describes the CX-Programmer operations that are related to the function block functions and Structured Text (ST) functions. The function block and structure text functionality of CX-Programmer is supported by CJ2H, CJ2M CPU Units, by CS1-H, CJ1-H, and CJ1M CPU Units with unit version 3.0 or later, by CP-series CPU Units, and by NSJ-series and FQM1-series Controllers.

Some function block and structure text functionality, however, is supported only by CJ2H CPU Units, by CS1-H, CJ1-H, and CJ1M CPU Units with unit version 4.0 or later.

For details, refer to *1-6 Version Upgrade Information*.

For information on functionality other than function blocks and structure text, refer to the following manuals.

- CX-Programmer
 - : CX-Programmer Operation Manual (W446) and CX-Programmer Operation Manual: SFC (W469)
- CPU Unit
 - : The operation manuals for the CS-series, CJ-series, CP-series, and NSJ-series Controllers

CX-Programmer Ver. 9.□ Manuals

Name	Cat. No.	Contents
CXONE-AL□□D-V4 CX-Programmer Operation Manual Function Blocks/Structured Text	W447 (this manual)	Explains how to use the CX-Programmer software's function block and structured text functions. For explanations of other shared CX-Programmer functions, refer to the <i>CX-Programmer Operation Manual (W446)</i> .
CXONE-AL□□D-V4 CX-Programmer Operation Manual	W446	Provides information on how to use the CX-Programmer for all functionality except for function blocks.
CXONE-AL□□D-V4 CX-Programmer Operation Manual: SFC	W469	Explains how to use the SFC programming functions. For explanations of other shared CX-Programmer functions, refer to the <i>CX-Programmer Operation Manual (W446)</i> .
CX-Net Operation Manual	W362	Information on setting up networks, such as setting data links, routing tables, and unit settings.
CXONE-AL□□D-V4 CX-Integrator Operation Manual	W464	Describes the operating procedures for the CX-Integrator.

CJ2H, CJ2M, CS1-H, CJ1-H, and CJ1M CPU Unit Manuals

Name	Cat. No.	Contents
SYSMAC CJ Series CJ2H-CPU6□-EIP, CJ2H-CPU6□ CJ2M-CPU1□, CJ2M-CPU3□ Programmable Controllers Hardware User's Manual	W472	Provides an outline of and describes the design, installation, maintenance, and other basic operations for the CJ-series CJ2 CPU Units. The following information is included: Overview and features System configuration Installation and wiring Troubleshooting Use this manual together with the W473.
SYSMAC CJ Series CJ2H-CPU6□-EIP, CJ2H-CPU6□ CJ2M-CPU1□, CJ2M-CPU3□ Programmable Controllers Software User's Manual	W473	Describes programming and other methods to use the functions of the CJ2 CPU Units. The following information is included: CPU Unit operation Internal memory areas Programming Tasks CPU Unit built-in functions Use this manual together with the W472.
SYSMAC CS/CJ Series CS1G/H-CPU□□ -EV1, CS1G/H-CPU□□H, CS1D-CPU□□H, CS1D-CPU□□S, CJ2H-CPU6□-EIP, CJ2H-CPU6□, CJ2M-CPU1□, CJ2M-CPU3□ CJ1H-CPU□□H-R CJ1G-CPU□□, CJ1G/H-CPU□□H, CJ1G-CPU□□P, CJ1M-CPU□□ SYSMAC One NSJ Series NSJ□-□□□□(B)-G5D NSJ□-□□□□(B)-M3D Programmable Controllers Instructions Reference Manual	W474	Describes the ladder diagram programming instructions supported by CS/CJ-series or NSJ-series PLCs. When programming, use this manual together with the <i>Operation Manual or Hardware User's Manual</i> (CS1: W339, CJ1: W393, or CJ2:W472) and <i>Programming Manual or Software User's Manual</i> (CS1/CJ1:W394 or CJ2:W473).
SYSMAC CS Series CS1G/H-CPU□□H Programmable Controllers Operation Manual	W339	Provides an outline of and describes the design, installation, maintenance, and other basic operations for the CS-series PLCs. The following information is included: An overview and features The system configuration Installation and wiring I/O memory allocation Troubleshooting Use this manual together with the W394.
SYSMAC CJ Series CJ1G-CPU□□, CJ1G/H-CPU□□H, CJ1H-CPU□□H-R, CJ1G-CPU□□P, CJ1M-CPU□□ Programmable Controllers Operation Manual	W393	Provides an outline of and describes the design, installation, maintenance, and other basic operations for the CJ-series PLCs. The following information is included: An overview and features The system configuration Installation and wiring I/O memory allocation Troubleshooting Use this manual together with the W394.

Name	Cat. No.	Contents
SYSMAC CS/CJ Series CS1G/H-CPU□□-EV1, CS1G/H-CPU□□H, CS1D-CPU□□H, CS1D-CPU□□S, CJ1G-CPU□□, CJ1G/H-CPU□□H, CJ1H-CPU□□H-R, CJ1G-CPU□□P, CJ1M-CPU□□, NSJ□-□□□□(B)-G5D, NSJ□-□□□□(B)-M3D Programmable Controllers Programming Manual	W394	Describes programming and other methods to use the functions of the CS/CJ-series and NSJ-series PLCs. The following information is included: Programming Tasks File memory Other functions Use this manual together with the W339 or W393.
SYSMAC CS/CJ Series CS1G/H-CPU□□-EV1, CS1G/H-CPU□□H, CS1D-CPU□□H, CS1D-CPU□□S, CJ1G-CPU□□, CJ1G/H-CPU□□H, CJ1H-CPU□□H-R, CJ1G-CPU□□P, CJ1M-CPU□□, NSJ□-□□□□(B)-G5D, NSJ□-□□□□(B)-M3D Programmable Controllers Instructions Reference Manual	W340	Describes the ladder diagram programming instructions supported by CS/CJ-series and NSJ-series PLCs. When programming, use this manual together with the <i>Operation Manual</i> (CS1: W339 or CJ1: W393) and <i>Programming Manual</i> (W394).
CS1G/H-CPU□□-EV1, CS1G/H-CPU□□H CS1D-CPU□□H, CS1D-CPU□□S, CJ1H-CPU□□H-R, CJ1G-CPU□□, CJ1M-CPU□□, CJ1G-CPU□□P, CJ1G/H-CPU□□H, CJ2H-CPU6□-EIP, CJ2H-CPU6□, CJ2M-CPU□□, CS1W-SCU□□-V1, CS1W-SCB□□-V1, CJ1W-SCU□□-V1, CP1H-X□□□□-□, CP1H-XA□□□□-□, CP1H-Y□□□□-□, CP1L-M/L□□□□-□, CP1E-N□□□□-□ NSJ□-□□□□(B)-G5D, NSJ□-□□□□(B)-M3D SYSMAC CS/CJ Series Communications Commands Reference Manual	W342	Describes the communications commands that can be addressed to CS/CJ-series CPU Units. The following information is included: C-series (Host Link) commands FINS commands Note: This manual describes commands that can be sent to the CPU Unit without regard for the communications path, which can be through a serial communications port on the CPU Unit, a communications port on a Serial Communications Unit/Board, or a port on any other Communications Unit.

NSJ-series NSJ Controller Manual

Refer to the following manual for NSJ-series NSJ Controller specifications and handling methods not given in this manual.

Cat. No.	Models	Name	Description
W452	NSJ5-TQ□□(B)-G5D NSJ5-SQ□□(B)-G5D NSJ8-TV□□(B)-G5D NSJ10-TV□□(B)-G5D NSJ12-TS□□(B)-G5D NSJ5-TQ□□(B)-M3D NSJ5-SQ□□(B)-M3D NSJ8-TV□□(B)-M3D NSJW-ETN21 NSJW-CLK21-V1 NSJW-IC101	NSJ Series Operation Manual	Provides the following information about the NSJ-series NSJ Controllers: Overview and features Designing the system configuration Installation and wiring I/O memory allocations Troubleshooting and maintenance Use this manual in combination with the following manuals: SYSMAC CS Series Operation Manual (W339), SYSMAC CJ Series Operation Manual (W393), SYSMAC CS/CJ Series Programming Manual (W394), and NS-V1/-V2 Series Setup Manual (V083)

FQM1 Series Manuals (Unit Version 3.0 or Later)

Refer to the following manuals for specifications and handling methods not given in this manual for FQM1 Series unit version 3.0 (FQM1-CM002/MMP22/MMA22).

Cat. No.	Models	Name	Description
O012	FQM1-CM002 FQM1-MMP22 FQM1-MMA22	FQM1 Series Operation Manual	Provides the following information about the FQM1-series Modules (unit version 3.0): Overview and features Designing the system configuration Installation and wiring I/O memory allocations Troubleshooting and maintenance
O013	FQM1-CM002 FQM1-MMP22 FQM1-MMA22	FQM1 Series Instructions Reference Manual	Individually describes the instructions used to program the FQM1. Use this manual in combination with the <i>FQM1 Series Operation Manual</i> (O012) when programming.

CP-series PLC Unit Manuals

Refer to the following manuals for specifications and handling methods not given in this manual for CP-series CPU Units.

Cat. No.	Models	Name	Description
W450	CP1H-X□□□□-□ CP1H-XA□□□□-□ CP1H-Y□□□□-□	SYSMAC CP Series CP1H CPU Unit Operation Manual	Provides the following information on the CP-series CP1H PLCs: • Overview/Features • System configuration • Mounting and wiring • I/O memory allocation • Troubleshooting Use this manual together with the <i>CP1H/CP1L Programmable Controllers Programming Manual</i> (W451).
W462	CP1L-M□□□□-□ CP1L-L□□□□-□	SYSMAC CP Series CP1L CPU Unit Oper- ation Manual	Provides the following information on the CP-series CP1L PLCs: • Overview/Features • System configuration • Mounting and wiring • I/O memory allocation • Troubleshooting Use this manual together with the <i>CP1H Programmable Controllers Programming Manual</i> (W451).
W451	CP1H-X□□□□-□ CP1H-XA□□□□-□ CP1H-Y□□□□-□ CP1L-M□□□□-□ CP1L-L□□□□-□	SYSMAC CP Series CP1H/CP1L CPU Unit Programming Manual	Provides the following information on the CP-series CP1H and CP1L PLCs: • Programming instructions • Programming methods • Tasks Use this manual together with the <i>CP1H/CP1L Programmable Controllers Operation Manual</i> (W450).

Installation from CX-One

For details on procedures for installing the CX-Programmer from CX-One FA Integrated Tool Package, refer to the *CX-One Ver. 3.0 Setup Manual* provided with CX-One.

Cat. No.	Model	Manual name	Contents
W463	CXONE-AL□□□D-V4/ CXONE-LT□□□-V4	CX-One Setup Manual	Installation and overview of CX-One FA Integrated Tool Package.

Overview of Contents

Precautions provides general precautions for using the CX-Programmer.

Part 1

Part 1 contains the following sections.

Section 1 introduces the function block functionality of the CX-Programmer and explains the features that are not contained in the non-function block version of CX-Programmer.

Section 2 provides specifications for reference when using function blocks, including specifications on function blocks, instances, and compatible PLCs, as well as usage precautions and guidelines.

Section 3 describes the procedures for creating function blocks on the CX-Programmer.

Part 2

Part 2 contains the following sections.

Section 4 introduces the structure text programming functionality of the CX-Programmer and explains the features that are not contained in the non-structured text version of CX-Programmer.

Section 5 provides specifications for reference when using structured text programming, as well as programming examples and restrictions.

Section 6 explains how to create ST programs.

Appendices provide information on structured text errors and ST function descriptions.



WARNING Failure to read and understand the information provided in this manual may result in personal injury or death, damage to the product, or product failure. Please read each section in its entirety and be sure you understand the information provided in the section and related sections before attempting any of the procedures or operations given.

Terms and Conditions Agreement

WARRANTY

- The warranty period for the Software is one year from the date of purchase, unless otherwise specifically agreed.
- If the User discovers defect of the Software (substantial non-conformity with the manual), and return it to OMRON within the above warranty period, OMRON will replace the Software without charge by offering media or download from OMRON's website. And if the User discovers defect of media which is attributable to OMRON and return it to OMRON within the above warranty period, OMRON will replace defective media without charge. If OMRON is unable to replace defective media or correct the Software, the liability of OMRON and the User's remedy shall be limited to the refund of the license fee paid to OMRON for the Software.

LIMITATION OF LIABILITY

- THE ABOVE WARRANTY SHALL CONSTITUTE THE USER'S SOLE AND EXCLUSIVE REMEDIES AGAINST OMRON AND THERE ARE NO OTHER WARRANTIES, EXPRESSED OR IMPLIED, INCLUDING BUT NOT LIMITED TO, WARRANTY OF MERCHANTABILITY OR FITNESS FOR PARTICULAR PURPOSE. IN NO EVENT, OMRON WILL BE LIABLE FOR ANY LOST PROFITS OR OTHER INDIRECT, INCIDENTAL, SPECIAL OR CONSEQUENTIAL DAMAGES ARISING OUT OF USE OF THE SOFTWARE.
- OMRON SHALL HAVE NO LIABILITY FOR DEFECT OF THE SOFTWARE BASED ON MODIFICATION OR ALTERNATION TO THE SOFTWARE BY THE USER OR ANY THIRD PARTY.
- OMRON SHALL HAVE NO LIABILITY FOR SOFTWARE DEVELOPED BY THE USER OR ANY THIRD PARTY BASED ON THE SOFTWARE OR ANY CONSEQUENCE THEREOF.

APPLICABLE CONDITIONS

USER SHALL NOT USE THE SOFTWARE FOR THE PURPOSE THAT IS NOT PROVIDED IN THE ATTACHED USER MANUAL.

CHANGE IN SPECIFICATION

The software specifications and accessories may be changed at any time based on improvements and other reasons.

ERRORS AND OMISSIONS

The information in this manual has been carefully checked and is believed to be accurate; however, no responsibility is assumed for clerical, typographical, or proofreading errors, or omissions.

PRECAUTIONS

This section provides general precautions for using the CX-Programmer and the Programmable Logic Controller.

The information contained in this section is important for the safe and reliable application of the CX-Programmer and Programmable Controller. You must read this section and understand the information contained before attempting to set up or operate the CX-Programmer and Programmable Controller.

1	Intended Audience	xx
2	General Precautions	xx
3	Safety Precautions	xx
4	Application Precautions	xxi

1 Intended Audience

This manual is intended for the following personnel, who must also have knowledge of electrical systems (an electrical engineer or the equivalent).

- Personnel in charge of installing FA systems.
- Personnel in charge of designing FA systems.
- Personnel in charge of managing FA systems and facilities.

2 General Precautions

The user must operate the product according to the performance specifications described in the operation manuals.

Before using the product under conditions which are not described in the manual or applying the product to nuclear control systems, railroad systems, aviation systems, vehicles, combustion systems, medical equipment, amusement machines, safety equipment, and other systems, machines, and equipment that may have a serious influence on lives and property if used improperly, consult your OMRON representative.

Make sure that the ratings and performance characteristics of the product are sufficient for the systems, machines, and equipment, and be sure to provide the systems, machines, and equipment with double safety mechanisms.

This manual provides information for programming and operating the product. Be sure to read this manual before attempting to use the product and keep this manual close at hand for reference during operation.

 **WARNING** It is extremely important that a PLC and all PLC Units be used for the specified purpose and under the specified conditions, especially in applications that can directly or indirectly affect human life. You must consult with your OMRON representative before applying a PLC System to the above-mentioned applications.

3 Safety Precautions

 **WARNING** Confirm safety sufficiently before transferring I/O memory area status from the CX-Programmer to the actual CPU Unit. The devices connected to Output Units may malfunction, regardless of the operating mode of the CPU Unit. Caution is required in respect to the following functions.

- Transferring from the CX-Programmer to real I/O (CIO Area) in the CPU Unit using the PLC Memory Window.
- Transferring from file memory to real I/O (CIO Area) in the CPU Unit using the Memory Card Window.

 **Caution** Variables must be specified either with AT settings (or external variables), or the variables must be the same size as the data size to be processed by the instruction when specifying the first or last address of multiple words in the instruction operand.

1. If a non-array variable with a different data size and without an AT setting is specified, the CX-Programmer will output an error when compiling.
2. Array Variable Specifications

- When the size to be processed by the instruction operand is fixed:
The number of array elements must be the same as the number of elements to be processed by the instruction. Otherwise, the CX-Programmer will output an error when compiling.
- When the size to be processed by the instruction operand is not fixed:
The number of array elements must be greater than or the same as the size specified in the other operands.
 - If the other operand specifying a size is a constant, the CX-Programmer will output an error when compiling.
 - If the other operand specifying a size is a variable, the CX-Programmer will not output an error when compiling, even if the size of the array variable is not the same as that specified by the other operand (variable). A warning message, however, will be displayed. In particular, if the number of array elements is less than the size specified by the other operand (e.g., the size of the instruction operand is 16, and the number of elements registered in the actual variable table is 10), the instruction will execute read/write processing for the area that exceeds the number of elements. For example, read/write processing will be executed for the 6 words following those for the number of elements registered in the actual variable table. If these words are used for other instructions (including internal variable allocations), unexpected operation will occur, which may result in serious accidents.
Check that the system will not be adversely affected if the size of the variable specified in the operand is less than the size in the operand definition before starting PLC operations.

 **Caution** Confirm safety at the destination node before transferring a program to another node or changing contents of the I/O memory area. Doing either of these without confirming safety may result in injury.

 **Caution** Execute online editing only after confirming that no adverse effects will be caused by extending the cycle time. Otherwise, the input signals may not be readable.

 **Caution** If synchronous unit operation is being used, perform online editing only after confirming that an increased synchronous processing time will not affect the operation of the main and slave axes.

 **Caution** Confirm safety sufficiently before monitoring power flow and present value status in the Ladder Section Window or when monitoring present values in the Watch Window. If force-set/reset or set/reset operations are inadvertently performed by pressing short-cut keys, the devices connected to Output Units may malfunction, regardless of the operating mode of the CPU Unit.

4 Application Precautions

Observe the following precautions when using the CX-Programmer.

- User programs cannot be uploaded to the CX-Programmer.
- Observe the following precautions before starting the CX-Programmer.
 - Exit all applications not directly related to the CX-Programmer. Particularly exit any software such as screen savers, virus checkers, E-mail or other communications software, and schedulers or other applications that start up periodically or automatically.

- Disable sharing hard disks, printers, or other devices with other computers on any network.
- With some notebook computers, the RS-232C port is allocated to a modem or an infrared line by default. Following the instructions in documentation for your computer and enable using the RS-232C port as a normal serial port.
- With some notebook computers, the default settings for saving energy do not supply the rated power to the RS-232C, USB and Ethernet port. There may be both Windows settings for saving energy, as well as setting for specific computer utilities and the BIOS. Following the instructions in documentation for your computer, disable all energy saving settings.
- Do not turn OFF the power supply to the PLC or disconnect the connecting cable while the CX-Programmer is online with the PLC. The computer may malfunction.
- Confirm that no adverse effects will occur in the system before attempting any of the following. Not doing so may result in an unexpected operation.
 - Changing the operating mode of the PLC.
 - Force-setting/force-resetting any bit in memory.
 - Changing the present value of any word or any set value in memory.
- Check the user program for proper execution before actually running it on the Unit. Not checking the program may result in an unexpected operation.
- When online editing is performed, the user program and parameter area data in CJ2, CS1-H, CJ1-H, CJ1M, and CP1H CPU Units is backed up in the built-in flash memory. The BKUP indicator will light on the front of the CPU Unit when the backup operation is in progress. Do not turn OFF the power supply to the CPU Unit when the BKUP indicator is lit. The data will not be backed up if power is turned OFF. To display the status of writing to flash memory on the CX-Programmer, select *Display dialog to show PLC Memory Backup Status* in the PLC properties and then select **Windows - PLC Memory Backup Status** from the View Menu.
- Programs including function blocks (ladder programming language or structured text (ST) language) can be downloaded or uploaded in the same way as standard programs that do not contain function blocks. Tasks including function blocks, however, cannot be downloaded in task units (uploading is possible).
- If a user program containing function blocks created on the CX-Programmer Ver. 5.0 or later is downloaded to a CPU Unit that does not support function blocks (CS/CJ-series CPU Units with unit version 2.0 or earlier), all instances will be treated as illegal commands and it will not be possible to edit or execute the user program.
- If the input variable data is not in boolean format, and numerical values only (e.g., 20) are input in the parameters, the actual value in the CIO Area address (e.g., 0020) will be passed. Therefore, be sure to include an &, #, or +, - prefix before inputting the numerical value.
- Addresses can be set in input parameters, but an address itself cannot be passed as an input variable. (Even if an address is set as an input parameter, the value passed to the function block will be that for the size of data of the input variable.) Therefore, an input variable cannot be used as the operand of an instruction in the function block when the operand specifies the first or last of multiple words. With CX-Programmer version 7.0, use

an input-output variable specified as an array variable (with the first address set for the input parameter) and specify the first or last element of the array variable, or, with any version of CX-Programmer, use an internal variable with an AT setting. Alternatively, specify the first or last element in an internal variable specified as an array variable.

- Values are passed in a batch from the input parameters to the input variables or input-output variables before algorithm execution (not at the same time as the instructions in the algorithm are executed). Therefore, to pass the value from a parameter to an input variable or input-output variable when an instruction in the function block algorithm is executed, use an internal variable or external variable instead of an input variable or input-output variable. The same applies to the timing for writing values to the parameters from output variables.
- Always use internal variables with AT settings in the following cases.
 - The addresses allocated to Basic I/O Units, Special I/O Units, and CPU Bus Units cannot be registered to global symbols, and these variables cannot be specified as external variables (e.g., the data set for global variables may not be stable).
 - Use internal variables when Auxiliary Area bits other than those pre-registered to external variables are registered to global symbols and these variables are not specified as external variables.
 - Use internal variables when specifying PLC addresses for another node on the network: For example, the first destination word at the remote node for SEND(090) and the first source word at the remote node for RECV(098).
 - Use internal variables when the first or last of multiple words is specified by an instruction operand and the operand cannot be specified as an array variable (e.g., the number of array elements cannot be specified).

Part 1: Function Blocks

SECTION 1

Introduction to Function Blocks

This section introduces the function block functionality of the CX-Programmer and explains the features that are not contained in the non-function block version of CX-Programmer.

1-1	Introducing the Function Blocks	4
1-1-1	Overview and Features	4
1-1-2	Function Block Specifications	5
1-1-3	Files Created with CX-Programmer Ver. 6.0 or Later	8
1-1-4	Function Block Menus in CX-Programmer Ver. 5.0 (and later Versions)	8
1-2	Function Blocks	11
1-2-1	Outline	11
1-2-2	Advantages of Function Blocks	12
1-2-3	Function Block Structure	13
1-3	Variables	18
1-3-1	Introduction.	18
1-3-2	Variable Usage and Properties	19
1-3-3	Variable Properties	19
1-3-4	Variable Properties and Variable Usage	20
1-3-5	Internal Allocation of Variable Addresses	21
1-4	Converting Function Block Definitions to Library Files	23
1-5	Usage Procedures	23
1-5-1	Creating Function Blocks and Executing Instances	23
1-5-2	Reusing Function Blocks	24
1-6	Version Upgrade Information	25

1-1 Introducing the Function Blocks

1-1-1 Overview and Features

The CX-Programmer Ver. 5.0 (and later versions) is a Programming Device that can use standard IEC 61131-3 function blocks. The CX-Programmer function block function is supported for CJ2 CPU Units, CP1H CPU Units, NSJ-series NSJ Controllers, and FQM1 Flexible Motion Controllers as well as CS/CJ-series CPU Units with unit version 3.0 or later and has the following features.

- User-defined processes can be converted to block format by using function blocks.
- Function block algorithms can be written in the ladder programming language or in the structured text (ST) language. (See note.)
 - When ladder programming is used, ladder programs created with non-CX-Programmer Ver. 4.0 or earlier can be reused by copying and pasting.
 - When ST language is used, it is easy to program mathematical processes that would be difficult to enter with ladder programming.

Note The ST language is an advanced language for industrial control (primarily Programmable Logic Controllers) that is described in IEC 61131-3. The ST language supported by CX-Programmer conforms to the IEC 61131-3 standard.

- Function blocks can be created easily because variables do not have to be declared in text. They are registered in variable tables. A variable can be registered automatically when it is entered in a ladder or ST program. Registered variables can also be entered in ladder programs after they have been registered in the variable table.
- A single function block can be converted to a library function as a single file, making it easy to reuse function blocks for standard processing.
- A program check can be performed on a single function block to easily confirm the function block's reliability as a library function.
- Programs containing function blocks (ladder programming language or structured text (ST) language) can be downloaded or uploaded in the same way as standard programs that do not contain function blocks. Tasks containing function blocks, however, cannot be downloaded in task units (uploading is possible).
- One-dimensional array variables are supported, so data handling is easier for many applications.

Note The IEC 61131 standard was defined by the International Electrotechnical Commission (IEC) as an international programmable logic controller (PLC) standard. The standard is divided into 7 parts. Specifications related to PLC programming are defined in *Part 3 Textual Languages (IEC 61131-3)*.

- A function block (ladder programming language or structured text (ST) language) can be called from another function block (ladder programming language or structured text (ST) language). Function blocks can be nested up to 8 levels and ladder/ST language function blocks can be combined freely.

1-1-2 Function Block Specifications

For specifications that are not listed in the following table, refer to the *CX-Programmer Operation Manual (W446)*.

Item	Specifications
Model number	CXONE-AL□□D-V4
Setup	Select the CX-Programmer from the CX-One setup disk.
<p>Compatible CPU Units (PLC models)</p> <p>Note The function block and structured text functions supported by CS/CJ-series CPU Units with unit version 4.0 or later can not be used in CS/CJ-series CPU Units with unit version 3.0 or earlier, CP-series PLCs, NSJ-series PLCs, or FQM1-series PLCs. For details, refer to <i>1-6 Version Upgrade Information</i>.</p>	<p>CS/CJ-series CS1-H, CJ1-H, and CJ1M CPU Units with unit version 3.0 or later are compatible.</p> <p>Device Type CPU Type</p> <ul style="list-style-type: none"> • CJ2H CJ2H-CPU68/67/66/65/64/68-EIP/67-EIP/66-EIP/65-EIP/64-EIP • CJ2M CJ2M-CPU11/12/13/14/15/31/32/33/34/35 • CS1G-H CS1G-CPU42H/43H/44H/45H • CS1H-H CS1H-CPU63H/64H/65H/66H/67H • CJ1G-H CJ1G-CPU42H/43H/44H/45H • CJ1H-H CJ1H-CPU65H/66H/67H/64H-R/65H-R/66H-R/67H-R • CJ1M CJ1M-CPU11/12/13/21/22/23 <p>The following CP-series CPU Units are compatible.</p> <ul style="list-style-type: none"> • CP1H CP1H-X/XA/Y • CP1L CP1L-M/L <p>Note If a user program containing function blocks created on the CX-Programmer Ver. 5.0 or later is downloaded to a CPU Unit that does not support function blocks (CS/CJ-series CPU Units with unit version 2.0 or earlier), all instances will be treated as illegal commands and it will not be possible to edit or execute the user program.</p> <ul style="list-style-type: none"> • NSJ G5D (Used for the NSJ5-TQ0□-G5D, NSJ5-SQ0□-G5D, NSJ8-TV0□-G5D, NSJ10-TV0□-G5D, and NSJ12-TS0□-G5D) M3D (Used for the NSJ5-TQ0□-M3D, NSJ5-SQ0□-M3D, and NSJ8-TV0□-M3D) • FQM1-CM FQM1-CM002 • FQM1-MMA FQM1-MMA22 • FQM1-MMP FQM1-MMP22 <p>CS/CJ/CP Series Function Restrictions</p> <ul style="list-style-type: none"> • Instructions Not Supported in Function Block Definitions Block Program Instructions (BPRG and BEND), Subroutine Instructions (SBS, GSBS, RET, MCRO, and SBN), Jump Instructions (JMP, CJP, and CJPN), Step Ladder Instructions (STEP and SNXT), Immediate Refresh Instructions (!), I/O REFRESH (IORF), ONE-MS TIMER (TMHH and TMHHX) (These timers can be used with CJ1-H-R CPU Units.) <p>Note For details and other restrictions, refer to <i>2-4 Programming Restrictions</i>.</p>

Item			Specifications
Functions not supported by CX-Programmer Ver. 4.0 or earlier.	Defining and creating function blocks	Number of function block definitions	CJ2H Units: <ul style="list-style-type: none"> • CJ2H-CPU6□(-EIP): 2,048 max. per CPU Unit CJ2M CPU Units: <ul style="list-style-type: none"> • CJ2M-CPU□1/□2/□3: 256 max. per CPU Unit • CJ2M-CPU□4/□5: 2,048 max. per CPU Unit CS1-H/CJ1-H CPU Units: <ul style="list-style-type: none"> • Suffix -CPU44H/45H/64H/65H/66H/67H/64H-R/65H-R/66H-R/67H-R: 1,024 max. per CPU Unit • Suffix -CPU42H/43H/63H: 128 max. per CPU Unit CJ1M CPU Units: <ul style="list-style-type: none"> • CJ1M-CPU11/12/13/21/22/23: 128 max. per CPU Unit CP1H CPU Units: <ul style="list-style-type: none"> • All models: 128 max. per CPU Unit CP1L CPU Units: <ul style="list-style-type: none"> • CP1L-M/L: 128 max. per CPU Unit NSJ Controllers: <ul style="list-style-type: none"> • NSJ□-□□□□-G5D: 1,024 max. per Controller; • NSJ□-□□□□-M3D: 128 max. per Controller FQM1 Flexible Motion Controllers: <ul style="list-style-type: none"> • FQM1-CM002/MMA22/MMP22: 128 max. per Controller
		Function block names	64 characters max.

Item		Specifications		
Functions not supported by CX-Programmer Ver. 4.0 or earlier.	Defining and creating function blocks	Variables	Variable names	30,000 characters max.
			Variable types	Input variables (Inputs), output variables (Outputs), input-output variables (In Out), internal variables (Internals), and external variables (Externals)
			Number of variables used in a function block (not including internal variables, external variables, EN, and EN0)	Maximum number of variables per function block definition <ul style="list-style-type: none"> • Input-output variables: 16 max. • Input variables + input-output variables: 64 max. • Output variables + input-output variables: 64 max.
			Allocation of addresses used by variables	Automatic allocation (The allocation range can be set by the user.)
			Actual address specification	Supported
			Array specifications	Supported (one-dimensional arrays only and only for internal variables and input-output variables)
	Language	Function blocks can be created in ladder programming language or structured text (ST, see note).		
	Creating instances	Number of instances	CJ2H CPU Units: <ul style="list-style-type: none"> • CJ2H-CPU6□(-EIP): 2,048 max. per CPU Unit 	
			CJ2M CPU Units: <ul style="list-style-type: none"> • CJ2M-CPU□1/□2/□3: 256 max. per CPU Unit • CJ2M-CPU□4/□5: 2,048 max. per CPU Unit 	
	Storing function blocks as files	Project files	CS1-H/CJ1-H CPU Units: <ul style="list-style-type: none"> • Suffix -CPU44H/45H/64H/65H/66H/67H/64H-R/65H-R/66H-R/67H-R: 2,048 max. per CPU Unit • Suffix -CPU42H/43H/63H: 256 max. per CPU Unit 	
CJ1M CPU Units: <ul style="list-style-type: none"> • CJ1M-CPU11/12/13/21/22/23: 256 max. per CPU Unit 				
CP1H CPU Units: <ul style="list-style-type: none"> • All models: 256 max. per CPU Unit 				
Storing function blocks as files	Program files	CP1L CPU Units: <ul style="list-style-type: none"> • CP1L-M/L: 256 max. per CPU Unit 		
		NSJ Controllers: <ul style="list-style-type: none"> • SJ□-□□□□-G5D: 2,048 max. per Controller; NSJ□-□□□□-M3D: 256 max. per Controller 		
		FQM1 Flexible Motion Controllers: <ul style="list-style-type: none"> • FQM1-CM002/MMA22/MMP22: 256 max. per Controller 		
Storing function blocks as files	Function block library files	Instance names	15,000 characters max.	
		Project files	The project file (.cpx/cxt) Includes function block definitions and instances.	
		Program files	The file memory program file (*.obj) includes function block definitions and instances.	
Storing function blocks as files	Function block library files	Function block library files	Each function block definition can be stored as a single file (.cxf) for reuse in other projects.	

Note The structured text (ST language) conforms to the IEC 61131-3 standard, but CX-Programmer Ver. 5.0 supports only assignment statements, selection statements (CASE and IF statements), iteration statements (FOR, WHILE, REPEAT, and EXIT statements), RETURN statements, arithmetic operators, logical operators, comparison functions, numeric functions, standard string functions, numeric string functions, OMRON expansion functions, and comments. For details, refer to *SECTION 5 Structured Text (ST) Language Specifications* in *Part 2: Structured Text (ST)*.

1-1-3 Files Created with CX-Programmer Ver. 6.0 or Later

Project Files (*.cpx) and File Memory Program Files (*.obj)

Projects created using CX-Programmer that contain function block definitions and projects with instances are saved in the same standard project files (*.cpx) and file memory program files (*.obj).

The following diagram shows the contents of a project. The function block definitions are created at the same directory level as the program within the relevant PLC directory.

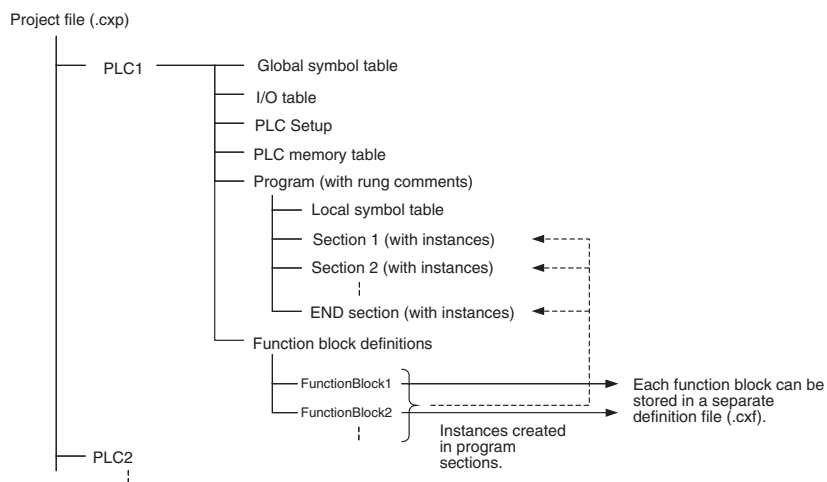

Function Block Library Files (*.cxf)

A function block definition created in a project with CX-Programmer Ver. 6.0 can be saved as a file (1 definition = 1 file), enabling definitions to be loaded into other programs and reused.

Note When function blocks are nested, all of the nested (destination) function block definitions are included in this function block library file (.cxf).

Project Text Files Containing Function Blocks (*.cxt)

Data equivalent to that in project files table created with CX-Programmer Ver. 6.0 (*.cpx) can be saved as CXT text files (*.cxt).

1-1-4 Function Block Menus in CX-Programmer Ver. 5.0 (and later Versions)

The following tables list menus related to function blocks in CX-Programmer Ver. 5.0 and later versions. For details on all menus, refer to the *CX-Programmer Operation Manual (W446)*.

Main Menu

Main menu	Submenu		Shortcut	Function	
File	Function Block	Load Function Block from File	---	Reads the saved function block library files (*.cxf).	
		Save Function Block to File	---	Saves the created function block definitions to a file ([function block library file]*.cxf).	
Edit	Update Function Block		---	When a function block definition's input variables, output variables, or input-output variables have been changed after the instance was created, an error will be indicated by displaying the instance's left bus bar in red. This command updates the instance with the new information and clears the error.	
	To Lower Layer		---	Jumps to the function block definition for the selected instance.	
	Function Block (ladder) generation		---	Generates a ladder-programmed function block for the selected program section while automatically determining address application conditions.	
View	Monitor FB Instance		---	When monitoring the program online, monitors ST variable status as well as I/O bit and word status (I/O bit monitor) of the ladder diagram in the instance. (Supported by CX-Programmer Ver. 6.1 and later only).	
	To Lower Layer		---	Displays on the right side the contents of the function block definition of the selected instance. (Supported by CX-Programmer Ver. 6.0 and later only.)	
	To Upper Layer		---	Returns to the calling instance (ladder diagram or ST). (Supported by CX-Programmer Ver. 6.0 and later only.)	
	Window	FB Instance Viewer	---	Displays the FB Instance Viewer. (When nesting, the display shows details such as the relationship between instance nesting levels and allocated variable addresses in the instances.)	
Insert	Function Block Invocation		F	Creates an instance in the program (section) at the present cursor location.	
	Function Block Parameter		P	When the cursor is located to the left of an input variable or the right of an output variable, sets the variable's input or output parameter.	
PLC	Memory Allocation	Function Block/SFC Memory	Function Block/SFC Memory Allocation	---	Sets the range of addresses (function block instance areas) internally allocated to the selected instance's variables.
			Function Block/SFC Memory Statistics	---	Checks the status of the addresses internally allocated to the selected instance's variables.
			Function Block Instance Address	---	Checks the addresses internally allocated to each variable in the selected instance.
			Optimize Function Block/SFC Memory	---	Optimizes the allocation of addresses internally allocated to variables.
Program	Online Edit		Begin	---	Starts online editing of a function block.
			Send Change	---	Transfers changes made during online editing of a function block.
			Cancel	---	Cancels changes made to a function block being edited online.
			Transfer FB Source	---	Transfers only the function block source.
			Release FB Online Edit Access Rights	---	Forcefully releases the access rights for function block, SFC, and ST online editing held by another user.

Main menu	Submenu		Shortcut	Function
Tools	Simulation	Break Point Set/Clear Break Point	---	Sets or clears a break point.
		Break Point Clear All Break Point	---	Clears all break points.
		Mode Run (Monitor Mode)	---	Executes continuous scanning. (Sets the ladder execution engine's run mode to MONITOR mode.)
		Mode Stop (Program Mode)	---	Sets the simulator's operation mode to PROGRAM mode.
		Mode Pause	---	Pauses simulator operation.
		Step Run	---	Executes just one step of the simulator's program.
		Step Run Step In	---	When there is a function block call instruction, this command moves to execution of the internal program step.
		Step Run Step Out	---	When a function block's internal program step is being executed, this command returns to the next higher level (call source) and pauses execution.
		Step Run Continuous Step Run	---	Executes steps continuously for a fixed length of time.
		Step Run Scan Run	---	Executes for one cycle and pauses execution.
		Always Display Current Execution Point	---	Used with the Step Run or Continuous Step Run commands to automatically scroll the display and always show the pause point.
		Break Point List	---	Displays a list of the break points that have been set. (Operation can be jumped to a specified point.)
	Change Input mode	Smart Input Mode	---	The Smart Input Mode can be used to automatically display candidates for instructions and addresses.
Classic Mode		---	The Classic Mode is the input mode that is used previous version of CX-Programmer.	

Main Pop-up Menus

Pop-up Menu for Function Block Definitions

Pop-up menu		Function
Insert Function Block	Ladder	Creates a function block definition with a ladder programming language algorithm.
	Structured Text	Creates a function block definition with an ST language algorithm.
	From file	Reads a function block definition from a function block library file (*.cxf).

Pop-up Menu for Inserted Function Blocks

Pop-up menu		Function
Open		Displays the contents of the selected function block definition on the right side of the window.
Save Function Block File		Saves the selected function block definition in a file.
Compile		Compiles the selected function block definition.
FB online Edit	Begin	Starts online editing of a function block.
	Send Change	Transfers changes made during online editing of a function block.
	Cancel	Cancel changes made to a function block being edited online.
	Transfer FB Source	Transfers only the function block source.
	Release FB Online Edit Access Rights	Forcefully releases the access rights for function block online editing held by another user.

Pop-up Menu for Function Block Variable Tables

Pop-up menu	Function
Edit	Edits the variable.
Insert Variable	Adds a variable to the last line.
Insert Variable	Above
	Below
Cut	Cuts the variable.
Copy	Copies the variable.
Paste	Pastes the variable.
Find	Searches for the variable. Variable names, variable comments, or all (text strings) can be searched.
Replace	Replaces the variable.
Delete	Deletes the variable.
Rename	Changes only the name of the variable.

Pop-up Menu for Instances

Pop-up menu	Function
Edit	Changes the instance name.
Update Invocation	When a function block definition's input variables, output variables, or input-output variables have been changed after the instance was created, an error will be indicated by displaying the instance's left bus bar in red. This command updates the instance with the new information and clears the error.
Monitor FB Ladder Instance	When monitoring the program online, monitors I/O bit and word status (I/O bit monitor) of the ladder diagram in the instance. (Supported by CX-Programmer Ver. 6.0 and later only).
Monitor FB Instance	When monitoring the program online, monitors ST variable status as well as I/O bit and word status (I/O bit monitor) of the ladder diagram in the instance. (Supported by CX-Programmer Ver. 6.1 and later only).
Register in Watch Window	Displays the <i>FB variables registration</i> Dialog Box in order to register a variable from the selected instance to the <i>Watch Window</i> .
Function Block Definition	Displays the selected instance's function block definition on the right side of the window.

Shortcut Keys**F Key: Pasting Function Block Definitions in Program**

Move the cursor to the position at which to create the copied function block instance in the Ladder Section Window, and press the **F** Key. This operation is the same as selecting *Insert - Function Block Invocation*.

Enter Key: Inputting Parameters

Position the cursor at the left of the input variable or input-output variable, or at the right of the output variable and press the **Enter** Key. This operation is the same as selecting *Insert - Function Block Parameter*.

1-2 Function Blocks**1-2-1 Outline**

A function block is a basic program element containing a standard processing function that has been defined in advance. Once the function block has been defined, the user just has to insert the function block in the program and set the I/O in order to use the function.

As a standard processing function, a function block does not contain actual addresses, but variables. The user sets addresses or constants in those variables. These address or constants are called parameters. The addresses used by the variables themselves are allocated automatically by the CX-Programmer for each program.

With the CX-Programmer, a single function block can be saved as a single file and reused in other PLC programs, so standard processing functions can be made into libraries.

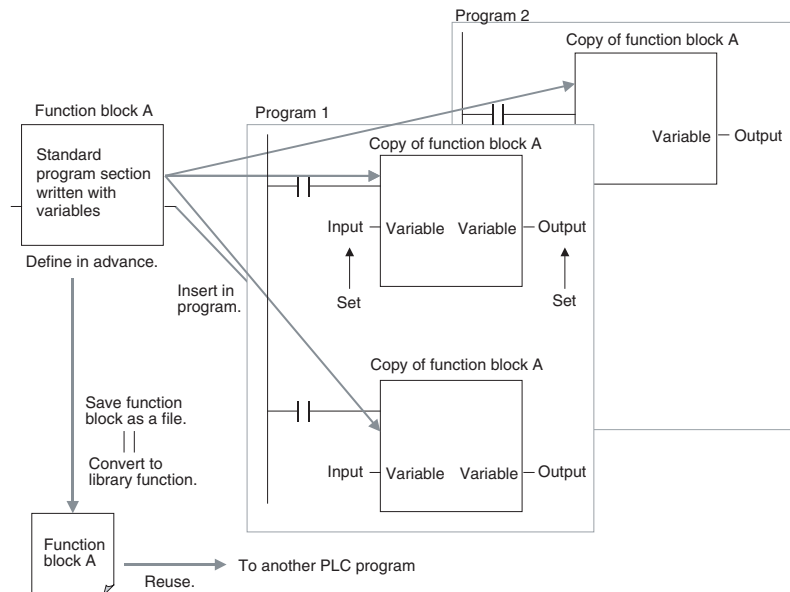

1-2-2 Advantages of Function Blocks

Function blocks allow complex programming units to be reused easily. Once standard programming is created in a function block and saved in a file, it can be reused just by placing the function block in a program and setting the parameters for the function block’s I/O. The ability to reuse existing function blocks will save significant time when creating/debugging programs, reduce coding errors, and make the program easier to understand.

Structured Programming

Structured programs created with function blocks have better design quality and require less development time.

Easy-to-read “Black Box” Design

The I/O operands are displayed as variable names in the program, so the program is like a “black box” when entering or reading the program and no extra time is wasted trying to understand the internal algorithm.

Use One Function Block for Multiple Processes

Many different processes can be created easily from a single function block by using the parameters in the standard process as input variables (such as timer SVs, control constants, speed settings, and travel distances).

Reduce Coding Errors

Coding mistakes can be reduced because blocks that have already been debugged can be reused.

Black-boxing Know-how

Read-protection can be set for function blocks to prevent programming know-how from being disclosed.

Data Protection

The variables in the function block cannot be accessed directly from the outside, so the data can be protected. (Data cannot be changed unintentionally.)

Improved Reusability with Variable Programming

The function block’s I/O is entered as variables, so it isn’t necessary to change data addresses in a block when reusing it.

Creating Libraries

Processes that are independent and reusable (such as processes for individual steps, machinery, equipment, or control systems) can be saved as function block definitions and converted to library functions.

The function blocks are created with variable names that are not tied to actual addresses, so new programs can be developed easily just by reading the definitions from the file and placing them in a new program.

Supports Nesting and Multiple Languages

Mathematical expressions can be entered in structured text (ST) language. With CX-Programmer Ver. 6.0 and later versions, function blocks can be nested. The function block nesting function allows just special processing to be performed in a ST-language function block nested within a ladder-language function block.

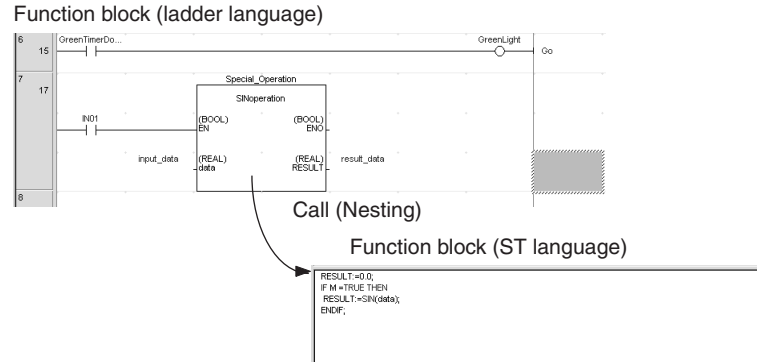

1-2-3 Function Block Structure

Function blocks consist of function block definitions that are created in advance and function block instances that are inserted in the program.

Function Block Definitions

Function block definitions are the programs contained in function blocks. Each function block definition contains the algorithm and variable definitions, as shown in the following diagram.

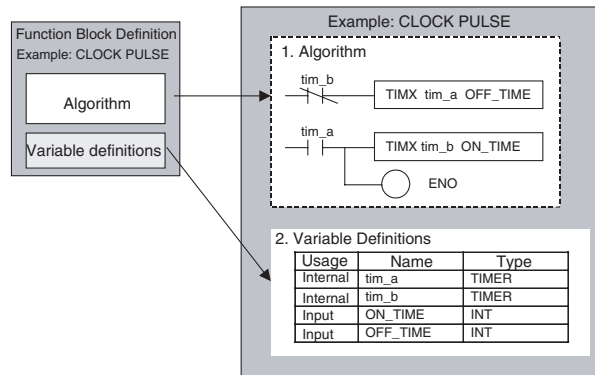

1. Algorithm

Standardized programming is written with variable names rather than real I/O memory addresses. In the CX-Programmer, algorithms can be written in either ladder programming or structured text.

2. Variable Definitions

The variable table lists each variable’s usage (input, output, input-output, or internal) and properties (data type, etc.). For details, refer to 1-3 Variables.

Number of Function Block Definitions

The maximum number of function block definitions that can be created for one CPU Unit is either 128 or 1,024 depending on the CPU Unit model.

Instances

To use an actual function block definition in a program, create a copy of the function block diagram and insert it in the program. Each function block definition that is inserted in the program is called an “instance” or “function block instance.” Each instance is assigned an identifier called an “instance name.” By generating instances, a single function block definition can be used to process different I/O data with the same function.

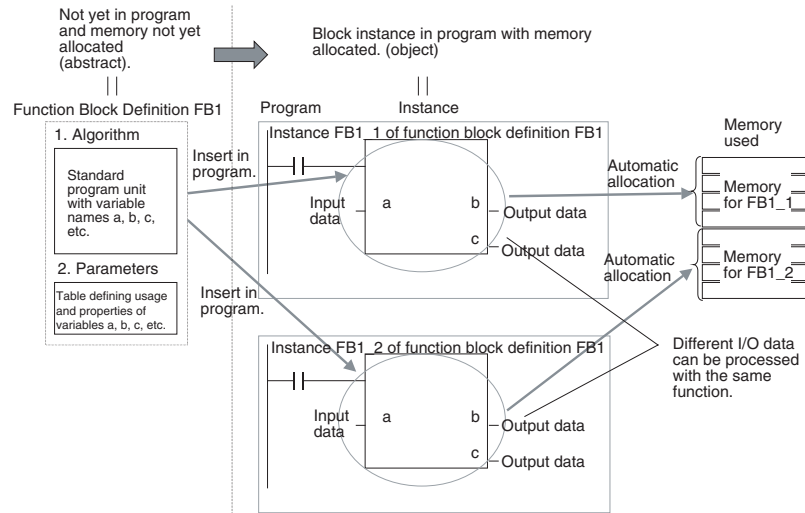

Note Instances are managed by names. More than one instance with the same name can also be inserted in the program. If two or more instances have the same name, they will use the same internal variables. Instances with different names will have different internal variables.

For example, consider multiple function blocks that use a timer as an internal variable. In this case all instances will have to be given different names. If more than one instance uses the same name, the same timer would be used in multiple locations, resulting in duplicated use of the timer.

If, however, internal variables are not used or they are used only temporarily and initialized the next time an instance is executed, the same instance name can be used to save memory.

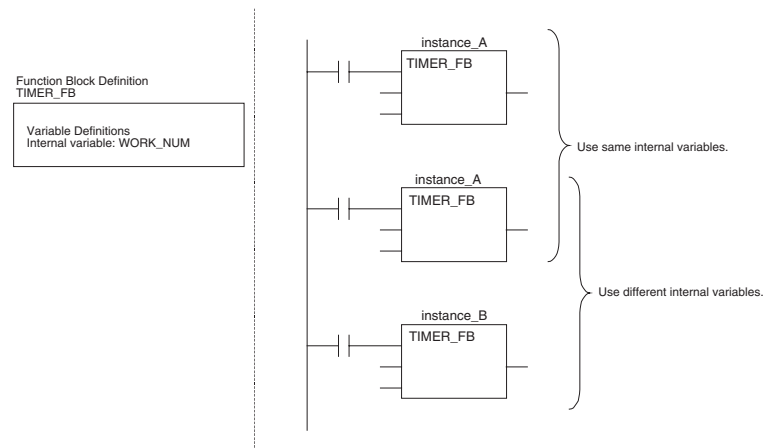

Number of Instances

Multiple instances can be created from a single function block definition. Up to either 256 or 2,048 instances can be created for a single CPU Unit depending on the CPU Unit model. The allowed number of instances is not related to the number of function block definitions and the number of tasks in which the instances are inserted.

Parameters

Each time an instance is created, set the real I/O memory addresses or constants for input variables, output variables, and input-output variables used to pass input data values to instances and obtain output data values from instances. These addresses and constants are called parameters.

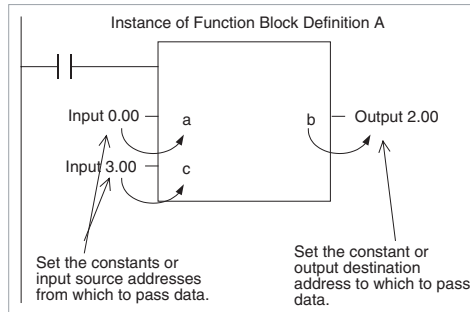

Using Input Variables and Output Variables

With input variables and output variables, it is not the input source address itself, but the contents at the input address in the form and size specified by the variable data type that is passed to the function block. In a similar fashion, it is not the output destination address itself, but the contents for the output address in the form and size specified by the variable data type that is passed from the function block.

Even if an input source address (i.e., an input parameter) or an output destination address (i.e., an output parameter) is a word address, the data that is passed will be the data in the form and size specified by the variable data type starting from the specified word address.

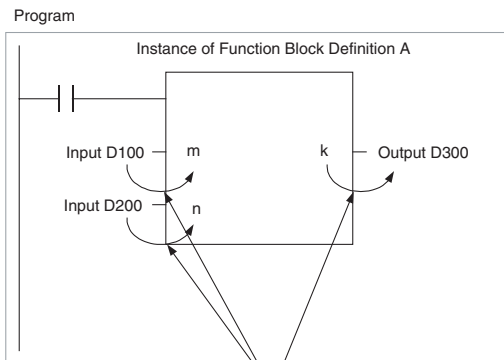

Examples:
 If m is type WORD, one word of data from D100 will be passed to the variable.
 If n is type DWORD, two words of data from D200 and D201 will be passed to the variable.
 If k is type LWORD, four words of data from the variable will be passed to the D300 to D303.

Note

- (1) Only addresses in the following areas can be used as parameters: CIO Area, Auxiliary Area, DM Area, EM Area (banks 0 to C), Holding Area, and Work Area.
 The following cannot be used: Index and Data Registers (both direct and indirect specifications) and indirect addresses to the DM Area and EM Area (both in binary and BCD mode).
- (2) Local and global symbols in the user program can also be specified as parameters. To do so, however, the data size of the local or global symbol must be the same as the data size of the function block variable.
- (3) When an instance is executed, input values are passed from parameters to input variables before the algorithm is processed. Output values are

passed from output variables to parameters just after processing the algorithm. If it is necessary to read or write a value within the execution cycle of the algorithm, do not pass the value to or from a parameter. Assign the value to an internal variable and use an AT setting (specified addresses).

- ⚠ **Caution** If an address is specified in an input parameter, the values in the address are passed to the input variable. The actual address data itself cannot be passed.
- ⚠ **Caution** Parameters cannot be used to read or write values within the execution cycle of the algorithm. Use an internal variable with an AT setting (specified addresses). Alternatively, reference a global symbol as an external variable.

Using Input-Output Variables (In Out)

When using an input-output variable, set the address for the input parameter. A constant cannot be set. The address set for the input parameter will be passed to the function block. If processing is performed inside the function block using the input-output variable, the results will be written to I/O starting at the address set for the size of the variable.

Program

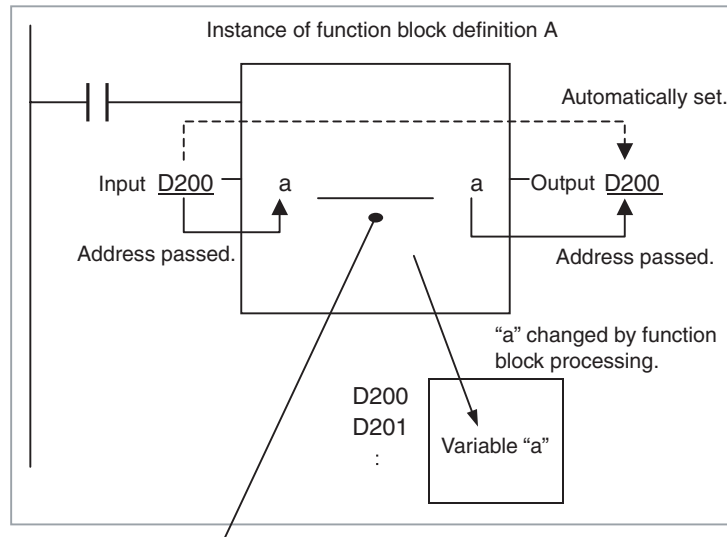

Processing is performed inside the function block using variable "a." The resulting value is written to I/O memory for the size of variable "a" starting at address D200.

- Note** Input-output variables are specified in a CX-Programmer variable table by selecting "In Out" for the variable usage.

n **Reference Information**

A variety of processes can be created easily from a single function block by using parameter-like elements (such as fixed values) as input variables and changing the values passed to the input variables for each instance.

Example: Creating 3 Instances from 1 Function Block Definition

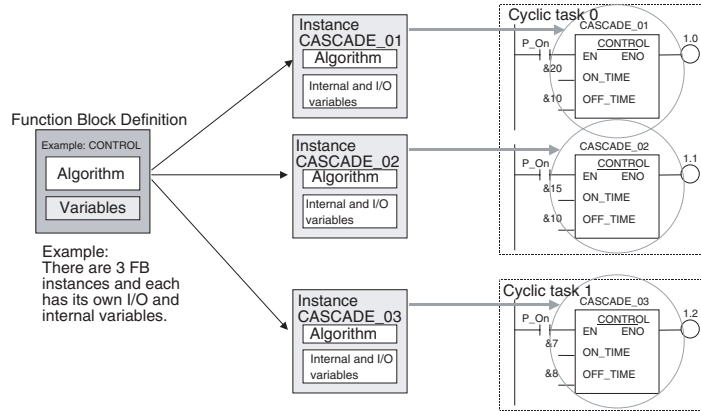

If internal variables are not used, if processing will not be affected, or if the internal variables are used in other locations, the same instance name can be used at multiple locations in the program.

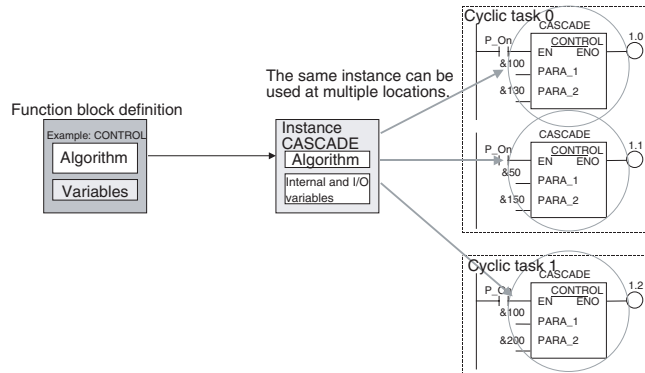

Some precautions are required when using the same memory area. For example, if the same instance containing a timer instruction is used in more than one program location, the same timer number will be used causing coil duplication, and the timer will not function properly if both instructions are executed.

Registration of Instances

Each instance name is registered in the global symbol table as a file name.

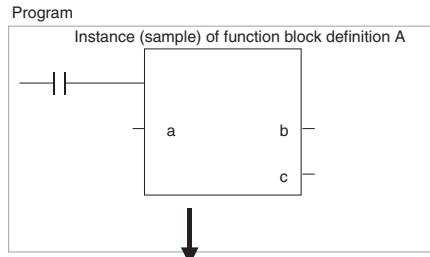

The instance is registered in the global symbol table with the instance name as the symbol name.

Name	Data type	Address/ value	
sample	FB [FunctionBlock1]	N/A[Auto]	

↑ Instance name ↑ The function block definition name is registered after FB in square parentheses [].

1-3 Variables

1-3-1 Introduction

In a function block, the addresses (see note) are not entered as real I/O memory addresses, they are all entered as variable names. Each time an instance is created, the actual addresses used by the variable are allocated automatically in the specified I/O memory areas by the CX-Programmer. Consequently, it isn't necessary for the user to know the real I/O memory addresses used in the function block, just as it isn't necessary to know the actual memory allocations in a computer. A function block differs from a subroutine in this respect, i.e., the function block uses variables and the addresses are like "black boxes."

Example:

Function block definition A

Standard program section with variable names a, b, c, etc.

Table indicating usage and properties of variables a, b, c, etc.

Usage: Inputs

Properties:				
Name	Type	AT	Initial Value	Retained
a	BOOL			
b	BOOL			
c	BOOL			

Usage: Outputs

Properties:				
Name	Type	AT	Initial Value	Retained
b	BOOL			

Program

Instance of function block definition A

Insert in program.

Specify inputs and outputs at the same time.

Status of 0.00 (1 or 0) is passed to a.

Status of 3.00 (1 or 0) is passed to c.

Status of b (1 or 0) is passed to 2.00.

The system automatically allocates the addresses used by variables a, b, and c. For example, when W100 to W120 is set as the system's non-retained memory area, bit addresses such as a = W10000, b = W10001, and c = W10002 will be allocated.

Note Constants are not registered as variables. Enter constants directly in instruction operands.

- Ladder programming language: Enter hexadecimal numerical values after the # and decimal values after the &.
- Structured text (ST language): Enter hexadecimal numerical values after 16# and enter decimal numerical values as is.

Exception: Enter directly or indirectly specified addresses for Index Registers IR0 to IR15 and Data Registers DR0 to DR15 directly into the instruction operand.

1-3-2 Variable Usage and Properties

Variable Usage

The following variable types (usages) are supported.

Internals: Internal variables are used only within an instance. They cannot be used pass data directly to or from I/O parameters.

Inputs: Input variables can input data from input parameters outside of the instance. The default input variable is an EN (Enable) variable, which passes input condition data.

Outputs: Output variables can output data to output parameters outside of the instance. The default output variable is an ENO (Enable Out) variable, which passes the instance's execution status.

In Out: Input-output variables can input data from input parameters outside of the instance and can return the results of processing in a function block instance to external parameters.

Externals: External variables are either system-defined variables registered in advance with the CX-Programmer, such as the Condition Flags and some Auxiliary Area bits, or user-defined global symbols for use within instances.

For details on variable usage, refer to the section on *Variable Type (Usage)* under *Variable Definitions* in *2-1-2 Function Block Elements*.

The following table shows the number of variables that can be used and the kind of variable that is created by default for each of the variable usages.

1-3-3 Variable Properties

Variables have the following properties.

Variable Name

The variable name is used to identify the variable in the function block. It doesn't matter if the same name is used in other function blocks.

Note The variable name can be up to 30,000 characters long, but must not begin with a number. Also, the name cannot contain two underscore characters in a row. The character string cannot be the same as that of an index register such as in IR0 to IR15. For details on other restrictions, refer to *Variable Definitions* in *2-1-2 Function Block Elements*.

Data Type

Select one of the following data types for the variable:

BOOL, INT, UINT, DINT, UDINT, LINT, ULINT, WORD, DWORD, LWORD, REAL, LREAL, TIMER, COUNTER, and STRING

For details on variable data types, refer to *Variable Definitions* in *2-1-2 Function Block Elements*.

AT Settings (Allocation to an Actual Addresses)

It is possible to set a variable to a particular I/O memory address rather than having it allocated automatically by the system. To specify a particular address, the user can input the desired I/O memory address in this property. This property can be set for internal variables only. Even if a specific address is set, the variable name must still be used in the algorithm.

Refer to *Variable Definitions* in 2-1-2 *Function Block Elements* for details on AT settings and 2-5-3 *AT Settings for Internal Variables* for details on using AT settings.

Array Settings

A variable can be treated as a single array of data with the same properties. To convert a variable to an array, specify that it is an array and specify the maximum number of elements.

This property can be set for internal variables and input-output variables only. Only one-dimensional arrays are supported by the CX-Programmer Ver. 5.0 and later versions.

- **Setting Procedure**
Click the **Advanced** Button, select the *Array Variable* option, and input the maximum number of elements.
- When entering an array variable name in the algorithm in a function block definition, enter the array index number in square brackets after the variable number.

For details on array settings, refer to *Variable Definitions* in 2-1-2 *Function Block Elements*.

Initial Value

This is the initial value set in a variable before the instance is executed for the first time. Afterwards, the value may be changed as the instance is executed.

For example, set a boolean (BOOL) variable (bit) to either 1 (TRUE) or 0 (FALSE). Set a WORD variable to a value between 0 and 65,535 (between 0000 and FFFF hex).

If an initial value is not set, the variable will be set to 0. For example, a boolean variable would be 0 (FALSE) and a WORD variable would be 0000 hex.

Retain

Select the *Retain Option* if you want a variable's data to be retained when the PLC is turned ON again and when the PLC starts operating.

- **Setting Procedure**
Select the *Retain Option*.

Size

When a STRING variable is used, the size required to store the text string can be set to between 1 and 255 characters.

1-3-4 Variable Properties and Variable Usage

The following table shows which properties must be set, can be set, and cannot be set, based on the variable usage.

Property	Variable usage			
	Internals	Inputs	Outputs	In Out
Name	Must be set.	Must be set.	Must be set.	Must be set.
Data Type	Must be set.	Must be set.	Must be set.	Must be set.
AT (specified address)	Can be set.	Cannot be set.	Cannot be set.	Cannot be set.
Array specification	Must be set.	Cannot be set.	Cannot be set.	Must be set.
Initial Value	Can be set.	Cannot be set. (See note 1.)	Can be set.	Cannot be set.
Retained	Can be set.	Cannot be set. (See note 1.)	Can be set.	Cannot be set.
Size	Can be set. (See note 2.)	Cannot be set.	Cannot be set.	Cannot be set.

(1) The value of the input parameter will be given.

(2) Valid only for STRING variables.

1-3-5 Internal Allocation of Variable Addresses

When an instance is created from a function block definition, the CX-Programmer internally allocates addresses to the variables. Addresses are allocated to all of the variables registered in the function block definition except for variables that have been assigned actual addresses with the *AT Settings* property.

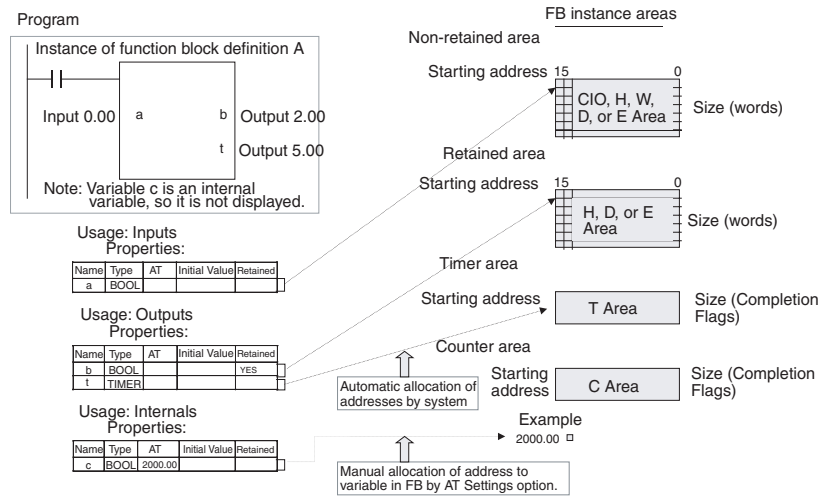

Setting Internal Allocation Areas for Variables

The user sets the function block instance areas in which addresses are allocated internally by the system. The variables are allocated automatically by the system to the appropriate instance area set by the user.

Setting Procedure

Select **Function Block/SFC Memory - Function Block/SFC Memory Allocation** from the *PLC Menu*. Set the areas in the Function Block/SFC Memory Allocation Dialog Box.

Function Block Instance Areas**CJ2-series CPU Units**

FB Instance Area	Default value			Applicable memory areas
	Start address	End address	Size	
Non Retain	H512	H1407	896	CIO, WR, HR, DM, EM (See note.)
Retain	H1408	H1535	128	HR, DM, EM (See note.)
Timers	T3072	T4095	1024	TIM
Counters	C3072	C4095	1024	CNT

Note Force-setting/resetting is enabled when the following EM banks are specified:

CJ2H-CPU64(-EIP)/-CPU65(-EIP)	EM bank 3
CJ2H-CPU66(-EIP)	EM banks 6 to 9
CJ2H-CPU67(-EIP)	EM banks 7 to E
CJ2H-CPU68(-EIP)	EM banks 11 to 18

CS/CJ-series CPU Units Ver. 3.0 or Later, and NSJ Controllers

FB Instance Area	Default value			Applicable memory areas
	Start address	End address	Size	
Non Retain	H512	H1407	896	CIO, WR, HR, DM, EM
Retain	H1408	H1535	128	HR, DM, EM
Timers	T3072	T4095	1024	TIM
Counters	C3072	C4095	1024	CNT

FQM1 Flexible Motion Controllers

FB Instance Area	Default value			Applicable memory areas
	Start address	End address	Size	
Non Retain	5000	5999	1000	CIO, WR, DM
Retain	None			
Timers	T206	T255	50	TIM
Counters	C206	C255	50	CNT

CP-series CPU Units

FB Instance Area	Default value			Applicable memory areas
	Start address	End address	Size	
Non Retain	H512	H1407	896	CIO, WR, HR, DM (See note.)
Retain	H1408	H1535	128	HR, DM (See note.)
Timers	T3072	T4095	1024	TIM
Counters	C3072	C4095	1024	CNT

Note DM area of CP1L-L

Address	CP1L-L
D0000 to D9999	Provided
D10000 to D31999	Not Provided
D32000 to D32767	Provided

Function Block Holding Area Words (H512 to H1535)

The Function Block Holding Area words are allocated from H512 to H1535. These words are different to the standard Holding Area used for programs (H000 to H511) and are used only for the function block instance area (internally allocated variable area). These words cannot be specified as instruction operands. They are displayed in red if input when a function block is not being created. Although the words can be input when creating a function block, an error will occur when the program is checked. If this area is specified not to be retained in the Function Block Memory Allocation Dialog Box, turn the power ON/OFF or clear the area without retaining the values when starting operation.

1-4 Converting Function Block Definitions to Library Files

A function block definition created using the CX-Programmer can be stored as a single file known as a function block definition file with filename extension *.cxf. These files can be reused in other projects (PLCs).

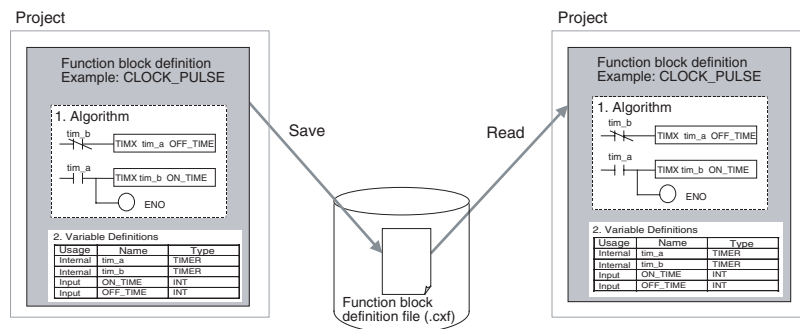

1-5 Usage Procedures

Once a function block definition has been created and an instance of the algorithm has been created, the instance is used by calling it when it is time to execute it. Also, the function block definition that was created can be saved in a file so that it can be reused in other projects (PLCs).

1-5-1 Creating Function Blocks and Executing Instances

The following procedure outlines the steps required to create and execute a function block.

- 1,2,3...**
1. First, create the function block definition including the algorithm and variable definitions in ladder program or ST language. Alternatively, insert a function block library file that has been prepared in advance.

- Note**
- (a) Create the algorithm entirely with variable names.
 - (b) When entering the algorithm in ladder programming language, project files created with versions of CX-Programmer earlier than Ver. 5.0 can be reused by reading the project file into CX-Programmer Ver. 5.0 or higher and copying and pasting useful parts.
 - (c) Existing ladder programming can be automatically turned into a function block using **Edit - Function Block (ladder) generation**.

2. When creating the program, insert copies of the completed function block definition. This step creates instances of the function block.
3. Enter an instance name for each instance.

4. Set the variables' input source addresses and/or constants and output destination addresses and/or constants as the parameters to pass data for each instance.
5. Select the created instance, select **Function Block Memory - Function Block Memory Allocation** from the PLC Menu, and set the internal data area for each type of variable.
6. Transfer the program to the CPU Unit.
7. Start program execution in the CPU Unit and the instance will be called and executed if their input conditions are ON.

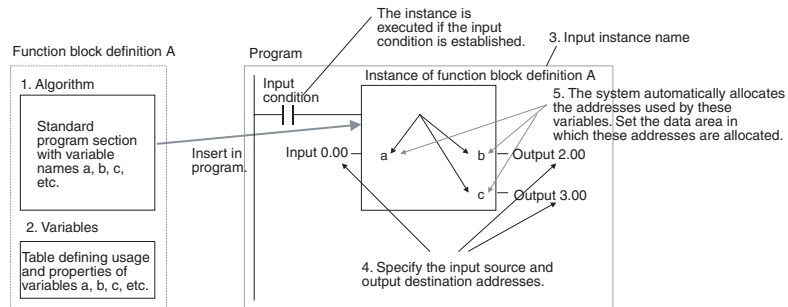

1-5-2 Reusing Function Blocks

Use the following procedure to save a function block definition as a file and use it in a program for another PLCs.

1,2,3...

1. Select the function block that you want to save and save it as a function block definition file (*.cxf).
2. Open the other PLC's project and open/read the function block definition file (*.cxf) that was saved.
3. Insert the function block definition in the program when creating the new program.

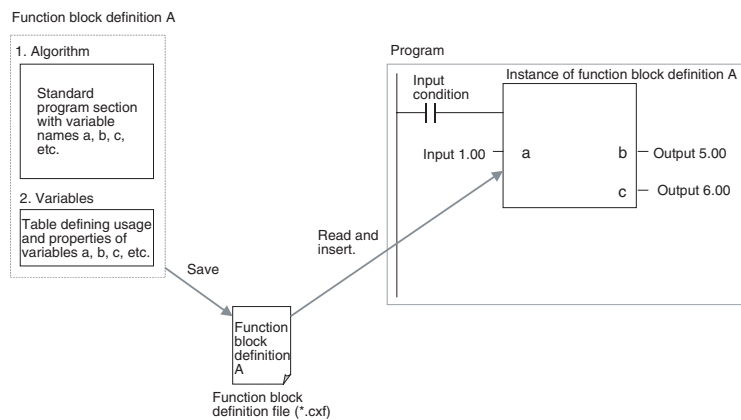

Note In the CX-Programmer Ver. 5.0, each function block definition can be compiled and checked as a program. We recommend compiling to perform a program check on each function block definition file before saving or reusing the file.

1-6 Version Upgrade Information

Refer to the *CX-Programmer Operation Manual (W446)* for information on upgraded functions other than those for function blocks and structure text.

Improvements were made in protection with password entry.

Ver. 9.5 to 9.6 Upgrade Information

Functionality Improved from Version 9.5 to 9.6

Compatible PLC Models

The following unit versions of CPU Units are supported. Read protection with extended passwords has been enabled.

CJ2H unit version 1.5, CJ2M unit version 2.1, CS1G-H unit version 4.1, CS1H-H unit version 4.1, CJ1G-H unit version 4.1, CS1D-H unit version 1.4, CS1D-S unit version 2.1, CP1H unit version 1.3, CP1L unit version 1.1, CP1L-L unit version 1.1, and CP1E unit version 1.3

Read Protection with Passwords

Read protection using longer passwords was added. Read protection with extended passwords provides stronger protection for the design assets of the user.

Ver. 9.2 to 9.3 Upgrade Information

Changed ST Editor View

- Added the indication of line numbers on the ST Editor View. And you can also specify a line number to jump there.
- Functions and registered Symbols are selectable from Word Lists.
- When you press the Tab key while the start function of a Control Statement is selected, you can enter the frame of the Control Statement very easily.
- Red wavy lines indicate ST syntax errors in a program. No programming check is required.

Smart input on FB Ladder View

You can use the Smart Input Mode on the FB Ladder View in the same way as on the Task Ladder View.

Ver. 9.1 to 9.2 Upgrade Information

Improvements on Structures

For the CJ2 CPU Units, the available range of structures is expanded.

- Structures (structure variables, structure member variables, and structure array variables) are made available in ST (Structured Text) programs.
- You can register and use structure variables as an external variable of FB (Function Block) ladder and ST.

Support of Structure Variables - Comparison with Previous Versions

Usage		Version 9.1 or earlier	Version 9.2 or higher
Global symbol table		Yes	Yes
Ladder program	Local symbol table	Yes	Yes
	Section view	Yes	Yes
ST program	Local symbol table	No	Yes
	ST editor	No	Yes

Usage		Version 9.1 or earlier	Version 9.2 or higher
SFC program	Local symbol table	No	Yes
	SFC chart view	No	No
	Sub-chart view	No	No
	Sub-chart symbol table	No	Yes
	Action ladder view	No	Yes
	Action ST view	No	Yes
	Transition ladder view	No	Yes
	Transition ST view	No	Yes
FB ladder	Variables	Internal variables	Yes
		Input variables	No
		Output variables	No
		Input-Output variables	Yes
		External variables	No
FBST	Variables	Internal variables	No
		Input variables	No
		Output variables	No
		Input-Output variables	No
		External variables	No

Improvements on TIMER/COUNTER Type Variables

For the CJ2 CPU Units, the available range of TIMER/COUNTER type variables is expanded.

- The TIMER/COUNTER type variables are made available in ST programs. You can use the timer/counter completion flags and the timer/counter present values in ST programs.
- In the ST program, you can start and stop the timers/counters.
- You can register and use TIMER/COUNTER type variables as an external variable of FB.

Support of TIMER/COUNTER Type Variables - Comparison with Previous Versions

Usage		Version 9.1 or earlier	Version 9.2 or higher
Global symbol table		Yes	Yes
Ladder program	Local symbol table	Yes	Yes
	Section view	Yes	Yes
ST program	Local symbol table	Yes	Yes
	ST editor	No	Yes
SFC program	Local symbol table	Yes	Yes
	SFC chart view	No	No
	Sub-chart view	No	No
	Sub-chart symbol table	Yes	Yes
	Action ladder view	Yes	Yes
	Action ST view	No	Yes
	Transition ladder view	Yes	Yes
	Transition ST view	No	Yes
FB ladder	Variables	Internal variables	Yes
		Input variables	No
		Output variables	No
		Input-Output variables	No
		External variables	Yes
FBST	Variables	Internal variables	No
		Input variables	No
		Output variables	No
		Input-Output variables	No
		External variables	Yes

Version 9.0 to 9.1 Upgrade Information

The new CPU Unit models of CJ2M-CPU□□ supporting function blocks and structured text are now supported.

When the PLC model is set to the CJ2M, FB Program Area usage can be displayed using the memory view function.

Version 8.3 to 9.0 Upgrade Information**Data Structures Supported as Symbol Data Types**

Version 8.3	Version 9.0
Data structures are not supported.	CJ2 CPU Units now support data structures as symbol data type.

Version 8.0 to 8.1 Upgrade Information

The new PLC models of CJ2H-CPU6□ supporting function blocks and structured text are now supported.

Version 7.2 to 8.0 Upgrade Information

The new PLC models of CJ2H-CPU6□-EIP supporting function blocks and structured text are now supported.

Version 7.0 to 7.2 Upgrade Information**Improved Support for Function Blocks and Structured Text**

For details on the other improvements to CX-Programmer functions in this upgrade, refer to the *CX-Programmer Operation Manual (W446)*.

n IEC61131-3 Language Improvements

Support has been improved for the structured text and SFC languages, which are IEC61131-3 languages. Ladder, structured text (ST), and SFC programming can be combined freely, so that the best language for each process can be used, which reduces program development time and makes the program easier to understand.

Support for ST Language in the Program (Task Allocation)

Version 7.0	Version 7.2
The ST language could be used only in function blocks.	The ST language can be used in programs (task allocation) other than function blocks. (ST programs can be allocated to tasks.) Other programming languages can be combined freely in a single user program. With this capability, numerical calculations can be written as ST programs, and other processing can be written as ladder or SFC programs. Note Structured text is supported only by CS/CJ-series CPU Units with unit version 4.0 or later. It is not supported by CP-series CPU Units.

Comparison of Function Block Definitions and ST Programs

Version 7.0	Version 7.2
Function block definitions could not be compared.	<ul style="list-style-type: none"> Function block definitions can be compared. With this capability, it is easy to check for differences in function block definitions in programs. ST programs can also be compared.

Version 6.1 to 7.0 Upgrade Information**Convenient Functions to Convert Ladder Diagrams to Function Blocks**

Version 6.1	Version 7.0
Ladder programming can be copied into a function block definition to create a function block. The symbols and addresses in the ladder programming, however, have to be checked and input variables, internal variables, and output variables have to be identified and manually registered.	One or more program sections can be selected from the program and then Function Block (ladder) generation selected from the menu to automatically create a function block definition and automatically allocate variables according to symbols and addresses in the program sections. (Allocations can later be changed as required.) This enables legacy programming to be easily converted to function blocks.

Online Function Block Editing

Version 6.1	Version 7.0
Function block definitions (i.e., the algorithms and variable tables) cannot be changed online when the PLC is running. (Only I/O parameters for function block instances can be changed.)	The algorithms and variables tables for function blocks can be changed while the PLC is operation. (See note.) This enables debugging and changing function block definitions in systems that cannot be stopped, such as systems that operate 24 hours a day. Operation: Right-click the function block definition in the Work Space and select FB Online Edit - Begin from the pop-up menu. Note Function block instances cannot be added. Note This function cannot be used for simulations on CX-Simulator.

Support for STRING Data Type and Processing Functions in Standard Text Programs

Version 6.1	Version 7.0
<ul style="list-style-type: none"> • The STRING data type (text) cannot be used in ST programming. (See note.) • There are no text processing functions supported for ST programming. • Even in a ladder program, the user has to consider the ASCII code and code size of text for display messages and no-protocol communications (see note) when executing string processing instructions, data conversion instructions, and serial communications instructions. <p>Note The user can use the PLC memory function of the CX-Programmer to input text strings in I/O memory. The data size in I/O memory, however, must be considered.</p>	<ul style="list-style-type: none"> • The STRING data type (text) can be used in ST programming. This enables, for example, substituting a text string for a variable (e.g., a := '@READ;') to easily set a variable containing text (i.e., ASCII characters). In doing this, the user does not have to be concerned with the ASCII code or code size. • Text processing functions are supported for ST programming, including text extraction, concatenation, and searching. This enables easily processing text strings and display messages in ST programming inside function blocks. • Functions are also supported for sending and receiving text strings. This enables easily processing no-protocol communications using ST programming in functions blocks without being concerned with ASCII codes.

Support for Input-Output Variables

Version 6.1	Version 7.0
<ul style="list-style-type: none"> • Input-output variables cannot be used in function blocks. (Only input variables, internal variables, and output variables can be used.) • Arrays cannot be specified for input variables. • Values are passed from input parameters to input variables. 	<ul style="list-style-type: none"> • Input-output variables can be used in function blocks. • Input-output variables can be specified as arrays. • Addresses are passed from input parameters to input variables instead of values. This enables using input-output variable arrays inside function blocks to enable easily passing large amounts of data to function blocks using the input parameters.

Version 6.0 to 6.1 Upgrade Information**Support for NSJ-series NSJ Controllers**

The PLC model (“device type”) can be set to “NSJ” and the CPU type can be set to the G5D.

Support for FQM1 Unit Version 3.0

The new models of the FQM1 Flexible Motion Controller are now supported (i.e., the FQM1-CM002 Coordinator Module and the FQM1-MMA22/MMP22 Motion Control Modules).

Instance ST/Ladder Program Simulation Function

Previous version (Ver. 6.0)	New version (Ver. 6.1)
<p>The CX-Simulator could be used to execute a ladder program step (Step Run), execute steps continuously (Continuous Step Run), execute a single cycle (Scan Run), and set I/O break point conditions.</p>	<p>The Step Run, Continuous Step Run, Scan Run, and Set/Clear Break Point functions can be executed as CX-Programmer functions.</p> <p>All of these functions can be used with ladder programs and ladder/ST programs in function blocks.</p> <p>Note The CX-Simulator Ver. 1.6 (sold separately) must be installed in order to use these functions.</p> <p>Note I/O break conditions cannot be set.</p>

Improved Function Block Functions**Monitoring ST Programs in Function Blocks**

Previous version (Ver. 6.0)	New version (Ver. 6.1)
<p>The operation of ST programs within function block instances could not be monitored while monitoring the program online.</p> <p>(It was possible to check the contents of a function block definition’s program and monitor the I/O status of a function block instance’s ladder diagram.)</p>	<p>The status of a function block instance’s ST program can be monitored while monitoring the program.</p> <p>To monitor the ST program’s status, either double-click the function block instance or right-click the instance and select Monitor FB Instance from the pop-up menu. At this point, it will be possible to change PVs and force-set/reset bits.</p> <p>Note Online editing is not supported.</p>

Password Protection of Function Blocks

Previous version (Ver. 6.0)	New version (Ver. 6.1)
The function block properties could be set to prevent the display of a function block definition's program.	The following two kinds of password protection can be set. <ul style="list-style-type: none"> • Password protection restricting both reading and writing. • Password protection restricting writing only.

Version 5.0 to 6.0 Upgrade Information**Nesting Function Blocks**

Previous version (Ver. 5.0)	New version (Ver. 6.0)
A function block could not be called from another function block. (Nesting not supported.)	A function block can be called from another function block (nested). Up to 8 nesting levels are supported. The languages of the calling function block and called function block can be either ladder language or ST language. The nesting level relationship between function blocks can be displayed in a directory tree format. When function blocks are nested, just one Function Block Library file (.xcf extension) is stored for the calling function block and its called (nested) function block definitions.

I/O Bit Monitor Support for Ladder Programs in Function Blocks

Previous version (Ver. 5.0)	New version (Ver. 6.0)
The I/O status of a function block instance's ladder diagram could not be monitored while monitoring the program online. (It was only possible to check the program in the function block definition.)	The I/O status of a function block instance's ladder diagram can be monitored while monitoring the program online. To monitor the I/O status, either double-click the function block instance or right-click the instance and select Monitor FB Ladder Instance from the pop-up menu. At this point, it will be possible to monitor the status of I/O bits and the content of words, change PVs, force-set/reset bits, and monitor differentiation (ON/OFF transitions) of bits. Note Online editing is not supported and timer/counter SVs cannot be changed.

Registering and Monitoring Function Block Instance Variables in a Watch Window

Previous version (Ver. 5.0)	New version (Ver. 6.0)
To register a function block instance's variable in a Watch Window, it was necessary to display the Watch Window, double-click the window, and select the desired variable from a pull-down list.	Multiple variables in a function block instance can be easily registered together in the Watch Window. The FB variables registration Dialog Box can be displayed with any of the following methods and the variables can be registered together in that Dialog Box. <ul style="list-style-type: none"> • Right-click the function block instance and select Register in Watch Window from the pop-up menu. • Select the desired function block instance in the program or variable table and either copy/paste or drag/drop the instance into the Watch Window. • Move the cursor to an empty line in the Watch Window and select Register in Watch Window from the pop-up menu.

Other Function Block Improvements

- The cross-reference pop-up function is supported in ladder programs within function blocks.
- The ST language help program can be started from the pop-up menu in ST Editor.
- A function block's definitions can be opened just by double-clicking the function block instance.
- The cursor automatically moves down after a function block instance's parameter input is confirmed.

SECTION 2

Function Block Specifications

This section provides specifications for reference when using function blocks, including specifications on function blocks, instances, and compatible PLCs, as well as usage precautions and guidelines.

2-1	Function Block Specifications	32
2-1-1	Function Block Specifications	32
2-1-2	Function Block Elements	33
2-2	Data Types Supported in Function Blocks	43
2-2-1	Basic Data Types	43
2-2-2	Derivative Data Types	43
2-3	Instance Specifications	44
2-3-1	Composition of an Instance	44
2-3-2	Parameter Specifications	49
2-3-3	Operating Specifications	51
2-4	Programming Restrictions	53
2-4-1	Ladder Programming Restrictions	53
2-4-2	ST Programming Restrictions	55
2-4-3	Programming Restrictions	56
2-5	Function Block Applications Guidelines	58
2-5-1	Deciding on Variable Data Types	58
2-5-2	Determining Variable Types (Inputs, Outputs, In Out, Externals, and Internals)	59
2-5-3	AT Settings for Internal Variables	61
2-5-4	Array Settings for Input-Output Variables and Internal Variables ..	61
2-5-5	Specifying Addresses Allocated to Special I/O Units	63
2-5-6	Using Index Registers	64
2-6	Precautions for Instructions with Operands Specifying the First or Last of Multiple Words	67
2-7	Instruction Support and Operand Restrictions	70
2-8	CPU Unit Function Block Specifications	71
2-8-1	Specifications	71
2-8-2	Operation of Timer Instructions	77
2-9	Number of Function Block Program Steps and Instance Execution Time ...	78
2-9-1	Number of Function Block Program Steps	78
2-9-2	Function Block Instance Execution Time	79

2-1 Function Block Specifications

2-1-1 Function Block Specifications

Item	Description
Number of function block definitions	CJ2H CPU Units: <ul style="list-style-type: none"> • CJ2H-CPU6□(-EIP): 2,048 max. per CPU Unit CJ2M CPU Units: <ul style="list-style-type: none"> • CJ2M-CPU□1/□2/□3: 256 max. per CPU Unit • CJ2M-CPU□4/□5: 2,048 max. per CPU Unit CS1-H/CJ1-H CPU Units: <ul style="list-style-type: none"> • Suffix -CPU44H/45H/64H/65H/66H/67H/64H-R/65H-R/66H-R/67H-R: 1,024 max. per CPU Unit • Suffix -CPU42H/43H/63H: 128 max. per CPU Unit CJ1M CPU Units: <ul style="list-style-type: none"> • CJ1M-CPU11/12/13/21/22/23: 128 max. per CPU Unit CP1H CPU Units: <ul style="list-style-type: none"> • CP1H-XA/X/Y: 128 max. per CPU Unit CP1L CPU Units: <ul style="list-style-type: none"> • CP1L-M/L: 128 max. per CPU Unit NSJ Controllers: <ul style="list-style-type: none"> • All models: 1,024 max. per Controller FQM1 Flexible Motion Controllers: <ul style="list-style-type: none"> • FQM1-CM002/MMA22/MMP22: 128 max. per Controller
Number of instances	CJ2H CPU Units: <ul style="list-style-type: none"> • CJ2H-CPU6□(-EIP): 2,048 max. per CPU Unit CJ2M CPU Units: <ul style="list-style-type: none"> • CJ2M-CPU□1/□2/□3: 256 max. per CPU Unit • CJ2M-CPU□4/□5: 2,048 max. per CPU Unit CS1-H/CJ1-H CPU Units: <ul style="list-style-type: none"> • Suffix -CPU44H/45H/64H/65H/66H/67H/64H-R/65H-R/66H-R/67H-R: 2,048 max. per CPU Unit • Suffix -CPU42H/43H/63H: 256 max. per CPU Unit CJ1M CPU Units: <ul style="list-style-type: none"> • CJ1M-CPU11/12/13/21/22/23: 256 max. per CPU Unit CP1H CPU Units: <ul style="list-style-type: none"> • CP1H-XA/X/Y: 256 max. per CPU Unit CP1L CPU Units: <ul style="list-style-type: none"> • CP1L-M/L: 256 max. per CPU Unit NSJ Controllers: <ul style="list-style-type: none"> • All models: 2,048 max. per Controller FQM1 Flexible Motion Controllers: <ul style="list-style-type: none"> • FQM1-CM002/MMA22/MMP22: 256 max. per Controller
Number of instance nesting levels	<ul style="list-style-type: none"> • CX-Programmer Ver. 5.0: Nesting is not supported. • CX-Programmer Ver. 6.0 and later versions: Supports nesting up to 8 levels. (The instance called from the program is counted as one nesting level.)
Number of variables used in a function block (not including internal variables, external variables, EN, and EN0)	Maximum number of variables per function block definition <ul style="list-style-type: none"> • Input-output variables: 16 max. • Input variables + input-output variables: 64 max. • Output variables + input-output variables: 64 max.

2-1-2 Function Block Elements

The following table shows the items that must be entered by the user when defining function blocks.

Item	Description
Function block definition name	The name of the function block definition
Language	The programming language used in the function block definition. Select ladder programming or structured text
Variable definitions	Variable settings, such as operands and return values, required when the function block is executed <ul style="list-style-type: none"> • Type (usage) of the variable • Name of the variable • Data type of the variable • Initial value of the variable
Algorithm	Enter the programming logic in ladder or structured text. <ul style="list-style-type: none"> • Enter the programming logic using variables. • Input constants directly without registering in variables.
Comment	Function blocks can have comments.

Function Block Definition Name

Each function block definition has a name. The names can be up to 64 characters long and there are no prohibited characters. The default function block name is FunctionBlock□, where □ is a number (assigned in order).

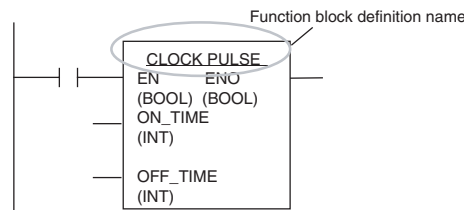

Language

Select either ladder programming language or structured text (ST language).

Note

- (1) For details on ST language, refer to *SECTION 5 Structured Text (ST) Language Specifications* in *Part 2: Structured Text (ST)*.
- (2) When nesting, function blocks using ST language and ladder language can be combined freely (version 6.0 and higher only).

Variable Definitions

Define the operands and variables used in the function block definition.

Variable Names

- Variable names can be up to 30,000 characters long.
- Variables name cannot contain spaces or any of the following characters:
! " # \$ % & ' () = - ~ ^ \ | ' @ { [+ ; * : }] < , > . ? /
- Variable names cannot start with a number (0 to 9).
- Variable names cannot contain two underscore characters in a row.
- The following characters cannot be used to indicate addresses in I/O memory.
A, W, H (or HR), D (or DM), E (or EM), T (or TIM), C (or CNT) followed by the numeric value (word address)

Variable Notation

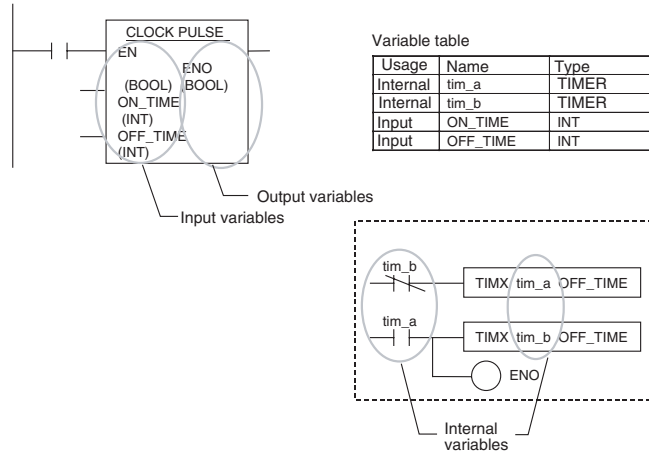

Variable Type (Usage)

Item (See note 3.)	Variable type				
	Inputs	Outputs	In Out	Internals	Externals (See note 1.)
Definition	Operands to the instance	Return values from the instance	Variables used to pass data to and from instances using addresses	Variables used only within instance	Global symbols registered as variables beforehand with the CX-Programmer or user-defined global symbols.
Status of value at next execution	The value of the input parameter will be given.	The value is passed on to the next execution.	The value of the external parameter	The value is passed on to the next execution.	The value of the variable registered externally
Display	Displayed on the left side of the instance.	Displayed on the right side of the instance.	Displayed on the left and right sides of the instance.	Not displayed.	Not displayed.
Number allowed	64 max. per function block (excluding EN)	64 max. per function block (excluding ENO)	16 max. per function block	Unlimited	Unlimited
AT setting	No	No	No	Supported	No
Array setting	No	No	Supported	Supported	No
Retain setting	Supported (See note 2.)	Supported	No	Supported	No
Variables created by default	EN (Enable): Receives an input condition.	ENO (Enable Output): Outputs the function block's execution status.	None	None	Pre-defined symbols registered in advance as variables in the CX-Programmer, such as Condition Flags and some Auxiliary Area bits.

- Note**
- (1) For details on Externals, refer to *Appendix A System-defined external variables supported in function blocks.*
 - (2) The value of the input parameter will be given.
 - (3) Structure variables and TIMER/COUNTER type variables can be used only for the following variables:
 Structure variables: Internal variables, input-output variables, and external variables
 TIMER/COUNTER type variables: Internal variables and external variables

n **Input Variables**

Input variables pass external operands to the instance. The input variables are displayed on the left side of the instance.

The value of the input source (data contained in the specified parameter just before the instance was called) will be passed to the input variable.

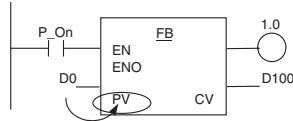

The value of the parameter specified as the input (value of D0) is passed to the instance's input variable (PV).

Example

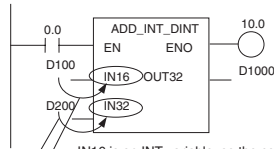

IN16 is an INT variable, so the content of D100 is used. IN32 is a DINT variable, so the content of D200 and D201 is used.

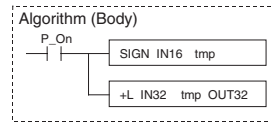

Variable table

Usage	Name	Type
Internal	tmp	DINT
Input	EN	BOOL
Input	IN16	INT
Input	IN32	DINT
Output	ENO	BOOL
Output	OUT32	DINT

Name	Data Type	AT	Initial Value	Retained	Comment
EN	BOOL		FALSE		Controls execution of the Function Block.
IN16	INT		0		
IN32	DINT		0		

- Note**
1. The same name cannot be assigned to an input variable and output variable. If it is necessary to receive a value from an external variable, change the variable inside the function block, and then return the result to the external variable, use an input-output variable.
 2. When the instance is executed, input values are passed from parameters to input variables before the algorithm is processed. Consequently, values cannot be read from parameters to input variables within the algorithm. If it is necessary to read a value within the execution cycle of the algorithm, do not pass the value from a parameter. Assign the value to an internal variable and use an AT setting (specified addresses). Alternatively, reference the global symbol as external variables.

Initial Value

Initial values can be set for input variables, but the value of the input parameter will be enabled (the input parameter value will be set when the parameter for input variable EN goes ON and the instance is executed).

Note The input parameter setting cannot be omitted when using the CX-Programmer.

EN (Enable) Variable

When an input variable is created, the default input variable is the EN variable. The instance will be executed when the parameter for input variable EN is ON.

n **Output Variables**

Output variables pass return values from the instance to external applications. The output variables are displayed on the right side of the instance.

After the instance is executed, the value of the output variable is passed to the specified parameter.

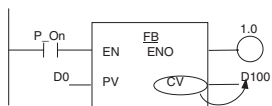

The value of the output variable (CV) is passed to the parameter specified as the output destination, which is D100 in this case.

Example

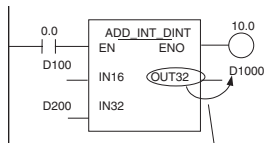

OUT32 is a DINT variable, so the variable's value is passed to D1000 and D1001.

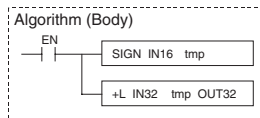

Variable table

Usage	Name	Data type
Internal	tmp	DINT
Input	EN	BOOL
Input	IN16	INT
Input	IN32	DINT
Output	ENO	BOOL
Output	OUT32	DINT

Name	Data Type	AT	Initial Value	Retained	Comment
ENO	BOOL		FALSE		Indicates successful execution of the Fun...
ENO	BOOL		FALSE		
OUT32	DINT		0		

Like internal variables, the values of output variables are retained until the next time the instance is executed (i.e., when EN turns OFF, the value of the output variable is retained).

Example:

In the following example, the value of output variable CV will be retained until the next time the instance is executed.

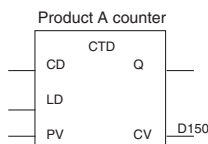

- Note**
1. The same name cannot be assigned to an input variable and output variable. If it is necessary to receive a value from an external variable, change the variable inside the function block, and then return the result to the external variable, use an input-output variable.
 2. When the instance is executed, output variables are passed to the corresponding parameters after the algorithm is processed. Consequently, values cannot be written from output variables to parameters within the algorithm. If it is necessary to write a value within the execution cycle of the algorithm, do not write the value to a parameter. Assign the value to an internal variable and use an AT setting (specified addresses).

Initial Value

An initial value can be set for an output variable that is not being retained, i.e., when the Retain Option is not selected. An initial value cannot be set for an output variable if the Retain Option is selected.

The initial value will not be written to the output variable if the IOM Hold Bit (A50012) is ON.

Auxiliary Area control bit		Initial value
IOM Hold Bit (A50012)	ON	The initial value will not be set.

ENO (Enable Output) Variable

The ENO variable is created as the default output variable. The ENO output variable will be turned ON when the instance is called. The user can change this value. The ENO output variable can be used as a flag to check whether or not instance execution has been completed normally.

Input-Output Variables

Input-output variables use addresses to pass data to and from a function block instance. An input-output variable is displayed on both the left and right side of the instance. The value of the input-output variable immediately after the instance is executed is not stored in the addresses internally allocated to the input-output variable by the system, but rather the value is stored in the address (and following addresses depending on the data size) of the parameter used to pass data to and from the input-output variable.

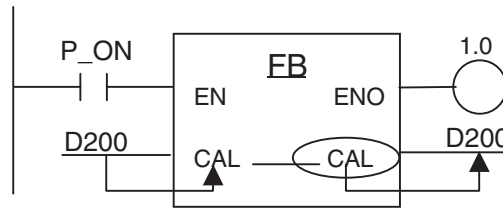

Address D200 is passed to the input-output variable CAL. Inside the function block, the specified data size of I/O memory starting from D200 is processed, and changes are thus passed outside the function block instance.

Note Input-output variables are specified a CX-Programmer variable table by selecting “In Out” for the variable usage.

n Internal Variables

Internal variables are used within an instance. These variables are hidden within each instance. They cannot be referenced from outside of the instance and are not displayed in the instance.

The values of internal variables are retained until the next time the instance is executed (i.e., when EN turns OFF, the value of the internal variable is retained). Consequently, even if instances of the same function block definition are executed with the same I/O parameters, the result will not necessarily be the same.

Example:

The internal variable tim_a in instance Pulse_2sON_1sOFF is different from internal variable tim_a in instance Pulse_4sON_1sOFF, so the instances cannot reference and will not affect each other's tim_a value.

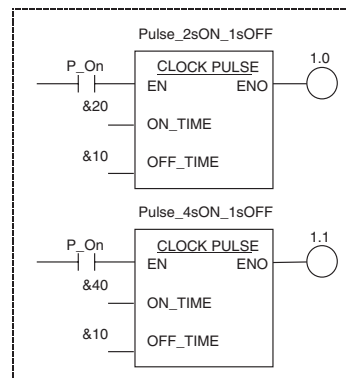

Variable table

Usage	Name	Data type
Internal	tim_a	TIMER
Internal	tim_b	TIMER
Input	ON_TIME	INT
Input	OFF_TIME	INT

Name	Data Type	AT	Initial Value	Retained	Comment
tmp	DINT		0		

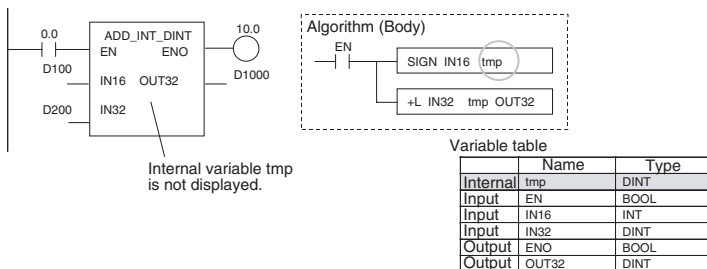

Retain Data through Power Interruptions and Start of Operation

Internal variables retain the value from the last time that the instance was called. In addition, the Retain Option can be selected so that an internal variable will also retains its value when the power is interrupted or operation starts (the mode is switched from PROGRAM to RUN or MONITOR mode).

When the Retain Option is selected, the value of the variable is retained when the power is interrupted or operation starts unless the CPU Unit does not have a backup battery. If the CPU Unit does not have a good battery, the value will be unstable.

Variables	Condition	Status
Variables set to <i>Retain</i>	Start of operation	Retained
	Power ON	Retained

When the Retain Option is not selected, the value of the variable will not be held when the power is interrupted or operation starts. Even variables not set to be retained, however, can be held at the start of operation by turning ON the IOM Hold Bit (A50012) and can be held during power interruptions by setting the PLC Setup, as shown in the following table.

Variables	Condition	IOM Hold Bit (A50012) setting		
		OFF	ON	
			IOM Hold Bit Status at Startup (PLC Setup) selected	IOM Hold Bit Status at Startup (PLC Setup) not selected
Variables not set to <i>Retain</i>	Start of operation	Not retained	Retained	Retained
	Power ON	Not retained	Retained	Not retained

Note The IOM Hold Bit (A50012) is supported for compatibility with previous models. To hold the values of variables in function blocks, however, use the *Retain Option* and not the IOM Hold Bit.

Initial Value

An initial value can be set for an internal variable that is not being retained (i.e., when the Retain Option not selected). An initial value cannot be set for an internal variable if the Retain Option is selected.

Internal variables that are not being retained will be initialized to 0.

The initial value will not be written to the internal variable if the IOM Hold Bit (A50012) is ON.

Auxiliary Area control bit	Initial value	
IOM Hold Bit (A50012)	ON	The initial value will not be set.
	OFF	The initial value will be set.

n **External Variables**

External variables are either system-defined variables that have been registered in CX-Programmer before hand, or variables that externally reference user-defined variables in the global symbol table.

- For details on system-defined variables, refer to *Appendix A System-defined external variables supported in function blocks*.
- To externally reference user-defined variables in the global symbol table, the variables of the same name and data type must be registered as an external variable.
However, it is impossible to externally reference the variables user-defined as a network symbol.

Variable Properties**Variable Name**

The variable name is used to identify the variable in the function block. The name can be up to 30,000 characters long. The same name can be used in other function blocks.

Note A variable name must be input for variables, even ones with AT settings (specified address).

Data Type

Any of the following types may be used.

Data type	Content	Size	Inputs	Outputs	In Out	Internals	Externals
BOOL	Bit data	1 bit	OK	OK	OK	OK	OK
INT	Integer	16 bits	OK	OK	OK	OK	OK
UNIT	Unsigned integer	16 bits	OK	OK	OK	OK	OK
DINT	Double integer	32 bits	OK	OK	OK	OK	OK
UDINT	Unsigned double integer	32 bits	OK	OK	OK	OK	OK
LINT	Long (4-word) integer	64 bits	OK	OK	OK	OK	OK
ULINT	Unsigned long (4-word) integer	64 bits	OK	OK	OK	OK	OK
WORD	16-bit data	16 bits	OK	OK	OK	OK	OK
DWORD	32-bit data	32 bits	OK	OK	OK	OK	OK
LWORD	64-bit data	64 bits	OK	OK	OK	OK	OK
REAL	Real number	32 bits	OK	OK	OK	OK	OK
LREAL	Long real number	64 bits	OK	OK	OK	OK	OK
TIMER	Timer (See note 1.)	Flag: 1 bit PV: 16 bits	Not supported	Not supported	Not supported	OK	OK
COUNTER	Counter (See note 2.)	Flag: 1 bit PV: 16 bits	Not supported	Not supported	Not supported	OK	OK
STRING	Text string data	Variable	Not supported	Not supported	OK	OK	Not supported
STRUCT	User-defined data type	Variable	Not supported	Not supported	OK	OK	OK

- Note**
- (1) The TIMER data type is used to enter variables for timer numbers (0 to 4095) in the operands for TIMER instructions (TIM, TIMH, etc.). When this variable is used in another instruction, the Timer Completion Flag (1 bit) or the timer present value (16 bits) is specified (depending on the instruction operand).
 - (2) The COUNTER data type is used to enter variables for counter numbers (0 to 4095) in the operands for COUNTER instructions (CNT, CNTR, etc.). When this variable is used in another instruction, the Counter Completion Flag (1 bit) or the counter present value (16 bits) is specified (depending on the instruction operand).

AT Settings (Allocation to Actual Addresses)

With internal variables, it is possible to set the variable to a particular I/O memory address rather than having it allocated automatically by the system. To specify a particular address, the user can input the desired I/O memory address in this property. It is still necessary to use variable name in programming even if a particular address is specified.

- Note**
- (1) The AT property can be set for internal variables only.
 - (2) AT settings can be used only with the CIO (Core I/O Area), A (Auxiliary Area), D (Data Memory Area), E (Extended Memory Area), H (Holding Relay Area), W (Internal Relay Area).
The AT property cannot be set in the following memory areas:
 - Index Register and Data Register Areas (directly/indirectly specified)
 - Indirectly specified DM/EM (: binary mode, *:BCD mode)
 - (3) AT settings can be used for the following allocations.
 - Addresses for Basic I/O Units, CPU Bus Units, or Special I/O Units
 - Auxiliary Area bits not registered as external variables in advance
 - PLC addresses for other nodes in the network

Example:

If the READ DATA FILE instruction (FREAD) is being used in the function block definition and it is necessary to check the File Memory Operation Flag (A34313), use an internal variable and specify the flag's address in the AT setting.

Register an internal variable, select the AT setting option, and specify A34313 as the address. The status of the File Memory Operation Flag can be checked through this internal variable.

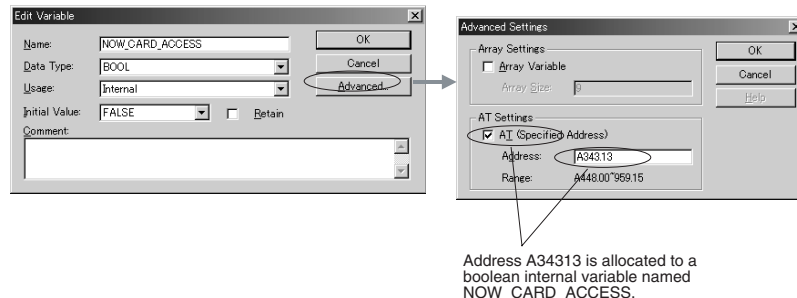

When the AT setting is used, the function block loses its flexibility. This function should thus be used only when necessary.

Array Setting

With internal variables and input-output variables, a variable can be defined as an array.

- Note** Only one-dimensional arrays are supported by the CX-Programmer.

With the array setting, a large number of variables with the same properties can be used by registering just one variable.

- An array set for an internal variable can have from 1 to 32,000 array elements. An array set for an input-output variable can have the number of elements given in the following table.

Data type	Number of elements
BOOL	2,048
INT/UINT/WORD	2,048

Data type	Number of elements
DINT/UDINT/DWORD	1,024
LINT/ULINT/LWORD	512

- An array can be set only for internal variables or input-output variables.
 - Any data type except for STRING can be specified for an array variable, as long as it is an internal variable.
 - When entering an array variable name in the algorithm of a function block definition, enter the array index number in square brackets after the variable name. The following three methods can be used to specify the index. (In this case the array variable is a[.]
 - Directly with numbers (for ladder or ST language programming)
Example: a[2]
 - With a variable (for ladder or ST language programming)
Example: a[n], where n is a variable
- Note** INT, DINT, LINT, UINT, UDINT, or ULINT can be used as the variable data type.
- With an equation (for ST language programming only)
Example: a[b+c], where b and c are variables

Note Equations can contain only arithmetic operators (+, -, *, and /).

An array is a collection of data elements that are the same type of data. Each array element is specified with the same variable name and a unique index. (The index indicates the location of the element in the array.)

A one-dimensional array is an array with just one index number.

Example: When an internal variable named SCL is set as an array variable with 10 elements, the following 10 variables can be used: SCL[0], SCL[1], SCL[2], SCL[3], SCL[4], SCL[5], SCL[6], SCL[7], SCL[8], and SCL[9]

SCL

0	WORD variable
1	WORD variable
2	WORD variable
3	WORD variable
4	WORD variable
5	WORD variable
6	WORD variable
7	WORD variable
8	WORD variable
9	WORD variable

← Specify SCL[3] to access this data element.

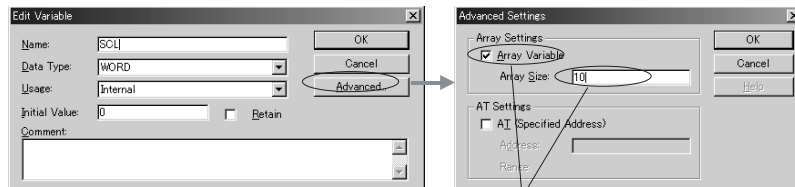

Settings for variable SCL as an array variable with element numbers 0 to 9.

Note Use an array variable when specifying the first or last of multiple words in an instruction operand to enable reusing the function block if an internal variable with a AT property cannot be set for the operand and an external variable cannot be set. When using an array setting for an input-output variable, specify the address of the first word for the input parameter (CX-Programmer version 7.0 or higher). When using an array setting for an internal variable, prepare an array variable with the number of elements for the required size, and after set-

ting the data in each array element, specify the first or last element in the array variable for the operand.

Example:

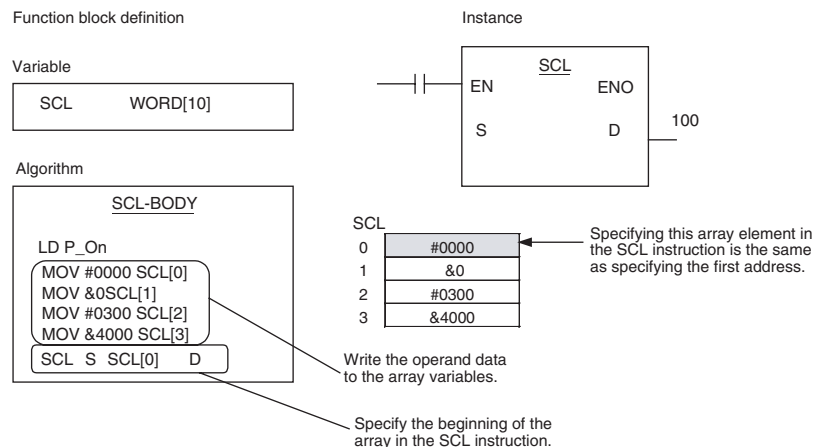

Note For details, refer to 2-6 Precautions for Instructions with Operands Specifying the First or Last of Multiple Words.

Initial Values

When an instance is executed the first time, initial values can be set for input variables, internal variables, and output variables. For details, refer to Initial Value under the preceding descriptions of input variables, internal variables, and output variables.

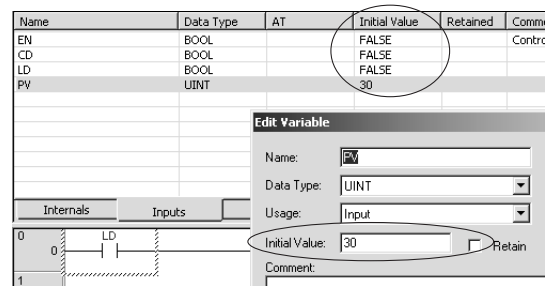

Retaining Data through Power Interruptions and Start of Operation

The values of internal variables can be retained through power interruptions and the start of operation. When the Retain Option is selected, the variable will be allocated to a region of memory that is retained when the power is interrupted and PLC operation starts.

Algorithm

Enter the logic programming using the registered variables.

Operand Input Restrictions

Addresses cannot be directly input into instruction operands within function blocks. Addresses that are directly input will be treated as variable names.

Note Exception: Input directly or indirectly specified addresses for Index Registers IR0 to IR15 and Data Registers DR0 to DR15 directly into the instruction operand. Do not input variables.

Input constants directly into instruction operands.

- Ladder programming: Enter decimal values after the &, and enter hexadecimal numerical values after the #.

- Structured text (ST language): Enter decimal numerical values as is and enter hexadecimal numerical values after 16#.

Comment

A comment of up to 30,000 characters long can be entered.

2-2 Data Types Supported in Function Blocks

2-2-1 Basic Data Types

Data type	Content	Size	Range of values
BOOL	Bit data	1	0 (FALSE), 1 (TRUE)
INT	Integer	16	-32,768 to +32,767
DINT	Double integer	32	-2,147,483,648 to +2,147,483,647
LINT	Long (8-byte) integer	64	-9,223,372,036,854,775,808 to +9,223,372,036,854,775,807
UINT	Unsigned integer	16	&0 to 65,535
UDINT	Unsigned double integer	32	&0 to 4,294,967,295
ULINT	Unsigned long (8-byte) integer	64	&0 to 18,446,744,073,709,551,615
REAL	Real number	32	-3.402823 × 10 ³⁸ to -1.175494 × 10 ⁻³⁸ , 0, +1.175494 × 10 ⁻³⁸ to +3.402823 × 10 ³⁸
LREAL	Long real number	64	-1.79769313486232 × 10 ³⁰⁸ to -2.22507385850720 × 10 ⁻³⁰⁸ , 0, 2.22507385850720 × 10 ⁻³⁰⁸ to 1.79769313486232 × 10 ³⁰⁸
WORD	16-bit data	16	#0000 to FFFF or &0 to 65,535
DWORD	32-bit data	32	#00000000 to FFFFFFFF or &0 to 4,294,967,295
LWORD	64-bit data	64	#0000000000000000 to FFFFFFFFFFFFFFFF or &0 to 18,446,744,073,709,551,615
STRING	Text string	Variable	1 to 255 ASCII characters
TIMER	Timer	Flag: 1 bit PV: 16 bits	Timer number: 0 to 4095 Completion Flag: 0 or 1 Timer PV: 0 to 9999 (BCD), 0 to 65535 (binary)
COUNTER	Counter	Flag: 1 bit PV: 16 bits	Counter number: 0 to 4095 Completion Flag: 0 or 1 Counter PV: 0 to 9999 (BCD), 0 to 65535 (binary)
FUNCTION BLOCK	Function block instance	---	---

2-2-2 Derivative Data Types

Data type	Content
Array	1-dimensional array; 32,000 elements max.
Structure	User-defined data type

2-3 Instance Specifications

2-3-1 Composition of an Instance

The following table lists the items that the user must set when registering an instance.

Item	Description
Instance name	Name of the instance
Language Variable definitions	The programming and variables are the same as in the function block definition.
Function block instance areas	The ranges of addresses used by the variables
Comments	A comment can be entered for each instance.

Instance Name

This is the name of the instance.

- Instance names can be up to 30,000 characters long.
- Instance names cannot contain spaces or any of the following characters:
! " # \$ % & ' () = - ~ ^ \ | ' @ { [+ ; * : }] < , > . ? /
- Instance names cannot start with a number (0 to 9).

There are no other restrictions.

The instance name is displayed above the instance in the diagram.

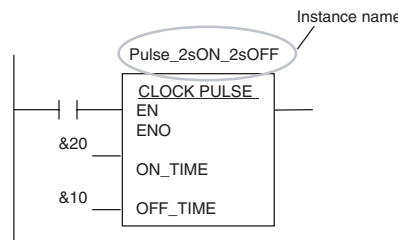

Function Block Instance Areas

To use a function block, the system requires memory to store the instance's internal variables, input variables, output variables, and input-output variables. These areas are known as the function block instance areas and the user must specify the first addresses and sizes of these areas. The first addresses and area sizes can be specified in 1-word units.

When the CX-Programmer compiles the function, it will output an error if there are any instructions in the user program that access words in these areas.

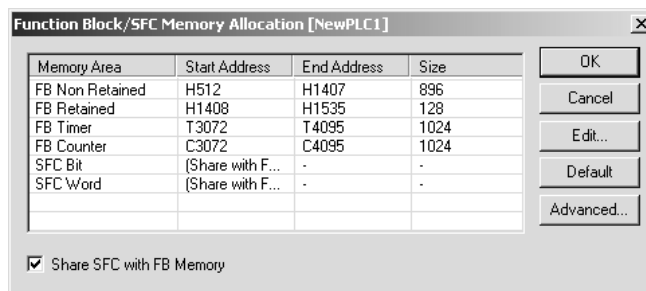

CJ2-series CPU Units

FB Instance Area	Default value			Applicable memory areas
	Start address	End address	Size	
Non Retain	H512	H1407	896	CIO, WR, HR, DM, EM (See note.)
Retain	H1408	H1535	128	HR, DM, EM (See note.)
Timers	T3072	T4095	1024	TIM
Counters	C3072	C4095	1024	CNT

Note Force-setting/resetting is enabled when the following EM banks are specified:

CJ2H-CPU64(-EIP)/-CPU65(-EIP)	EM bank 3
CJ2H-CPU66(-EIP)	EM banks 6 to 9
CJ2H-CPU67(-EIP)	EM banks 7 to E
CJ2H-CPU68(-EIP)	EM banks 11 to 18

CS/CJ-series CPU Units Ver. 3.0 or Later, and NSJ Controllers

FB Instance Area	Default value			Applicable memory areas
	Start address	End address	Size	
Non Retain	H512	H1407	896	CIO, WR, HR, DM, EM
Retain	H1408	H1535	128	HR, DM, EM
Timers	T3072	T4095	1024	TIM
Counters	C3072	C4095	1024	CNT

FQM1 Flexible Motion Controllers

FB Instance Area	Default value			Applicable memory areas
	Start address	End address	Size	
Non Retain	5000	5999	1000	CIO, WR, DM
Retain	None			
Timers	T206	T255	50	TIM
Counters	C206	C255	50	CNT

CP-series CPU Units

FB Instance Area	Default value			Applicable memory areas
	Start address	End address	Size	
Non Retain	H512	H1407	896	CIO, WR, HR, DM (See note.)
Retain	H1408	H1535	128	HR, DM (See note.)
Timers	T3072	T4095	1024	TIM
Counters	C3072	C4095	1024	CNT

Note DM area of CP1L-L

Address	CP1L-L
D0000 to D9999	Provided
D10000 to D31999	Not Provided
D32000 to D32767	Provided

Function Block Instance Area Types

The following settings are made in the function block instance area:

CS/CJ-series CPU Units Ver. 3.0 or Later, CP-series PLCs, and NSJ Controllers**Non-retained Areas**

Item	Contents
Allocated variables	Variables for which the retain property for power OFF and operation start is set as non-retained (See note 1.)
Applicable areas	H (Function block Special Holding Area), I/O (CIO Area), H (Holding Area), W (Internal Relay Area), D (Data Memory Area) (see note 2), E (Extended Data Memory Area) (See notes 2 and 3.)
Setting unit	Set in words
Allocated words (default)	H512 to H1407

- Note**
- (1) Except when the data type is set to TIMER or COUNTER.
 - (2) Bit data can be accessed even if the DM or EM Area is specified for the non-retained area or retained area.
 - (3) The same bank number cannot be specified as the current bank in the user program if the EM Area is specified for the non-retained area or retained area.

Retained Area

Item	Contents
Allocated variables	Variables for which the retain property for power OFF and operation start is set as retained (See note 1.)
Applicable areas	H (Function block Special Holding Area), H (Holding Area), D (Data Memory Area) (see note 1), E (Extended Data Memory Area) (See notes 2 and 3.)
Setting unit	Set in words
Allocated words (default)	H1408 to H1535

- Note**
- (1) Except when the data type is set to TIMER or COUNTER.
 - (2) Bit data can be accessed even if the DM or EM Area is specified for the non-retained area or retained area.
 - (3) The same bank number cannot be specified as the current bank in the user program if the EM Area is specified for the non-retained area or retained area.

Timer Area

Item	Contents
Allocated variables	Variables with TIMER set as the data type.
Applicable areas	T (Timer Area) Timer Flag (1 bit) or timer PVs (16 bits)
Allocated words (default)	T3072 to T4095 Timer Flag (1 bit) or timer PVs (16 bits)

Counter Area

Item	Contents
Allocated variables	Variables with COUNTER set as the data type.
Applicable areas	C (Counter Area) Counter Flag (1 bit) or counter PVs (16 bits)
Allocated words (default)	C3072 to C4095 Counter Flag (1 bit) or counter PVs (16 bits)

Function Block Holding Area (H512 to H1535)

The default allocation of Function Block Holding Area words set as retained and non-retained words is H512 to H1535. These words are different to the standard Holding Area used for programs (H000 to H511), and are used only for the function block instance area (internally allocated variable area).

- These words cannot be specified in AT settings for internal variables.
- These words cannot be specified as instruction operands.
 - These words are displayed in red if they are input when a function block is not being created.
 - Although the words can be input when creating a function block, an error will occur when the program is checked.
- If this area is specified as non-retained, turn the power ON/OFF or clear the area without retaining the values when starting operation.

Note To prevent overlapping of instance area addresses with addresses used in the program, set H512 to H1535 (Function Block Holding Area words) for the non-retained area and retained area. If there are not sufficient words, use words in areas not used by the user program.

FQM1 Flexible Motion controller

FB Instance Area	Default value			Applicable memory areas
	Start address	End address	Size	
Non Retain	5000	5999	1000	CIO, WR, DM
Retain	None			
Timers	T206	T255	50	TIM
Counters	C206	C255	50	CNT

Non-retained Areas

Item	Contents
Allocated variables	Variables for which the retain property for power OFF and operation start is set as retained. (See note 1.)
Applicable areas	I/O (CIO), W (Work Area), and D (DM Area) (See note 2.)
Setting unit	Set in words
Allocated words (default)	CIO 5000 to CIO 5999

- Note**
- (1) Except when the data type is set to TIMER or COUNTER.
 - (2) Bit data can be accessed even if the DM Area is specified for the non-retained area.

Retained Area

None

Timer Area

Item	Contents
Allocated variables	Variables with TIMER set as the data type.
Applicable areas	T (Timer Area) Timer Flag (1 bit) or timer PVs (16 bits)
Allocated words (default)	T206 to T255 Timer Flag (1 bit) or timer PVs (16 bits)

Counter Area

Item	Contents
Allocated variables	Variables with COUNTER set as the data type.

Item	Contents
Applicable areas	C (Counter Area) Counter Flag (1 bit) or counter PVs (16 bits)
Allocated words (default)	C206 to C255 Counter Flag (1 bit) or counter PVs (16 bits)

Accessing Function Block Instance Area from the User Program

If the user program contains an instruction to access the function block instance area, an error will be displayed in the Compile Tab of the Output Window of CX-Programmer if the following operations are attempted.

- Attempting to write during online editing (writing not possible)
- Executing program check (Selecting *Compile* from the Program Menu or *Compile All PLC Programs* from the PLC Menu)

Example: If W0 to W511 is specified as the non-retained area of the function block instance area and W0.00 is used in the ladder program, an error will occur when compiling and be displayed as “ERROR: [omitted]...- Address - W0.00 is reserved for Function Block use].

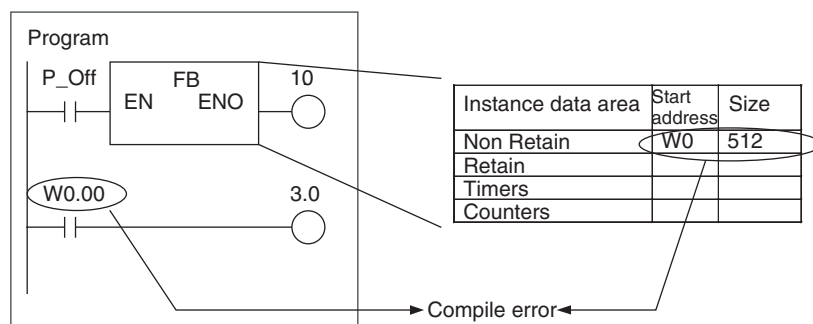

Note The allocations in the function block instance area for variables are automatically reallocated when a variable is added or deleted. A single instance requires addresses in sequence, however, so if addresses in sequence cannot be obtained, all variables will be allocated different addresses. As a result, unused areas will be created. If this occurs, execute the optimization operation to effectively use the allocated areas and remove the unused areas.

Comments

A comment of up to 30,000 characters long can be entered.

Creating Multiple Instances

Calling the Same Instance

A single instance can be called from multiple locations. In this case, the internal variables will be shared.

Making Multiple Instances

Multiple instances can be created from a single function block definition. In this case, the values of internal variables will be different in each instance.

Example: Counting Product A and Product B

Prepare a function block definition called Down Counter (CTD) and set up counters for product A and product B. There are two types of programs, one for automatic operation and another for manual operation. The user can switch to the appropriate mode of operation.

In this case, multiple instances will be created from a single function block. The same instance must be called from multiple locations.

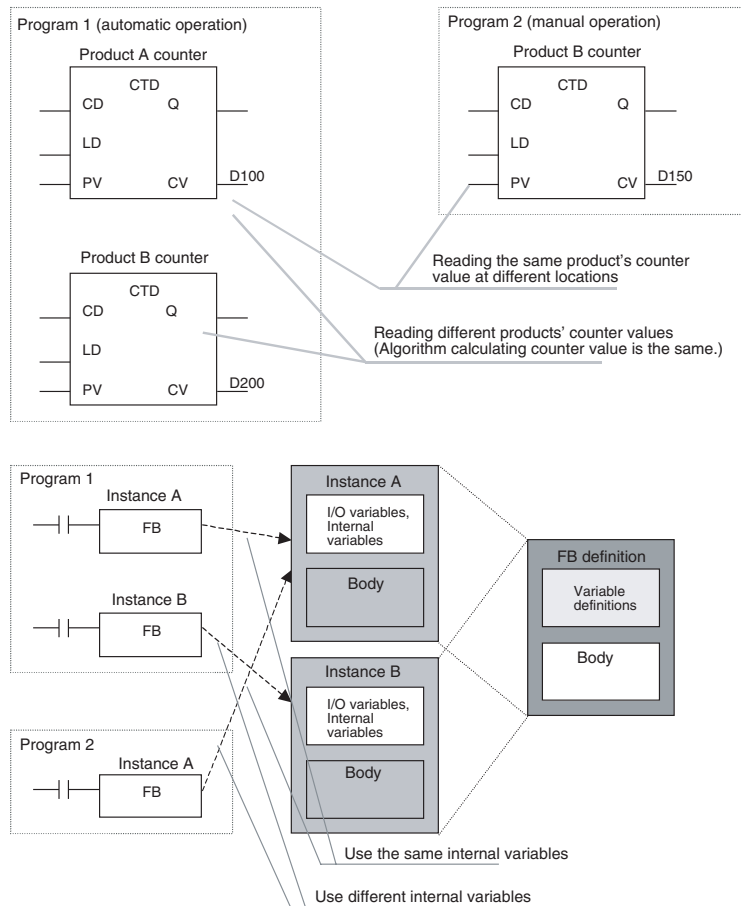

2-3-2 Parameter Specifications

The data that can be set by the user in the input parameters and output parameters is as follows:

Item	Applicable data
Input parameters	Values (See note 1.), addresses, and program symbols (global symbols and local symbols) (See note 2.) Note The data that is passed to the input variable from the parameter is the actual value of the size of the input variable data. (An address itself will not be passed even if an address is set in the parameter.) Note Input parameters must be set. If even one input parameter has not been set, a fatal error will occur and the input parameters will not be transferred to the actual PLC.
Output parameters	Addresses, program symbols (global symbols, local symbols) (See note 2.)
Input-output parameters	Addresses, program symbols (global symbols, local symbols)

Note (1) The following table shows the methods for inputting values in parameters.

Input variable data type	Contents	Size	Parameter value input method	Setting range
BOOL	Bit data	1 bit	P_Off, P_On	0 (FALSE), 1 (TRUE)

Input variable data type	Contents	Size	Parameter value input method	Setting range
INT	Integer	16 bits	Positive value: & or + followed by integer Negative value: – followed by integer	–32,768 to 32,767
DINT	Double integer	32 bits		–2,147,483,648 to 2,147,483,647
LINT	Long (8-byte) integer	64 bits	Positive value: & or + followed by integer Negative value: – followed by integer	–9,223,372,036,854,775,808 to 9,223,372,036,854,775,807
UINT	Unsigned integer	16 bits		&0 to 65,535
UDINT	Unsigned double integer	32 bits		&0 to 4,294,967,295
ULINT	Unsigned long (8-byte) integer	64 bits		&0 to 18,446,744,073,709,551,615
REAL	Real number	32 bits	Positive value: & or + followed by real number (with decimal point) Negative value: – followed by real number (with decimal point)	–3.402823 × 10 ³⁸ to –1.175494 × 10 ^{–38} , 0, 1.175494 × 10 ^{–38} to 3.402823 × 10 ³⁸
LREAL	Long real number	64 bits		–1.79769313486232 × 10 ³⁰⁸ to –2.22507385850720 × 10 ^{–308} , 0, 2.22507385850720 × 10 ^{–308} , 1.79769313486232 × 10 ³⁰⁸
WORD	16-bit data	16 bits	# followed by hexadecimal number (4 digits max.) & or + followed by decimal number	#0000 to FFFF or &0 to 65,535
DWORD	32-bit data	32 bits	# followed by hexadecimal number (8 digits max.) & or + followed by decimal number	#00000000 to FFFFFFFF or &0 to 4,294,967,295
LWORD	64-bit data	64 bits	# followed by hexadecimal number (16 digits max.) & or + followed by decimal number	#0000000000000000 to FFFFFFFFFFFFFFFF or &0 to 18,446,744,073,709,551,615

(2) The size of function block input variables and output variables must match the size of program symbols (global and local), as shown in the following table.

Size	Function block variable data type	Program symbol (global, local) data type
1 bit	BOOL	BOOL
16 bits	INT, UINT, WORD	INT, UINT, UINT BCD, WORD
32 bits	DINT, UDINT, REAL, DWORD	DINT, UDINT, UDINT BCD, REAL, DWORD
64 bits	LINT, ULINT, LREAL, LWORD	LINT, ULINT, ULINT BCD, LREAL, LWORD
More than 1 bit	Non-boolean	CHANNEL, NUMBER (see note)

Note The program symbol NUMBER can be set only in the input parameters. The value that is input must be within the size range for the function block variable data type.

2-3-3 Operating Specifications

Calling Instances

The user can call an instance from any location. The instance will be executed when the input to EN is ON.

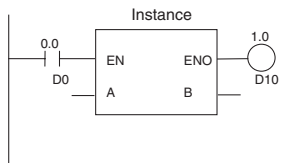

- In this case, the input to EN is bit 0.0 at the left of the diagram.
- When the input to EN is ON, the instance is executed and the execution results are reflected in bit 1.0 and word D10.
 - When the input to EN is OFF, the instance is not executed, bit 1.0 is turned OFF, and the content of D10 is not changed.

Operation when the Instance Is Executed

The system calls a function block when the input to the function block's EN input variable is ON. When the function block is called, the system generates the instance's variables and copies the algorithm registered in the function block. The instance is then executed.

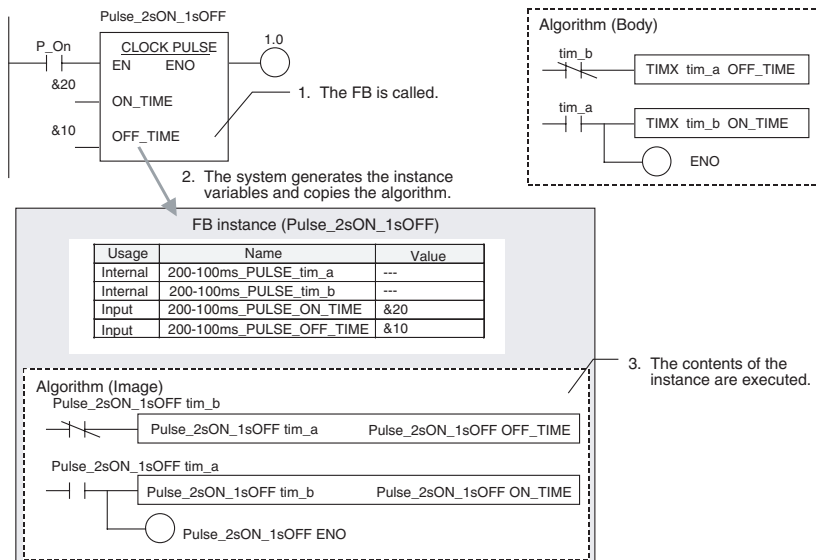

The order of execution is as follows:

1. Read data from parameters to input variables.
2. Execute the algorithm.
3. Write data from output variables to parameters.

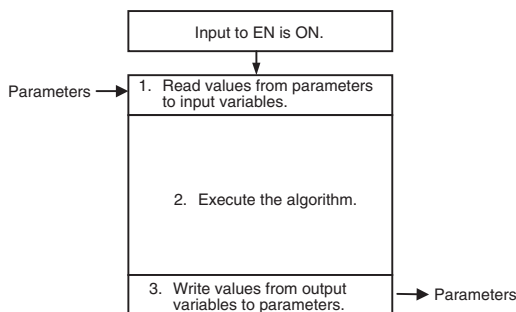

Data cannot be exchanged with parameters in the algorithm itself. In addition, if an output variable is not changed by the execution of the algorithm, the output parameter will retain its previous value.

Operation when the Instance Is Not Executed

When the input to the function block's EN input variable is OFF, the function block is not called, so the internal variables of the instance do not change (values are retained). In the same way the output variables do not change when EN is OFF (values are retained).

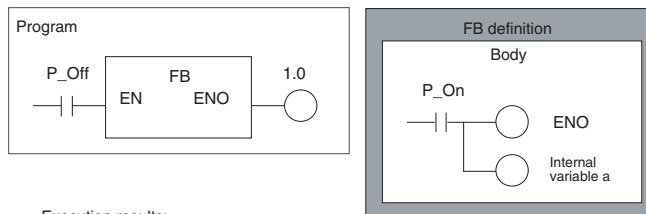

Execution results:
Output variable 1.0 is turned OFF, but internal variable a retains its previous value.

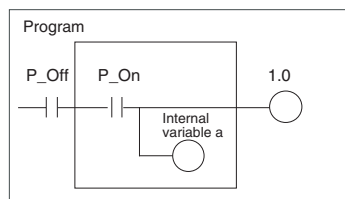

If the programming were entered directly into the program instead of in a function block definition, both bit 1.0 and variable a would be turned OFF.

Caution An instance will not be executed while its EN input variable is OFF, so Differentiation and Timer instructions will not be initialized while EN is OFF. If you use Differentiation or Timer instructions inside a function block, use the Always ON Flag (P_On) for the EN input condition. Also, make sure that the Always ON Flag is not made ineffective by interlock instructions, jump instructions, or subroutine instructions.

Nesting

With CX-Programmer Ver. 6.0 and later versions, a function block can be called from another function block, i.e., nesting is supported. Function blocks can be nested up to 8 levels (including the function block called from the program).

The calling function block and called function block can be either ST language, ladder diagram, or either combination of the two.

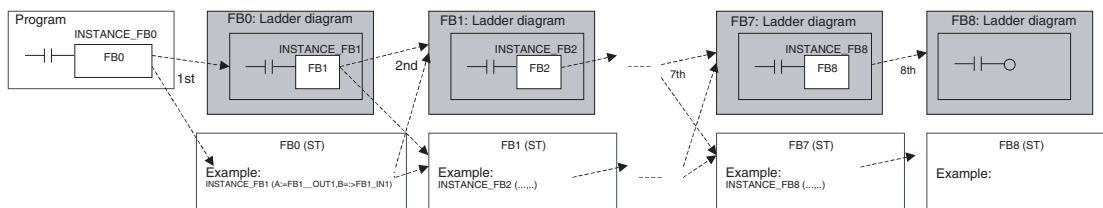

"INSTANCE_FB1," "INSTANCE_FB2," etc., are the FUNCTION BLOCK data type instance names.
Note: Any combination of ladder diagrams and structured text programming can be used between the called and the calling function block.

The function block nesting levels can also be displayed in a directory tree format with the FB Instance Viewer function.

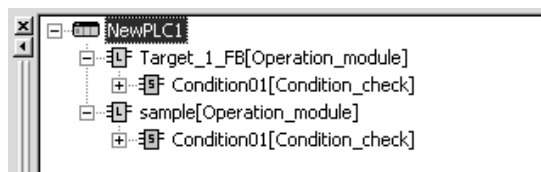

The nested function blocks' function block definitions are included in the function block library file (.cxf) containing the calling function block's definitions.

2-4 Programming Restrictions

2-4-1 Ladder Programming Restrictions

There are some restrictions on instructions used in ladder programs.

Instructions Prohibited in Function Block Definitions

Refer to the *Programmable Controllers Instructions Reference Manual* (Cat. No. W474)

AT Setting Restrictions (Unsupported Data Areas)

Addresses in the following areas cannot be used for AT settings.

- Index Registers (neither indirect nor direct addressing is supported) and Data Registers

Note Input the address directly, not the AT setting.

- Indirect addressing of DM or EM Area addresses (Neither binary-mode nor BCD-mode indirect addressing is supported.)

Direct Addressing of I/O Memory in Instruction Operands

- Addresses, not variables, can be directly input in Index Registers (both indirect and direct addressing) and Data Registers.

The following values can be input in instruction operands:

Direct addressing: IR0 to IR15; Indirect addressing: ,IR0 to ,IR15; Constant offset (example): +5,IR0; DR offset: DR0,IR0; Auto-increment: ,IR0++; Auto-decrement: --,IR0

- Direct addressing in instruction operands is not supported for any other areas in I/O memory.

Restrictions for Input Variables, Output Variables, and Input-Output Variables (Unsupported Data Areas)

Addresses in the following data areas cannot be used as parameters for input variables, output variables, and input-output variables.

- Index Registers (neither indirect nor direct addressing is supported) and Data Registers
- Indirect addressing of DM or EM Area addresses (Neither binary-mode nor BCD-mode indirect addressing is supported.)

Interlock Restrictions

When a function block is called from an interlocked program section, the contents of the function block definition will not be executed. The interlocked function block will behave just like an interlocked subroutine.

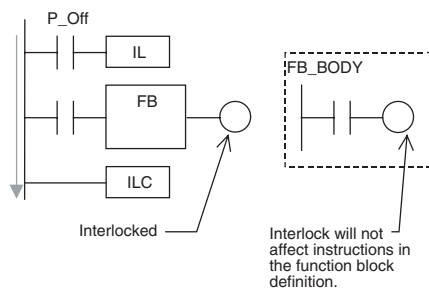

Differentiation Instructions in Function Block Definitions

An instance will not be executed while its EN input variable is OFF, so the following precautions are essential when using a Differentiation Instruction in a function block definition. (Differentiation Instructions include DIFU, DIFD, and any instruction with an @ or % prefix.)

- As long as the instance's EN input variable is OFF, the execution condition will retain its previous status (the last status when the EN input variable was ON) and the Differentiation Instruction will not operate.

- When the instance's EN input variable goes ON, the present execution condition status will not be compared to the last cycle's status. The present execution condition will be compared to the last condition when the EN input variable was ON, so the Differentiation Instruction will not operate properly. (If the EN input variable remains ON, the Differentiation Instruction will operate properly when the next rising edge or falling edge occurs.)

Example:

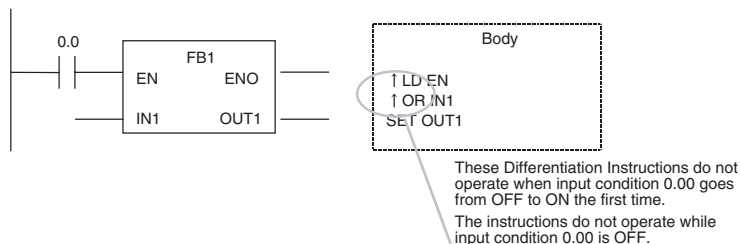

If Differentiation Instructions are being used, always use the Always ON Flag (P_On) for the EN input condition and include the instruction's input condition within the function block definition.

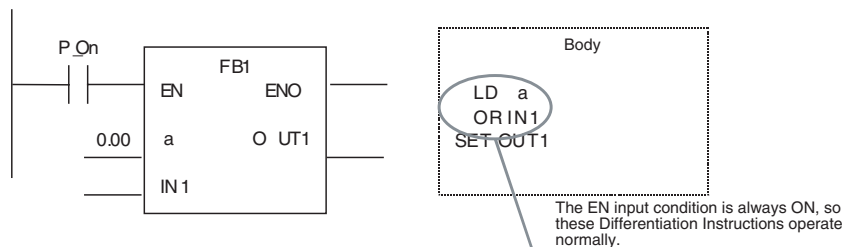

- Input a decimal numerical value after “#” when specifying the first operand of the following instructions.
MILH(517), MILR(518), MILC(519), DIM(631), MSKS(690), MSKR(692), CLI(691), FAL(006), FALS(007), TKON(820), TKOF(821)
Note “&” is not supported.
- CNR(545), CNRX(547) (RESET TIMER/COUNTER) instructions cannot be used to reset multiple timers and counters within a function block at the same time.
Always specify the same variable for the first operand (timer/counter number 1) and second operand (timer/counter number 2). Different variables cannot be specified for the first and second operand.

Timer Instructions in Function Block Definitions

An instance will not be executed while its EN input variable is OFF, so the following precautions are essential when using a Timer Instruction in a function block definition.

The Timer Instruction will not be initialized even though the instance's EN input variable goes OFF. Consequently, the timer's Completion Flag will not be turned OFF if the EN input variable goes OFF after the timer started operating.

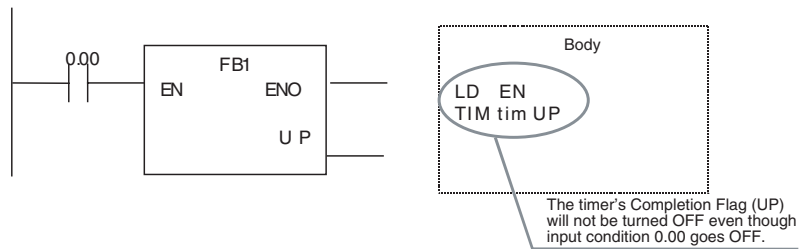

If Timer Instructions are being used, always use the Always ON Flag (P_On) for the EN input condition and include the instruction's input condition within the function block definition.

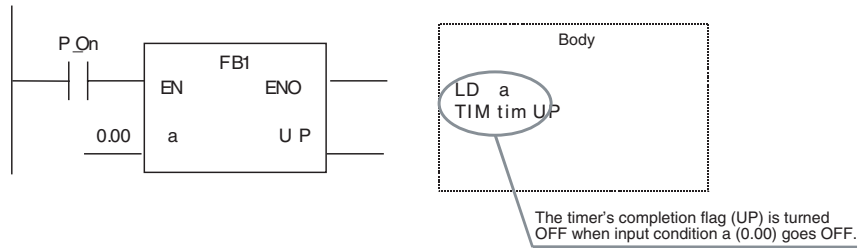

- If the same instance containing a timer is used in multiple locations at the same time, the timer will be duplicated.

2-4-2 ST Programming Restrictions

Restrictions when Using ST Language in Function Blocks

- Only the following statements and operators are supported.
 - Assignment statements
 - Selection statements (CASE and IF statements)
 - Iteration statements (FOR, WHILE, REPEAT, and EXIT statements)
 - RETURN statements
 - Function block calling statements
 - Arithmetic operators
 - Logical operators
 - Comparison operators
 - Numerical functions
 - Arithmetic functions
 - Standard text string functions
 - Numeric text string functions
 - OMRON expansion functions
 - Comments

For further details, refer to *SECTION 5 Structured Text (ST) Language Specifications* in *Part 2: Structured Text (ST)*.

2-4-3 Programming Restrictions

Restrictions in Locating Function Block Instances

No Branches to the Left of the Instance

Branches are not allowed on the left side of the instance. Branches are allowed on the right side.

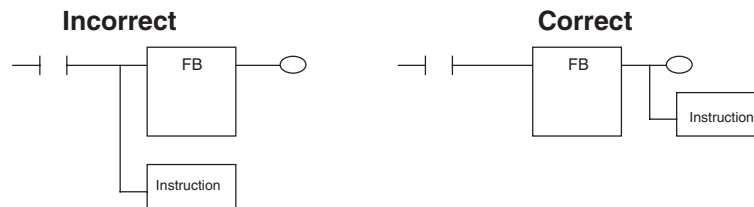

Only One Instance per Rung

A program rung cannot have more than one instance.

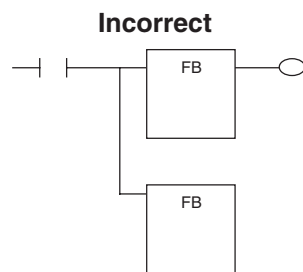

No Function Block Connections

A function block's input cannot be connected to another function block's output. In this case, a variable must be registered to transfer the execution status from the first function block's output to the second function block's input.

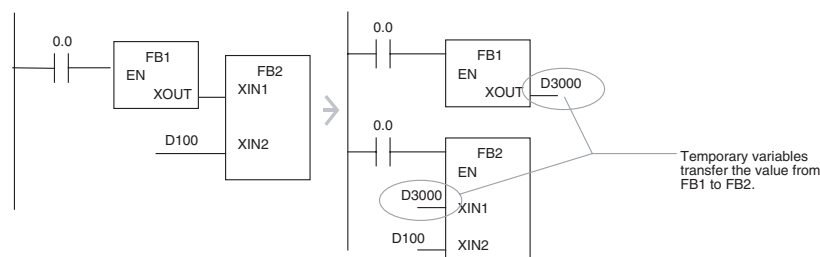

Downloading in Task Units

Tasks including function blocks cannot be downloaded in task units, but uploading is possible.

Programming Console Displays

When a user program created with the CX-Programmer is downloaded to the CPU Unit and read by a Programming Console, the instances will all be displayed as question marks. (The instance names will not be displayed.)

Online Editing Restrictions

The following online editing operations cannot be performed on the user program in the CPU Unit.

- Changing or deleting function block definitions (variable table or algorithm)
- Inserting instances or changing instance names

Note The instance's I/O parameters can be changed, instances can be deleted, and instructions outside of an instance can be changed.

Error-related Restrictions

If a fatal error occurs in the CPU Unit while a function block definition is being executed, ladder program execution will stop at the point where the error occurred.

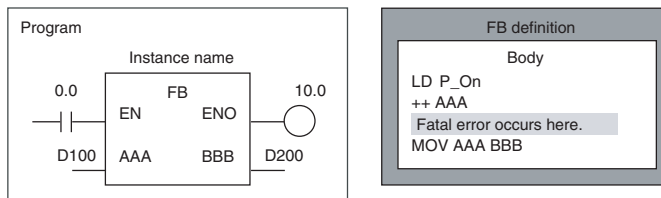

In this case, the MOV AAA BBB instruction will not be executed and output variable D200 will retain the same value that it had before the function block was executed.

Prohibiting Access to FB Instance Areas

To use a function block, the system requires memory areas to store the instance's internal variables, input variables, output variables, and input-output variables.

CJ2-series CPU Units

Function block instance area	Initial value of start address	Initial value of size	Allowed data areas
Non-retained	H512	896	CIO, WR, HR, DM, EM (See note.)
Retained	H1408	128	HR, DM, EM (See note.)
Timer	T3072	1024	TIM
Counter	C3072	1024	CNT

Note Force-setting/resetting is enabled when the following EM banks are specified:

CJ2H-CPU64(-EIP)/-CPU65(-EIP)	EM bank 3
CJ2H-CPU66(-EIP)	EM banks 6 to 9
CJ2H-CPU67(-EIP)	EM banks 7 to E
CJ2H-CPU68(-EIP)	EM banks 11 to 18

CS/CJ-series CPU Units Ver. 3.0 or Later, and NSJ Controllers

Function block instance area	Initial value of start address	Initial value of size	Allowed data areas
Non-retained	H512	896	CIO, WR, HR, DM, EM
Retained	H1408	128	HR, DM, EM
Timer	T3072	1,024	TIM
Counter	C3072	1,024	CNT

FQM1 Flexible Motion Controllers

FB Instance Area	Default value			Applicable memory areas
	Start address	End address	Size	
Non Retain	5000	5999	1000	CIO, WR, DM
Retain	None			
Timers	T206	T255	50	TIM
Counters	C206	C255	50	CNT

CP-series CPU Units

Function block instance area	Initial value of start address	Initial value of size	Allowed data areas
Non-retained	H512	896	CIO, WR, HR, DM (See note.)
Retained	H1408	128	HR, DM (See note.)
Timer	T3072	1024	TIM
Counter	C3072	1024	CNT

Note DM area of CP1L-L

Address	CP1L-L
D0000 to D9999	Provided
D10000 to D31999	Not Provided
D32000 to D32767	Provided

If there is an instruction in the user program that accesses an address in an FB instance area, the CX-Programmer will output an error in the following cases.

- When a program check is performed by the user by selecting **Program - Compile** from the Program Menu or **Compile All Programs** from the PLC Menu.
- When attempting to write the program through online editing (writing is not possible).

Restriction on Specifying Data Structures as Parameters When Nesting Function Blocks

When calling another function block from within a function block (i.e., when nesting function blocks), you cannot specify individual members of the data structure as parameters for the nested function block. You must specify the entire data structure.

Restriction on the Address Incremental Copy Function

When a function block is used in the selected section, the Address Incremental Copy function cannot be used.

2-5 Function Block Applications Guidelines

This section provides guidelines for using function blocks with the CX-Programmer.

2-5-1 Deciding on Variable Data Types

Integer Data Types (1, 2, or 4-word Data)

Use the following data types when handling single numbers in 1, 2, or 4-word units.

- INT and UINT
- DINT and DINT
- LINT and ULINT

Note Use signed integers if the numbers being used will fit in the range.

Word Data Types (1, 2, or 4-word Data)

Use the following data types when handling groups of data (non-numeric data) in 1, 2, or 4-word units.

- WORD
- DWORD
- LWORD

Text String Data

Use the following data type for text string data.

- STRING

2-5-2 Determining Variable Types (Inputs, Outputs, In Out, Externals, and Internals)

Using Input Variable to Change Passed Values

To paste a function block into the program and then change the value (not the address itself) to be passed to the function block for each instance, use an input variable.

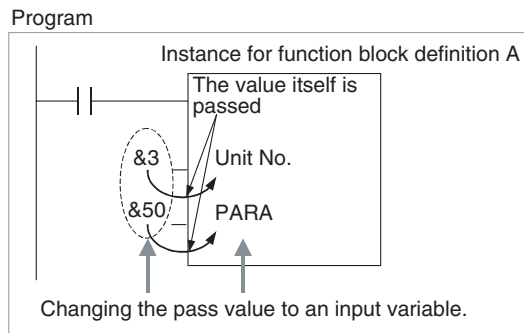

The following two restrictions apply.

- An address can be set in an input parameter, but an address itself cannot be passed to an input variable (even if an address is set in the input parameter, the value for the size of the input variable data type is passed to the function block). Therefore, when the first or last of multiple words is specified in the instruction operand within the function block, an input variable cannot be used for the operand. Specify either to use internal variables with AT settings, specify the first or last element in an input-output array variable (set the input parameter to the first address) (CX-Programmer version 7.0 or higher), specify the first or last element in an internal array variable, or use an external variable (as described in 2-5-4 Array Settings for Input-Output Variables and Internal Variables).

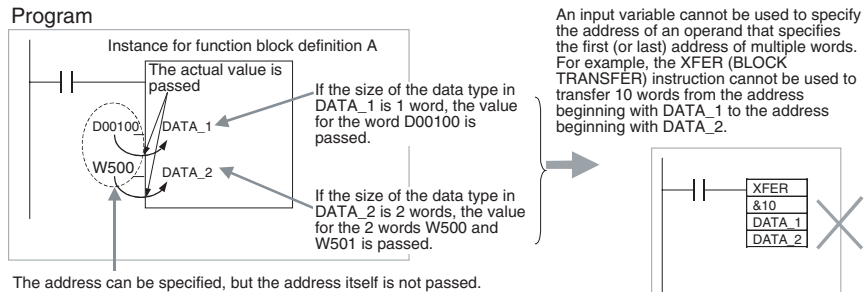

- Values are passed in a batch from the input parameters to the input variables before algorithm execution (not at the same time as the instruction in the algorithm is executed). Therefore, to pass the value from a parameter to an input variable when the instruction in the function block algorithm is executed, use an internal variable or external variable instead of an input variable.

Passing Values from or Monitoring Output Variables

To paste into the program and then pass values outside (the program) from the function block for each instance, or monitor values, use output variables.

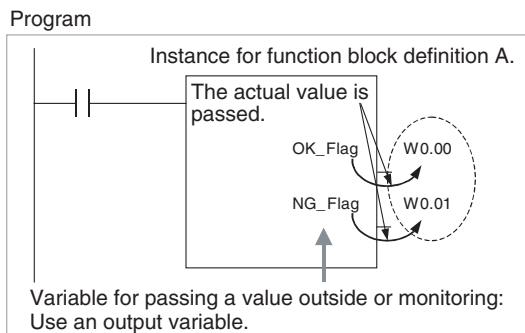

The following restrictions apply.

- Values are passed from output variables to output parameters all at once after algorithm execution.

Input-Output Variables to Return FB Processing Results from Values Passed from Input Parameters to Output Parameters

An input-output variable can be used to implement the functionality of both input and output parameters. Internal operation involves passing the address set for the parameter to the input-output variable, but the use of the input-output variable inside the function block is the same as that of other variables.

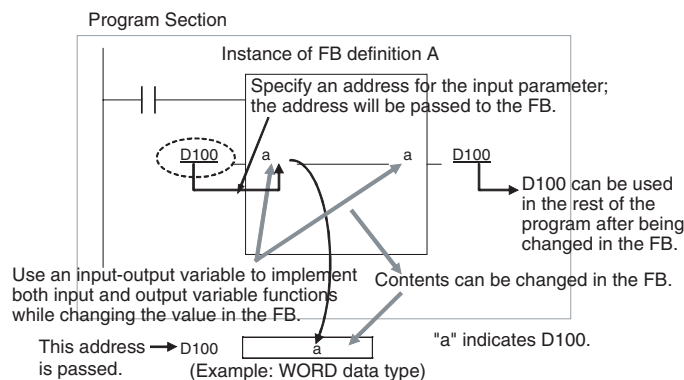

Input-Output Array Variables to Pass Large Amounts of Data

Input-output variables can be set as arrays (which is not possible for input variables and output variables). If an input-output array variable is used, a range of addresses of the specified size starting from the address set for the input parameter can be used inside the FB. Input-output variables should thus be used when it's necessary to pass large quantities of data to a function block.

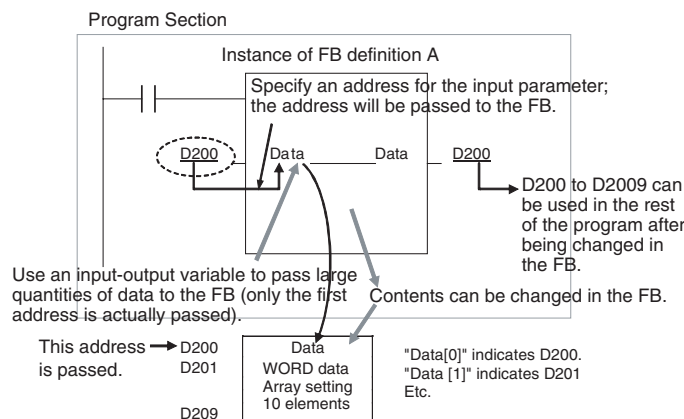

**External Variables:
Condition Flags, Clock
Pulses, Auxiliary Area
Bits, Global Symbols in
Program**

Condition Flags (e.g., Always ON Flag, Equals Flag), Clock Pulses (e.g., 1.0 second clock pulse bit), pre-registered Auxiliary Area Bits (e.g., First Cycle Flag), and global symbols used in the program are all external variables defined by the system.

**Internal Variables:
Internally Allocated
Variables and Variables
Requiring AT Settings**

Variables that are not specified as Inputs, Outputs, In Out, or Externals are Internals. Internal variables include variables with internally allocated addresses and variables requiring addresses with AT settings (e.g., I/O allocation addresses, addresses specially allocated for Special I/O Units). Variables requiring array settings include input-output variables and internal variables. For details on conditions requiring AT settings or array settings, refer to 2-5-3 *AT Settings for Internal Variables*, and 2-5-4 *Array Settings for Input-Output Variables and Internal Variables*.

2-5-3 AT Settings for Internal Variables

Always specify AT settings for internal variables under the following conditions.

- When addresses allocated to Basic I/O Units, Special I/O Units, or CPU Bus Units are used and these addresses are registered to global symbols that cannot be specified as external variables (e.g., data set for global symbols is unstable).

Note The method for specifying Index Registers for Special I/O Unit allocation addresses requires AT settings to be specified for the first address of the allocation area. (For details, refer to 2-5-5 *Specifying Addresses Allocated to Special I/O Units*.)

- When Auxiliary Area bits that are not pre-registered to external variables are used, and these bits are registered to global symbols that are not specified as external variables.
- When setting the first destination word at the remote node for SEND(090) and the first source word at the local node for RECV(098).
- When the instruction operand specifies the first or last of multiple words, and an array variable cannot be specified for the operand (e.g., the number of array elements cannot be specified).

2-5-4 Array Settings for Input-Output Variables and Internal Variables

**Using Array Variables
to Specify First or Last
Word in Multiword
Operands**

When specifying the first or last of a range of words in an instruction operand (see note), the instruction operates according to the address after AT specification or internal allocation. (Therefore, the variable data type and number of elements for the variable are unrelated to the operation of the instruction.) Always specify a variable with an AT setting or an array variable with a number of elements that matches the data size to be processed by the instruction.

Note Some examples are the first source word or first destination word of the XFER(070) (BLOCK TRANSFER) instruction, the first source word for SEND(090), or control data for applicable instructions.

For details, refer to 2-6 *Precautions for Instructions with Operands Specifying the First or Last of Multiple Words*. Use the following method to specify an array variable.

When using input-output variables, set the input parameter to the first address of multiple words.

Use the following procedure for internal variables.

- 1,2,3...**
1. Prepare an internal array variable with the required number of elements.

Note Make sure that the data size to be processed by the instruction is the same as the number of elements. For details on the data sizes processed by each instruction, refer to *2-7 Instruction Support and Operand Restrictions*.

2. Set the data in each of the array elements using the MOV instruction in the function block definition.
3. Specify the first (or last) element of the array variable for the operand. This enables specification of the first (or last) address in a range of words.

Examples are provided below.

Handling a Single String of Data in Multiple Words

In this example, an array contains the directory and filename (operand S2) for an FREAD instruction.

- Variable Table
Input-output variable or internal variable, data type = WORD, array setting with 10 elements, variable names = filename[0] to filename[9]
- Data Settings and Internal Function Block Processing
 - Input-output variables:
Set the input parameter to the address of the first word in the data (example: D100). The data (#5C31, #3233, #0000, etc.) is set in D100 to D109 in advance from the main user program.

FREAD (omitted) (omitted) read_num[0] (omitted) ← Specify the first element of the array in the instruction operand.

- Internal variables:
Use ladder programming within the function block to set data into the array.

```
MOV #5C31 file_name[0] }
MOV #3233 file_name[1] } ← Set data in each array element.
MOV #0000 file_name[2] }
FREAD (omitted) (omitted) file_name[0] (omitted) ← Specify the first element
of the array in the instruction
operand.
```

Handling Control Data in Multiple Words

In this example, an array contains the number of words and first source word (operand S1) for an FREAD instruction.

- Variable table
Input-output variable or internal variable, data type = DINT, array setting with 3 elements, variable names = read_num[0] to read_num[9]
- Data Settings and Internal Function Block Processing
 - Input-output variables:
Set the input parameter to the address of the first word in the data (example: D200). The data is set in D200 to D205 in advance from the main user program.

FREAD (omitted) read_num[0] (omitted) (omitted) ← Specify the first element of the array in the instruction operand.

- Internal variables:
Use ladder programming within the function block to set data into the array.

- Ladder Programming

```
MOVL &100 read_num[0] (No_of_words) }
MOVL &0 read_num[1] (1st_source_word) } ← Set data in each array element.
FREAD (omitted) read_num[0] (omitted) (omitted) ← Specify the first element of the array
in the instruction operand.
```

Handling a Block of Read Data in Multiple Words

The allowed amount of read data must be determined in advance and an array must be prepared that can handle the maximum amount of data. In this example, an array receives the FREAD instruction's read data (operand D).

- Variable table
Input-output variable or internal variable, data type = WORD, array setting with 100 elements, variable names = read_data[0] to read_data[99]
- Data Settings and Internal Function Block Processing
 - Input-output variables:
Set the input parameter to the address of the first word in the read data (example: D200).

FREAD (omitted) (omitted) (omitted) read_data[0]

- Internal variables:

FREAD (omitted) (omitted) (omitted) read_data[0]

Division Using Integer Array Variables (Ladder Programming Only)

A two-element array can be used to store the result from a ladder program's SIGNED BINARY DIVIDE (/) instruction. The result from the instruction is D (quotient) and D+1 (remainder). This method can be used to obtain the remainder from a division operation in ladder programming.

- Note** When ST language is used, it isn't necessary to use an array to receive the result of a division operation. Also, the remainder can't be calculated directly in ST language. The remainder must be calculated as follows:
Remainder = Dividend – (Divisor × Quotient)

2-5-5 Specifying Addresses Allocated to Special I/O Units

Use Index Registers IR0 to IR15 (indirectly specified constant offset) to specify addresses allocated to Special I/O Units based on the value passed for the unit number as an input parameter within the function block definition as shown in the following examples.

- Note** For details on using Index Registers in function blocks, refer to *2-5-6 Using Index Registers*.

Examples

Example 1: Specifying the CIO Area within a Function Block (Same for DM Area)

Special I/O Units

Variables: Use the unit number as an input variable, and specifying the first allocation address as an internal variable with the AT set to CIO 2000.

Programs: Use the following procedure.

- 1,2,3...**
1. Multiply the unit number (input variable) by &10, and create the unit number offset (internal variable, DINT data type).
 2. Use the MOV(R)560 (MOVE TO REGISTER) instruction to store the real I/O memory address for the first allocation address (internal variable, AT = CIO 2000) in the Index Register (e.g., IR0).
 3. Add the unit number offset to the real I/O memory address within the Index Register (e.g., IR0).

Example 2: Specifying the Designated Bit in the CIO Area (e.g., CIO Word n+a, Bit b)

Programs: Use either of the following methods.

- Word addresses: Specify the constant offset of the Index Register using an indirect specification (e.g., +a,IR0).
- Bit addresses: Specify an instruction that can specify a bit address within a word (e.g., &b in second operand of SETB instruction when writing and TST instruction when reading).

Example: Special I/O Units

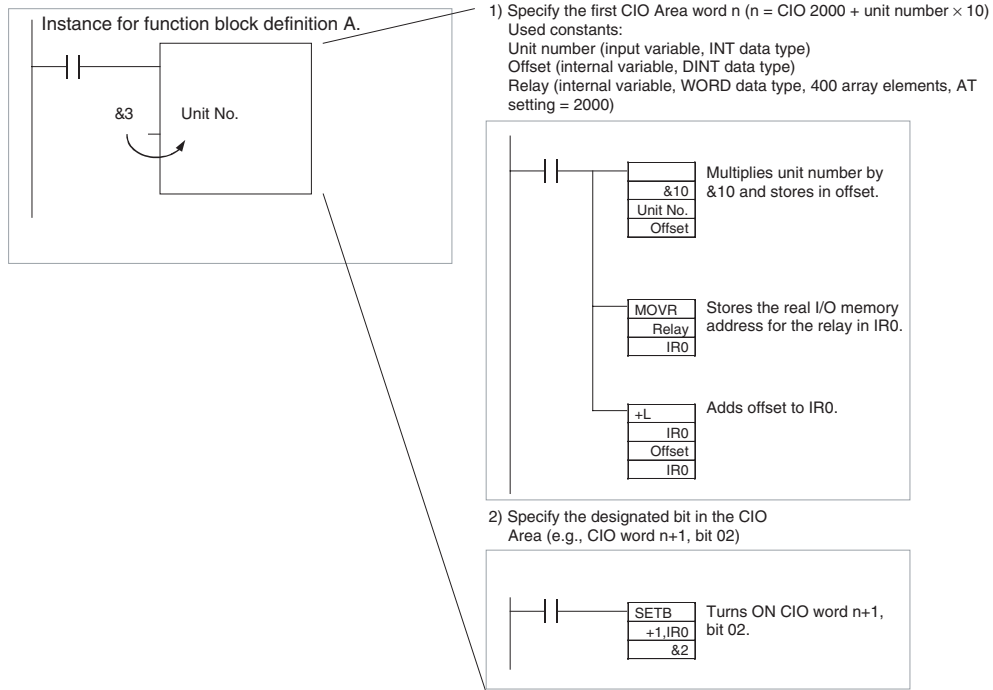

2-5-6 Using Index Registers

Index Registers IR0 to IR15 function as pointers for specifying I/O memory addresses. These Index Registers can be used within function blocks to directly specify addresses using IR0 to IR15 and not the variable names (Index Register direct specification: IR0 to IR15; Index Register indirect specification: ,IR0 to ,IR15)

Note After storing the real I/O memory addresses in the Index Registers using the MOVR(560) instruction, Index Registers can be indirectly specified using general instructions. This enables all I/O memory areas to be specified dynamically.

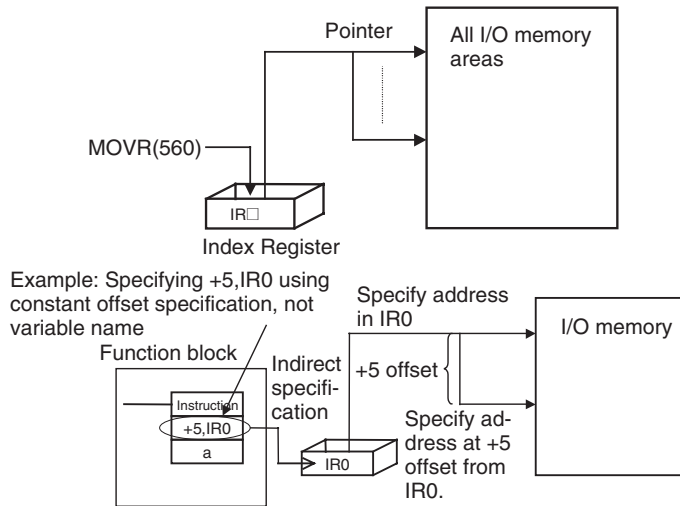

- Note**
- (1) When Index Registers IR0 to IR15 are used within function blocks, using the same Index Register within other function blocks or in the program outside of function blocks will create competition between the two instances and the program will not execute properly. Therefore, when using Index Registers (IR0 to IR15), always save the value of the Index Register at the point when the function block starts (or before the Index Register is used), and when the function block is completed (or after the Index Register has been used), incorporate processing in the program to return the Index Register to the saved value.

Example: Starting function block (or before using Index Register):
 1. Save the value of IR (e.g., A).

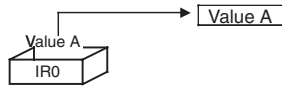

Within function block:
 2. Use IR.

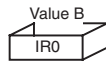

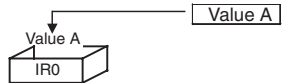

At start of function block (or before Index Register is used):
 3. Return IR to saved value (e.g., A)

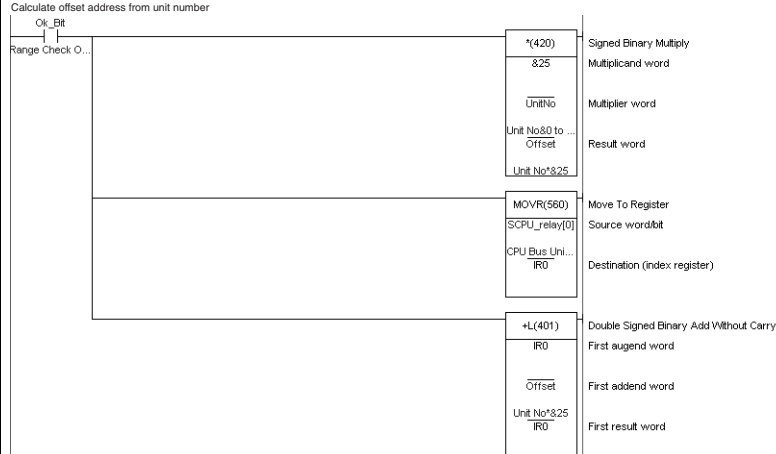

- (2) Always set the value before using Index Registers. Operation will not be stable if Index Registers are used without the values being set.

Application Examples The following examples are for using Index Registers IR0 to IR15 within function blocks.

Example	Details
<p>Saving the Index Register Value before Using Index Register</p> <p>Store IR0 temporarily in backup buffer</p> 	<p>When Index Registers are used within this function block, processing to save the Index Register value is performed when the function starts (or before the Index Register is used) to enable the value to be returned to the original Index Register value after the function block is completed (or after the Index Register is used).</p> <p>Example: Save the contents of Index Register IR0 by storing it in <i>SaveIR[0]</i> (internal variable, data type DINT, 1 array element).</p>
<p>Using Index Registers</p> <p>1) Setting the value in the Index Register. (Stores the real I/O memory address for first CIO Area word n.)</p> <p>Calculate offset address from unit number</p> 	<p>Example: The real I/O memory address for the first word of CIO 1500 + unit number × 25 allocated in the CPU Bus Unit allocation area based on the CPU Bus Unit's unit number (&0 to &15) passed from the function block is stored in IR0.</p> <p>Procedure:</p> <p>Assumes that unit numbers &0 to &15 have already been input (from outside the function block) in <i>UnitNo</i> (input variables, INT data type).</p> <ol style="list-style-type: none"> 1. Multiple <i>UnitNo</i> by &25, and store in <i>Offset</i> (internal variable, DINT data type) 2. Store the real I/O memory address for <i>SCPU_Relay</i> (internal variable, WORD data type, (if required, specify the array as 400 elements (see note), AT setting = 1500)) in Index Register IR0. <p>Note Specifying an array for <i>SCPU_relay</i>, such as <i>SCPU_relay [2]</i>, for example, enables the address CIO 1500 + (<i>UnitNo</i> × &25) + 2 to be specified. This also applies in example 2 below.</p> <ol style="list-style-type: none"> 3. Increment the real I/O memory address in Index Register IR0 by the value for the variable <i>Offset</i> (variable <i>UnitNo</i> × &25).

Example	Details
<p>2) Specifying constant offset of Index Register (Specifying a bit between CIO n+0 to n+24)</p> 	<p>The real I/O memory address for CIO 1500 + (<i>UnitNo</i> × &25) is stored in Index Register IR0 by the processing in step 1 above. Therefore the word address is specified using the constant offset from IR0. For example, specifying +2,IR0 will specify CIO 1500 + (<i>UnitNo</i> × &25) + 2.</p> <p>Note CIO 1500 + (<i>UnitNo</i> × &25) + 2 can also be specified by specifying <i>SCPU_relay</i> [2] using the array setting with <i>SCPU_relay</i>.</p> <p>Specify bit addresses using instructions that can specify bit addresses within words (e.g., second operand of TST(350/351)/SETB(532) instructions).</p> <p>Example: Variable <i>NodeSelf_OK</i> turns ON when <i>NetCheck_OK</i> (internal variable, BOOL data type) is ON and bit 15 of the word at the +6 offset from IR0 (CIO 1500 + <i>UnitNo</i> × &25 +6) is ON.</p>
<p>Returning the Index Register to the Prior Value</p> 	<p>The Index Register returns to the original value after this function block is completed (or after the Index Register has been used).</p> <p>Example: The value for variable <i>SaveIR[0]</i> that was saved is stored in Index Register IR0, and the value is returned to the contents from when this function started (or prior to using the Index Register).</p>

2-6 Precautions for Instructions with Operands Specifying the First or Last of Multiple Words

When using ladder programming to create function blocks with instruction operands specifying the first or last of a range of words, the following precautions apply when specifying variables for the operand.

When the operand specifies the first or last word of multiple words, the instruction operates according to the internally allocated address for AT setting (or external variable setting). Therefore, the variable data type and number of array elements are unrelated to the operation of the instruction. Either specify a variable with an AT setting, or an array variable with a size that matches the data size to be processed by the instruction.

Note To specify the first or last of multiple words in an instruction operand, always specify a variable with AT setting (or an external variable), or a variable with the same size as the data size to be processed in the instruction. The following precautions apply.

- 1,2,3...**
1. If a non-array variable is specified without AT setting and without a matching data size, the CX-Programmer will output an error when compiling.
 2. The following precautions apply to when an array variable is specified.

Size to Be Processed in the Instruction Operand Is Fixed

Make sure that the number of elements in the array is the same as size to be processed by the instruction. Otherwise, the CX-Programmer will output an error when compiling.

Size to Be Processed in the Instruction Operand Is Not Fixed

Make sure that the number of elements in the array is the same or greater than the size specified by another operand.

Other Operand Specifying Size: Constant

The CX-Programmer outputs an error when compiling.

Other Operand Specifying Size: Variable

The CX-Programmer will not output an error when compiling (a warning message will be displayed) even if the number of elements in the array does not match the size specified in another operand (variable).

In particular, when the number of elements in the array is less than the size specified by another operand, (for example, when instruction processing size is 16 and the number of elements actually registered in the variable table is 10), the instruction will execute read/write processing in the areas exceeding the number of elements. (In this example, read/write processing will be executed for the next 6 words after the number of elements registered in the actual variable table.) If the same area is being used by another instruction (including internal variable allocations), unexpected operation may occur, which may result in a serious accident.

Do not use variables with a size that does not match the data size to be processed by the instruction in the operand specifying the first address (or last address) for a range of words. Always use either non-array variables data type with a size that is the same as the data size required by the instruction or array variable with the number of elements that is the same as the data size required by the instruction. Otherwise, the following errors will occur.

If the operand specifying the first address (or last address) of multiple words uses a non-array variable data type with a size that does not match the data size required by the instruction and an AT setting is also not used, the CX-Programmer will output a compile error.

Example: BLOCK TRANSFER(070) instruction: XFER W S D
 (W: Number of words, S: First source word; D: First destination word)
 When &10 is specified in W, variable *a* with data type WORD is specified in S, and variable *b* with data type WORD is specified in D: XFER &10 a b
 The XFER(070) instruction will transfer the data in the 10 words beginning from the automatically allocated address in variable *a* to the 10 words beginning with the automatically allocated address in variable *b*. Therefore, the CX-Programmer will output a compile error.

Non-array Variables without Matching Data Size and without AT Setting

Example: XFER &10 a b
 (variables a and b are WORD data types)

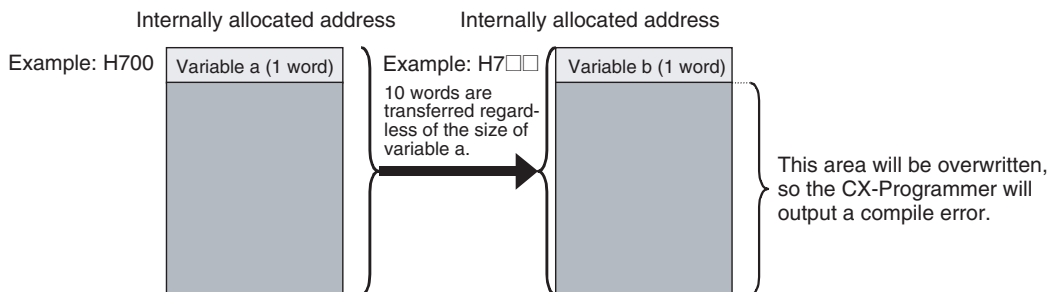

Array Variables

The result depends on the following conditions.

Size to Be Processed by Instruction Is Fixed

If the size to be processed by the instruction is a fixed operand, and this size does not match the number of array elements, the CX-Programmer will output a compile error.

Example: LINE TO COLUMN(064) instruction; COLM S D N

(S: Bit number, D: First destination word, N: Source word)

E.g., COLM a b[0] c

If an array for a WORD data type with 10 array elements is specified in D when it should be for 16 array elements, the CX-Programmer will output an error when compiling.

Size to Be Processed by Instruction Is Not Fixed

When the operand size to be processed by the instruction is not fixed (when the size is specified by another operand in the instruction), make sure that the number of array elements is the same or greater than the size specified in the other operand (i.e., size to be processed by the instruction).

Other Operand Specifying Size: Constant

The CX-Programmer will output an error when compiling.

Example: BLOCK TRANSFER: XFER W S D

(W: Number of words, S: First source word; D: First destination word)

When &20 is specified in W, array variable *a* with data type WORD and 10 elements is specified in S, and array variable *b* with data type WORD and 10 elements is specified in D:

XFER &20 a[0] b[0]

Even though the array variables *a*[0] and *b*[0] are both 10 words, the XFER(070) instruction will execute transfer processing for the 20 words specified in W. As a result, the XFER(070) instruction will perform read/write processing for the I/O memory area following the number of array elements that was allocated, as shown in the following diagram.

Therefore, if *a*[10 elements] is internally allocated words (e.g., H700 to H709), and *b*[10 elements] is internally allocated words (e.g., H800 to H809), XFER(070) will transfer data in words H700 to H719 to words H800 to H819. In this operation, if another internally allocated variable (e.g., *c*), is allocated words in H810 to H819, the words will be overwritten, causing unexpected operation to occur. To transfer 20 words, make sure that the number of elements is specified as 20 elements for both array variable *a* and *b*.

XFER &20 a[0] b[0]

Using a WORD data type with 10 elements for both variables *a* and *b*:

To transfer 20 words, be sure to specify 20 elements for both array variables *a* and *b*.

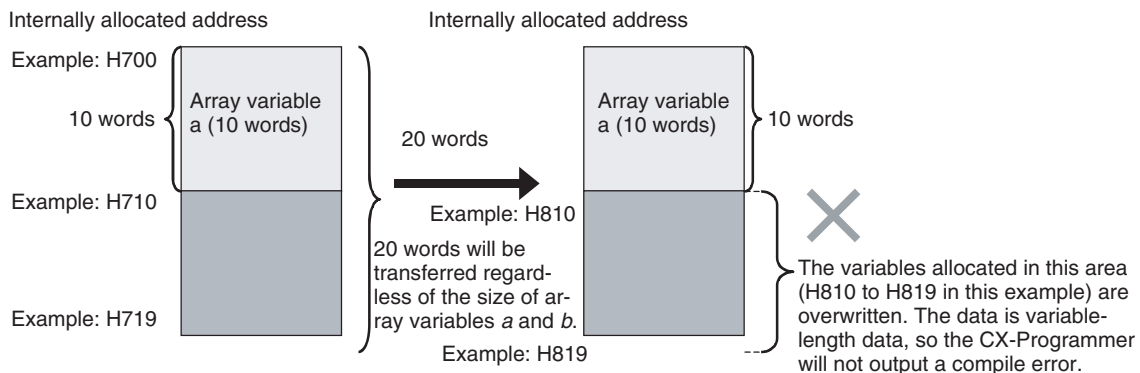

Other Operand Specifying Size: Variable

Even if the number of array elements does not match the size (i.e., size to be processed by the instruction) specified in another operand (variable), the CX-Programmer will not output an error when compiling. The instruction will be executed according to the size specified by the operand, regardless of the number of elements in the array variable.

Particularly if the number of elements in the array is less than the size (i.e., size to be processed by the instruction) specified by another operand (variable), other variables will be affected and unexpected operation may occur.

2-7 Instruction Support and Operand Restrictions

Instruction Support

Refer to the instruction help of the CX-Programmer or the command reference manual of your PLC for whether or not each instruction of the CS/CJ/NSJ-series CPU Units, CP-series CPU Units, and FQM1-series Units can be used.

Restrictions on Operands

- When you use any instruction that has operands specifying the first or last of multiple words, be sure to read the *Section 2-6 Precautions for Instructions with Operands Specifying the First or Last of Multiple Words* before using the instruction.
- When specifying the first or last word of multiple words in an instruction operand, input parameters cannot be used to pass data to or from variables. Use an AT setting or an input-output or internal variable array setting.
 - When you use an input-output variable array setting, set the first word for the input parameter.
 - When you use an internal variable array setting, prepare an array variable with the required number of elements, set the array data in the function block definition, and then specify the first or last element in the array variable for the operand.
- Use an AT setting variable for the operands for which an I/O memory address on a remote node in the network must be specified.

2-8 CPU Unit Function Block Specifications

The specifications of the functions blocks used in CS/CJ-series and CP-series CPU Units are given in the following tables. Refer to the other operation manuals for the CS/CJ Series and CP Series for other specifications.

2-8-1 Specifications

CJ2H CPU Units

Item		Specification				
Model		CJ2H-CPU68 (-EIP)	CJ2H-CPU67 (-EIP)	CJ2H-CPU66 (-EIP)	CJ2H-CPU65 (-EIP)	CJ2H-CPU64 (-EIP)
I/O points		2,560				
Program capacity (steps)		400K	250K	150K	100K	50K
Data memory		32K words (The DM and EM areas can be accessed in bit-units.)				
Extended Data Memory		32K words × 25 banks E0_00000 to E18_32767	32K words × 15 banks E0_00000 to EE_32767	32K words × 10 banks E0_00000 to E9_32767	32K words × 4 banks E0_00000 to E3_32767	32K words × 4 banks E0_00000 to E3_32767
	Force-set/ reset enabled area	EM 11 to EM 18	EM 7 to EM E	EM 6 to EM9	EM3	EM3
Function blocks	Maximum number of def- initions	1,024				
	Maximum number of instances	2,048				
Source/ Com- ment areas	Symbol tables/ comments/ program indexes	3.5MB (See note.)				

Note There is no restriction on the memory capacity by the stored data.
The total capacity of source and comment areas is 3.5 MB.

CJ2M CPU Units

Item		Specification				
Model		CJ2M-CPU11/ 31	CJ2M-CPU12/ 32	CJ2M-CPU13/ 33	CJ2M-CPU14/ 34	CJ2M-CPU15/ 35
I/O points		2,560				
Program capacity (steps)		5 K	10 K	20 K	30 K	60 K
Data memory		32K words				
Extended Data Memory		32K words × 1 bank E0_00000 to E0_32767			32K words × 4 banks E0_00000 to E3_32767	
Function blocks	Maximum number of definitions	256			2,048	
	Maximum number of instances	256			2,048	
Source/ Com- ment areas	Symbol tables/ comments/ pro- gram indexes	1MB (See note.)				

Note There is no restriction on the memory capacity by the stored data.
The total capacity of source and comment areas is 1 MB.

Area Used for Function Blocks

The area used for function blocks for CJ2 CPU Units depends on the model of the CPU Unit, as shown in the following table. CJ2M CPU Units have a special area for function blocks called the FB Program Area. The CJ2H CPU Units do not have this area.

CPU Unit	Model	Area used for function blocks
CJ2H	CJ2H-CPU6□-EIP CJ2H-CPU6□	Function blocks use memory in the user program area.
CJ2M	CJ2M-CPU3□ CJ2M-CPU1□	Function blocks use memory in the FB Program Area. If the capacity of the FB Program Area is exceeded, the user program area is used.

CS1-H CPU Units

Item		Specification									
Model		CS1H-CPU67H	CS1H-CPU66H	CS1H-CPU65H	CS1H-CPU64H	CS1H-CPU63H	CS1G-CPU45H	CS1G-CPU44H	CS1G-CPU43H	CS1G-CPU42H	
I/O points		5,120						1,280	960		
Program capacity (steps)		250K	120K	60K	30K	20K	60K	30K	20K	10K	
Data memory		32K words									
Extended Data Memory		32K words × 13 banks E0_00000 to EC_32767	32K words × 7 banks E0_00000 to E6_32767	32K words × 3 banks E0_00000 to E2_32767	32K words × 1 bank E0_00000 to E0_32767		32K words × 3 banks E0_00000 to E2_32767	32K words × 1 bank E0_00000 to E0_32767			
Function blocks	Maximum number of definitions	1,024	1,024	1,024	1,024	128	1,024	1,024	128	128	
	Maximum number of instances	2,048	2,048	2,048	2,048	256	2,048	2,048	256	256	
Comment Memory Unit (ver. 4.0 or later)	Total for all files (Kbytes)	2,048	2,048	1,280	1,280	1,280	1,280	704	704	704	
Inside comment memory (ver. 3.0 or later)	Function block program memory (Kbytes)	1,664	1,664	1,024	512	512	1,024	512	512	512	
	Comment files (Kbytes)	128	128	64	64	64	64	64	64	64	
	Program index files (Kbytes)	128	128	64	64	64	64	64	64	64	
	Variable tables (Kbytes)	128	128	128	64	64	128	64	64	64	

CJ1-H CPU Units

Item		Specification							
Model		CJ1H-CPU67H/ CPU67H-R	CJ1H-CPU66H/ CPU66H-R	CJ1H-CPU65H/ CPU65H-R	CPU64H-R	CJ1G-CPU45H	CJ1G-CPU44H	CJ1G-CPU43H	CJ1G-CPU42H
I/O points		2,560				1,280		960	
Program capacity (steps)		250K	120K	60K	30K	60K	30K	20K	10K
Data memory		32K words							
Extended Data Memory		32K words × 13 banks E0_00000 to EC_32767	32K words × 7 banks E0_00000 to E6_32767	32K words × 3 banks E0_00000 to E2_32767	32K words × 1 bank E0_00000 to E2_32767	32K words × 3 banks E0_00000 to E2_32767	32K words × 1 bank E0_00000 to E0_32767		
Function blocks	Maximum number of definitions	1,024	1,024	1,024	1,024	1,024	1,024	128	128
	Maximum number of instances	2,048	2,048	2,048	2,048	2,048	2,048	256	256
Comment Memory Unit (ver. 4.0 or later)	Total for all files (Kbytes)	2,048	2,048	1,280	1,280	1,280	1,280	1,280	704
Inside comment memory (ver. 3.0 or later)	Function block program memory (Kbytes)	1,664	1,664	1,024	512	1,024	512	512	512
	Comment files (Kbytes)	128	128	64	64	64	64	64	64
	Program index files (Kbytes)	128	128	64	64	64	64	64	64
	Variable tables (Kbytes)	128	128	128	64	128	64	64	64

CJ1M CPU Units

Item	Specification					
	Units with internal I/O functions			Units without internal I/O functions		
Model	CJ1M-CPU23	CJ1M-CPU22	CJ1M-CPU21	CJ1M-CPU13	CJ1M-CPU12	CJ1M-CPU11
I/O points	640	320	160	640	320	160
Program capacity (steps)	20K	10K	5K	20K	10K	5K
Number of Expansion Racks	1 max.	Expansion not supported		1 max.	Expansion not supported	
Data memory	32K words					
Extended Data Memory	None					

Item	Specification			
	Units with internal I/O functions		Units without internal I/O functions	
Pulse start times	46 μs (without acceleration/ deceleration) 70 μs (with acceleration/decel- eration)	63 μs (without acceleration/ deceleration) 100 μs (with acceleration/ deceleration)	---	
Number of sched- uled interrupts	2	1	2	1
PWM outputs	2	1	None	
Maximum value of subroutine number	1,024	256	1,024	256
Maximum value of jump number in JMP instruction	1,024	256	1,024	256
Internal inputs	10 points • 4 interrupt inputs (pulse catch) • 2 high-speed counter inputs (50-kHz phase dif- ference or 100-kHz single-phase)		---	
Internal outputs	6 points • 2 pulse outputs (100 kHz) • 2 PWM outputs	6 points • 2 pulse out- puts (100 kHz) • 1 PWM out- put	---	
Function blocks	Maxi- mum number of definitions	128		
	Maxi- mum number of instances	256		
Com- ment Memory Unit (ver. 4.0 or later)	Total for all files (Kbytes)	704		
Inside com- ment memory (ver. 3.0 or later)	Function block pro- gram memory (Kbytes)	256		
	Com- ment files (Kbytes)	64		
	Program index files (Kbytes)	64		
	Variable tables (Kbytes)	64		

CP1H CPU Units

Item		X models	XA models	Y models
Model		CP1H-X40DR-A CP1H-X40DT-D CP1H-X40DT1-D	CP1H-XA40DR-A CP1H-XA40DT-D CP1H-XA40DT1-D	CP1H-Y20DT-D
Max. number of I/O points		320 points (40 built-in points + 40 points/Expansion Rack x 7 Racks)		300 points (20 built-in points + 40 points/Expansion Rack x 7 Racks)
Program capacity (steps)		20K		
Data memory		32K words		
Number of connectable Expansion Units and Expansion I/O Units		7 Units (CP-series Expansion Units and Expansion I/O Units)		
Function blocks	Maximum number of definitions	128		
	Maximum number of instances	256		
Inside comment memory	Function block program memory (Kbytes)	256		
	Comment files (Kbytes)	64		
	Program index files (Kbytes)	64		
	Variable tables (Kbytes)	64		

CP1L CPU Units

Item		M models			L models		
Model		CP1L-M60D□-□	CP1L-M40D□-□	CP1L-M30D□-□	CP1L-L20D□-□	CP1L-L14D□-□	CP1L-L10D□-□
Max. number of I/O points		180 points (60 built-in points + 40 points/ Expansion Rack x 3 Racks)	160 points (40 built-in points + 40 points/ Expansion Rack x 3 Racks)	150 points (30 built-in points + 40 points/ Expansion Rack x 3 Racks)	60 points (20 built-in points + 40 points/ Expansion Rack x 1 Rack)	54 points (14 built-in points + 40 points/ Expansion Rack x 1 Racks)	10 points
Program capacity (steps)		10K			5K		
Data memory		32K words (D00000 to D32767)			10K words (D00000 to D09999, and D32000 to D32767)		
Number of connectable Expansion Units and Expansion I/O Units		3 Units (CP-series Expansion Units and Expansion I/O Units)			1 Unit (CP-series Expansion Unit or Expansion I/O Unit)		None
Function blocks	Maximum number of definitions	128					
	Maximum number of instances	256					
Inside comment memory	Function block program memory (Kbytes)	256					
	Comment files (Kbytes)	64					
	Program index files (Kbytes)	64					
	Variable tables (Kbytes)	64					

NSJ-series NSJ Controllers

Model		NSJ5-TQ0□-G5D, NSJ5-SQ0□-G5D, NSJ8-TV0□-G5D, NSJ10-TV0□-G5D, NSJ12-TS0□-G5D,	NSJ5-TQ0□-M3D, NSJ5-SQ0□-M3D, NSJ8-TV0□-M3D
Max. number of I/O points		1,280	640
Program capacity (steps)		60K	20K
Data memory		32K words	
Extended data memory		32K words × 3 banks E0_00000 to E2_32767	None
Function blocks	Maximum number of definitions	1,024	128
	Maximum number of instances	2,048	256
Inside comment memory	Function block program memory (Kbytes)	1,024	256
	Comment files (Kbytes)	64	64
	Program index files (Kbytes)	64	64
	Variable tables (Kbytes)	128	64

FQM1 Flexible Motion Controllers

Item		Coordinator Module	Motion Control Modules	
Model		FQM1-CM002	FQM1-MMA22	FQM1-MMP22
Max. number of I/O points		344 points (24 built-in points + 320 points on Basic I/O Units)	20 built-in points	
Program capacity (steps)		10K		
Data memory		32K words		
Function blocks	Maximum number of definitions	128		
	Maximum number of instances	256		
Inside comment memory	Function block program memory (Kbytes)	256		
	Comment files (Kbytes)	64		
	Program index files (Kbytes)	64		
	Variable tables (Kbytes)	64		

2-8-2 Operation of Timer Instructions

There is an option called *Apply the same spec as T0-2047 to T2048-4095* in the PLC properties. This setting affects the operation of timers as described in this section.

Selecting the Option

If this option is selected, all timers will operate the same regardless of timer number, as shown in the following table.

Timer Operation for Timer Numbers T0000 to T4095

Refresh	Description
When instruction is executed	The PV is refreshed each time the instruction is executed. If the PV is 0, the Completion Flag is turned ON. If it is not 0, the Completion Flag is turned OFF.
When execution of all tasks is completed	All PV are refreshed once each cycle.
Every 80 ms	If the cycle time exceeds 80 ms, all PV are refreshed once every 80 ms.

Not Selecting the Option (Default)

If this option is not selected, the refreshing of timer instructions with timer numbers T0000 to T2047 will be different from those with timer numbers T2048 to T4095, as given below. This behavior is the same for CPU Units that do not support function blocks. (Refer to the descriptions of individual instruction in the *CS/CJ Series Instruction Reference* for details.)

Timer Operation for Timer Numbers T0000 to T2047

Refresh	Description
When instruction is executed	The PV is refreshed each time the instruction is executed. If the PV is 0, the Completion Flag is turned ON. If it is not 0, the Completion Flag is turned OFF.
When execution of all tasks is completed	All PV are refreshed once each cycle.
Every 80 ms	If the cycle time exceeds 80 ms, all PV are refreshed once every 80 ms.

Timer Operation for Timer Numbers T2048 to T4095

Refresh	Description
When instruction is executed	The PV is refreshed each time the instruction is executed. If the PV is 0, the Completion Flag is turned ON. If it is not 0, the Completion Flag is turned OFF.
When execution of all tasks is completed	PV are not updated.
Every 80 ms	PV are not updated even if the cycle time exceeds 80 ms.

Select the *Apply the same spec as TO-2047 to T2048-4095* Option to ensure consistent operation when using the timer numbers allocated by default to function block variables (T3072 to T4095).

2-9 Number of Function Block Program Steps and Instance Execution Time

2-9-1 Number of Function Block Program Steps

Number of Steps Used for Function Blocks

When function blocks are used, program memory (steps) is used for the following two items.

1. Function block definitions
2. Instances of function block definitions created in programs

Therefore, the more instances of function block definitions that you create, the more memory (steps) will be used.

Guide for Number of Program Steps When Using Function Blocks

This section applies only to CP-series CPU Units with unit version Ver. 1.0 or later and CS/CJ-series CPU Units with unit version Ver. 3.0 or later, NSJ Controllers, and FQM1 Flexible Motion Controllers.

Use the following equation to calculate the approximate number of program steps when function block definitions have been created and the instances copied into the user program of the CPU Unit.

Number of steps = Number of instances × (Call part size m + I/O parameter transfer part size n × Number of parameters) + Number of instruction steps in the function block definition p (See note.)

Note The number of instruction steps in the function block definition (p) will not be diminished in subsequent instances when the same function block definition is copied to multiple locations (i.e., for multiple instances). Therefore, in the above equation, the number of instances is not multiplied by the number of instruction steps in the function block definition (p).

The following table applies only to CP-series CPU Units with unit version Ver. 1.0 or later and CS/CJ-series CPU Units with unit version Ver. 3.0 or later, NSJ Controllers, and FQM1 Flexible Motion Controllers.

Contents			Number of steps
m	Call part	---	57 steps
n	I/O parameter transfer part The data type is shown in parentheses.	1-bit (BOOL) input variable or output variable	6 steps
		1-word (INT, UINT, or WORD) input variable or output variable	6 steps
		2-word (DINT, UDINT, DWORD, or REAL) input variable or output variable	6 steps
		4-word (LINT, ULINT, LWORD, or LREAL) input variable or output variable	18 steps
		Input-output variables	6 steps
p	Number of instruction steps in function block definition	The total number of instruction steps (same as standard user program) + 27 steps.	

Example:

Input variables with a 1-word data type (INT): 5

Output variables with a 1-word data type (INT): 5

Function block definition section: 100 steps

Number of steps for 1 instance = 57 + (5 + 5) × 6 steps + 100 steps + 27 steps
= 244 steps

When the program is written in ST language, the actual number of steps cannot be calculated. The number of instruction steps in each function block definition can be found in the function block definition's properties.

2-9-2 Function Block Instance Execution Time

This section applies only to CP-series CPU Units with unit version Ver. 1.0 or later and CS/CJ-series CPU Units with unit version Ver. 3.0 or later, NSJ Controllers, and FQM1 Flexible Motion Controllers.

Use the following equation to calculate the effect of instance execution on the cycle time when function block definitions have been created and the instances copied into the CPU Unit's user program.

Effect of Instance Execution on Cycle Time = Startup time (A) + I/O parameter transfer processing time (B) + Execution time of instructions in function block definition (C)

The following table shows the length of time for A, B, and C.

Operation			CPU Unit model						
			CJ1H-CPU6□H-R CJ2H-CPU6□(-EIP)	CJ2M-CPU□□	CS1H-CPU6□H CJ1H-CPU6□H	CS1G-CPU4□H CJ1G-CPU4□H NSJ	CJ1M-CPU□□	CP1H-X□□□-□ CP1H-XA□□□-□ CP1H-Y□□□-□	CP1L-M□□□-□ CP1L-L□□□-□
A	Startup time	Startup time not including I/O parameter transfer	3.3 μs	7.4 μs	6.8 μs	8.8 μs	15.0 μs	15.0 μs	320.4 μs
B	I/O parameter transfer processing time The data type is indicated in parentheses.	1-bit input variable or output variable (BOOL)	0.24 μs	0.88 μs	0.4 μs	0.7 μs	1.0 μs	1.0 μs	59.52 μs
		1-word input variable or output variable (INT, UINT, WORD)	0.19 μs	0.88 μs	0.3 μs	0.6 μs	0.8 μs	0.8 μs	13.16 μs
		2-word input variable or output variable (DINT, UDINT, DWORD, REAL)	0.19 μs	1.2 μs	0.5 μs	0.8 μs	1.1 μs	1.1 μs	15.08 μs
		4-word input variable or output variable (LINT, ULINT, LWORD, LREAL)	0.38 μs	2.96 μs	1.0 μs	1.6 μs	2.2 μs	2.2 μs	30.16 μs
		Input-output variable	0.114 μs	0.4 μs	0.4 μs	0.5 μs	1.2 μs	(Not supported)	(Not supported)
C	Function block definition instruction execution time	Total instruction processing time (same as standard user program)							

Example: CJ1H-CPU67H-R

Input variables with a 1-word data type (INT): 3

Output variables with a 1-word data type (INT): 2

Total instruction processing time in function block definition section: 10 μs

Execution time for 1 instance = 3.3 μs + (3 + 2) × 0.19 μs + 10 μs = 14.25 μs

Note The execution time is increased according to the number of multiple instances when the same function block definition has been copied to multiple locations.

SECTION 3

Creating Function Blocks

This section describes the procedures for creating function blocks on the CX-Programmer.

3-1	Procedural Flow	82
3-2	Procedures	84
3-2-1	Creating a Project	84
3-2-2	Creating a New Function Block Definition	84
3-2-3	Defining Function Blocks Created by User	87
3-2-4	Creating Instances from Function Block Definitions	99
3-2-5	Setting Function Block Parameters Using the Enter Key.	101
3-2-6	Setting the FB Instance Areas.	104
3-2-7	Checking Internal Address Allocations for Variables	106
3-2-8	Copying and Editing Function Block Definitions	108
3-2-9	Checking the Source Function Block Definition from an Instance	108
3-2-10	Checking Instance Information such as Nesting Levels.	108
3-2-11	Checking Function Block Usage	109
3-2-12	Compiling Function Block Definitions (Checking Program).	110
3-2-13	Printing Function Block Definition	110
3-2-14	Password Protection of Function Block Definitions	111
3-2-15	Comparing Function Blocks	114
3-2-16	Saving and Reusing Function Block Definition Files	114
3-2-17	Downloading/Uploading Programs to the Actual CPU Unit	115
3-2-18	Monitoring and Debugging Function Blocks	116
3-2-19	Online Editing Function Block Definitions	124

3-1 Procedural Flow

The following procedures are used to create function blocks, save them in files, transfer them to the CPU Unit, monitor them, and debug them.

Creating Function Blocks

Create a Project

Refer to *3-2-1 Creating a Project* for details.

n **Creating a New Project**

- 1,2,3...**
1. Start the CX-Programmer and select **New** from the File Menu.
 2. Select a *Device type*: CS1G-H, CS1H-H, CJ1G-H, CJ1H-H, CJ1M, or CP1H, CP1L, NSJ, or FQM1-CM (MMA/MMP).

n **Reusing an Existing CX-Programmer Project**

- 1,2,3...**
1. Start the CX-Programmer, and read the existing project file (.cxp) created using CX-Programmer Ver. 4.0 or earlier by selecting the file from the File Menu.
 2. Select a *Device type*: CS1H-H, CS1G-H, CJ1G-H, CJ1H-H, CJ1M, or CP1H, CP1L, NSJ, or FQM1-CM (MMA/MMP).

Create a Function Block Definition

Refer to *3-2-2 Creating a New Function Block Definition* for details.

- 1,2,3...**
1. Select *Function Blocks* in the project workspace and right-click.
 2. Select **Insert Function Block - Ladder** or **Insert Function Blocks - Structured Text** from the pop-up menu.

Define the Function Block

Refer to *3-2-3 Defining Function Blocks Created by User* for details.

n **Registering Variables before Inputting the Ladder Program or ST Program**

- 1,2,3...**
1. Register variables in the variable table.
 2. Create the ladder program or ST program.

n **Registering Variables as Necessary while Inputting the Ladder Program or ST Program**

- 1,2,3...**
1. Create the ladder program or ST program.
 2. Register a variable in the variable table whenever required.

Create an Instance from the Function Block Definition

Refer to *3-2-4 Creating Instances from Function Block Definitions* for details.

n **Inserting Instances in the Ladder Section Window and then Inputting the Instance Name**

- 1,2,3...**
1. Place the cursor at the location at which to create an instance (i.e., a copy) of the function block and press the **F** Key.
 2. Input the name of the instance.
 3. Select the function block definition to be copied.

n **Registering Instance Names in the Global Symbol Table and then Selecting the Instance Name when Inserting**

- 1,2,3...**
1. Select *Function Block* as the data type for the variable in the global symbol table.
 2. Press the **F** Key in the Ladder Section Window.

3. Select the name of the instance that was registered from the pull-down menu on the *FB Instance* Field.

Allocate External I/O to the Function Block

Refer to *3-2-5 Setting Function Block Parameters Using the Enter Key* for details.

1,2,3...

1. Place the cursor at the position of the input variable or output variable and press the **P** Key.
2. Input the source address for the input variable or the destination address for the output variable.

Set the Function Block Memory Allocations (Instance Areas)

Refer to *3-2-6 Setting the FB Instance Areas* for details.

1,2,3...

1. Select the instance and select **Function Block/SFC Memory - Function Block/SFC Memory Allocation** from the PLC Menu.
2. Set the function block memory allocations.

Printing, Saving, and Reusing Function Block Files**Compile the Function Block Definition and Save It as a Library File**

Refer to *3-2-12 Compiling Function Block Definitions (Checking Program)* and *3-2-16 Saving and Reusing Function Block Definition Files* for details.

1,2,3...

1. Compile the function block that has been saved.
2. Print the function block.
3. Save the function block as a function block definition file (.cxf).
4. Read the file into another PLC project.

Transferring the Program to the PLC

Refer to *3-2-17 Downloading/Uploading Programs to the Actual CPU Unit*.

Monitoring and Debugging the Function Block

Refer to *3-2-18 Monitoring and Debugging Function Blocks*.

3-2 Procedures

3-2-1 Creating a Project

Creating New Projects with CX-Programmer

- 1,2,3...
1. Start the CX-Programmer and select **New** from the File Menu.
 2. In the Change PLC Window, select a *Device Type* that supports function blocks. These are listed in the following table.

Device	CPU
CJ2H	CPU68/67/66/65/64/68-EIP/67-EIP/66-EIP/65-EIP/64-EIP
CJ2M	CPU11/12/13/14/15/31/32/33/34/35
CS1G-H	CPU42H/43H/44H/45H
CS1H-H	CPU63H/64H/65H/66H/67H
CJ1G-H	CPU42H/43H/44H/45H
CJ1H-H	CPU65H/66H/67H/64H-R/65H-R/66H-R/67H-R
CJ1M	CPU11/12/13/21/22/23
CP1H	CP1H-XA/X/Y
CP1L	CP1L-M/L
NSJ	G5D (Used for the NSJ5-TQ0□-G5D, NSJ5-SQ0□-G5D, NSJ8-TV0□-G5D, NSJ10-TV0□-G5D, and NSJ12-TS0□-G5D) M3D (Used for the NSJ5-TQ0□-M3D, NSJ5-SQ0□-M3D, and NSJ8-TV0□-M3D)
FQM1-CM	FQM1-CM002
FQM1-MMA	FQM1-MMA22
FQM1-MMP	FQM1-MMP22

3. Press the Settings Button and select the *CPU Type*. For details on other settings, refer to the *CX-Programmer Operation Manual (W446)*.

3-2-2 Creating a New Function Block Definition

- 1,2,3...
1. When a project is created, a *Function Blocks* icon will appear in the project workspace as shown below.

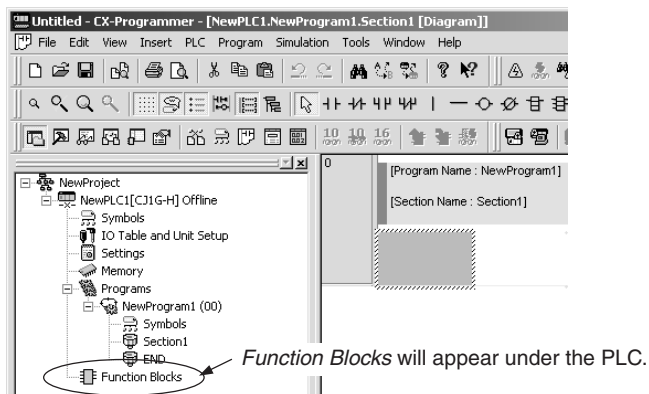

2. Function block definitions are created by inserting function block definitions after the Function Blocks icon.

Creating Function Block Definitions

Function blocks can be defined by the user using either ladder programming or structured text.

Creating (Inserting) Function Block Definitions with Ladders

1. Select **Function Blocks** in the project workspace, right-click, and select **Insert Function Blocks - Ladder** from the pop-up menu. (Or select **Function Block - Ladder** from the Insert Menu.)

Creating (Inserting) Function Block Definitions with Structured Text

1. Select **Function Blocks** in the project workspace, right-click, and select **Insert Function Blocks - Structured Text** from the pop-up menu. (Or select **Function Block - Structured Text** from the Insert Menu.)

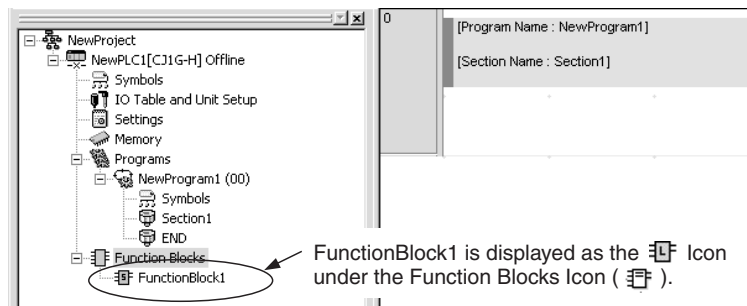

2. A function block called FunctionBlock1 will be automatically inserted either after the [Ladder icon] for ladder programming language (default) or the [ST icon] for ST language. This icon contains the definitions for the newly created (inserted) function block.
3. Whenever a function block definition is created, the name FunctionBlock□ will be assigned automatically, where □ is a serial number. These names can be changed. All names must contain no more than 64 characters.

Using OMRON FB Library Files

Use the following procedure to insert OMRON FB Library files (.cxf).

1. Select **Function Blocks** in the project workspace, right-click, and select **Insert Function Blocks - Library File** from the pop-up menu. (Or select **Function Block - Library File** from the Insert Menu.)
2. The following Select Function Block Library File Dialog Box will be displayed.

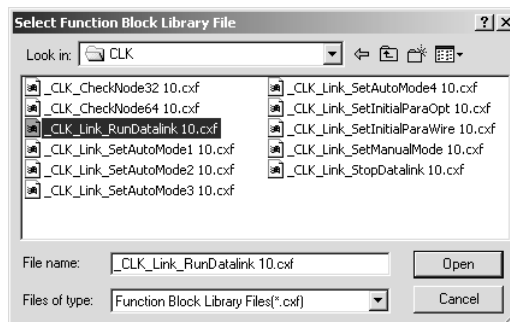

Note To specify the default folder (file location) in the Function Block Library File Dialog Box, select **Tools - Options**, click the **General** Tab and the select the default file in the *OMRON FB library storage location* field.

3. Specify the folder in which the OMRON FB Library file is located, select the library file, and click the **Open** Button. The library file will be inserted as a function block definition after the [Ladder icon].

Function Block Definitions

Creating Function Block Definitions

One of the following windows will be displayed when the newly created Function Block 1 icon is double-clicked (or if it is right-clicked and **Open** is selected from the pop-up menu). A variable table for the variables used in the function block is displayed on top and an input area for the ladder program or structured text is displayed on the bottom.

Ladder Program

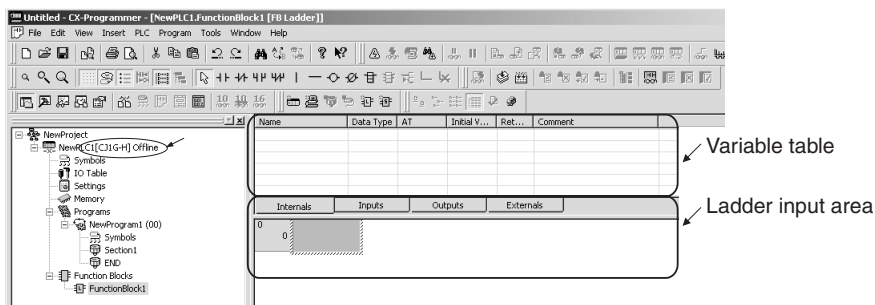

Structured Text

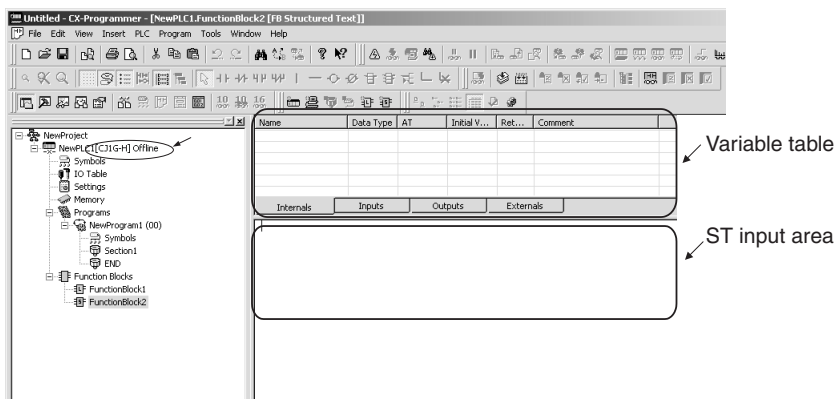

As shown, a function block definition consists of a variable table that serves as an interface and a ladder program or structured text that serves as an algorithm.

Variable Table as an Interface

At this point, the variable table is empty because there are no variables allocated for I/O memory addresses in the PLC.

Ladder Program or Structure Text as an Algorithm

- With some exceptions, the ladder program for the function block can contain any of the instructions used in the normal program. Refer to *2-4 Programming Restrictions* for restrictions on the instructions that can be used.
- Structured text can be input according to the ST language defined in IEC61131-3.

Using OMRON FB Library Files

Double-click the inserted function block library (or right-click and select **Open** from the pop-up menu) to display the variable table that has finished being created at the top right window, and the ladder program that has finished being created in the bottom right window. Both windows are displayed in gray and cannot be edited.

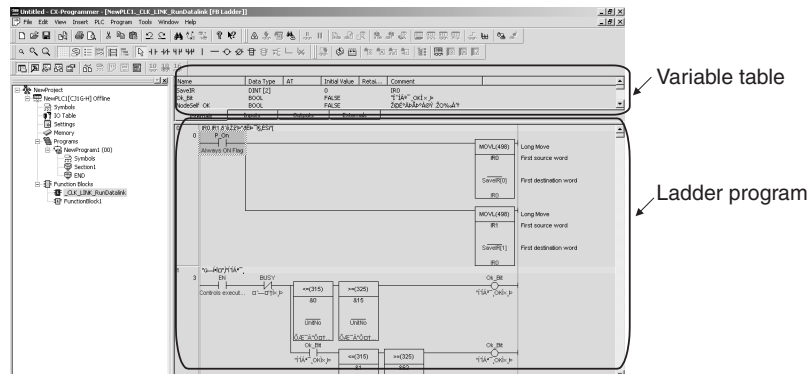

Note Function block definitions are not displayed in the default settings for OMRON FB Library files (.cxf). To display definitions, select the **Display the inside of FB** option in the function block properties. (Select the OMRON FB Library file in the project workspace, right-click, select **Properties**, and select the **Display the inside of FB** option in the General Tab.)

3-2-3 Defining Function Blocks Created by User

A function block is defined by registering variables and creating an algorithm. There are two ways to do this.

- Register the variables first and then input the ladder program or structure text.
- Register variables as they are required while inputting input the ladder program or structure text.

Registering Variables First

Registering Variables in the Variable Table

The variables are divided by type into five sheets in the variable table: Internals, Inputs, Outputs, Input-Output, and Externals.

These sheets must be switched while registering or displaying the variables.

- 1,2,3...
1. Make the sheet for the type of variable to be registered active in the variable table. (See note.) Place the cursor in the sheet, right-click, and perform either of the following operations:
 - To add a variable to the last line, select **Insert Variable** from the pop-up menu.
 - To add the variable to the line above or below a line within the list, select **Insert Variable - Above** or **Below** from the pop-up menu.

Note The sheet where a variable is registered can also be switched when inserting a variable by setting the usage (N: Internals, I: Inputs, O: Outputs, E: Externals, P: In Out).

The New Variable Dialog Box shown below will be displayed.

- **Name:** Input the name of the variable.
- **Data Type:** Select the data type.
- **Usage:** Select the variable type.
- **Initial Value:** Select the initial value of the variable at the start of operation.
- **Retain:** Select if the value of the variable is to be maintained when the power is turned ON or when the operating mode is changed from PROGRAM or MONITOR mode to RUN mode. The value will be cleared at these times if *Retain* is not selected.

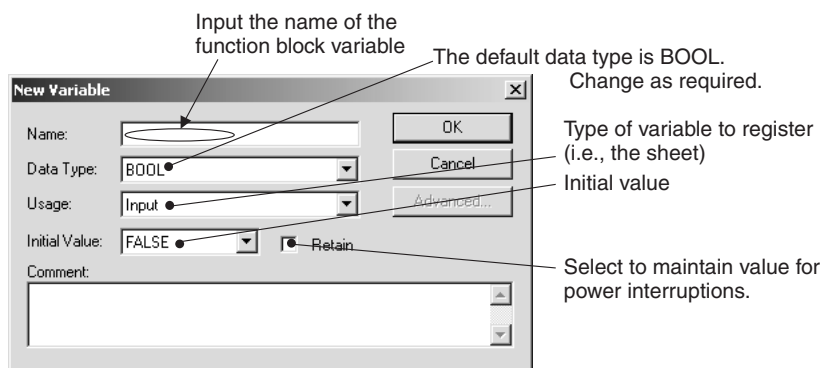

- Note** (a) For user-defined external variables, the global symbol table can be browsed by registering the same variable name in the global symbol table.
- (b) External variables defined by the system are registered in the external variable table in advance.

- For example, input “aaa” as the variable name and click the **OK** Button. As shown below, a BOOL variable called *aaa* will be created on the Inputs Sheet of the Variable Table.

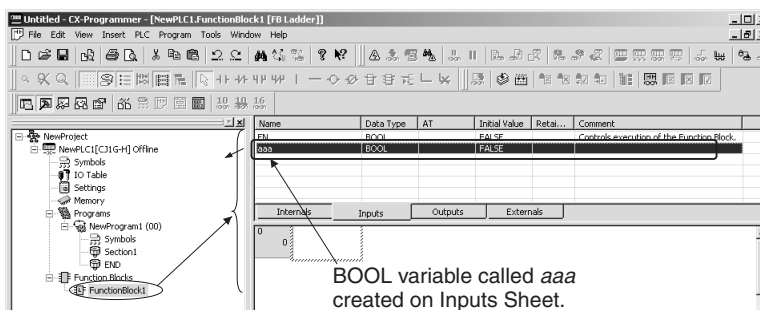

- Note**
- After a variable is added, it can be selected to display in reverse video, then moved to another line by dragging and dropping. To select a variable for dragging and dropping, select the variable in any of the columns except the *Name* field.
 - After inputting a variable, the sheet where the variable is registered can be changed by double-clicking and changing the setting in the *Usage* field (N: Internals, I: Inputs, O: Outputs, E: Externals, P: In Out). The variable can also be copied or moved between the sheets for internal, external, input, output, and input-output variables. Select the variable, right-click, and select **Copy** or **Cut** from the pop-up menu, and then select **Paste**.
 - Variable names must also be input for variables specified with AT (allocating actual address) settings.
 - The following text is used to indicate I/O memory addresses in the PLC and thus cannot be input as variable names in the function block variable table.
 - A, W, H, HR, D, DM, E, EM, T, TIM, C, or CNT followed by a numeric value

Creating the Algorithm

Using a Ladder Program

1,2,3...

1. Press the **C** Key and select *aaa* registered earlier from the pull-down menu in the New Contact Dialog Box.

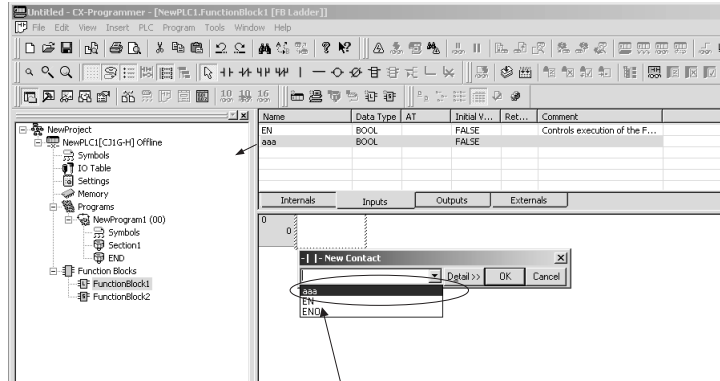

Press the C Key and select *aaa* registered earlier from the pull-down menu in the New Contact Dialog Box.

2. Click the **OK** Button. A contact will be entered with the function block internal variable *aaa* as the operand (variable type: internal).

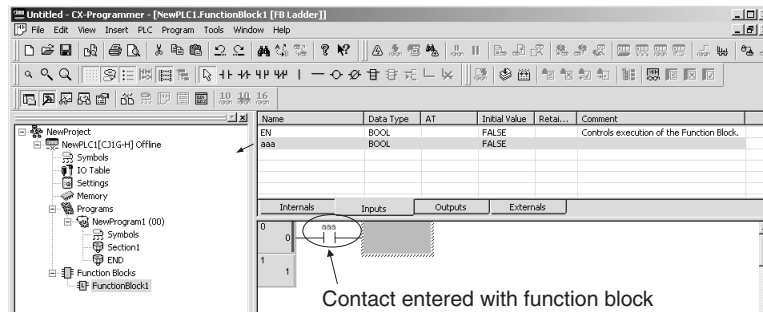

Contact entered with function block internal variable *aaa* as operand.

The rest of the ladder program is input in exactly the same way as for standard programs with CX-Programmer.

Note Addresses cannot be directly input for instruction operands within function blocks. Only Index Registers (IR) and Data Registers (DR) can be input directly as follows (not as variables): Addresses DR0 to DR5, direct specifications IR0 to IR15, and indirect specifications ,IR0 to ,IR15.

Using Structured Text

An ST language program (see note) can either be input directly into the ST input area or a program input into a general-purpose text editor can be copied and then pasted into the ST input area using the *Paste* Command on the Edit Menu.

Note The ST language conforms to IEC61131-3. For details, refer to *SECTION 5 Structured Text (ST) Language Specifications* in *Part 2: Structured Text (ST)*.

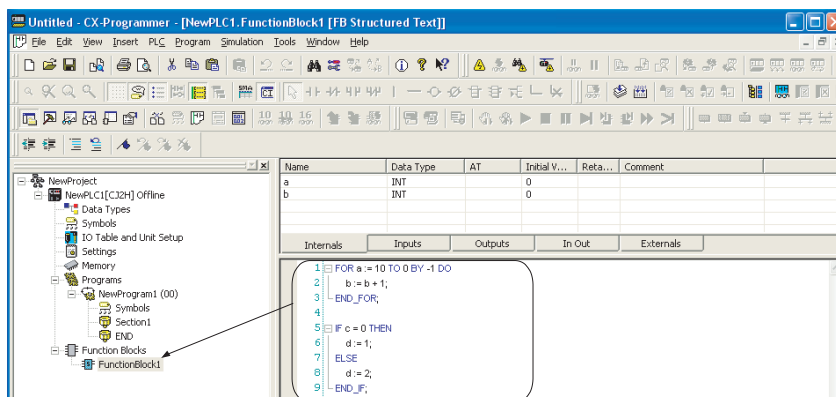

ST program input directly or pasted from one created in a text editor.

- Note**
- (1) Tabs or spaces can be input to create indents. They will not affect the algorithm.
 - (2) When an ST language program is input or pasted into the ST input area, syntax keywords reserved words will be automatically displayed in blue, comments in green, errors in red, and everything else in black.
 - (3) To change the font size or colors, select **Options** from the Tools Menu and then click the **ST Font** Button on the Appearance Tab Page. The font names, font size (default is 8 point) and color can be changed.
 - (4) For details on structured text specifications, refer to *SECTION 5 Structured Text (ST) Language Specifications* in *Part 2: Structured Text (ST)*.

Registering Variables as Required

The ladder program or structured text program can be input first and variable registered as they are required.

Using a Ladder Program

When using a ladder diagram, a dialog box will be displayed to register the variable whenever a variable name that has not been registered is input. The variable is registered at that time.

Use the following procedure.

- 1,2,3... 1. Press the **C** Key and input a variable name that has not been registered, such as *aaa*, in the New Contact Dialog Box.

Note Addresses cannot be directly input for instruction operands within function blocks. Only Index Registers (IR) and Data Registers (DR) can be input directly as follows (not as variables): Addresses DR0 to DR5, direct specifications IR0 to IR15, and indirect specifications ,IR0 to ,IR15.
2. Click the **OK** Button. The New Variable Dialog Box will be displayed. With special instructions, a New Variable Dialog Box will be display for each operand in the instruction.

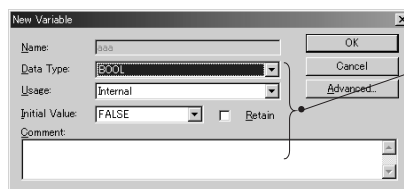

Set the data type and other properties other than the name.

The properties for all input variables will initially be displayed as follows:

- Usage: Internal

- Data Type: BOOL for contacts and WORD for channel (word)
 - Initial Value: The default for the data type.
 - Retain: Not selected.
3. Make any required changes and click the **OK** Button.
 4. As shown below, the variable that was registered will be displayed in the variable table above the program.

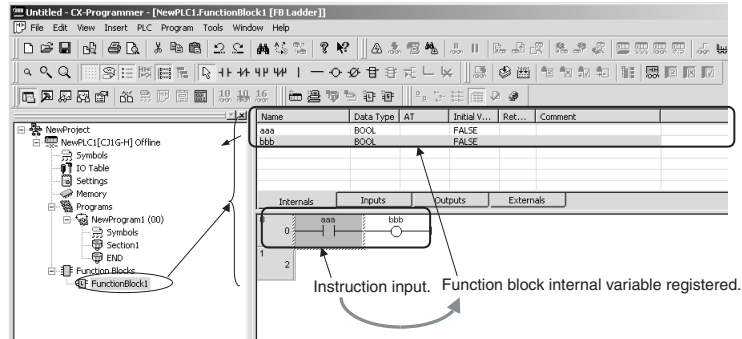

5. If the type or properties of a variable that was input are not correct, double-click the variable in the variable table and make the required corrections.

n **Reference Information**

AT Settings (Specified Address)

AT settings can be made in the variable properties to specify allocation addresses for Basic I/O Units, Special I/O Units, or CPU Bus Units, or Auxiliary Area addresses not registered using the CX-Programmer. A variable name is required to achieve this. Use the following procedure to specify an address.

1,2,3...

1. After inputting the variable name in the New Variable Dialog Box, click the **Advanced** Button. The Advanced Settings Dialog Box will be displayed.
2. Select *AT (Specified Address)* under *AT Settings* and input the desired address.

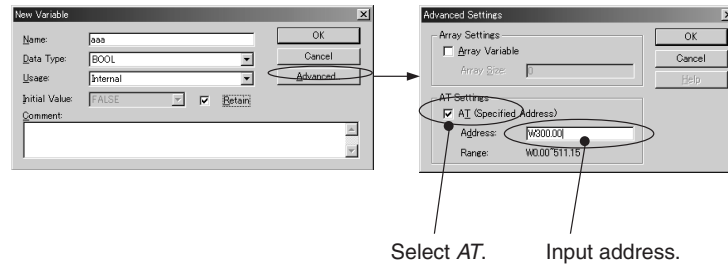

The variable name is used to enter variables into the algorithm in the function block definition even when they have an address specified for the AT settings (the same as for variables without a specified address).

For example, if a variable named *Restart* has an address of A50100 specified for the AT settings, *Restart* is specified for the instruction operand.

Array Settings

An array can be specified to use the same data properties for more than one variable and manage the variables as a group.

Use the following procedure to set an array.

1,2,3...

1. After inputting the variable name in the New Variable Dialog Box, click the **Advanced** Button. The Advanced Settings Dialog Box will be displayed.

2. Select *Array Variable* in the *Array Settings* and input the maximum number of elements in the array.

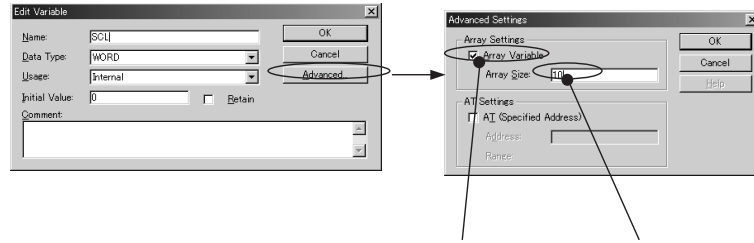

Select *Array Variable*. Input the number of elements.

When the name of an array variable is entered in the algorithm in the function block definition, square brackets surrounding the index will appear after the array name.

For example, if you create a variable named PV with a maximum of 3 elements, PV[0], PV[1], and PV[2] could be specified as instruction operands.

There are three ways to specify indices.

- Directly with numbers, e.g., PV[1] in the above example (for ladder programming or ST language programming)
- With a variable, e.g., PV[a] in the above example, where “a” is the name of a variable with a data type of INT (for ladder programming or ST language programming)
- With an equation, e.g., PV[a+b] or PV[a+1] in the above example, where “a” and “b” are the names of variables with a data type of INT (for ST language programming only)

Using Structured Text

When using structured text, a dialog box will not be displayed to register the variable whenever a variable name that has not been registered is input. Be sure to always register variables used in standard text programming in the variable table, either as you need them or after completing the program. (Place the cursor in the tab page on which to register the variable, right-click, and select **Insert Variable** from the pop-up menu.

Note For details on structured text specifications, refer to *SECTION 5 Structured Text (ST) Language Specifications* in *Part 2: Structured Text (ST)*.

Copying User Program Circuits and Pasting in Ladder Programming of Function Block Definitions

A single circuit or multiple circuits in the user program can be copied and pasted in the ladder programming of function block definitions. This operation, however, is subject to the following restrictions.

**Source Instruction
Operand: Address Only**

Addresses are not registered in the function block definition variable tables. After pasting, the addresses will be displayed in the operand in red. Double-click on the instruction and input the variable name into the operand.

Note Index Registers (IR) and Data Registers (DR), however, do not require modification after pasting and function in the operand as is.

**Source Instruction
Operand: Address and I/O
Comment**

Automatically generate symbol name Option Selected in Symbols Tab under Options in Tools Menu

The user program symbol names (in the global symbol table only) will be generated automatically as AutoGen_ + Address (if the option is deselected, the symbol names will be removed).

Example 1: For address 100.01, the symbol name will be displayed as AutoGen_100_01.

Example 2: For address D0, the symbol name will be displayed as AutoGen_D0.

If circuits in the user program are copied and pasted into the function block definition program as is, the symbols will be registered automatically in the function block definition symbol table (at the same time as copying the circuits) as the symbol name *AutoGen_Address* and I/O comments as *Comment*. This function enables programmed circuits to be easily reused in function blocks as addresses and I/O comments.

Note The prefix AutoGen_ is not added to Index Registers (IR) and Global Data Registers (DR), and they cannot be registered in the original global symbol table.

Automatically generate symbol name Option Not Selected in Symbols Tab under Options in Tools Menu

Addresses and I/O comments are not registered in the function block definition variable tables. Addresses are displayed in the operand in red. I/O comments will be lost. Double-click on the instruction and input the symbol name into the operand.

Index Registers (IR) and Data Registers (DR), however, do not require modification after pasting and function in the operand as is.

**Source Instruction
Operand: Symbol**

The user program symbol is automatically registered in the internal variables of the function block definition variable table. This operation, however, is subject to the following restrictions.

Addresses

Symbol addresses are not registered. Use AT settings to specify the same address.

Symbol Data Types

The symbol data types are converted when pasted from the user program into the function block definition, as shown in the following table.

Symbol data type in user program	→	Variable data type after pasting in function block program
CHANNEL	→	WORD
NUMBER	→	The variable will not be registered, and the value (number) will be pasted directly into the operand as a constant.
UINT BCD	→	WORD
UDINT BCD	→	DWORD
ULINT BCD	→	LWORD

Symbol data types CHANNEL, NUMBER, UINT BCD, UDINT BCD, or ULINT BCD, however, cannot be copied from the symbol table (not the program) and then pasted into the variable table in the function block definition.

Note Symbols with automatically generated symbol names (AutoGen_ + Address) cannot be copied from a global symbol table and pasted into the function block definition symbol table.

Generating Function Block Definitions from Existing Ladder Programming

One or more program circuits in a user program can be converted to the ladder programming in a function block definition.

Note This function is designed to help you create function block definitions based on existing ladder programming. It does not automatically generate finish definitions. After generating a function block definition with this function, always check the warning messages in the FB Variable Allocation Dialog Box and Output Window and check the program that was generated, and be sure to make any required changes.

- 1,2,3...** 1. Right-click one or more program circuits in the user program and select *Function Block (ladder) generation* from the pop-up menu.

Note When any structure definitions exist on the data type view, the *Function Block (ladder) generation* cannot be selected from the menu.



2. The following FB Variable Allocation Dialog Box will be displayed.

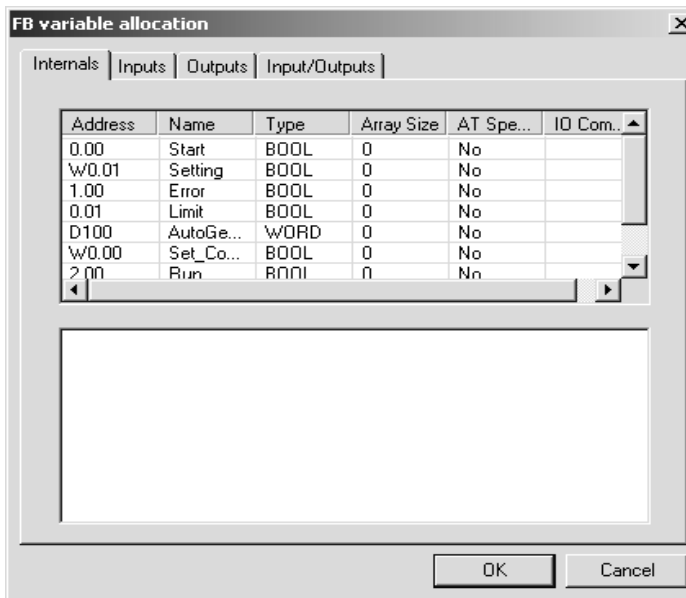

The addresses of the operands used in the instructions in the selected program circuits will be automatically allocated as listed below depending on application conditions.

Application outside selected program circuits	Application inside selected program circuits			
	Not used	Used in input section	Used in output section	Used in input and output sections
Not used (See note.)	---	Internal variable	Internal variable	Internal variable
Used	---	Input variable	Output variable	Input-output variable

Note Even if an address is allocated to I/O, it will be considered to be “not used” and converted to an internal variable if it is not used outside the selected circuits (no matter where it is used inside the selected circuits).

Note Names will be automatically set for addresses without symbol names as follows: AutoGen_*address*. AT specifications will be automatically removed.

3. Change the allocations to internal, input, output, or input-output variables as required. Right-click the variable and select the desired variable type from the **Change usage** Menu.

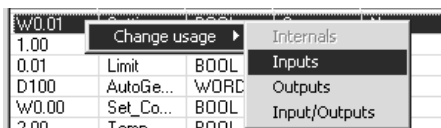

If necessary, double-click any variable in the variable list and change the name or comment. The array and AT settings can also be changed.

4. Click the **OK** Button. The following Function Block (Ladder) Generation Dialog Box will be displayed.

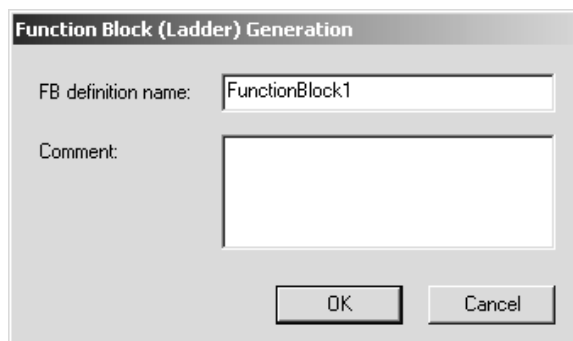

Input the FB definition name and comment, and then click the **OK** Button.

5. The function block definition will be generated based on the settings and will appear under the function blocks in the Workspace.

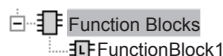

6. The following dialog box will be displayed asking if you want to insert an instance of the function block definition below the original program circuits.

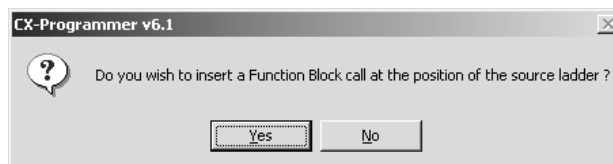

7. Click the **Yes** Button to insert an instance and click the **No** Button to not insert an instance.

- The following New Function Block Invocation Dialog Box will appear if the Yes Button was clicked.

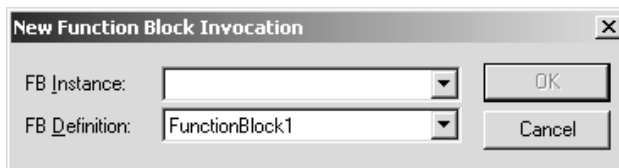

Enter the function block instance name and click the **OK** Button. An instance of the function block definition will be inserted below the original program circuits as shown below.

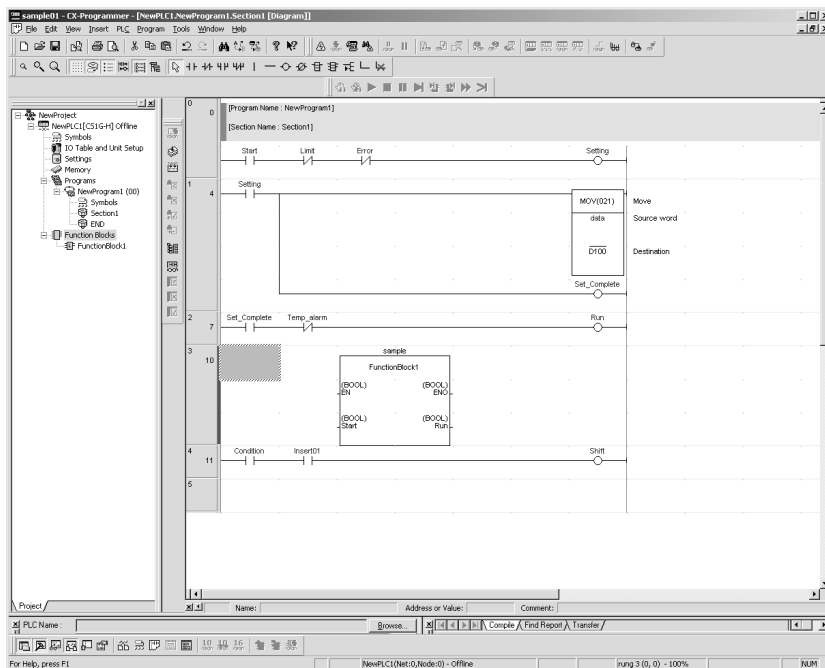

- Enter the input conditions and parameters for the instance that was inserted.

Note The function block definition generation function is convenient for converting existing ladder programming that has been proven in actual operation into function blocks. The application of addresses within the selected program circuits is analyzed both inside and outside the selection to allocate internal, input, output, and input-output variables as accurately as possible. Program circuits that contain operands that are only symbols (i.e., that are not addresses) cannot be converted. To create function blocks from program circuits that contain operands that are only symbols, copy and paste the program circuits into a function block definition. Refer to *Copying User Program Circuits and Pasting in Ladder Programming of Function Block Definitions* on page 92 for details.

Program Circuits That Must Be Altered before Generating a Function Block Definition

In the following case, the program circuits must be altered before a function block definition can be automatically generated.

Addresses Used Both as Bits and Words

The bit and word addresses will be registered as different variables. The program can be altered in advance to avoid this.

Example: MOV(021) for W0 and SET for W0.02

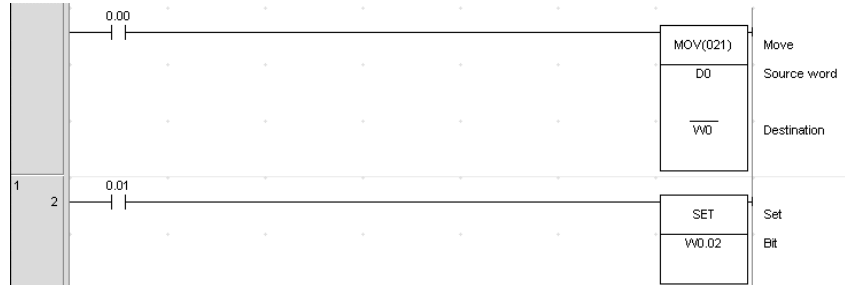

Here, the instruction can be changed to specify a word instead of a bit. As shown below, W0 is used both for MOV(021) and SETB(532), and the bit number for SETB(532) is specified using &2.



Program Circuits That Must Be Altered after Generating a Function Block Definition

In the following cases, operand specifications must be changed using array settings after generating the function block definition.

Instructions with Multiword Operands, Some of Which Are Changed by Another Instruction in the Program Circuits

Example: D0 Specified as the First Word for MOVL(498) and D1 Specified for MOV(021)





As shown below, the variables must be changed to specify the first word in an array and a specific word in the same array after the function block definition has been generated.

Example: DT_WORD is set as a WORD array variable with 2 elements. DT_WORD[0] is specified for MOVL(498) and DT_WORD[1] is specified for MOV(021).

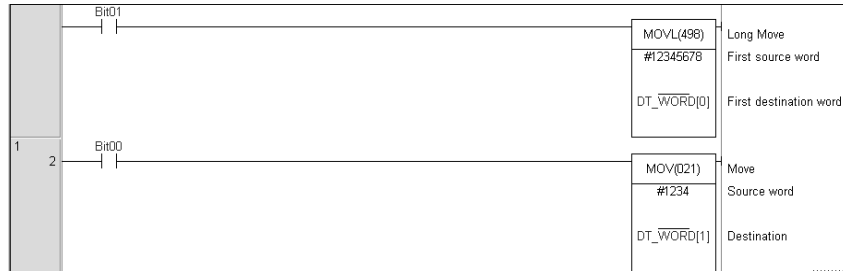

Instructions with Two Operands Specifying Starting and Ending Words

Example: D0 to D9 Specified for BSET(071)

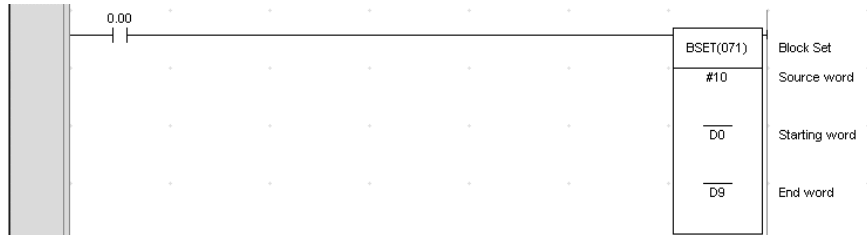

As shown below, the variables must be changed to specify the first word in an array and a specific word in the same array after the function block definition has been generated.

Example: DT_WORD is set as a WORD array variable with 10 elements. DT_WORD[0] is specified for the first operand and DT_WORD[9] is specified for the second operand of BSET(071).



Operands with Sizes Affected by Other Operands

Example: Five Transfer Words, D0 Specified for the First Source Word, and D100 Specified for the First Destination Word for XFER(070)



As shown below, the variables must be changed to set the first elements in two different arrays after the function block definition has been generated.

Example: DT_WORD1 and DT_WORD2 are set as WORD array variables with 5 elements each. DT_WORD1[0] is specified for the first word for the first operand and DT_WORD2[0] is specified for first word for the second operand of XFER(070).



3-2-4 Creating Instances from Function Block Definitions

If a function block definition is registered in the global symbol table, either of the following methods can be used to create instances.

Method 1: Select the function block definition, insert it into the program, and input a new instance name. The instance will automatically be registered in the global symbol table.

Method 2: Set the data type in the global symbol table to "FUNCTION BLOCK," specify the function block definition to use, and input the instance name to register it.

Note When using ST language, a function block can be called by selecting "FUNCTION BLOCK" as the variable's data type, using the desired instance name, and entering a function block call statement.

n **Method 1: Using the F Key in the Ladder Section Window and Inputting the Instance Name**

1,2,3...

1. In the Ladder Section Window, place the cursor in the program where the instance is to be inserted and press the **F** Key. (Alternately, select **Function Block Invocation** from the Insert Menu.) The New Function Block Invocation Dialog Box will be displayed.

When using ST language, a function block can be called by selecting “FUNCTION BLOCK” as the variable’s data type, using the desired instance name, and entering the following function block call statement. Specify arguments in parentheses after the instance name (to pass input variable values from the calling function block to input variables in the called function block) and also specify return values (to receive output variable values from the called function block to output variables in the calling function block). The instance name can be set to any internal variable with the “FUNCTION BLOCK” data type.

2. Input the instance name, select the function block from which to create an instance, and click the **OK** Button.

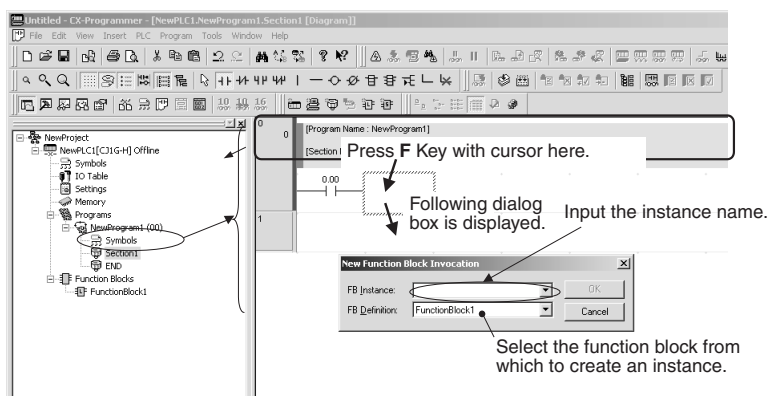

3. As an example, set the instance name in the *FB Instance* Field to **sample**, set the function block in the *FB Definition* Field to **FunctionBlock1**, and click the **OK** Button. As shown below, a copy of the function block definition called *FunctionBlock1* will be created with an instance name of *sample*.

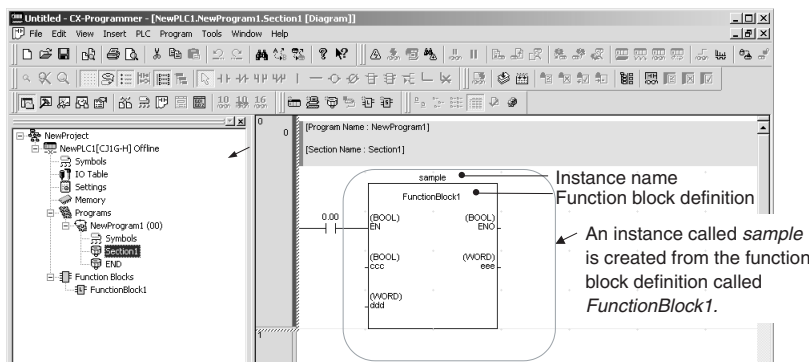

The instance will be automatically registered in the global symbol table with an instance name of *sample* and a data type of *FUNCTION BLOCK*.

n **Method 2: Registering the Instance Name in the Global Symbol Table in Advance and Then Selecting the Instance Name**

If the instance name is registered in the global symbol table in advance, the instance name can be selected from the global symbol table to create other instances.

- 1,2,3...**
1. For a ladder diagram, select a data type of *Function block* in the global symbol table, input the instance name, and registered the instance.
For ST, select a data type of *Function block*, use the instance name, and use a call statement for the function block as follows to call the function block:
Input the instance name (any internal variable name with a function block data type) followed by the arguments in parentheses (i.e., specify the input variable values of the calling function block to pass to the input variables of the called function block). Also include the return values (i.e., specify the output variable values of the called function block to pass back to the output variables of the calling function block).
 2. Press the **F** Key in the Ladder Section Window. The Function Block Invocation Dialog Box will be displayed.
 3. Select the instance name that was previously registered from the pulldown menu on the *FB Instance* Field. The instance will be created.

Restrictions

Observe the following restrictions when creating instances. Refer to *2-4 Programming Restrictions* for details.

- No more than one function block can be created in each program circuit.
- The rung cannot be branched to the left of an instance.
- Instances cannot be connected directly to the left bus bar, i.e., an EN must always be inserted.

Note If changes are made in the I/O variables in a variable table for a function block definition, the bus bar to the left of all instances that have been created from that function block definition will be displayed in red to indicate an error. When this happens, select the function block, right-click, and select **Update Invocation**. The instance will be updated for any changes that have been made in the function block definition and the red bus bar display indicating an error will be cleared.

3-2-5 Setting Function Block Parameters Using the Enter Key

After an instance of a function block has been created, input parameters must be set for input variables and output parameters must be set for output variables to enable external I/O.

- Values, addresses, and program symbols (global symbols and local symbols) can be set in input parameters. (See note a.)
- Addresses and program symbols (global symbols and local symbols) can be set in output parameters. (See note b.)

Note (a) The function block's input variable data size and the program's symbol data size must match.

(b) The function block's output variable data size and the program's symbol data size must match.

- 1,2,3...**
1. Inputs are located on the left of the instance and outputs on the right. Place the cursor where the parameter is to be set and press the **Enter** Key. (Alternately, select **Function Block Parameter** from the Insert Menu.) The New Parameter Dialog Box will be displayed as shown below.

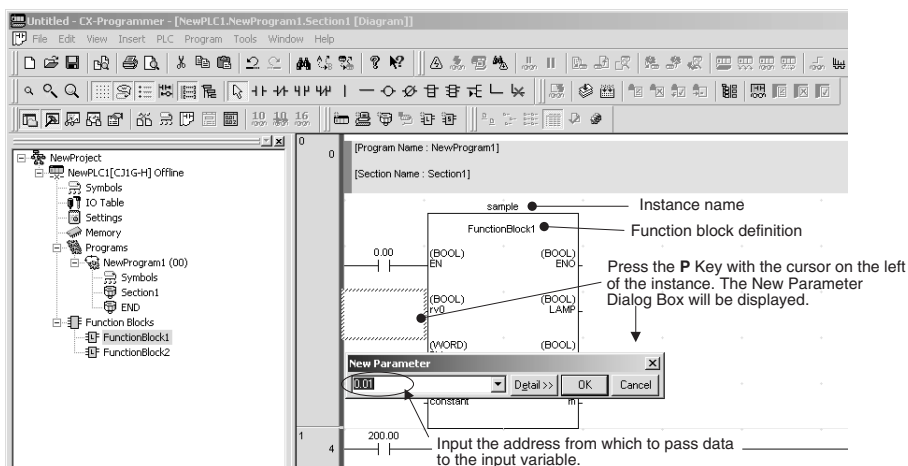

2. Set the source address from which to pass the address data to the input variable. Also set the destination address to which the address data will be passed from the output variable.

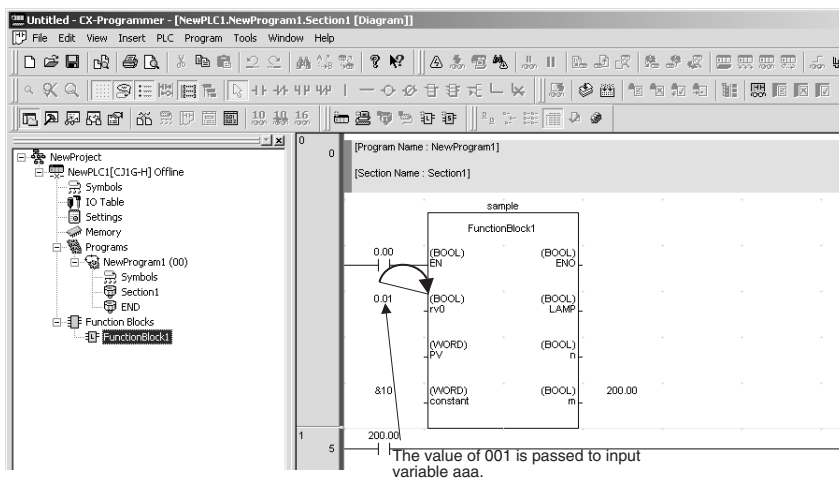

Note Set the data in all the input parameters. If even a single input parameter remains blank, the left bus bar for the instance will be displayed in red to indicate an error. If this happens, the program cannot be transferred to the CPU Unit.

Inputting Values in Parameters

The following table lists the methods for inputting values in parameters.

Input variable data type	Content	Size	Input method	Setting range
BOOL	Bit data	1 bit	P_Off, P_On	0 (FALSE), 1 (TRUE)
INT	Integer	16 bits	Positive value: & or + followed by integer Negative value: – followed by integer	–32768 to +32767
DINT	Double integer	32 bits		–2147483648 to +2147483647
LINT	Long (4-word) integer	64 bits		–9223372036854775808 to +9223372036854775807
UINT	Unsigned integer	16 bits	Positive value: & or + followed by integer	&0 to 65535
UDINT	Unsigned double integer	32 bits		&0 to 4294967295
ULINT	Unsigned long (4-word) integer	64 bits		&0 to 18446744073709551615

Input variable data type	Content	Size	Input method	Setting range
REAL	Real number	32 bits	Positive value: & or + followed by real number (with decimal point) Negative value: – followed by real number (with decimal point)	-3.402823×10^{38} to $-1.175494 \times 10^{-38}$, 0, $+1.175494 \times 10^{-38}$ to $+3.402823 \times 10^{38}$
LREAL	Long real number	64 bits		$-1.79769313486232 \times 10^{308}$ to $-2.22507385850720 \times 10^{-308}$, 0, $+2.22507385850720 \times 10^{-308}$ to $+1.79769313486232 \times 10^{308}$
WORD	16-bit data	16 bits	# followed by hexadecimal number (4 digits max.) & or + followed by decimal number	#0000 to FFFF or &0 to 65535
DWORD	32-bit data	32 bits	# followed by hexadecimal number (8 digits max.) & or + followed by decimal number	#00000000 to FFFFFFFF or &0 to 4294967295
LWORD	64-bit data	64 bits	# followed by hexadecimal number (16 digits max.) & or + followed by decimal number	#0000000000000000 to FFFFFFFFFFFFFFFF or &0 to 18446744073709551615

Note If a non-boolean data type is used for the input variable and only a numerical value (e.g., 20) is input, the value for the CIO Area address (e.g, CIO 0020) will be passed, and not the numerical value. To set a numerical value, always insert an &, #, + or – prefix before inputting the numerical value.

Example Programs:

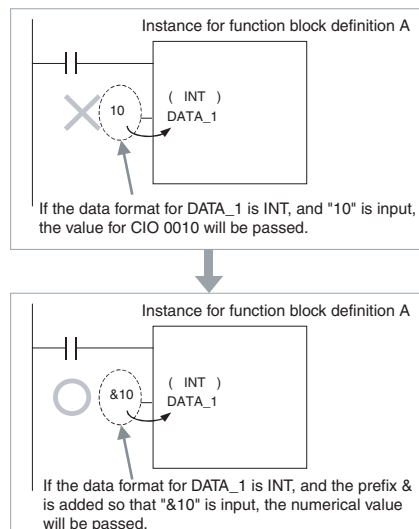

If the input variable data type is boolean and a numerical value only (e.g., 0 or 1) is input in the parameter, the value for CIO 000000 (0.00) or CIO 000001 (0.01) will be passed. Always input P_Off for 0 (OFF) and P_On for 1 (ON).

3-2-6 Setting the FB Instance Areas

The areas where addresses for variables used in function blocks are allocated can be set. These areas are called the function block instance areas.

- 1,2,3...
1. Select the instance in the Ladder Section Window or in the global symbol table, and then select **Function Block/SFC Memory - Function Block/SFC Memory Allocation** from the PLC Menu.
The Function Block/SFC Memory Allocation Dialog shown below will appear.
 2. Set the FB instance areas.

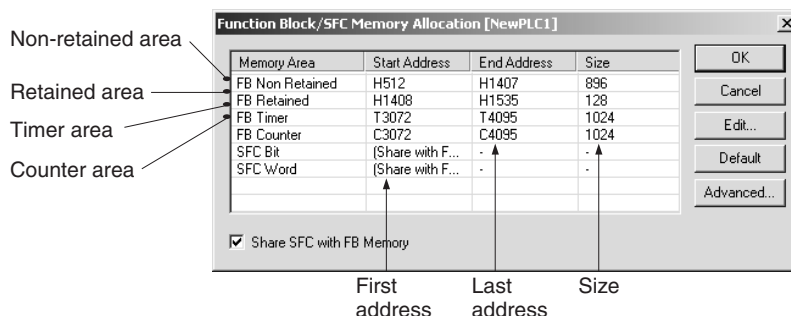

The non-retained and retained areas are set in words. The timer and counter areas are set by time and counter numbers.

The default values are as follows:

CJ2-series CPU Units

FB Instance Area	Default value			Applicable memory areas
	Start address	End address	Size	
Non Retain	H512	H1407	896	CIO, WR, HR, DM, EM (See note.)
Retain	H1408	H1535	128	HR, DM, EM (See note.)
Timers	T3072	T4095	1024	TIM
Counters	C3072	C4095	1024	CNT

Note Force-setting/resetting is enabled when the following EM banks are specified:

CJ2H-CPU64(-EIP)/-CPU65(-EIP)	EM bank 3
CJ2H-CPU66(-EIP)	EM banks 6 to 9
CJ2H-CPU67(-EIP)	EM banks 7 to E
CJ2H-CPU68(-EIP)	EM banks 11 to 18

CS/CJ-series CPU Units Ver. 3.0 or Later, and NSJ Controllers

FB Instance Area	Default value			Applicable memory areas
	Start address	End address	Size	
Non Retain (See notes 1 and 3.)	H512 (See note 2.)	H1407 (See note 2.)	896	CIO, WR, HR, DM, EM
Retain (See note 1.)	H1408 (See note 2.)	H1535 (See note 2.)	128	HR, DM, EM
Timers	T3072	T4095	1024	TIM
Counters	C3072	C4095	1024	CNT

Note (1) Bit data can be accessed even if the DM or EM Area is specified for the non-retained area or retained area.

- (2) The Function Block Holding Area words are allocated in H512 to H1535. These words cannot be specified in instruction operands in the user program. These words can also not be specified in the internal variable's AT settings.
- (3) Words H512 to H1535 are contained in the Holding Area, but the addresses set as non-retained will be cleared when the power is turned OFF and ON again or when operation is started.
- (4) To prevent overlapping of instance area addresses and addresses used in the program, set H512 to H1535 (Function Block Holding Area words) for the non-retained area and retained area. If there are not sufficient words, use words in areas not used by the user program. If another area is set, the addresses may overlap with addresses that are used in the user program.

If the addresses in the function block instance areas overlap with any of the addresses used in the user program, an error will occur when compiling. This error will also occur when a program is downloaded, edited on-line, or checked by the user.

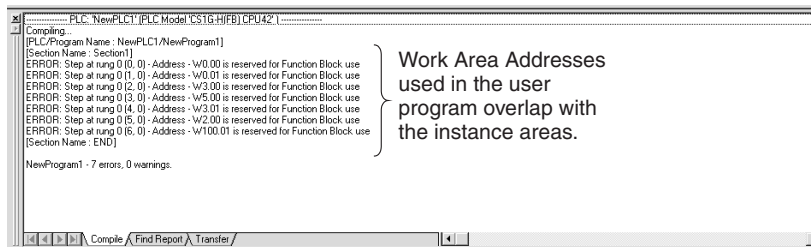

If addresses are duplicated and an error occurs, either change the function block instance areas or the addresses used in the user program.

FQM1 Flexible Motion Controllers

FB Instance Area	Default value			Applicable memory areas
	Start address	End address	Size	
Non Retain (See note.)	5000	5999	1000	CIO, WR, DM
Retain	None			
Timers	T206	T255	50	TIM
Counters	C206	C255	50	CNT

Note Bit data can be accessed even if the DM Area is specified for the non-retained area.

CP-series CPU Units

FB Instance Area	Default value			Applicable memory areas
	Start address	End address	Size	
Non Retain	H512	H1407	896	CIO, WR, HR, DM (See note.)
Retain	H1408	H1535	128	HR, DM (See note.)
Timers	T3072	T4095	1024	TIM
Counters	C3072	C4095	1024	CNT

Note DM area of CP1L-L

Address	CP1L-L
D0000 to D9999	Provided
D10000 to D31999	Not Provided
D32000 to D32767	Provided

3-2-7 Checking Internal Address Allocations for Variables

The following procedure can be used to check the I/O memory addresses internally allocated to variables.

- 1,2,3...
1. Select **View - Symbols - Global**.
 2. Select the instance in the global symbol table, right-click, and select **Function Block/SFC Memory Address** from the pop-up menu. (Alternately, select **Memory Allocation - Function Block/SFC Memory - Function Block/SFC Memory Address** from the PLC Menu.)

Example: Instance name displayed in global variable table (automatically registered)

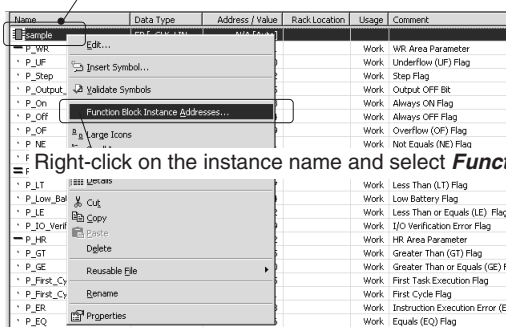

3. The FB Interface Memory Dialog Box will be displayed. Check the I/O memory addresses internally allocated to variables here.

Example: Addresses used internally for the input variables.

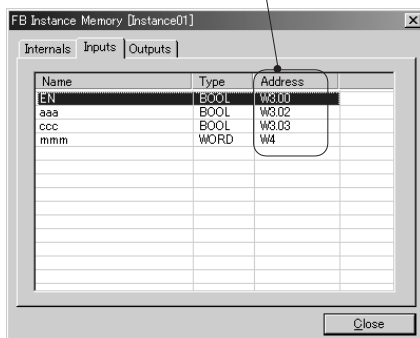

Method Used for Checking Addresses Internally Allocated to Variables

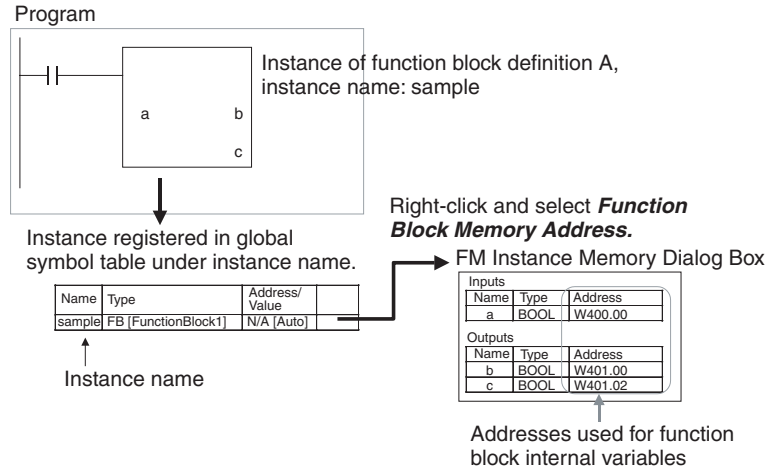

Checking the Status of Addresses Internally Allocated to Variables

The following procedure can be used to check the number of addresses allocated to variables and the number still available for allocation in the function block instance areas.

1,2,3...

1. Select the instance in the Ladder Section Window, right-click, and select **Memory Allocation - Function Block/SFC Memory - Function Block/SFC Memory Statistics** from the PLC Menu.
2. The Function Block/SFC Memory Statistics Dialog Box will be displayed as shown below. Check address usage here.

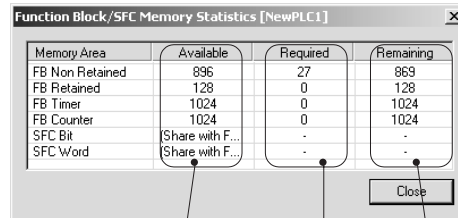

The total number of words in each interface area.

The number of words already used.

The number of words still available.

Optimizing Function Memory

When a variable is added or deleted, addresses are automatically re-allocated in the variables' instance area. Consecutive addresses are required for each instance, so all of the variables will be allocated to a different block of addresses if the original block of addresses cannot accommodate the change in variables. This will result in an unused block of addresses. The following procedure can be used to eliminate the unused areas in memory so that memory is used more efficiently.

1,2,3...

1. Select the instance in the Ladder Section Window, right-click, and select **Memory Allocation - Function Block/SFC Memory - Optimize Function/SFC Memory** from the PLC Menu.

The following dialog box will be displayed.

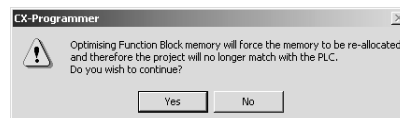

2. Click the **OK** Button. Allocations to the function block instance areas will be optimized.

3-2-8 Copying and Editing Function Block Definitions

Use the following operation to copy and edit the function block definition that has been created.

1. Select the function block to copy, right-click, and select **Copy** from the pop-up menu.
2. Position the cursor over the function block item under the PLC in the project directory, right-click and select **Paste** from the pop-up menu.
3. The function block definition will be copied (“copy” is indicated before the name of the function block definition at the copy source).
4. To change the function block name, left-click or right-click and select **Re-name** from the pop-up menu.
5. Double-click the function block definition to edit it.

3-2-9 Checking the Source Function Block Definition from an Instance

Use the following procedure to check the function block definition from which an instance was created.

Either double-click the instance or right-click the instance and select **To Lower Layer** from the pop-up menu. The function block definition will be displayed.

3-2-10 Checking Instance Information such as Nesting Levels

When function blocks are nested in the created program, the structure of the nesting levels can be checked by selecting **Windows - FB Instance Viewer** from the View Menu. The function block relationships will be shown in a directory tree format, with the calling function blocks at the higher level and the called function blocks at the lower level.

The FB Instance Viewer Window will provide other information, such as the array variables being used and internal addresses allocated to the variables, as shown in the following diagram. Variables can be registered in the Watch Window just by dragging the variable from the list of variables used in the instance and dropping the variable in the Watch Window.

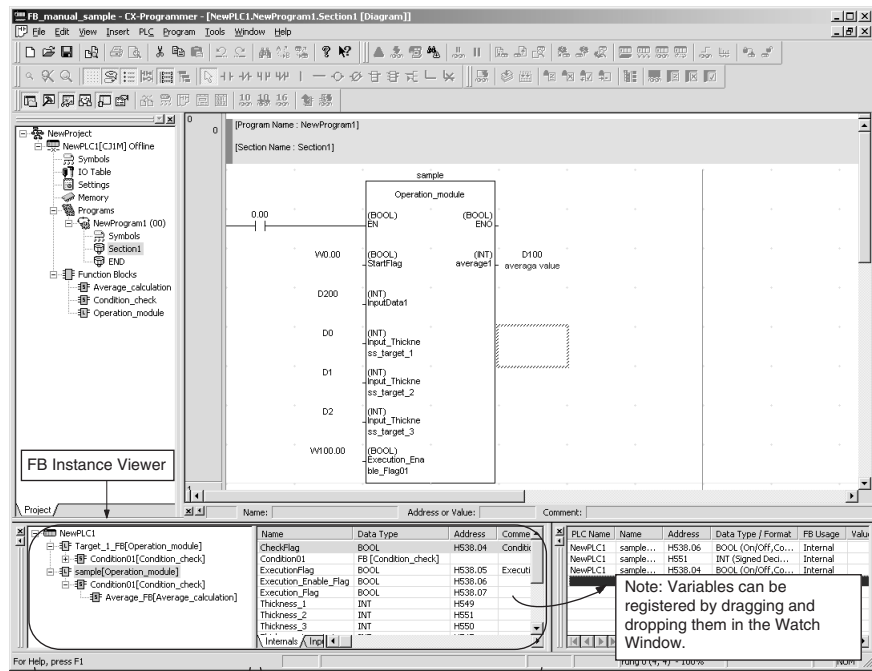

When nesting, this area shows the nesting level relationship between instances (function block definition names in parentheses). The higher-level is the calling block and the lower-level is the called block. Also, if there are array variables or timer/counter variables, they are displayed just below the instance.

The variable names, data types, addresses (allocated internal addresses), and comments are displayed for variables used in the active instance selected in the directory tree in the area on the left.

Note: Variables can be registered by dragging and dropping them in the Watch Window.

3-2-11 Checking Function Block Usage

The following memory areas are used when you use function blocks.

n **User Memory Area (UM)**

The object code for function blocks is stored in this area.

n **FB Source Memory**

The function block source code is stored in this area so that the function block definitions and function block variable table can be displayed on the CX-Programmer.

The CX-Programmer can be used to check memory usage for function blocks. The procedure is as follows:

1. Select **Memory View** from the View Menu.

- The Memory View Dialog Box will be displayed as shown below.
Example: CJ2H-CPU68

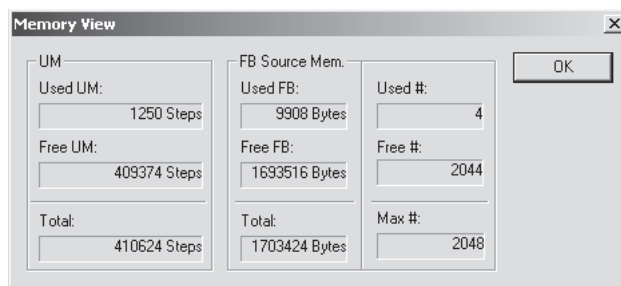

- The Memory View Dialog Box varies with the PLC model. For details, refer to information on the memory view function in the *CX-Programmer Operation Manual* (Cat. No. W446).
- For information on calculating the number of program steps used for the function block object code, refer to *2-9 Number of Function Block Program Steps and Instance Execution Time*.

3-2-12 Compiling Function Block Definitions (Checking Program)

A function block definition can be compiled to perform a program check on it. Use the following procedure.

- 1,2,3... Select the function block definition, right-click, and select **Compile** from the pop-up menu. (Alternately, press the **Ctrl + F7** Keys.)

The function block will be compiled and the results of the program check will be automatically displayed on the Compile Table Page of the Output Window.

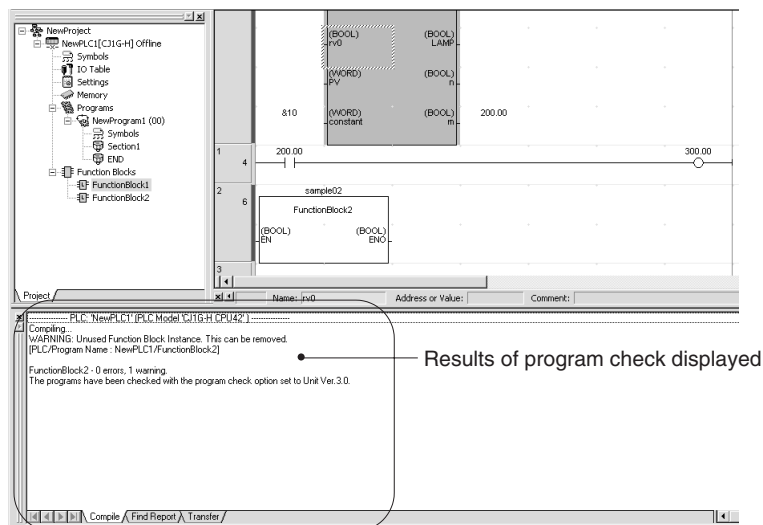

3-2-13 Printing Function Block Definition

Use the following procedure to print function block definitions.

- 1,2,3... 1. Double-click the function block definition to be printed, and with the variable table and algorithm displayed, select **Print** from the File Menu. The following Target Print Rung Dialog Box will be displayed.

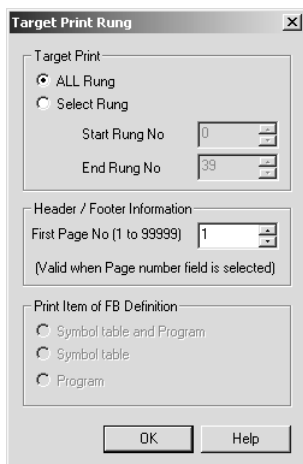

2. Select the **All Rung** or **Select Rung** option. When the Select Rung option is selected, specify the start rung and end rung numbers. When a page number has been specified in the header and footer fields in *File - Page Setup*, the first page number can be specified.
3. Select either of the following options for the function block printing range.
 - Symbol table and program (default)
 - Symbol table
 - Program
4. Click the **OK** Button, and display the Print Dialog Box. After setting the printer, number of items to print and the paper setting, click the OK button.
5. The following variable table followed by the algorithm (e.g, ladder programming language) will be printed.

Variable Type	Name	Type	Retained	AT	Initial Value	Comment
Inputs	EN	BOOL	No		FALSE	Controls execution of the Function Block.
Outputs	ENO	BOOL	No		FALSE	Indicates successful execution of the Function Block.

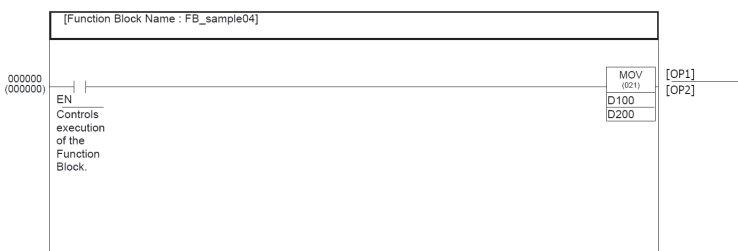

Note For details on print settings, refer to the section on printing in the *CX-Programmer Operation Manual (W446)*.

3-2-14 Password Protection of Function Block Definitions

Overview

Function block definitions in a project can be protected by setting a password to restrict access. The following two levels of password protection that can be set, depending on the application.

Password Protection on both Writing and Reading

This password protection level restricts both writing (changing) and displaying the contents of the function block definition.

To set read/write protection, select *Prohibit writing and display* as the *Protection type* in the function block's properties. This level of protection prevents unintended program changes/modifications and also protects against misappropriation of program materials.

Password Protection on Writing Only

This password protection level restricts writing (changing) the contents of the function block definition.

To set write protection, select *Prohibit writing* as the *Protection type* in the function block's properties. This level of protection prevents unintentional program changes/modifications.

Setting Password Protection

This operation can be performed offline only.

Password protection can be applied to individual function block definitions or multiple function block definitions together.

Protecting an Individual Function Block Definition

Use the following procedure to set the password protection for an individual function block definition.

1,2,3...

1. In the project workspace, select the function block definition, right-click, and select **Properties** from the pop-up menu. (Alternately, select **Properties** from the View Menu.)
2. The Function Block Properties Dialog Box will be displayed. Click the **Protection** Tab and click the **Set** Button.

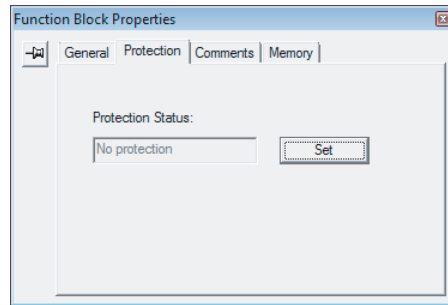

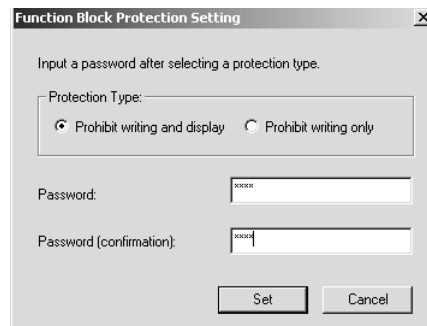

3. The Function Block Protect Setting Dialog Box will be displayed. Select the protection level in the *Protection Type* Field.



The following table shows the functions restricted in each protection level.

Function	Protect Type	
	Prohibit writing and display	Prohibit writing
Displaying function block contents	Prohibited	Allowed
Printing function block contents		Allowed
Editing function block contents		Prohibited
Saving/loading to function block library files	Allowed	Allowed

- Input the password in the *Password* Field of the Function Block Protect Setting Dialog Box. Input the same password again in the confirmation field to verify the password and click the **Set** Button. The password can be up to 8 characters long and only alphanumeric characters can be used.
- When a function block definition has been password protected, the function block definition's icon will change to indicate that it is protected. The icon also indicates the protection level, as shown below.

-  : Prohibit writing and display (same for ladder and ST)
-  : Prohibit writing (ladder)
-  : Prohibit writing (ST)

Protecting Multiple Function Block Definitions

1,2,3...

Use the following procedure to set the password protection for two or more function block definitions at the same time.

- Select **Function Blocks** in the project workspace, right-click, and select **Function Block Protection - Set** from the pop-up menu.
- The Function Block Protection Collective Setting Dialog Box will be displayed. Select the names of the function blocks that you want to protect, select the *Protection Type* (protection level), input the password, and click the **Set** Button.

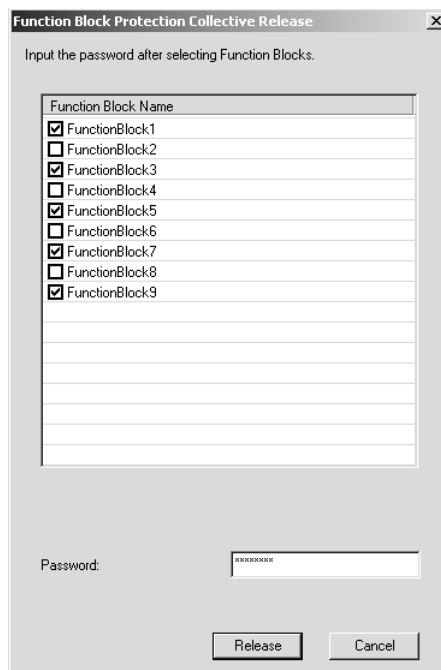

- The selected function block definitions will be password protected.

Clearing Password Protection

This operation can be performed offline only.

Password protection can be cleared from an individual function block definition or multiple function block definitions together.

Clearing Password Protection on an Individual Function Block

Use the following procedure to clear the password protection on an individual function block definition.

- 1,2,3...**
1. In the project workspace, select the function block definition, right-click, and select **Properties** from the pop-up menu. (Alternately, select **Properties** from the View Menu.)
 2. The Function Block Properties Dialog Box will be displayed. Click the **Protection** Tab and click the **Release** Button.
 3. The Function Block Protection Release Dialog Box will be displayed. Input the password in the *Password* Field and click the **Release** Button.
 4. If the password was correct, the protection will be cleared and the function block definition's icon will change to a normal icon in the project workspace.

Clearing Password Protection on Multiple Function Blocks

Use the following procedure to clear the password protection on two or more function block definitions at the same time.

- 1,2,3...**
1. Select **Function Blocks** in the project workspace, right-click, and select **Function Block Protection - Release** from the pop-up menu.
 2. The Function Block Protection Collective Release Dialog Box will be displayed. Select the names of the function blocks that you want to be unprotected, input the password, and click the **Release** Button.
 3. If the password input matches the selected function blocks' passwords, the protection will be cleared for all of the function block definitions at once.

3-2-15 Comparing Function Blocks

It is possible to compare the edited function block with a function block in the actual PLC or another project file to check whether the two function blocks are identical. For details on comparing programs, refer to the *CX-Programmer Operation Manual* (W446).

3-2-16 Saving and Reusing Function Block Definition Files

The function block definition that has been created can be saved independently as a function block library file (*.cxf) to enable reusing it in other projects.

- Note**
- (1) Before saving to file, or reusing in another project, compile the function block definition and perform a program check.
 - (2) When function blocks are being nested, the function block definition of the called (nested) function blocks are included and saved in the function block library file.

Saving a Function Block Library File

Use the following procedure to save a function block definition to a function block library file.

- 1,2,3...**
1. Select the function block definition, right-click, and select **Save Function Block to File** from the pop-up menu. (Alternately, select **Function Block - Save Function Block to File** from the File Menu.)

- The following dialog box will be displayed. Input the file name. *Function Block Library Files (*.cxf)* should be selected as the file type.

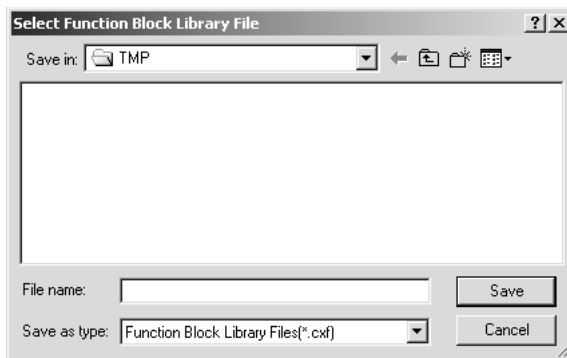

Reading Function Block Library Files into Other Projects

Use the following procedure to read a function block library file (*.cxf) into a project.

1,2,3...

- Select the function block definition item under the PLC directory in the Project Workspace, right-click, and select **Insert Function Block - From File** from the pop-up menu (or select **File - Function Block - Load Function Block from File**).
- The following dialog box will be displayed. Select a function block library file (*.cxf) and click the **Open** Button.

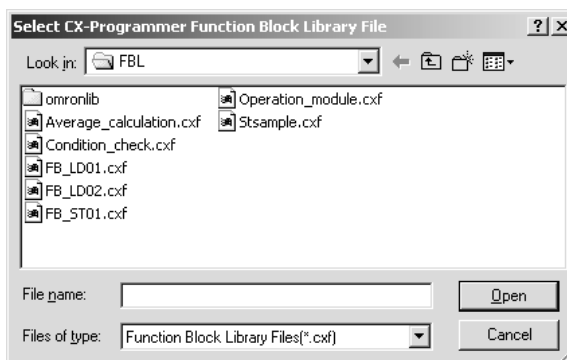

- A function block called **FunctionBlock1** will be automatically inserted after the Function Blocks icon. This icon contains the definition of the function block.
- Double-click the **FunctionBlock1** Icon. The variable table and algorithm will be display.

3-2-17 Downloading/Uploading Programs to the Actual CPU Unit

After a program containing function blocks has been created, it can be downloaded from the CX-Programmer to an actual CPU Unit that it is connected to online. Programs can also be uploaded from the actual CPU Unit. It is also possible to check if the programs on the CX-Programmer (personal computer) and in the actual CPU Unit are the same. When the program contains function blocks, however, downloading in task units is not possible (uploading is possible).

3-2-18 Monitoring and Debugging Function Blocks

The following procedures can be used to monitor programs containing function blocks.

Monitoring I/O in Ladder Programs within Instances

With the CX-Programmer Ver. 6.0 and later versions, it is possible to monitor the status of bits and content of words in a ladder program within an instance when monitoring the program. To monitor I/O bits and words (I/O Bit Monitor), either double-click the instance or right-click the instance and select **Monitor FB Ladder Instance** from the pop-up menu. At this point, it is possible to monitor bits and words, change PVs, force-set/reset bits, and perform differentiation monitoring.

Note

- (1) It is not possible to change timer/counter SVs.
- (2) Changing PVs and force-setting/resetting bits is not possible for input-output variables. Also, if data structures are used as input-output variables, you cannot display forced-set/reset information (key icons) for any BOOL members of those data structures.

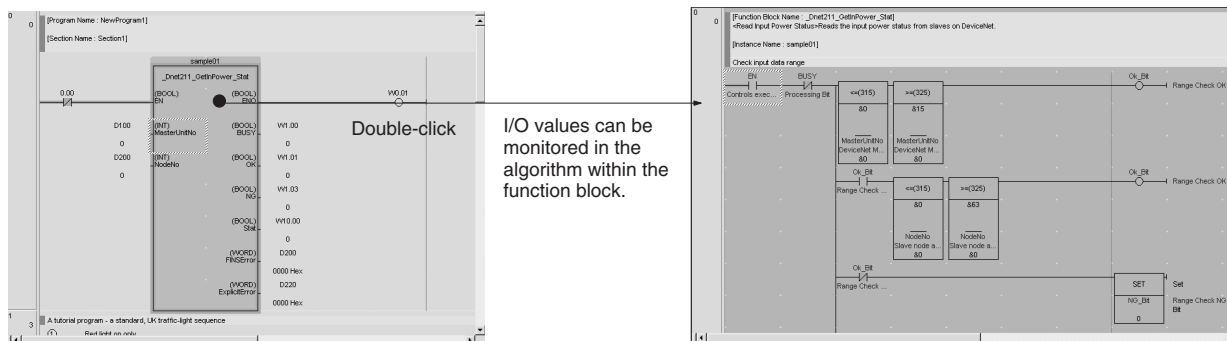

- (3) If an array variable is used in a function block and a symbol is used for the array variable's arguments, the present value cannot be monitored if that array variable is used as the operand of an input condition or special instruction. In this case, the input condition or instruction will be displayed in red.

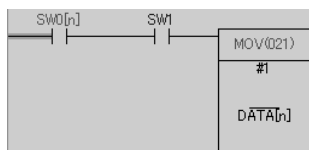

Monitoring Variables of ST Programs within Instances

With the CX-Programmer Ver. 6.1 and later versions, it is possible to monitor the ST programs within an instance when monitoring the program. To monitor I/O bits and words (I/O Bit Monitor), either double-click the instance or right-click the instance and select **Monitor FB Instance** from the pop-up menu.

To return to the original instance, right-click in the ST program monitor window and select **To Upper Layer** from the pop-up menu.

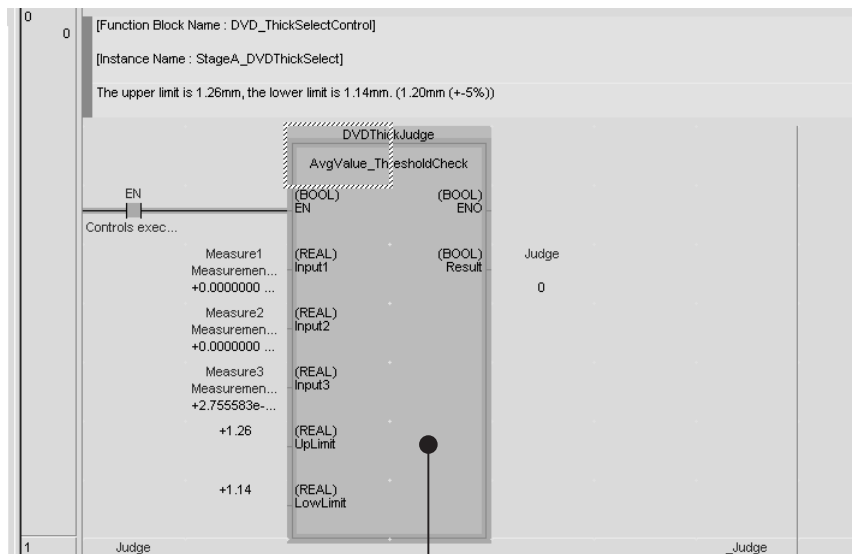

Right-click and select **To Upper Layer**.

Double-click the instance. The ST program and variable monitoring areas are displayed.

Left side: ST program monitor window

```
(* Average value calculation and check of threshold for three values
AvgValue := ( Input1 + Input2 + Input3 ) / 3.0; (* Divides 1
IF ((AvgValue <=UpLimit) AND (AvgValue >=LowLimit)) THEN (* Comp
  Result := TRUE;
ELSE
  Result := FALSE;
END_IF;
```

Right side: ST variable monitor window

```
AvgValue = +0.0000000 Float , Input1 = +2.304856e-041 Float , Inp
AvgValue = (0.0000000 Float , UpLimit = +0.0000000 Float , AvgV%
Result = 0
Result = 0
```

The variable's PV is displayed in blue characters.

The ST program is displayed in the left side of the window (called the ST program monitor window).

The values of variables used in the ST program are displayed in the right side of the window (called the ST variable monitor window).

At this point, it is possible to monitor variable values, change PVs, force-set or force-reset bits, and copy/paste variables in the Watch Window. (These operations are described below.)

Monitoring Variables

Variable values are displayed in blue in the ST variable monitor window.

- Note**
- (1) With a CJ2 CPU Unit, you cannot obtain the present value of the TIMER type variable argument of the TENTH-MS TIMER or HUNDREDTH-MS TIMER instruction. Therefore, "-" is displayed for the present value on the ST monitor view.
 - (2) When you use the present value of the TIMER type variable argument of the TENTH-MS TIMER or HUNDREDTH-MS TIMER instruction in any item other than timer instructions, the present value cannot be displayed correctly (i.e. the value is undependable.). When the present value is assigned to a different variable, its present value is also undependable.

Changing PVs

To change a PV, select the desired variable in the ST variable monitor window (displayed in reverse video when selected), right-click, and select **Set - Value** from the pop-up menu.

Select the variable.

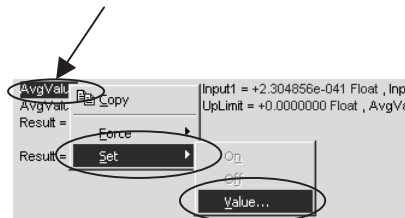

The Set New Value Dialog Box will be displayed. Input the new value in the *Value* field.

Force-setting and Force-resetting Bits

To force-set, force-reset, or clear the forced status, select the desired variable in the ST variable monitor window (displayed in reverse video when selected), right-click, and select **Force - On**, **Force - Off**, **Force - Cancel**, or **Force - Cancel All Forces** from the pop-up menu.

Copying and Pasting in the Watch Window

1,2,3...

1. To copy a variable to the Watch Window, select the desired variable in the ST variable monitor window (displayed in reverse video when selected), right-click, and select **Copy** from the pop-up menu.
2. Right-click in the Watch Window and select **Paste** from the pop-up menu.

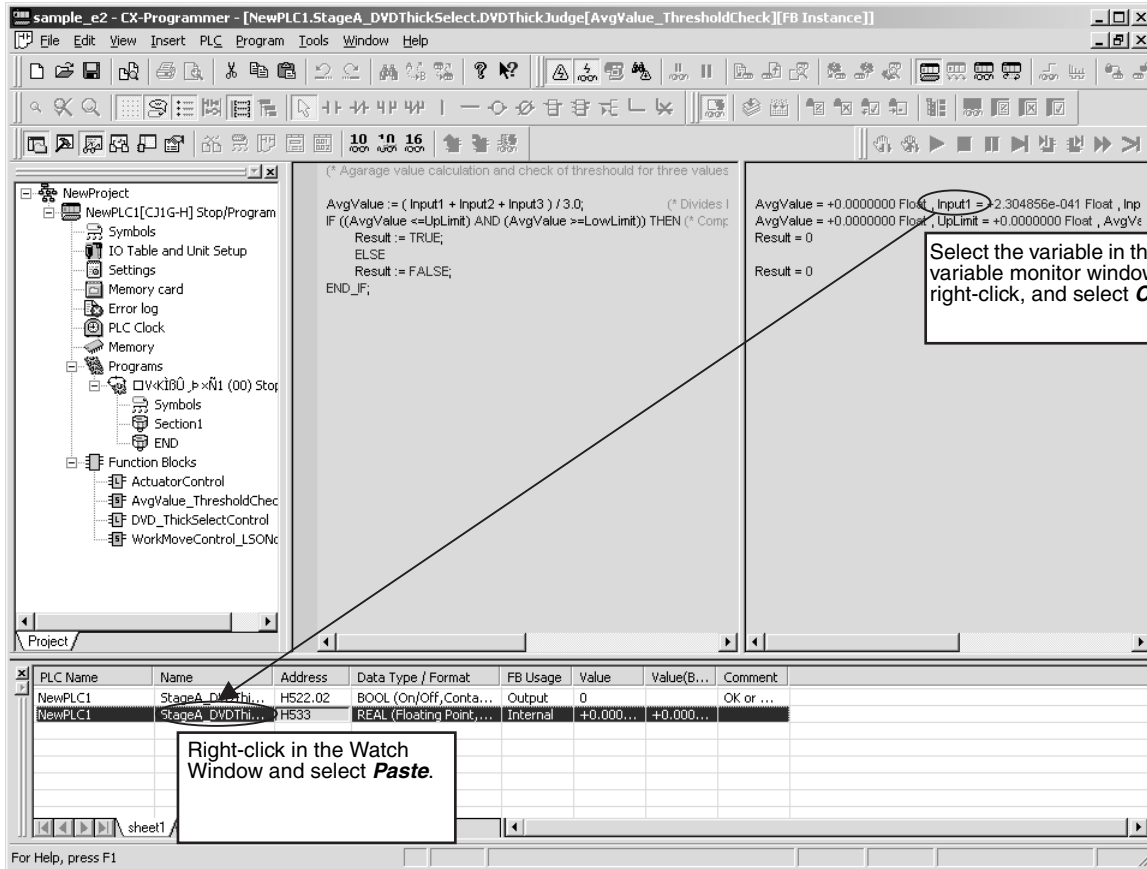

Checking Programs within Function Block Definitions

Use the following procedure to check the program in the function block definition for an instance during monitoring.

- 1,2,3...** Right-click the instance and select **To Lower Layer** from the pop-up menu. The function block definition will be displayed.

Monitoring Instance Variables in the Watch Window

Use the following procedure to monitor instance variables.

- 1,2,3...**
1. Select **View - Window - Watch**.
A Watch Window will be displayed.
 2. Use any one of the three following methods to display the *FB variables registration* Dialog Box.
 - a. Right-click the instance and select **Register in Watch Windows** from the pop-up menu.
 - b. Copy the instance and paste it in the Watch Window.
 - c. Right-click an empty row in the Watch Window and select **Register in Watch Windows** from the pop-up menu.

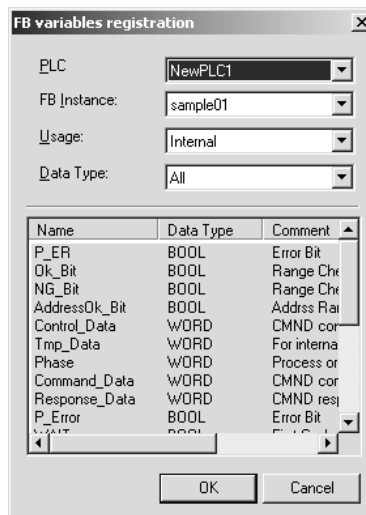

3. Select **Usage - Data Type**. The **FB Instance** setting can also be selected. The default *Usage* is **N: Internal** and the other available selections are **I: Input**, **O: Output**, and **E: External**.
The default *Data Type* is **A: All**. Special data types **BOOL** and **INT** can also be selected.
4. Click the **OK** Button. The selected variable will be registered in the Watch Window and the value will be displayed as shown below.

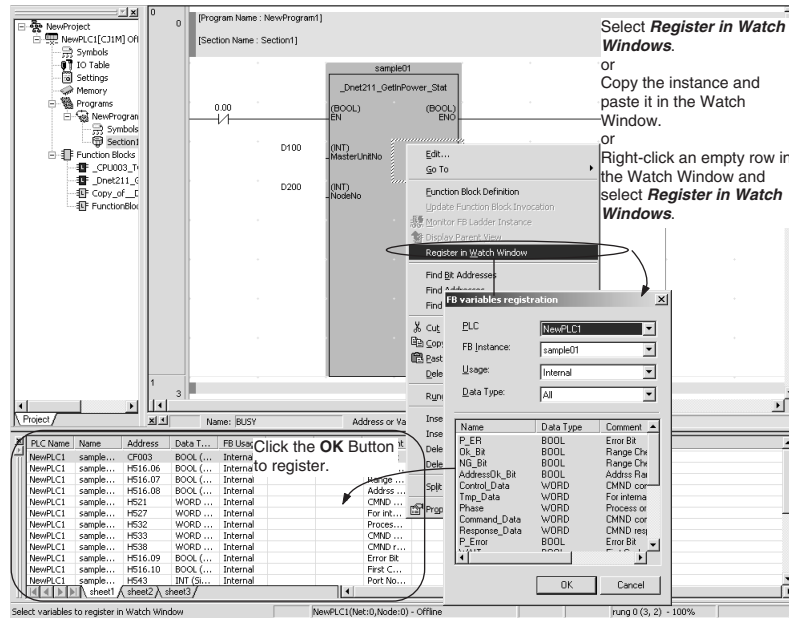

Monitoring Input Variables and Output Variables in Instances

The present values of input variables and output variables (parameters) are displayed below the parameters.

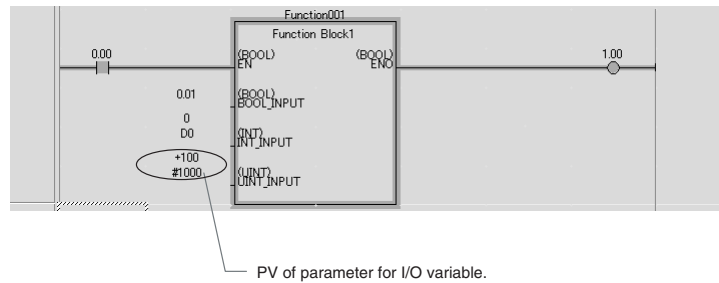

Simulation of Ladder/ST Programs in Instances

The CX-One Ver 1.1 (CX-Programmer Ver. 6.1) and later versions have a simulation function that can simulate the operation of a ladder program or ST program within a function block instance. Both step execution and break point operation are supported.

To return to the original instance, right-click in the ST program monitor window and select **To Upper Layer** from the pop-up menu.

Enabling the Simulation Function

Use the following procedure to enable the simulation function.

1,2,3...

1. Open the program containing the instance to be debugged.
2. Select **View - Toolbars** and select the **Simulator Debug** Option in the **Toolbars** Tab.
3. Select **Work Online Simulator** from the CX-Programmer's **PLC** Menu and transfer the program to the CX-Simulator in the computer.

Note Steps 2 and 3 can be done in the opposite order.

Step Execution (Step Run)

Executes the program in step (instruction) increments. When the instance is stopped, this function can move to the first step (instruction) of the ladder or ST program in that instance.

The program in the instance can be executed with the Step Run or Continuous Step Run method (see note).

Note Set the duration of the step execution for Continuous Step Run operation by selecting the CX-Programmer's **Tools - Options** command and setting the *Continuous Step Interval* on the PLCs Tab Page.

Step In

Use the following procedure to begin step execution of a ladder/ST program within an instance (called Step Run operation).

- 1,2,3...**
1. Pause execution of the instance. (See note.)
 2. Click the **Step In** Icon or select **Tools - Simulation - Mode - Step In**.

Example: Step In from Instance to Internal Ladder Program

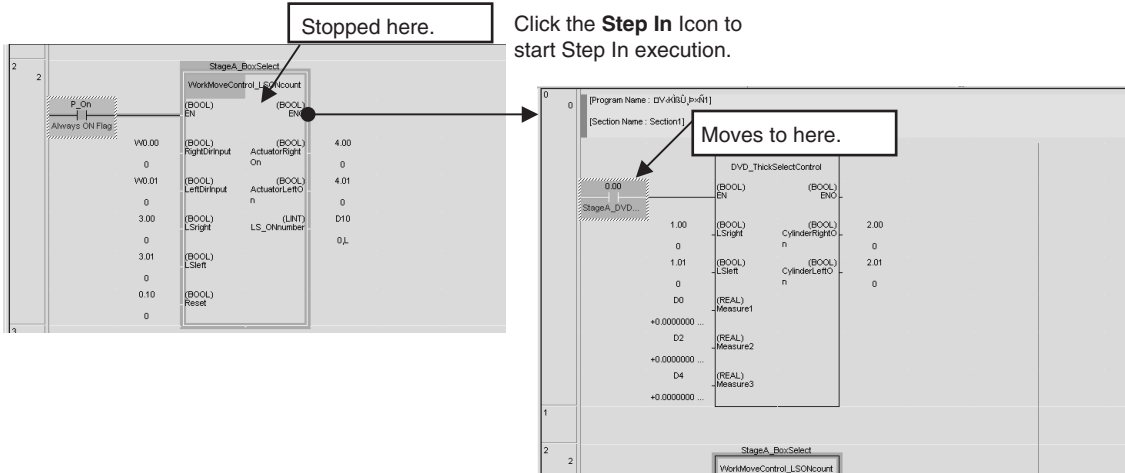

Example: Step In from ST Program to Internal Ladder Program

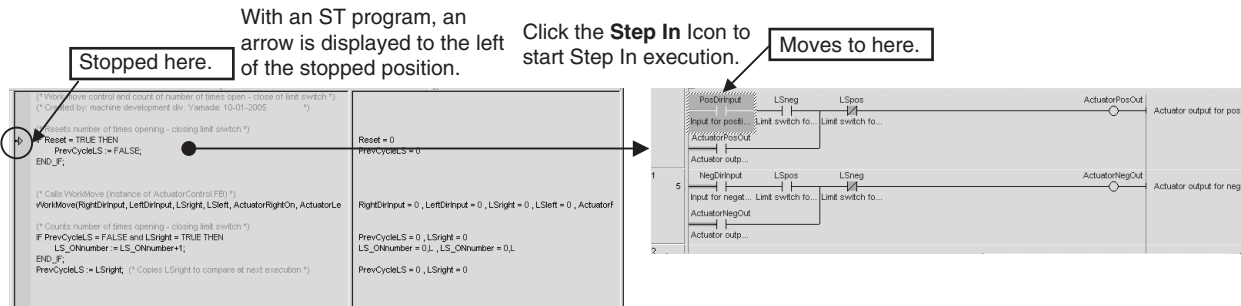

Note When the program is being executed at a point outside of the function block instance, the processing is the same as normal Step Run operation.

Step Out

Use the following procedure to pause step execution of a ladder/ST program within an instance (Step Run operation) and return to one level higher in the program (the program or instance that was the source of the call).

- 1,2,3...**
1. During Step Run operation, move the cursor to any stopping point in the instance.
 2. Click the **Step Out** Icon or select **Tools - Simulation - Mode - Step Out**.

**Example:
Returning from an ST Program to the Calling Program or Instance**

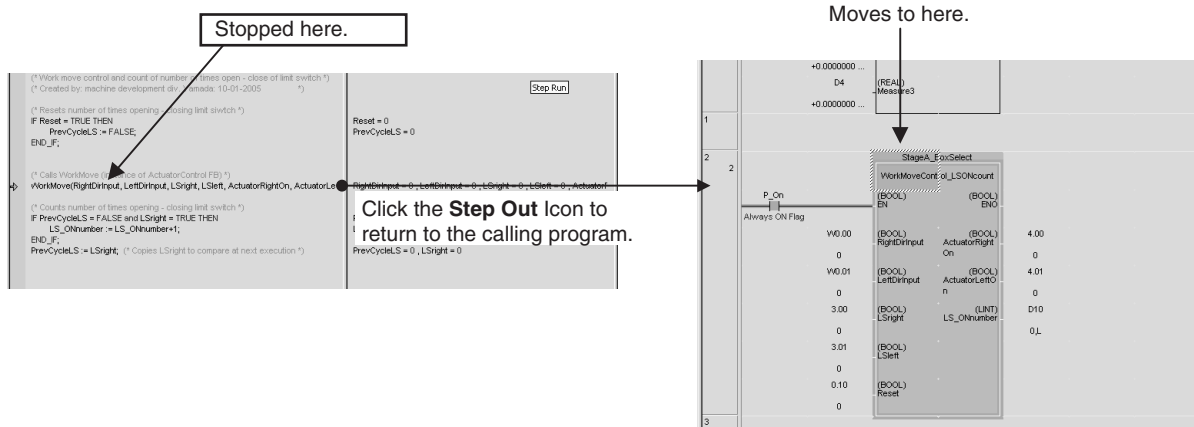

Note The Step Out command can be executed only in a ladder/ST program within an instance.

Display when Operation is Paused by the Simulation Function

The color of the cursor (or arrow in an ST program) indicates whether an operation has been paused in the Simulation Function Window, as well as which operation has been paused.

Debug operation	Color (default)	Program execution status	Details
Step Run or Continuous Step Run	Pink	Simulator paused status	Paused by Step Run operation or the Pause Button
	Regular color	Not executed due to interlock or other function.	Step is not being executed because of an instruction such as IL, MILR/MILH, JMP0, or FOR/BREAK.
Break point	Blue	Simulator instruction break	Paused (break status) by a break point.

Note (1) When **Tools - Simulation - Always Display Current Execution Point** has been selected, the Simulator automatically scrolls the display to show the paused point in the instance when performing Step Run or Continuous Step Run operation.

(2) The color of the cursor (or arrow in an ST program), which indicates when an operation has been paused in the Simulation Function Window, can be changed from its default color. To change the color, select **Tools - Options** and click the **Appearance** Tab. Select *Pause Simulator*, *Simulator Instruction Break*, or *Simulator IO Break*, and change the color for that condition.

Break Point Operation in an Instance

Execution can be paused automatically at the preset break point in the instance. (In this case, the Step In operation cannot be used.)

Note When a break point is set for an instance, the break point is valid for that instance only. (The break point is not valid for other instances created from the same function block definition.)

3-2-19 Online Editing Function Block Definitions

Ladder diagrams for ST programs in function block definitions can be edited even when the CPU Unit is operating in MONITOR mode. This enables debugging or changing function block definitions even in systems that cannot be shut down, such as systems that operate 24 hours a day.

To edit function block definitions online, you must use CX-Programmer version 7.0 or higher (i.e., CX-One version 2.0 or higher) and a CS/CJ-series CPU Unit with unit version 4.0 or later (See note.) or a CJ2-series CPU Unit.

This function cannot be used for simulations on CX-Simulator.

Note With CS/CJ-series CPU Units with unit version 3.0, online editing can be used to change peripheral aspects of function block instances.

- Parameters passing data to/from instances can be changed, instructions not in instances can be changed, and instances can be deleted.
- Instances cannot be added, instance names cannot be changed, and changes cannot be made to variable tables or algorithms in function block definitions.

Editing Reserved Memory to Add an Internal Variable with Online Editing

To add an internal variable to the variable table in a function block definition, the memory required for the size of the variable being added must be reserved in advance. This memory is separate from the internally allocated range for the variable in the function block instance area. Use the following procedure to reserve memory before starting online editing of the function block.

- 1,2,3... 1. In the Workspace, right-click the function block definition to be edited and select **Properties** from the pop-up menu.
2. Click the **Memory** Tab, right-click the area for which to reserve memory, and select **Online edit reserved memory** from the pop-up menu.

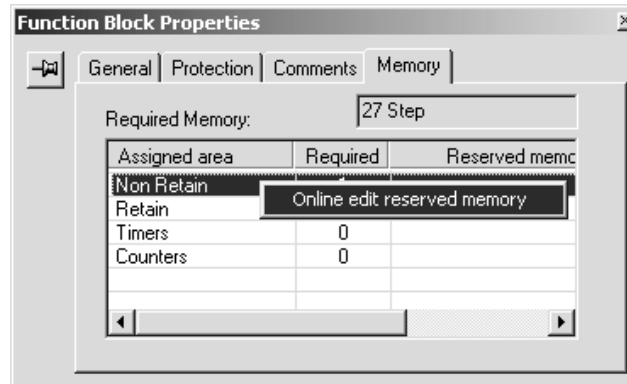

3. Enter the size of memory to reserve in each field in the Memory Size Edit for FB Online Edit Dialog Box.

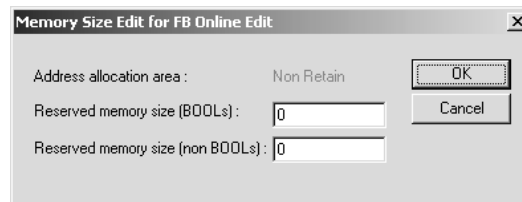

Editing and Transferring a Function Block Definition

- 1,2,3... 1. While online with the PLC, right-click a function block definition in the Workspace (see note) and select **FB online Edit - Begin** from the pop-up menu.

Note Online editing can also be started from the Function Block Definition Window, the Instance Ladder/ST Monitor Window, or a function block call instruction (from the normal ladder program or from a ladder program in a function block).

The following dialog box will be displayed before the FB Online Editor is started.

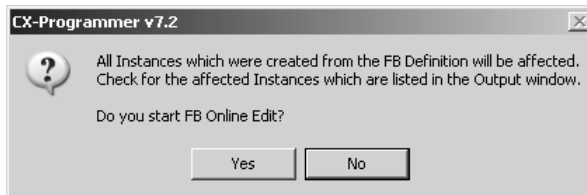

At the same time, a list of instances that will be affected is displayed in the Output Window.

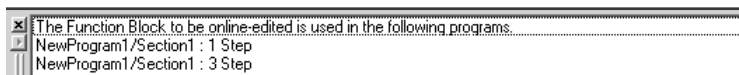

Note **Affect of Function Block Definition Changes on Instances**
When a function block definition is changed, the contents of all instances that call that function block definition will also be changed. This is illustrated below.

Example

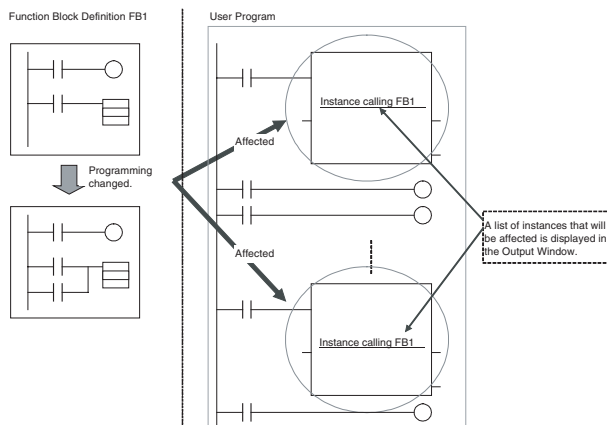

Change function block definitions only after considering the affect of the change on overall program operation.

2. Click the **Yes** Button. The contents of the function block definition will be displayed and can be edited.

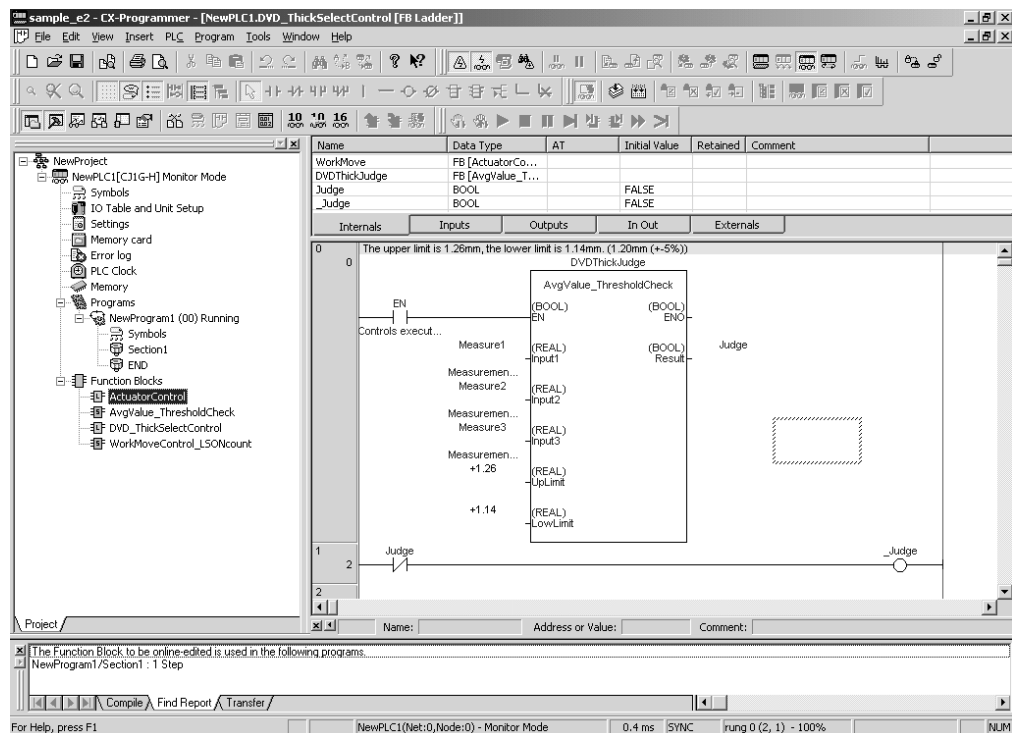

3. After editing the contents of the function block definition, select **FB online Edit - Send Changes**. The following FB Online Edit - Transfer Dialog Box will be displayed.

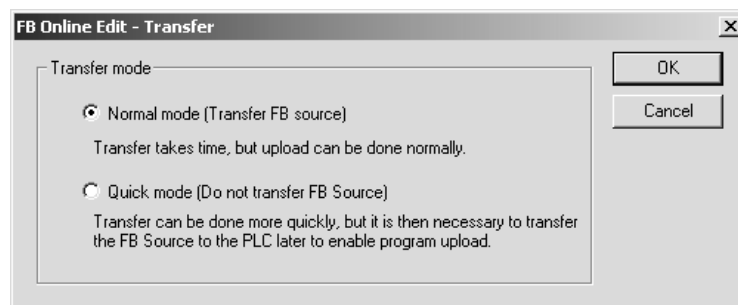

4. Select one of the following transfer modes and click the **Yes** Button.
 - Normal Mode
 - Quick Mode

Refer to *Transfer Modes* on page 127 and *Selecting a Transfer Mode* on page 128 for details on the transfer modes.

The new function block definition will be transferred to the buffer memory in the CPU Unit and the progress of the transfer will be displayed in a dialog box.

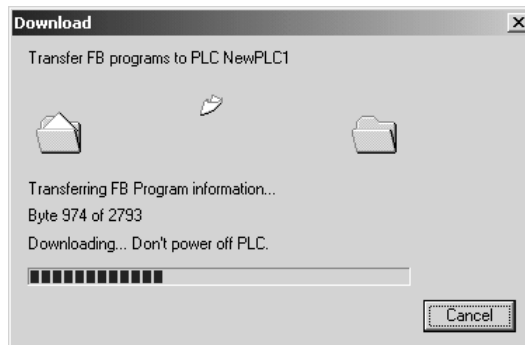

(At this point, the CPU Unit will still be operating with the previous function block definition.)

The following dialog box will appear when the transfer has been completed.

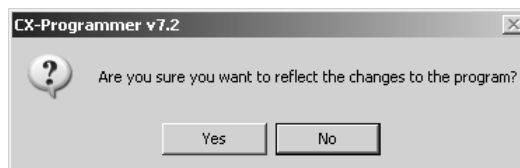

(At this point, the CPU Unit will still be operating with the previous function block definition.)

5. Click the **Yes** Button. The user program in the CPU Unit will be updated with the new function block definition from the buffer memory of the CPU Unit. (If the **No** Button is click, the new function block definition in the buffer memory will be discarded and the program will not be changed.)

In either case, the program will return to the status in which function block definitions cannot be edited. To edit another function block definition, select **FB online Edit - Begin** and begin the online editing procedure from the beginning.

Transfer Modes

Normal Mode

In Normal Mode, both the source code and object code are transferred to the CPU Unit. Some time may be required for Normal Mode transfers because of the quantity of data that must be sent. Other editing or transfer operations cannot be performed until the transfer has been completed.

Note The *Display confirmation of FB online edit changes* Option can be selected to display a confirmation dialog box after the source code has been transferred but just before updating the user memory in the CPU Unit.

Quick Mode

In Quick Mode, only the object code is transferred to the CPU Unit. The source code is not transferred, making Quick Mode faster than Normal Mode. After transferring the object code either 1) select **Program - Transfer FB Source** to transfer the source code or 2) transfer the source code according to instructions displayed in a dialog box when you go offline.

After transferring the object code, "FB Source" will be displayed in yellow at the bottom of the window to indicate that the source code has not yet been transferred. This message will disappear when the source code is transferred.

Selecting a Transfer Mode

As a rule, use Normal Mode to transfer function block definition changes. If too much time is required, increase the baud rate as much as possible before the transfer. If too much time is still required and debugging efficiency is hindered by continuous online editing, use Quick Mode as an exception, but be sure you understand the restrictions given in the following note (*Mode Restrictions in Quick Mode*).

Guidelines for transfer times are given below for eight function block definitions with a source code totaling 8 Kbytes for all 8 definitions and all instances.

	Normal Mode	Quick Mode
At 115.2 kbps:	5 s	1 s
At 19.2 kbps:	10 s	2 s

Note Restrictions in Quick Mode

A program containing function blocks cannot be uploaded correctly to the CX-Programmer unless the source code for all function block definitions has been transferred to the CPU Unit. Whenever using Quick Mode to transfer changes to function block definitions, always select **Program - Transfer FB Source** later to transfer the source code as well. Even if the source code is not transferred, it will be automatically transferred when you go offline unless the computer or CX-Programmer crashes before the source code can be transferred. In that happens, it may be impossible to upload the program. (See note.)

Note It may be still be possible to transfer the source code even if the above problem occurs.

- a. The following dialog box will be displayed the next time the CX-Programmer is started.

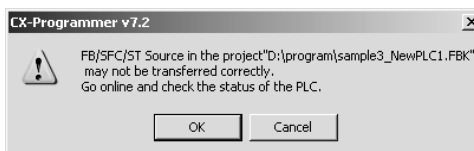

- b. Click the **OK** Button.
- c. Go online with the CPU Unit to which a transfer was made using Quick Mode.
- d. When you go online, the CXP project automatically backed up in the computer will be started and the following dialog box will be displayed.

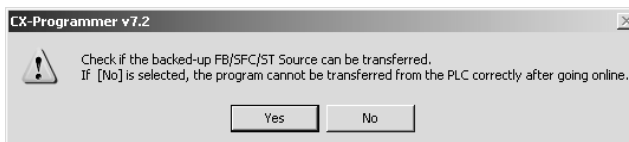

- e. Click the **Yes** Button and then following the instructions provided in the dialog boxes. The source code automatically backed up in the computer can be compared to the object code in the CPU Unit and if they match, the source code can be transferred.

Note Source Code and Object Code

Before transferring a program, the CX-Programmer normally compiles the source code into object code so that the CPU Unit can execute it and then transfers both the source code and object code to the CPU Unit. The CPU Unit stores the source code and object code in user memory and built-in flash memory. Only when both the source code and object code exist in the CPU Unit can the CX-Programmer transfer and restore the program for the upload operation.

Canceling Changes to Function Block Definitions

Select **FB online Edit - Cancel** to discard any changes made to a function block definition. The function block definition will not be transferred to the CPU Unit and the original definition will be restored.

Effects on CPU Unit Operation

The following will occur if online editing is performed with the CPU Unit operating in MONITOR mode: 1) The cycle time of the CPU Unit will be extended by several cycle times when the program in the CPU Unit is rewritten and 2) The cycle time will again be extended when the results of online editing are backed up to built-in flash memory. (At this time, the BKUP indicator on the front of the CPU Unit will flash and the progress will be displayed on the CX-Programmer.)

Maximum Cycle Time Extensions for Online Editing

The maximum extensions to the cycle time are given in the following table.

During online editing	During backup
12 ms max.	4% of cycle time

Note Cycle Time Monitor Time

Be sure that the cycle time monitor time set in the PLC Setup is not exceeded when the program is rewritten as a result of online editing in MONITOR mode. If the monitor time is exceeded, a cycle time exceeded error will occur and CPU Unit operation will stop. If this occurs, switch to PROGRAM mode and then to MONITOR or RUN mode to restart operation.

 **Caution** If synchronous unit operation is being used, an increase in the synchronous processing time caused by online editing may result in unexpected operation timing. Perform online editing only after confirming that an increased synchronous processing time will not affect the operation of the main and slave axes.

Restrictions in Online Editing of Function Block Definitions

The following restrictions apply to online editing of function block definitions.

- Online editing is not possible for function block definitions that exceed 4 Ksteps. (except for CJ2-series CPU Units)
- A maximum of 0.5 Ksteps can be added to or deleted from a function block definition during one online editing operation. (except for CJ2-series CPU Units)
- Input variables, output variables, and input-output variables cannot be added or deleted.
- New function block instances cannot be added.
- Instance names cannot be changed.

- Internal variables can be added, internal variable comments can be changed, and internal variables can be deleted from the variable table in the function block definition. To add an internal variable, however, memory must be reserved in advance. Refer to *Editing Reserved Memory to Add an Internal Variable with Online Editing* on page 124 for details.
- The previous status flags for all differentiated instructions (DIFU(013), @ instructions, DIFD(014), and % instructions) will be initialized (i.e., turned OFF) when online editing is finished.
- After performing online editing, do not turn OFF the power supply to the PLC until the CPU Unit has finished backing up data to the built-in flash memory (i.e., until the BKUP indicator stops flashing). If the power supply is turned OFF before the data is backed up, the data will not be backed up and the program will return to the status it had before online editing was performed.

Part 2: Structured Text (ST)

SECTION 4

Introduction to Structured Text

This section introduces the structure text programming functionality of the CX-Programmer and explains the features that are not contained in the non-structured text version of CX-Programmer.

4-1	ST Language	134
4-1-1	Overview	134
4-2	CX-Programmer Specifications	135
4-2-1	PLC Models Compatible with ST Programs (ST Tasks)	135
4-2-2	Specifications	135

4-1 ST Language

This section explains the specifications and operating procedures for ST programs directly allocated to CX-Programmer tasks (ST tasks). Refer to the following sections for information on functions and operations specific to ST programs used in other programs (function blocks or SFC).

- ST programs used in function block instances:
Refer to *Part 1: Function Blocks* in this manual.
- ST programs used in SFC:
Refer to the *CX-Programmer Operation Manual: SFC (W469)*.

4-1-1 Overview

The ST (Structured Text) language is a high-level language code for industrial controls (mainly PLCs) defined by the IEC 61131-3 standard. The standard control statements, operators, and functions make the ST language ideal for mathematical processing that is difficult to write in ladder programming. (The ST language does not support all of the processing that can be written in ladder language.)

The ST language supported by CX-Programmer Ver. 7.2 or higher conforms with the IEC 61131-3 standard, and these ST-language programs can be allocated to tasks.

The PLC must be a CS/CJ-series CPU Unit with unit version 4.0 or later, or a CJ2-series CPU Unit.

The following list shows the features of the ST language.

- There are many control statements available, such as loop statements and IF-THEN-ELSE statements, many operators such as arithmetic operators, comparison operators, and AND/OR operators, as well as many mathematical functions, string extract and merge functions, Memory Card processing functions, string transfer functions, and trigonometric functions.
- Programs can be written like high-level languages such as C, and comments can be included to make the program easy to read.

```

ST Program
IF score > setover THEN      (*If score>setover*)
  underNG := FALSE;        (*Turn OFF underNG*)
  OK := FALSE;             (*Turn OFF OK*)
  overNG := TRUE;          (*Turn ON overNG*)

ELSIF score < setunder THEN (*If score=<setover and score < setunder*)
  overNG := FALSE;        (*Turn ON overNG*)
  OK := FALSE;            (*Turn OFF OK*)
  underNG := TRUE;        (*Turn ON underNG*)

ELSE                          (*If setover>score>setunder*)
  underNG := FALSE;        (*Turn OFF underNG*)
  overNG := FALSE;        (*Turn OFF overNG*)
  OK := TRUE;              (*Turn OFF OK*)

END_IF;                       (*End of IF statement*)

```

- ST programs can be uploaded and downloaded just like ordinary programs, but ST program tasks cannot be uploaded and downloaded in task units.
- Function blocks (ladder or ST language) can be called in ST programs.

- One-dimensional array variables are supported for easier data handling in applications.

4-2 CX-Programmer Specifications

This section describes the operating environment for CX-Programmer ST programs (ST tasks). For details on the basic CX-Programmer operating environment, refer to the *CX-Programmer Operation Manual (W446)*.

- For details on the CX-Programmer operating environment used with other programs (function block or SFC), refer to *Part 1: Function Blocks* in this manual, or the *CX-Programmer Operation Manual: SFC (W469)*.

4-2-1 PLC Models Compatible with ST Programs (ST Tasks)

The following PLC models support ST tasks.

PLC model	CPU Unit model
CJ2H	CJ2H-CPU68/67/66/65/64/68-EIP/67-EIP/66-EIP/65-EIP/64-EIP
CJ2M	CJ2M-CPU11/12/13/14/15/31/32/33/34/35
CS1G-H with unit version 4.0	CS1G-CPU45H/44H/43H/42H
CS1H-H with unit version 4.0	CS1H-CPU67H/66H/65H/64H/63H
CJ1G-H with unit version 4.0	CJ1G-CPU45H/44H/43H/42H
CJ1H-H with unit version 4.0	CJ1H-CPU67H/66H/65H/67H-R/66H-R/65H-R/64H-R
CJ1M with unit version 4.0	CJ1M-CPU23/22/21/13/12/11

4-2-2 Specifications

Item	Specification
Program languages that can be allocated to tasks	SFC, ladder, or ST (These programs can be combined freely.)
ST program units	Task units Up to 288 tasks (32 cyclic tasks, and 256 extra cyclic tasks)
Tasks to which ST programs can be allocated	Cyclic tasks and extra cyclic tasks
Online editing	ST chart editing Note The user can select standard mode (ST source code included in transfer) or quick mode (ST source code not included in transfer).
Array variables	Array variables can be used in SFC, ladder, and ST programs.

SECTION 5

Structured Text (ST) Language Specifications

This section provides specifications for reference when using structured text programming, as well as programming examples and restrictions.

5-1	Structured Text Language Specifications	138
5-1-1	Overview of the Structured Text Language	138
5-2	Data Types Used in ST Programs	139
5-2-1	Basic Data Types	139
5-2-2	Derivative Data Types	140
5-3	Inputting ST Programs	140
5-3-1	Syntax Rules	140
5-3-2	CX-Programmer's ST Input Screen Display	143
5-4	ST Language Configuration	144
5-4-1	Statements	144
5-4-2	Variables	145
5-4-3	Inputting Constants	145
5-4-4	Operators	145
5-4-5	Standard Functions	146
5-4-6	OMRON Expansion Functions	152
5-5	Statement Descriptions	155
5-5-1	Assignment	155
5-5-2	Control Statements	155
5-6	ST-language Program Example	173
5-6-1	Using an ST Program in a Function Block	173
5-7	Restrictions	174
5-7-1	Restrictions	174
5-7-2	Commonly Asked Questions	175

5-1 Structured Text Language Specifications

5-1-1 Overview of the Structured Text Language

Structured text is a high-level textual language that has selection and iteration structures, and is similar to PASCAL.

ST Language Configuration

■ ST Language Configuration

An ST language program is composed from statements. There are two kinds of statements: assignment and control.

- Assignment statement: This statement uses an equation to store a calculation result in a variable.
- Control statement: Includes statements such as selection statements and iteration statements.

For details on each kind of statement, refer to 5-4 *ST Language Configuration*.

■ Statement Contents

Statements are composed of the following elements.

- Variables (Refer to 5-4-2 *Variables*.)
- Constants (Refer to 5-4-3 *Inputting Constants*.)
- Operators (Refer to 5-4-4 *Operators*.)
- Functions (Refer to 5-4-5 *Standard Functions* and 5-4-6 *OMRON Expansion Functions*.)

■ Example of a Control Statement

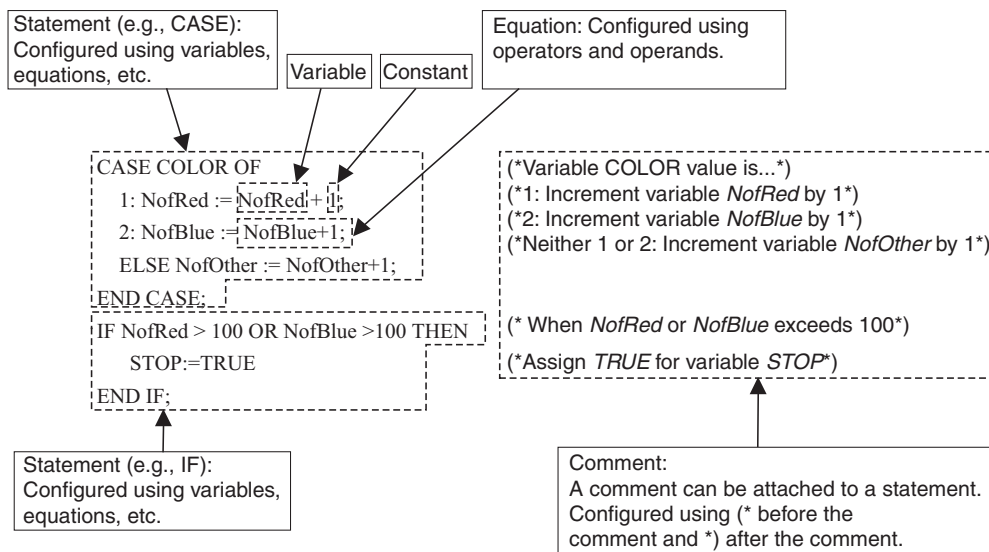

Note In an ST program, addresses are not input as actual I/O memory addresses. Variable names are used for all address inputs. The addresses that use variables are set by the user. For details on variable specifications and setting methods, refer to the *CX-Programmer Operation Manual (W446)*.

5-2 Data Types Used in ST Programs

The following tables show the data types used in ST programs. For details on the data types that can be used in ST programs within function blocks, refer to *Part 1: Function Blocks* in this manual.

5-2-1 Basic Data Types

Data type	Content	Size	Range of values
BOOL	Bit data	1	0 (FALSE), 1 (TRUE)
INT	Integer	16	-32,768 to +32,767
DINT	Double integer	32	-2,147,483,648 to +2,147,483,647
LINT	Long (8-byte) integer	64	-9,223,372,036,854,775,808 to +9,223,372,036,854,775,807
UINT	Unsigned integer	16	&0 to 65,535
UINT BCD	Unsigned BCD integer	---	(See note 1.)
UDINT	Unsigned double integer	32	&0 to 4,294,967,295
UDINT BCD	Unsigned double BCD integer	---	(See note 1.)
ULINT	Unsigned long (8-byte) integer	64	&0 to 18,446,744,073,709,551,615
ULINT BCD	Unsigned long (8-byte) BCD integer	---	(See note 1.)
REAL	Real number	32	-3.402823×10^{38} to $-1.175494 \times 10^{-38}$, 0, $+1.175494 \times 10^{-38}$ to $+3.402823 \times 10^{38}$
LREAL	Long real number	64	$-1.79769313486232 \times 10^{308}$ to $-2.22507385850720 \times 10^{-308}$, 0, $2.22507385850720 \times 10^{-308}$ to $1.79769313486232 \times 10^{308}$
WORD	16-bit data	16	#0000 to FFFF or &0 to 65,535
DWORD	32-bit data	32	#00000000 to FFFFFFFF or &0 to 4,294,967,295
LWORD	64-bit data	64	#0000000000000000 to FFFFFFFFFFFFFFFF or &0 to 18,446,744,073,709,551,615
STRING (See note 3.)	Text string	Variable	---
FUNCTION BLOCK	Function block instance	---	---
CHANNEL	Word	---	(See note 1.)
NUMBER	Constant or number	---	(See note 2.)
TIMER	Timer	Completion flag: 1 Present value: 16	Timer No.: 0 to 4095 Timer completion flag: 0, 1 Timer PV: 0 to 9999 (BCD), 0 to 65535 (Binary)
COUNTER	Counter	Completion flag: 1 Present value: 6	Counter No.: 0 to 4095 Counter completion flag: 0, 1 Counter PV: 0 to 9999 (BCD), 0 to 65535 (Binary)

- Note**
- (1) In ST programs, these data types are recognized as the following data types.
 - UNIT BCD is recognized as WORD.
 - UDINT BCD is recognized as DWORD.
 - ULINT BCD is recognized as LWORD.
 - CHANNEL is recognized as WORD.
 - (2) This data type cannot be used in an ST program. A program error will occur if this data type is specified.
 - (3) Refer to the *Section 5-3 Inputting ST Programs* for the input method.

5-2-2 Derivative Data Types

Data type	Content
Array	1-dimensional array; 32,000 elements max.
Structure	User-defined data type

5-3 Inputting ST Programs

5-3-1 Syntax Rules

Statement Delimiters

- Statements (assignment and control statements) must always end in a semicolon (;). The statement cannot be completed by simply using a carriage return.
- Do not use a semicolon (;) as a delimiter within a statement such as following reserved words, values, or equations. Inserting a semicolon within a statement, except at the end of a statement, will result in a syntax error.

Comments

- Comments are enclosed in parentheses and asterisks, i.e., (**comment**). Any characters except parentheses and asterisks can be used within a comment. Nesting within comments is not supported.

Notation

(**comment**)

Example

(**this is the comment**)

Note Nesting in comments is not possible, i.e.,

(**(*this type of nesting is not supported*)**)

Spaces, Carriage Returns, Tabs

- Any number of spaces, carriage returns, and tabs, or combinations of these can be used anywhere within statements. Therefore, use spaces, carriage returns, and tabs between reserved words and equations to make them easier to read.
- Spaces, carriage returns, and tabs cannot be used between the following tokens (the smallest meaningful unit for compiling), in which case they are referred to as token separators.

Tokens: Reserved words, variable names, special characters, constants (numerical values)

Reserved words (upper or lower case): AND, CASE, DO, ELSE, FOR, IT, NOT, OF, OR, REPEAT, THEN, TO, UNTIL, WHILE, XOR, TRUE, FALSE, ELSIF, BY, EXIT, RETURN

Variable names:

Any text that is not a reserved word will be recognized as a variable name.

Special characters:

<=, >=, <>, :=, .., &, (*, *)

Constants (numerical values):

- Numerical value only for decimal numbers
- 16# followed by numerical value for hexadecimal numbers
- 2# followed by numerical value for binary numbers
- 8# followed by numerical value for octal numbers

If a space, carriage return, or tab is used between any of the above tokens, the parts of the token on either side will be treated as separate tokens. Therefore, make sure that spaces, carriage returns, or tabs are not used within a single token.

- Always use a space, carriage return, tab, or other token separator between reserved words and variable names. Using token separators between other token combinations is optional. In the following example, the box (□) indicates where a space, carriage return, tab, or other token separator is required.

```
IF□A>0THEN□X=10;
ELSE□
    X:=0;
END_IF;
```

Upper and Lower Case

- Reserved words and variable names do not distinguish between upper and lower case (either can be used).

Prohibited Characters for Variable Names

- The following characters enclosed in square brackets cannot be used in variable names.
- [!], ["], [#], [\$], [%], [&], [], [(, [)], [-], [=], [^], [~], [N], [], [@], [], [{], [:], [+], [:], [*], []], [], [], [<], [.], [>], [/], [?]
- The numbers 0 to 9 cannot be used as the first character of variable names.
- An underscore cannot be followed immediately by another underscore in variable names.
- Spaces cannot be used in variable names.

An error message will occur if any of these characters are used in this way.

Operator Priority

- Consider the operator priority in the structured text syntax, or enclose operations requiring priority in parentheses.
Example: AND takes priority over OR. Therefore, in the example X OR Y AND Z, priority will be given to Y AND Z.

STRING Data Type

- The following text strings are supported:
Strings with up to 255 alphanumeric characters
The text strings are not case sensitive.
- Text strings defined in the ST language are stored in PLC memory as follows:

Data for the Text String "123456"

n	31 32
n+1	33 34
n+2	35 36
n+3	00 00

The null code (00) is stored at the end of the text string.

- Place text strings inside signal quotation marks.

Notation	Description
'A'	Indicates the text string "A" (ASCII 41).
' '	Indicates a text string containing a single space (ASCII 20).
"	Indicates an empty text string.

- Two hexadecimal digits following a dollar sign (\$) are interpreted as hexadecimal values.

Notation	Description
'\$02'	The hexadecimal number 02 (start code)
'\$03'	The hexadecimal number 03 (end code)

- Certain alphabet characters following a dollar sign (\$) are interpreted as listed in the following table.

Notation	Description
'\$\$'	The dollar sign (ASCII 24)
'\$'	A single quotation mark (ASCII 27)
'\$L' or '\$l'	Line feed (ASCII 0A)
'\$N' or '\$n'	Carriage return + line feed (ASCII 0D 0A)
'\$P' or '\$p'	New page (ASCII 0C)
'\$R' or '\$r'	Carriage return (ASCII 0D)
'\$T' or '\$t'	Tab (ASCII 09)

- When a text string is being stored from the ladder program in an ST function block's STRING variable, append a NULL character (#00) to the end of the text string.

Example: Passing string data to the function block STRING variable StrX:

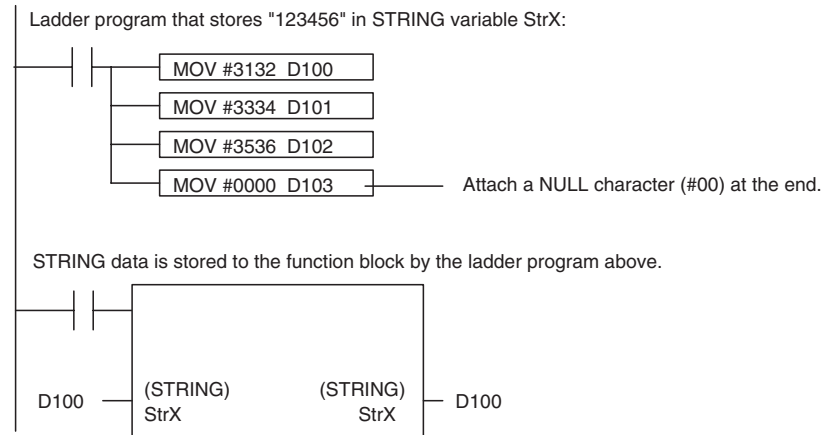

About TIMER and COUNTER Data Types

Describe the TIMER and COUNTER type variables as shown below.

- How to describe the TIMER type variables in the structured text.
 - Timer completion flag: TIMER_type_variable_name.CF
 - Timer PV: TIMER_type_variable_name.PV
 - (Example) Timer completion flag: Timer1.CF
 - Timer PV: Timer1.PV
- How to describe the COUNTER type variables
 - Counter completion flag: COUNTER_type_variable_name.CF
 - Counter PV: COUNTER_type_variable_name.PV
 - (Example) Counter completion flag: Counter1.CF
 - Counter PV: Counter1.PV

The completion flags are read only. Writing is not allowed.
The present values can be read/written.

5-3-2 CX-Programmer's ST Input Screen Display

Text Display Color

The CX-Programmer automatically displays text in the following colors when it is input or pasted in the ST Input Screen.

- Text keywords (reserved words): Blue
- Comments: Green
- Errors: Red
- Other: Black

Changing Fonts

To change font sizes or display colors, select **Tools - Options**, click the **Appearance** Tab, and then click the **ST Font** Button. The font name, font size (default is 8 point), and color can be changed.

5-4 ST Language Configuration

5-4-1 Statements

Statement		Function	Example
End of statement		Ends the statement	;
Comment		All text between (* and *) is treated as a comment.	(*comment*)
Assign- ment state- ment	Assignment	Substitutes the results of the expres- sion, variable, or value on the right for the variable on the left.	A:=B;
Control statements	IF, THEN, ELSIF, ELSE, END_IF	Evaluates an expression when the condition for it is true.	IF (<i>condition_1</i>) THEN (<i>expression 1</i>); ELSIF (<i>condition_2</i>) THEN (<i>expression 2</i>); ELSE (<i>expression 3</i>); END_IF;
	CASE, ELSE, END_CASE	Evaluates an express based on the value of a variable.	CASE (<i>variable</i>) OF 1: (<i>expression 1</i>); 2: (<i>expression 2</i>); 3: (<i>expression 3</i>); ELSE (<i>expression 4</i>); END_CASE;
	FOR, TO, BY, DO, END_FOR	Repeatedly evaluates an expression according to the initial value, final value, and increment.	FOR (<i>identifier</i>) := (<i>initial_value</i>) TO (<i>final_value</i>) BY (<i>increment</i>) DO (<i>expression</i>); END_FOR;
	WHILE, DO, END_WHILE	Repeatedly evaluates an expression as long as a condition is true.	WHILE (<i>condition</i>) DO (<i>expression</i>); END_WHILE;
	REPEAT, UNTIL, END_REPEAT	Repeatedly evaluates an expression until a condition is true.	REPEAT (<i>expression</i>); UNTIL (<i>condition</i>) END_REPEAT;
	EXIT	Stops repeated processing.	EXIT;
	RETURN	ST program: Ends the ST task that is being exe- cuted, and executes the next task. ST used in SFC: Ends the SFC action program that is being executed, and executes the next action program. ST used in a function block: Returns from the called program to the point in the calling program where the call occurred.	RETURN;
Function block instance call	Calls a function block definition.	When used in a function block: Variable name with FUNCTION BLOCK data type (called function block definition's input variable name := calling function block definition's variable name or constant, ..., called function block definition's output vari- able name or constant => calling func- tion block definition's output variable name, ...);	

5-4-2 Variables

For details on variable specifications and setting methods, refer to the *CX-Programmer Operation Manual (W469)*.

5-4-3 Inputting Constants

Numerical values can be expressed in decimal, hexadecimal, octal, or binary, as shown in the following examples.

Notation	Method	Example (for the decimal value 12)
Decimal:	Numerical value only	12
Hexadecimal:	16# followed by numerical value	16#C
Octal:	8# followed by numerical value	8#14
Binary:	2# followed by numerical value	2#1100
Text string:	Place in single quotation marks	'Hello world'

Note Negative hexadecimal, octal, and binary numbers are expressed as 2's complements.

The valid range of INT data is -32,768 to 32,767 in decimal, but 0000 to FFFF in hexadecimal, so the 2's complement is used for negative integers. For example, when a value of -10 decimal is set in an INT variable, it will be expressed as 16#FFF6 in hexadecimal.

5-4-4 Operators

Operation	Symbol	Data types supported by operator	Priority 1: Lowest 11: Highest
Parentheses and brackets	<i>(expression)</i> , <i>array[index]</i>		1
Function evaluation	<i>identifier</i>	Depends on the function (refer to <i>Appendix C Function Descriptions</i>)	2
Exponential	**	Base: REAL, LREAL Exponent: INT, DINT, LINT, UINT, UDINT, ULINT, REAL, LREAL	3
Complement	NOT	BOOL, WORD, DWORD, LWORD	4
Multiplication	*	INT, DINT, LINT, UINT, UDINT, ULINT, REAL, LREAL	5
Division	/	INT, DINT, LINT, UINT, UDINT, ULINT, REAL, LREAL	5
Addition	+	INT, DINT, LINT, UINT, UDINT, ULINT, REAL, LREAL, STRING	6
Subtraction	-	INT, DINT, LINT, UINT, UDINT, ULINT, REAL, LREAL	6
Comparisons	<, >, <=, >=	BOOL, INT, DINT, LINT, UINT, UDINT, ULINT, WORD, DWORD, LWORD, REAL, LREAL, STRING	7
Equality	=	BOOL, INT, DINT, LINT, UINT, UDINT, ULINT, WORD, DWORD, LWORD, REAL, LREAL, STRING	8
Non-equality	<>	BOOL, INT, DINT, LINT, UINT, UDINT, ULINT, WORD, DWORD, LWORD, REAL, LREAL, STRING	8
Boolean AND	&	BOOL, WORD, DWORD, LWORD	9
Boolean AND	AND	BOOL, WORD, DWORD, LWORD	9
Boolean exclusive OR	XOR	BOOL, WORD, DWORD, LWORD	10
Boolean OR	OR	BOOL, WORD, DWORD, LWORD	11

Note Operations are performed according to the data type.

Therefore, the addition result for INT data, for example, must be a variable using the INT data type. Particularly care is required when a carry or borrow occurs in an operation for integer type variables. For example, using integer type variables A=3 and B= 2, if the operation (A/B)*2 is performed, the result of A/B is 1 (1.5 with the value below the decimal discarded), so (A/B)*2 = 2.

5-4-5 Standard Functions

Function type	Syntax
Numerical Functions	Absolute values, trigonometric functions, etc.
Arithmetic Functions	Exponential (EXPT)
Data Type Conversion Functions	<i>Source_data_type_TO_New_data_type (Variable_name)</i>
Number-String Conversion Functions	<i>Source_data_type_TO_STRING (Variable_name)</i> <i>STRING_TO_New_data_type (Variable_name)</i>
Data Shift Functions	Bitwise shift (SHL and SHR), bitwise rotation (ROL and ROR), etc.
Data Control Functions	Upper/lower limit control (LIMIT), etc.
Data Selection Functions	Data selection (SEL), maximum value (MAX), minimum value (MIN), multiplexer (MUX), etc.

Numerical Functions

Function	Argument data type	Return value data type	Description	Example
ABS (<i>argument</i>)	INT, DINT, LINT, UINT, UDINT, ULINT, REAL, LREAL	INT, DINT, LINT, UINT, UDINT, ULINT, REAL, LREAL	Absolute value [<i>argument</i>]	a: = ABS (b) (*absolute value of variable <i>b</i> stored in variable <i>a</i> *)
SQRT (<i>argument</i>)	REAL, LREAL	REAL, LREAL	Square root: $\sqrt{\text{argument}}$	a: = SQRT (b) (*square root of variable <i>b</i> stored in variable <i>a</i> *)
LN (<i>argument</i>)	REAL, LREAL	REAL, LREAL	Natural logarithm: LOG _e argument	a: = LN (b) (*natural logarithm of variable <i>b</i> stored in variable <i>a</i> *)
LOG (<i>argument</i>)	REAL, LREAL	REAL, LREAL	Common logarithm: LOG ₁₀ argument	a: = LOG (b) (*common logarithm of variable <i>b</i> stored in variable <i>a</i> *)
EXP (<i>argument</i>)	REAL, LREAL	REAL, LREAL	Natural exponential: e ^{ar-} gument	a: = EXP (b) (*natural exponential of variable <i>b</i> stored in variable <i>a</i> *)
SIN (<i>argument</i>)	REAL, LREAL	REAL, LREAL	Sine: SIN argument	a: = SIN (b) (*sine of variable <i>b</i> stored in variable <i>a</i> *)
COS (<i>argument</i>)	REAL, LREAL	REAL, LREAL	Cosine: COS argument	a: = COS (b) (*cosine of variable <i>b</i> stored in variable <i>a</i> *)
TAN (<i>argument</i>)	REAL, LREAL	REAL, LREAL	Tangent: TAN argument	a: = TAN (b) (*tangent of variable <i>b</i> stored in variable <i>a</i> *)
ASIN (<i>argument</i>)	REAL, LREAL	REAL, LREAL	Arc sine: SIN ⁻¹ argument	a: = ASIN (b) (*arc sine of variable <i>b</i> stored in variable <i>a</i> *)
ACOS (<i>argument</i>)	REAL, LREAL	REAL, LREAL	Arc cosine: COS ⁻¹ argument	a: = ACOS (b) (*arc cosine of variable <i>b</i> stored in variable <i>a</i> *)

Function	Argument data type		Return value data type	Description	Example
ATAN (<i>argument</i>)	REAL, LREAL		REAL, LREAL	Arc tangent: TAN^{-1} argument	a: = ATAN (b) (*arc tangent of variable <i>b</i> stored in variable <i>a</i> *)
EXPT (<i>base, exponent</i>)	Base	REAL, LREAL	REAL, LREAL	Exponential: Base ^{exponent}	a: = EXPT (b, c) (*Exponential with variable <i>b</i> as the base and variable <i>c</i> as the exponent is stored in variable <i>a</i> *)
	Exponent	INT, DINT, LINT, UINT, UDINT, ULINT, REAL, LREAL			
MOD (dividend data, divisor)	Dividend data	INT, UINT, UDINT, ULINT, DINT, LINT	INT, UINT, UDINT, ULINT, DINT, LINT	Remainder	a := MOD(b, c) (* Remainder found by dividing variable <i>b</i> by variable <i>c</i> is stored in variable <i>a</i> *)
	Divisor	INT, UINT, UDINT, ULINT, DINT, LINT			

Note The data type returned for numerical functions is the same as that used in the argument. Therefore, variables substituted for function return values must be the same data type as the argument.

Text String Functions The following functions can be used with CS/CJ-series CPU Units with unit version 4.0 or later, or CJ2-series CPU Units.

Function	Argument data type		Return value data type	Description	Example
LEN(<i>String</i>)	String	STRING	INT	Detects the length of a text string.	a: = LEN (b) (*number of characters in string <i>b</i> stored in variable <i>a</i> *)
LEFT(< <i>Source_string</i> >, < <i>Number_of_characters</i> >)	Source_string	STRING	STRING	Extracts characters from a text string starting from the left.	a: = LEFT (b,c) (*number of characters specified by variable <i>c</i> extracted from the left of text string <i>b</i> and stored in variable <i>a</i> *)
	Number_of_characters	INT, UINT			
RIGHT(< <i>Source_string</i> >, < <i>Number_of_characters</i> >)	Source_string	STRING	STRING	Extracts characters from a text string starting from the right.	a: = RIGHT (b,c) (*number of characters specified by variable <i>c</i> extracted from the right of text string <i>b</i> and stored in variable <i>a</i> *)
	Number_of_characters	INT, UINT			
MID(< <i>Source_string</i> >, < <i>Number_of_characters</i> >, < <i>Position</i> >)	Source_string	STRING	STRING	Extracts characters from a text string.	a: = MID (b,c,d) (*number of characters specified by variable <i>c</i> extracted from text string <i>b</i> starting at position specified by variable <i>d</i> and stored in variable <i>a</i> *)
	Number_of_characters	INT, UINT			
	Position	INT, UINT			

Function	Argument data type		Return value data type	Description	Example
CONCAT(<Source_string_1>,<Source_string_2>,...) *Up to 32 source strings.*	Source_string	STRING	STRING	Concatenates text strings.	a: = CONCAT (b,c,...) (*text strings b, c... are joined and stored in variable a*)
INSERT(<Source_string>,<Insert_string>,<Position>)	Source_string	STRING	STRING	Insert one text string into another.	a: = INSERT (b,c,d) (*text string c inserted into text string b at position specified by variable d and resulting string stored in variable a*)
	Insert_string	STRING			
	Position	INT, UINT			
DELETE(<Source_string>,<Number_of_characters>,<Position>)	Source_string	STRING	STRING	Deletes characters from a text string.	a: = DELETE (b,c,d) (*number of characters specified by variable c deleted from text string b starting from position specified by variable d and resulting string stored in variable a*)
	Number_of_characters	INT, UINT			
	Position	INT, UINT			
REPLACE(<Source_string>,<Replace_string>,<Number_of_characters>,<Position>)	Source_string	STRING	STRING	Replaces characters in a text string.	a: = REPLACE (b,c,d,e) (*number of characters specified by variable d in source string b replaced with text string c starting from position specified by variable e and resulting string stored in variable a*)
	Replace_string	STRING			
	Number_of_characters	INT, UINT			
	Position	INT, UINT			
FIND(<Source_string>,<Find_string>)	Source_string	STRING	INT	Finds characters within a text string.	a: = FIND (b,c) (*first occurrence of text string c found in text string b and position stored in variable a; 0 stored if text string c is not found.*)
	Find_string	STRING			

Data Type Conversion Functions

The following data type conversion functions can be used in structured text.

Syntax

Source_data_type_TO_New_data_type (Variable_name)

Example: REAL_TO_INT (C)

In this example, the data type for variable C will be changed from REAL to INT.

The fractional part of the value of variable C is rounded off to the closest integer. The following table shows how values are rounded.

Value of fractional part	Treatment	Examples	
Less than 0.5	The fractional part is truncated.	1.49 → 1	-1.49 → -1
0.5	If the ones digit is an even number, the fractional part is truncated. If the ones digit is an odd number, the fractional part is rounded up.	0.5 → 0	-0.5 → 0
		1.5 → 2	-1.5 → -2
		2.5 → 2	-2.5 → -2
		3.5 → 4	-3.5 → -4
Greater than 0.5	The fractional part is rounded up.	1.51 → 2	-1.51 → -2

Data Type Combinations

The combinations of data types that can be converted are given in the following table.

(YES = Conversion possible, No = Conversion not possible)

FROM	TO													
	BOOL	INT	DINT	LINT	UINT	UDINT	ULINT	WORD	DWORD	LWORD	REAL	LREAL	BCD_WORD	BCD_DWORD
BOOL	No	No	No	No	No	No	No	No	No	No	No	No	No	No
INT	No	No	YES	YES	YES	YES	YES	YES	YES	YES	YES	YES	YES	YES
DINT	No	YES	No	YES	YES	YES	YES	YES	YES	YES	YES	YES	YES	YES
LINT	No	YES	YES	No	YES	YES	YES	YES	YES	YES	YES	YES	No	No
UINT	No	YES	YES	YES	No	YES	YES	YES	YES	YES	YES	YES	YES	YES
UDINT	No	YES	YES	YES	YES	No	YES	YES	YES	YES	YES	YES	YES	YES
ULINT	No	YES	YES	YES	YES	YES	No	YES	YES	YES	YES	YES	No	No
WORD	No	YES	YES	YES	YES	YES	YES	No	YES	YES	No	No	No	No
DWORD	No	YES	YES	YES	YES	YES	YES	YES	No	YES	No	No	No	No
LWORD	No	YES	YES	YES	YES	YES	YES	YES	YES	No	No	No	No	No
REAL	No	YES	YES	YES	YES	YES	YES	No	No	No	No	YES	No	No
LREAL	No	YES	YES	YES	YES	YES	YES	No	No	No	YES	No	No	No
WORD_BCD	No	YES	YES	No	YES	YES	No	No	No	No	No	No	No	No
DWORD_BCD	No	YES	YES	No	YES	YES	No	No	No	No	No	No	No	No

Number-String Conversion Functions

The following number-string conversion functions can be used in structured text.

Syntax

Source_data_type_TO_STRING (Variable_name)

Example: INT_TO_STRING (C)

In this example, the integer variable C will be changed to a STRING variable.

STRING_TO_New_data_type (Variable_name)

Example: STRING_TO_INT (C)

In this example, the STRING variable C will be changed to an integer.

Data Type Combinations

The combinations of data types that can be converted are given in the following table.

(YES = Conversion possible, No = Conversion not possible)

FROM	TO													
	BOOL	INT	DINT	LINT	UINT	UDINT	ULINT	WORD	DWORD	LWORD	REAL	LREAL	STRING	
BOOL	No	No	No	No	No	No	No	No	No	No	No	No	No	
INT	No	No	YES	YES	YES	YES	YES	YES	YES	YES	YES	YES	YES	
DINT	No	YES	No	YES	YES	YES	YES	YES	YES	YES	YES	YES	YES	
LINT	No	YES	YES	No	YES	YES	YES	YES	YES	YES	YES	YES	No	
UINT	No	YES	YES	YES	No	YES	YES	YES	YES	YES	YES	YES	YES	
UDINT	No	YES	YES	YES	YES	No	YES	YES	YES	YES	YES	YES	YES	
ULINT	No	YES	YES	YES	YES	YES	No	YES	YES	YES	YES	YES	No	
WORD	No	YES	YES	YES	YES	YES	YES	No	YES	YES	No	No	YES	
DWORD	No	YES	YES	YES	YES	YES	YES	YES	No	YES	No	No	YES	
LWORD	No	YES	YES	YES	YES	YES	YES	YES	YES	No	No	No	No	
REAL	No	YES	YES	YES	YES	YES	YES	YES	YES	YES	No	No	No	
LREAL	No	YES	YES	YES	YES	YES	YES	YES	YES	YES	No	No	No	
STRING	No	YES	YES	No	YES	YES	No	YES	YES	No	No	No	No	

Data Shift Functions

Function	1st argument data type	2nd argument data type	Return value data type	Description	Example
SHL(<Shift_target_data>, <Number_of_bits>)	BOOL, WORD, DWORD, LWORD	INT, UINT, UDINT, ULINT, DINT, LINT	BOOL, WORD, DWORD, LWORD	Shifts a bit string to the left by n bits. When shifted, zeros are entered on the right side of the bit string.	a := SHL(b,c) (* Result of shifting bit string b to the left by c bits is stored in a*)
SHR(<Shift_target_data>, <Number_of_bits>)	BOOL, WORD, DWORD, LWORD	INT, UINT, UDINT, ULINT, DINT, LINT	BOOL, WORD, DWORD, LWORD	Shifts a bit string to the right by n bits. When shifted, zeros are entered on the left side of the bit string.	a := SHR(b,c) (* Result of shifting bit string b to the right by c bits is stored in a*)
ROL(<Rotation_target_data>, <Number_of_bits>)	BOOL, WORD, DWORD, LWORD	INT, UINT, UDINT, ULINT, DINT, LINT	BOOL, WORD, DWORD, LWORD	Rotates a bit string to the left by n bits.	a := ROL(b,c) (* Result of rotating bit string b to the left by c bits is stored in a*)
ROR(<Rotation_target_data>, <Number_of_bits>)	BOOL, WORD, DWORD, LWORD	INT, UINT, UDINT, ULINT, DINT, LINT	BOOL, WORD, DWORD, LWORD	Rotates a bit string to the right by n bits.	a := ROR(b, c) (* Result of rotating bit string b to the right by c bits is stored in a*)

Data Control Functions

Function	1st argument data type	2nd argument data type	3rd argument data type	Return value data type	Description	Example
LIMIT (<Lower_limit_data>, <Input_data>, <Upper_limit_data>)	BOOL, INT, UINT, UDINT, ULINT, DINT, LINT, WORD, DWORD, LWORD, REAL, LREAL	BOOL, INT, UINT, UDINT, ULINT, DINT, LINT, WORD, DWORD, LWORD, REAL, LREAL	BOOL, INT, UINT, UDINT, ULINT, DINT, LINT, WORD, DWORD, LWORD, REAL, LREAL	BOOL, INT, UINT, UDINT, ULINT, DINT, LINT, WORD, DWORD, LWORD, REAL, LREAL	Controls the output data depending on whether the input data is within the range between the upper and lower limits.	a := LIMIT(b,c,d) (*When $c < b$, b is stored in a. When $b \leq c \leq d$, c is stored in a. When $d < c$, d is stored in a.*)

Data Selection Functions

Function	1st argument data type	2nd argument data type	3rd argument data type	Return value data type	Description	Example
SEL(<Selection_condition>, <Selection_target_data1>, <Selection_target_data2>)	BOOL	BOOL, INT, UINT, UDINT, ULINT, DINT, LINT, WORD, DWORD, LWORD, REAL, LREAL	BOOL, INT, UINT, UDINT, ULINT, DINT, LINT, WORD, DWORD, LWORD, REAL, LREAL	BOOL, INT, UINT, UDINT, ULINT, DINT, LINT, WORD, DWORD, LWORD, REAL, LREAL	Selects one of two data according to the selection condition.	a := SEL(b,c,d) (*When b is FALSE, c is stored in a. When b is TRUE, d is stored in a.*)
MUX(<Extraction_condition>, <Extraction_target_data1>, <Extraction_target_data2>, ...)	INT, UINT, UDINT, ULINT, DINT, LINT	BOOL, INT, UINT, UDINT, ULINT, DINT, LINT, WORD, DWORD, LWORD, REAL, LREAL	BOOL, INT, UINT, UDINT, ULINT, DINT, LINT, WORD, DWORD, LWORD, REAL, LREAL	BOOL, INT, UINT, UDINT, ULINT, DINT, LINT, WORD, DWORD, LWORD, REAL, LREAL	Selects a specified data from a maximum of 30 data according to the extraction condition.	a := MUX(b,c,d,...) (*The (b+1)th data is stored in a.*)
MAX(<Target_data1>, <Target_data2>, <Target_data3>, ...) *2	BOOL, INT, UINT, UDINT, ULINT, DINT, LINT, WORD, DWORD, LWORD, REAL, LREAL	BOOL, INT, UINT, UDINT, ULINT, DINT, LINT, WORD, DWORD, LWORD, REAL, LREAL	BOOL, INT, UINT, UDINT, ULINT, DINT, LINT, WORD, DWORD, LWORD, REAL, LREAL	BOOL, INT, UINT, UDINT, ULINT, DINT, LINT, WORD, DWORD, LWORD, REAL, LREAL	Selects the maximum value from a maximum of 31 data.	a := MAX(b,c,d,...) (* The maximum value of c, d, ... is stored in a.*)
MIN(<Target_data1>, <Target_data2>, <Target_data3>, ...) *2	BOOL, INT, UINT, UDINT, ULINT, DINT, LINT, WORD, DWORD, LWORD, REAL, LREAL	BOOL, INT, UINT, UDINT, ULINT, DINT, LINT, WORD, DWORD, LWORD, REAL, LREAL	BOOL, INT, UINT, UDINT, ULINT, DINT, LINT, WORD, DWORD, LWORD, REAL, LREAL	BOOL, INT, UINT, UDINT, ULINT, DINT, LINT, WORD, DWORD, LWORD, REAL, LREAL	Selects the minimum value from a maximum of 31 data.	a := MIN(b,c,d,...) (* The minimum value of c, d, ... is stored in a.*)

Note (1) For MUX, the arguments can be specified up to 31st argument (i.e. 30 extraction target data at the maximum).

(2) For MAX and MIN, the target data can be specified from 1st argument up to 31st argument (i.e. 31 target data at the maximum).

5-4-6 OMRON Expansion Functions

Function type	Description
Memory Card Functions	Functions that write data to Memory Cards
Communications Functions	Functions that send and received text strings
Angle Conversion Functions	Functions that convert between degrees and radians.
Timer/Counter Functions	Functions that execute various types of timers/counters.

Memory Card Functions

The following functions can be used with CS/CJ-series CPU Units with unit version 4.0 or later, or CJ2-series CPU Units.

Function	Argument data type		Return value data type	Description	Example
WRITE_TEXT(<Write_string>, <Directory_name_and_file_name>, <Delimiter>, <Parameter>)	Write_string	STRING	---	Writes a text string to a Memory Card.	WRITE_TEXT(a,b,c,d) (*text string <i>a</i> is written to a file with the file name and directory specified by variable <i>b</i> ; if variable <i>d</i> is 0, the text string is added to the file along with delimiter specified by variable <i>c</i> ; if variable <i>d</i> is 1, a new file is created*)
	Directory_name_and_file_name	STRING			
	Delimiter	STRING			
	Parameter	INT, UINT, WORD			

Communications Functions

The following functions can be used with CS/CJ-series CPU Units with unit version 4.0 or later, or CJ2-series CPU Units.

Function	Argument data type		Return value data type	Description	Example
TXD_CPU(<Send_string>)	Send_string	STRING	---	Sends a text string to the RS-232C port on the CPU Unit.	TXD_CPU(a) (*text string <i>a</i> is sent from the RS-232C port on the CPU Unit*)
TXD_SCB(<Send_string>, <Serial_port>)	Send_string	STRING	---	Sends a text string to the serial port on a Serial Communications Board.	TXD_SCB(a,b) (*text string <i>a</i> is sent from the serial port specified by variable <i>b</i> on the Serial Communications Board*)
	Serial_port	INT, UINT, WORD			
TXD_SCU(<Send_string>, <SCU_unit_number>, <Serial_port>, <Internal_logic_port>)	Send_string	STRING	---	Sends a text string to a serial port on a Serial Communications Unit.	TXD_SCU(a,b,c,d) (*text string <i>a</i> is sent from the serial port specified by variable <i>c</i> on the Serial Communications Unit specified by variable <i>b</i> using the internal logic port specified by variable <i>d</i> . The variable <i>d</i> indicates the internal logic port number.)
	SCU_unit_number	INT, UINT, WORD			
	Serial_port	INT, UINT, WORD			
	Internal_logic_port	INT, UINT, WORD	---		
RXD_CPU(<Storage_location>, <Number_of_characters>)	Storage_location	STRING	---	Receives a text string from the RS-232C port on the CPU Unit.	RXD_CPU(a,b) (*number of characters specified by variable <i>b</i> are received from the RS-232C port on the CPU Unit and stored in variable <i>a</i> *)
	Number_of_characters	INT, UINT, WORD			

Function	Argument data type		Return value data type	Description	Example
RXD_SCB(<Storage_location>,<Number_of_characters>,<Serial_port>)	Storage_location	STRING	---	Receives a text string from the serial port on a Serial Communications Board.	RXD_SCB(a,b,c) (*number of characters specified by variable <i>b</i> are received from the serial port specified by variable <i>c</i> on the Serial Communications Board and stored in variable <i>a</i> *)
	Number_of_characters	INT, UINT, WORD			
	Serial_port	INT, UINT, WORD			
RXD_SCU(<Storage_location>,<Number_of_characters>,<SCU_unit_number>,<Serial_port>,<Internal_logic_port>)	Storage_location	STRING	---	Receives a text string from a serial port on a Serial Communications Unit.	RXD_SCU(a,b,c,d,e) (*number of characters specified by variable <i>b</i> are received from the serial port specified by variable <i>d</i> on the Serial Communications Unit specified by variable <i>c</i> using the internal logic port specified by variable <i>e</i> and stored in variable <i>a</i> *. The variable <i>e</i> indicates the internal logic port number.)
	Number_of_characters	INT, UINT, WORD			
	SCU_unit_number	INT, UINT, WORD			
	Serial_port	INT, UINT, WORD			
	Internal_logic_port	INT, UINT, WORD			

Angle Conversion Instructions

The following functions can be used with CS/CJ-series CPU Units with unit version 4.0 or later, or CJ2-series CPU Units.

Function	Argument data type	Return value data type	Description	Example
DEG_TO_RAD(<i>argument</i>)	REAL, LREAL	REAL, LREAL	Converts an angle from degrees to radians.	a:=DEG_TO_RAD(b) (*an angle in degrees in variable <i>b</i> is converted to radians and stored in variable <i>a</i> *)
RAD_TO_DEG(<i>argument</i>)	REAL, LREAL	REAL, LREAL	Converts an angle from radians to degrees.	a:=RAD_TO_DEG(b) (*an angle in radians in variable <i>b</i> is converted to degrees and stored in variable <i>a</i> *)

Timer/Counter Functions

The following functions can be used with CJ2-series CPU Units.

Function	Argument data type		Return value data type	Description	Example
TIMX (<Execution_condition>,<Timer_address>,<Timer_set_value>)	Execution_condition	BOOL	None	Name: HUNDRED-MS TIMER Operation: Operates a decrementing timer with units of 100 ms.	TIMX(a,b,c) (*When execution condition <i>a</i> is satisfied, the TIMX timer set to timer set value <i>c</i> in timer address <i>b</i> is started.*)
	Timer_address	TIMER			
	Timer_set_value	UINT			
TIMHX (<Execution_condition>,<Timer_address>,<Timer_set_value>)	Execution_condition	BOOL	None	Name: TEN-MS TIMER Operation: Operates a decrementing timer with units of 10 ms.	TIMHX(a,b,c) (*When execution condition <i>a</i> is satisfied, the TIMHX timer set to timer set value <i>c</i> in timer address <i>b</i> is started.*)
	Timer_address	TIMER			
	Timer_set_value	UINT			

Function	Argument data type		Return value data type	Description	Example
TMHHX (<Execution_condition>, <Timer_address>, <Timer_set_value>)	Execution_condition	BOOL	None	Name: ONE-MS TIMER Operation: Operates a decrementing timer with units of 1 ms.	TMHHX(a,b,c) (*When execution condition a is satisfied, the TMHHX timer set to timer set value c in timer address b is started.*)
	Timer_address	TIMER			
	Timer_set_value	UINT			
TIMUX (<Execution_condition>, <Timer_address>, <Timer_set_value>)	Execution_condition	BOOL	None	Name: TENTH-MS TIMER Operation: Operates a decrementing timer with units of 0.1 ms.	TIMUX(a,b,c) (*When execution condition a is satisfied, the TIMUX timer set to timer set value c in timer address b is started.*)
	Timer_address	TIMER			
	Timer_set_value	UINT			
TMUHX (<Execution_condition>, <Timer_address>, <Timer_set_value>)	Execution_condition	BOOL	None	Name: HUNDREDTH-MS TIMER Operation: Operates a decrementing timer with units of 0.01 ms.	TMUHX(a,b,c) (*When execution condition a is satisfied, the TMUHX timer set to timer set value c in timer address b is started.*)
	Timer_address	TIMER			
	Timer_set_value	UINT			
TTIMX (<Execution_condition>, <Reset_input>, <Timer_address>, <Timer_set_value>)	Execution_condition	BOOL	None	Name: ACCUMULATIVE TIMER Operation: Operates an incrementing timer with units of 0.1 s.	TTIMX(a,b,c,d) (*While execution condition a is satisfied, the TTIMX timer set to timer set value d in timer address c is started. When the reset input b is ON, the timer's PV and completion flag are reset.*)
	Reset_input	BOOL			
	Timer_address	TIMER			
	Timer_set_value	UINT			
CNTX(<Count_input>, <Reset_input>, <Counter_address>, <Counter_set_value>)	Count_input	BOOL	None	Name: COUNTER Operation: Operates a decrementing counter.	CNTX(a,b,c,d) (*The CNTX counter set to counter set value d in counter address c is executed every time count input a is turned ON. When the reset input b is ON, the counter's PV and completion flag are reset.*)
	Reset_input	BOOL			
	Counter_address	COUNTER			
	Counter_set_value	UINT			
CNTRX (<Increment_count>, <Decrement_count>, <Reset_input>, <Counter_address>, <Counter_set_value>)	Increment_count	BOOL	None	Name: REVERSIBLE COUNTER Operation: Operates an incrementing / decrementing counter.	CNTRX(a,b,c,d,e) (*The CNTRX counter set to counter set value e in counter address d is executed. The PV is incremented when increment count input a is turned ON and decremented when decrement count input b is turned ON. When the reset input c is ON, the counter's PV and completion flag are reset.*)
	Decrement_count	BOOL			
	Reset_input	BOOL			
	Counter_address	COUNTER			
	Counter_set_value	UINT			
TRSET (<Execution_condition>, <Timer_address>)	Execution_condition	BOOL	None	Name: TIMER RESET Operation: Resets the specified timer.	TRSET(a,b) (*When execution condition a is satisfied, the timer in timer address b is reset.*)
	Timer_address	TIMER			

5-5 Statement Descriptions

5-5-1 Assignment

■ **Summary**

The left side of the statement (variable) is substituted with the right side of the statement (equation, variable, or constant).

■ **Reserved Words**

:=

Combination of colon (:) and equals sign (=).

■ **Statement Syntax**

Variable: = *Equation, variable, or constant*;

■ **Usage**

Use assignment statements for inputting values in variables. This is a basic statement for use before or within control statements. This statement can be used for setting initial values, storing calculation results, and incrementing or decrementing variables.

■ **Description**

Substitutes (stores) an *equation, variable, or constant* for the *variable*.

Examples

Example 1: Substitute variable A with the result of the equation X+1.

A:=X+1;

Example 2: Substitute variable A with the value of variable B.

A:=B;

Example 3: Substitute variable A with the constant 10.

A:=10;

■ **Precautions**

The data type of the equation, variable, or constant to be assigned must be the same as the data type of the variable to be substituted. Otherwise, a syntax error will occur.

5-5-2 Control Statements

IF Statement (Single Condition)

■ **Summary**

This statement is used to execute an expression when a specified condition is met. If the condition is not met, a different expression is executed.

■ **Reserved Words**

IF, THEN, (ELSE), END_IF

Note ELSE can be omitted.

■ **Statement Syntax**

```
IF <condition> THEN
  <expression_1>;
ELSE
  <expression_2>;
END_IF;
```

■ **Process Flow Diagram**

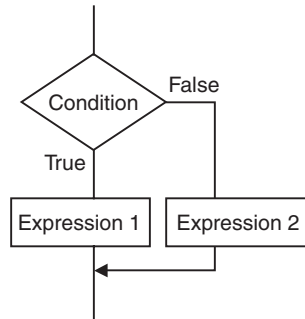

■ **Usage**

Use the IF statement to perform a different operation depending on whether a single condition (condition equation) is met.

■ **Description**

Condition = If true, execute expression_1

Condition = If false, execute expression_2

■ **Precautions**

- IF must be used together with END_IF.
- The *condition* must include a true or false equation for the evaluation result.
Example: IF(A>10)
The *condition* can also be specified as a boolean variable only rather than an equation. As a result, the variable value is 1 (ON) = True result, 0 (OFF) = False result.
- Statements that can be used in *expression_1* and *expression_2* are assignment statements, IF, CASE, FOR, WHILE, or REPEAT.

Example:

```
IF <condition_1> THEN
  IF <condition_2> THEN
    <expression_1>;
  ELSE
    <expression_2>;
  END_IF;
END_IF;
```

The processing flow diagram is as follows:

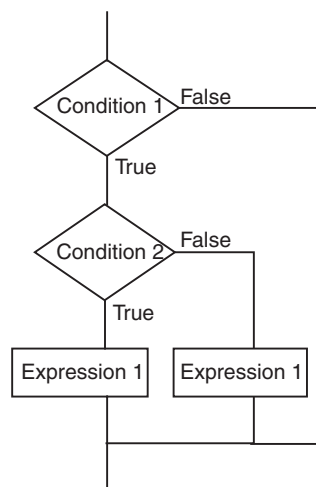

ELSE corresponds to THEN immediately before it, as shown in the above diagram.

- Multiple statements can be executed within *expression_1* and *expression_2*. Be sure to use a semicolon (;) delimiter between multiple statements in an *expression*.
- The ELSE statement can be omitted. When ELSE is omitted, no operation is executed if the result of the *condition* equation is false.

■ Processing Flow Diagram

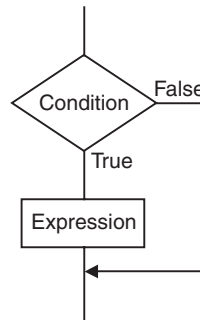

■ Examples

Example 1: If variable $A > 0$ is true, variable X will be substituted with numerical value 10. If $A > 0$ is false, variable X will be substituted with numerical value 0.

```

IF A>0 THEN
  X:=10;
ELSE
  X:=0;
END_IF;
  
```

Example 2: If variable $A > 0$ and variable $B > 1$ are both true, variable X will be substituted with numerical value 10, and variable Y will be substituted with numerical value 20. If variable $A > 0$ and variable $B > 1$ are both false, variable X and variable Y will both be substituted with numerical value 0.

```

IF A>0 AND B>1 THEN
  X:=10; Y:=20;
ELSE
  X:=0; Y:=0;
END_IF;
  
```

Example 3: If the boolean (BOOL data type) variable $A=1$ (ON), variable X will be substituted with numerical value 10. If variable $A=0$ (OFF), variable X will be substituted with numerical value 0.

```

IF A THEN X:=10;
ELSE X:=0;
END_IF;
  
```

IF Statement (Multiple Conditions)

■ Summary

This statement is used to execute an expression when a specified condition is met. If the first condition is not met, but another condition is met, a corresponding expression is executed. If none of the conditions is met, a different expression is executed.

■ Reserved Words

IF, THEN, ELSIF, (ELSE), END_IF

Note ELSE can be omitted.

Statement Syntax

```

IF <condition_1> THEN <expression_1>;
  ELSIF <condition_2> THEN <expression_2>;
  ELSIF <condition_3> THEN <expression_3>;
  . . .
  ELSIF <condition_n> THEN <expression_n>;
ELSE <expression_m>;
END_IF;

```

Processing Flow Chart

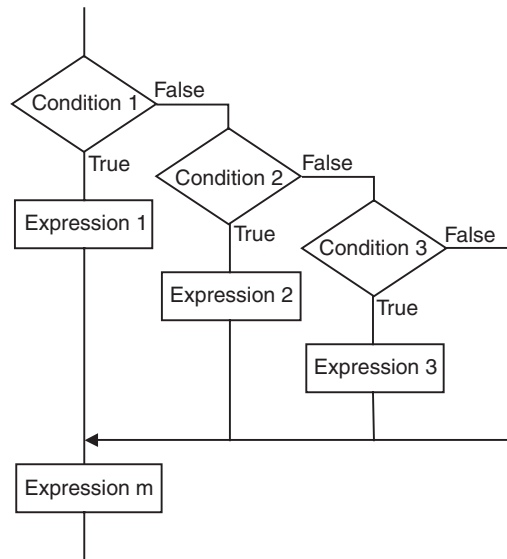

■ Usage

Use the IF statement to perform different operations depending which of multiple conditions (*condition* equation) is met.

■ Description

Condition 1 = If true, execute expression 1

Condition 1 = If false,

Condition 2 = If true, execute *expression 2*

Condition 2 = If false,

Condition 3 = If true, execute *expression 3*

etc.

Condition *n* = If true, execute *expression n*

If none of these conditions are met, *condition m* is executed.

■ Precautions

- IF must be used together with END_IF.
- *Condition_□* contains the true or false result of the equation (e.g., IF(A>10)).
A boolean (BOOL data type) variable only can also be specified as the *condition* rather than an equation. For boolean conditions, the result is true when the variable value is 1 (ON) and false when it is 0 (OFF).
- Statements that can be used in *expression_□* are assignment statements, IF, CASE, FOR, WHILE, or REPEAT.

- Multiple statements can be executed in *expression*. Be sure to use a semicolon (;) delimiter between multiple statements in an *expression*.
- The ELSE statement can be omitted. When ELSE is omitted, no operation is executed if the result of any *condition* equation is false.

■ **Examples**

Example 1: If variable A>0 is true, variable X will be substituted with numerical value 10.

If A>0 is false, but variable B=1, variable X will be substituted with numerical value 1.

If A>0 is false, but variable B=2, variable X will be substituted with numerical value 2.

If either of these conditions is met, variable X will be substituted with numerical value 0.

```
IF A>0 THEN X:=10;
      ELSIF B=1 THEN X:=1;
      ELSIF B=2 THEN X:=2;
ELSE X:=0;
END_IF;
```

CASE Statement

■ **Summary**

This statement executes an expression containing a selected integer that matches the value from an integer equation. If the selected integer value is not the same, either no expression or a specified expression is executed.

■ **Reserved Word**

CASE

■ **Statement Syntax**

```
CASE <integer_equation> OF
      <integer_equation_value_1> : <expression_1>;
      <integer_equation_value_2> : <expression_2>;
      . . .
      <integer_equation_value_n> : <expression_n>;
ELSE <expression_m>;
END_CASE;
```

■ Processing Flow Chart

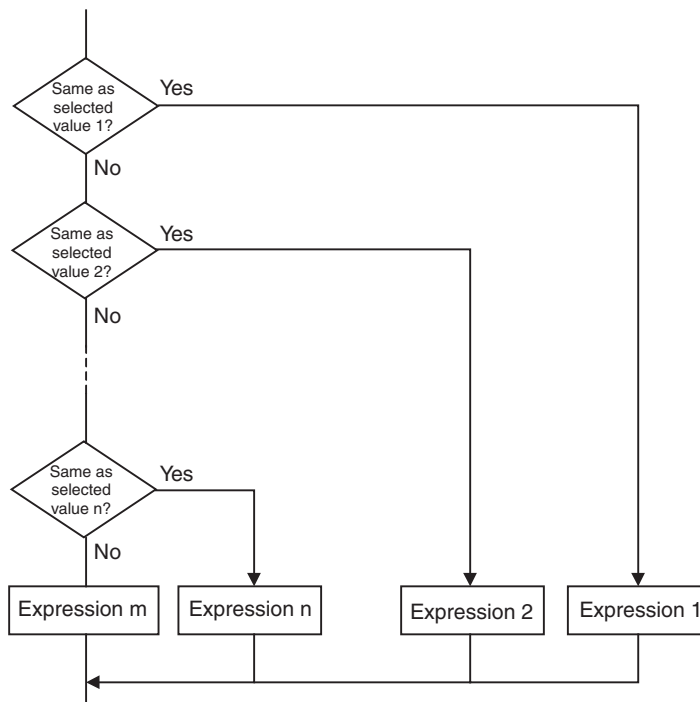

■ Usage

Use the CASE statement to execute different operations depending on specified integer values.

■ Description

If the *integer_equation* matches *integer_equation_value_n*, *expression_n* is executed.

if the *integer_equation* does not match any of *integer_equation_value_n*, *expression_m* is executed.

■ Precautions

- CASE must be used together with END_CASE.
- The result of the *integer_equation* must be in integer format (INT, DINT, LINT, UINT, UDINT, or ULINT).
- Statements that can be used in *expression_□* are assignment statements, IF, CASE, FOR, WHILE, or REPEAT.
- Multiple statements can be executed in *expression_□*. Be sure to use a semicolon (;) delimiter between multiple statements in an *expression*.
- Variables in integer format (INT, DINT, LINT, UINT, UDINT, or ULINT), or equations that return integer values can be specified in the *integer_equation*.
- When OR logic is used for multiple integers in the *integer_equation_value_n*, separate the numerical value using a comma delimiter. To specify a sequence of integers, use two periods (..) as delimiters between the first and last integers.

■ Examples

Example 1: If variable A is 1, variable X is substituted with numerical value 1. If variable A is 2, variable X is substituted with numerical value 2. If variable A is 3, variable X is substituted with numerical value 3. If neither of these cases matches, variable Y will be substituted with 0.

```
CASE A OF
    1:X:=1;
    2:X:=2;
    3:X:=3;
ELSE Y:=0;
END_CASE;
```

Example 2: If variable A is 1, variable X is substituted with numerical value 1. If variable A is 2 or 5, variable X is substituted with numerical value 2. If variable A is a value between 6 and 10, variable X is substituted with numerical value 3. If variable A is 11, 12, or a value between 15 and 20, variable X is substituted with numerical value 4. If neither of these cases matches, variable Y will be substituted with 0.

```
CASE A OF
    1:X:=1;
    2,5:X:=2;
    6..10:X:=3;
    11,12,15..20:X:=4;
ELSE Y:=0;
END_CASE;
```

FOR Statement

■ Summary

This statement is used to execute a specified expression repeatedly until a variable (referred to here as an iteration variable) reaches a specified value.

■ Reserved Words

FOR, TO, (BY), DO, END_FOR

Note BY can be omitted.

■ Statement Syntax

```
FOR <iteration_variable> := <initial_value> TO <final_value_equation> BY
<increment_value_equation>
DO
<expression>;
END_FOR;
```

■ Processing Flow Chart

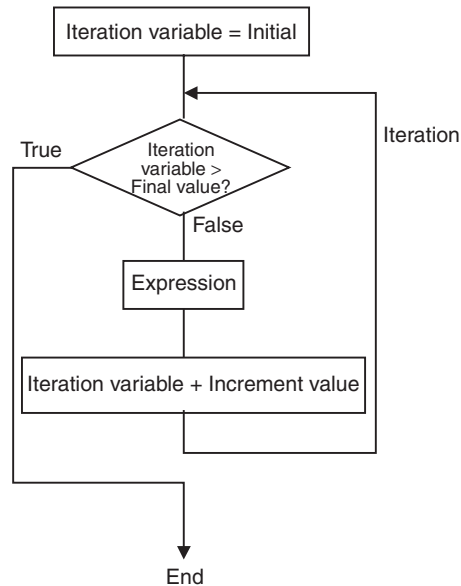

■ Usage

Use the FOR statement when the number of iterations has been determined beforehand. FOR is particularly useful when switching the number of elements in an array variable according to the value of a specified iteration variable.

■ Description

When the *iteration_variable* is the *initial_value*, the *expression* is executed. After execution, the value obtained from the *increment_equation* is added to the *iteration_variable*, and if the *iteration_variable* \leq *final_value_equation* (see note 1), the *expression* is executed. After execution, the value obtained from the *increment_equation* is added to the *iteration_variable*, and if the *iteration_variable* \leq *final_value_equation* value (see note 1), the *expression* is executed. This process is repeated.

If the *iteration_variable* $>$ *final_value_equation* (see note 2), the processing ends.

- Note**
- (1) If the value from the *increment_equation* is negative, the condition is *iteration_variable* \geq *final_value_equation* value.
 - (2) If the value from the *increment_equation* is negative, the condition is *iteration_variable* $<$ *final_value_equation*.

■ Precautions

- A negative value can be specified in the *increment_equation*
- FOR must be used in combination with END_FOR.
- The *initial_value*, *final_value_equation*, and *final_value_equation* must be an integer data type (INT, DINT, LINT, UINT, UDINT, or ULINT).
- After processing is executed with the final value, the iteration value is incremented to the final value + 1 and iteration processing ends.
Example: In the following structured text, the value of “a” becomes TRUE.

```
FOR i:=0 TO 100 DO
  DATA[i] :=0;
END_FOR;
```

```
IF i=101 THEN
  a:=TRUE;
ELSE
  a:=FALSE;
END_IF;
```

- Do not use a FOR statement in which an iteration variable is changed directly. Doing so may result in unexpected operations.

Example:

```
FOR i:=0 TO 100 BY 1 DO
  DATA[i] :=0;
  i:=i+5;
END_FOR;
```

- Statements that can be used in the *expression* are assignment statements, IF, CASE, FOR, WHILE, or REPEAT.
- Multiple statements can be executed in the *expression*. Be sure to use a semicolon (;) delimiter between multiple statements in an *expression*.
- BY *increment_equation* can be omitted. When omitted, BY is taken as 1.
- Variables with integer data types (INT, DINT, LINT, UINT, UDINT, or ULINT), or equations that return integer values can be specified in the *initial_value*, *final_value_equation*, and *increment_equation*.

Example 1: The iteration is performed when the iteration variable n = 0 to 50 in increments of 5, and the array variable SP[n] is substituted with 100.

```
FOR n:=0 TO 50 BY 5 DO
  SP[n] :=100;
END_FOR;
```

Example 2: The total value of elements DATA[1] to DATA[50] of array variable DATA[n] is calculated, and substituted for the variable SUM.

```
FOR n:=0 TO 50 BY 1 DO
  SUM:=SUM+DATA[n];
END_FOR;
```

Example 3: The maximum and minimum values from elements DATA[1] to DATA[50] of array variable DATA[n] are detected. The maximum value is substituted for variable MAX and the minimum value is substituted for variable MIN. The value for DATA[n] is between 0 and 1000.

```
MAX:=0;
MIN:=1000;
FOR n:=1 TO 50 BY 1 DO
  IF DATA[n]>MAX THEN
    MAX:=DATA[n];
  END IF;
  IF DATA[n]<MIN THEN
    MIN:=DATA[n];
  END IF;
END_FOR;
```

WHILE Statement

■ Summary

This statement is used to execute a specified expression repeatedly for as long as a specified condition is true.

■ **Reserved Words**

WHILE, DO, END_WHILE

■ **Statement Syntax**

```
WHILE <condition> DO
  <expression>;
END_WHILE;
```

■ **Processing Flow Chart**

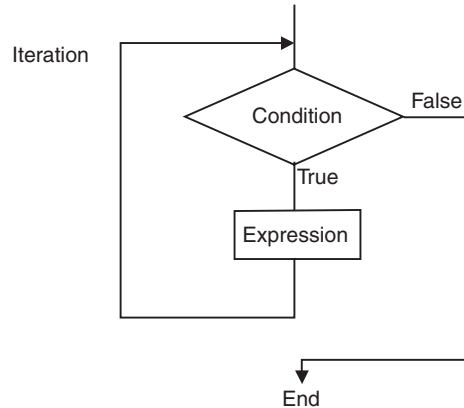

■ **Usage**

Use the WHILE statement when the number of iterations has not been determined beforehand (depends on the condition being met) to repeat specified processing for the duration that the condition is met. This statement can be used to execute processing while the condition equation is true only (pretest loop).

■ **Description**

Before the *expression* is executed, the *condition* is evaluated. If the *condition* is true, the *expression* is executed. Afterwards, the *condition* is evaluated again. This process is repeated. If the *condition* is false, the *expression* is not executed and the *condition* evaluation ends.

■ **Precautions**

- WHILE must be used in combination with END_WHILE.
- Before executing the *expression*, if the *condition* equation is false, the process will end without executing the *expression*.
- Statements that can be used in the *expression* are assignment statements, IF, CASE, FOR, WHILE, or REPEAT.
- Multiple statements can be executed in the *expression*. Be sure to use a semicolon (;) delimiter between multiple statements in an *expression*.
- The *condition* can also be specified as a boolean variable (BOOL data type) only rather than an equation.

■ **Examples**

Example 1: The value exceeding 1000 in increments of 7 is calculated and substituted for variable A.

```
A:=0;
WHILE A<=1000 DO
  A:=A+7;
END_WHILE;
```

Example 2: While $X < 3000$, the value of X is doubled, and the value is substituted for the array variable $DATA[1]$. The value of X is then multiplied by 2 again, and the value is substituted for the array variable $DATA[2]$. This process is repeated.

```
n:=1'
WHILE X<3000 DO
  X:=X*2;
  DATA [n] :=X;
  n:=n+1;
END_WHIE;
```

REPEAT Statement

■ Summary

This statement is used to repeatedly execute an expression until a specified condition is true.

■ Reserved Words

REPEAT, UNTIL, END_REPEAT

■ Statement Syntax

```
REPEAT
  <expression>;
UNTIL <condition>
END_REPEAT
```

■ Processing Flow Chart

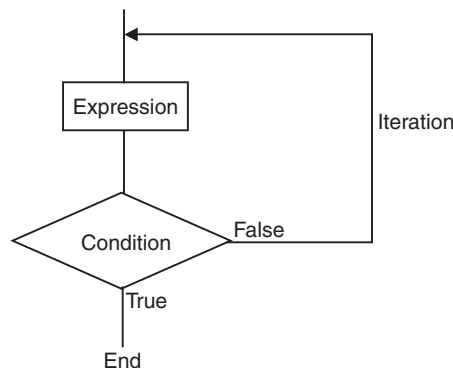

■ Usage

Use the REPEAT statement to repeat processing for as long as a condition is met after specified processing, when the number of iterations is undetermined beforehand (depends on whether the condition is met). This statement can be used to determine whether to repeat processing according to the results of specified processing execution (post-test loop).

n Description

The *expression* will execute the first time without a condition. Thereafter, the *condition* equation will be evaluated. If the *condition* is false, the *expression* will be executed again. If the *condition* is true, processing will end without executing the *expression*.

■ Precautions

- REPEAT must be used together with END_REPEAT.
- Even if the *condition* equation is true before the *expression* has been executed, the *expression* will be executed.

- Statements that can be used in the *expression* are assignment statements, IF, CASE, FOR, WHILE, or REPEAT.
- Multiple statements can be executed in the *expression*. Be sure to use a semicolon (;) delimiter between multiple statements in an *expression*.
- The *condition* can also be specified as a boolean variable (BOOL data type) only rather than an equation.

■ Examples

Example 1: Numeric values from 1 through 10 are incremented and the total is substituted for the variable TOTAL.

```
A:=1;
TOTAL:=0;
REPEAT
    TOTAL:=TOTAL+A;
    A:=A+1;
UNTIL A>10
END_REPEAT;
```

EXIT Statement

■ Summary

This statement is used within iteration statements (FOR, WHILE, REPEAT) only to force an iteration statement to end. This statement can also be used within an IF statement to force an iteration statement to end when a specified condition is met.

■ Reserved Words

EXIT

■ Statement Syntax (Example: Using within IF Statement)

```
FOR (WHILE, REPEAT) expression
    . . .
    IF <condition> THEN EXIT;
    END_IF;
    . . .
END_FOR (WHILE, REPEAT);
```

■ Usage

Use the EXIT statement to force iteration processing to end before the end condition is met.

■ Description (Example: Using within IF Statement)

When the *condition* equation is true, the iteration statement (FOR, WHILE, REPEAT) is forced to end, and any statements after EXIT will not be executed.

- Note**
- (1) The *condition* can also be specified as a boolean variable (BOOL data type) only rather than an equation.
 - (2) Even if the *condition* equation is true before the *expression* has been executed, the *expression* will be executed.

■ Example

Processing is repeated from when variable $n = 1$ until 50 in increments of 1 and n is added to array variable $DATA[n]$. If $DATA[n]$ exceeds 100, however, processing will end.

```

FOR n:=1; TO 50 BY 1 DO
  DATA [n] :=DATA [n] +n;
  IF DATA [n]>100 THEN EXIT;
  END_IF;
END_FOR;

```

RETURN Statement

■ Summary

The function of the RETURN statement depends on the type of program in which ST is used.

- ST program:
Forcibly ends the ST task that is being executed, and executes the next task.
- ST used in SFC:
Forcibly ends the action program that is being executed, and executes the next action program or transition program.
- ST used in a function block:
Forcibly ends the ST-language function block containing the RETURN statement, returns to the place in the calling function block instance where the call occurred, and executes the next instruction.

■ Reserved Words

RETURN

■ Statement Syntax

RETURN

■ Usage

Use the RETURN statement to forcibly end an SFC program and function block that is executing an ST task.

Function Block Call Statement

■ Summary

This statement calls a function block definition.

■ Reserved Words

None

■ Statement Syntax

Enter the arguments (specified variable values that are passed to the called function block's input variables) and return value (specified variable that receives the function block's output variable value) in parentheses after the instance name (see note). The two methods (entry method 1 and entry method 2) that can be used to enter these parameters are described in the following paragraphs.

Note The data type is any of the function block's internal variable names (when ST is used in the function block's instance) or global variable names (when ST is used in an ST task or SFC action program).

■ Entry Method 1

Use this method to enter both the argument specification (called function block definition's variable name) and return value specification.

A (B:=C, ,D=>E)

- A: Instance name
- B: Called function block definition's input variable name
- C: One of the following values, depending on the ST program being used
 - Calling function block's input variable or a constant (when ST is being used in the function block's instance)
 - Global variable or local variable name (when ST is being used in an ST task or SFC action program)
- D: Called function block definition's output variable name or constant
- E: One of the following values, depending on the ST program being used
 - Calling function block's output variable or constant (when ST is being used in the function block's instance)
 - Global variable or local variable name (when ST is being used in an ST task or SFC action program)

Note Delimit all of the "B:=C" type assignments with commas.
 Delimit only the required number of "D=>E" type assignments with commas.

■ **Entry Method 2**

Use this method to enter just the return value specification, and omit the argument specification (called function block definition's variable name).

A (C, , E)

- A: Instance name
- B: Omitted (called function block definition's input variable name)
- C: One of the following values, depending on the ST program being used
 - Calling function block's input variable or a constant (when ST is being used in the function block's instance)
 - Global variable or local variable name (when ST is being used in an ST task or SFC action program)
- D: Omitted (called function block definition's output variable name or constant)
- E: One of the following values, depending on the ST program being used
 - Calling function block's output variable or constant (when ST is being used in the function block's instance)
 - Global variable or local variable name (when ST is being used in an ST task or SFC action program)

Note When B and D are omitted, as shown above, C is moved to the B position and passed automatically in the order that values are registered in that variable table. In contrast, the values from the D position are automatically received at E in the order that values are registered in that variable table.

■ **Usage**

Use the function block call statement to call a function block definition (ST or ladder language) from an ST-language program.

■ **Description**

1. The following instance is registered in the internal or global variables in the variable table.

Internal variable element	Content	Example
Name	Any instance name	Calcu_execute
Data type	FUNCTION BLOCK	FUNCTION BLOCK
FB definition	Selects the called function block definition.	Calculation

2. The values that will be passed between variables are specified within parentheses after the instance name registered in step 1 (Calcu_execute in this example), and a semi-colon marks the end of the statement, as shown in the following example.

Calcu_execute (A:=B,C=>D) ;

The value of B is passed to A, and at the same time the value of C is received at D.

A: Called function block definition's input variable name

B: One of the following values, depending on the ST program being used

- Calling function block's input variable or a constant (when ST is being used in the function block's instance)
- Global variable or local variable name (when ST is being used in an ST task or SFC action program)

C: Called function block definition's output variable name or constant

D: One of the following values, depending on the ST program being used

- Calling function block's output variable or constant (when ST is being used in the function block's instance)
- Global variable or local variable name (when ST is being used in an ST task or SFC action program)

■ **Examples Showing Additional Details**

The following two examples show how to actually use an ST program to call a function block.

Example 1:

These examples show how to call a function block from each kind of source program (ST task, SFC, and function block).

- Conditions:

A function block is called.

The called function block is written in ladder language or ST language.

Call Details

- a. Calling a function block from an ST task or SFC program

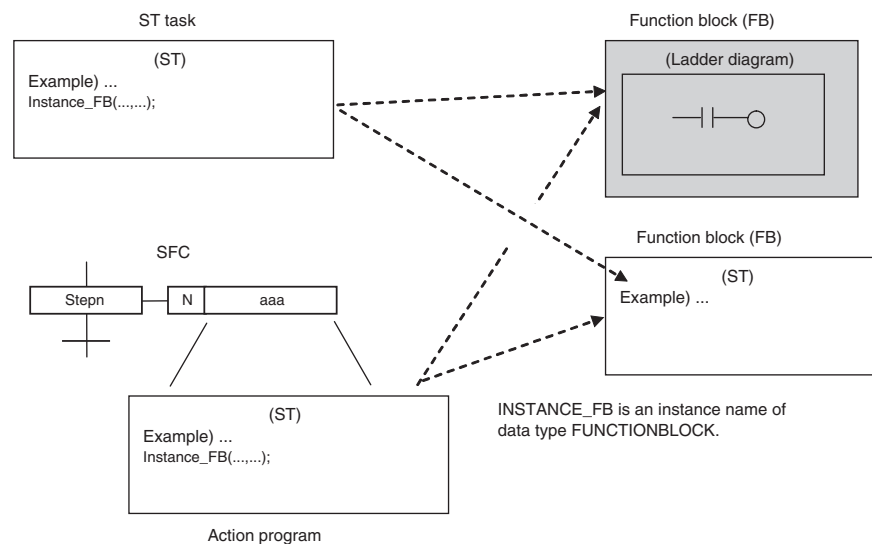

b. Calling a function block from another function block

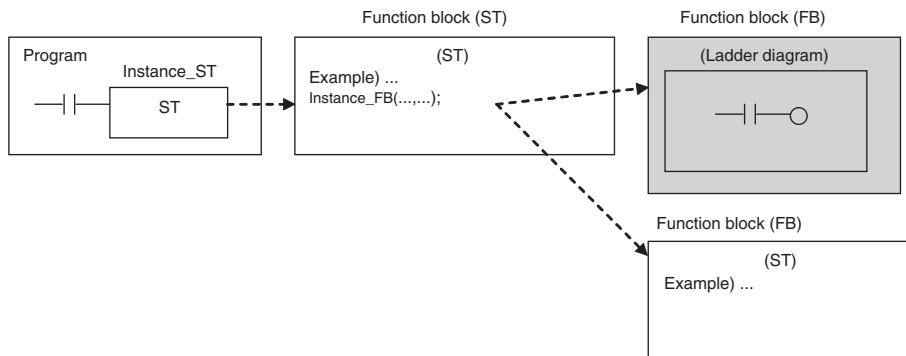

INSTANCE_FB is an instance name of data type FUNCTIONBLOCK.

Variable Settings

- Setting the variables of the ST program and SFC program (call source)
The ST program and SFC program have the following variables, and the following values are passed with the called function block.

Variable name in ST task/ SFC program	Values passed to (or received from) variables in the called function block
IN1	Passed to FB_IN1 (input variable).
IN2	Passed to FB_IN2 (input variable).
IN3	Passed to FB_IN3 (input variable).
OUT1	Received from FB_OUT1 (output variable).
OUT2	Received from FB_OUT2 (output variable).
OUT3	Received from FB_OUT3 (output variable).
A Note Data type: BOOL	Passed to EN (internal variable).
B Note Data type: BOOL	Received from ENO (internal variable).
Instance_FB Note Data type: FUNCTIONBLOCK	Calling function block definition: Function block

- Function block (call source) variable settings
The function block (call source) has the following variables, and the following values are passed with the called function block.

Variable type	Function block (call source) variable name	Values passed to (or received from) variables in the called function block
Input variables	IN1	Passed to FB2_IN1.
	IN2	Passed to FB2_IN2.
	IN3	Passed to FB2_IN3.
Output variables	OUT1	Received from FB2_OUT1.
	OUT2	Received from FB2_OUT2.
	OUT3	Received from FB2_OUT3.

Variable type	Function block (call source) variable name	Values passed to (or received from) variables in the called function block
Internal variables	A Note Data type: BOOL	Passed to EN.
	B Note Data type: BOOL	Received from ENO.
Internal variables (instance)	Instance_FB Note Data type: FUNCTIONBLOCK	Calling function block definition: Function block 2

- Function block (call destination) variable settings

The function block (call destination) has the following variables, and the following values are passed with the call source (ST program, SFC program, or call source function block).

Variable type	Function block (call destination) variable name	Values received from (or passed to) variables in the calling function block
Input variables	FB_IN1	Received from IN1.
	FB_IN2	Received from IN2.
	FB_IN3	Received from IN3.
Output variables	FB_OUT1	Passed to OUT1.
	FB_OUT2	Passed to OUT2.
	FB_OUT3	Passed to OUT3.

Examples

■ Example of Entry Method 1

Instance_FB(EN:=A,FB_IN1:=IN1,FB_IN2:=IN2,FB_IN3:= IN3, FB_OUT1=>OUT1,FB_OUT2=> OUT2,FB_OUT3=> OUT3,ENO=>B)

- It is all right for the arguments and return values to be listed in irregular order.
- The input variables' arguments must be at the beginning of the list, or just after the EN variable if the EN variable is listed.
- Output variables may be omitted if the data is not used.
- Specification method 2 cannot be used together with specification method A in the same function block call statement.

■ Examples of other Entry Formats

- EN not entered:

Instance_FB(FB_IN1:=IN1,FB_IN2:=IN2,FB_IN3:= IN3, FB_OUT1=>OUT1,FB_OUT2=> OUT2,FB_OUT3=> OUT3,ENO=>B)

- EN and ENO not entered:

Instance_FB(FB_IN1:=IN1,FB_IN2:=IN2,FB_IN3:= IN3, FB_OUT1=>OUT1,FB_OUT2=> OUT2,FB_OUT3=> OUT3)

- ENO not entered:

Instance_FB(EN:=A,FB_IN1:=IN1,FB_IN2:=IN2,FB_IN3:=IN3, FB_OUT1=>OUT1,FB_OUT2=>OUT2,FB_OUT3=>OUT3)

- FB_OUT2 data not required:

Instance_FB(EN:=A,FB_IN1:=IN1,FB_IN2:=IN2,FB_IN3:=IN3, FB_OUT1=>OUT1,FB_OUT3=>OUT3,ENO=>B)

```
Instance_FB(FB_IN1:=IN1,FB_IN2:=IN2,FB_IN3:=IN3,
FB_OUT1=>OUT1,FB_OUT3=>OUT3)
```

- Different order of entry:

```
Instance_FB(EN:=A,FB_IN1:=IN1,FB_OUT1=> OUT1,FB_IN2:=IN2,
FB_OUT2=>OUT2,FB_IN3:= IN3,FB_OUT3=> OUT3,ENO=>B)
```

■ **Example of Entry Method 2**

In this example, only parameter variables (including constants) of a new instance are entered.

```
Instance_FB(IN1, IN2, IN3, OUT1, OUT2, OUT3)
```

```
Instance_FB(IN1, IN2, IN3, OUT1)
```

- The arguments and return values must be listed in a fixed order. Input variable 1, Input variable 2, ..., Output variable 1, Output variable 2, ...
- The input variables' arguments must be at the beginning of the list, or just after the EN variable if the EN variable is listed.
- An output variable can be omitted if the data is not actually being used and the output variable is not in the middle of the list of output variables.

Example: Instance_FB(IN1, IN2, IN3, OUT1, OUT3)

In this case, the OUT3 at the end of the list would return the value from FB_OUT2.

- The EN and ENO data cannot be entered as an argument or return value.
- Specification method 1 cannot be used together with specification method B in the same function block call statement.

■ **Example 2**

In the following example, function block 1 calls function block 2, which calculate the average value by calling a function block from within a function block.

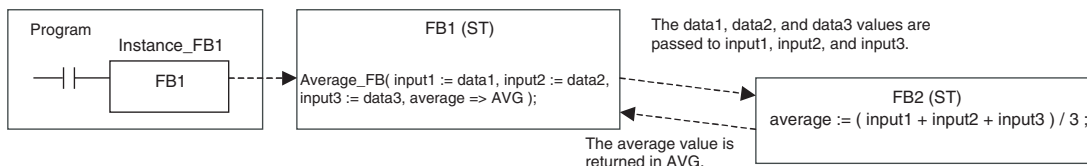

Average_FB is an instance name with data type FUNCTION BLOCK.

Function Block 1

- Variable Table

Variable type	Variable name	Data type	Passage to/from FB2
Input variable	EN	BOOL	---
Input variable	data1	INT	Passed to input1
Input variable	data2	INT	Passed to input2
Input variable	data3	INT	Passed to input3
Input variable	bCheck	BOOL	---
Output variable	ENO	BOOL	---
Output variable	AVG	INT	Received from average
Internal variable	Average_FB	FUNCTION BLOCK Called function block definition: Function block 2	---

- ST-language Algorithm

If bCheck is true, function block 2 is called to calculate the average value. The 3 values data1, data2, and data3 are passed to function block 2 input variables input1, input2, and input3 respectively. The result of the calculation (*average*) is returned to AVG.

Note The following diagram shows the Average_FB function block called with specification method A (both function block's variables listed).

```
IF bCheck = TRUE THEN
    Average (input1:=data1, input2:=data2, input3:=data3, average=>AVG) ;
ELSE
    RETURN;
END_IF;
```

Function Block 2

- Variable Table

Variable type	Variable name	Data type	Passage to/from FB1
Input variable	EN	BOOL	---
Input variable	input1	INT	Received from data1
Input variable	input2	INT	Received from data2
Input variable	input3	INT	Received from data3
Output variable	ENO	BOOL	---
Output variable	average	INT	Passed to AVG

- ST-language Algorithm

Calculates the average value of input1, input2, and input3 and stores the result in *average*.

```
average := (input1+input2+input3) / 3;
```

5-6 ST-language Program Example

5-6-1 Using an ST Program in a Function Block

Converting an Integer to BCD and Outputting It as a Text String

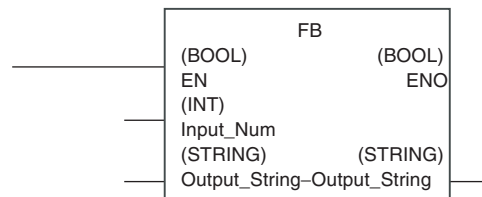

Input Variable

```
INT Input_Num;
```

Input-Output Variable

```
STRING Output_String;
```

Internal Variable

```
WORD Num_BCD;
```

(*Check Input_BCD input parameter (BCD data)*)

```
IF (Input_BCDNum >= 0 & Input_BCD <= 16 # Num <= 9999) THEN
```

```

        ENO:=true;
ELSE
        ENO:=false;
        RETURN;
END_IF;

Num_BCD:=INT_TO_BCD_WORD(Input_Num);
(*For example, if Num is 100 (16#0064), it is converted to BCD 0100*)
Output_String:=WORD_TO_STRING(Num_BCD);
(*Convert BCD 0100 to text string*)

```

5-7 Restrictions

5-7-1 Restrictions

■ Nesting

- There is no restriction on the number of nests that can be used in IF, CASE, FOR, WHILE, or REPEAT statements.

■ Data Type Restrictions

- Integers can only be allocated to variables with data types WORD, DWORD, INT, DINT, UINT, UDINT, or ULINT. For example, if A is an INT data type, A:=1; is possible. If the value is not an integer data type, a syntax error will occur. For example, if A is an INT data type, a syntax error will occur for A:=2.5;.
- If a real number (floating point decimal data) can only be allocated to variables with data types REAL and UREAL. For example, if A is a REAL data type, A:=1.5; is possible. If the value is not a real data type, a syntax error will occur. For example, if A is a REAL data type, a syntax error will occur for A:=2;. Use A:=2.0;.
- Bits (TRUE, FALSE) can only be allocated to variables with the BOOL data type. For example, if A is a BOOL data type, A:=FALSE; is possible. If a BOOL data type is not used, a syntax error will occur. For example, if A is an INT data type, a syntax error will occur for A:=FALSE;.
- Data types must all be consistent within the structured text. For example, if A, B, and C are INT data types, A:=B+C; is possible. If, however, A and B are INT data types, but C is a REAL data type or LINT data type, a syntax error will occur for A:=B+C;.
- In the structured text, the following cannot be used:
P_CY, P_EQ, P_ER, P_N, P_GE, P_GT, P_LE, P_LT, P_NE, P_OF, and P_UF

■ Monitor Restrictions

- There are following restrictions on monitoring timer functions:
When you use a TIMER type variable in a TENTH-MS TIMER or HUNDREDTH-MS TIMER, the present value of the TIMER type variable of the timer function is not displayed on the ST monitor view. In this case, "-" is displayed for the present value.
When the present value of the TIMER type variable is used in another place on the ST editor or assigned to a different variable, their present values are undependable.

- There are following restrictions on using 2-byte characters in variable names:

When you use any 2-byte characters in a variable name, insert a single-byte space between the variable and the operator. Without the space, the present value of the variable may not be monitored correctly.

5-7-2 Commonly Asked Questions

Q: How is a hexadecimal value expressed?

A: Add "16#" before the value, e.g., 16#123F.

The prefixes 8# and 2# can also be added to express octal numbers and binary numbers, respectively. Numbers without these prefixes will be interpreted as decimal numbers.

Q: How many times can FOR be used?

A: In the following example, the contents of the FOR statement is executed 101 times. The loop processing ends when the value of "i" is equal to 101.

```
FOR i:=0 TO 100 BY 1 DO
  a:=a+1;
END_FOR;
```

Q: What occurs when the array subscript is exceeded?

A: For the array variable INT[10] with 10 elements, an error will not be detected for the following type of statement. Operation will be unstable when this statement is executed.

```
i:=15;
INT[i]:=10;
```

Q: Are the variables in the structured text editor automatically registered in the variable tables?

A: No. Register the variables in the variable table before using them.

Q: Can ladder programming instructions be called directly?

A: No.

SECTION 6

Creating ST Programs

This section explains how to create ST programs.

- 6-1 Procedures 178
 - 6-1-1 Creating a Project 178
 - 6-1-2 Creating a New ST Program 178
 - 6-1-3 Allocating the ST Program to a Task 179
 - 6-1-4 Creating the ST Program 180
 - 6-1-5 Compiling the ST Program (Checking Program) 184
 - 6-1-6 Downloading/Uploading Programs to the Actual CPU Unit 184
 - 6-1-7 Comparing ST Programs 184
 - 6-1-8 Monitoring and Debugging the ST Program 185
 - 6-1-9 Online Editing of ST Programs 186

6-1 Procedures

This section explains how to create ST programs. For details on creating a function block with ST language, refer to *SECTION 3 Creating Function Blocks* in *Part 1: Function Blocks* of this manual.

6-1-1 Creating a Project

- 1,2,3...
1. Start the CX-Programmer and select **File -New**.
 2. In the Change PLC Dialog Box, select a PLC model that supports ST programs from the *Device Type* list. Refer to *4-2-1 PLC Models Compatible with ST Programs (ST Tasks)* for a table of the PLC models that support ST programs.
 3. Click the **Settings** Button, and select the *CPU Type*. For details on other settings, refer to the *CX-Programmer Operation Manual (W446)*.

6-1-2 Creating a New ST Program

Use the following procedure to create an ST program in a project.

- 1,2,3...
1. Right-click the **Programs** Item in the project workspace to display the pop-up menu.
 2. Select **Insert Program - ST** from the pop-up menu.

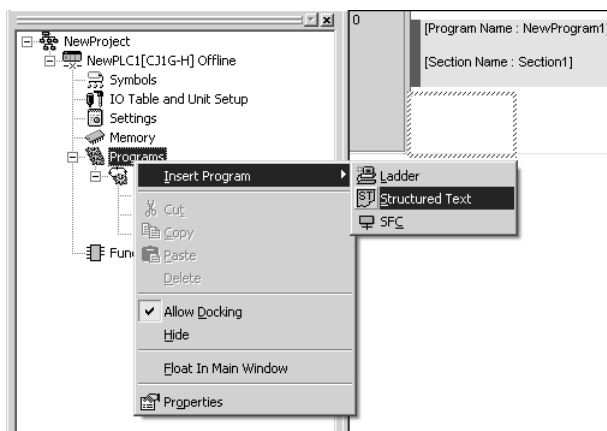

An ST program will be inserted in the project workspace, and the ST Editor will be displayed on the right side of the workspace.

- Note**
- (1) Ladder and SFC programs can also be created. To create these programs, right-click the **Programs** Item in the project workspace to display the pop-up menu, and select **Insert Program - Ladder** or **Insert Program - SFC**.

For details on ladder programming, refer to the *CX-Programmer Operation Manual (W446)*.

For details on SFC programming, refer to the *CX-Programmer Operation Manual: SFC (W469)*.

- (2) When a new project has been created, ST programs can be set as the PLC's initial program type. Select **Tools - Options** and click the **PLCs** Tab to set this option.

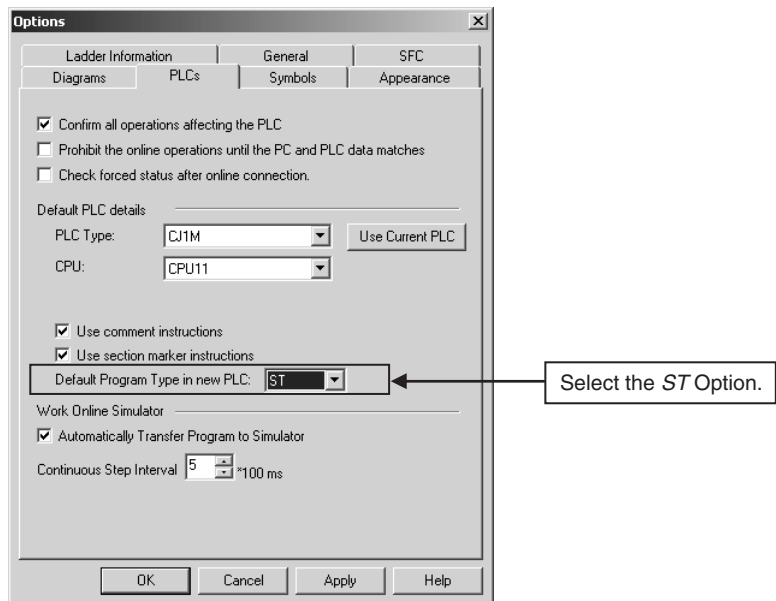

6-1-3 Allocating the ST Program to a Task

The ST program that was inserted in the project must be allocated to a task as an execution unit. If a program has not been allocated to a task, there will be a check mark over that program's icon in the project workspace.

Note The following procedure, which allocates a program to a task, can be performed after the program has been created, but always allocate the programs before transferring the user program to the PLC.

Use the following procedure to allocate a program to a task.

- 1,2,3... 1. Right-click the inserted ST program item in the project workspace, and select **Properties** from the pop-up menu.

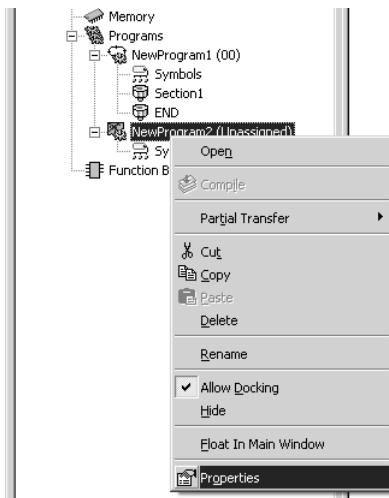

- Click the **General** Tab in the displayed Program Properties Dialog box, and select the task from the *Task Type* List. To set a program name, input the program name in the *Name* Text Box in this tab page.

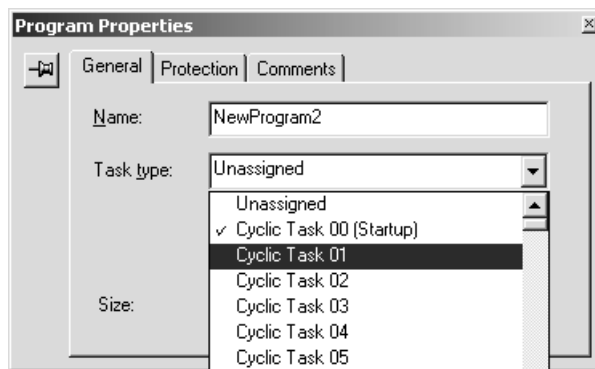

- Click the **Close** Button to close the Program Properties Dialog Box.

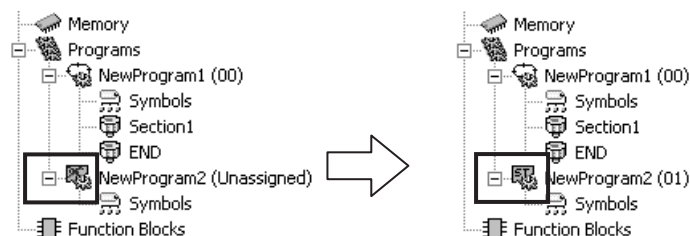

- When the program is allocated to a task, the check mark over the ST program's icon will be deleted. The allocated task number will be shown in parentheses after the program name.

6-1-4 Creating the ST Program

There are two ways to create the ST program's content.

- Input the ST language after registering the variables.
- Register the variables as you input the ST language.

Inputting the ST Language after Registering Variables

There are two kinds of variables: global variables and local variables. This section explains how to set local variables. For details on setting global variables, refer to the *CX-Programmer Operation Manual (W446)*.

1. Registering Variables (with Local Addresses)

- 1,2,3...* 1. Double-click the inserted ST program's **Symbols** in the project workspace.

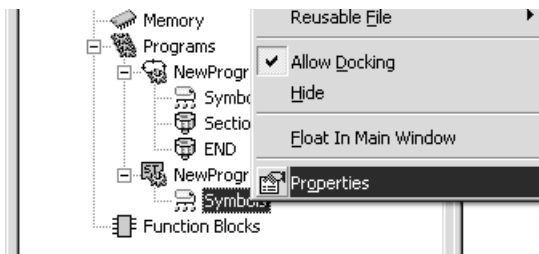

- The symbol table will be displayed. Right-click to display the pop-up menu, and select **Insert Symbol** from the pop-up menu. (It is also possible to select **Insert - Symbol**.)
- The New Symbol Dialog Box will be displayed. Set the following items, and click the **OK** Button.

- Name: Input the variable name.
- Data type: Select the data type.
- Address or Value: Input the address.

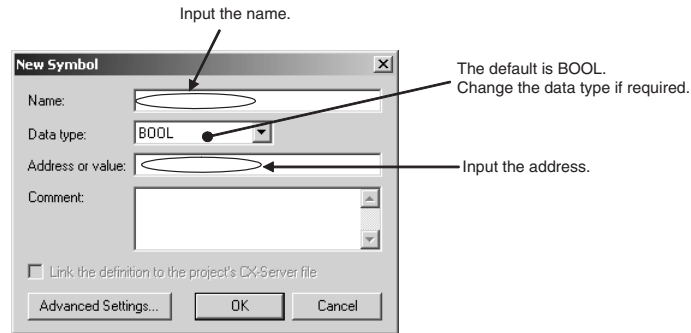

4. The variables set in the symbol table will be registered.

Note When variables are being registered without specifying addresses, the CX-Programmer can be set to allocate addresses automatically. For details on Automatic Allocation, refer to the *CX-Programmer Operation Manual (W446)*.

2. Creating the ST Program

- 1,2,3... 1. The ST language can be input directly in the ST Editor Window, or the ST data can be created in a text editor and then pasted in the ST Editor Window by selecting **Edit - Paste**.

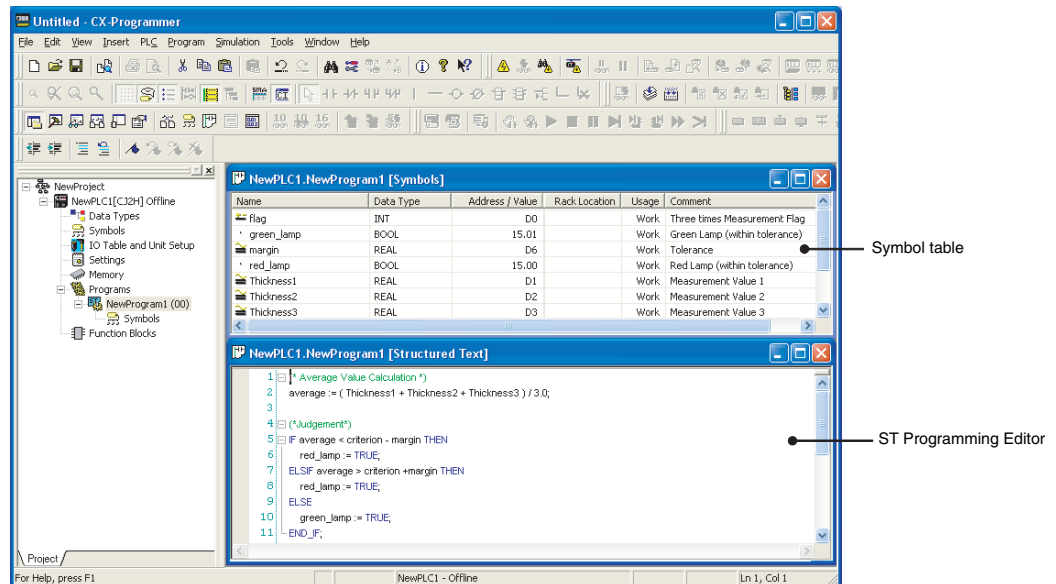

If the symbol table with the registered variables is displayed while inputting the ST program, it is easy to reference the variable names for programming.

- Note**
- (1) Tabs or spaces can be input to create indents. They will not affect the algorithm.
 - (2) When an ST language program is input or pasted into the ST input area, syntax keywords reserved words will be automatically displayed in blue, comments in green, text strings in brown, errors in red, and everything else in black.

- (3) To change the font size or colors, select **Options** from the Tools Menu and then click the **ST Font** Button on the Appearance Tab Page. The font names, font size (default is 8 point) and color can be changed.
- (4) For details on ST language specifications, refer to *SECTION 5 Structured Text (ST) Language Specifications* in *Part 2: Structured Text (ST)* in this manual.

Registering Variables While Using Structured Text

When using structured text, a dialog box will not be displayed to register the variable whenever a variable name that has not been registered is input. Be sure to always register variables used in standard text programming in the variable table, either as you need them or after completing the program.

Entering Functions and Variables

1,2,3...

- 1. Enter the first letter of a function or a registered variable on the ST Program Editor to display the keyword list.

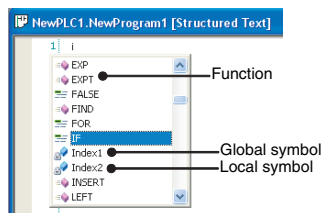

You can identify whether each keyword is a function or a variable by the icon on the left side of the keyword.

Icon	Keyword Type
	Function
	Elements of ST statements
	Global symbol
	Local symbol
	Function block symbol

- 2. Select a function or a variable to enter on the list and press the **Enter**, **Space**, or **Tab** key. The selection is entered and reflected onto the ST Program Editor.

Note (a) To cancel the selection on the keyword list, press the **Esc** key.
 (b) You can directly enter functions and variables on the ST Program Editor without selecting from the keyword list.

Registering Variables While Entering ST Language

When you use unregistered variables in writing ST language, the dialog that asks you to register the variables to the symbol table will not appear while you enter the ST language.

1,2,3...

- 1. When you press the **Enter** key after writing a line, a double underline is attached to each unregistered variable.

```
IF average < criterion - margin THEN
  red_lamp = TRUE;
```

- When you place the mouse cursor on the double underline, a button will be displayed.

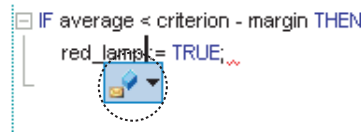

- Press this button to display a dialog for registering new variables. Set each item on the dialog and click the **OK** button.

Entry Assistance Function on ST Editor

1,2,3...

- Entering a control statement

You can easily enter a control statement frame in the following two ways.

- Select **Insert Code Snippets** from the pop-up menu and select one from the following list.

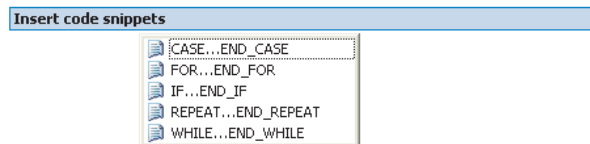

- Select and enter the first element of the control statement from the keyword list and press the **Tab** key.

Keyword	Control Statement Frame
IF	<pre>IF expression THEN ELSE END_IF;</pre>
FOR	<pre>FOR variable := expression1 TO expression2 BY expression3 DO END_FOR;</pre>
CASE	<pre>CASE expression OF ELSE END_CASE;</pre>
REPEAT	<pre>REPEAT UNTIL expression END_REPEAT;</pre>
WHILE	<pre>WHILE expression DO END_WHILE;</pre>

Note For each *expression* and *variable*, you need to enter the execution condition of the control statement.

- 2) The content of the keyword selected on the list is displayed by a tool tip. You can select the most appropriate item while confirming the operation of the keyword function and the comments for the variable.
- 3) The indent of each line can be increased and decreased by a menu item or a tool button.
- 4) Whether to handle the selected line as a comment or a part of the program can be switched by a menu item or a tool button.

6-1-5 Compiling the ST Program (Checking Program)

The ST program can be compiled to perform a program check on it. Use the following procedure.

- 1,2,3... 1. Select the ST program, right-click, and select **Compile** from the pop-up menu. (Alternately, press the **Ctrl + F7** Keys.)
2. The ST program will be compiled and the results of the program check will be automatically displayed on the Compile Table Page of the Output Window.

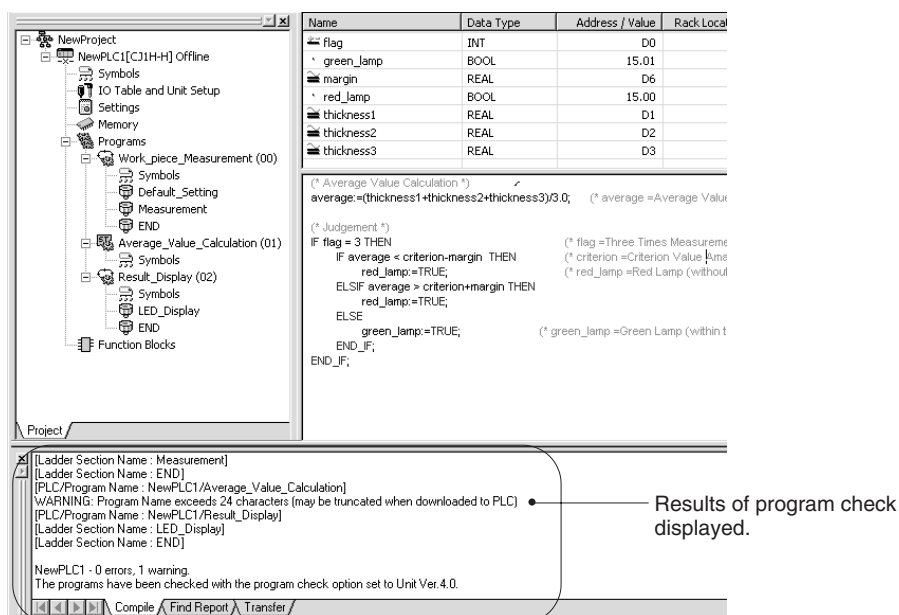

6-1-6 Downloading/Uploading Programs to the Actual CPU Unit

After a program containing the ST programs has been created, the CX-Programmer can be connected online to the actual PLC, and the program downloaded to the actual PLC. Conversely, the program can be uploaded from an actual PLC.

Program tasks cannot be downloaded or uploaded individually in task units.

6-1-7 Comparing ST Programs

It is possible to compare the edited ST program with an ST program block in the actual PLC or another project file to check whether the two ST programs are identical. For details on comparing programs, refer to the *CX-Programmer Operation Manual (W446)*.

6-1-8 Monitoring and Debugging the ST Program

Monitoring the ST Program's Variables

The ST program can be monitored.

The ST program is displayed in the left side of the window (called the ST program monitor window).

The values of variables used in the ST program are displayed in the right side of the window (called the ST variable monitor window).

At this point, it is possible to monitor variable values, change PVs, force-set or force-reset bits, and copy/paste variables in the Watch Window. (These operations are described below.)

n **Monitoring Variables**

Variable values are displayed in blue in the ST variable monitor window.

Note When you use a TIMER type variable in a TENTH-MS TIMER or HUNDREDTH-MS TIMER, "-" is displayed for the present value of the TIMER type variable. Refer to the *Section 5-7 Restrictions* for details.

n **Changing PVs**

To change a PV, select the desired variable in the ST variable monitor window (displayed in reverse video when selected), right-click, and select **Set - Value** from the pop-up menu.

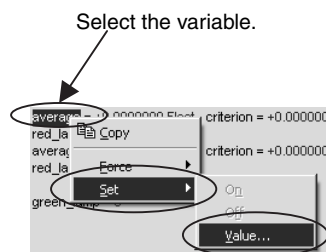

The Set New Value Dialog Box will be displayed. Input the new value in the *Value* field.

n **Force-setting and Force-resetting Bits**

To force-set, force-reset, or clear the forced status, select the desired variable in the ST variable monitor window (displayed in reverse video when selected), right-click, and select **Force - On**, **Force - Off**, **Force - Cancel**, or **Force - Cancel All Forces** from the pop-up menu.

n **Copying and Pasting in the Watch Window**

- 1,2,3...**
1. To copy a variable to the Watch Window, select the desired variable in the ST variable monitor window (displayed in reverse video when selected), right-click, and select **Copy** from the pop-up menu.

2. Right-click in the Watch Window and select **Paste** from the pop-up menu.

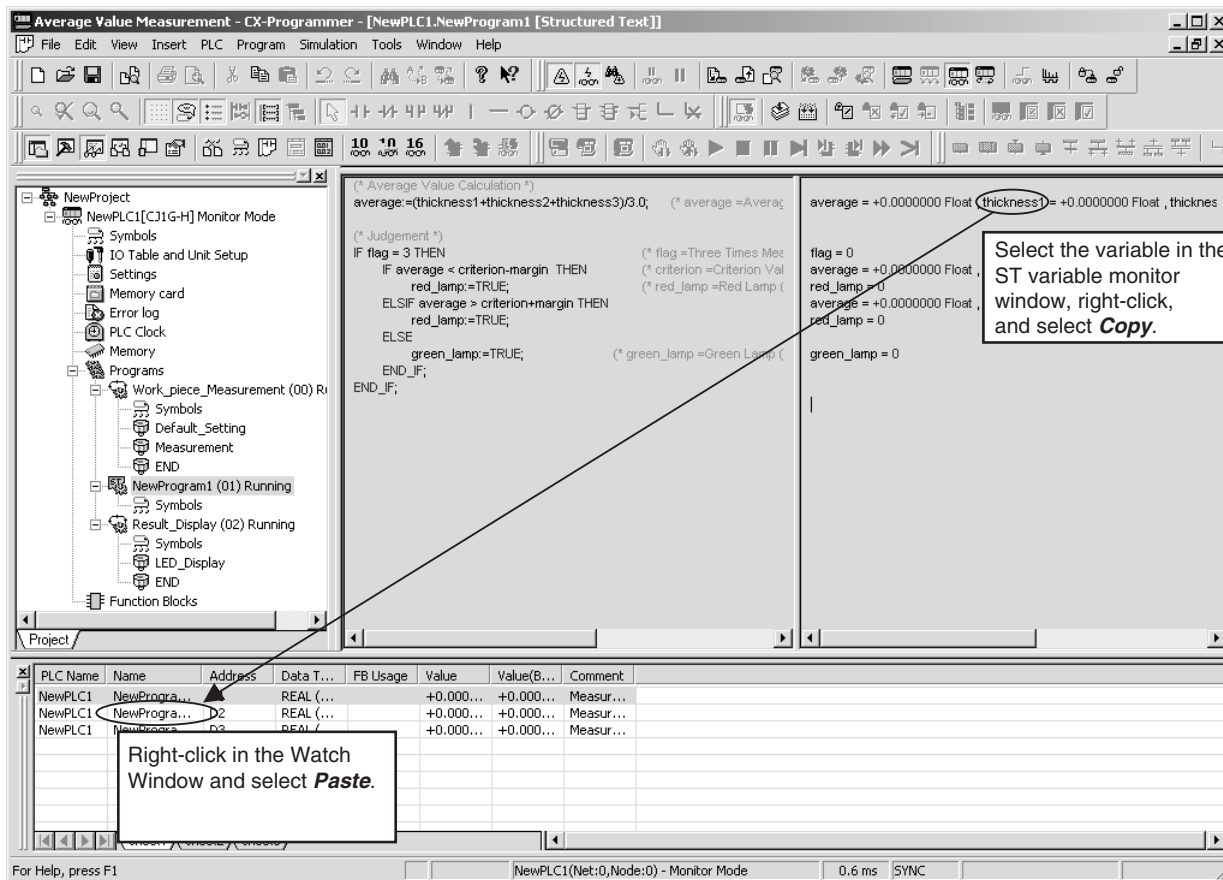

ST Program Simulation Function

The ST program can be connected to a simulator and monitored.

6-1-9 Online Editing of ST Programs

ST programs can be edited even when the PLC (CPU Unit) is operating. This allows ST programs to be debugged or changed in systems that cannot be shut down, such as systems that operate 24 hours/day.

ST programs can be edited online when the PLC is in an operating mode other than RUN mode.

This function cannot be used with the simulator.

Starting Online Editing

1,2,3...

1. Start monitoring.
2. Select the desired ST program in the project workspace, and display it in program view.
3. Select **Program - Online Edit - Begin**. At this point, it will be possible to edit the ST program.
4. Start editing the ST program.

Transferring the Changes

- 1,2,3...
1. After editing is completed, select **Program - Online Edit - Send Changes**. The Send Changes Dialog Box will be displayed.
 2. Select the desired transfer mode and click the **OK** Button. The edited ST program will be transferred to the PLC.
For details on the transfer modes, refer to *Transfer Modes* on page 187 and *Selecting a Transfer Mode* on page 187.
 3. After the transfer is completed, the ST program will return to its previous status in which the ST program cannot be edited. If further editing is necessary, resume the online editing procedure from the beginning of the procedure (Starting Online Editing).

Cancelling the Changes

To discard the changes made to the ST program, select **Program - Online Edit - Cancel**. The edited ST program will not be sent to the PLC, and the ST program will revert to the original status before online editing was started.

Transfer Modes

Standard Mode

In Standard Mode, both the ST program's source code and object code are transferred to the CPU Unit. Some time may be required for Standard Mode transfers because of the quantity of data that must be sent. Other editing or transfer operations cannot be performed until the transfer has been completed.

Quick Mode

In Quick Mode, only the ST program's object code is transferred to the CPU Unit. The ST source code is not transferred, making Quick Mode faster than Normal Mode. After transferring the object code in Quick Mode, either 1) select **Program - Transfer SFC/ST Source to PLC** to transfer the source code or 2) transfer the source code according to instructions displayed in a dialog box when you go offline.

After transferring the object code, a yellow mark will be displayed at the bottom of the window until offline status is entered to indicate that the source code has not yet been transferred. This yellow mark will disappear when the source code is transferred.

Selecting a Transfer Mode

As a rule, use Standard Mode to transfer ST program changes, unless online editing is performed frequently. If too much time is required, increase the baud rate as much as possible before the transfer. If too much time is still required and debugging efficiency is hindered by continuous online editing, use Quick Mode as an exception, but be sure you understand the restrictions given in the following note (*Mode Restrictions in Quick Mode*).

Caution Restrictions in Quick Mode (ST Source Code Not Transferred)

When the ST program's ST source code is not being transferred, the CX-Programmer cannot upload the program correctly the next time.

Consequently, after the ST program's online editing changes have been transferred in Quick Mode, it may be impossible to upload the program later (see note) if the computer or CX-Programmer crashes before the source code can be transferred.

Note It may be still be possible to transfer the source code with the following procedure, even if the above problem occurs.

Transferring Source Code from a Backup Project

1,2,3...

1. Start the CX-Programmer.
2. The following dialog box will be displayed if a project's ST source code was being transferred in Quick Mode and the transfer failed.

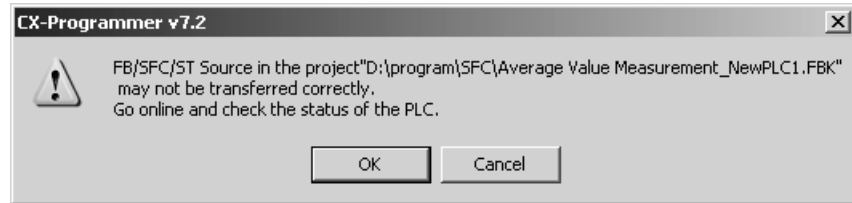

3. Click the **OK** Button. the CX-Programmer will start the backup project from the previous Quick Mode transfer.
4. Connect online with the PLC that was the destination of the Quick Mode transfer. The following dialog box will be displayed.

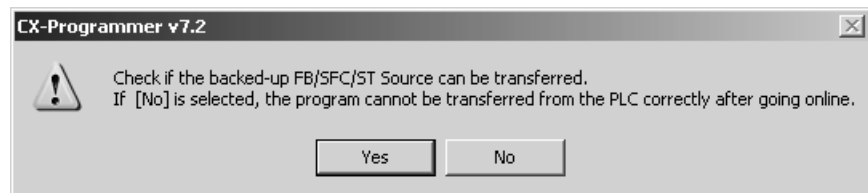

5. Click the **Yes** Button.
If the PLC is not in RUN mode, the program will be compared between the project and PLC, and the ST source code will be transferred if the programs match.
If the PLC is in RUN mode, switch the operating mode to another mode, and execute the ST source code transfer from the CX-Programmer menu.

Manually Transferring the ST Source Code

1,2,3...

1. Start the CX-Programmer, and open the project file with the ST source code to be transferred.
2. Connect online with the PLC that was the destination of the Quick Mode transfer. The flashing yellow message *Src, Fail* will be displayed in the CX-Programmer's status bar
3. Select **Program - Online Edit - Transfer SFC/ST Source to PLC**. The ST source code transfer dialog box will be displayed.
4. Click the **OK** Button.
The ST source code that was automatically backed up in the computer will be compared with the object code in the actual PLC, and the ST source code can be transferred if the code matches.

Note Before transferring a program, the CX-Programmer normally compiles the program code (ST source code) into object code, which can be executed in the CPU Unit, and then transfers both the source code and object code to the CPU Unit. The CPU Unit stores the programs ST source code and object code in user memory and built-in flash memory. Only when both the source code and object code exist in the CPU Unit can the CX-Programmer transfer and restore the program for the upload operation.

Restrictions in Online Editing of ST Programs

The following restrictions apply to online editing of ST programs.

- For CJ2-series CPU Units, there is no restriction on the number of steps that can be added to or deleted from a function block definition during one online editing operation.
- Online editing is not possible for ST programs that exceed 4 Ksteps (except for CJ2-series CPU Units).
- A maximum of 0.5 Ksteps can be added to or deleted from an ST program during one online editing operation (except for CJ2-series CPU Units).
- After performing online editing, do not turn OFF the power supply to the PLC until the CPU Unit has finished backing up data to the built-in flash memory (i.e., until the BKUP indicator goes OFF). If the power supply is turned OFF before the data is backed up, the data will not be backed up and the program will return to the status it had before online editing was performed.

Appendix A

System-defined external variables supported in function blocks

Classification	Name	External variable in CX-Programmer	Data type	Address
Conditions Flags	Greater Than or Equals (GE) Flag	P_GE	BOOL	CF00
	Not Equals (NE) Flag	P_NE	BOOL	CF001
	Less Than or Equals (LE) Flag	P_LE	BOOL	CF002
	Instruction Execution Error (ER) Flag	P_ER	BOOL	CF003
	Carry (CY) Flag	P_CY	BOOL	CF004
	Greater Than (GT) Flag	P_GT	BOOL	CF005
	Equals (EQ) Flag	P_EQ	BOOL	CF006
	Less Than (LT) Flag	P_LT	BOOL	CF007
	Negative (N) Flag	P_N	BOOL	CF008
	Overflow (OF) Flag	P_OF	BOOL	CF009
	Underflow (UF) Flag	P_UF	BOOL	CF010
	Access Error Flag	P_AER	BOOL	CF011
	Always OFF Flag	P_Off	BOOL	CF114
	Always ON Flag	P_On	BOOL	CF113
Clock Pulses	0.02 second clock pulse bit	P_0_02s	BOOL	CF103
	0.1 second clock pulse bit	P_0_1s	BOOL	CF100
	0.2 second clock pulse bit	P_0_2s	BOOL	CF101
	1 minute clock pulse bit	P_1mim	BOOL	CF104
	1.0 second clock pulse bit	P_1s	BOOL	CF102
Auxiliary Area Flags/ Bits	First Cycle Flag	P_First_Cycle	BOOL	A200.11
	Step Flag	P_Step	BOOL	A200.12
	First Task Execution Flag	P_First_Cycle_Task	BOOL	A200.15
	Maximum Cycle Time	P_Max_Cycle_Time	UDINT	A262
	Present Scan Time	P_Cycle_Time_Value	UDINT	A264
	Cycle Time Error Flag	P_Cycle_Time_Error	BOOL	A401.08
	Low Battery Flag	P_Low_Battery	BOOL	A402.04
	I/O VerIfication Error Flag	P_IO_Verify_Error	BOOL	A402.09
	Output OFF Bit	P_Output_Off_Bit	BOOL	A500.15
OMRON FB Library words (see note)	CIO Area specification	P_CIO	WORD	A450
	HR Area specification	P_HR	WORD	A452
	WR Area specification	P_WR	WORD	A451
	DM Area specification	P_DM	WORD	A460
	EM0 to C Area specification	P_EM0 to P EMC	WORD	A461 to A473

Note These words are external variables for the OMRON FB Library. Do not use these words for creating function blocks.

Appendix B

Structured Text Errors

Error Messages

Error Message	Cause of error	Example
%s' Input variables cannot be assigned a value	A value was substituted for an input variable.	
%s' operator not supported by %s data type	A numerical value or variable for a data type that is not supported by the operator was used.	A:=B+1; (*A and B are WORD type variables*)
%s' variable had a read only memory AT Address and cannot be assigned a value	A value was substituted for a variable allocated to a read-only memory address (read-only Auxiliary Area address or Condition Flag).	
Array index out of range	An array index larger than the array size was specified.	Array[100]:=10; (*Array is an array variable with an array size of 100*)
Conversion cannot convert from %s to %s	A numeric equation in which the data type of the operation result does not match the variable at the substitution destination and a variable that is different from the data type was substituted.	Y:=ABS(X); (*X is an INT type variable, Y is a UINT type variable*)
Division by Zero	The numeric expression contains division by 0.	
End of comment not found	The comment does not have a closing parenthesis and asterisk "**)" corresponding to the opening parenthesis and asterisk "(" of the comment.	(*comment
Invalid Literal Format '%s'	The numeric format is illegal.	X:=123_; (*There is no numeral after underscore*) X:=1__23; (*The underscore is followed immediately by another underscore*) X:=2#301; Y:=8#90; (*A numeral that cannot be used with binary or octal values has been used*) Note The underscore can be inserted between numerals to make them easier to read. Placing 2#, 8#, and 16# at the beginning of the numeral expresses the numerals as binary, octal, and hexadecimal values, respectively.
Invalid Literal Value	The numeric value is illegal.	X:=1e2; (*an index was used for a numeric value that was not a REAL data type*) Note "e" indicates an exponent of 10.
Invalid array index	A numeric equation with a non-integer type operation result or a non-integer variable has been specified in the array index.	Array[Index]:=10; (*Index is a WORD type variable*)

Error Message	Cause of error	Example
Invalid constant	A numeric equation with a non-integer type operation result, or a non-integer variable or numeric value has been specified in the integer equation of a CASE statement.	CASE A OF (*A is a REAL type variable*) 1: X:=1; 2: X:=2; END_CASE;
Invalid expression	The numeric equation is illegal. For example, the integer equation or condition equation is illegal or has not been specified in the syntax (IF, WHILE, REPEAT, FOR, CASE).	WHILE DO (*The WHILE statement does not contain a condition equation*) X:=X+1; END_WHILE;
Invalid parameter in FOR loop declaration	A variable with data type other than INT, DINT, LINT, UINT, UDINT, or ULINT has been used for variables in a FOR statement.	FOR I:=1 TO 100 DO (*I is a WORD type variable*) X:=X+1; END_FOR;
Invalid statement	The statement is illegal. E.g., The statement (IF, WHILE, REPEAT, FOR, CASE, REPEAT) does not contain an IF, WHILE, REPEAT, FOR, CASE, or REPEAT in the syntax, respectively.	X:=X+1; (*There is no REPEAT in the syntax*) UNTIL X>10 END_REPEAT;
Invalid variable for Function output	The specified variable for the function output is illegal (A non-boolean (BOOL) variable or numeral has been specified as the ENO transfer destination.)	Y:=SIN(X1, ENO=>1);
Missing (The call for a data format conversion instruction or function does not contain a "(" (opening parenthesis).	Y:=INT_TO_DINT X);
Missing)	The operator parentheses or the call for a data format conversion instruction or function does not contain a ")" (closing parenthesis) corresponding to "(" (opening parenthesis).	Y:=(X1+X2/2
Missing :	The integer equation in the CASE statement is not followed by a ":" (colon).	CASE A OF 1 X:=1; END_CASE;
Missing :=	":=" is not included in the assignment equation.	
Missing ;	The statement is not concluded by a ";" (semicolon).	
Missing DO	"DO" is not provided in the FOR or WHILE statement.	
Missing END_CASE	"END_CASE" is not provided at the end of the CASE statement.	
Missing END_FOR	"END_FOR" is not provided at the end of the FOR statement.	
Missing END_IF	"END_IF" is not provided at the end of the IF statement.	
Missing END_REPEAT	"END_REPEAT" is not provided at the end of the REPEAT statement.	

Error Message	Cause of error	Example
Missing END_WHILE	"END_WHILE" is not provided at the end of the WHILE statement.	
Missing Input Parameter. All input variables must be set.	The function argument is not specified or is insufficient.	Y:=EXPT(X);
Missing OF	"OF" is not included in CASE statement.	
Missing THEN	"THEN" is not included in IF statement.	
Missing TO	"TO" is not included in FOR statement.	
Missing UNTIL	"UNTIL" is not included in REPEAT statement.	
Missing [The array index for the array variable has not been specified.	X:=Array; (*Array is an array variable*)
Missing]	The array index for the array variable has not been specified.	X:=Array[2]; (*Array is an array variable*)
Missing constant	A constant is not provided in the integer equation of the CASE statement.	CASE A OF 2..: X:=1; 2,: X:=2; END_CASE;
NOT operation not supported on a literal number	The NOT operator was used for a numeric value.	Result:=NOT 1;
Negation not supported by %s data type	A minus symbol was used before a variable with a data type that does not support negative values (UINT, UDINT, ULINT).	Y:=-X; (*X is an UINT type variable, Y is an INT type variable*)
There must be one line of valid code (excluding comments)	There is no line of valid code (excluding comments).	
Too many variables specified for Function	Too many parameter settings are specified for the function.	Y:=SIN(X1,X2);
Undefined identifier '%s'	A variable that is not defined in the variable table has been used.	
Unexpected syntax '%s'	A keyword (reserved word) or variable has been used illegally.	FOR I:=1 TO 100 DO BY -1 (*The DO position is illegal*) X:=X+1; END_FOR;
Usage mismatch in Function variable	The function parameter has been used illegally.	Y:=SIN(X1,EN=>BOOL1); (*The input parameter EN has been used as an output parameter*)
Value out of range	A value outside the range for the variable data type has been substituted in the variable.	X:=32768; (*X is an INT type variable*)
Variable '%s' is not a Function parameter	A variable that cannot be specified in the function parameter has been specified in the parameter.	Y:=SIN(Z:=X); (*X and Y are REAL type variables, and Z is not a SIN function parameter *)

Warning Messages

Warning message	Cause of warning	Example
Keyword '%s' is redundant	The keyword has been used in an invalid location. For example, use of the EXIT statement outside a loop syntax.	
Conversion from '%s' to '%s', possible loss of data	Data may be lost due to conversion of a data type with a large data size to a data type with a small data size.	Y:=DINT_TO_INT(X); (*X is a DINT type variable, Y is an INT type variable*)

Appendix C

Function Descriptions

Standard Functions

Text String Functions

LEN: Detect String Length

- Function
Finds the length of a specified text string.
- Application
Return_value := LEN(string);
- Arguments and Return Values

Variable name	Data type	Description
String	STRING	Specifies the text string for which to find the length.
Return_value	INT	Returns the size of the specified text string.

- Example

Variables
STRING Message Message

A	B	C	D	E	F	G	H
---	---	---	---	---	---	---	---

INT Result

Result:=LEN(Message);
→ "8" is stored in *Result* variable.

LEFT: Extract Characters from Left

- Function
Extracts the specified number of characters from the left of the specified text string.
- Application
Return_value := LEFT(Source_string, Number_of_characters);
- Arguments and Return Values

Variable name	Data type	Description
Source_string	STRING	Specifies the text string from which to extract characters.
Number_of_characters	INT, UINT	Specifies the number of characters to extract.
Return_value	STRING	Returns the extracted characters.

- Example

Variables
STRING Message Message

A	B	C	D	E	F	G	H
---	---	---	---	---	---	---	---

STRING Result

Result:=LEFT(Message,3);
→ "ABC" is stored in the *Result* variable.

RIGHT: Extract Characters from Right

- Function
Extracts the specified number of characters from the right of the specified text string.
- Application
Return_value := RIGHT(Source_string, Number_of_characters);

• Arguments and Return Values

Variable name	Data type	Description
Source_string	STRING	Specifies the text string from which to extract characters.
Number_of_characters	INT, UINT	Specifies the number of characters to extract.
Return_value	STRING	Returns the extracted characters.

• Example

Variables
 STRING Message
 STRING Result

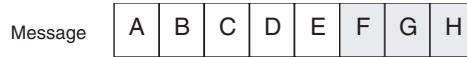

Result:=RIGHT(Message,3);
 → "FGH" is stored in the *Result* variable.

MID: Extract Characters from Middle

• Function

Extracts the specified number of characters starting from the specified position of the specified text string.

• Application

Return_value := MID (Source_string, Number_of_characters, Position);

• Arguments and Return Values

Variable name	Data type	Description
Source_string	STRING	Specifies the text string from which to extract characters.
Number_of_characters	INT, UINT	Specifies the number of characters to extract.
Position	INT, UINT	Specifies the position from which to start extracting characters. The first character is position "1" (e.g., position 1 is "A" in message 1 in the following illustration).
Return_value	STRING	Returns the extracted characters.

• Example

Variables
 STRING Message
 STRING Result



Result:=MID(Message,3,2);
 → "BCD" is stored in the *Result* variable.

CONCAT: Concatenate Strings

• Function

Joins the specified text strings.
 Up to 31 text strings can be specified.

• Application

Return_value := CONCAT (Source_string_1, Source_string_2, ...);

• Arguments and Return Values

Variable name	Data type	Description
Source_string_1	STRING	Specifies a text string to be joined.
Source_string_2	STRING	Specifies a text string to be joined.
:		
Return_value	STRING	Returns the joined text strings.

• Example

Variables
 STRING Message1
 STRING Message2
 STRING Message3
 STRING Result

Message 1

A	B	C
---	---	---

 Message 2

D	E
---	---

 Message 3

F	G	H
---	---	---

Result:=CONCAT(Message1,Message2,Message3);
 → "ABCDEFGH" is stored in the *Result* variable.

Result

A	B	C	D	E	F	G	H
---	---	---	---	---	---	---	---

INSERT: Insert Characters

• Function

Inserts the specified characters into a text string.

• Application

Return_value := INSERT(*Source_string*, *Insert_string*, *Position*);

• Arguments and Return Values

Variable name	Data type	Description
Source_string	STRING	Specifies the text string into which to insert characters.
Insert_string	STRING	Specifies the text string to be inserted.
Position	INT, UINT	Specifies the position at which to insert characters. The first character is position "1" (e.g., position 1 is "A" in message 1 in the following illustration).
Return_value	STRING	Returns the text string with the characters inserted.

• Example

Variables
 STRING Message1
 STRING Message2
 STRING Result

Message 1

A	B	C	D
---	---	---	---

 Message 2

E	F	G	H
---	---	---	---

Result := INSERT(Message1, Message2, 2);
 → "ABEFGHC" is stored in the *Result* variable.

Result

A	B	E	F	G	H	C	D
---	---	---	---	---	---	---	---

DELETE: Delete Characters

• Function

Deletes the specified number of characters starting from the specified position of the specified text string.

• Application

Return_value := DEL (*Source_string*, *Number_of_characters*, *Position*);

• Arguments and Return Values

Variable name	Data type	Description
Source_string	STRING	Specifies the text string from which to delete characters.
Number_of_characters	INT, UINT	Specifies the number of characters to delete.
Position	INT, UINT	Specifies the position from which to delete characters. The first character is position "1" (e.g., position 1 is "A" in message 1 in the following illustration).
Return_value	STRING	Returns the text string with the specified number of characters deleted.

• Example

Variables
 STRING Message1
 STRING Result



Result:=DEL(Message1,4,2);
 → "AFGH" is stored in the *Result* variable.



REPLACE: Replace Characters

• Function

Replaces the specified number of characters starting from the specified position of the specified text string.

• Application

Return_value := REPLACE(*Source_string*, *Replace_string*, *Number_of_characters*, *Position*);

• Arguments and Return Values

Variable name	Data type	Description
Source_string	STRING	Specifies the text string in which to replace characters.
Replace_string	STRING	Specifies the replace text string.
Number_of_characters	INT, UINT	Specifies the number of characters to be replaced.
Position	INT, UINT	Specifies the position from which to replace characters. The first character is position "1" (e.g., position 1 is "A" in message 1 in the following illustration).
Return_value	STRING	Returns the text string with the characters replaced.

• Example

Variables
 STRING Message1
 STRING Message2
 STRING Result



Result:=REPLACE(Message1,Message2,2,3);
 → "ABXYEFGH" is stored in the *Result* variable.

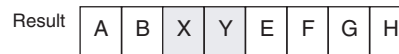

FIND: Find Characters

• Function

Finds the first occurrence of the specified text string in another text string and returns the position. If the text string is not found, 0 is returned.

• Application

Return_value := FIND(*Source_string*, *Find_string*);

• Arguments and Return Values

Variable name	Data type	Description
Source_string	STRING	Specifies the text string to search.
Find_string	STRING	Specifies the text string to find.
Return_value	INT	Returns the position of the first occurrence of the find text string. The first character is position "1" (e.g., position 1 is "A" in message 1 in the following illustration).

- Example

Variables
 STRING Message1
 STRING Message2
 INT Result

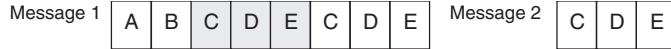

Result:=FIND(Message1,Message2);
 → "2" is stored in the *Result* variable.

Data Shift Functions

SHL: Bitwise Shift Left

- Function

Shifts a bit string to the left by n bits.
 When shifted, zeros are entered on the right side of the bit string.

- Application

Return_value := SHL (Shift_target_data, Number_of_bits);

- Arguments and Return Values

Variable name	Data type	Description
Shift_target_data (S1)	BOOL, WORD, DWORD, LWORD	Specifies the data to be shifted
Number_of_bits (n)	INT, UINT, UDINT, ULINT, DINT, LINT	Specifies the number of bits by which the bit string is to be shifted
Return_value	BOOL, WORD, DWORD, LWORD	Returns the output data

- Note

The same data type must be set for the 1st argument and the return value.

- Example

[Variables]
 WORD Data1 Data1 = B26E (hex) → 1011 0010 0110 1110 (binary)
 INT N N = 1 (decimal)
 WORD Result

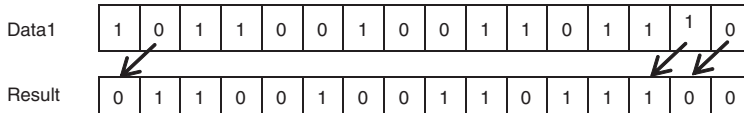

Result := SHL(Data1,N);
 → '64DC' is stored in the **Result** variable.

SHR: Bitwise Shift Right

- Function

Shifts a bit string to the right by n bits.
 When shifted, zeros are entered on the left side of the bit string.

- Application

Return_value := SHR (Shift_target_data, Number_of_bits);

- Arguments and Return Values

Variable name	Data type	Description
Shift_target_data (S1)	BOOL, WORD, DWORD, LWORD	Specifies the data to be shifted
Number_of_bits (n)	INT, UINT, UDINT, ULINT, DINT, LINT	Specifies the number of bits by which the bit string is to be shifted
Return_value	BOOL, WORD, DWORD, LWORD	Returns the output data

• Note

The same data type must be set for the 1st argument and the return value.

• Example

[Variables]
 WORD Data1 Data1 = B26E (hex) → 1011 0010 0110 1110 (binary)
 INT N N = 1 (decimal)
 WORD Result

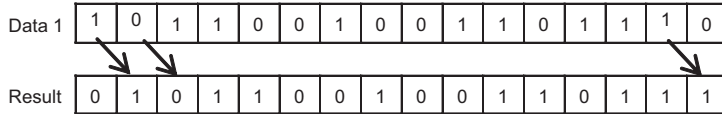

Result := SHR(Data1,N);
 → '5937' is stored in the **Result** variable.

ROL: Bitwise Rotate Left

• Function

Rotates a bit string to the left by n bits.

• Application

Return_value := ROL (Rotation_target_data, Number_of_bits);

• Arguments and Return Values

Variable name	Data type	Description
Rotation_target_data (S1)	BOOL, WORD, DWORD, LWORD	Specifies the data to be rotated
Number_of_bits (n)	INT, UINT, UDINT, ULINT, DINT, LINT	Specifies the number of bits by which the bit string is to be rotated
Return_value	BOOL, WORD, DWORD, LWORD	Returns the output data

• Note

The same data type must be set for the 1st argument and the return value.

• Example

[Variables]
 WORD Data1 Data1 = B26E (hex) → 1011 0010 0110 1110 (binary)
 INT N N = 1 (decimal)
 WORD Result

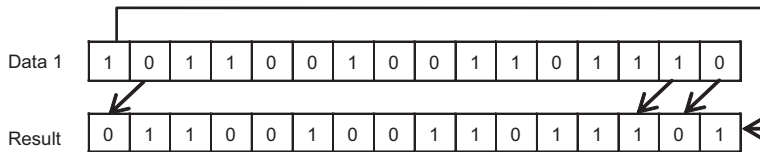

Result := ROL(Data1,N);
 → '64DD' is stored in the **Result** variable.

ROR: Bitwise Rotate Right

• Function

Rotates a bit string to the right by n bits.

• Application

Return_value := ROR (Rotation_target_data, Number_of_bits);

• Arguments and Return Values

Variable name	Data type	Description
Rotation_target_data (S1)	BOOL, WORD, DWORD, LWORD	Specifies the data to be rotated
Number_of_bits (n)	INT, UINT, UDINT, ULINT, DINT, LINT	Specifies the number of bits by which the bit string is to be rotated
Return_value	BOOL, WORD, DWORD, LWORD	Returns the output data

• Note

The same data type must be set for the 1st argument and the return value.

• Example

[Variables]
 WORD Data1 Data1 = B26E (hex) → 1011 0010 0110 1110 (binary)
 INT N N = 1 (decimal)
 WORD Result

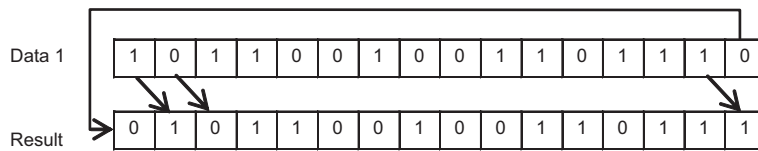

Result := ROR(Data1,N);
 → '5937' is stored in the **Result** variable.

Data Control Functions

LIMIT: Upper/Lower Limit Control

• Function

Controls the output data depending on whether the input data is within the range between the upper and lower limits.

• Application

Return_value := LIMIT (Lower_limit_data, Input_data, Upper_limit_data);

• Arguments and Return Values

Variable name	Data type	Description
Lower_limit_data	BOOL, INT, UINT, UDINT, ULINT, DINT, LINT, WORD, DWORD, LWORD, REAL, LREAL	Specifies the lower limit.
Input_data	BOOL, INT, UINT, UDINT, ULINT, DINT, LINT, WORD, DWORD, LWORD, REAL, LREAL	Specifies the input data.
Upper_limit_data	BOOL, INT, UINT, UDINT, ULINT, DINT, LINT, WORD, DWORD, LWORD, REAL, LREAL	Specifies the upper limit.
Return_value	BOOL, INT, UINT, UDINT, ULINT, DINT, LINT, WORD, DWORD, LWORD, REAL, LREAL	Returns the output data.

• Note

When the input data is smaller than the lower limit data, the value of the lower limit data is returned as the result.

When the input data is bigger than the upper limit data, the value of the upper limit data is returned as the result.

When the input data is a value between the upper limit data and lower limit data, the value of the input data is returned as the result.

The same data type must be set for the arguments and the return value.

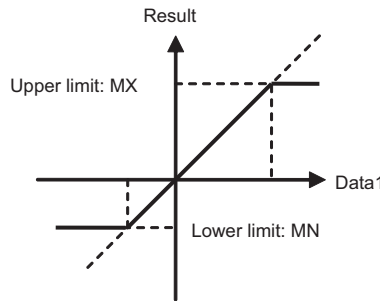

• Example

```
[Variables]
INT MN      MN = 123 Data1 = 456 MX = 789
INT Data1
INT MX      Result := LIMIT(MN,Data1,MX);
INT Result  →'456' is stored in the Result variable.
```

Data Selection Functions

SEL: Data Selection

• Function

Selects one of two data according to the selection condition.

• Application

Return_value := SEL (*Selection_condition*, *Selection_target_data1*, *Selection_target_data2*);

• Arguments and Return Values

Variable name	Data type	Description
Selection_condition (g)	BOOL	Selects S2, if the selection condition g is TRUE (= 1). Selects S1, if it is FALSE (= 0).
Selection_target_data1 (S1)	BOOL, INT, UINT, UDINT, ULINT, DINT, LINT, WORD, DWORD, LWORD, REAL, LREAL	Specifies the selection target data.
Selection_target_data2 (S2)	BOOL, INT, UINT, UDINT, ULINT, DINT, LINT, WORD, DWORD, LWORD, REAL, LREAL	Specifies the selection target data.
Return_value	BOOL, INT, UINT, UDINT, ULINT, DINT, LINT, WORD, DWORD, LWORD, REAL, LREAL	Returns the output data.

• Note

The same data type must be set for both Selection_target_data arguments.

• Example

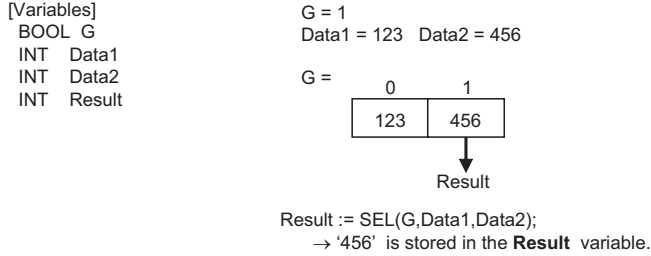

MUX: Multiplexer

• Function

Extracts a specified data according to the extraction condition.
Up to 30 data can be specified as extraction targets.

• Application

Return_value := MUX (Extraction_condition, Extraction_target_data1, Extraction_target_data2, ...);

• Arguments and Return Values

Variable name	Data type	Description
Extraction_condition (n)	INT, UINT, UDINT, ULINT, DINT, LINT	Specifies the data to be extracted. Extraction condition $n = 0, 1, 2, \dots, 29$ When $n = 0$, extraction target data1 $S1$ is output. When $n = 1$, extraction target data2 $S2$ is output. : : When $n = n$, extraction target data($n+1$) $S(n+1)$ is output.
Extraction_target_data1 (S1)	BOOL, INT, UINT, UDINT, ULINT, DINT, LINT, WORD, DWORD, LWORD, REAL, LREAL	Specifies the extraction target data.
Extraction_target_data2 (S2)	BOOL, INT, UINT, UDINT, ULINT, DINT, LINT, WORD, DWORD, LWORD, REAL, LREAL	Specifies the extraction target data.
:		
Return_value	BOOL, INT, UINT, UDINT, ULINT, DINT, LINT, WORD, DWORD, LWORD, REAL, LREAL	Returns the output data.

• Note

Return_value := MUX(Selection_condition, Extraction_target_data1, Extraction_target_data2, ...);
The same data type must be set for the return value and all arguments except for 1st one (Extraction_condition).
When any value other than 0 to 29 is specified for the extraction condition, the value stored in the Result becomes undependable.

• Example

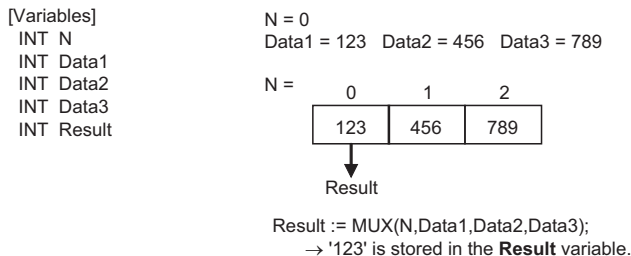

MAX: Maximum Value

- Function

Selects the maximum value from the target data.
Up to 31 data can be specified as target data.

- Application

Return_value := MAX (Target_data1, Target_data2, Target_data3, ..., Target_data31);

- Arguments and Return Values

Variable name	Data type	Description
Target_data1 (S1)	BOOL, INT, UINT, UDINT, ULINT, DINT, LINT, WORD, DWORD, LWORD, REAL, LREAL	Specifies the target data.
Target_data2 (S2)	BOOL, INT, UINT, UDINT, ULINT, DINT, LINT, WORD, DWORD, LWORD, REAL, LREAL	Specifies the target data.
Target_data3 (S3)	BOOL, INT, UINT, UDINT, ULINT, DINT, LINT, WORD, DWORD, LWORD, REAL, LREAL	Specifies the target data.
:		
Target_data31 (S31)	BOOL, INT, UINT, UDINT, ULINT, DINT, LINT, WORD, DWORD, LWORD, REAL, LREAL	Specifies the target data.
Return_value	BOOL, INT, UINT, UDINT, ULINT, DINT, LINT, WORD, DWORD, LWORD, REAL, LREAL	Returns the output data.

- Note

Return_value := MAX(Target_data1, Target_data2, Target_data3, ..., Target_data31);
The same data type must be set for all arguments and the return value.

- Example

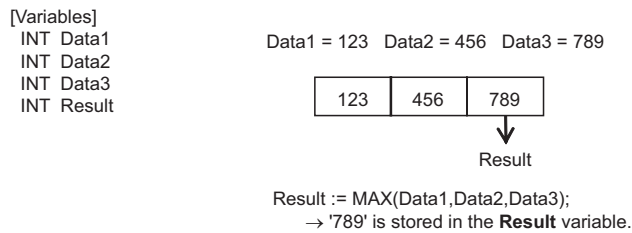

MIN: Minimum Value

- Function

Selects the minimum value from the target data.
Up to 31 data can be specified as target data.

- Application

Return_value := MIN (Target_data1, Target_data2, Target_data3, ..., Target_data31);

• Arguments and Return Values

Variable name	Data type	Description
Target_data1 (S1)	BOOL, INT, UINT, UDINT, ULINT, DINT, LINT, WORD, DWORD, LWORD, REAL, LREAL	Specifies the target data.
Target_data2 (S2)	BOOL, INT, UINT, UDINT, ULINT, DINT, LINT, WORD, DWORD, LWORD, REAL, LREAL	Specifies the target data.
Target_data3 (S3)	BOOL, INT, UINT, UDINT, ULINT, DINT, LINT, WORD, DWORD, LWORD, REAL, LREAL	Specifies the target data.
:		
Target_data31 (S31)	BOOL, INT, UINT, UDINT, ULINT, DINT, LINT, WORD, DWORD, LWORD, REAL, LREAL	Specifies the target data.
Return_value	BOOL, INT, UINT, UDINT, ULINT, DINT, LINT, WORD, DWORD, LWORD, REAL, LREAL	Returns the output data.

• Note

Return_value := MIN(Target_data1, Target_data2, Target_data3, ..., Target_data31);
 The same data type must be set for all arguments and the return value.

• Example

[Variables]
 INT Data1
 INT Data2
 INT Data3
 INT Result

Data1 = 123 Data2 = 456 Data3 = 789



Result

Result := MIN(Data1,Data2,Data3);
 →'123' is stored in the **Result** variable.

OMRON Expansion Function

Memory Card Functions

WRITE_TEXT: Create Text File

- Function

Writes the specified text sting into the specified file in the Memory Card.

- Application

Write_Text (*Write_string, Directory_name_and_file_name, Delimiter, Parameter*);

- Arguments and Return Values

Variable name	Data type	Description
Write_string	STRING	Specifies the text string to write to a file.
Directory_name_and_file_name	STRING	Specifies the directory and file name, including the root directory(\). The file name must be 8 characters or less. The file name extension is always TXT. For example, the following file name creates a file named LINE_A.TXT in the root directory: \LINE_A.
Delimiter	STRING	": Empty character ' ': Comma "\$L" or "\$l": Line feed (ASCII 0A) "\$N" or "\$n": Carriage return + line feed (ASCII 0D 0A) "\$P" or "\$p": New page (ASCII 0C) "\$R" or "\$r": Carriage return (ASCII 0D) "\$T" or "\$t": Tab (ASCII 09)
Parameter	INT, UINT, WORD	0: Append 1: Create new file

• Example

Variables		
BOOL	P_MemCardBusyFlag	(* File Memory Operation Flag *) AT A343.13
BOOL	P_MemCardAskFlag	(* Memory Card Detected Flag *) AT A343.15
STRING	FileName	(* File name *)
INT	LogData1 2 3	(* Log number *)
STRING	FiledStr1 2 3	(* Log number text string *)
STRING	CsvLineStr	(* CSV-format log, 1-line text string *)

```

FileName := 'LOGFILE';
LogData1 := 12;
LogData2 := 345;
LogData3 := 6789;

(* Output data to text file if Memory Card write conditions are met. *)
IF ( P_MemCardAckFlag AND (NOT P_MemCardBusyFlag) ) THEN

  (* Convert from number to text string *)
  FieldStr1 := INT_TO_STRING( LogData1 );
  FieldStr2 := INT_TO_STRING( LogData2 );
  FieldStr3 := INT_TO_STRING( LogData3 );
  (* Create 1-row CSV-format numeric value text string *)
  CsvLineStr := FieldStr1 + ',' + FieldStr2 + ',' + FieldStr3;
  (* Output one line of numeric data to file *)
  WRITE_TEXT( CsvLineStr, FileName, '$n', 0 );
END_IF;
    
```

Contents of output file

```

LOGFILE.TXT

12,345,6789
    
```

Related Auxiliary Area Flag	Address	Description
File Memory Operation Flag	A343.13	ON when any of the following conditions exists: <ul style="list-style-type: none"> • CMND instruction sending a FINS command to the local CPU Unit. • File Memory Instruction being executed. • Program replacement using the control bit in the Auxiliary Area. • Easy backup operation.
Memory Card Detected Flag	A343.15	ON when a Memory Card has been detected.

For further information and precautions on related Auxiliary Area flags, refer to the section on the FWRIT File Memory Instruction in the CS/CJ-series Instruction Reference Manual.

Communications Functions

TXD_CPU: Send String via CPU Unit RS-232C Port

- Function
 - Sends a text string from the RS-232C port on the CPU Unit.
- Application
 - TXD_CPU (*Send_string*);
- Conditions
 - The serial communications mode of the RS-232C port must be set to no-protocol communications.
- Arguments and Return Values

Variable name	Data type	Description
Send_string	STRING	Specifies the text string to send.

• Example

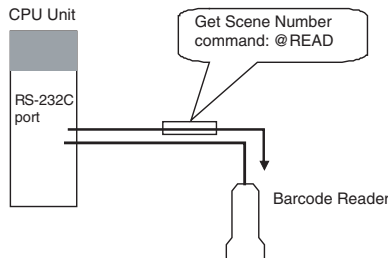

```

Variables
BOOL   DoSendData      (* Variable to control send function *)
INT    iProcess        (* Process number *)
STRING Message         (* Send message *)
BOOL   SendEnableCPUPort (* Send Ready Flag *)    AT A392.05
    
```

```

(* Send data when DoSendData is ON and iProcess is 0 *)
IF (DoSendData = TRUE) AND (iProcess = 0) THEN
    iProcess := 1;
    DoSendData := FALSE;
END_IF;
(* Execute send processing according to process number *)
CASE iProcess OF
    1:      (* Create send text data *)
        Message := '@READ';
        iProcess := 2;
    2:      (* Execute send function if sending is enabled *)
        IF SendEnableCPUPort = TRUE THEN
            TXD_CPU(Message);
            iProcess := 3;
        END_IF;
    3:      (* Sending is finished if Send Ready Flag is ON *)
        IF SendEnableCPUPort = TRUE THEN
            iProcess := 0;
        END_IF;
END_CASE;
    
```

Related Auxiliary Area Flag	Address	Description
RS-232C Port Send Ready Flag	A392.05	ON when sending is enabled in no-protocol mode.

For further information and precautions on related Auxiliary Area flags, refer to the section on TXD Serial Communications Instruction in the CS/CJ-series Instruction Reference Manual.

TXD_SCB: Send String via Serial Port on Serial Communications Board

• Function

Sends a text string from a serial port on a Serial Communications Board (SCB).

• Application

TXD_SCB (*Send_string*, *Serial_port*);

• Conditions

The serial communications mode of the serial port must be set to no-protocol communications.

• Arguments and Return Values

Variable name	Data type	Description
Send_string	STRING	Specifies the text string to send.
Serial_port	INT, UINT, WORD	Specifies the number of the serial port. 1: Serial port 1 2: Serial port 2

• Example

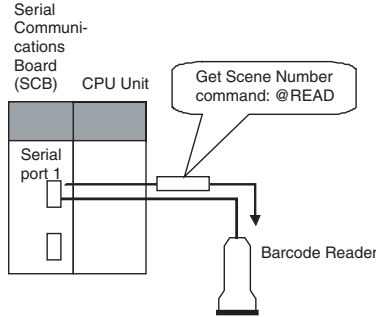

```

Variables
  BOOL    P_DoSendData    (* Variable to control send function *)
  INT     iProcess        (* Process number *)
  STRING  Message         (* Send message *)
  BOOL    P_SendEnableSCBPort1 (* Send Ready Flag *) AT A356.05
          Serial port 1 used.
    
```

```

(* Use serial port number 1 *)

(*Send data when P_DoSendData is ON and iProcess is 0 *)
IF (P_DoSendData = TRUE) AND (iProcess = 0) THEN
    iProcess := 1;
    P_DoSendData := FALSE;
END_IF;

(* Execute send processing according to process number *)
CASE iProcess OF
  1: (* Create send text data *)
    Message := '@READ';
    iProcess := 2;
  2: (* Execute send function if sending is enabled *)
    IF P_SendEnableSCBPort1 = TRUE THEN
        TXD_SCB(Message, 1);
        iProcess := 3;
    END_IF;
  3: (* Sending is finished if Send Ready Flag is ON *)
    IF P_SendEnableSCBPort1 = TRUE THEN
        iProcess := 0;
    END_IF;
END_CASE;
    
```

Related Auxiliary Area Flag	Address	Description
Port 1 Send Ready Flag	A356.05	ON when sending is enabled in no-protocol mode.
Port 2 Send Ready Flag	A356.13	ON when sending is enabled in no-protocol mode.

For further information and precautions on related Auxiliary Area flags, refer to the section on TXD Serial Communications Instruction in the CS/CJ-series Instruction Reference Manual.

TXD_SCU: Send String via Serial Port on Serial Communications Unit

- Function
 - Sends a text string from a serial port on a Serial Communications Unit (SCU).
- Application
 - TXD_SCU (*Send_string, SCU_unit_number, Serial_port, Internal_logic_port*);
- Conditions
 - The serial communications mode of the serial port must be set to no-protocol communications.

• Arguments and Return Values

Variable name	Data type	Description
Send_string	STRING	Specifies the text string to send.
SCU_unit_number	INT, UINT, WORD	Specifies the number of the Serial Communications Unit.
Serial_port	INT, UINT, WORD	1: Serial port 1 2: Serial port 2
Internal_logic_port	INT, UINT, WORD	0 to 7: Internal logic port number specified 16#F: Automatic internal logic port allocation

• Example

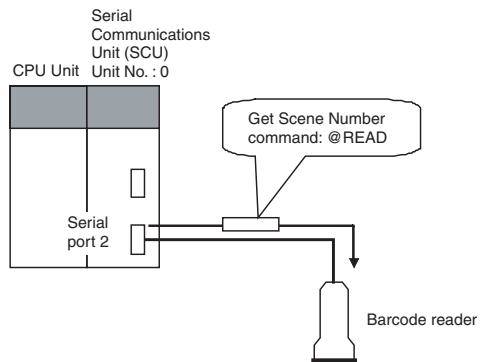

Variables

BOOL P_DoSendData (* Variable to control send function *)
 INT iProcess (* Process number *)
 STRING Message (* Send message *)
 BOOL P_TXDU_Exe (* TXDU Execution Flag *) AT 1519.05 Unit number 0, Use serial port 2.
 BOOL P_ComInstEnable (* Communications Port Enable Flag *) AT A202.07 Use port 7.

```

(* Use the following: Unit number: 0, Serial port number: 2, Logical port number: 7 *)

(* Send data when P_DoSendData is ON and iProcess is 0 *)
IF (P_DoSendData = TRUE) AND (iProcess = 0) THEN
    iProcess := 1;
    P_DoSendData := FALSE;
END_IF;

(* Execute send processing according to process number *)
CASE iProcess OF
    1: (* Create send text data *)
        Message := '@READ';
        iProcess := 2;
    2: (* Execute send function if Communications Port Enable Flag and TXDU Execution Flag are ON *)
        IF (P_ComInstEnable = TRUE) AND (P_TXDU_Exe = FALSE) THEN
            TXD_SCU(Message, 0, 2, 7);
            iProcess := 3;
        END_IF;
    3: (* Sending has been completed if Communications Port Enable Flag is ON *)
        IF P_ComInstEnable = TRUE THEN
            iProcess := 0;
        END_IF;
END_CASE;
    
```

Related Auxiliary Area Flag	Address	
Communications Instruction Enable Flags	A202.00 to A202.07	ON when network communications can be executed. The bit numbers correspond directly to the internal logic port numbers Bits 00 to 07: Internal logic ports 0 to 7

Related CPU Bus Unit Area bits	Bit	
n = CIO 150 + 25 x unit number Port 1: n+9 Port 2: n+19	05	ON when TXDU is being executed.

For further information and precautions on related Auxiliary Area flags, refer to the section on TXDU Serial Communications Instruction in the CS/CJ-series Instruction Reference Manual.

RXD_CPU: Receive String via CPU Unit RS-232C Port

- Function
 - Receives a text string from the RS-232C port on the CPU Unit.
- Application
 - RXD_CPU (*Storage_location, Number_of_characters*)
- Conditions
 - The serial communications mode of the RS-232C port must be set to no-protocol communications.
- Arguments and Return Values

Variable name	Data type	Description
Storage_location	STRING	Specifies the storage location for the received text string.
Number_of_characters	INT, UINT, WORD	Specifies the number of characters to receive. 0 to 255

• Example

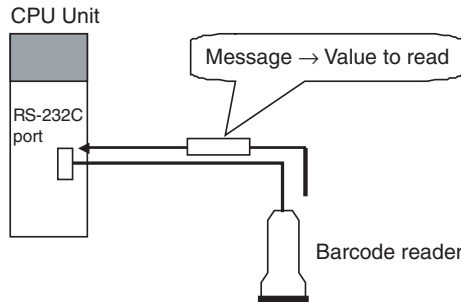

Variables		
BOOL	P_DoRecvData	(* Variable to control receive function *)
STRING	Message	(* Variable to store received message *)
BOOL	P_EndRecvCPUPort	(* Reception Completed Flag *) AT A392.06

```
(* Receive data when P_DoRecvData is ON and reception has been completed*)
IF (P_DoRecvData = TRUE) AND (P_EndRecvCPUPort = TRUE) THEN
  (* Get 16 characters *)
  RXD_CPU(Message, 16);
  P_DoRecvData := FALSE;
END_IF;
```

Related Auxiliary Area Flag	Address	Description
RS-232C Port Reception Completed Flag	A392.06	ON when reception has been completed in no-protocol mode.
RS-232C Port Reception Overflow Flag	A392.07	ON when a data overflow occurred during reception in no-protocol mode.
RS-232C Port Reception Counter	A393	Contains the number of characters received in no-protocol mode.

For further information and precautions on related Auxiliary Area flags, refer to the section on RXD Serial Communications Instruction in the CS/CJ-series Instruction Reference Manual.

RXD_SCB: Receive String via Serial Port on Serial Communications Board

• Function

Receives a text string from a serial port on a Serial Communications Board (SCB).

• Application

RXD_SCB (*Storage_location*, *Number_of_characters*, *Serial_port*)

• Conditions

The serial communications mode of the serial port must be set to no-protocol communications.

• Arguments and Return Values

Variable name	Data type	Description
Storage_location	STRING	Specifies the storage location for the received text string.
Number_of_characters	INT, UINT, WORD	Specifies the number of characters to receive. 0 to 255
Serial_port	INT, UINT, WORD	Specifies the number of the serial port. 1: Serial port 1 2: Serial port 2

• Example

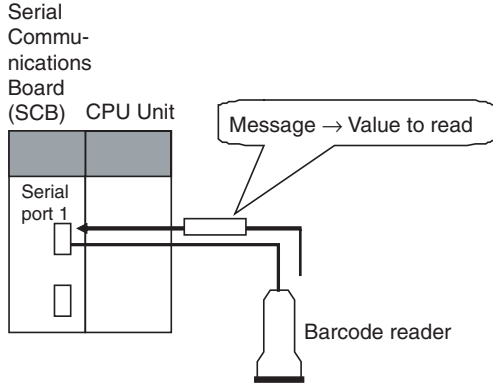

```

Variables
BOOL   P_DoRecvData      (* Variable to control receive function *)
STRING Message           (* Variable to store received message *)
BOOL   P_EndRecvSCBPort1 (* Reception Completed Flag *) AT A356.06
                                Use serial port 1
    
```

```

(* Use serial port number 1 *)
(* Receive data when P_DoRecvData is ON and reception has been completed*)
IF (P_DoRecvData = TRUE) AND (P_EndRecvSCBPort1 = TRUE) THEN
    (* Get 16 characters *)
    RXD_SCB(Message, 16, 1);
    P_DoRecvData := FALSE;
END_IF;
    
```

Related Auxiliary Area Flag	Address	Description
Port 1 Reception Completed Flag	A356.06	ON when reception has been completed in no-protocol mode.
Port 1 Reception Overflow Flag	A356.07	ON when a data overflow occurred during reception in no-protocol mode.
Port 1 Reception Counter	A357	Contains the number of characters received in no-protocol mode.
Port 2 Reception Completed Flag	A356.14	ON when reception has been completed in no-protocol mode.
Port 2 Reception Overflow Flag	A356.15	ON when a data overflow occurred during reception in no-protocol mode.
Port 2 Reception Counter	A358	Contains the number of characters received in no-protocol mode.

For further information and precautions on related Auxiliary Area flags, refer to the section on RXD Serial Communications Instruction in the CS/CJ-series Instruction Reference Manual.

RXD_SCU: Receive String via Serial Port on Serial Communications Unit

• Function

Receives a text string from a serial port on a Serial Communications Unit (SCU).

• Application

RXD_SCU (*Storage_location*, *Number_of_characters*, *SCU_unit_number*, *Serial_port*, *Internal_logic_port*);

• Conditions

The serial communications mode of the serial port must be set to no-protocol communications.

• Arguments and Return Values

Variable name	Data type	Description
Storage_location	STRING	Specifies the storage location for the received text string.
Number_of_characters	INT, UINT, WORD	Specifies the number of characters to receive. 0 to 255
SCU_unit_number	INT, UINT, WORD	Specifies the number of the Serial Communications Unit.
Serial_port	INT, UINT, WORD	1: Serial port 1 2: Serial port 2
Internal_logic_port	INT, UINT, WORD	0 to 7: Internal logic port number specified 16#F: Automatic internal logic port allocation

• Example

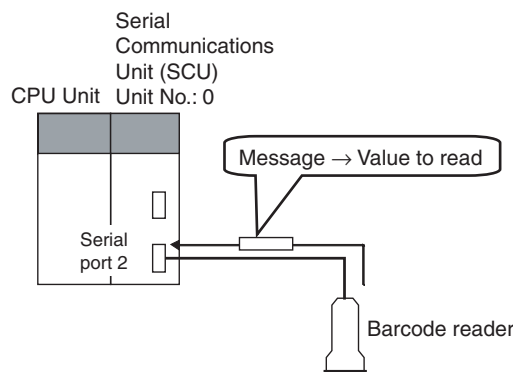

Variables

- BOOL P_DoRecvData (* Variable to control receive function *)
- INT iProcess (* Process number *)
- STRING Message (* Variable to store received message *)
- BOOL P_RXDU_Recv (* Status of Serial Communications Unit *) AT 1519.06 Unit No. 0
Use serial port 2
- BOOL P_ComInstEnable (* Communications Port Enable Flag *) AT A202.07 Use port 7

```
(* Use the following: Unit number: 0, Serial port number: 2, Logical port number: 7 *)
(* Receive data when P_DoRecvData is ON and iProcess is 0 *)
IF (P_DoRecvData = TRUE) AND (iProcess = 0) THEN
    iProcess := 1;
    P_DoRecvData := FALSE;
END_IF;

(* Execute receive processing according to process number *)
CASE iProcess OF
    1: (* Reception function executed if Communications Enabled Flag and Reception Completed
        Flag are ON. *);
        IF (P_ComInstEnable = TRUE) AND (P_RXDU_Recv = TRUE) THEN
            RXD_SCU(Message, 16, 0, 2, 7);
            iProcess := 2;
        END_IF;
    2: (* Reception has been completed if Communications Port Enable Flag is ON *)
        IF P_ComInstEnable = TRUE THEN
            iProcess := 0;
        END_IF;
END_CASE;
```

Related Auxiliary Area Flag	Address	
Communications Instruction Enable Flag	A202.00 to A202.07	ON when network communications can be executed. The bit numbers correspond directly to the internal logic port numbers Bits 00 to 07: Internal logic ports 0 to 7

Related CPU Bus Unit Area bits	Bit	
n = CIO 150 + 25 x unit number Port 1: n+9 Port 2: n+19	06	ON when reception has been completed in no-protocol mode.
n = CIO 150 + 25 x unit number Port 1: n+9 Port 2: n+19	07	ON when a data overflow occurred during reception in no-protocol mode.
n = CIO 150 + 25 x unit number Port 1: n+10 Port 2: n+20	---	Contains the number of characters received in no-protocol mode.

For further information and precautions on related Auxiliary Area flags, refer to the section on RXDU Serial Communications Instruction in the CS/CJ-series Instruction Reference Manual.

Angle Conversion Functions

DEG_TO_RAD: Convert Degrees to Radians

- Function
Converts an angle in degrees to radians.
- Application
Return_value := DEG_TO_RAD (argument)
- Arguments and Return Values

Variable name	Data type	Description
Argument	REAL, LREAL	Specifies an angle in degrees.
Return_value	REAL, LREAL	Returns an angle in radians.

RAD_TO_DEG: Convert Radians to Degrees

- Function
Converts an angle in radians to degrees.
- Application
Return_value := RAD_TO_DEG (argument)
- Arguments and Return Values

Variable name	Data type	Description
Argument	REAL, LREAL	Specifies an angle in radians.
Return_value	REAL, LREAL	Returns an angle in degrees.

Timer/Counter Functions

TIMX: HUNDRED-MS TIMER

- Function
Operates a decrementing timer with units of 100 ms.
(Equivalent to the TIMX (550) ladder instruction)
- When the execution condition goes from FALSE to TRUE, the timer specified in the timer address is started and the present value is decremented by one starting from the value specified in the timer set value once every 100 ms.

- The present value will continue timing down as long as the execution condition remains TRUE. When the present value reaches 0, the timer completion flag of the specified timer address will be turned ON. If the present value is not zero, the timer completion flag is OFF.
 - While the execution condition is FALSE, the timer set value is set in the present value of the timer address and the timer completion flag is OFF.
- Application
- `TIMX(Execution_condition, Timer_address, Timer_set_value);`

• Arguments

Variable name	Data type	Description
Execution_condition	BOOL	Executes the timer operation while this execution condition is TRUE.
Timer_address	TIMER	Specifies the timer address (T0 to T4095) variable to use.
Timer_set_value	UINT	Specifies the delay time in units of 100 ms. (&0 to &65535, #0 to #FFFF)

• Note

- Only when the *Apply the same spec. as T0-2047 to T2048-4095* option is selected in the PLC's property setting, the present value is updated when all cyclic tasks are completed and also once every 80 ms.
- When the timer completion flag is referenced from the user program, the reflection of the status change may be delayed by one cycle depending on the access timing.

TIMHX: TEN-MS TIMER

• Function

Operates a decremting timer with units of 10 ms.
(Equivalent to the TIMHX (551) ladder instruction)

- When the execution condition goes from FALSE to TRUE, the timer specified in the timer address is started and the present value is decremented by one starting from the value specified in the timer set value once every 10 ms.
 - The present value will continue timing down as long as the execution condition remains TRUE. When the present value reaches 0, the timer completion flag of the specified timer address will be turned ON. If the present value is not zero, the timer completion flag is OFF.
 - While the execution condition is FALSE, the timer set value is set in the present value of the timer address and the timer completion flag is OFF.
- Application
- `TIMHX(Execution_condition, Timer_address, Timer_set_value);`

• Arguments

Variable name	Data type	Description
Execution_condition	BOOL	Executes the timer operation while this execution condition is TRUE.
Timer_address	TIMER	Specifies the timer address (T0 to T4095) variable to use.
Timer_set_value	UINT	Specifies the delay time in units of 10 ms. (&0 to &65535, #0 to #FFFF)

• Note

- Only when the *Apply the same spec. as T0-2047 to T2048-4095* option is selected in the PLC's property setting, the present value is updated when all cyclic tasks are completed and also once every 80 ms.
- When the timer PV is referenced from the user program, the timer present values may be different between timer numbers 0 to 255, 256 to 2047, and 2048 to 4095 due to different refresh timing.

- When the timer completion flag is referenced from the user program, the reflection of the status change may be delayed by one cycle depending on the access timing.

TMHHX: ONE-MS TIMER

- Function

Operates a decremting timer with units of 1 ms.
(Equivalent to the TMHHX (552) ladder instruction)

- When the execution condition goes from FALSE to TRUE, the timer specified in the timer address is started and the present value is decremented by one starting from the value specified in the timer set value once every 1 ms.
- The present value will continue timing down as long as the execution condition remains TRUE. When the present value reaches 0, the timer completion flag of the specified timer address will be turned ON. If the present value is not zero, the timer completion flag is OFF.
- While the execution condition is FALSE, the timer set value is set in the present value of the timer address and the timer completion flag is OFF.

- Application

TMHHX(*Execution_condition*, *Timer_address*, *Timer_set_value*);

- Arguments

Variable name	Data type	Description
Execution_condition	BOOL	Executes the timer operation while this execution condition is TRUE.
Timer_address	TIMER	Specifies the timer address (T0 to T4095) variable to use.
Timer_set_value	UINT	Specifies the delay time in units of 1 ms. (&0 to &65535, #0 to #FFFF)

- Note

- Only when the *Apply the same spec. as T0-2047 to T2048-4095* option is selected in the PLC's property setting, the present value is updated when all cyclic tasks are completed.
- When the timer PV is referenced from the user program, the obtained timer present value of timer numbers 16 and later may be different from that of timer numbers 0 to 15. The present value of the timer numbers 16 and later is refreshed only when the instruction is executed. On the other hand, the present value of the timer numbers 0 to 15 is updated once every 1 ms.
- When the timer completion flag is referenced from the user program, the reflection of the status change may be delayed by one cycle depending on the access timing.

TIMUX: TENTH-MS TIMER

- Function

Operates a decremting timer with units of 0.1 ms.
(Equivalent to the TIMUX (556) ladder instruction)

- When the execution condition goes from FALSE to TRUE, the timer specified in the timer address is started and the present value is decremented by one starting from the value specified in the timer set value once every 0.1 ms.
- The present value will continue timing down as long as the execution condition remains TRUE. When the present value reaches 0, the timer completion flag of the specified timer address will be turned ON. If the present value is not zero, the timer completion flag is OFF.
- While the execution condition is FALSE, the timer set value is set in the present value of the timer address and the timer completion flag is OFF.

- Application

TIMUX(*Execution_condition*, *Timer_address*, *Timer_set_value*);

- Argument

Variable name	Data type	Description
Execution_condition	BOOL	Executes the timer operation while this execution condition is TRUE.
Timer_address	TIMER	Specifies the timer address (T0 to T4095) variable to use.
Timer_set_value	UINT	Specifies the delay time in units of 0.1 ms. (&0 to &65535, #0 to #FFFF)

- Note

- This timer may not operate properly when the cycle time is 100 ms or longer.
- When the timer PV is referenced from the user program, the present value may be different by one cycle from the actual value depending on the access timing.
- When the timer completion flag is referenced from the user program, the reflection of status change may be delayed by one cycle depending on the access timing.

TMUHX: HUNDREDTH-MS TIMER

- Function

Operates a decrementing timer with units of 0.01 ms.
(Equivalent to the TMUHX (557) ladder instruction)

- When the execution condition goes from FALSE to TRUE, the timer specified in the timer address is started and the present value is decremented by one starting from the value specified in the timer set value once every 0.01 ms.
- The present value will continue timing down as long as the execution condition remains TRUE. When the present value reaches 0, the timer completion flag of the specified timer address will be turned ON. If the present value is not zero, the timer completion flag is OFF.
- While the execution condition is FALSE, the timer set value is set in the present value of the timer address and the timer completion flag is OFF.

- Application

TMUHX(*Execution_condition*, *Timer_address*, *Timer_set_value*);

- Arguments

Variable name	Data type	Description
Execution_condition	BOOL	Executes the timer operation while this execution condition is TRUE.
Timer_address	TIMER	Specifies the timer address (T0 to T4095) variable to use.
Timer_set_value	UINT	Specifies the delay time in units of 0.01 ms. (&0 to &65535, #0 to #FFFF)

- Note

- This timer may not operate properly when the cycle time is 10 ms or longer.
- When the timer PV is referenced from the user program, the present value may be different by one cycle from the actual value depending on the access timing.
- When the timer completion flag is referenced from the user program, the reflection of status change may be delayed by one cycle depending on the access timing.

TTIMX: ACCUMULATIVE TIMER

- Function

Operates an incrementing timer with units of 0.1 s.
(Equivalent to the TTIMX (555) ladder instruction)

- As long as the execution condition is TRUE, the present value is incremented (accumulated).

- When the execution condition goes FALSE, the timer will stop incrementing the present value, but the present value will retain its value. When the execution condition goes TRUE again, it will resume incrementing the present value.
 - When the present value reaches the timer set value, the timer completion flag will be turned ON.
 - The timer present value and the status of the timer completion flag will be maintained after the timer times out.
 - When the reset input is turned ON, the timer will be reset.
- Application
`TTIMX(Execution_condition, Reset_input, Timer_address, Timer_set_value);`

• Arguments

Variable name	Data type	Description
Execution_condition	BOOL	Increments (accumulates) the present value while the execution condition is TRUE.
Reset_input	BOOL	Resets the timer's PV and completion flag when the reset input is ON.
Timer_address	TIMER	Specifies the timer address (T0 to T4095) variable to use.
Timer_set_value	UINT	Specifies the delay time in units of 0.1 s. (&0 to &65535, #0 to #FFFF)

• Note

- Because the present value is incremented only when the instruction is executed, this timer may not operate properly if the cycle time is 100 ms or longer.
- When the timer completion flag is referenced from the user program, the reflection of status change may be delayed by one cycle depending on the access timing.

CNTX: COUNTER

• Function

Operates a decrementing counter.
 (Equivalent to the CNTX (546) ladder instruction)

- The counter present value is decremented by one every time the count input is turned ON. The counter completion flag is turned ON when the present value reaches 0.
- When the reset input is ON, the counter will be reset and the present value will become equal to the counter set value. Also, the counter completion flag is turned OFF and the count input is made invalid.

• Application

`CNTX(Count_input, Reset_input, Counter_address, Counter_set_value);`

• Arguments

Variable name	Data type	Description
Count_input	BOOL	The counter present value is decremented every time the count input is turned ON.
Reset_input	BOOL	When the reset input is ON, the counter's PV and completion flag are reset.
Counter_address	COUNTER	Specifies the counter address (C0 to C4095) variable to use.
Counter_set_value	UINT	Specifies the default value from which the counter value is decremented. (&0 to &65535, #0 to #FFFF)

CNTRX: REVERSIBLE COUNTER

• Function

Operates an incrementing/decrementing counter.
 (Equivalent to the CNTRX (548) ladder instruction)

- When the increment input is turned ON, the value is incremented.
 - When the decrement input is turned ON, the value is decremented.
 - When incrementing, the counter completion flag will be turned ON when the present value is incremented from the set value back to 0 and it will be turned OFF again when the present value is incremented from 0 to 1.
 - When decrementing, the counter completion flag will be turned ON when the present value is decremented from 0 up to the set value and it will be turned OFF again when the present value is decremented by one from the set value.
 - The present value will not be changed if the increment and decrement inputs both go from OFF to ON at the same time.
 - When the reset input is ON, the counter present value will become 0 and the count input is made invalid.
- Application
`CNTRX(Increment_count, Decrement_count, Reset_input, Counter_address, Counter_set_value);`

• Arguments

Variable name	Data type	Description
Increment_count	BOOL	The counter present value is incremented every time the increment input is turned ON.
Decrement_count	BOOL	The counter present value is decremented every time the decrement input is turned ON.
Reset_input	BOOL	When the reset input is ON, the counter's PV and completion flag are reset.
Counter_address	COUNTER	Specifies the counter address (C0 to C4095) variable to use.
Counter set value	UINT	Specifies the default value from which the counter value is decremented. (&0 to &65535, #0 to #FFFF)

TRSET: TIMER RESET

- Function
 Resets the specified timer.
 (Equivalent to the TRSET (549) ladder instruction)
- Application
`TRSET(Execution_condition, Timer_address);`

• Arguments

Variable name	Data type	Description
Execution_condition	BOOL	The timer is reset when the execution condition is turned ON.
Timer_address	TIMER	Specifies the timer address (T0 to T4095) variable to use.

Index

A

- addresses
 - allocation areas, 44
 - checking internal allocations, 106
 - setting allocation areas, 104
- algorithm
 - creating, 89
- applications
 - precautions, xxi
- array settings, 20, 40, 61, 91
- AT settings, 19, 40, 91
 - restrictions, 53
- automatically generating function block definitions, 93

C

- compiling, 110

D

- data types, 19, 39
 - determining, 58
- debugging function blocks, 116
- differentiation
 - restrictions, 53

E

- errors
 - function blocks, 57
- external variables, 39
- externals, 19

F

- features, 4
- files
 - function block definitions, 114
 - library, 8
 - project text files, 8
- function block definitions, 13
 - checking for an instance, 108
 - compiling, 110
 - creating, 84
 - saving to files, 114
- function blocks

- advantages, 12
- application guidelines, 58
- creating, 23
- debugging, 116
- defining, 87
- elements, 33
- errors, 57
- monitoring, 116
- operating specifications, 51
- outline, 11
- restrictions, 53
- reusing, 24
- setting parameters, 101
- specifications, 6, 7, 32
- structure, 13
- functions, 4
 - function blocks, 6, 7
 - restrictions, 5

G

- global symbol table, 18

I

- IEC 61131-3, 4, 8
- input variables, 35
- input-output variables, 37
- inputs, 19
- instance areas, 21, 44
 - setting, 21, 104
- instances
 - creating, 23, 99
 - multiple, 48
 - number of, 14
 - outline, 14
 - registering in global symbol table, 18
 - specifications, 44
- internal variables, 37
- internals, 19

L

- ladder programming
 - function block definition, 86
 - restrictions in function blocks, 53

M

- menus, 8
 - main, 9
 - popup, 10
- monitoring function blocks, 116

O

- online editing
 - function block definitions, 124
 - restrictions, 56
- output variables, 35
- outputs, 19

P

- parameters
 - outline, 15
- precautions, xix
 - applications, xxi
 - general, xx
 - safety, xx
- Programming Consoles, 56
- projects
 - creating, 84

S

- safety precautions, xx
- specifications
 - CX-Programmer Ver. 5.0, 5
 - function block operation, 51
 - instances, 44
- structured text
 - function block definition, 86
 - restrictions, 55
- symbol name
 - automatically generating, 92

T

- timer instructions
 - operation, 77
 - restrictions, 54

V

- variable names, 19
- variables
 - address allocations, 21
 - checking address allocations, 106
 - creating as needed, 90
 - definitions, 33
 - introduction, 18
 - properties, 19, 39
 - registering in advance, 87
 - restrictions, 53
 - setting allocation areas, 21
 - usage, 19, 34

Revision History

A manual revision code appears as a suffix to the catalog number on the front cover of the manual.

Cat. No. W447-E1-15

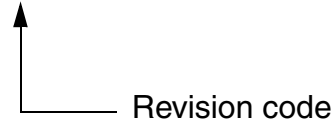

The following table outlines the changes made to the manual during each revision. Page numbers refer to the previous version.

Revision code	Date	Revised content
01	February 2005	Original production
02	November 2005	Added Ver. 6.1 upgrade information, such as information on the Simulation functions and ST program variable monitoring.
03	July 2006	Added Ver. 7.0 upgrade information.
04	January 2007	Pages 17 and 18: Changed “can” to “cannot” in table (two locations) and changed note. Page 29: Changed text in “inputs” cell for the status of value at next execution. Page 213: Changed illustration. Pages 214, 216 to 218, and 202: Changed illustration and changed code. Pages 215 and 219: Changed text in bottom right cell.
05	July 2007	Added upgrade information from Ver. 7.0 to Ver. 7.2.
07	June 2008	Added upgrade information from Ver. 7.2 to Ver. 8.0.
08	February 2009	Added upgrade information from Ver. 8.0 to Ver. 8.1.
09	December 2009	Added upgrade information from Ver. 8.3 to Ver. 9.0.
10	February 2010	Added upgrade information from Ver. 9.0 to Ver. 9.1.
11	October 2010	Added upgrade information from Ver. 9.1 to Ver. 9.2.
12	January 2011	Added upgrade information from Ver. 9.2 to Ver. 9.3.
13	August 2012	Page xi: Changed catalog number from W445 to W464. Pages xii and xiii: Changed manual names for W339, W394, W340, and W342. Page xiii and xiv: Added model numbers for W452 and W463. Page xxiv: Modified the description of the third paragraph from the top. Page 52: Modified the description of the caution in the middle of the page. Page 142: Changed notations in top two tables. Page 145: Changed data types for "Exponential." Page 147: Changed data types for "Exponent." Page 148: Added information on rounding the fractional part of variable C. Page 151: Reversed "TRUE" and "FALSE" in the example column for SEL.
14	October 2015	Added upgrade information from Ver. 9.5 to Ver. 9.6 and corrected mistakes.
15	April 2016	Revisions accompanying change in CX-One model number.

Revision History

OMRON Corporation Industrial Automation Company
Kyoto, JAPAN

Contact: www.ia.omron.com

Regional Headquarters

OMRON EUROPE B.V.

Wegalaan 67-69, 2132 JD Hoofddorp
The Netherlands
Tel: (31)2356-81-300/Fax: (31)2356-81-388

OMRON ELECTRONICS LLC

2895 Greenspoint Parkway, Suite 200
Hoffman Estates, IL 60169 U.S.A.
Tel: (1) 847-843-7900/Fax: (1) 847-843-7787

OMRON ASIA PACIFIC PTE. LTD.

No. 438A Alexandra Road # 05-05/08 (Lobby 2),
Alexandra Technopark,
Singapore 119967
Tel: (65) 6835-3011/Fax: (65) 6835-2711

OMRON (CHINA) CO., LTD.

Room 2211, Bank of China Tower,
200 Yin Cheng Zhong Road,
PuDong New Area, Shanghai, 200120, China
Tel: (86) 21-5037-2222/Fax: (86) 21-5037-2200

Authorized Distributor:

© OMRON Corporation 2005-2016 All Rights Reserved.
In the interest of product improvement,
specifications are subject to change without notice.

Cat. No. W447-E1-15

0416