

**SYSMAC CS/CJ Series**

**WS02-EDMC1-V2**

**SYSMAC SPU Data  
Management Middleware**

**USER'S MANUAL**

**OMRON**



**SYSMAC CS/CJ Series**  
**WS02-EDMC1-V2**  
**SYSMAC SPU Data**  
**Management Middleware**  
**User's Manual**

*Revised August 2013*





## Notice:

OMRON products are manufactured for use according to proper procedures by a qualified operator and only for the purposes described in this manual.

The following conventions are used to indicate and classify precautions in this manual. Always heed the information provided with them. Failure to heed precautions can result in injury to people or damage to property.

 **DANGER** Indicates an imminently hazardous situation which, if not avoided, will result in death or serious injury. Additionally, there may be severe property damage.

 **WARNING** Indicates a potentially hazardous situation which, if not avoided, could result in death or serious injury. Additionally, there may be severe property damage.

 **Caution** Indicates a potentially hazardous situation which, if not avoided, may result in minor or moderate injury, or property damage.

## OMRON Product References

All OMRON products are capitalized in this manual. The word “Unit” is also capitalized when it refers to an OMRON product, regardless of whether or not it appears in the proper name of the product.

The abbreviation “Ch,” which appears in some displays and on some OMRON products, often means “word” and is abbreviated “Wd” in documentation in this sense.

The abbreviation “PLC” means Programmable Controller. “PC” is used, however, in some Programming Device displays to mean Programmable Controller.

## Visual Aids

The following headings appear in the left column of the manual to help you locate different types of information.

**Note** Indicates information of particular interest for efficient and convenient operation of the product.

**1,2,3...** 1. Indicates lists of one sort or another, such as procedures, checklists, etc.

## © OMRON, 2005

All rights reserved. No part of this publication may be reproduced, stored in a retrieval system, or transmitted, in any form, or by any means, mechanical, electronic, photocopying, recording, or otherwise, without the prior written permission of OMRON.

No patent liability is assumed with respect to the use of the information contained herein. Moreover, because OMRON is constantly striving to improve its high-quality products, the information contained in this manual is subject to change without notice. Every precaution has been taken in the preparation of this manual. Nevertheless, OMRON assumes no responsibility for errors or omissions. Neither is any liability assumed for damages resulting from the use of the information contained in this publication.



# TABLE OF CONTENTS

<b>PRECAUTIONS</b> .....	<b>xiii</b>
1    Intended Audience .....	xiv
2    General Precautions .....	xiv
3    Safety Precautions .....	xiv
4    Precautions for Safe Use .....	xv
5    Conformance to EC Directives .....	xviii
<b>SECTION 1</b>	
<b>Overview</b> .....	<b>1</b>
1-1  Overview .....	2
<b>SECTION 2</b>	
<b>Installation and Starting/Exiting</b> .....	<b>7</b>
2-1  Installing and Uninstalling .....	8
2-2  Starting and Exiting the EDMS-Console .....	12
2-3  Basic Operating Procedures .....	12
<b>SECTION 3</b>	
<b>Copy Function</b> .....	<b>15</b>
3-1  Window Configuration of Copy Function .....	16
3-2  Operating Procedures .....	20
3-3  Copy Task Service .....	27
<b>SECTION 4</b>	
<b>Database Storage Function</b> .....	<b>29</b>
4-1  Overview of Database Storage Function .....	30
4-2  Database Storage Tab Page .....	32
4-3  Basic Database Storage Procedure .....	33
4-4  Detailed Database Storage Settings .....	40
4-5  Data Table Storage Operations .....	49
<b>SECTION 5</b>	
<b>Troubleshooting and EDMS Capabilities</b> .....	<b>51</b>
5-1  Troubleshooting .....	52
5-2  EDMS Capabilities .....	54
<b>Revision History</b> .....	<b>55</b>





## About this Manual:

This manual describes the installation and operation of the WS02-EDMC1-V2 SYSMAC SPU Data Management Middleware (EDMS) and includes the sections described below.

The EDMS reads files from SYSMAC Storage and Processing Units (called SYSMAC SPU Units) and copies the files to the hard disk of a network computer for storage into a database. You must be thoroughly acquainted with EDMS functions and performance characteristics to ensure proper use of the product and optimize SYSMAC SPU Unit operation.

Please read this manual and all related manuals listed in the following table, and be sure you understand the information provided before attempting to install or operate the SPU Data Management Middleware. Be sure to read the precautions provided in the following section.

Name	Cat. No.	Contents
WS02-EDMC1-V2 SYSMAC SPU Data Management Mid- dleware User's Manual (this manual)	V232	Describes the installation and operation of the SYSMAC SPU Data Management Middleware.
CS1W-SPU01/SPU02-V2 CJ1-SPU01-V2 SYSMAC SPU Units Operation Manual	V236	Describes the installation and operation of the SYSMAC SPU Units.
WS02-SPTC1-V2 SPU-Console Ver.2.2 Operation Manual	V237	Describes the operation of the SYSMAC SPU Console.
WS02-EQMC1-V1 SYSMAC CS/CJ Series EQView Operation Manual	V234	Describes the operation of the SYSMAC EQView.

**Precautions** provides general precautions for using the SPU Data Management Middleware and related devices.

**Section 1** provides an overview of the SPU Data Management Middleware and its capabilities and specifications.

**Section 2** describes how to install and uninstall the software and how to start and exit the EDMS-Console.

**Section 3** provides operating procedures for the copy function of the SPU Data Management Middleware.

**Section 4** provides operating procedures for the data storage function of the SPU Data Management Middleware.

**Section 5** provides information on troubleshooting errors that can occur with the SPU Data Management Middleware and provides information on the capabilities of the SPU Data Management Middleware.



# Terms and Conditions Agreement

Please read and understand this catalog before purchasing the products. Please consult your OMRON representative if you have any questions or comments.

## ● WARRANTY

- The warranty period for the Software is one year from the date of purchase, unless otherwise specifically agreed.
- If the User discovers defect of the Software (substantial non-conformity with the manual), and return it to OMRON within the above warranty period, OMRON will replace the Software without charge by offering media or download from OMRON's website. And if the User discovers defect of media which is attributable to OMRON and return it to OMRON within the above warranty period, OMRON will replace defective media without charge. If OMRON is unable to replace defective media or correct the Software, the liability of OMRON and the User's remedy shall be limited to the refund of the license fee paid to OMRON for the Software.

## ● LIMITATION OF LIABILITY

- THE ABOVE WARRANTY SHALL CONSTITUTE THE USER'S SOLE AND EXCLUSIVE REMEDIES AGAINST OMRON AND THERE ARE NO OTHER WARRANTIES, EXPRESSED OR IMPLIED, INCLUDING BUT NOT LIMITED TO, WARRANTY OF MERCHANTABILITY OR FITNESS FOR PARTICULAR PURPOSE. IN NO EVENT, OMRON WILL BE LIABLE FOR ANY LOST PROFITS OR OTHER INDIRECT, INCIDENTAL, SPECIAL OR CONSEQUENTIAL DAMAGES ARISING OUT OF USE OF THE SOFTWARE.
- OMRON SHALL HAVE NO LIABILITY FOR DEFECT OF THE SOFTWARE BASED ON MODIFICATION OR ALTERNATION TO THE SOFTWARE BY THE USER OR ANY THIRD PARTY.
- OMRON SHALL HAVE NO LIABILITY FOR SOFTWARE DEVELOPED BY THE USER OR ANY THIRD PARTY BASED ON THE SOFTWARE OR ANY CONSEQUENCE THEREOF.

## ● APPLICABLE CONDITIONS

USER SHALL NOT USE THE SOFTWARE FOR THE PURPOSE THAT IS NOT PROVIDED IN THE ATTACHED USER MANUAL.

## ● CHANGE IN SPECIFICATION

The software specifications and accessories may be changed at any time based on improvements and other reasons.

## ● EXTENT OF SERVICE

The license fee of the Software does not include service costs, such as dispatching technical staff.

## ● ERRORS AND OMISSIONS

The information in this manual has been carefully checked and is believed to be accurate; however, no responsibility is assumed for clerical, typographical, or proofreading errors, or omissions.



# PRECAUTIONS

This section provides general precautions for using the SYSMAC SPU Data Management Middleware.

**The information contained in this section is important for the safe and reliable application of the SYSMAC SPU Data Management Middleware. You must read this section and understand the information contained before attempting to set up or operate the SYSMAC SPU Data Management Middleware.**

1	Intended Audience .....	xiv
2	General Precautions .....	xiv
3	Safety Precautions.....	xiv
4	Precautions for Safe Use.....	xv
5	Conformance to EC Directives .....	xviii
5-1	Applicable Directives .....	xviii
5-2	Concepts .....	xviii

## 1 Intended Audience

This manual is intended for the following personnel, who must also have knowledge of electrical systems (an electrical engineer or the equivalent).

- Personnel in charge of installing FA systems
- Personnel in charge of designing FA systems
- Personnel in charge of managing FA systems and facilities
- Personnel qualified in computer application technology
- Personnel qualified in network application technology

## 2 General Precautions

The user must operate the product according to the performance specifications described in the operation manuals.

Before using the product under conditions which are not described in the manual or applying the product to nuclear control systems, railroad systems, aviation systems, vehicles, combustion systems, medical equipment, amusement machines, safety equipment, and other systems, machines, and equipment that may have a serious influence on lives and property if used improperly, consult your OMRON representative.

Make sure that the ratings and performance characteristics of the product are sufficient for the systems, machines, and equipment, and be sure to provide the systems, machines, and equipment with double safety mechanisms.

This manual provides information for programming and operating the Unit. Be sure to read this manual before attempting to use the Unit and keep this manual close at hand for reference during operation.

 **WARNING** It is extremely important that a PLC and all PLC Units be used for the specified purpose and under the specified conditions, especially in applications that can directly or indirectly affect human life. You must consult with your OMRON representative before applying a PLC System to the above-mentioned applications.

## 3 Safety Precautions

 **WARNING** Do not attempt to take any Unit apart while the power is being supplied. Doing so may result in electric shock.

 **WARNING** Do not touch any of the terminals or terminal blocks while the power is being supplied. Doing so may result in electric shock.

 **WARNING** Fail-safe measures must be taken by the customer to ensure safety in the event of incorrect, missing, or abnormal signals caused by broken signal lines, momentary interruptions, or other causes.

 **WARNING** Emergency stop circuits, interlock circuits, limit circuits, and similar safety measures must be provided in external control circuits. Not doing so may result in serious accidents.

- ⚠ **Caution** Execute online editing only after confirming that no adverse effects will be caused by extending the cycle time. Otherwise, the input signals may not be readable.
- ⚠ **Caution** Confirm safety at the destination node before transferring a program to another node or changing contents of the I/O memory area. Doing either of these without confirming safety may result in injury.
- ⚠ **Caution** Tighten the screws on the power supply terminals to the torque specified in the operation manual. The loose screws may result in burning or malfunction.

## 4 Precautions for Safe Use

- ⚠ **Caution** Observe the following precautions for safe use of the SYSMAC SPU Unit and PLC.

- Always use the power supply voltages specified in the operation manuals
- Take appropriate measures to ensure that the specified power with the rated voltage and frequency is supplied. Be particularly careful in places where the power supply is unstable.
- Install external breakers and take other safety measures against short-circuiting in external wiring.
- Do not apply voltages to the Input Units in excess of the rated input voltage.
- Do not apply voltages or connect loads to the Output Units in excess of the maximum switching capacity.
- Disconnect the functional ground terminal when performing withstand voltage test.
- Always ground the system to 100  $\Omega$  or less when installing the product.















- ⚠ **Caution** Do not operate the product in the following locations:

- Locations subject to direct sunlight
- Locations subject to temperature or humidity outside the range specified in the specifications
- Locations subject to condensation as the result of severe changes in temperature
- Locations subject to corrosive or flammable gases
- Locations subject to dust (especially iron dust) or salts
- Locations subject to water, oil, or chemicals
- Locations subject to shock or vibration

- ⚠ **Caution** The SYSMAC SPU Unit must be installed referring to the *CS Series CPU Unit Operation Manual* (Cat. No. W339) or the *CJ Series CPU Unit Operation Manual* (Cat. No. W393).

- ⚠ Caution** Take appropriate and sufficient measures when installing systems in the following locations.
- Locations subject to static electricity or other forms of noise
  - Locations subject to strong electromagnetic fields
  - Locations subject to possible exposure to radioactivity
  - Locations close to power supplies
- ⚠ Caution** Always turn OFF the power supply to the PLC before attempting any of the following. Not turning OFF the power may result in malfunction or electric shock.
- Mounting or dismounting SYSMAC CPU Units, or Memory Cassettes
  - Assembling the Units
  - Setting DIP switches or rotary switches
  - Connecting cables or wiring the system
  - Connecting or disconnecting the connectors
- ⚠ Caution** Do not disassemble, repair, or modify the products.
- ⚠ Caution** Make sure that all the mounting screws, terminal screws, and cable connector screws are tightened to the torque specified in the reference manuals when mounting the SYSMAC SPU Unit and PLC.
- ⚠ Caution** Leave the label attached to the Unit when wiring.
- ⚠ Caution** Remove the label after the completion of wiring to ensure proper heat dissipation.
- ⚠ Caution** Use crimp terminals for wiring. Do not connect bare stranded wires directly to terminals.
- ⚠ Caution** Double-check all wiring before turning ON the power supply.
- ⚠ Caution** Wire all connections correctly.
- ⚠ Caution** Mount the products only after carefully checking the terminal blocks.
- ⚠ Caution** Be sure that the terminal blocks, Memory Units, expansion cables, and other items with locking devices are properly locked into place.
- ⚠ Caution** Check the user program for proper execution before actually running it on the Unit.
- ⚠ Caution** Resume operation only after transferring to the new SYSMAC SPU Unit and PLC the contents of the DM Area, HR Area, and all other data required for resuming operation.
- ⚠ Caution** Do not place objects on the cable or other wiring lines.



-  **Caution** Always use the power supply voltages specified in this manual.
-  **Caution** Do not pull on the cables or bend the cables beyond their natural limit.
-  **Caution** Confirm that no adverse effect will occur in the system before attempting any of the following.
- Changing the operation mode of the PLC
  - Force-setting/force-resetting any bit in memory
  - Changing the present value of any word or any set value in memory
-  **Caution** Before touching a Unit, be sure to first touch a grounded metallic object to discharge any built-up static electricity.
-  **Caution** Do not remove the Memory Card when the CARD indicator is lit. Otherwise the files on the Memory Card may be corrupted.
-  **Caution** Do not turn OFF the power supply while the Memory Card is being accessed. Otherwise the files on the Memory Card may be corrupted.
-  **Caution** Observe the operating conditions (e.g., operating temperature) specified for the Memory Card that is used. For operating details, consult the manufacturer of the Memory Card.
-  **Caution** OMRON has verified the operation only for the Memory Cards sold by OMRON. The operation or write performance of any other Memory Cards may not be according to specifications.
-  **Caution** We recommend backing up all PC Cards and Memory Cards in case data is accidentally deleted or files are corrupted.
-  **Caution** The PC card slot is strictly for Memory Cards and cannot be used for Modem, Ethernet, or other Cards. Only insert Memory Cards into the PC card slot.
-  **Caution** Be sure the Memory Card is properly seated in the guide when it is inserted. Otherwise it may cause the Unit to malfunction.
-  **Caution** Be sure to lock the Memory Card in place after it is inserted into the PC card slot. Otherwise the Card may come out and cause the Unit to malfunction.
-  **Caution** Check to see which way the Memory Card is facing before inserting it into the PC card slot. The Memory Card or the guide may be damaged if the Memory Card is forced into the slot the wrong way.
-  **Caution** Check the 7-segment display to see which instruction is being executed before pressing the **Enter** Key. The Unit may malfunction if the wrong instruction is executing when the **Enter** Key is pressed.

**⚠ Caution** Never restart the SYSMAC SPU Unit or turn OFF the power while settings are being changed, e.g., using the *Change sampling settings* instruction. The 7-segment display will count up consecutively from P1 and to PE while the instruction is being executed. Restarting the SYSMAC SPU Unit or turning OFF the power at this during these displays may corrupt the system files that are being changed.

**⚠ Caution** Do not turn OFF the Unit power supply while setting information is being transferred to the Unit. Otherwise invalid information may be transferred and the Unit may malfunction.

## 5 Conformance to EC Directives

### 5-1 Applicable Directives

- EMC Directives
- Low Voltage Directive

### 5-2 Concepts

#### **EMC Directives**

OMRON devices that comply with EC Directives also conform to the related EMC standards so that they can be more easily built into other devices or the overall machine. The actual products have been checked for conformity to EMC standards (see the following note). Whether the products conform to the standards in the system used by the customer, however, must be checked by the customer.

EMC-related performance of the OMRON devices that comply with EC Directives will vary depending on the configuration, wiring, and other conditions of the equipment or control panel on which the OMRON devices are installed. The customer must, therefore, perform the final check to confirm that devices and the overall machine conform to EMC standards.

**Note** Applicable EMS (Electromagnetic Susceptibility) and EMI (Electromagnetic Interference) Standards in the EMC (Electromagnetic Compatibility) standards are as follows:

Unit/Board	EMS	EMI
CS1W-SPU01-V2	EN 61000-6-2	EN 61000-6-4
CS1W-SPU02-V2		
CJ1W-SPU01-V2		

The EN 61000-6-4 radiated emission standard is based on 10-m regulations

#### **Low Voltage Directive**

Always ensure that devices operating at voltages of 50 to 1,000 V AC and 75 to 1,500 V DC meet the required safety standards for the PLC (EN 61131-2).

When switching a load with a high inrush current such as an incandescent lamp, suppress the inrush current as shown below.

# SECTION 1

## Overview

This section provides an overview of the SPU Data Management Middleware and its capabilities and specifications.

1-1	Overview . . . . .	2
1-1-1	Software Overview . . . . .	2
1-1-2	Features . . . . .	2
1-1-3	EDMS Structure . . . . .	3
1-1-4	EDMS Specifications . . . . .	3
1-1-5	Software Package Contents . . . . .	5

# 1-1 Overview

## 1-1-1 Software Overview

The SYSMAC SPU Data Management Middleware (hereafter the EDMS) is software that reads CSV-format files from an SPU Unit and copies the files to a specified folder on a computer hard disk over an Ethernet network.

With version 2.0 or higher, the collected data can be stored in a database.

## 1-1-2 Features

- Use easy settings to write data automatically from the SPU Unit to a computer hard disk. The collected data can also be stored in a database.
- Start and stop copying and database storage at the press of a button or start copying and database storage automatically in the background on computer startup.

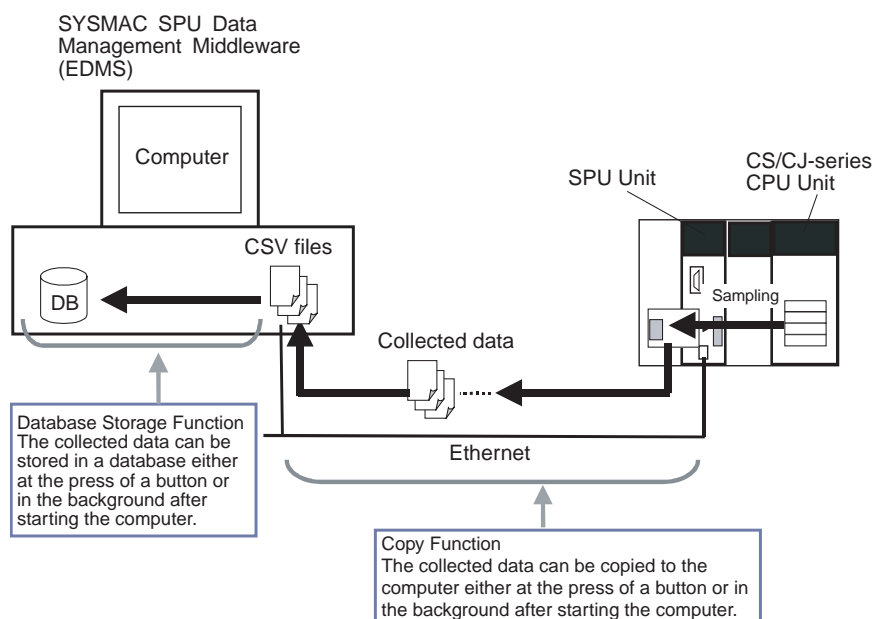

- Save copied files to any folder on the computer (see note) and automatically create file names using any combination of objects, i.e., any text string, time, or consecutive file numbers.

**Note** By default, a file named *SPU\_Unit\_name\copy\_name* will be created and saved in the EDMS Data\Copy Files\ folder in My Documents.

- Display data in a list that shows the file name, file size, time of start record, and time of last record.
- A log enables easy copy, database storage, and error status confirmation.
- Collecting data is continued by the SPU Unit even if network interference or some other problem shuts down the computer. Files that have not been copied to that point will start being copied when the system is restored if they are stored on Memory Card.
- The specified PLC and SPU Unit clocks are periodically synchronized with the computer clock to maintain consistent time throughout the system.

### 1-1-3 EDMS Structure

The EDMS consists of the following programs.

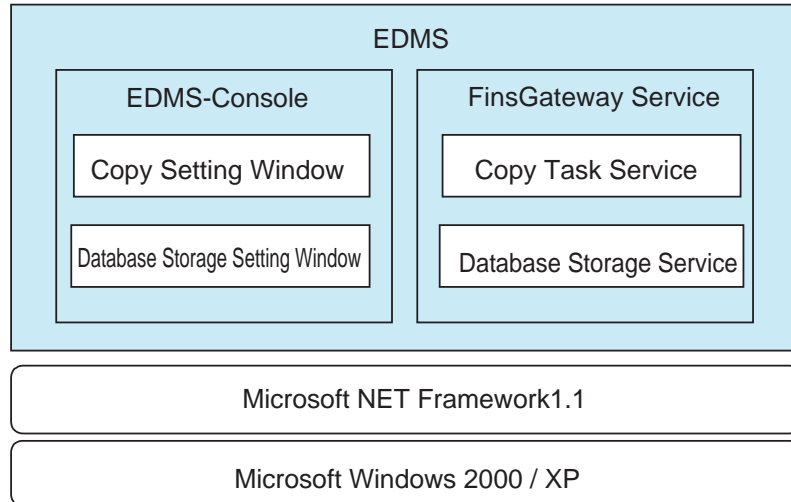

#### Copy Task Service

The Copy Task Service copies files from an SPU Unit and saves them to a computer hard disk on the same network. The service operates in the background and is used to monitor SPU Units.

#### Database Storage Service

The Database Storage Service stores the files that are copied to the computer into a database. The service operates in the background.

#### EDMS-Console

The EDMS-Console is a user-interface program that provides access to the setting windows. It accesses the Copy Setting Window, for example, to allow the user to input Copy Task Service settings, specify operations, and monitor operating conditions. The program displays the files that have been copied to the computer in a list that can be used for data management.

The Database Storage Windows enable setting the database storage service, controlling the storage operation, and monitoring operating status.

### 1-1-4 EDMS Specifications

Item	Description
Model	WS02-EDMC1-V2

Item		Description
System requirements	Processor	Intel Pentium, Celeron, or compatible processor
	CD-ROM drive	Required for installation
	Display	Super VGA (800 x 600) or better high-resolution video adaptor and monitor
	Mouse	Mouse supported by the applicable OS.
	Network card	Computers without a LAN port require an Ethernet network card (sold separately).
	OS	Microsoft Windows XP Home Edition / Professional Microsoft Windows Vista Microsoft Windows 7 (32-bit/64-bit edition) Microsoft Windows 8 (32-bit/64-bit edition) Microsoft Windows 2003 Server Microsoft Windows 2008 Server Microsoft Windows 2012 Server
	Application platform (execution environment)	Microsoft .NET Framework version 1.1
Communications platform		FinsGateway version 2003
Other software requirements		SPU-Console (sold separately) required to input SPU Unit settings.
Registration of applicable SPU Units		SPU Units can be registered by specifying the IP address and name of the Unit (same for the SPU-Console).
Copy function	Copies files from the Memory Card in a registered SPU Unit to a specified folder on a computer hard disk. The function is enabled only when two or more is set in the <i>Number of files</i> Field from the SPU-Console.	
	Settable number of copies	256 max.
	Copy start conditions	<b>Start</b> Button or automatically on computer startup.
	Copy timing	Files will be saved to the computer hard disk over the network automatically when copying is enabled (data collection has stopped or files have been transferred).
	Storage location	Any specified folder
	Saved file name	File names can be created automatically using one or any combination of the following objects: Any text string, the name of the copy, the name of the source SPU Unit, the time or date (month, day, year) the file was copied, consecutive file numbers, the date or time of the start record, and the date or time of the last record.
	Copy monitoring cycle	Settable cycle for monitoring when copying is enabled. Default: 10 s
	Status indicators	Used to check starting, started (monitoring copying), copying, stopped, and error status conditions.
	Log display	Press the <b>Display of log</b> Button to display the operating status or an error log list that shows the month/day/year, time, event ID, and description.

Item	Description		
Database storage function	Data files that are copied to a specified folder on a computer hard disk are stored in a database. The function is enabled only when three or more is set in the <i>Number of files</i> Field from the SPU-Console.		
	Settable number of data base storage services	65 max.	
	Database storage start conditions	<b>Start</b> Button or automatically on computer startup.	
	Storage timing	Files will be automatically stored in the database as soon as storable files are detected.	
	Applicable data-bases	Microsoft Access 2003 Microsoft SQL Server 2005 Oracle Database 10g	
	Copy folder monitoring cycle	Settable cycle for monitoring when there are storable files. Default: 10 s	
	Status indicators	Used to check whether storage is in progress (monitoring for storable files) or stopped.	
	Log display	Press the <b>Display of log</b> Button to display the operating status or an error log list that shows the month/day/year, time, and description.	
SPU clock synchronization function	The SPU Unit (version 1.2 or later only) and CPU Unit clocks are periodically synchronized with the computer clock.		

### 1-1-5 Software Package Contents

The WS02-EDMC1-V2 software package contains the following items.

**EDMS Installation Program**

The EDMS installation program is used to install the Copy Task Service and EDMS-Console on a computer.

**Microsoft .NET Framework Version 1.1 Redistributable Package**

Microsoft .NET Framework Version 1.1 is required to run the SPU-Console. The Redistributable Package provided in the software package can be used to install .NET Framework on the computer.

**FinsGateway Version 2003**

The FinsGateway version 2003 communications middleware is required to run the SPU-Console.

**Operation Manual**

This operation manual is included in PDF format in the software package.





# SECTION 2

## Installation and Starting/Exiting

This section describes how to install and uninstall the software and how to start and exit the EDMS-Console.

2-1	Installing and Uninstalling . . . . .	8
2-1-1	Prior to Installation . . . . .	8
2-1-2	Installing the EDMS . . . . .	8
2-1-3	Installing Microsoft .NET Framework . . . . .	9
2-1-4	Installing FinsGateway . . . . .	9
2-1-5	Installing the MDAC . . . . .	10
2-1-6	Uninstalling EDMS . . . . .	11
2-2	Starting and Exiting the EDMS-Console . . . . .	12
2-2-1	Starting the EDMS-Console . . . . .	12
2-2-2	Exiting the EDMS-Console . . . . .	12
2-3	Basic Operating Procedures . . . . .	12
2-3-1	Procedural Flow for Copying Data . . . . .	12
2-3-2	Procedural Flow for Database Storage . . . . .	13

## 2-1 Installing and Uninstalling

### 2-1-1 Prior to Installation

- Make sure that the computer on which EDMS will be installed conforms to the conditions specified in *1-1-4 EDMS Specifications* before attempting to install the software.
- The following software must be installed on the computer before EDMS is installed.

- 1,2,3...**
1. Microsoft .NET Framework version 1.1
  2. FinsGateway Version 2003 ETN\_UNIT
  3. Microsoft Data Access Components (MDAC) 2.6 or higher
  4. SPU-Console (Only if the SPU-Console is to be used.)

All of the above software except for SPU-Console can all be installed from the EDMS installation disk.

The installation and uninstallation procedures for the EDMS are provided below, along with the installation procedures for the Microsoft .NET Framework first, FinsGateway, and the MDAC.

**Note** Administrator privileges are required to install and operate the EDMS.

### 2-1-2 Installing the EDMS

Use the following procedure to install the EDMS. If a previous version of EDMS is already installed, uninstall the previous version before you install the new version.

- 1,2,3...**
1. Start the computer and log on as the administrator.
  2. Insert the EDMS installation disk into the CD drive.  
The following installation program will start automatically.

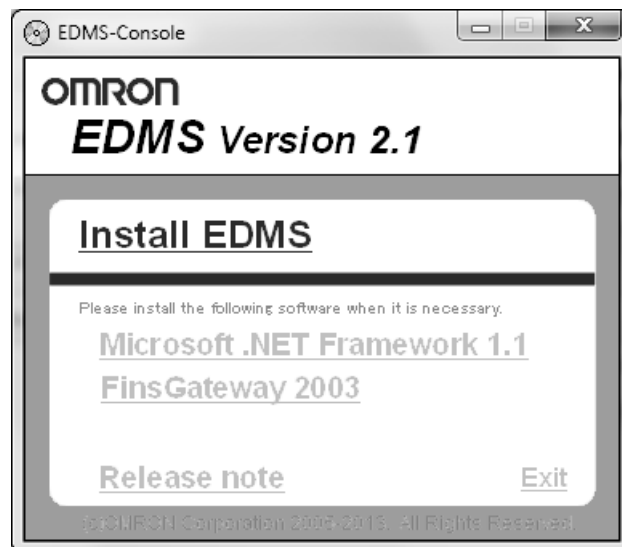

If the installation program does not start automatically, execute the following file.

*CD-ROM\_drive:\SetupLauncher.exe*

3. Click **Install EDMS**.  
The OMRON EDMS Version 2.1 Setup Program will start.
4. Follow the instructions provided by the program.

- Note**
- (1) If Microsoft.NET Framework or other operating requirements for the EDMS are not met, a warning message will be displayed and the setup program will end. If that happens, install the required software and then install the EDMS.
  - (2) If a new version of EDMS is installed without uninstalling a previous version, files will not be copied correctly. Always uninstall any previous version of EDMS and then install the new version.

### 2-1-3 Installing Microsoft .NET Framework

Microsoft .NET Framework version 1.1 is required to run the EDMS. Install it using the following procedure if it is not already installed. Microsoft .NET Framework version 1.1 is provided on the EDMS installation disk as a Redistributable Package that can be installed.

#### Using the Redistributable Package

- 1,2,3...**
1. Start the computer and log on as the administrator.
  2. Insert the EDMS installation disk into the CD drive.  
The following installation program will start automatically.



If the installation program does not start automatically, execute the following file.

CD-ROM\_drive:\SetupLauncher.exe

3. Click **Microsoft .NET Framework 1.1**.  
The Microsoft .NET Framework 1.1 Setup Program will start.
4. Follow the instructions provided by the program.

- Note**
- (1) Microsoft .NET Framework must be version 1.1 to use the EDMS. Version 1.0, version 2.0, or any other version will not work. Always install Microsoft.
  - (2) NET Framework version 1.1. (Only one version of Microsoft .NET Framework can be installed on any one computer.)

### 2-1-4 Installing FinsGateway

FinsGateway version 2003 ENT\_UNIT must be installed to run the EDMS. If an earlier version of the program is installed, be sure to uninstall the earlier version prior to installing version 2003. The computer must be restarted to complete the installation.

- 1,2,3...
1. Start the computer and log on as the administrator.
  2. Insert the EDMS installation disk into the CD drive.  
The following installation program will start automatically.

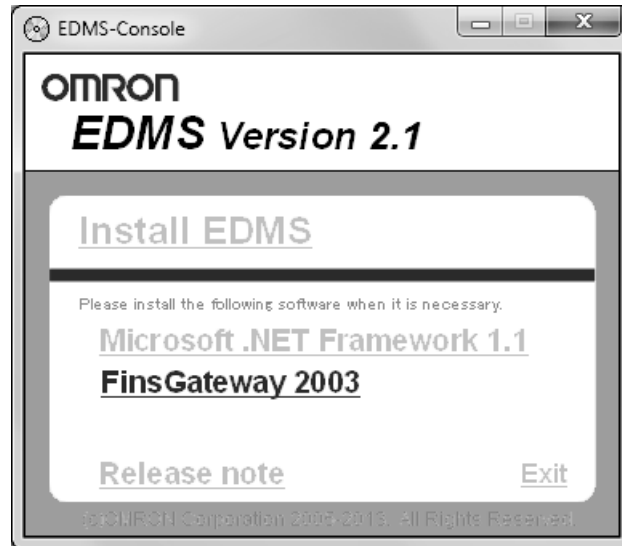

If the installation program does not start automatically, execute the following file.

CD-ROM\_drive:\SetupLauncher.exe

3. Click **FinsGateway 2003**.  
The OMRON FinsGateway Version 2003 Embedded Edition (ETN\_UNIT) Setup Program will start.
4. Follow the instructions provided by the program.
5. Restart the computer to complete the installation.

## 2-1-5 Installing the MDAC

MDAC (Microsoft Data Access Components) 2.6 or higher is required to run the EDMS. Install it using the following procedure if it is not already installed.

- 1,2,3...
1. Start the computer and log on as the administrator.
  2. Insert the EDMS installation disk into the CD drive.  
The following installation program will start automatically.

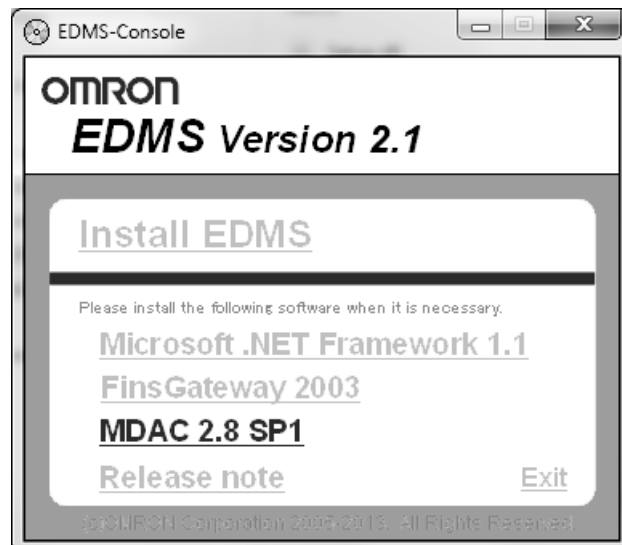

If the installation program does not start automatically, execute the following file.

*CD-ROM\_drive:\SetupLauncher.exe*

3. Click **MDAC 2.8 SP1**.  
The Microsoft Data Access Components 2.8 SP1 Setup Program will start.
4. Follow the instructions provided by the program.

## 2-1-6 Uninstalling EDMS

Follow the procedure below to uninstall the EDMS.

- 1,2,3...**
1. Start the computer and log on as the administrator.
  2. Select Control Panel from the Windows Start Menu.
  3. Select **Add or Remove Programs (Programs – Programs and Features** in Windows Vista/7).
  4. Select OMRON EDMS Version 2.1 from the list and click the **Add or Remove** Button (the **Uninstall** Button in Windows Vista/7).
  5. Select the *Remove* option from the setup maintenance program and click the **Next** Button.  
Follow the instructions provided by the program.

## 2-2 Starting and Exiting the EDMS-Console

### 2-2-1 Starting the EDMS-Console

Select **Program - OMRON - EDMS - EDMS-Console** from the Windows Start Menu to start the EDMS-Console. The following window will be displayed when the EDMS-Console starts.

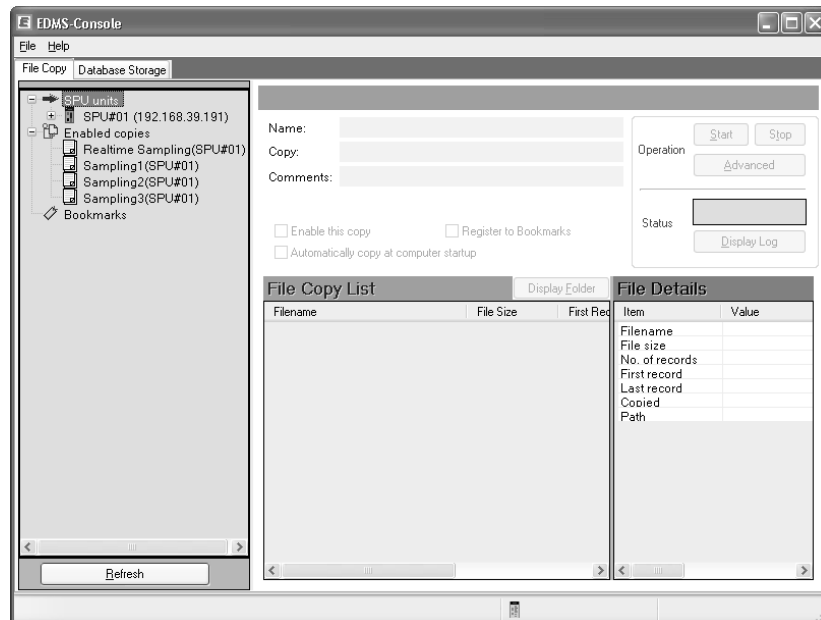

- Note**
- (1) Administrator privileges are required to use the EDMS-Console. Log on as the administrator.
  - (2) Only one copy of the EDMS-Console can be run at the same time.

### 2-2-2 Exiting the EDMS-Console

Select **Exit** from the File Menu of the EDMS-Console. The EDMS-Console will close.

## 2-3 Basic Operating Procedures

The basic operating procedures are given below. Perform the procedure in 2-3-1 *Procedural Flow for Copying Data* to use the EDMS-Console copy function to copy data from SPU Units to the computer. Perform the procedure in 2-3-2 *Procedural Flow for Database Storage* to store the data copied to the computer in a database.

### 2-3-1 Procedural Flow for Copying Data

- 1,2,3... 1. Connect a computer with the EDMS-Console installed to a SYSMAC SPU Unit via a LAN cable.  
The method is the same as that for the SPU-Console.
2. Select **Program - OMRON - EDMS - EDMS-Console** from the Windows Start Menu to start the EDMS-Console.  
Refer to 2-2-1 *Starting the EDMS-Console* and 3-2-1 *Procedural Flow*.
3. Register the SPU Units (specify the IP addresses).

- Refer to 3-2-3 *Registering SPU Units*.
4. Click the **Refresh** Button to update the list if necessary.  
Refer to 3-2-4 *Updating the List of SPU Units and Copies (as Required)*.
  5. The List of Copied Files Pane will be updated in the SPU/Copy Tree.
  6. Select the *Copy of file* and *Activate this copy* Options.  
Refer to 3-2-5 *Setting Files to Copy*.
  7. Click the Advanced Setting Button if necessary to specify the folder to copy to, the name of the copied file, or the monitoring cycle for determining whether copying is possible.  
Refer to 3-2-6 *Selecting Advanced Setting (as Required)*.
  8. Click the **Start** Button to start copying or select the *Start copying automatically on computer startup* and restart the computer.  
Refer to 3-2-7 *Starting Copying Files*.
  9. Copying will start and the Copy Information Window will be displayed.  
Refer to 3-2-7 *Starting Copying Files*.
  10. Check the copy status conditions in the Status Area.  
Refer to 3-2-8 *Checking the Copy Status Conditions*.
  11. Click the **Display of log** Button.  
Refer to 3-2-9 *Checking the Log*.

## 2-3-2 Procedural Flow for Database Storage

Always perform the procedure given in 2-3-1 *Procedural Flow for Copying Data* before performing the following procedure to store the copied data in a database.

- 1,2,3... 1. Use the SPU-Console to set the data to be collected from SPU Units. Be sure to set three or more data collection files.  
Refer to the *SPU-Console Operation Manual* (Cat. No. V231).
2. Select **File - SPU Device** from the menu bar to place the EDMS-Console online with an SPU Unit.  
Refer to the 3-2-3 *Registering SPU Units*.
3. Enable copying files in the EDMS-Console's File Copy Window.  
Refer to the 3-2-5 *Setting Files to Copy*.
4. Set up database storage on the EDMS-Console's Database Storage Window.  
Refer to the 4-3-1 *Database Storage Settings*.
5. Start database storage on the EDMS-Console's Database Storage Window.  
Refer to the 4-3-2 *Starting Database Storage* and 4-5 *Data Table Storage Operations*.





# SECTION 3

## Copy Function

This section provides operating procedures for the copy function of the SPU Data Management Middleware.

3-1	Window Configuration of Copy Function. . . . .	16
3-1-1	SPU/Copy Tree. . . . .	16
3-1-2	SPU Unit Information Pane . . . . .	17
3-1-3	Copy Information Window . . . . .	17
3-2	Operating Procedures . . . . .	20
3-2-1	Procedural Flow . . . . .	20
3-2-2	Starting the EDMS-Console . . . . .	20
3-2-3	Registering SPU Units . . . . .	21
3-2-4	Updating the List of SPU Units and Copies (as Required) . . . . .	21
3-2-5	Setting Files to Copy . . . . .	22
3-2-6	Selecting Advanced Setting (as Required) . . . . .	22
3-2-7	Starting Copying Files . . . . .	23
3-2-8	Checking the Copy Status Conditions . . . . .	24
3-2-9	Checking the Log . . . . .	25
3-2-10	Stopping Copying Files . . . . .	26
3-2-11	Disabling the Copy Function . . . . .	26
3-2-12	Displaying SPU Unit Information . . . . .	26
3-3	Copy Task Service. . . . .	27
3-3-1	Starting the FinsGateway Copy Task Service. . . . .	28
3-3-2	Stopping the FinsGateway Copy Task Service. . . . .	28

### 3-1 Window Configuration of Copy Function

The File Copy Window consists of the following parts.

Name	Description
SPU/Copy Tree	Displays the Copy Tree for all SPU Units. Select an SPU Unit to display the SPU Unit Information Pane. Select <b>Copy of file</b> to display the Copy Information Window.
SPU Unit Information Pane	Displays SPU Unit information and operations.
Copy Information Window	Displays copy information and operations.

#### 3-1-1 SPU/Copy Tree

The following pane shows the Copy Tree for all SPU Units.

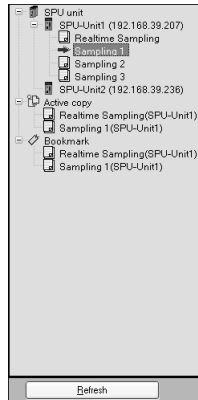

The SPU/Copy Tree displays the following information.

Display	Description
SPU Units	Displays all registered SPU Units, as well as the sampling/collection pattern file names registered to the SPU Units.
Active Copy	Displays all files for Units with <b>Activate this copy</b> selected on the Copy Information Window.
Bookmark	Displays all files for Units with <b>Register to Bookmark</b> selected on the Copy Information Window.

#### Refresh Button

Click the **Refresh** Button to update the list as required if SPU Units are registered, deleted, or changed using the procedures in 3-2-3 *Registering SPU Units*. The list of SPU Units and copied files will be updated and displayed in the SPU/Copy Tree.

### 3-1-2 SPU Unit Information Pane

Select an SPU Unit from the SPU/Copy Tree to display the SPU Unit Information Pane.

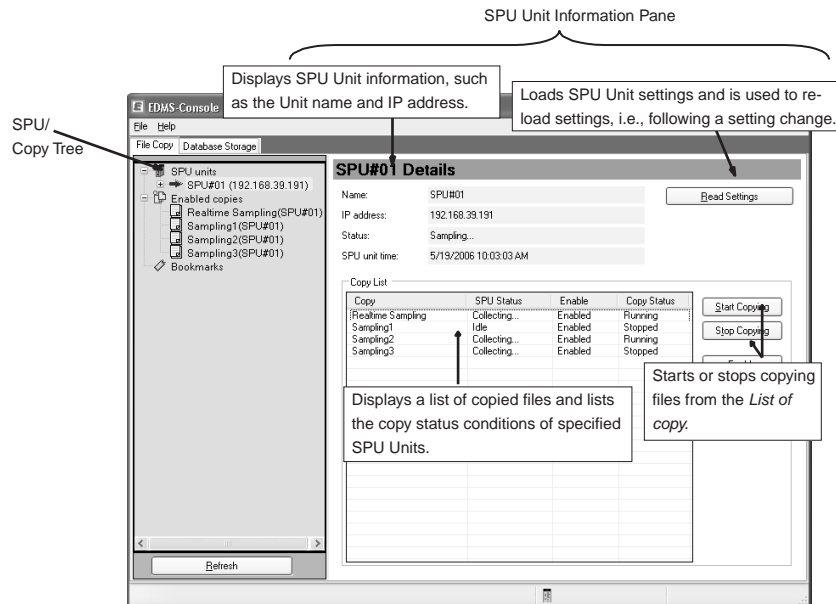

The SPU Unit Information Pane is described in the following table.

Name	Description
SPU Unit Information Pane	Displays the copy status conditions and lists copied files for an SPU Unit selected from the SPU/Copy Tree. It can also be used to start and stop copying.

### 3-1-3 Copy Information Window

Select a file from the SPU/Copy Tree to display the Copy Information Window.

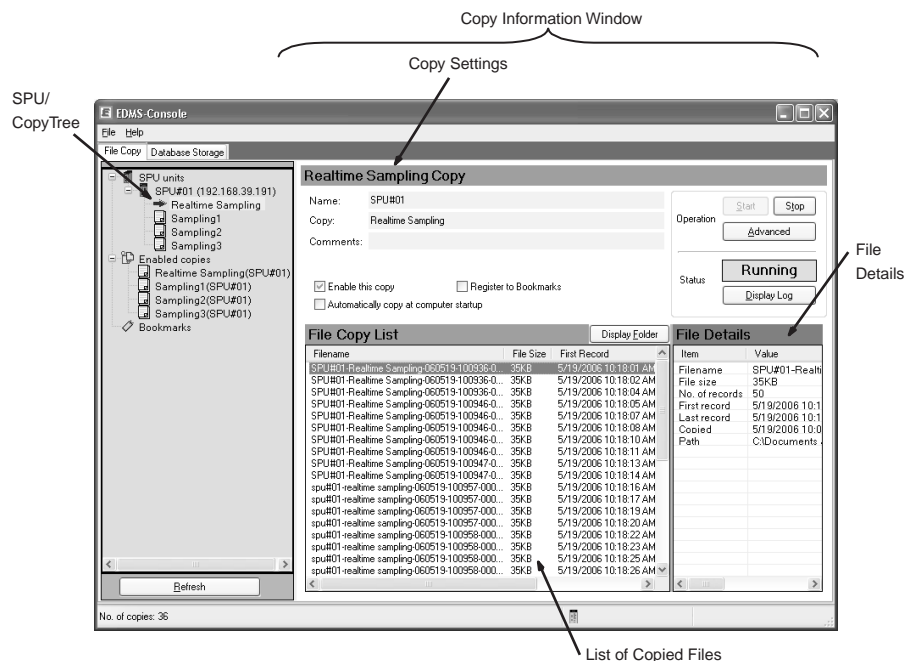

The Copy Information Window consists of the following panes.

Name	Description
Copy Settings	Selects the copy function and starts or stops copying.
List of Copied Files	Displays the files that have been copied to the computer.
File Details	The details on a file copied to the computer will be displayed if the file name in the File Copy List Pane is clicked.

### Copy Settings

The Copy Setting Pane is used to select the copy function or to start and stop copying a file selected from the SPU/Copy Tree. It is also used to display copy status conditions.



### Copy Settings

Copy settings are selected using the following options.

Option	Description
Activate this copy	When this option is selected, files are copied to a computer hard disk. Copying files will start when the <b>Start</b> Button is clicked in the Operation Area. If the <i>Start copying automatically on computer startup</i> Option is selected, a maximum of 256 files can be copied automatically when the computer starts. Files that have this option selected are displayed under <i>Active copies</i> in the SPU Unit/Copy Tree. This option is available only when two or more is set in the <i>Number of files</i> Field from the SPU-Console.
Register to Bookmark	These options will be available if a file has the <i>Activate this copy</i> Option selected. Otherwise they will be grayed out. Files that have this option selected are registered under <i>Bookmark</i> in the SPU/ Copy Tree.
Start copying automatically on computer startup	Files that have this option selected are copied automatically on computer startup without having to click the <b>Start</b> Button from the Operation Area.

### Operation Area

Button	Description
Start	Starts copying files to the computer automatically if the files have the <i>Activate this copy</i> Option selected.
Stop	Stops copying files to the computer.
Advanced setting	Displays a window to enable setting the folder to copy to, the format of the file name, the copy monitoring cycle, and whether or not to synchronize the SPU Unit clock to the computer clock. (Refer to 3-2-6 <i>Selecting Advanced Setting (as Required)</i> .)

### Status Area

Item	Description
Current copy status	Displays starting, started, copying, stopped, warnings, and errors.

Button	Description
Display of log	Used to check whether copying has started or stopped as well as the date and time that errors have occurred.

**List of Copied Files**

The List of Copied Files Pane displays a list of all data files that have been copied from the SPU Unit to the computer.

File name	File size	Time of start record	Time of last record
SPU-Unit1-Sampling 1-050510-184916-00065.csv	1KB	5/10/2005 6:40:34 PM.460	5/10/2005 6:40:43 PM.460
SPU-Unit1-Sampling 1-050510-184916-00066.csv	1KB	5/10/2005 6:40:44 PM.460	5/10/2005 6:40:53 PM.460
SPU-Unit1-Sampling 1-050510-184916-00067.csv	1KB	5/10/2005 6:40:54 PM.460	5/10/2005 6:41:03 PM.460
SPU-Unit1-Sampling 1-050510-184916-00068.csv	1KB	5/10/2005 6:41:04 PM.459	5/10/2005 6:41:13 PM.460
SPU-Unit1-Sampling 1-050510-195054-00069.csv	1KB	5/10/2005 7:41:34 PM.460	5/10/2005 7:41:43 PM.460
SPU-Unit1-Sampling 1-050510-195054-00070.csv	1KB	5/10/2005 7:41:44 PM.460	5/10/2005 7:41:53 PM.460
SPU-Unit1-Sampling 1-050510-195054-00071.csv	1KB	5/10/2005 7:41:54 PM.459	5/10/2005 7:42:03 PM.460
SPU-Unit1-Sampling 1-050510-195054-00072.csv	1KB	5/10/2005 7:42:04 PM.460	5/10/2005 7:42:13 PM.459
SPU-Unit1-Sampling 1-050510-195105-00073.csv	1KB	5/10/2005 7:42:14 PM.460	5/10/2005 7:42:23 PM.460
SPU-Unit1-Sampling 1-050510-195115-00074.csv	1KB	5/10/2005 7:42:24 PM.460	5/10/2005 7:42:33 PM.460
SPU-Unit1-Sampling 1-050510-195125-00075.csv	1KB	5/10/2005 7:42:34 PM.460	5/10/2005 7:42:43 PM.460

The following items are displayed for each file that has been copied.

Display item	Description
File name	The name of the copied data file.
File size	The size of the copied data file.
Time of start record	The time of the start record registered for a copied data file. Displayed in milliseconds (ms).
Time of last record	The time of the last record registered for a copied data file. Displayed in milliseconds (ms).

The Display of Folder Button can be clicked to display the copied folders.

**File Details**

Details on data files that have been copied to the computer will be displayed when a file name is selected in the File Copy List Pane.

Property name	Value
File name	SPU-Unit1-Sampling 1-050510-184916-00065.csv
File size	1KB
Record count	10
Time of start rec...	5/10/2005 6:40:34 PM.460249766
Time of last rec...	5/10/2005 6:40:43 PM.460098338
Copied time	5/10/2005 6:49:16 PM
File path	C:\Documents and Settings\loc\My Documents\EDMS

The following items are displayed in the Details of File Pane.

Property name	Value
File name	The name of the copied data file.
File size	The size of the copied data file.
Record count	The number of records registered to a copied data file.
Time of start record	The time of the start record registered to a copied data file.
Time of last record	The time of the last record registered to a copied data file.

Property name	Value
Copied time	The date and time that a data file was copied.
File path	The path for saving a copied data file.

## 3-2 Operating Procedures

### 3-2-1 Procedural Flow

- 1,2,3...**
1. Connect a computer with the EDMS-Console installed to a SYSMAC SPU Unit via a LAN cable.  
The method is the same as that for the SPU-Console.
  2. Select **Program - OMRON - EDMS - EDMS-Console** from the Windows Start Menu to start the EDMS-Console.  
Refer to 3-2-2 *Starting the EDMS-Console*.
  3. Register the SPU Units (specify the IP addresses).  
Refer to 3-2-3 *Registering SPU Units*.
  4. Click the **Refresh** Button to update the list if necessary.  
Refer to 3-2-4 *Updating the List of SPU Units and Copies (as Required)*.
  5. The List of Copied Files Pane will be updated in the SPU/Copy Tree.
  6. Select the *Copy of file* and *Activate this copy* Options.  
Refer to 3-2-5 *Setting Files to Copy*.
  7. Click the Advanced Setting Button if necessary to specify the folder to copy to, the name of the copied file, or the monitoring cycle for determining whether or not copying is possible.  
Refer to 3-2-6 *Selecting Advanced Setting (as Required)*.
  8. Click the **Start** Button to start copying or select the *Start copying automatically on computer startup* and restart the computer.  
Refer to 3-2-7 *Starting Copying Files*.
  9. Copying will start and the Copy Information Window will be displayed.  
Refer to 3-2-7 *Starting Copying Files*.
  10. Check the copy status conditions in the Status Area.  
Refer to 3-2-8 *Checking the Copy Status Conditions*.
  11. Click the **Display of log** Button.  
Refer to 3-2-9 *Checking the Log*.

### 3-2-2 Starting the EDMS-Console

Select **Program - OMRON - EDMS - EDMS-Console** from the Windows Start Menu to start the EDMS-Console.

### 3-2-3 Registering SPU Units

Register the SPU Units with the files that will be copied.

- 1,2,3... 1. Select **SPU Device** from the File Menu.

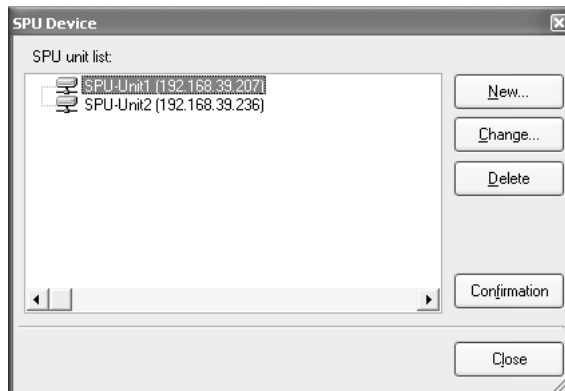

2. Click the **New** Button to register the SPU Unit.

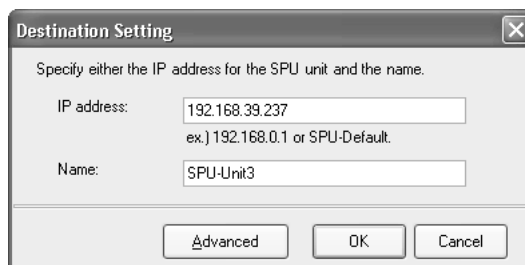

- Specify the IP address of the SPU Unit in the *IP Address* Field.
- Specify any text string in the *Name* Field to identify the SPU Unit that will be registered. (If nothing is entered in the field, then the IP address will be entered in the *Name* Field automatically.)

**Note** The FINS address of the SPU Unit can be checked using the 05 IP Address Display (LAN1) command.

### 3-2-4 Updating the List of SPU Units and Copies (as Required)

Click the **Refresh** Button to update the list whenever SPU Units have been newly registered, changed, or deleted in the SPU Device Window. The list of SPU Units and copied files will be updated and displayed in the SPU/Copy Tree.

### 3-2-5 Setting Files to Copy

Select the file to copy in the SPU/Copy Tree and then select the *Activate this copy* Option from the Copy Information Window.

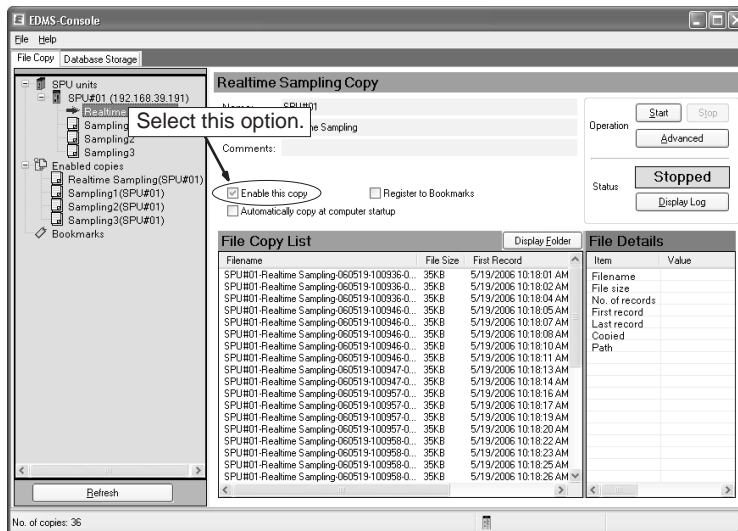

Other options, operations, and status conditions are enabled when the *Activate this copy* Option is selected.

### 3-2-6 Selecting Advanced Setting (as Required)

Click the **Advanced Setting** Button to display the following window.





The following items can be selected from the Advanced Setting Window.

Item	Description
Folder to copy to	Shows the save path for copied files. A path can be entered directly or it can be selected or created by clicking the ... Button.  Default values (see note) can be restored by clicking the <b>Restore Defaults</b> Button.  Note: The default values are as follows: <i>SPU_Unit_name\Copy_name</i> files are saved to the EDMS Data\Copy Files\ folder in My Documents.
Format of the copied file	Specifies the name of a copied file using one or a combination of objects, such as the month, day, and year or the hour, minutes, and seconds the file was copied, the data collection name, or consecutive file numbers.  Standard formats can be specified from the Template Area or they can be edited to specify a non-standard format.  Examples of actual file names are available in the <i>Sample</i> file.
Monitoring cycle of the unit	Sets the monitoring cycle in seconds for determining whether or not copying is possible. The default setting is 10 s.
Set the time of PC to that of the unit	Synchronizes the SPU Unit and CPU Unit clocks to the computer clock. The setting is reflected in all copies from the same SPU Unit.  This function is only available with SPU Units version 1.2 or later.

**Note** When enabling the *Set the time of PC to that of the unit* setting, confirm that the personal computer clock is setting is accurate.

### 3-2-7 Starting Copying Files

Either of the following methods can be used to start copying files.

- Clicking the **Start** Button
- Copying automatically on computer startup

#### Clicking the Start Button

Click the Start Button from the Operations Area.

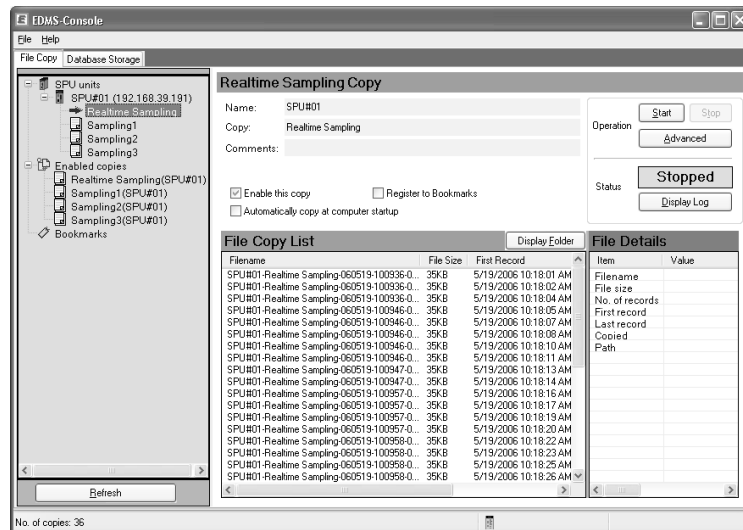

Copying will begin and the files that have been copied will be displayed in the List of Copied File Pane in the order they were copied.

### Automatically Starting Copying at Computer Startup

- 1,2,3...
1. Select the *Start copying automatically on computer startup* Option from the Operations Area.
    - Note** Files can be copied automatically at computer startup without clicking the **Start** Button by selecting this option. Files will not start copying immediately, however, just by selecting and enabling the option.
  2. There are two ways to start copying.
    - a. Click the **Start** Button.
    - b. Restart the computer.
  3. To stop copying files, click the **Stop** Button in the Operations Area.

**Note** When the space available on the drive where the files are stored drops to 5%, a warning will occur; when it drops to 2.5%, an error will occur and copying files will stop. Make sure there is sufficient space available on the drive before copying files.

### 3-2-8 Checking the Copy Status Conditions

Files that have been copied will be added to the List of Copied File Pane in the order they were copied. The current status conditions can be checked from the Status Area.

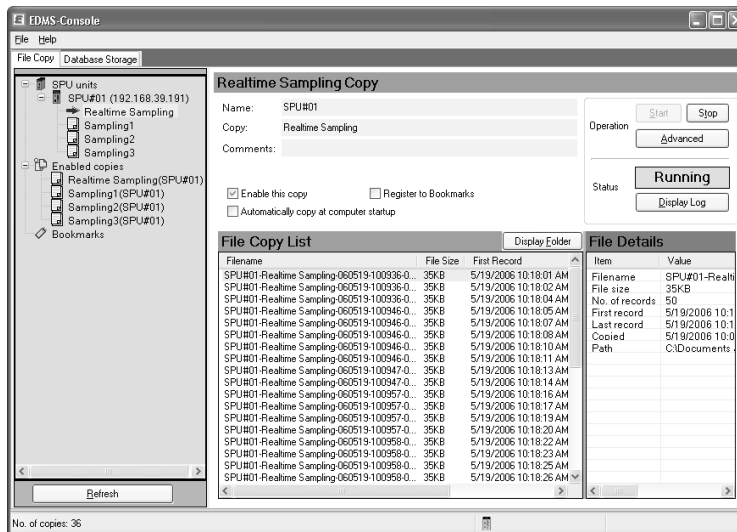

The Status Area displays the following status conditions.

Item	Description
Starting	Copying has started.
Started	Copying is being monitored.
Copying	Files are being copied.
Stopped	Copying has stopped.
Warning	Copying cannot be executed, but monitoring continues.
Error	Copying cannot be executed, and monitoring stops.

### 3-2-9 Checking the Log

EDMS provides a log that allows the copy start and stop status conditions, as well as the date and time that errors have occurred, to be checked. If an error or some other problem prevents files from being copied, the cause can sometimes be determined by checking the log.

- 1,2,3... 1. Click the **Display of log** Button to check the log.

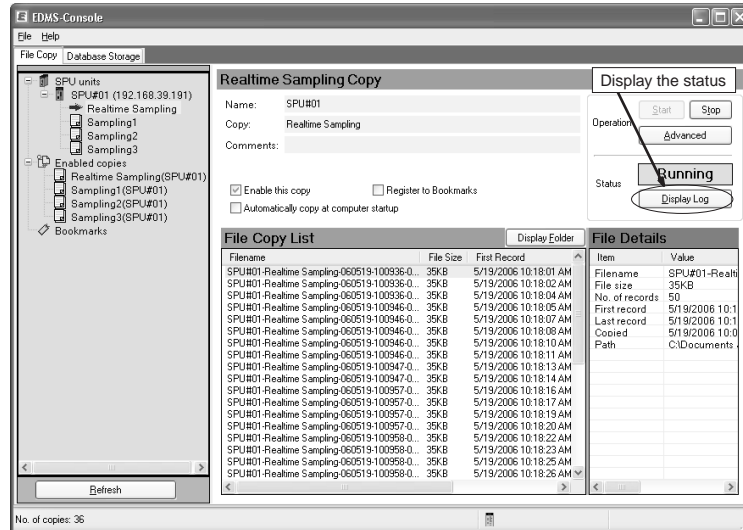

The following Display of Log Window will be displayed.

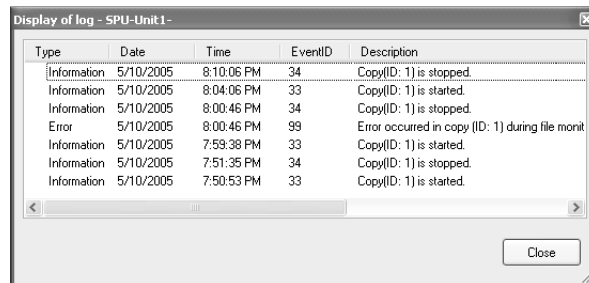

Only events for the selected copy will be displayed. They are displayed in order of occurrence starting from the most recent event.

The following items will be displayed.

Item	Description
Type	The type of event, such as data or error.
Date	The date the event occurred.
Time	The time the event occurred.
Event ID	The event ID unique to the application
Description	The event details.

2. Press the F5 Key to update the event display.

**Note** The log uses the Windows Event Log, and can be viewed from the Windows Event Viewer.

### 3-2-10 Stopping Copying Files

Click the **Stop** Button to stop copying files.

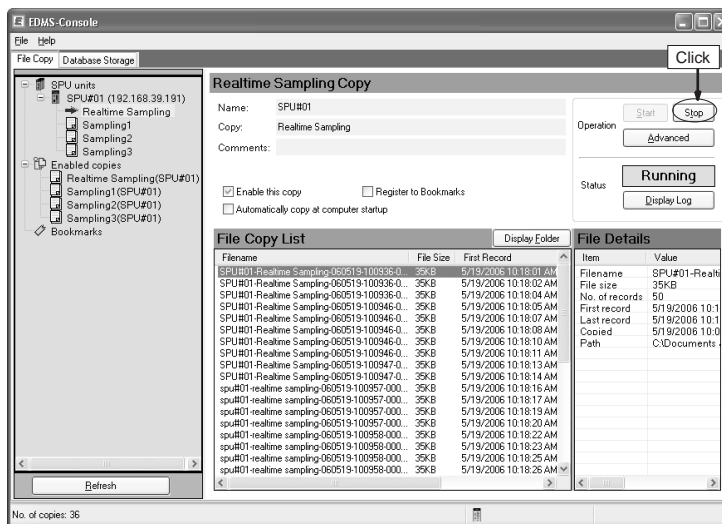

### 3-2-11 Disabling the Copy Function

Stop copying files and then clear the *Activate this copy* Option from the Copy Information Window to disable the copy function.

### 3-2-12 Displaying SPU Unit Information

Select an SPU Unit from the SPU/Copy Tree to check the Unit's settings (i.e., the IP address or current time), to display a list of copies for that Unit, or to start and stop copying.

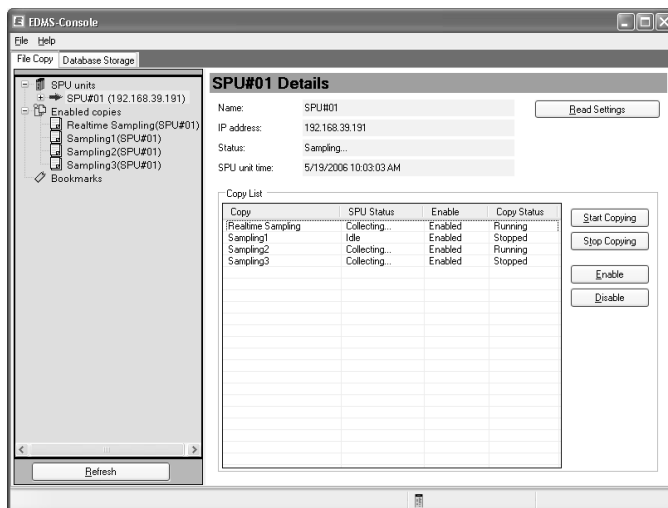

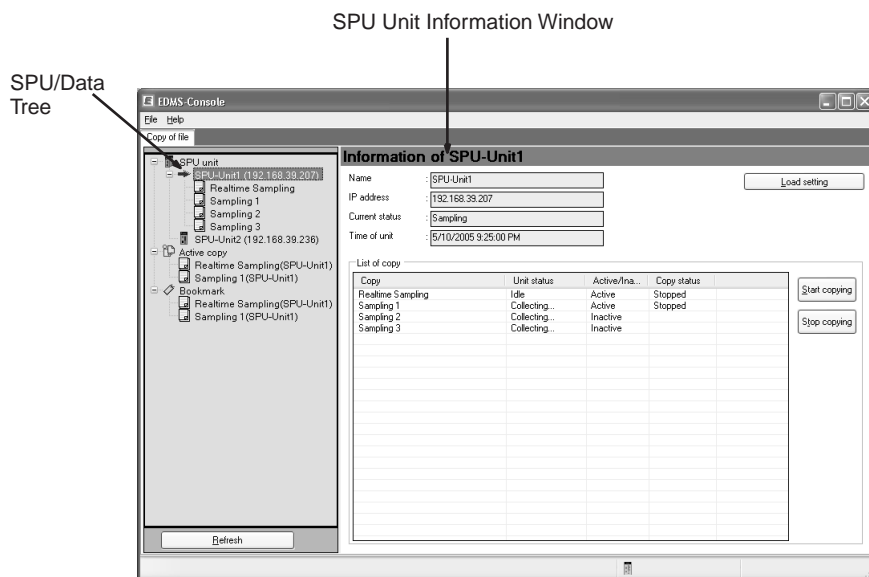

Item	Description
Name	Displays the name of the SPU Unit.
IP address	Displays the IP address of the SPU Unit.
Status	Displays the current status of the SPU Unit, including idle status, sampling status, changes to settings, active status, and initialization.
SPU Unit time	Displays the current time of the SPU Unit clock.
Load Settings Button	Loads SPU Unit settings and reloads settings when a change is made.
Copy List	Lists the copied files for a specified SPU Unit as well as the copy status conditions.
Start Copying Button	Starts copying a file selected from the Copy List.
Stop Copying Button	Stops copying a file selected from the Copy List.
Enable Button	Enables copying for the copy setting file selected in the Copy List.
Disable Button	Disables copying for the copy setting file selected in the Copy List.

**Note** When an SPU Unit setting has been changed, click the **Load Setting** Button to reflect the change in the EDMS-Console. Otherwise copying will be executed using the previous settings and may not execute properly.

### 3-3 Copy Task Service

The FinsGateway Copy Task Service is a Windows service that is used by the EDMS. Normally the service starts automatically without any action on the part of the user. If it does not start automatically, however, start it manually as described in the start/stop procedures below.

### 3-3-1 Starting the FinsGateway Copy Task Service

- 1,2,3... 1. Select **Program - FinsGateway - FinsGateway Configuration** from the Windows Start Menu.

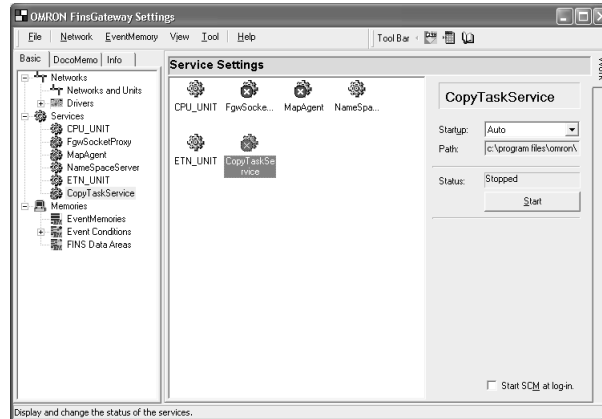

2. Click the **Basic** Tab and select **Services**.  
3. Select **Copy Task Service**.  
4. Click the **Start** Button.

### 3-3-2 Stopping the FinsGateway Copy Task Service

- 1,2,3... 1. Select **Program - FinsGateway - FinsGateway Configuration** from the Windows Start Menu.



2. Press the **Basic** Tab and select **Services**.  
3. Select **Copy Task Service**.  
4. Click the **Stop** Button.

# SECTION 4

## Database Storage Function

This section provides operating procedures for the data storage function of the SPU Data Management Middleware.

4-1	Overview of Database Storage Function. . . . .	30
4-1-1	The Database Storage Function . . . . .	30
4-1-2	Procedural Flow for Database Storage . . . . .	30
4-1-3	Automatically Creating Database Tables . . . . .	30
4-2	Database Storage Tab Page . . . . .	32
4-2-1	Displaying the Database Storage Tab Page . . . . .	32
4-2-2	Exiting the EDMS-Console . . . . .	33
4-3	Basic Database Storage Procedure . . . . .	33
4-3-1	Database Storage Settings. . . . .	33
4-3-2	Starting Database Storage. . . . .	37
4-4	Detailed Database Storage Settings . . . . .	40
4-4-1	EDMS Database Settings . . . . .	40
4-4-2	Changing and Deleting EDMS Databases . . . . .	44
4-4-3	Confirming Connection to the Database. . . . .	45
4-4-4	Selecting the Variable to Store in the Data Table . . . . .	46
4-4-5	Database Storage Settings Based on the EDMS Database . . . . .	47
4-5	Data Table Storage Operations . . . . .	49
4-5-1	Controlling Data Storage from a List . . . . .	49

## 4-1 Overview of Database Storage Function

This section describes the database storage function added for EDMS version 2.0.

### 4-1-1 The Database Storage Function

The database storage function takes data collected by SPU Units and automatically stores it in databases. This enables easily creating information systems using SPU Units for database management of quality control data or manufacturing results. There is no need to write programs to store data in databases, so the cost of constructing systems is greatly reduced.

The setting information in SPU Units can be used to automatically design databases. You can thus store data in a database with only a few easy settings even if you have no knowledge of databases.

Also databases can be linked to EQView (WS02-EQMC1-V1) to graphically display the data stored in databases by the EDMS.

### 4-1-2 Procedural Flow for Database Storage

The basic procedure for making the settings required to start database storage and for controlling database storage is given below.

- Note**
- (1) Refer to the *SPU-Console Operation Manual* (Cat. No. V237) for SPU-Console operating methods.
  - (2) Refer to *SECTION 3 Copy Function* for operating methods for the file copying function of the EDMS-Console.

- 1,2,3...**
1. Use the SPU-Console to set the data to be collected from SPU Units. Be sure to set three or more data collection files.  
Refer to the *SPU-Console Operation Manual* (Cat. No. V237).
  2. Select **File - SPU Device** from the menu bar to place the EDMS-Console online with an SPU Unit.  
Refer to the *3-2-3 Registering SPU Units*.
  3. Enable copying files in the EDMS-Console's File Copy Window.  
Refer to the *3-2-5 Setting Files to Copy*.
  4. Set up database storage on the EDMS-Console's Database Storage Window.  
Refer to the *4-3-1 Database Storage Settings*.
  5. Start database storage on the EDMS-Console's Database Storage Window.  
Refer to the *4-3-2 Starting Database Storage* and *4-5 Data Table Storage Operations*.

### 4-1-3 Automatically Creating Database Tables

The database storage function of the EDMS-Console can automatically create tables to store data from CSV files into a database based on SPU Unit setting information. This greatly reduces the work required to design the database and lets you build a database system even if you do not have knowledge of databases.

The following three types of tables are created from the setting information in SPU Units (i.e., from settings for variables and collection patterns).

- Data tables



- Variable tables
- Administrative tables

These tables are described in order in the following sections.

### Data Tables

The database storage service stores data from CSV files into data tables. An empty data table is made according to the format in the CSV file. Tables can be named automatically or manually, and each database can contain more than one data table. Automatically assigned names are in the form “EDMS0000,” i.e., a serial number is added after “EDMS.”

The fields in a data table correspond 1:1 to the fields in the CSV file. Fields include index fields and other header fields, as well as the data fields that are used to store the actual data.

Field name	Field type	Description
RECORD_INDEX	Long integer	A header field that stores an index for the record. This field corresponds to column 0 in the CSV file.
TIME_STAMP	Time	A header field that stores the time (year, month, day of month, hour, minutes, and seconds) that the data was collected. This field corresponds to column 1 in the CSV file.
TIME_STAMP_NANO	Long integer	A header field that stores the time (milli-seconds and less) the data was collected. This field corresponds to column 2 in the CSV file.
SAMPLING_INDEX	Long integer	A header field that stores the sampling index. This field corresponds to column 3 in the CSV file.
DATA_n	Depends on data type of variable	Data fields, which store the actual data. Field names consist of “Data_” followed by a serial number starting from 0. Data fields correspond to columns 4 and on in the CSV file.

**Note** Data tables must be recreated if the number of variables in the SPU Unit is changed. If the data tables are not recreated, the data types of variables will not match the data types of the fields, and it may not be possible to store data correctly in the database. To recreate the data tables, delete the database storage settings and then make the database storage settings again.

### Variable Tables

Variable tables store the attributes (variable information) on the data stored in the data tables. The tables are automatically named by the EDMS-Console. Variable tables and data tables correspond 1:1.

Each record in a variable table corresponds to one data field in the data table. A variable table can be searched to find details on the variables stored in the data table.

Field name	Field type	Description
FIELD_NAME	Text string	The name of the field in the data table Example: DATA_0
NAME	Text string	The name of the variable set with SPU-Console
DESCRIPTION	Text string	The variable description set with SPU-Console
DATATYPE_NAME	Text string	The data type of the variable Example: UINT

Field name	Field type	Description
ADDRESS_MEMORY_NAME	Text string	The memory name of the variable Example: DM
ADDRESS_OFFSET	Integer	The address offset of the variable
ADDRESS_BIT	Integer	The bit position of the variable This field is used only for BIT variables. It is NULL (empty) for any other type of variable.
PLC_DATA_FORMAT	Text string	Data format in the PLC
SYSTEM_DATATYPE	Text string	The system data type of the variable
DATA_SIZE	Integer	The data size in bytes of the variable data
UNIT	Text string	The industrial unit of the variable
OPTION1	Text string	Option; reserved for future expansion.
OPTION2	Text string	Option; reserved for future expansion.
OPTION3	Text string	Option; reserved for future expansion.
OPTION4	Text string	Option; reserved for future expansion.
OPTION5	Text string	Option; reserved for future expansion.

### Administrative Table

The administrative table manages the correspondence between data tables and variable tables. There is only one administrative table in each database. The name is always EDMS\_SYSTEM.

The administrative table can be searched to find details on the data tables and variable tables in the database.

Field name	Field type	Description
DATA_TABLE	Text string	The name of a data table Example: EDMS00000
VARIABLE_TABLE	Text string	The name of a variable table Example: VARS00000
SOURCE	Text string	The name of the SPU Unit Example: SPU/SPU Unit name
PATTERN	Text string	The name of the collection pattern set with the SPU-Console Example: SPU/pattern name
DESCRIPTION	Text string	The comment created with the SPU-Console
CREATE_DATE	Time	The date and time the table was created
OPTION1	Text string	Option; reserved for future expansion.
OPTION2	Text string	Option; reserved for future expansion.
OPTION3	Text string	Option; reserved for future expansion.
OPTION4	Text string	Option; reserved for future expansion.
OPTION5	Text string	Option; reserved for future expansion.

## 4-2 Database Storage Tab Page

This section describes the display methods for the Database Storage Tab Page, i.e., the Database Storage Setting Pane.

### 4-2-1 Displaying the Database Storage Tab Page

- 1,2,3... 1. Select **Program - OMRON - EDMS - EDMS-Console** from the Windows Start Menu.  
The EDMS-Console will start.

2. Click the **Database Storage** Tab in the EDMS-Console. The following window will be displayed.

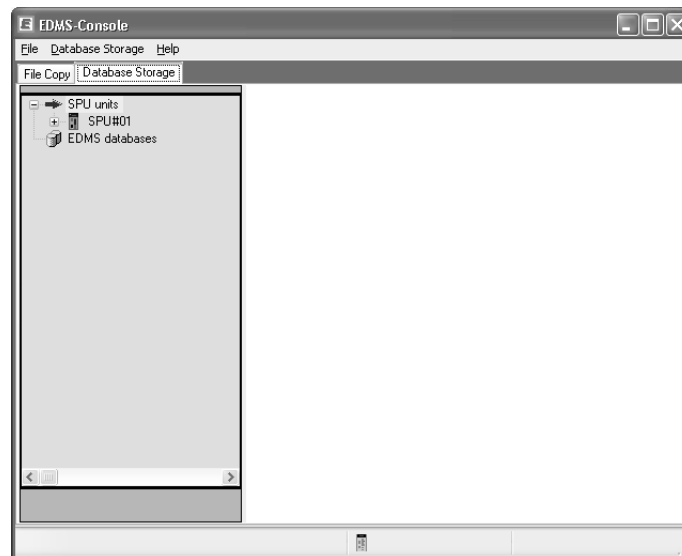

#### 4-2-2 Exiting the EDMS-Console

Select **Exit** from the File Menu of the EDMS-Console. The EDMS-Console will close.

### 4-3 Basic Database Storage Procedure

This section provides the basic procedures for setting up database storage. Here, the basic setting procedure when setting up database storage for the first time and the data storage procedure are described.

#### 4-3-1 Database Storage Settings

The settings required for database storage are described in this section. Here, we assume that the SPU Units have already been set. (Refer to the *SPU-Console Ver. 2.2 Operation Manual* (Cat. No. V237) and the *SPU Units Operation Manual* (Cat. No. V236) for information on setting SPU Units.) We also assume that the EDMS-Console has been connected online with SPU Units and copying data has been enabled on the File Copy Tab Page. (Refer to *SECTION 3 Copy Function*.)

- 1,2,3... 1. Start the EDMS-Console.  
 2. Click the **Database Storage** Tab in the EDMS-Console.  
 The following window will be displayed.

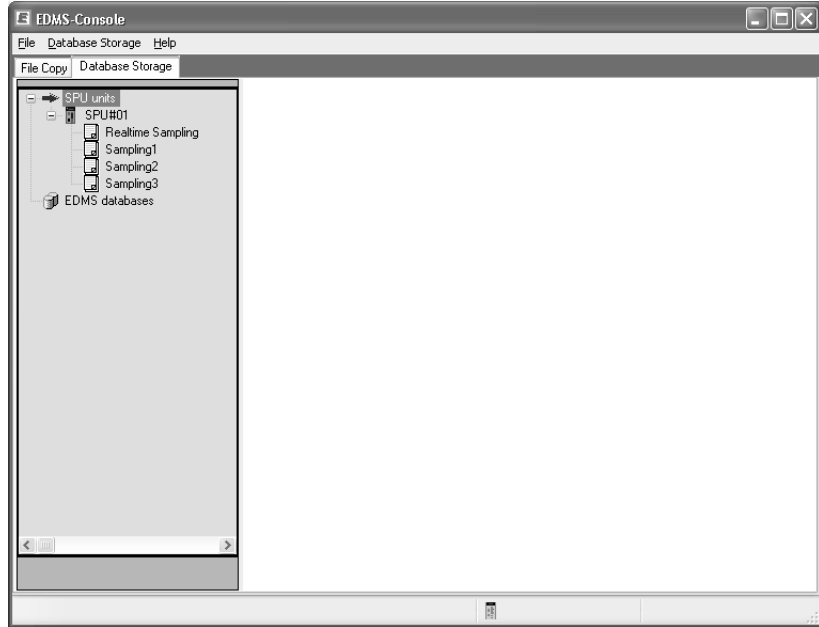

3. Select the collection pattern setting file for the data to be stored in the database. In this example, the file called "Realtime Sampling" is selected. The window will change as shown below.

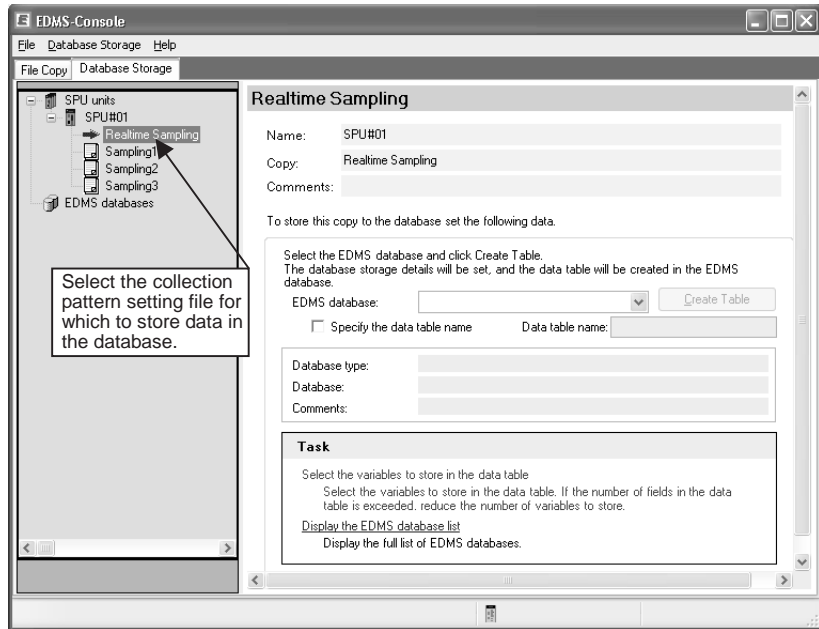

4. A new EDMS database will be registered. (If an EDMS database is already registered, it can be selected.)
- Click the down arrow on the right side of the *EDMS database* Field and select **(Add a new EDMS database)**.

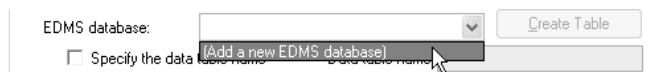

- The EDMS Database Settings Dialog Box will be displayed. Here, we will describe an example for Microsoft Access.

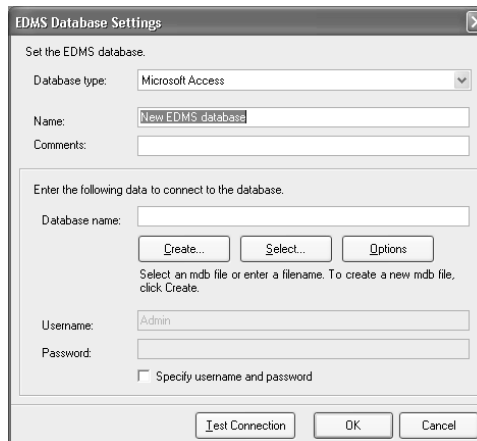

Select the type of database to be created in the *Database type* Field. Here, Microsoft Access is selected.

Enter a name in the *Name* Field.

Enter a comment if desired (optional).

Enter the name of the database in which to store the data in the *Database name* Field. To create a new database, click the **Create** Button. (A new database is being created in this example.) To use an existing database, click the **Select** Button.

To enable specifying a user name and password, select the *Specify user name and password* Option.

Setting Example:

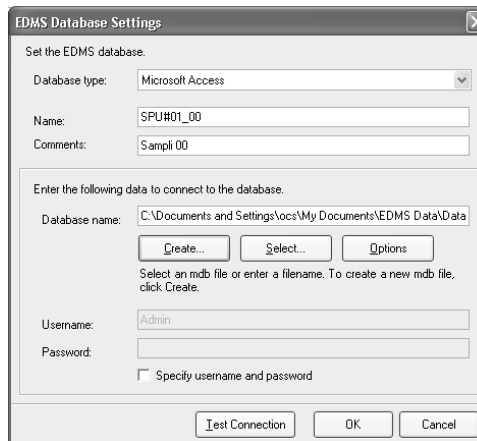

- Click the **Test Connection** Button.

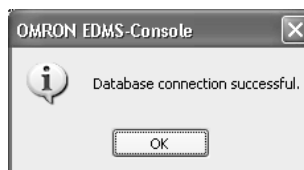

- Click the **OK** Button.
- The EDMS Database Settings Dialog Box will return.
- Click the **OK** Button.
- The Database Storage Tab Page of the EDMS-Console will return.

- Select the database that was just created, as shown below.



5. Click the **Create Table** Button to create the EDMS database tables.

- To specify the name of the data table, select the *Specify the data table name* Option before clicking the Create Table Button. If this option is not selected, the EDMS-Console will automatically name the data table.
- The following dialog box will be displayed if the tables are created normally.



- Click the **OK** Button.
- The Database Storage Tab Page will return.

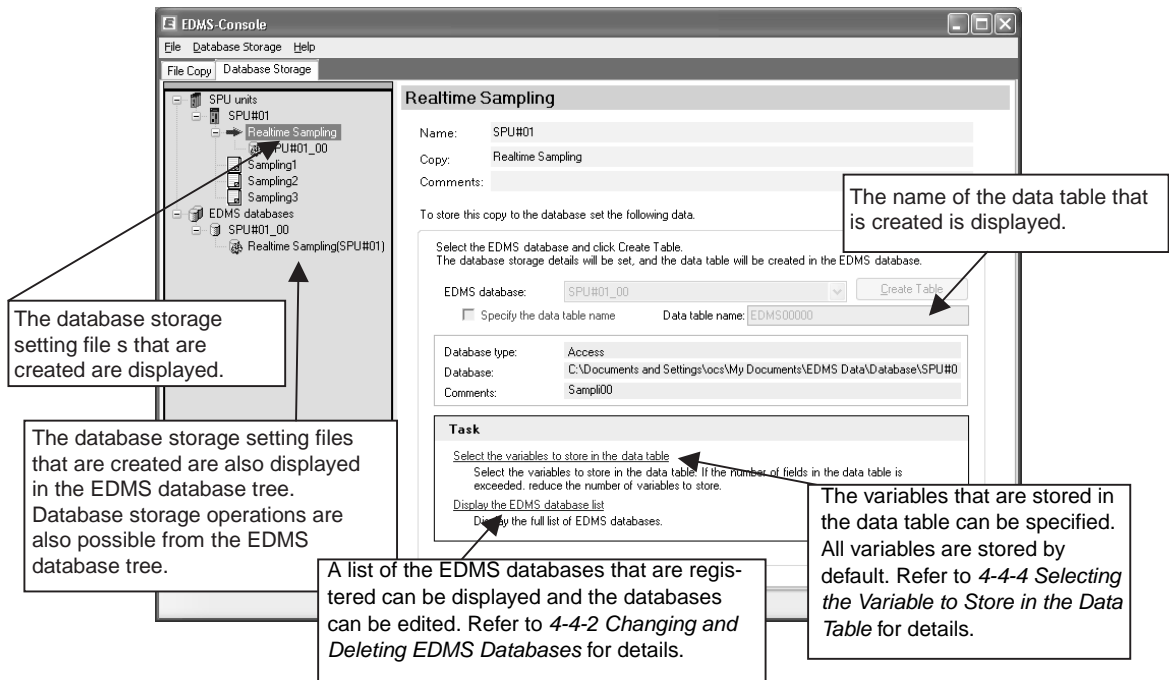

This completes setting up database storage. Repeat the above procedure for each collection pattern setting file for which data is to be stored in a database.

**Note** Data tables must be recreated if the number of variables in the SPU Unit is changed. If the data tables are not recreated, the data types of variables will not match the data types of the fields, and it may not be possible to store data correctly in the database. To recreate the data tables, delete the database storage settings and then make the database storage settings again.

### 4-3-2 Starting Database Storage

Use the following procedure to start storing data into a database.

- 1,2,3... 1. Click the **Database Storage Tab**.

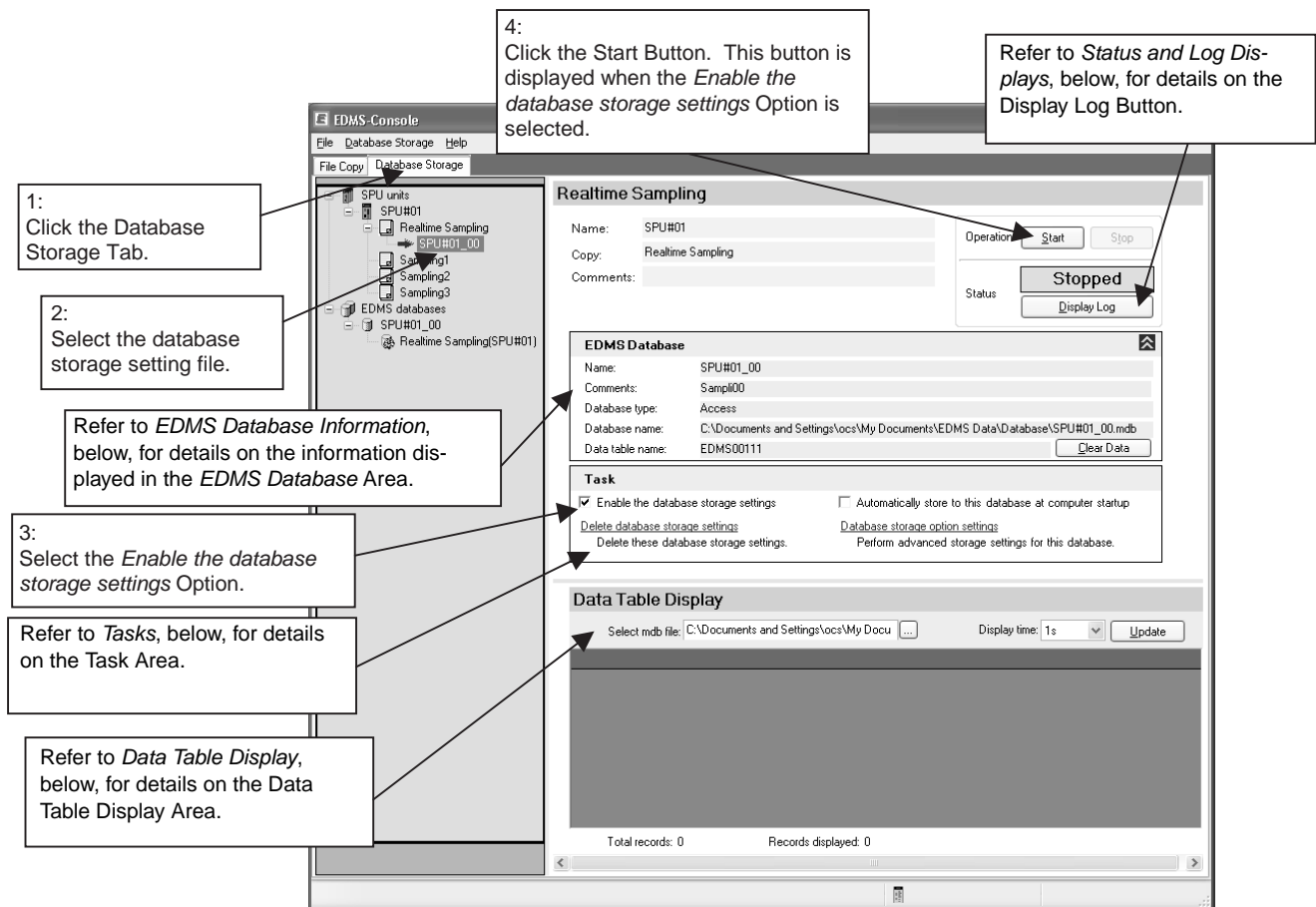

2. Select the database storage settings.
3. Select the *Enable the database storage settings* Option in the Task Area.
  - To set database options, refer to *Database Storage Options* on page 39.
4. Click the **Start** Button.  
The EDMS will start storing data into the database.
  - For the default setting, copying data will be started automatically if data is not already being copied. (Refer to *4-5-1 Controlling Data Storage from a List* for details.)
  - Click the **Update** Button to display the contents of the data table. Refer to *Data Table Display*, below, for details on data tables.
  - To stop data storage, click the **Stop** Button.

**Status and Log Displays**

The current status of the EDMS is displayed in the Status Area.

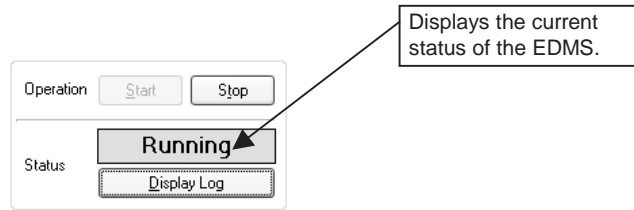

The following status is displayed in the Status Area.

Status	Description
Stopped	Storage of data into the database is stopped.
Running	Data is being stored into the database.
---	The database storage settings are not enabled or the DBRegistService is not running.

Click the **Display Log** Button to select a log file and display it in a text editor. The log is a set of up to 5 text files in ring format that record errors. The file names are DBRegist\_1.log to DBRegist\_5.log.

- Note**
- (1) An error will be recorded in a log file when data cannot be stored in a database for some reason.
  - (2) The CSV file for which the error occurred will be saved in a folder called "bad," which will be automatically created in the copy folder.

**EDMS Database Information**

The *EDMS Database* Area displays information on the database for the databases storage settings that are currently being edited. An example is shown below.

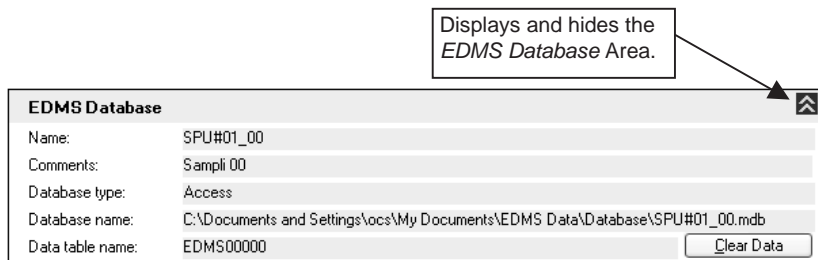

If the **Clear Database** Button is pressed, the data currently in the data table will be cleared, leaving an empty data table. The data table will not be deleted.

**Tasks**

This section describes operating methods for the *Task* Area.

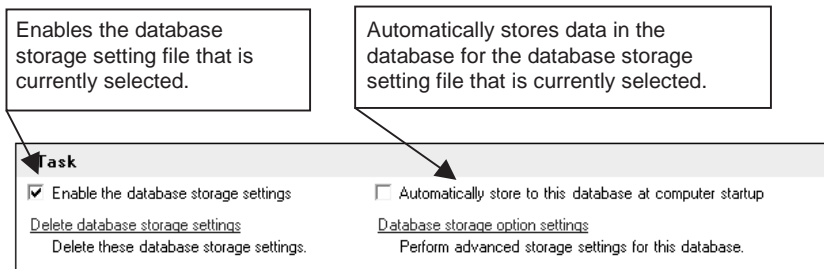



**Deleting Database Storage Settings**

Stop database storage before deleting the database storage settings.

1,2,3...

1. Click **Delete database storage settings** to delete the database storage settings. The following window will be displayed.



- Select the *Delete the data table* Option to delete the data table at the same time.

2. Click the **OK** Button.

**Note**

If the *Delete the data table* Option is selected, the data table and variable tables will be deleted at the same time, along with all data that has been stored. Do not select the *Delete the data table* Option unless you want to delete the data as well.

**Database Storage Options**

Stop database storage before setting the database storage options.

1,2,3...

1. Click **Database storage option settings** to set options for database storage. The following dialog box will be displayed.

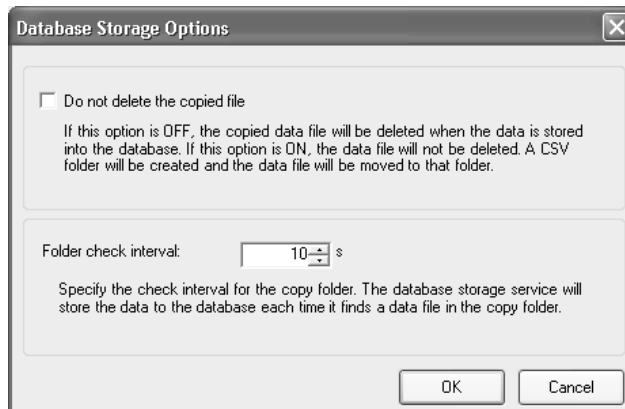

- Select the *Do not delete the copied file* Option if you do not want to delete the file of data copied from the SPU Unit after the data in the file has been stored in the database. If this option is selected, the copied files will be moved to a folder called CSV automatically created in the copy folder after database storage has been completed.
- To change the interval at which the EDMS checks for data files in the copy folder, set the desired interval in seconds in the *Folder check interval* Field.

2. Click the **OK** Button.

### Data Table Display

This section describes the *Data Table Display Area*.

The screenshot shows the 'Data Table Display' window. It includes a file selection field, a 'Display time' dropdown set to '1s', and an 'Update' button. Below these is a table with columns: RECORD\_IN, TIME\_STAM, TIME\_STAMP, SAMPLING\_I, DATA\_0, DATA\_1, DATA\_2, and DATA\_3. The table shows records 1745 through 1748. At the bottom, it displays 'Total records: 1767' and 'Records displayed: 22'. Callout boxes provide instructions: 'Select the database file to display (for Microsoft Access only)', 'Select the data display time range. Data is displayed backward in time from the currently stored data.', 'Displays the stored data. The display is refreshed when this button is clicked again.', and 'The total number of records is displayed along with the number of records for the time range specified for the Display time. In this example, there are a total of 50,442 records and 9 records displayed over the last second.'

**Note** If the Display time Field is set to 1 second, data that is stored at the same time and second as the last data that was stored will be displayed. In the following example, the records with record indices of 1 and 2 will be displayed, but the record with a record index of 0 will not be displayed.

RECORD_INDEX	TIME_STAMP	TIME_STAMP_NANO	SAMPLING_INDEX	DATA_0	DATA_1
0	2006/04/11 16:28:47.978	978897702	1	62241	18006
1	2006/04/11 16:28:48.080	80890182	2	62241	18006
2	2006/04/11 16:28:48.182	182882662	3	62241	18006

## 4-4 Detailed Database Storage Settings

This section described the detailed database storage settings that are not described in *4-3-1 Database Storage Settings*.

### 4-4-1 EDMS Database Settings

The “EDMS database” is the database to which the EDMS is connected. The following databases are supported: Microsoft Access, Microsoft SQL Server, and Oracle. The EDMS database settings for each are different and are described below for each type of database.

**Microsoft Access**

Select *Microsoft Access* in the *Database type Field* in the EDMS Database Settings Dialog Box.

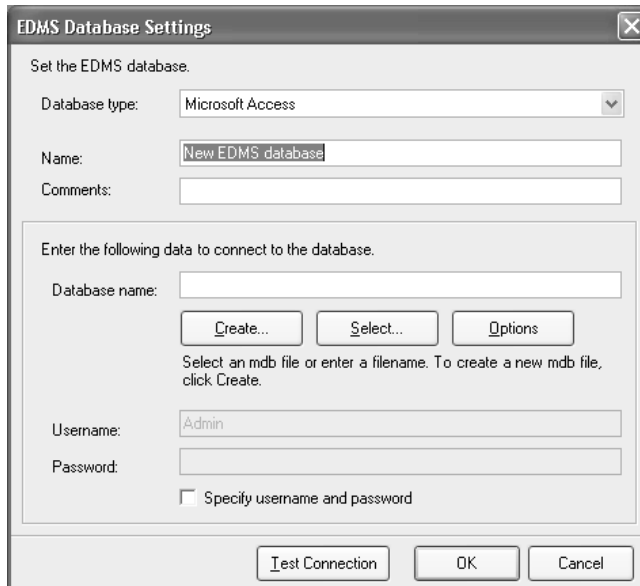

The items that can be set are listed below.

Item	Description
Name	Enter any desired name for the EDMS database settings.
Comments	Enter a description of the EDMS database. This field may be left blank.
Database name	Select or enter the file path name of the Microsoft Access database file (mdb). To specify an existing mdb file, click the Select Button and select the file. To create a new mdb file, click the Create Button and enter the file name.
User name and Password	To use a password-protected Microsoft Access database, select the <i>Specify user name and password</i> Option and enter the user name and password.

**Options**

Microsoft Access databases are restricted to a file size of 2 GB. There is an option to change files to store data when this limit is exceeded. Click the **Options** Button to set this option.

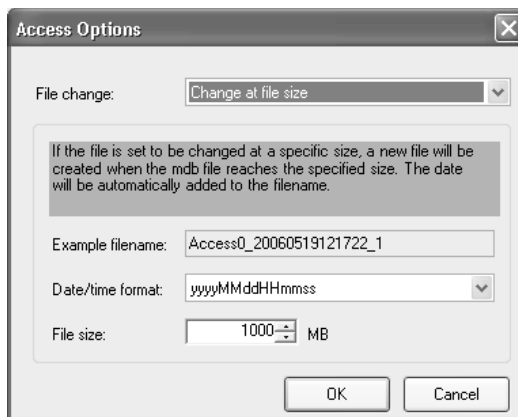

The items that can be set are listed below.

Item	Description
File change	Specify the method for changing files. The following settings are possible. <ul style="list-style-type: none"> <li>• File size (default)</li> <li>• Number of records</li> <li>• Do not change.</li> </ul>
Date/time format	Specify the format for the file name after changing files. A time stamp will be automatically added to the file name according to the format set here.
File size	If the file size is used to trigger changing files, specify the file size in megabytes.
Number of records	If the number of records is used to trigger changing files, specify the number of records.

**Note**

- (1) If changing files is not specified, the mdb file may reach 2 GB. If that happens, only the first 2 GB of data will be stored. Be sure to maintain the database so that a file size of 2 GB is not exceeded.
- (2) If changing files is specified, changing files may not be possible if the mdb file is opened by any other application.
- (3) If changing files is specified, the mdb file with previously stored data will be renamed according to the date/time format and a new mdb data storage file will be created. The name of the mdb file in which data is stored will not change even after the file is changed.

## Microsoft SQL Server

Select *Microsoft SQL Server* in the *Database type Field* in the EDMS Database Settings Dialog Box.

The items that can be set are listed below.

Item	Description
Name	Enter any desired name for the EDMS database settings.
Comments	Enter a description of the EDMS database. This field may be left blank.
Server name	Specify the name or IP address of the server running the Microsoft SQL Server database.

Item	Description
Database name	Enter the name of the Microsoft SQL Server database.
User name and Password	Enter the user name and password.

**Note** Windows authentication is not supported. Set the SQL Server's security settings to enable connection with SQL Server authentication.

**Oracle Database**

Select *Oracle Database* in the *Database type Field* in the EDMS Database Settings Dialog Box.

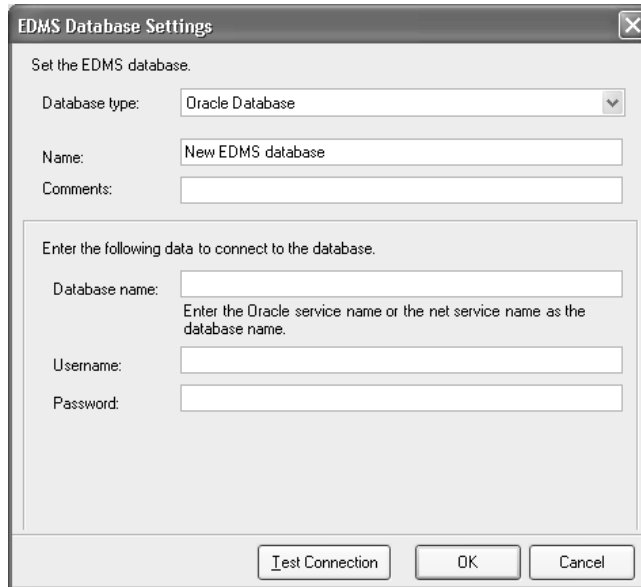

The items that can be set are listed below.

Item	Description
Name	Enter any desired name for the EDMS database settings.
Comments	Enter a description of the EDMS database. This field may be left blank.
Database name	Specify the Oracle database service name or the network service name.
User name and Password	Enter the user name and password.

**Note** When connecting to an Oracle database on a remote machine, install the Oracle client first and then set the network service.

## 4-4-2 Changing and Deleting EDMS Databases

Use the following procedure to change or delete EDMS database settings.

- 1,2,3... 1. Select a collection pattern setting file and display the Database Storage Setting Pane.

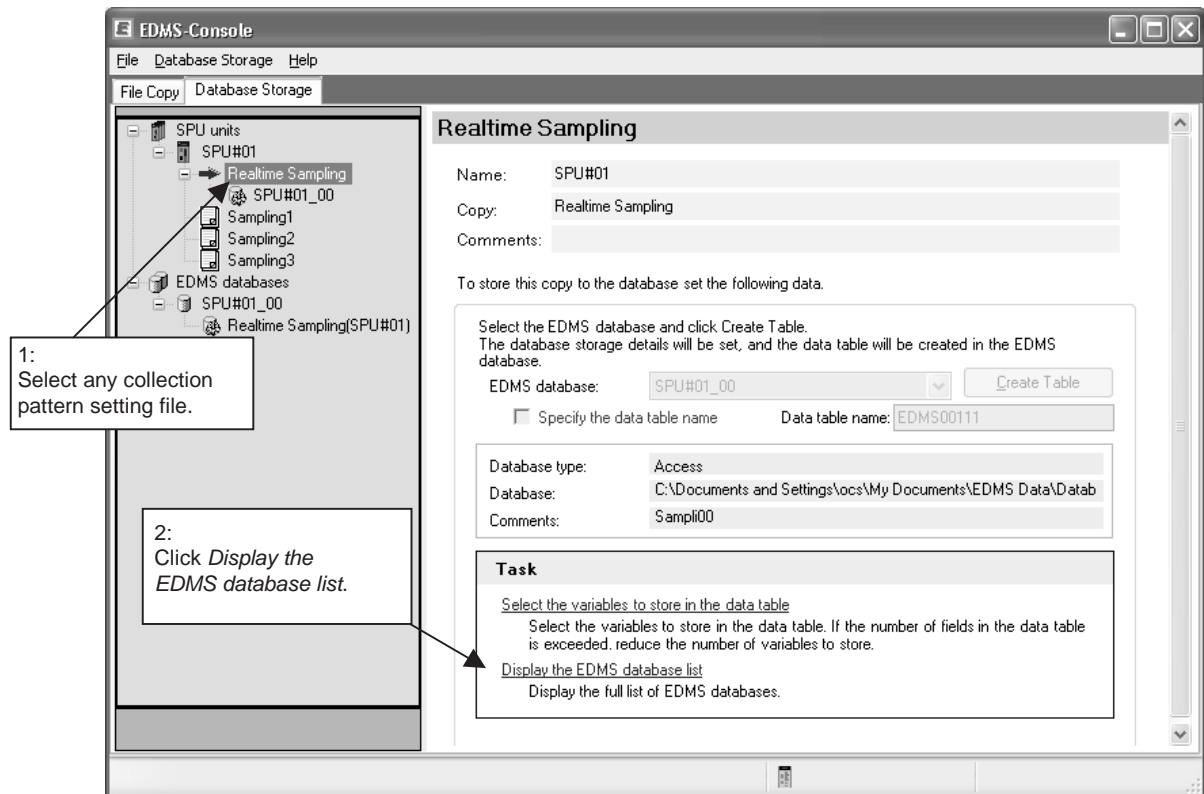

2. Click **Display the EDMS database list** or select **EDMS Database List** from the Database Storage Menu. The EDMS Database List Dialog Box will be displayed.

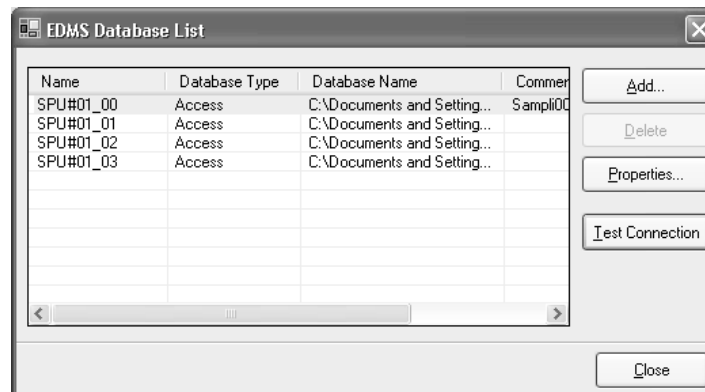

3. Select the EDMS database and click the **Properties** or **Delete** Button.

**Note** To delete or change the setting for an EDMS database, the database storage settings for the corresponding EDMS database must first be deleted. (Refer to *Tasks* under 4-3-2 *Starting Database Storage*.)

### 4-4-3 Confirming Connection to the Database

Use the following procedure to confirm that connection to the database is possible for the registered EDMS database settings.

- 1,2,3...**
1. Select the name of the database in the EDMS Database List Dialog Box.
  2. Click the **Test Connection** Button.  
The following dialog box will be displayed if the database is successfully connected to.

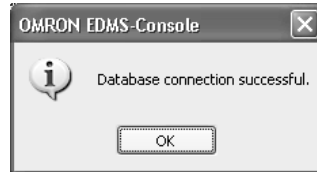

The following dialog box will be displayed if connection was not possible. Check the database structural settings.

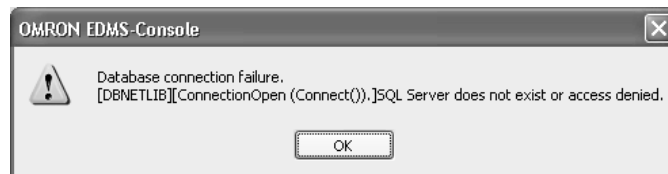

### 4-4-4 Selecting the Variable to Store in the Data Table

The variables that are stored in the data table can be specified. By default, all variables are set for storage in the data table.

- 1,2,3... 1. As shown below, select any collection pattern setting file and display the Database Storage Setting Pane.

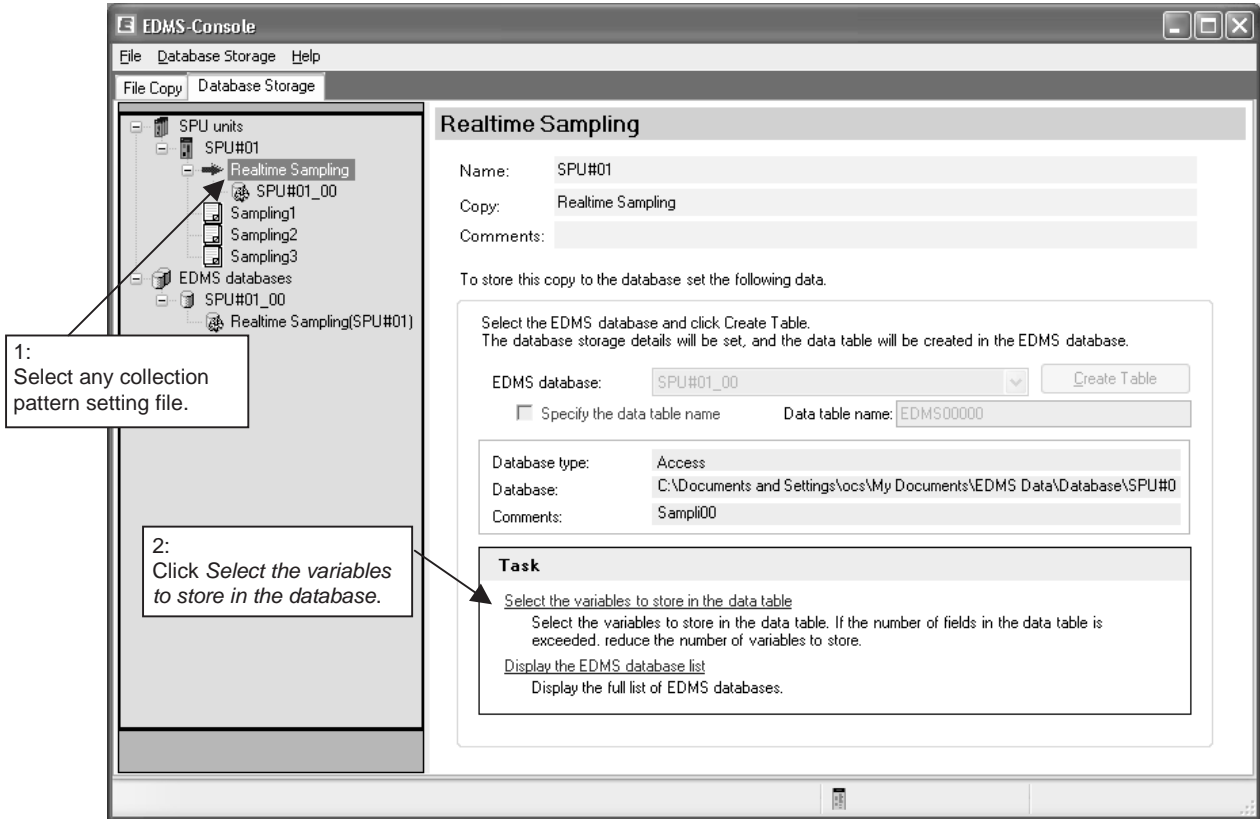

2. Click **Select the variables to store in the database.**  
The Select Variables Dialog Box will be displayed.

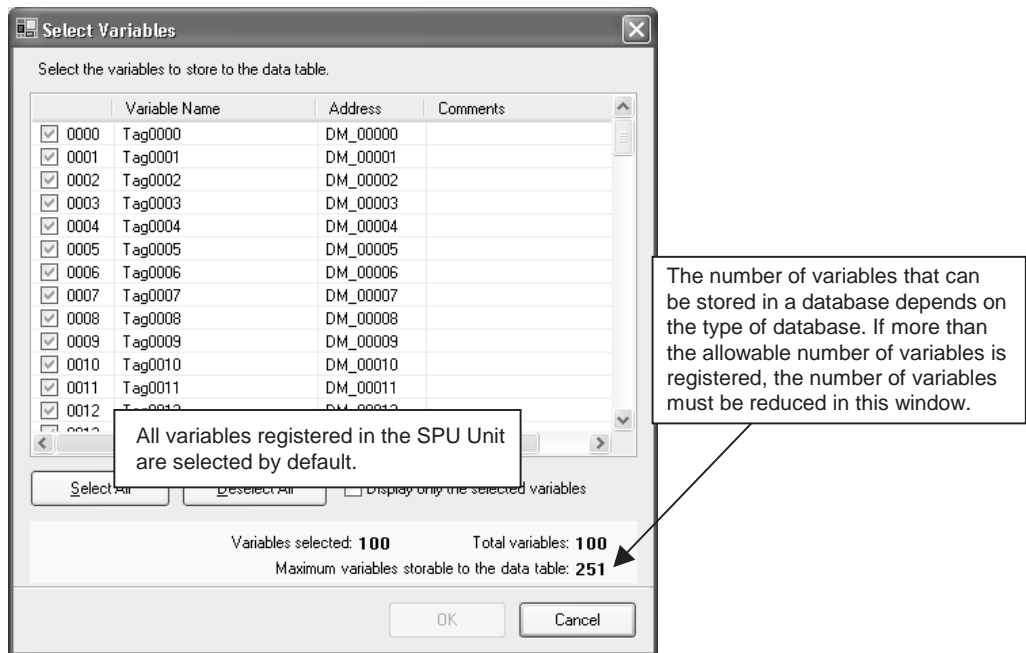



3. Select the variables to store in the database using the check boxes and then click the OK Button.

- Note**
- (1) There are limits to the number of variables that can be stored in a data table. The limit depends on the type of database being used.  
Microsoft Access: 251  
Microsoft SQL Server: 1,020  
Oracle Database: 996
  - (2) If the limit to the number of variable is exceeded, reduce the number using step 3, above.
  - (3) Even if the data table is deleted when deleting the database storage settings, the settings for the variables selected for storage in the database will not be deleted. Thus, if the data table is recreated, a data table with the same variables will be created.

### 4-4-5 Database Storage Settings Based on the EDMS Database

In the basic setting procedures in *4-3-1 Database Storage Settings*, setting methods were described so that the collection pattern setting file was selected and then the EDMS database into which the data was to be stored was set.

In the following procedure, the EDMS database is selected first and then the data to be copied into it is specified.

- 1,2,3... 1. Select the EDMS database on the Database Storage Tab Page. The following window will be displayed.

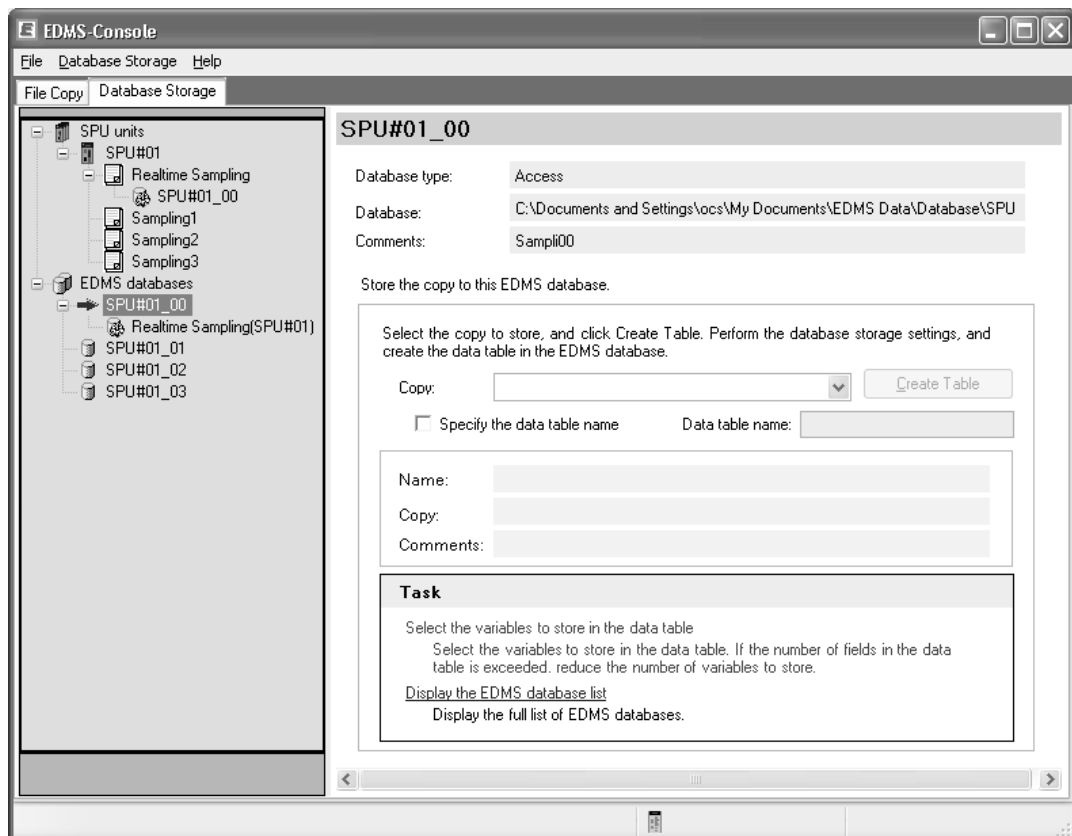

- Specify the collection pattern setting file in the *Copy* Field and then click the **Create Table** Button. The EDMS database tables will be created.

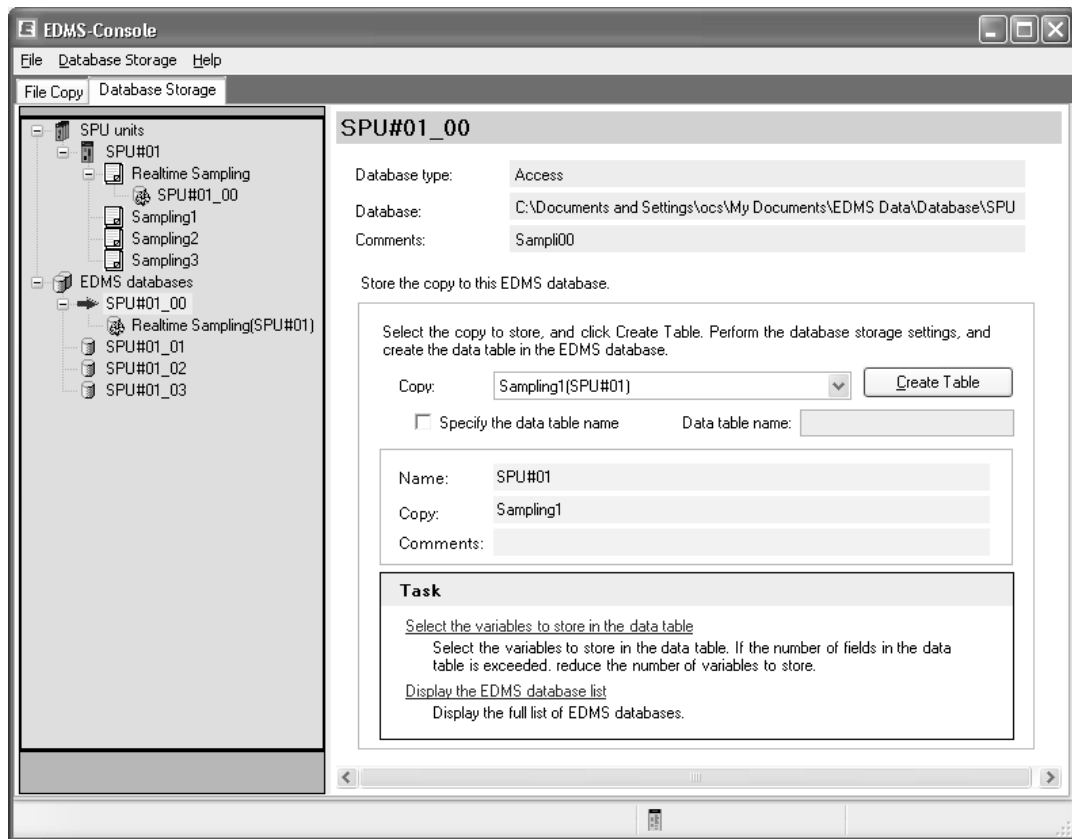

- The following dialog box will be displayed if the tables are created normally.



Click the **OK** Button.

## 4-5 Data Table Storage Operations

This section describes the procedure for storing data in a database.

### 4-5-1 Controlling Data Storage from a List

Database storage settings can be enabled or disabled and data storage can be stopped or started from a list of database storage setting files. These operations are possible for one or for more than one database storage setting files at the same time.

- 1,2,3...
1. Select the SPU Unit connected to the database on the Database Storage Tab Page. As shown below, a pane that enables controlling database storage for the databases set for the selected SPU Unit will be displayed.

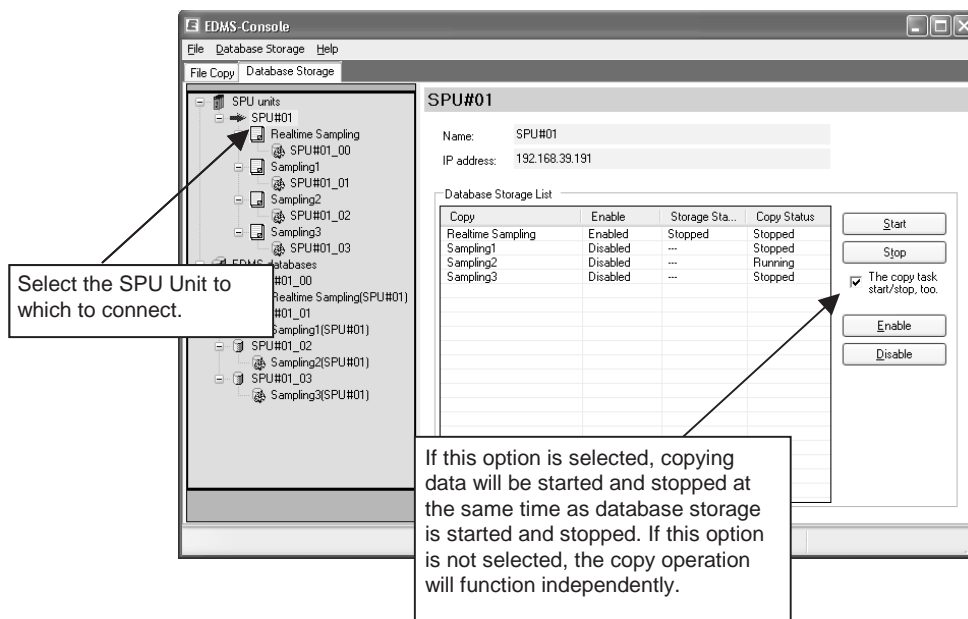

**Note** The *Database Storage List* Area shows the collection pattern setting files for which database storage has been set. To control data storage from this list, set up database storage first.

2. Select one or more collection pattern setting files in the list.
3. Click the **Start**, **Stop**, **Enable**, or **Disable** Button.

**Note** The **Start** and **Stop** Buttons can be used only for database storage settings that have been enabled. To use the **Start** and **Stop** Buttons, first click the **Enable** Button to enable the database storage settings.



# SECTION 5

## Troubleshooting and EDMS Capabilities

This section provides information on troubleshooting errors that can occur with the SPU Data Management Middleware and provides information on the capabilities of the SPU Data Management Middleware.

- 5-1 Troubleshooting ..... 52
  - 5-1-1 Troubleshooting the File Copy Function ..... 52
  - 5-1-2 Troubleshooting the Database Storage Function ..... 53
- 5-2 EDMS Capabilities ..... 54

## 5-1 Troubleshooting

### 5-1-1 Troubleshooting the File Copy Function

All errors that occur while using the file copying function are logged. The cause of the error can sometimes be determined by checking the log. Refer to 3-2-9 *Checking the Log* for details on the checking procedure.

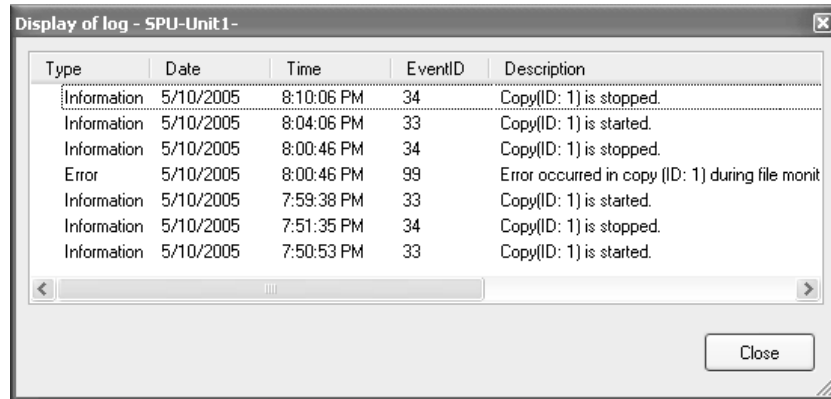

The following table lists the most common errors, probable cause, and required corrective action.

Event ID	Description	Probable cause	Corrective action
85	Available hard disk space below *	An insufficient amount of hard disk space is available.	Delete unnecessary files and make sure there is sufficient space available for copied files.
97 101	Initialization failed Incorrect copy setting	The SPU Unit power supply is turned OFF.	Turn ON the SPU Unit power supply.
		Network interference	Check the cables, hub, and other connections and make sure that the network is free of interference.
		SPU Unit collection settings do not match copy settings.	Click the <b>Load setting</b> Button to reload the SPU Unit settings and then enter the copy settings.
		The <i>Enable the User Authorization</i> Option is selected in the Unit settings.	Clear the selection.
99	Error occurred while monitoring files	The SPU Unit power supply is turned OFF.	Turn ON the SPU Unit power supply.
		Network interference	Check the cables, hub, and other connections and make sure that the network is free of interference.
		Files can no longer be copied from the SPU Unit because settings or some other factor has changed.	Stop copying files and then change the SPU Unit settings.
100	Copying failed	Insufficient space available on the hard disk.	Delete unnecessary files and make sure there is sufficient space available for copied files.
102	Lost file(s)	The number of files for data collection is set to 2.	Increase the setting in the <i>Number of files</i> Field from the Collection Setting Panel of the SPU-Console.
		Unit monitoring cycle is too long.	Shorten the unit monitoring cycle from the Advanced Setting Window.

### 5-1-2 Troubleshooting the Database Storage Function

All errors that occur while using the database storage function are logged. The cause of the error can sometimes be determined by checking the log. Refer to 3-2-9 *Checking the Log* for details on the checking procedure.

The main errors that can occur, the assumed causes, and the required corrections are listed in the following table.

Error message	Assumed cause	Correction
Data conversion failure.	The data type of the variable set with the SPU-Console is different from the actual data type in the PLC.	Correct the data type of the variable with the SPU-Console. Then use the EDMS-Console to delete the database storage settings and then recreate the table.
	The data type of a variable being collected by the SPU-Console has been changed and no longer agrees with the data type in the database.	Use the EDMS-Console to delete the database storage settings and then recreate the table.
	A variable for collection has been deleted or added with the SPU-Console, so the number of CSV file fields does not agree with the number of database fields.	
Database storage failure	The database is not started.	Start the database and then start data storage.
	If the database is connected remotely, then there may be a network problem preventing a connection to the database.	Correct the problem with the network and then start data storage.
	There is some problem with the database that is causing errors when storing data.	Correct the problem with the database and then start data storage.
Cannot open CSV file.	An application, such as Excel, is using the CSV file, preventing it being opened for database storage.	Close the CSV file.

**Note** Data is stored in the error log as follows:  
Date, time, error number, service name, data source name, block name, error details.

- The service name, data source name, and block name will tell you the data storage service in which the error occurred.
- The error details include the cause of the error, what record the error occurred in, and other details. The error details that are actually recorded depend on the error that occurs.

## 5-2 EDMS Capabilities

The copying and database storage capabilities of the EDMS are affected by the following factors.

- Operating Environment  
The operating environment includes the capabilities of the computer, network, database, and other factors.
- Load on the SPU Unit  
The load on the SPU Unit includes the SPU Unit cycle time, the number of variables being sampled, the collection patterns being used, etc.
- Unit Monitoring Cycle and Number of Copies Made

The copying and database storage performance of the EDMS is not limited by any specific restrictions for these factors. We assume, however, that you will test the application before actual implementation to confirm that the required capabilities can be provided by the actual system to be used. We recommend that you completely test all of the above factors and suitably set up the system to achieve the required performance.

Some examples of actual trials that can be performed are given below.

### **Copying and Database Storage with a Short Cycle without Losing Data**

Set the SPU Unit as follows:

- Increase the number of files.
- Decrease the number of collection patterns.
- Decrease the number of variables stored as data.

Decrease the number of copies.

### **Copying Large Quantities of Data**

Set the SPU Unit as follows:

- Increase the number of files.
- Increase the cycle times for collection patterns.
- Decrease the number of variables stored as data.

Increase the Unit monitoring time.



## Revision History

A manual revision code appears as a suffix to the catalog number on the front cover of the manual.

Cat. No. V232-E1-03

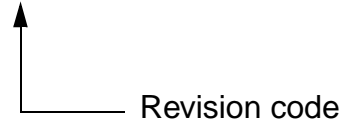

The following table outlines the changes made to the manual during each revision. Page numbers refer to the previous version.

Revision code	Date	Revised content
01	June 2005	Original production
02	June 2006	Changes and additions for version 2.0.
03	August 2013	Changes and additions for compatibility with Windows 7 and Windows 8.





**OMRON Corporation Industrial Automation Company**  
Tokyo, JAPAN

Contact: [www.ia.omron.com](http://www.ia.omron.com)

**Regional Headquarters**

**OMRON EUROPE B.V.**

Wegalaan 67-69-2132 JD Hoofddorp  
The Netherlands

Tel: (31)2356-81-300/Fax: (31)2356-81-388

**OMRON ELECTRONICS LLC**

One Commerce Drive Schaumburg,  
IL 60173-5302 U.S.A.

Tel: (1) 847-843-7900/Fax: (1) 847-843-7787

**OMRON ASIA PACIFIC PTE. LTD.**

No. 438A Alexandra Road # 05-05/08 (Lobby 2),  
Alexandra Technopark,  
Singapore 119967

Tel: (65) 6835-3011/Fax: (65) 6835-2711

**OMRON (CHINA) CO., LTD.**

Room 2211, Bank of China Tower,  
200 Yin Cheng Zhong Road,  
PuDong New Area, Shanghai, 200120, China

Tel: (86) 21-5037-2222/Fax: (86) 21-5037-2200

**Authorized Distributor:**

© OMRON Corporation 2005 All Rights Reserved.  
In the interest of product improvement,  
specifications are subject to change without notice.

**Cat. No. V232-E1-03**

0813