



Smarter. Greener. Together.

Industrial Automation Headquarters

Delta Electronics, Inc.

Taoyuan Technology Center
No.18, Xinglong Rd., Taoyuan City,
Taoyuan County 33068, Taiwan
TEL: 886-3-362-6301 / FAX: 886-3-371-6301

Asia

Delta Electronics (Jiangsu) Ltd.

Wujiang Plant 3
1688 Jiangxing East Road,
Wujiang Economic Development Zone
Wujiang City, Jiang Su Province,
People's Republic of China (Post code: 215200)
TEL: 86-512-6340-3008 / FAX: 86-769-6340-7290

Delta Greentech (China) Co., Ltd.

238 Min-Xia Road, Pudong District,
ShangHai, P.R.C.
Post code : 201209
TEL: 86-21-58635678 / FAX: 86-21-58630003

Delta Electronics (Japan), Inc.

Tokyo Office
2-1-14 Minato-ku Shibadaimon,
Tokyo 105-0012, Japan
TEL: 81-3-5733-1111 / FAX: 81-3-5733-1211

Delta Electronics (Korea), Inc.

1511, Byucksan Digital Valley 6-cha, Gasan-dong,
Geumcheon-gu, Seoul, Korea, 153-704
TEL: 82-2-515-5303 / FAX: 82-2-515-5302

Delta Electronics Int'l (S) Pte Ltd

4 Kaki Bukit Ave 1, #05-05, Singapore 417939
TEL: 65-6747-5155 / FAX: 65-6744-9228

Delta Electronics (India) Pvt. Ltd.

Plot No 43 Sector 35, HSIIIDC
Gurgaon, PIN 122001, Haryana, India
TEL : 91-124-4874900 / FAX : 91-124-4874945

Americas

Delta Products Corporation (USA)

Raleigh Office
P.O. Box 12173, 5101 Davis Drive,
Research Triangle Park, NC 27709, U.S.A.
TEL: 1-919-767-3800 / FAX: 1-919-767-8080

Delta Greentech (Brasil) S.A

Sao Paulo Office
Rua Itapeva, 26 - 3º andar Edificio Itapeva One-Bela Vista
01332-000-São Paulo-SP-Brazil
TEL: +55 11 3568-3855 / FAX: +55 11 3568-3865

Europe

Delta Electronics (Netherlands) B.V.

Eindhoven Office
De Witbogt 20, 5652 AG Eindhoven, The Netherlands
TEL: 31-40-2592850 / FAX: 31-40-2592851

*We reserve the right to change the information in this catalogue without prior notice.

5012611200
2015-11



CTE0

Delta Textile Vector Control Drive CT2000 Series User Manual



Delta Textile Vector Control Drive CT2000 Series User Manual



www.deltaww.com



PLEASE READ PRIOR TO INSTALLATION FOR SAFETY.



- ☑ AC input power must be disconnected before any wiring to the AC motor drive is made.
- ☑ Even if the power has been turned off, a charge may still remain in the DC-link capacitors with hazardous voltages before the POWER LED is OFF. Please do not touch the internal circuit and components.
- ☑ There are highly sensitive MOS components on the printed circuit boards. These components are especially sensitive to static electricity. Please do not touch these components or the circuit boards before taking anti-static measures. Never reassemble internal components or wiring.
- ☑ Ground the AC motor drive using the ground terminal. The grounding method must comply with the laws of the country where the AC motor drive is to be installed.
- ☑ DO NOT install the AC motor drive in a place subjected to high temperature, direct sunlight and inflammables.



- ☑ Never connect the AC motor drive output terminals U/T1, V/T2 and W/T3 directly to the AC mains circuit power supply.
- ☑ Only qualified persons are allowed to install, wire and maintain the AC motor drives.
- ☑ Even if the 3-phase AC motor is stop, a charge may still remain in the main circuit terminals of the AC motor drive with hazardous voltages.
- ☑ If the AC motor drive is stored in no charge condition for more than 3 months, the ambient temperature should not be higher than 30 °C. Storage longer than one year is not recommended, it could result in the degradation of the electrolytic capacitors.
- ☑ The performance of electrolytic capacitor will degrade if it is not charged for a long time. It is recommended to charge the drive which is stored in no charge condition every 2 years for 3~4 hours. NOTE: When the AC motor drive is in charge condition, it should supply 70~80% of rated voltage by using variable AC power (ex. AC autotransformer) for 30 minutes first (don't operate it), and then provide rated voltage for 1 hour (still don't operate it), to make electrolytic capacitor revive and start operating. Do not provide rated voltage to operate the drive directly.
- ☑ Pay attention to the following when transporting and installing this package (including wooden crate, wood stave and carton box)
 1. If you need to sterilize, deworm the wooden crate or carton box, please do not use steamed smoking sterilization or you will damage the VFD.
 2. Please use other ways to sterilize or deworm.
 3. You may use high temperature to sterilize or deworm. Leave the packaging materials in an environment of over 56°C for 30 minutes.
 4. It is strictly forbidden to use steamed smoking sterilization. The warranty does not covered VFD damaged by steamed smoking sterilization.
- ☑ Type of electrical supply system (3WYE) to which the drive shall be connected.

 **NOTE**

The content of this manual may be revised without prior notice. Please consult our distributors or download the most updated version at <http://www.deltaww.com/services/DownloadCenter2.aspx?seclD=8&pid=2&tid=0&itemID=&typeID=1&downloadID=&title=&dataType=&check=0&hl=en-US&CID=06>

Table of Contents

Chapter 1 Introduction	1-1
Chapter 2 Installation	2-1
Chapter 3 Unpacking	3-1
Chapter 4 Wiring.....	4-1
Chapter 5 Main Circuit Terminals	5-1
Chapter 6 Control Terminals	6-1
Chapter 7 Optional Accessories.....	7-1
Chapter 8 Option Cards.....	8-1
Chapter 9 Specification.....	9-1
Chapter 10 Digital Keypad.....	10-1
Chapter 11 Summary of Parameters	11-1
Chapter 12 Descriptions of Parameter Settings.....	12-1
Chapter 13 Warning Codes	13-1
Chapter 14 Fault Codes and Descriptions	14-1
Chapter 15 CANopen Overview.....	15-1
Chapter 16 PLC Function	16-1
Chapter 17 How to Select the Right AC Motor Drive	17-1
Chapter 18 Suggestions and Error Corrections for Standard AC Motor Drives.....	18-1
Chapter 19 EMC Standard Installation Guide.....	19-1
Appendix A. Publication History.....	A-1

Application

Control Board: V1.3
Keypad: V1.10

Chapter 1 Introduction

Receiving and Inspection

After receiving the AC motor drive, please check for the following:

1. Please inspect the unit after unpacking to assure it was not damaged during shipment. Make sure that the part number printed on the package corresponds with the part number indicated on the nameplate.
2. Make sure that the voltage for the wiring lie within the range as indicated on the nameplate. Please install the AC motor drive according to this manual.
3. Before applying the power, please make sure that all the devices, including power, motor, control board and digital keypad, are connected correctly.
4. When wiring the AC motor drive, please make sure that the wiring of input terminals “R/L1, S/L2, T/L3” and output terminals “U/T1, V/T2, W/T3” are correct to prevent drive damage.
5. When power is applied, select the language and set parameter groups via the digital keypad (KPC-CC01). When executes trial run, please begin with a low speed and then gradually increases the speed until the desired speed is reached.

Nameplate Information

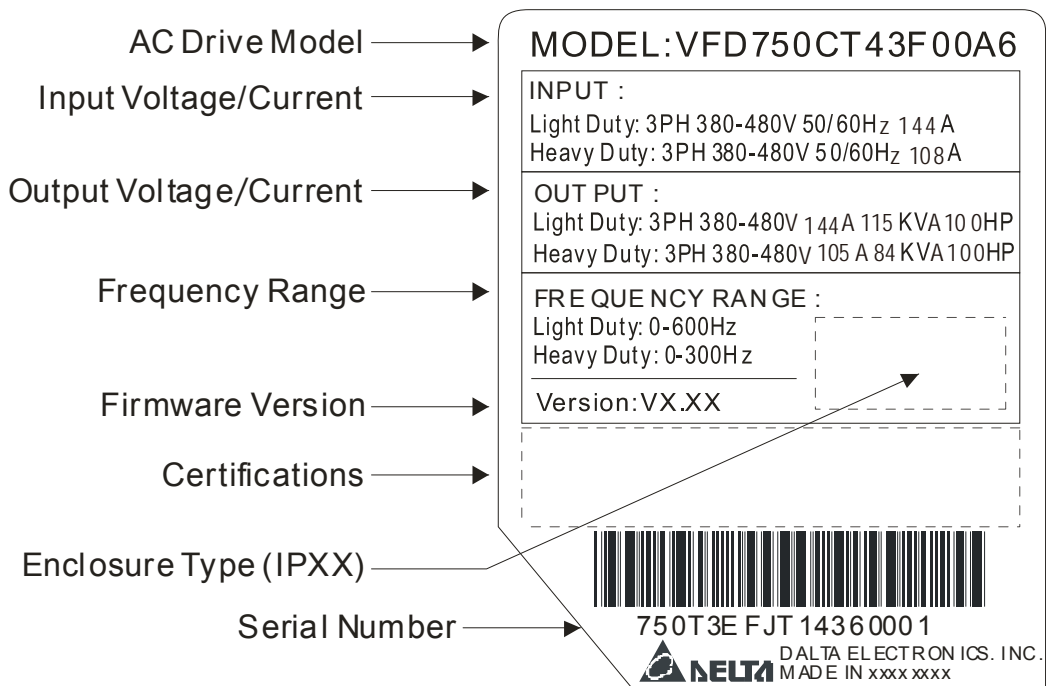

Model Name

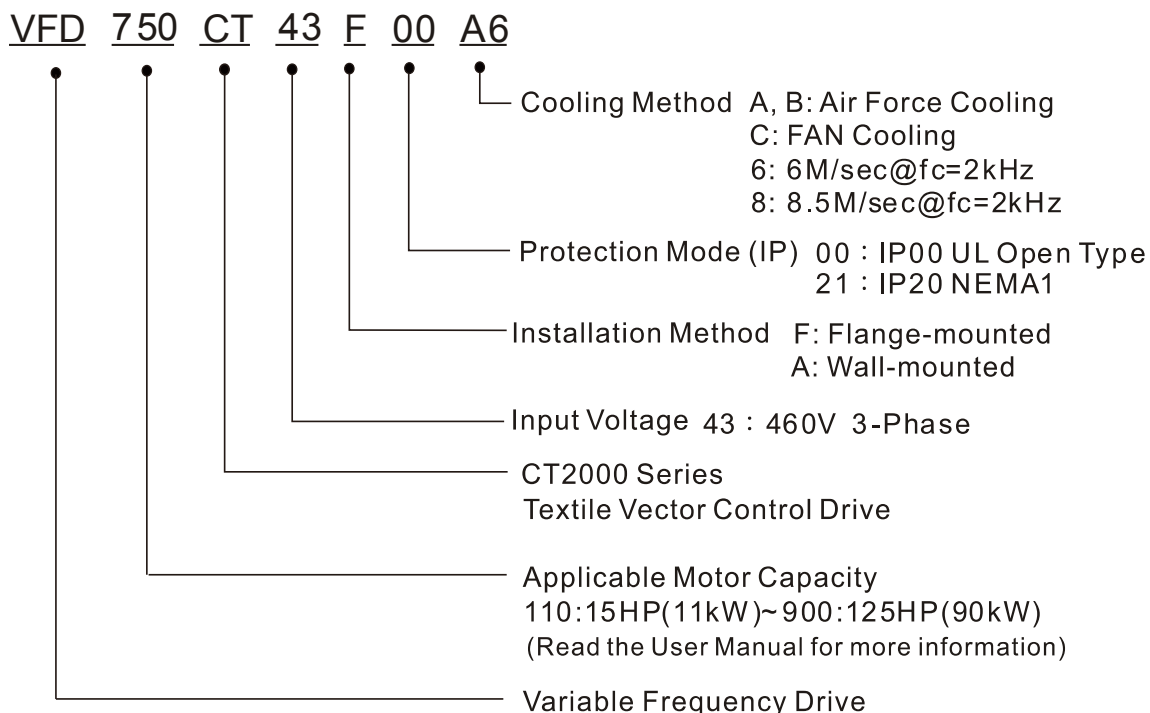

Serial Number

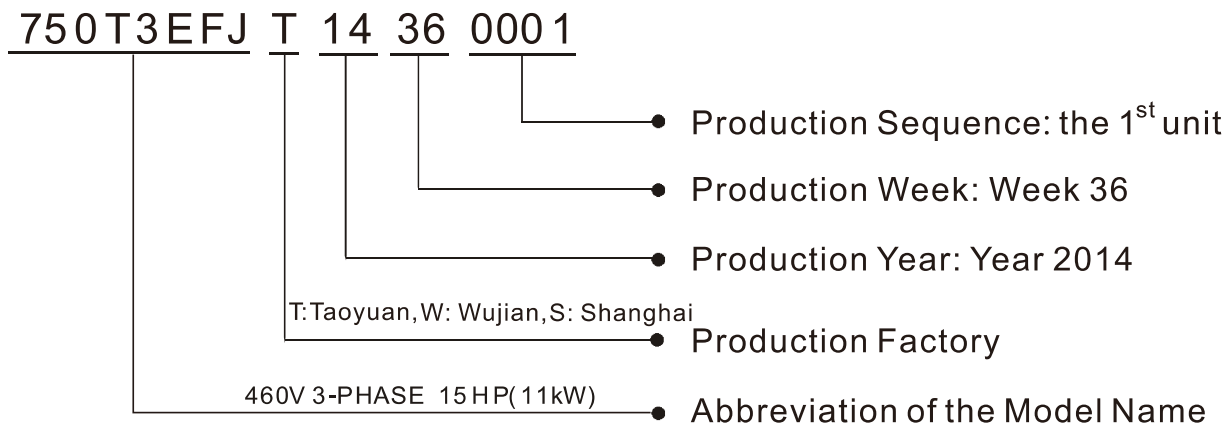

RFI Jumper

RFI Jumper: The AC motor drive may emit the electrical noise. The RFI jumper can enable internal filter to suppress the interference (Radio Frequency Interference) on the power line.

Frame B~C Screw Torque: 8~10kg-cm(6.9-8.7 lb -in.)

Loosen the screws and remove the RFI jumper. Fasten the screws back to the original position after RFI jumper is removed.

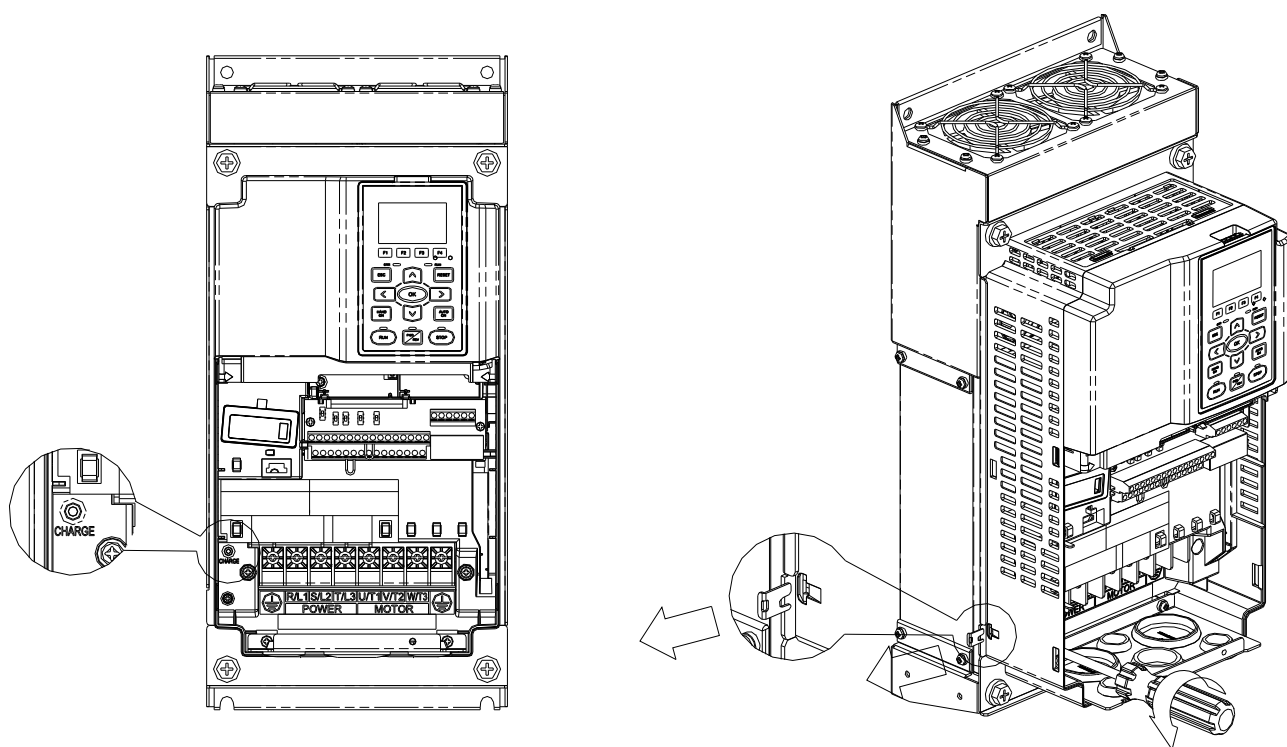

Frame D

Remove the RFI jumper by hands, no screws need to be loosen.

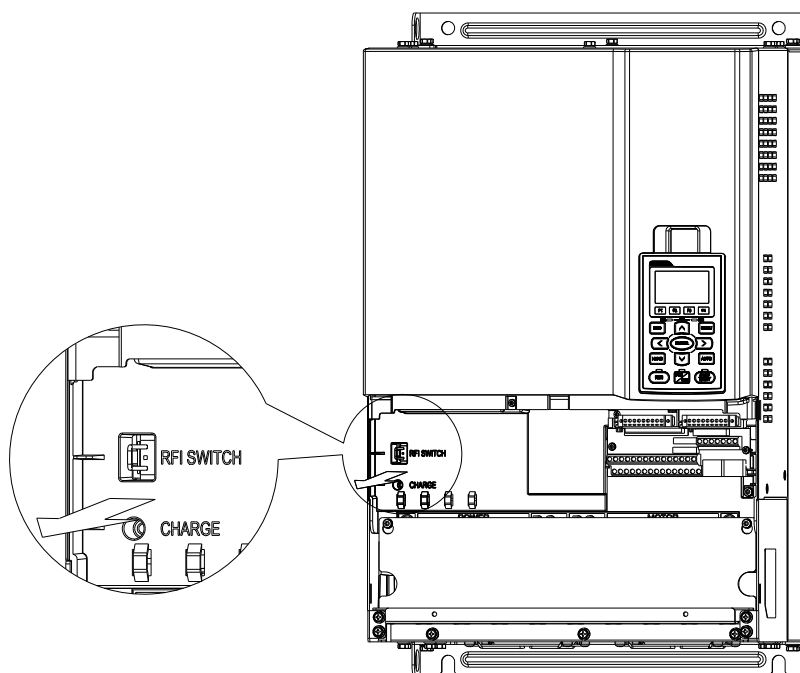

Main power isolated from earth:

When the power distribution system of the AC motor drive is a floating ground system (IT) or an asymmetric ground system (TN), the RFI jumper must be removed. After removing RFI jumper, cuts off the internal RFI capacitor (filter capacitor) between the system's frame and the central circuits to avoid damaging the central circuits and (according to IEC 61800-3) reduce the ground leakage current.

Important points regarding ground connection

- ☑ To ensure the safety of personnel, proper operation, and to reduce electromagnetic radiation, the AC motor drive must be properly grounded during installation.
- ☑ The diameter of the cables must meet the size specified by safety regulations.
- ☑ The earthing cable must be connected to the ground of the AC motor drive to meet safety regulations.
- ☑ The earthing cable can only be used as the ground for equipment when the aforementioned points are met.
- ☑ When installing multiple sets of AC motor drive, do not connect the grounds of the AC motor drive in series. As shown below

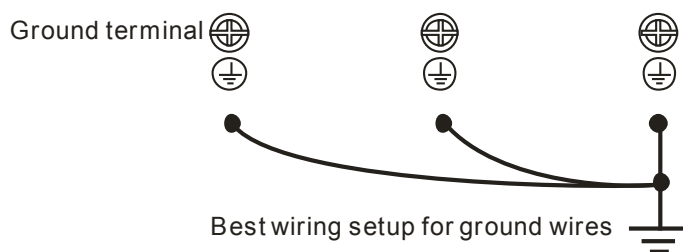

Pay particular attention to the following points:

- ☑ After turning on the main power, do not remove the RFI jumper while the power is on.
- ☑ Make sure the main power is turned off before removing the RFI jumper.
- ☑ Removing the RFI jumper will also cut off the conductivity of the capacitor. Gap discharge may occur once the transient voltage exceeds 1000V.

If the RFI jumper is removed, there will no longer be reliable electrical isolation. In other words, all controlled input and outputs can only be seen as low-voltage terminals with basic electrical isolation. Also, when the internal RFI capacitor is cut off, the AC motor drive will no longer be electromagnetic compatible.

- ☑ The RFI jumper may not be removed if the main power is a grounded power system.
- ☑ The RFI jumper may not be removed while conducting high voltage tests. When conducting a high voltage test to the entire facility, the main power and the motor must be disconnected if leakage current is too high.

Floating Ground System(IT Systems)

A floating ground system is also called IT system, ungrounded system, or high impedance/resistance (greater than 30Ω) grounding system.

- ☑ Disconnect the ground cable from the internal EMC filter.
- ☑ In situations where EMC is required, check whether there is excess electromagnetic radiation affecting nearby low-voltage circuits. In some situations, the adapter and cable naturally provide

enough suppression. If in doubt, install an extra electrostatic shielded cable on the power supply side between the main circuit and the control terminals to increase security.

- ☑ Do not install an external RFI/EMC filter, the EMC filter will pass through a filter capacitor, thus connecting power input to ground. This is very dangerous and can easily damage the AC motor drive.

Asymmetric Ground System(Corner Grounded TN Systems)

- ☑ Caution: Do not cut the RFI jumper while the input terminal of the AC motor drive carries power.
- ☑ In the following four situations, the RFI jumper must be removed. This is to prevent the system from grounding through the RFI capacitor, damaging the AC motor drive.

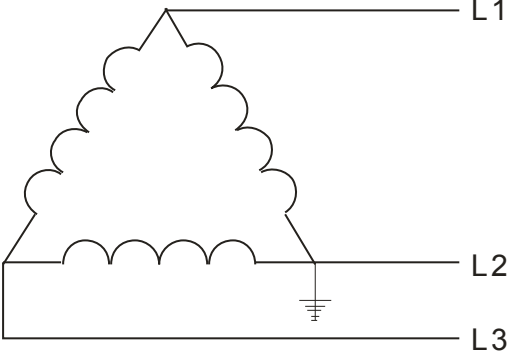
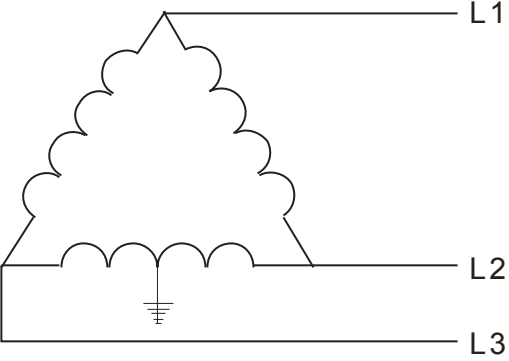
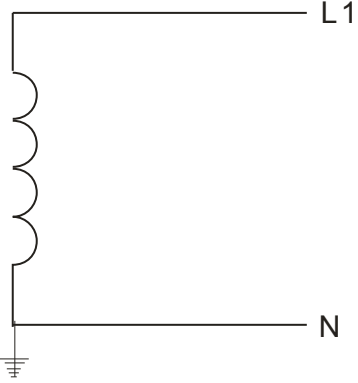
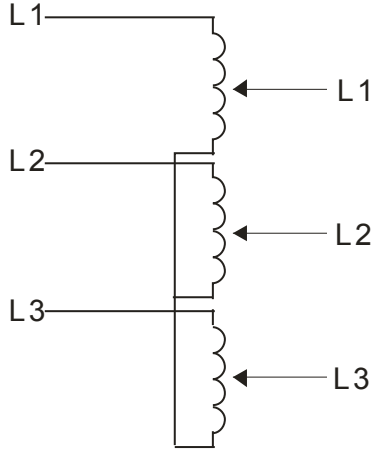
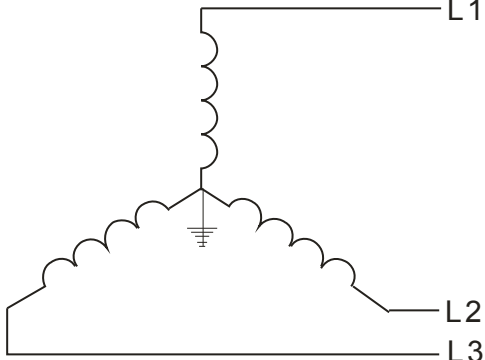
RFI jumper must be removed	
<p>1 Grounding at a corner in a triangle configuration</p> 	<p>2 Grounding at a midpoint in a polygonal configuration</p> 
<p>3 Grounding at one end in a single-phase configuration</p> 	<p>4 No stable neutral grounding in a three-phase autotransformer configuration</p> 
RFI jumper can be used	
<p>Internal grounding through internal RFI filter, which reduces electromagnetic radiation. In a situation with higher requirements for electromagnetic compatibility, and using a symmetrical grounding power system, an EMC filter can be installed. As a reference, the diagram on the right is a symmetrical grounding power system.</p>	

Fan Extension Slot

Backup one or two empty DC power plugs for users to install cooling fans when necessary.

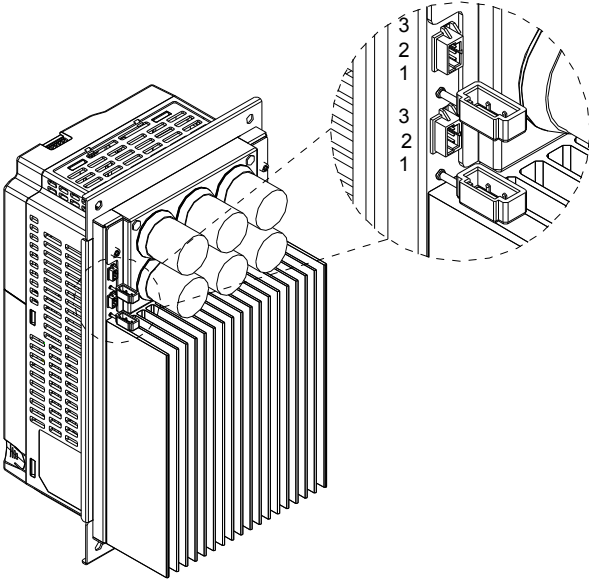
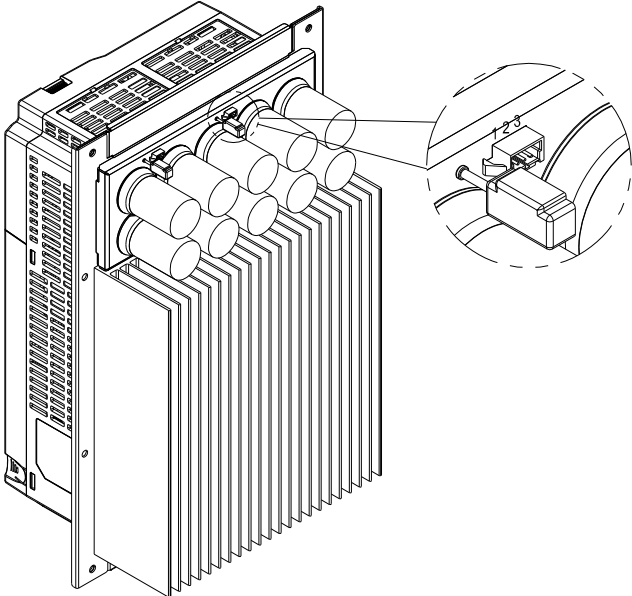
<p>Frame B</p> <p>Electrical Specification: 24Vdc, 0.51A(Max. Current)</p> <p>Cooling Fan's Adaptor: JWT A2007 Series</p> <p>PIN Definition</p> <ul style="list-style-type: none">PIN 1: -PIN 2: ReservedPIN 3: +	<p>Air Force Cooling (New)</p> 
<p>Frame C</p> <p>Electrical Specification: 24Vdc, 0.75A (Single set's Max. Current)</p> <p>Cooling Fan's Adaptor: JWT A2007 Series</p> <p>PIN Definition:</p> <ul style="list-style-type: none">PIN 1: -PIN 2: ReservedPIN 3: +	<p>Air Force Cooling (New)</p> 

Frame D

Electrical Specification: 24Vdc, 1A
(Single set's Max. Current)

Cooling Fan's Adaptor: JWT A2007 Series
A2007T0P-00(gilding), applicable: 26~28AWG

PIN Definition

- PIN 1: -
- PIN 2: Reserved
- PIN 3: +

Air Force Cooling

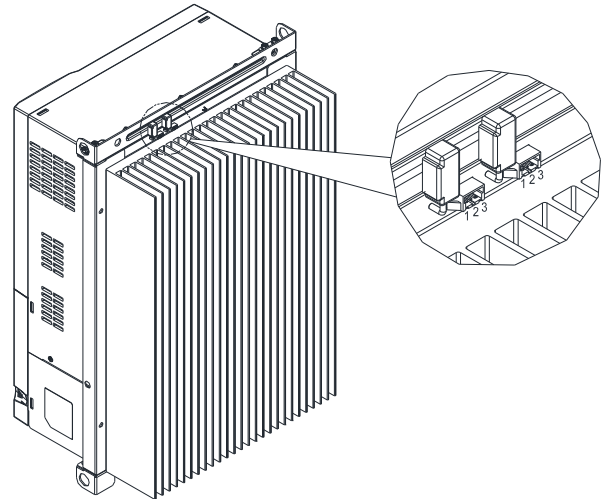

Air Force Cooling (New)

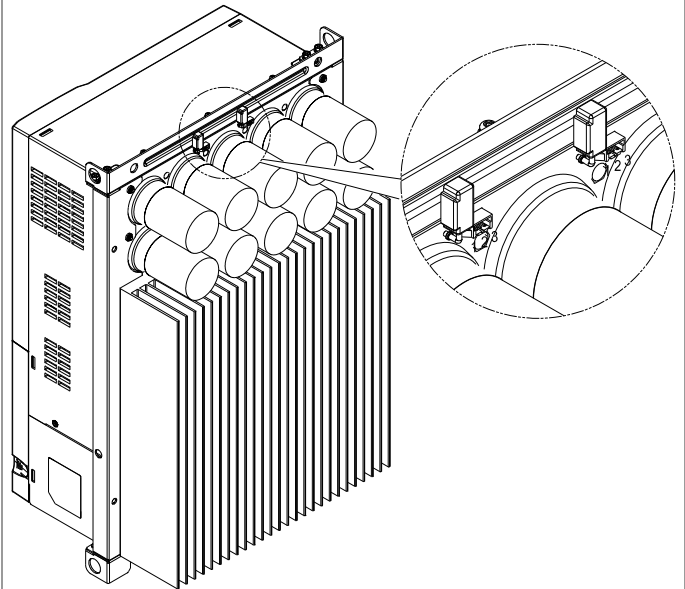

Flange Mounting Kit

Frame B

Screw Torque:

40kg-cm(34.7 lb-in.)

Air Force Cooling (New)

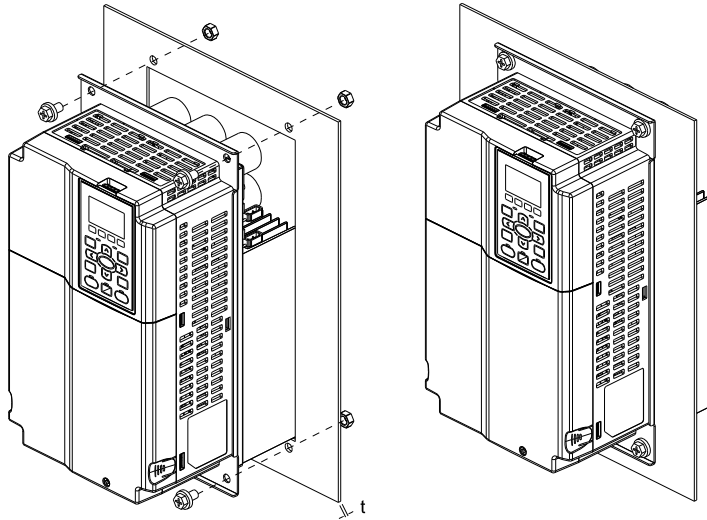

Frame C

Screw Torque:

40kg-cm(34.7 lb-in.)

Air Force Cooling (New)

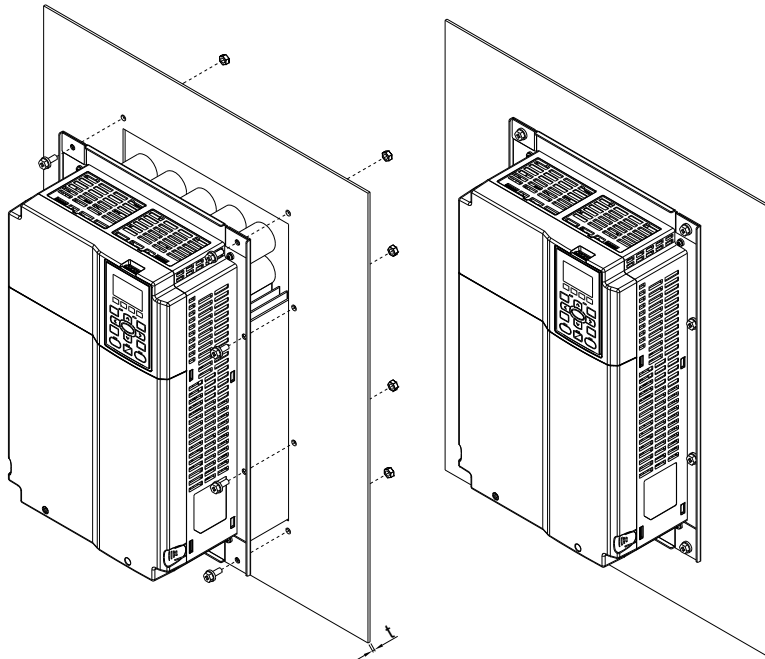

Frame D

M6 Screw Torque:

40kg-cm(34.7 lb-in.)

M10 Screw Torque:

200 kg-cm(173.4 lb-in.)

Air Force Cooling

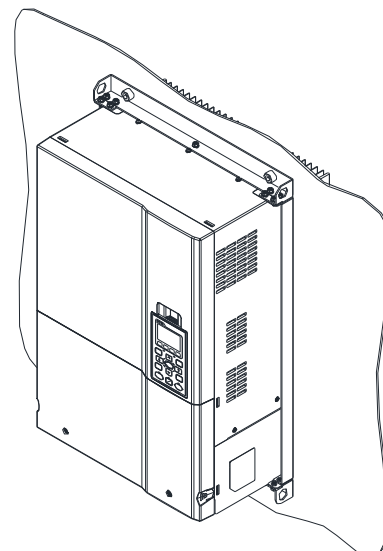
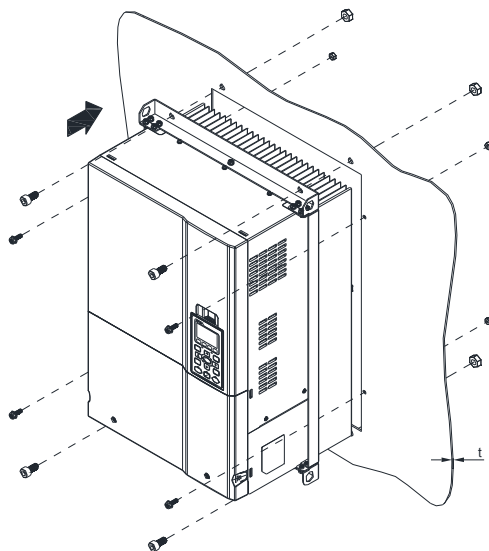

Air Force Cooling (New)

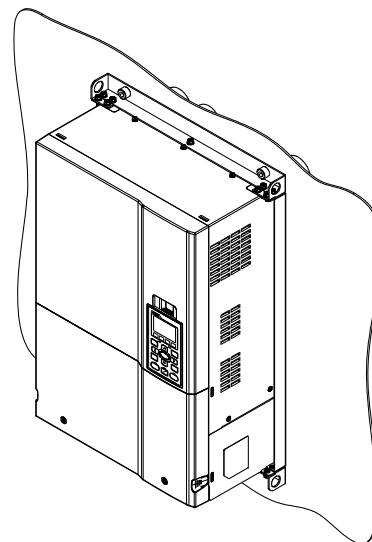
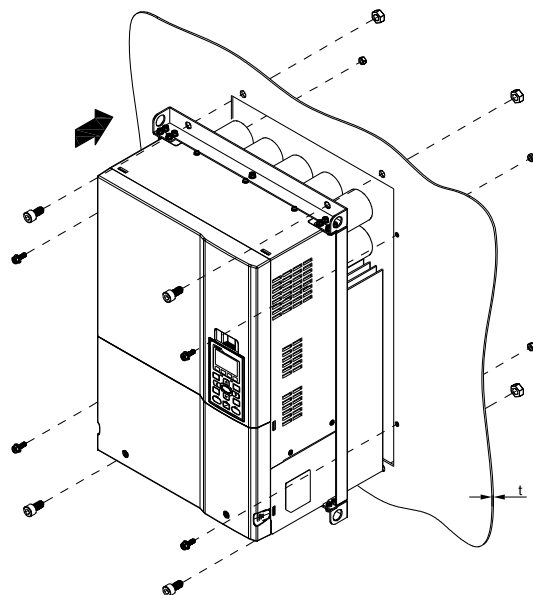

Cutout Dimensions

Frame B

Flange mounted models

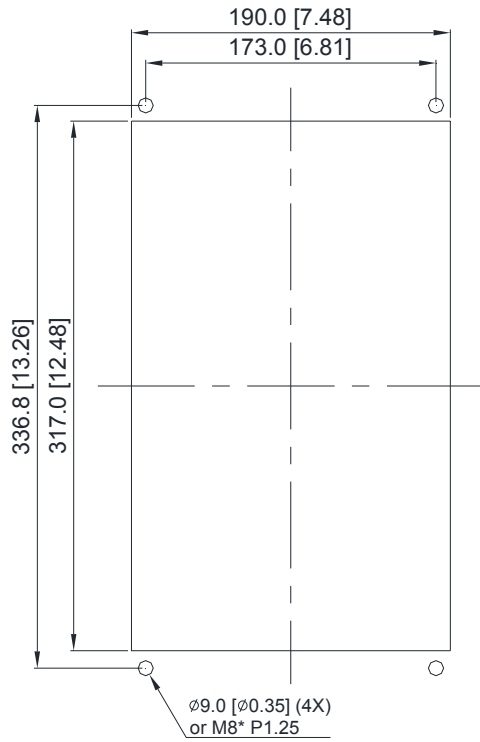

Wall-mounted models

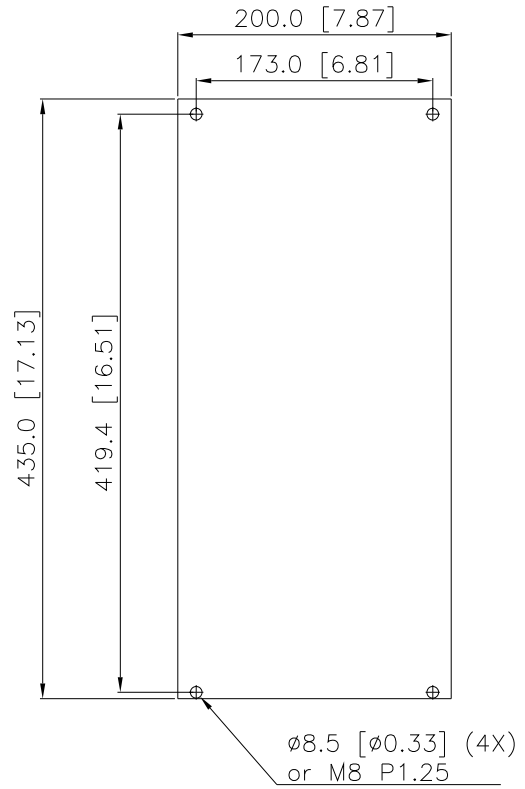

Frame C

Flange mounted models

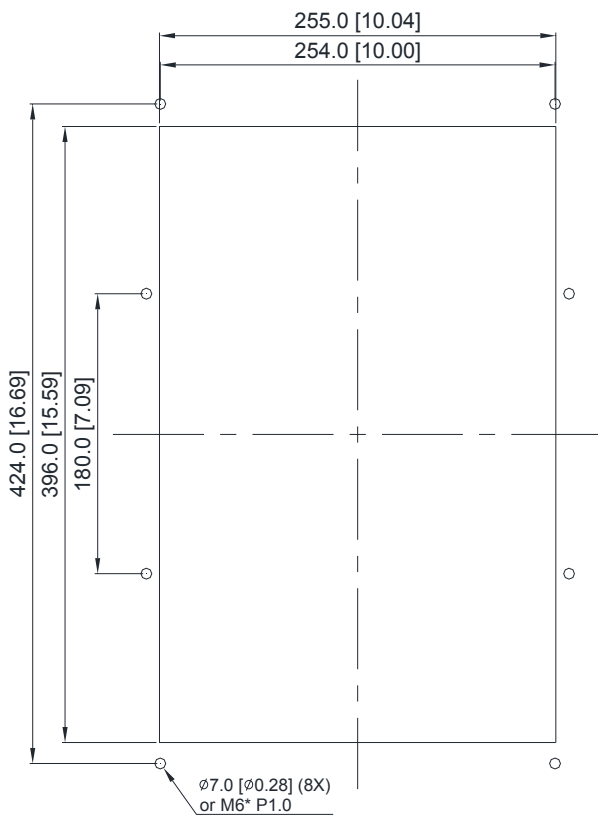

Wall-mounted models

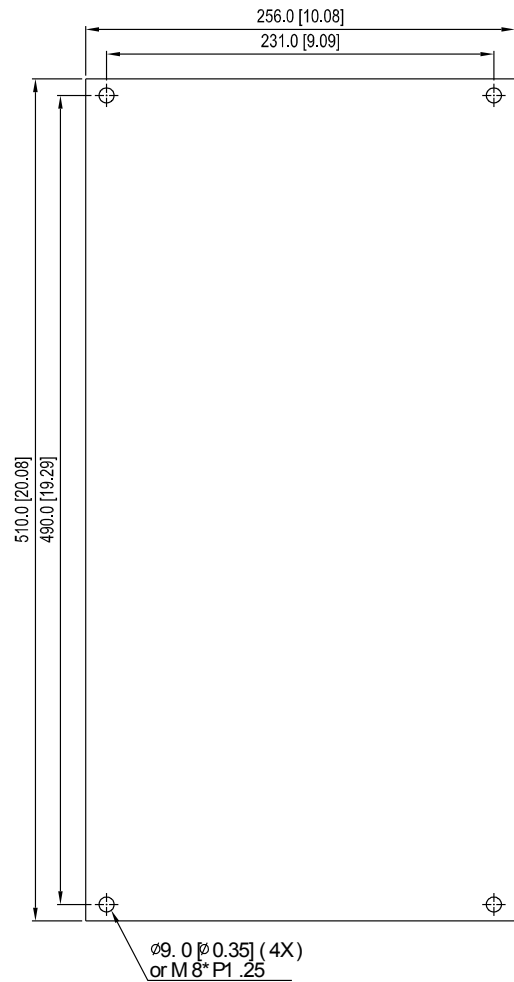

Frame D

Flange mounted models

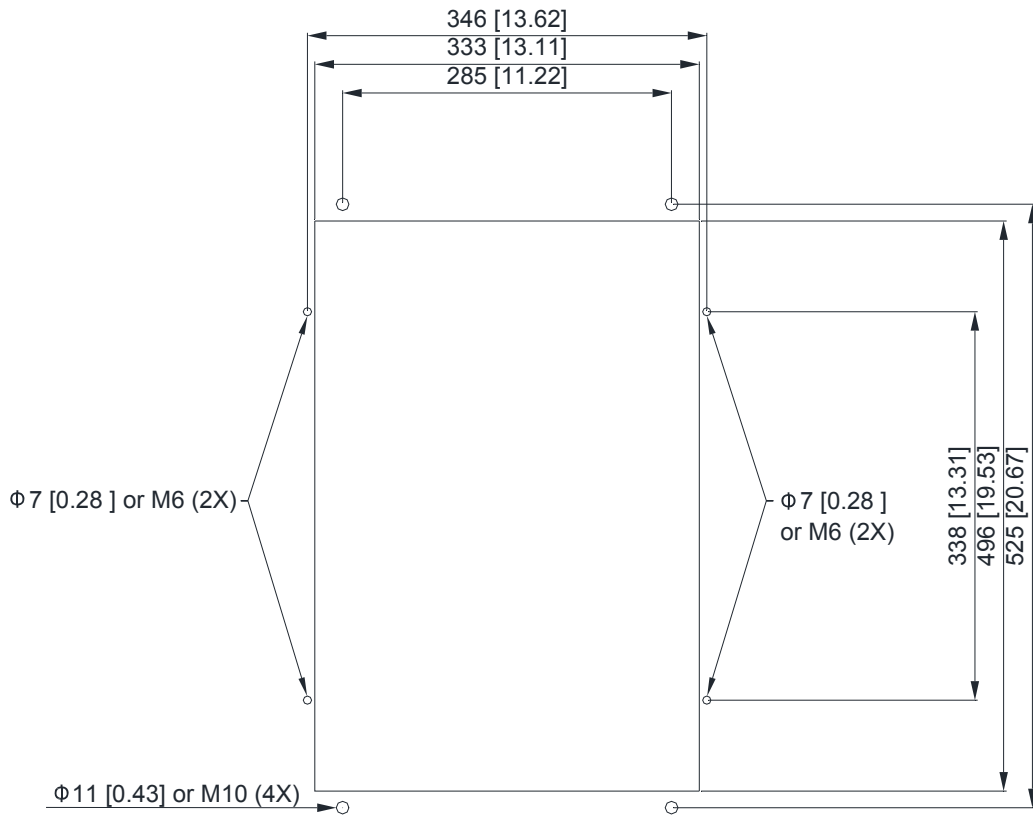

Wall-mounted models

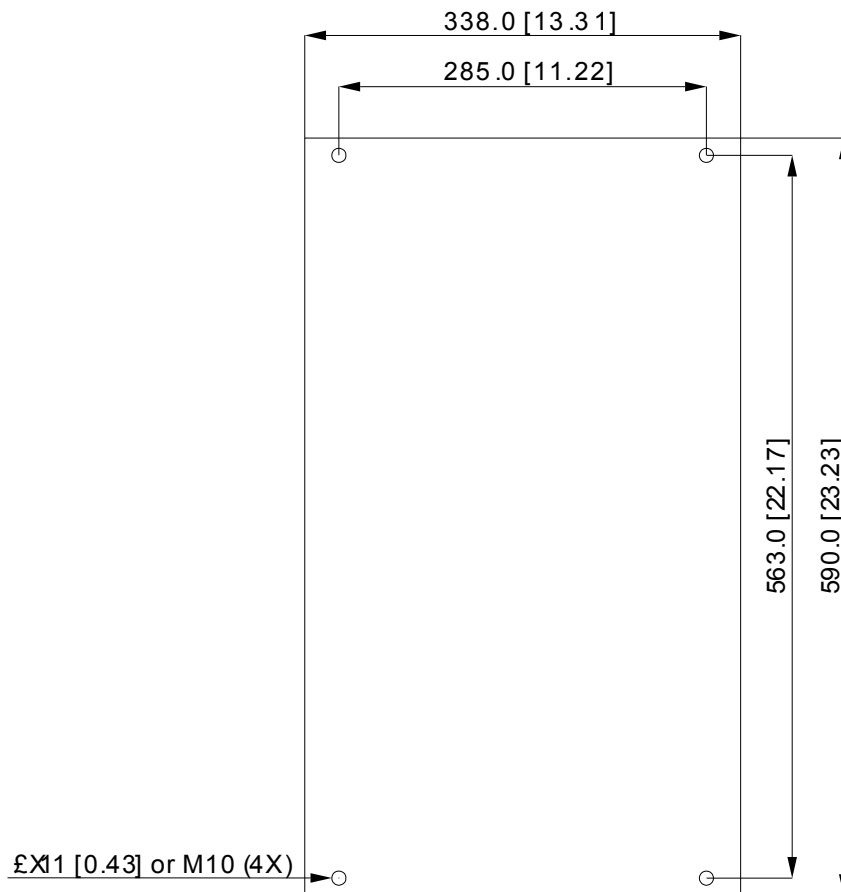

Dimensions

Frame B

Flange mounted models: VFD110CT43F00B; VFD150CT43F00B; VFD185CT43F00B

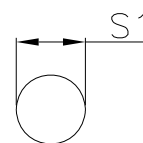
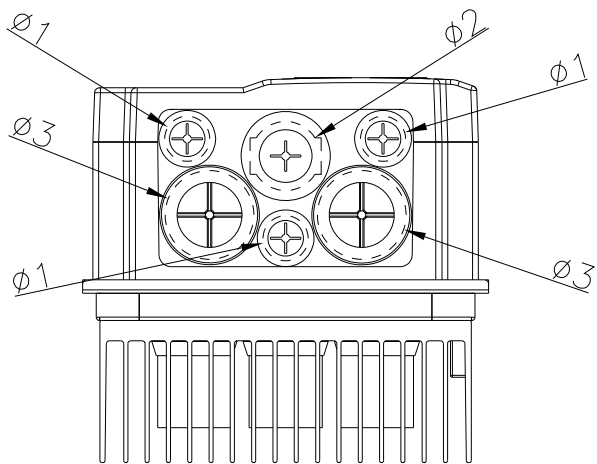
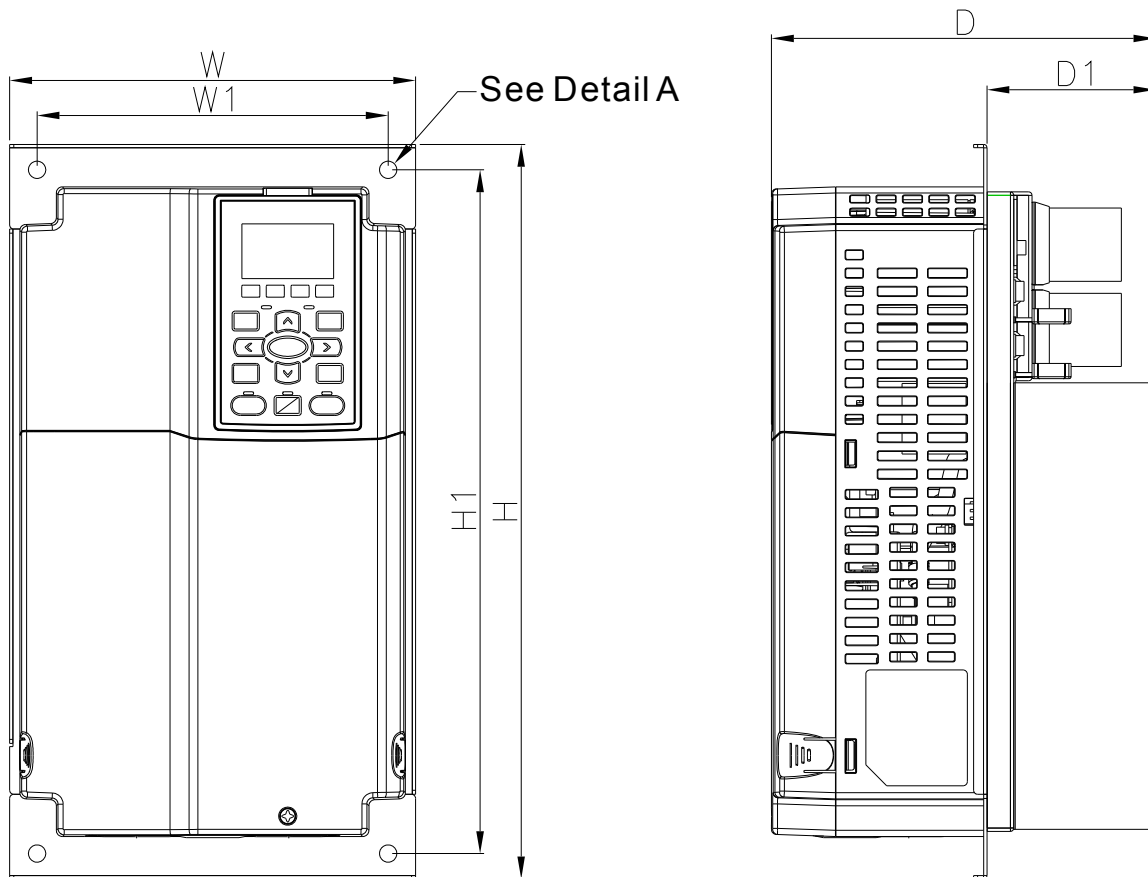

Detail A (Mounting Hole)

Unit: mm [inch]

Frame	W	W1	H	H1	D	D1	S1	$\phi 1$	$\phi 2$	$\phi 3$
B	200.0 [7.87]	173.0 [6.81]	361.8 [14.24]	336.8 [13.26]	189.4 [7.46]	83.2 [3.28]	8.5 [0.33]	22.2 [0.87]	34.0 [1.34]	43.8 [1.72]

Frame B

Wall-mounted models: VFD110CT43A21C; VFD150CT43A21C; VFD185CT43A21C

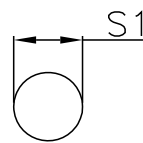
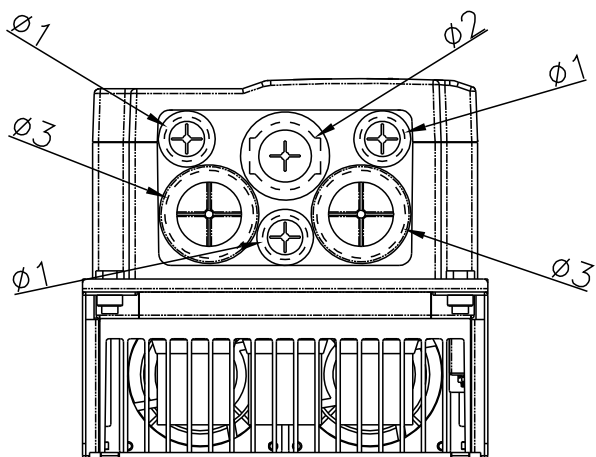
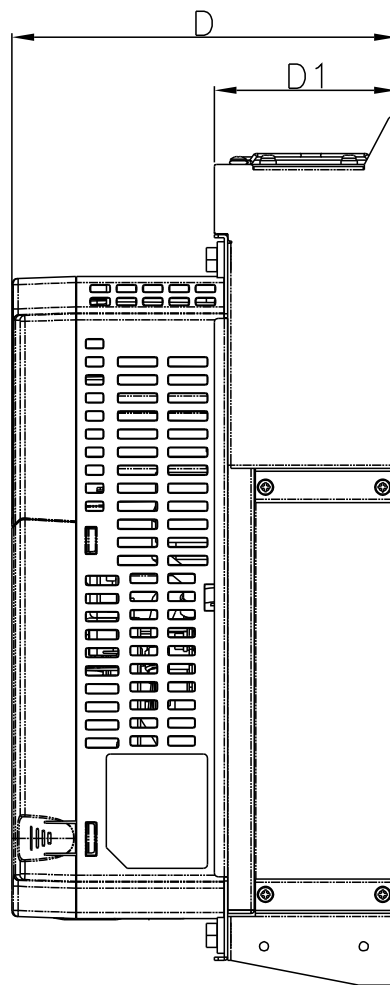
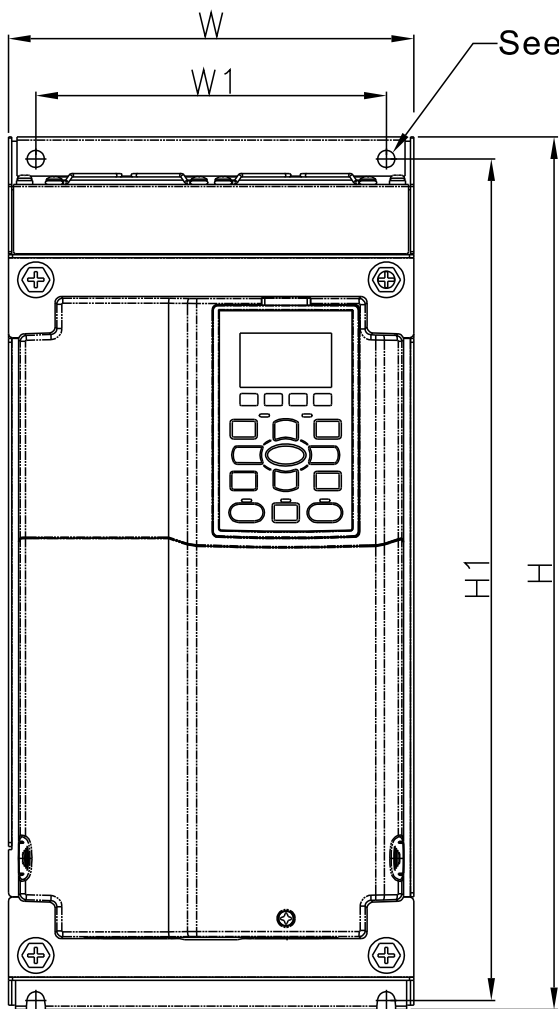

Detail A (Mounting Hole)

Unit: mm [inch]

Frame	W	W1	H	H1	D	D1	S1	Φ1	Φ2	Φ3
B	200.0 [7.87]	173.0 [6.81]	435.0 [17.13]	419.4 [16.51]	189.4 [7.46]	89.8 [3.54]	8.5 [0.33]	22.2 [0.87]	34.0 [1.34]	43.8 [1.72]

Frame C

Flange mounted models: VFD220CT43F00B; VFD300CT43F00B; VFD370CT43F00B

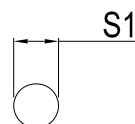
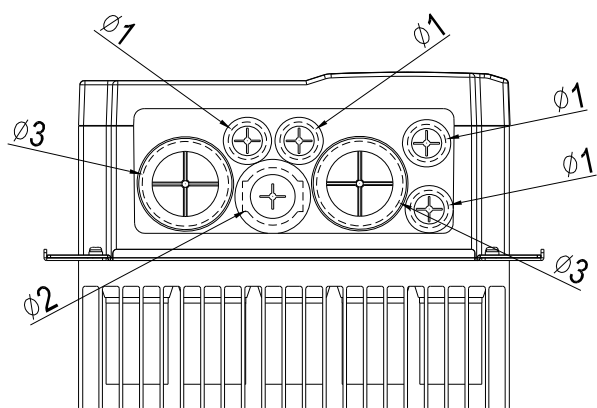
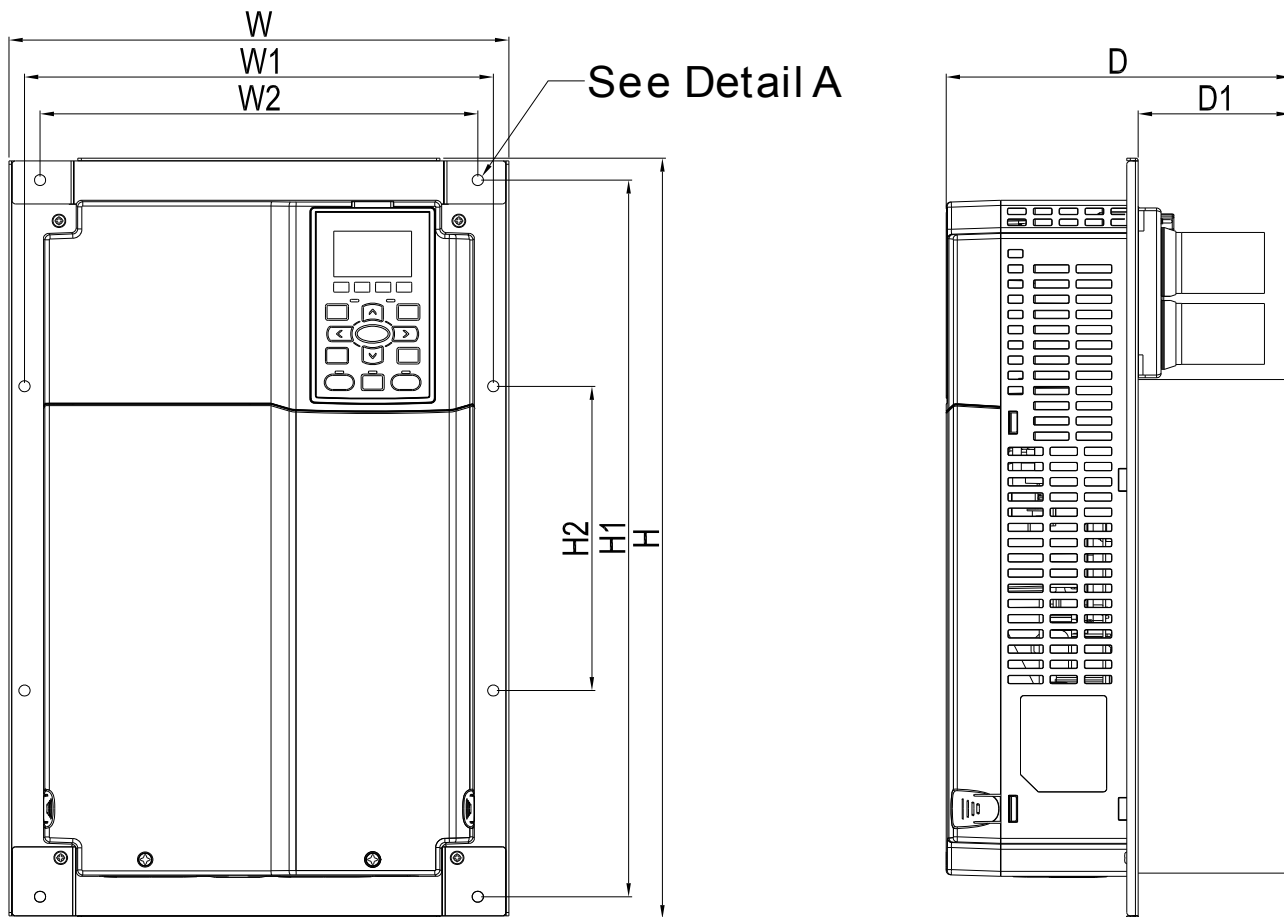

Detail A (Mounting Hole)

Frame	W	W1	W2	H	H1	H2	D	D1	S1	Unit: mm [inch]		
										$\phi 1$	$\phi 2$	$\phi 3$
C	290.0 [11.42]	272.0 [10.71]	254.0 [10.00]	450.0 [17.72]	424.0 [16.69]	180.0 [7.09]	199.5 [7.86]	88.2 [3.47]	6.5 [0.26]	22.2 [0.87]	34.0 [1.34]	50.0 [1.97]

Frame C

Wall-mounted models: VFD220CT43A21C; VFD300CT43A21C; VFD370CT43A21C

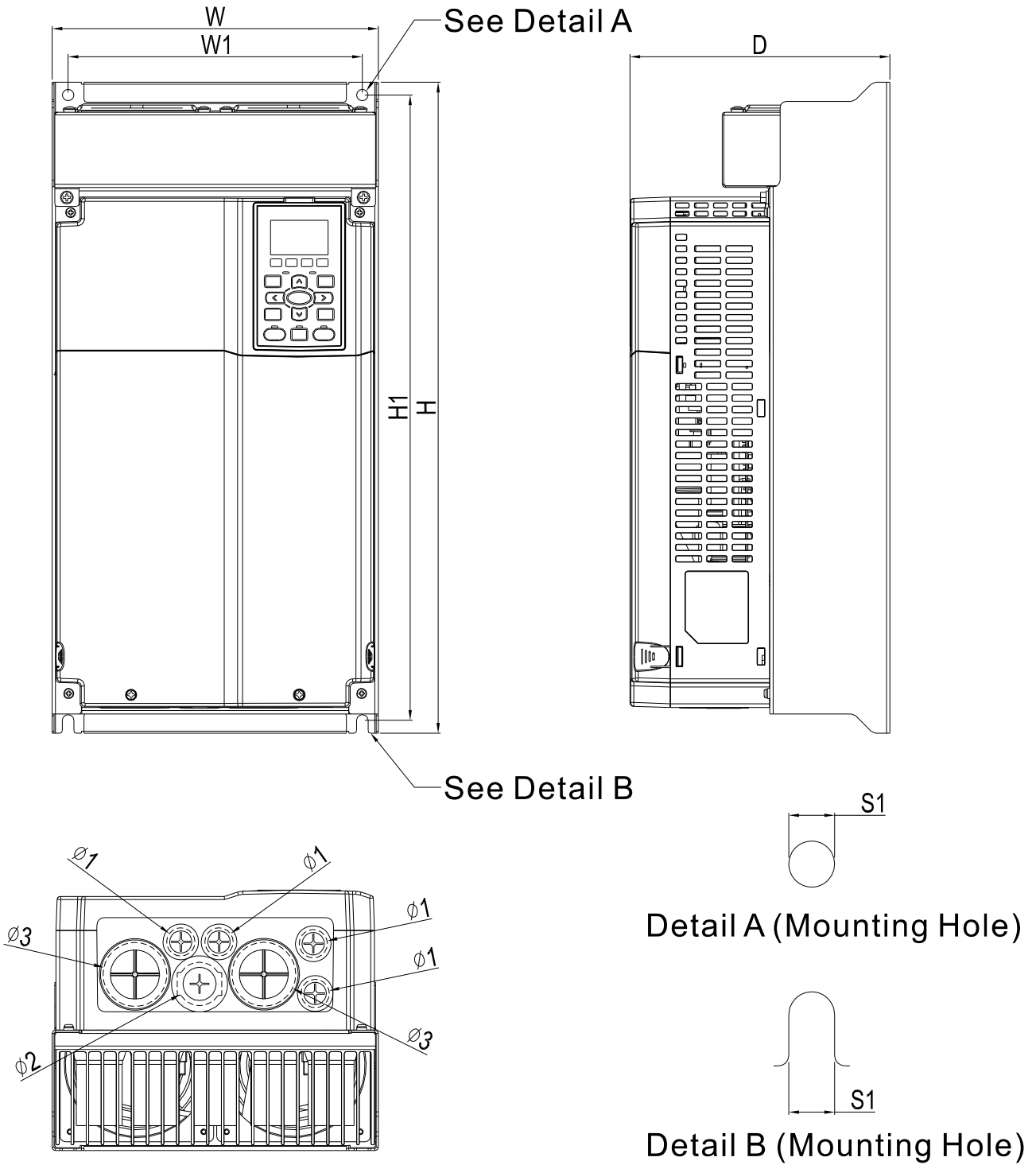

Unit: mm [inch]

Frame	W	W1	H	H1	D	S1	Φ1	Φ2	Φ3
C	256.0 [10.08]	231.0 [9.09]	510.0 [20.08]	490.0 [19.29]	204.0 [8.03]	9.0 [0.35]	22.2 [0.87]	34.0 [1.34]	50.0 [1.97]

Frame D

Flange mounted models: VFD750CT43F00A6; VFD900CT43F00A8

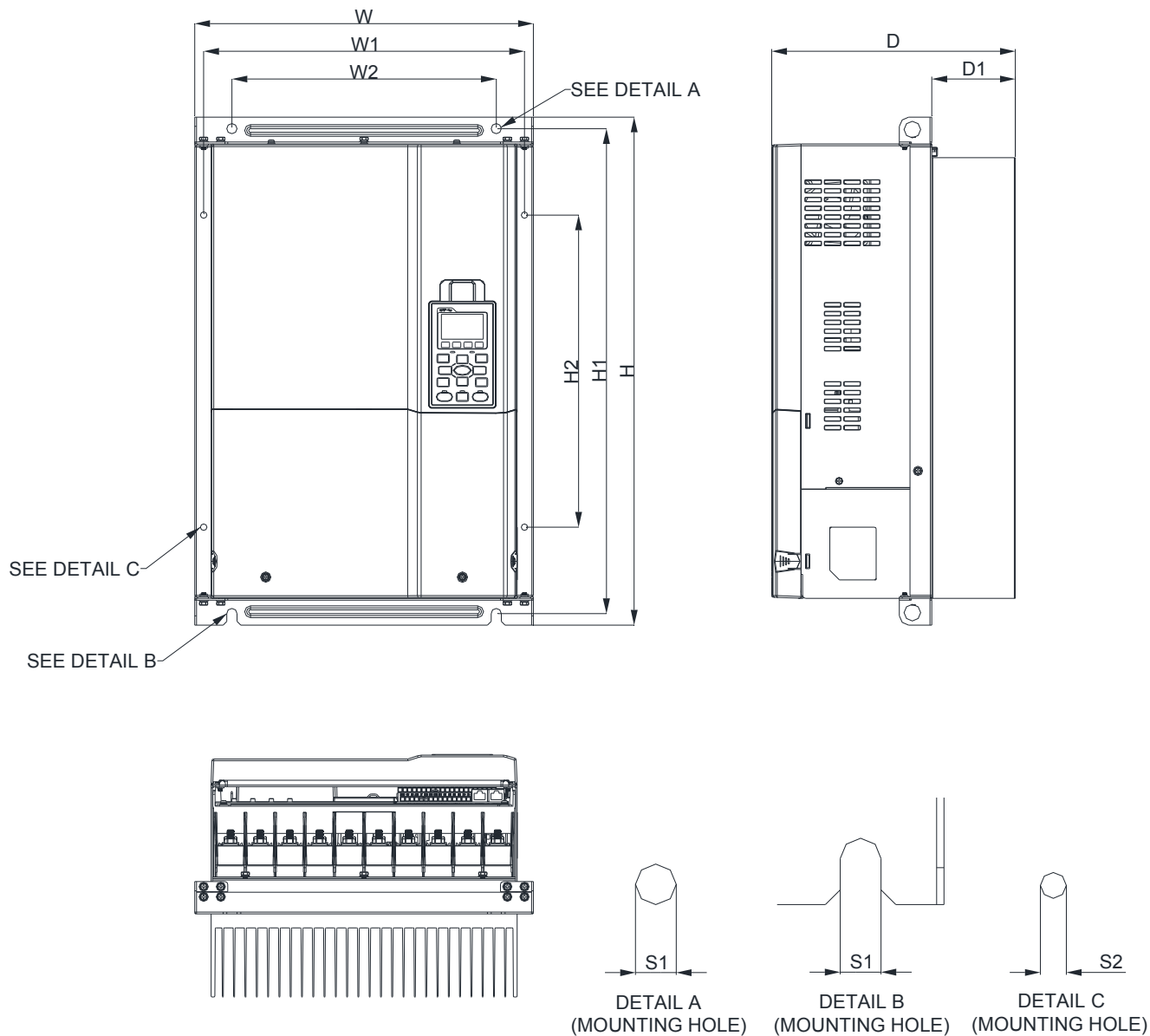

Unit: mm [inch]

Frame	W	H	D	W1	W2	H1	H2	D1	S1	S2
D	365.2 [13.38]	550.0 [21.65]	262.8 [10.35]	346.0 [13.62]	285.0 [11.22]	525.0 [20.67]	338.0 [13.31]	90.0 [3.54]	11.0 [0.43]	7.0 [0.28]

Frame D

Flange mounted models: VFD450CT43F00B; VFD550CT43F00B

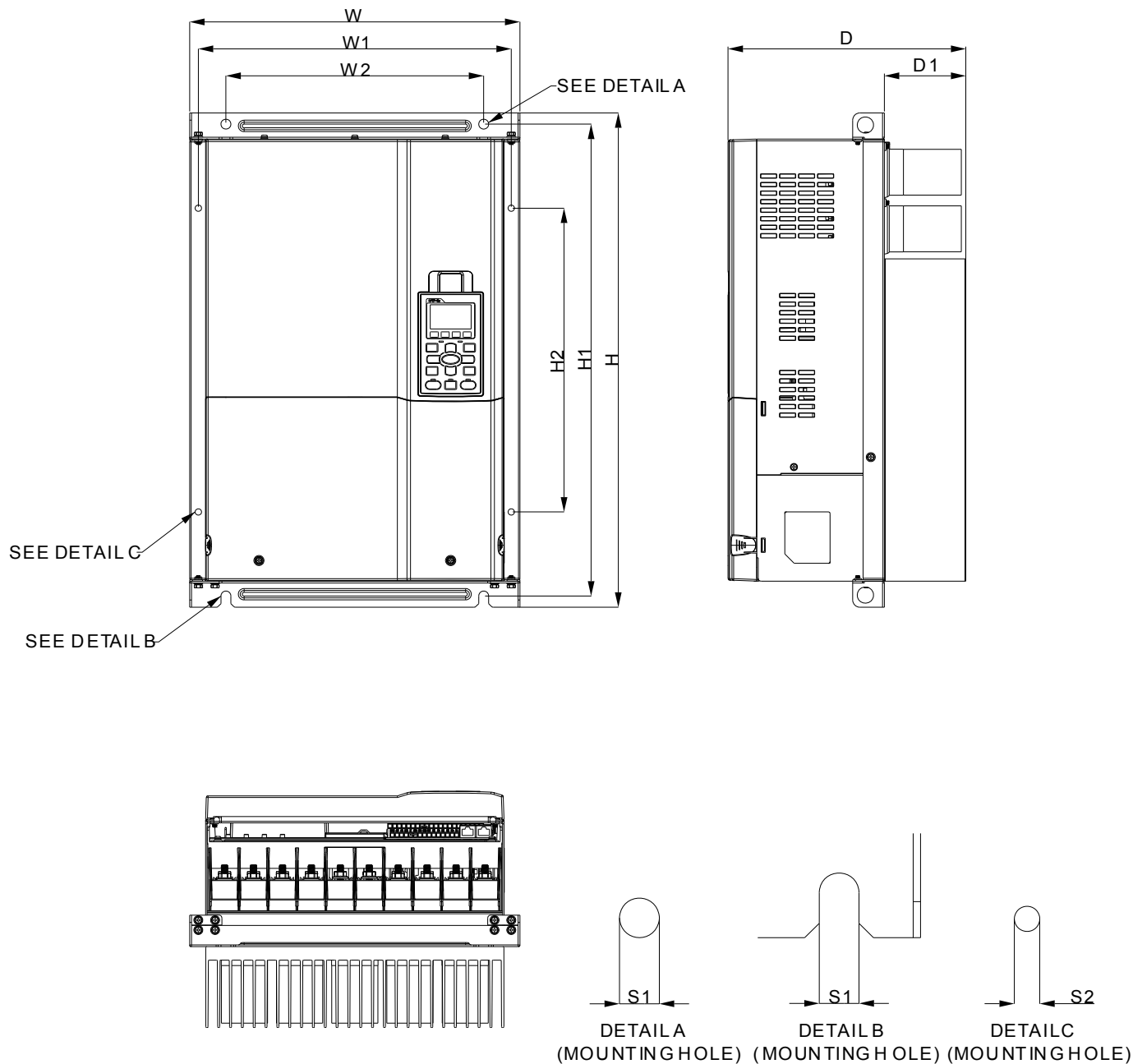

Unit: mm [inch]

Frame	W	W1	W2	H	H1	H2	D	D1	S1	S2
D	365.2 [13.38]	346.0 [13.62]	285.0 [11.22]	550.0 [21.65]	525.0 [20.67]	338.0 [13.31]	262.8 [10.35]	90.0 [3.54]	11.0 [0.43]	7.0 [0.28]

Frame D

Wall-mounted models: VFD450CT43A00C; VFD550CT43F00C

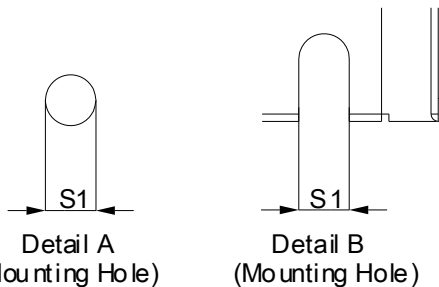
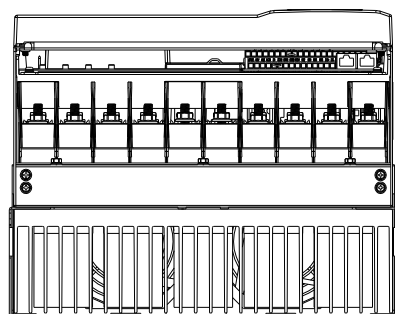
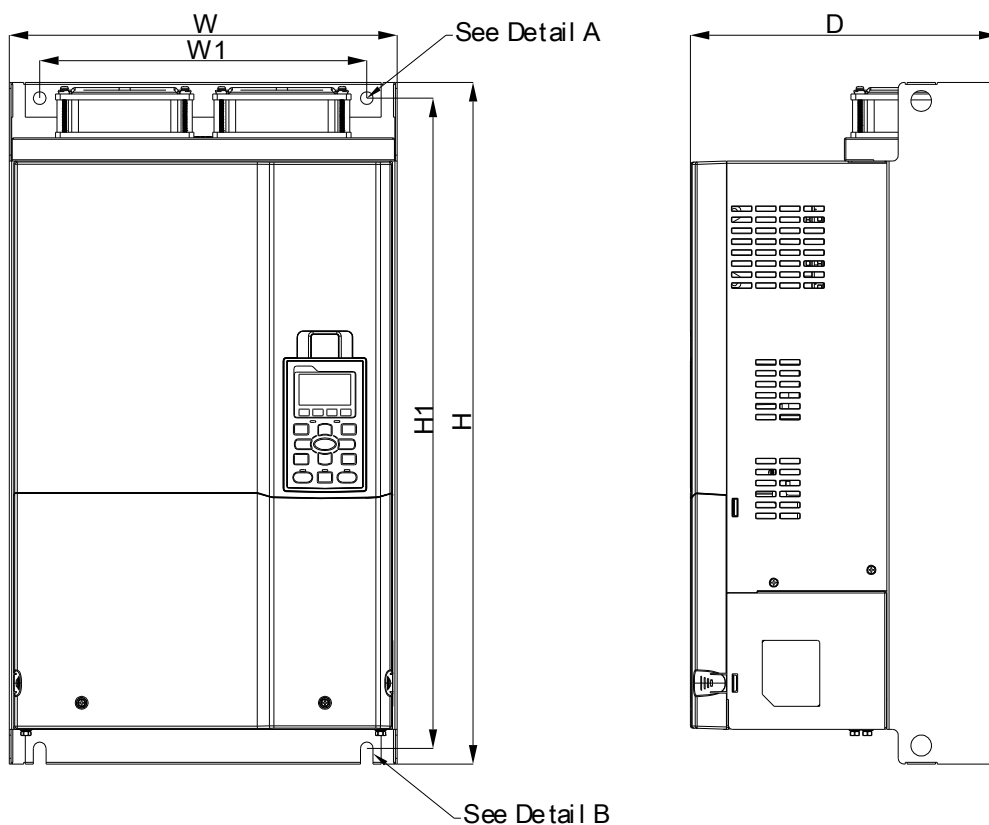

Unit: mm [inch]

Frame	W	W1	H	H1	D	S1
D	338.0 [13.31]	285.0 [11.22]	590.0 [23.22]	563.0 [22.17]	268.0 [10.55]	11.0 [0.43]

Digital Keypad
KPC-CC01 & KPC-CE01

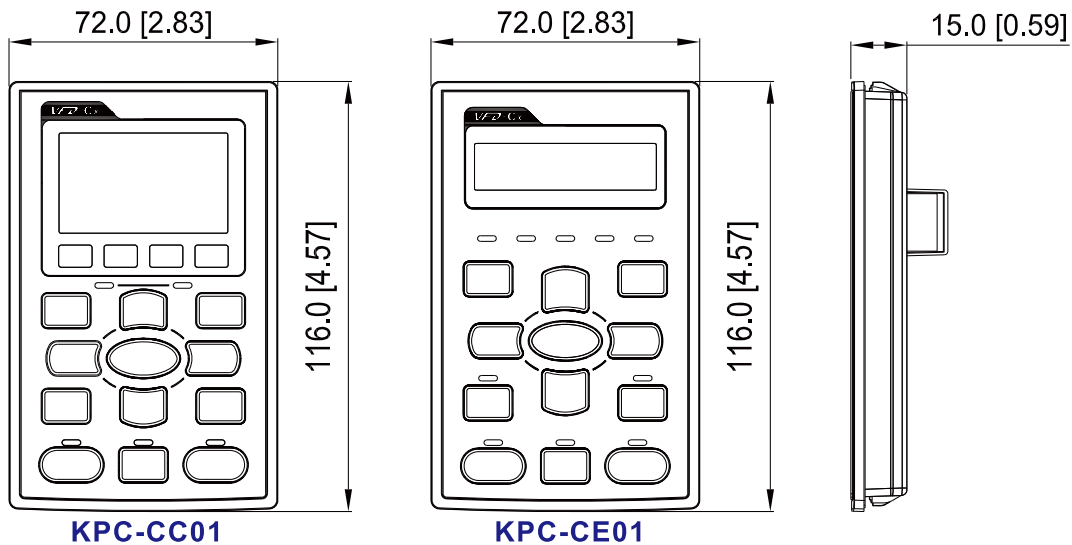

Unit: mm [inch]

[This page intentionally left blank]



Chapter 2 Installation

Minimum Mounting Clearance and Installation

NOTE

- ☑ Prevent fiber particles, scraps of paper, shredded wood saw dust, metal particles, etc. from adhering to the heat sink
- ☑ Install the AC motor drive in a metal cabinet. When installing one drive below another one, use a metal separation between the AC motor drives to prevent mutual heating and to prevent the risk of fire accident.
- ☑ Install the AC motor drive in Pollution Degree 2 environments only: normally only nonconductive pollution occurs and temporary conductivity caused by condensation is expected.

The appearances shown in the following figures are for reference only.

Airflow direction:  (Blue arrow) inflow  (Red arrow) outflow

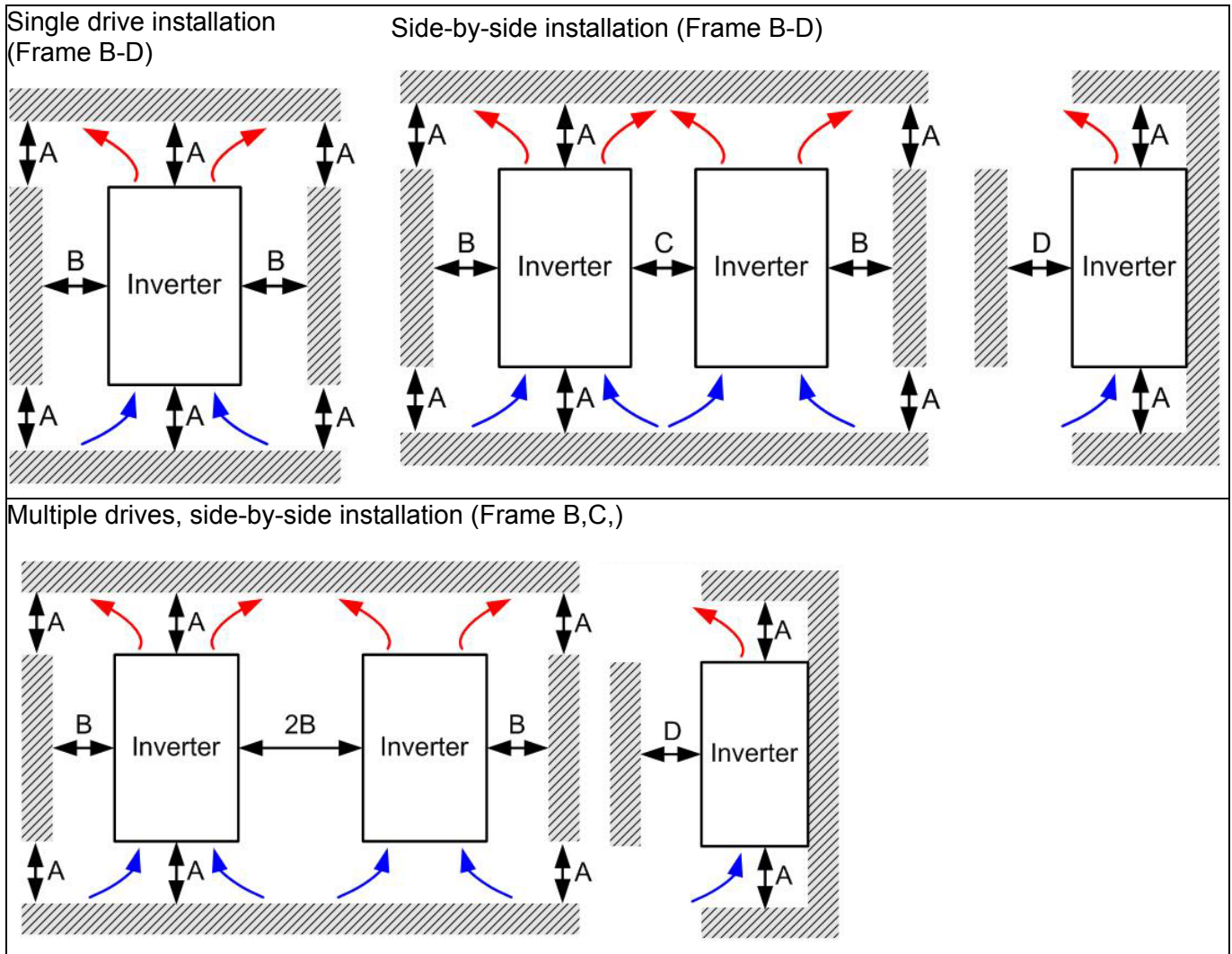

Multiple drives, side-by-side installation (Frame D) Install metal separation between the drives.

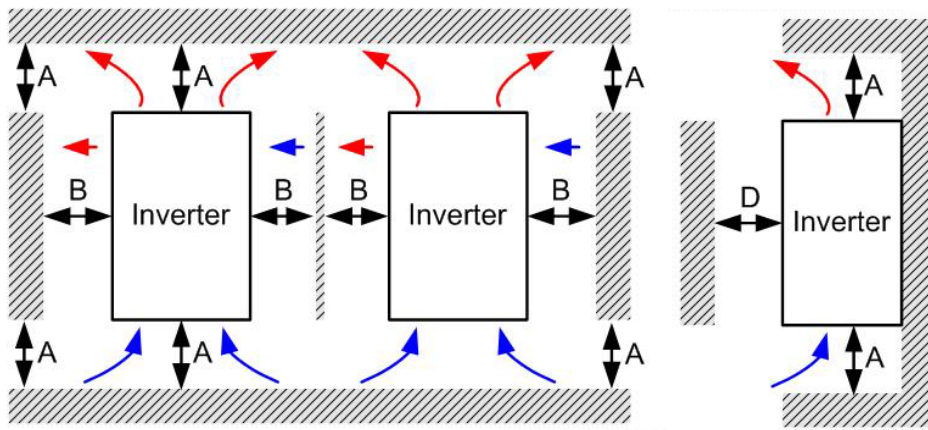

Multiple drives side-by-side installation and in rows (Frame B,C)

When installing one AC motor drive below another one (top-bottom installation), use a metal separation between the drives to prevent mutual heating. The temperature measured at the fan's inflow side must be lower than the temperature measured at the operation side. If the fan's inflow temperature is higher, use a thicker or larger size of metal separation. Operation temperature is the temperature measured at 50mm from the fan's inflow side. (As shown in the figure below)

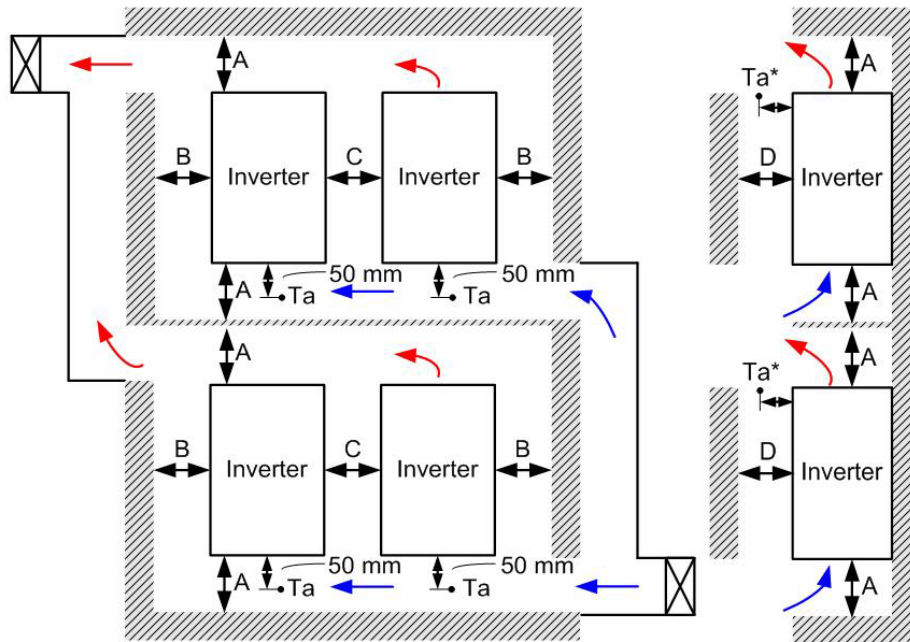

Minimum mounting clearance

Frame	A (mm)	B (mm)	C (mm)	D (mm)
B~C	60	30	10	0
D	100	50	-	0

Frame B	VFD110CT43F00B; VFD150CT43F00B; VFD185CT43F00B; VFD110CT43A21C; VFD150CT43A21C; VFD185CT43A21C
Frame C	VFD220CT43F00B; VFD300CT43F00B; VFD370CT43F00B; VFD220CT43A21C; VFD300CT43A21C; VFD370CT43A21C
Frame D	VFD450CT43F00B; VFD550CT43F00B; VFD450CT43A00C; VFD550CT43A00C; VFD750CT43F00A6; VFD900CT43F00A8

NOTE

1. The minimum mounting clearances stated in the table above applies to AC motor drives frame A to D. A drive fails to follow the minimum mounting clearances may cause the fan to malfunction and heat dissipation problem.

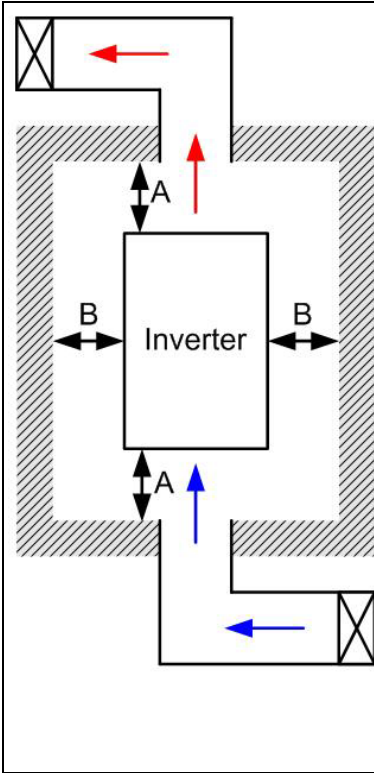

NOTE

- ※ The mounting clearances stated in the figure is for installing the drive in an open area. To install the drive in a confined space (such as cabinet or electric box), please follow the following three rules: (1) Keep the minimum mounting clearances. (2) Install a ventilation equipment or an air conditioner to keep surrounding temperature lower than operation temperature. (3) Refer to parameter setting and set up Pr. 00-16, Pr.00-17, and Pr. 06-55.
- ※ The following table shows the heat dissipation and the required air volume when installing a single drive in a confined space. When installing multiple drives, the required air volume shall be multiplied by the number the drives.
- ※ Refer to the chart (Air flow rate for cooling) for ventilation equipment design and selection.
- ※ Refer to the chart (Power dissipation) for air conditioner design and selection.

Model No.	Air flow rate for cooling						Power Dissipation		
	Flow Rate (cfm)			Flow Rate (m ³ /hr)			Power Dissipation		
	External	Internal	Total	External	Internal	Total	Loss External (Heat sink)	Internal	Total
VFD110CT43A21C	134	-	134	228	-	228	177	164	341
VFD150CT43A21C	134	-	134	228	-	228	363	194	557
VFD185CT43A21C	134	-	134	228	-	228	426	192	618
VFD220CT43A21C	173	-	173	294	-	294	523	358	881
VFD300CT43A21C	173	-	173	294	-	294	665	363	1028
VFD370CT43A21C	173	-	173	294	-	294	748	405	1153
VFD450CT43A00C	202	-	202	343	-	343	906	459	1365
VFD550CT43A00C	202	-	202	343	-	343	1098	669	1767
VFD750CT43F00A6	-	30	-	-	51	-	1639	657	2296
VFD900CT43F00A8	-	30	-	-	51	-	1787	955	2742
<ul style="list-style-type: none"> ※ The required airflow shown in chart is for installing single drive in a confined space. ※ When installing the multiple drives, the required air volume should be the required air volume for single drive X the number of the drives. 							<ul style="list-style-type: none"> ※ The heat dissipation shown in the chart is for installing single drive in a confined space. ※ When installing the multiple drives, volume of heat dissipation should be the heat dissipated for single drive X the number of the drives. ※ Heat dissipation for each model is calculated by rated voltage, current and default carrier. 		

LD:

1. VF, VF+PG, SVC, FOC+PG

Fc	VFD110 ~ 185CT43	Fc	VFD220 ~ 370CT43	Fc	VFD450 ~ 550CT43
0	100	0	100	0	100
4	100	4	100	4	100
6	89.1	6	89.1	6	85.5
7.5	81.8	7.5	81.8	7.5	75.5
9	74.5	9	74.5	9	66.4
10	71.1	10	71.1	10	60.9
12	64.5	10	0.0	10	0.0
14	57.9				
15	55.3				
15	0.0				

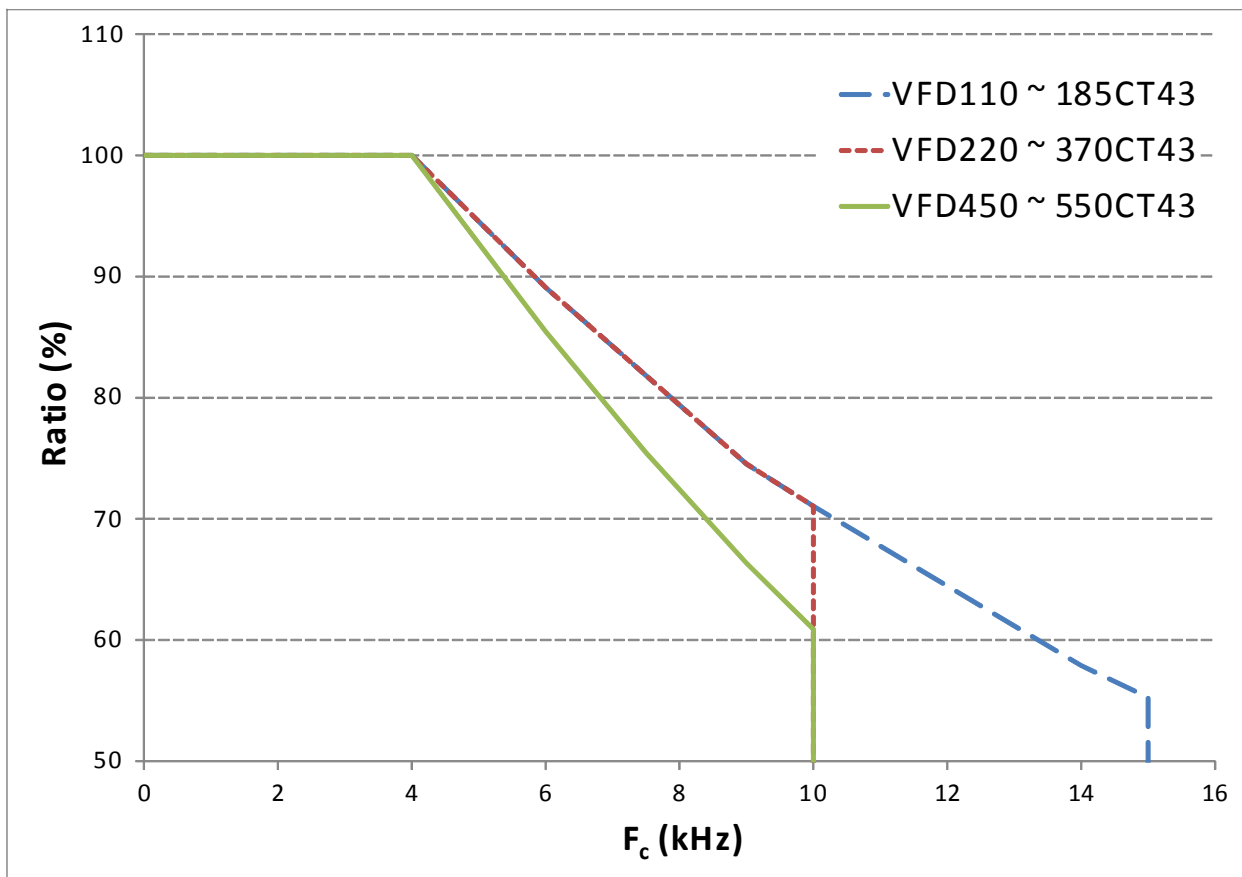

2. FOC, PMFOC, PMFOC+PG, TQC, TQC+PG

F _c	VFD110 ~ 185CT43	F _c	VFD220 ~ 370CT43	F _c	VFD450 ~ 550CT43
0	100	0	100	0	100
3	100	2.666666667	100	3	100
4	89.1	4.0	89.1	4	85.5
5	81.8	5.0	81.8	5	75.5
6	74.5	6.0	74.5	6	66.4
7	71.1	6.0	0.0	6	0
8	64.5				
9	57.9				
10	55.3				
10	0				

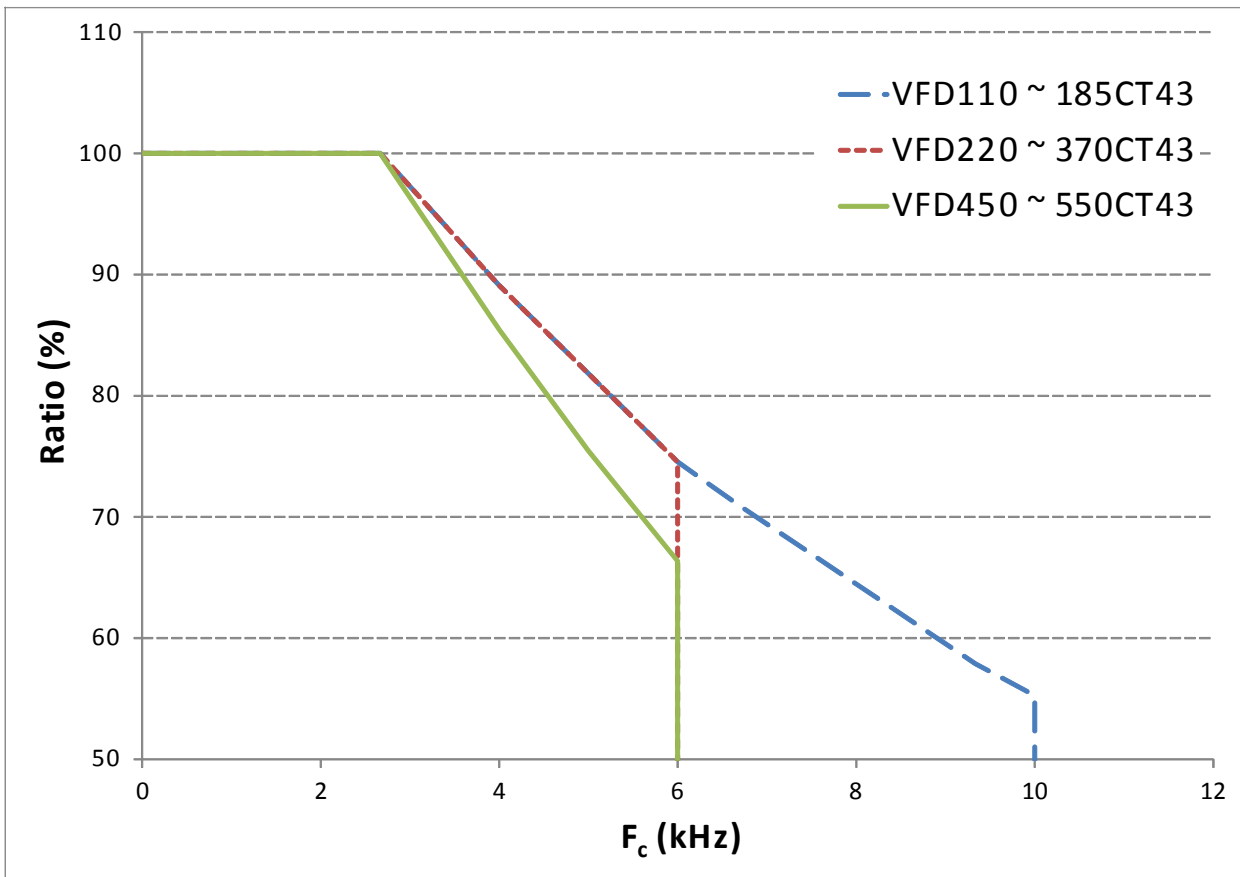

HD:

F _c	VFD110 ~ 185CT43	F _c	VFD220 ~ 370CT43	F _c	VFD450 ~ 550CT43
0	100	0	100	0	100
4	100	4	100	4	100.0
5	90.0	5	90.0	5	87.2
6	83.3	6	83.3	6	75.6
7	76.7	7	76.7	7	66.3
8	70.0	8	70.0	8	57.0
9	65.0	9	65.0	9	47.7
10	60.0	10	60.0	10	41.9
11	55.0	10	0.0	10	0
12	51.7				
13	48.3				
14	45.0				
15	41.7				
15	0.0				

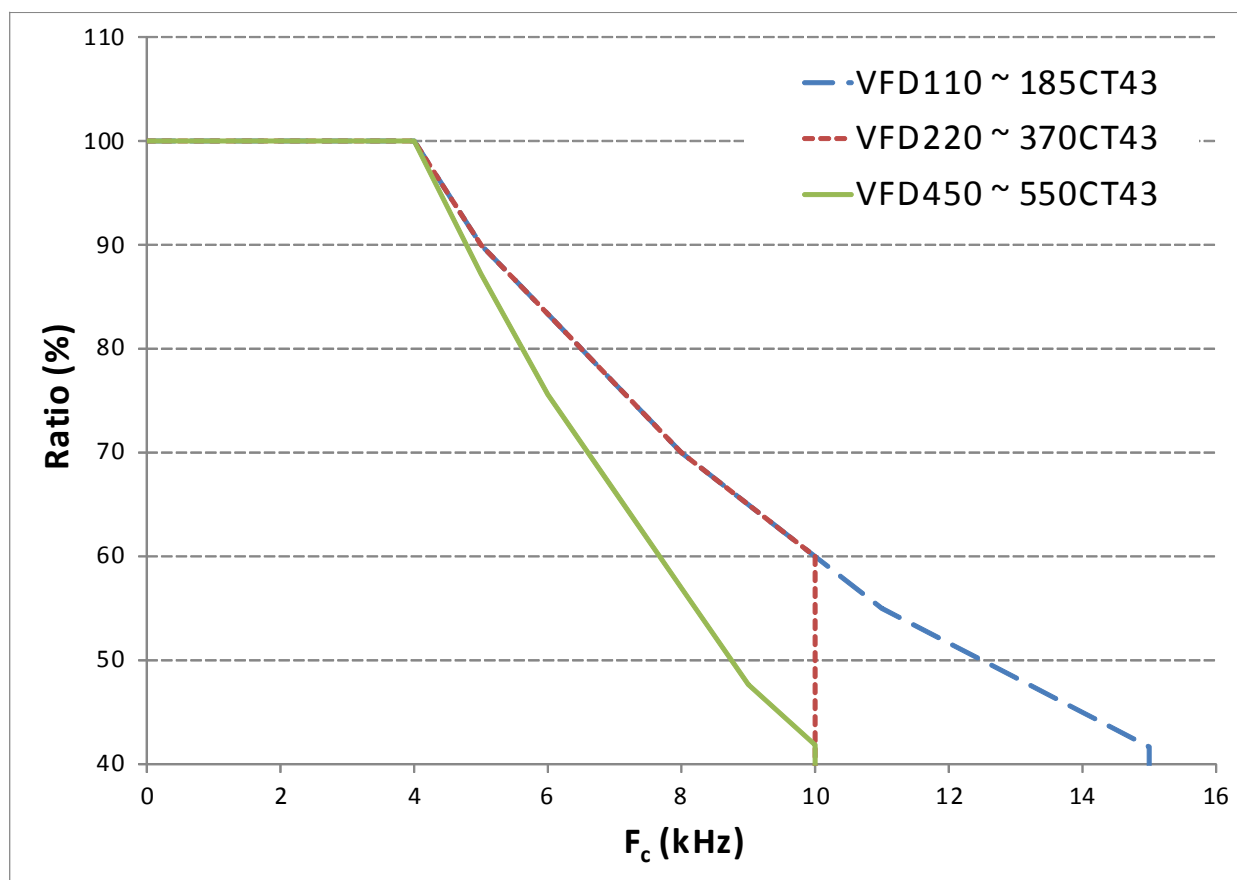



Derating curve diagram of VF, VF+PG, SVC, FOC+PG

VF, VF+PG, SVC, FOC+PG		
Ta	UL Open- Type	UL TYPE1 UL Open- Type with side by side
0	100	100
10	100	100
20	100	100
30	100	100
40	100	100
50	100	80.0
60	80.0	60.0

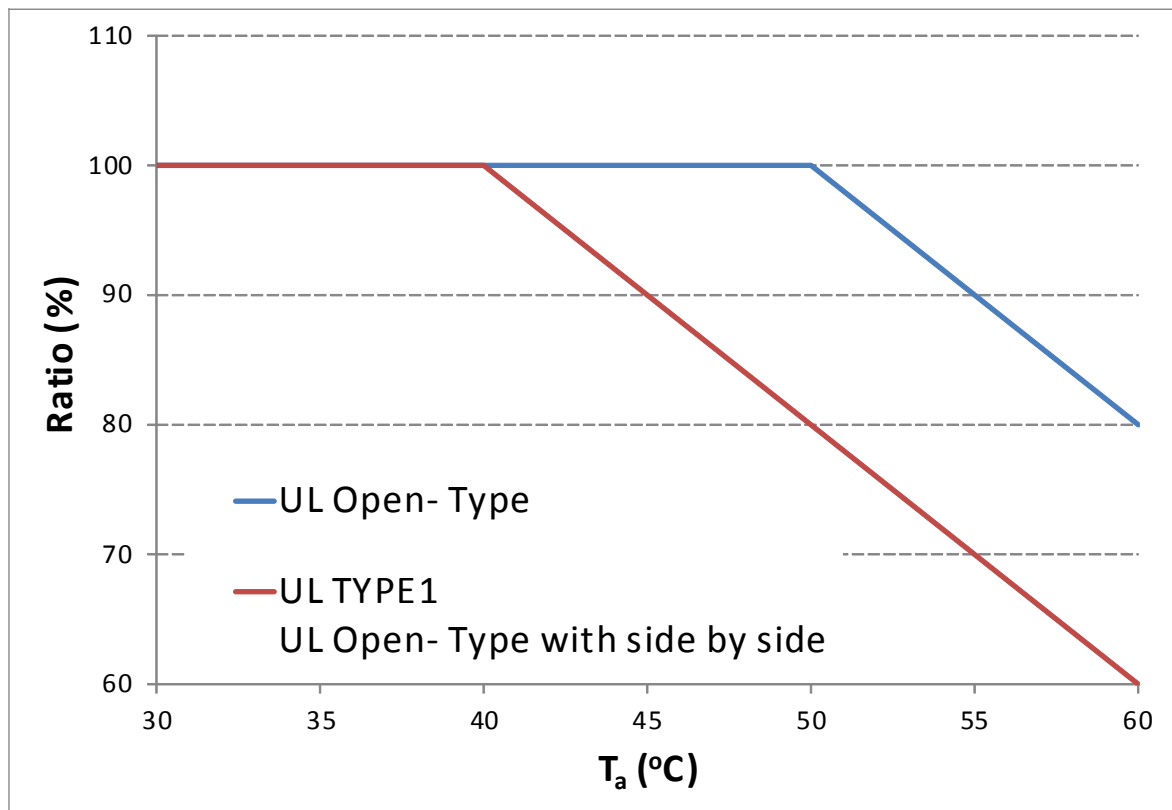

Derating curve diagram of FOC, PMFOC, PMFOC+PG, TQC, TQC+PG

FOC, PMFOC, PMFOC+PG, TQC, TQC+PG	
Ta	UL Open- Type, UL TYPE1 & UL Open- Type with side by side
0	100
10	100
20	100
30	100
40	100
50	80.0
60	60.0

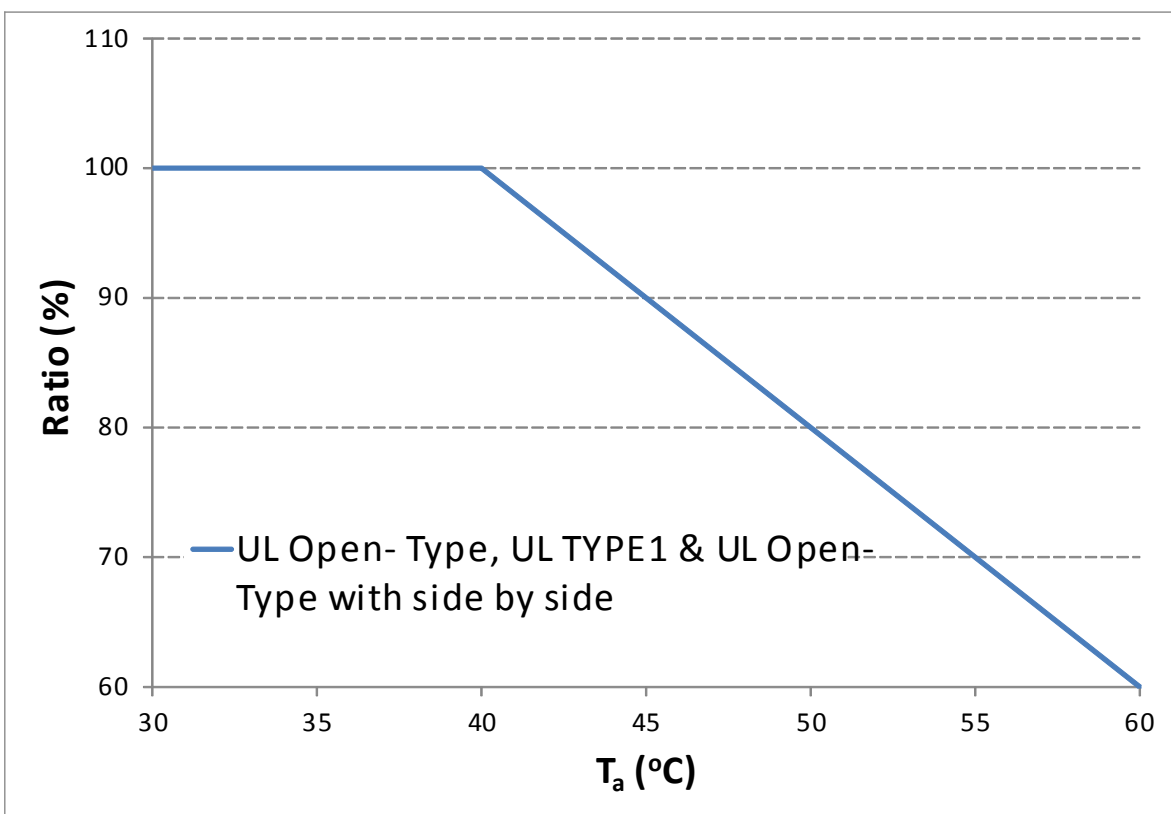

Chapter 3 Unpacking

The AC motor drive should be kept in the shipping carton or crate before installation. In order to retain the warranty coverage, the AC motor drive should be stored properly when it is not to be used for an extended period of time.

The AC motor drive is packed in the crate. Follows the following step for unpack:

Frame D (Flange mounted models)

1. Loosen the 12 cover screws to open the crate.

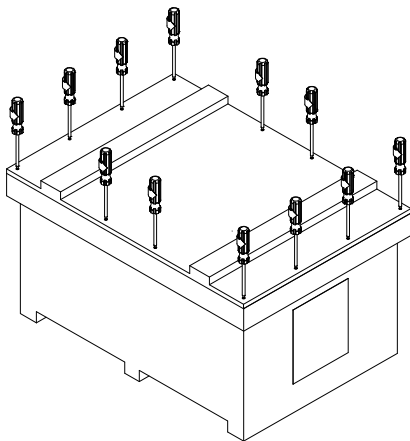

2. Remove the EPEs and manual.

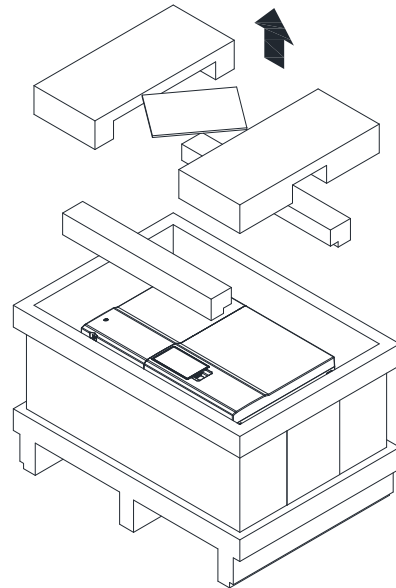

3. Loosen the 4 screws.

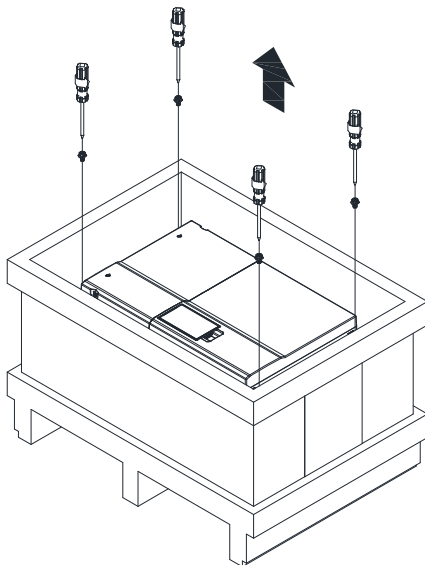

4. Lift the drive by hooking the lifting hole. It's ready for installation. Note: Refer to picture a if the second-last word of model is "A"; if it's "B" then refer to picture b.

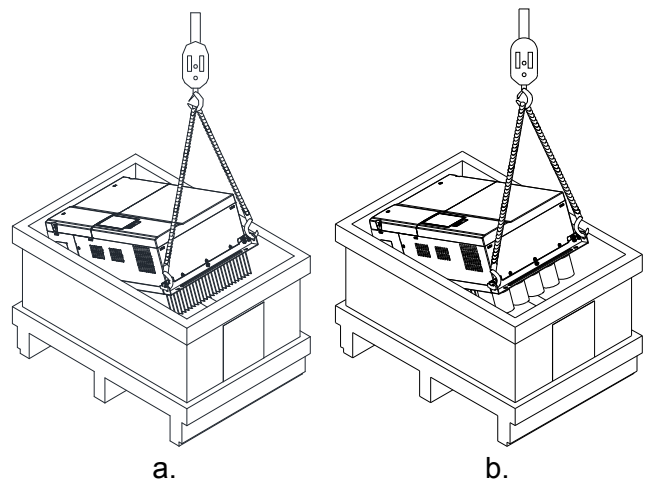

Frame D (Wall mounted models)

1. Remove the 4 clips on the side of the crate with a flat-head screwdriver

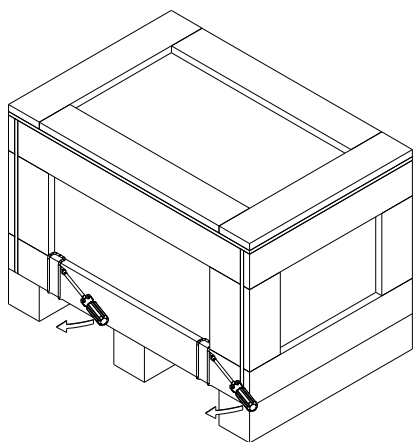

2. Remove the crate cover, EPEs, and manual.

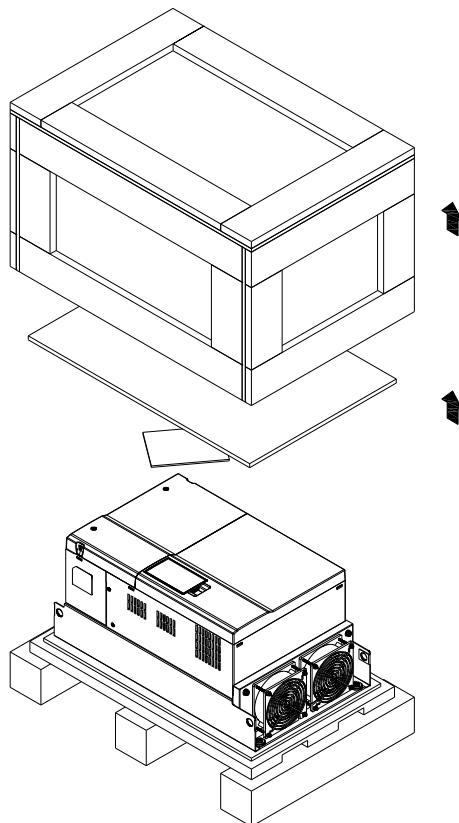

3. Loosen the four screws.

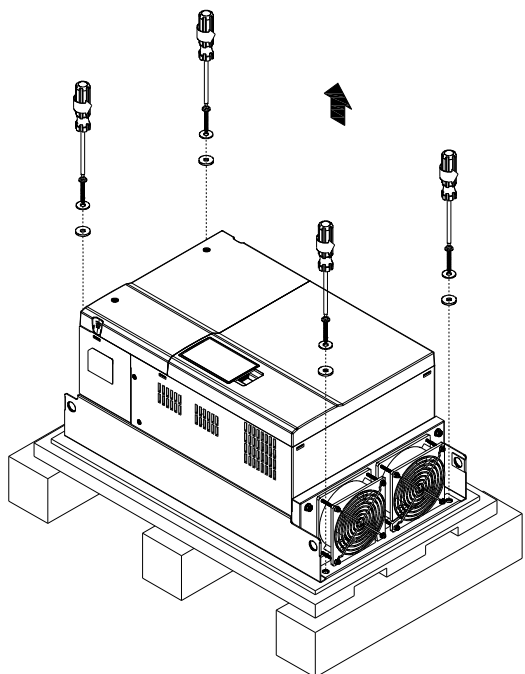

4. Lift the drive by hooking the lifting hole. It's ready for installation.

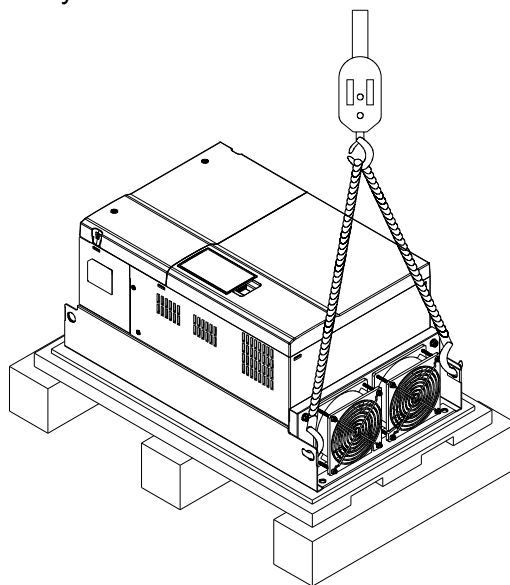

The Lifting Hook

Frame D (Flange mounted models)

The arrows indicate the location of the lifting holes of frame D, as shown in figure below. Note: Refer to figure a if the second-last word of model is "A"; if it's "B" then refer to figure b.

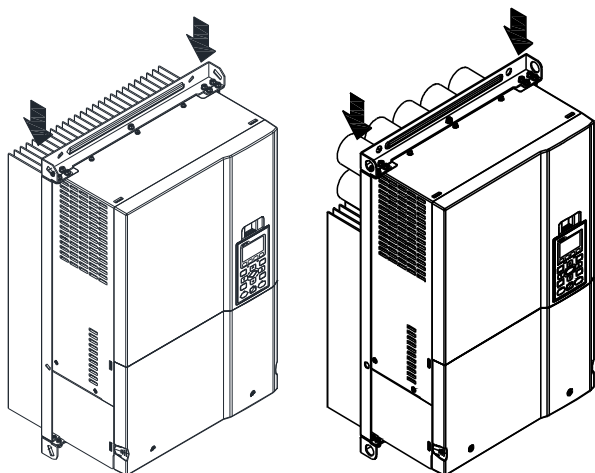

a.

b.

Ensure the lifting hook properly goes through the lifting hole, as shown in the following diagram.

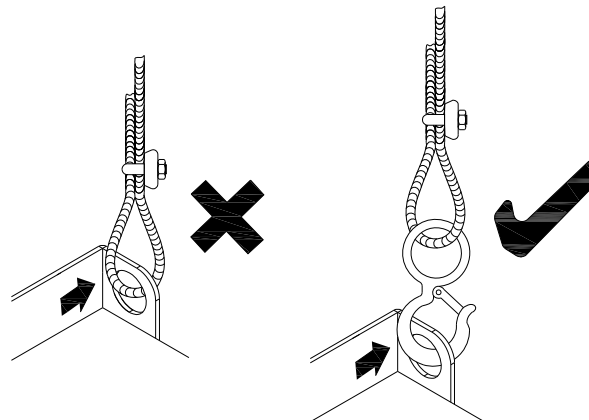

Ensure the angle between the lifting holes and the lifting device is within the specification, as shown in the following figure.

Applicable to Frame D (VFD450CT43F00B; VFD550CT43F00B; VFD750CT43F00A6; VFD900CT43F00A8)

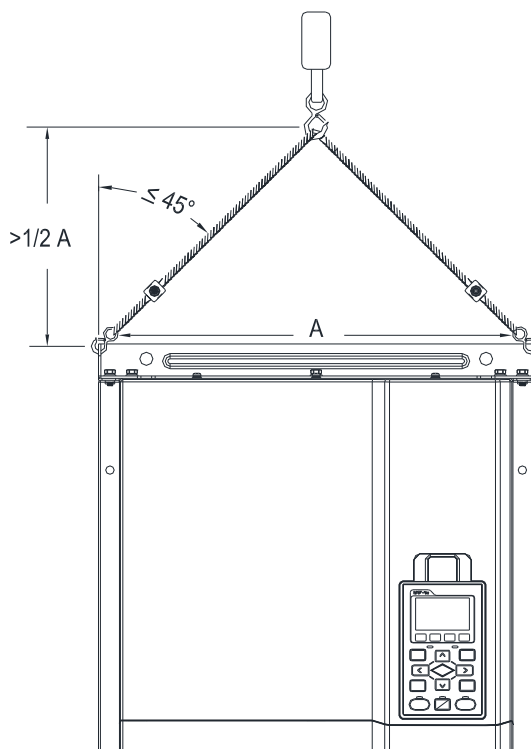

Weight: 37.6kg (82.9lbs.)±0.5%

Frame D (Wall mounted models)

The arrows indicate the location of the lifting holes of frame D, as shown in figure c below.

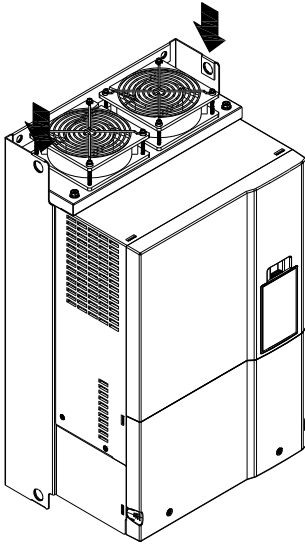

C.

Ensure the lifting hook properly goes through the lifting hole, as shown in the following diagram.

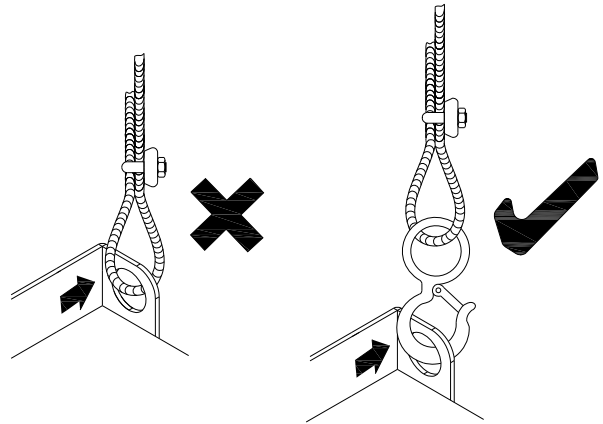

Ensure the angle between the lifting holes and the lifting device is within the specification, as shown in the following figure.

Applicable to Frame D (VFD450CT43A00C; VFD550CT43A00C)

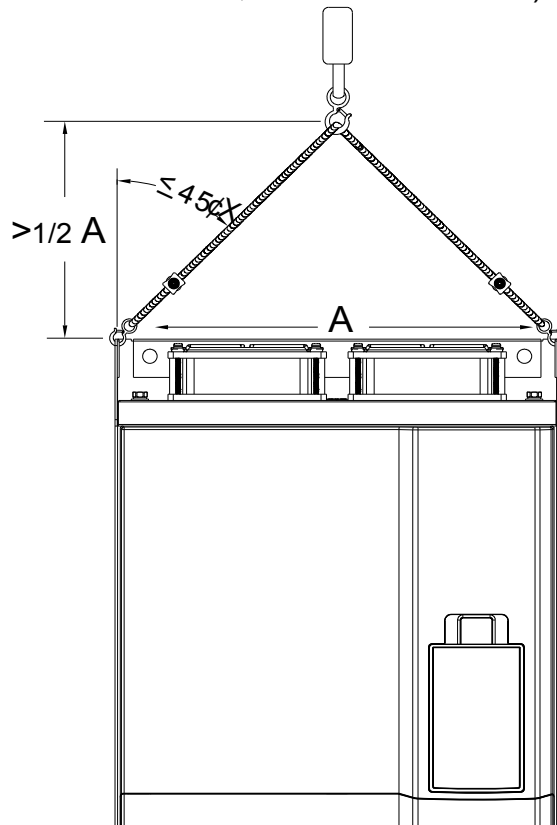

Weight: 37.6kg (82.9lbs.)±0.5%

Chapter 4 Wiring

After removing the front cover, examine if the power and control terminals are clearly noted. Please read following precautions before wiring.



- ☑ It is crucial to **turn off the AC motor drive power** before any wiring installation are made. A charge may still remain in the DC bus capacitors with hazardous voltages even if the power has been turned off therefore it is suggested for users to measure the remaining voltage before wiring. For your personnel safety, please do not perform any wiring before the voltage drops to a safe level < 25 Vdc. Wiring installation with remaining voltage condition may cause sparks and short circuit.
- ☑ Only qualified personnel familiar with AC motor drives is allowed to perform installation, wiring and commissioning. Make sure the power is turned off before wiring to prevent electric shock.
- ☑ Make sure that power is only applied to the R/L 1, S/L2, T/L3 terminals. Failure to comply may result in damage to the equipments. The voltage and current should lie within the range as indicated on the nameplate (Chapter 1-1).
- ☑ All the units must be grounded directly to a common ground terminal to prevent lightning strike or electric shock.
- ☑ Please make sure to fasten the screw of the main circuit terminals to prevent sparks which is made by the loose screws due to vibration



- ☑ When wiring, please choose the wires with specification that complies with local regulation for your personnel safety.
- ☑ Check following items after finishing the wiring:
 1. Are all connections correct?
 2. Any loosen wires?
 3. Any short-circuits between the terminals or to ground?

4-1 Wiring

Frame B, C
It provides 3-phase power

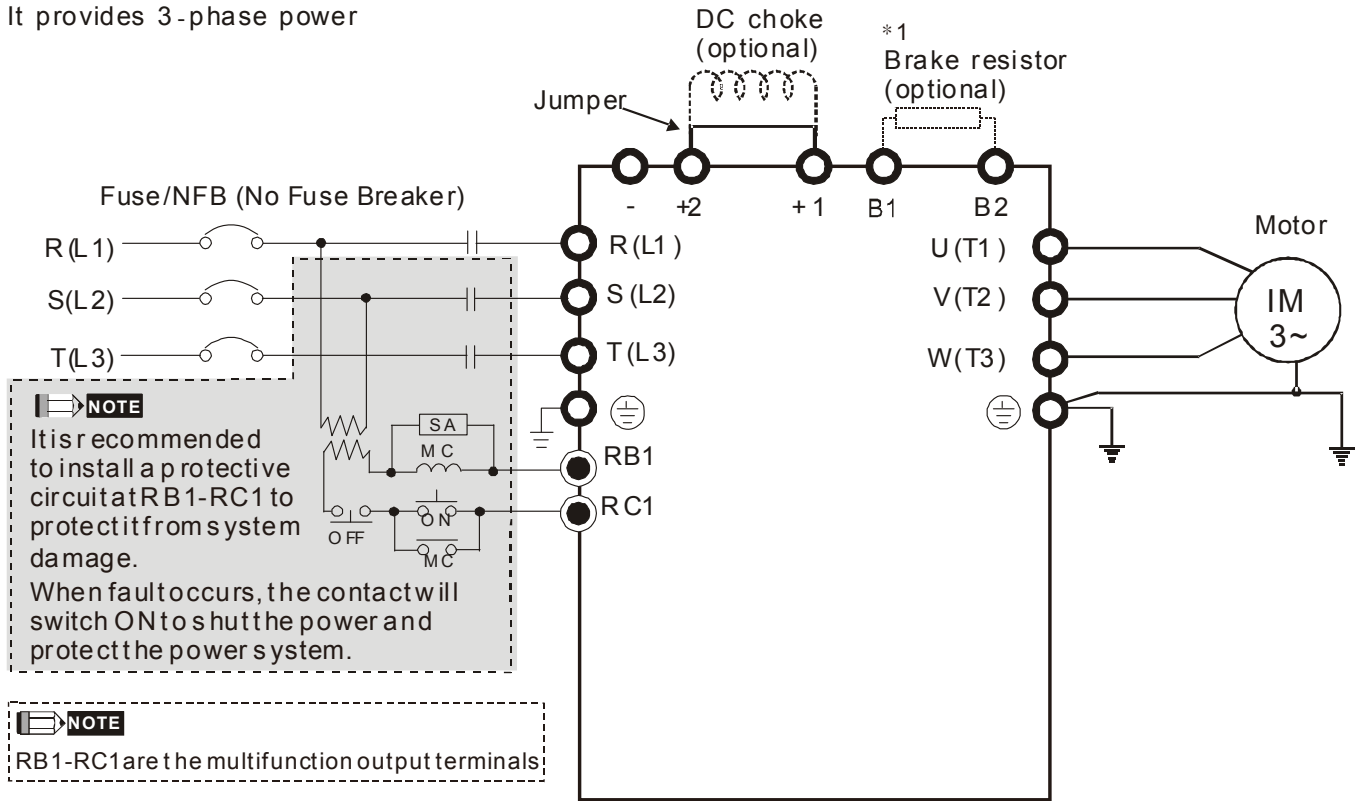

Frame D
It provides 3-phase power

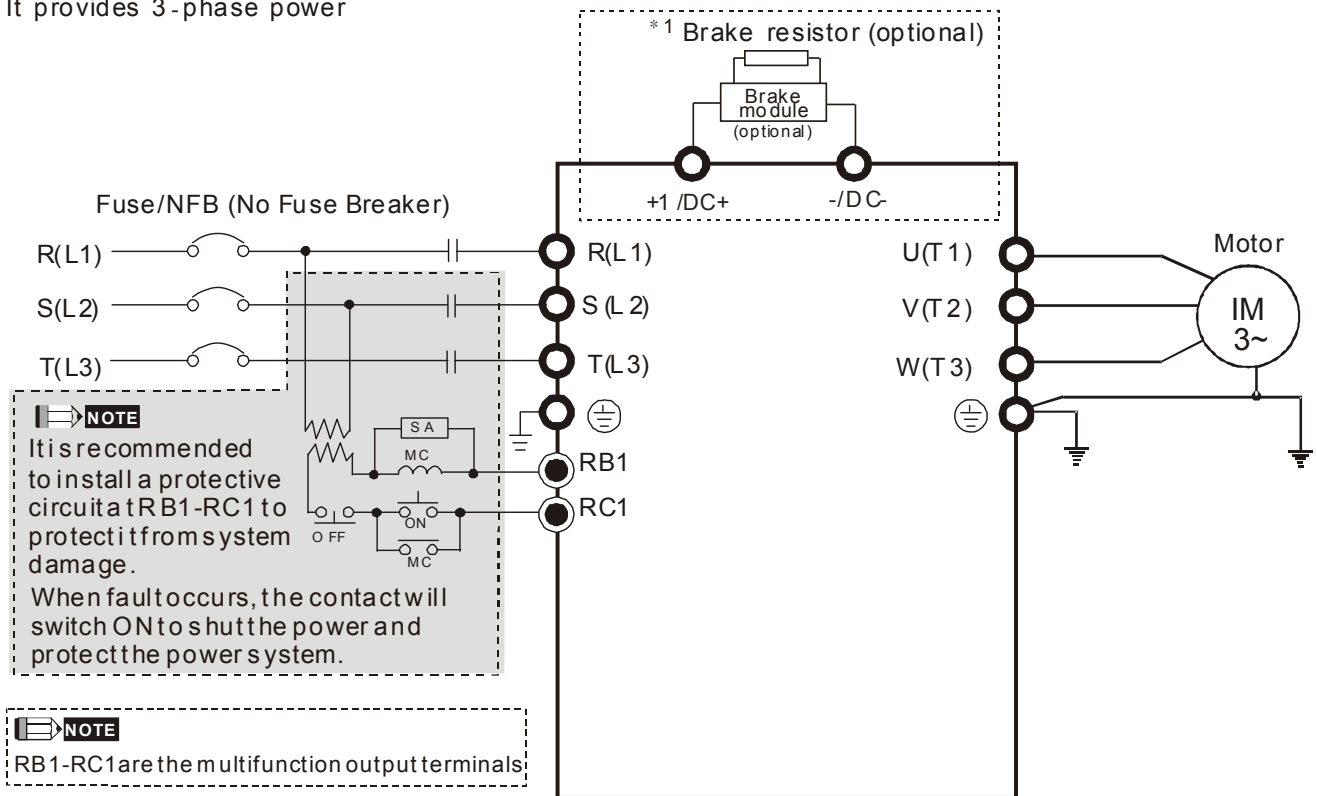

*1 Refer to Chapter 7-1 for detailed information about brake unit.

Frame B~D

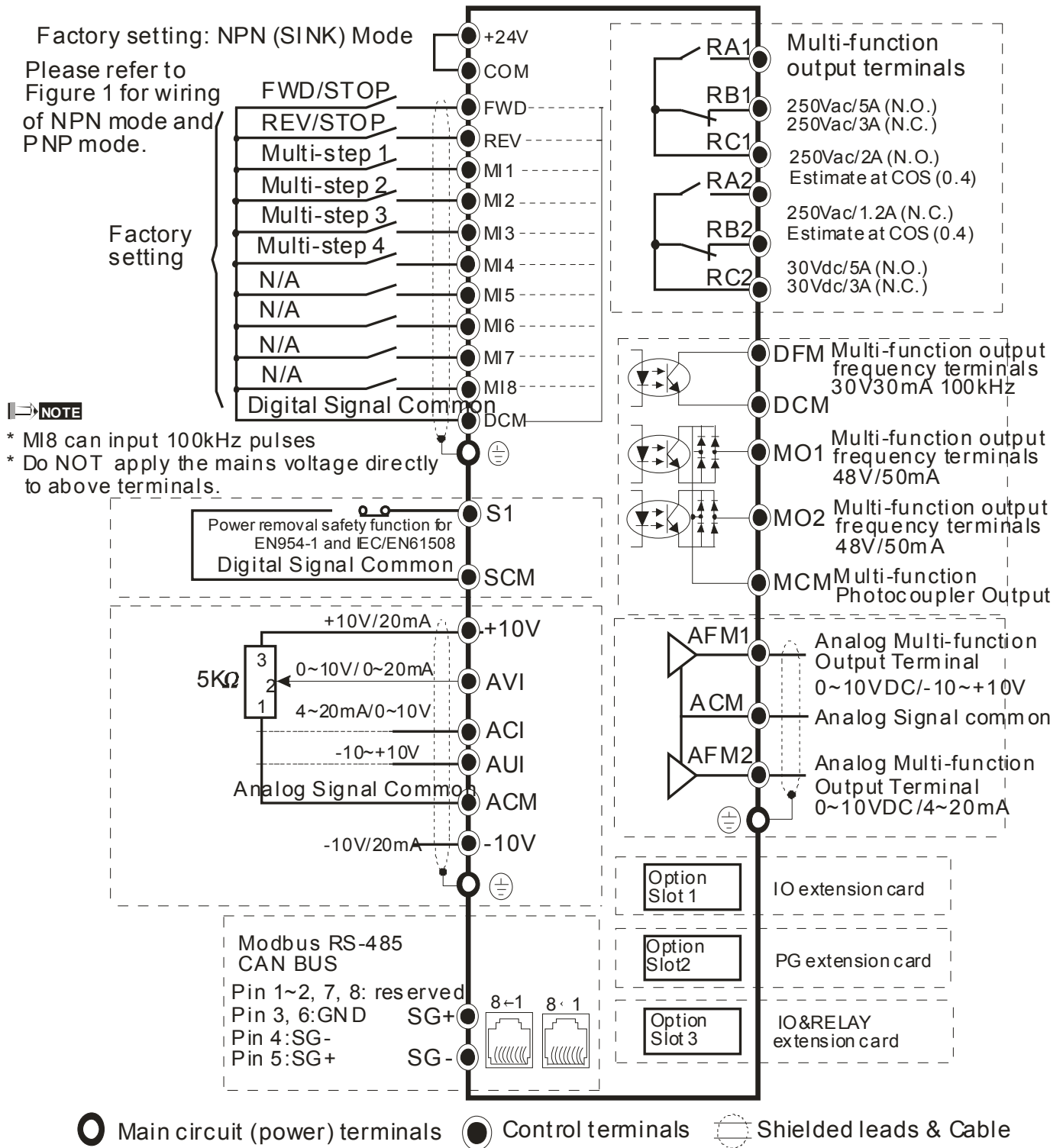
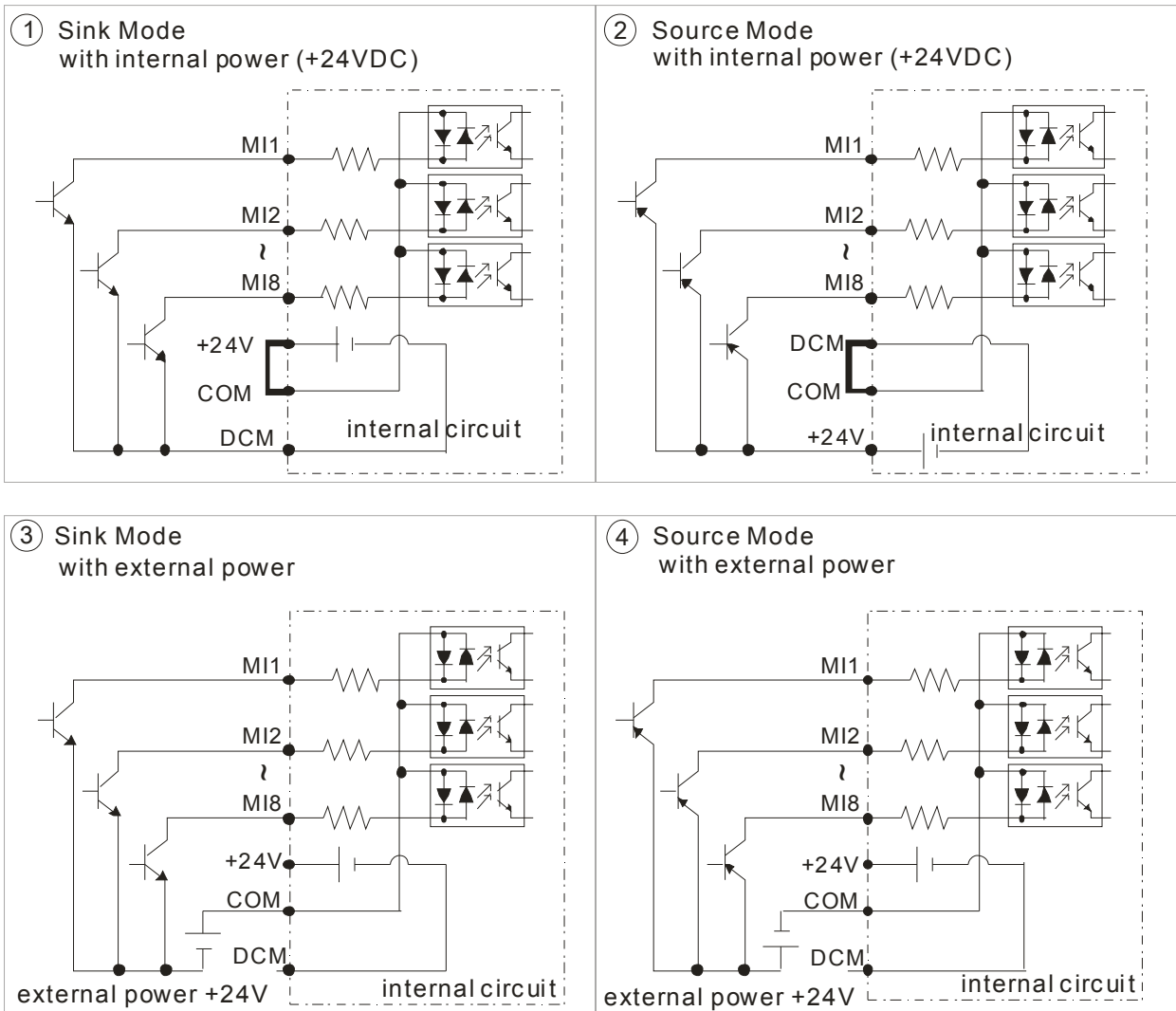
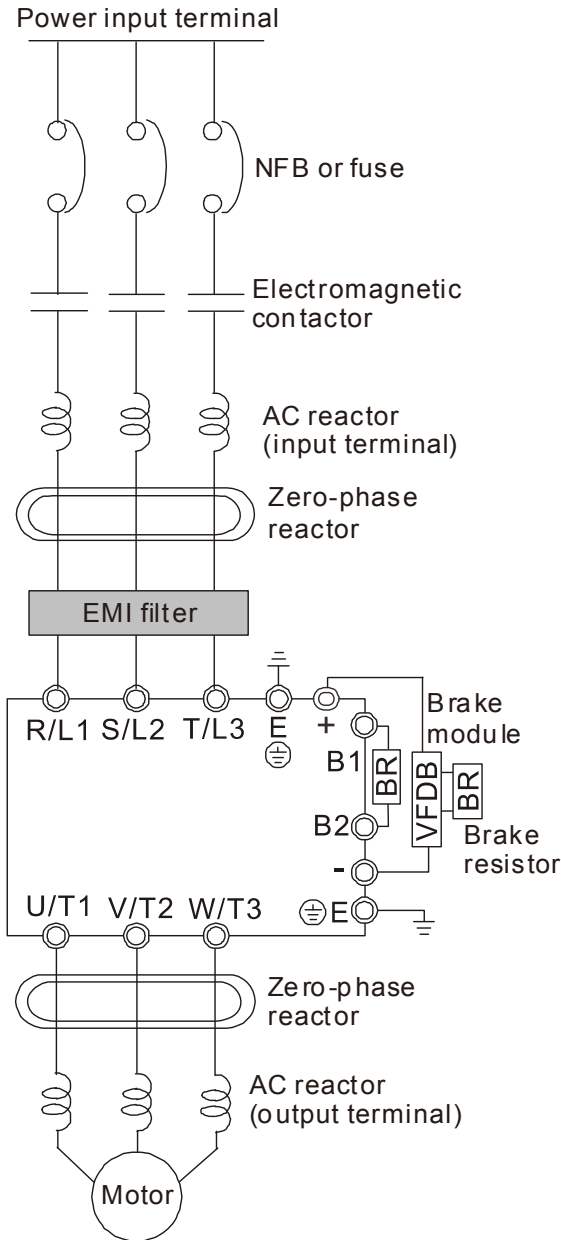

Figure 1

SINK (NPN) /SOURCE (PNP) Mode



4-2 System Wiring Diagram



Power input terminal	Supply power according to the rated power specifications indicated in the manual. (Refer to Chapter 9 Specification)
NFB or fuse	There may be a large inrush current during power on. Refer to Chapter 7-2 NFB to select a suitable NFB or fuse.
Electromagnetic contactor	Switching ON/OFF the primary side of the electromagnetic contactor can run the integrated elevator device ON/OFF, but frequent switching is a cause of machine failure. Do not switch ON/OFF more than once an hour. Do not use the electromagnetic contactor as the power switch for the integrated elevator drive; doing so will shorten the life of the integrated elevator drive.
AC reactor (input terminal)	When the main power supply capacity is greater than 500kVA, or when it switches into the phase capacitor, the instantaneous peak voltage and current generated will destroy the internal circuit of the integrated elevator drive. It is recommended to install an input side AC reactor in the integrated elevator drive. This will also improve the power factor and reduce power harmonics. The wiring distance should be within 10m. Refer to Chapter 7-4 for more information.
Zero-phase reactor	Used to reduce radiated interference, especially in environments with audio devices, and reduce input and output side interference. The effective range is AM band to 10MHz. Refer to Appendix 7-5 for more information.
EMI filter	Can be used to reduce electromagnetic interference.
Brake resistor & Brake module	Used to shorten deceleration time of the motor. Refer to Chapter 7-1 for more information.
AC reactor (output terminal)	The wiring length of the motor will affect the size of the reflected wave on the motor end. Refer to Chapter 7-4 for more information.

[This page intentionally left blank]

Chapter 5 Main Circuit Terminals



- ☑ Fasten the screws in the main circuit terminal to prevent sparks condition made by the loose screws due to vibration.
- ☑ When it needs to install the filter at the output side of terminals U/T1, V/T2, W/T3 on the AC motor drive. Please use inductance filter. Do not use phase-compensation capacitors or L-C (Inductance-Capacitance) or R-C (Resistance-Capacitance), unless approved by Delta.
- ☑ DO NOT connect phase-compensation capacitors or surge absorbers at the output terminals of AC motor drives.
- ☑ DO NOT connect [+1, -], [+2, -], [+1/DC+, -/DC-] or brake resistor directly to prevent drive damage.
- ☑ Follow related wiring safety regulations to ensure the isolation of main circuit.



Main power terminals

- ☑ Do not connect 3-phase model to one-phase power. R/L1, S/L2 and T/L3 has no phase-sequence requirement, it can be used upon random selection.
- ☑ It is recommend to add a magnetic contactor (MC) to the power input wiring to cut off power quickly and reduce malfunction when activating the protection function of the AC motor drive. Both ends of the MC should have an R-C surge absorber.
- ☑ Please use voltage and current within the specification.
- ☑ When using a general GFCI (Ground Fault Circuit Interrupter), select a current sensor with sensitivity of 200mA or above and not less than 0.1-second operation time to avoid nuisance tripping.
- ☑ Please use the shield wire or tube for the power wiring and ground the two ends of the shield wire or tube.
- ☑ Do NOT run/stop AC motor drives by turning the power ON/OFF.
Run/stop AC motor drives by RUN/STOP command via control terminals or keypad. If you still need to run/stop AC motor drives by turning power ON/OFF, it is recommended to do so only ONCE per hour.
- ☑ Type of electrical supply system (3WYE) to which the drive shall be connected.

Output terminals for main circuit

- ☑ Use well-insulated motor, suitable for inverter operation.
- ☑ Note down the rated data and the torque force of the wiring when the output terminal is below 75°C. This information provides the right wiring method to wire terminals (It corresponds to the terminals of the motor wire and non-motor wire).

- When the AC drive output terminals U/T1, V/T2, and W/T3 are connected to the motor terminals U/T1, V/T2, and W/T3, respectively, the motor will rotate counterclockwise (as viewed on the shaft end of the motor) when a forward operation command is received. To permanently reverse the direction of motor rotation, switch over any of the two motor leads

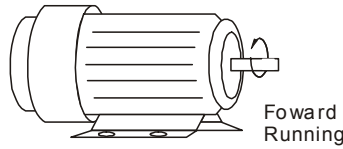

Terminals for connecting DC reactor, external brake resistor, external brake resistor and DC circuit (brake unit or common DC bus connection)

- This is the terminals used to connect the DC reactor to improve the power factor. For the factory setting, it connects the short-circuit object. Please remove this short-circuit object before connecting to the DC reactor.

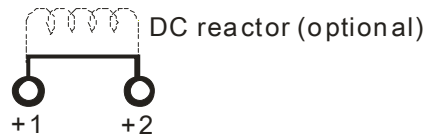

- Connect a brake resistor or brake unit in applications with frequent deceleration ramps, short deceleration time, too low brake torque or requiring increased brake torque.

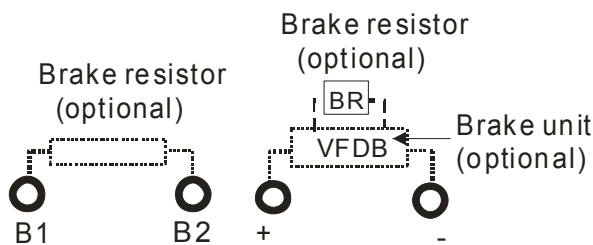

- The external brake resistor of Frame A, B and C should connect to the terminals (B1, B2) of AC motor drives.
- For those models without built-in brake resistor, please connect external brake unit and brake resistor (both of them are optional) to increase brake torque.
- When the terminals +1, +2 and - are not used, please leave the terminals open.
- DC+ and DC- are connected by common DC bus, please refer to Chapter 5-1(Main Circuit Terminal) for the wiring terminal specification and the wire gauge information.
- Please refer to the VFDB manual for more information on wire gauge when installing the brake unit.

Main Circuit Diagram 1

For frame B~C

* Provide 3-phase input power

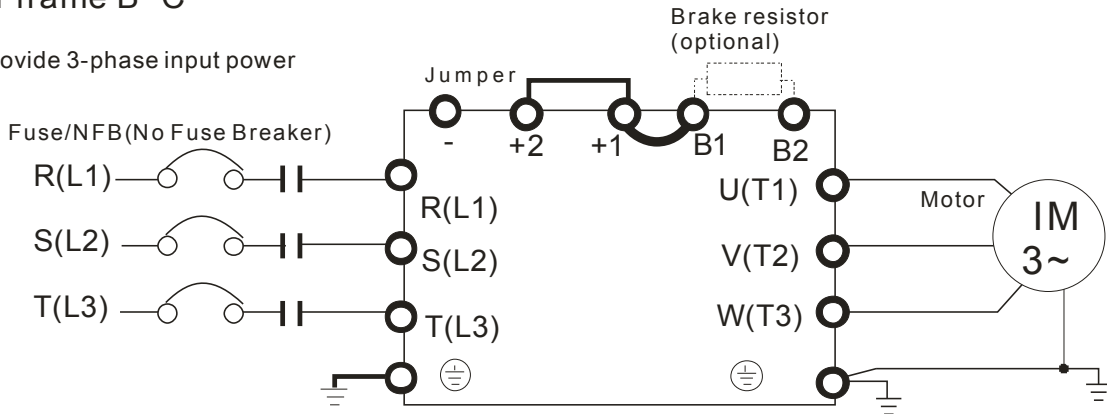

For frame B~C

* Provide 3-phase input power

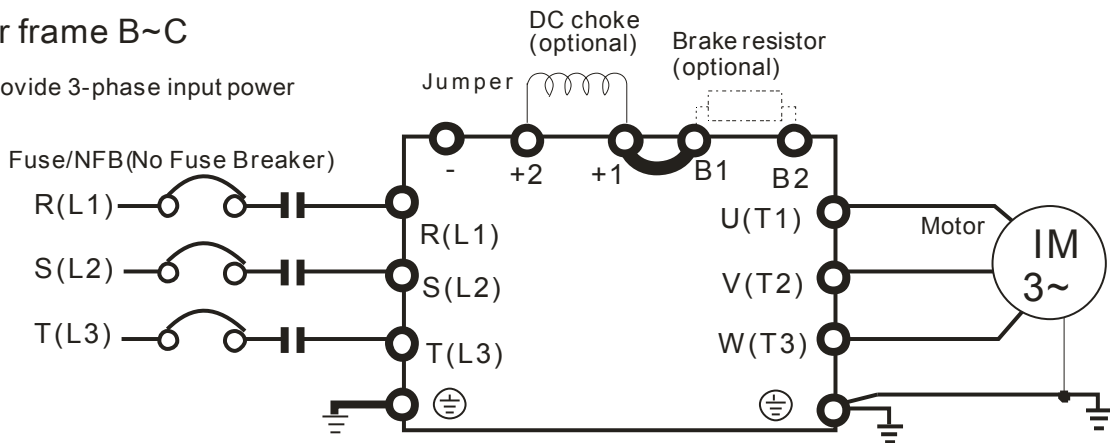

Main Circuit Diagram 2

For frame D

* Provide 3-phase input power

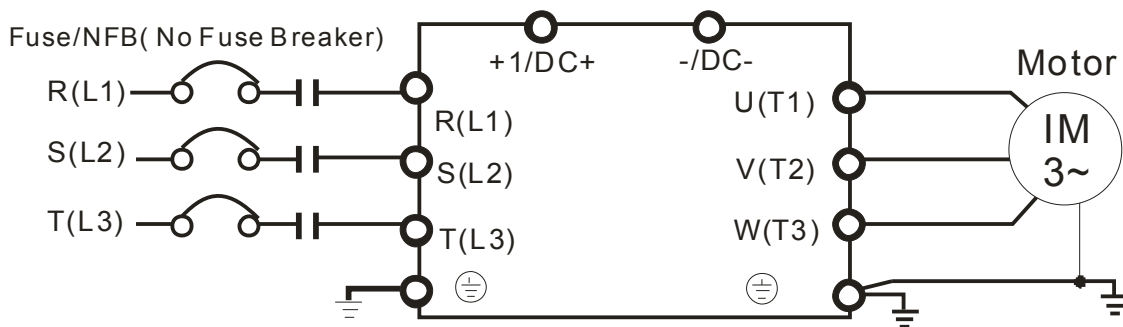

Terminals	Descriptions
R/L1, S/L2, T/L3	AC line input terminals 3-phase
U/T1, V/T2, W/T3	AC drive output terminals for connecting 3-phase induction motor
+1, +2	Applicable to frame B~C Connections for DC reactor to improve the power factor. It needs to remove the jumper for installation.
+1/DC+, -/DC-	Connections for brake unit (VFDB series) (for 460V models: $\leq 30\text{kW}$, built-in brake unit) Common DC Bus
B1, B2	Connections for brake resistor (optional)
⊕	Earth connection, please comply with local regulations.

Main Circuit Terminals

Frame B

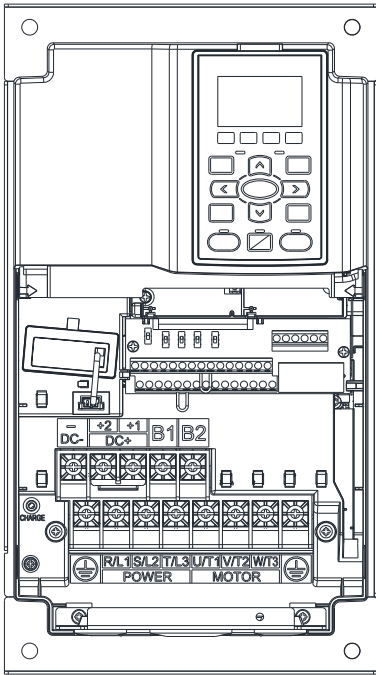

Main circuit terminals:

R/L1, S/L2, T/L3, U/T1, V/T2, W/T3, ⊕, B1, B2, +1, +2, -

Models	Max. Wire Gauge	Min. Wire Gauge	Torque
VFD110CT43F00B	4 AWG (21.2mm ²)	8 AWG (8.4mm ²)	M5 35kg-cm (30.4 lb-in.) (3.434Nm)
VFD150CT43F00B		6 AWG (13.3mm ²)	
VFD185CT43F00B		4 AWG (21.2mm ²)	
VFD110CT43A21C		8 AWG (8.4mm ²)	
VFD150CT43A21C		6 AWG (13.3mm ²)	
VFD185CT43A21C		4 AWG (21.2mm ²)	

UL installations must use 600V, 75°C or 90°C wire. Use copper wire only.

NOTE

Terminal D+ [+2 & +1]: Torque: 45 kg-cm [39.0lb-in.] (4.415Nm) (±10%)

1. VFD110C23A must use 600V, 90°C wire when surrounding temperature exceeds 45°C.
2. Figure 1 shows the terminal specification.
3. Figure 2 shows the specification of insulated heat shrink tubing that comply with UL (600V, YDPU2).

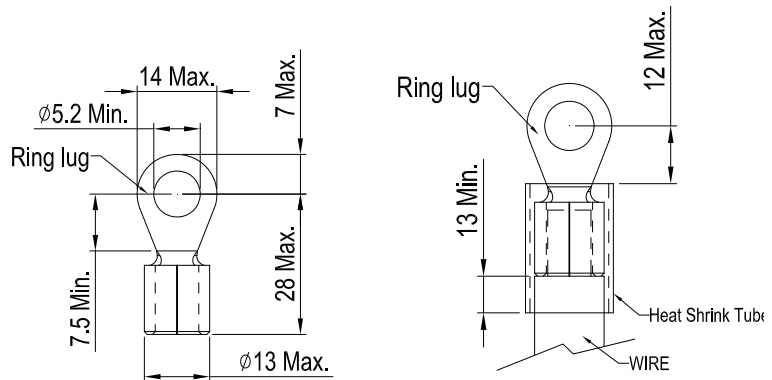

Unit: mm

Frame C

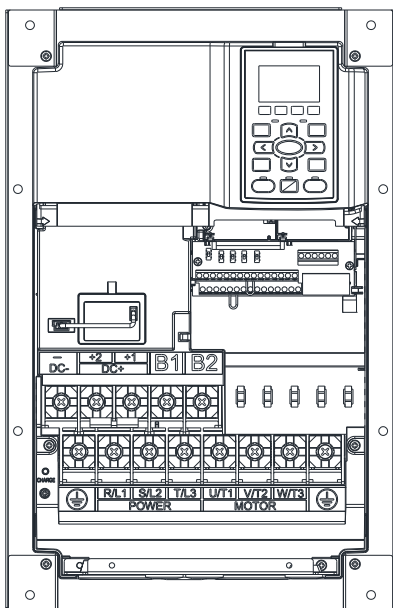

Main circuit terminals:

R/L1, S/L2, T/L3, U/T1, V/T2, W/T3, ⊕, B1, B2, +1, +2, -

Models	Max. Wire Gauge	Min. Wire Gauge	Torque
VFD220CT43F00B	1/0 AWG (53.5mm ²)	4 AWG (21.2mm ²)	M8 80kg-cm (69.4 lb-in.) (7.85Nm)
VFD300CT43F00B		2 AWG (33.6mm ²)	
VFD370CT43F00B		1/0 AWG (53.5mm ²)	
VFD220CT43A21C		4 AWG (21.2mm ²)	
VFD300CT43A21C		2 AWG (33.6mm ²)	
VFD370CT43A21C		1/0 AWG (53.5mm ²)	

UL installations must use 600V, 75°C or 90°C wire. Use copper wire only.

NOTE

Terminal D+ [+2 & +1]: Torque: 90 kg-cm [78.2lb-in.] (8.83Nm) (±10%)

1. VFD220C23A must use 600V, 90°C wire when surrounding temperature exceeds 40°C.
2. Figure 1 shows the terminal specification.
3. Figure 2 shows the specification of insulated heat shrink tubing that comply with UL (600V, YDPU2).

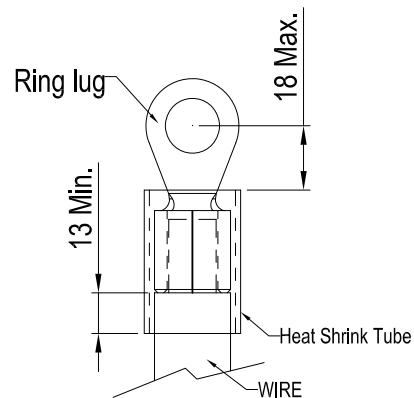
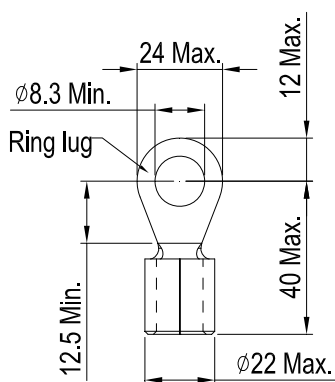

Unit: mm

Frame D

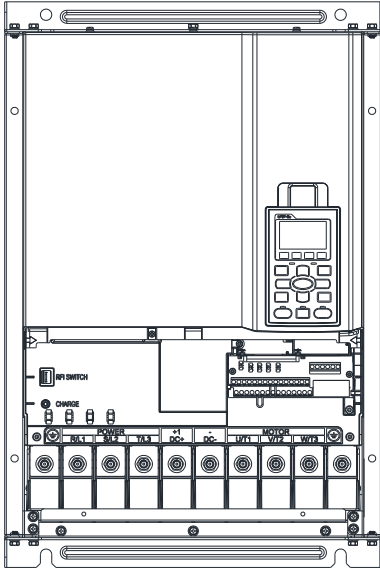

Main circuit terminals:

R/L1, S/L2, T/L3, U/T1, V/T2, W/T3, ⊕, +1/DC+, -/DC-

Models	Max. Wire Gauge	Min. Wire Gauge	Torque
VFD750CT43F00A6;	300MCM (152mm ²)	250MCM (127mm ²)	M8 200kg-cm (173 lb-in.) (19.62Nm)
VFD900CT43F00A8;		300MCM (152mm ²)	
VFD450CT43F00B		2/0 AWG (67.4mm ²)	
VFD550CT43F00B		3/0 AWG (85mm ²)	
VFD450CT43A21C		2/0 AWG (67.4mm ²)	
VFD550CT43A21C		3/0 AWG (85mm ²)	

1. UL installations must use 600V, 75°C or 90°C wires. Use copper wire only.
2. Figure 1 shows the terminal specification.
3. Figure 2 shows the specification of insulated heat shrink tubing that comply with UL (600V, YDPU2).

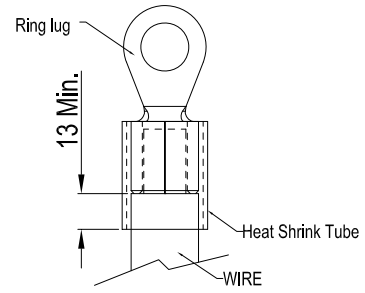
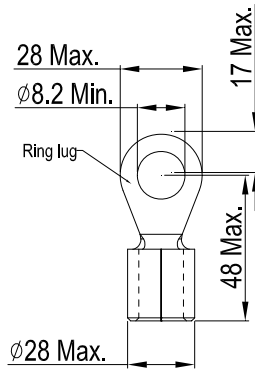

Unit: mm

Chapter 6 Control Terminals



Analog input terminals (AVI, ACI, AUI, ACM)

- ☑ Analog input signals are easily affected by external noise. Use shielded wiring and keep it as short as possible (<20m) with proper grounding. If the noise is inductive, connecting the shield to terminal ACM can bring improvement.
- ☑ When inputting analog signal in a circuit, use twisted pairs to handle weak signals.
- ☑ If the analog input signals are affected by noise from the AC motor drive, please connect a capacitor and ferrite core as indicated in the following diagram.

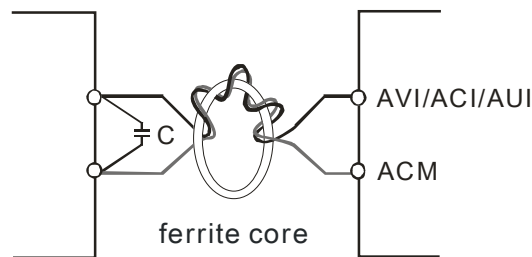

Wind each wires 3 times or more around the core

Digital inputs (FWD, REV, MI1~MI8, COM)

- ☑ When using contacts or switches to control the digital inputs, please use high quality components to avoid contact bounce.

Transistor outputs (MO1, MO2, MCM)

- ☑ Make sure to connect the digital outputs to the right polarity.
- ☑ When connecting a relay to the digital outputs connect a surge absorber across the coil and check the polarity.

Please remove the top cover before wiring the multi-function input and output terminals,

The drive appearances shown in the figures are for reference only, a real drive may look different.

Remove the cover for wiring.

Frame B

Loosen the screws and press the tabs on both sides to remove the cover.

Screw torque: 12~15Kg-cm [10.4~13lb-in.]

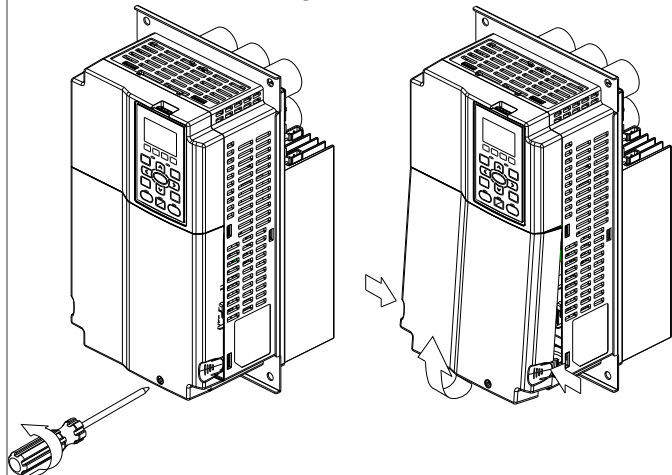

Frame C

Loosen the screws and press the tabs on both sides to remove the cover.

Screw torque: 12~15Kg-cm [10.4~13lb-in.]

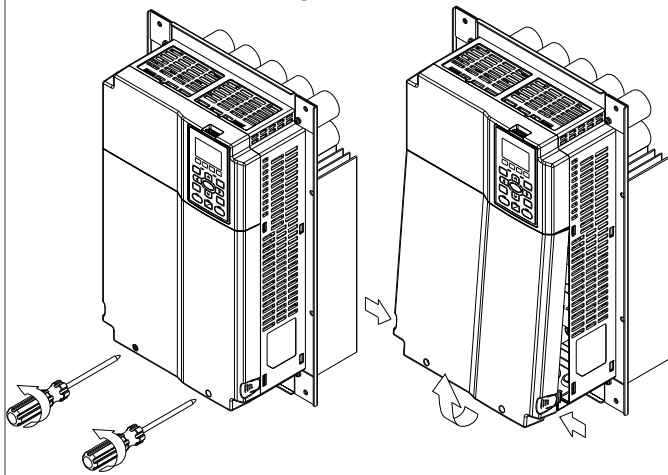

Frame D

Loosen the screws and press the tabs on both sides to remove the cover.

Screw torque: 12~15Kg-cm [10.4~13lb-in.]

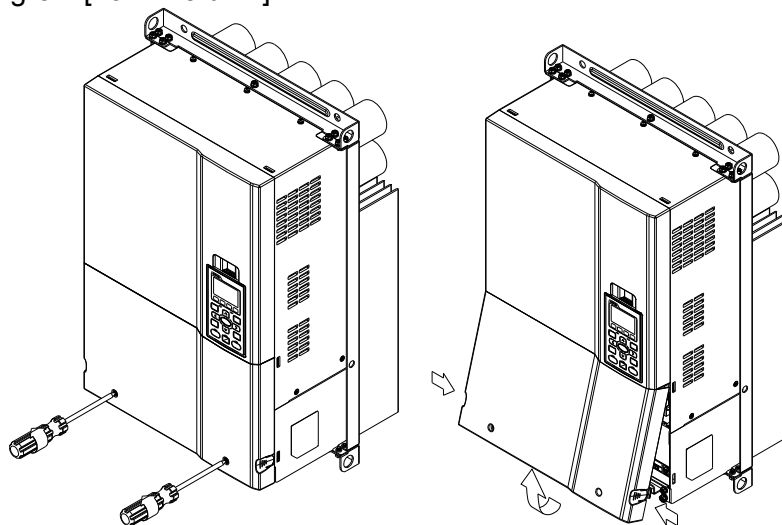

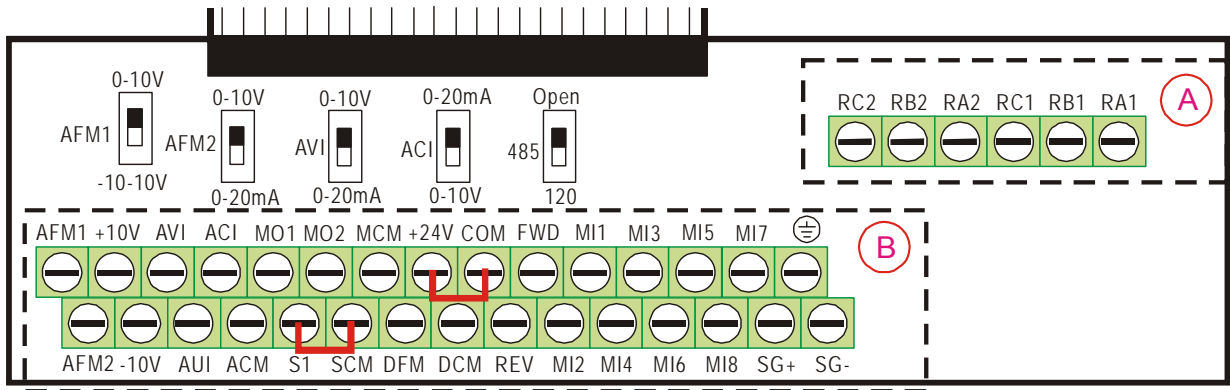

Removable Terminal Block

Specifications of Control Terminal

Wire Gauge: 26~16AWG (0.1281-1.318mm²)

Torque: Ⓐ 5kg-cm [4.31lb-in.] (0.49Nm) (As shown in figure above)

Ⓑ 8kg-cm [6.94lb-in.] (0.78Nm) (As shown in figure above)

Wiring precautions:

- Properly install signal & control cable into the terminal; fasten the installation by a slotted screwdriver. If the wire is stripped, sort the wire before install into the terminal. Noted that bare signal cable should reserve at least 5mm to prevent from occurring bad connection and signal cable comes off.
- Flathead screwdriver: blade width 3.5mm, tip thickness 0.6mm
- In the figure above, the factory setting for S1, SCM is short circuit. The factory setting for +24V-COM is short circuit and SINK mode (NPN); please refer to Chapter 4 Wiring for more detail.

Terminals	Terminal Function	Factory Setting (NPN mode)
+24V	Digital control signal common (Source)	+24V±5% 200mA
COM	Digital control signal common (Sink)	Common for multi-function input terminals
FWD	Forward-Stop command	FWD-DCM: ON → forward running OFF → deceleration to stop
REV	Reverse-Stop command	REV-DCM: ON → reverse running OFF → deceleration to stop
MI1 ~ MI8	Multi-function input 1~8	Refer to parameters 02-01~02-08 to program the multi-function inputs MI1~MI8. ON: the activation current is 6.5mA ≥ 11Vdc OFF: leakage current tolerance is 10µA ≤ 11Vdc
DFM	Digital frequency meter	Regard the pulse voltage as the output monitor signal Duty-cycle: 50% Min. load impedance: 1kΩ/100pf Max. current: 30mA
DCM	Digital frequency signal common	Max. voltage: 30Vdc

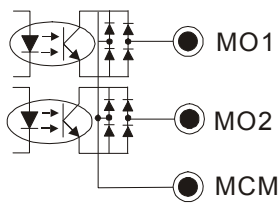
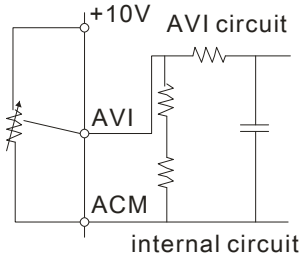
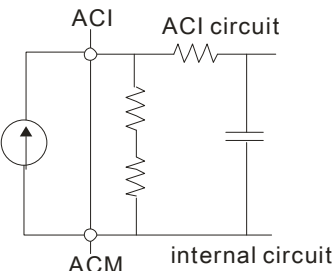
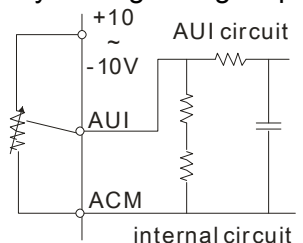
Terminals	Terminal Function	Factory Setting (NPN mode)
MO1	Multi-function Output 1 (photocoupler)	<p>The AC motor drive releases various monitor signals, such as drive in operation, frequency attained and overload indication, via transistor (open collector).</p> 
MO2	Multi-function Output 2 (photocoupler)	
MCM	Multi-function Output Common	
RA1	Multi-function relay output 1 (N.O.) a	<p>Resistive Load: 5A(N.O.)/3A(N.C.) 250VAC 5A(N.O.)/3A(N.C.) 30VDC</p> <p>Inductive Load (COS 0.4): 2.0A(N.O.)/1.2A(N.C.) 250VAC 2.0A(N.O.)/1.2A(N.C.) 30VDC</p> <p>It is used to output each monitor signal, such as drive is in operation, frequency attained or overload indication.</p>
RB1	Multi-function relay output 1 (N.C.) b	
RC1	Multi-function relay common	
RA2	Multi-function relay output 2 (N.O.) a	
RB2	Multi-function relay output 2 (N.C.) b	
RC2	Multi-function relay common	
+10V	Potentiometer power supply	Analog frequency setting: +10Vdc 20mA
-10V	Potentiometer power supply	Analog frequency setting: -10Vdc 20mA
AVI	<p>Analog voltage input</p> 	<p>Impedance: 20kΩ</p> <p>Range: 4 ~ 20mA/0~10V =0~Max. Output Frequency (Pr.01-00)</p> <p>AVI switch, factory setting is 0~10V</p>
ACI	<p>Analog current input</p> 	<p>Impedance: 250Ω</p> <p>Range: 4 ~ 20mA/0~10V= 0 ~ Max. Output Frequency (Pr.01-00)</p> <p>ACI Switch, factory setting is 4~20mA</p>
AUI	<p>Auxiliary analog voltage input</p> 	<p>Impedance: 20kΩ</p> <p>Range: -10~+10VDC=0 ~ Max. Output Frequency(Pr.01-00)</p>

Terminals	Terminal Function	Factory Setting (NPN mode)
AFM1		0~10V impedance 100kΩ (voltage output) -10~10V impedance 100kΩ (voltage output) Output current: 2mA max Resolution: 0~10V corresponds to Max. operation frequency Range: 0~10V → -10~+10V AFM Switch, factory setting is 0~10V
AFM2		0~10V impedance 100kΩ (voltage output) 0~20mA impedance 100Ω (current output) Output current: 20mA max Resolution: 0~10V corresponds to Max. operation frequency Range: 0~10V → 4~20mA AFM Switch, factory setting is 0~10V
ACM	Analog Signal Common	Common for analog terminals
S1	Factory setting is in short condition	
SCM		
SG+	Modbus RS-485	
SG-	PIN 1,2,7,8: Reserved PIN 4: SG-	PIN 3, 6: GND PIN 5: SG+

NOTE: Wire size of analog control signals: 18 AWG (0.75 mm²) with shielded wire

Remove the Terminal Block

1. Loosen the screws by screwdriver. (As shown in figure below).

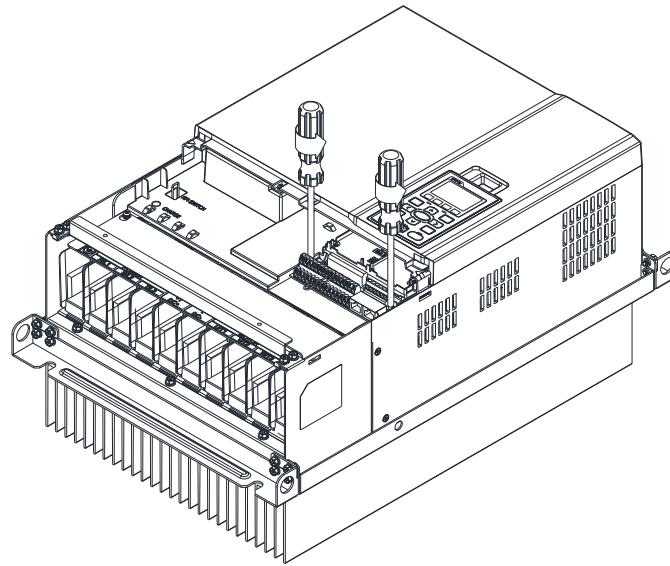

2. Remove the control board by pulling it out for a distance 6~8 cm (as 1 in the figure) then lift the control board upward (as 2 in the figure).

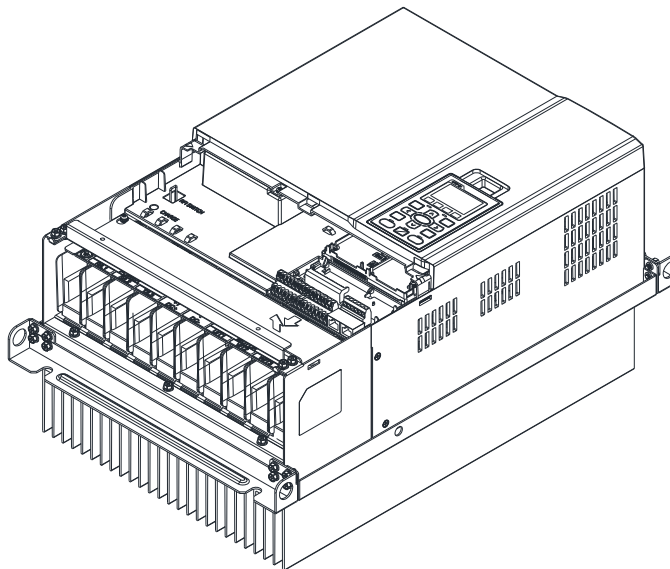

Chapter 7 Optional Accessories

The optional accessories listed in this chapter are available upon request. Installing additional accessories to your drive would substantially improve the drive's performance. Please select an applicable accessory according to your need or contact the local distributor for suggestion.

- All Brake Resistors and Brake Units Used in AC Motor Drives
- Non-fuse Circuit Breaker
- Fuse (Specification Chart)
- AC/DC Reactor
- Zero Phase Reactor
- EMI Filter
- Digital Keypad
- Panel Mounting
- Fan Kit
- USB/RS-485 Communication Interface IFD6530

7-1 All Brake Resistors and Brake Units Used in AC Motor Drives

460V

Applicable Motor		*1 125%Braking Torque 10%ED					*2 Max. Brake Torque			
HP	kW	Braking Torque (kg-m)	Brake Unit *4VFDB	*3Braking Resistor series for each Brake Unit		Resistor value spec. for each AC motor Drive	Total Braking Current (A)	Min. Resistor Value (Ω)	Max. Total Braking Current (A)	Peak Power (kW)
				15	11					
20	15	10.2	-	BR1K0W016*2	2 series	2000W32Ω	24	26.2	29	22.0
25	18	12.2	-	BR1K0W016*2	2 series	2000W32Ω	24	23.0	33	25.1
30	22	14.9	-	BR1K5W013*2	2 series	3000W26Ω	29	23.0	33	25.1
40	30	20.3	-	BR1K0W016*4	2 parallel, 2 series	4000W16Ω	47.5	14.1	54	41.0
50	40	25.1	4045*1	BR1K2W015*4	2 parallel, 2 series	4800W15Ω	50	12.7	60	45.6
60	45	30.5	4045*1	BR1K5W013*4	2 parallel, 2 series	6000W13Ω	59	12.7	60	45.6
75	55	37.2	4030*2	BR1K0W5P1*4	4 parallel	8000W10.2Ω	76	9.5	80	60.8
100	75	50.8	4045*2	BR1K2W015*4	2 parallel, 2 series	9600W7.5Ω	100	6.3	120	91.2
125	90	60.9	4045*2	BR1K5W013*4	2 parallel, 2 series	12000W6.5Ω	117	6.3	120	91.2

*1 Calculation for 125% brake torque: (kw)*125%*0.8; where 0.8 is motor efficiency.

Because there is a resistor limit of power consumption, the longest operation time for 10%ED is 10sec (on: 10sec/ off: 90sec).

*2 Please refer to the Brake Performance Curve for "Operation Duration & ED" vs. "Braking Current".

*3 For heat dissipation, a resistor of 400W or lower should be fixed to the frame and maintain the surface temperature below 50°C; a resistor of 1000W and above should maintain the surface temperature below 350°C.

*4 Please refer to VFDB series Braking Module Instruction for more detail on braking resistor.

 **NOTE**

1. Definition for Brake Usage ED%

Explanation: The definition of the brake usage ED (%) is for assurance of enough time for the brake unit and brake resistor to dissipate away heat generated by braking. When the brake resistor heats up, the resistance would increase with temperature, and brake torque would decrease accordingly. Recommended cycle time is one minute.

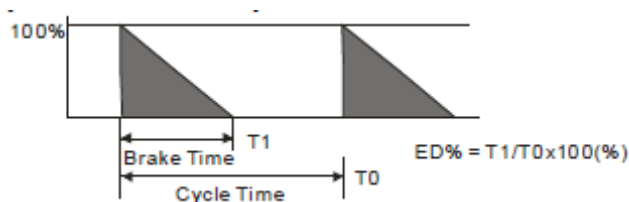

For safety concern, install an overload relay (O.L) between the brake unit and the brake resistor in conjunction with the magnetic contactor (MC) prior to the drive for abnormal protection. The purpose of installing the thermal overload relay is to protect the brake resistor from damage due to frequent brake, or due to brake unit keeping operating resulted from unusual high input voltage. Under such circumstance, just turn off the power to prevent damaging the brake resistor.

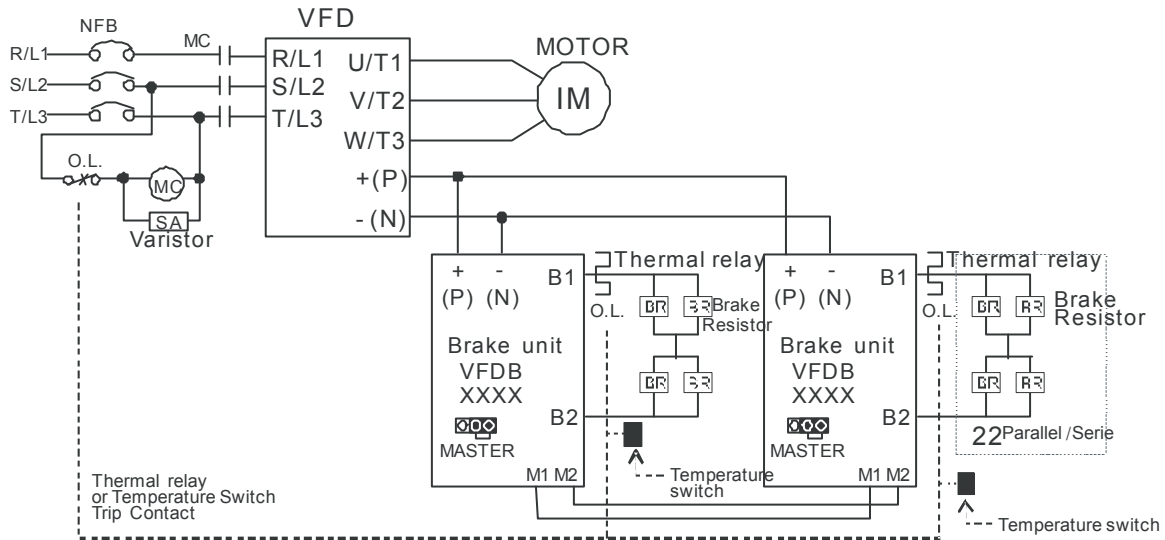

- When AC Drive is equipped with a DC reactor, please read user manual to know the wiring method of input circuit of brake unit +(P).
- Do Not connect input circuit -(N) to the neutral point of the power system.

2. If damage to the drive or other equipment is due to the fact that the brake resistors and brake modules in use are not provided by Delta, the warranty will be void.
3. Take into consideration the safety of the environment when installing the brake resistors. If the minimum resistance value is to be utilized, consult local dealers for the calculation of Watt figures.
4. When using more than 2 brake units, equivalent resistor value of parallel brake unit can't be less than the value in the column "Minimum Equivalent Resistor Value for Each AC Drive" (the right-most column in the table). Please read the wiring information in the user manual of brake unit thoroughly prior to operation
5. This chart is for normal usage; if the AC motor drive is applied for frequent braking, it is suggested to enlarge 2~3 times of the Watts.
6. Thermal Relay:

Thermal relay selection is basing on its overload capability. A standard braking capacity for C2000 is 10%ED (Tripping time=10s). The figure below is an example of 406V, 110kw AC motor drive. It requires the thermal relay to take 260% overload capacity in 10s (Host starting) and the braking current is 126A. In this case, user should select a rated 50A thermal relay. The property of each thermal relay may vary among different manufacturer, please carefully read specification.

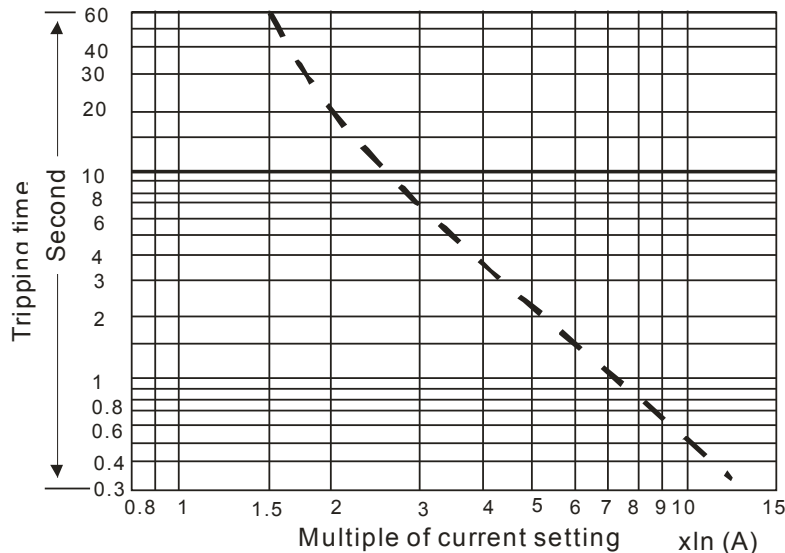

7-2 Non-fuse Circuit Breaker

Comply with UL standard: Per UL 508, paragraph 45.8.4, part a,
The rated current of the breaker shall be 1.6~2.6 times of the maximum rated input current of AC motor drive.

3-phase 460V	
Model	Recommended non-fuse breaker (A)
VFD110CT43F00B VFD110CT43A21C	50
VFD150CT43F00B VFD150CT43A21C	60
VFD185CT43F00B VFD185CT43A21C	75
VFD220CT43F00B VFD220CT43A21C	100
VFD300CT43F00B VFD300CT43A21C	125
VFD370CT43F00B VFD370CT43A21C	150
VFD450CT43F00B VFD450CT43A00C	175
VFD550CT43F00B VFD550CT43F00C	250
VFD750CT43F00A6	300
VFD900CT43F00A8	300

7-3 Fuse Specification Chart

- Use only the fuses comply with UL certificated.
- Use only the fuses comply with local regulations.

460VModel	Input Current I (A)		Line Fuse	
	Heavy Duty	Normal Duty	I (A)	Bussmann P/N
VFD110CT43F00B	17	24	50	JJS-50
VFD110CT43A21C	17	24	50	JJS-50
VFD150CT43F00B	23	32	60	JJS-60
VFD150CT43A21C	23	32	60	JJS-60
VFD185CT43F00B	30	38	75	JJS-75
VFD185CT43A21C	30	38	75	JJS-75
VFD220CT43F00B	36	45	100	JJS-100
VFD220CT43A21C	36	45	100	JJS-100
VFD300CT43F00B	43	60	125	JJS-125
VFD300CT43A21C	43	60	125	JJS-125
VFD370CT43F00B	57	73	150	JJS-150
VFD370CT43A21C	57	73	150	JJS-150
VFD450CT43F00B	69	91	175	JJS-175
VFD450CT43A00C	69	91	175	JJS-175
VFD550CT43F00B	86	110	225	JJS-225
VFD550CT43F00C	86	110	225	JJS-225
VFD750CT43F00A6;	105	150	300	JJS-300
VFD900CT43F00A8;	143	180	300	JJS-300

7-4 AC/DC Reactor

AC Input Reactor

When the AC Motor Drive is connected directly to a large-capacity power transformer (500kVA or above) or when a phase lead capacitor is switched, excess peak currents may occur in the power input circuit due to the load changes and the converter section may be damaged. To avoid this, it is recommend using a serial connected AC input reactor at the AC Motor Drive mains input side to reduce the current and improve the input power efficiency.

Method of set up

AC input reactor sets up between electric power and R, S, T which are at three-phase input side of AC motor drive in series-connected way. See the figure below:

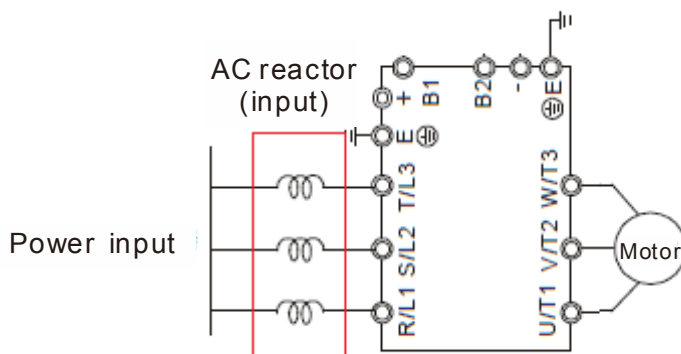

AC input reactor setup

Specifications of AC input reactors (standard item)

The following table shows the specifications of AC input reactors (standard items) for Delta CT2000 series products, and their part numbers to choose:

380V~460V/ 50~60Hz

Model	HP	Rated Amps (Arms)		Max. continuous Amps (Apeak)		3% reactor (mH)		5% reactor (mH)		Built-in DC reactor	3% input reactor Delta part#	
		Light Duty	Heavy Duty	Light Duty	Heavy Duty	Light Duty	Heavy Duty	Light Duty	Heavy Duty		Light Duty	Heavy Duty
VFD750CT43F00A6	100	144	105	318	223	0.162	0.221	0.270	0.34	O	DR150AP162	DR110AP221
VFD900CT43F00A8	120	180	143	382	303	0.135	0.162	0.225	0.25	O	DR180AP135	DR150AP162
VFD110CT43F00B	15	24	17	41	36	0.881	1.174	1.468	2.07	X	DR024AP880	DR018A0117
VFD150CT43F00B	20	32	23	54	49	0.66	0.881	1.100	1.53	X	DR032AP660	DR024AP880
VFD185CT43F00B	25	38	30	64	64	0.639	0.66	1.065	1.17	X	DR038AP639	DR032AP660
VFD220CT43F00B	30	45	36	76	76	0.541	0.639	0.902	0.98	X	DR045AP541	DR038AP639
VFD300CT43F00B	40	60	43	102	91	0.405	0.541	0.675	0.82	X	DR060AP405	DR045AP541
VFD370CT43F00B	50	73	57	124	121	0.334	0.405	0.557	0.62	X	DR073AP334	DR060AP405
VFD450CT43F00B	60	91	69	154	146	0.267	0.334	0.445	0.51	X	DR091AP267	DR073AP334
VFD550CT43F00B	75	110	86	187	182	0.221	0.267	0.368	0.41	X	DR110AP221	DR091AP267

Model	HP	Rated Amps (Arms)		Max. continuous Amps (Apeak)		3% reactor (mH)		5% reactor (mH)		Built-in DC reactor	3% input reactor Delta part#	
		Light Duty	Heavy Duty	Light Duty	Heavy Duty	Light Duty	Heavy Duty	Light Duty	Heavy Duty		Light Duty	Heavy Duty
VFD110CT43A21C	15	24	17	41	36	0.881	1.174	1.468	2.07	X	DR024AP880	DR018A0117
VFD150CT43A21C	20	32	23	54	49	0.66	0.881	1.100	1.53	X	DR032AP660	DR024AP880
VFD185CT43A21C	25	38	30	64	64	0.639	0.66	1.065	1.17	X	DR038AP639	DR032AP660
VFD220CT43A21C	30	45	36	76	76	0.541	0.639	0.902	0.98	X	DR045AP541	DR038AP639
VFD300CT43A21C	40	60	43	102	91	0.405	0.541	0.675	0.82	X	DR060AP405	DR045AP541
VFD370CT43A21C	50	73	57	124	121	0.334	0.405	0.557	0.62	X	DR073AP334	DR060AP405
VFD450CT43A00C	60	91	69	154	146	0.267	0.334	0.445	0.51	X	DR091AP267	DR073AP334
VFD550CT43A00C	75	110	86	187	182	0.221	0.267	0.368	0.41	X	DR110AP221	DR091AP267

DC Reactor

DC reactor can increase the impedance, improve the power factor, decrease input current, increase system's capacity and decrease harmonic which generates from AC motor drive. Furthermore, DC reactor can steady the DC voltage of AC motor drive. Compare with the reactor which sets up at input side, it is small, lower price, and low pressure drop.

Method of set up

DC reactor sets up between +1 and +2 of the circuit, and the jumper should be removed. See the figure below:

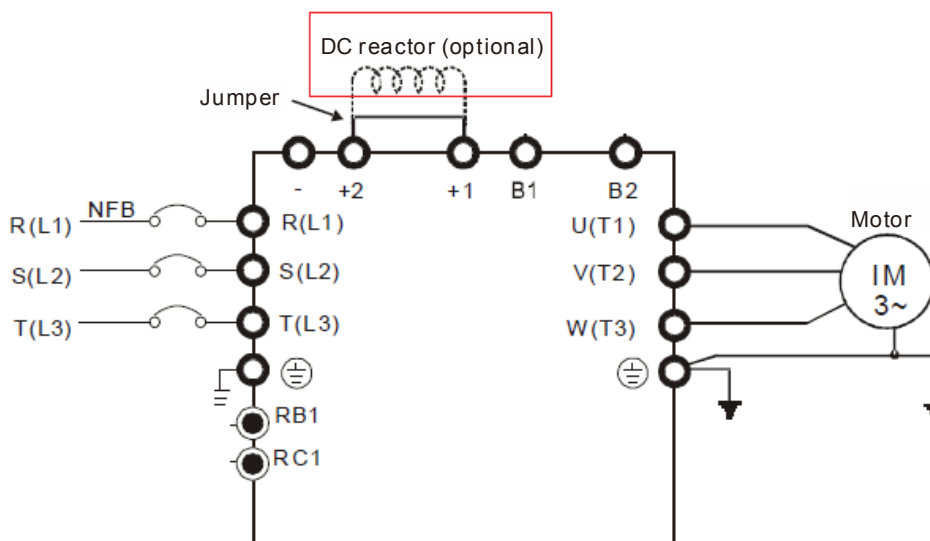

DC reactor setup

Specifications of DC reactors (standard item)

The following table shows the specifications of DC reactors (standard items) for Delta CT2000 series products.

380V~460V/ 50~60Hz

Model	HP	Rated Amps (Arms)		Max. continuous Amps (Apeak)		DC reactor (mH)		DC reactor Delta part#	
		Light Duty	Heavy Duty	Light Duty	Heavy Duty	Light Duty	Heavy Duty	Light Duty	Heavy Duty
VFD750CT43F00A6	100	144	105	207	181	0.374	0.535	N/A	N/A
VFD900CT43F00A8	120	180	143	248	247	0.312	0.393	N/A	N/A
VFD110CT43F00B	15	24	17	33	29	2.338	3.119	DR024D0233	DR018D0311
VFD150CT43F00B	20	32	23	44	40	1.754	2.338	DR032D0175	DR024D0233
VFD185CT43F00B	25	38	30	52	52	1.477	1.754	DR038D0147	DR032D0175
VFD220CT43F00B	30	45	36	62	62	1.247	1.477	DR045D0124	DR038D0147
VFD300CT43F00B	40	60	43	83	74	0.935	1.247	DR060DP935	DR045D0124
VFD370CT43F00B	50	73	57	101	98	0.769	0.935	N/A	DR060DP935
VFD450CT43F00B	60	91	69	126	119	0.617	0.813	N/A	N/A
VFD550CT43F00B	75	110	86	152	148	0.510	0.653	N/A	N/A
VFD110CT43A21C	15	24	17	33	29	2.338	3.119	DR024D0233	DR018D0311
VFD150CT43A21C	20	32	23	44	40	1.754	2.338	DR032D0175	DR024D0233
VFD185CT43A21C	25	38	30	52	52	1.477	1.754	DR038D0147	DR032D0175
VFD220CT43A21C	30	45	36	62	62	1.247	1.477	DR045D0124	DR038D0147
VFD300CT43A21C	40	60	43	83	74	0.935	1.247	DR060DP935	DR045D0124
VFD370CT43A21C	50	73	57	101	98	0.769	0.935	N/A	DR060DP935
VFD450CT43A00C	60	91	69	126	119	0.617	0.813	N/A	N/A
VFD550CT43A00C	75	110	86	152	148	0.510	0.653	N/A	N/A

The following table is spec. of THDi that Delta AC motor drives use with AC/DC reactors.

AC motor drive	Without built-in DC reactor (Frame A~C)				With built-in DC reactor (Frame D and above)		
	Without adding input AC/DC reactor	3% Input AC Reactor	5% Input AC Reactor	4% DC Reactor	Built-in DC reactor, and without adding input AC/DC reactor	3% Input AC Reactor	5% Input AC Reactor
5th	73.3%	38.5%	30.8%	25.5%	31.16%	27.01%	25.5%
7th	52.74%	15.3%	9.4%	18.6%	23.18%	9.54%	8.75%
11th	7.28%	7.1%	6.13%	7.14%	8.6%	4.5%	4.2%
13th	0.4%	3.75%	3.15%	0.48%	7.9%	0.22%	0.17%
THDi	91%	43.6%	34.33%	38.2%	42.28%	30.5%	28.4%
Note	THDi may have some difference due to different installation conditions and environment						

Specification of THDi

AC Output Reactor

If the length of cable between AC motor drive and motor is too long, it may make AC motor drive trigger protection mechanism for GF (Ground Fault), OV (Over Current) and the AC motor drive stops running. The cause is the over long motor cable will generate extremely large stray capacitance, make common mode current of 3-phase output get too large and then trigger GF protection mechanism; OC protection is triggered which is caused by stray capacitance of cable-cable and cable-ground are getting larger, and its surge current makes AC motor drive output over large current. To prevent from the common mode current that stray capacitance generates, set up AC output reactor between AC motor drive and motor to increase the high frequency impedance.

Power transistor is switched via PWM to control the output voltage and frequency for AC motor drive. During the switch process, impulse voltage (dv/dt) rises and falls rapidly will make inner voltage of motor distribute unequally, and then the isolation of motor will be getting worse, and have interference of bearing current and electromagnet. Especially when AC motor drive and motor are connected by long leading wire, the influence of damping of high frequency resonance and reflected voltage that caused by cable spreading parameters is getting large, and it will generate twice incoming voltage at motor side to be over voltage, destroy the isolation.

Method of set up

AC output reactor sets up between motor and U, V, W which are at output side of AC motor drive in series-connected way. See the figure below:

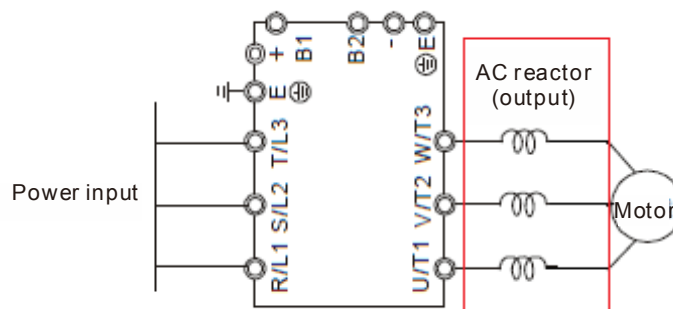

AC output reactor setup

Specifications of AC output reactors (standard item)

The following table shows the specifications of AC output reactors (standard items) and the part numbers of reactors (optional). Since high frequency occurs from the output will make huge iron loss, input and output reactors cannot use mutually.

380V~460V/ 50~60Hz

Model	HP	Rated Amps (Arms)		Max. continuous Amps (Apeak)		3% reactor (mH)		5% reactor (mH)		Built-in DC reactor	3% input reactor Delta part#	
		Light Duty	Heavy Duty	Light Duty	Heavy Duty	Light Duty	Heavy Duty	Light Duty	Heavy Duty		Light Duty	Heavy Duty
VFD750CT43F00A6	100	144	105	318	223	0.162	0.221	0.270	0.34	O	N/A	N/A
VFD900CT43F00A8	120	180	143	382	303	0.135	0.162	0.225	0.25	O	N/A	N/A
VFD110CT43F00B	15	24	17	41	36	0.881	1.174	1.468	2.07	X	N/A	N/A
VFD150CT43F00B	20	32	23	54	49	0.66	0.881	1.100	1.53	X	N/A	N/A
VFD185CT43F00B	25	38	30	64	64	0.639	0.66	1.065	1.17	X	N/A	N/A

Model	HP	Rated Amps (Arms)		Max. continuous Amps (Apeak)		3% reactor (mH)		5% reactor (mH)		Built-in DC reactor	3% input reactor Delta part#	
		Light Duty	Heavy Duty	Light Duty	Heavy Duty	Light Duty	Heavy Duty	Light Duty	Heavy Duty		Light Duty	Heavy Duty
VFD220CT43F00B	30	45	36	76	76	0.541	0.639	0.902	0.98	X	N/A	N/A
VFD300CT43F00B	40	60	43	102	91	0.405	0.541	0.675	0.82	X	N/A	N/A
VFD370CT43F00B	50	73	57	124	121	0.334	0.405	0.557	0.62	X	N/A	N/A
VFD450CT43F00B	60	91	69	154	146	0.267	0.334	0.445	0.51	X	N/A	N/A
VFD550CT43F00B	75	110	86	187	182	0.221	0.267	0.368	0.41	X	N/A	N/A
VFD110CT43A21C	15	24	17	41	36	0.881	1.174	1.468	2.07	X	N/A	N/A
VFD150CT43A21C	20	32	23	54	49	0.66	0.881	1.100	1.53	X	N/A	N/A
VFD185CT43A21C	25	38	30	64	64	0.639	0.66	1.065	1.17	X	N/A	N/A
VFD220CT43A21C	30	45	36	76	76	0.541	0.639	0.902	0.98	X	N/A	N/A
VFD300CT43A21C	40	60	43	102	91	0.405	0.541	0.675	0.82	X	N/A	N/A
VFD370CT43A21C	50	73	57	124	121	0.334	0.405	0.557	0.62	X	N/A	N/A
VFD450CT43A00C	60	91	69	154	146	0.267	0.334	0.445	0.51	O	N/A	N/A
VFD550CT43A00C	75	110	86	187	182	0.221	0.267	0.368	0.41	O	N/A	N/A

The length of motor cable

- Never connect phase lead capacitors or surge absorbers to the output terminals of the AC motor drive.
 - If the length is too long, the stray capacitance between cables will increase and may cause leakage current. It will activate the protection of over current, increase leakage current or not insure the correction of current display. The worst case is that AC motor drive may damage.
 - If more than one motor is connected to the AC motor drive, the total wiring length is the sum of the wiring length from AC motor drive to each motor.
 - For the 460V series AC motor drive, when an overload relay is installed between the drive and the motor to protect motor over heating, the connecting cable must be shorter than 50m. However, an overload relay malfunction may still occur. To prevent the malfunction, install an output reactor (optional) to the drive or lower the carrier frequency setting (Pr.00-17).
- When motor is driven by an AC motor drive of PWM type, the motor terminals will experience surge voltages easily due to components conversion of AC motor drive and cable capacitance. When the motor cable is very long (especially for the 460V series), surge voltages may reduce insulation quality. To prevent this situation, please follow the rules below:
 - Use a motor with enhanced insulation.
 - Connect an output reactor (optional) to the output terminals of the AC motor drive
 - The length of the cable between AC motor drive and motor should be as short as possible (10 to 20 m or less)

The following table refers to IEC 60034-17 shows specification of the length of shielding cable for CT2000 series motor. It applies to the motors which rated voltage is under 500Vac, peak-peak voltage isolation rating is above (including) 1.35kV:

Model	HP	Rated Amps (Arms)		Without output AC reactor		Output AC reactor	
		Light duty	Heavy duty	Shielding cable (meter)	Un-shielding cable (meter)	Shielding cable (meter)	Un-shielding cable (meter)
VFD110CT43F00B VFD110CT43A21C	15	22.5	17	100	150	150	225
VFD150CT43F00B VFD150CT43A21C	20	30	23	100	150	150	225
VFD185CT43F00B VFD185CT43A21C	25	36	30	100	150	150	225
VFD220CT43F00B VFD220CT43A21C	30	45	36	100	150	150	225
VFD300CT43F00B VFD300CT43A21C	40	56	43	100	150	150	225
VFD370CT43F00B VFD370CT43A21C	50	72	57	100	150	150	225
VFD450CT43F00B VFD450CT43A00C	60	91	69	150	225	225	325
VFD550CT43F00B VFD550CT43A00C	75	110	86	150	225	225	325
VFD750CT43F00A6	100	144	105	150	225	225	325
VFD900CT43F00A8	125	180	143	150	225	225	325

7-5 Zero Phase Reactors

RF220X00A

UNIT: mm (inch)

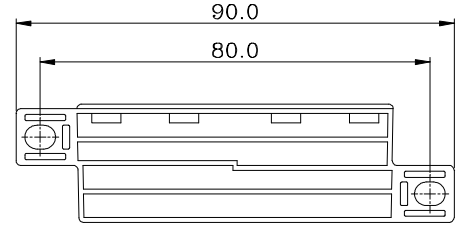
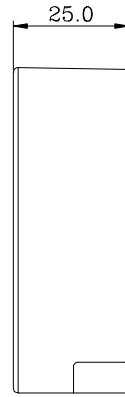
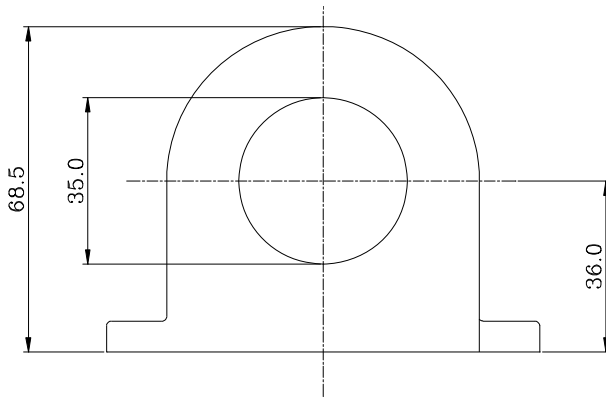

Cable type (Note)	Recommended Wire Size (mm ²)			Qty.	Wiring Method
	AWG	mm ²	Nominal (mm ²)		
Single-core	≤10	≤5.3	≤5.5	1	Diagram A
	≤2	≤33.6	≤38	4	Diagram B
Three-core	≤12	≤3.3	≤3.5	1	Diagram A
	≤1	≤42.4	≤50	4	Diagram B

Diagram A

Wind each wire around the core for 4 times. The reactor must be placed at the AC motor drive output side as close as possible.

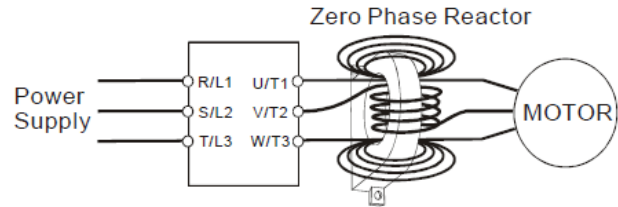

NOTE

600V insulated cable wire

1. The table above gives approximate wire size for the zero phase reactors but the selection is ultimately governed by the type and the diameter of the cable, i.e. the cable diameter must small enough to go through the center of the zero phase reactor.
2. When wiring, do not goes through the earth core. It only needs to pass through the motor cable or the power cable.
3. When a long motor cable for output is used, a zero phase reactor may be necessary to reduce the radiated emission.

Diagram B

Put the wires/cables through the middle of the 4 cores that lines in parallel.

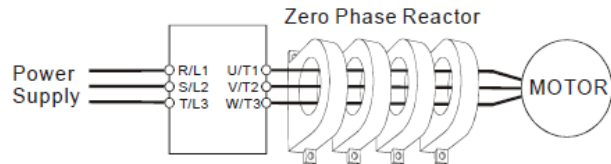

7-6 EMI Filter

The following table shows external EMI filter models for each CT2000 series AC motor drive. Users can choose corresponding zero phase reactor and applicable shielding cable according to required noise emission and electromagnetic disturbance rating, to make the best assembly and restrain electromagnetic disturbance.

CT2000			EMI Filter	Zero phase reactor	CE Cable Length	Radiation Emission
Frame	Model	Rated Amps (Arms)			Default carrier frequency	Default carrier frequency
					EN61800-3	EN61800-3
					C2	C2
B	VFD110CT43F00B	25	EMF039A43A	RF004X00A	100m	100m
	VFD110CT43A21C					
	VFD150CT43F00B	33				
	VFD150CT43A21C					
VFD185CT43F00B	40					
VFD185CT43A21C						
C	VFD220CT43F00B	50	KMF370A	RF002X00A	100m	100m
	VFD220CT43A21C					
	VFD300CT43F00B	62				
	VFD300CT43A21C					
VFD370CT43F00B	79	KMF3100A				
VFD370CT43A21C						
D	VFD450CT43F00B	91	B84143D0200 R127	RF002X00A	100m	100m
	VFD450CT43A00C					
	VFD550CT43F00B	110				
	VFD550CT43A00C					
VFD750CT43F00A6	144					
VFD900CT43F00A8	180					

EMI Filter Installation

All electrical equipment, including AC motor drives, will generate high-frequency/low-frequency noise and will interfere with peripheral equipment by radiation or conduction when in operation. By using an EMI filter with correct installation, much interference can be eliminated. It is recommended to use DELTA EMI filter to have the best interference elimination performance.

We assure that it can comply with following rules when AC motor drive and EMI filter are installed and wired according to user manual:

- **EN61000-6-4**
- **EN61800-3: 1996**
- **EN55011 (1991) Class A Group 1 (1st Environment, restricted distribution)**

General precaution

1. EMI filter and AC motor drive should be installed on the same metal plate.
2. Please install AC motor drive on footprint EMI filter or install EMI filter as close as possible to the AC motor drive.
3. Please wire as short as possible.
4. Metal plate should be grounded.
5. The cover of EMI filter and AC motor drive or grounding should be fixed on the metal plate and the contact area should be as large as possible.

Choose suitable motor cable and precautions

Improper installation and choice of motor cable will affect the performance of EMI filter. Be sure to observe the following precautions when selecting motor cable.

1. Use the cable with shielding (double shielding is the best).
2. The shielding on both ends of the motor cable should be grounded with the minimum length and maximum contact area.
3. Remove any paint on metal saddle for good ground contact with the plate and shielding.

Remove any paint on metal saddle for good ground contact with the plate and shielding.

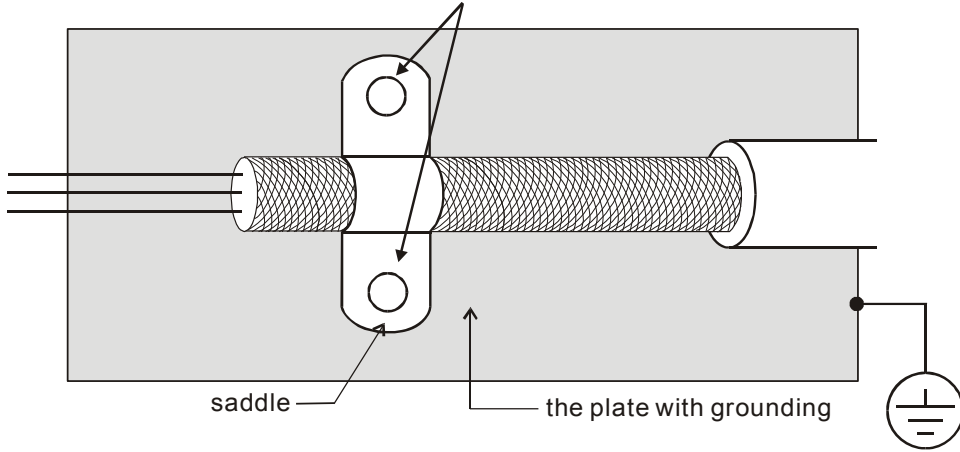

Figure 1

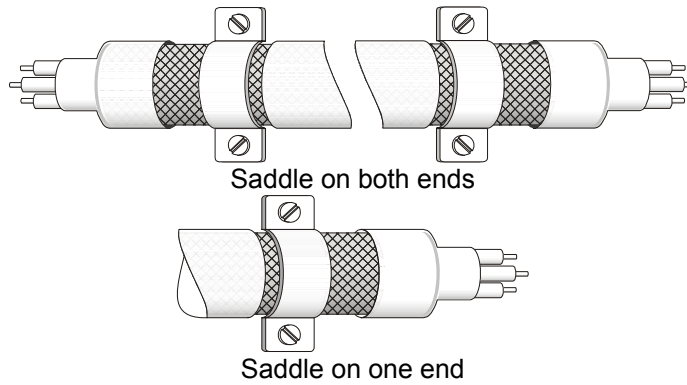

Figure 2

7-7 Digital Keypad

KPC-CE01



A: LED Display

Display frequency, current, voltage and error etc.

B: Status Indicator

F: Frequency Command
 H: Output Frequency
 U: User Defined Units
 ERR: CAN Error Indicator
 RUN: CAN Run Indicator

C: Function

(Refer to the chart follows for detail description)

Key	Description
ESC	ESC Key Press ESC key to return to the previous page. It also functions as a return to last category key in the sub-menu.
MENU	Menu Key Press MENU key under any condition will return to the main MENU. Menu content: 1. Parameter Detail 2. Copy Parameter 3. Keypad locked 4. PLC Function
ENTER	ENTER Key Press ENTER and go to the next level. If it is the last level then press ENTER to execute the command.
HAND	HAND ON Key 1. HAND key will operates according to the parameter settings when the source of HAND master frequency command and the source of HAND operation command is properly set,. The factory setting of the source command for frequency and operation are from the digital keypad . 2. Press HAND key in stop status, the drive setting switches to the parameter setting of HAND. Press HAND key in during operation, the drive will come to stop then switches to the parameter setting of HAND. 3. When process complete: H/A LED ON.
AUTO	Auto Operation Key 1. AUTO function executes according to the parameter settings of the source of AUTO frequency and AUTO operation. The factory setting is the external terminal (source of operation is 4-20mA). 2. Press the ATUO key in stop status, the drivel switches to auto-setting. Press the auto key during operation status, the drivel will come to stop and switch to auto-setting. 3. When process complete: H/A LED is OFF
FWD/REV	Operation Direction Key 1. FWD/REV key controls the operation direction but will NOT activate the drive. FWD: forward, REV: reverse. 2. The drive operates in the direction as shown by the LED light.
RUN	Start Key 1. It is only valid when the source of operation command is from the keypad. 2. Press the RUN key, the drive will according to the start-up setting and the RUN LED will be ON. 3. RUN key can be pressed for many times when the drive is in stop status. 4. "HAND" mode is enabled only when the source of operation command is by keypad.
STOP	Stop Key. 1. STOP key has the highest priority in command. 2. Press STOP key, the drive will come to stop under any condition. 3. The RESET key can be used to reset the drive when faults occur. If the RESET key is not responding, check MENU → Fault Records and check the most recent fault.

Dimension

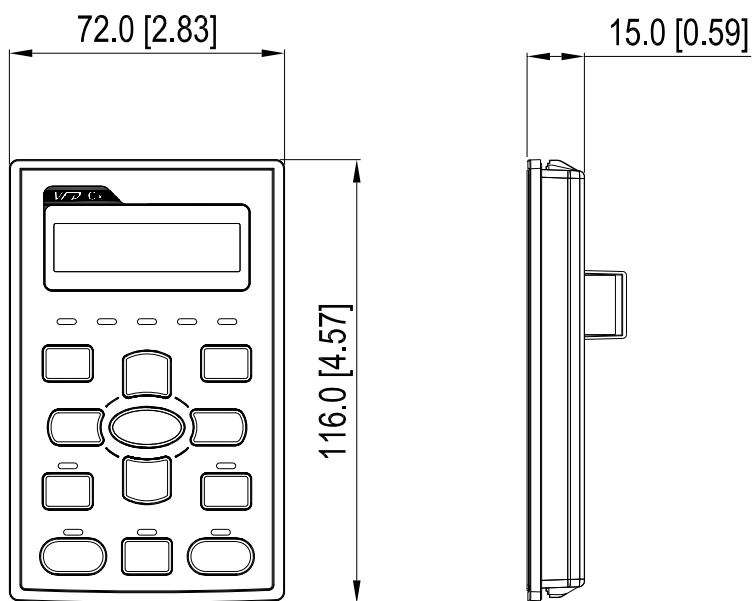

RJ45 Extension Lead for Digital Keypad

Part #	Description
CBC-K3FT	3 feet RJ45 extension lead (approximately 0.9m)
CBC-K5FT	5 feet RJ45 extension lead (approximately 1.5 m)
CBC-K7FT	7 feet RJ45 extension lead (approximately 2.1 m)
CBC-K10FT	10 feet RJ45 extension lead (approximately 3 m)
CBC-K16FT	16 feet RJ45 extension lead (approximately 4.9 m)

7-8 Panel Mounting (MKC-KPPK)

For MKC-KPPK model, user can choose wall mounting or embedded mounting, protection level is IP66.

Applicable to the digital keypads (KPC-CC01 & KPC-CE01).

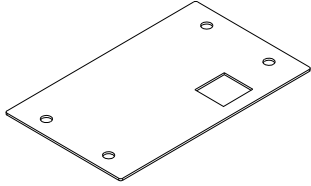
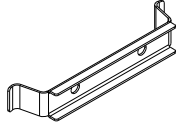
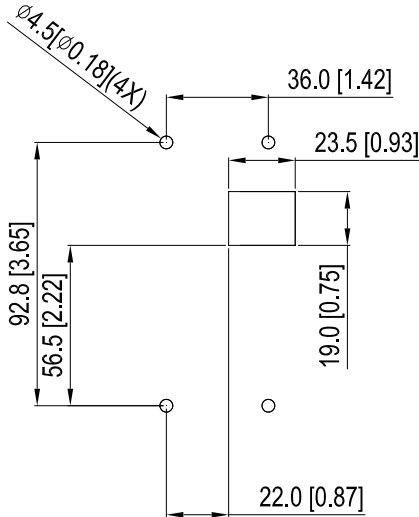
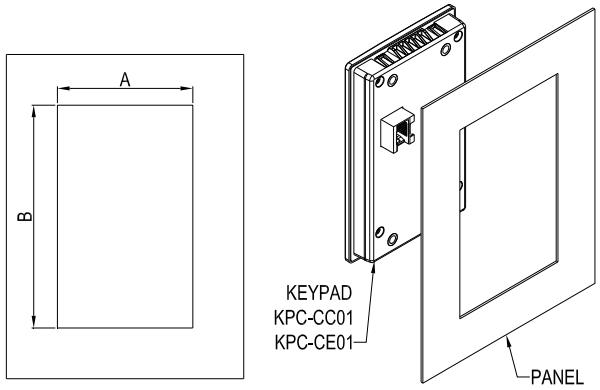
Wall Mounting		Embedded Mounting													
accessories*1 		accessories*2 													
Screw *4 ~M4*p 0.7 *L8mm Torque: 10-12kg-cm (8.7-10.4lb-in.)		Screw *4 ~M4*p 0.7 *L8mm Torque: 10-12kg-cm (8.7-10.4lb-in.)													
Panel cutout dimension	Unit: mm [inch]	Panel cutout dimension	Unit: mm [inch]												
															
Normal cutout dimension															
<table border="1"> <thead> <tr> <th>Panel thickness</th> <th>1.2mm</th> <th>1.6mm</th> <th>2.0mm</th> </tr> </thead> <tbody> <tr> <td>A</td> <td colspan="3">66.4 [2.614]</td> </tr> <tr> <td>B</td> <td>110.2 [4.339]</td> <td>111.3 [4.382]</td> <td>112.5 [4.429]</td> </tr> </tbody> </table>	Panel thickness	1.2mm	1.6mm	2.0mm	A	66.4 [2.614]			B	110.2 [4.339]	111.3 [4.382]	112.5 [4.429]	*Deviation: ±0.15mm /±0.0059inch		
Panel thickness	1.2mm	1.6mm	2.0mm												
A	66.4 [2.614]														
B	110.2 [4.339]	111.3 [4.382]	112.5 [4.429]												
Cutout dimension (Waterproof level: IP56)															
<table border="1"> <thead> <tr> <th>Panel thickness</th> <th>1.2mm</th> <th>1.6mm</th> <th>2.0mm</th> </tr> </thead> <tbody> <tr> <td>A</td> <td colspan="3">66.4 [2.614]</td> </tr> <tr> <td>B</td> <td colspan="3">110.8 [4.362]</td> </tr> </tbody> </table>	Panel thickness	1.2mm	1.6mm	2.0mm	A	66.4 [2.614]			B	110.8 [4.362]			*Deviation: ±0.15mm /±0.0059inch		
Panel thickness	1.2mm	1.6mm	2.0mm												
A	66.4 [2.614]														
B	110.8 [4.362]														

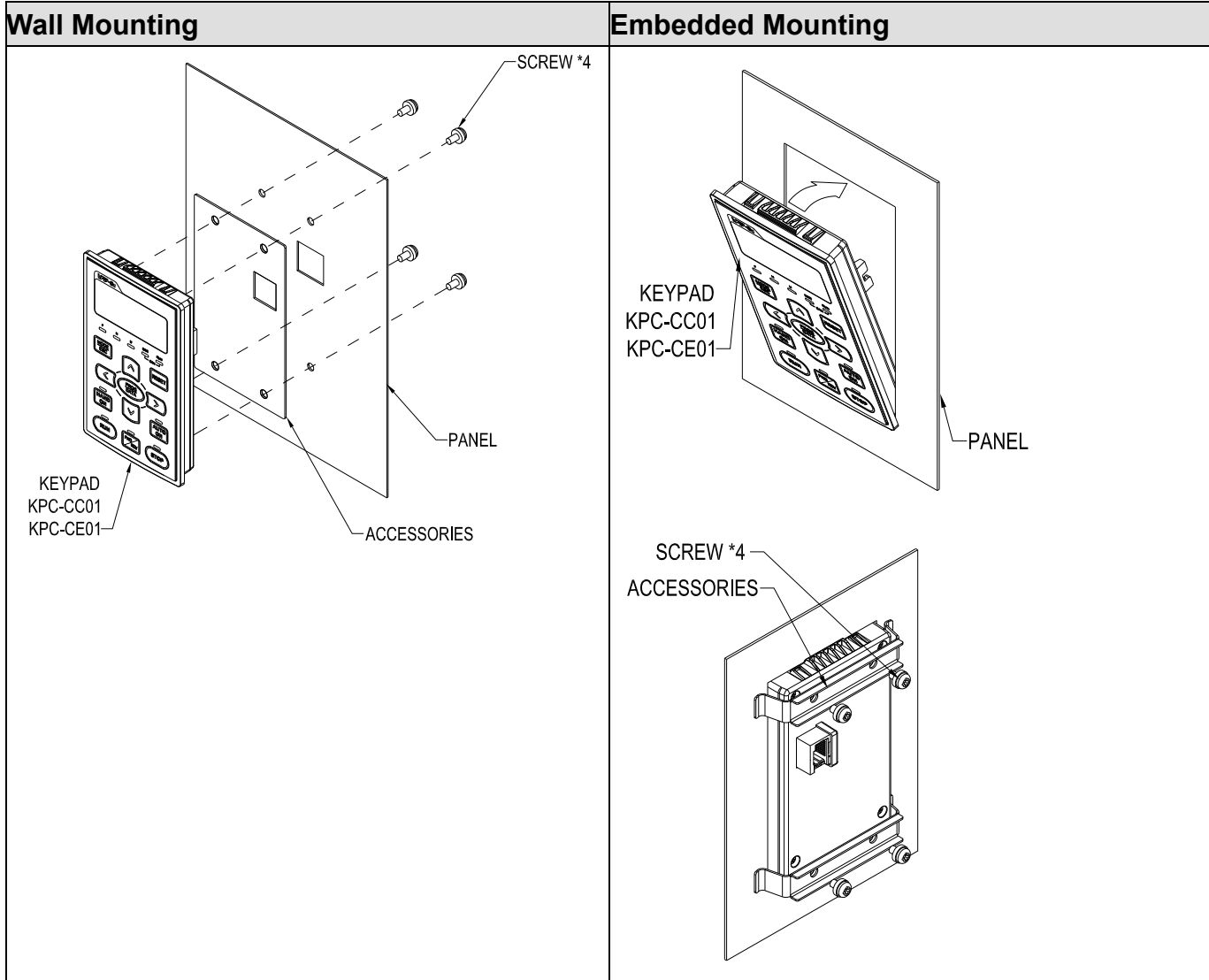

7-9 Fan Kit

- Frames of the fan kit

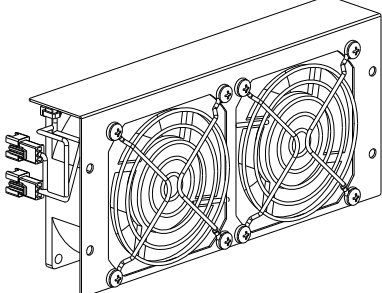
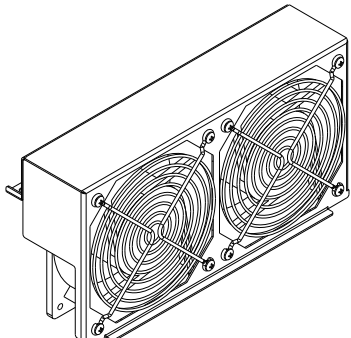
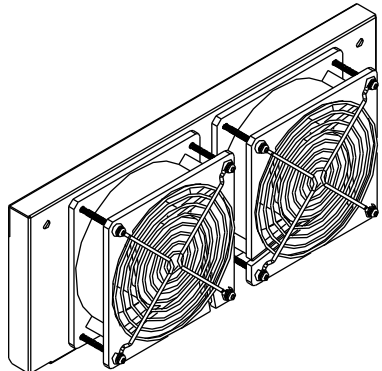
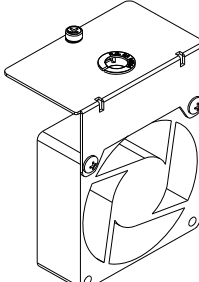
<p>Frame B</p> <p>Applicable Model VFD110CT43A21C; VFD150CT43A21C; VFD185CT43A21C</p>	<p>Model 『MKCT-BFKM』</p> 
<p>Frame C</p> <p>Applicable Model VFD220CT43A21C; VFD300CT43A21C; VFD370CT43A21C</p>	<p>Model 『MKCT-CFKM』</p> 
<p>Frame D</p> <p>Applicable Model VFD450CT43A00C; VFD550CT43F00C</p>	<p>Model 『MKCT-DFKM』</p> 
<p>Frame D</p> <p>Applicable Model VFD750CT43F00A6; VFD900CT43F00A8;</p>	<p>Model 『MKC-DFKB』</p> 

■ Fan Removal

Frame B

Applicable model

VFD110CT43A21C; VFD150CT43A21C; VFD185CT43A21C

Loosen 4 screws of the fan (see the picture below), and disconnect the fan power. Screw torque: 14~16 kg-cm

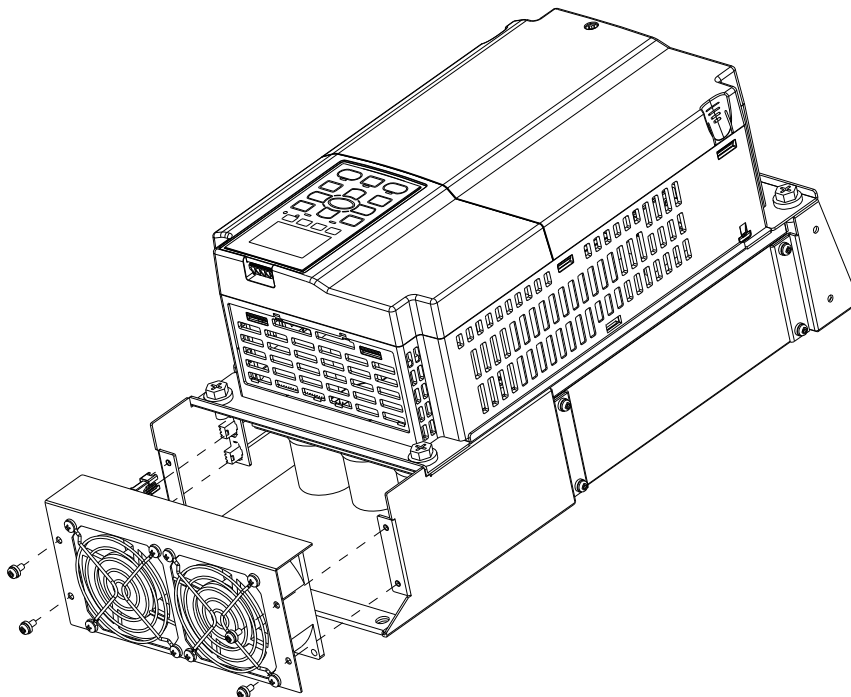

Frame C

Applicable model

VFD220CT43A21C; VFD300CT43A21C; VFD370CT43A21C

Loosen screw 1~2 (see the picture below), and disconnect the fan power. Screw torque: 14~16 kg-cm

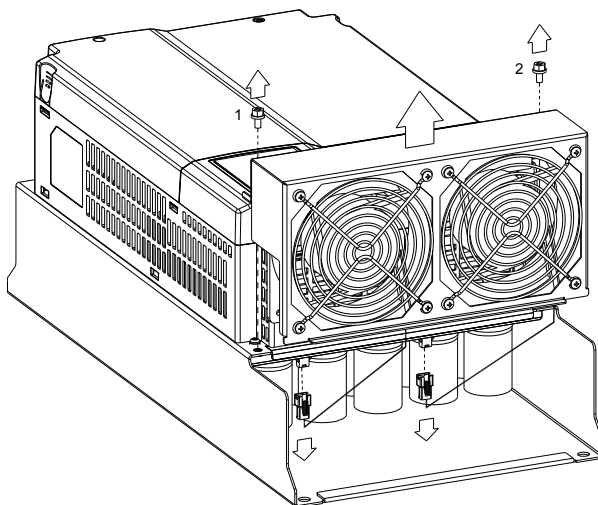

Frame D

Applicable model

VFD450CT43A00C; VFD550CT43F00C

1. Loosen screw 1~2, and pull out the fan. Screw torque: 24~26 kg-cm

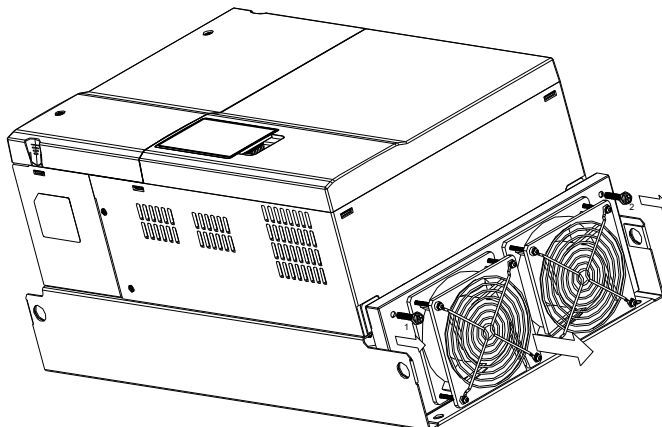

2. Disconnect the fan power.

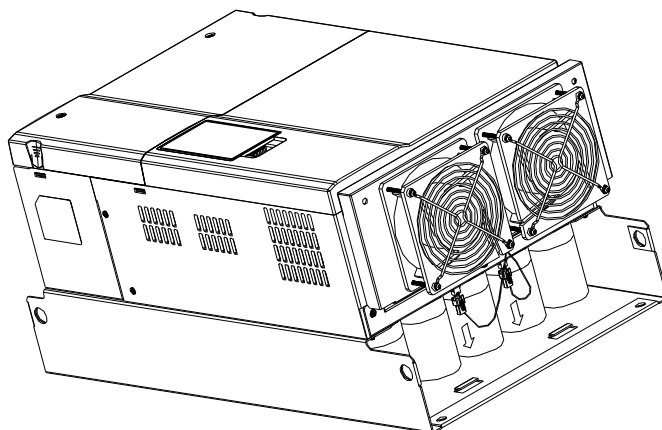

Frame D

Applicable model

VFD750CT43F00A6; VFD900CT43F00A8

1. Loosen screw 1 and 2, press the right and left side (see the arrows showed in the picture below), and then remove the cover. Press top of the keypad to remove it. Screw torque: 10~12kgf-cm (8.6~10.4in-lbf)

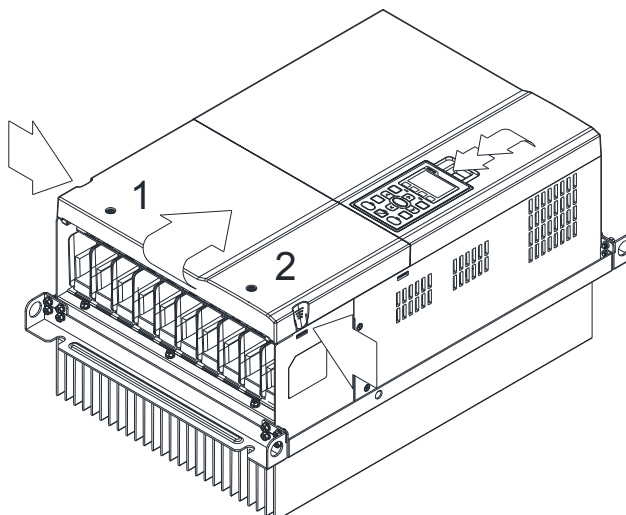

2. Remove screw 3 and 4, and then press the right and the left side to remove the cover. Screw torque: 6~8kgf-cm (5.2~6.9in-lbf)

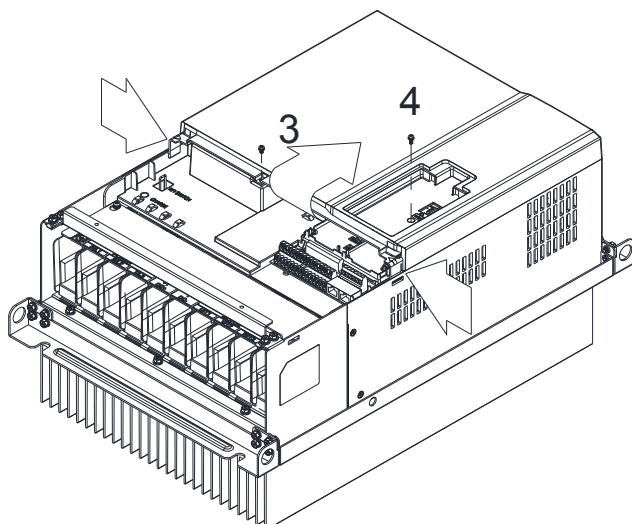

3. Loosen screw 5 (see the picture below), and disconnect the fan power (see the enlarged partial picture), and then remove the fan. Screw torque: 10~12kgf-cm (8.6~10.4in-lbf)

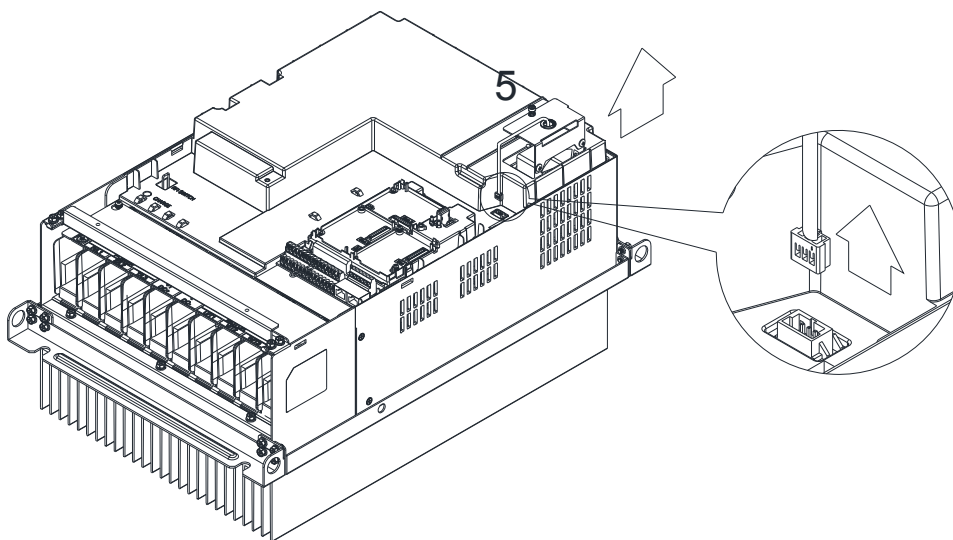

7-10 USB/RS-485 Communication Interface --- IFD6530

Warning

- ✓ Please thoroughly read this instruction sheet before installation and putting it into use.
- ✓ The content of this instruction sheet and the driver file may be revised without prior notice. Please consult our distributors or download the most updated instruction/driver version at http://www.delta.com.tw/product/em/control/cm/control_cm_main.asp

1. Introduction

IFD6530 is a convenient RS-485-to-USB converter, which does not require external power-supply and complex setting process. It supports baud rate from 75 to 115.2kbps and auto switching direction of data transmission. In addition, it adopts RJ-45 in RS-485 connector for users to wire conveniently. And its tiny dimension, handy use of plug-and-play and hot-swap provide more conveniences for connecting all DELTA IABU products to your PC.

Applicable Models: All DELTA IABU products.

(Application & Dimension)

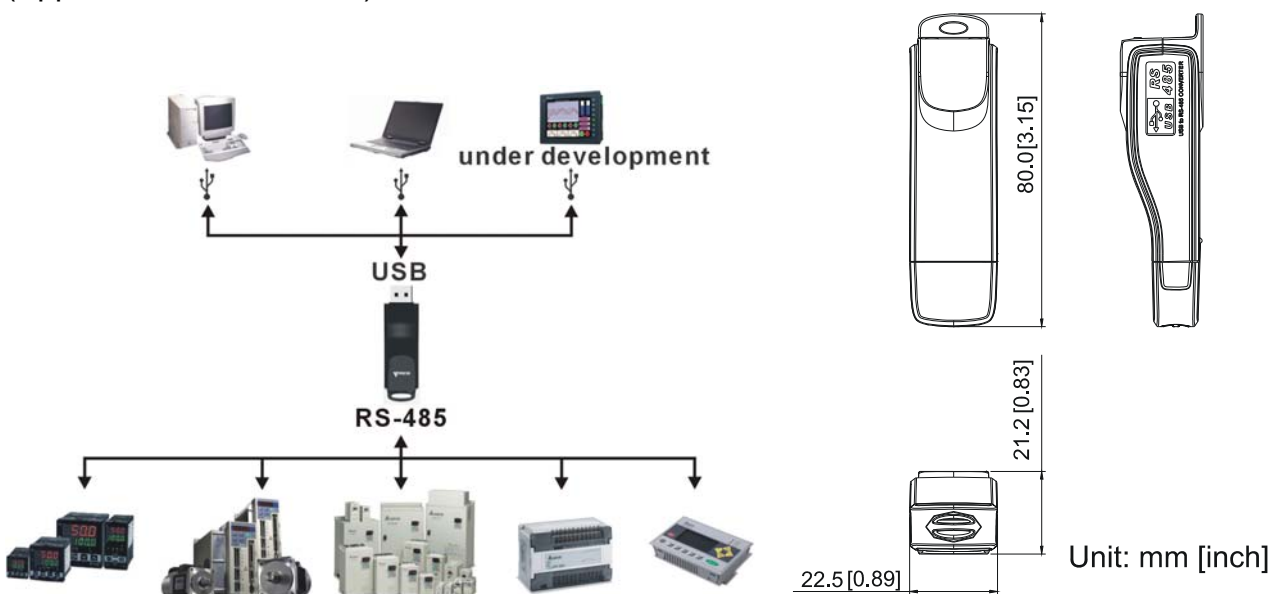

2. Specifications

Power supply	No external power is needed
Power consumption	1.5W
Isolated voltage	2,500VDC
Baud rate	75, 150, 300, 600, 1,200, 2,400, 4,800, 9,600, 19,200, 38,400, 57,600, 115,200 bps
RS-485 connector	RJ-45
USB connector	A type (plug)
Compatibility	Full compliance with USB V2.0 specification
Max. cable length	RS-485 Communication Port: 100 m
Support RS-485 half-duplex transmission	

■ RJ-45



PIN	Description
1	Reserved
2	Reserved
3	GND
4	SG-

PIN	Description
5	SG+
6	GND
7	Reserved
8	+9V

3. Preparations before Driver Installation

Please extract the driver file (IFD6530_Drivers.exe) by following steps. You could find driver file (IFD6530_Drivers.exe) in the CD supplied with IFD6530.

Note: DO NOT connect IFD6530 to PC before extracting the driver file.

STEP 1 **STEP 2**

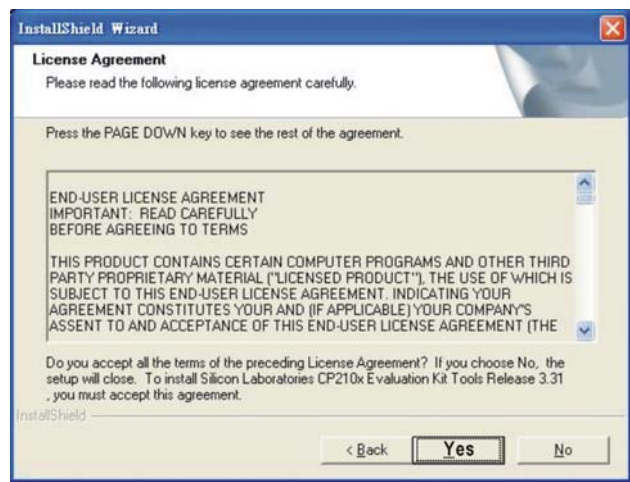
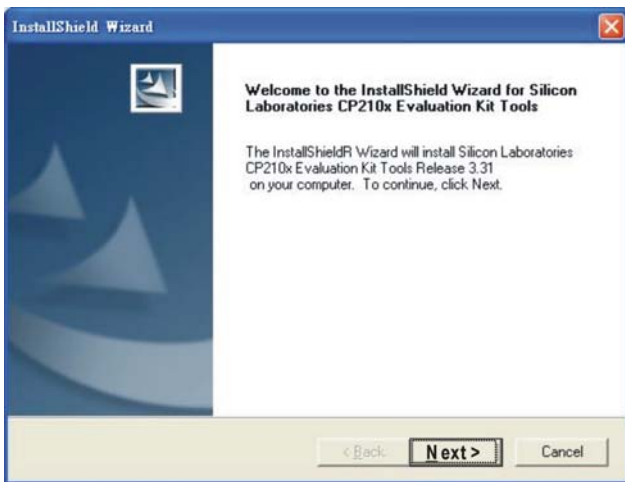

STEP 3 **STEP 4**

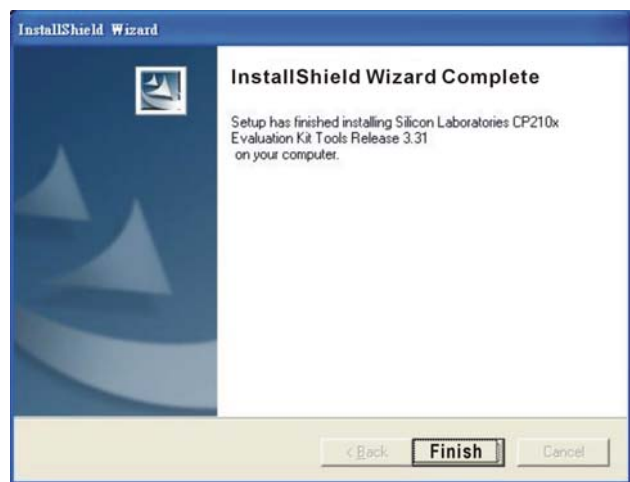
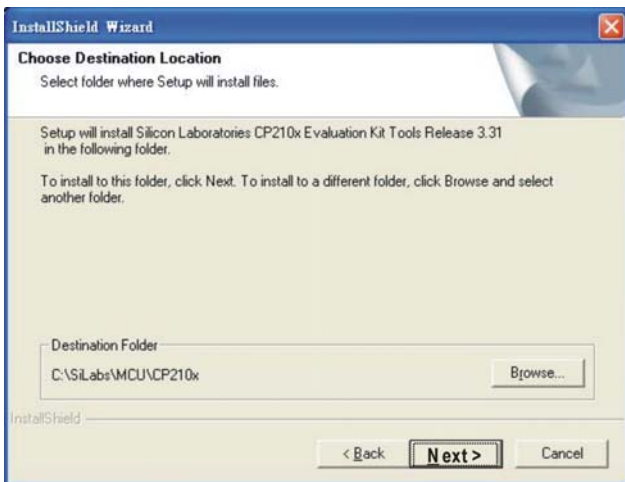

STEP 5

You should have a folder marked SiLabs under drive C. c:\ SiLabs

4. Drive Installation

After connecting IFD6530 to PC, please install driver by following steps.

STEP 1



STEP 2

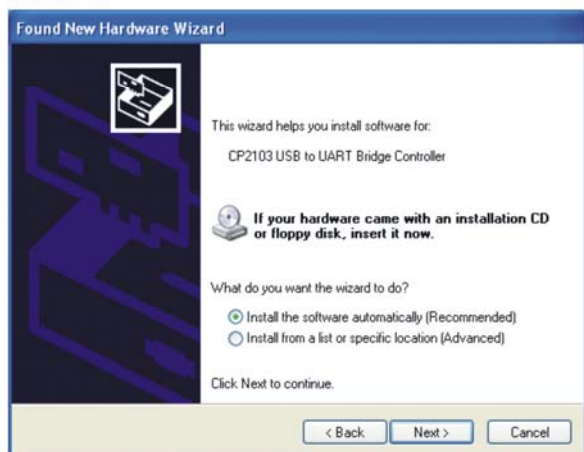

OR

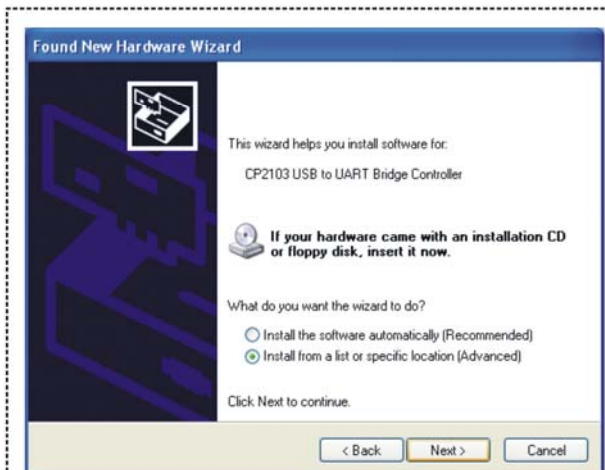

Browse and select directory, or enter
C:\SiLabs\MCU\CP210x\WIN

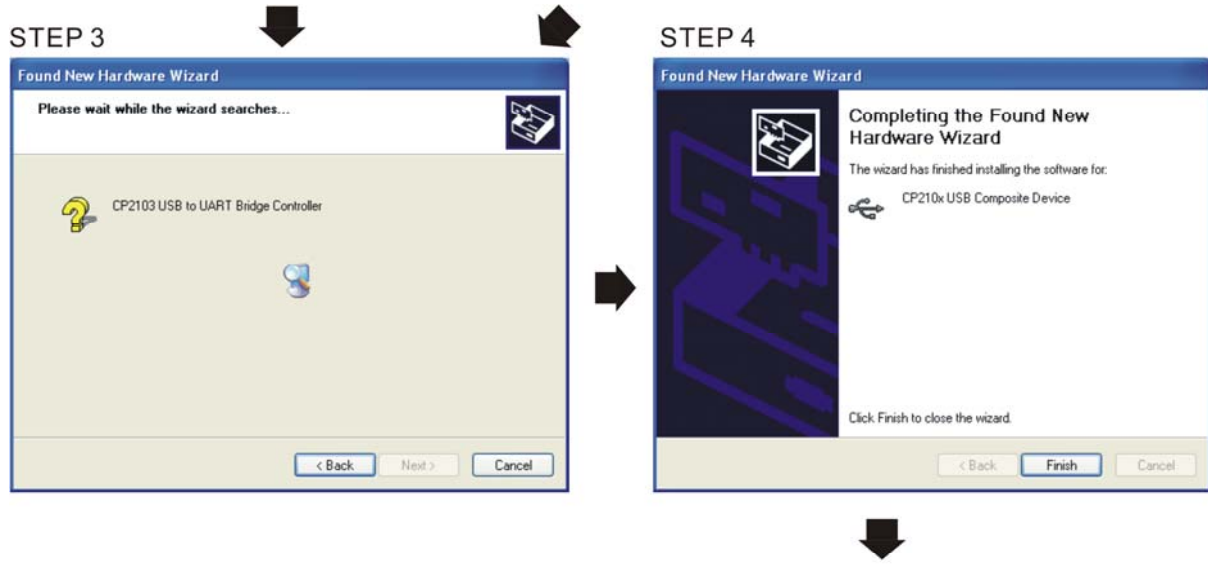

STEP 5
Repeat Step 1 to Step 4 to complete COM PORT setting.

5. LED Display

1. Steady Green LED ON: power is ON.
2. Blinking orange LED: data is transmitting.

Chapter 8 Option Cards

8-1 Removed Key Cover

8-2 Screws Specification for Option Card Terminals

8-3 EMC-D42A

8-4 EMC-D611A

8-5 EMC-R6AA

8-6 EMC-BPS01

8-7 EMC-PG01/02L

8-8 EMC-PG01/02O

8-9 EMC-PG01/02U

8-10 EMC-PG01R

8-11 CMC-MOD01

8-12 CMC-PD01

8-13 CMC-DN01

8-14 CMC-EIP01

8-15 EMC-COP01

Please select applicable option cards for your drive or contact local distributor for suggestion. To prevent drive damage during installation, please removes the digital keypad and the cover before wiring. Refer to the following instruction.

8-1 Remove key cover

Step 1

Frame B (Take flange mounted models as an example)

Screw torque: 12~15Kg-cm [10.4~13lb-in.]

Loosen the screw, and press the snap locks on the both side and rotate to pull it out.

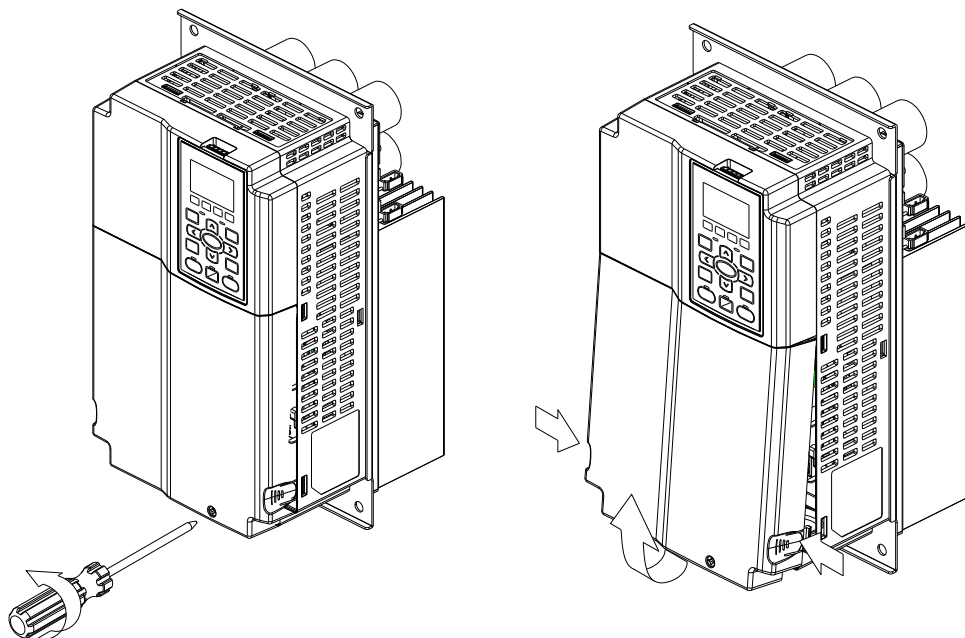

Frame C (Take flange mounted models as an example)

Screw torque: 12~15Kg-cm [10.4~13lb-in.]

Loosen the screw, and press the snap locks on the both side and rotate to pull it out.

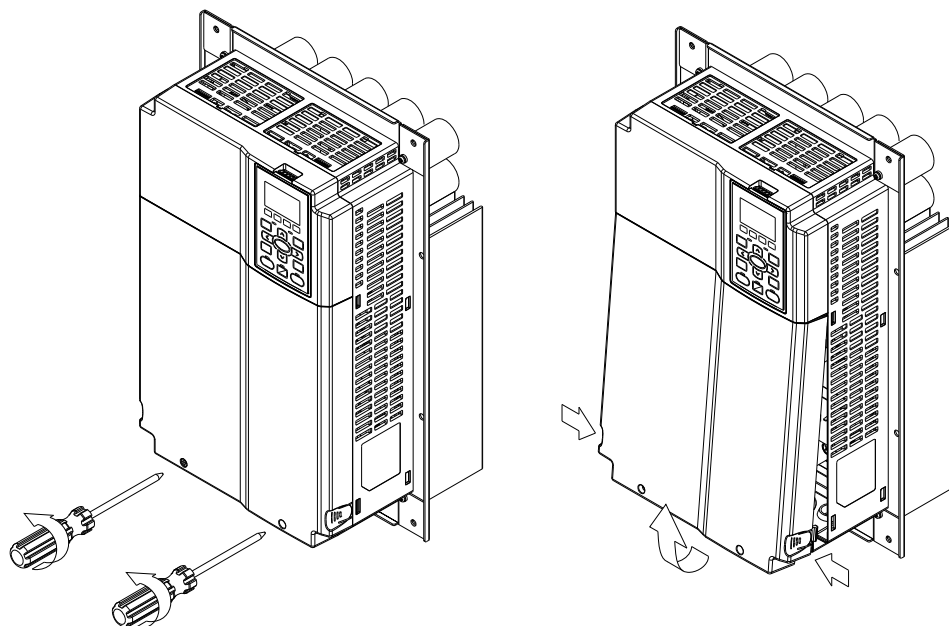

Frame D (Take flange mounted models as an example)

Screw torque: 10~12Kg-cm [8.7~10.4lb-in.]

Loosen the screw, and press the snap locks on the both side and rotate to pull it out.

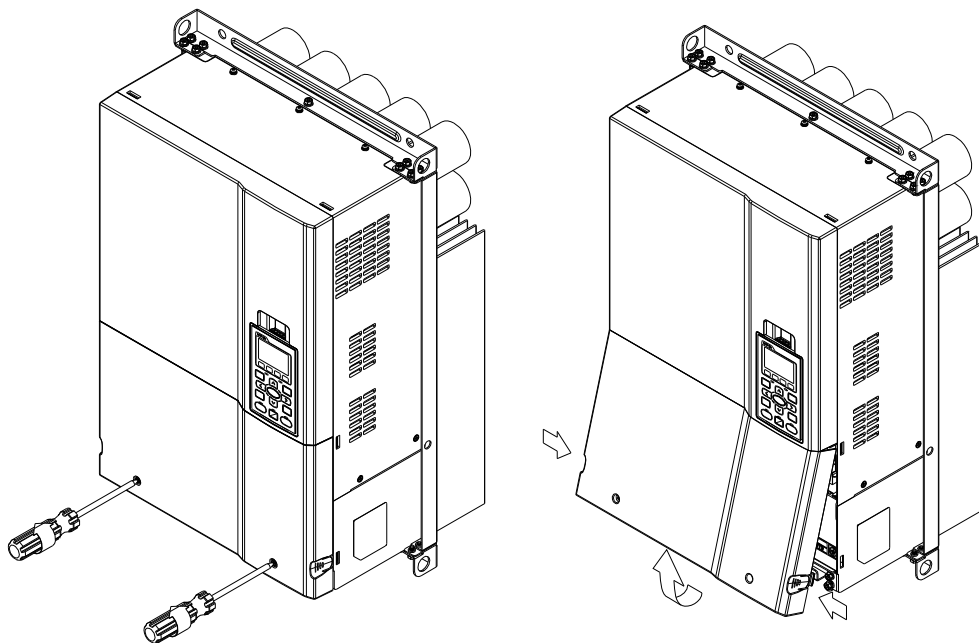

Step 2

Frame B~D (Take flange mounted models as an example)

Screw torque: 6~8Kg-cm [5.2~6.9lb-in.]

Loosen the screw, and press the snap locks on the both side and rotate to pull it out.

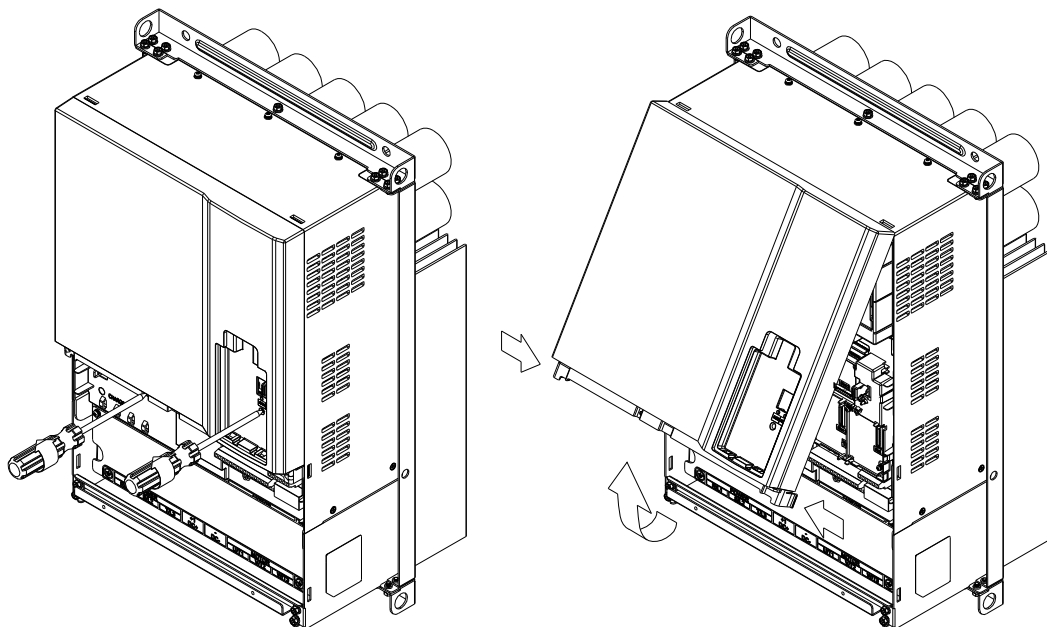

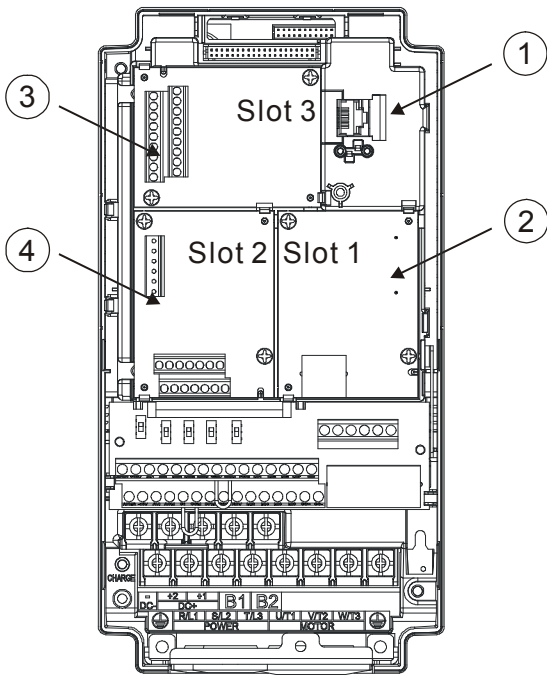

1	<p>RJ45 (Socket) for digital keypad KPC-CC01; KPC-CE01</p> <p><u>Please refer to CH10 Digital Keypad for more details on KPC-CE01.</u></p> <p><u>Please refer to CH10 Digital Keypad for more details on optional accessory RJ45 extension cable.</u></p>
2	<p>Communication extension card (Slot 1)</p> <p><u>CMC-MOD01;</u> <u>CMC-PD01;</u> <u>CMC-DN01;</u> <u>CMC-EIP01;</u> <u>EMC-COP01;</u></p>
3	<p>I/O & Relay extension card (Slot 3)</p> <p><u>EMC-D42A;</u> <u>EMC-D611A;</u> <u>EMC-R6AA;</u> <u>EMC-BPS01;</u></p>
4	<p>PG card (Slot 2)</p> <p><u>EMC-PG01L;</u> <u>EMC-PG01O;</u> <u>EMC-PG01U;</u> <u>EMC-PG01R;</u></p>

8-2 Screws specification for option card terminals

EMC-D42A; EMC-D611A; EMC-BPS01	Wire gauge	24~12AWG (0.205~3.31mm ²)
	Torque	5Kg-cm [4.4 lb-in] (0.5Nm)
EMC-R6AA	Wire gauge	26~16AWG (0.128~1.31mm ²)
	Torque	8Kg-cm [7 lb-in] (0.8Nm)
EMC-PG01L; EMC-PG01O; EMC-PG01R; EMC-PG01U	Wire gauge	30~16AWG (0.0509~1.31mm ²)
	Torque	2Kg-cm [1.73 lb-in] (0.2Nm)

I/O & Relay extension card (Slot 3)

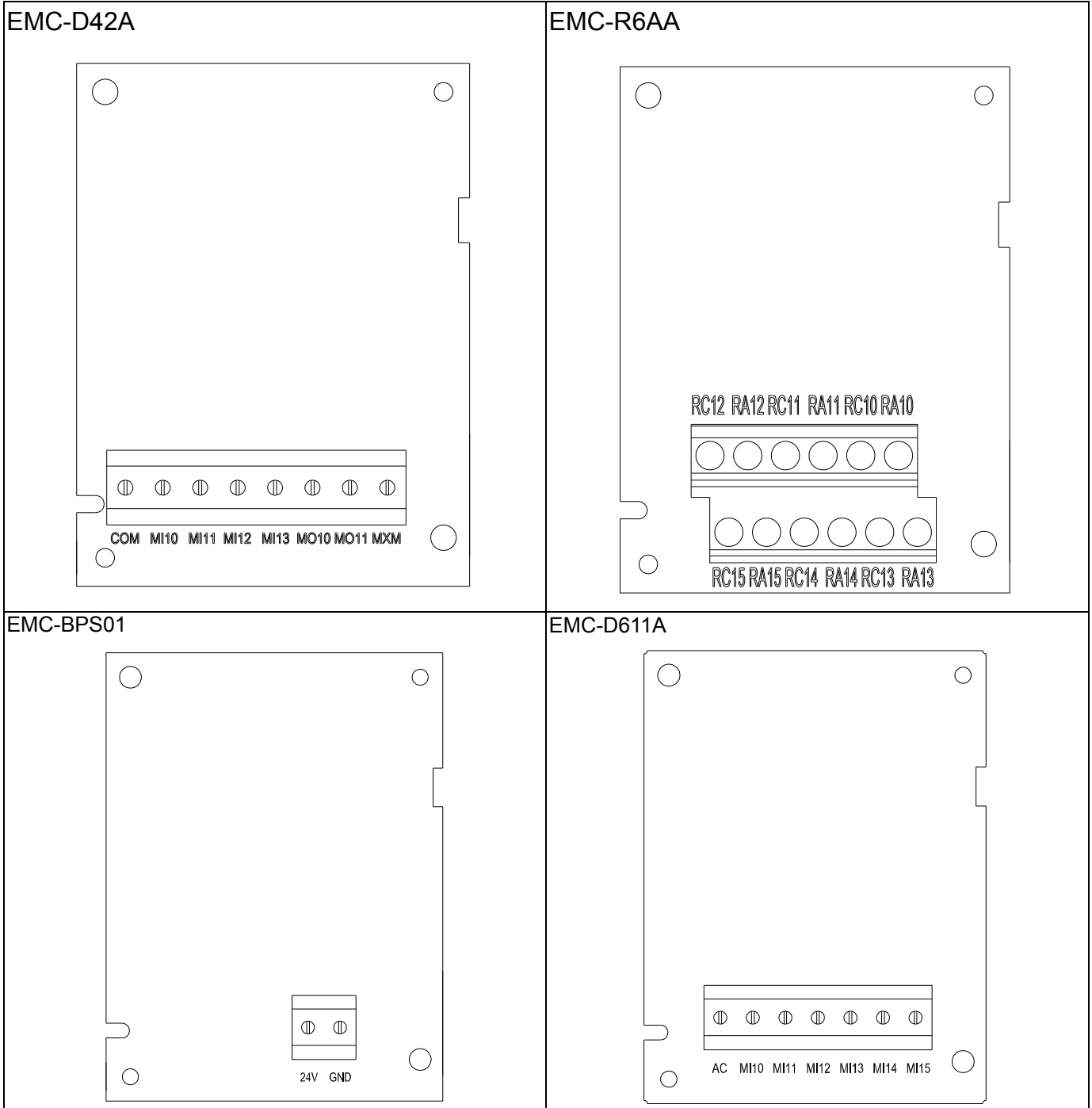

PG card (Slot 2)

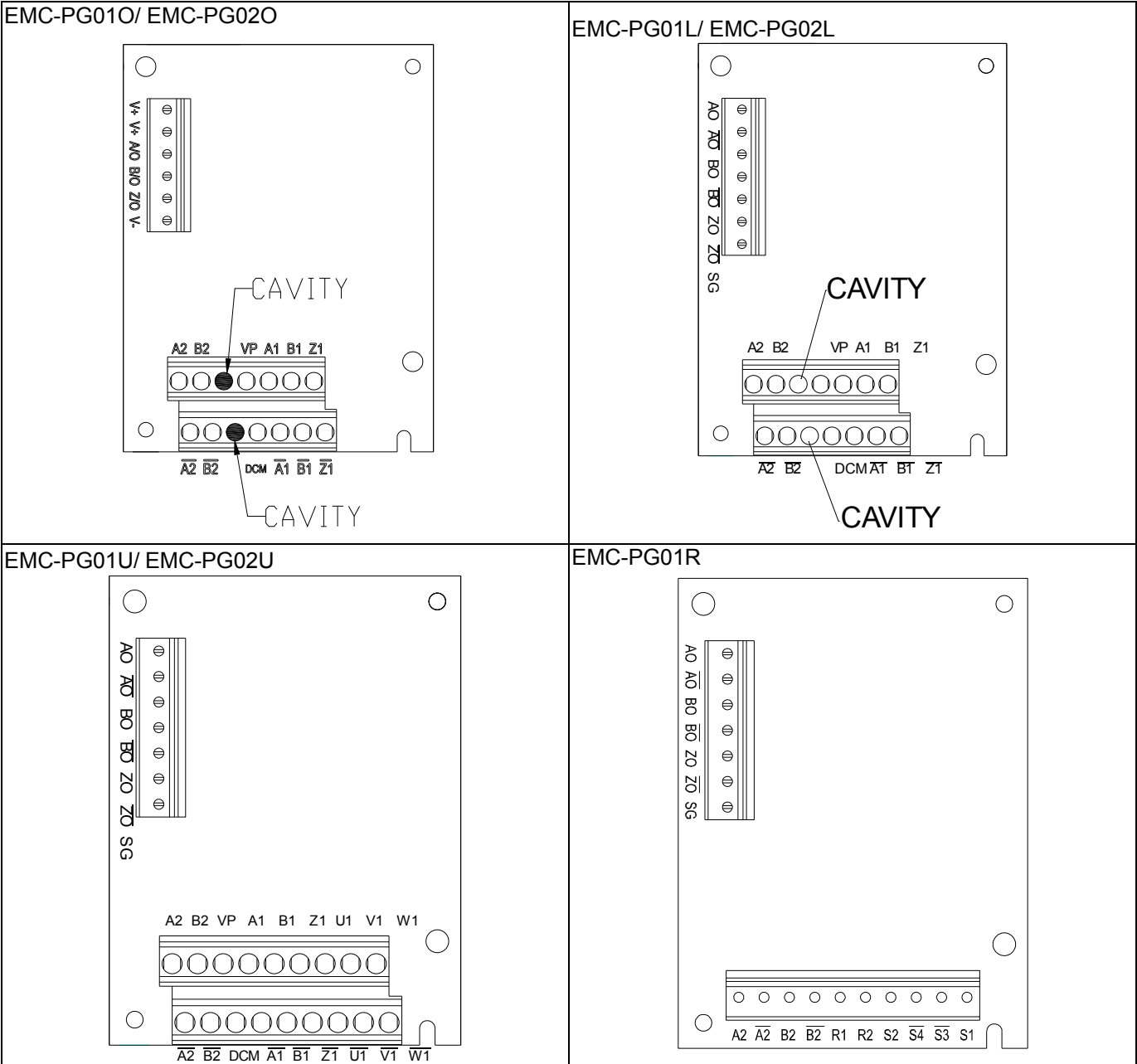

Communication extension card (Slot 1)

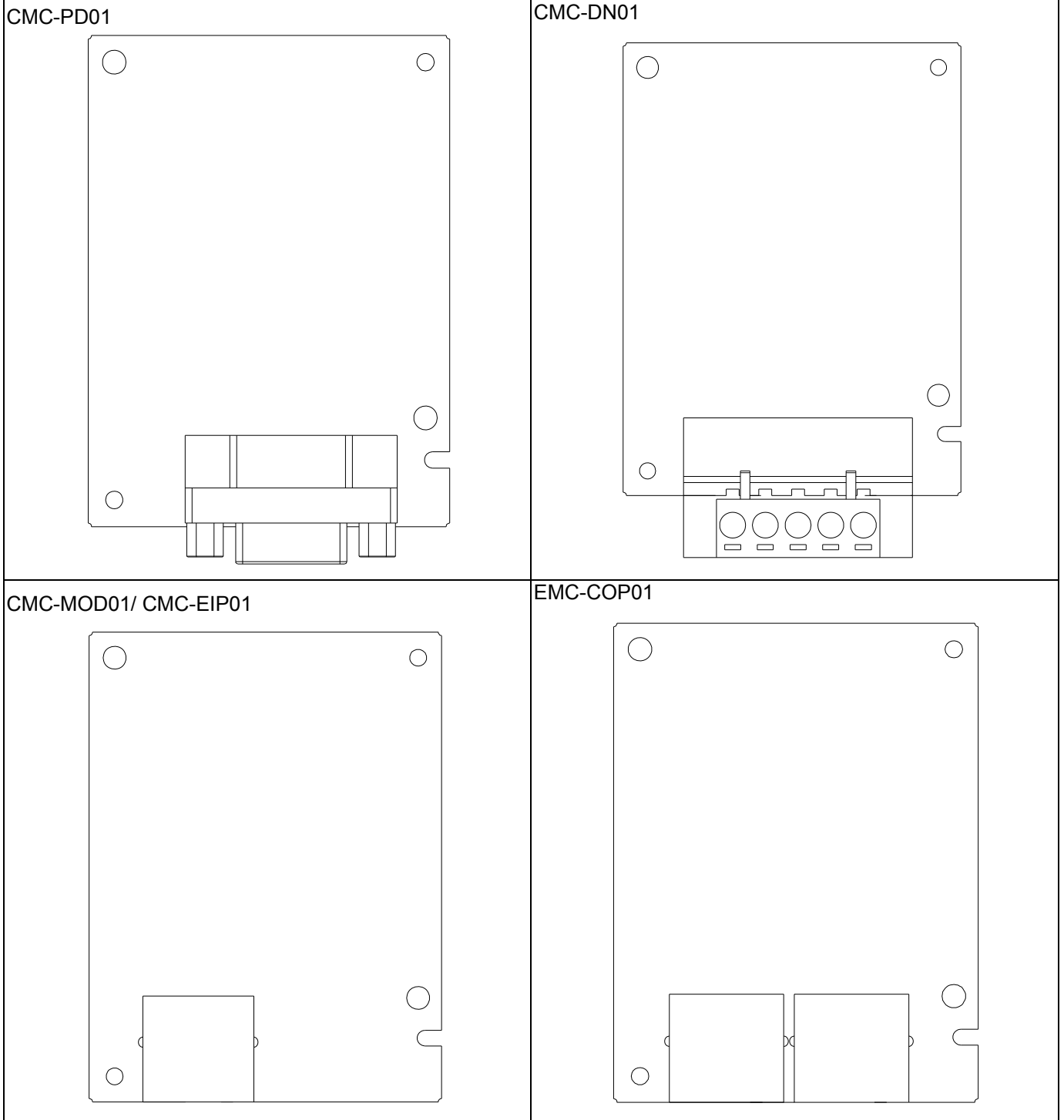

PG Card intallation

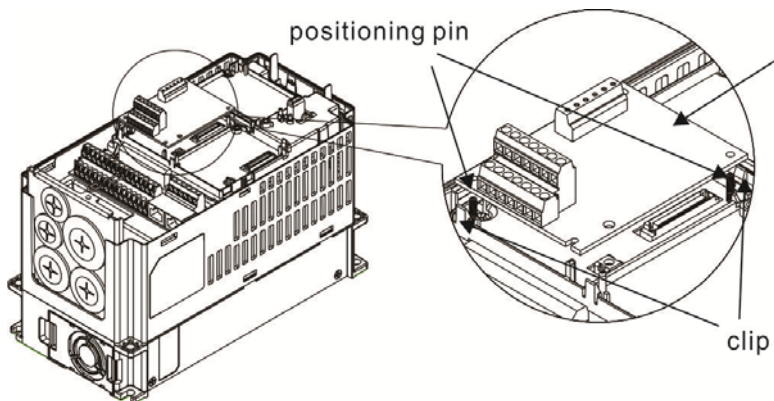

PG card

As shown in the figure on the left, aim the two holes at the positioning pin. Press the pin to clip the holes with the PCB.

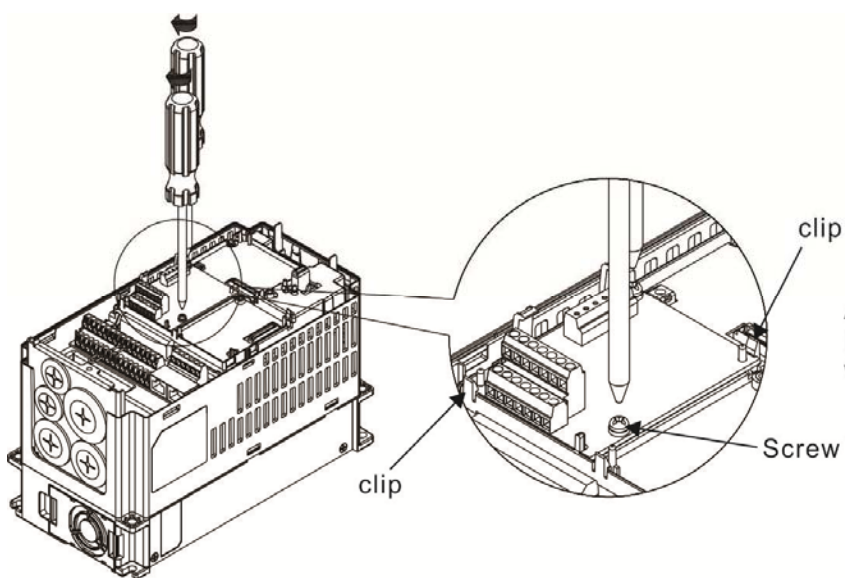

As shown in the figure on the left. Fasten, the screw after the PCB is clipped with the holes.

Screw Torque: 6-8kg-cm [5.21-6.94lb-g-in.]

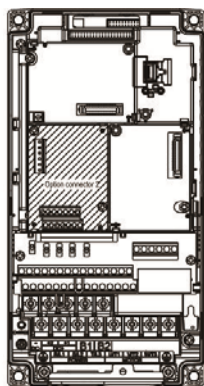
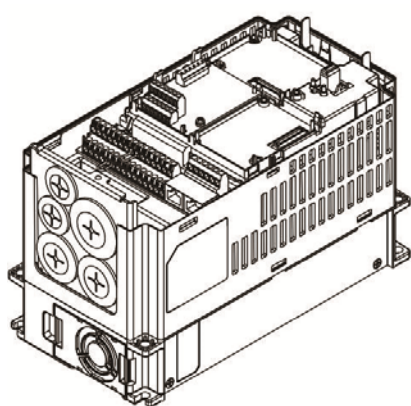

As shown in the figure on the left, installation is completed.

Disconnecting the extension card

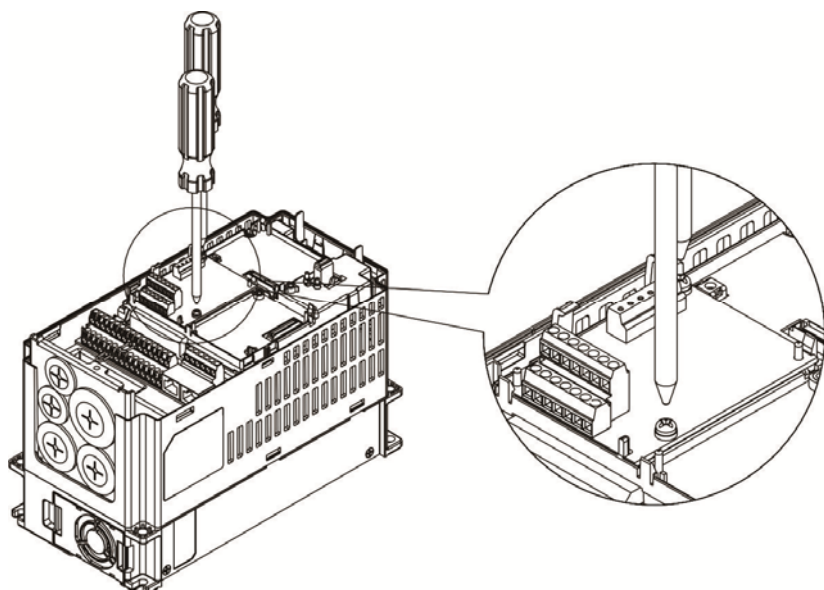

Remove the two screws as shown in the figure on the left.

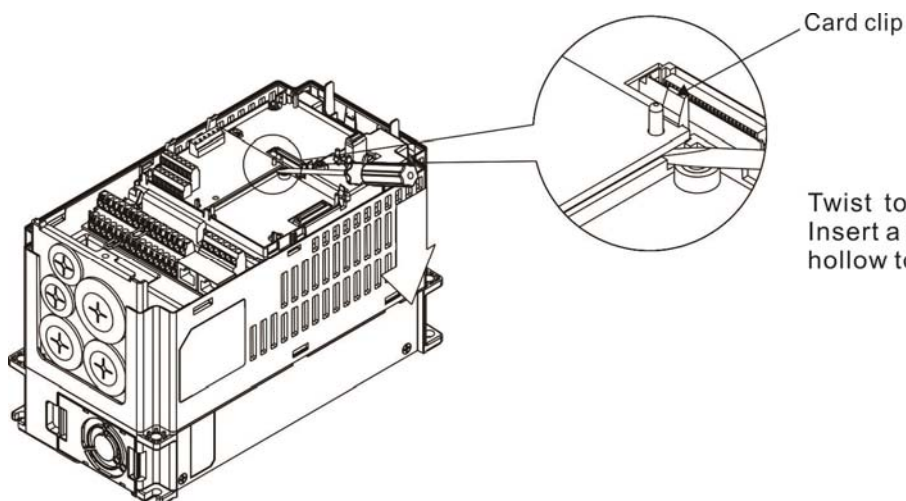

Twist to open the card clip. Insert a slot type screwdriver into the hollow to prize the PCB off the card clip.

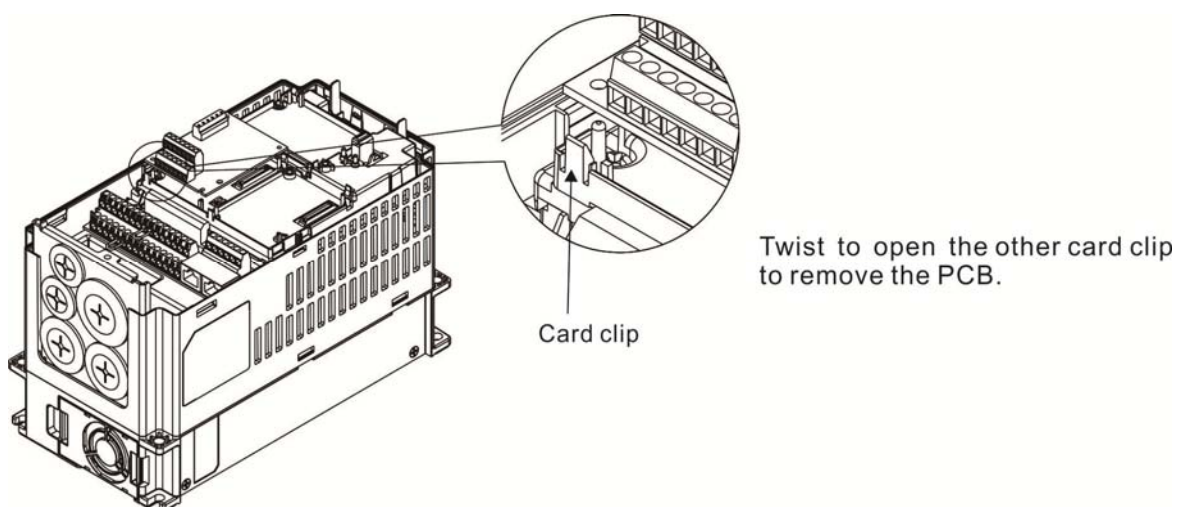

Twist to open the other card clip to remove the PCB.

8-3 EMC-D42A

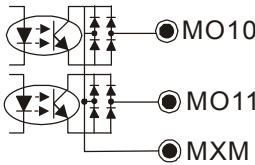
	Terminals	Descriptions
I/O Extension Card	COM	Common for Multi-function input terminals Select SINK(NPN)/SOURCE(PNP) in J1 jumper / external power supply
	MI10~ MI13	Refer to parameters 02-26~02-29 to program the multi-function inputs MI10~MI13. Internal power is applied from terminal E24: +24Vdc±5% 200mA, 5W External power +24VDC: max. voltage 30VDC, min. voltage 19VDC, 30W ON: the activation current is 6.5mA OFF: leakage current tolerance is 10µA
	MO10~MO11	Multi-function output terminals (photocoupler) The AC motor drive releases various monitor signals, such as drive in operation, frequency attained and overload indication, via transistor (open collector). 
	MXM	Common for multi-function output terminals MO10, MO11(photocoupler) Max 48VDC 50mA

8-4 EMC-D611A

	Terminals	Descriptions
I/O Extension Card	AC	AC power Common for multi-function input terminal (Neutral)
	MI10~ MI15	Refer to Pr. 02.26~ Pr. 02.31 for multi-function input selection Input voltage: 100~130VAC Input frequency: 47~63Hz Input impedance: 27Kohm Terminal response time: ON: 10ms OFF: 20ms

8-5 EMC-R6AA

	Terminals	Descriptions
Relay Extension Card	R10A~R15A R10C~R15C	Refer to Pr. 02.36~ Pr. 02.41 for multi-function output selection Resistive load: 5A(N.O.) 250VAC 5A(N.O.) 30VDC Inductive load (COS 0.4) 2.0A(N.O.) 250VAC 2.0A(N.O.) 30VDC It is used to output each monitor signal, such as drive is in operation, frequency attained or overload indication.

8-6 EMC-BPS01

	Terminals	Descriptions
External Power Supply		Input power: 24V±5% Maximum input current:0.5A Note: 1) Do not connect control terminal +24V (Digital control signal common: SOURCE) directly to the EMC-BPS01input terminal 24V. 2) Do not connect control terminal GND directly to the EMC-BPS01 input terminal GND.
	24V GND	Function: When the drive only power supplied by EMC-BPS01, the communication works normally, it also can support all communication cards and the functions mentioned below. --- Read and Write parameters --- Keypad can display information --- Operate keys on the operator panel (except RUN command) --- Analog input is valid --- Multi-input (FWD, RV, MI1~MI8) exexute when using external power Do NOT support: Relay output (include extension card), PG card, PLC function

Note: Refer to I/O & Relay extension card installation/ disconnecting method for PG Card installation/ disconnecting.

8-7 EMC-PG01L/EMC-PG02L

Terminal description

Set by Pr.10-00~10-02, 10-16~10-18

Terminals		Descriptions
PG1	VP	Output voltage for power: +5V/+12V±5% (use FSW3 to switch +5V/+12V) Max. output current: 200mA
	DCM	Common for power and signal
	A1, /A1, B1, /B1, Z1, /Z1	Encoder input signal (Line Driver or Open Collector) Open Collector input voltage: +5~+24V (Note 1) It can be 1-phase or 2-phase input. EMC-PG01L: Max. input frequency: 300kHz EMC-PG02L: Max. input frequency: 30kHz(Note 2)
PG2	A2, /A2, B2, /B2	Pulse Input signal (Line Driver or Open Collector) Open Collector input voltage: +5~+24V (Note1) It can be 1-phase or 2-phase input. EMC-PG01L: Max. input frequency: 300kHz EMC-PG02L: Max. input frequency: 30kHz(Note 2)
PG OUT	AO, /AO, BO, /BO, ZO, /ZO, SG,	PG Card Output signals. It has division frequency function: 1~255 times Max. output voltage for Line driver: 5VDC Max. output current: 50mA EMC-PG01L Max. output frequency: 300kHz EMC-PG02L Max. output frequency: 30kHz SG is the GND of PG card. It is also the GND of position machine or PLC to make the ouput signal to be the common pivot point.

Note 1: Open Collector application, input current 5~15mA to each set then each set needs one pull-up resistor. If input voltage of open collector is 24V, the power of encoder needs to be connected externally. Please refer diagram 2 of PG1.

5V	Recommended pull-up resistor: above100~220Ω, 1/2W
12V	Recommended pull-up resistor: above 510Ω~1.35kΩ, 1/2W
24V	Recommended pull-up resistor, above1.8k~3.3kΩ, 1/2W

Note 2: If the required bandwidth is not over 30kHz at the application, it is recommended to use EMC-PG02O/L (bandwidth 30kHz) to avoid interference.

PG1 card wiring diagram (the image 1 and 2 below are wiring diagrams of Open Collector encoder)

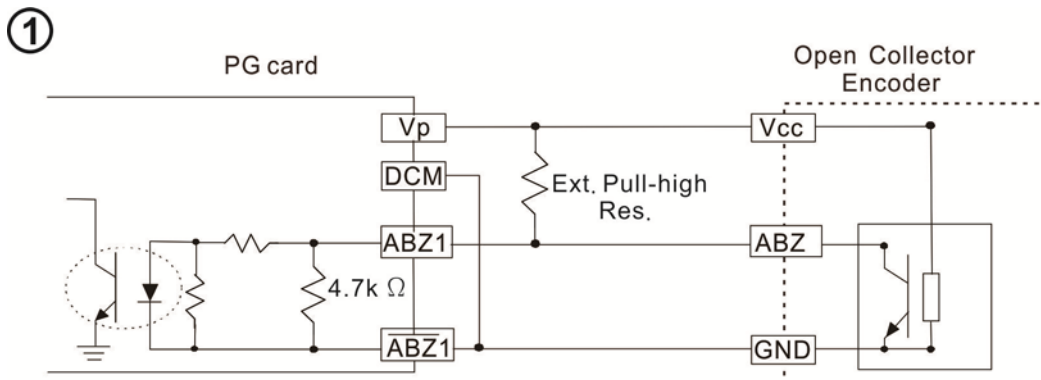

②

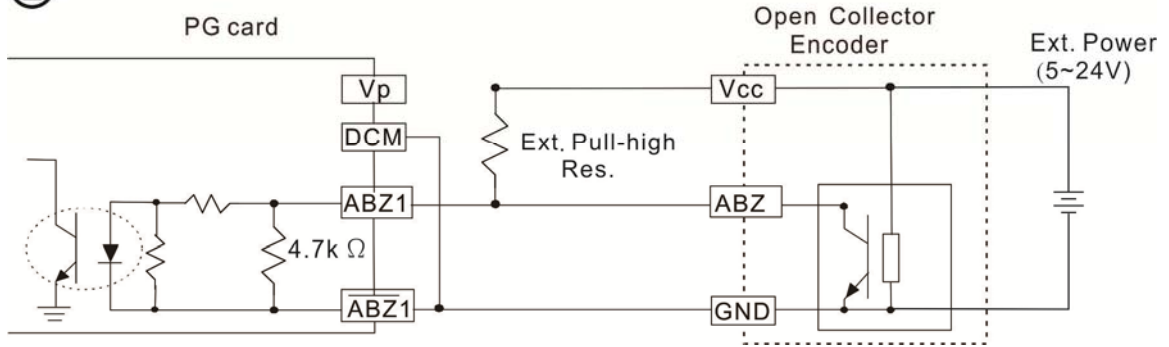

PG2 Wiring Diagram

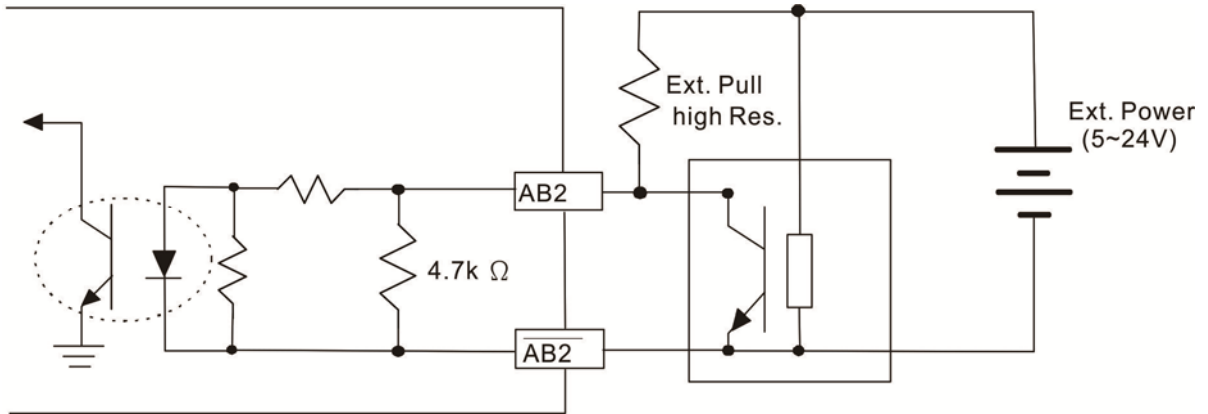

■ **EMC-PG01L/EMC-PG02L Wiring Diagram**

- ☑ Please use a shielded cable to prevent interference. Do not run control wires parallel to any high voltage AC power line (200 V and above).
- ☑ Recommended wire size 0.21 to 0.81mm² (AWG24 to AWG18).
- ☑ Cable length: Less than 100m

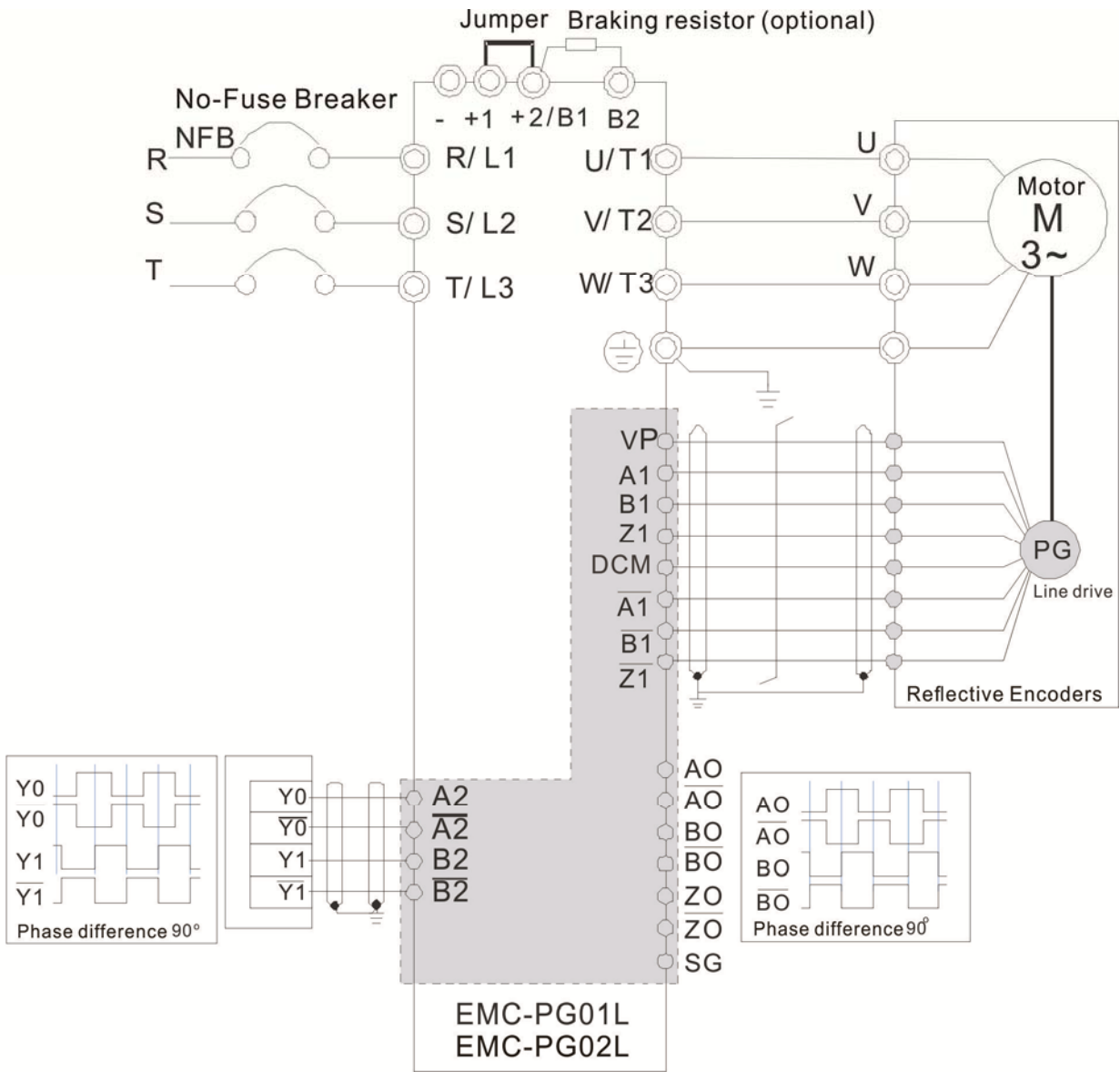

8-8 EMC-PG010/EMC-PG020

Terminal descriptions

Set by Pr.10-00~10-02, 10-16~10-18

Terminals		Descriptions
PG1	VP	Output voltage for power: +5V/+12V±5% (use FSW3 to switch +5V/+12V) Max. output current: 200mA
	DCM	Common for power and signal
	A1, /A1, B1, /B1, Z1, /Z1	Encoder Input signal (Line Driver or Open Collector) Open Collector Input Voltage: +5V~+24V (Note 1) It can be 1-phase or 2-phase input. EMC-PG010 Max. input frequency: 300kHz EMC-PG020 Max. input frequency: 30kHz(Note 2)
PG2	A2, /A2, B2, /B2	Pulse Input Signal (Line Driver or Open Collector) Open Collector Input Voltage: +5~+24V (Note 1) EMC-PG010 Max. input frequency: 300kHz EMC-PG020 Max. input frequency: 30kHz(Note 2)
PG OUT	V+, V+	Needs external power source for PG OUT circuit. Input voltage of power:+12V ~ +24V
	V-	Input voltage for the negative side
	A/O, B/O, Z/O	PG Card Output signals has division frequency function: 1~255 times. On the open collector's output signal, add a high-pull resistor on the external power V+ ~ V- (e.g. power of PLC) to prevent the interference of the receiving signal. Max. [Three pull-up resistor are included in the package (1.8kW/1W)] (Note 1) EMC-PG010 Max. input frequency: 300kHz EMC-PG020 Max. input frequency: 30kHz

Note 1: Open Collector application, input current 5~15mA to each set then each set needs one pull-up resistor. If input voltage of open collector is 24V, the power of encoder needs to be connected externally. Please refer diagram 2 of PG1.

5V	Recommended pull-up resistor: above 100~220Ω, 1/2W
12V	Recommended pull-up resistor: above 510Ω~1.35kΩ, 1/2W
24V	Recommended pull-up resistor, above 1.8k~3.3kΩ, 1/2W

Note 2: If the required bandwidth is not over 30kHz at the application, it is recommended to use EMC-PG020/L (bandwidth 30kHz) to avoid interference.

PG1 card wiring diagram (the image 1 and 2 below are wiring diagrams of Open Collector encoder)

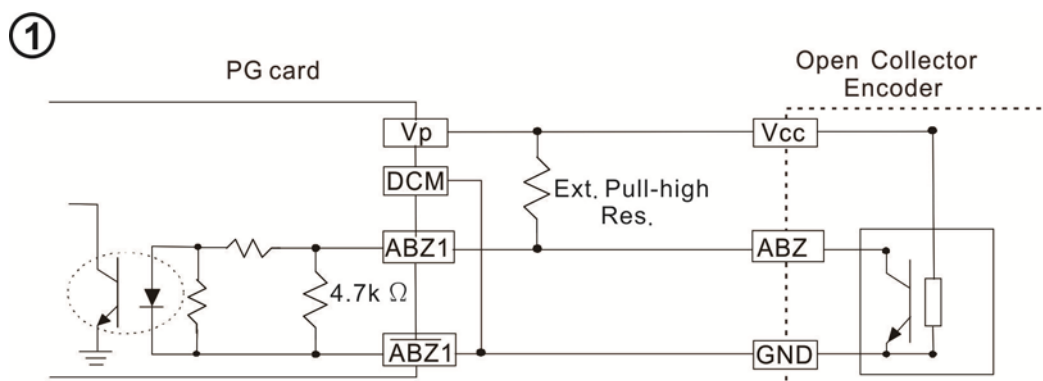

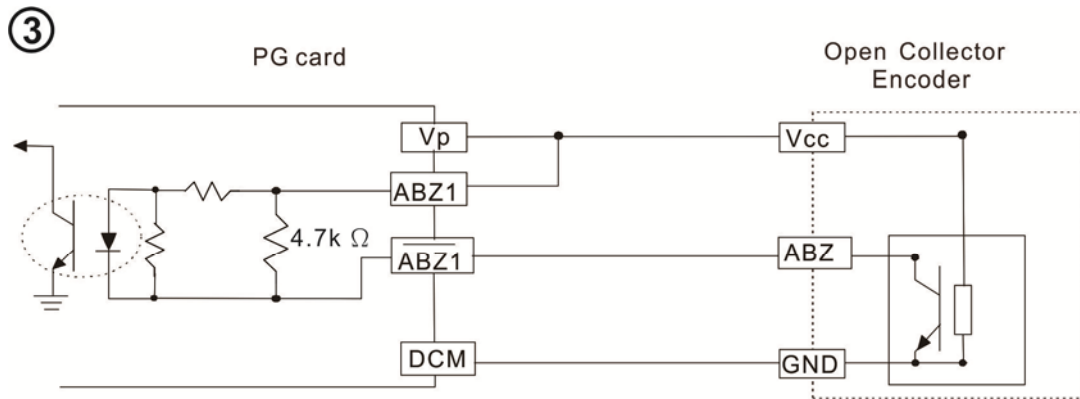
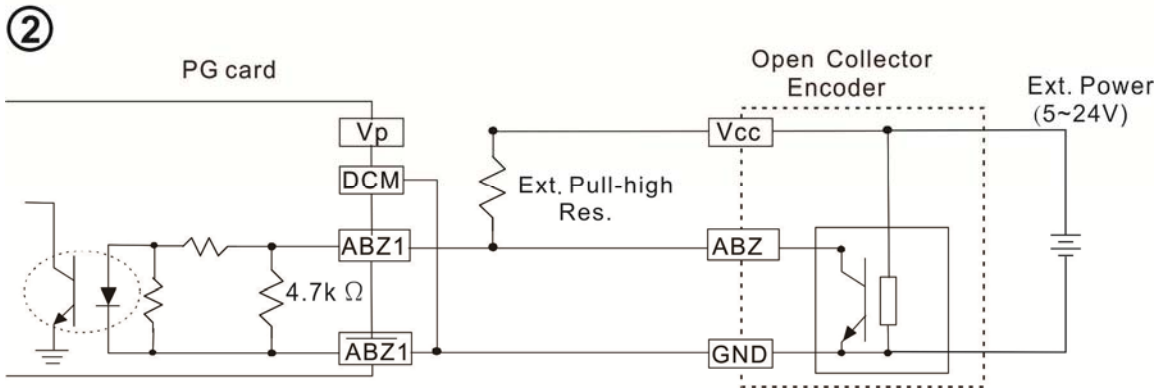

When wiring in this way, if there is a signal on EMC-PG010's A1, B1 and Z1, LED lights is OFF.

If A1, B1 and Z1 have no signals, LED lights is ON.

PG2 Wiring Diagram

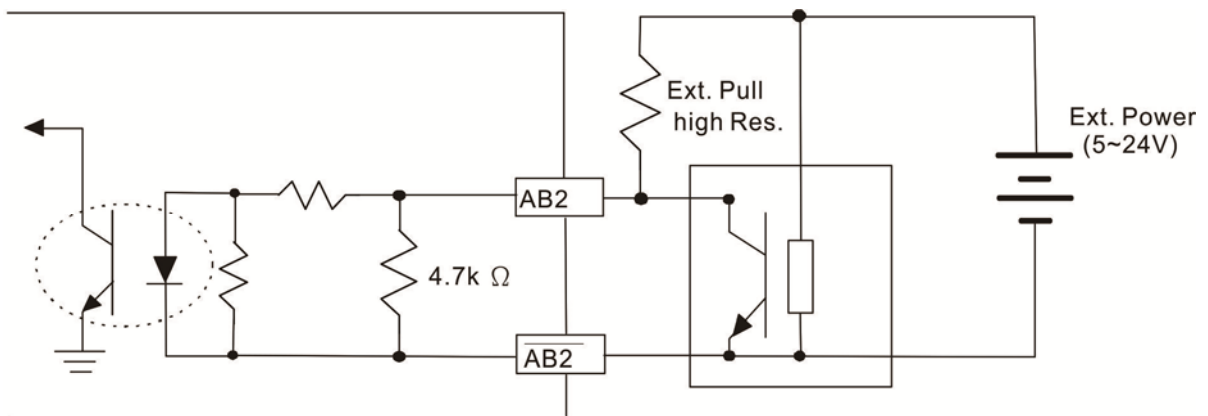

■ **EMC-PG010/EMC-PG020 Wiring Diagram**

- ☑ Please use a shielded cable to prevent interference. Do not run control wires parallel to any high voltage AC power line (200 V and above).
- ☑ Recommended wire size 0.21 to 0.81mm² (AWG24 to AWG18).
- ☑ Cable length: Less than 30m

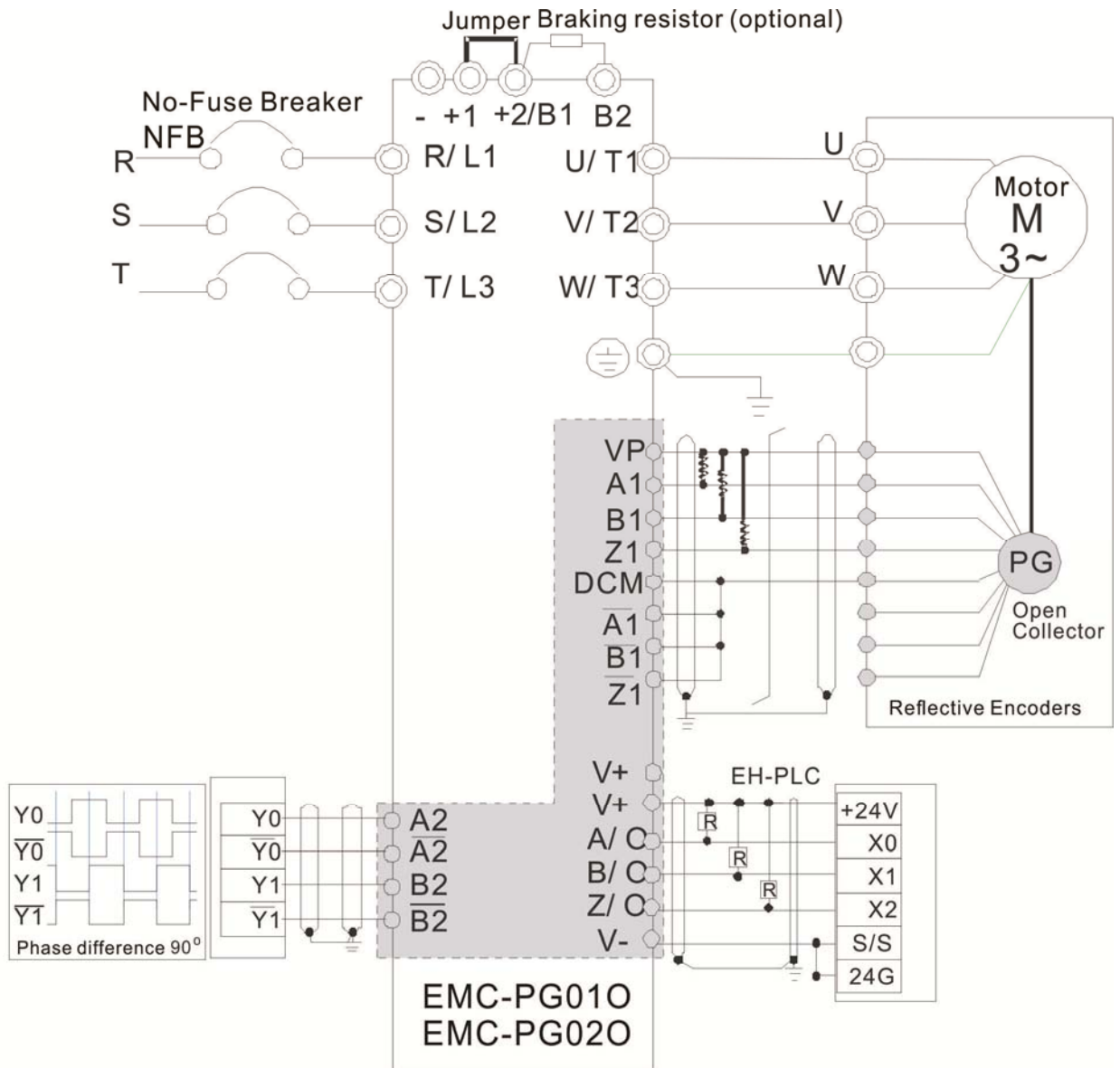

8-9 EMC-PG01U/ EMC-PG02U

- FSW1 \boxed{S} : Standard UVW Output Encoder; \boxed{D} : Delta Encoder
- When using the Delta Encoder, wait for at least 250ms after powering up to receive signals from UVW. If a running command is received before UVW signals finish, a PGF5 error message will be given. So wait for 250ms before sending a running command.
- EMC-PG02U has encoder disconnection detection function.
- Set by Pr.10-00~10-02, 10-16~10-18

Terminals		Descriptions
PG1	VP	Output voltage for power: +5V/+12V±5% (use FSW3 to switch +5V/+12V) Max. output current: 200mA
	DCM	Common for power and signal
	A1, /A1, B1, /B1, Z1, /Z1	Encoder input signal (Line Driver) It can be 1-phase or 2-phase input. Max. output frequency: 300kP/sec
	U1, /U1, V1, /V1, W1, /W1	Encoder input signal
PG2	A2, /A2, B2, /B2	Pulse Input signal (Line Driver or Open Collector) Open Collector Input Voltage: +5~+24V (Note1) It can be 1-phase or 2-phase input. Max. output frequency: 300kP/sec.
PG OUT	AO, /AO, BO, /BO, ZO, /ZO, SG	PG Card Output signals. It has division frequency function: 1~255 times Max. output voltage for Line driver: 5Vdc Max. output current: 50mA Max. output frequency: 300kP/sec SG is the GND of PG card. It is also the GND of position machine or PLC to make the output signal to be the common pivot point.

Note 1: Open Collector application, input current 5~15mA to each set then each set needs one pull-up resistor.

5V	Recommended pull-up resistor: above100~220Ω, 1/2W
12V	Recommended pull-up resistor: above 510Ω~1.35kΩ, 1/2W
24V	Recommended pull-up resistor, above1.8k~3.3kΩ, 1/2W

PG2 Wiring Diagram

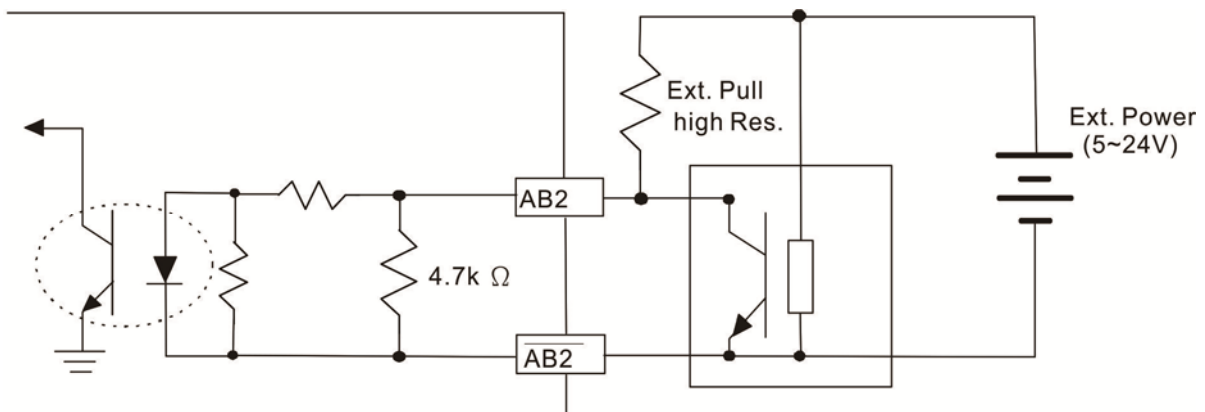

■ **EMC-PG01U Wiring Diagram**

- ☑ Please use a shielded cable to prevent interference. Do not run control wires parallel to any high voltage AC power line (200 V and above).
- ☑ Recommended wire size 0.21 to 0.81mm² (AWG24 to AWG18).
- ☑ Cable length: Less than 30m

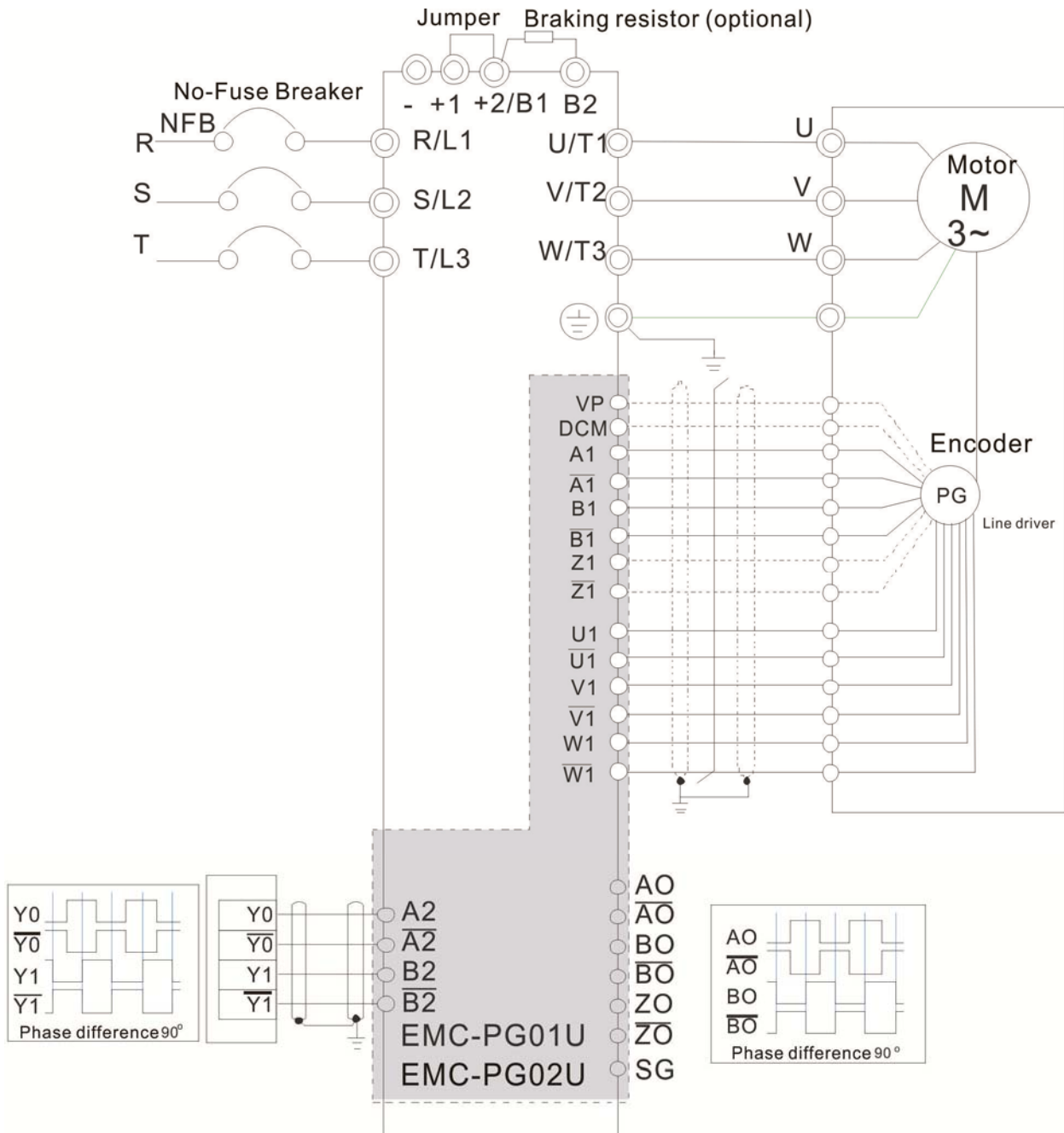

8-10 EMC-PG01R

Terminal Descriptions

Set by Pr.10-00~10-02

Terminals		Descriptions
PG1	R1- R2	Resolver Output Power 7Vrms, 10kHz
	S1, /S3, S2, /S4,	Resolver Input Signal (S2, /S4=Sin; S1, /S3=Cos) 3.5±0.175Vrms, 10kHz
PG2	A2, /A2, B2, /B2	Pulse Input signal (Line Driver or Open Collector) Open Collector Input Voltage: +5~+24V (Note1) It can be 1-phase or 2-phase input. Max. output frequency: 300kP/sec.
PG OUT	AO, /AO, BO, /BO, ZO, /ZO, SG,	PG Card Output signals. It has division frequency function: 1~255 times Max. output voltage for Line driver: 5VDC Max. output current: 50mA Max. output frequency: 300kP/sec SG is the GND of PG card. It is also the GND of position machine or PLC to make the output signal to be the common pivot point.

Note 1: Open Collector application, input current 5~15mA to each set then each set needs one pull-up resistor.

5V	Recommended pull-up resistor: above100~220Ω, 1/2W
12V	Recommended pull-up resistor: above 510Ω~1.35kΩ, 1/2W
24V	Recommended pull-up resistor, above1.8k~3.3kΩ, 1/2W

PG2 Wiring Diagram

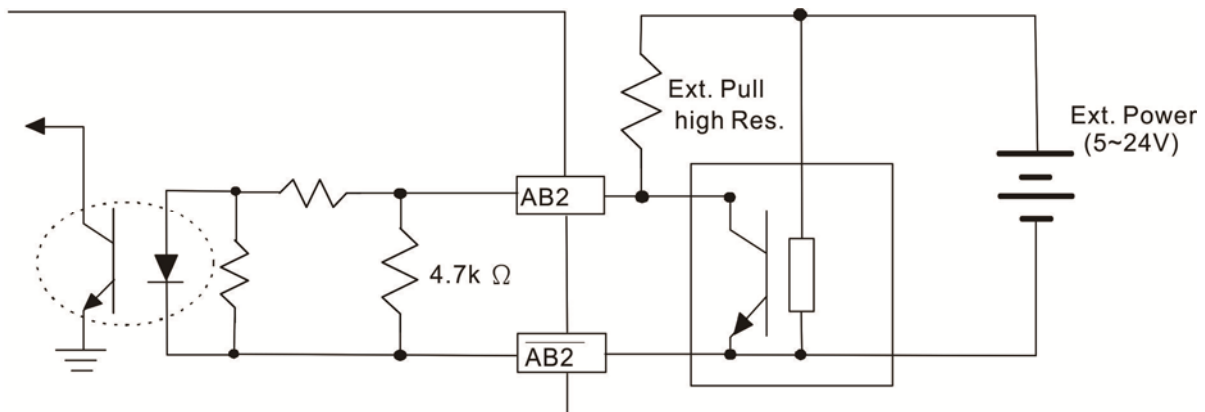

DOS(Degradation of Signal) : If the amplitude of the sine wave input of the S1-/S3/ S2-/S4 is lower than or higher than the encoder IC's specification, a red light will be on. The possible reasons which cause this problem are the following.

1. The turns ratio of the resolver encoder is not 1:0.5 which makes the sine wave input of the S1-/S3/S2-/S4 not equal to 3.5±0.175Vrms.
2. While motor is running, motor creates common mode noise which makes accumulated voltage to be more than 3.5±0.175Vrms

LOT(Loss of Tracking): Compare the angle of S1-/S3/S2-/S4 sine wave input to the R1-R2 cosine wave. If their difference is more than 5 degree, a red light will be on. Here are the possible reasons why that happens:

1. The output frequency of the PG card is incorrect.
2. The specification of Resolver's encoder is not 10KHz
3. The motor creates common mode noise while it is running. That causes a big difference, while the motor is rotating, between main winding's cosine wave angle and the sine wave angle of second and third windings.

■ **EMC-PG01R Wiring Diagram**

- ☑ Please use a shielded cable to prevent interference. Do not run control wires parallel to any high voltage AC power line (200 V and above).
- ☑ Recommended wire size 0.21 to 0.81mm² (AWG24 to AWG18).
- ☑ Cable length: Less than 100m

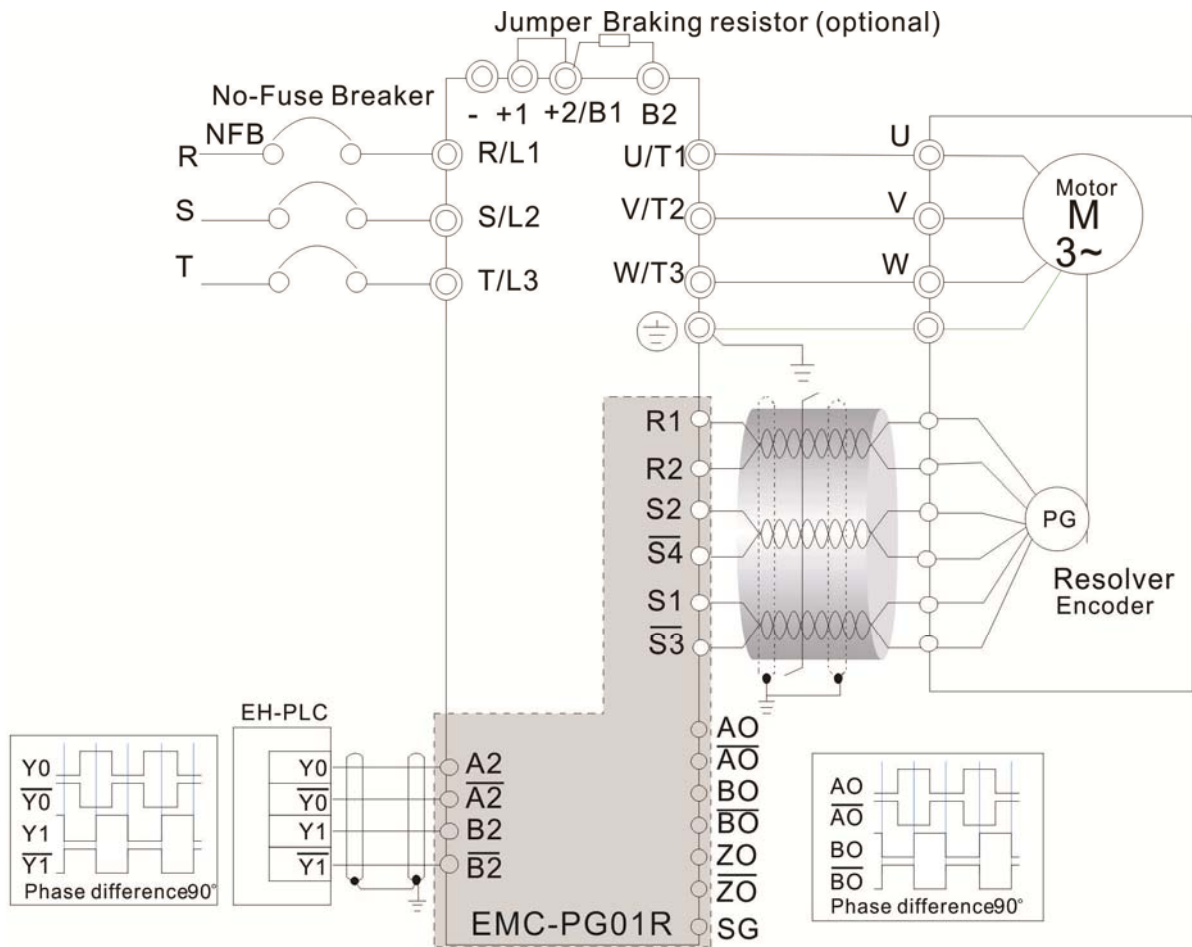

8-11 CMC-MOD01

■ Features

1. Supports Modbus TCP protocol
2. MDI/MDI-X auto-detect
3. Baud rate: 10/100Mbps auto-detect
4. E-mail alarm
5. AC motor drive keypad/Ethernet configuration
6. Virtual serial port.

■ Product File

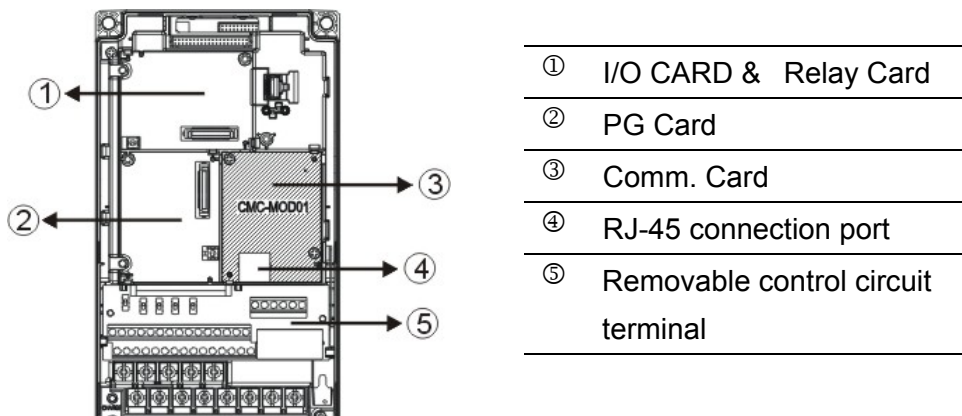

■ Specifications

Network Interface

Interface	RJ-45 with Auto MDI/MDIX
Number of ports	1 Port
Transmission method	IEEE 802.3, IEEE 802.3u
Transmission cable	Category 5e shielding 100M
Transmission speed	10/100 Mbps Auto-Detect
Network protocol	ICMP, IP, TCP, UDP, DHCP, HTTP, SMTP, MODBUS OVER TCP/IP, Delta Configuration

Electrical Specification

Power supply voltage	5VDC (supply by the AC motor drive)
Insulation voltage	2KV
Power consumption	0.8W
Weight	25g

Environment

Noise immunity	ESD (IEC 61800-5-1, IEC 61000-4-2) EFT (IEC 61800-5-1, IEC 61000-4-4) Surge Test (IEC 61800-5-1, IEC 61000-4-5) Conducted Susceptibility Test (IEC 61800-5-1, IEC 61000-4-6)
Operation/storage	Operation: -10°C ~ 50°C (temperature), 90% (humidity) Storage: -25°C ~ 70°C (temperature), 95% (humidity)
Vibration/shock immunity	International standard: IEC 61800-5-1, IEC 60068-2-6/IEC 61800-5-1, IEC 60068-2-27

■ Install CMC-MOD01 to VFD-C2000

1. Switch off the power supply of VFD-C2000.
2. Open the front cover of VFD-C2000.
3. Place the insulation spacer into the positioning pin at Slot 1 (shown in Figure 3), and aim the two holes on the PCB at the positioning pin. Press the pin to clip the holes with the PCB (shown in Figure 4).
4. Screw up at torque 6 ~ 8 kg-cm (5.21 ~ 6.94 in-lbs) after the PCB is clipped with the holes (shown in Figure 5).

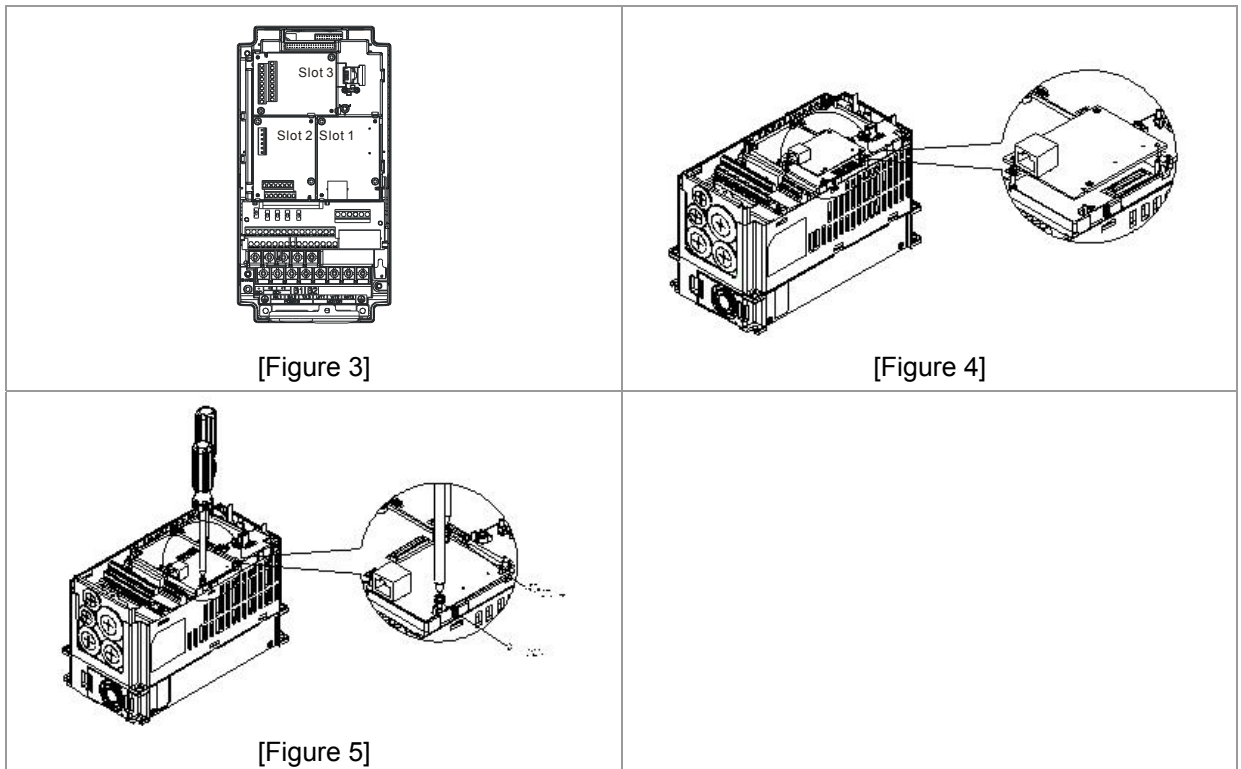

■ Communication Parameters for VFD-C2000 Connected to Ethernet

When VFD-C2000 is link to Ethernet, please set up the communication parameters base on the table below. Ethernet master will be able to read/write the frequency word and control word of VFD-C2000 after communication parameters setup.

Parameter	Function	Set value (Dec)	Explanation
P00-20	Source of frequency command setting	8	The frequency command is controlled by communication card.
P00-21	Source of operation command setting	5	The operation command is controlled by communication card.
P09-30	Decoding method for communication	0	Decoding method for Delta AC motor drive

Parameter	Function	Set value (Dec)	Explanation
P09-75	IP setting	0	Static IP(0) / Dynamic distribution IP(1)
P09-76	IP address -1	192	IP address 192.168.1.5
P09-77	IP address -2	168	IP address 192.168.1.5
P09-78	IP address -3	1	IP address 192.168.1.5
P09-79	IP address -4	5	IP address 192.168.1.5
P09-80	Netmask -1	255	Netmask 255.255.255.0
P09-81	Netmask -2	255	Netmask 255.255.255.0
P09-82	Netmask -3	255	Netmask 255.255.255.0
P09-83	Netmask -4	0	Netmask 255.255.255.0
P09-84	Default gateway -1	192	Default gateway 192.168.1.1
P09-85	Default gateway -2	168	Default gateway 192.168.1.1
P09-86	Default gateway -3	1	Default gateway 192.168.1.1
P09-87	Default gateway -4	1	Default gateway 192.168.1.1

■ **Disconnecting CMC- MOD01 from VFD-C2000**

1. Switch off the power supply of VFD-C2000.
2. Remove the two screws (shown in Figure 6).
3. Twist opens the card clip and inserts the slot type screwdriver to the hollow to prize the PCB off the card clip (shown in Figure 7).
4. Twist opens the other card clip to remove the PCB (shown in Figure 8).

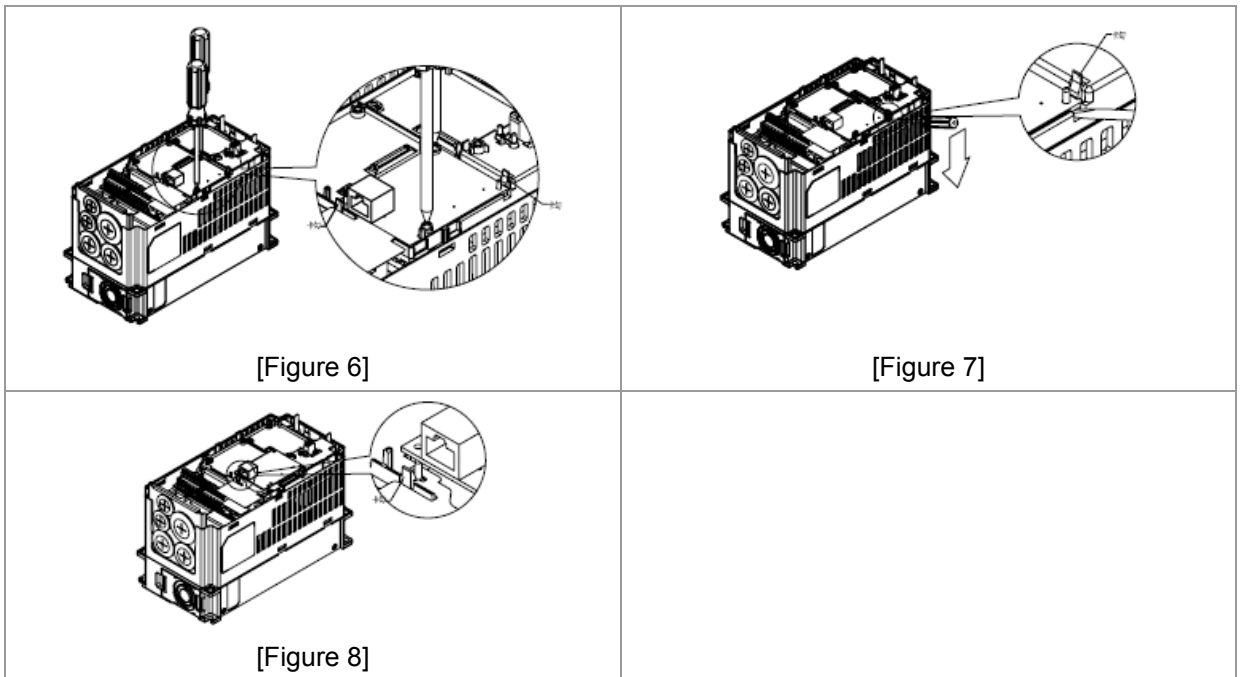

■ **Basic Registers**

BR#	R/W	Content	Explanation
#0	R	Model name	Set up by the system; read only. The model code of CMC-MOD01=H'0203
#1	R	Firmware version	Displaying the current firmware version in hex, e.g. H'0100 indicates the firmware version V1.00.
#2	R	Release date of the version	Displaying the data in decimal form. 10,000s digit and 1,000s digit are for "month"; 100s digit and 10s digit are for "day". For 1 digit: 0 = morning; 1 = afternoon.
#11	R/W	Modbus Timeout	Pre-defined setting: 500 (ms)
#13	R/W	Keep Alive Time	Pre-defined setting: 30 (s)

■ LED Indicator & Troubleshooting

LED Indicators

LED	Status	Indication	How to correct it?	
POWER	Green	On	Power supply in normal status	--
		Off	No power supply	Check the power supply
LINK	Green	On	Network connection in normal status	--
		Flashes	Network in operation	--
		Off	Network not connected	Check if the network cable is connected

Troubleshooting

Abnormality	Cause	How to correct it?
POWER LED off	AC motor drive not powered	Check if AC motor drive is powered, and if the power supply is normal.
	CMC-MOD01 not connected to AC motor drive	Make sure CMC-MOD01 is connected to AC motor drive.
LINK LED off	CMC-MOD01 not connected to network	Make sure the network cable is correctly connected to network.
	Poor contact to RJ-45 connector	Make sure RJ-45 connector is connected to Ethernet port.
No module found	CMC-MOD01 not connected to network	Make sure CMC-MOD01 is connected to network.
	PC and CMC-MOD01 in different networks and blocked by network firewall.	Search by IP or set up relevant settings by AC motor drive keypad.
Fail to open CMC-MOD01 setup page	CMC-MOD01 not connected to network	Make sure CMC-MOD01 is connected to the network.
	Incorrect communication setting in DCISoft	Make sure the communication setting in DCISoft is set to Ethernet.
	PC and CMC-MOD01 in different networks and blocked by network firewall.	Conduct the setup by AC motor drive keypad.
Able to open CMC-MOD01 setup page but fail to utilize webpage monitoring	Incorrect network setting in CMC-MOD01	Check if the network setting for CMC-MOD01 is correct. For the Intranet setting in your company, please consult your IT staff. For the Internet setting in your home, please refer to the network setting instruction provided by your ISP.
Fail to send e-mail	Incorrect network setting in CMC-MOD01	Check if the network setting for CMC-MOD01 is correct.
	Incorrect mail server setting	Please confirm the IP address for SMTP-Server.

8-12 CMC-PD01

■ Features

1. Supports PZD control data exchange.
2. Supports PKW polling AC motor drive parameters.
3. Supports user diagnosis function.
4. Auto-detects baud rates; supports Max. 12Mbps.

■ Product Profile

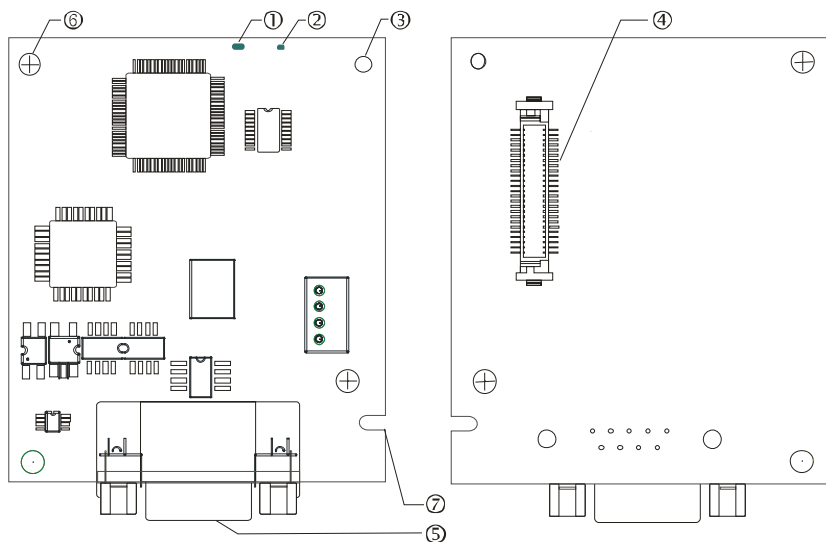

- 1. NET indicator
- 2. POWER indicator
- 3. Positioning hole
- 4. AC motor drive connection port
- 5. PROFIBUS DP connection port
- 6. Screw fixing hole
- 7. Fool-proof groove

■ Specifications

PROFIBUS DP Connector

Interface	DB9 connector
Transmission method	High-speed RS-485
Transmission cable	Shielded twisted pair cable
Electrical isolation	500VDC

Communication

Message type	Cyclic data exchange
Module name	CMC-PD01
GSD document	DELA08DB.GSD
Company ID	08DB (HEX)
Serial transmission speed supported (auto-detection)	9.6kbps; 19.2kbps; 93.75kbps; 187.5kbps; 125kbps; 250kbps; 500kbps; 1.5Mbps; 3Mbps; 6Mbps; 12Mbps (bit per second)

Electrical Specification

Power supply	5VDC (supplied by AC motor drive)
Insulation voltage	500VDC
Power consumption	1W
Weight	28g

Environment

Noise immunity	ESD(IEC 61800-5-1,IEC 6100-4-2) EFT(IEC 61800-5-1,IEC 6100-4-4) Surge Teat(IEC 61800-5-1,IEC 6100-4-5) Conducted Susceptibility Test(IEC 61800-5-1,IEC 6100-4-6)
Operation /storage	Operation: -10°C ~ 50°C (temperature), 90% (humidity) Storage: -25°C ~ 70°C (temperature), 95% (humidity)
Shock / vibration resistance	International standards: IEC61131-2, IEC68-2-6 (TEST Fc)/IEC61131-2 & IEC 68-2-27 (TEST Ea)

- Inst allation

PROFIBUS DP Connector

PIN	PIN name	Definition
1	-	Not defined
2	-	Not defined
3	Rxd/Txd-P	Sending/receiving data P(B)
4	-	Not defined
5	DGND	Data reference ground
6	VP	Power voltage – positive
7	-	Not defined
8	Rxd/Txd-N	Sending/receiving data N(A)
9	-	Not defined

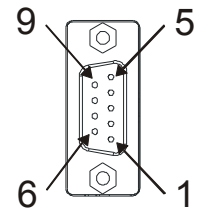

- LED Indicator & Troubleshooting

There are 2 LED indicators on CMC-PD01. POWER LED displays the status of the working power. NET LED displays the connection status of the communication.

POWER LED

LED status	Indication	How to correct it?
Green light on	Power supply in normal status.	--
Off	No power	Check if the connection between CMC-PD01 and AC motor drive is normal.

NET LED

LED status	Indication	How to correct it?
Green light on	Normal status	--
Red light on	CMC-PD01 is not connected to PROFIBUS DP bus.	Connect CMC-PD01 to PROFIBUS DP bus.
Red light flashes	Invalid PROFIBUS communication address	Set the PROFIBUS address of CMC-PD01 between 1 ~ 125 (decimal)
Orange light flashes	CMC-PD01 fails to communication with AC motor drive.	Switch off the power and check whether CMC-PD01 is correctly and normally connected to AC motor drive.

8-13 CMC-DN01

■ Functions

1. Based on the high-speed communication interface of Delta HSSP protocol, able to conduct immediate control to AC motor drive.
2. Supports Group 2 only connection and polling I/O data exchange.
3. For I/O mapping, supports Max. 32 words of input and 32 words of output.
4. Supports EDS file configuration in DeviceNet configuration software.
5. Supports all baud rates on DeviceNet bus: 125kbps, 250kbps, 500kbps and extendable serial transmission speed mode.
6. Node address and serial transmission speed can be set up on AC motor drive.
7. Power supplied from AC motor drive.

■ Product Profile

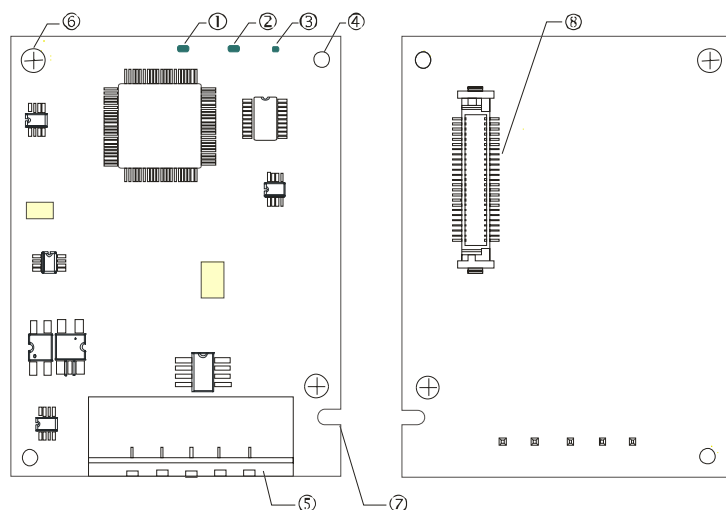

1. NS indicator
2. MS indicator
3. POWER indicator
4. Positioning hole
5. DeviceNet connection port
6. Screw fixing hole
7. Fool-proof groove
8. AC motor drive connection port

■ Specifications

DeviceNet Connector

Interface	5-PIN open removable connector. Of 5.08mm PIN interval
Transmission	CAN
Transmission cable	Shielded twisted pair cable (with 2 power cables)
Transmission speed	125kbps, 250kbps, 500kbps and extendable serial transmission speed
Network protocol	DeviceNet protocol

AC Motor Drive Connection Port

Interface	50 PIN communication terminal
Transmission method	SPI communication
Terminal function	1. Communicating with AC motor drive 2. Transmitting power supply from AC motor drive
Communication	Delta HSSP protocol

Electrical Specification

Power supply voltage	5VDC (supplied by AC motor drive)
Insulation voltage	500VDC
Communication wire power consumption	0.85W
Power consumption	1W
Weight	23g

Environment

Noise immunity	ESD (IEC 61800-5-1,IEC 6100-4-2) EFT (IEC 61800-5-1,IEC 6100-4-4) Surge Teat(IEC 61800-5-1,IEC 6100-4-5) Conducted Susceptibility Test (IEC 61800-5-1,IEC 6100-4-6)
Operation /storage	Operation: -10°C ~ 50°C (temperature), 90% (humidity) Storage: -25°C ~ 70°C (temperature), 95% (humidity)
Shock / vibration resistance	International standards: IEC61131-2, IEC68-2-6 (TEST Fc)/IEC61131-2 & IEC 68-2-27 (TEST Ea)

DeviceNet Connector

PIN	Signal	Color	Definition
1	V+	Red	DC24V
2	H	White	Signal+
3	S	-	Earth
4	L	Blue	Signal-
5	V-	Black	0V

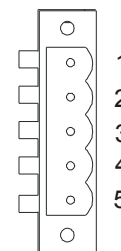

- LED Indicator & Troubleshooting

There are 3 LED indicators on CMC-DN01. POWER LED displays the status of power supply. MS LED and NS LED are dual-color LED, displaying the connection status of the communication and error messages.

POWER LED

LED status	Indication	How to correct it?
On	Power supply in abnormal status.	Check the power supply of CMC-DN01.
Off	Power supply in normal status	--

NS LED

LED status	Indication	How to correct it?
Off	No power supply or CMC-DN01 has not completed MAC ID test yet.	<ol style="list-style-type: none"> 1. Check the power of CMC-DN01 and see if the connection is normal. 2. Make sure at least one or more nodes are on the bus. 3. Check if the serial transmission speed of CMC-DN01 is the same as that of other nodes.
Green light flashes	CMC-DN01 is on-line but has not established connection to the master.	<ol style="list-style-type: none"> 1. Configure CMC-DN01 to the scan list of the master. 2. Re-download the configured data to the master.
Green light on	CMC-DN01 is on-line and is normally connected to the master	--
Red light flashes	CMC-DN01 is on-line, but I/O connection is timed-out.	<ol style="list-style-type: none"> 1. Check if the network connection is normal. 2. Check if the master operates normally.
Red light on	<ol style="list-style-type: none"> 1. The communication is down. 2. MAC ID test failure. 3. No network power supply. 4. CMC-DN01 is off-line. 	<ol style="list-style-type: none"> 1. Make sure all the MAC IDs on the network are not repeated. 2. Check if the network installation is normal. 3. Check if the baud rate of CMC-DN01 is consistent with that of other nodes. 4. Check if the node address of CMC-DN01 is illegal. 5. Check if the network power supply is normal.

MS LED

LED status	Indication	How to correct it?
Off	No power supply or being off-line	Check the power supply of CMC-DN01 and see if the connection is normal.
Green light flashes	Waiting for I/O data	Switch the master PLC to RUN status
Green light on	I/O data are normal	--
Red light flashes	Mapping error	<ol style="list-style-type: none"> 1. Reconfigure CMC-DN01 2. Re-power AC motor drive
Red light on	Hardware error	<ol style="list-style-type: none"> 1. See the error code displayed on AC motor drive. 2. Send back to the factory for repair if necessary.
Orange light flashes	CMC-DN01 is establishing connection with AC motor drive.	If the flashing lasts for a long time, check if CMC-DN01 and AC motor drive are correctly installed and normally connected to each other.

8-14 CMC-EIP01

■ Features

1. Supports Modbus TCP and Ethernet/IP protocol
2. MDI/MDI-X auto-detect
3. Baud rate: 10/100Mbps auto-detect
4. AC motor drive keypad/Ethernet configuration
5. Virtual serial port

■ Product Profile

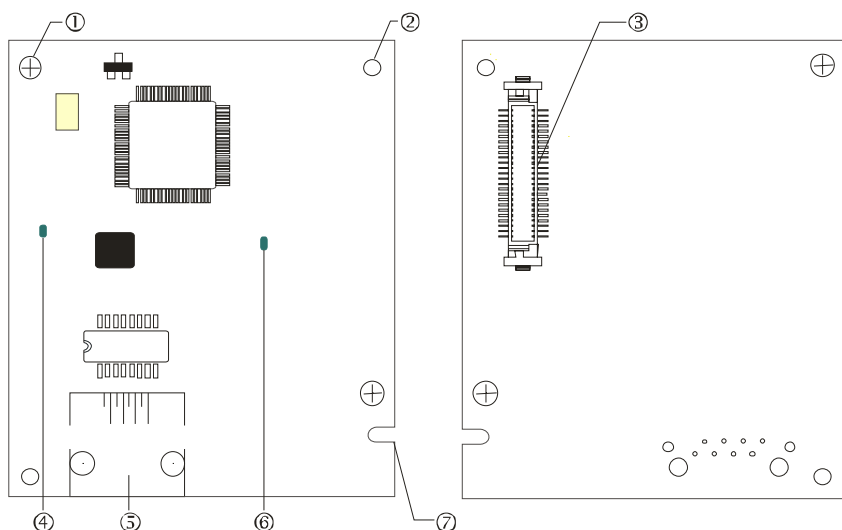

[Figure1]

1. Screw fixing hole
2. Positioning hole
3. AC motor drive connection port
4. LINK indicator
5. RJ-45 connection port
6. POWER indicator
7. Fool-proof groove

■ Specifications

Network Interface

Interface	RJ-45 with Auto MDI/MDIX
Number of ports	1 Port
Transmission method	IEEE 802.3, IEEE 802.3u
Transmission cable	Category 5e shielding 100M
Transmission speed	10/100 Mbps Auto-Detect
Network protocol	ICMP, IP, TCP, UDP, DHCP, HTTP, SMTP, MODBUS OVER TCP/IP, EtherNet/IP, Delta Configuration

Electrical Specification

Weight	25g
Insulation voltage	500VDC
Power consumption	0.8W
Power supply voltage	5VDC

Environment

Noise immunity	ESD (IEC 61800-5-1,IEC 61000-4-2) EFT (IEC 61800-5-1,IEC 61000-4-4) Surge Test (IEC 61800-5-1,IEC 61000-4-5) Conducted Susceptibility Test (IEC 61800-5-1,IEC 61000-4-6)
Operation/storage	Operation: -10°C ~ 50°C (temperature), 90% (humidity) Storage: -25°C ~ 70°C (temperature), 95% (humidity)
Vibration/shock immunity	International standard: IEC 61800-5-1, IEC 60068-2-6/IEC 61800-5-1, IEC 60068-2-27

■ Installation

Connecting CMC-EIP01 to Network

1. Turn off the power of AC motor drive.
2. Open the cover of AC motor drive.
3. Connect CAT-5e network cable to RJ-45 port on CMC-EIP01 (See Figure 2).

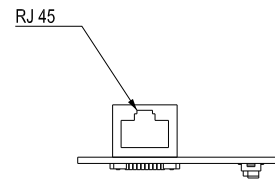

[Figure 2]

RJ-45 PIN Definition

PIN	Signal	Definition	PIN	Signal	Definition
1	Tx+	Positive pole for data transmission	5	--	N/C
2	Tx-	Negative pole for data transmission	6	Rx-	Negative pole for data receiving
3	Rx+	Positive pole for data receiving	7	--	N/C
4	--	N/C	8	--	N/C

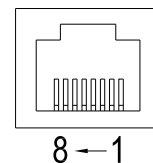

■ Connecting CMC-EIP01 to VFD-C2000

1. Switch off the power of AC motor drive.
2. Open the front cover of AC motor drive.
3. Place the insulation spacer into the positioning pin at Slot 1 (shown in Figure 3), and aim the two holes on the PCB at the positioning pin. Press the pin to clip the holes with the PCB (see Figure 4).
4. Screw up at torque 6 ~ 8 kg-cm (5.21 ~ 6.94 in-lbs) after the PCB is clipped with the holes (see Figure 5).

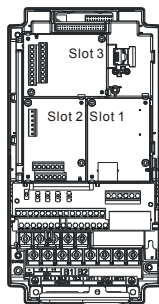

[Figure 3]

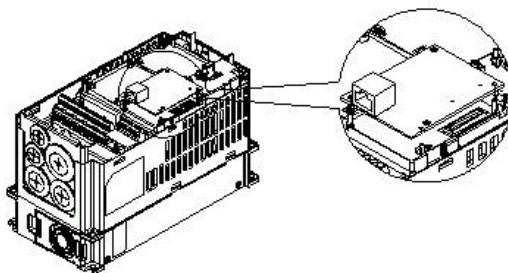

[Figure 4]

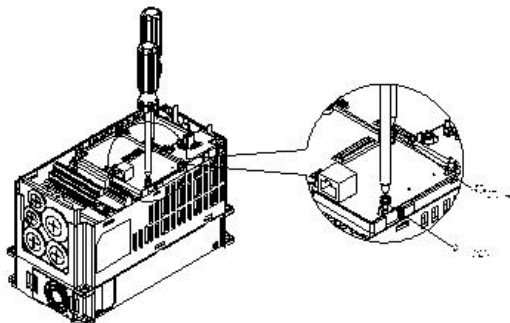

[Figure 5]

■ **Communication Parameters for VFD-C2000 Connected to Ethernet**

When VFD-C2000 is connected to Ethernet network, please set up the communication parameters for it according to the table below. The Ethernet master is only able to read/write the frequency word and control word of VFD-C2000 after the communication parameters are set.

Parameter	Function	Set value (Dec)	Explanation
P00-20	Source of frequency command setting	8	The frequency command is controlled by communication card.
P00-21	Source of operation command setting	5	The operation command is controlled by communication card.
P09-30	Decoding method for communication	0	The decoding method for Delta AC motor drive
P09-75	IP setting	0	Static IP(0) / Dynamic distribution IP(1)
P09-76	IP address -1	192	IP address 192.168.1.5
P09-77	IP address -2	168	IP address 192.168.1.5
P09-78	IP address -3	1	IP address 192.168.1.5
P09-79	IP address -4	5	IP address 192.168.1.5
P09-80	Netmask -1	255	Netmask 255.255.255.0
P09-81	Netmask -2	255	Netmask 255.255.255.0
P09-82	Netmask -3	255	Netmask 255.255.255.0
P09-83	Netmask -4	0	Netmask 255.255.255.0
P09-84	Default gateway -1	192	Default gateway 192.168.1.1
P09-85	Default gateway -2	168	Default gateway 192.168.1.1
P09-86	Default gateway -3	1	Default gateway 192.168.1.1
P09-87	Default gateway -4	1	Default gateway 192.168.1.1

■ **Disconnecting CMC- EIP01 from VFD-C2000**

1. Switch off the power supply of VFD-C2000.
2. Remove the two screws (see Figure 6).
3. Twist opens the card clip and inserts the slot type screwdriver to the hollow to prize the PCB off the card clip (see Figure 7).
4. Twist opens the other card clip to remove the PCB (see Figure 8).

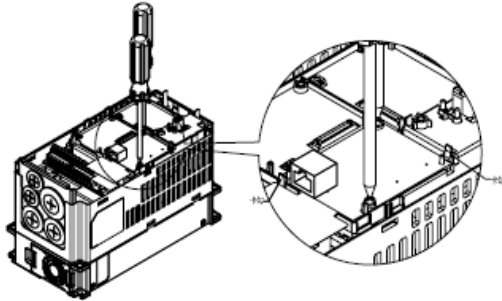

[Figure 6]

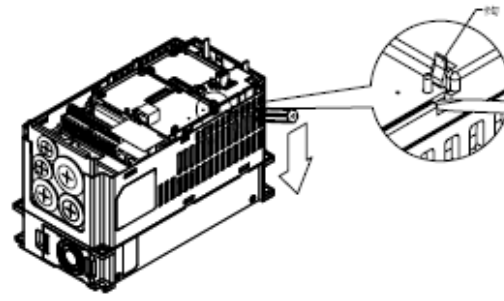

[Figure 7]

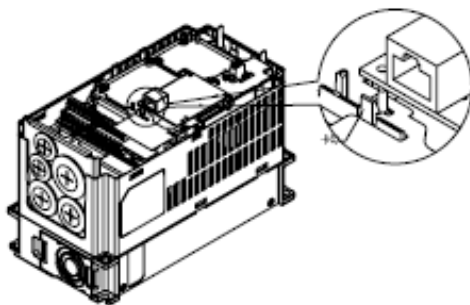

[Figure 8]

■ **LED Indicator & Troubleshooting**

There are 2 LED indicators on CMC-EIP01. The POWER LED displays the status of power supply, and the LINK LED displays the connection status of the communication.

LED Indicators

LED	Status		Indication	How to correct it?
POWER	Green	On	Power supply in normal status	--
		Off	No power supply	Check the power supply.
LINK	Green	On	Network connection in normal status	--
		Flashes	Network in operation	--
		Off	Network not connected	Check if the network cable is connected.

Troubleshooting

Abnormality	Cause	How to correct it?
POWER LED off	AC motor drive not powered	Check if AC motor drive is powered, and if the power supply is normal.
	CMC-EIP01 not connected to AC motor drive	Make sure CMC-EIP01 is connected to AC motor drive.
LINK LED off	CMC-EIP01 not connected to network	Make sure the network cable is correctly connected to network.
	Poor contact to RJ-45 connector	Make sure RJ-45 connector is connected to Ethernet port.

Abnormality	Cause	How to correct it?
No communication card found	CMC-EIP01 not connected to network	Make sure CMC-EIP01 is connected to network.
	PC and CMC-EIP01 in different networks and blocked by network firewall.	Search by IP or set up relevant settings by AC motor drive keypad.
Fail to open CMC-EIP01 setup page	CMC-EIP01 not connected to network	Make sure CMC-EIP01 is connected to the network.
	Incorrect communication setting in DCISoft	Make sure the communication setting in DCISoft is set to Ethernet.
	PC and CMC-EIP01 in different networks and blocked by network firewall.	Conduct the setup by AC motor drive keypad.
Able to open CMC-EIP01 setup page but fail to utilize webpage monitoring	Incorrect network setting in CMC-EIP01	Check if the network setting for CMC-EIP01 is correct. For the Intranet setting in your company, please consult your IT staff. For the Internet setting in your home, please refer to the network setting instruction provided by your ISP.
Fail to send e-mail	Incorrect network setting in CMC-EIP01	Check if the network setting for CMC-EIP01 is correct.
	Incorrect mail server setting	Please confirm the IP address for SMTP-Server.

8-15 EMC-COP01

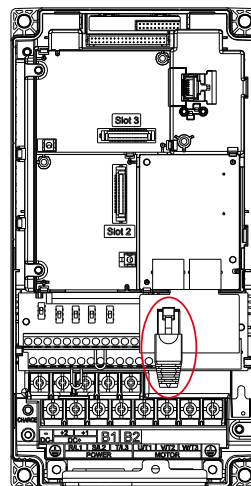
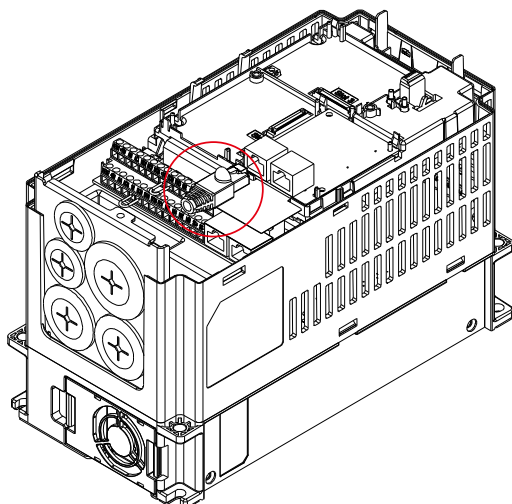

■ **RJ-45 Pin definition**



RS485 socket

Pin	Pin name	Definition
1	CAN_H	CAN_H bus line (dominant high)
2	CAN_L	CAN_L bus line (dominant low)
3	CAN_GND	Ground/0V/V-
7	CAN_GND	Ground/0V/V-

■ **Specifications**

Interface	RJ-45
Number of ports	1 Port
Transmission method	CAN
Transmission cable	CAN standard cable
Transmission speed	1M 500k 250k 125k 100k 50k
Communication protocol	CANopen

■ **CANopen Communication Cable**

Model: TAP-CB03, TAP-CB04

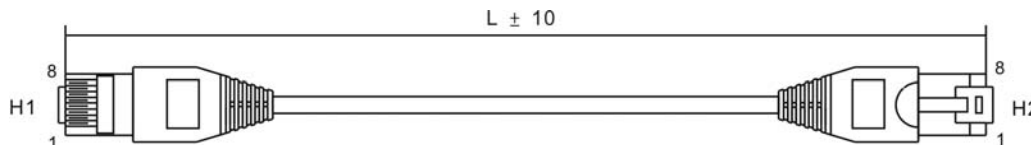

Title	Part No.	L	
		mm	inch
1	TAP-CB03	500 ± 10	19 ± 0.4
2	TAP-CB04	1000 ± 10	39 ± 0.4

■ CANopen Dimension

Model: TAP-CN03

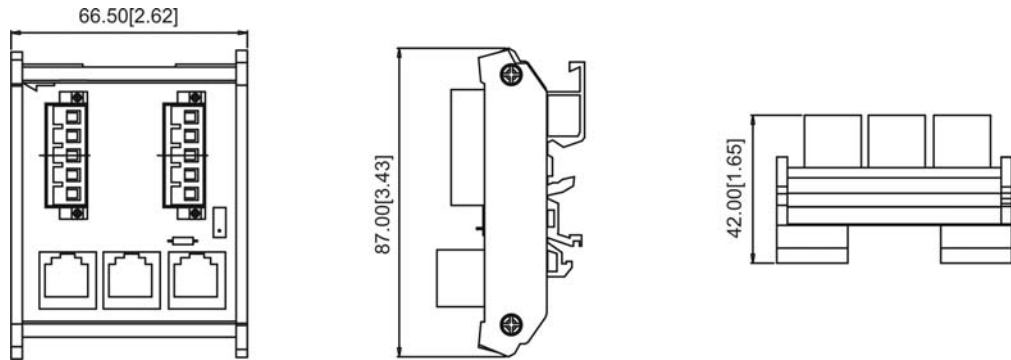

NOTE

For more information on CANopen, please refer to Chapter 15 CANopen Overview or CANopen user manual can also be downloaded on Delta website: <http://www.delta.com.tw/industrialautomation/>.

[This page intentionally left blank]

Chapter 9 Specification

460V Series



Frame		B			C			D				
Model: VFD___CT43_____		110	150	185	220	300	370	450	550	750*	900*	
Max. Applicable Motor Output (kW)		11	15	18.5	22	30	37	45	55	75	90	
Max. Applicable Motor Output (HP)		15	20	25	30	40	50	60	75	100	125	
Output Rating	Heavy Duty	Rated Output Capacity (kVA)	14	18	24	29	34	45	55	69	84	114
		Rated Output Current (A)	17	23	30	36	43	57	69	86	105	143
		Carrier Frequency (kHz)	2~6kHz									
	Light Duty	Rated Output Capacity (kVA)	18	24	29	36	45	57	73	88	115	143
		Rated Output Current (A)	24	33	40	50	62	79	91	110	144	180
		Carrier Frequency (kHz)	323~528Vac									
Input Rating	Input Current (A) Heavy Duty		19	25	33	38	45	60	70	96	108	149
	Input Current (A) Light Duty		25	33	40	50	62	79	91	110	144	180
	Rated Voltage/Frequency		3-phase, AC 380V~480V (-15%~+10%), 50/60Hz									
	Operating Voltage Range		323~528Vac									
	Frequency Tolerance		47~63Hz									
Cooling Method		Flange mounted models are natural cooling, it is suitable for air cooling dust design place; wall mounted models are fan cooling										
Wind Speed of Heat Sink Airway	Wind speed when the carrier frequency is 2kHz (m/s)		3.5			3.5		7	3.5	4.5	6 8.5	
	Wind speed when the carrier frequency is default setting (m/s)		3.5	6.5	8.5	3.5	7.0	9.5	5.5	6 8.5		9.5
Braking Chopper		Frame B, C: Built-in; Frame D: Optional										
DC reactor		Frame B, C: Optional; Frame D: Built-in										
EMI Filter		Optional										

NOTE

- Rated input current may be influenced by connection condition of power transformer, input reactor, and fluctuates as the impedance of power side.
- “ * ” only for drives with model names ending in the letter A

General Specifications

Control Characteristics	Control Method	1: V/F, 2: SVC, 3: VF+PG, 4: FOC+PG, 5: TQC+PG
	Starting Torque	Reach up to 150% or above at 0.5Hz. Under FOC+PG mode, starting torque can reach 150% at 0Hz.
	V/F Curve	4 point adjustable V/F curve and square curve
	Speed Response Ability	5Hz (vector control can reach up to 40Hz)
	Torque Limit	Light duty: 130% torque current; Heavy duty: 180% torque current
	Torque Accuracy	±5%
	*Max. Output Frequency (Hz)	Light duty: 0.01~600.00Hz; Heavy duty: 0.00 ~ 300.00Hz
	Frequency Output Accuracy	Digital command ±0.01%, -10°C~+40°C; Analog command ±0.1%, 25±10°C
	Output Frequency Resolution	Digital command 0.01Hz; Analog command: 0.3*max. output frequency/60 Hz (±11 bit)
Overload Tolerance	Light duty: When rated output current is 120%, 60 seconds for every 5 minutes W hen rated output current is 160%, 3 seconds for every 30 seconds Heavy duty: When rated output current is 150%, 60 seconds for every 5 minutes W hen rated output current is 180%, 3 seconds for every 30 seconds	

	Frequency Setting Signal	+10V~-10, 0~+10V, 4~20mA, 0~20mA, Pulse input
	Accel./decel. Time	0.00~600.00/0.0~6000.0 seconds
	Main Control Function	Torque control, Droop control, Speed/torque control switching, Feed forward control, Zero-servo control, Momentary power loss ride thru, Speed search, Over-torque detection, Torque limit, 17-step speed (max), Accel/decel time switch, S-curve accel/decel, 3-wire sequence, Auto-Tuning (rotational, stationary), Dwell, Slip compensation, Torque compensation, JOG frequency, Frequency upper/lower limit settings, DC injection braking at start/stop, High slip braking, PID control (with sleep function), Energy saving control, MODOBUS communication (RS-485 RJ45, max. 115.2 kbps), Fault restart, Parameter copy
	Fan Control	CT2000 Ver.B do not have fan built-in when leave the factory
Protection Characteristics	Motor Protection	Electronic thermal relay protection
	Over-current Protection	Over-current protection for 220% rated current current clamp 『Light duty: 130~140%』 ; 『Heavy duty: 180~185%』
	Over-voltage Protection	460: drive will stop when DC-BUS voltage exceeds 820V
	Over-temperature Protection	Built-in temperature sensor
	Stall Prevention	Stall prevention during acceleration, deceleration and running independently
	Restart After Instantaneous Power Failure	Parameter setting up to 20 seconds
	Grounding Leakage Current Protection	Leakage current is higher than 50% of rated current of the AC motor drive
	Certifications	   GB/T 12668-2,

 **NOTE**

* The setting range of maximum output frequency changes as the carrier wave and control mode change. Refer to Pr. 01-00 and Pr.06-55 for more information.

Environment for Operation, Storage and Transportation

DO NOT expose the AC motor drive in the bad environment, such as dust, direct sunlight, corrosive/inflammable gasses, humidity, liquid and vibration environment. The salt in the air must be less than 0.01mg/cm² every year.

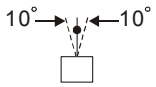
Environment	Installation location	IEC60364-1/IEC60664-1 Pollution degree 2, Indoor use only		
	Surrounding Temperature	Storage	-25 °C ~ +70 °C	
		Transportation	-25 °C ~ +70 °C	
	Only allowed at non-condensation, non-frozen, non-conductive pollution environment.			
	Rated Humidity	Operation	Max. 95%	
		Storage/ Transportation	Max. 95%	
	Only allowed at non-condensation, non-frozen, non-conductive pollution environment.			
	Air Pressure	Operation/ Storage	86 to 106 kPa	
		Transportation	70 to 106 kPa	
	Pollution Level	IEC 60721-3-3		
		Operation	Class 3C2; Class 3S2	
		Storage	Class 2C2; Class 2S2	
		Transportation	Class 1C2; Class 1S2	
Only allowed at non-condensation, non-frozen, non-conductive pollution environment.				
Altitude	Operation	If AC motor drive is installed at altitude 0~1000m, follow normal operation restriction. If it is install at altitude 1000~3000m, decrease 2% of rated current or lower 0.5°C of temperature for every 100m increase in altitude. Maximum altitude for Corner Grounded is 2000m.		
Package Drop	Storage	ISTA procedure 1A(according to weight) IEC60068-2-31		
	Transportation			
Vibration	1.0mm, peak to peak value range from 2Hz to 13.2 Hz; 0.7G~1.0G range from 13.2Hz to 55Hz; 1.0G range from 55Hz to 512 Hz. Comply with IEC 60068-2-6			
Impact	IEC/EN 60068-2-27			
Operation Position	Max. allowed offset angle ±10° (under normal installation position)			

Specification for Operation Temperature and Protection Level

Model	Frame	Top cover	Conduit Box	Protection Level	Operation Temperature
VFDxxxCT43_	B, C	Top cover Removed	Standard conduit box	IP20/UL Open Type	Flange mounted models
	D	N/A	No conduit box	IP00 IP20/UL Open Type This circled part is IP00, other areas are IP20	Body: -10~50°C Heat sink: -10~40°C Wall mounted models -10~50°C



Heat Dissipation System Diagram

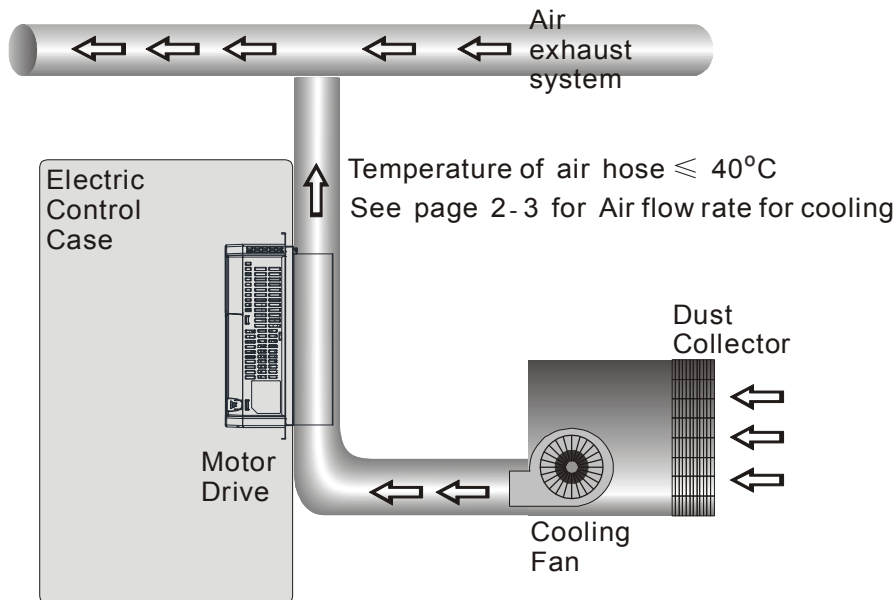

Air Velocity Specification at Heat Dissipation Channel

Frame	B			C			D			
Model VFD__CT43_____	110	150	185	220	300	370	450	550	750	900
Air Velocity @fc=2kHz (M/sec)	3.5	3.5	3.5	3.5	3.5	7	3.5	4.5	6	8.5
Air Velocity @ default fc (M/sec)	3.5	6.5	8.5	3.5	7	9.5	5.5	6	8.5	9.5

Definition of Air Velocity: When the dissipation channels are at bypass condition, the air speed that equally flows 5cm in front of the heatsink. As shown in the Figure 1 below, dotted lines are required size in mm to calculate the minimum air velocity (table above) to cool down the heat. The closer the size of the heat dissipation channel to the size of the heatsink, the better the result of heat dissipation.

Frame B

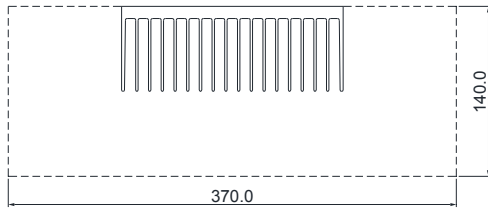

Frame C

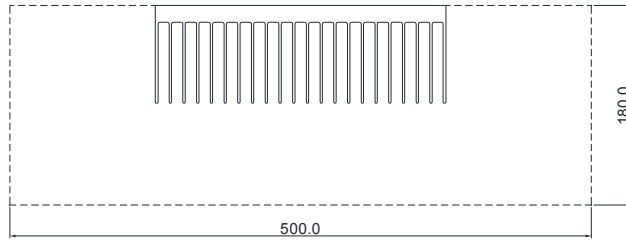

Frame D

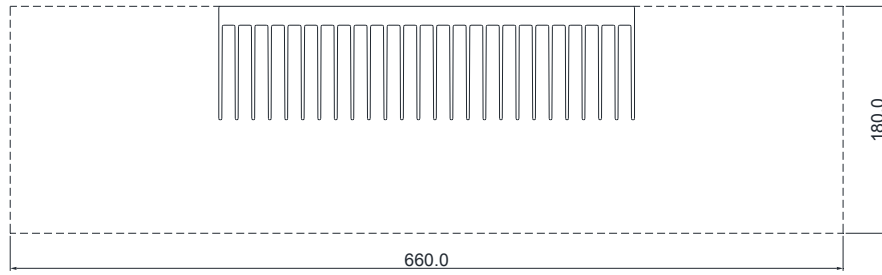

Figure 1

Chapter 10 Digital Keypad

10-1 Descriptions of Digital Keypad

10-2 Function of Digital Keypad KPC-CC01

10-3 TPEditor Installation Instruction

10-4 Fault Code Description of Digital Keypad KPC-CC01

10-1 Descriptions of Digital Keypad

KPC-CC01

KPC-CE01(Optional)

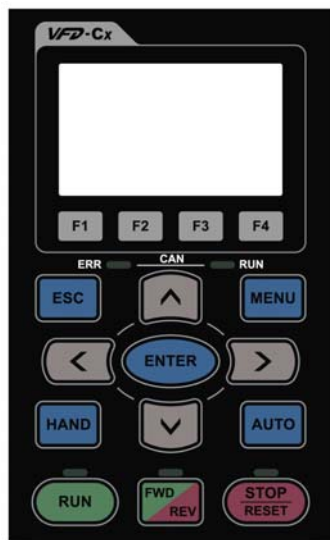











Communication Interface
RJ-45 (socket) \ RS-485 interface;

Installation Method

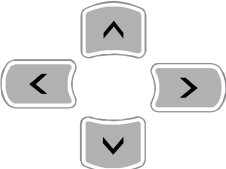



1. Embedded type and can be put flat on the surface of the control box. The front cover is water proof.
2. Buy a MKC-KPPK model to do wall mounting or embedded mounting. Its protection level is IP66.
3. The maximum RJ45 extension lead is 5 m (16ft)
4. This keypad can only be used on Delta's motor drive CT2000, C2000, CH2000 and CP2000.

Descriptions of Keypad Functions

Key	Descriptions																		
	<p>Start Operation Key</p> <ol style="list-style-type: none"> 1. It is only valid when the source of operation command is from the keypad. 2. It can operate the AC motor drive by the function setting and the RUN LED will be ON. 3. It can be pressed again and again at stop process. 4. When enabling "HAND" mode, it is only valid when the source of operation command is from the keypad. 																		
	<p>Stop Command Key. This key has the highest processing priority in any situation.</p> <ol style="list-style-type: none"> 1. When it receives STOP command, no matter the AC motor drive is in operation or stop status, the AC motor drive needs to execute "STOP" command. 2. The RESET key can be used to reset the drive after the fault occurs. For those faults that can't be reset by the RESET key, see the fault records after pressing MENU key for details. 																		
	<p>Operation Direction Key</p> <ol style="list-style-type: none"> 1. This key is only control the operation direction NOT for activate the drive. FWD: forward, REV: reverse. 2. Refer to the LED descriptions for more details. 																		
	<p>ENTER Key</p> <p>Press ENTER and go to the next level. If it is the last level then press ENTER to execute the command.</p>																		
	<p>ESC Key</p> <p>ESC key function is to leave current menu and return to the last menu. It is also functioned as a return key in the sub-menu.</p>																		
	<p>Press menu to return to main menu.</p> <p>Menu content:</p> <p>KPC-CE01 does not support function 5 ~13.</p> <table border="0"> <tr> <td>1. Detail Parameter</td> <td>7. Quick/Simple Setup</td> <td>13. PC Link</td> </tr> <tr> <td>2. Copy Parameter</td> <td>8. Display Setup</td> <td></td> </tr> <tr> <td>3. Keypad Locked</td> <td>9. Time Setup</td> <td></td> </tr> <tr> <td>4. PLC Function</td> <td>10. Language Setup</td> <td></td> </tr> <tr> <td>5. Copy PLC</td> <td>11. Startup Menu</td> <td></td> </tr> <tr> <td>6. Fault Record</td> <td>12. Main Page</td> <td></td> </tr> </table>	1. Detail Parameter	7. Quick/Simple Setup	13. PC Link	2. Copy Parameter	8. Display Setup		3. Keypad Locked	9. Time Setup		4. PLC Function	10. Language Setup		5. Copy PLC	11. Startup Menu		6. Fault Record	12. Main Page	
1. Detail Parameter	7. Quick/Simple Setup	13. PC Link																	
2. Copy Parameter	8. Display Setup																		
3. Keypad Locked	9. Time Setup																		
4. PLC Function	10. Language Setup																		
5. Copy PLC	11. Startup Menu																		
6. Fault Record	12. Main Page																		
	<p>Direction: Left/Right/Up/Down</p> <ol style="list-style-type: none"> 1. In the numeric value setting mode, it is used to move the cursor and change the numeric value. 2. In the menu/text selection mode, it is used for item selection. 																		

	<p>Function Key</p> <ol style="list-style-type: none"> 1. It has the factory setting function and the function can be set by the user. The present factory setting: F1 is JOG function. 2. Other functions must be defined by TPEditor first. TPEditor software V1.40 or later is available for download at: http://www.deltaww.com/services/DownloadCenter2.aspx?seclD=8&pid=2&tid=0&CID=06&itemID=060303&typeID=1&downloadID=&title=-%20%E8%AB%8B%E9%81%B8%E6%93%87%20--&dataType=8.&check=1&hl=zh-TW Installation Instruction for TPEditor is on page 10-15 of this chapter.
	<p>HAND ON Key</p> <ol style="list-style-type: none"> 1. This key is executed by the parameter settings of the source of Hand frequency and hand operation. The factory settings of both source of Hand frequency and hand operation are the digital keypad. 2. Press HAND ON key at stop status, the setting will switch to hand frequency source and hand operation source. Press HAND ON key at operation status, it stops the AC motor drive first (display AHSP warning), and switch to hand frequency source and hand operation source. 3. Successful mode switching for KPC-CE01, "H/A" LED will be on; for KPC-CC01, it will display HAND mode/ AUTO mode on the screen.
	<ol style="list-style-type: none"> 1. This key is executed by the parameter settings of the source of AUTO frequency and AUTO operation. The factory setting is the external terminal (source of operation is 4-20mA). 2. Press Auto key at stop status, the setting will switch to hand frequency source and hand operation source. Press Auto key at operation status, it stops the AC motor drive first (display AHSP warning), and switch to hand frequency source and hand operation source. 3. Successful mode switching for KPC-CE01, "H/A" LED will be off; for KPC-CC01, it will display HAND mode/ AUTO mode on the screen

Descriptions of LED Functions

LED	Descriptions
	<p>Steady ON: operation indicator of the AC motor drive, including DC brake, zero speed, standby, restart after fault and speed search. Blinking: drive is decelerating to stop or in the status of base block. Steady OFF: drive doesn't execute the operation command</p>
	<p>Steady ON: stop indicator of the AC motor drive. Blinking: drive is in the standby status. Steady OFF: drive doesn't execute "STOP" command.</p>
	<p>Operation Direction LED</p> <ol style="list-style-type: none"> 1. Green light is on, the drive is running forward. 2. Red light is on, the drive is running backward. 3. Twinkling light: the drive is changing direction.
	<p>(Only KPC-CE01 support this function) Setting can be done during operation. HAND LED: When HAND LED is on (HAND mode); when HAND LED is off (AUTO mode).</p>
	<p>(Only KPC-CE01Support this function) Setting can be done during operation. AUTO LED: when AUTO LED is on (AUTO mode); when AUTO LED is off (HAND mode).</p>

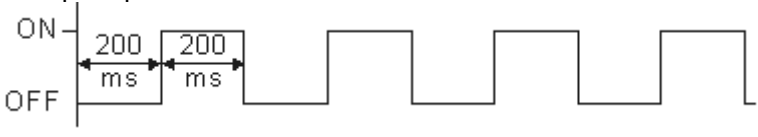
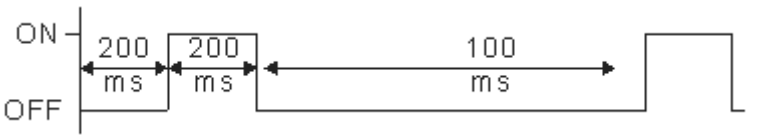
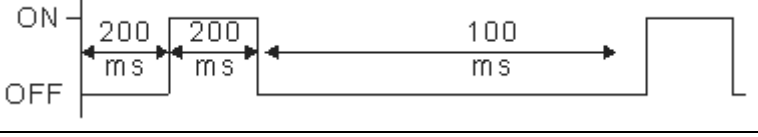
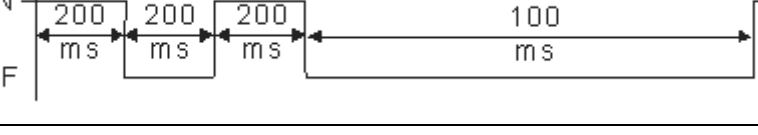
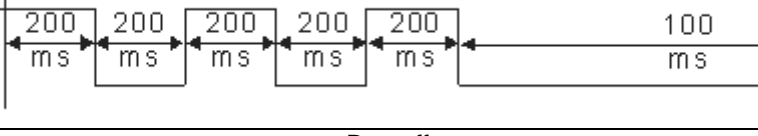
CANopen ~"RUN"	RUN LED:	
	LED status	Condition/State
	OFF	CANopen at initial No LED
	Blinking	CANopen at pre-operation 
	Single flash	CANopen at stopped 
ON	CANopen at operation status No LED	
CANopen ~"ERR"	ERR LED:	
	LED status	Condition/ State
	OFF	No Error
	Single flash	One message fail 
	Double flash	Guarding fail or heartbeat fail 
Triple flash	SYNC fail 	
ON	Bus off	

10-2 Function of Digital Keypad KPC-CC01

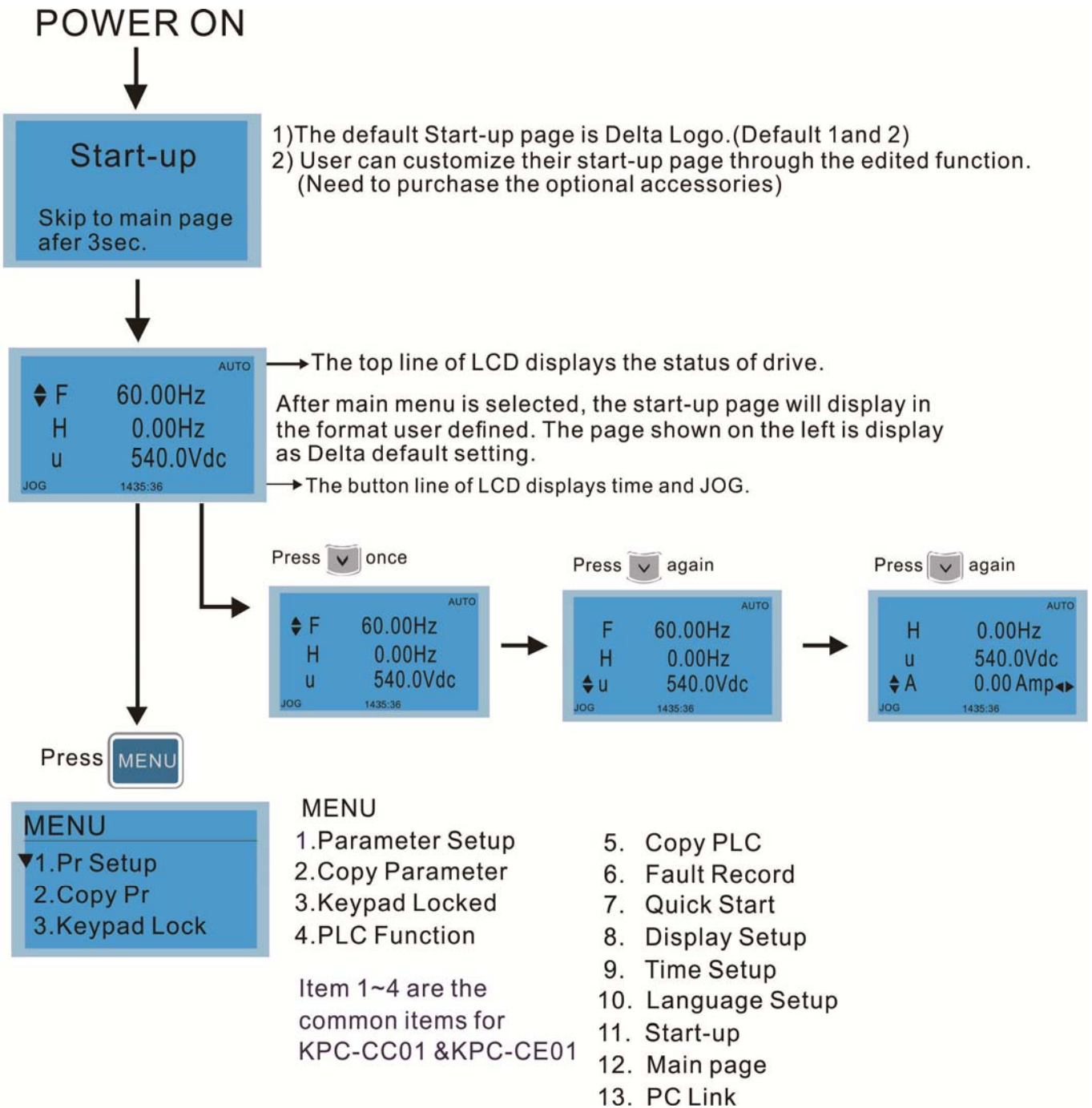

NOTE

1. Startup page can only display pictures, no flash.
2. When Power ON, it will display startup page then the main page. The main page displays Delta's default setting F/H/A/U, the display order can be set by Pr.00.03 (Startup display). When the selected item is U page, use left key and right key to switch between the items, the display order of U page is set by Pr.00.04 (User display).

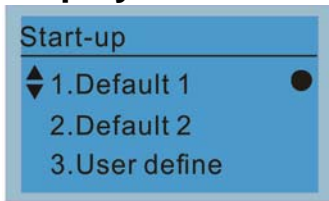

Display Icon

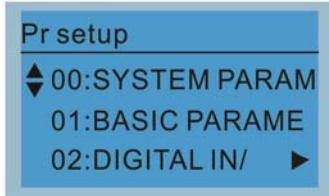

- : present setting
- ▲ : roll down the page for more options

Press  for more options.



- ▶ : show complete sentence
- Press   for complete information



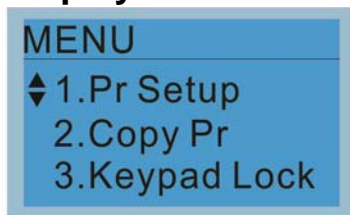

Display item

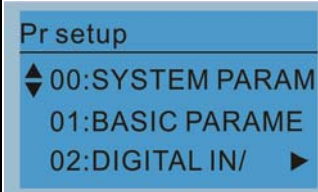

- MENU
- | | |
|-------------------|--------------------|
| 1.Parameter Setup | 5. Copy PLC |
| 2.Copy Parameter | 6. Fault Record |
| 3.Keypad Locked | 7. Quick Start |
| 4.PLC Function | 8. Display Setup |
| | 9. Time Setup |
| | 10. Language Setup |
| | 11. Start-up |
| | 12. Main page |
| | 13. PC Link |

Item 1~4 are the common items for KPC-CC01 &KPC-CE01

1. Parameter Setup

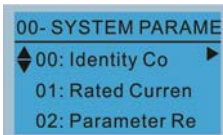
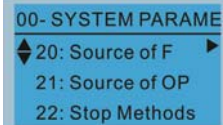
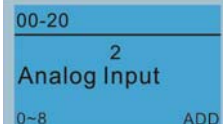
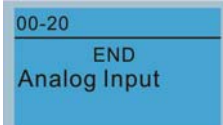



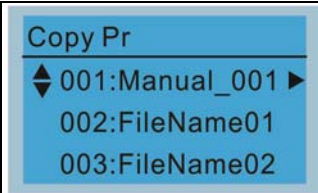
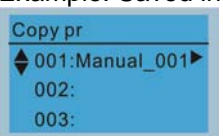
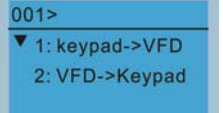

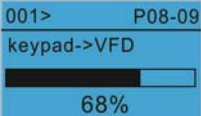
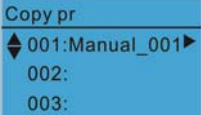
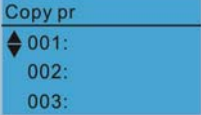
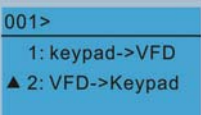
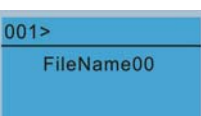
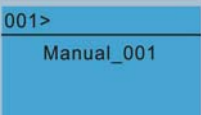
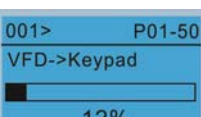
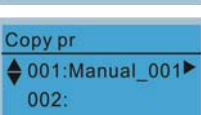
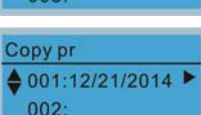
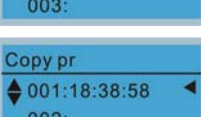
 <p>Press  to select.</p> <p>Press  to select a parameter group.</p> <p>Once a parameter group is selected, press  to go into that group.</p>	<p>For example: Setup source of master frequency command.</p>  <p>Once in the Group 00 Motor Drive Parameter, Use Up/Down key to select parameter 20: Auto Frequency Command.</p>  <p>When this parameter is selected, press ENTER key to go to this parameter's setting menu.</p>  <p>Use Up/Down key to choose a setting. For example: Choose "2 Analogue Input, then press the ENTER key.</p>  <p>After pressing the ENTER key, an END will be displayed which means that the parameter setting is done.</p>
---	---

2. Copy Parameter

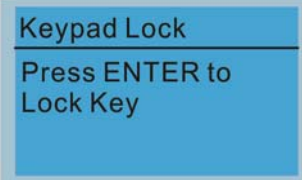

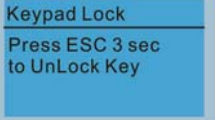

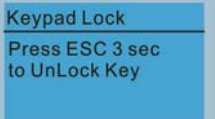
 <p>Press ENTER key to go to 001~004: content storage</p>	<p>4 duplicates are provided</p> <p>The steps are shown in the example below.</p> <p>Example: Saved in the motor drive.</p>  <p>1 Go to Copy Parameter 2 Select the parameter group which needs to be copied and press ENTER key.</p>  <p>1 Select 1: Save in the motor drive. 2. Press ENTER key to go to "Save in the motor drive" screen.</p>
--	--

	<p>Begin to copy parameters until it is done.</p>
	<p>Once copying parameters is done, keypad will automatically be back to this screen.</p>
<p>Example: Saved in the keypad.</p>	
	<ol style="list-style-type: none"> 1. Once copying parameters is done, keypad will automatically be back to this screen. 2. Select the parameter group which needs to be copied and press ENTER key.
	<p>Press ENTER key to go to “Save in the motor drive” screen.</p>
	<p>Use Up/Down key to select a symbol. Use Left/Right key to move the cursor to select a file name.</p>
<p>String & Symbol Table: ! ” # \$ % & ’ () * + , - . / 0 1 2 3 4 5 6 7 8 9 : ; < = > ? @ A B C D E F G H I J K L M N O P Q R S T U V W X Y Z [\] ^ _ ‘ a b c d f g h i j k l m n o p q r s t u v w x y z { } ~</p>	
	<p>Once the file name is confirmed, press ENTER key.</p>
	<p>To begin copying parameters until it is done.</p>
	<p>When copying parameters is completed, keypad will automatically be back to this screen.</p>
	<p>Press Right key to see the date of copying parameters.</p>
	<p>Press Right key to see the time of copying parameters.</p>

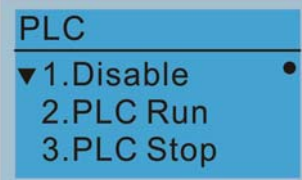
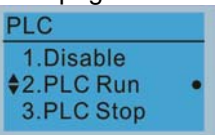

3. Keypad locked

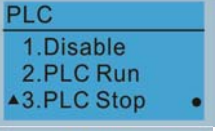
 <p>Press  to lock</p>	<p>Keypad Locked</p> <p>This function is used to lock the keypad. The main page would not display “keypad locked” when the keypad is locked, however it will display the message “please press ESC and then ENTER to unlock the keypad” when any key is pressed.</p> <p>When the keypad is locked, the main screen doesn't display any status to show that.</p> <p>Press any key on the keypad; a screen as shown in image on the left will be displayed.</p> <p>If ESC key is not pressed, the keypad will automatically be back to this screen.</p> <p>The keypad is still locked at this moment. By pressing any key, a screen as shown in the image on the left will still be displayed.</p> <p>Press ESC for 3 seconds to unlock the keypad and the keypad will be back to this screen. Then each key on the keypad is functional.</p> <p>Turn off the power and turn on the power again will not lock keypad.</p>	
		
		
		
		
		

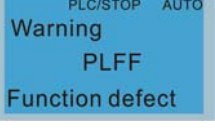
4. PLC Function



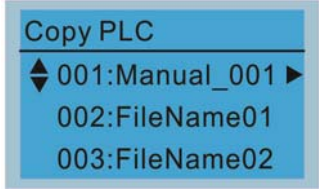
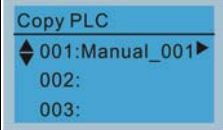
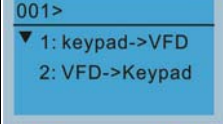
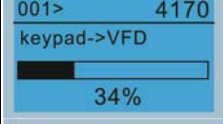
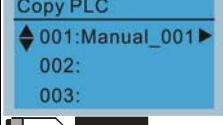
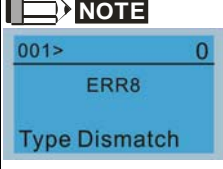
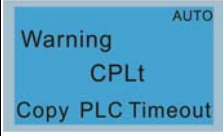
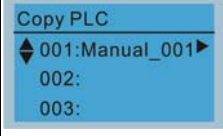

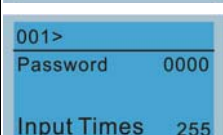
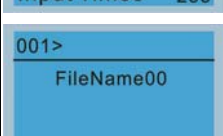

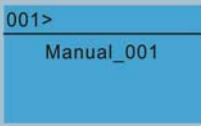
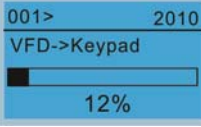
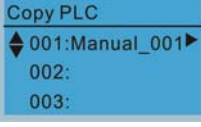
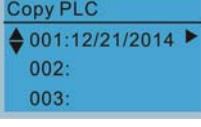
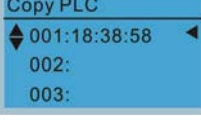
 <p>Press Up/Down key to select a PLC's function. Then press ENTER.</p>	<p>When activate and stop PLC function, the PLC status will be displayed on main page of Delta default setting.</p> <p>Optipn 2: Enable PLC function</p> <p>Factory setting on the main screen displays PLC/RUN status bar.</p> <p>Option 3: Disable PLC function</p> <p>Factory setting on the main screen displays PLC/STOP status bar</p> <p>If the PLC program is not available in the control board, PLFF warning will be displayed when choosing option 2 or 3. In this case, select option 1 : No Function to clear PLFF warning.</p> <p>The PLC function of KPC-CE01 can only displays:</p> <ol style="list-style-type: none"> 1. PLC0 2. PLC1 3. PLC2 	
		
		
		
		
		

5. Copy PLC

	<p>4 duplicates are provided</p> <p>The steps are shown in the example below.</p> <p>Example: Saved in the motor drive.</p>
	<p>1 Go to Copy PLC</p> <p>2 Select a parameter group to copy then press ENTER</p>
	<p>1 Select 1: Save in the motor drive.</p> <p>2. Press ENTER key to go to "Save in the motor drive" screen.</p>
	<p>Begin to copy PLC until it is done.</p>
	<p>Once copying PLC is done, keypad will automatically be back to this screen.</p>
	<p>NOTE</p> <p>If "Option 1: Save in the motor drive" is selected, verify if the PLC program is built-in to KPC-CC01 keypad. If PLC program is not available in the keypad while "Option 1: Save in the motor drive" is selected, an "ERR8 Warning: Type not matching" will be display on the screen.</p>
	<p>Unplug and plug back the keypad while copying the PLC program will have a CPLt warning.</p>
<p>Example: Saved in the keypad.</p>	<p>1. Once copying PLC is done, keypad will automatically be back to this screen.</p> <p>2. Select the parameter group which needs to be copied and press ENTER key.</p>
	<p>Press ENTER key to go to "Save in the motor drive" screen.</p>
	<p>If WPLSoft editor is installed and password is set, enter the password to save the file onto digital display.</p>
	<p>Use Up/Down key to select a symbol.</p> <p>Use Left/Right key to move the cursor to select a file name.</p>
	<p>String & Symbol Table:</p> <p>!"#\$%&'()*+,-./0123456789:;<=>?@A B C D E F G H I J K L M N O P Q R S T U V W X Y Z [\] ^ _ ` a b c d e f g h i j k l m n o p q r s t u v w x y z { } ~</p>

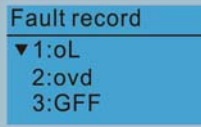
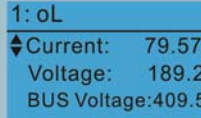
		<p>Once the file name is confirmed, press ENTER key.</p>
		<p>To begin copying parameters until it is done.</p>
		<p>When copying parameters is completed, keypad will automatically be back to this screen.</p>
		<p>Press Right key to see the date of copying parameters.</p>
		<p>Press Right key to see the time of copying parameters.</p>

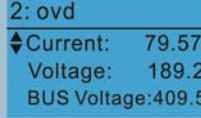
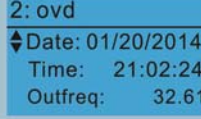
6. Fault record

	<p>Able to store 6 error code (Keypad V1.02 and previous versions) Able to store 20 error code(Keypad V1.0e3 and previous version) The most recent error record is shown as the first record. Select an error record to see its detail such as date, tme, frequency, current, voltage, DCBUS voltage)</p>
<p>Press  to select.</p> <p>KPC-CE01 does not support this function.</p>	 <p>Press Up/Down key to select an error record. After selecting an error code, press ENTER to see that error record's detail</p>
	 <p>Press Up/Down key to see an error record's detail such as date, time, frequency, current, voltage, DCBus voltage.</p>
	 <p>Press Up/Down key to select an error record. After selecting an error code, press ENTER to see that error record's detail</p>
	 <p>Press Up/Down key to see an error record's detail such as date, time, frequency, current, voltage, DCBus voltage.</p>
	 <p> NOTE Fault actions of AC motor drive are record and save to KPC-CC01. When KPC-CC01 is removed and apply to another AC motor drive, the previous fault records will not be deleted. The new fault records of the present AC motor drive will accumulate to KPC-CC01.</p>

7. Quick Start

<div data-bbox="199 168 510 347" style="border: 1px solid black; padding: 5px;"> <p>Quick Start</p> <p>▼ 1: V/F Mode 2: VFPG Mode 3: SVC Mode</p> </div> <p data-bbox="199 369 542 436">Press  to select.</p> <p data-bbox="191 459 335 481">Quick Start:</p> <ol data-bbox="191 481 414 672" style="list-style-type: none"> 1. V/F Mode 2. VFPG Mode 3. SVC Mode 4. FOCPG Mode 5. TQCPG Mode 6. My Mode 	<p data-bbox="571 174 718 201">Description:</p> <p data-bbox="571 224 750 250">1. VF Mode</p> <div data-bbox="646 280 901 436" style="border: 1px solid black; padding: 5px;"> <p>V/F Mode :P00-07</p> <p>◆01:Password De ▶</p> <p>02:Password Inp</p> <p>03:Control Meth</p> </div> <p data-bbox="638 459 901 486">01:Password Decoder</p> <div data-bbox="646 515 901 672" style="border: 1px solid black; padding: 5px;"> <p>00-07</p> <p>0</p> <p>Password Decoder</p> <p>0~65535</p> </div> <p data-bbox="917 257 989 284">Items</p> <ol data-bbox="917 291 1452 1243" style="list-style-type: none"> 1. Parameter Protection Password Input (P00-07) 2. Parameter Protection Password Setting (P00-08) 3. Control Mode (P00-10) 4. Control of Speed Mode (P00-11) 5. Load Selection (P00-16) 6. Source of the Master Frequency Command (AUTO) (P00-20) 7. Source of the Operation Command (AUTO) (P00-21) 8. Stop Method (P00-22) 9. Digital Keypad STOP function (P00-32) 10. Max. Operation Frequency (P01-00) 11. Base Frequency of Motor 1 (P01-01) 12. Max. Output Voltage Setting of Motor 1 (P01-02) 13. Min. Output Frequency of Motor 1 (P01-07) 14. Min. Output Voltage of Motor 1 (P01-08) 15. Output Frequency Upper Limit (P01-10) 16. Output Frequency Lower Limit (P01-11) 17. Accel. Time 1 (P01-12) 18. Decel Time 1 (P01-13) 19. Over-voltage Stall Prevention (P06-01) 20. Software Brake Level (P07-00) 21. Filter Time of Torque Command (P07-24) 22. Filter Time of Slip Compensation (P07-25) 23. Slip Compensation Gain (P07-27) <p data-bbox="571 1243 790 1270">2. VFPG Mode</p> <div data-bbox="646 1299 901 1456" style="border: 1px solid black; padding: 5px;"> <p>VFPG Mode :P00-07</p> <p>◆01:Password De ▶</p> <p>02:Password Inp</p> <p>03:Control Meth</p> </div> <p data-bbox="638 1478 901 1505">01: Password Decoder</p> <div data-bbox="646 1534 901 1691" style="border: 1px solid black; padding: 5px;"> <p>00-07</p> <p>0</p> <p>Password Decoder</p> <p>0~65535</p> </div> <p data-bbox="917 1288 989 1314">Items</p> <ol data-bbox="917 1321 1452 2116" style="list-style-type: none"> 1. Parameter Protection Password Input (P00-07) 2. Parameter Protection Password Setting (P00-08) 3. Control Mode (P00-10) 4. Control of Speed Mode (P00-11) 5. Load Selection (P00-16) 6. Source of the Master Frequency Command (AUTO) (P00-20) 7. Source of the Operation Command (AUTO) (P00-21) 8. Stop Method (P00-22) 9. Digital Keypad STOP function (P00-32) 10. Max. Operation Frequency (P01-00) 11. Base Frequency of Motor 1 (P01-01) 12. Max. Output Voltage Setting of Motor 1 (P01-02) 13. Min. Output Frequency of Motor 1 (P01-07) 14. Min. Output Voltage of Motor 1 (P01-08) 15. Output Frequency Upper Limit (P01-10) 16. Output Frequency Lower Limit (P01-11) 17. Accel. Time 1 (P01-12)
--	--

	<p>18. Decel Time 1 (P01-13)</p> <p>19. Over-voltage Stall Prevention (P06-01)</p> <p>20. Software Brake Level (P07-00)</p> <p>21. Filter Time of Torque Command (P07-24)</p> <p>22. Filter Time of Slip Compensation (P07-25)</p> <p>23. Slip Compensation Gain (P07-27)</p> <p>24. Encoder Type Selection (P10-00)</p> <p>25. Encoder Pulse (P10-01)</p> <p>26. Encoder Input Type Setting (P10-02)</p> <p>27. ASR Control (P) 1 (P11-06)</p> <p>28. ASR Control (I) 1 (P11-07)</p> <p>29. ASR Control (P) 2 (P11-08)</p> <p>30. ASR Control (I) 2 (P11-09)</p> <p>31. P Gain of Zero Speed (P11-10)</p> <p>32. I Gain of Zero Speed (P11-11)</p> <p>3. SVC Mode</p> <div data-bbox="614 728 877 884" style="border: 1px solid black; padding: 5px; margin: 10px 0;"> <p>SVC Mode :P00-07</p> <p>01:Password De</p> <p>02:Password Inp</p> <p>03:Control Meth</p> </div> <p>01: Password Decoder</p> <div data-bbox="614 974 877 1131" style="border: 1px solid black; padding: 5px; margin: 10px 0;"> <p>00-07</p> <p>0</p> <p>Password Decoder</p> <p>0-65535</p> </div> <p>Items</p> <ol style="list-style-type: none"> 1. Parameter Protection Password Input (P00-07) 2. Parameter Protection Password Setting (P00-08) 3. Control Mode (P00-10) 4. Control of Speed Mode (P00-11) 5. Load Selection (P00-16) 6. Carrier Frequency (P00-17) 7. Source of the Master Frequency Command (AUTO) (P00-20) 8. Source of the Operation Command (AUTO) (P00-21) 9. Stop Method (P00-22) 10. Digital Keypad STOP function (P00-32) 11. Max. Operation Frequency (P01-00) 12. Base Frequency of Motor 1 (P01-01) 13. Max. Output Voltage Setting of Motor 1 (P01-02) 14. Min. Output Frequency of Motor 1 (P01-07) 15. Min. Output Voltage of Motor 1 (P01-08) 16. Output Frequency Upper Limit (P01-10) 17. Output Frequency Lower Limit (P01-11) 18. Accel. Time 1 (P01-12) 19. Decel Time 1 (P01-13) 20. Full-load Current of Induction Motor 1 (P05-01) 21. Rated Power of Induction Motor 1 (P05-02) 22. Rated Speed of Induction Motor 1 (P05-03) 23. Pole Number of Induction Motor 1 (P05-04) 24. No-load Current of Induction Motor 1 (P05-05) 25. Over-voltage Stall Prevention (P06-01) 26. Over-current Stall Prevention during Acceleration (P06-03) 27. Derating Protection (P06-55) 28. Software Brake Level (P07-00)
--	--

29. Emergency Stop (EF) & Force to Stop Selection (P07-20)
30. Filter Time of Torque Command (P07-24)
31. Filter Time of Slip Compensation (P07-25)
32. Slip Compensation Gain (P07-27)

4. FOCPG Mode

FOCPG Mode :P00-07
 ↕01:Password De
 02:Password Inp
 03:Control Meth

01: Password Decoder

00-07
 0
 Password Decoder
 0~65535

Items

1. Parameter Protection Password Input (P00-07)
2. Parameter Protection Password Setting (P00-08)
3. Control Mode (P00-10)
4. Control of Speed Mode (P00-11)
5. Source of the Master Frequency Command (AUTO) (P00-20)
6. Source of the Operation Command (AUTO) (P00-21)
7. Stop Method (P00-22)
8. Max. Operation Frequency (P01-00)
9. Base Frequency of Motor 1 (P01-01)
10. Max. Output Voltage Setting of Motor 1 (P01-02)
11. Output Frequency Upper Limit (P01-10)
12. Output Frequency Lower Limit (P01-11)
13. Accel. Time 1 (P01-12)
14. Decel Time 1 (P01-13)
15. Full-load Current of Induction Motor 1 (P05-01)
16. Rated Power of Induction Motor 1 (P05-02)
17. Rated Speed of Induction Motor 1 (P05-03)
18. Pole Number of Induction Motor 1 (P05-04)
19. No-load Current of Induction Motor 1 (P05-05)
20. Over-voltage Stall Prevention (P06-01)
21. Over-current Stall Prevention during Acceleration (P06-03)
22. Derating Protection (P06-55)
23. Software Brake Level (P07-00)
24. Emergency Stop (EF) & Force to Stop Selection (P07-20)
25. Encoder Type Selection (P10-00)
26. Encoder Pulse (P10-01)
27. Encoder Input Type Setting (P10-02)
28. System Control (P11-00)
29. Per Unit of System Inertia (P11-01)
30. ASR1 Low-speed Bandwidth (P11-03)
31. ASR2 High-speed Bandwidth (P11-04)
32. Zero-speed Bandwidth (P11-05)

5. TQCPG Mode

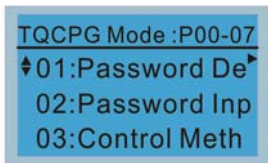

01: Password Decoder

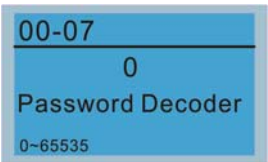

Items

1. Password Input (Decode) (P00-07)
2. Password Setting (P00-08)
3. Control Mode (P00-10)
4. Control of Speed Mode (P00-11)
5. Source of the Master Frequency Command (P00-20)
6. Source of the Operation Command (P00-21)
7. Max. Operation Frequency (P01-00)
8. Base Frequency of Motor 1 (P01-01)
9. Max. Output Voltage Setting of Motor 1 (P01-02)
10. Full-load Current of Induction Motor 1 (P05-01)
11. Rated Power of Induction Motor 1 (P05-02)
12. Rated Speed of Induction Motor 1 (P05-03)
13. Pole Number of Induction Motor 1 (P05-04)
14. No-load Current of Induction Motor 1 (P05-05)
15. Over-voltage Stall Prevention (P06-01)
16. Software Brake Level (P07-00)
17. Encoder Type Selection (P10-00)
18. Encoder Pulse (P10-01)
19. Encoder Input Type Setting (P10-02)
20. System Control (P11-00)
21. Per Unit of System Inertia (P11-01)
22. ASR1 Low-speed Bandwidth (P11-03)
23. ASR2 High-speed Bandwidth (P11-04)
24. Zero-speed Bandwidth (P11-05)
25. Max. Torque Command (P11-27)
26. Source of Torque Offset (P11-28)
27. Torque Offset Setting (P11-29)
28. Source of Torque Command (P11-33)
29. Torque Command (P11-34)
30. Speed Limit Selection (P11-36)
31. Forward Speed Limit (torque mode) (P11-37)
32. Reverse Speed Limit (torque mode) (P11-38)

6. My Mode

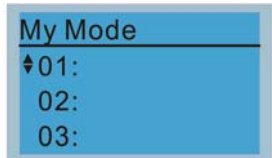

Click F4 in parameter setting page, the parameter will save to My Mode. To delete or correct the parameter, enter this parameter and click the "DEL" on the bottom right corner.

Items

It can save 01~32 sets of parameters (Pr).

Setup process

- Go to Parameter Setup function. Press ENTER to go to the parameter which you need to use. There is an ADD on the bottom right-hand corner of the screen. Press F4 on the key pad to add this parameter to My Mode

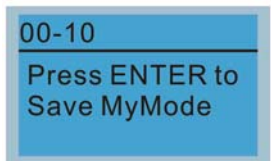
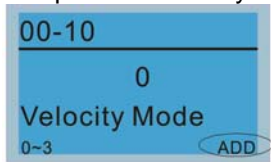

- The parameter (Pr) will be displayed in My mode if it is properly saved. To correct or to delete this Pr. clicks DEL.

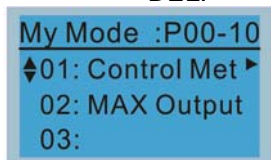



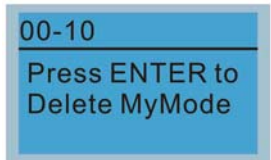
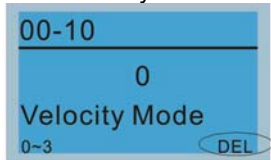



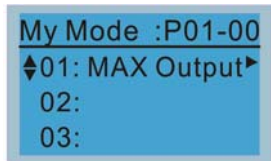

- To delete a parameter, go to My Mode and select a parameter which you need to delete. Press ENTER to enter the parameter setting screen. There is a DEL on the bottom left-hand corner of the screen. Press F4 on the keypad to delete this parameter from My Mode.

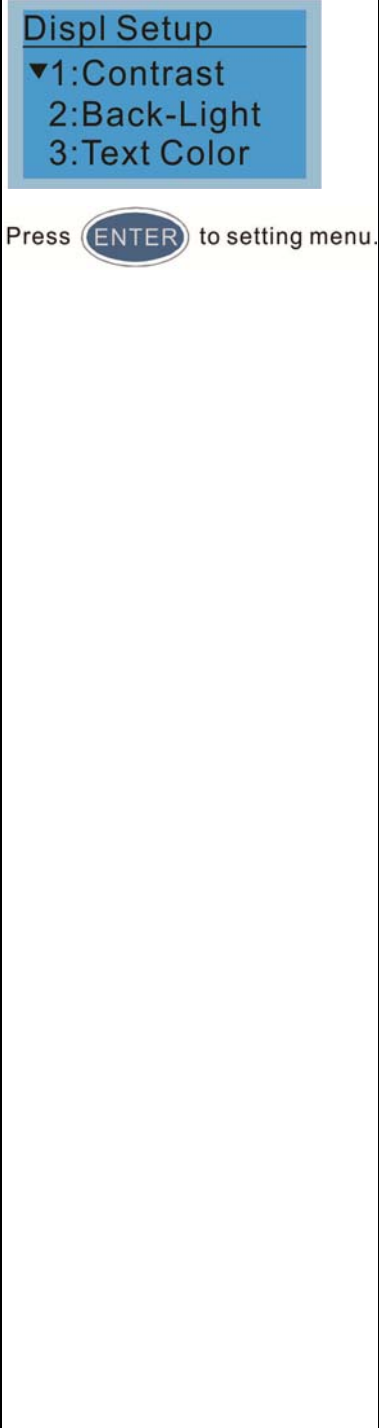

- After pressing ENTER to delete <01 Control Mode>, the <02 Maximum Operating Frequency > will automatically replace <01 Control Mode>.

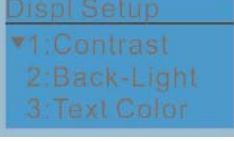

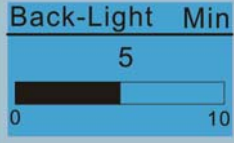
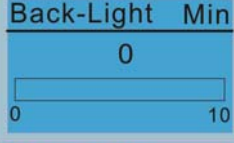

8. Display setup

 <p>Press ENTER to setting menu.</p>	<p>1. Contrast</p>      <p>2. Back-light</p>    	<p>Use Up/Down key to adjust the setting value.</p> <p>After selecting a setting value. Press ENTER to see screen's display after contrast is adjusted to be +10.</p> <p>When the setting value is 0 Min, the back light will be steady on.</p> <p>Then press ENTER.</p> <p>After select a setting value Press ENTER to see screen's display result after contrast is adjusted to be -10.</p> <p>Press ENTER to go to Back Light Time Setting screnn.</p> <p>Use Up/Down key to adjust the setting value.</p> <p>When the setting value is 0 Min, the back light will be steady on.</p> <p>When the setting value is 10 Min, the backlight will be off in 10 minutes.</p>
---	--	---

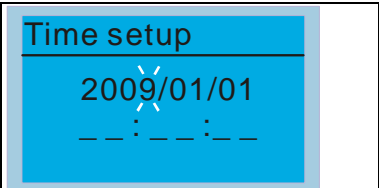
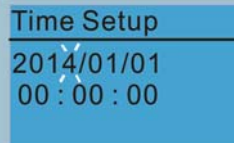
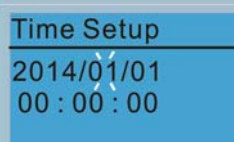
9. Time setting

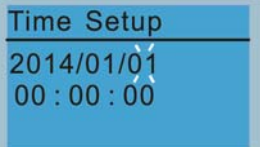
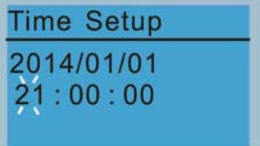
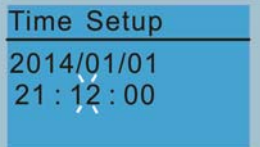
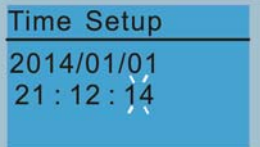
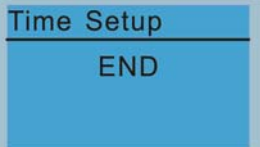
 <p>Use Left/Right key to select Year, Month, Day, Hour, Minute or Second to set up</p>	 	<p>Use Up/Down key to set up Year</p> <p>Use Up/Down key to set up Month</p>
--	---	--



	<p>Use Up/Down key to set up day</p>
	<p>Use Up/Down key to set up hour</p>
	<p>Use Up/Down key to set up Minute</p>
	<p>Use Up/Down key to set up Second</p>
	<p>After setting up, press ENTER to confirm the setup.</p>

 **NOTE**
 When the digital keypad is removed, the time setting will be in standby status for 7 days. After this period, the time needs to be reset.

10. Language setup



	<p>Language setting option is displayed in the language of the user's choice. Language setting options:</p>								
<p>Use Up/Down key to select language, than press ENTER.</p>	<table border="0"> <tr> <td>1. English</td> <td>5.</td> </tr> <tr> <td>2. 繁體中文</td> <td>6. Espanol</td> </tr> <tr> <td>3. 简体中文</td> <td>7. Portugues</td> </tr> <tr> <td>4. Turkce</td> <td></td> </tr> </table>	1. English	5.	2. 繁體中文	6. Espanol	3. 简体中文	7. Portugues	4. Turkce	
1. English	5.								
2. 繁體中文	6. Espanol								
3. 简体中文	7. Portugues								
4. Turkce									

11. Startup-up

	<p>1. Default 1 DELTA LOGO</p>
	
	<p>2. Default 2 DELTA Text</p>
	

	<p>3. User Defined: optional accessory is require (TPEditor & USB/RS-485 Communication Interface-IFD6530)</p> <p>Install an editing accessory would allow users to design their own start-up page.If editor accessory is not installed, “user defined” option will dispay a blank page.</p>  <p>DELTA VFD C2000 X-Y-Z 3-axis station X-axis</p> <p><u>USB/RS-485 Communication Interface-IFD6530</u> Please refer to Chapter 07 Optional Acessories for more detail.</p> <p><u>TPEditor</u> Go to Delta’s website to download TPEditor V1.40 or later versions. http://www.deltaww.com/services/DownloadCenter2.aspx?seclD=8&pid=2&tid=0&CID=06&itemID=060303&typeID=1&downloadID=&title=-%20%E8%AB%8B%E9%81%B8%E6%93%87%20--&dataType=8&check=1&hl=zh-TW</p>
--	---

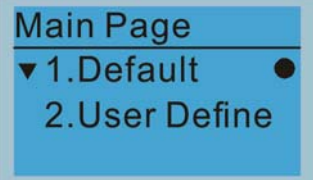
12. Main page

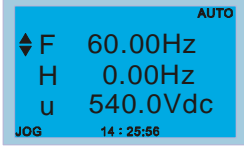
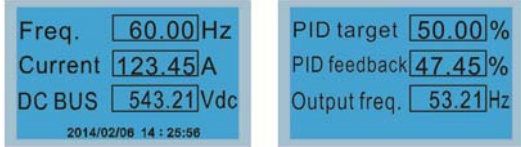
 <p>Default picture and editable picture are available upon selection.</p> <p>Press  to select.</p>	<p>1. Default page</p>  <p>F 600.00Hz >>> H >>> A >>> U (circulate)</p> <p>2. User Defined: optional accessory is require (TPEditor & USB/RS-485 Communication Interface-IFD6530)</p> <p>Install an editing accessory would allow users to design their own start-up page.If editor accessory is not installed, “user defined” option will dispay a blank page.</p>  <p><u>USB/RS-485 Communication Interface-IFD6530</u> Please refer to Chapter 07 Optional Acessories for more detail.</p> <p><u>TPEditor</u> Go to Delta’s website to download TPEditor V1.40 or later versions. http://www.deltaww.com/services/DownloadCenter2.aspx?seclD=8&pid=2&tid=0&CID=06&itemID=060303&typeID=1&downloadID=&title=-%20%E8%AB%8B%E9%81%B8%E6%93%87%20--&dataType=8&check=1&hl=zh-TW</p>
--	---

13. PC Link

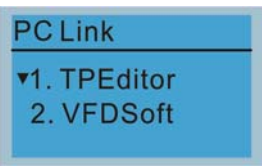
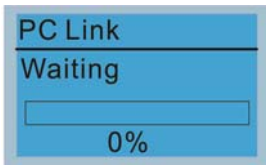
	<p>1. TPEditor: This function allows users to connect the keypad to a computer then to download and edit user defined pages.</p>  <p>Click ENTER to go to <Waiting to connect to PC></p>
---	---

In TPEditor, choose <Communication>, then choose “Write to HMI”

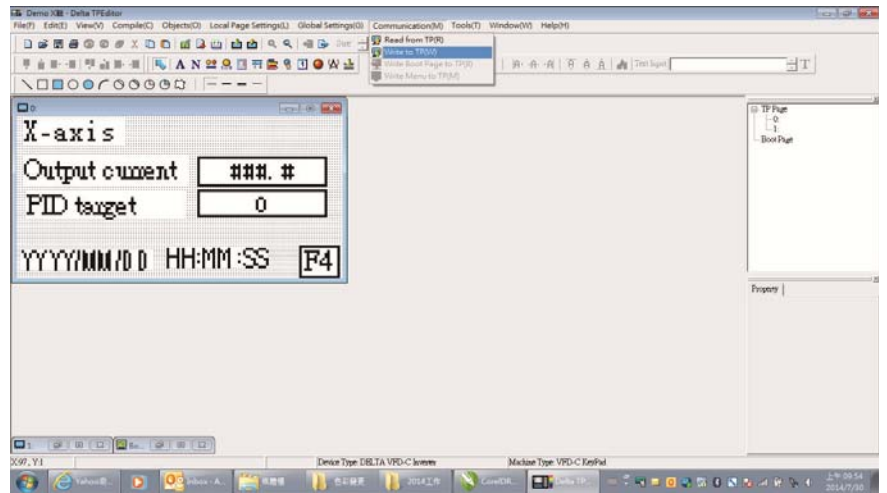

Choose <YES> in the <Confirm to Write> dialogue box.

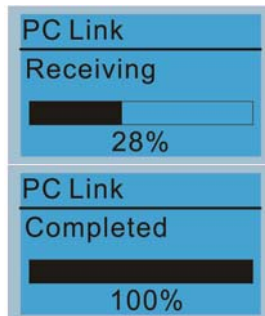
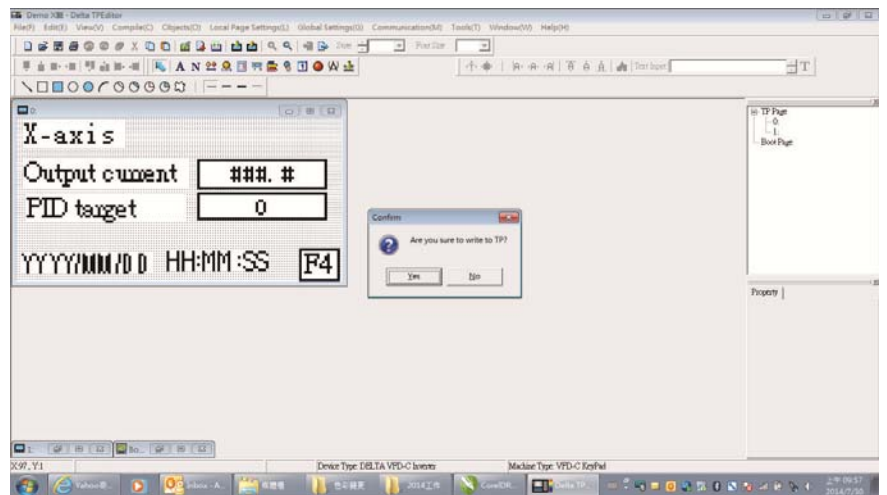

Start downloading pages to edit KPC-CC01.

Download completed

2. VFDSOft: this function allows user to link to the VFDSOft Operating software then to upload data

Copy parameter 1~4 in KPC-CC01

Connect KPC-CC01 to a computer

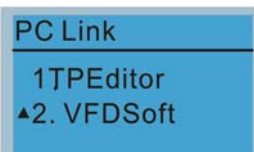

Start downloading pages to edit to KPC-CC01

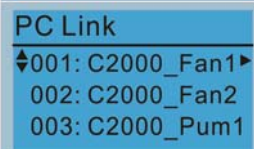

Use Up/Down key to select a parameter group to upload to VFDSOft. Press ENTER

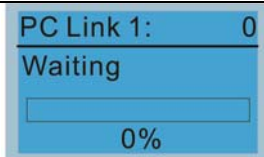

Waiting to connect to PC

Open VFDSOft, choose <Parameter Manager function>

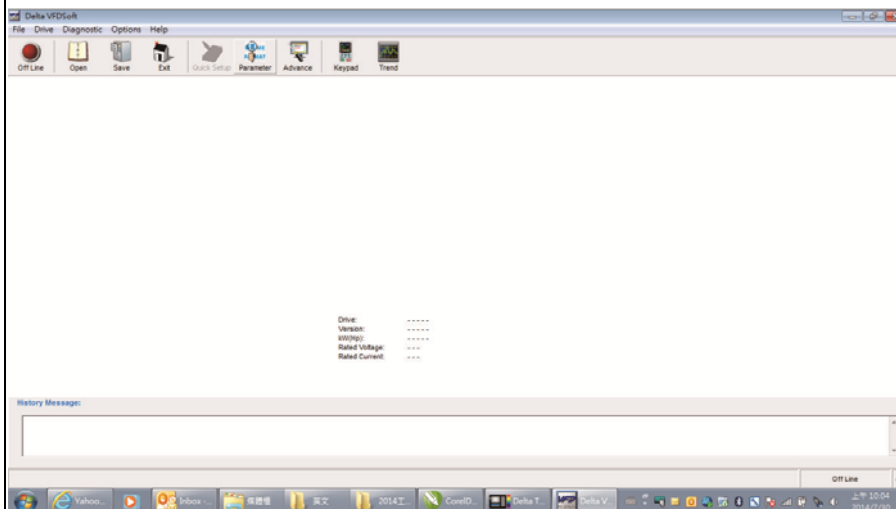

In Parameter Manager, choose <Load parameter table from KPC-CC01>

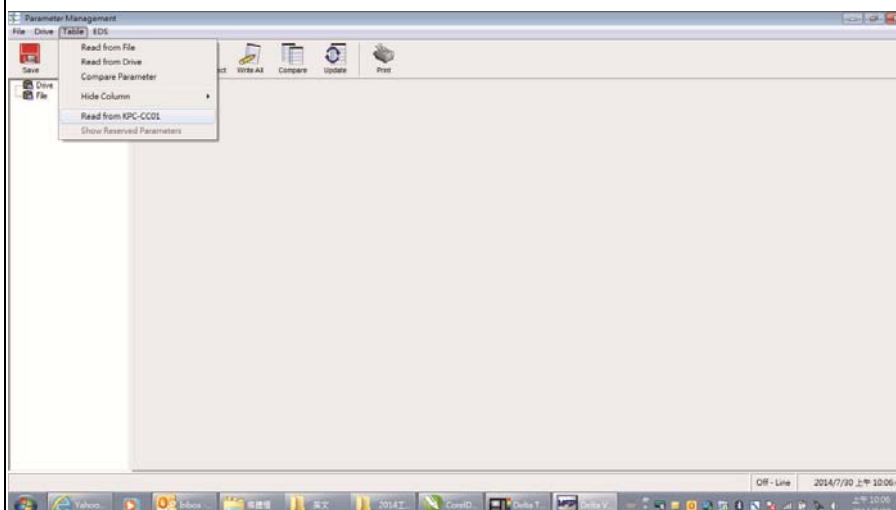

Choose the right communication port and click OK

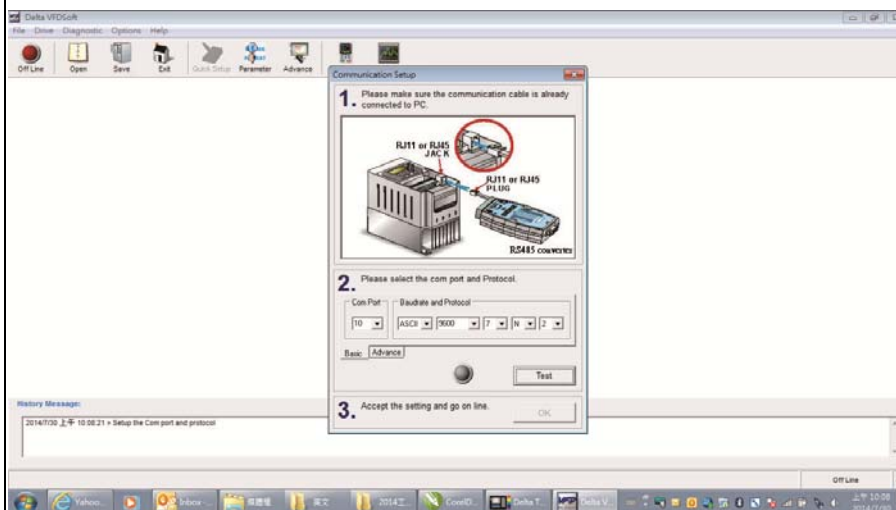

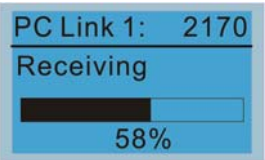
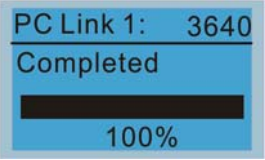
	<div data-bbox="630 129 895 288"><p>PC Link 1: 2170 Receiving 58%</p></div> <div data-bbox="922 197 1380 226"><p>Start to upload parameters to VFDSOft</p></div> <div data-bbox="630 324 895 483"><p>PC Link 1: 3640 Completed 100%</p></div> <div data-bbox="922 387 1332 416"><p>Uploading parameter is completed</p></div> <p data-bbox="608 508 1453 633">Before using the user defined starting screen and user defined main screen, the starting screen setup and the main screen setup have to be preset as user defined.</p> <p data-bbox="608 651 1453 725">If the user defined page are not downloaded to KPC-CC01, the starting screen and the main screen will be blank.</p>
--	--

Other display

When fault occur, the menu will display:



1. Press ENTER and start RESET. If still no response, please contact local distributor or return to the factory. To view the fault DC BUS voltage, output current and output voltage, press "MENU"→"Fault Record".
2. Press ENTER again, if the screen returns to main page, the fault is clear.
3. When fault or warning message appears, backlight LED will blinks until the fault or the warning is cleared.

Optional accessory: RJ45 Extension Lead for Digital Keypad

Part No.	Description
CBC-K3FT	RJ45 extension lead, 3 feet (approximately 0.9m)
CBC-K5FT	RJ45 extension lead, 5 feet (approximately 1.5 m)
CBC-K7FT	RJ45 extension lead, 7 feet (approximately 2.1 m)
CBC-K10FT	RJ45 extension lead, 10 feet (approximately 3 m)
CBC-K16FT	RJ45 extension lead, 16 feet (approximately 4.9 m)

Note: When you need to buy communication cables, buy non-shielded , 24 AWG, 4 twisted pair, 100 ohms communication cables.

10-3 TPEditor Installation Instruction

TPEditor can edit up to 256 HMI (Human-Machine Interface) pages with a total storage capacity of 256kb. Each page can edit 50 normal objects and 10 communication objects.

- 1) TPEditor: Setup & Basic Functions
 1. Run TPEditor version 1.30

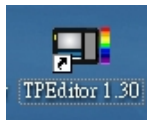

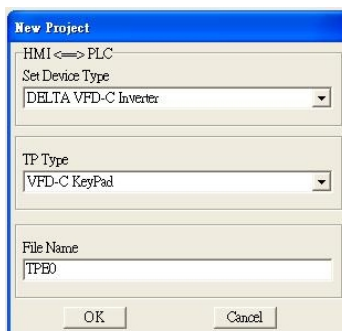

2. Go to File(F)→Click on New. The Window below will pop up. At the device type, click on the drop down menu and choose DELTA VFD-C Inverter. At the TP type, click on the drop down menu and choose VFD-C KeyPad. As for File Name, enter TPE0. Now click on OK.



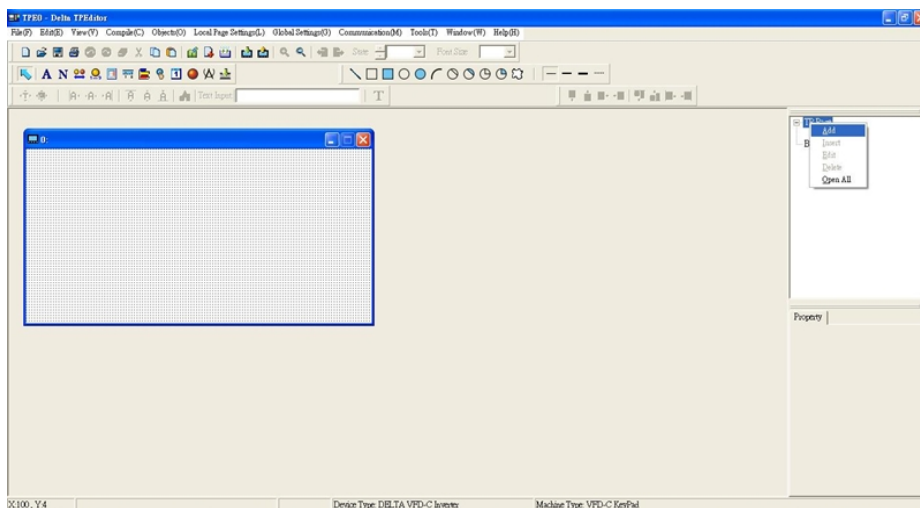

3. You are now at the designing page. Go to Edit (E)→Click on Add a New Page (A) or go to the TP page on the upper right side, right click once on TP page and choose Add to increase one more page for editing. The current firmware of Keypad is version1.00 and can support up to 4 pages.

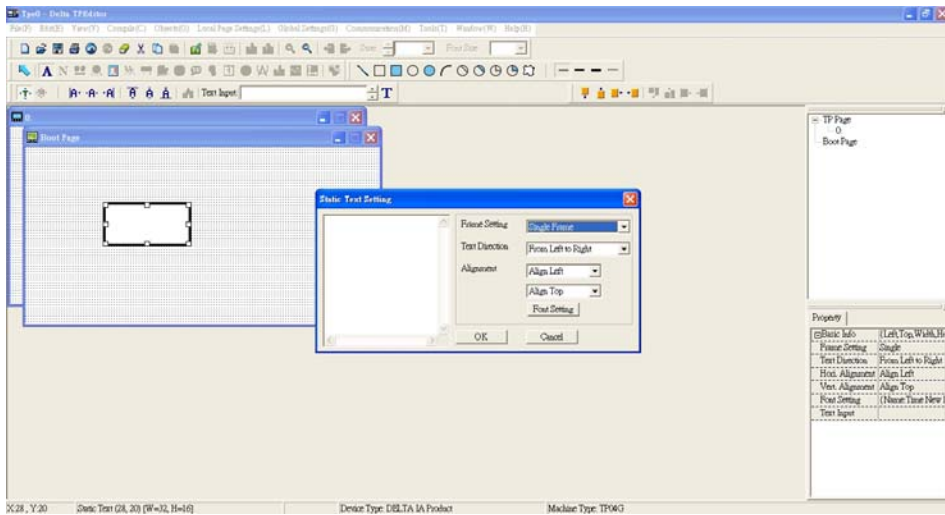

4. Edit Startup Page

5. Static Text . Open a blank page, click once on this button , and then double click on that blank page. The following windows will pop up.



6. Static Bitmap  → Open a blank page, then click once on this button  and then double click on that blank page. The following window will pop up.

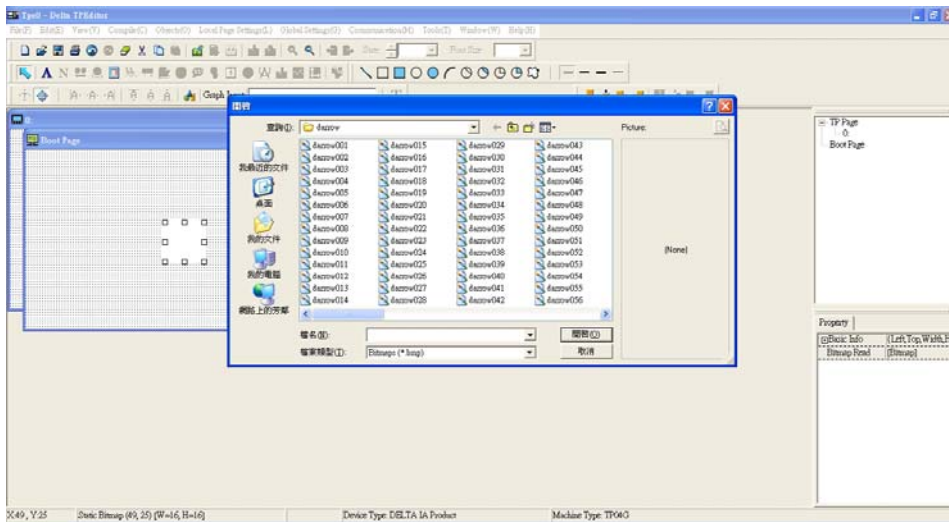

Please note that Static Bitmap setting support only images in BMP format. Now choose a image that you need and click open, then that image will appear in the Static Bitmap window.

7. Geometric Bitmap  → As shown in the picture on the left side, there are 11 kinds of geometric bitmap to choose. Open a new blank page then click once on a geometric bitmap icon that you need. Then drag that icon and enlarge it to the size that you need on that blank page.

- Finish editing the keypad starting screen and select **Communication>Input User Defined Keypad Starting Screen**.

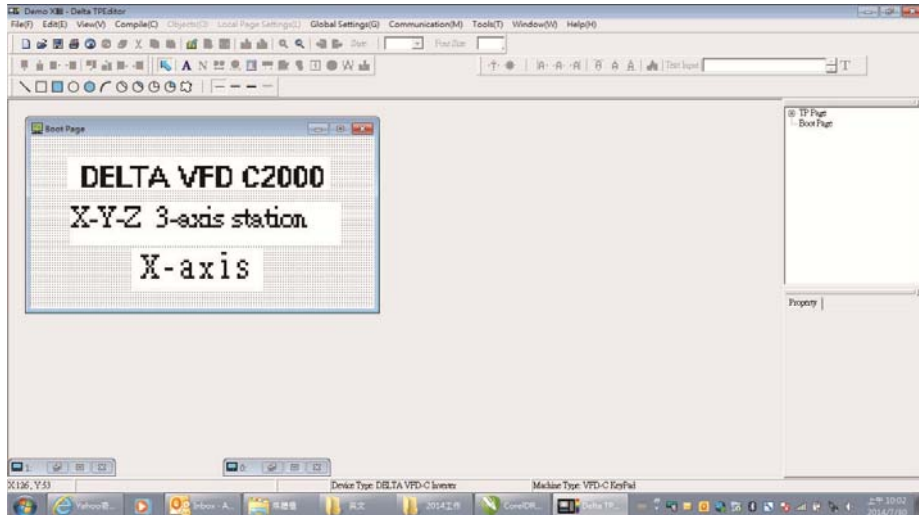

- Downloading setting: Go to Tool > Communication. Set up communication port and speed of IFD6530.
- Only three speed selections are available: 9600 bps, 19200 bps and 38400 bps.

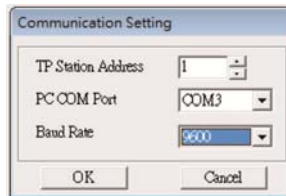

- When a dialogue box displayed on the screen asking to confirm writing or not, press buttons on the keypad to go to MENU, select PC LINK and then press ENTER and wait for few seconds. Then select YES on the screen to start downloading.

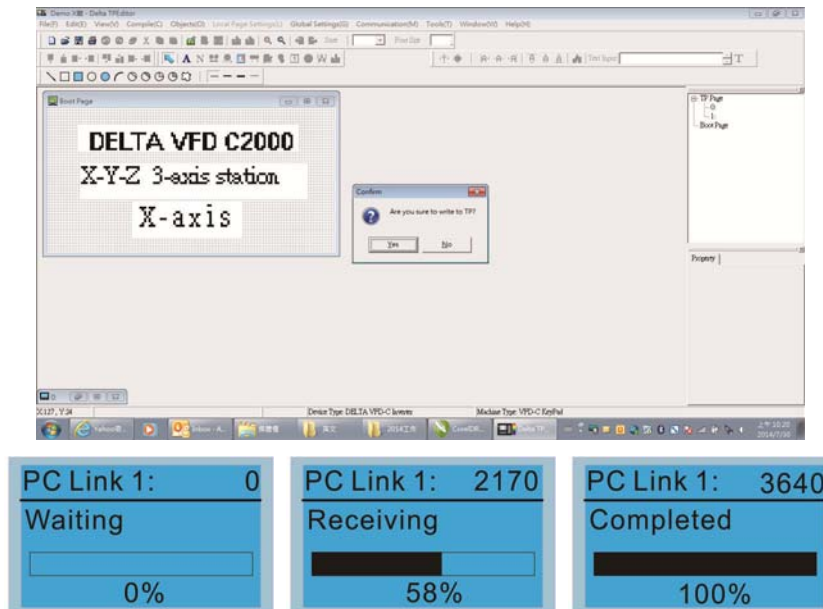

2) Edit Main Page & Example of Download

1. Go to editing page, select Edit>Add one page or press the button ADD on the right hand side of the HMI page to increase number of pages to edit. This keypad currently support up to 256 pages.

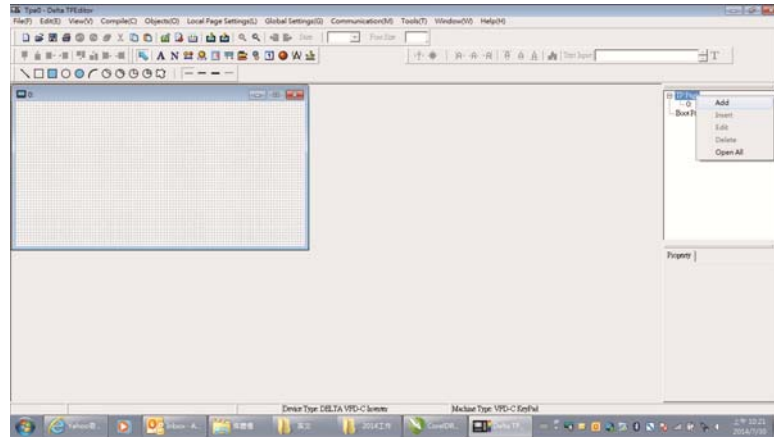

2. On the bottom right-hand corner of the HMI, click on a page number to edit or go to VIEW >HMI page to start editing main page. As shown in the image, the following objects are available. From left to right: Static Text, ASCII Display, Static Bitmap, Scale, Bar Graph, Button, Clock Display, Multi-state bit map, Units, Numeric Input and 11 geometric bitmaps and lines of different width. The application of Static Text, Static Bitmap, and geometric bitmap is the same as the editing startup page.



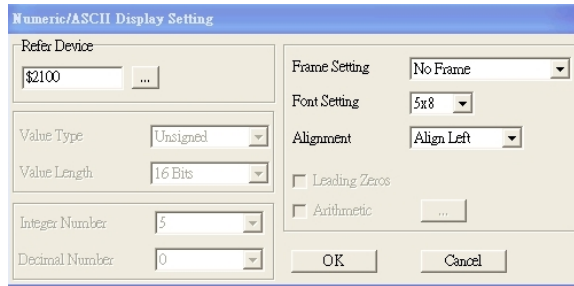

3. Numeric/ASCII Display : To add a Numeric/ASCII Display object to a screen, double click on the object to set up Related Devices, Frame Setting , Fonts and Alignment.



Related Device: Choose the VFD Communication Port that you need, if you want to read output frequency (H), set the VFD Communication Port to \$2202. For other values, please refer to ACMD ModBus Comm Address List.



4. Scale Setting  : On the Tool Bar, click on this  for Scale Setting. You can also edit Scale Setting in the Property Window on the right hand side of your computer screen.

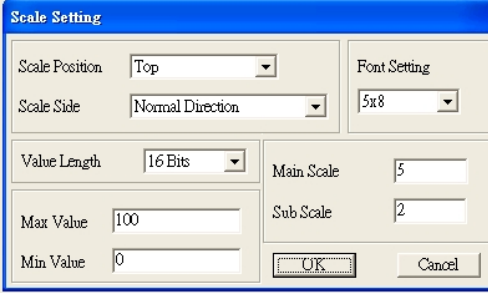

The Scale Setting dialog box contains the following fields and controls:

- Scale Position: Top (dropdown)
- Scale Side: Normal Direction (dropdown)
- Font Setting: 5x8 (dropdown)
- Value Length: 16 Bits (dropdown)
- Main Scale: 5 (text input)
- Sub Scale: 2 (text input)
- Max Value: 100 (text input)
- Min Value: 0 (text input)
- Buttons: OK, Cancel

- Scale Position: Click on the drop down list to choose which position that you need to place a scale.
- Scale Side: Click on the drop down list to choose if you want to number your scale from smaller number to bigger number or from big to small. Click OK to accept this setting or click Cancel to abort.
- Font Setting: Click on the drop down list to choose the Font setting that you need then click OK to accept the setting or click Cancel to abort.
- Value Length: Click on the drop down to choose 16bits or 32 bits. Then click OK to accept the setting or click Cancel to abort.
- Main Scale & Sub Scale: In order to divide the whole scale into equal parts, key in the numbers of your choices for main scale and sub scale.
- Maximum value & Minimum Value are the numbers on the two ends of a scale. They can be negative numbers. But the values allowed to be input are limited by the length of value. For example, when the length of value is set to **be hexadecimal**, the maximum and the minimum value cannot be input as -4000.
Follow the Scale setting mentioned above; you will have a scale as shown below.

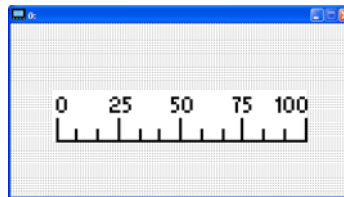

5. Bar Graph setting  :

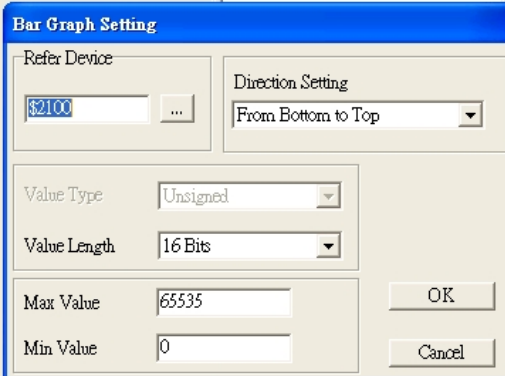

The Bar Graph Setting dialog box contains the following fields and controls:

- Refer Device: \$2100 (text input)
- Direction Setting: From Bottom to Top (dropdown)
- Value Type: Unsigned (dropdown)
- Value Length: 16 Bits (dropdown)
- Max Value: 65535 (text input)
- Min Value: 0 (text input)
- Buttons: OK, Cancel

- Related Device: Choose the VFD Communication Port that you need.
- Direction Setting: Click on the drop down menu to choose one of the following directions: From Bottom to Top, From Top to Bottom, From Left to Right or From Right to Left.
- Maximum Value & Minimum Value: They define the range covered by the maximum value and minimum value. If a value is smaller than or equal to the minimum value, then the bar graph will be blank. If a value is bigger or equal to the maximum value, then the bar graph will be full. If a value is between minimum and maximum value, then the bar graph will be filled proportionally.

6. Button  : Currently this function only allows the Keypad to switch pages, other functions are not yet available. Text input function and Image inserted functions are not yet supported.

Double click on  to open set up window.

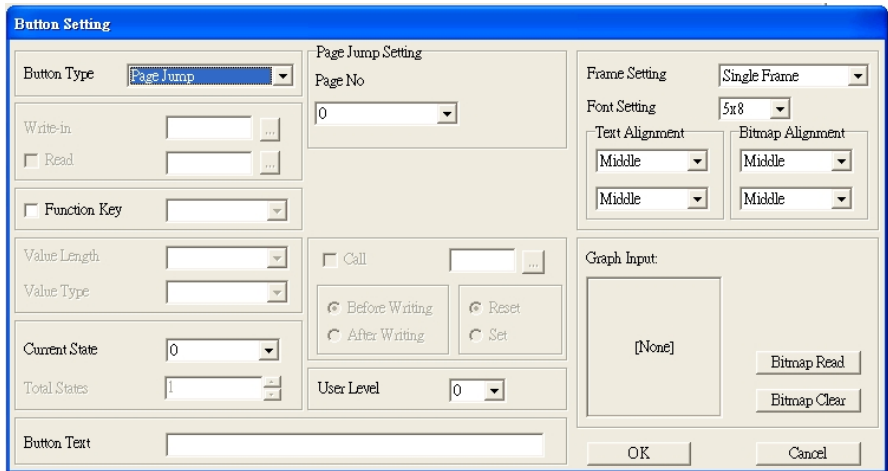

<Button Type> allows users set up buttons' functions. <Page Jump> and <Constant Setting> are the only two currently supported functions.

A [Page Jump] function setting

- Page Jump setting: After you choose the Page Jump function in the drop down list, you will see this Page Jump Setting Menu
- <Function Key> allows you to assign functions to the following keys on the KPC-CC01 keypad: F1, F2, F3, F4, Up, Down, Left and Right. Please note that the Up and Down keys are locked by TPEditor. These two keys cannot be programmed. If you want to program Up and Down keys, go to Tool→Function Key Settings (F)→Re-Define Up/Down Key(R).

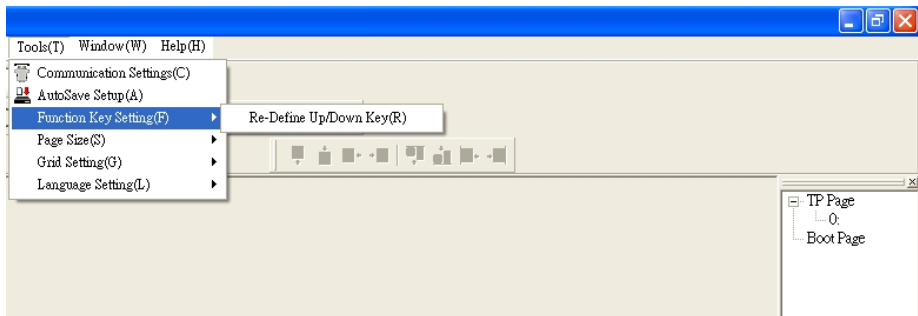

- Button Text: This function allows user to name buttons. For example, key in <Next Page> in the empty space, a button will have the wording <Next Page> displayed on it.

B [Constant setting] function

This function is to set up the memory address' value of the VFD or PLC. When pressing the <function button> set up in before, a value will be written to the memory address of the <Constant Setting>. This function can be used as initializing a variable.

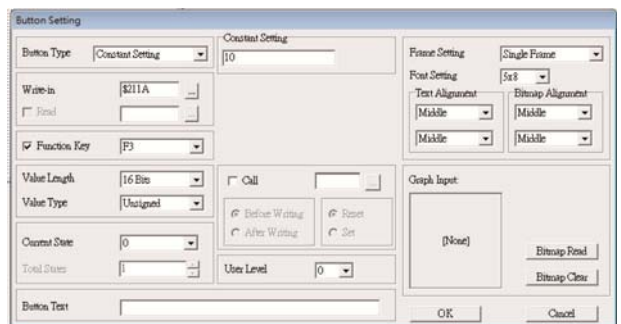

7. Clock Display Setting  : The setup window of the Clock Display is shown as the image below. Time, Day or Date can be displayed on the keypad.
Open a new file and click once in that window, you will see the following
In the clock display setting, you can choose to display Time, Day or Date on the Keypad. To adjust time, go to #9 on the Keypad's menu. You can also adjust Frame Setting, Font Setting and Alignment.

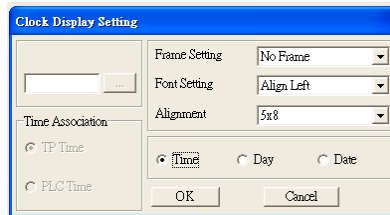

8. Multi-state bitmap  : The setup window of the multi-state is shown as the image below. This object reads the bit's property value of the PLC. It defines what image or wording is when this bit is 0 or when this bit is 1. Set the initial status to be 0 or 1 to define the displayed image or wording.

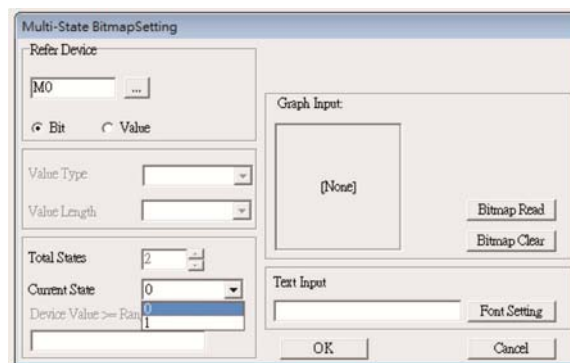

9. Unit Measurement  : Click once on this Button:
Open a new file and double click on that window, you will see the following

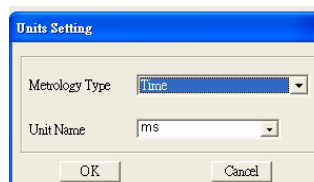

Choose from the drop down list the Metrology and the Unity Name that you need. As for Metrology, you have the following choices Length, Square Measure, Volume/Solid Measure, Weight, Speed, Time and Temperature. The unit name changes automatically when you change metrology type.

10. Numeric Input Setting 

This menu allows you to provide parameters or communication ports and to input numbers.

Click once on this button .

Open a new file and double click on that window, you will see the following:

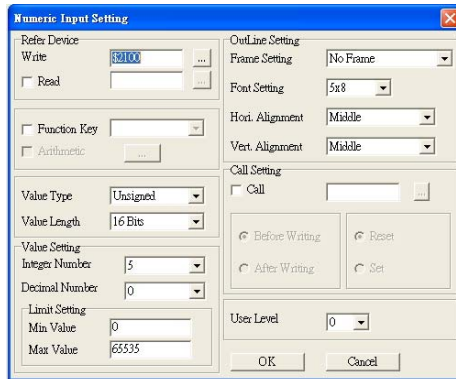

- a. Related Device: There are two blank spaces to fill in, one is <Write> and another one is <Read>. Input the numbers that you want to display and the corresponding numbers of a parameter and that of a communication port. For example, input 012C to Read and Write Parameter P01-44.
- b. OutLine Setting: The Frame setting, Font setting, Vertical Alignment and Horizontal Alignment are the same as mentioned before. Click on the drop down menu and choose the setting that you need.
- c. Function key: The setting here allows you to program keys on the keypad. Press the key on the menu then the corresponding key on the keypad will start to blink, then press Enter to confirm the setting.
- d. Value Type & Value Length: These two factors influence the range of the Minimum and Maximum Value of the Limit Setting. Please note that the corresponding supporting values for C2000 have to be 16bits. The 32bits values are not supported.
- e. Value Setting: This part is set automatically by the keypad itself.
- f. Limit Setting: Input the range the security setting here.
- g. For example, if you set Function Key as F1, Minimum Value as 0 and Maximum Value as 4, then press F1 on Keypad Then you can press Up and Down key on the keypad to increase or decrease the value. Press Enter Key on the keypad to confirm your setting. You can also go to parameter table 01-44 to verify if your input correctly the value.

11. Download TP Page : Press Up or Down key on the keypad until you reach #13 PC Link.

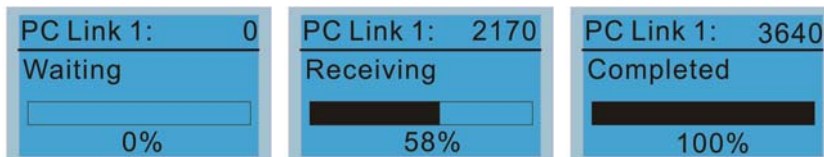
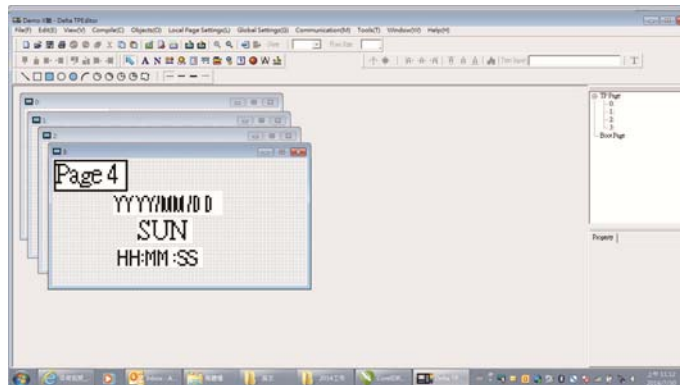

Then press Enter on the keypad and you will see the word "Waiting" on keypad's screen. Now choose a page that you have created then go to Communication (M)→Write to TP(W) to start downloading the page to the keypad

When you see the word Completed on the keypad's screen, that means the download is done. Then you can press ESC on the keypad to go back to the menu of the keypad.



10-4 Digital Keypad KPC-CC01 Fault Codes and Descriptions

Following fault codes and description are for digital keypad KPC-CC01 with version V1.01 and version higher.

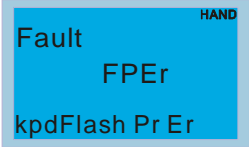
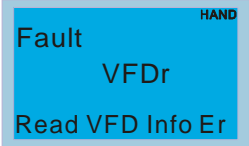
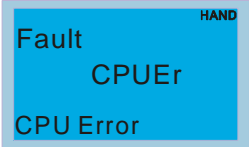
LCM Display *	Description	Corrective Actions
	Keypad flash memory read error	<p>An error has occurred on keypad's flash memory.</p> <ol style="list-style-type: none"> 1. Press RESET on the keypad to clear errors. 2. Verify what kind of error has occurred on keypad's flash memory. 3. Shut down the system, wait for ten minutes, and then power on again the system. <p>If none of the solution above works, contact your authorized local dealer.</p>
	Keypad flash memory save error	<p>An error has occurred on keypad's flash memory.</p> <ol style="list-style-type: none"> 1. Press RESET on the keypad to clear errors. 2. Press RESET on the keypad to clear errors. 3. Shut down the system, wait for ten minutes, and then power on again the system. <p>If none of the solution above works, contact your authorized local dealer.</p>
	Keypad flash memory parameter error	<p>Errors occurred on parameters of factory setting. It might be caused by firmware update.</p> <ol style="list-style-type: none"> 1. Press RESET on the keypad to clear errors. 2. Verify if there's any problem on Flash IC. 3. Shut down the system, wait for ten minutes, and then power on again the system. <p>If none of the solution above works, contact your local authorized dealer.</p>
	Keypad flash memory when read AC drive data error	<p>Keypad can't read any data sent from VFD.</p> <ol style="list-style-type: none"> 1. Verify if the keypad is properly connect to the motor drive by a communication cable such as RJ-45. 2. Press RESET on the keypad to clear errors. 3. Shut down the system, wait for ten minutes, and then power on again the system. <p>If none of the solution above works, contact your local authorized dealer.</p>
	and then power on again the system.	<p>A Serious error has occurred on keypad's CPU.</p> <ol style="list-style-type: none"> 1. Verify if there's any problem on CPU clock? 2. Verify if there's any problem on Flash IC? 3. Verify if there's any problem on RTC IC? 4. Verify if the communication quality of the RS485 is good? 5. Shut down the system, wait for ten minutes, and then power on again the system. If none of the solution above works, contact your local authorized dealer.

Warning Code

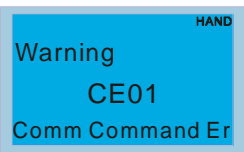
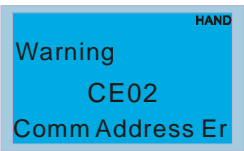
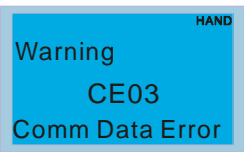
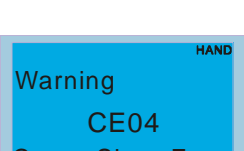
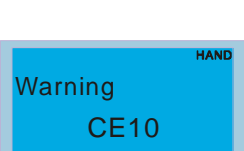
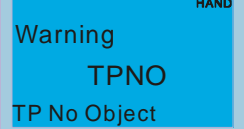
LCM Display *	Description	Corrective Actions
 <p>Warning CE01 Comm Command Er</p>	Modbus function code error	Motor drive doesn't accept the communication command sent from keypad. 1. Verify if the keypad is properly connected to the motor drive on the communication contact by a communication cable such as RJ-45. 2. Press RESET on the keypad to clear errors. If none of the solution above works, contact your local authorized dealer.
 <p>Warning CE02 Comm Address Er</p>	Modbus data address error	Motor rive doesn't accept keypad's communication address. 1. Verify if the keypad is properly connected to the motor drive on the communication contact by a communication cable such as RJ-45. 2. Press RESET on the keypad to clear errors. If none of the solution above works, contact your local authorized dealer.
 <p>Warning CE03 Comm Data Error</p>	Modbus data value error	Motor drive doesn't accept the communication data sent from keypad. 1. Verify if the keypad is properly connected to the motor drive on the communication contact by a communication cable such as RJ-45. 2. Press RESET on the keypad to clear errors. If none of the solution above works, contact your local authorized dealer.
 <p>Warning CE04 Comm Slave Error</p>	Modbus slave drive error	Motor drive cannot process the communication command sent from keypad. 1. Verify if the keypad is properly connected to the motor drive on the communication contact by a communication cable such as RJ-45. 2. Press RESET on the keypad to clear errors. 3. Shut down the system, wait for ten minutes, and then power on again the system. If none of the solution above works, contact your local authorized dealer.
 <p>Warning CE10 KpdComm Time Out</p>	Modbus transmission time-Out	Motor drive doesn't respond to the communication command sent from keypad. 1. Verify if the keypad is properly connected to the motor drive on the communication contact by a communication cable such as RJ-45. 2. Press RESET on the keypad to clear errors. 3. Shut down the system, wait for ten minutes, and then power on again the system. If none of the solution above works, contact your local authorized dealer.
 <p>Warning TPNO TP No Object</p>	Object not supported by TP Editor	Keypad's TP Editor uses unsupported object. 1. Verify how the TP editor should use that object. Delete unsupported object and unsupported setting. 2. Reedit the TP editor and then download it. If none of the solution above works, contact your local authorized dealer.

File Copy Setting Fault Description

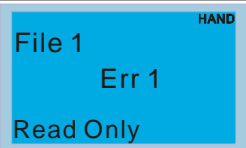
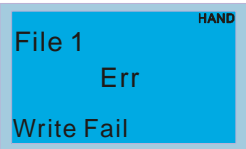
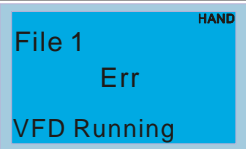
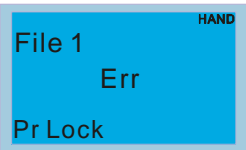
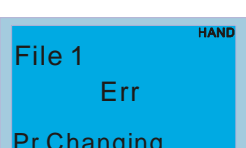
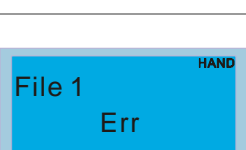
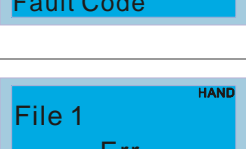
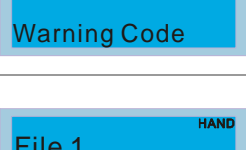
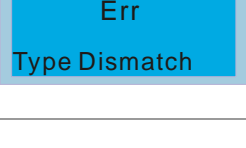
LCM Display *	Description	Corrective Actions
	Parameter and file are read only	The property of the parameter/file is read-only and cannot be written to. 1. Verify the specification on the user manual. If the solution above doesn't work, contact your local authorized dealer.
	Fail to write parameter and file	An error occurred while write to a parameter/file. 1. Verify if there's any problem on the Flash IC. 2. Shut down the system, wait for ten minutes, and then power on again the system. If none of the solution above work, contact your local authorized dealer.
	AC drive is in operating status	A setting cannot be made while motor drive is in operation. 1. Verify if the drive is not in operation. If the solution above doesn't work, contact your local authorized dealer.
	AC drive parameter is locked	A setting cannot be made because a parameter is locked. 1. Verify if the parameter is locked or not. If it is locked, unlock it and try to set up the parameter again. If the solution above doesn't work, contact your local authorized dealer.
	AC drive parameter changing	A setting cannot be made because a parameter is being modified. 1. Verify if the parameter is being modified. If it is not being modified, try to set up that parameter again. If the solution above doesn't work, contact your local authorized dealer.
	Fault code	A setting cannot be made because an error has occurred on the motor drive. 1. Verify if there's any error occurred on the motor drive. If there isn't any error, try to make the setting again. If the solution above doesn't work, contact your local authorized dealer.
	Warning code	A setting cannot be made because of a warning message given to the motor drive. 1. Verify if there's any warning message given to the motor drive. If the solution above doesn't work, contact your local authorized dealer.
	File type dismatch	Data need to be copied are not same type, so the setting cannot be made. 1. Verify if the products' serial numbers need to be copied fall in the category. If they are in the same category, try to make the setting again. If the solution above doesn't work, contact your authorized dealer.
	File is locked with password	A setting cannot be made, because some data are locked. 1. Verify if the data are unlocked or able to be unlocked. If the data are unlocked, try to make the setting again. 2. Shut down the system, wait for ten minutes, and then power on again the system. If none of the solution above works, contact your local authorized dealer.

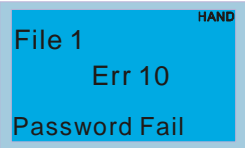
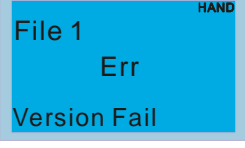
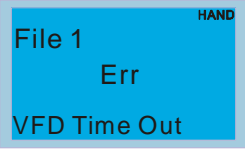
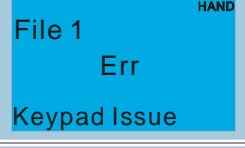
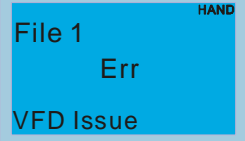
LCM Display *	Description	Corrective Actions
	File version mismatch	A setting cannot be made because the password is incorrect. 1. Verify if the password is correct. If the password is correct, try to make the setting again. 2. Shut down the system, wait for ten minutes, and then power on again the system. If none of the solution above works, contact your local authorized dealer.
	AC drive copy function time-out	A setting cannot be made, because the version of the data is incorrect. 1. Verify if the version of the data matches the motor drive. If it matches, try to make the setting again. If none of the solution above works, contact your local authorized dealer.
	Other keypad error	A setting cannot be made, because data copying timeout expired. 1. Redo data copying. 2. Verify if copying data is authorized. If it is authorized, try again to copy data. 3. Shut down the system, wait for ten minutes, and then power on again the system. If none of the solution above works, contact your local authorized dealer.
	Other AC drive error	This setting cannot be made, due to other keypad issues. (Reserved functions) If such error occurred, contact your local authorized dealer.
	File is locked with password	This setting cannot be made, due to other motor drive issues. (Reserved functions). If such error occurred, contact your local authorized dealer.

※ The content in this chapter only applies on V1.01 and above of KPC-CC01 keypad.

Chapter 11 Summary of Parameter Settings



This chapter provides summary of parameter settings for user to gather the parameter setting ranges, factory settings and set parameters. The parameters can be set, changed and reset by the digital keypad.

NOTE

- 1) : the parameter can be set during operation
- 2) For more detail on parameters, please refer to Ch12 Description of Parameter Settings.

00 Drive Parameters

 NOTE IM: Induction Motor; PM: Permanent Magnet Motor

Pr.	Explanation	Settings	Factory Setting
00-00	Identity Code of the AC Motor Drive	410: 460V, 11kW 411: 460V, 15 kW 412: 460V, 18.5 kW 413: 460V, 22 kW 414: 460V, 30 kW 415: 460V, 37 kW 416: 460V, 45 kW 417: 460V, 55 kW 418: 460V, 75 kW 419: 460V, 90 kW	Read only
00-01	Display AC Motor Drive Rated Current	Display by models	Read only
00-02	Parameter Reset	0: No function 1: Parameter write protection 5: Reset KWH display to 0 6: Reset PLC (including CANopen Master Index) 7: Reset CANopen Index (Slave) 9: All parameters are reset to factory settings(base frequency is 50Hz) 10: All parameters are reset to factory settings (base frequency is 60Hz)	0
 00-03	Start-up Display Selection	0: F (frequency command) 1: H (output frequency) 2: U (multi-function display, see Pr.00-04) 3: A (output current)	0
 00-04	Content of Multi-function Display	0: Display output current (A) 1: Display counter value (c) 2: Display actual output frequency (H.) 3: Display DC-BUS voltage (v) 4: Display output voltage (E) 5: Display output power angle (n) 6: Display output power in kW (P) 7: Display actual motor speed rpm (r) 8: Display estimate output torque % (t) 9: Display PG feedback (G) (refer to Pr.10-00,10-01) 10: Display PID feedback in % (b) 11: Display AVI in % (1.) 12: Display ACI in % (2.) 13: Display AUI in % (3.) 14: Display the temperature of IGBT in oC (i.) 15: Display the temperature of capacitance in oC (c.) 16: The status of digital input (ON/OFF) (i) 17: The status of digital output (ON/OFF) (o)	3

Pr.	Explanation	Settings	Factory Setting
		18: Multi-step speed (S) 19: The corresponding CPU pin status of digital input (d.) 20: The corresponding CPU pin status of digital output (0.) 21: Actual motor position (PG1 of PG card) (P.) The max. value showed as 32bits 22: Pulse input frequency (PG2 of PG card) (S.) 23: Pulse input position (PG2 of PG card) (q.) The max. value showed as 32bits 24: Position command tracing error (E.) 25: Overload count (0.00~100.00%) (h.) 26: Ground Fault GFF (Unit :%)(G.) 27: DC Bus voltage ripple (Unit: Vdc) (r.) 28: Display PLC data D1043 (C) 29: Display PM motor pole section (EMC-PG01U application) (4.) 30: Display output of user defined (U) 31: Display Pr.00-05 user Gain(K) 32: Number of actual motor revolution during operation (PG card plug in and Z phase signal input) (Z.) 33: Motor actual position during operation (when PG card is connected)(q) 34: Operation speed of fan(%) (F.) 35: Control Mode display: 0= Speed control mode (SPD), 1= torque control mode (TQR) (t.) 36: Present operating carrier frequency of drive (Hz) (J.) 37: Reserved 38: Display drive status (6.) 39: Display estimated output torque, positive and negative, using Nt-m as unit (t 0.0: positive torque; -0.0: negative torque (C.) 40: Torque command (L.) (Unit: %) 41: Display the kWh (J) (Unit: kWh) 42: PID Reference (h.) (Unit: %) 43: PID offset (o.) (Unit: %) 44: PID Output Fcmd(Hz) (b.) (Unit: Hz) 45: Hardware ID	
00-05	Coefficient Gain in Actual Output Frequency	0.00~160.00	1.00
00-06	Software Version	Read-only	##
↗ 00-07	Parameter Protection Password Input	0~65535 0~4: the times of password attempts	0
↗ 00-08	Parameter Protection Password Setting	0 ~ 65535 0: No password protection / password is entered correctly (Pr00-07) 1: Parameter is locked	0
00-09	Reserved		
↗ 00-10	Control Mode	0: Speed mode 1: Point-to-Point position control 2: Torque mode 3: Home mode	0
00-11	Control of Speed Mode	0: VF (IM V/f control) 1: VFPG (IM V/f control+ Encoder) 2: SVC(IM Sensorless vector control) 3: FOCPG (IM FOC vector control+ encoder) 4: FOCPG (PM FOC vector control + Encoder)	0

Pr.	Explanation	Settings	Factory Setting								
		5: FOC Sensorless (IM field oriented sensorless vector control) 6: PM Sensorless (PM field oriented sensorless vector control) 7: IPM Sensorless (IPM field oriented sensorless vector control)									
00-12	Point-to-Point Position mode	0: Relative position 1: Absolute position	0								
00-13	Torque Mode Control	0: TQCPG (IM Torque control + Encoder) 1: TQCPG (PM Torque control + Encoder) 2: TQC Sensorless (IM Sensorless torque control)	0								
00-14	Reserved										
00-15	Reserved										
↗ 00-16	Load Selection	0: Light duty 1: Heavy duty	0								
00-17	Carrier Frequency	Light duty	8 6 4								
		<table border="1"> <tr> <td>460V</td> <td>Carrier Frequency</td> </tr> <tr> <td>1-20HP</td> <td>2~15KHz</td> </tr> <tr> <td>25-75HP</td> <td>2~10KHz</td> </tr> <tr> <td>100-475HP</td> <td>2~09KHz</td> </tr> </table>		460V	Carrier Frequency	1-20HP	2~15KHz	25-75HP	2~10KHz	100-475HP	2~09KHz
460V	Carrier Frequency										
1-20HP	2~15KHz										
25-75HP	2~10KHz										
100-475HP	2~09KHz										
		Heavy duty	2								
		<table border="1"> <tr> <td>460V</td> <td>Carrier Frequency</td> </tr> <tr> <td>1-20HP</td> <td>2~15KHz</td> </tr> <tr> <td>25-75HP</td> <td>2~10KHz</td> </tr> <tr> <td>100-475HP</td> <td>2~09KHz</td> </tr> </table>	460V	Carrier Frequency	1-20HP	2~15KHz	25-75HP	2~10KHz	100-475HP	2~09KHz	
460V	Carrier Frequency										
1-20HP	2~15KHz										
25-75HP	2~10KHz										
100-475HP	2~09KHz										
00-18	Reserved										
00-19	PLC Command Mask	Bit 0: Control command by PLC force control Bit 1: Frequency command by PLC force control Bit 2: Position command by PLC force control Bit 3: Torque command by PLC force control	Read only								
↗ 00-20	Source of Master Frequency Command (AUTO)	0: Digital keypad 1: RS-485 serial communication 2: External analog input (Pr.03-00) 3: External UP/DOWN terminal 4: Pulse input without direction command (Pr.10-16 without direction) 5: Pulse input with direction command (Pr.10-16) 6: CANopen communication card 7: Reserved 8: Communication card (no CANopen card)	0								
00-21	Source of the Operation Command (AUTO)	0: Digital keypad 1: External terminals. Keypad STOP disabled. 2: RS-485 serial communication. Keypad STOP disabled. 3: CANopen communication card 4: Reserved 5: Communication card (no CANopen card)	0								
↗ 00-22	Stop Method	0: Ramp to stop 1: Coast to stop	0								
↗ 00-23	Control of Motor Direction	0: Enable forward/reverse 1: Reverse disable 2: Forward disable	0								
00-24	Memory of Frequency Command	Read only	Read only								
↗ 00-25	User Defined Characteristics	Bit 0~3: user define on decimal place 0000b: no decimal place 0001b: one decimal place	0								

Pr.	Explanation	Settings	Factory Setting
		0010b: two decimal place 0011b: three decimal place Bit 4~15: user define on unit 000xh: Hz 001xh: rpm 002xh: % 003xh: kg 004xh: m/s 005xh: kW 006xh: HP 007xh: ppm 008xh: 1/m 009xh: kg/s 00Axh: kg/m 00Bxh: kg/h 00Cxh: l/s 00Dxh: l/m 00Exh: l/h 00Fxm: ft/s 010xm: ft/m 011xm: m 012xm: ft 013xm: degC 014xm: degF 015xm: mbar 016xm: bar 017xm: Pa 018xm: kPa 019xm: mWG 01Axm: inWG 01Bxm: ftWG 01Cxm: psi 01Dxm: atm 01Exm: L/s 01Fxm: L/m 020xm: L/h 021xm: m ³ /s 022xm: m ³ /h 023xm: GPM 024xm: CFM Xxxxm: Hz	
00-26	Max. User Defined Value	0: Disable 0~65535 (when Pr.00-25 set to no decimal place) 0.0~6553.5 (when Pr.00-25 set to 1 decimal place) 0.0~655.35 (when Pr.00-25 set to 2 decimal place) 0.0~65.535 (when Pr.00-25 set to 3 decimal place)	0
00-27	User Defined Value	Read only	Read Only
00-28	Reserved		
00-29	LOCAL/REMOTE Selection	0: Standard HOA function 1: Switching Local/Remote, the drive stops 2: Switching Local/Remote, the drive runs as the REMOTE setting for frequency and operation status 3: Switching Local/Remote, the drive runs as the LOCAL setting for frequency and operation status 4: Switching Local/Remote, the drive runs as LOCAL setting when switch to Local and runs as REMOTE setting when switch to Remote for frequency and operation status.	0

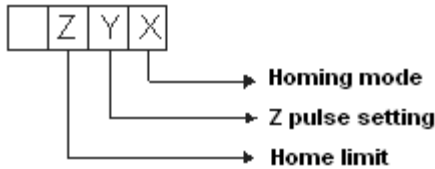
Pr.	Explanation	Settings	Factory Setting
00-30	Source of the Master Frequency Command (HAND)	0: Digital keypad 1: RS-485 serial communication 2: External analog input (Pr.03-00) 3: External UP/DOWN terminal 4: Pulse input without direction command (Pr.10-16 without direction) 5: Pulse input with direction command (Pr.10-16) 6: CANopen communication card 7: Reserved 8: Communication card (no CANopen card)	0
00-31	Source of the Operation Command (HAND)	0: Digital keypad 1: External terminals. Keypad STOP disabled. 2: RS-485 serial communication. Keypad STOP disabled. 3: CANopen communication card 4: Reserved 5: Communication card (not include CANopen card)	0
00-32	Digital Keypad STOP Function	0: STOP key disable 1: STOP key enable	0
00-33 ~ 00-39	Reserved		
00-40	Homing mode		0000
		<p>Note: Forward run = clockwise (CW) Reverse run = counterclockwise (CCW)</p> <p>0: Forward run to home. Set PL forward limit as check point. 1: Reverse run (CCW) to home. Set NL reverse limit (CCWL) as check point. 2: Forward run to home. Set ORG : OFF→ON as check point. 3: Reverse to home. Set ORG : OFF→ON as check point. 4: Forward run and search for Z-pulse as check point. 5: Forward run and search for Z-pulse as check point. 6: Forward run to home. Set ORG: ON→OFF as check point. 7: Reverse run to home. Set ORG : ON→OFF as check point. 8: Define current position as home.</p>	
		<p>Set X to 0, 1, 2, 3, 6, 7 first.</p> <p>Y 0: reverse run to Z pulse 1: continue forward run to Z pulse 2: Ignore Z pulse</p>	
		<p>When home limit is reached, set X to 2, 3, 4, 5, 6, 7 first.</p> <p>Z 0: display the error 1: reverse the direction</p>	
00-41	Homing by frequency 1	0.00~599.00Hz	8.00

	Pr.	Explanation	Settings	Factory Setting
↗	00-42	Homing by frequency 2	0.00~599.00Hz	2.00
	00-43 ~ 00-47	Reserved		
↗	00-48	Display Filter Time (Current)	0.001~65.535 sec	0.100
↗	00-49	Display Filter Time (Keypad)	0.001~65.535 sec	0.100
	00-50	Software Version (date)	Read only	#####
	00-51 ~ 00-61	Reserved		

01 Basic Parameters

	Pr.	Explanation	Settings	Factory Setting
✓	01-00	Max. Operation Frequency	0.00~599.00Hz z	60.00/ 50.00
	01-01	Output Frequency of Motor 1	0.00~599.00Hz	60.00/ 50.00
	01-02	Output Voltage of Motor 1	460V: 0.0V~510.0V	400.0
	01-03	Mid-point Frequency 1 of Motor 1	0.00~599.00Hz	3.00
✓	01-04	Mid-point Voltage 1 of Motor 1	460V: 0.0V~480.0V	22.0
	01-05	Mid-point Frequency 2 of Motor 1	0.00~599.00Hz	1.50
✓	01-06	Mid-point Voltage 2 of Motor 1	460V: 0.0V~480.0V	10.0
	01-07	Min. Output Frequency of Motor 1	0.00~599.00Hz	0.50
✓	01-08	Min. Output Voltage of Motor 1	460V: 0.0V~480.0V	2.0
	01-09	Start-Up Frequency	0.00~599.00Hz	0.50
✓	01-10	Output Frequency Upper Limit	0.00~599.00Hz	599.00
✓	01-11	Output Frequency Lower Limit	0.00~599.00Hz	0
✓	01-12	Accel. Time 1	Pr.01-45=0: 0.00~600.00 second Pr.01-45=1: 0.00~6000.0 second AC drive with power greater than 30HP: 60.00/60.0	10.00 10.0
✓	01-13	Decel Time 1	Pr.01-45=0: 0.00~600.00 second Pr.01-45=1: 0.00~6000.0 second AC drive with power greater than 30HP: 60.00/60.0	10.00 10.0
✓	01-14	Accel Time 2	Pr.01-45=0: 0.00~600.00 second Pr.01-45=1: 0.00~6000.0 second AC drive with power greater than 30HP: 60.00/60.0	10.00 10.0
✓	01-15	Decel Time 2	Pr.01-45=0: 0.00~600.00 second Pr.01-45=1: 0.00~6000.0 second AC drive with power greater than 30HP: 60.00/60.0	10.00 10.0
✓	01-16	Accel Time 3	Pr.01-45=0: 0.00~600.00 second Pr.01-45=1: 0.00~6000.0 second AC drive with power greater than 30HP: 60.00/60.0	10.00 10.0
✓	01-17	Decel Time 3	Pr.01-45=0: 0.00~600.00 second Pr.01-45=1: 0.00~6000.0 second AC drive with power greater than 30HP: 60.00/60.0	10.00 10.0
✓	01-18	Accel Time 4	Pr.01-45=0: 0.00~600.00 second Pr.01-45=1: 0.00~6000.0 second AC drive with power greater than 30HP: 60.00/60.0	10.00 10.0
✓	01-19	Decel Time 4	Pr.01-45=0: 0.00~600.00 second Pr.01-45=1: 0.00~6000.0 second AC drive with power greater than 30HP: 60.00/60.0	10.00 10.0
✓	01-20	JOG Acceleration Time	Pr.01-45=0: 0.00~600.00 second Pr.01-45=1: 0.00~6000.0 second AC drive with power greater than 30HP: 60.00/60.0	10.00 10.0
✓	01-21	JOG Deceleration Time	Pr.01-45=0: 0.00~600.00 second Pr.01-45=1: 0.00~6000.0 second AC drive with power greater than 30HP: 60.00/60.0	10.00 10.0
✓	01-22	JOG Frequency	0.00~599.00Hz	6.00

Pr.	Explanation	Settings	Factory Setting
✓ 01-23	1st/4th Accel/decel Frequency	0.00~599.00Hz	0.00
✓ 01-24	S-curve Acceleration Begin Time 1	Pr.01-45=0: 0.00~25.00 second Pr.01-45=1: 0.0~250.0 second	0.20 0.2
✓ 01-25	S-curve Acceleration Arrival Time 2	Pr.01-45=0: 0.00~25.00 second Pr.01-45=1: 0.0~250.0 second	0.20 0.2
✓ 01-26	S-curve Deceleration Begin Time 1	Pr.01-45=0: 0.00~25.00 second Pr.01-45=1: 0.0~250.0 second	0.20 0.2
✓ 01-27	S-curve Deceleration Arrival Time 2	Pr.01-45=0: 0.00~25.00 second Pr.01-45=1: 0.0~250.0 second	0.20 0.2
01-28	Skip Frequency 1 (upper limit)	0.00~599.00Hz	0.00
01-29	Skip Frequency 1 (lower limit)	0.00~599.00Hz	0.00
01-30	Skip Frequency 2 (upper limit)	0.00~599.00Hz	0.00
01-31	Skip Frequency 2 (lower limit)	0.00~599.00Hz	0.00
01-32	Skip Frequency 3 (upper limit)	0.00~599.00Hz	0.00
01-33	Skip Frequency 3 (lower limit)	0.00~599.00Hz	0.00
01-34	Zero-speed Mode	0: Output waiting 1: Zero-speed operation 2: Fmin (Refer to Pr.01-07, 01-41)	0
01-35	Output Frequency of Motor 2	0.00~599.00Hz	60.00/ 50.00
01-36	Output Voltage of Motor 2	460V: 0.0V~510.0V	400.0
01-37	Mid-point Frequency 1 of Motor 2	0.00~599.00Hz	3.00
✓ 01-38	Mid-point Voltage 1 of Motor 2	460V: 0.0V~480.0V	22.0
01-39	Mid-point Frequency 2 of Motor 2	0.00~599.00Hz	1.50
✓ 01-40	Mid-point Voltage 2 of Motor 2	460V: 0.0V~480.0V	10.0
01-41	Min. Output Frequency of Motor 2	0.00~599.00Hz	0.50
✓ 01-42	Min. Output Voltage of Motor 2	460V: 0.0V~480.0V	2.0
01-43	V/f Curve Selection	0: V/f curve determined by Pr.01-00~01-08 1: Curve to the power of 1.5 2: Curve to the power of 2 3: 60Hz, voltage is saturated when it's 50Hz 4: 72Hz, voltage is saturated when it's 60Hz 5: 50Hz, decrease gradually with third power 6: 50Hz, decrease gradually with square 7: 60Hz, decrease gradually with third power 8: 60Hz, decrease gradually with square 9: 50Hz, medium starting torque 10: 50Hz, large starting torque 11: 60Hz, medium starting torque 12: 60Hz, large starting torque 13: 90Hz, voltage is saturated when it's 60Hz 14: 120Hz, voltage is saturated when it's 60Hz 15: 180Hz, voltage is saturated when it's 60Hz	0
✓ 01-44	Optimal Acceleration/Deceleration Setting	0: Linear accel./decel. 1: Auto accel.; linear decel. 2: Linear accel.; auto decel. 3: Auto accel./decel. 4: Linear, stall prevention by auto accel./decel. (limit by Pr.01-12~01-21)	0

Pr.	Explanation	Settings	Factory Setting
01-45	Time Unit for Accel. /Decel. and S Curve	0: Unit: 0.01 sec 1: Unit: 0.1sec	0
01-46	CANopen Quick Stop Time	Pr. 01-45=0: 0.00~600.00 sec Pr. 01-45=1: 0.0~6000.0 sec	1.00

02 Digital Input/Output Parameters

Pr.	Explanation	Settings	Factory Setting
02-00	2-wire/3-wire Operation Control	0: 2-wire mode, power on for operation control 1: 2-wire mode 2, power on for operation control 2: 3-wire, power on for operation control	0
02-01	Multi-function Input Command 1 (MI1)	0: No function	1
02-02	Multi-function Input Command 2 (MI2)	1: Multi-step speed command 1/multi-step position command 1	2
02-03	Multi-function Input Command 3 (MI3)	2: Multi-step speed command 2/multi-step position command 2	3
02-04	Multi-function Input Command 4 (MI4)	3: Multi-step speed command 3/multi-step position command 3	4
02-05	Multi-function Input Command 5 (MI5)	4: Multi-step speed command 4/multi-step position command 4	0
02-06	Multi-function Input Command 6 (MI6)	5: Reset	0
02-07	Multi-function Input Command 7 (MI7)	6: JOG command (By KPC-CC01 or external control)	0
02-08	Multi-function Input Command 8 (MI8)	7: Acceleration/deceleration speed inhibit	0
02-26	Input terminal of I/O extension card (MI10)	8: The 1 st , 2 nd acceleration/deceleration time selection	0
02-27	Input terminal of I/O extension card (MI11)	9: The 3 rd , 4 th acceleration/deceleration time selection	0
02-28	Input terminal of I/O extension card (MI12)	10: EF Input (Pr.07-20)	0
02-29	Input terminal of I/O extension card (MI13)	11: B.B input from external (Base Block)	0
02-30	Input terminal of I/O extension card (MI14)	12: Output stop	0
02-31	Input terminal of I/O extension card (MI15)	13: Cancel the setting of optimal accel. /decel. time 14: Switch between motor 1 and motor 2 15: Operation speed command from AVI 16: Operation speed command from ACI 17: Operation speed command from AUI 18: Emergency stop (Pr.07-20) 19: Digital up command 20: Digital down command 21: PID function disabled 22: Clear counter 23: Input the counter value (MI6) 24: FWD JOG command 25: REV JOG command 26: TQC/FOCmodel selection 27: ASR1/ASR2 selection 28: Emergency stop (EF1) 29: Signal confirmation for Y-connection 30: Signal confirmation for Δ-connection 31: High torque bias (Pr.11-30) 32: Middle torque bias (Pr.11-31) 33: Low torque bias (Pr.11-32) 34: Switch between multi-step position and multi-speed control 35: Enable single point position control 36: Enable multi-step position learning function (valid at stop) 37: Full position control pulse command input enable 38: Disable EEPROM write function	0

Pr.	Explanation	Settings	Factory Setting
		39: Torque command direction	
		40: Force coast to stop	
		41: HAND switch	
		42: AUTO switch	
		43: Enable resolution selection (Pr.02-48)	
		44: Reversed direction homing	
		45: Forward direction homing	
		46: Homing (ORG)	
		47: Homing function enable	
		48: Mechanical gear ratio switch	
		49: Drive enable	
		50: Slave dEb execution	
		51: Selection for PLC mode bit0	
		52: Selection for PLC mode bit1	
		53: Trigger CANopen quick stop	
		54: Reserved	
		55: Brake Released Signal	
		56: Local/Remote Selection	
		57~70: Reserved	
✓ 02-09	UP/DOWN key mode	0: up/down by the accel. /decel. time 1: up/down constant speed (Pr.02-10)	0
✓ 02-10	Constant speed. The Accel. /Decel. Speed of the UP/DOWN Key	0.001~1.000Hz/ms	0.001
✓ 02-11	Digital Input Response Time	0.000~30.000 sec	0.005
✓ 02-12	Digital Input Mode Selection	0000h~FFFFh (0: N.O.; 1: N.C.)	0000
✓ 02-13	Multi-function Output 1 RY1	0: No function	11
✓ 02-14	Multi-function Output 2 RY2	1: Operation Indication	1
✓ 02-16	Multi-function Output 3 (MO1)	2: Operation speed attained	66
✓ 02-17	Multi-function Output 4 (MO2)	3: Desired frequency attained 1 (Pr.02-22)	0
✓ 02-36	Output terminal of the I/O extension card (MO10)	4: Desired frequency attained 2 (Pr.02-24)	0
✓ 02-37	Output Terminal of I/O Extension Card (MO11)	5: Zero speed (Frequency command)	0
✓ 02-38	Output Terminal of I/O Extension Card (MO12)	6: Zero speed, include STOP(Frequency command)	0
✓ 02-39	Output Terminal of I/O Extension Card (MO13)	7: Over torque 1(Pr.06-06~06-08)	0
✓ 02-40	Output Terminal of I/O Extension Card (MO14)	8: Over torque 2(Pr.06-09~06-11)	0
✓ 02-41	Output Terminal of I/O Extension Card (MO15)	9: Drive is ready	0
✓ 02-42	Output Terminal of I/O Extension Card (MO16)	10: Low voltage warning (LV) (Pr.06-00)	0
✓ 02-43	Output Terminal of I/O Extension Card (MO17)	11: Malfunction indication	0
✓ 02-44	Output Terminal of I/O Extension Card (MO18)	12: Mechanical brake release(Pr.02-32)	0
✓ 02-45	Output Terminal of I/O Extension Card (MO19)	13: Overheat warning (Pr.06-15)	0
✓ 02-46	Output Terminal of I/O Extension Card (MO20)	14: Software brake signal indication(Pr.07-00)	0
		15: PID feedback error	
		16: Slip error (oSL)	

Pr.	Explanation	Settings	Factory Setting
		17: Terminal count value attained, does not return to 0 (Pr.02-20)	
		18: Preliminary count value attained, returns to 0 (Pr.02-19)	
		19: Base Block	
		20: Warning output	
		21: Over voltage warning	
		22: Over-current stall prevention warning	
		23: Over-voltage stall prevention warning	
		24: Operation mode indication	
		25: Forward command	
		26: Reverse command	
		27: Output when current \geq Pr.02-33 (\geq 02-33)	
		28: Output when current \leq Pr.02-33 (\leq 02-33)	
		29: Output when frequency \geq Pr.02-34 (\geq 02-34)	
		30: Output when frequency \leq Pr.02-34 (\leq 02-34)	
		31: Y-connection for the motor coil	
		32: Δ -connection for the motor coil	
		33: Zero speed (actual output frequency)	
		34: Zero speed include stop(actual output frequency)	
		35: Error output selection 1(Pr.06-23)	
		36: Error output selection 2(Pr.06-24)	
		37: Error output selection 3(Pr.06-25)	
		38: Error output selection 4(Pr.06-26)	
		39: Position attained (Pr.10-19)	
		40: Speed attained (including Stop)	
		41: Multi-position attained	
		42: Crane function	
		43: Actual motor speed slower than Pr.02-47	
		44: Low current output (use with Pr.06-71~06-73)	
		45: UVW Output Electromagnetic valve Switch	
		46: Master dEb warning output	
		47: Closed brake output	
		48: Reserved	
		49: Homing action complete	
		50: Output for CANopen control	
		51: Output for communication card	
		52: Output for RS485	
		53~62: Reserved	
02-15	Reserved		
✓ 02-18	Multi-function output direction	0000h~FFFFh (0: N.O.; 1: N.C.)	0000
✓ 02-19	Terminal counting value attained (returns to 0)	0~65535	0
✓ 02-20	Preliminary counting value attained (not return to 0)	0~65535	0
✓ 02-21	Digital Output Gain (DFM)	1~166	1
✓ 02-22	Desired Frequency Attained 1	0.00~599.00Hz	60.00/ 50.00
✓ 02-23	The Width of the Desired Frequency Attained 1	0.00~599.00Hz	2.00
✓ 02-24	Desired Frequency Attained 2	0.00~599.00Hz	60.00/ 50.00
✓ 02-25	The Width of the Desired Frequency Attained 2	0.00~599.00Hz	2.00
02-32	Brake Delay Time	0.000~65.000 sec.	0.000
✓ 02-33	Output Current Level Setting for Multi-function External Terminals	0~100%	0

Pr.	Explanation	Settings	Factory Setting
✓ 02-34	Output frequency setting for multi-function output terminal	0.00~599.00Hz (Motor speed when using PG Card)	3.00
✓ 02-35	External Operation Control Selection after Reset and Activate	0: Disable 1: Drive runs if run command exists after reset	0
✓ 02-47	Zero-speed Level of Motor	0~65535 rpm	0
✓ 02-48	Max. Frequency of Resolution Switch	0.00~599.00Hz	60.00
✓ 02-49	Switch the delay time of Max. output frequency	0~65000 ms	0
02-50	Status of Multi-function Input Terminal	Monitor the status of multi-function input terminals	Read only
02-51	Status of Multi-function Output Terminal	Monitor the status of multi-function output terminals	Read only
02-52	Display External Output terminal occupied by PLC	Monitor the status of PLC input terminals	Read only
02-53	Display External Multi Output Terminal Occupied by PLC	Monitor the status of PLC output terminals	Read only
02-54	Display the Frequency Command Executed by External Terminal	0.00~599.00Hz (Read only)	Read only
02-55	Reserved		
02-56	Release Brake Check Time	0.000~65.000 sec	0.000
✓ 02-57	Multi-function output terminal: Function 42: Brake Current Checking Point	0~100%	0
✓ 02-58	Multi-function output terminal: Function 42: Brake Frequency Checking Point	0.00~3.00Hz	0.00
02-59 ~ 02-62	Reserved		
02-63	Speed Area Band	0.00~599.00Hz	0.00
02-64 ~ 02-69	Reserved		
02-70	IO Card Types	0 : NO IO card 1 : EMC-BPS01 2 : NO IO card 3 : NO IO card 4 : EMC-D611A 5 : EMC-D42A 6 : EMC-R6AA 7 : NO IO card	Read only

03 Analog Input/Output Parameters

	Pr.	Explanation	Settings	Factory Setting		
✓	03-00	Analog Input Selection (AVI)	0: No function	1		
✓	03-01	Analog Input Selection (ACI)	1: Frequency command (torque limit under torque control mode)	0		
✓	03-02	Analog Input Selection (AUI)	2: Torque command (torque limit under speed mode)	0		
			3: Torque compensation command			
			4: PID target value			
			5: PID feedback signal			
			6: PTC thermistor input value			
			7: Positive torque limit			
			8: Negative torque limit			
			9: Regenerative torque limit			
			10: Positive/negative torque limit			
			11: PT100 thermistor input value			
			12: Reserved			
					13: PID Offset (%) (h.)	
					14~20: Reserved	
✓	03-03	Analog Input Bias (AVI)	-100.0~100.0%	0		
✓	03-04	Analog Input Bias (ACI)	-100.0~100.0%	0		
✓	03-05	Analog Positive Voltage Input Bias (AUI)	-100.0~100.0%	0		
	03-06	Reserved				
✓	03-07	Positive/negative Bias Mode (AVI)	0: No bias 1: Lower than or equal to bias 2: Greater than or equal to bias 3: The absolute value of the bias voltage while serving as the center 4: Serve bias as the center	0		
✓	03-08	Positive/negative Bias Mode (ACI)				
✓	03-09	Positive/negative Bias Mode (AUI)				
✓	03-10	Analog Frequency Command for Reverse Run	0: Negative frequency is not valid. Forward and reverse run is controlled by digital keypad or external terminal. 1: Negative frequency is valid. Positive frequency = forward run; negative frequency = reverse run. Direction can not be switched by digital keypad or external terminal control.	0		
✓	03-11	Analog Input Gain (AVI)	-500.0~500.0%	100.0		
✓	03-12	Analog Input Gain (ACI)	-500.0~500.0%	100.0		
✓	03-13	Analog Positive Input Gain (AUI)	-500.0~500.0%	100.0		
✓	03-14	Analog Negative Input Gain (AUI)	-500.0~500.0%	100.0		
✓	03-15	Analog Input Filter Time (AVI)	0.00~20.00 sec.	0.01		
✓	03-16	Analog Input Filter Time (ACI)	0.00~20.00 sec.	0.01		
✓	03-17	Analog Input Filter Time (AUI)	0.00~20.00 sec.	0.01		
✓	03-18	Addition Function of the Analog Input	0: Disable (AVI, ACI, AUI) 1: Enable	0		

Pr.	Explanation	Settings	Factory Setting
✓ 03-19	ACI Signal Loss	0: Disable 1: Continue operation at the last frequency 2: Decelerate to 0Hz 3: Stop immediately and display ACE	0
✓ 03-20	Multi-function Output 1 (AFM1)	0: Output frequency (Hz)	0
✓ 03-23	Multi-function Output 2 (AFM2)	1: Frequency command (Hz) 2: Motor speed (Hz) 3: Output current (rms) 4: Output voltage 5: DC Bus voltage 6: Power factor 7: Power 8: Output torque 9: AVI 10: ACI 11: AUI 12: Iq current 13: Iq feedback value 14: Id current 15: Id feedback value 16: Vq-axis voltage 17: Vd-axis voltage 18: Torque command 19: PG2 frequency command 20: CANopen analog output 21: RS485 analog output 22: Communication card analog output 23: Constant voltage/current output 24: Reserved 25: CAN & 485 output	0
✓ 03-21	Gain of Analog Output 1 (AFM1)	0.0~500.0%	100.0
✓ 03-22	Analog Output 1 when in REV Direction (AFM1)	0: Absolute output voltage 1: Reverse output 0V; Positive output 0-10V 2: Reverse output 5-0V; Positive output 5-10V	0
✓ 03-24	Gain of Analog Output 2 (AFM2)	0.0~500.0%	100.0
✓ 03-25	Analog Output 2 when in REV Direction (AFM2)	0: Absolute output voltage 1: Output 0V in REV direction; output 0-10V in FWD direction 2: Output 5-0V in REV direction; output 5-10V in FWD direction	0
03-26	Reserved		
✓ 03-27	AFM2 Output Bias	-100.00~100.00%	0.00
✓ 03-28	AVI Selection	0: 0-10V 1: 0-20mA 2: 4-20mA	0
✓ 03-29	ACI Selection	0: 4-20mA 1: 0-10V 2: 0-20mA	0
03-30	Status of PLC Output Terminal	Monitor the status of PLC output terminals	Read only
✓ 03-31	AFM2 0-20mA Output Selection	0: 0-20mA Output 1: 4-20mA Output	0
✓ 03-32	AFM1 DC output setting level	0.00~100.00%	0.00

	Pr.	Explanation	Settings	Factory Setting
✓	03-33	AFM2 DC Output Setting Level	0.00~100.00%	0.00
	03-34	Reserved		
✓	03-35	AFM1 Filter Output Time	0.00 ~ 20.00 Seconds	0.01
✓	03-36	AFM2 Filter Output Time	0.00 ~ 20.00 Seconds	0.01
	03-37 ~ 03-43	Reserved		
✓	03-44	MO by Source of AI Level	0: AVI 1: ACI 2: AUI	0
✓	03-45	AI Upper Level	-100.00%~100.00%	50.00
✓	03-46	AI Lower Level	-100.00%~100.00%	10.00
	03-47 ~ 03-49	Reserved		
✓	03-50	Analog Input Curve Selection	0: Regular Curve 1: 3 point curve of AVI 2: 3 point curve of ACI 3: 3 point curve of AVI & ACI 4: 3 point curve of AUI 5: 3 point curve of AVI & AUI 6: 3 point curve of ACI & AUI 7: 3 point curve of AVI & ACI & AUI	0
✓	03-51	AVI Low Point	Pr.03-28=0, 0.00~10.00V Pr.03-28≠0, 0.00~20.00mA	0.00
✓	03-52	AVI Proportional Low Point	-100.00~100.00%	0.00
✓	03-53	AVI Mid Point	Pr.03-28=0, 0.00~10.00V Pr.03-28≠0, 0.00~20.00mA	5.00
✓	03-54	AVI Proportional Mid Point	-100.00~100.00%	50.00
✓	03-55	AVI High Point	Pr.03-28=0, 0.00~10.00V Pr.03-28≠0, 0.00~20.00mA	10.00
✓	03-56	AVI Proportional High Point	-100.00~100.00%	100.00
✓	03-57	ACI Low Point	Pr.03-29=1, 0.00~10.00V Pr.03-29≠1, 0.00~20.00mA	4.00
✓	03-58	ACI Proportional Low Point	-100.00~100.00%	0.00
✓	03-59	ACI Mid Point	Pr.03-29=1, 0.00~10.00V Pr.03-29≠1, 0.00~20.00mA	12.00
✓	03-60	ACI Proportional Mid Point	-100.00~100.00%	50.00
✓	03-61	ACI High Point	Pr.03-29=1, 0.00~10.00V Pr.03-29≠1, 0.00~20.00mA	20.00
✓	03-62	ACI Proportional High Point	-100.00~100.00%	100.00
✓	03-63	Positive AUI Voltage Low Point	0.00~10.00V	0.00
✓	03-64	Positive AUI Voltage Proportional Low Point	0.00~100.00%	0.00
✓	03-65	Positive AUI Voltage Mid Point	0.00~10.00V	5.00
✓	03-66	Positive AUI Voltage Proportional Mid Point	0.00~100.00%	50.00
✓	03-67	Positive AUI Voltage High Point	0.00~10.00V	10.00

	Pr.	Explanation	Settings	Factory Setting
✓	03-68	Positive AUI Voltage Proportional High Point	0.00~100.00%	100.00
✓	03-69	Negative AUI Voltage Low Point	-10.00~0.00 V	0.00
✓	03-70	Negative AUI Voltage Proportional Low Point	0.00~ -100.00%	0.00
✓	03-71	Negative AUI Voltage Mid Point	0.00~ -10.00V	-5.00
✓	03-72	Negative AUI Voltage Proportional Mid Point	0.00~ -100.00%	-50.00
✓	03-73	Negative AUI Voltage High Point	0.00~ -10.00V	-10.00
✓	03-74	Negative AUI Voltage Proportional High Point	0.00~ -100.00%	-100.00

04 Multi-step Speed Parameters

	Pr.	Explanation	Settings	Factory Setting
✓	04-00	1st Step Speed Frequency	0.00~599.00Hz	0.00
✓	04-01	2nd Step Speed Frequency	0.00~599.00Hz	0.00
✓	04-02	3rd Step Speed Frequency	0.00~599.00Hz	0.00
✓	04-03	4th Step Speed Frequency	0.00~599.00Hz	0.00
✓	04-04	5th Step Speed Frequency	0.00~599.00Hz	0.00
✓	04-05	6th Step Speed Frequency	0.00~599.00Hz	0.00
✓	04-06	7th Step Speed Frequency	0.00~599.00Hz	0.00
✓	04-07	8th Step Speed Frequency	0.00~599.00Hz	0.00
✓	04-08	9th Step Speed Frequency	0.00~599.00Hz	0.00
✓	04-09	10th Step Speed Frequency	0.00~599.00Hz	0.00
✓	04-10	11th Step Speed Frequency	0.00~599.00Hz	0.00
✓	04-11	12th Step Speed Frequency	0.00~599.00Hz	0.00
✓	04-12	13th Step Speed Frequency	0.00~599.00Hz	0.00
✓	04-13	14th Step Speed Frequency	0.00~599.00Hz	0.00
✓	04-14	15th Step Speed Frequency	0.00~599.00Hz	0.00
✓	04-15	Position command 1 (revolution)	-30000~30000	0
✓	04-16	Position command 1 (pulse)	-32767~32767	0
✓	04-17	Position command 2 (revolution)	-30000~30000	0
✓	04-18	Position command 2 (pulse)	-32767~32767	0
✓	04-19	Position command 3 (revolution)	-30000~30000	0
✓	04-20	Position command 3 (pulse)	-32767~32767	0
✓	04-21	Position command 4 (revolution)	-30000~30000	0
✓	04-22	Position command 4 (pulse)	-32767~32767	0
✓	04-23	Position command 5 (revolution)	-30000~30000	0
✓	04-24	Position command 5 (pulse)	-32767~32767	0
✓	04-25	Position command 6 (revolution)	-30000~30000	0
✓	04-26	Position command 6 (pulse)	-32767~32767	0
✓	04-27	Position command 7 (revolution)	-30000~30000	0
✓	04-28	Position command 7 (pulse)	-32767~32767	0
✓	04-29	Position command 8 (revolution)	-30000~30000	0
✓	04-30	Position command 8 (pulse)	-32767~32767	0
✓	04-31	Position command 9 (revolution)	-30000~30000	0
✓	04-32	Position command 9 (pulse)	-32767~32767	0
✓	04-33	Position command 10 (revolution)	-30000~30000	0
✓	04-34	Position command 10 (pulse)	-32767~32767	0
✓	04-35	Position command 11 (revolution)	-30000~30000	0
✓	04-36	Position command 11 (pulse)	-32767~32767	0

	Pr.	Explanation	Settings	Factory Setting
✓	04-37	Position command 12 (revolution)	-30000~30000	0
✓	04-38	Position command 12 (pulse)	-32767~32767	0
✓	04-39	Position command 13 (revolution)	-30000~30000	0
✓	04-40	Position command 13 (pulse)	-32767~32767	0
✓	04-41	Position command 14 (revolution)	-30000~30000	0
✓	04-42	Position command 14 (pulse)	-32767~32767	0
✓	04-43	Position command 15 (revolution)	-30000~30000	0
✓	04-44	Position command 15 (pulse)	-32767~32767	0
	04-45 ~ 04-49	Reserved		
✓	04-50 ~ 04-69	PLC buffer 0~19	0~65535	0

05 Motor Parameters

Pr.	Explanation	Settings	Factory Setting
05-00	Motor Auto Tuning	0: No function 1: Rolling test for induction motor(IM) (Rs, Rr, Lm, Lx, no-load current) 2: Static test for induction motor(IM) 3: No function 4: Rolling test for PM motor magnetic pole 5: Rolling test for PM (SPM) motor 6: Rolling test for IM motor flux curve 12: FOC Sensorless inertia estimation 13: Stacic test for (IPM/SPM) motor	0
05-01	Full-load Current of Induction Motor 1(A)	0~xxxx (Depends on the power of motor)	###
05-02	Rated Power of Induction Motor 1(kW)	0~655.35kW	###
05-03	Rated Speed of Induction Motor 1 (rpm)	Depends on the power of motor	Depends on the power of motor
05-04	Pole Number of Induction Motor 1	2~64	4
05-05	No-load Current of Induction Motor 1 (A)	0~ Pr.05-01 factory setting	###
05-06	Stator Resistance (Rs) of Induction Motor 1	0~65.535Ω	####
05-07	Rotor Resistance (Rr) of Induction Motor 1	0~65.535Ω	####
05-08	Magnetizing Inductance (Lm) of Induction Motor 1	0~6553.5mH	##
05-09	Stator Inductance (Lx) of Induction Motor 1	0~6553.5mH	##
05-10 ~ 05-12	Reserved		
05-13	Full-load Current of Induction Motor 2 (A)	0~xxxx (Depends on the power of motor)	###
05-14	Rated Power of Induction Motor 2 (kW)	0~655.35kW	###
05-15	Rated Speed of Induction Motor 2 (rpm)	0~xxxx (Depends on the power of motor)	Depends on the power of motor
05-16	Pole Number of Induction Motor 2	2~64	4
05-17	No-load Current of Induction Motor 2 (A)	0~ Pr.05-01 factory setting	###
05-18	Stator Resistance (Rs) of Induction Motor 2	0~65.535Ω	####
05-19	Rotor Resistance (Rr) of Induction Motor 2	0~65.535Ω	####
05-20	Magnetizing Inductance (Lm) of Induction Motor 2	0~6553.5mH	##
05-21	Stator Inductance (Lx) of Induction Motor 2	0~6553.5mH	##
05-22	Induction Motor 1/ 2 Selection	1: motor 1 2: motor 2	1
05-23	Frequency for Y-connection/△-connection Switch of Induction Motor	0.00~599.00Hz	60.00

Pr.	Explanation	Settings	Factory Setting
05-24	Y-connection/ Δ -connection Switch of Induction Motor	0: Disable 1: Enable	0
↗ 05-25	Delay Time for Y-connection/ Δ -connection Switch of Induction Motor	0.000~60.000 sec.	0.200
05-26	Accumulative Watt-second of Motor in Low Word (W-sec)	Read only	##
05-27	Accumulative Watt-second of Motor in High Word (W-sec)	Read only	##
05-28	Accumulative Watt-hour of Motor (W-Hour)	Read only	##
05-29	Accumulative Kilo Watt-hour of Motor in Low Word (KW-Hour)	Read only	##
05-30	Accumulative Kilo Watt-hour of Motor in High Word (KW-Hour)	Read only	##
05-31	Accumulative Motor Operation Time (Min)	00~1439	0
05-32	Accumulative Motor Operation Time (day)	00~65535	0
05-33	Induction Motor and Permanent Magnet Motor Selection	0: Induction Motor 1: SPM Permanent Magnet Motor 2: IPM Permanent Magnet Motor	0
05-34	Full-load current of Permanent Magnet Motor	Depends on the power of motor	Depends on the power of motor
↗ 05-35	Rated Power of Permanent Magnet Motor	0.00~655.35kW	Depends on the power of motor
↗ 05-36	Rated speed of Permanent Magnet Motor	0~65535rpm	2000
05-37	Pole number of Permanent Magnet Motor	0~65535	10
05-38	Inertia of Permanent Magnet Motor	0.0~6553.5 kg.cm ²	Depends on the power of motor
05-39	Stator Resistance of PM Motor	0.000~65.535 Ω	0.000
05-40	Permanent Magnet Motor Ld	0.00~655.35mH	0.000
05-41	Permanent Magnet Motor Lq	0.00~655.35mH	0.000
↗ 05-42	PG Offset angle of PM Motor	0.0~360.0°	0.0
↗ 05-43	Ke parameter of PM Motor	0~65535 (Unit: V/1000rpm)	0

06 Protection Parameters

Pr.	Explanation	Settings	Factory Setting
06-00	Low Voltage Level	460V: Frame A to D: 300.0~440.0Vdc Frame E and frames above E: 380.0~440.0V	360.0 400.0
06-01	Over-voltage Stall Prevention	0: Disabled 460V: 0.0~900.0Vdc	760.0
06-02	Selection for Over-voltage Stall Prevention	0: Traditional over-voltage stall prevention 1: Smart over-voltage prevention	0
06-03	Over-current Stall Prevention during Acceleration	Light duty: 0~160%(100%: drive's rated current) Heavy duty: 0~180%(100%: drive's rated current)	120 150
06-04	Over-current Stall Prevention during Operation	Light duty: 0~160%(100%: drive's rated current) Heavy duty: 0~180%(100%: drive's rated current)	120 150
06-05	Accel. /Decel. Time Selection of Stall Prevention at Constant Speed	0: by current accel/decel time 1: by the 1st accel/decel time 2: by the 2nd accel/decel time 3: by the 3rd accel/decel time 4: by the 4th accel/decel time 5: by auto accel/decel	0
06-06	Over-torque Detection Selection (OT1)	0: No function 1: Over-torque detection during constant speed operation, continue to operate after detection 2: Over-torque detection during constant speed operation, stop operation after detection 3: Over-torque detection during operation, continue to operate after detection 4: Over-torque detection during operation, stop operation after detection	0
06-07	Over-torque Detection Level (OT1)	10~250% (100%: drive's rated current)	120
06-08	Over-torque Detection Time (OT1)	0.0~60.0 sec.	0.1
06-09	Over-torque Detection Selection (OT2)	0: No function 1: Over-torque detection during constant speed operation, continue to operate after detection 2: Over-torque detection during constant speed operation, stop operation after detection 3: Over-torque detection during operation, continue to operation after detection 4: Over-torque detection during operation, stop operation after detection	0
06-10	Over-torque Detection Level (OT2)	10~250% (100%: drive's rated current)	120
06-11	Over-torque Detection Time (OT2)	0.0~60.0 sec.	0.1
06-12	Current Limit	0~250% (100%: drive's rated current)	150
06-13	Electronic Thermal Relay Selection (Motor 1)	0: Inverter motor (fan doesn't run with the axel synchronously) 1: Standard motor (fan runs with the axel synchronously) 2: Electronic thermal relay disabled	2
06-14	Electronic Thermal Characteristic for Motor 1	30.0~600.0 sec.	60.0
06-15	Heat Sink Over-heat (OH) Warning	0.0~110.0°C	85.0
06-16	Stall Prevention Limit Level	0~100% (Pr.06-03, Pr.06-04)	50
06-17	Present Fault Record	0: No fault record	0

Pr.	Explanation	Settings	Factory Setting
06-18	Second Most Recent Fault Record	1: Over-current during acceleration (ocA)	0
06-19	Third Most Recent Fault Record	2: Over-current during deceleration (ocd)	0
06-20	Fourth Most Recent Fault Record	3: Over-current during constant speed(ocn)	0
06-21	Fifth Most Recent Fault Record	4: Ground fault (GFF)	0
06-22	Sixth Most Recent Fault Record	5: IGBT short-circuit (occ)	0
		6: Over-current at stop (ocS)	
		7: Over-voltage during acceleration (ovA)	
		8: Over-voltage during deceleration (ovd)	
		9: Over-voltage during constant speed (ovn)	
		10: Over-voltage at stop (ovS)	
		11: Low-voltage during acceleration (LvA)	
		12: Low-voltage during deceleration (Lvd)	
		13: Low-voltage during constant speed (Lvn)	
		14: Stop mid-low voltage (LvS)	
		15: Phase loss protection (OrP)	
		16: IGBT over-heat (oH1)	
		17: Capacitance over-heat (oH2)	
		18: tH1o (TH1 open: IGBT over-heat protection error)	
		19: tH2o (TH2 open: capacitance over-heat protection error)	
		20: Reserved	
		21: Drive over-load (oL)	
		22: Electronics thermal relay 1 (EoL1)	
		23: Electronics thermal relay 2 (EoL2)	
		24: Motor overheat (oH3) (PTC/PT100)	
		25: Reserved	
		26: Over-torque 1 (ot1)	
		27: Over-torque 2 (ot2)	
		28: Low current (uC)	
		29: Home limit error (LMIT)	
		30: Memory write-in error (cF1)	
		31: Memory read-out error (cF2)	
		32: Reserved	
		33: U-phase current detection error (cd1)	
		34: V-phase current detection error (cd2)	
		35: W-phase current detection error (cd3)	
		36: Clamp current detection error (Hd0)	
		37: Over-current detection error (Hd1)	
		38: Over-voltage detection error (Hd2)	
		39: Ground current detection error (Hd3)	
		40: Auto tuning error (AUE)	
		41: PID feedback loss (AFE)	
		42: PG feedback error (PGF1)	
		43: PG feedback loss (PGF2)	
		44: PG feedback stall (PGF3)	
		45: PG slip error (PGF4)	
		46: Reserved	
		47: Reserved	
		48: Analog current input loss (ACE)	
		49: External fault input (EF)	
		50: Emergency stop (EF1)	
		51: External Base Block (bb)	
		52: Password error (PcodE)	
		53: Reserved	
		54: Communication error (CE1)	
		55: Communication error (CE2)	

Pr.	Explanation	Settings	Factory Setting	
		56: Communication error (CE3)		
		57: Communication error (CE4)		
		58: Communication Time-out (CE10)		
		59: Reserved		
		60: Brake transistor error (bF)		
		61: Y-connection/ Δ -connection switch error (ydc)		
		62: Decel. Energy Backup Error (dEb)		
		63: Slip error (oSL)		
		64: Electromagnet switch error (ryF)		
		65 : PG Card Error (PGF5)		
		66-67: Reserved		
		68: Sensorless estimated speed have wrong direction		
		69: Sensorless estimated speed is over speed		
		70: Sensorless estimated speed deviated		
		71~72: Reserved		
		73: External safety gate S1		
		74~81: Reserved		
		82: U phase output phase loss (OPHL)		
		83: V phase output phase loss (OPHL)		
		84: W phase output phase loss (OPHL)		
		85: PG-02U ABZ hardware disconnection		
		86: PG-02U UVW hardware disconnection		
		87~88: Reserved		
		89: Initial rotor position detection error		
		90: Inner PLC function is forced to stop		
		91~100: Reserved		
		101: CANopen software disconnect1 (CGdE)		
		102: CAN open software disconnect2 (CHbE)		
		103: Reserved		
		104: CANopen hardware disconnect (CbFE)		
		105: CANopen index setting error (CIdE)		
		106: CANopen slave station number setting error (CAde)		
		107: CANopen index setting exceed limit (CFrE)		
		108~110: Reserved		
		111: Internal communication overtime error(InrCOM)		
		112: PM sensorless shaft Lock error		
		113: Reserved		
✓	06-23	Fault Output Option 1	0~65535(refer to bit table for fault code)	0
✓	06-24	Fault Output Option 2	0~65535(refer to bit table for fault code)	0
✓	06-25	Fault Output Option 3	0~65535(refer to bit table for fault code)	0
✓	06-26	Fault Output Option 4	0~65535(refer to bit table for fault code)	0
✓	06-27	Electronic Thermal Relay Selection 2 (Motor 2)	0: Inverter motor (fan doesn't run with the axel synchronously) 1: Standard motor (fan runs with the axel synchronously) 2: Electronic thermal relay disabled	2
✓	06-28	Electronic Thermal Characteristic for Motor 2	30.0~600.0 sec	60.0
✓	06-29	PTC/PT100 Detection Selection	0: Warn and keep operation 1: Warn and ramp to stop 2: Warn and coast to stop 3: No warning	0
✓	06-30	PTC Level	0.0~100.0%	50.0
✓	06-31	Frequency Command for Malfunction	0.00~599.00Hz	Read only

Pr.	Explanation	Settings	Factory Setting
06-32	Output Frequency at Malfunction	0.00~599.00Hz	Read only
06-33	Output Voltage at Malfunction	0.0~6553.5 V	Read only
06-34	DC Voltage at Malfunction	0.0~6553.5 V	Read only
06-35	Output Current at Malfunction	0.00~6553.5 Amp	Read only
06-36	IGBT Temperature at Malfunction	-3276.7~3276.7 °C	Read only
06-37	Capacitance Temperature at Malfunction	-3276.7~3276.7 °C	Read only
06-38	Motor Speed in rpm at Malfunction	-32767~32767 rpm	Read only
06-39	Torque Command at Malfunction	-3276.7~3276.7 %	Read only
06-40	Status of Multi-function Input Terminal at Malfunction	0000h~FFFFh	Read only
06-41	Status of Multi-function Output Terminal at Malfunction	0000h~FFFFh	Read only
06-42	Drive Status at Malfunction	0000h~FFFFh	Read only
06-43	Reserved		
06-44	Reserved		
✎ 06-45	Treatment to Output Phase Loss Detection (OPHL)	0: Warn and keep operation 1: Warn and ramp to stop 2: Warn and coast to stop 3: No warning	3
✎ 06-46	Deceleration Time of Output Phase Loss	0.000~65.535 sec	0.500
✎ 06-47	Current Bandwidth	0.00~100.00%	1.00
✎ 06-48	DC Brake Time of Output Phase Loss	0.000~65.535sec	0.100
✎ 06-49	LvX Auto Reset	0: Disable 1: Enable	0
✎ 06-50	Time for Input Phase Loss Detection	0.00~600.00 sec.	0.20
06-51	Reserved		
✎ 06-52	Ripple of Input Phase Loss	460V model: 0.0~320.0 Vdc	60.0
✎ 06-53	Treatment for the detected Input Phase Loss (OrP)	0: warn and ramp to stop 1: warn and coast to stop	0
06-54	Reserved		
✎ 06-55	Derating Protection	0: constant rated current and limit carrier wave by load current and temperature 1: constant carrier frequency and limit load current by setting carrier wave 2: constant rated current(same as setting 0), but close current limit	0
✎ 06-56	PT100 Detected Level 1	0.000~10.000V	5.000
✎ 06-57	PT100 Detected Level 2	0.000~10.000V	7.000
✎ 06-58	PT100 Level 1 Frequency Protect	0.00~599.00Hz	0.00
✎ 06-59	PT100 Activation Level Delay Time	0~6000 sec.	60

	Pr.	Explanation	Settings	Factory Setting
✓	06-60	Software Detection GFF Current Level	0.0~6553.5 %	60.0
✓	06-61	Software Detection GFF Filter Time	0.00~655.35 sec.	0.10
	06-62	Reserved		
	06-63	Fault Record 1 (Day)	0~65535 days	Read only
	06-64	Fault Record 1 (Min)	0~1439 min.	Read only
	06-65	Fault Record 2 (Day)	0~65535 days	Read only
	06-66	Fault Record 2 (Min)	0~1439 min.	Read only
	06-67	Fault Record 3 (Day)	0~65535 days	Read only
	06-68	Fault Record 3 (Min)	0~1439 min.	Read only
	06-69	Fault Record 4 (Day)	0~65535 days	Read only
	06-70	Fault Record 4 (Min)	0~1439 min.	Read only
✓	06-71	Low Current Setting Level	0.0 ~ 100.0 %	0.0
	06-72	Low Current Detection Time	0.00 ~ 360.00 sec.	0.00
✓	06-73	Treatment for low current	0 : No function 1 : Warn and coast to stop 2 : Warn and ramp to stop by 2nd deceleration time 3 : Warn and operation continue	0

07 Special Parameters

	Pr.	Explanation	Settings	Factory Setting
✓	07-00	Software Brake Level	460V: 700.0~900.0Vdc	760.0
✓	07-01	DC Brake Current Level	0~100%	0
✓	07-02	DC Brake Time at Start-up	0.0~60.0 sec.	0.0
✓	07-03	DC Brake Time at Stop	0.0~60.0 sec.	0.0
✓	07-04	Startup Frequency for DC Brake	0.00~599.00Hz	0.00
✓	07-05	Maximum Power Loss Duration	1~200%	100
✓	07-06	Restart after Momentary Power Loss	0: No function 1: Speed search for last frequency command 2: Speed search for minimum output frequency	0
✓	07-07	Maximum Power Loss Duration	0.0~20.0 sec.	2.0
✓	07-08	Base Block Time	0.1~5.0 sec.	0.5
✓	07-09	Current Limit for Speed Search	20~200%	100
✓	07-10	Treatment to Reboots After Fault	0: No function 1: Speed search starts with current speed 2: Speed search starts with minimum output frequency	0
✓	07-11	Auto Restart After Fault	0~10	0
✓	07-12	Speed Search during Start-up	0: Disable 1: Speed search for maximum output frequency 2: Speed search for start-up motor frequency 3: Speed search for minimum output frequency	0
✓	07-13	dEb Function Selection	0: Disable 1: dEb with auto accel./decel., the output frequency will not return after power reply. 2: dEb with auto accel./decel., the output frequency will return after power reply.	0
✓	07-14	Reserved		
✓	07-15	Dwell Time at Accel.	0.00 ~ 600.00 sec	0.00
✓	07-16	Dwell Frequency at Accel.	0.00 ~ 599.00Hz	0.00
✓	07-17	Dwell Time at Decel.	0.00 ~ 600.00sec	0.00
✓	07-18	Dwell Frequency at Decel.	0.00 ~ 599.00Hz	0.00
✓	07-19	Fan Cooling Control	0: Fan always ON 1: 1 minute after the AC motor drive stops, fan will be OFF 2: When the AC motor drive runs, the fan is ON. When the AC motor drive stops, the fan is OFF 3: Fan turns ON when preliminary heat sink temperature (around 60°C) is attained. 4: Fan always OFF	0
✓	07-20	Emergency Stop (EF) & Force to Stop Selection	0: Coast stop 1: By deceleration Time 1 2: By deceleration Time 2 3: By deceleration Time 3 4: By deceleration Time 4 5: System Deceleration 6: Automatic Deceleration	0
✓	07-21	Auto Energy-saving Operation	0: Disable 1: Enable	0

	Pr.	Explanation	Settings	Factory Setting
↗	07-22	Energy-saving Gain	10~1000%	100
↗	07-23	Auto Voltage Regulation(AVR) Function	0: Enable AVR 1: Disable AVR 2: Disable AVR during deceleration	0
↗	07-24	Filter Time of Torque Command (V/F and SVC control mode)	0.001~10.000 sec	0.500
↗	07-25	Filter Time of Slip Compensation (V/F and SVC control mode)	0.001~10.000 sec	0.100
↗	07-26	Torque Compensation Gain (V/F and SVC control mode)	0~10	0
↗	07-27	Slip Compensation Gain (V/F and SVC control mode)	0.00~10.00 (SVC control mode: the factory value is 1)	0.00
	07-28	Reserved		
↗	07-29	Slip Deviation Level	0.0~100.0%	0
↗	07-30	Detection Time of Slip Deviation	0.0~10.0 sec	1.0
↗	07-31	Over Slip Treatment	0: Warn and keep operation 1: Warn and ramp to stop 2: Warn and coast to stop 3: No warning	0
↗	07-32	Motor Hunting Gain	0~10000	1000
↗	07-33	Auto Reset Time for Restart after Fault	0.0~6000.0 sec	60.0

08 High-function PID Parameters

Pr.	Explanation	Settings	Factory Setting
✓ 08-00	Input Terminal for PID Feedback	0: No function 1: Negative PID feedback: input from external terminal AVI (Pr.03-00) 2: Negative PID feedback from PG card (Pr.10-15, skip direction) 3: Negative PID feedback from PG card (Pr.10-15) 4: Positive PID feedback from external terminal AVI (Pr.03-00) 5: Positive PID feedback from PG card (Pr.10-15, skip direction) 6: Positive PID feedback from PG card (Pr.10-15) 7: Negative PID feedback from communication protocol 8: Positive PID feedback from communication protocol	0
✓ 08-01	Proportional Gain (P)	0.0~500.0	1.0
✓ 08-02	Integral Time (I)	0.00~100.00sec	1.00
✓ 08-03	Derivative Control (D)	0.00~1.00sec	0.00
✓ 08-04	Upper Limit of Integral Control	0.0~100.0%	100.0
✓ 08-05	PID Output Frequency Limit	0.0~110.0%	100.0
✗ 08-06	PID feedback value by communication protocol	-200.00~200.00%	Read only
✓ 08-07	PID Delay Time	0.0~35.0 sec.	0.0
✓ 08-08	Feedback Signal Detection Time	0.0~3600.0sec	0.0
✓ 08-09	Feedback Signal Fault Treatment	0: Warn and keep operation 1: Warn and ramp to stop 2: Warn and coast to stop 3: Warn and operate at last frequency	0
✓ 08-10	Sleep Frequency	0.00 ~ 599.00Hz	0.00
✓ 08-11	Wake-up Frequency	0.00 ~ 599.00Hz	0.00
✓ 08-12	Sleep Time	0.0 ~ 6000.0sec	0.0
✓ 08-13	PID Deviation Level	1.0 ~ 50.0%	10.0
✓ 08-14	PID Deviation Time	0.1~300.0 sec	5.0
✓ 08-15	Filter Time for PID Feedback	0.1~300.0 sec	5.0
✓ 08-16	PID Compensation Selection	0: Parameter setting 1: Analog input	0
✓ 08-17	PID Compensation	-100.0~100.0%	0
08-18	Setting of Sleep Mode Function	0: Follow PID output command 1: Follow PID feedback signal	0
✓ 08-19	Wake-up Integral Limit	0.0~200.0%	50.0
08-20	PID Mode Selection	0: Serial connection 1: Parallel connection	0
08-21	Enable PID to Change Operation Direction	0: Operation direction can be changed 1: Operation direction can not be changed	0
✓ 08-22	Wakeup Delay Time	0.00~600.00 Seconds	0.00
✓ 08-23	PID Control Flag	Bit 0 = 1, PID reverse running must follow the setting of Pr00-23. Bit 0 = 0, PID reverse running follow PID's calculated value.	0

09 Communication Parameters

	Pr.	Explanation	Settings	Factory Setting
✓	09-00	COM1 Communication Address	1~254	1
✓	09-01	COM1 Transmission Speed	4.8~115.2Kbps	9.6
✓	09-02	COM1 Transmission Fault Treatment	0: Warn and continue operation 1: Warn and ramp to stop 2: Warn and coast to stop 3: No warning and continue operation	3
✓	09-03	COM1 Time-out Detection	0.0~100.0 sec.	0.0
✓	09-04	COM1 Communication Protocol	1: 7N2 (ASCII) 2: 7E1 (ASCII) 3: 7O1 (ASCII) 4: 7E2 (ASCII) 5: 7O2 (ASCII) 6: 8N1 (ASCII) 7: 8N2 (ASCII) 8: 8E1 (ASCII) 9: 8O1 (ASCII) 10: 8E2 (ASCII) 11: 8O2 (ASCII) 12: 8N1 (RTU) 13: 8N2 (RTU) 14: 8E1 (RTU) 15: 8O1 (RTU) 16: 8E2 (RTU) 17: 8O2 (RTU)	1
	09-05 ~ 09-08	Reserved		
✓	09-09	Response Delay Time	0.0~200.0ms	2.0
✓	09-10	Main Frequency of the Communication	0.00~599.00Hz	60.00
✓	09-11	Block Transfer 1	0~65535	0
✓	09-12	Block Transfer 2	0~65535	0
✓	09-13	Block Transfer 3	0~65535	0
✓	09-14	Block Transfer 4	0~65535	0
✓	09-15	Block Transfer 5	0~65535	0
✓	09-16	Block Transfer 6	0~65535	0
✓	09-17	Block Transfer 7	0~65535	0
✓	09-18	Block Transfer 8	0~65535	0
✓	09-19	Block Transfer 9	0~65535	0
✓	09-20	Block Transfer 10	0~65535	0
✓	09-21	Block Transfer 11	0~65535	0
✓	09-22	Block Transfer 12	0~65535	0
✓	09-23	Block Transfer 13	0~65535	0
✓	09-24	Block Transfer 14	0~65535	0
✓	09-25	Block Transfer 15	0~65535	0
✓	09-26	Block Transfer 16	0~65535	0

Pr.	Explanation	Settings	Factory Setting
09-27 ~ 09-29	Reserved		
09-30	Communication Decoding Method	0: Decoding Method 1 (20xx) 1: Decoding Method 2 (60xx)	1
09-31	Internal Communication Protocol	0: Modbus 485 -1: Internal Communication Slave 1 -2: Internal Communication Slave 2 -3: Internal Communication Slave 3 -4: Internal Communication Slave 4 -5: Internal Communication Slave 5 -6: Internal Communication Slave 6 -7: Internal Communication Slave 7 -8: Internal Communication Slave 8 -9: Reserve -10: Internal Communication Master -11: Reserve -12: Internal PLC Control	0
09-32	Reserve		
09-33	PLC command force to 0	0~65535	0
09-34	Reserved		
09-35	PLC Address	1~254	2
09-36	CANopen Slave Address	0: Disable 1~127	0
09-37	CANopen Speed	0: 1M bps 1: 500K bps 2: 250K bps 3: 125K bps 4: 100K bps (Delta only) 5: 50K bps	0
09-38	Reserved		
09-39	CANopen Warning Record	bit 0: CANopen Guarding Time out bit 1: CANopen Heartbeat Time out bit 2: CANopen SYNC Time out bit 3: CANopen SDO Time out bit 4: CANopen SDO buffer overflow bit 5: Can Bus Off bit 6: Error protocol of CANopen	Read only
09-40	CANopen Decoding Method	0: Delta defined decoding method 1: CANopen DS402 Standard	1
09-41	CANopen Communication Status	0: Node Reset State 1: Com Reset State 2: Boot up State 3: Pre Operation State 4: Operation State 5: Stop State	Read Only
09-42	CANopen Control Status	0: Not ready for use state 1: Inhibit start state 2: Ready to switch on state 3: Switched on state 4: Enable operation state 7: Quick Stop Active state 13: Err Reaction Activation state 14: Error state	Read Only
09-43	Reserved		
09-44	Reserved		

Pr.	Explanation	Settings	Factory Setting
09-45	CANopen Master Function	0: Disable 1: Enable	0
09-46	CANopen Master Address	0~127	100
09-47 ~ 09-59	Reserved		
09-60	Identifications for Communication Card	0: No communication card 1: DeviceNet Slave 2: Profibus-DP Slave 3: CANopen Slave/Master 4: Modbus-TCP Slave 5: Ethernet/IP Slave 6~8: Reserved	##
09-61	Firmware Version of Communication Card	Read only	##
09-62	Product Code	Read only	##
09-63	Error Code	Read only	##
09-64 ~ 09-69	Reserved		
↗ 09-70	Address of Communication Card (Special parameter for DeviceNet card and PROFIBUS card)	DeviceNet: 0-63 Profibus-DP: 1-125	1
↗ 09-71	Setting of DeviceNet Speed (Special parameter for DeviceNet card and PROFIBUS card)	Standard DeviceNet: 0: 125Kbps 1: 250Kbps 2: 500Kbps 3: 1Mbps (Delta Only) Non standard DeviceNet: (Delta Only) 0: 10Kbps 1: 20Kbps 2: 50Kbps 3: 100Kbps 4: 125Kbps 5: 250Kbps 6: 500Kbps 7: 800Kbps 8: 1Mbps	2
↗ 09-72	Other Setting of DeviceNet Speed (Special parameter for DeviceNet card and PROFIBUS card)	0: Disable In this mode, baud rate can only be 125K bps, 250K bps, 500K bps in standard DeviceNet speed 1: Enable In this mode, the baud rate of DeviceNet can be same as CANopen (0-8).	0
09-73	Reserved		
09-74	Reserved		
↗ 09-75	IP Configuration of the Communication Card (Special parameter for MODBUS TCP card)	0: Static IP 1: Dynamic IP (DHCP)	0
↗ 09-76	IP Address 1 of the Communication Card (Special parameter for MODBUS TCP card)	0~65535	0

Pr.	Explanation	Settings	Factory Setting
✎ 09-77	IP Address 2 of the Communication Card (Special parameter for MODBUS TCP card)	0~65535	0
✎ 09-78	IP Address 3 of the Communication Card (Special parameter for MODBUS TCP card)	0~65535	0
✎ 09-79	IP Address 4 of the Communication Card (Special parameter for MODBUS TCP card)	0~65535	0
✎ 09-80	Address Mask 1 of the Communication Card (Special parameter for MODBUS TCP card)	0~65535	0
✎ 09-81	Address Mask 2 of the Communication Card (Special parameter for MODBUS TCP card)	0~65535	0
✎ 09-82	Address Mask 3 of the Communication Card (Special parameter for MODBUS TCP card)	0~65535	0
✎ 09-83	Address Mask 4 of the Communication Card (Special parameter for MODBUS TCP card)	0~65535	0
✎ 09-84	Gateway Address 1 of the Communication Card (Special parameter for MODBUS TCP card)	0~65535	0
✎ 09-85	Gateway Address 2 of the Communication Card (Special parameter for MODBUS TCP card)	0~65535	0
✎ 09-86	Gateway Address 3 of the Communication Card (Special parameter for MODBUS TCP card)	0~65535	0
✎ 09-87	Gateway Address 4 of the Communication Card (Special parameter for MODBUS TCP card)	0~65535	0
✎ 09-88	Password for Communication Card (Low word) (Special parameter for MODBUS TCP card)	0~99	0
✎ 09-89	Password for Communication Card (High word) (Special parameter for MODBUS TCP card)	0~99	0
✎ 09-90	Reset Communication Card (Special parameter for MODBUS TCP card)	0: No function 1: Reset, return to factory setting	0

Pr.	Explanation	Settings	Factory Setting
09-91	Additional Setting for Communication Card (Special parameter for MODBUS TCP card)	Bit0: Enable IP filter Bit1: Enable to write internet parameters (1bit). Bit 1: Enable to write internet parameters (1bit). This bit will change to disable when it finishes saving the internet parameter updates. Bit 2: Enable login password (1bit). This bit will be changed to disable when it finishes saving the internet parameter updates.	0
09-92	Status of Communication Card (Special parameter for MODBUS TCP card)	Bit 0: password enable When the communication card is set with password, this bit is enabled. When the password is clear, this bit is disabled.	0

10 Speed Feedback Control Parameters



NOTE IM: Induction Motor; PM: Permanent Magnet Motor

Pr.	Explanation	Settings	Factory Setting
10-00	Encoder Type Selection	0: Disable 1: ABZ 2: ABZ (Delta Encoder for PM motor) 3: Resolver 1x (Standard encoder for PM motor) 4: ABZ/UVW (Standard encoder for PM motor) 5: MI8 single phase pulse input	0
10-01	Encoder Pulse	1~20000	600
10-02	Encoder Input Type Setting	0: Disable 1: Phase A leads in a forward run command and phase B leads in a reverse run command 2: Phase B leads in a forward run command and phase A leads in a reverse run command 3: Phase A is a pulse input and phase B is a direction input. (low input=reverse direction, high input=forward direction) 4: Phase A is a pulse input and phase B is a direction input. (low input=forward direction, high input=reverse direction) 5: Single-phase input	0
✓ 10-03	Output Setting for Frequency Division (denominator)	1~255	1
✓ 10-04	Electrical Gear at Load Side A1	1~65535	100
✓ 10-05	Electrical Gear at Motor Side B1	1~65535	100
✓ 10-06	Electrical Gear at Load Side A2	1~65535	100
✓ 10-07	Electrical Gear at Motor Side B2	1~65535	100
✓ 10-08	Treatment for Encoder Feedback Fault	0: Warn and keep operation 1: Warn and ramp to stop 2: Warn and coast to stop	2
✓ 10-09	Detection Time of Encoder Feedback Fault	0.0~10.0sec 0: No function	1.0
✓ 10-10	Encoder Stall Level	0~120% 0: No function	115
✓ 10-11	Detection Time of Encoder Stall	0.0 ~ 2.0sec	0.1
✓ 10-12	Treatment for Encoder Stall	0: Warn and keep operation 1: Warn and ramp to stop 2: Warn and coast to stop	2
✓ 10-13	Encoder Slip Range	0~50% (0: disable)	50
✓ 10-14	Detection Time of Encoder Slip	0.0~10.0sec	0.5
✓ 10-15	Treatment for Encoder Stall and Slip Error	0: Warn and keep operation 1: Warn and ramp to stop 2: Warn and coast to stop	2
✓ 10-16	Pulse Input Type Setting	0: Disable 1: Phase A leads in a forward run command and phase B leads in a reverse run command 2: Phase B leads in a forward run command and phase A leads in a reverse run command 3: Phase A is a pulse input and phase B is a direction input. (L=reverse direction, H=forward direction). 4: Phase A is a pulse input and phase B is a direction input. (L=forward direction, H=reverse direction).	0
✓ 10-17	Electrical Gear A	1~65535	100
✓ 10-18	Electrical Gear B	1~65535	100

Pr.	Explanation	Settings	Factory Setting
✓ 10-19	Positioning for Encoder Position	-32767~2400	0
✓ 10-20	Range for Encoder Position Attained	0~65535pulse	10
✓ 10-21	Filter Time (PG2)	0~65.535 sec	0.100
10-22	Speed Mode (PG2)	0: Electronic Frequency 1: Mechanical Frequency (base on pole pair)	0
10-23	Reserved		
✓ 10-24	FOC&TQC Function Control	0~65535	0
✓ 10-25	FOC Bandwidth of Speed Observer	20.0~100.0Hz	40.0
✓ 10-26	FOC Minimum Stator Frequency	0.0~2.0%fN	2.0
✓ 10-27	FOC Low-pass Filter Time Constant	1~1000ms	50
✓ 10-28	FOC Excitation Current Rise Time	33~100%Tr	100
✓ 10-29	Top Limit of Frequency Deviation	0.00~200.00Hz	20.00
10-30	Resolver Pole Pair	1~50	1
✓ 10-31	I/F Mode, current command	0~150%Irated (Rated current % of the drive)	40
✓ 10-32	PM Sensorless Observer Bandwidth for High Speed Zone	0.00~600.00Hz	5.00
10-33	Reserved		
✓ 10-34	PM Sensorless Observer Low-pass Filter Gain	0.00~655.35	1.00
✓ 10-35	AMR (Kp)	0.00~3.00	1.00
✓ 10-36	AMR (Ki)	0.00~3.00	0.20
✓ 10-37	PM Sensorless Control Word	0000~FFFFh	0000
10-38	Reserved		
✓ 10-39	Frequency when switch from I/F Mode to PM sensorless mode.	0.00~599.00Hz	20.00
✓ 10-40	Frequency when switch from PM sensorless observer mode to V/F mode.	0.00~599.00Hz	20.00
✓ 10-41	I/F mode, low pass-filter time	0.0~6.0sec	0.2
✓ 10-42	Initial Angle Detection Time	0~50ms	10
10-43	PG Card Version	0~655.35	Read only
10-44 ~ 10-48	Reserved		
✓ 10-49	Zero voltage time while start up	00.000~60.000 sec	0.000
✓ 10-50	Reverse angle limit (Electrical angle)	0.00~30.00 degree	10.00
✓ 10-51	Injection Frequency	0~1200Hz	500
✓ 10-52	Injection Magnitude	0.0~200.0V	15/30
✓ 10-53	PM Motor Initial Rotor Position Detection Method	0: No functon 1: DC injection 2: High frequency injection 3: Pulse injection 4~5: Reserved	0

11 Advanced Parameters



NOTE IM: Induction Motor; PM: Permanent Magnet Motor

Pr.	Explanation	Settings	Factory Setting
11-00	System Control	bit 0: Auto tuning for ASR and APR bit 1: Inertia estimate (only for FOCPG mode) bit 2: Zero servo bit 3: Dead Time compensation closed bit 7: Selection to save or not save the frequency bit 8: Maximum speed of point to point position control	0
11-01	Per Unit of System Inertia	1~65535 (256=1PU)	256
↗ 11-02	ASR1/ASR2 Switch Frequency	5.00~599.00Hz	7.00
↗ 11-03	ASR1 Low-speed Bandwidth	1~40Hz (IM)/ 1~100Hz (PM)	10
↗ 11-04	ASR2 High-speed Bandwidth	1~40Hz (IM)/ 1~100Hz (PM)	10
↗ 11-05	Zero-speed Bandwidth	1~40Hz (IM)/ 1~100Hz (PM)	10
↗ 11-06	ASR Control (P) 1	0~40Hz (IM)/ 1~100Hz (PM)	10
↗ 11-07	ASR Control (I) 1	0.000~10.000 sec	0.100
↗ 11-08	ASR Control (P) 2	0~40Hz (IM)/ 0~100Hz (PM)	10
↗ 11-09	ASR Control (I) 2	0.000~10.000 sec	0.100
↗ 11-10	P Gain of Zero Speed	0~40Hz (IM)/ 0~100Hz (PM)	10
↗ 11-11	I Gain of Zero Speed	0.000~10.000 sec	0.100
↗ 11-12	Gain for ASR Speed Feed Forward	0~100%	0
↗ 11-13	PDF Gain	0~200%	30
↗ 11-14	Low-pass Filter Time of ASR Output	0.000~0.350 sec	0.008
↗ 11-15	Notch Filter Depth	0~20db	0
↗ 11-16	Notch Filter Frequency	0.00~200.00Hz	0.0
↗ 11-17	Forward Motor Torque Limit	0~500%	200
↗ 11-18	Forward Regenerative Torque Limit	0~500%	200
↗ 11-19	Reverse Motor Torque Limit	0~500%	200
↗ 11-20	Reverse Regenerative Torque Limit	0~500%	200
↗ 11-21	Gain Value of Flux Weakening Curve for Motor 1	0~200%	90
↗ 11-22	Gain Value of Flux Weakening Curve for Motor 2	0~200%	90
↗ 11-23	Speed Response of Flux Weakening Area	0~150%	65
↗ 11-24	APR Gain	0.00~40.00Hz (IM)/ 0~100.00Hz (PM)	10.00
↗ 11-25	Gain Value of APR Feed Forward	0~100	30
↗ 11-26	APR Curve Time	0.00~655.35 sec	3.00
↗ 11-27	Max. Torque Command	0~500%	100
↗ 11-28	Source of Torque Offset	0: No function 1: Analog signal input (Pr.03-00) 2: RS485 communication (Pr.11-29) 3: Control by external terminal (Pr.11-30~11-32)	0

	Pr.	Explanation	Settings	Factory Setting
↗	11-29	Torque Offset Setting	-100.0%~100.0%	0.0
↗	11-30	High Torque Offset	-100.0%~100.0%	30.0
↗	11-31	Middle Torque Offset	-100.0%~100.0%	20.0
↗	11-32	Low Torque Offset	-100.0%~100.0%	10.0
↗	11-33	Source of Torque Command	0: Digital keypad 1: RS-485 communication (Pr.11-34) 2: Analog input (Pr.03-00) 3: CANopen 4: Reserved 5: Communication extension card	0
↗	11-34	Torque Command	-100.0~+100.0% (Pr11-27=100%)	0.0
↗	11-35	Filter Time of Torque Command	0.000~1.000sec	0.000
	11-36	Speed Limit Selection	0: Set by Pr.11-37 (Forward speed limit) and Pr.11-38 (Reverse speed limit) 1: Set by Pr.11-37,11-38 and Pr.00-20 (Source of Master Frequency Command) 2: Set by Pr.00-20 (Source of Master Frequency Command).	0
↗	11-37	Forward Speed Limit (torque mode)	0~120%	10
↗	11-38	Reverse Speed Limit (torque mode)	0~120%	10
	11-39	Zero Torque Command Mode	0: Torque mode 1: Speed mode	0
↗	11-40	Command Source of Point-to-Point Position Control	0: External terminal 1: Reserved 2: RS485 3: CAN 4: Reserved 5: Communication card	0
	11-41	Reserved		
↗	11-42	System Control Flags	0000~FFFFh	0000
↗	11-43	Max. Frequency of Point-to-Point Position Control	0.00~599.00Hz	10.00
↗	11-44	Accel. Time of Point-to Point Position Control	0.00~655.35 sec	1.00
↗	11-45	Decel. Time of Point-to Point Position Control	0.00~655.35 sec	3.00

Chapter 12 Description of Parameter Settings

12-1 Description of parameter settings

00 Drive Parameters

✎ This parameter can be set during operation.

00-00 Identity Code of the AC Motor Drive

Factory Setting: ##

Settings Read Only

00-01 Display AC Motor Drive Rated Current

Factory Setting: ##

Settings Read Only

- 📖 Pr. 00-00 displays the identity code of the AC motor drive. Using the following table to check if Pr.00-01 setting is the rated current of the AC motor drive. Pr.00-01 corresponds to the identity code Pr.00-01.
- 📖 The factory setting is the rated current for normal duty. Please set Pr.00-16 to 1 to display the rated current for the heavy duty.

460V series												
Frame	B			C			D0			D		
kW	11	15	18.5	22	30	37	37	45	55	55	75	90
Pr.00-00	410	411	412	413	414	415	415	416	417	417	418	419
Rated Current for Heavy Duty	17	23	30	36	43	57	57	69	86	86	105	143
Rated Current for Light Duty	22.5	30	36	45	56	72	72	91	110	110	144	180

00-02 Parameter Reset

Factory Setting: 0

- Settings
- 0: No Function
 - 1: Write protection for parameters
 - 5: Reset KWH display to 0
 - 6: Reset PLC (including CANopen Master Index)
 - 7: Reset CANopen Index (Slave)
 - 9: All parameters are reset to factory settings(base frequency is 50Hz)
 - 10: All parameters are reset to factory settings (base frequency is 60Hz)

- 📖 When it is set to 1, all parameters are read only except Pr.00-02~00-08 and it can be used with password setting for password protection. It needs to set Pr.00-02 to 0 before changing other parameter settings.
- 📖 When it is set to 9 or 10: all parameters are reset to factory settings. If password is set in Pr.00-08, input the password set in Pr.00-07 to reset to factory settings.
- 📖 When it is set to 5, KWH display value can be reset to 0 even when the drive is operating. Pr. 05-26, 05-27, 05-28, 05-29, 05-30 reset to 0.
- 📖 When it is set to 6: clear internal PLC program (includes the related settings of PLC internal CANopen master)
- 📖 When it is set to 7: reset the related settings of CANopen slave.

00-03 Start-up Display Selection

Factory setting: 0

- Settings
- 0: Display the frequency command (F)
 - 1: Display the actual output frequency (H)
 - 2: Display User define (U)
 - 3: Output current (A)

 This parameter determines the start-up display page after power is applied to the drive. User defined choice display according to the setting in Pr.00-04.

00-04 Content of Multi-function Display

Factory setting: 3

- Settings
- 0: Display output current (A)
 - 1: Display counter value (c)
 - 2: Display actual output frequency (H.)
 - 3: Display DC-BUS voltage (v)
 - 4: Display output voltage (E)
 - 5: Display output power angle (n)
 - 6: Display output power in kW (P)
 - 7: Display actual motor speed rpm (r = 00: positive speed; -00 negative speed)
 - 8: Display estimate output torque % (t = 00: positive torque; -00 negative torque) (t)
 - 9: Display PG feedback (G) (refer to Note 1)
 - 10: Display PID feedback in % (b)
 - 11: Display AVI in % (1.), 0~10V/4-20mA/0-20mA corresponds to 0~100% (Refer to Note 2)
 - 12: Display ACI in % (2.), 4~20mA/0~10V/0-20mA corresponds to 0~100% (Refer to Note 2)
 - 13: Display AUI in % (3.), -10V~10V corresponds to -100~100%(Refer to Note 2)
 - 14: Display the temperature of IGBT in oC (i.)
 - 15: Display the temperature of capacitance in oC (c.)
 - 16: The status of digital input (ON/OFF) refer to Pr.02-12 (i) (Refer to Note3)
 - 17: Display digital output status ON/OFF (Pr.02-18) (o) (refer to NOTE 4)
 - 18: Display the multi-step speed that is executing (S)
 - 19: The corresponding CPU pin status of digital input (d) (refer to NOTE 3)
 - 20: The corresponding CPU pin status of digital output (0.) (refer to NOTE 4)

- 21: Actual motor position (PG1 of PG card). When the motor direction changes or the drive stops, the counter will start from 0 (display value restarts counting from 0) (Max. 65535) (P.) The maximum value showed as 32 bits.
- 22: Pulse input frequency (PG2 of PG card) (S.)
- 23: Pulse input position (PG2 of PG card) (max. 65535) (q.) The maximum value showed as 32 bits.
- 24: Position command tracing error (E.)
- 25: Overload counting (0.00~100.00%) (o.) (Refer to Note 6)
- 26: GFF Ground Fault (Unit :%)(G.)
- 27:DC Bus voltage ripple (Unit: Vdc)(r.)
- 28: Display PLC register D1043 data (C) display in hexadecimal
- 29: Display PM motor pole section (EMC-PG01U application) (4.)
- 30 : Display output of user defined (U)
- 31 : H page x 00-05 Display user Gain(K)
- 32: Number of actual motor revolution during operation (PG card plug in and Z phase signal input) (Z.)
- 33: Motor actual position during operation (when PG card is connected)(q)
- 34: Operation speed of fan(%) (F.)
- 35: Control Mode display: 0= Speed control mode (SPD), 1= torque control mode (TQR) (t.)
- 36: Present operating carrier frequency of drive (Hz) (J.)
- 37: Reserved
- 38: Display drive status (6.) (Refer to Note 7)
- 39: Display estimated output torque, positive and negative, using Nt-m as unit (t 0.0: positive; -0.0 negative torque (C.)
- 40: Torque command (L.) (Unit: %)
- 41: Display the kWH (J) (Unit: kWH)
- 42: PID reference (h.) (Unit: %)
- 43: PID offset (o.) (Unit: %)
- 44: PID output Fcmd (Hz) (b.) (Unit: Hz)
- 45: Hardware ID

 **NOTE**

1. When Pr.10-01 is set to 1000 and Pr.10-02 is set to 1/2, the display range for PG feedback will be from 0 to 4000.
When Pr.10-01 is set to 1000 and Pr.10-02 is set to 3/4/5, the display range for PG feedback will be from 0 to 1000.
Home position: If it has Z phase, Z phase will be regarded as home position. Otherwise, home position will be the encoder start up position.
2. It can display negative values when setting analog input bias (Pr.03-03~03-10).
Example: assume that AVI input voltage is 0V, Pr.03-03 is 10.0% and Pr.03-07 is 4 (Serve bias as the center).
3. Example: If REV, MI1 and MI6 are ON, the following table shows the status of the terminals.
0: OFF, 1: ON

Terminal	MI15	MI14	MI13	MI12	MI11	MI10	MI8	MI7	MI6	MI5	MI4	MI3	MI2	MI1	REV	FWD
Status	0	0	0	0	0	0	0	0	1	0	0	0	0	1	1	0

MI10~MI15 are the terminals for extension cards (Pr.02-26~02-31).

If REV, MI1 and MI6 are ON, the value is 0000 0000 1000 0110 in binary and 0086h in HEX. When Pr.00-04 is set to "16" or "19", it will display "0086h" with LED U is ON on the keypad KPC-CE01. The setting 16 is the status of digital input by Pr.02-12 setting and the setting 19 is the corresponding CPU pin status of digital input, the FWD/REV action and the three-wire MI are not controlled by Pr.02-12. User can set to 16 to monitor digital input status and then set to 19 to check if the wire is normal.

- Assume that RY1: Pr.02-13 is set to 9 (Drive ready). After applying the power to the AC motor drive, if there is no other abnormal status, the contact will be ON. The display status will be shown as follows.

N.O. switch status:

Terminal	Reserved				Reserved				Reserved				MO2	MO1	Reserved	RY2	RY1
Status	0	0	0	0	0	0	0	0	0	0	0	0	0	0	0	0	1

At the meanwhile, if Pr.00-04 is set to 17 or 20, it will display in hexadecimal "0001h" with LED U is ON on the keypad. The setting 17 is the status of digital output by Pr.02-18 setting and the setting 20 is the corresponding CPU pin status of digital output. User can set 17 to monitor the digital output status and then set to 20 to check if the wire is normal.

- Setting 8: 100% means the motor rated torque. Motor rated torque = (motor rated power x60/2π)/motor rated speed
- If Pr.00-04 = 25, when display value reaches 100.00%, the drive will show "oL" as an overload warning.
- If Pr.00-04 = 38,
 - Bit 0: The drive is running forward.
 - Bit 1: The drive is running backward.
 - Bit 2: The drive is ready.
 - Bit 3: Errors occurred on the drive.
 - Bit 4: The drive is running.
 - Bit 5: Warnings on the drive.

00-05	Coefficient Gain in Actual Output Frequency	Factory Setting: 1.00
Settings 0.00~160.00		

This parameter is to set coefficient gain in actual output frequency. Set Pr.00-04= 31 to display the calculation result on the screen (calculation = output frequency * Pr.00-05).

00-06	Software Version	Factory Setting: ##
Settings Read only		

00-07	Parameter Protection Password Input	Factory Setting: 0
Settings 0~65535		
Display 0~4 (the times of password attempts)		

- This parameter allows user to enter their password (which is set in Pr.00-08) to unlock the parameter protection and to make changes to the parameter.
- Pr.00-07 and Pr.00-08 are used to prevent the personal misoperation.
- When the user have forgotten the password, clear the setting by input 9999 and press ENTER key, then input 9999 again and press Enter within 10 seconds. After decoding, all the settings will return to factory setting.

00-08 Parameter Protection Password Setting

Factory Setting: 0

Settings 1~9998, 10000~65535

- 0: No password protection / password is entered correctly (Pr00-07)
- 1: Password has been set

To set a password to protect your parameter settings. If the display shows 0, no password is set nor password has been correctly entered in Pr.00-07. All parameters can then be changed, including Pr.00-08. The first time you can set a password directly. After successful setting of password the display will show 1. Be sure to write down the password for later use. To cancel the parameter lock, set the parameter to 0 after inputting correct password into Pr. 00-07.

How to retrieve parameter protection after decoding by Pr.00-07:

- Method 1: Re-enter the password to Pr.00-08 (input the password once).
- Method 2: After reboots, password function will be recovered.
- Method 3: Input any value into Pr.00-07 (Do not enter the password).

Password Decode Flow Chart

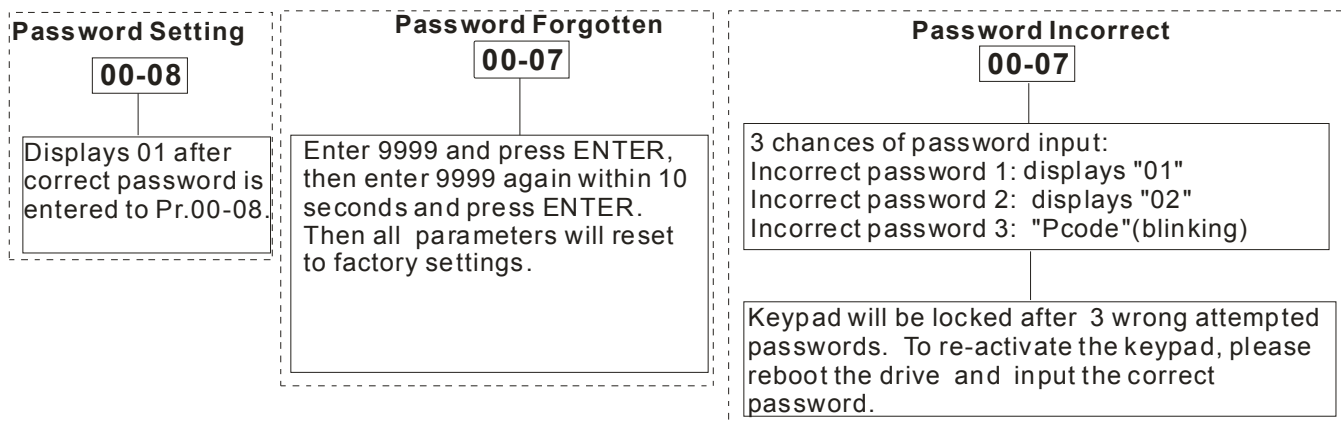

Decode Flow Chart

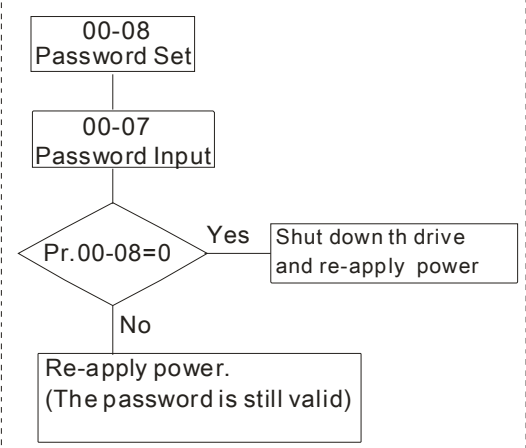

00-09 Reserved

00-10 Control Mode

Factory Setting: 0

- Settings 0: Speed mode
- 1: Point-to-Point position control
- 2: Torque mode
- 3: Home mode

This parameter determines the control mode of C2000 series AC motor drive.

00-11 Control of Speed Mode

Factory Setting: 0

- Settings
- 0: VF (IM V/f control)
 - 1: VFPG (IM V/f control+ Encoder)
 - 2: SVC(IM sensorless vector control)
 - 3: FOCPG (IM FOC vector control+ encoder)
 - 4: FOCPG (PM FOC vector control + Encoder)
 - 5: FOC Sensorless (IM field oriented sensorless vector control)
 - 6 : PM Sensorless (PM field oriented sensorless vector control)
 - 7: IPM Sensorless (IPM field oriented sensorless vector control)

This parameter determines the control method of the AC motor drive:

- 0: (IM V/f control): user can design proportion of V/f as required and can control multiple motors simultaneously.
- 1: (IM V/f control + Encoder): user can use optional PG card with encoder for the closed-loop speed control.
- 2: (IM Sensorless vector control): get the optimal control by the auto-tuning of motor parameters.
- 3: (IM FOC vector control+ encoder): besides torque increases, the speed control will be more accurate (1:1000).
- 4: (PM FOC vector control + Encoder): besides torque increases, the speed control will be more accurate (1:1000).
- 5: FOC Sensorless: IM field oriented sensorless vector control
- 6: PM Sensorless (PM field oriented sensorless vector control)

When setting Pr.00-11 to 0, the V/F control diagram is shown as follows.

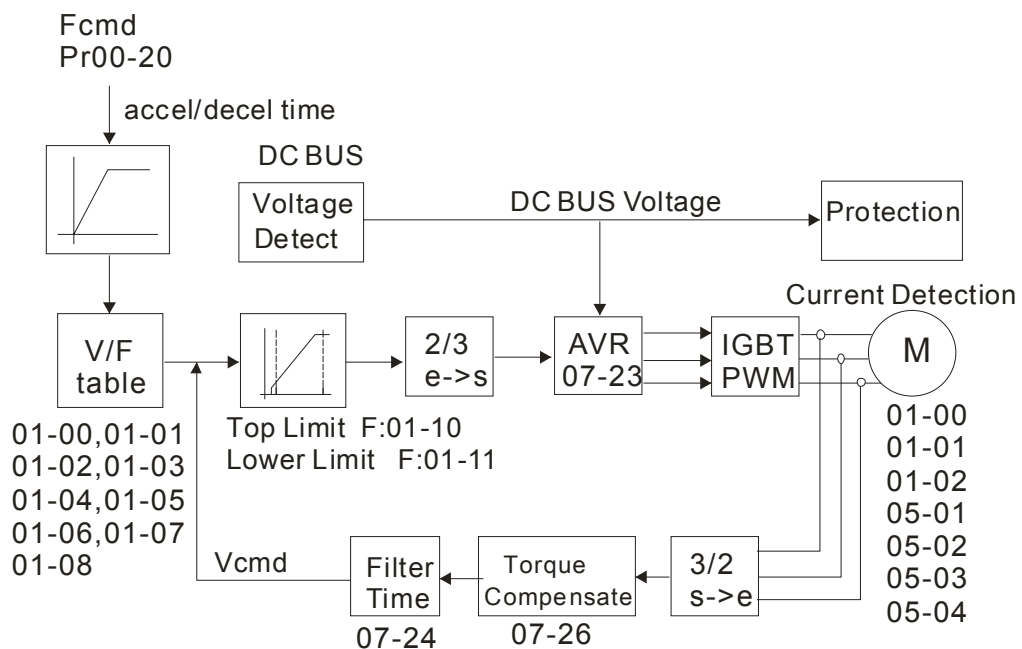

When setting Pr.00-11 to 1, the V/F control + encoder diagram is shown as follows.

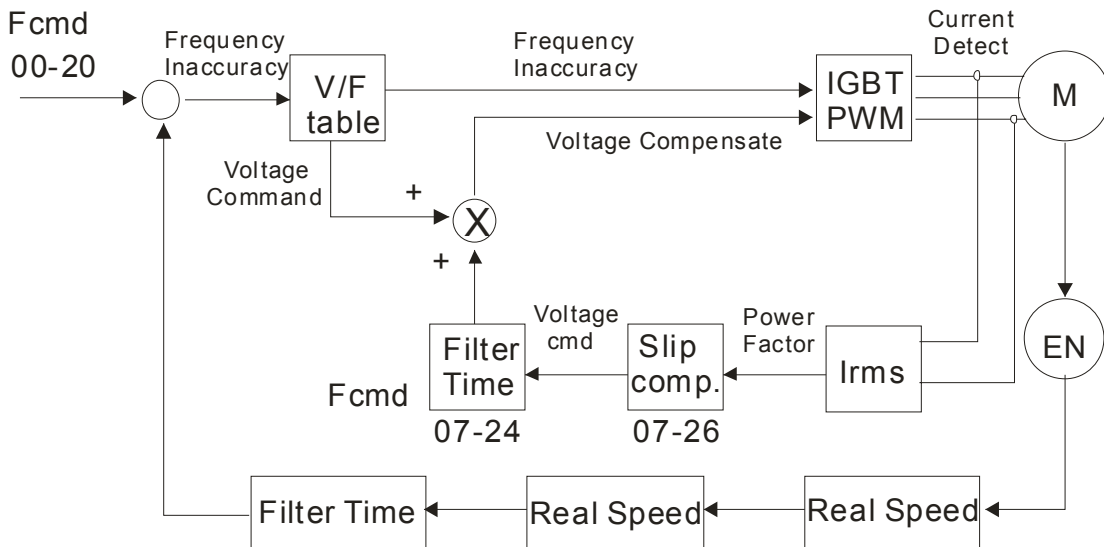

When setting Pr.00-11 to 2, the sensorless vector control diagram is shown as follows.

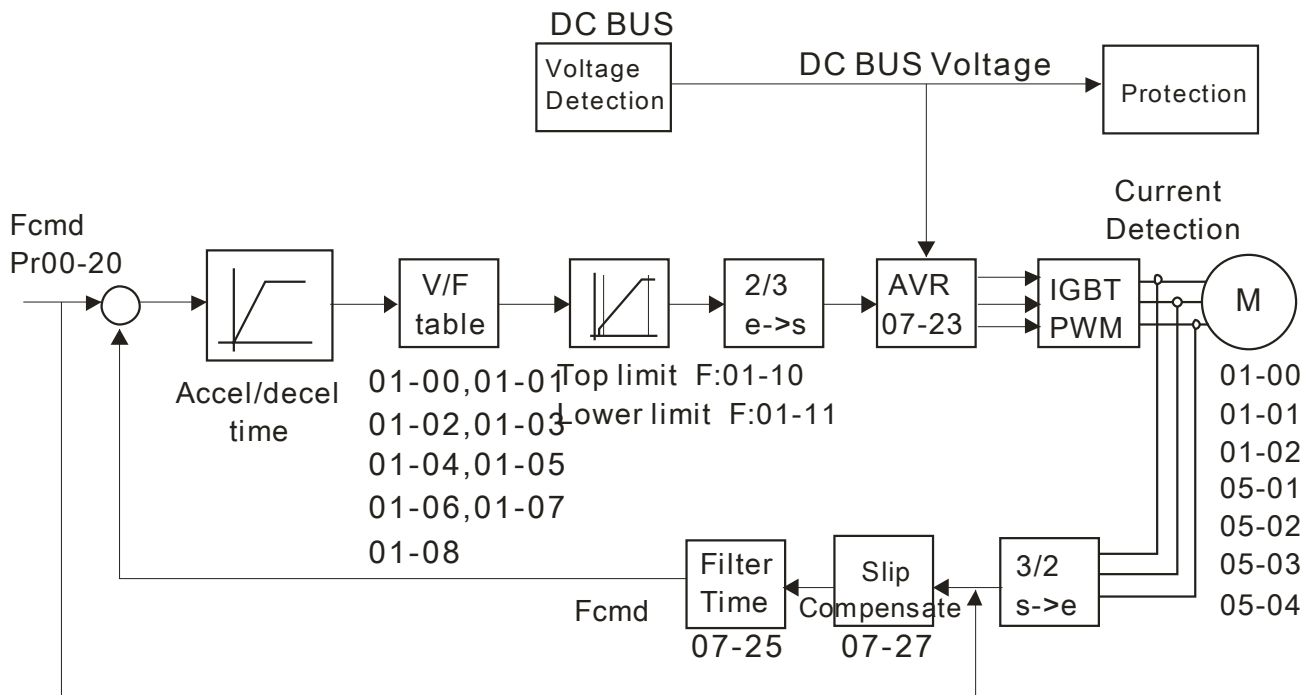

When setting Pr.00-11 to 3, the FOCPG control diagram is shown as follows.

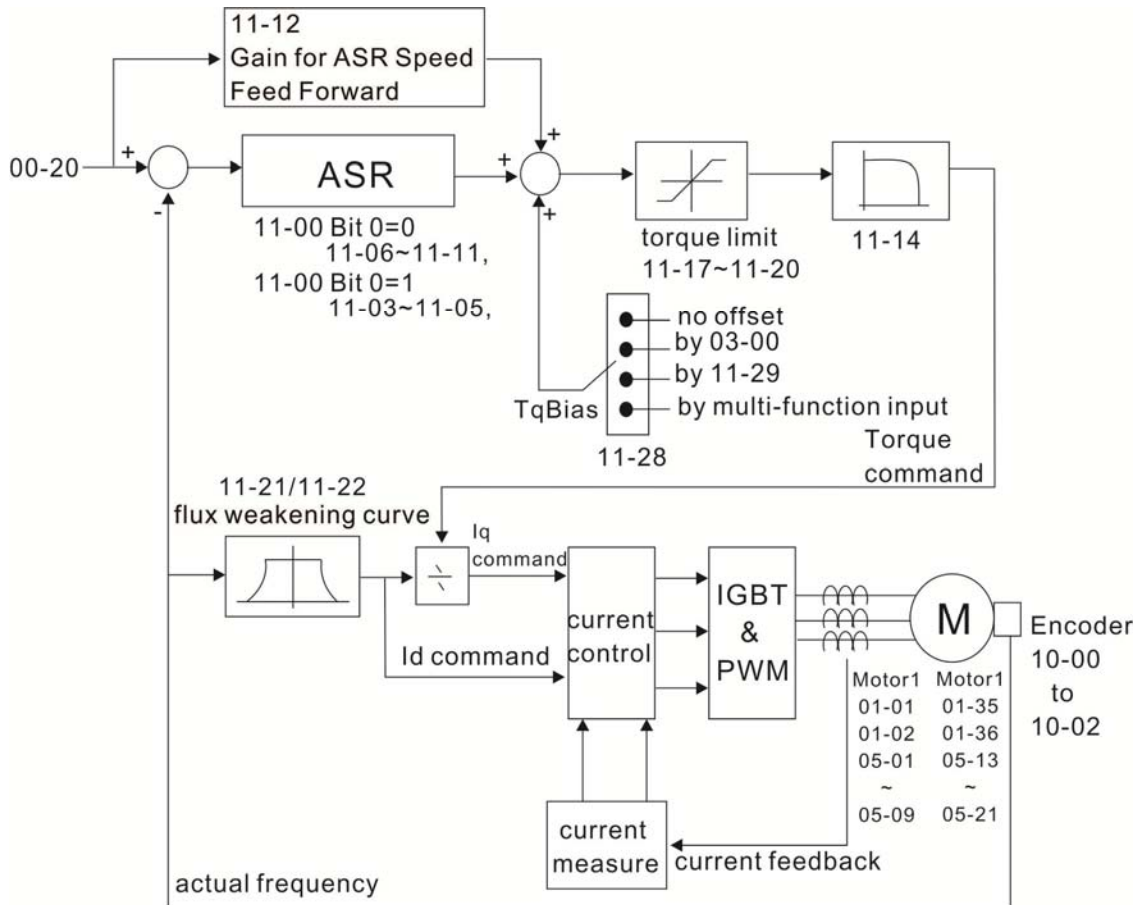

When setting Pr.00-11 to 5, FOC sensorless control diagram is shown as follows.

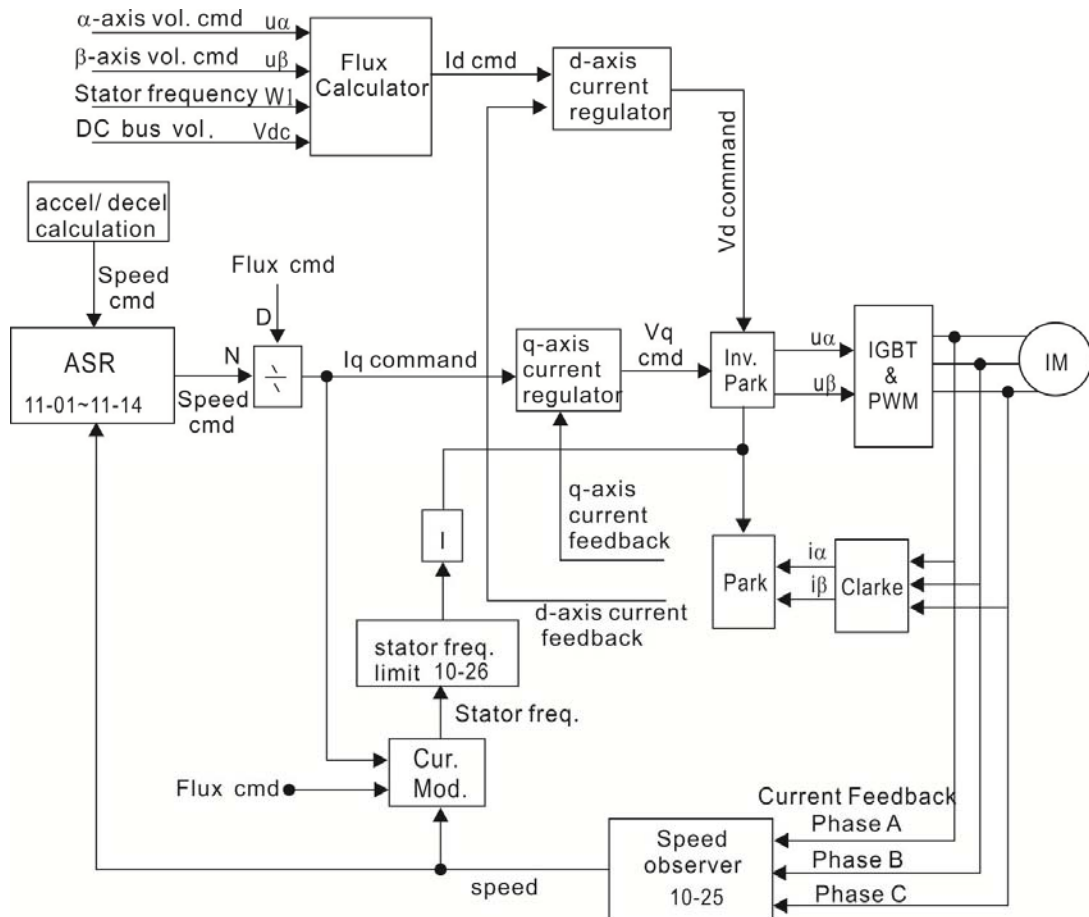

When setting Pr.00-11 to 6, PM FOC sensorless control diagram is shown as follows:

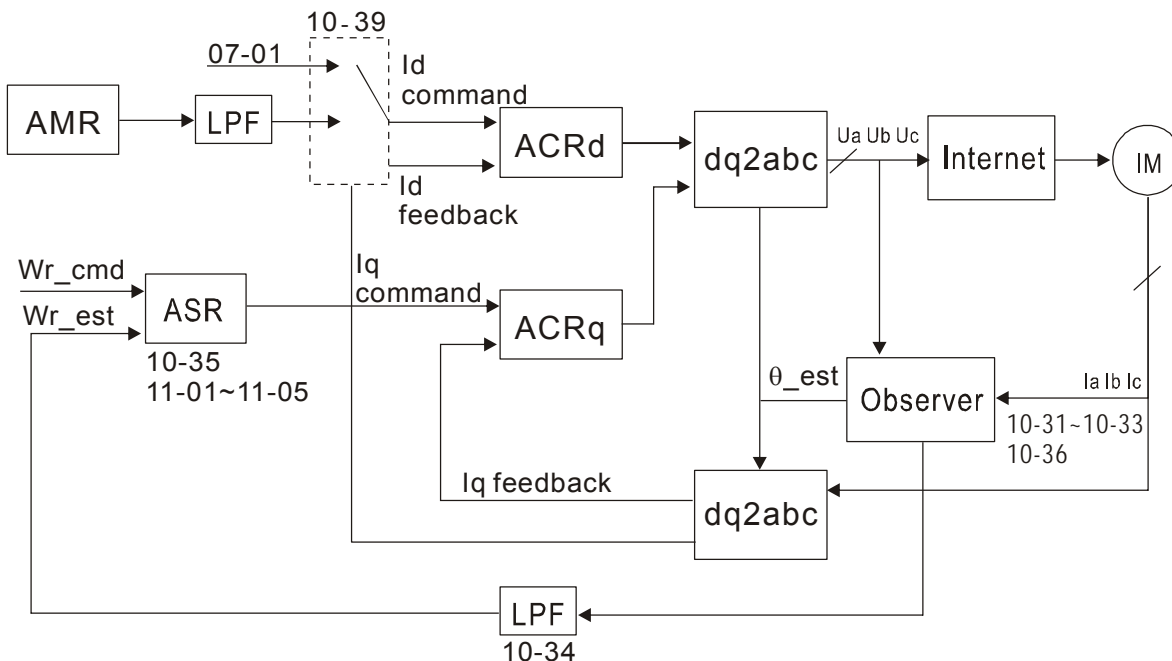

00-12 Point to Point Position control

Factory Settings: 0

- Settings: 0: Incremental Type
- 1: Absolute Type

Pr. 00-12 = 0 is incremental type P2P; Pr.00-12 = 1 is absolute type P2P

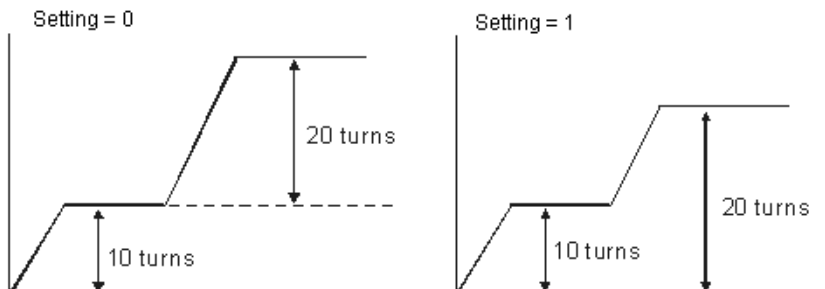

00-13 Control of Torque Mode

Factory Setting: 0

- Settings 0: TQCPG (IM Torque control + Encoder)
- 1: TQCPG (PM Torque control + Encoder)
- 2: TQC Sensorless (IM Sensorless torque control)

TQCPG control diagram is shown in the following:

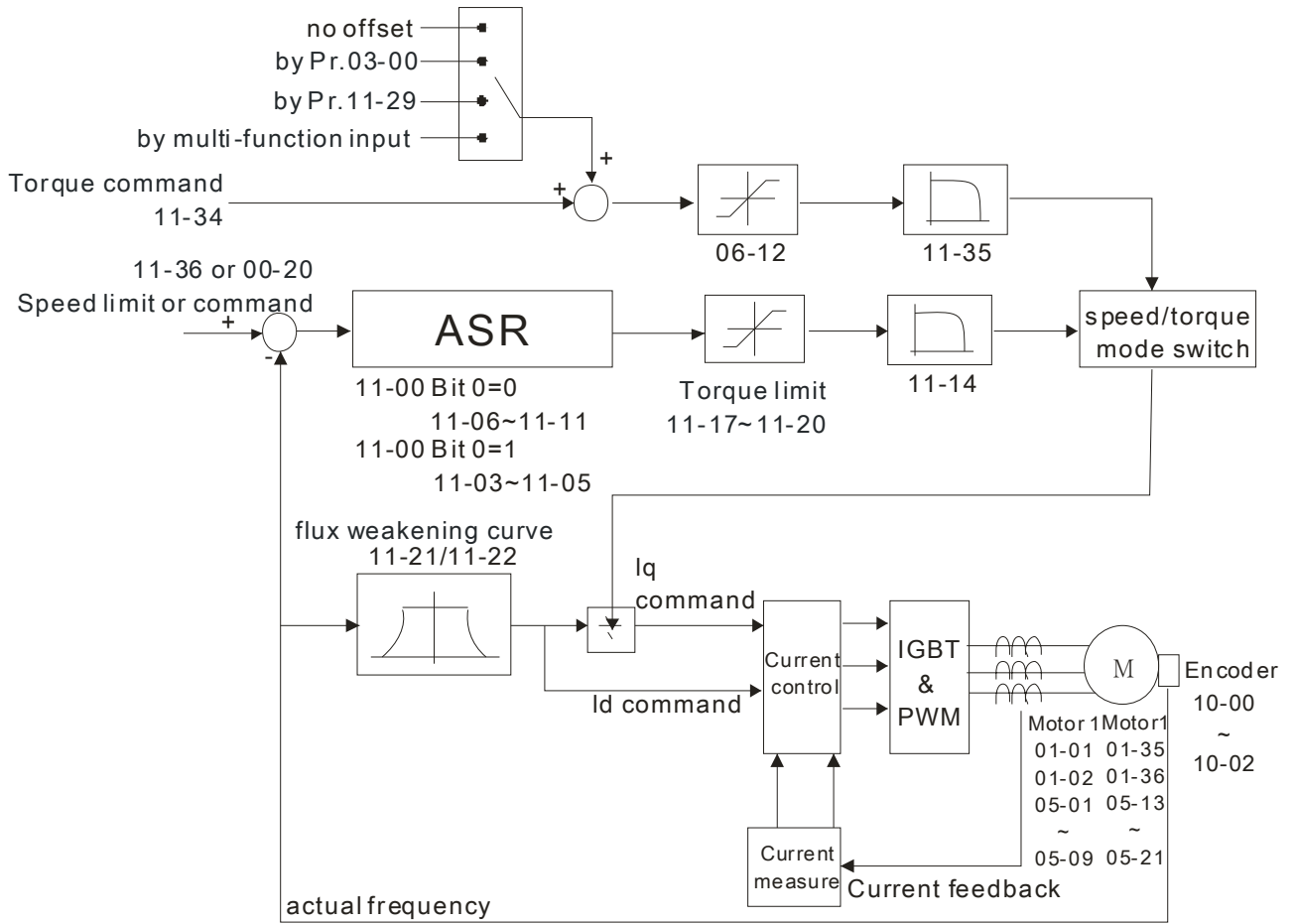

TQC Sensorless control diagram is shown in the following:

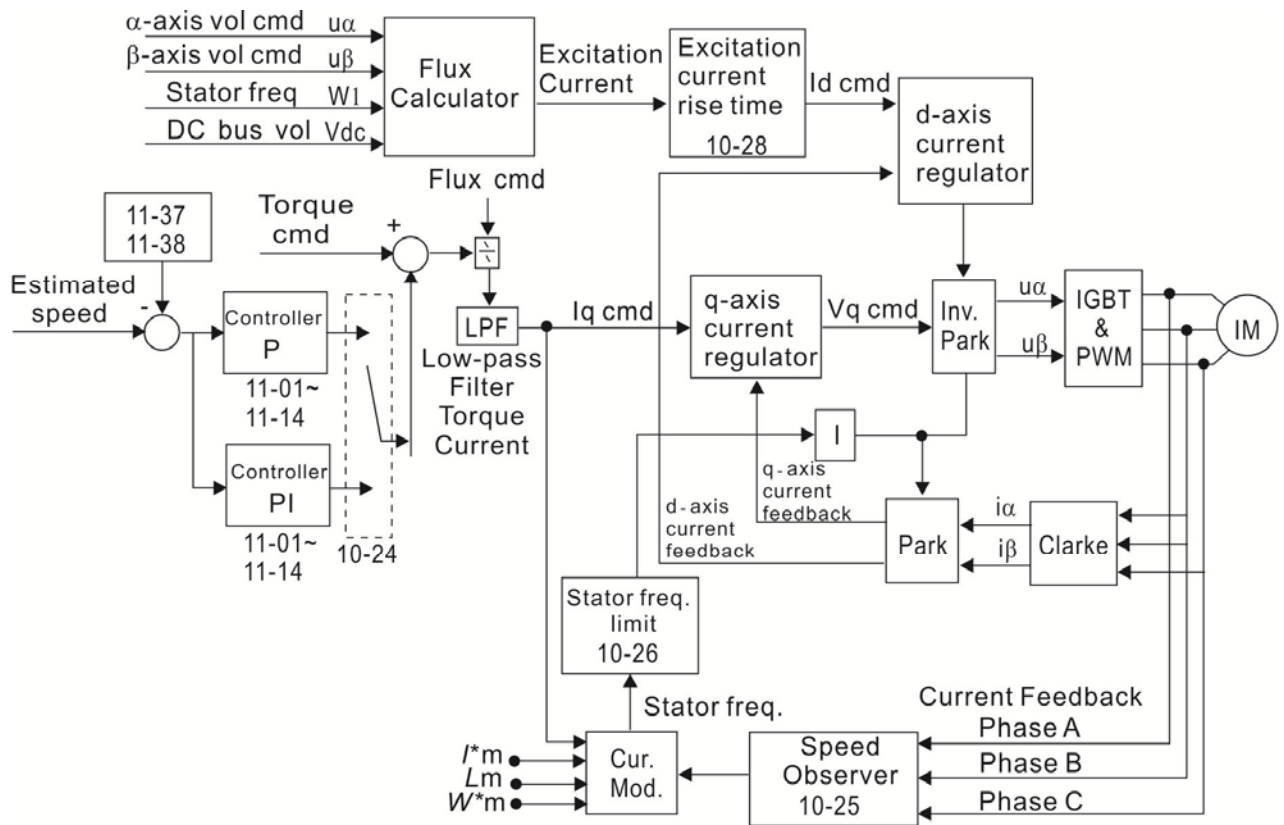

00-14 Reserved

00-15 Reserved

00-16 Load Selection

Factory Setting: 0

- Settings 0: Light Duty
- 1: Heavy Duty

- 📖 Light duty: over load, rated output current 160% in 3 second. Please refer to Pr.00-17 for the setting of carrier wave. Refer to chapter specifications or Pr.00-01 for the rated current.
- 📖 Heavy duty: over load, rated output current 180% in 3 second. Please refer to Pr.00-17 for the setting of carrier wave. Refer to chapter specifications or Pr.00-01 for the rated current.

00-17 Carrier Frequency

Factory setting: Table below

- Settings 2~15kHz

📖 This parameter determinates the PWM carrier frequency of the AC motor drive.

460V Series			
Models	1-20HP [0.75-15kW]	25-75HP [18.5-55kW]	100-475HP [75-355kW]
Setting Range	02~15kHz	02~10kHz	02~09kHz
Light Duty Factory Setting	8kHz	6kHz	4kHz
Heavy Duty Factory Setting	2kHz		

Carrier Frequency	Acoustic Noise	Electromagnetic Noise or Leakage Current	Heat Dissipation	Current Wave
1kHz	Significant ↑ ↓ Minimal	Minimal ↑ ↓ Significant	Minimal ↑ ↓ Significant	
8kHz				
15kHz				

- 📖 From the table, we see that the PWM carrier frequency has a significant influence on the electromagnetic noise, AC motor drive heat dissipation, and motor acoustic noise. Therefore, if the surrounding noise is greater than the motor noise, lower the carrier frequency is good to reduce the temperature rise. Although it is quiet operation in the higher carrier frequency, the entire wiring and interference resistance should be considerate.
- 📖 When the carrier frequency is higher than the factory setting, it needs to protect by decreasing the carrier frequency. See Pr.06-55 for the related setting and details.

00-18 Reserved

00-19 PLC Command Mask

Factory Setting: Read Only

- Settings Bit 0: Control command by PLC force control
- Bit 1: Frequency command by PLC force control
- Bit 2: Position command by PLC force control
- Bit 3: Torque command by PLC force control

📖 This parameter determines if frequency command or control command is occupied by PLC.

↖ **00-20** Source of the Master Frequency Command (AUTO)

Factory Setting: 0

- Settings
- 0: Digital keypad
 - 1: RS-485 serial communication
 - 2: External analog input (Pr.03-00)
 - 3: External UP/DOWN terminal
 - 4: Pulse input without direction command (Pr.10-16 without direction)
 - 5: Pulse input with direction command (Pr.10-16)
 - 6: CANopen communication card
 - 7: Reserved
 - 8: Communication card (no CANopen card)

- 📖 It is used to set the source of the master frequency in AUTO mode.
- 📖 Pr.00-20 and 00-21 are for the settings of frequency source and operation source in AUTO mode. Pr.00-30 and 00-31 are for the settings of frequency source and operation source in HAND mode. The AUTO/HAND mode can be switched by the keypad KPC-CC01 or multi-function input terminal (MI).
- 📖 The factory setting of frequency source or operation source is for AUTO mode. It will return to AUTO mode whenever power on again after power off. If there is multi-function input terminal used to switch AUTO/HAND mode. The highest priority is the mutli-function input terminal. When the external terminal is OFF, the drive won't receive any operation signal and can't execute JOG.

00-21 Source of the Operation Command (AUTO)

Factory Setting: 0

- Settings
- 0: Digital keypad
 - 1: External terminals. Keypad STOP disabled.
 - 2: RS-485 serial communication. Keypad STOP disabled.
 - 3: CANopen card
 - 4: Reserved
 - 5: Communication card (not includes CANopen card)

- 📖 It is used to set the source of the operation frequency in AUTO mode.
- 📖 When the operation command is controlled by the keypad KPC-CC01, keys RUN, STOP and JOG (F1) are valid.

↖ **00-22** Stop Method

Factory Setting: 0

- Settings
- 0: Ramp to stop
 - 1:Coast to stop

- 📖 The parameter determines how the motor is stopped when the AC motor drive receives a valid stop command.

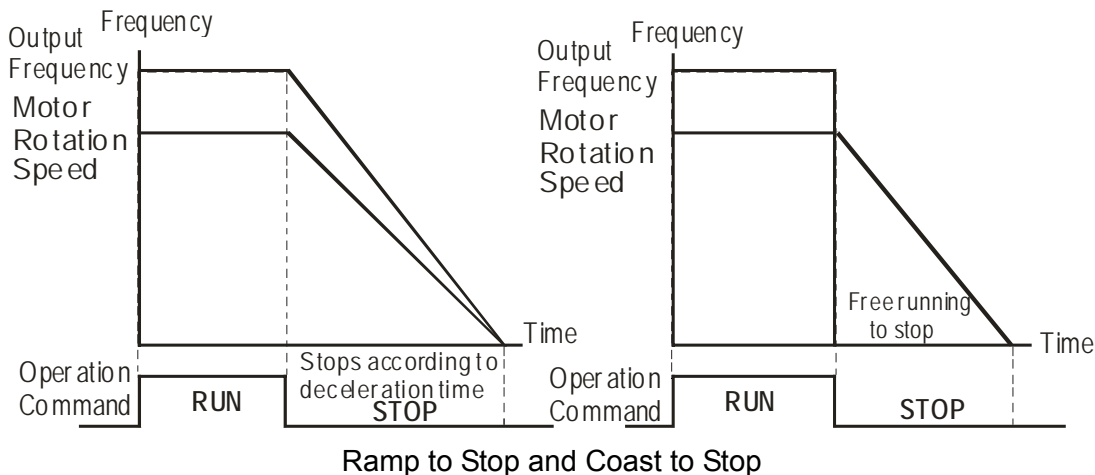

- 📖 **Ramp to stop:** the AC motor drive decelerates from the setting of deceleration time to 0 or minimum output frequency (Pr. 01-09) and then stop (by Pr.01-07).
- 📖 **Coast to stop:** the AC motor drive stops the output instantly upon a STOP command and the motor free runs until it comes to a complete standstill.
 - (1) It is recommended to use “ramp to stop” for safety of personnel or to prevent material from being wasted in applications where the motor has to stop after the drive is stopped. The deceleration time has to be set accordingly.
 - (2) If the motor free running is allowed or the load inertia is large, it is recommended to select “coast to stop”. For example, blowers, punching machines and pumps
- 📖 The stop method of the torque control is also set by Pr.00-22.

🚩 **00-23** Control of Motor Direction Factory Setting: 0

- Settings
- 0: Enable forward/ reverse
 - 1: Disable reverse
 - 2: Disable forward

📖 This parameter enables the AC motor drives to run in the forward/reverse Direction. It may be used to prevent a motor from running in a direction that would consequently injure the user or damage the equipment.

🚩 **00-24** Memory of Frequency Command Factory Setting: Read Only



- Settings Read only

📖 If keypad is the source of frequency command, when Lv or Fault occurs the present frequency command will be saved in this parameter.

🚩 **00-25** User Defined Characteristics Factory Setting: 0

- Settings
- Bit 0~3: user define on decimal place
 - 0000b: no decimal place
 - 0001b: one decimal place
 - 0010b: two decimal place
 - 0011b: three decimal place

- Bit 4~15: user define on unit
- 000xh: Hz
- 001xh: rpm
- 002xh: %
- 003xh: kg
- 004xh: m/s
- 005xh: kW
- 006xh: HP
- 007xh: ppm
- 008xh: 1/m
- 009xh: kg/s
- 00Axh: kg/m
- 00Bxh: kg/h
- 00Cxh: lb/s
- 00Dxh: lb/m
- 00Exh: lb/h
- 00Fhx: ft/s
- 010xh: ft/m
- 011xh: m
- 012xh: ft
- 013xh: degC
- 014xh: degF
- 015xh: mbar
- 016xh: bar
- 017xh: Pa
- 018xh: kPa
- 019xh: mWG
- 01Axh: inWG
- 01Bxh: ftWG
- 01Cxh: psi
- 01Dxh: atm
- 01Exh: L/s
- 01Fhx: L/m
- 020xh: L/h
- 021xh: m³/s
- 022xh: m³/h
- 023xh: GPM
- 024xh: CFM
- Xxxxh: Hz

-  Bit 0~3: F & H page unit and Pr.00-26 decimal display is supported up to 3 decimal places.
-  Bit 4~15: F & H page unit and Pr.00-26 unit display is supported up to 4 types of unit display.

00-26 Max. User Defined Value

Factory Setting: 0

- Settings 0: Disable
- 0~65535 (when Pr.00-25 set to no decimal place)
- 0.0~6553.5 (when Pr.00-25 set to 1 decimal place)
- 0.0~655.35 (when Pr.00-25 set to 2 decimal place)
- 0.0~65.535 (when Pr.00-25 set to 3 decimal place)



-  User define is enabled when Pr.00-26 is not 0. The setting of Pr.00-26 corresponds to Pr.01.00 (Max. output frequency of the drive).
Example: User define: 100.0%, Pr.01.00 = 60.00Hz
Pr.00.25 setting is 0021h; Pr.0026 setting is 100.0%

 **NOTE** The drive will display as Pr.00-25 setting when Pr.00-25 is properly set and Pr.00-26 is not 0.

00-27 User Defined Value

Factory Setting: Read only

Settings Read only





-  Pr.00-27 will show user defined value when Pr.00-26 is not set to 0.
-  User defined function is valid when Pr.00-20 is set to digital keypad control or RS-285 communication input control.

00-28 Reserved**00-29** LOCAL/REMOTE Selection

Factory Setting: 0

Settings

- 0: Standard HOA function
- 1: Switching Local/Remote, the drive stops
- 2: Switching Local/Remote, the drive runs as the REMOTE setting for frequency and operation status
- 3: Switching Local/Remote, the drive runs as the LOCAL setting for frequency and operation status
- 4: Switching Local/Remote, the drive runs as LOCAL setting when switch to Local and runs as REMOTE setting when switch to Remote for frequency and operation status.

-  The factory setting of Pr.00-29 is 0 (standard Hand-Off-Auto function). The AUTO frequency and source of operation can be set by Pr.00-20 and Pr.00-21, and the HAND frequency and source of operation can be set by Pr.00-30 and Pr.00-31. AUTO/HAND mode can be selected or switched by using digital keypad(KPC-CC01) or setting multi-function input terminal MI= 41, 42.
-  When external terminal MI is set to 41 and 42 (AUTO/HAND mode), the settings Pr.00-29=1,2,3,4 will be disabled. The external terminal has the highest priority among all command, Pr.00-29 will always function as Pr.00-29=0, standard HOA mode.
-  When Pr.00-29 is not set to 0, Local/Remote function is enabled, the top right corner of digital keypad (KPC-CC01) will display "LOC" or "REM" (the display is available when KPC-CC01 is installed with firmware version higher than version 1.021). The LOCAL frequency and source of operation can be set by Pr.00-20 and Pr.00-21, and the REMOTE frequency and source of operation can be set by Pr.00-30 and Pr.00-31. Local/Remote function can be selected or switched by using digital keypad(KPC-CC01) or setting external terminal MI=56. The AUTO key of the digital keypad now controls for the REMOTE function and HAND key now controls for the LOCAL function.
-  When MI is set to 56 for LOC/REM selection, if Pr.00-29 is set to 0, then the external terminal is disabled.
-  When MI is set to 56 for LOC/REM selection, if Pr.00-29 is not set to 0, the external terminal has the highest priority of command and the ATUO/HAND keys will be disabled.

00-30 Source of the Master Frequency Command (HAND)

Factory Setting: 0

Settings

- 0: Digital keypad
- 1: RS-485 serial communication
- 2: External analog input (Pr.03-00)

- 3: External UP/DOWN terminal
- 4: Pulse input without direction command (Pr.10-16 without direction)
- 5: Pulse input with direction command (Pr.10-16)
- 6: CANopen communication card
- 7: Reserved
- 8: Communication card (no CANopen card)

 It is used to set the source of the master frequency in HAND mode.

00-31 Source of the Operation Command (HAND)

Factory Setting: 0

- Settings
- 0: Digital keypad
 - 1: External terminals. Keypad STOP disabled.
 - 2: RS-485 serial communication. Keypad STOP disabled.
 - 3: CANopen communication card
 - 4: Reserved
 - 5: Communication card (not include CANopen card)

 It is used to set the source of the operation frequency in HAND mode.

 Pr.00-20 and 00-21 are for the settings of frequency source and operation source in AUTO mode. Pr.00-30 and 00-31 are for the settings of frequency source and operation source in HAND mode. The AUTO/HAND mode can be switched by the keypad KPC-CC01 or multi-function input terminal (MI).

 The factory setting of frequency source or operation source is for AUTO mode. It will return to AUTO mode whenever power on again after power off. If there is multi-function input terminal used to switch AUTO/HAND mode. The highest priority is the multi-function input terminal. When the external terminal is OFF, the drive won't receive any operation signal and can't execute JOG.

00-32 Digital Keypad STOP Function

Factory Setting: 0

- Settings
- 0: STOP key disable
 - 1: STOP key enable

00-33
~
00-39 Reserved

00-40 Homing mode

Factory Setting: 0000h

Settings:

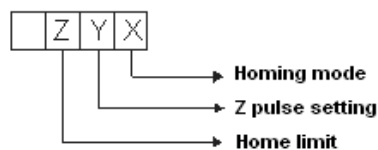

Note: Forward run = clockwise (CW)
Reverse run = counterclockwise (CCW)

- X 0: Forward run to home. Set PL forward limit as check point.
 1: Reverse run (CCW) to home. Set NL reverse limit (CCWL) as check point.
 2: Forward run to home. Set ORG : OFF→ON as check point.
 3: Reverse to home. Set ORG : OFF→ON as check point.
 4: Forward run and search for Z-pulse as check point.
 5: Forward run and search for Z-pulse as check point.
 6: Forward run to home. Set ORG: ON→OFF as check point.
 7: Reverse run to home. Set ORG : ON→OFF as check point.
 8: Define current position as home.
- Y Set X to 0, 1, 2, 3, 6, 7 .
 0: reverse run to Z pulse
 1: continue forward run to Z pulse
 2: Ignore Z pulse
- Z When home limit is reached, set X to 2, 3, 4, 5, 6, 7 first.
 0: display error
 1: reverse the direction

 Homing action is control by Pr. 00-40, 00-41, 00-42 and 02-01~02-08.

1. When Y=0, X=0 or Y=0, X=2

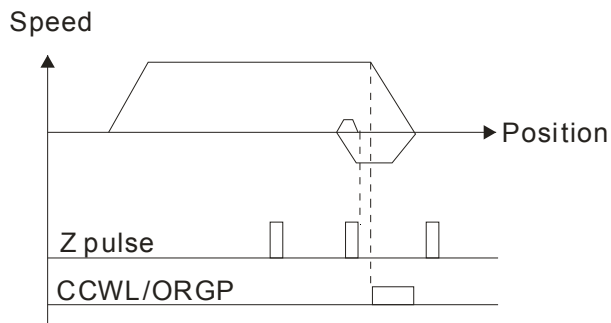

2. When Y=0, X=1 or Y=0, X=3

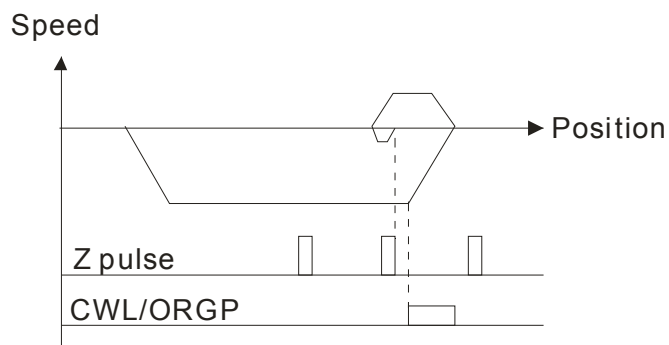

3. When Y=1, X=2

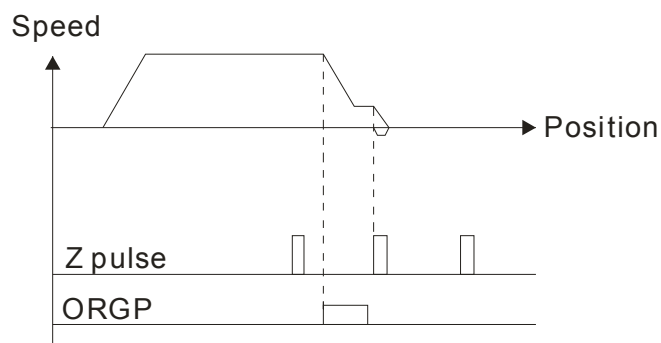

4. When $Y=1, X=3$

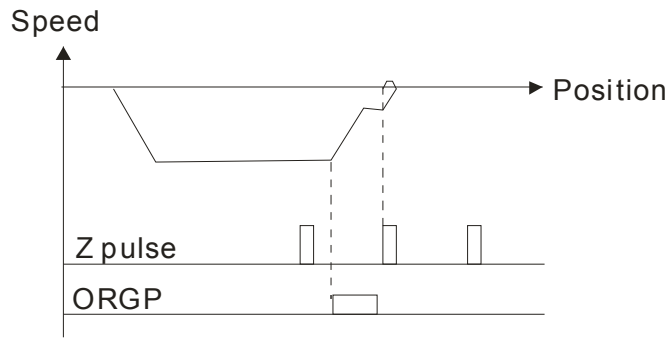

5. When $Y=2, X=2$

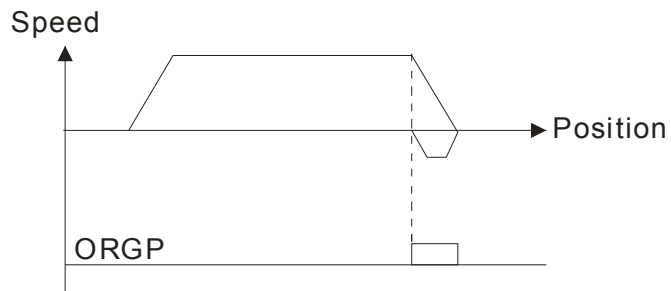

6. When $Y=2, X=3$

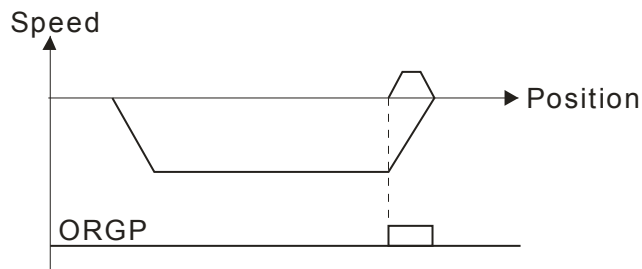

7. When $Y=2, X=4$

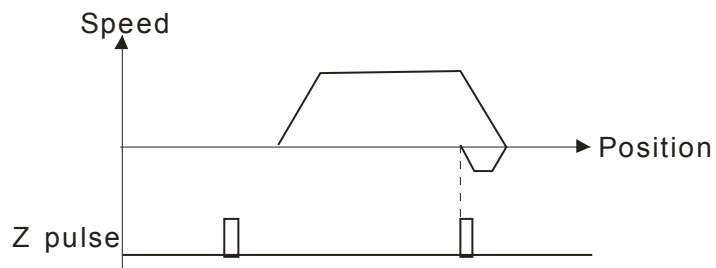

8. When $Y=2, X=5$

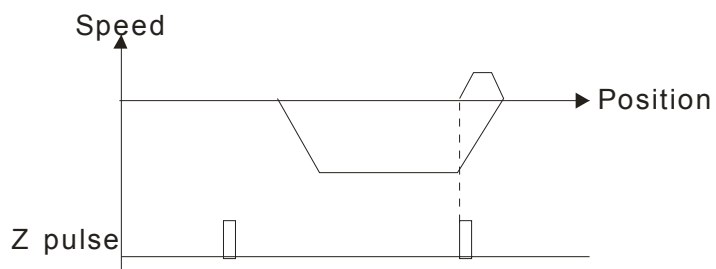

↗ **00-41** Homing by Frequency 1

Factory Setting: 8.00

Settings 0.00~599.00Hz

↗ **00-42** Homing by Frequency 2

Factory Setting: 2.00

Settings 0.00~599.00Hz

📖 Control by Multi-function Input Terminal Pr. 02-01~02-08 (44~47).

44: Reverse direction homing

45: Forward direction homing

46: Homing (ORG)

47: Homing function enable

📖 If the drive is not control by CAN or PLC, set Pr.00-10 =1 (Control mode = P2P position control) and set external output terminal to 47 (homing function enable) for homing.

📖 When Pr.00-10 is set to 3, after homing is complete, user must set control mode setting Pr.00-10 to 1 in order to perform P2P position control.

00-43

~

Reserved

00-47

↗ **00-48** Display Filter Time (Current)

Factory Settings: 0.100

Settings: 0.001~65.535 sec

📖 Set this parameter to minimize the current fluctuation displayed by digital keypad.

↗ **00-49** Display Filter Time (Keypad)

Factory Settings: 0.100

Settings: 0.001~65.535 sec

📖 Set this parameter to minimize the display value fluctuation displayed by digital keypad.

00-50

Software Version (date)

Factory Settings: #####

Settings: Read only

📖 This parameter displays the drive's software version by date.

00-51

~

Reserved

00-61

01 Basic Parameters

✎ This parameter can be set during operation.

01-00 Maximum Output Frequency

Factory Setting: 60.00/50.00

Settings 0.00~599.00Hz

📖 This parameter determines the AC motor drive's Maximum Output Frequency. All the AC motor drive frequency command sources (analog inputs 0 to +10V, 4 to 20mA, 0 to 20mA and $\pm 10V$) are scaled to correspond to the output frequency range.

📖 Light duty:

- VF, SVC, VFPG, FOCPG: 0~599Hz
- FOC sensorless (IM/PM): 0~300Hz/500Hz

📖 Heavy duty:

- The range of output is 0~300Hz

01-01 Output Frequency of Motor 1 (base frequency and motor rated frequency)

01-35 Output Frequency of Motor 2 (base frequency and motor rated frequency)

Factory Setting: 60.00/50.00

Settings 0.00~599.00Hz

📖 This value should be set according to the rated frequency of the motor as indicated on the motor nameplate. If the motor is 60Hz, the setting should be 60Hz. If the motor is 50Hz, it should be set to 50Hz.

📖 Pr.01-35 is used for the application occasion that uses double base motor.

01-02 Output Voltage of Motor 1 (base frequency and motor rated frequency)

01-36 Output Voltage of Motor 2 (base frequency and motor rated frequency)

Factory Setting: 400.0

Settings 460V series: 0.0~510.0V

📖 This value should be set according to the rated voltage of the motor as indicated on the motor nameplate. If the motor is 440V, the setting should be 440.0. If the motor is 400V, it should be set to 400.0.

📖 There are many motor types in the market and the power system for each country is also difference. The economic and convenience method to solve this problem is to install the AC motor drive. There is no problem to use with the different voltage and frequency and also can amplify the original characteristic and life of the motor.

01-03 Mid-point Frequency 1 of Motor 1

Factory Setting: 3.00

Settings 0.00~599.00Hz

✎ **01-04** Mid-point Voltage 1 of Motor 1

Factory Setting: 22.0

Settings 460V series: 0.0~480.0V

01-37	Mid-point Frequency 1 of Motor 2	Factory Setting: 3.00
	Settings 0.00~599.00Hz	
↗ 01-38	Mid-point Voltage 1 of Motor 2	Factory Setting: 22.0
	Settings 460V series: 0.0~480.0V	
01-05	Mid-point Frequency 2 of Motor 1	Factory Setting: 1.50
	Settings 0.00~599.00Hz	
↗ 01-06	Mid-point Voltage 2 of Motor 1	Factory Setting: 10.0
	Settings 460V series: 0.0~480.0V	
01-39	Mid-point Frequency 2 of Motor 2	Factory Setting: 1.50
	Settings 0.00~600.00Hz	
↗ 01-40	Mid-point Voltage 2 of Motor 2	Factory Setting: 10.0
	Settings 460V series: 0.0~480.0V	
01-07	Min. Output Frequency of Motor 1	Factory Setting: 0.50
	Settings 0.00~599.00Hz	
↗ 01-08	Min. Output Voltage of Motor 1	Factory Setting: 2.0
	Settings 460V series: 0.0~480.0V	
01-41	Min. Output Frequency of Motor 2	Factory Setting: 0.50
	Settings 0.00~599.00Hz	
↗ 01-42	Min. Output Voltage of Motor 2	Factory Setting: 2.0
	Settings 460V series: 0.0~480.0V	

 V/f curve setting is usually set by the motor's allowable loading characteristics. Pay special attention to the motor's heat dissipation, dynamic balance, and bearing lubricity, if the loading characteristics exceed the loading limit of the motor.

 There is no limit for the voltage setting, but a high voltage at low frequency may cause motor damage, overheat, and stall prevention or over-current protection. Therefore, please use the low voltage at the low frequency to prevent motor damage.

 Pr.01-35 to Pr.01-42 is the V/f curve for the motor 2. When multi-function input terminals Pr.02-01~02-08 and Pr.02-26 ~Pr.02-31 are set to 14 and enabled, the AC motor drive will act as the 2nd V/f curve.

The V/f curve for the motor 1 is shown as follows. The V/f curve for the motor 2 can be deduced from it.

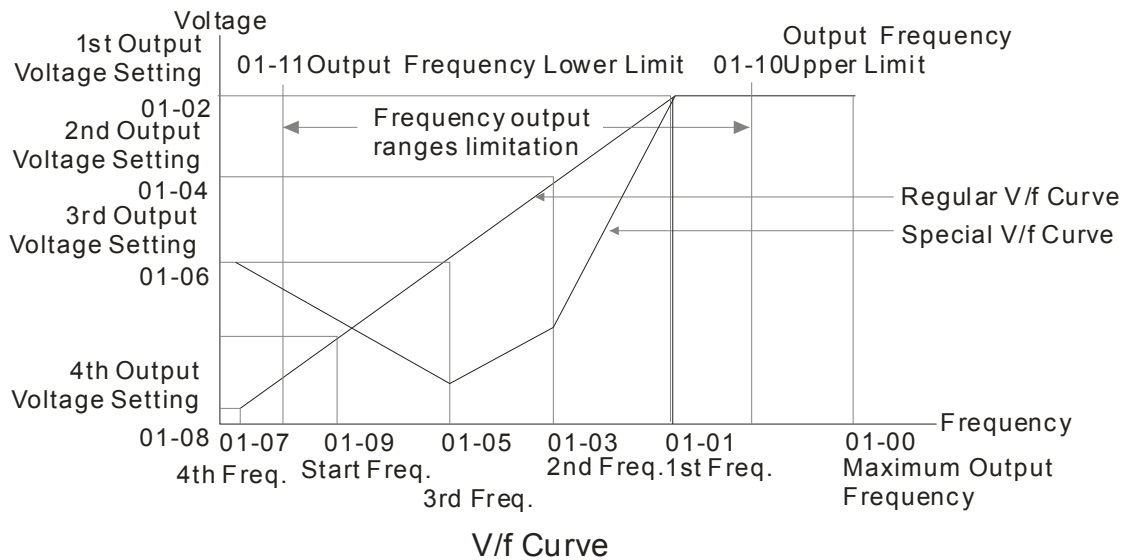

Common settings of V/f curve:

(1) General purpose

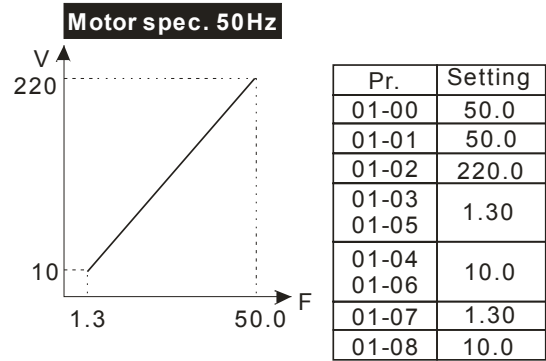
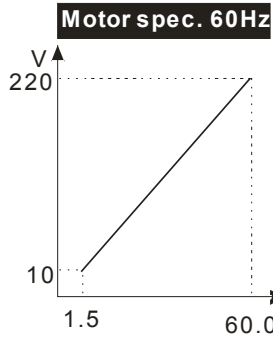

(2) Fan and hydraulic machinery

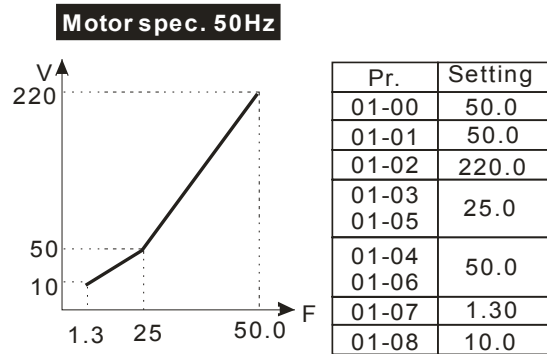
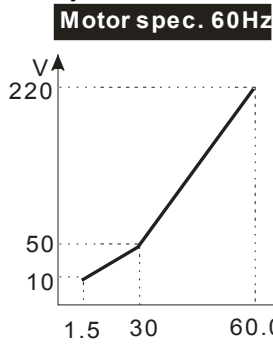

(3) High starting torque

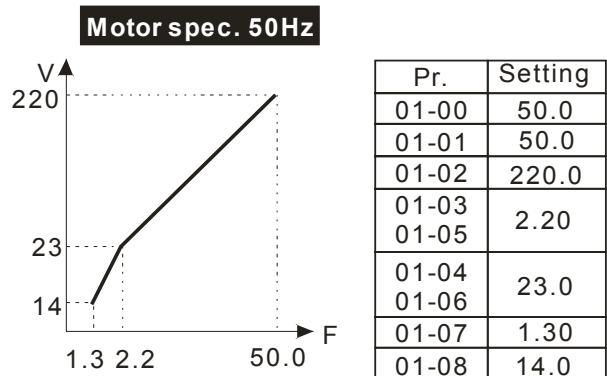
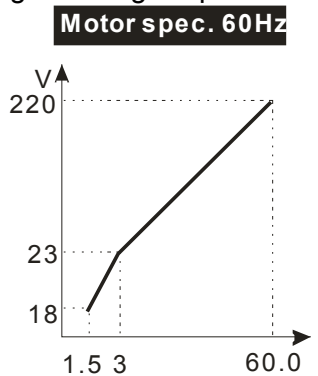

01-09 Start-Up Frequency

Factory Setting: 0.50

Settings 0.0~599.00Hz

When start frequency is higher than the min. output frequency, drives' output will be from start frequency to the setting frequency. Please refer to the following diagram for details.

- 📖 Fcmd=frequency command,
 - Fstart=start frequency (Pr.01-09),
 - fstart=actual start frequency of drive,
 - Fmin=4th output frequency setting (Pr.01-07/Pr.01-41),
 - Flow=output frequency lower limit (Pr.01-11)

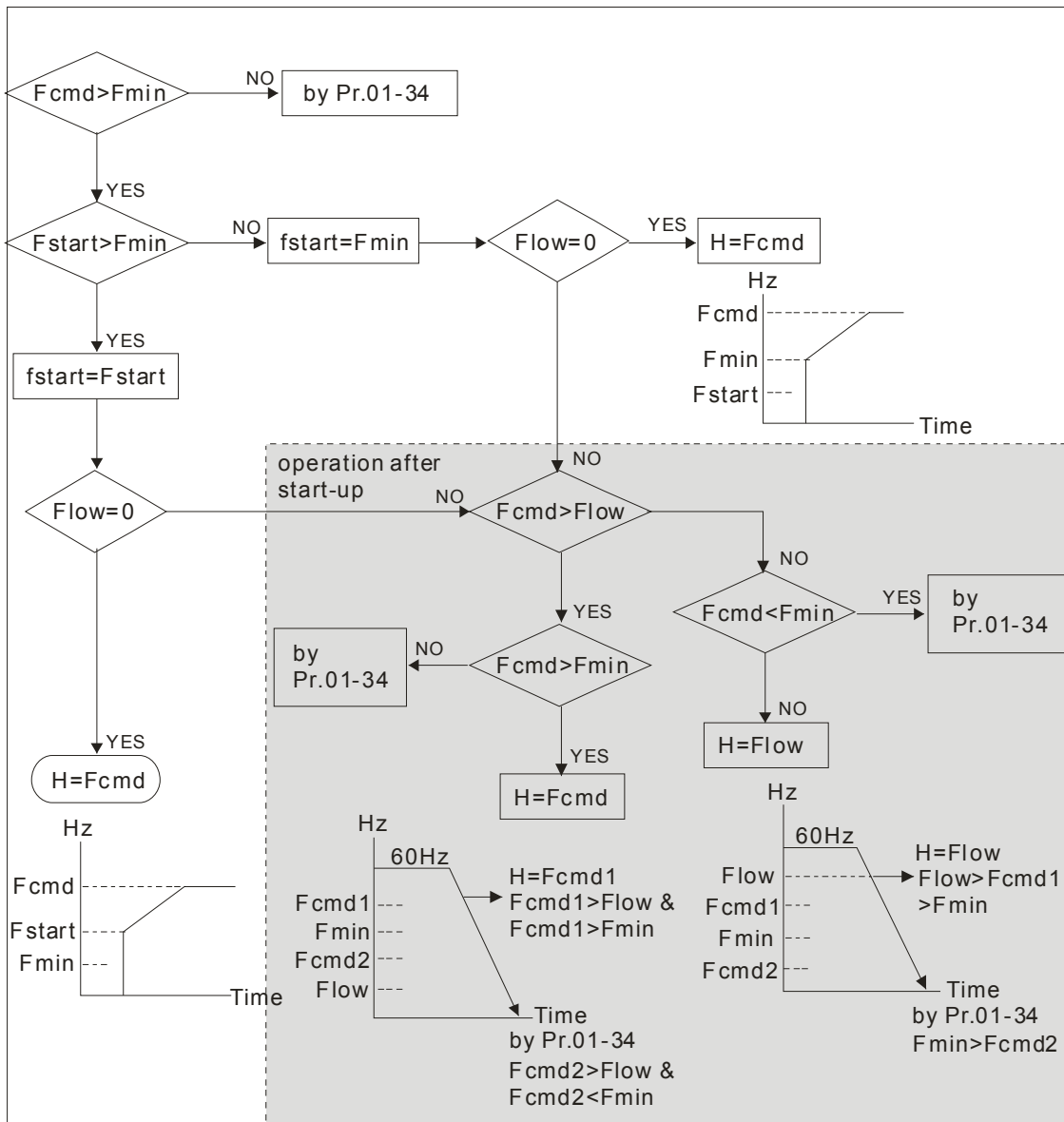

01-10 Output Frequency Upper Limit

Factory Setting: 599.00

Settings 0.0~599.00Hz

01-11 Output Frequency Lower Limit

Factory Setting: 0.00

Settings 0.0~599.00Hz

- 📖 The upper/lower output frequency setting is used to limit the actual output frequency. If the frequency setting is higher than the upper limit, it will run with the upper limit frequency. If output frequency lower than output frequency lower limit and frequency setting is higher than min. frequency, it will run with lower limit frequency. The upper limit frequency should be set to be higher than the lower limit frequency.
- 📖 Pr.01-10 setting must be \geq Pr.01-11 setting. Pr.01-00 setting is regarded as 100.0%.
- 📖 Output frequency upper limit = $(Pr.01-00 \times Pr.01-10) / 100$
- 📖 This setting will limit the max. Output frequency of drive. If frequency setting is higher than Pr.01-10, the output frequency will be limited by Pr.01-10 setting.
- 📖 When the drive starts the function of slip compensation (Pr.07-27) or PID feedback control, drive output frequency may exceed frequency command but still be limited by this setting.
- 📖 Related parameters: Pr.01-00 Max. Operation Frequency and Pr.01-11 Output Frequency Lower Limit

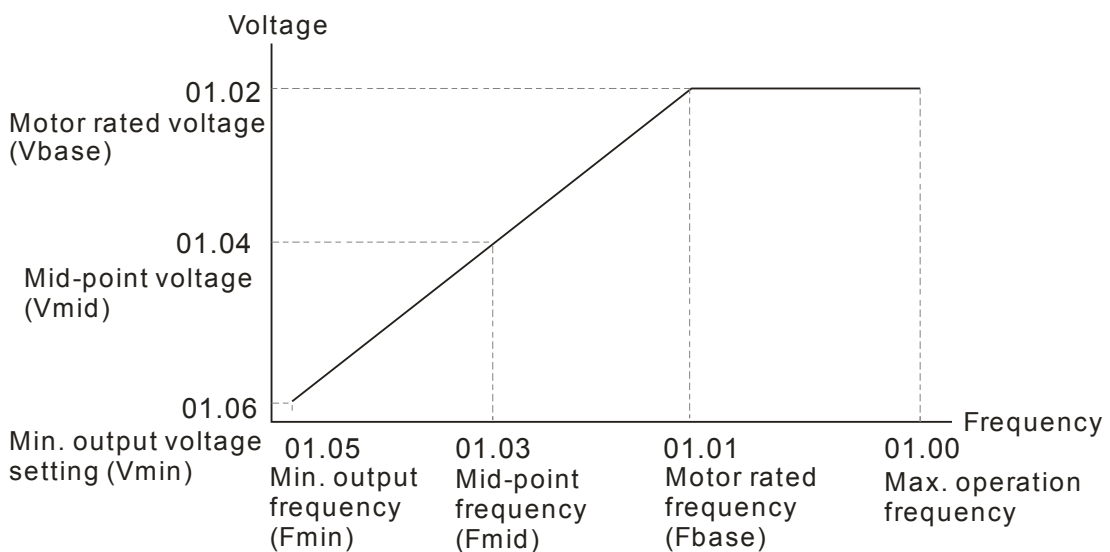

- 📖 This setting will limit the min. output frequency of drive. When drive frequency command or feedback control frequency is lower than this setting, drive output frequency will limit by the lower limit of frequency.
- 📖 When the drive starts, it will operate from min. output frequency (Pr.01-05) and accelerate to the setting frequency. It won't limit by this parameter setting.
- 📖 The setting of output frequency upper/lower limit is used to prevent personal misoperation, overheat due to too low operation frequency or damage due to too high speed.
- 📖 If the output frequency upper limit setting is 50Hz and frequency setting is 60Hz, max. output frequency will be 50Hz.
- 📖 If the output frequency lower limit setting is 10Hz and min. operation frequency setting (Pr.01-05) is 1.5Hz, it will operate by 10Hz when the frequency command is greater than Pr.01-05 and less than 10Hz. If the frequency command is less than Pr.01-05, the drive will be in ready status and no output.
- 📖 If the frequency output upper limit is 60Hz and frequency setting is also 60Hz, it won't exceed 60Hz even after slip compensation. If the output frequency needs to exceed 60Hz, it can increase output frequency upper limit or max. operation frequency.











↗	01-12	Accel. Time 1
↗	01-13	Decel. Time 1
↗	01-14	Accel. Time 2
↗	01-15	Decel. Time 2
↗	01-16	Accel. Time 3
↗	01-17	Decel. Time 3
↗	01-18	Accel. Time 4
↗	01-19	Decel. Time 4
↗	01-20	JOG Acceleration Time
↗	01-21	JOG Deceleration Time

Factory Setting: 10.00/10.0

Factory Setting for AC drive with power
greater than 30HP: 60.00/60.0

Settings Pr.01-45=0: 0.00~600.00 seconds

Pr.01-45=1: 0.00~6000.00 seconds

-  The Acceleration Time is used to determine the time required for the AC motor drive to ramp from 0Hz to Maximum Output Frequency (Pr.01-00).
-  The Deceleration Time is used to determine the time require for the AC motor drive to decelerate from the Maximum Output Frequency (Pr.01-00) down to 0Hz.
-  The Acceleration/Deceleration Time is invalid when using Pr.01-44 Optimal Acceleration/Deceleration Setting.
-  The Acceleration/Deceleration Time 1, 2, 3, 4 are selected according to the Multi-function Input Terminals settings. The factory settings are Accel./Decel. time 1.
-  When enabling torque limits and stalls prevention function, actual accel./decel. time will be longer than the above action time.
-  Please note that it may trigger the protection function (Pr.06-03 Over-current Stall Prevention during Acceleration or Pr.06-01 Over-voltage Stall Prevention) when the setting of accel./decel. time is too short.
-  Please note that it may cause motor damage or drive protection enabled due to over current during acceleration when the setting of acceleration time is too short.
-  Please note that it may cause motor damage or drive protection enabled due to over current during deceleration or over-voltage when the setting of deceleration time is too short.
-  It can use suitable brake resistor (see Chapter 06 Accessories) to decelerate in a short time and prevent over-voltage.
-  When enabling Pr.01-24~Pr.01-27, the actual accel./decel. time will be longer than the setting.

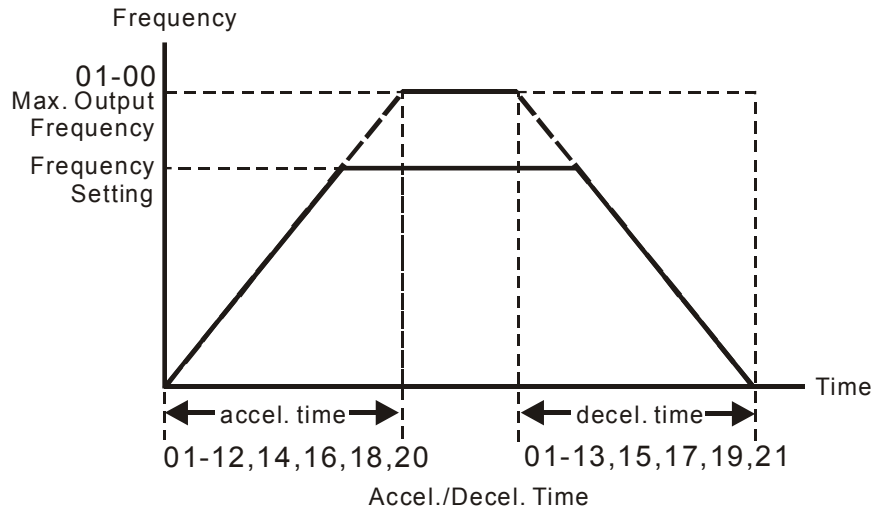

➤ **01-22** JOG Frequency

Factory Setting: 6.00

Settings 0.00~600.00Hz

- 📖 Both external terminal JOG and key “F1” on the keypad KPC-CC01 can be used. When the jog command is ON, the AC motor drive will accelerate from 0Hz to jog frequency (Pr.01-22). When the jog command is OFF, the AC motor drive will decelerate from Jog Frequency to zero. The Jog Accel./Decel. time (Pr.01-20, Pr.01-21) is the time that accelerates from 0.0Hz to Pr.01-22 JOG Frequency.
- 📖 The JOG command can't be executed when the AC motor drive is running. In the same way, when the JOG command is executing, other operation commands are invalid except forward/reverse commands and STOP key on the digital keypad.
- 📖 It does not support JOG function in the optional keypad KPC-CE01.

➤ **01-23** 1st/4th Accel./decel. Frequency

Factory Setting: 0.00

Settings 0.00~599.00Hz

- 📖 The transition from acceleration/deceleration time 1 to acceleration/deceleration time 4, may also be enabled by the external terminals. The external terminal has priority over Pr. 01-23.

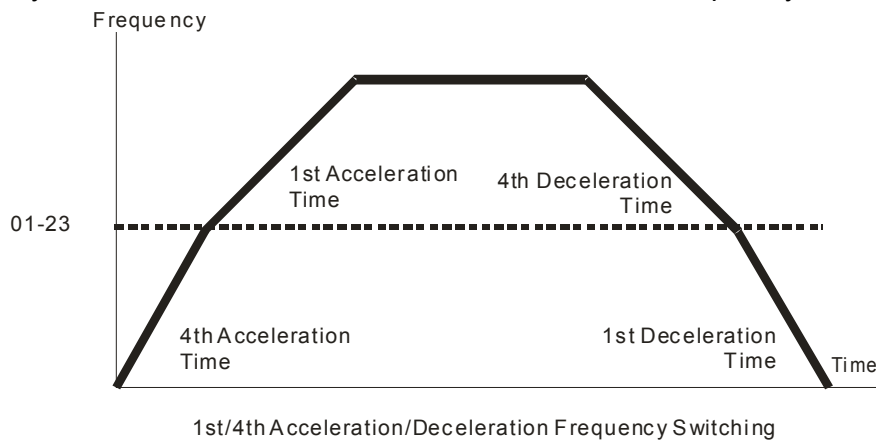

➤ **01-24** S-curve Acceleration Begin Time 1

➤ **01-25** S-curve Acceleration Arrival Time 2

➤ **01-26** S-curve Deceleration Begin Time 1

01-27 S-curve Deceleration Arrival Time 2

Factory Setting: 0.20/0.2

Settings Pr.01-45=0: 0.00~25.00 seconds

Pr.01-45=1: 0.00~250.0 seconds

- 📖 It is used to give the smoothest transition between speed changes. The accel./decel. curve can adjust the S-curve of the accel./decel. When it is enabled, the drive will have different accel./decel. curve by the accel./decel. time.
- 📖 The S-curve function is disabled when accel./decel. time is set to 0.
- 📖 When Pr.01-12, 01-14, 01-16, 01-18 \geq Pr.01-24 and Pr.01-25,
The Actual Accel. Time = Pr.01-12, 01-14, 01-16, 01-18 + (Pr.01-24 + Pr.01-25)/2
- 📖 When Pr.01-13, 01-15, 01-17, 01-19 \geq Pr.01-26 and Pr.01-27,
The Actual Decel. Time = Pr.01-13, 01-15, 01-17, 01-19 + (Pr.01-26 + Pr.01-27)/2

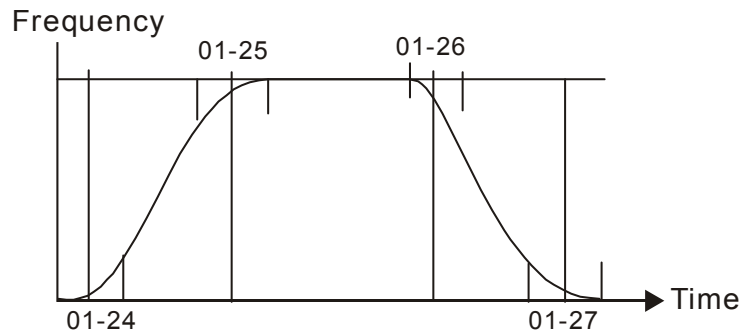

01-28	Skip Frequency 1 (upper limit)
--------------	--------------------------------

01-29	Skip Frequency 1 (lower limit)
--------------	--------------------------------

01-30	Skip Frequency 2 (upper limit)
--------------	--------------------------------

01-31	Skip Frequency 2 (lower limit)
--------------	--------------------------------

01-32	Skip Frequency 3 (upper limit)
--------------	--------------------------------

01-33	Skip Frequency 3 (lower limit)
--------------	--------------------------------

Factory Setting: 0.00

Settings 0.00~599.00Hz

- 📖 These parameters are used to set the skip frequency of the AC drive. But the frequency output is continuous. There is no limit for the setting of these six parameters and can be used as required.
- 📖 The skip frequencies are useful when a motor has vibration at a specific frequency bandwidth. By skipping this frequency, the vibration will be avoided. It offers 3 zones for use.
- 📖 These parameters are used to set the skip frequency of the AC drive. But the frequency output is continuous. The limit of these six parameters is 01-28 \geq 01-29 \geq 01-30 \geq 01-31 \geq 01-32 \geq 01-33. This function will be invalid when setting to 0.0.
- 📖 The setting of frequency command (F) can be set within the range of skip frequencies. In this moment, the output frequency (H) will be limited by these settings.
- 📖 When accelerating/decelerating, the output frequency will still pass the range of skip frequencies.

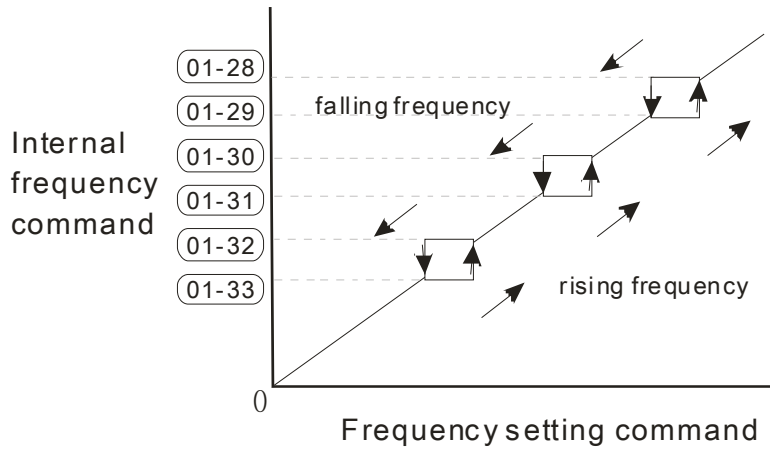

01-34 Zero-speed Mode

Factory Setting: 0

- Settings 0: Output waiting
 1: Zero-speed operation
 2: Fmin (Refer to Pr.01-07, 01-41)

- 📖 When the frequency is less than Fmin (Pr.01-07 or Pr.01-41), it will operate by this parameter.
- 📖 When it is set to 0, the AC motor drive will be in waiting mode without voltage output from terminals U/V/W.
- 📖 When setting 1, it will execute DC brake by Vmin(Pr.01-08 and Pr.01-42) in V/f, VFPG and SVC modes. It executes zero-speed operation in VFPG and FOCPG mode.
- 📖 When it is set to 2, the AC motor drive will run by Fmin (Pr.01-07, Pr.01-41) and Vmin (Pr.01-08, Pr.01-42) in V/f, VFPG, SVC and FOCPG modes.
- 📖 In V/f, VFPG and SVC modes

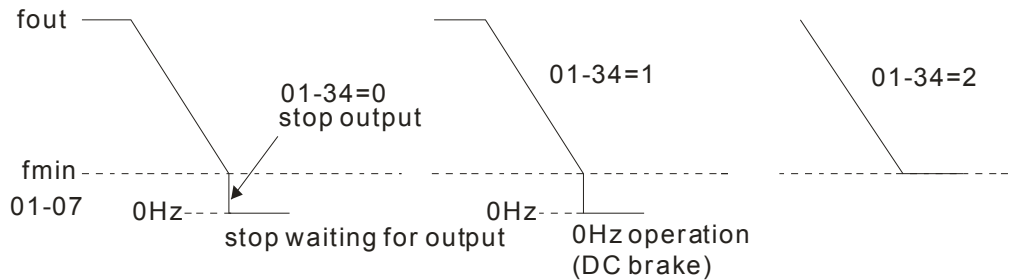

- 📖 In FOCPG mode, when Pr.01-34 is set to 2, it will act according Pr.01-34 setting.

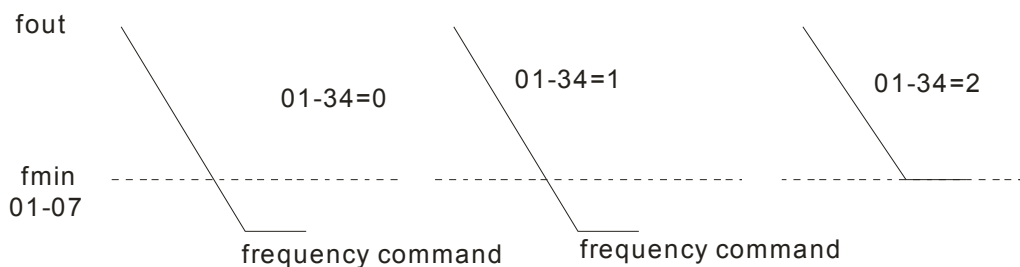

01-43 V/f Curve Selection

Factory Setting: 0

- Settings 0: V/f curve determined by group 01
 1: 1.5 power curve
 2: Square curve

- 3: 60Hz, voltage is saturated when it's 50Hz
- 4: 72Hz, voltage is saturated when it's 60Hz
- 5: 50Hz, decrease gradually with third power
- 6: 50Hz, decrease gradually with square
- 7: 60Hz, decrease gradually with third power
- 8: 60Hz, decrease gradually with square
- 9: 50Hz, medium starting torque
- 10: 50Hz, large starting torque
- 11: 60Hz, medium starting torque
- 12: 60Hz, large starting torque
- 13: 90Hz, voltage is saturated when it's 60Hz
- 14: 120Hz, voltage is saturated when it's 60Hz
- 15: 180Hz, voltage is saturated when it's 60Hz

- 📖 When setting to 0, refer to Pr.01-01~01-08 for motor 1 V/f curve. For motor 2, please refer to Pr.01-35~01-42.
- 📖 When setting to 1 or 2, 2nd and 3rd voltage frequency setting are invalid.
- 📖 If motor load is variable torque load (torque is in direct proportion to speed, such as the load of fan or pump), it can decrease input voltage to reduce flux loss and iron loss of the motor at low speed with low load torque to raise the entire efficiency.
- 📖 When setting higher power V/f curve, it is lower torque at low frequency and is not suitable for rapid acceleration/deceleration. It is recommended Not to use this parameter for the rapid acceleration/deceleration.

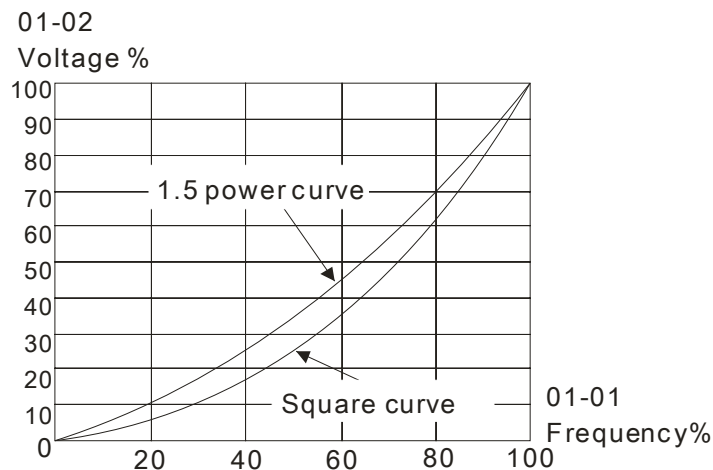

🔍 01-44 Optimal Acceleration/Deceleration Setting

Factory Setting: 0

- Settings
- 0: Linear accel./decel.
 - 1: Auto accel., linear decel.
 - 2: Linear accel., auto decel.
 - 3: Auto accel./decel. (auto calculate the accel./decel. time by actual load)
 - 4: Stall prevention by auto accel./decel. (limited by 01-12 to 01-21)

- 📖 Pr.01-44 is used to reduce the drive's vibration during load starts and stops. Also it will speed up to the setting frequency with the fastest and smoothest start-up current when it detects small torque.

At deceleration, it will auto stop the drive with the fastest and the smoothest deceleration time when the regenerated voltage of the load is detected.

- 📖 Setting 0 Linear accel./decel.: it will accelerate/decelerate according to the setting of Pr.01-12~01-19.
- 📖 Setting to Auto accel./decel.: it can reduce the mechanical vibration and prevent the complicated auto-tuning processes. It won't stall during acceleration and no need to use brake resistor. In addition, it can improve the operation efficiency and save energy.
- 📖 Setting 3 Auto accel./decel. (auto calculate the accel./decel. time by actual load): it can auto detect the load torque and accelerate from the fastest acceleration time and smoothest start current to the setting frequency. In the deceleration, it can auto detect the load re-generation and stop the motor smoothly with the fastest decel. time.
- 📖 Setting 4 Stall prevention by auto accel./decel. (limited by 01-12 to 01-21): if the acceleration/deceleration is in the reasonable range, it will accelerate/decelerate by Pr.01-12~01-19. If the accel./decel. time is too short, the actual accel./decel. time is greater than the setting of accel./decel. time.

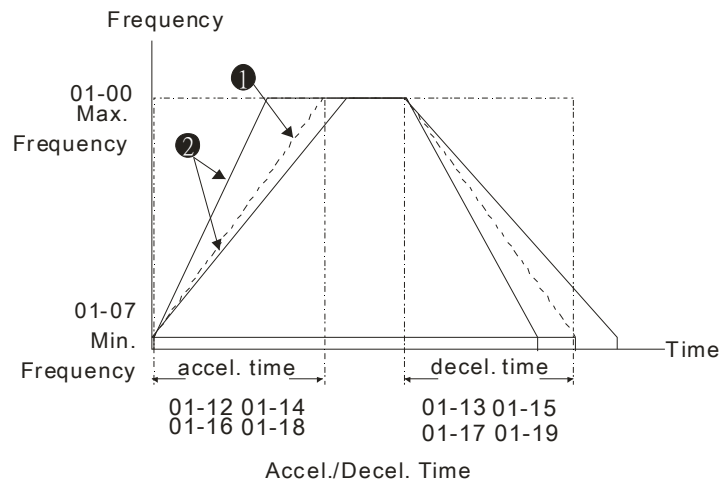

- ① When Pr.01-44 is set to 0.
- ② When Pr.01-44 is set to 3.

01-45 Time Unit for Acceleration/Deceleration and S Curve

Factory Setting: 0

Settings 0: Unit 0.01 sec
1: Unit 0.1 sec

01-46 Time for CANopen Quick Stop

Factory Setting: 1.00

Settings Pr. 01-45=0: 0.00~600.00 sec
Pr. 01-45=1: 0.0~6000.0 sec

📖 It is used to set the time that decelerates from the max. operation frequency (Pr.01-00) to 0.00Hz in CANopen control

02 Digital Input/Output Parameter

✎ This parameter can be set during operation.

02-00 2-wire/3-wire Operation Control

Factory Setting: 0

- Settings 0: 2 wire mode 1
- 1: 2 wire mode 2
- 2: 3 wire mode

📖 It is used to set the operation control method:

Pr.02-00	Control Circuits of the External Terminal
<p>0 2-wire mode 1 FWD/STOP REV/STOP</p>	
<p>1 2-wire mode 2 RUN/STOP REV/FWD</p>	
<p>3 3-wire operation control</p>	

02-01 Multi-function Input Command 1 (MI1)
(MI1= STOP command when in 3-wire operation control)

Factory Setting: 1

02-02 Multi-function Input Command 2 (MI2)

Factory Setting: 2

02-03 Multi-function Input Command 3 (MI3)

Factory Setting: 3

02-04 Multi-function Input Command 4 (MI4)

Factory Setting: 4

02-05 Multi-function Input Command 5 (MI5)

02-06 Multi-function Input Command 6 (MI6)

02-07 Multi-function Input Command 7 (MI7)

02-08 Multi-function Input Command 8 (MI8)

02-26 Input terminal of I/O extension card (MI10)

02-27 Input terminal of I/O extension card (MI11)

02-28	Input terminal of I/O extension card (MI12)
02-29	Input terminal of I/O extension card (MI13)
02-30	Input terminal of I/O extension card (MI14)
02-31	Input terminal of I/O extension card (MI15)

Factory Setting: 0

Settings

- 0: no function
- 1: multi-step speed command 1/multi-step position command 1
- 2: multi-step speed command 2/multi-step position command 2
- 3: multi-step speed command 3/multi-step position command 3
- 4: multi-step speed command 4/multi-step position command 4
- 5: Reset
- 6: JOG command (By KPC-CC01 or external control)
- 7: acceleration/deceleration speed not allow
- 8: the 1st, 2nd acceleration/deceleration time selection
- 9: the 3rd, 4th acceleration/deceleration time selection
- 10: EF Input (Pr.07-20)
- 11: B.B input from external (Base Block)
- 12: Output stop
- 13: cancel the setting of the optimal acceleration/deceleration time
- 14: switch between motor 1 and motor 2
- 15: operation speed command from AVI
- 16: operation speed command from ACI
- 17: operation speed command from AUI
- 18: Emergency stop (Pr.07-20)
- 19: Digital up command
- 20: Digital down command
- 21: PID function disabled
- 22: Clear counter
- 23: Input the counter value (MI6)
- 24: FWD JOG command
- 25: REV JOG command
- 26: FOCG/TQC model selection
- 27: ASR1/ASR2 selection
- 28: Emergency stop (EF1)
- 29: Signal confirmation for Y-connection
- 30: Signal confirmation for Δ -connection
- 31: High torque bias (Pr.11-30)
- 32: Middle torque bias (Pr.11-31)
- 33: Low torque bias (Pr.11-32)
- 34: Switch between multi-step position and multi-speed control
- 35: Enable position control
- 36: Enable multi-step position learning function (valid at stop)
- 37: Enable pulse position input command
- 38: Disable write EEPROM function
- 39: Torque command direction
- 40: Force coast to stop
- 41: HAND switch
- 42: AUTO switch
- 43: Enable resolution selection (Pr.02-48)
- 44: Reverse direction homing
- 45: Forward direction homing
- 46: Homing ORG
- 47: Homing function enable
- 48: Mechanical gear ratio switch
- 49: Drive enable
- 50: Slave dEb execution

- 51: Selection for PLC mode bit0
- 52: Selection for PLC mode bit1
- 53: Trigger CANopen quick stop
- 54: Reserved
- 55: Brake Released Signal
- 56: Local/Remote Selection
- 57~70: Reserved

- 📖 This parameter selects the functions for each multi-function terminal.
- 📖 The terminals of Pr.02-26~Pr.02-29 are virtual and set as MI10~MI13 when using with optional card EMC-D42A. Pr.02-30~02-31 are virtual terminals.
- 📖 When being used as a virtual terminal, it needs to change the status (0/1: ON/OFF) of bit 8-15 of Pr.02-12 by digital keypad KPC-CC01 or communication.
- 📖 If Pr.02-00 is set to 3-wire operation control. Terminal MI1 is for STOP contact. Therefore, MI1 is not allowed for any other operation.
- 📖 Summary of function settings (Take the normally open contact for example, ON: contact is closed, OFF: contact is open)

Settings	Functions	Descriptions
0	No Function	
1	Multi-step speed command 1/multi-step position command 1	15 step speeds could be conducted through the digital status of the 4 terminals, and 16 in total if the master speed is included. (Refer to Parameter set 4)
2	Multi-step speed command 2/ multi-step position command 2	
3	Multi-step speed command 3/ multi-step position command 3	
4	Multi-step speed command 4/ multi-step position command 4	
5	Reset	After the error of the drive is eliminated, use this terminal to reset the drive.
6	JOG Command	<p>Before executing this function, it needs to wait for the drive stop completely. During running, it can change the operation direction and STOP key on the keypad is valid. Once the external terminal receives OFF command, the motor will stop by the JOG deceleration time. Refer to Pr.01-20~01-22 for details.</p> <p>01-22 JOG frequency</p> <p>01-07 Min. output frequency of motor 1</p> <p>JOG accel. time 01-20</p> <p>JOG decel. time 01-21</p> <p>Mix-GND ON OFF</p>
7	Acceleration/deceleration Speed Inhibit	When this function is enabled, acceleration and deceleration is stopped. After this function is disabled, the AC motor drive starts to accel./decel. from the inhibit point.

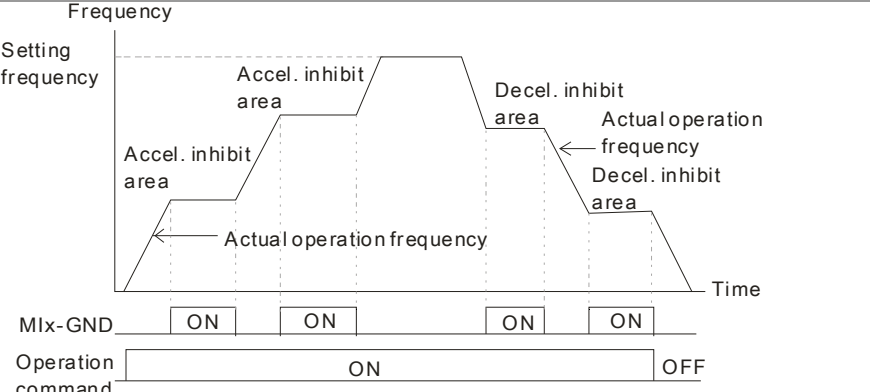
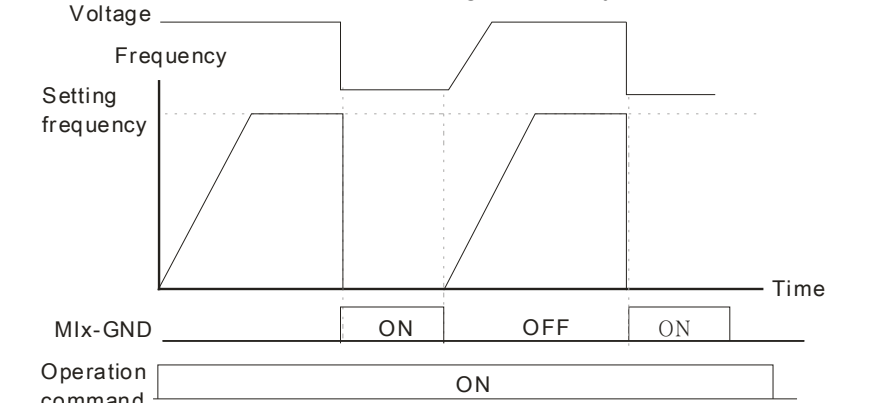
Settings	Functions	Descriptions
		 <p>The graph shows Frequency on the vertical axis and Time on the horizontal axis. A horizontal dashed line represents the 'Setting frequency'. The 'Actual operation frequency' starts at zero, rises through an 'Accel. inhibit area' to the setting frequency, stays constant, and then falls through a 'Decel. inhibit area' back to zero. Below the graph, the 'MIx-GND' signal is shown as a series of four pulses labeled 'ON'. The 'Operation command' signal is shown as a single long pulse labeled 'ON' that covers the duration of the frequency ramp-up and ramp-down.</p>
8	The 1 st , 2 nd acceleration or deceleration time selection	<p>The acceleration/deceleration time of the drive could be selected from this function or the digital status of the terminals; there are 4 acceleration/deceleration speeds in total for selection.</p>
9	The 3 rd , 4 th acceleration or deceleration time selection	
10	EF Input (EF: External fault)	<p>External fault input terminal. It will decelerate by Pr.07-20 setting (it will have fault record when external fault occurs)</p>
11	External B.B. Input (Base Block)	<p>When this contact is ON, output of the drive will be cut off immediately, and the motor will be free run and display B.B. signal. Refer to Pr.07-08 for details.</p>
12	Output Stop	<p>If this contact is ON, output of the drive will be cut off immediately, and the motor will then be free run. And once it is turned to OFF, the drive will accelerate to the setting frequency.</p>  <p>The graph shows Frequency on the vertical axis and Time on the horizontal axis. A horizontal dashed line represents the 'Setting frequency'. The 'Actual operation frequency' ramps up to the setting frequency, then drops to zero when the 'MIx-GND' signal is 'ON'. When 'MIx-GND' is 'OFF', the frequency ramps back up to the setting frequency. Below the graph, the 'MIx-GND' signal is shown as a pulse labeled 'ON' followed by a period labeled 'OFF' and then another pulse labeled 'ON'. The 'Operation command' signal is shown as a single long pulse labeled 'ON' covering the entire duration.</p>
13	Cancel the setting of the optimal accel./decel. time	<p>Before using this function, Pr.01-44 should be set to 01/02/03/04 first. When this function is enabled, OFF is for auto mode and ON is for linear accel./decel.</p>
14	Switch between drive settings 1 and 2	<p>When the contact is ON: use motor 2 parameters. OFF: use motor 1 parameters.</p>
15	Operation speed command form AVI	<p>When the contact is ON, the source of the frequency will force to be AVI. (If the operation speed commands are set to AVI, ACI and AUI at the same time. The priority is AVI > ACI > AUI)</p>
16	Operation speed command form ACI	<p>When the contact is ON, the source of the frequency will force to be ACI. (If the operation speed commands are set to AVI, ACI and AUI at the same time. The priority is AVI > ACI > AUI)</p>
17	Operation speed command form AUI	<p>When this function is enabled, the source of the frequency will force to be AUI. (If the operation speed commands are set to AVI, ACI and AUI at the same time. The priority is AVI > ACI > AUI)</p>
18	Emergency Stop (07-20)	<p>When the contact is ON, the drive will ramp to stop by Pr.07-20 setting.</p>
19	Digital Up command	<p>When the contact is ON, the frequency will be increased and decreased. If this function is constantly ON, the frequency will be</p>

Settings	Functions	Descriptions
20	Digital Down command	increased/decreased by Pr.02-09/Pr.02-10.
21	PID function disabled	When the contact is ON, the PID function is disabled.
22	Clear counter	When the contact is ON, it will clear current counter value and display "0". Only when this function is disabled, it will keep counting upward.
23	Input the counter value (multi-function input command 6)	The counter value will increase 1 once the contact is ON. It needs to be used with Pr.02-19.
24	FWD JOG command	When the contact is ON, the drive will execute forward Jog command. When execute JOG command under torque mode, the drive will automatically switch to speed mode; after JOG command is done, the drive will return to torque mode.
25	REV JOG command	When the contact is ON the drive will execute reverse Jog command. When execute JOG command under torque mode, the drive will automatically switch to speed mode; after JOG command is done, the drive will return to torque mode.
26	FOCPG/TQCPG mode selection	<p>When the contact is ON: TQCPG mode. When the contact is OFF: FOCPG mode.</p> <p>03-00~02=1 (AVI/AUI/ACI is frequency command) 03-00~02=2 (AVI/AUI/ACI is torque command)</p> <p>control mode: speed control, torque control, speed control, torque control, speed control (decel. to stop)</p> <p>Switch timing for torque/speed control (00-10=0/4, multi-function input terminal is set to 26)</p>
27	ASR1/ASR2 selection	When the contact is ON: speed will be adjusted by ASR 2 setting. OFF: speed will be adjusted by ASR 1 setting. Refer to Pr.11-02 for details.
28	Emergency stop (EF1)	<p>When the contact is ON, the drive will execute emergency stop and display EF1 on the keypad. The motor won't run and be in the free run until the fault is cleared after pressing RESET" (EF: External Fault)</p> <p>Mix-GND: ON, OFF, ON Reset: ON, OFF Operation command: ON</p>

Settings	Functions	Descriptions
29	Signal confirmation for Y-connection	When is the contact is ON, the drive will operate by 1st V/f.
30	Signal confirmation for Δ-connection	When the contact is ON, the drive will operate by 2nd V/f.
31	High torque bias	Refer to Pr.11-30~11-32 for details.
32	Middle torque bias	
33	Low torque bias	
34	Switch between multi-step position and multi-speed control	

Settings	Functions	Descriptions
35	Enable single-point position control	<p>When the contact is ON, the AC motor drive will execute internal single-point position control according to the setting in Pr.10-19. This function is valid in FOCPG mode only.</p>
36	Enable multi-step position learning function (valid at stop)	<p>When the contact is ON/OFF, the drive will base the multi-function inputs 1-4 ON/OFF status to find the corresponding multi-step positions and write current motor position into such corresponding multi-step position.</p> <p>Run/Stop</p> <p>$1011_2=11$ corresponds to Pr.04-36 $1010_2=10$ corresponds to Pr.04-34</p> <p>MI=d1 1 0 0</p> <p>MI=d2 1 1 1</p> <p>MI=d3 0 0 0</p> <p>MI=d4 1 1 1</p> <p>MI=d36</p> <p>Writing the motor position into the Pr.04-36 Writing the motor position into the Pr.04-34</p>

Settings	Functions	Descriptions															
37	Full position control pulse command input enable	<p>When Pr.00-20 is set to 4 or 5 and this contact is ON, the input pulse of PG card is position command. When using this function, it is recommended to set Pr.11-25 to 0. Example: please refer to the following diagram when using this function with MI=d35 return to home position,.</p>															
38	Disable EEPROM write function	When this contact is ON, write to EEPROM is disabled.															
39	Torque command direction	For torque control (Pr.00-10=2), when torque command is AVI or ACI, the contact is ON and it is negative torque.															
40	Force coast to stop	When this contact is ON during the operation, the drive will free run to stop.															
41	HAND switch	1. When MI is switched to off status, it executes a STOP command. , If MI is switched to off during operation, the drive will also stop.															
42	AUTO switch	2. Using keypad KPC-CC01 to switch between HAND/AUTO, the drive will stop first then switch to the HAND or AUTO status. 3. On the digital keypad KPC-CC01, it will display current drive status (HAND/OFF/AUTO). <table border="1" style="margin-left: auto; margin-right: auto;"> <thead> <tr> <th></th> <th>Bit 1</th> <th>Bit 0</th> </tr> </thead> <tbody> <tr> <td>OFF</td> <td>0</td> <td>0</td> </tr> <tr> <td>AUTO</td> <td>0</td> <td>1</td> </tr> <tr> <td>HAND</td> <td>1</td> <td>0</td> </tr> <tr> <td>OFF</td> <td>1</td> <td>1</td> </tr> </tbody> </table>		Bit 1	Bit 0	OFF	0	0	AUTO	0	1	HAND	1	0	OFF	1	1
	Bit 1	Bit 0															
OFF	0	0															
AUTO	0	1															
HAND	1	0															
OFF	1	1															
43	Enable resolution selection	Refer to Pr.02-48 for details.															
44	Reverse direction homing	Signal input for reverse direction limit switch. When this terminal is ON, the drive will react to the setting in Pr.00-40, 00-41, 00-42 accordingly to execute homing in a reverse direction (counter clockwise).															
45	Forward direction homing	Signal input for forward direction limit switch. When this terminal is ON, the drive will react to the setting in Pr.00-40, 00-41, 00-42 accordingly to execute homing in a forward direction (clockwise).															
46	Homing ORG	ORG point input. When this terminal is ON, the drive will refer to the setting in Pr.00-40, 00-41, 00-42 accordingly to execute homing.															
47	Homing function enable	Pr.00-10 = 3 (homing mode), if the external terminal MIx=47 is OFF, the drive will ignore the home command and execute Point to Point position control.															

Settings	Functions	Descriptions															
48	Mechanical gear ratio switch	When this contact is ON, the mechanical gear ratio switch will be the second group A2/B2 (refer to Pr.10-08 and Pr.10-09).															
49	Drive enable	When drive=enable, RUN command is valid. When drive= disable, RUN command is invalid. When drive is in operation, motor coast to stop.															
50	Slave dEb execution	Input the message setting in this parameter when dEb occurs to Master. This will ensure dEb also occurs to Slave, then Master and Slave will stop simultaneously.															
51	Selection for PLC mode bit0	<table border="1"> <thead> <tr> <th>PLC status</th> <th>Bit 1</th> <th>Bit 0</th> </tr> </thead> <tbody> <tr> <td>Disable PLC function (PLC 0)</td> <td>0</td> <td>0</td> </tr> <tr> <td>Trigger PLC to operation (PLC 1)</td> <td>0</td> <td>1</td> </tr> <tr> <td>Trigger PLC to stop (PLC 2)</td> <td>1</td> <td>0</td> </tr> <tr> <td>No function</td> <td>1</td> <td>1</td> </tr> </tbody> </table>	PLC status	Bit 1	Bit 0	Disable PLC function (PLC 0)	0	0	Trigger PLC to operation (PLC 1)	0	1	Trigger PLC to stop (PLC 2)	1	0	No function	1	1
PLC status	Bit 1	Bit 0															
Disable PLC function (PLC 0)	0	0															
Trigger PLC to operation (PLC 1)	0	1															
Trigger PLC to stop (PLC 2)	1	0															
No function	1	1															
52	Selection for PLC mode bit1	<table border="1"> <thead> <tr> <th>PLC status</th> <th>Bit 1</th> <th>Bit 0</th> </tr> </thead> <tbody> <tr> <td>Disable PLC function (PLC 0)</td> <td>0</td> <td>0</td> </tr> <tr> <td>Trigger PLC to operation (PLC 1)</td> <td>0</td> <td>1</td> </tr> <tr> <td>Trigger PLC to stop (PLC 2)</td> <td>1</td> <td>0</td> </tr> <tr> <td>No function</td> <td>1</td> <td>1</td> </tr> </tbody> </table>	PLC status	Bit 1	Bit 0	Disable PLC function (PLC 0)	0	0	Trigger PLC to operation (PLC 1)	0	1	Trigger PLC to stop (PLC 2)	1	0	No function	1	1
PLC status	Bit 1	Bit 0															
Disable PLC function (PLC 0)	0	0															
Trigger PLC to operation (PLC 1)	0	1															
Trigger PLC to stop (PLC 2)	1	0															
No function	1	1															
53	Enable CANopen quick stop	When this function is enabled under CANopen control, it will change to quick stop. Refer to Chapter 15 for more details.															
54	Reserved																
55	Brake Released Signal																
56	LOCAL/REMOTE Selection	Use Pr.00-29 to select for LOCAL/REMOTE mode(refer to Pr.00-29) When Pr.00-29 is not set to 0, on the digital keypad KPC-CC01 it will display LOC/REM status. (It will display on the KPC-CC01 if the firmware version is above version 1.021). <table border="1"> <thead> <tr> <th></th> <th>Bit 0</th> </tr> </thead> <tbody> <tr> <td>REM</td> <td>0</td> </tr> <tr> <td>LOC</td> <td>1</td> </tr> </tbody> </table>		Bit 0	REM	0	LOC	1									
	Bit 0																
REM	0																
LOC	1																
57~70	Reserved																

✎ **02-09** UP/DOWN Key Mode Factory Setting: 0

Settings 0: Up/down by the accel/decel time
 1: Up/down constant speed (Pr.02-10)

✎ **02-10** Constant speed. The Accel. /Decel. Speed of the UP/DOWN Key Factory Setting: 0.001

Settings 0.001~1.000Hz/ms

📖 These settings are used when multi-function input terminals are set to 19/20. Refer to Pr.02-09 and 02-10 for the frequency up/down command.

📖 Pr.02-09 set to 0: it will increase/decrease frequency command (F) by the external terminal UP/DOWN key as shown in the following diagram. In this mode, it also can be controlled by UP/DOWN key on the digital keypad.

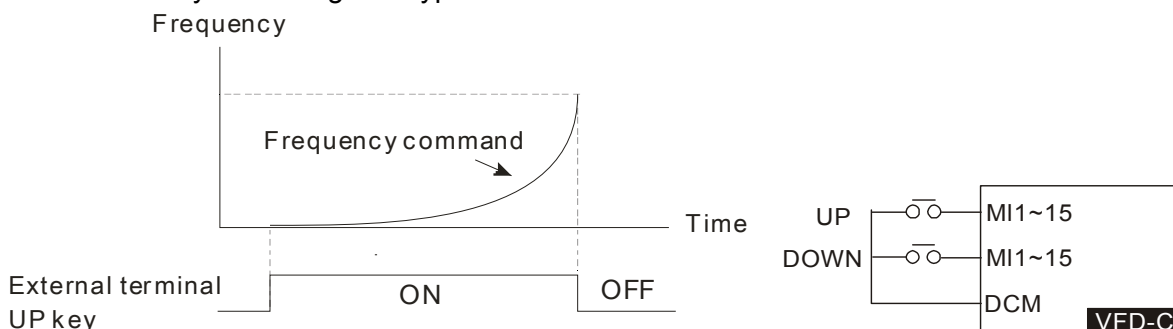

📖 Pr.02-09 set to 1: it will increase/decrease frequency command (F) by the setting of acceleration/deceleration (Pr.01-12~01-19) and only be valid during operation.

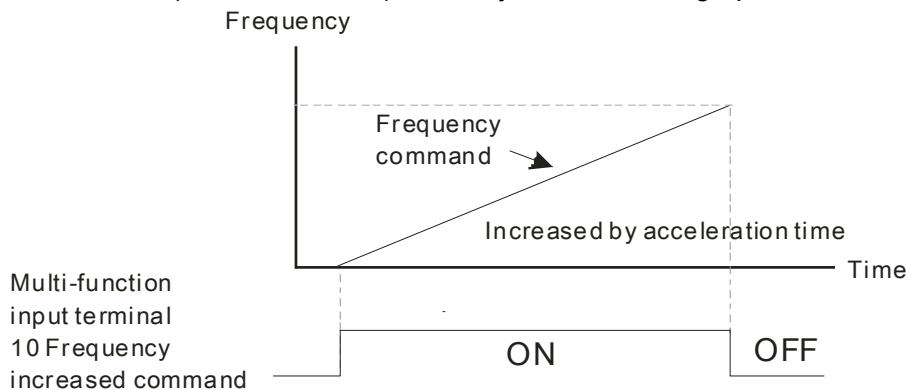

↗ **02-11** Digital Input Response Time Factory Setting: 0.005

Settings 0.000~30.000 sec

- 📖 This parameter is used to set the response time of digital input terminals FWD, REV and MI1~MI8.
- 📖 It is used for digital input terminal signal delay and confirmation. The delay time is confirmation time to prevent some uncertain interference that would cause error in the input of the digital terminals. Under this condition, confirmation for this parameter would improve effectively, but the response time will be somewhat delayed.

↗ **02-12** Digital Input Operation Direction Factory Setting: 0000

Settings 0000h~FFFFh (0:N.O. ; 1:N.C.)

- 📖 The setting of this parameter is In hexadecimal.
- 📖 This parameter is used to set the input signal level and it won't be affected by the SINK/SOURCE status.
- 📖 Bit0 is for FWD terminal, bit1 is for REV terminal and bit2 to bit15 is for MI1 to MI14.
- 📖 User can change terminal status by communicating.

For example, MI1 is set to 1 (multi-step speed command 1), MI2 is set to 2 (multi-step speed command 2). Then the forward + 2nd step speed command=1001(binary)=9 (Decimal). Only need to set Pr.02-12=9 by communication and it can forward with 2nd step speed. It doesn't need to wire any multi-function terminal.

Bit15	bit14	bit13	bit12	bit11	bit10	bit9	bit8	bit7	bit6	bit5	bit4	bit3	bit2	bit1	bit0
MI14	MI13	MI12	MI11	MI10	MI9	MI8	MI7	MI6	MI5	MI4	MI3	MI2	MI1	X	X

↗ **02-13** Multi-function Output 1 (Relay1) Factory Setting: 11

↗ **02-14** Multi-function Output 2 (Relay2) Factory Setting: 1

↗ **02-16** Multi-function Output 3 (MO1) Factory Setting: 66

↗ **02-17** Multi-function Output 4 (MO2)

↗ **02-36** Output terminal of I/O extension card (MO10)





↗	02-37	Output terminal of I/O extension card (MO11)
↗	02-38	Output terminal of I/O extension card (MO12)
↗	02-39	Output terminal of I/O extension card (MO13)
↗	02-40	Output terminal of I/O extension card (MO14)
↗	02-41	Output terminal of I/O extension card (MO15)
↗	02-42	Output terminal of I/O extension card (MO16)
↗	02-43	Output terminal of I/O extension card (MO17)
↗	02-44	Output terminal of I/O extension card (MO18)
↗	02-45	Output terminal of I/O extension card (MO19)
↗	02-46	Output terminal of the I/O extension card (MO20)

Factory Setting: 0

Settings

- 0: No function
- 1: Operation Indication
- 2: Operation speed attained
- 3: Desired frequency attained 1 (Pr.02-22)
- 4: Desired frequency attained 2 (Pr.02-24)
- 5: Zero speed (Frequency command)
- 6: Zero speed, include STOP(Frequency command)
- 7: Over torque 1(Pr.06-06~06-08)
- 8: Over torque 2(Pr.06-09~06-11)
- 9: Drive is ready
- 10: Low voltage warning (LV) (Pr.06-00)
- 11: Malfunction indication
- 12: Mechanical brake release(Pr.02-32)
- 13: Overheat warning (Pr.06-15)
- 14: Software brake signal indication(Pr.07-00)
- 15: PID feedback error
- 16: Slip error (oSL)
- 17: Terminal count value attained (Pr.02-20; not return to 0)
- 18: Preliminary count value attained (Pr.02-19; returns to 0)
- 19: Base Block
- 20: Warning output
- 21: Over voltage warning
- 22: Over-current stall prevention warning
- 23: Over-voltage stall prevention warning
- 24: Operation mode indication
- 25: Forward command
- 26: Reverse command
- 27: Output when current \geq Pr.02-33 (\geq 02-33)
- 28: Output when current \leq Pr.02-33 (\leq 02-33)

- 29: Output when frequency \geq Pr.02-34 (\geq 02-34)
- 30: Output when frequency \leq Pr.02-34 (\leq 02-34)
- 31: Y-connection for the motor coil
- 32: Δ -connection for the motor coil
- 33: Zero speed (actual output frequency)
- 34: Zero speed include stop(actual output frequency)
- 35: Error output selection 1(Pr.06-23)
- 36: Error output selection 2(Pr.06-24)
- 37: Error output selection 3(Pr.06-25)
- 38: Error output selection 4(Pr.06-26)
- 39: Position attained (Pr.10-19)
- 40: Speed attained (including Stop)
- 41: Multi-position attained
- 42: Crane function
- 43: Actual motor speed slower than Pr.02-47
- 44: Low current output (Pr.06-71 to Pr.06-73)
- 45: UVW Output Electromagnetic valve On/Off Switch
- 46: Master dEb action output
- 47: Closed brake output
- 48: Reserved
- 49: Homing action complete
- 50: Output for CANopen control
- 51: Output for communication card
- 52: Output for RS485
- 53~62: Reserved

-  This parameter is used for setting the function of multi-function terminals.
-  Pr.02-36~Pr.02-41 requires additional extension cards to display the parameters, the choices of optional cards are EMC-D42A and EMC-R6AA.
-  The optional card EMC-D42A provides 2 output terminals and can be used with Pr.02-36~02-37.
-  The optional card EMC-R6AA provides 6 output terminals and can be used with Pr.02-36~02-41.
-  Summary of function settings (Take the normally open contact for example, ON: contact is closed, OFF: contact is open)

Settings	Functions	Descriptions
0	No Function	
1	Operation Indication	Active when the drive is not at STOP.
2	Master Frequency Attained	Active when the AC motor drive reaches the output frequency setting.
3	Desired Frequency Attained 1 (Pr.02-22)	Active when the desired frequency (Pr.02-22) is attained.
4	Desired Frequency Attained 2 (Pr.02-24)	Active when the desired frequency (Pr.02-24) is attained.
5	Zero Speed (frequency command)	Active when frequency command =0. (the drive should be at RUN mode)
6	Zero Speed with Stop (frequency command)	Active when frequency command =0 or stop.

Settings	Functions	Descriptions
7	Over Torque 1	Active when detecting over-torque. Refer to Pr.06-07 (over-torque detection level-OT1) and Pr.06-08 (over-torque detection time-OT1). Refer to Pr.06-06~06-08.
8	Over Torque 2	Active when detecting over-torque. Refer to Pr.06-10 (over-torque detection level-OT2) and Pr.06-11 (over-torque detection time-OT2). Refer to Pr.06-09~06-11.
9	Drive Ready	Active when the drive is ON and no abnormality detected.
10	Low voltage warn (Lv)	Active when the DC Bus voltage is too low. (refer to Pr.06-00 low voltage level)
11	Malfunction Indication	Active when fault occurs (except Lv stop).
12	Mechanical Brake Release (Pr.02-32)	When drive runs after Pr.02-32, it will be ON. This function should be used with DC brake and it is recommended to use contact "b"(N.C).
13	Overheat	Active when IGBT or heat sink overheats to prevent OH turn off the drive. (refer to Pr.06-15)
14	Software Brake Signal Indication	Active when the soft brake function is ON. (refer to Pr.07-00)
15	PID Feedback Error	Active when the feedback signal is abnormal.
16	Slip Error (oSL)	Active when the slip error is detected.
17	Terminal Count Value Attained (Pr.02-20; not return to 0)	Active when the counter reaches Terminal Counter Value (Pr.02-19). This contact won't active when Pr.02-20>Pr.02-19.
18	Preliminary Counter Value Attained (Pr.02-19; returns to 0)	Active when the counter reaches Preliminary Counter Value (Pr.02-19).
19	External Base Block input (B.B.)	Active when the output of the AC motor drive is shut off during base block.
20	Warning Output	Active when the warning is detected.
21	Over-voltage Warning	Active when the over-voltage is detected.
22	Over-current Stall Prevention Warning	Active when the over-current stall prevention is detected.
23	Over-voltage Stall prevention Warning	Active when the over-voltage stall prevention is detected.
24	Operation Mode Indication	Active when the operation command is controlled by external terminal. (Pr.00-20≠0)
25	Forward Command	Active when the operation direction is forward.
26	Reverse Command	Active when the operation direction is reverse.
27	Output when Current >= Pr.02-33	Active when current is >= Pr.02-33.
28	Output when Current <= Pr.02-33	Active when current is <= Pr.02-33
29	Output when frequency >= Pr.02-34	Active when frequency is >= Pr.02-34.
30	Output when Frequency <= Pr.02-34	Active when frequency is <= Pr.02-34.
31	Y-connection for the Motor Coil	Active when PR.05-24 is less than Pr.05-23 and time is more than Pr.05-25.
32	-connection for the Motor Coil	Active when PR.05-24 is higher than Pr.05-23 and time is more than Pr.05-25.
33	Zero Speed (actual output frequency)	Active when the actual output frequency is 0. (the drive should be at RUN mode)
34	Zero Speed with Stop (actual output frequency)	Active when the actual output frequency is 0 or Stop.
35	Error Output Selection 1 (Pr.06-23)	Active when Pr.06-23 is ON.
36	Error Output Selection 2 (Pr.06-24)	Active when Pr.06-24 is ON.
37	Error Output Selection 3 (Pr.06-25)	Active when Pr.06-25 is ON.

Settings	Functions	Descriptions																																																																																
38	Error Output Selection 4 (Pr.06-26)	Active when Pr.06-26 is ON.																																																																																
39	Position Attained (Pr.10-19)	Active when the PG position control point reaches Pr.10-19.																																																																																
40	Speed Attained (including zero speed)	Active when the output frequency reaches frequency setting or stop.																																																																																
41	Multi-position Attained	<p>User can set any three multi-function input terminals to 41. The current position action status of these three terminals will be outputted. Example: if setting Pr.02-36~02-38 to 41 and only the multi-position of the second point has been done. Therefore, current status is RA (ON), RA (OFF) and MO1 (OFF). In this way, their status is 010. Bit0 is RA and so on.</p> <table border="1"> <thead> <tr> <th></th> <th>MO2 Pr.02-17=41</th> <th>MO1 Pr.02-16=41</th> <th>RY2 Pr.02-14=41</th> <th>RY1 Pr.02-13=41</th> </tr> </thead> <tbody> <tr><td>Pr.04-16</td><td>0</td><td>0</td><td>0</td><td>1</td></tr> <tr><td>Pr.04-18</td><td>0</td><td>0</td><td>1</td><td>0</td></tr> <tr><td>Pr.04-20</td><td>0</td><td>0</td><td>1</td><td>1</td></tr> <tr><td>Pr.04-22</td><td>0</td><td>1</td><td>0</td><td>0</td></tr> <tr><td>Pr.04-24</td><td>0</td><td>1</td><td>0</td><td>1</td></tr> <tr><td>Pr.04-26</td><td>0</td><td>1</td><td>1</td><td>0</td></tr> <tr><td>Pr.04-28</td><td>0</td><td>1</td><td>1</td><td>1</td></tr> <tr><td>Pr.04-30</td><td>1</td><td>0</td><td>0</td><td>0</td></tr> <tr><td>Pr.04-32</td><td>1</td><td>0</td><td>0</td><td>1</td></tr> <tr><td>Pr.04-34</td><td>1</td><td>0</td><td>1</td><td>0</td></tr> <tr><td>Pr.04-36</td><td>1</td><td>0</td><td>1</td><td>1</td></tr> <tr><td>Pr.04-38</td><td>1</td><td>1</td><td>0</td><td>0</td></tr> <tr><td>Pr.04-40</td><td>1</td><td>1</td><td>0</td><td>1</td></tr> <tr><td>Pr.04-42</td><td>1</td><td>1</td><td>1</td><td>0</td></tr> <tr><td>Pr.04-44</td><td>1</td><td>1</td><td>1</td><td>1</td></tr> </tbody> </table>		MO2 Pr.02-17=41	MO1 Pr.02-16=41	RY2 Pr.02-14=41	RY1 Pr.02-13=41	Pr.04-16	0	0	0	1	Pr.04-18	0	0	1	0	Pr.04-20	0	0	1	1	Pr.04-22	0	1	0	0	Pr.04-24	0	1	0	1	Pr.04-26	0	1	1	0	Pr.04-28	0	1	1	1	Pr.04-30	1	0	0	0	Pr.04-32	1	0	0	1	Pr.04-34	1	0	1	0	Pr.04-36	1	0	1	1	Pr.04-38	1	1	0	0	Pr.04-40	1	1	0	1	Pr.04-42	1	1	1	0	Pr.04-44	1	1	1	1
			MO2 Pr.02-17=41	MO1 Pr.02-16=41	RY2 Pr.02-14=41	RY1 Pr.02-13=41																																																																												
		Pr.04-16	0	0	0	1																																																																												
		Pr.04-18	0	0	1	0																																																																												
		Pr.04-20	0	0	1	1																																																																												
		Pr.04-22	0	1	0	0																																																																												
		Pr.04-24	0	1	0	1																																																																												
		Pr.04-26	0	1	1	0																																																																												
		Pr.04-28	0	1	1	1																																																																												
		Pr.04-30	1	0	0	0																																																																												
		Pr.04-32	1	0	0	1																																																																												
		Pr.04-34	1	0	1	0																																																																												
		Pr.04-36	1	0	1	1																																																																												
		Pr.04-38	1	1	0	0																																																																												
		Pr.04-40	1	1	0	1																																																																												
		Pr.04-42	1	1	1	0																																																																												
		Pr.04-44	1	1	1	1																																																																												
42	Crane Function	<p>This function should be used with Pr.02-32, Pr.02-33, Pr.02-34, Pr.02-57 and Pr.02-58.</p> <p>Active when setting Pr.07-16=Pr.02-34 and Fcmd > Pr.02-34 and output current > Pr.02-33 and Time > Pr.02-32.</p> <p>The example of the crane application is in the following for your reference.</p>																																																																																
43	Motor Zero-speed Output (Pr.02-47)	Active when motor actual speed is less than Pr.02-47.																																																																																
44	Low Current Output	This function needs to be used with Pr.06-71 ~ Pr.06-73																																																																																
45	UVW Phase Magnet Contractor ON/ OFF Switch	<ol style="list-style-type: none"> Under FOCPG control mode, set MI=49 (drive enable) and MO=45 (electromagnetic contractor On/Off switch), then the magnetic contractor will follow the drive status to be On or Off. For brake control, set MO=12 (mechanical brake release), Pr.02-31=T1 sec (mechanical brake delay time); then enable/disable DC braking by set 07-01 (DC brake current) to any level except 0 and set Pr.07-02 = T2 (DC brake time at start up) and Pr.07-03 = T2 (DC brake current at stop). It is recommend to set T2 >T1 and try to activate brake control during zero-speed status. 																																																																																

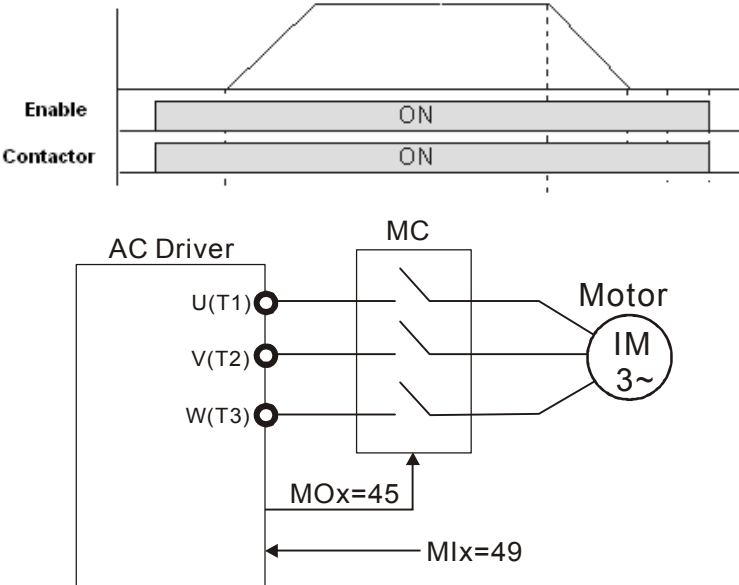
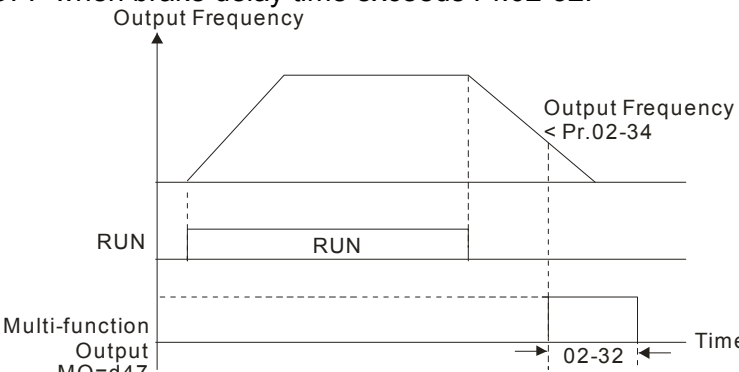
Settings	Functions	Descriptions
		
46	Master dEb signal output	When dEb arise at Master, MO will send a dEb signal to Slave. Then Slave will follow Master's command and decelerate to stop simultaneously.
47	Brake Release at Stop	<p>When drive stops, the corresponding multi-function terminal will be ON if the frequency is less than Pr.02-34. After it is ON, it will be OFF when brake delay time exceeds Pr.02-32.</p> 
48	Reserved	
49	Homing Action Complete	Output when homing action complete.
50	Output for CANopen control	For CANopen communication output
51	Output for communication card	For communication output of communication cards (CMC-MOD01, CMC-EIP01, CMC-PN01 and CMC-DN01)
52	Output for RS-485	For RS-485 output
53~62	Reserved	

Example: Crane Application

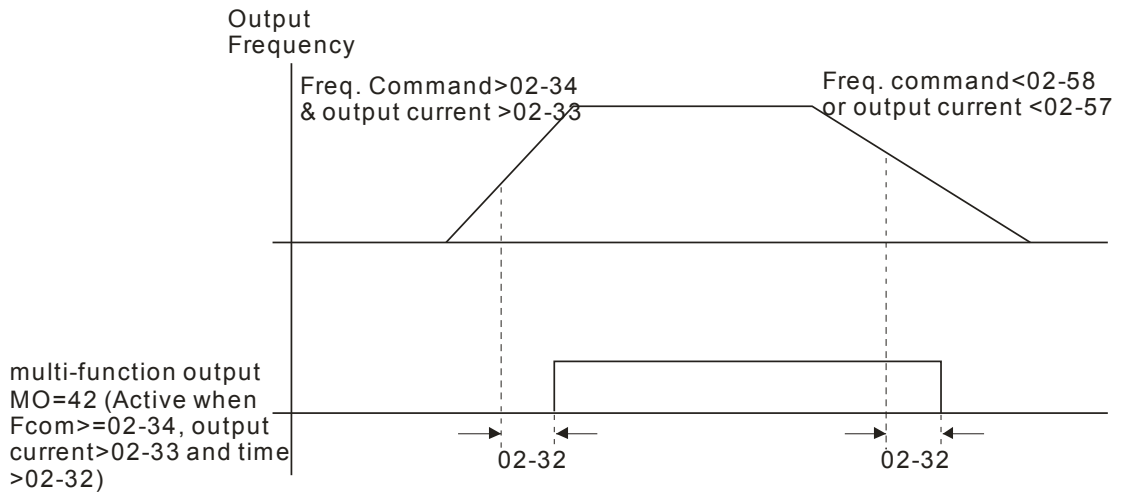

It is recommended to be used with Dwell function as shown in the following:

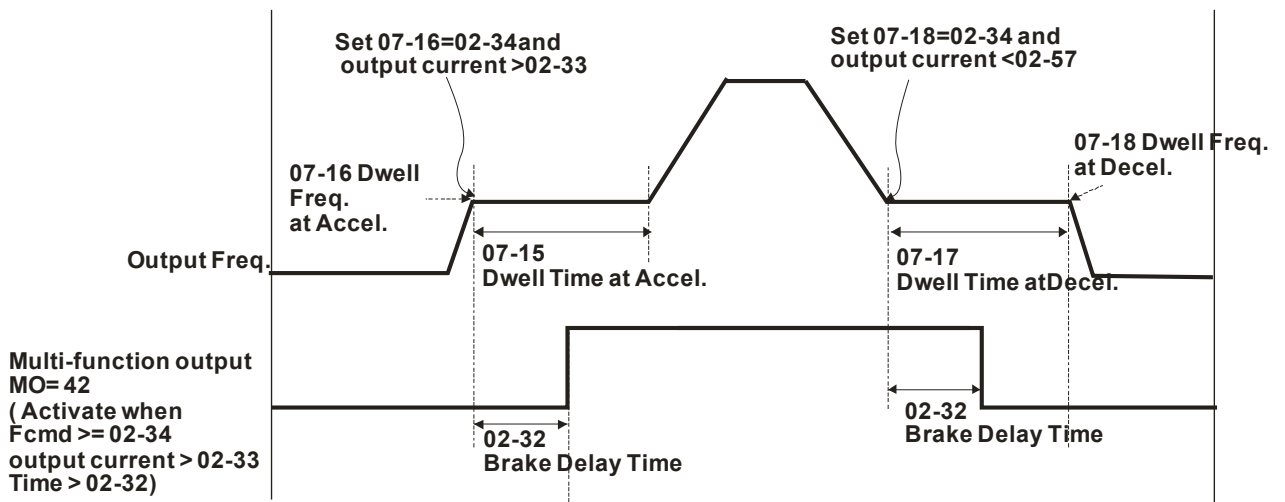

02-18 Multi-function Output Direction

Factory Setting: 0000

Settings 0000h~FFFFh (0:N.O. ; 1:N.C.)

The setting of this parameter is in hexadecimal.

This parameter is set via bit setting. If a bit is 1, the corresponding output acts in the opposite way.

Example:

If Pr02-13=1 and Pr02-18=0, Relay 1 is ON when the drive runs and is open when the drive is stopped.

If Pr02-13=1 and Pr02-18=1, Relay 1 is open when the drive runs and is closed when the drive is stopped.

Bit setting

bit15	bit14	bit13	bit12	bit11	bit10	bit9	bit8	bit7	bit6	bit5	bit4	bit3	bit2	bit1	bit0
MO20	MO19	MO18	MO17	MO16	MO15	MO14	MO13	MO12	MO11	MO10	MO2	MO1	Reserved	RY2	RY1

02-19 Terminal Counting Value Attained (return to 0)

Factory Setting: 0

Settings 0~65535

- 📖 The counter trigger can be set by the multi-function terminal MI6 (set Pr.02-06 to 23). Upon completion of counting, the specified output terminal will be activated (Pr.02-13~02-14, Pr.02-36, 02-37 is set to 18). Pr.02-19 can't be set to 0.
- 📖 When the display shows c5555, the drive has counted 5,555 times. If display shows c5555●, it means that real counter value is between 55,550 to 55,559.

➤ **02-20** Preliminary Counting Value Attained (not return to 0)

Factory Setting: 0

Settings 0~65535

- 📖 When the counter value counts from 1 and reaches this value, the corresponding multi-function output terminal will be activated, provided one of Pr. 02-13, 02-14, 02-36, 02-37 set to 17 (Preliminary Count Value Setting). This parameter can be used for the end of the counting to make the drive runs from the low speed to stop.

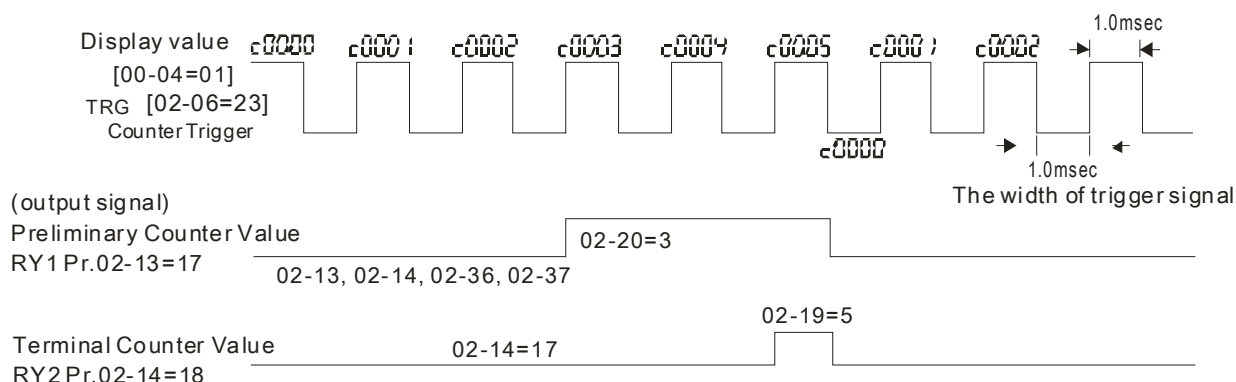

➤ **02-21** Digital Output Gain (DFM)

Factory Setting: 1

Settings 1~166

- 📖 It is used to set the signal for the digital output terminals (DFM-DCM) and digital frequency output (pulse X work period=50%). Output pulse per second = output frequency X Pr.02-21.

➤ **02-22** Desired Frequency Attained 1

Factory Setting: 60.00/50.00

Settings 0.00~599.00Hz

➤ **02-23** The Width of the Desired Frequency Attained 1

Factory Setting: 2.00

Settings 0.00~599.00Hz

➤ **02-24** Desired Frequency Attained 2

Factory Setting: 60.00/50.00

Settings 0.00~599.00Hz

➤ **02-25** The Width of the Desired Frequency Attained 2

Factory Setting: 2.00

Settings 0.00~599.00Hz

- 📖 Once output frequency reaches desired frequency and the corresponding multi-function output terminal is set to 3 or 4 (Pr.02-13, 02-14, 02-36, and 02-37), this multi-function output terminal will be ON.

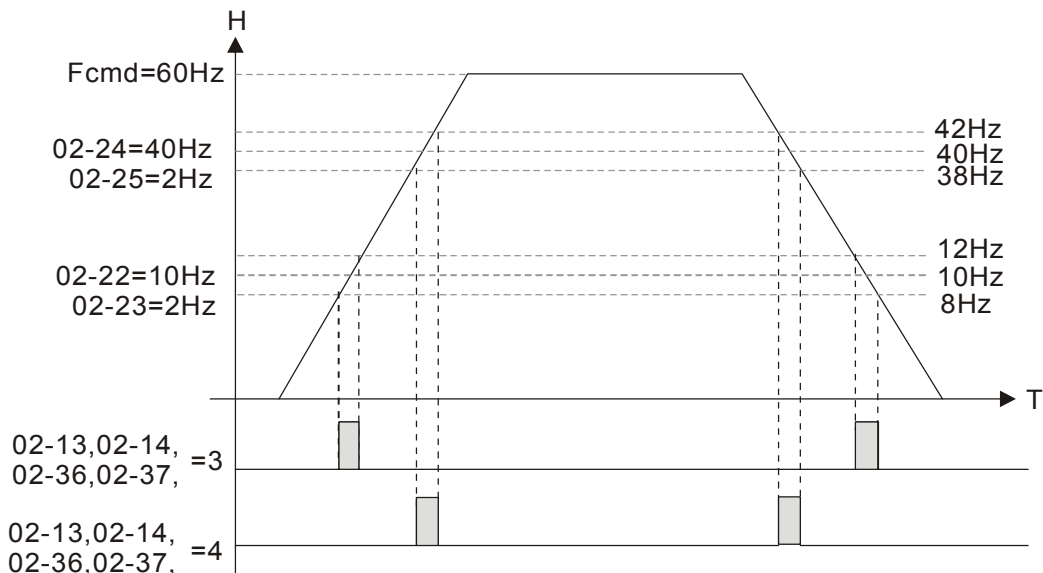

02-32 Brake Delay Time

Factory Setting: 0.000

Settings 0.000~65.000 sec

When the AC motor drive runs after Pr.02-32 delay time, the corresponding multi-function output terminal (12: mechanical brake release) will be ON. It is recommended to use this function with DC brake.

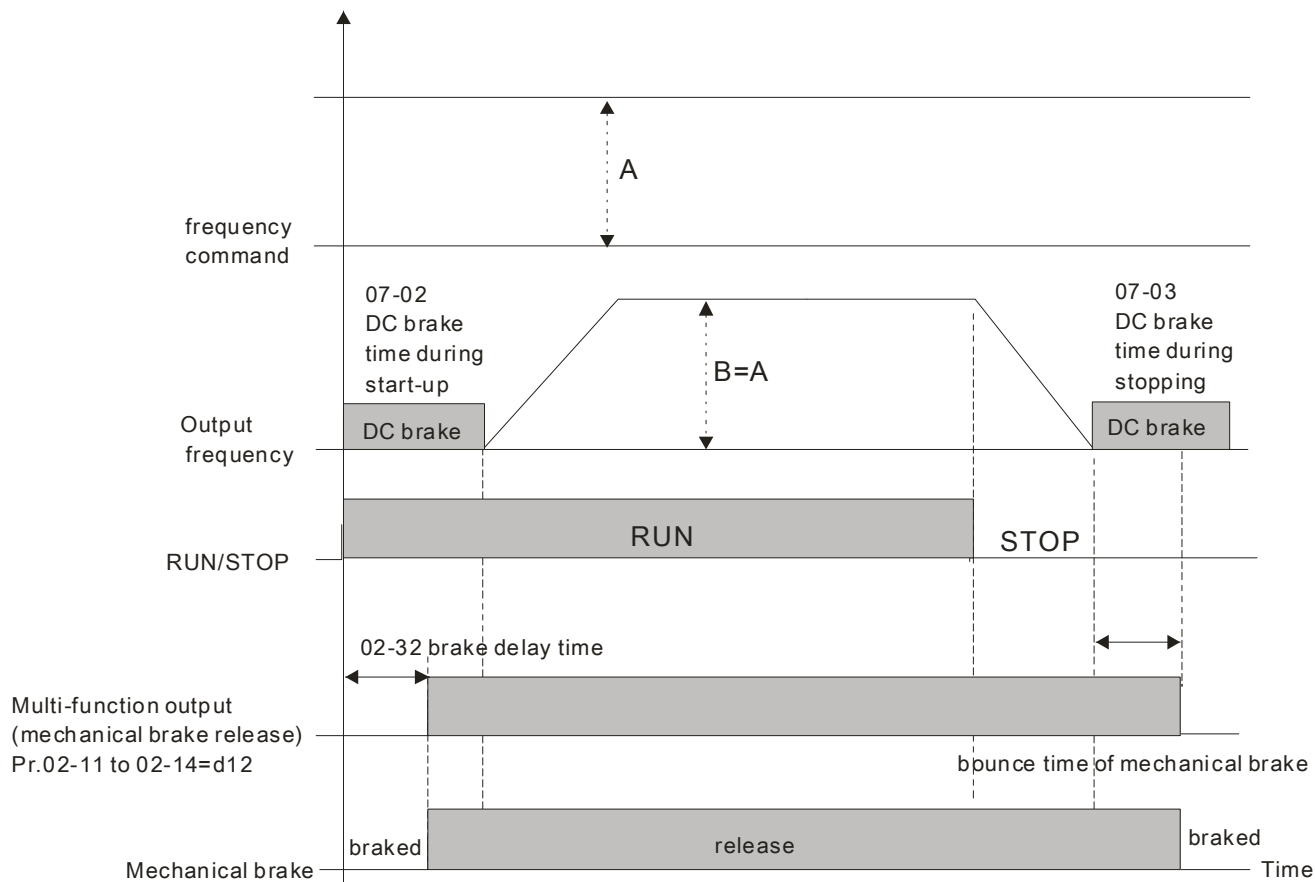

📖 If this parameter is used without DC brake, it will be invalid. Refer to the following operation timing.

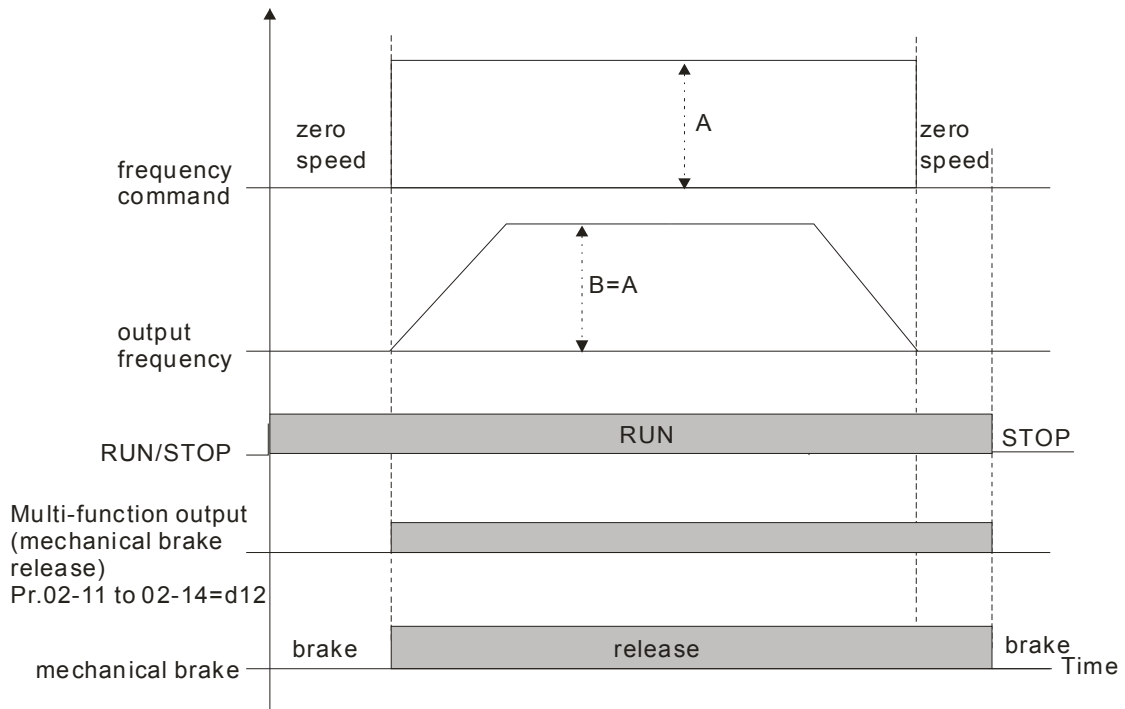

🔧 02-33 Output Current Level Setting for Multi-function Output Terminals

Factory Setting: 0

Settings 0~100%

📖 When output current is higher or equal to Pr.02-33, it will activate multi-function output terminal (Pr.02-13, 02-14, 02-16, and 02-17 is set to 27).

📖 When output current is lower or equal to Pr.02-33, it will activate multi-function output terminal (Pr.02-13, 02-14, 02-16, and 02-17 is set to 28).

🔧 02-34 Output Boundary for Multi-function Output Terminals

Factory Setting: 0.00

Settings 0.00~599.00Hz

📖 When output frequency is higher or equal to Pr.02-34, it will activate the multi-function terminal (Pr.02-13, 02-14, 02-16, 02-17 is set to 29).

📖 When output frequency is lower or equal to Pr.02-34, it will activate the multi-function terminal (Pr.02-13, 02-14, 02-16, 02-17 is set to 30).

🔧 02-35 External Operation Control Selection after Reset and Activate

Factory Setting: 0

Settings 0: Disable

1: Drive runs if the run command still exists after reset or re-boots.

📖 Setting 1:

Status 1: After the drive is powered on and the external terminal for RUN keeps ON, the drive will run.

Status 2: After clearing fault once a fault is detected and the external terminal for RUN keeps ON, the drive can run after pressing RESET key.

➤ **02-47** Zero-speed Level of Motor

Factory Setting: 0

Settings 0~65535 rpm

- 📖 This parameter should be used with the multi-function output terminals (set to 43). It needs to be used with PG card and motor with encoder feedback.
- 📖 This parameter is used to set the level of motor zero-speed. When the actual speed is lower than this setting, the corresponding multi-function output terminal 43 will be ON as shown as follows.

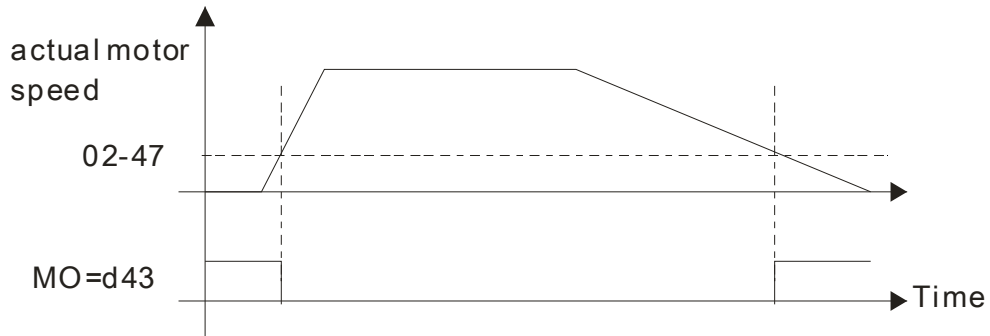

➤ **02-48** Max. Frequency of Resolution Switch

Factory Setting: 60.00

Settings 0.00~599.00Hz

➤ **02-49** Switch the delay time of Max. output frequency

Factory Setting: 0

Settings 0~65000 ms

- 📖 It is used to improve the unstable speed or unstable position due to the insufficient of analog resolution. It needs to be used with external terminal (set to 43). After setting this parameter, it needs to adjust the analog output resolution of controller simultaneously by this setting.

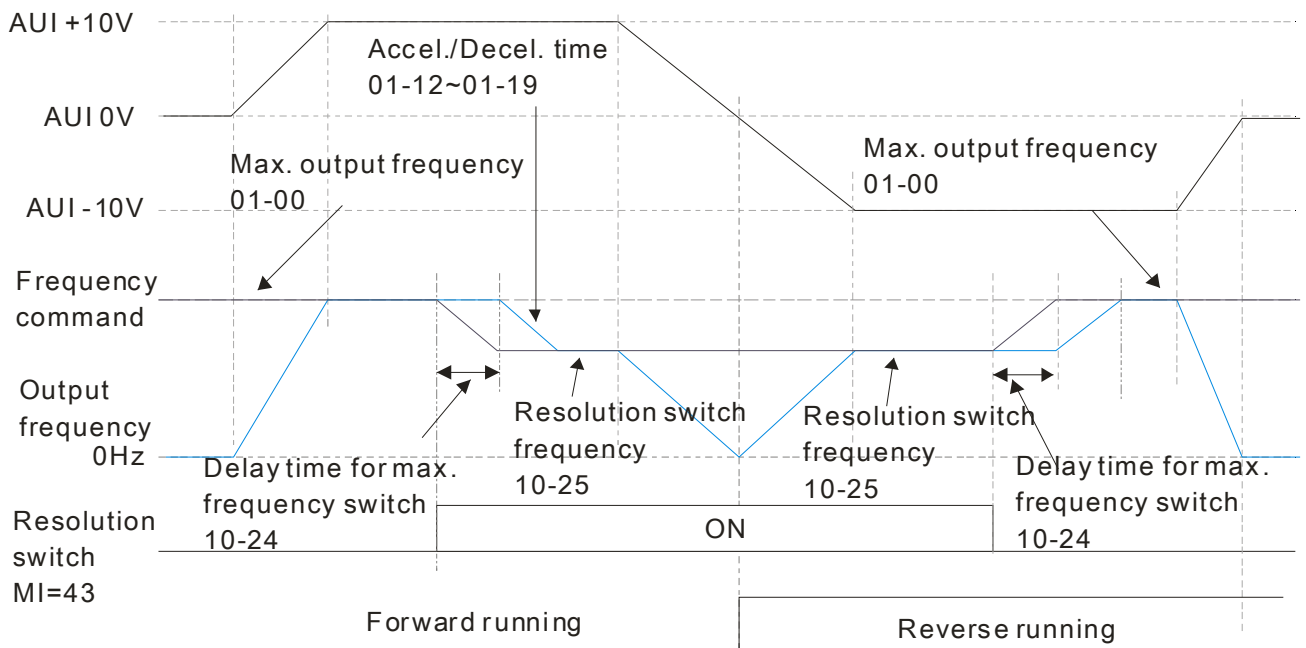

02-50 Display the Status of Multi-function Input Terminal

Factory Setting: Read only

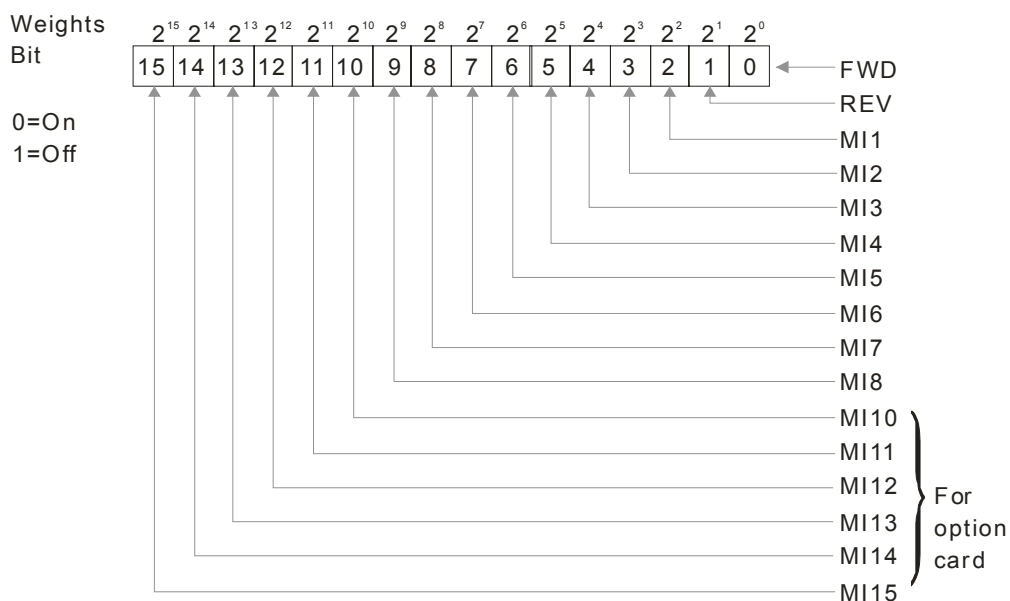

For Example:

If Pr.02-50 displays 0034h (Hex), i.e. the value is 52, and 110100 (binary). It means MI1, MI3 and MI4 are active.

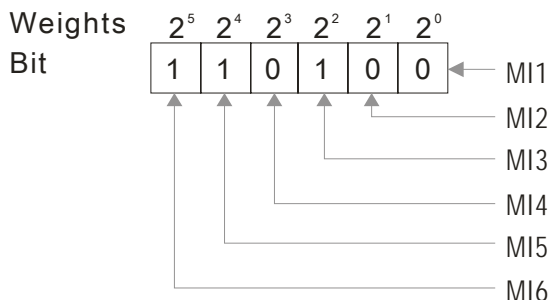

0=ON
1=OFF

Settings
 $= \text{bit}5 \times 2^5 + \text{bit}4 \times 2^4 + \text{bit}2 \times 2^2$
 $= 1 \times 2^5 + 1 \times 2^4 + 1 \times 2^2$
 $= 32 + 16 + 4 = 52$

NOTE					
$2^5 = 32$	$2^4 = 16$	$2^3 = 8$	$2^2 = 4$		
$2^1 = 2$	$2^0 = 1$				

02-51 Status of Multi-function Output Terminal

Factory Setting: Read only

For Example:

If Pr.02-51 displays 000Bh (Hex), i.e. the value is 11, and 1011 (binary). It means RY1, RY2 and MO1 are ON.

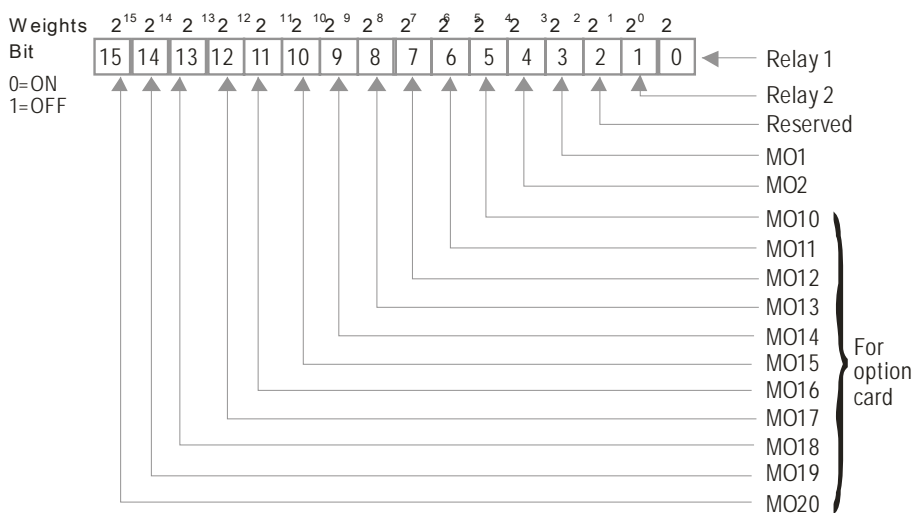

NOTE					
$2^7 = 128$	$2^6 = 64$	$2^5 = 32$	$2^4 = 16$	$2^3 = 8$	
$2^2 = 4$	$2^1 = 2$	$2^0 = 1$			

02-52 Display External Output terminal occupied by PLC

Factory Setting: Read only

P.02-52 shows the external multi-function input terminal that used by PLC.

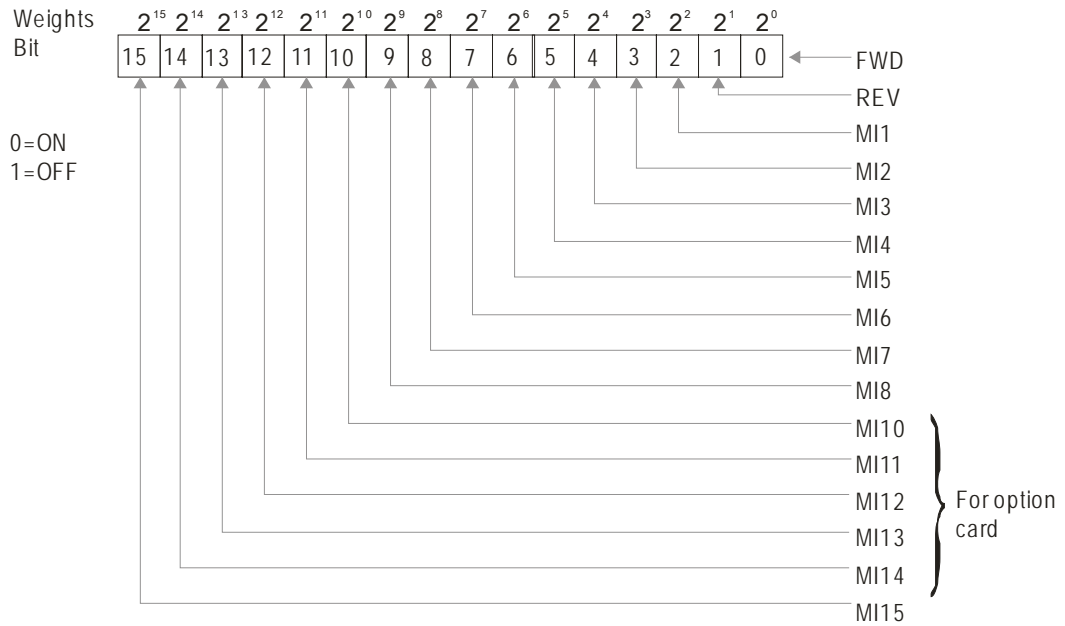

For Example:

When Pr.02-52 displays 0034h(hex) and switching to 110100 (binary), it means MI1, MI3 and MI4 are used by PLC.

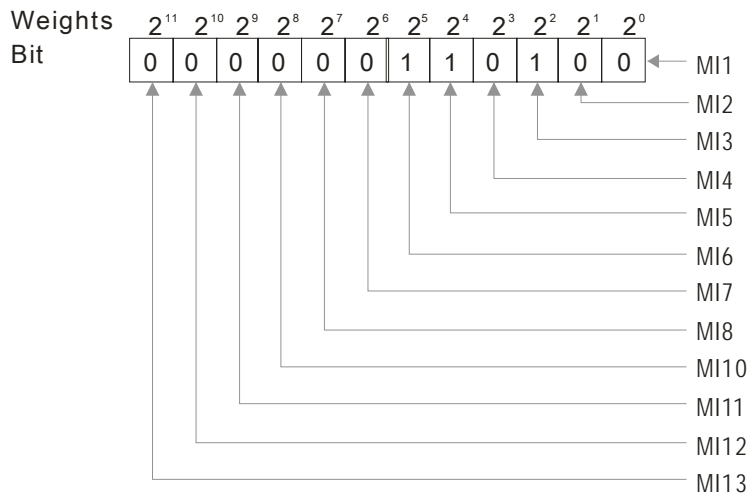

0: not used by PLC

1: used by PLC

Displays

$$= \text{bit}5 \times 2^5 + \text{bit}4 \times 2^4 + \text{bit}2 \times 2^2$$

$$= 1 \times 2^5 + 1 \times 2^4 + 1 \times 2^2$$

$$= 32 + 16 + 4 = 52$$

NOTE

$2^{14} = 16384$	$2^{13} = 8192$	$2^{12} = 4096$
$2^{11} = 2048$	$2^{10} = 1024$	$2^9 = 512$
$2^8 = 256$	$2^7 = 128$	$2^6 = 64$
$2^5 = 32$	$2^4 = 16$	$2^3 = 8$
$2^2 = 4$	$2^1 = 2$	$2^0 = 1$

02-53 Display External Multi Output Terminal Occupied by PLC

Factory Setting: Read only

P.02-53 shows the external multi-function output terminal that used by PLC.

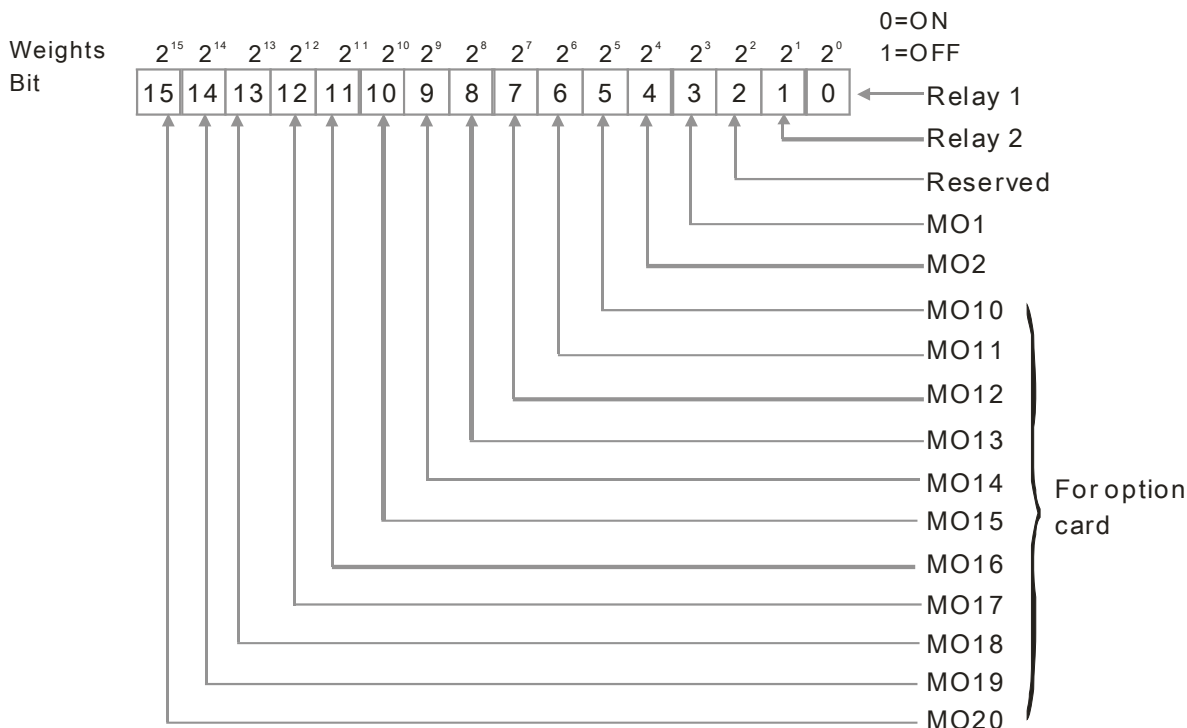

NOTE
 2⁷=128 2⁶=64
 2⁵=32 2⁴=16 2³=8
 2²=4 2¹=2 2⁰=1

For Example:

If the value of Pr.02-53 displays 0003h (Hex), it means RY1 and RY2 are used by PLC.

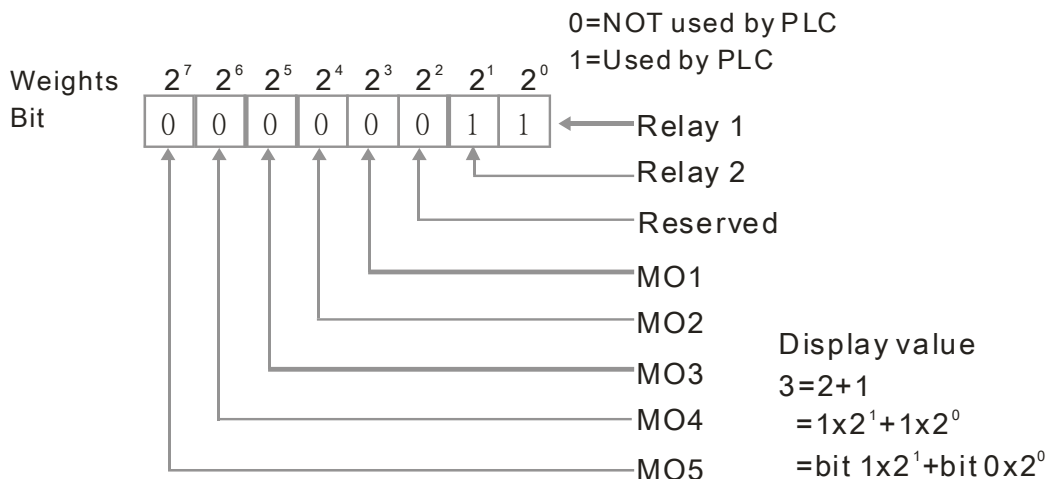

02-54 Display the Frequency Command Executed by External Terminal

Factory Setting: Read only

Settings 0.00~599.00Hz (Read only)

When the source of frequency command comes from the external terminal, if Lv or Fault occurs at this time, the frequency command of the external terminal will be saved in this parameter.

02-55 Reserved

02-56 Release Brake Check Time

Factory Setting: 0.000

Settings .000~65.000 sec.

↗ **02-57** Multi-function output terminal: Function 42: Brake Current Checking Point

Factory setting: 0

Settings 0~100%

↗ **02-58** Multi-function output terminal: Function 42: Brake Frequency Checking Point

Factory setting : 0.00

Settings 0.00~3.00Hz

- 📖 Pr02-32, Pr02-33, Pr02-34, Pr02-57 and Pr02-58 can be applied on setting up cranes. (Choose crane action #42 to set up multi-functional output Pr02-13, Pr02-14, Pr02-16, and Pr02-17)
- 📖 When output current of a drive is higher than the setting of Pr02-33 Pivot Point of the Current (\geq 02-33) and when output frequency is higher than the setting of Pr02-34 Pivot Point of the Frequency (\geq 02-34), choose #42 to set up Multi-functional output Pr02-13, Pr02-14, Pr02-16 and Pr002-17 after the delay time set at Pr402-32.
- 📖 When the Pivot Point of the Current 's setting 02-57 \neq 0 and when the output current of the drive is lower than the setting of Pr02-57 ($<$ 02-57), or when the output frequency is lower than the setting of Pr02-58 ($<$ 02-58), the disable the setting #42 of the multi-functional output Pr02-13, Pr02-14, Pr02-16, Pr02-17
- 📖 When Pr02-57 = 0, the output current is lower than setting of Pr02-33 Pivot Point of the Current($<$ 02-33) or when output frequency is lower than the setting of Pr02-58($<$ 02-58), disable the setting of #42 of the multi-functional output Pr02-13, Pr02-14, Pr02-16, Pr02-17.

02-59

~ Reserved

02-62

02-63 Speed Area Band

Factory Setting: 0.00

Settings 0.00~599.00Hz

02-64

~ Reserved

02-69

02-70 IO Card Type

Factory Setting: Read only

Settings Read only

0: No IO card

1: EMC-BPS01

2: No IO card
3: No IO card
4: EMC-D611A
5: EMC-D42A
6: EMC-R6AA
7: No IO card

03 Analog Input/Output Parameter

✎ This parameter can be set during operation.

✎ 03-00 Analog Input Selection (AVI)	Factory Setting: 1
✎ 03-01 Analog Input Selection (ACI)	Factory Setting: 0
✎ 03-02 Analog Input Selection (AUI)	Factory Setting: 0

Settings

- 0: No function
- 1: Frequency command (torque limit under torque control mode)
- 2: Torque command (torque limit under speed mode)
- 3: Torque compensation command
- 4: PID target value
- 5: PID feedback signal
- 6: PTC thermistor input value
- 7: Positive torque limit
- 8: Negative torque limit
- 9: Regenerative torque limit
- 10: Positive/negative torque limit
- 11: PT100 thermistor input value
- 12: Reserved
- 13: PID Offset (%) (h.)
- 14~20: Reserved

- 📖 When use analog input as PID reference value, Pr00-20 must set 2(analog input).
 Setting method 1: Pr03-00~03-02 set 1 as PID reference input
 Setting method 2: Pr03-00~03-02 set 4 as PID reference input
 If the setting value 1 and set value 4 existed at the same time, AVI input has highest priority to become PID reference input.
- 📖 When use analog input as PID compensation value, Pr08-16 must set 1(Source of PID compensation is analog input). The compensation value can be observed via Pr08-17.
- 📖 When it is frequency command or TQC speed limit, the corresponding value for 0~±10V/4~20mA is 0 – max. output frequency(Pr.01-00)
- 📖 When it is torque command or torque limit, the corresponding value for 0~±10V/4~20mA is 0 – max. output torque (Pr.11-27).
- 📖 When it is torque compensation, the corresponding value for 0~±10V/4~20mA is 0 – rated torque.

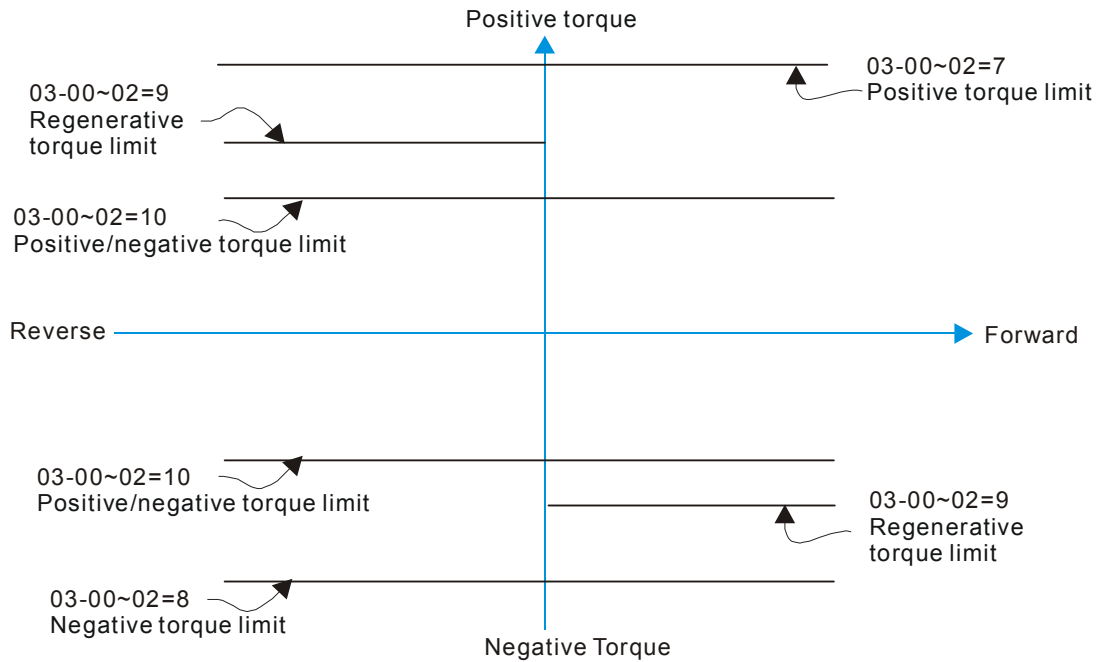

When Pr.03-00~Pr.03-02 have the same setting, then the AVI will be the prioritized selection.

03-03 Analog Input Bias (AVI) Factory Setting: 0

Settings -100.0~100.0%

It is used to set the corresponding AVI voltage of the external analog input 0.

03-04 Analog Input Bias (ACI) Factory Setting: 0

Settings -100.0~100.0%

It is used to set the corresponding ACI voltage of the external analog input 0.

03-05 Analog Voltage Input Bias (AUI) Factory Setting: 0

Settings -100.0~100.0%

It is used to set the corresponding AUI voltage of the external analog input 0.

The relation between external input voltage/current and setting frequency: 0~10V (4-20mA) corresponds to 0-60Hz.

03-06 Reserved

03-07 Positive/negative Bias Mode (AVI)

03-08 Positive/negative Bias Mode (ACI)

03-09 Positive/negative Bias Mode (AUI)

Factory Setting: 0

- Settings
- 0: Zero bias
 - 1: Lower than or equal to bias
 - 2: Greater than or equal to bias
 - 3: The absolute value of the bias voltage while serving as the center
 - 4: Serve bias as the center

 In a noisy environment, it is advantageous to use negative bias to provide a noise margin. It is recommended NOT to use less than 1V to set the operation frequency.

In the diagram below: Black color line: Frequency. Gray color line: Voltage

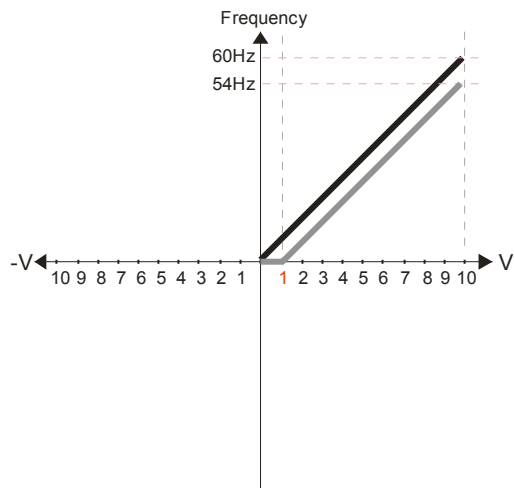

- Pr.03-03=10%
- Pr.03-07~03-09 (Positive/Negative Bias Mode)
 - 0: No bias
 - 1: Lower than or equal to bias
 - 2: Greater than or equal to bias
 - 3: The absolute value of the bias voltage while serving as the center
 - 4: Serve bias as the center
- Pr.03-10 (Analog Frequency Command for Reverse Run)
 - 0: Negative frequency is not valid. Forward and reverse run is controlled by digital keypad or external terminal.
 - 1: Negative frequency is valid. Positive frequency = forward run; negative frequency = reverse run. Direction can not be switched by digital keypad or external terminal control.
- Pr.03-11 Analog Input Gain (AVI)= 100%

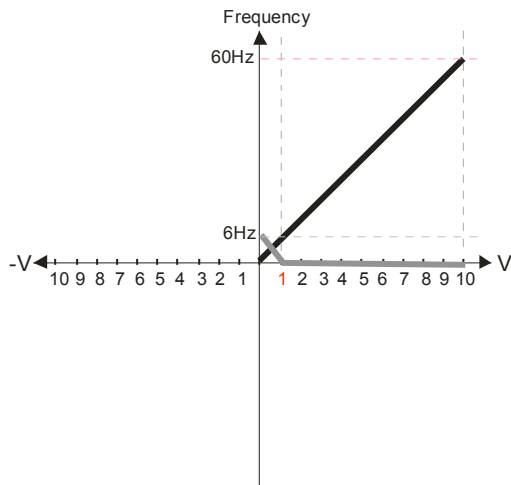

- Pr.03-03=10%
- Pr.03-07~03-09 (Positive/Negative Bias Mode)
 - 0: No bias
 - 1: Lower than or equal to bias
 - 2: Greater than or equal to bias
 - 3: The absolute value of the bias voltage while serving as the center
 - 4: Serve bias as the center
- Pr.03-10 (Analog Frequency Command for Reverse Run)
 - 0: Negative frequency is not valid. Forward and reverse run is controlled by digital keypad or external terminal.
 - 1: Negative frequency is valid. Positive frequency = forward run; negative frequency = reverse run. Direction can not be switched by digital keypad or external terminal control.
- Pr.03-11 Analog Input Gain (AVI)=100%

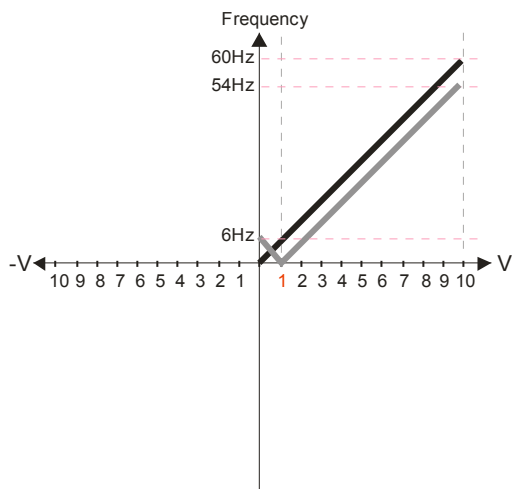

- Pr.03-03=10%
- Pr.03-07~03-09 (Positive/Negative Bias Mode)
 - 0: No bias
 - 1: Lower than or equal to bias
 - 2: Greater than or equal to bias
 - 3: The absolute value of the bias voltage while serving as the center
 - 4: Serve bias as the center
- Pr.03-10 (Analog Frequency Command for Reverse Run)
 - 0: Negative frequency is not valid. Forward and reverse run is controlled by digital keypad or external terminal.
 - 1: Negative frequency is valid. Positive frequency = forward run; negative frequency = reverse run. Direction can not be switched by digital keypad or external terminal control.
- Pr.03-11 Analog Input Gain (AVI) = 100%

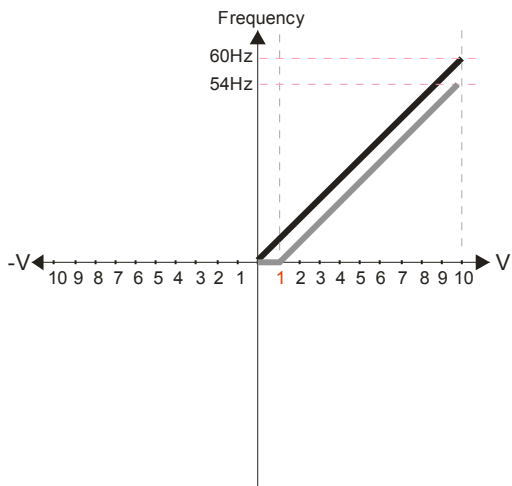

- Pr.03-03=10%
- Pr.03-07~03-09 (Positive/Negative Bias Mode)
 - 0: No bias
 - 1: Lower than or equal to bias
 - 2: Greater than or equal to bias
 - 3: The absolute value of the bias voltage while serving as the center
 - 4: Serve bias as the center

- Pr.03-10 (Analog Frequency Command for Reverse Run)
 - 0: Negative frequency is not valid. Forward and reverse run is controlled by digital keypad or external terminal.
 - 1: Negative frequency is valid. Positive frequency = forward run; negative frequency = reverse run. Direction can not be switched by digital keypad or external terminal control.

Pr.03-11 Analog Input Gain (AVI) = 100%

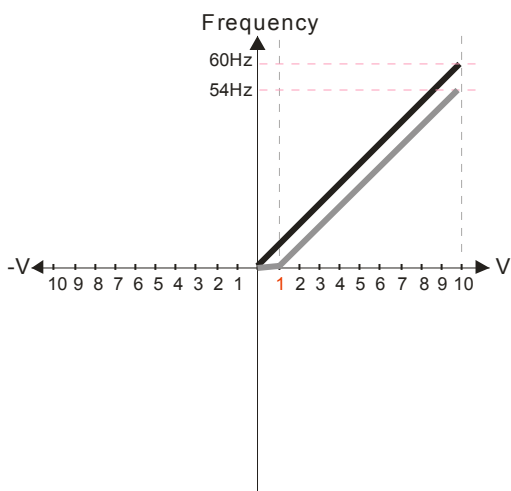

- Pr.03-03=10%
- Pr.03-07~03-09 (Positive/Negative Bias Mode)
 - 0: No bias
 - 1: Lower than or equal to bias
 - 2: Greater than or equal to bias
 - 3: The absolute value of the bias voltage while serving as the center
 - 4: Serve bias as the center

- Pr.03-10 (Analog Frequency Command for Reverse Run)
 - 0: Negative frequency is not valid. Forward and reverse run is controlled by digital keypad or external terminal.
 - 1: Negative frequency is valid. Positive frequency = forward run; negative frequency = reverse run. Direction can not be switched by digital keypad or external terminal control.

Pr.03-11 Analog Input Gain (AVI)= 100%

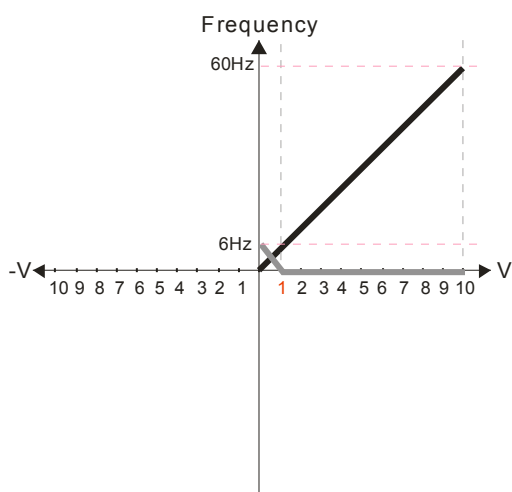

- Pr.03-03=10%
- Pr.03-07~03-09 (Positive/Negative Bias Mode)
 - 0: No bias
 - 1: Lower than or equal to bias
 - 2: Greater than or equal to bias
 - 3: The absolute value of the bias voltage while serving as the center
 - 4: Serve bias as the center

- Pr.03-10 (Analog Frequency Command for Reverse Run)
 - 0: Negative frequency is not valid. Forward and reverse run is controlled by digital keypad or external terminal.
 - 1: Negative frequency is valid. Positive frequency = forward run; negative frequency = reverse run. Direction can not be switched by digital keypad or external terminal control.

Pr.03-11 Analog Input Gain (AVI)= 100%

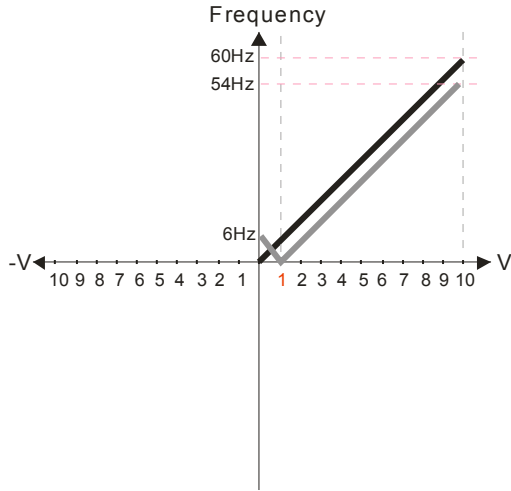

Pr.03-03=10%

Pr.03-07~03-09 (Positive/Negative Bias Mode)

- 0: No bias
- 1: Lower than or equal to bias
- 2: Greater than or equal to bias
- 3: The absolute value of the bias voltage while serving as the center
- 4: Serve bias as the center

Pr.03-10 (Analog Frequency Command for Reverse Run)

- 0: Negative frequency is not valid. Forward and reverse run is controlled by digital keypad or external terminal.
- 1: Negative frequency is valid. Positive frequency = forward run; negative frequency = reverse run. Direction can not be switched by digital keypad or external terminal control.

Pr.03-11 Analog Input Gain (AVI) = 100%

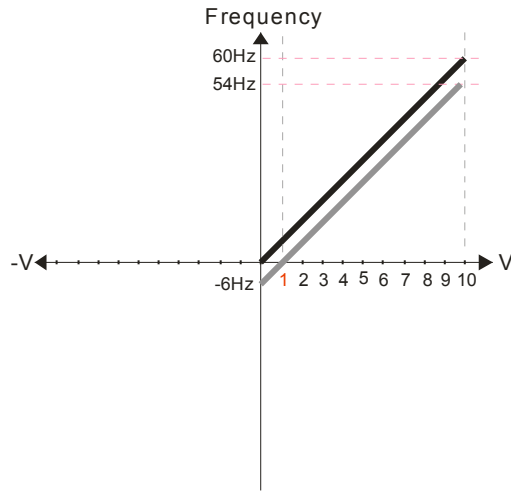

Pr.03-03=10%

Pr.03-07~03-09 (Positive/Negative Bias Mode)

- 0: No bias
- 1: Lower than or equal to bias
- 2: Greater than or equal to bias
- 3: The absolute value of the bias voltage while serving as the center
- 4: Serve bias as the center

Pr.03-10 (Analog Frequency Command for Reverse Run)

- 0: Negative frequency is not valid. Forward and reverse run is controlled by digital keypad or external terminal.
- 1: Negative frequency is valid. Positive frequency = forward run; negative frequency = reverse run. Direction can not be switched by digital keypad or external terminal control.

Pr.03-11 Analog Input Gain (AVI) = 100%

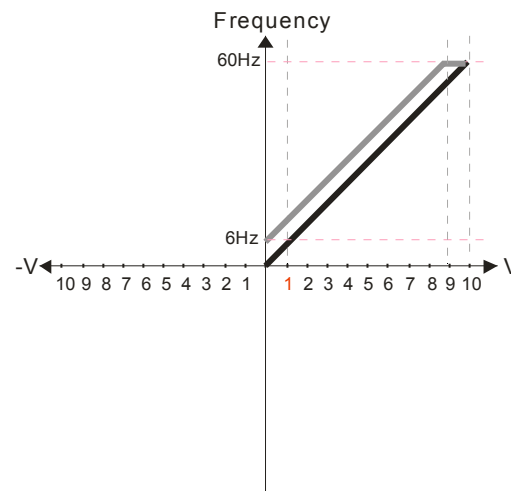

Pr.03-03=-10%

Pr.03-07~03-09 (Positive/Negative Bias Mode)

- 0: No bias
- 1: Lower than or equal to bias
- 2: Greater than or equal to bias
- 3: The absolute value of the bias voltage while serving as the center
- 4: Serve bias as the center

Pr.03-10 (Analog Frequency Command for Reverse Run)

- 0: Negative frequency is not valid. Forward and reverse run is controlled by digital keypad or external terminal.
- 1: Negative frequency is valid. Positive frequency = forward run; negative frequency = reverse run. Direction can not be switched by digital keypad or external terminal control.

Pr.03-11 Analog Input Gain (AVI)= 100%

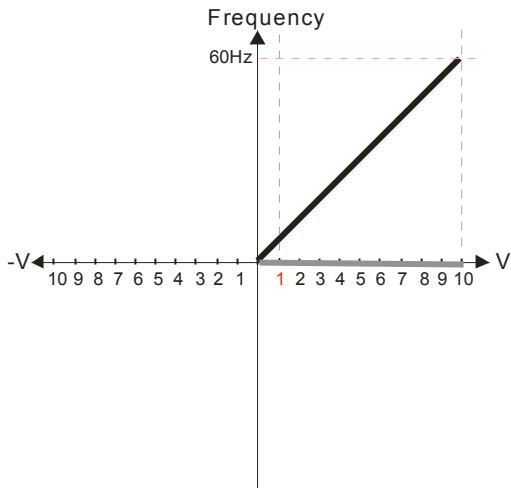

Pr.03-03=-10%
 Pr.03-07~03-09 (Positive/Negative Bias Mode)
 0: No bias
 1: Lower than or equal to bias
 2: Greater than or equal to bias
 3: The absolute value of the bias voltage while serving as the center
 4: Serve bias as the center
 Pr.03-10 (Analog Frequency Command for Reverse Run)
 0: Negative frequency is not valid. Forward and reverse run is controlled by digital keypad or external terminal.
 1: Negative frequency is valid. Positive frequency = forward run; negative frequency = reverse run. Direction can not be switched by digital keypad or external terminal control.
 Pr.03-11 Analog Input Gain (AVI)= 100%

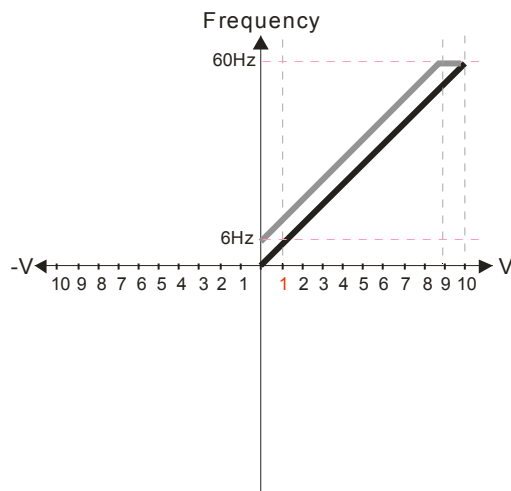

Pr.03-03=-10%
 Pr.03-07~03-09 (Positive/Negative Bias Mode)
 0: No bias
 1: Lower than or equal to bias
 2: Greater than or equal to bias
 3: The absolute value of the bias voltage while serving as the center
 4: Serve bias as the center
 Pr.03-10 (Analog Frequency Command for Reverse Run)
 0: Negative frequency is not valid. Forward and reverse run is controlled by digital keypad or external terminal.
 1: Negative frequency is valid. Positive frequency = forward run; negative frequency = reverse run. Direction can not be switched by digital keypad or external terminal control.
 Pr.03-11 Analog Input Gain (AVI) = 100%

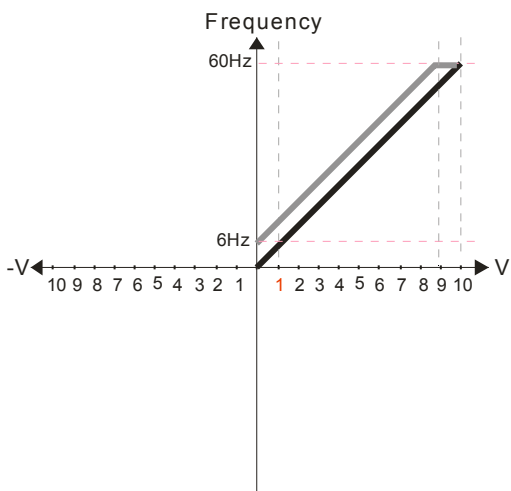

Pr.03-03=-10%
 Pr.03-07~03-09 (Positive/Negative Bias Mode)
 0: No bias
 1: Lower than or equal to bias
 2: Greater than or equal to bias
 3: The absolute value of the bias voltage while serving as the center
 4: Serve bias as the center
 Pr.03-10 (Analog Frequency Command for Reverse Run)
 0: Negative frequency is not valid. Forward and reverse run is controlled by digital keypad or external terminal.
 1: Negative frequency is valid. Positive frequency = forward run; negative frequency = reverse run. Direction can not be switched by digital keypad or external terminal control.
 Pr.03-11 Analog Input Gain (AVI) = 100%

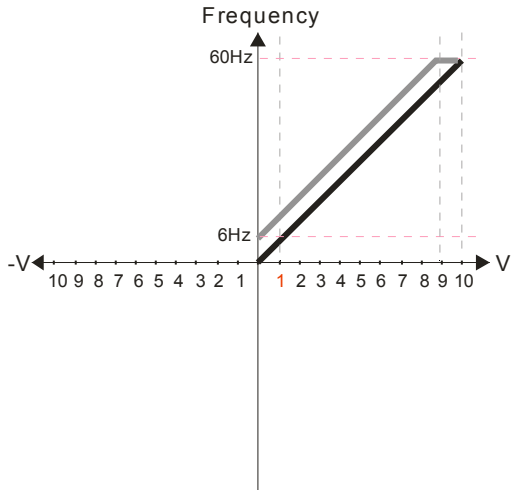

Pr.03-03=-10%

Pr.03-07~03-09 (Positive/Negative Bias Mode)

- 0: No bias
- 1: Lower than or equal to bias
- 2: Greater than or equal to bias
- 3: The absolute value of the bias voltage while serving as the center
- 4: Serve bias as the center

Pr.03-10 (Analog Frequency Command for Reverse Run)

- 0: Negative frequency is not valid. Forward and reverse run is controlled by digital keypad or external terminal.
- 1: Negative frequency is valid. Positive frequency = forward run; negative frequency = reverse run. Direction can not be switched by digital keypad or external terminal control.

Pr.03-11 Analog Input Gain (AVI)= 100%

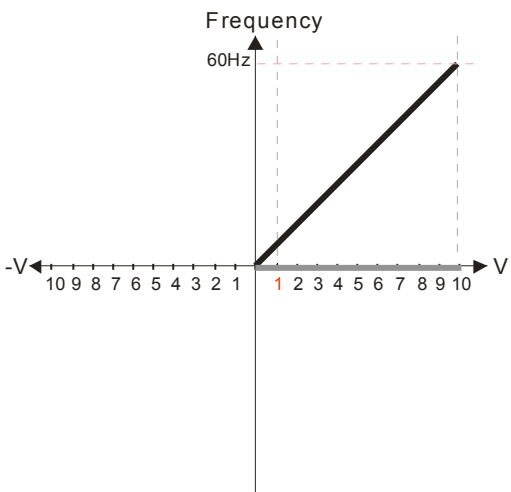

Pr.03-03=-10%

Pr.03-07~03-09 (Positive/Negative Bias Mode)

- 0: No bias
- 1: Lower than or equal to bias
- 2: Greater than or equal to bias
- 3: The absolute value of the bias voltage while serving as the center
- 4: Serve bias as the center

Pr.03-10 (Analog Frequency Command for Reverse Run)

- 0: Negative frequency is not valid. Forward and reverse run is controlled by digital keypad or external terminal.
- 1: Negative frequency is valid. Positive frequency = forward run; negative frequency = reverse run. Direction can not be switched by digital keypad or external terminal control.

Pr.03-11 Analog Input Gain (AVI)= 100%

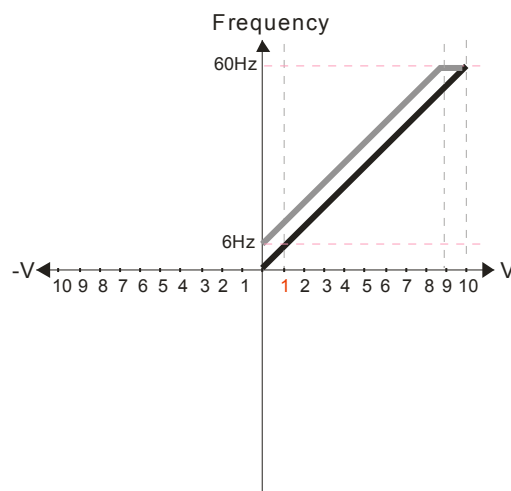

Pr.03-03=-10%

Pr.03-07~03-09 (Positive/Negative Bias Mode)

- 0: No bias
- 1: Lower than or equal to bias
- 2: Greater than or equal to bias
- 3: The absolute value of the bias voltage while serving as the center
- 4: Serve bias as the center

Pr.03-10 (Analog Frequency Command for Reverse Run)

- 0: Negative frequency is not valid. Forward and reverse run is controlled by digital keypad or external terminal.
- 1: Negative frequency is valid. Positive frequency = forward run; negative frequency = reverse run. Direction can not be switched by digital keypad or external terminal control.

Pr.03-11 Analog Input Gain (AVI) = 100%

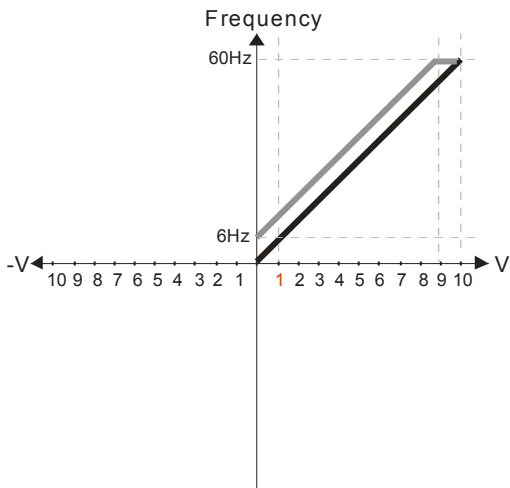

- Pr.03-03=-10%
- Pr.03-07~03-09 (Positive/Negative Bias Mode)
 - 0: No bias
 - 1: Lower than or equal to bias
 - 2: Greater than or equal to bias
 - 3: The absolute value of the bias voltage while serving as the center
 - 4: Serve bias as the center

- Pr.03-10 (Analog Frequency Command for Reverse Run)
 - 0: Negative frequency is not valid. Forward and reverse run is controlled by digital keypad or external terminal.
 - 1: Negative frequency is valid. Positive frequency = forward run; negative frequency = reverse run. Direction can not be switched by digital keypad or external terminal control.

Pr.03-11 Analog Input Gain (AVI) = 100%

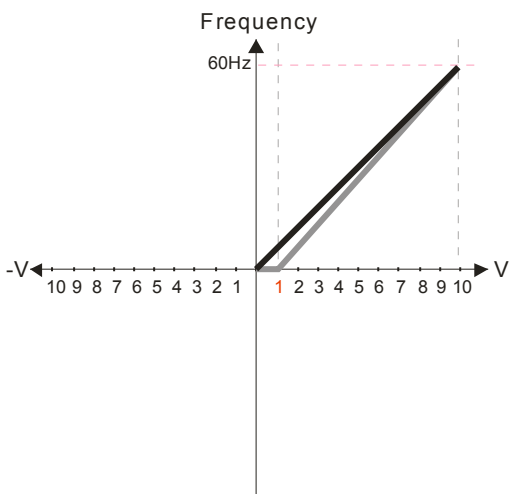

- Pr.03-03=-10%
- Pr.03-07~03-09 (Positive/Negative Bias Mode)
 - 0: No bias
 - 1: Lower than or equal to bias
 - 2: Greater than or equal to bias
 - 3: The absolute value of the bias voltage while serving as the center
 - 4: Serve bias as the center

- Pr.03-10 (Analog Frequency Command for Reverse Run)
 - 0: Negative frequency is not valid. Forward and reverse run is controlled by digital keypad or external terminal.
 - 1: Negative frequency is valid. Positive frequency = forward run; negative frequency = reverse run. Direction can not be switched by digital keypad or external terminal control.

Pr.03-11 Analog Input Gain (AVI)= 111.1%
10/9=111.1%

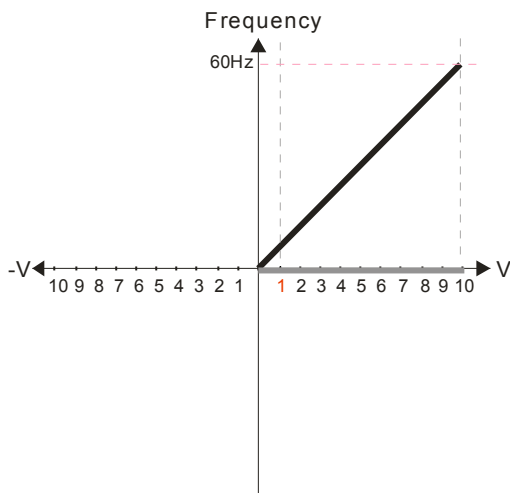

- Pr.03-03=10%
- Pr.03-07~03-09 (Positive/Negative Bias Mode)
 - 0: No bias
 - 1: Lower than or equal to bias
 - 2: Greater than or equal to bias
 - 3: The absolute value of the bias voltage while serving as the center
 - 4: Serve bias as the center

- Pr.03-10 (Analog Frequency Command for Reverse Run)
 - 0: Negative frequency is not valid. Forward and reverse run is controlled by digital keypad or external terminal.
 - 1: Negative frequency is valid. Positive frequency = forward run; negative frequency = reverse run. Direction can not be switched by digital keypad or external terminal control.

Pr.03-11 Analog Input Gain (AVI)=111.1%
10/9 = 111.1%

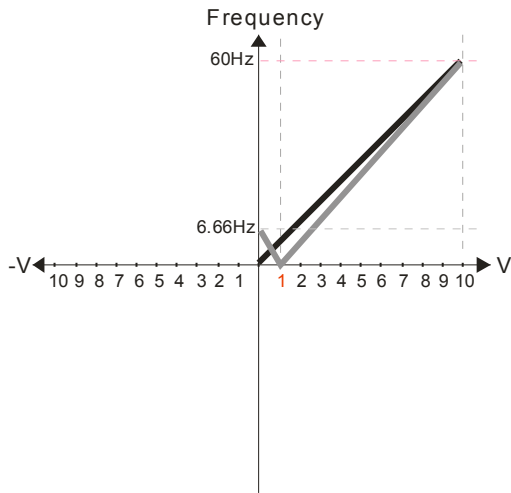

Pr.03-03=10%

Pr.03-07~03-09 (Positive/Negative Bias Mode)

- 0: No bias
- 1: Lower than or equal to bias
- 2: Greater than or equal to bias
- 3: The absolute value of the bias voltage while serving as the center
- 4: Serve bias as the center

Pr.03-10 (Analog Frequency Command for Reverse Run)

- 0: Negative frequency is not valid. Forward and reverse run is controlled by digital keypad or external terminal.
- 1: Negative frequency is valid. Positive frequency = forward run; negative frequency = reverse run. Direction can not be switched by digital keypad or external terminal control.

Pr.03-11 Analog Input Gain (AVI) = 111.1%
 $10/9 = 111.1\%$

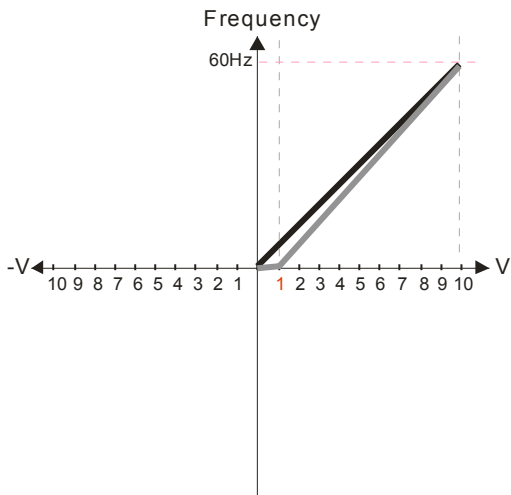

Pr.03-03=10%

Pr.03-07~03-09 (Positive/Negative Bias Mode)

- 0: No bias
- 1: Lower than or equal to bias
- 2: Greater than or equal to bias
- 3: The absolute value of the bias voltage while serving as the center
- 4: Serve bias as the center

Pr.03-10 (Analog Frequency Command for Reverse Run)

- 0: Negative frequency is not valid. Forward and reverse run is controlled by digital keypad or external terminal.
- 1: Negative frequency is valid. Positive frequency = forward run; negative frequency = reverse run. Direction can not be switched by digital keypad or external terminal control.

Pr.03-11 Analog Input Gain (AVI) = 111.1%
 $10/9 = 111.1\%$

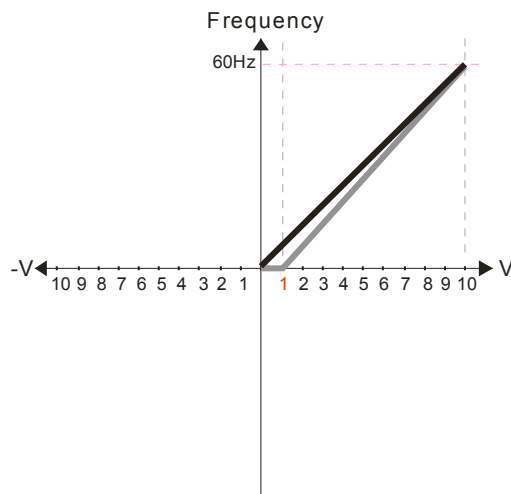

Pr.03-03=10%

Pr.03-07~03-09 (Positive/Negative Bias Mode)

- 0: No bias
- 1: Lower than or equal to bias
- 2: Greater than or equal to bias
- 3: The absolute value of the bias voltage while serving as the center
- 4: Serve bias as the center

Pr.03-10 (Analog Frequency Command for Reverse Run)

- 0: Negative frequency is not valid. Forward and reverse run is controlled by digital keypad or external terminal.
- 1: Negative frequency is valid. Positive frequency = forward run; negative frequency = reverse run. Direction can not be switched by digital keypad or external terminal control.

Pr.03-11 Analog Input Gain (AVI) = 111.1%
 $10/9 = 111.1\%$

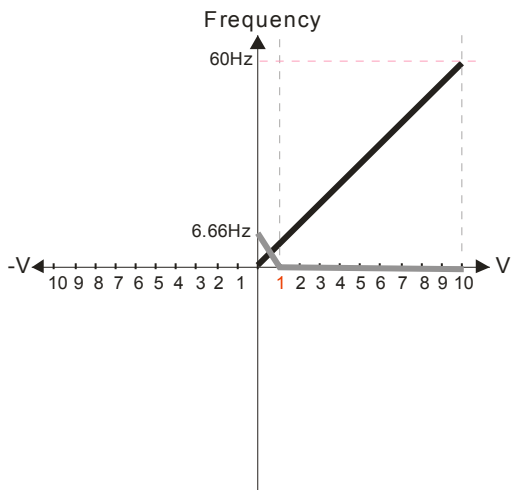

- Pr.03-03=10%
- Pr.03-07~03-09 (Positive/Negative Bias Mode)
 - 0: No bias
 - 1: Lower than or equal to bias
 - 2: Greater than or equal to bias
 - 3: The absolute value of the bias voltage while serving as the center
 - 4: Serve bias as the center

- Pr.03-10 (Analog Frequency Command for Reverse Run)
 - 0: Negative frequency is not valid. Forward and reverse run is controlled by digital keypad or external terminal.
 - 1: Negative frequency is valid. Positive frequency = forward run; negative frequency = reverse run. Direction can not be switched by digital keypad or external terminal control.

Pr03-11 Analog Input Gain (AVI) = 111.1%
 $10/9 = 111.1\%$

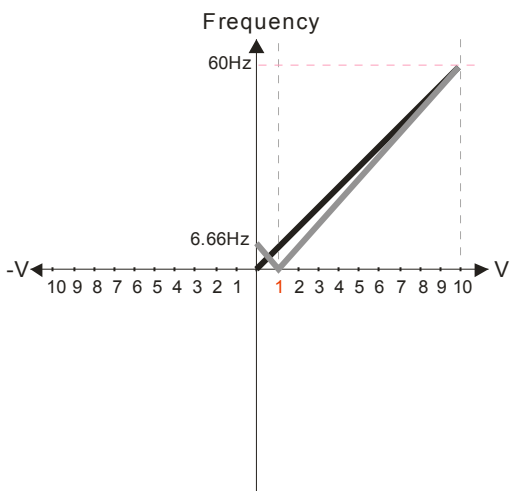

- Pr.03-03=10%
- Pr.03-07~03-09 (Positive/Negative Bias Mode)
 - 0: No bias
 - 1: Lower than or equal to bias
 - 2: Greater than or equal to bias
 - 3: The absolute value of the bias voltage while serving as the center
 - 4: Serve bias as the center

- Pr.03-10 (Analog Frequency Command for Reverse Run)
 - 0: Negative frequency is not valid. Forward and reverse run is controlled by digital keypad or external terminal.
 - 1: Negative frequency is valid. Positive frequency = forward run; negative frequency = reverse run. Direction can not be switched by digital keypad or external terminal control.

Pr03-11 Analog Input Gain (AVI) = 111.1%
 $10/9 = 111.1\%$

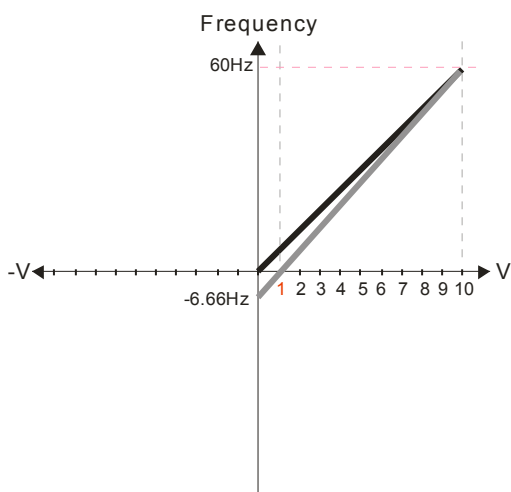

- Pr.03-03=10%
- Pr.03-07~03-09 (Positive/Negative Bias Mode)
 - 0: No bias
 - 1: Lower than or equal to bias
 - 2: Greater than or equal to bias
 - 3: The absolute value of the bias voltage while serving as the center
 - 4: Serve bias as the center

- Pr.03-10 (Analog Frequency Command for Reverse Run)
 - 0: Negative frequency is not valid. Forward and reverse run is controlled by digital keypad or external terminal.
 - 1: Negative frequency is valid. Positive frequency = forward run; negative frequency = reverse run. Direction can not be switched by digital keypad or external terminal control.

Pr03-11 Analog Input Gain (AVI) = 100%
 $10/9 = 111.1\%$

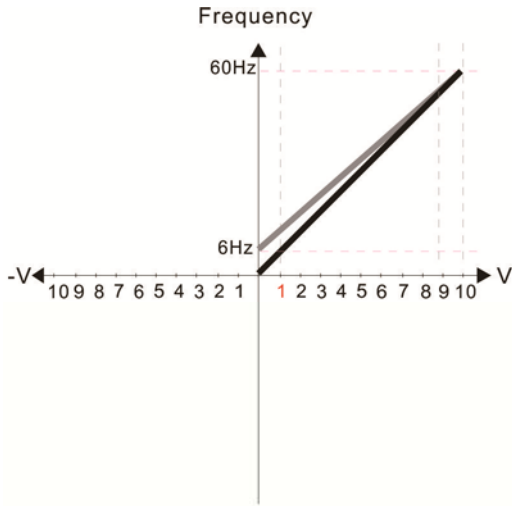

Pr.03-07~03-09 (Positive/Negative Bias Mode)

- 0: No bias
- 1: Lower than or equal to bias
- 2: Greater than or equal to bias
- 3: The absolute value of the bias voltage while serving as the center
- 4: Serve bias as the center

Pr.03-10 (Analog Frequency Command for Reverse Run)

- 0: Negative frequency is not valid. Forward and reverse run is controlled by digital keypad or external terminal.
- 1: Negative frequency is valid. Positive frequency = forward run; negative frequency = reverse run. Direction can not be switched by digital keypad or external terminal control.

Calculate the bias:

$$\frac{60-6\text{Hz}}{10\text{V}} = \frac{6-0\text{Hz}}{(0-X\text{V})} \quad X\text{V} = \frac{100}{-9} = -1.11\text{V} \quad \therefore 03-03 = \frac{-1.11}{10} \times 100\% = -11.1\%$$

Calculate the gain: $03-11 = \frac{10\text{V}}{11.1\text{V}} \times 100\% = 90.0\%$

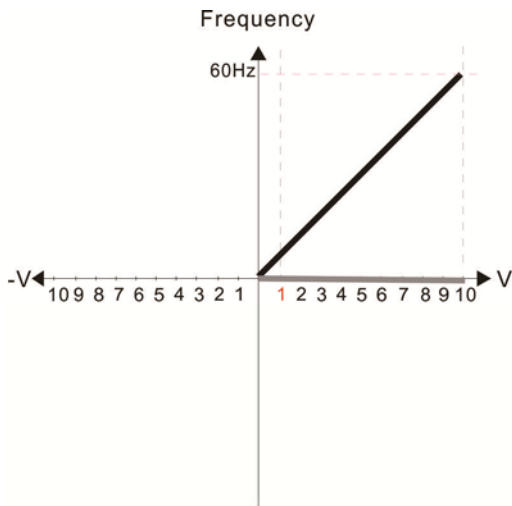

Pr.03-07~03-09 (Positive/Negative Bias Mode)

- 0: No bias
- 1: Lower than or equal to bias
- 2: Greater than or equal to bias
- 3: The absolute value of the bias voltage while serving as the center
- 4: Serve bias as the center

Pr.03-10 (Analog Frequency Command for Reverse Run)

- 0: Negative frequency is not valid. Forward and reverse run is controlled by digital keypad or external terminal.
- 1: Negative frequency is valid. Positive frequency = forward run; negative frequency = reverse run. Direction can not be switched by digital keypad or external terminal control.

Calculate the bias:

$$\frac{60-6\text{Hz}}{10\text{V}} = \frac{6-0\text{Hz}}{(0-X\text{V})} \quad X\text{V} = \frac{100}{-9} = -1.11\text{V} \quad \therefore 03-03 = \frac{-1.11}{10} \times 100\% = -11.1\%$$

Calculate the gain: $03-11 = \frac{10\text{V}}{11.1\text{V}} \times 100\% = 90.0\%$

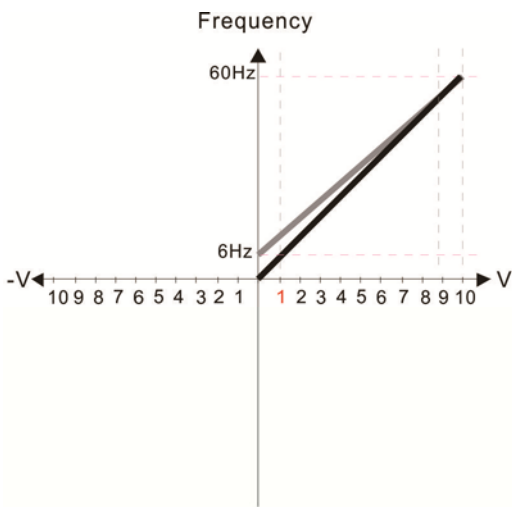

Pr.03-07~03-09 (Positive/Negative Bias Mode)

- 0: No bias
- 1: Lower than or equal to bias
- 2: Greater than or equal to bias
- 3: The absolute value of the bias voltage while serving as the center
- 4: Serve bias as the center

Pr.03-10 (Analog Frequency Command for Reverse Run)

- 0: Negative frequency is not valid. Forward and reverse run is controlled by digital keypad or external terminal.
- 1: Negative frequency is valid. Positive frequency = forward run; negative frequency = reverse run. Direction can not be switched by digital keypad or external terminal control.

Calculate the bias:

$$\frac{60-6\text{Hz}}{10\text{V}} = \frac{6-0\text{Hz}}{(0-X\text{V})} \quad X\text{V} = \frac{100}{-9} = -1.11\text{V} \quad \therefore 03-03 = \frac{-1.11}{10} \times 100\% = -11.1\%$$

Calculate the gain: $03-11 = \frac{10\text{V}}{11.1\text{V}} \times 100\% = 90.0\%$

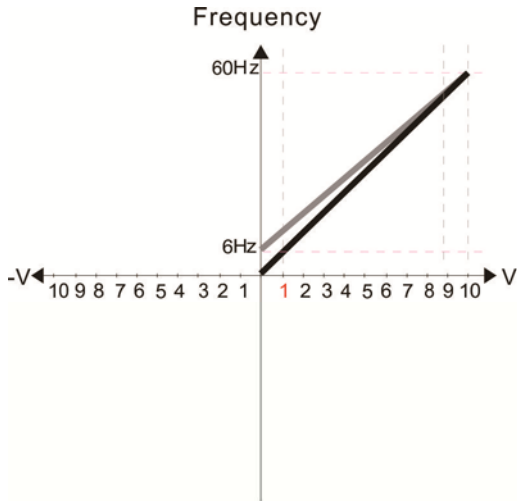

Pr.03-07~03-09 (Positive/Negative Bias Mode)

- 0: No bias
- 1: Lower than or equal to bias
- 2: Greater than or equal to bias
- 3: The absolute value of the bias voltage while serving as the center
- 4: Serve bias as the center

Pr.03-10 (Analog Frequency Command for Reverse Run)

- 0: Negative frequency is not valid. Forward and reverse run is controlled by digital keypad or external terminal.
- 1: Negative frequency is valid. Positive frequency = forward run; negative frequency = reverse run. Direction can not be switched by digital keypad or external terminal control.

Calculate the bias:

$$\frac{60-6\text{Hz}}{10\text{V}} = \frac{6-0\text{Hz}}{(0-X\text{V})} \quad X\text{V} = \frac{100}{-9} = -1.11\text{V} \quad \therefore 03-03 = \frac{-1.11}{10} \times 100\% = -11.1\%$$

Calculate the gain: $03-11 = \frac{10\text{V}}{11.1\text{V}} \times 100\% = 90.0\%$

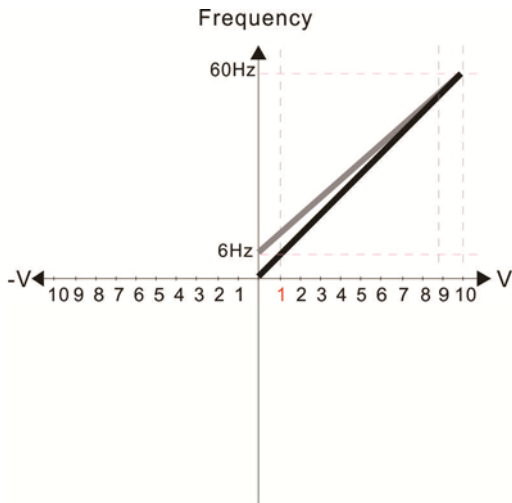

Pr.03-07~03-09 (Positive/Negative Bias Mode)

- 0: No bias
- 1: Lower than or equal to bias
- 2: Greater than or equal to bias
- 3: The absolute value of the bias voltage while serving as the center
- 4: Serve bias as the center

Pr.03-10 (Analog Frequency Command for Reverse Run)

- 0: Negative frequency is not valid. Forward and reverse run is controlled by digital keypad or external terminal.
- 1: Negative frequency is valid. Positive frequency = forward run; negative frequency = reverse run. Direction can not be switched by digital keypad or external terminal control.

Calculate the bias:

$$\frac{60-6\text{Hz}}{10\text{V}} = \frac{6-0\text{Hz}}{(0-X\text{V})} \quad X\text{V} = \frac{100}{-9} = -1.11\text{V} \quad \therefore 03-03 = \frac{-1.11}{10} \times 100\% = -11.1\%$$

Calculate the gain: $03-11 = \frac{10\text{V}}{11.1\text{V}} \times 100\% = 90.0\%$

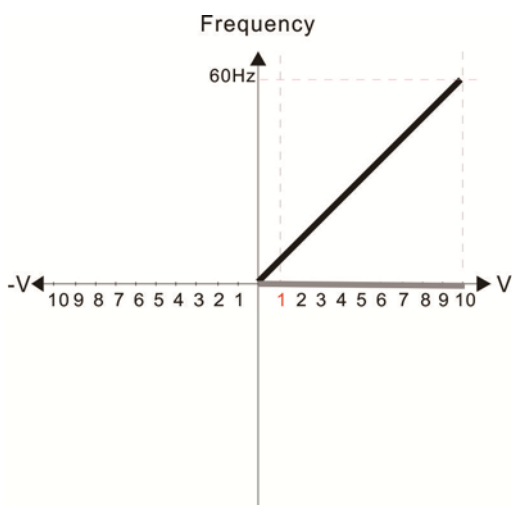

Pr.03-07~03-09 (Positive/Negative Bias Mode)

- 0: No bias
- 1: Lower than or equal to bias
- 2: Greater than or equal to bias
- 3: The absolute value of the bias voltage while serving as the center
- 4: Serve bias as the center

Pr.03-10 (Analog Frequency Command for Reverse Run)

- 0: Negative frequency is not valid. Forward and reverse run is controlled by digital keypad or external terminal.
- 1: Negative frequency is valid. Positive frequency = forward run; negative frequency = reverse run. Direction can not be switched by digital keypad or external terminal control.

Calculate the bias:

$$\frac{60-6\text{Hz}}{10\text{V}} = \frac{6-0\text{Hz}}{(0-X\text{V})} \quad X\text{V} = \frac{100}{-9} = -1.11\text{V} \quad \therefore 03-03 = \frac{-1.11}{10} \times 100\% = -11.1\%$$

Calculate the gain: $03-11 = \frac{10\text{V}}{11.1\text{V}} \times 100\% = 90.0\%$

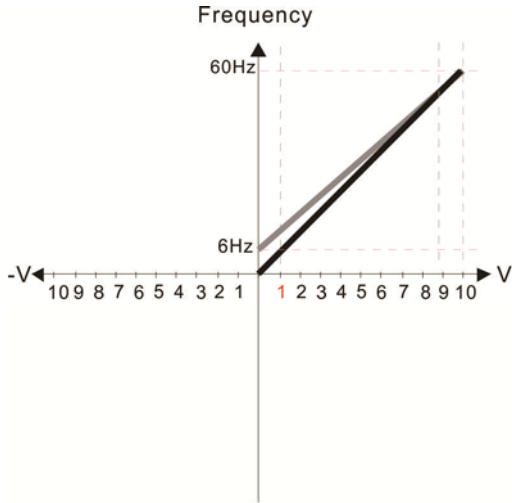

Pr.03-07~03-09 (Positive/Negative Bias Mode)

- 0: No bias
- 1: Lower than or equal to bias
- 2: Greater than or equal to bias
- 3: The absolute value of the bias voltage while serving as the center
- 4: Serve bias as the center

Pr.03-10 (Analog Frequency Command for Reverse Run)

- 0: Negative frequency is not valid. Forward and reverse run is controlled by digital keypad or external terminal.
- 1: Negative frequency is valid. Positive frequency = forward run; negative frequency = reverse run. Direction can not be switched by digital keypad or external terminal control.

Calculate the bias:

$$\frac{60-6\text{Hz}}{10\text{V}} = \frac{6-0\text{Hz}}{(0-X\text{V})} \quad X\text{V} = \frac{100}{-9} = -1.11\text{V} \quad \therefore 03-03 = \frac{-1.11}{10} \times 100\% = -11.1\%$$

Calculate the gain: $03-11 = \frac{10\text{V}}{11.1\text{V}} \times 100\% = 90.0\%$

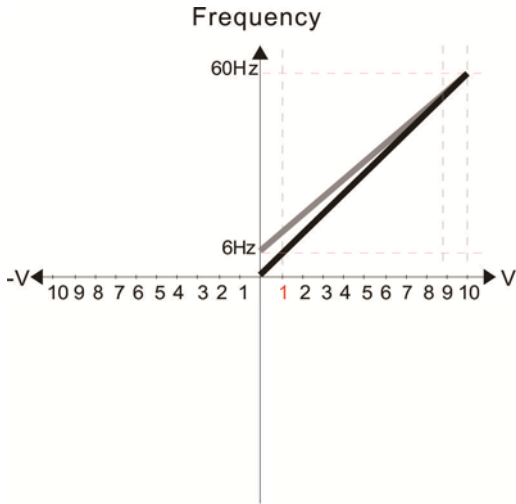

Pr.03-07~03-09 (Positive/Negative Bias Mode)

- 0: No bias
- 1: Lower than or equal to bias
- 2: Greater than or equal to bias
- 3: The absolute value of the bias voltage while serving as the center
- 4: Serve bias as the center

Pr.03-10 (Analog Frequency Command for Reverse Run)

- 0: Negative frequency is not valid. Forward and reverse run is controlled by digital keypad or external terminal.
- 1: Negative frequency is valid. Positive frequency = forward run; negative frequency = reverse run. Direction can not be switched by digital keypad or external terminal control.

Calculate the bias:

$$\frac{60-6\text{Hz}}{10\text{V}} = \frac{6-0\text{Hz}}{(0-X\text{V})} \quad X\text{V} = \frac{100}{-9} = -1.11\text{V} \quad \therefore 03-03 = \frac{-1.11}{10} \times 100\% = -11.1\%$$

Calculate the gain: $03-11 = \frac{10\text{V}}{11.1\text{V}} \times 100\% = 90.0\%$

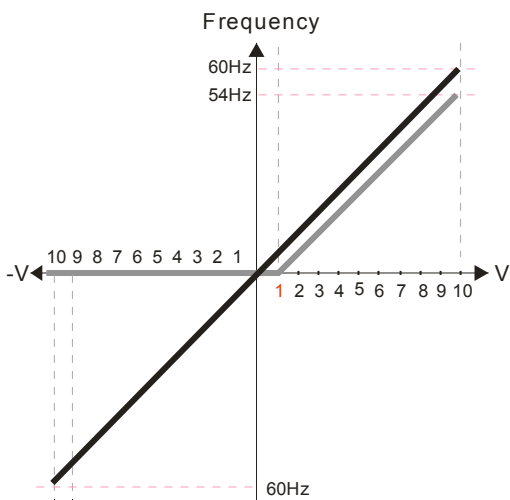

Pr.00-21=0 (Digital keypad control and run in FWD direction)

Pr.03-05 Analog Positive Voltage Input Bias (AUI) = 10%

Pr.03-07~03-09 (Positive/Negative Bias Mode)

- 0: No bias
- 1: Lower than or equal to bias
- 2: Greater than or equal to bias
- 3: The absolute value of the bias voltage while serving as the center
- 4: Serve bias as the center

Pr.03-10 (Analog Frequency Command for Reverse Run)

- 0: Negative frequency is not valid. Forward and reverse run is controlled by digital keypad or external terminal.
- 1: Negative frequency is valid. Positive frequency = forward run; negative frequency = reverse run. Direction can not be switched by digital keypad or external terminal control.

Pr.00-13 Analog Positive Input Gain (AUI) = 100%

Pr.03-14 Analog Negative Input Gain (AUI) = 100%

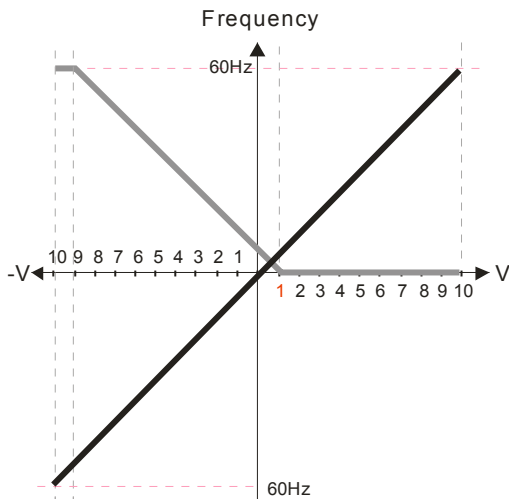

- Pr.00-21=0 (Digital keypad control and d run in FWD direction)
 Pr.03-05 Analog Positive Voltage Input Bias (AUI) = 10%
 Pr.03-07~03-09 (Positive/Negative Bias Mode)
- 0: No bias
 - 1: Lower than or equal to bias
 - 2: Greater than or equal to bias
 - 3: The absolute value of the bias voltage while serving as the center
 - 4: Serve bias as the center

- Pr.03-10 (Analog Frequency Command for Reverse Run)
- 0: Negative frequency is not valid. Forward and reverse run is controlled by digital keypad or external terminal.
 - 1: Neagtive frequency is valid. Positive frequency = forward run; negative frequency = reverse run. Direction can not be switched by digital keypad or external teriminal control.

Pr.00-13 Analog Positive Input Gain (AUI)= 100%
 Pr.03-14 Analog Negative Input Gain (AUI)= 100%

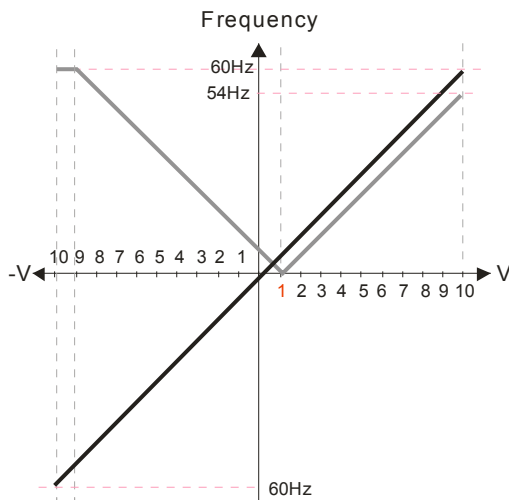

- Pr.00-21=0 (Dgital keypad control and d run in FWD direction)
 Pr.03-05 Analog Positive Voltage Input Bias (AUI) = 10%
 Pr.03-07~03-09 (Positive/Negative Bias Mode)
- 0: No bias
 - 1: Lower than or equal to bias
 - 2: Greater than or equal to bias
 - 3: The absolute value of the bias voltage while serving as the center
 - 4: Serve bias as the center

- Pr.03-10 (Analog Frequency Command for Reverse Run)
- 0: Negative frequency is not valid. Forward and reverse run is controlled by digital keypad or external terminal.
 - 1: Neagtive frequency is valid. Positive frequency = forward run; negative frequency = reverse run. Direction can not be switched by digital keypad or external teriminal control.

Pr.00-13 Analog Positive Input Gain (AUI)= 100%
 Pr.03-14 Analog Negative Input Gain (AUI)= 100%

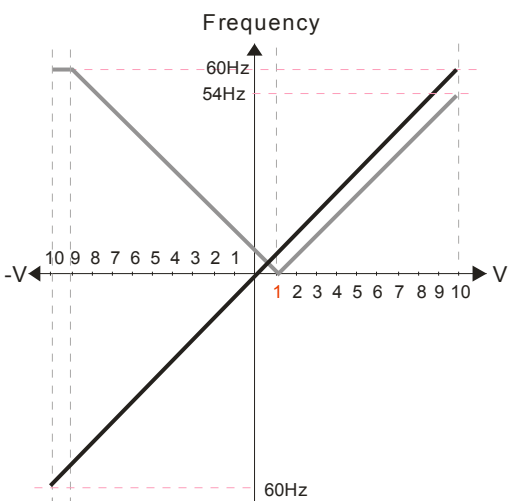

- Pr.00-21=0 (Dgital keypad control and d run in FWD direction)
 Pr.03-05 Analog Positive Voltage Input Bias (AUI) = 10%
 Pr.03-07~03-09 (Positive/Negative Bias Mode)
- 0: No bias
 - 1: Lower than or equal to bias
 - 2: Greater than or equal to bias
 - 3: The absolute value of the bias voltage while serving as the center
 - 4: Serve bias as the center

- Pr.03-10 (Analog Frequency Command for Reverse Run)
- 0: Negative frequency is not valid. Forward and reverse run is controlled by digital keypad or external terminal.
 - 1: Neagtive frequency is valid. Positive frequency = forward run; negative frequency = reverse run. Direction can not be switched by digital keypad or external teriminal control.

Pr.00-13 Analog Positive Input Gain (AUI)= 100%
 Pr.03-14 Analog Negative Input Gain (AUI)= 100%

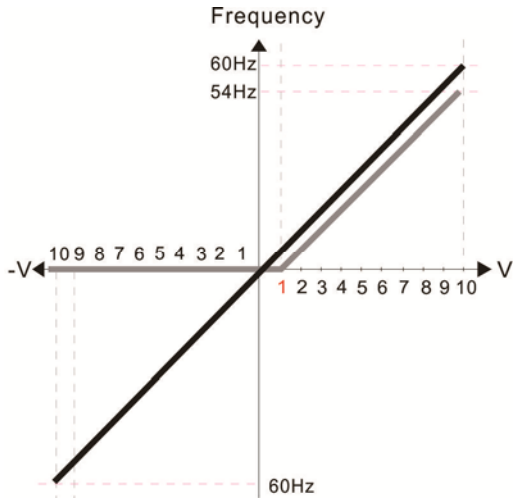

Pr.00-21=0 (Digital keypad control and run in FWD direction)

Pr.03-05 Analog Positive Voltage Input Bias (AUI) = 10%

Pr.03-07~03-09 (Positive/Negative Bias Mode)

0: No bias

1: Lower than or equal to bias

2: Greater than or equal to bias

3: The absolute value of the bias voltage while serving as the center

4: Serve bias as the center

Pr.03-13 Analog Positive Input Gain (AUI)= 100%

Pr.03-14 Analog Negative Input Gain (AUI)= 100%

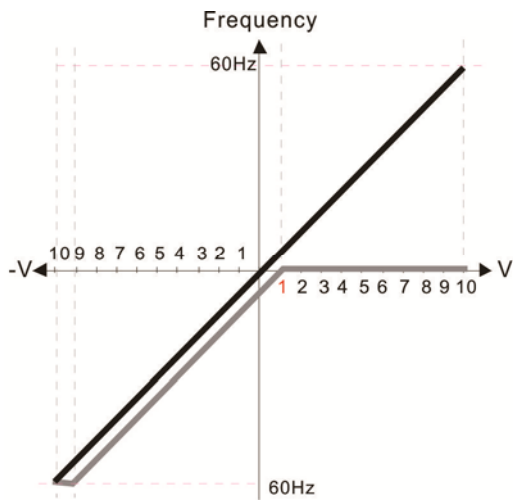

Pr.00-21=0 (Digital keypad control and run in FWD direction)

Pr.03-05 Analog Positive Voltage Input Bias (AUI) = 10%

Pr.03-07~03-09 (Positive/Negative Bias Mode)

0: No bias

1: Lower than or equal to bias

2: Greater than or equal to bias

3: The absolute value of the bias voltage while serving as the center

4: Serve bias as the center

Pr.03-13 Analog Positive Input Gain (AUI)= 100%

Pr.03-14 Analog Negative Input Gain (AUI)= 100%

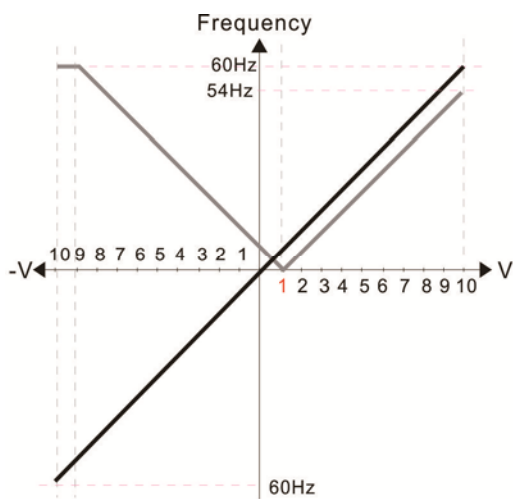

Pr.00-21=0 (Digital keypad control and run in FWD direction)

Pr.03-05 Analog Positive Voltage Input Bias (AUI) = 10%

Pr.03-07~03-09 (Positive/Negative Bias Mode)

0: No bias

1: Lower than or equal to bias

2: Greater than or equal to bias

3: The absolute value of the bias voltage while serving as the center

4: Serve bias as the center

Pr.03-13 Analog Positive Input Gain (AUI)= 100%

Pr.03-14 Analog Negative Input Gain (AUI)= 100%

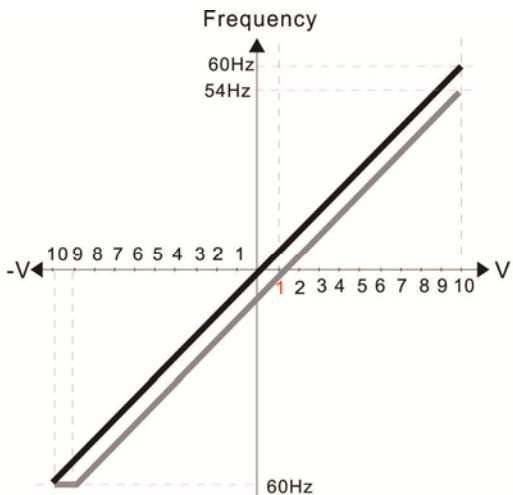

Pr.00-21=0 (Digital keypad control and run in FWD direction)
 Pr.03-05 Analog Positive Voltage Input Bias (AUI) = 10%

- Pr.03-07~03-09 (Positive/Negative Bias Mode)
- 0: No bias
 - 1: Lower than or equal to bias
 - 2: Greater than or equal to bias
 - 3: The absolute value of the bias voltage while serving as the center
 - 4: Serve bias as the center

Pr.03-13 Analog Positive Input Gain (AUI)= 100%
 Pr.03-14 Analog Negative Input Gain (AUI)= 100%

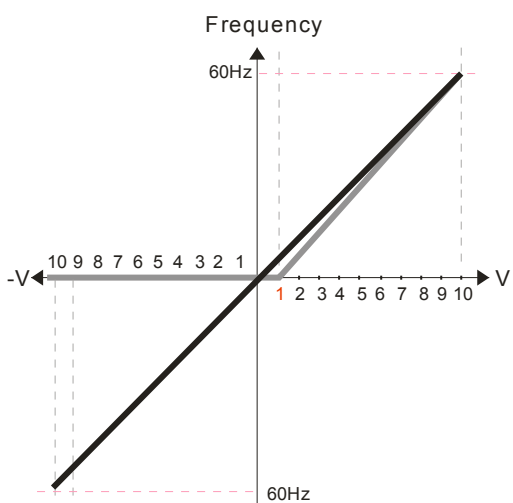

Pr.00-21=0 (Digital keypad control and run in FWD direction)
 Pr.03-05 Analog Positive Voltage Input Bias (AUI) = 10%

- Pr.03-07~03-09 (Positive/Negative Bias Mode)
- 0: No bias
 - 1: Lower than or equal to bias
 - 2: Greater than or equal to bias
 - 3: The absolute value of the bias voltage while serving as the center
 - 4: Serve bias as the center

- Pr.03-10 (Analog Frequency Command for Reverse Run)
- 0: Negative frequency is not valid. Forward and reverse run is controlled by digital keypad or external terminal.
 - 1: Neagative frequency is valid. Positive frequency = forward run; negative frequency = reverse run. Direction can not be switched by digital keypad or external teriminal control.

Pr.00-13 Analog Positive Input Gain (AUI)= 111.1%
 $(10/9) * 100\% = 111.1\%$
 Pr.00-14 Analog Negative Input Gain (AUI) = 100%

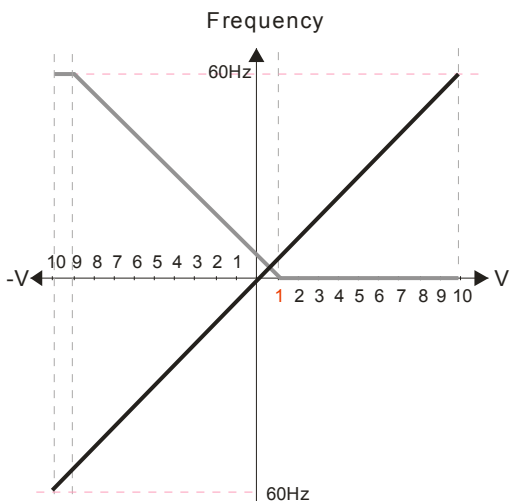

Pr.00-21=0 (Digital keypad control and run in FWD direction)

Pr.03-05 Analog Positive Voltage Input Bias (AUI) = 10%
 Pr.03-07~03-09 (Positive/Negative Bias Mode)

- 0: No bias
- 1: Lower than or equal to bias
- 2: Greater than or equal to bias
- 3: The absolute value of the bias voltage while serving as the center
- 4: Serve bias as the center

- Pr.03-10 (Analog Frequency Command for Reverse Run)
- 0: Negative frequency is not valid. Forward and reverse run is controlled by digital keypad or external terminal.
 - 1: Neagative frequency is valid. Positive frequency = forward run; negative frequency = reverse run. Direction can not be switched by digital keypad or external teriminal control.

Pr.00-13 Analog Positive Input Gain (AUI)= 111.1%
 $(10/9) * 100\% = 111.1\%$
 Pr.00-14 Analog Negative Input Gain (AUI) = 100%

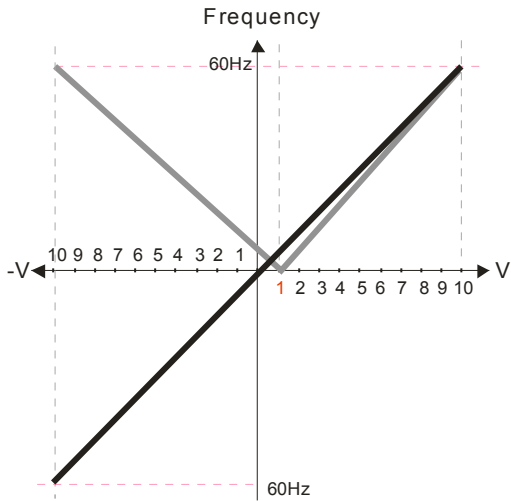

Pr.00-21=0 (Digital keypad control and run in FWD direction)
 Pr.03-05 Analog Positive Voltage Input Bias (AUI) = 10%
 Pr.03-07~03-09 (Positive/Negative Bias Mode)
 0: No bias
 1: Lower than or equal to bias
 2: Greater than or equal to bias
 3: The absolute value of the bias voltage while serving as the center
 4: Serve bias as the center

Pr.03-10 (Analog Frequency Command for Reverse Run)
 0: Negative frequency is not valid. Forward and reverse run is controlled by digital keypad or external terminal.
 1: Negative frequency is valid. Positive frequency = forward run; negative frequency = reverse run. Direction can not be switched by digital keypad or external terminal control.

Pr.00-13 Analog Positive Input Gain (AUI)= 111.1%
 $(10/9) * 100\% = 111.1\%$
 Pr.00-14 Analog Negative Input Gain (AUI) = 100%

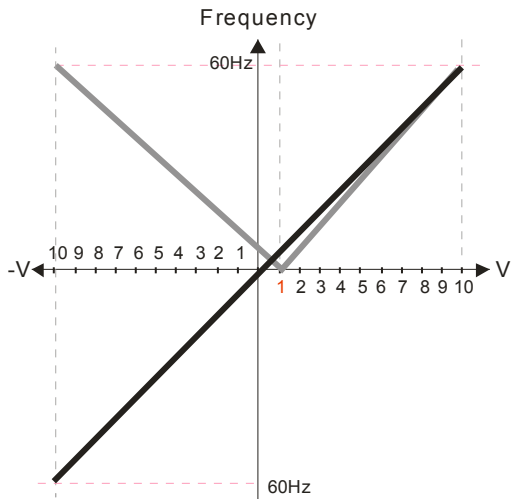

Pr.00-21=0 (Digital keypad control and run in FWD direction)
 Pr.03-05 Analog Positive Voltage Input Bias (AUI) = 10%
 Pr.03-07~03-09 (Positive/Negative Bias Mode)
 0: No bias
 1: Lower than or equal to bias
 2: Greater than or equal to bias
 3: The absolute value of the bias voltage while serving as the center
 4: Serve bias as the center

Pr.03-10 (Analog Frequency Command for Reverse Run)
 0: Negative frequency is not valid. Forward and reverse run is controlled by digital keypad or external terminal.
 1: Negative frequency is valid. Positive frequency = forward run; negative frequency = reverse run. Direction can not be switched by digital keypad or external terminal control.

Pr.00-13 Analog Positive Input Gain (AUI)= 111.1%
 $(10/9) * 100\% = 111.1\%$
 Pr.00-14 Analog Negative Input Gain (AUI) = 100%

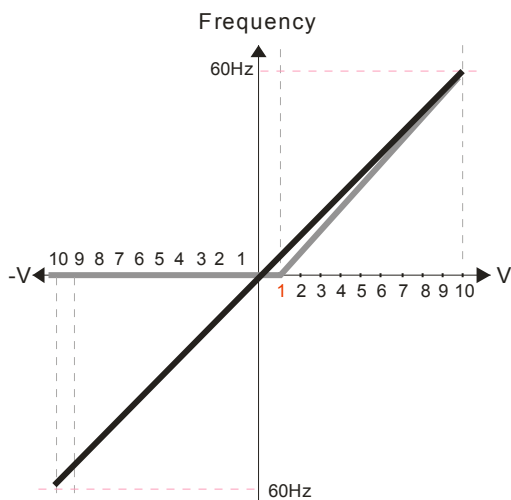

Pr.00-21=0 (Digital keypad control and run in FWD direction)
 Pr.03-05 Analog Positive Voltage Input Bias (AUI) = 10%
 Pr.03-07~03-09 (Positive/Negative Bias Mode)
 0: No bias
 1: Lower than or equal to bias
 2: Greater than or equal to bias
 3: The absolute value of the bias voltage while serving as the center
 4: Serve bias as the center

Pr.03-10 (Analog Frequency Command for Reverse Run)
 0: Negative frequency is not valid. Forward and reverse run is controlled by digital keypad or external terminal.
 1: Negative frequency is valid. Positive frequency = forward run; negative frequency = reverse run. Direction can not be switched by digital keypad or external terminal control.

Pr.00-13 Analog Positive Input Gain (AUI)= 111.1%
 $(10/9) * 100\% = 111.1\%$
 Pr.00-14 Analog Negative Input Gain (AUI) = 90.9%
 $(10/11) * 100\% = 90.9\%$

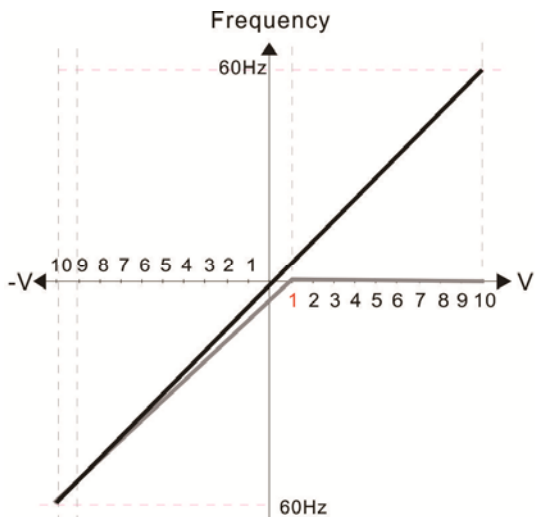

Pr.00-21=0 (Digital keypad control and run in FWD direction)
 Pr.03-05 Analog Positive Voltage Input Bias (AUI) = 10%

- Pr.03-07~03-09 (Positive/Negative Bias Mode)
- 0: No bias
 - 1: Lower than or equal to bias
 - 2: Greater than or equal to bias
 - 3: The absolute value of the bias voltage while serving as the center
 - 4: Serve bias as the center

Pr.03-13 Analog Positive Input Gain (AUI)= 100%
 Pr.03-14 Analog Negative Input Gain (AUI)= 90.9%
 (10/11) * 100% = 90.9%

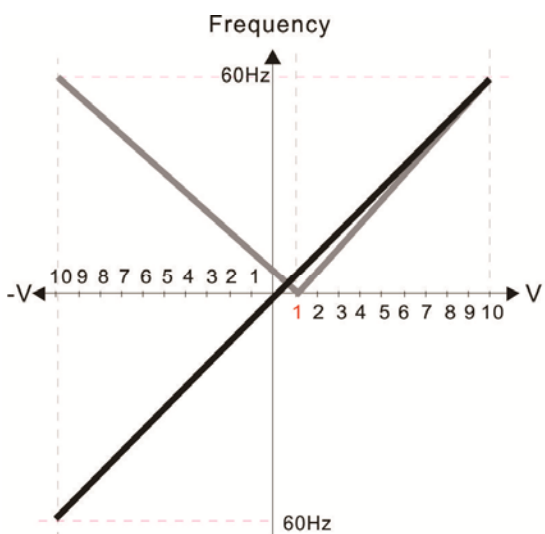

Pr.00-21=0 (Digital keypad control and run in FWD direction)
 Pr.03-05 Analog Positive Voltage Input Bias (AUI) = 10%

- Pr.03-07~03-09 (Positive/Negative Bias Mode)
- 0: No bias
 - 1: Lower than or equal to bias
 - 2: Greater than or equal to bias
 - 3: The absolute value of the bias voltage while serving as the center
 - 4: Serve bias as the center

Pr.00-13 Analog Positive Input Gain (AUI)= 111.1%
 (10/9) * 100% = 111.1%
 Pr.03-14 Analog Negative Input Gain (AUI)= 90.9%
 (10/11) * 100% = 90.9%

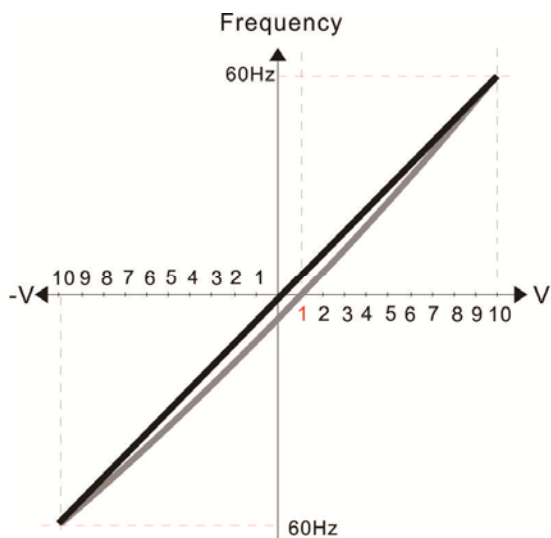

Pr.00-21=0 (Digital keypad control and run in FWD direction)
 Pr.03-05 Analog Positive Voltage Input Bias (AUI) = 10%

- Pr.03-07~03-09 (Positive/Negative Bias Mode)
- 0: No bias
 - 1: Lower than or equal to bias
 - 2: Greater than or equal to bias
 - 3: The absolute value of the bias voltage while serving as the center
 - 4: Serve bias as the center

Pr.00-13 Analog Positive Input Gain (AUI)= 111.1%
 (10/9) * 100% = 111.1%
 Pr.03-14 Analog Negative Input Gain (AUI)= 90.9%
 (10/11) * 100% = 90.9%

➤ **03-10** Analog Frequency Command for Reverse Run

Factory Setting: 0

- Settings 0: Negative frequency is not valid. Forward and reverse run is controlled by digital keypad or external terminal.
 1: Negative frequency is valid. Positive frequency = forward run; negative frequency = reverse run. Run direction can not be switched by digital keypad or the external terminal control.

📖 Parameter 03-10 is used to enable reverse run command when a negative frequency (negative bias and gain) is input to AVI or ACI analog signal input.

➤ **03-11** Analog Input Gain (AVI)

➤ **03-12** Analog Input Gain (ACI)

➤ **03-13** Analog Positive Input Gain (AUI)

➤ **03-14** Analog Negative Input Gain (AUI)

Factory Setting: 100.0

Settings -500.0~500.0%

📖 Parameters 03-03 to 03-14 are used when the source of frequency command is the analog voltage/current signal.

➤ **03-15** Analog Input Filter Time (AVI)

➤ **03-16** Analog Input Filter Time (ACI)

➤ **03-17** Analog Input Filter Time (AUI)

Factory Setting: 0.01

Settings 0.00~20.00 sec

📖 These input delays can be used to filter noisy analog signal.

📖 When the setting of the time constant is too large, the control will be stable but the control response will be slow. When the setting of time constant is too small, the control response will be faster but the control may be unstable. To find the optimal setting, please adjust the setting according to the control stable or response status.

➤ **03-18** Addition Function of the Analog Input

Factory Setting: 0

- Settings 0: Disable (AVI, ACI, AUI)
 1: Enable

📖 When Pr.03-18 is set to 0 and the analog input setting is the same, the priority for AVI, ACI and AUI are AVI>ACI>AUI.

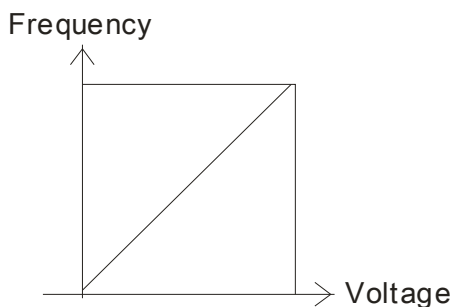





$$F_{\text{command}} = [(a_y \text{ bias}) * \text{gain}] * \frac{F_{\text{max}}(01-00)}{10\text{V or } 16\text{mA or } 20\text{mA}}$$

F_{command}: the corresponding frequency for 10V or 20mA
 a_y: 0-10V, 4-20mA, 0-20mA
 bias: Pr.03-03, Pr. 03-04, Pr.03-05
 gain: Pr.03-11, Pr.03-12, Pr.03-13, Pr.03-14

03-19 Treatment to 4-20mA Analog Input Signal Loss

Factory Setting: 0

- Settings 0: Disable
 1: Continue operation at the last frequency
 2: Decelerate to stop
 3: Stop immediately and display ACE

-  This parameter determines the behavior when 4~20mA signal is loss, when AVIc(Pr.03-28=2) or ACIc (03-29=0).
-  When Pr.03-28 is not set to 2, it means the voltage input to AVI terminal is 0-10V or 0-20mA. At this moment, Pr.03-19 will be invalid.
-  When Pr.03-29 is set to 1, it means the voltage input to ACI terminal is for 0-10V. At this moment, Pr.03-19 will be invalid.
-  When setting is 1 or 2, it will display warning code “AnL” on the keypad. It will be blinking until the loss of the ACI signal is recovered or drive is stop.

03-20 Multi-function Output 1 (AFM1)

Factory Setting: 0

03-23 Multi-function Output 2 (AFM2)

Factory Setting: 0

Settings 0~25

Function Chart

Settings	Functions	Descriptions
0	Output frequency (Hz)	Max. frequency Pr.01-00 is regarded as 100%.
1	Frequency command (Hz)	Max. frequency Pr.01-00 is regarded as 100%.
2	Motor speed (Hz)	600Hz is regarded as 100%
3	Output current (rms)	(2.5 X rated current) is regarded as 100%
4	Output voltage	(2 X rated voltage) is regarded as 100%
5	DC Bus Voltage	450V (900V)=100%
6	Power factor	-1.000~1.000=100%
7	Power	Rated power is regarded as 100%
8	Output torque	Full-load torque is regarded as 100%
9	AVI	0~10V=0~100%
10	ACI	0~20mA=0~100%
11	AUI	-10~10V=0~100%
12	q-axis current (Iq)	(2.5 X rated current) is regarded as 100%
13	q-axis feedback value (Iq)	(2.5 X rated current) is regarded as 100%
14	d-axis current (Id)	(2.5 X rated current) is regarded as 100%
15	d-axis feedback value (Id)	(2.5 X rated current) is regarded as 100%
16	q-axis voltage (Vq)	250V (500V) =100%
17	d-axis voltage(Vd)	250V (500V) =100%
18	Torque command	Rated torque is regarded as 100%

Settings	Functions	Descriptions
19	PG2 frequency command	Max. frequency Pr.01-00 is regarded as 100%.
20	Output for CANopen control	For CANopen analog output
21	RS485 analog output	For communication output (CMC-MOD01, CMC-EIP01, CMC-PN01, CMC-DN01)
22	Analog output for communication card	For communication output (CMC-MOD01, CMC-EIP01, CMC-PN01, CMC-DN01)
23	Constant voltage/current output	Pr.03-32 and Pr.03-33 controls voltage/current output level 0~100% of Pr.03-32 corresponds to 0~10V of AFM1.
24	Reserved	
25	CAN & 485 output	

➤ **03-21** Gain of Analog Output 1 (AFM1) Factory Setting: 100.0

➤ **03-24** Gain of Analog Output 2 (AFM2) Factory Setting: 100.0

Settings 0.0~500.0%

📖 It is used to adjust the analog voltage level (Pr.03-20) that terminal AFM outputs.

📖 This parameter is set the corresponding voltage of the analog output 0.

➤ **03-22** Analog Output 1 when in REV Direction (AFM1) Factory Setting: 0

➤ **03-25** Analog Output 2 when in REV Direction (AFM2) Factory Setting: 0

- Settings
- 0: Absolute value in REV direction
 - 1: Output 0V in REV direction; output 0-10V in FWD direction
 - 2: Output 5-0V in REV direction; output 5-10V in FWD direction

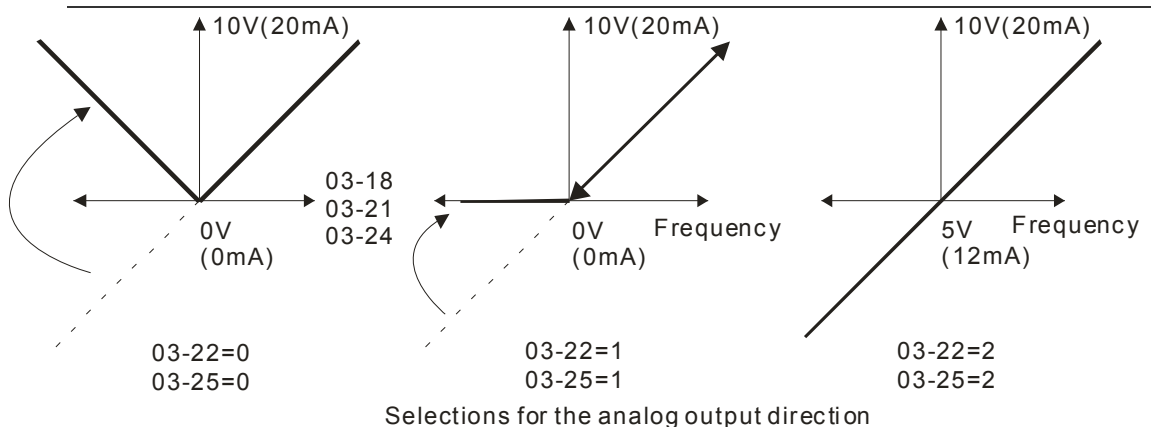

➤ **03-26** Reserved

➤ **03-27** AFM2 Output Bias Factory Setting: 0.00

Settings -100.00~100.00%

Example 1, AFM2 0-10V is set output frequency, the output equation is

$$10V \times \left(\frac{\text{Output Frequency}}{01-00} \right) \times 03-24 + 10V \times 03-27$$

Example 2, AFM2 0-20mA is set output frequency, the output equation is

$$20mA \times \left(\frac{\text{Output Frequency}}{01-00} \right) \times 03-24 + 20mA \times 03-27$$

Example 3, AFM2 4-20mA is set output frequency, the output equation is

$$4mA + 16mA \times \left(\frac{\text{Output Frequency}}{01-00} \right) \times 03-24 + 16mA \times 03-27$$

03-28 AVI Selection Factory Setting: 0

- Settings
- 0: 0-10V
 - 1: 0-20mA
 - 2: 4-20mA

03-29 ACI Selection Factory Setting: 0

- Settings
- 0: 4-20mA
 - 1: 0-10V
 - 2: 0-20mA

When changing the input mode, please check if the switch of external terminal (SW3, SW4) corresponds to the setting of Pr.03-28~03-29.

03-30 Status of PLC Output Terminal Factory Setting: ##

Settings 0~65535
Monitor the status of PLC analog output terminals

P.03-30 shows the external multi-function output terminal that used by PLC.

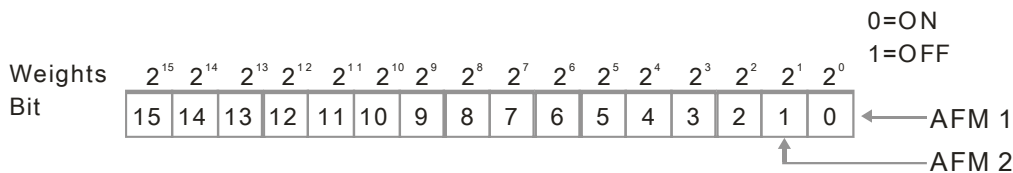

NOTE

$2^7 = 128$	$2^6 = 64$	
$2^5 = 32$	$2^4 = 16$	$2^3 = 8$
$2^2 = 4$	$2^1 = 2$	$2^0 = 1$

For Example:

If the value of Pr.02-30 displays 0002h(Hex), it means AFM1 and AFM2 are used by PLC.

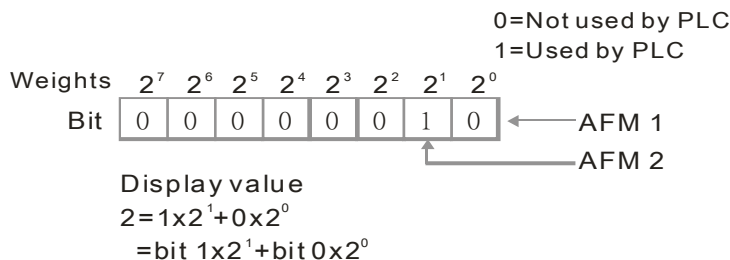

↗	03-31	AFM2 0-20mA Output Selection	Factory Setting: 0
		Settings 0: 0-20mA output 1: 4-20mA output	
↗	03-32	AFM1 DC output setting level	
↗	03-33	AFM2 DC Output Setting Level	Factory Setting: 0.00
		Settings 0.00~100.00%	
↗	03-34	Reserved	
	03-35	AFM1 Filter Output Time	Factory Setting: 0.01
		Settings 0.00~20.00 sec.	
	03-36	AFM2 Filter Output Time	Factory Setting: 0.01
		Settings 0.00~ 20.00 sec.	
	03-37	Reserved	
	~		
	03-43		
↗	03-44	MO by Source of AI Level	Factory Setting: 0
		Settings 0: AVI 1: ACI 2: AUI	
↗	03-45	AI Upper Level	Factory Setting: 50.00%
		Settings -100.00%~100.00%	
↗	03-46	AI Lower Level	Factory Setting: 10.00%
		Settings -100.00%~100.00%	

 This function requires to work with Multi-function Output item “67” Analog signal level achieved. The MO active when AI input level is higher than Pr03-45 AI Upper level. The MO shuts off when the AI input is lower that Pr03-46 AI Lower level.

 AI Upper level must bigger than AI Lower level.

03-47

~

Reserved

03-49**03-50** Analog Input Curve Selection

Factory Setting: 0

- Settings
- 0: Regular Curve
 - 1: 3 point curve of AVI
 - 2: 3 point curve of ACI
 - 3: 3 point curve of AVI & ACI
 - 4: 3 point curve of AUI
 - 5: 3 point curve of AVI & AUI
 - 6: 3 point curve of ACI & AUI
 - 7: 3 point curve of AVI & ACI & AUI

03-51 AVI Low Point

Factory Setting: 0.00

- Settings
- 03-28=0, 0.00~10.00V
 - 03-28≠0, 0.00~20.00mA

03-52 AVI Proportional Low Point

Factory Setting: 0.00

- Settings -100.00~100.00%

03-53 AVI Mid Point

Factory Setting: 5.00

- Settings
- 03-28=0, 0.00~10.00V
 - 03-28≠0, 0.00~20.00mA

03-54 AVI Proportional Mid Point

Factory Setting: 50.00

- Settings -100.00~100.00%

03-55 AVI High Point





Factory Setting: 10.00

- Settings
- 03-28=0, 0.00~10.00V
 - 03-28≠0, 0.00~20.00mA

03-56 AVI Proportional High Point

Factory Setting: 100.00

- Settings -100.00~100.00%

-  When Pr.03-28 = 0, AVI setting is 0-10V and the unit is in voltage (V).
-  When Pr.03-28 ≠ 0, AVI setting is 0-20mA or 4-20mA and the unit is in current (mA).
-  When setting analog input AVI to frequency command, it 100% corresponds to Fmax (Pr.01-00 Max. operation frequency).
-  Three of the AVI points can be set according to user's demand on voltage(current) and proportion, there is no setting limit for ACI points.

↗	03-57 ACI Low Point	Factory Setting: 4.00
	Settings Pr.03-29=1, 0.00~10.00V Pr.03-29≠1, 0.00~20.00mA	
↗	03-58 ACI Proportional Low Point	Factory Setting: 0.00
	Settings -100.00~100.00%	
↗	03-59 ACI Mid Point	Factory Setting: 12.00
	Settings 03-29=1, 0.00~10.00V 03-29≠1, 0.00~20.00mA	
↗	03-60 ACI Proportional Mid Point	Factory Setting: 50.00
	Settings -100.00~100.00%	
↗	03-61 ACI High Point	Factory Setting: 20.00
	Settings 03-29=1, 0.00~10.00V 03-29≠1, 0.00~20.00mA	
↗	03-62 ACI Proportional High Point	Factory Setting: 100.00
	Settings -100.00~100.00%	
	<ul style="list-style-type: none"> 📖 When Pr.03-29=1, ACI setting is 0-10V and the unit is in voltage (V). 📖 When Pr.03-29≠1, ACI setting is 0-20mA or 4-20mA and the unit is in current (mA). 📖 When setting analog input ACI to frequency command, it 100% corresponds to Fmax (Pr.01-00 Max. operation frequency). 📖 Three of the ACI points can be set according to user's demand on voltage(current) and proportion, there is no setting limit for ACI points. 	
↗	03-63 Positive AUI Voltage Low Point	Factory Setting: 0.00
	Settings 0.00~10.00V	
↗	03-64 Positive AUI Voltage Proportional Low Point	Factory Setting: 0.00
	Settings 0.00~100.00%	
↗	03-65 Positive AUI Voltage Mid Point	Factory Setting: 5.00
	Settings 0.00~10.00V	
↗	03-66 Positive AUI Voltage Proportional Mid Point	Factory Setting: 50.00
	Settings 0.00~100.00%	

↗ **03-67** Positive AUI Voltage High Point

Factory Setting: 10.00

Settings 0.00~10.00V

↗ **03-68** Positive AUI Voltage Proportional High Point

Factory Setting: 100.00

Settings 0.00~100.00%

📖 When setting positive voltage AUI to frequency command, it 100% corresponds to Fmax (Pr.01-00 Max. operation frequency) and the motor runs in forward direction.

Three of the positive voltage AUI points can be set according to user's demand on voltage and proportion, there is no setting limit for AUI points.

↗ **03-69** Negative AUI Voltage Low Point

Factory Setting: 0.00

Settings -10.00~0.00V

↗ **03-70** Negative AUI Voltage Proportional Low Point

Factory Setting: 0.00

Settings 0.00~-100.00%

↗ **03-71** Negative AUI Voltage Mid Point

Factory Setting: -5.00

Settings 0.00~-10.00V

↗ **03-72** Negative AUI Voltage Proportional Mid Point

Factory Setting: -50.00

Settings 0.00~-100.00%

↗ **03-73** Negative AUI Voltage High Point

Factory Setting: -10.00

Settings 0.00~-10.00V

↗ **03-74** Negative AUI Voltage Proportional High Point

Factory Setting: -100.00

Settings 0.00~-100.00%

📖 When setting negative voltage AUI to frequency command, it 100% corresponds to Fmax (Pr.01-00 Max. operation frequency) and the motor runs in reverse direction.

📖 Three of the negative voltage AUI points can be set according to user's demand on voltage and proportion, there is no setting limit for AUI points.

04 Multi-Step Speed Parameters

✎ This parameter can be set during operation.

✎	04-00	1st Step Speed Frequency
✎	04-01	2nd Step Speed Frequency
✎	04-02	3rd Step Speed Frequency
✎	04-03	4th Step Speed Frequency
✎	04-04	5th Step Speed Frequency
✎	04-05	6th Step Speed Frequency
✎	04-06	7th Step Speed Frequency
✎	04-07	8th Step Speed Frequency
✎	04-08	9th Step Speed Frequency
✎	04-09	10th Step Speed Frequency
✎	04-10	11th Step Speed Frequency
✎	04-11	12th Step Speed Frequency
✎	04-12	13th Step Speed Frequency
✎	04-13	14th Step Speed Frequency
✎	04-14	15th Step Speed Frequency

Factory Setting: 0.00

Settings 0.00~599.00Hz

- 📖 The Multi-function Input Terminals (refer to setting 1~4 of Pr.02-01~02-08 and 02-26~02-31) are used to select one of the AC motor drive Multi-step speeds(max. 15 speeds). The speeds (frequencies) are determined by Pr.04-00 to 04-14 as shown in the following.
- 📖 The run/stop command can be controlled by the external terminal/digital keypad/communication via Pr.00-21.
- 📖 Each one of multi-step speeds can be set within 0.0~600.0Hz during operation.
- 📖 Explanation for the timing diagram for multi-step speeds and external terminals
The Related parameter settings are:
 1. Pr.04-00~04-14: setting multi-step speeds (to set the frequency of each step speed)
 2. Pr.02-01~02-08, 02-26~02-31: setting multi-function input terminals (multi-step speed 1~4)
 - Related parameters: 01-22 JOG Frequency, 02-01 Multi-function Input Command 1 (MI1), 02-02 Multi-function Input Command 2 (MI2), 02-03 Multi-function Input Command 3 (MI3), 02-04 Multi-function Input Command 4 (MI4)

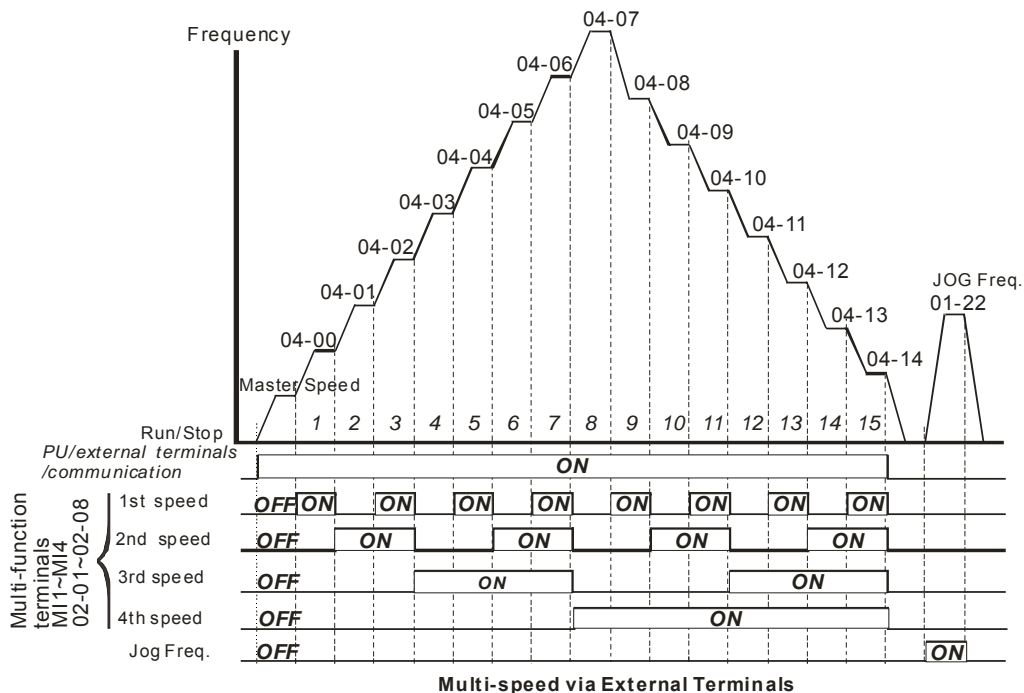

✎	04-15	Position command 1 (revolution)
✎	04-17	Position command 2 (revolution)
✎	04-19	Position command 3 (revolution)
✎	04-21	Position command 4 (revolution)
✎	04-23	Position command 5 (revolution)
✎	04-25	Position command 6 (revolution)
✎	04-27	Position command 7 (revolution)
✎	04-29	Position command 8 (revolution)
✎	04-31	Position command 9 (revolution)
✎	04-33	Position command 10 (revolution)
✎	04-35	Position command 11 (revolution)
✎	04-37	Position command 12 (revolution)
✎	04-39	Position command 13 (revolution)
✎	04-41	Position command 14 (revolution)
✎	04-43	Position command 15 (revolution)

Factory Setting: 0

Settings -30000~30000

To switch the target position of the external terminal, set external terminal parameters to Pr.02-01=1, Pr.02-02=2, Pr.02-03=3, Pr.02-04= 4 by selecting the P2P target position via multi-step speed.

Setting: Target Position = 04-15 × (10-01*4) + 04-16

Multi-step Speed Status	Target Position of P2P		Maximum Speed of P2P	
0000	0		11-00 bit8=0	11-00 bit8=1
0001	Position 1	04-15 04-16	11-43	04-00
0010	Position 2	04-17 04-18		04-01

Multi-step Speed Status	Target Position of P2P			Maximum Speed of P2P		
0011	Position 3	04-19	04-20		04-02	
0100	Position 4	04-21	04-22		04-03	
0101	Position 5	04-23	04-24		04-04	
0110	Position 6	04-25	04-26		04-05	
0111	Position 7	04-27	04-28		04-06	
1000	Position 8	04-29	04-30		11-43	04-07
1001	Position 9	04-31	04-32			04-08
1010	Position 10	04-33	04-34	04-09		
1011	Position 11	04-35	04-36	04-10		
1100	Position 12	04-37	04-38	04-11		
1101	Position 13	04-39	04-40	04-12		
1110	Position 14	04-41	04-42	04-13		
1111	Position 15	04-43	04-44		04-14	

- ↗ **04-16** Position command 1 (pulse)
- ↗ **04-18** Position command 2 (pulse)
- ↗ **04-20** Position command 3 (pulse)
- ↗ **04-22** Position command 4 (pulse)
- ↗ **04-24** Position command 5 (pulse)
- ↗ **04-26** Position command 6 (pulse)
- ↗ **04-28** Position command 7 (pulse)
- ↗ **04-30** Position command 8 (pulse)
- ↗ **04-32** Position command 9 (pulse)
- ↗ **04-34** Position command 10 (pulse)
- ↗ **04-36** Position command 11 (pulse)
- ↗ **04-38** Position command 12 (pulse)
- ↗ **04-40** Position command 13 (pulse)
- ↗ **04-42** Position command 14 (pulse)
- ↗ **04-44** Position command 15 (pulse)

Factory Setting: 0

Settings -32767~32767

📖 Please refer to Pr.02-01~02-08 (Multi-function Input Command) for description on setting 34 (Switch between multi-step position and multi-speed control) and setting 36 (Enable multi-step position learning function).

Multi-step position corresponding	MI4	MI3	MI2	MI1	Multi-step speed corresponding
10-19	0	0	0	0	Positioning for Encoder Position
04-16 Position command 1 (pulse)	0	0	0	1	04-00 1 st step speed frequency
04-18 Position command 1 (pulse)	0	0	1	0	04-01 2 nd step speed frequency
04-20 Position command 1 (pulse)	0	0	1	1	04-02 3 rd step speed frequency
04-22 Position command 1 (pulse)	0	1	0	0	04-03 4 th step speed frequency
04-24 Position command 1 (pulse)	0	1	0	1	04-04 5 th step speed frequency
04-26 Position command 1 (pulse)	0	1	1	0	04-05 6 th step speed frequency

04-28 Position command 1 (pulse)	0	1	1	1	04-06 7 th step speed frequency
04-30 Position command 1 (pulse)	1	0	0	0	04-07 8 th step speed frequency
04-32 Position command 1 (pulse)	1	0	0	1	04-08 9 th step speed frequency
04-34 Position command 1 (pulse)	1	0	1	0	04-09 10 th step speed frequency
04-36 Position command 1 (pulse)	1	0	1	1	04-10 11 th step speed frequency
04-38 Position command 1 (pulse)	1	1	0	0	04-11 12 th step speed frequency
04-40 Position command 1 (pulse)	1	1	0	1	04-12 13 th step speed frequency
04-42 Position command 1 (pulse)	1	1	1	0	04-13 14 th step speed frequency
04-44 Position command 1 (pulse)	1	1	1	1	04-14 15 th step speed frequency

04-45

~

Reserved

04-49

↘	04-50	PLC buffer 0
↘	04-51	PLC buffer 1
↘	04-52	PLC buffer 2
↘	04-53	PLC buffer 3
↘	04-54	PLC buffer 4
↘	04-55	PLC buffer 5
↘	04-56	PLC buffer 6
↘	04-57	PLC buffer 7
↘	04-58	PLC buffer 8
↘	04-59	PLC buffer 9
↘	04-60	PLC buffer 10
↘	04-61	PLC buffer 11
↘	04-62	PLC buffer 12
↘	04-63	PLC buffer 13
↘	04-64	PLC buffer 14
↘	04-65	PLC buffer 15
↘	04-66	PLC buffer 16
↘	04-67	PLC buffer 17
↘	04-68	PLC buffer 18
↘	04-69	PLC buffer 19

Factory Setting: 0

Settings

0~65535

 The PLC buffer can be combined with PLC or HMI programming for variety application.

05 Motor Parameters

✎ This parameter can be set during operation.

05-00 Motor Auto Tuning

Factory Setting: 0

- Settings
- 0: No function
 - 1: Rolling test for induction motor (Rs, Rr, Lm, Lx, no-load current)
 - 2: Rolling test for induction motor
 - 3: No function
 - 4: Rolling test for PM motor magnetic pole
 - 5: Rolling test for PM(SPM) motor
 - 6: Rolling test for IM motor flux curve
 - 12: FOC Sensorless inertia estimation
 - 13: High frequency and blocked rotor test for IPM/SPM motor parameter

Induction Motor

📖 Press **【Run】** to begin auto tuning. The measured value will be written into motor 1 (Pr.05-05 ~05-09, Rs, Rr, Lm, Lx, no-load current) and motor 2 (Pr.05-17 to Pr.05-21) automatically.

To begin AUTO-Tuning in rolling test:

1. Make sure that all the parameters are set to factory settings and the motor wiring is correct.
2. Make sure the motor has no-load before executing auto-tuning and the shaft is not connected to any belt or gear motor. It is recommended to set to 2 if the motor can't separate from the load.
- 3.

	Motor 1 Parameter	Motor 2 Parameter
Motor Rated Frequency	01-01	01-35
Motor Rated Voltage	01-02	01-36
Motor Full-load Current	05-01	05-13
Motor Rated Power	05-02	05-14
Motor Rated Speed	05-03	05-15
Motor Pole Numbers	05-04	05-16

4. Set Pr.05-00=1 and press **【Run】**, the drive will begin auto-tuning. Please be aware of the motor that it starts spinning as **【Run】** is pressed.
5. When auto-tuning is completed, please check if the measured values are written into motor 1 (Pr.05-05 ~05-09) and motor 2 (Pr.05-17 ~05-21) automatically.
6. Mechanical equivalent circuit

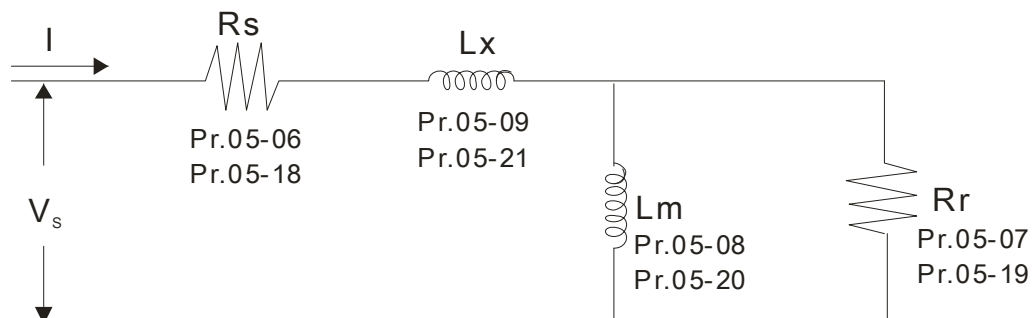

✘ If Pr.05-00 is set to 2 (static test), user needs to input the no-load current value of motor into Pr.05-05 for motor 1/Pr.05-17 for motor 2.

 Set Pr.05-00=6 to begin rolling test for IM motor flux curve. This function is available when the drive is in FOC/TQC Sensorless control. User may begin auto-tuning after setting up the motor information.

- Set up Pr.01-01, 01-02, 05-01~05-04 according to the motor nameplate information.
- Set Pr.05-00=6 and press **【Run】**, make sure no loading is applied to the motor before setting Pr.05-00 to 6 and before performing auto-tuning.

 When Pr.05-00=12, the drive begins FOC Sensorless inertia estimation for IM motor. This function is available when the drive is in FOC/TQC Sensorless control. User may begin auto-tuning after setting up the motor information.

- Note: Make sure the motor parameters (no-load current, Rs, Rr, Lm and Lx) of the drive are set before performing Pr.05-00=12 (auto-tuning for FOC Sensorless inertia estimation for IM motor).

1. Set Pr.00-10=2 (torque mode)
2. Set Pr. 00-13=2 (TQCPG, Open-loop torque mode)
3. Set Pr. 05-00=12 and press **【Run】** to begin FOC Sensorless inertia measure
4. When the process of inertia estimation is completed, check Pr.11-01 (unit: PU Q8) and see if the measured value is acceptable.

Set up Sensorless FOC Mode

1. Set Pr.00-10 = 0 (speed mode)
2. Set Pr.00-11 = 5 (FOC sensorless mode)
3. Set bit0 of Pr.11-00 to 1 (use ASR gain function to automatically adjust the ASR bandwidth in Pr.11-03,11-04,11-05)

NOTE

- In torque/vector control mode, it is not recommended to have motors run in parallel.
- It is not recommended to use torque/vector control mode if motor rated power exceeds the rated power of the AC motor drive.
- When auto-tuning 2 motors, it needs to set multi-function input terminals (setting 14) or change Pr.05-22 for motor 1/motor 2 selection.
- The no-load current is usually 20~50% X rated current.
- The rated speed can not be greater than or equal to $120f/p$ (f = rated frequency Pr.01-01/01-35; P : number of motor poles Pr.05-04/05-16).

Permanent Magnet Motor (PM)

 Set Pr.05-00= 5 or 13 and press **【Run】** to begin auto tuning for PM motor. The measured values will be written into Pr.05-39 (Rs), Pr.05-40 & 41 (Ld & Lq) and Pr.05-43 (PM motor's Ke parameter).

To begin AUTO-Tuning for PM motor in rolling test:

1. Make sure all the parameters are reset to factory setting and the motor wiring installation is correct.

2. For PM motor, set Pr.05-33=1 and complete the following settings according to your motor specifications, Pr.05-34 rated current, Pr.05-35 rated power, Pr.05-36 rated speed and Pr.05-37 pole number. The acceleration time and deceleration time should be set according to your motor capacity.
3. Set Pr.05-00 to 5 and press **【Run】** to begin auto tuning for PM motor. Please be aware of the motor that it starts spinning as **【Run】** is pressed.
4. When auto-tuning is completed, please check if the measured values are written into Pr.05-39~05-41 and Pr.05-43 automatically.

 Set Pr.05-00=4 and press **【Run】** to begin auto-tuning for PM motor PG offset angle. The measured value will be written into Pr.05-42 automatically.

- ☑ Note 1: When execute auto-tuning for PM motor PG origin, please make sure the encoder setting are correct (Pr.10-00, 10-01, 10-02), otherwise the PG origin measure error and motor stall may occur.
- ☑ Note 2: If PM motor runs in an opposite direction of the drive's command, switch any two of the UVW cable and re-connect, then execute PG origin search again. It is crucial to execute auto-tuning after the switch otherwise PG origin measure error and motor stall may occur.

 Auto-tuning process for measuring PG offset angle of PM motor:

1. Set Pr.05-00=5 and press RUN, or manually input the values into Pr. 01-01, 05-34~541 and Pr.05-43.
2. It is strongly suggested to remove the motor and unload before beings auto-tuning.
3. Set Pr.05-00=4 and press **【Run】** to begin auto-tuning. Please be aware of the motor that it starts spinning as **【Run】** is pressed.
4. When auto-tuning is completed, please check if the PG offset angle is written into Pr.05-42 automatically.

 **NOTE**

When auto-tuning for PM motor is completed and the control mode setting is done, it is recommend to turn the drive's power off and restart again to ensure the drive operates according to the motor parameter settings.

05-01 Full-load Current of Induction Motor 1 (A)

Unit: Amper

Factory Setting: #.##

Settings 0~xxxx (Depends on the power of motor)

 This value should be set according to the rated frequency of the motor as indicated on the motor nameplate. The factory setting is 90% X rated current.

Example: The rated current for 7.5HP (5.5kW) is 25 and factory setting is 22.5A. The range for setting will be 10~30A.(25*40%=10A and 25*120%=30A)

↖	05-02	Rated Power of Induction Motor 1(kW)	Factory Setting: ###
		Settings 0~655.35 kW	
		📖 It is used to set rated power of the motor 1. The factory setting is the power of the drive.	
↖	05-03	Rated Speed of Induction Motor 1 (rpm)	Factory Setting: Depends on the power of motor
		Settings 0~xxxx (Depends on the power of motor)	
		📖 It is used to set the rated speed of the motor and need to set according to the value indicated on the motor nameplate.	
	05-04	Pole Number of Induction Motor 1	Factory Setting: 4
		Settings 2~64	
		📖 It is used to set the number of motor poles (must be an even number).	
	05-05	No-load Current of Induction Motor 1 (A)	Unit: Amper Factory Setting: ###
		Settings 0 to the factory setting in Pr.05-01	
		📖 The factory setting is 40% of rated current.	
	05-06	Stator Resistance(Rs) of Induction Motor 1	
	05-07	Rotor Resistance(Rr) of Induction Motor 1	Factory Setting: ####
		Settings 0~65.535Ω	
	05-08	Magnetizing Inductance(Lm) of Induction Motor 1	
	05-09	Stator inductance(Lx) of Induction Motor 1	Factory Setting: ##
		Settings 0~6553.5mH	
	05-10	Reserved	
	~		
	05-12		
	05-13	Full-load Current of Induction Motor 2 (A)	Unit: Amper Factory Setting:###
		Settings 0~xxxx (Depends on the power of motor)	
		📖 This value should be set according to the rated frequency of the motor as indicated on the motor	

nameplate. The factory setting is 90% X rated current.

Example: The rated current for 7.5HP (5.5kW) is 25A and factory setting is 22.5A. The range for setting will be 10~30A.(25*40%=10A and 25*120%=30A)

↗ **05-14** Rated Power of Induction Motor 2 (kW) Factory Setting: #.##

Settings 0~655.35 kW

📖 It is used to set rated power of the motor 2. The factory setting is the power of the drive.

↗ **05-15** Rated Speed of Induction Motor 2 (rpm) Factory Setting:
Depends on the power
of motor

Settings 0~xxxx (Depends on the power of motor)

📖 It is used to set the rated speed of the motor and need to set according to the value indicated on the motor nameplate.

05-16 Pole Number of Induction Motor 2 Factory Setting: 4

Settings 2~64

📖 It is used to set the number of motor poles (must be an even number).

05-17 No-load Current of Induction Motor 2 (A) Unit: Amper
Factory Setting: #.##

Settings 0 to the factory setting in Pr.05-01

📖 The factory setting is 40% X rated current.

05-18 Stator Resistance (Rs) of Induction Motor 2
05-19 Rotor Resistance (Rr) of Induction Motor 2 Factory Setting: #.###

Settings 0~65.535Ω

05-20 Magnetizing Inductance (Lm) of Induction Motor 2
05-21 Stator Inductance (Lx) of Induction Motor 2 Factory Setting: #.#

Settings 0~6553.5 mH

↗ **05-22** Induction Motor 1/ 2 Selection Factory Setting: 1

Settings 1: Motor 1
2: Motor 2

📖 It is used to set the motor that driven by the AC motor drive.

05-23 Frequency for Y-connection/ Δ -connection Switch of Induction Motor

Factory Setting: 60.00

Settings 0.00~599.00Hz

05-24 Y-connection/ Δ -connection Switch of Induction Motor IM

Factory Setting: 0

Settings 0: Disable

1: Enable

05-25 Delay Time for Y-connection/ Δ -connection Switch of Induction Motor

Factory Setting: 0.200

Settings 0.000~60.000 sec

- 📖 P.05-23 and Pr.05-25 are applied in the wide range motors and the motor coil will execute the switch of Y-connection/ Δ -connection as required. (The wide range motors has relation with the motor design. In general, it has higher torque at low speed and Y-connection and it has higher speed at high speed and Δ -connection.)
- 📖 Pr.05-24 is used to enable/disable Y-connection/ Δ - connection Switch.
- 📖 When Pr.05-24 is set to 1, the drive will select by Pr.05-23 setting and current motor frequency to switch motor to Y-connection or Δ - connection. At the same time, it will also affect motor parameters.
- 📖 Pr.05-25 is used to set the switch delay time of Y-connection/ Δ - connection.
- 📖 When output frequency reaches Y-connection/ Δ -connection switch frequency, drive will delay by Pr.05-25 before multi-function output terminals are active.

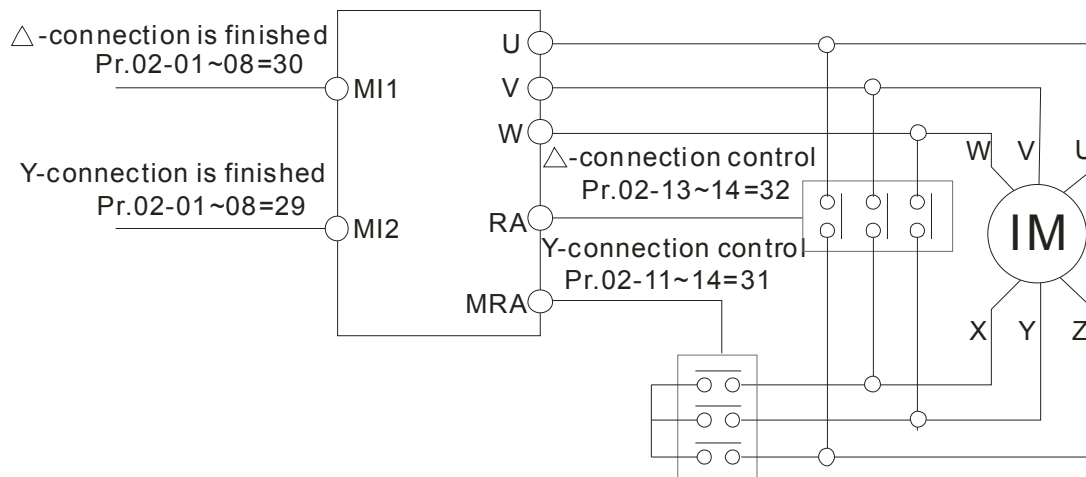

Y- Δ connection switch: can be used for wide range motor

Y-connection for low speed: higher torque can be used for rigid tapping

Δ -connection for high speed: higher torque can be used for high-speed drilling

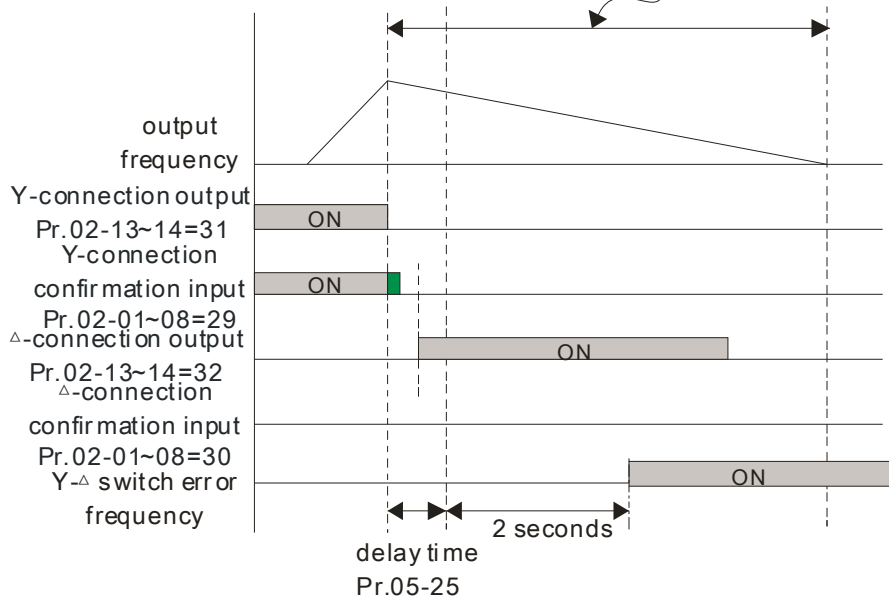
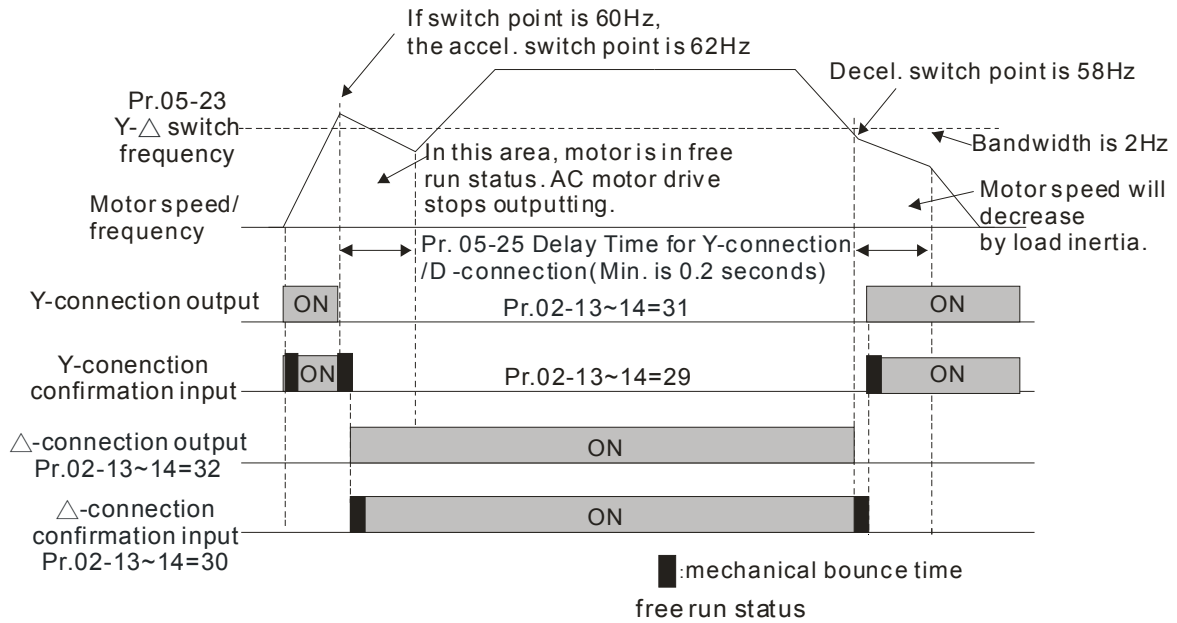

05-26 Accumulative Watt Per Second of Motor in Low Word (W-sec)

Factory Setting: 0.0

Settings Read only

05-27 Accumulative Watt Per Second of Motor in High Word (W-sec)

Factory Setting: 0.0

Settings Read only

05-28 Accumulative Watt-hour of Motor (W-Hour)

Factory Setting: 0.0

Settings Read only

05-29 Accumulative Watt-hour of Motor in Low Word (KW-Hour)

Factory Setting: 0.0

Settings Read only

05-30 Accumulative Watt-hour of Motor in High Word (KW-Hour)

Factory Setting: 0.0

Settings Read only

📖 Pr.05-26~05-29 records the amount of power consumed by motors. The accumulation begins when the drive is activated and record is saved when the drive stops or turns OFF. The amount of consumed watts will continue to accumulate when the drive activate again. To clear the accumulation, set Pr.00-02 to 5 then the accumulation record will return to 0.

05-31 Accumulative Motor Operation Time (Min)

Factory Setting: 0

Settings 00~1439

05-32 Accumulative Motor Operation Time (day)

Factory Setting: 0

Settings 00~65535

📖 Pr. 05-31 and Pr.05-32 are used to record the motor operation time. To clear the operation time, set Pr.05-31 and Pr.05-32 to 00. Operation time shorter than 60 seconds will not be recorded.

05-33 Induction Motor (IM) and Permanent Magnet Motor Selection

Factory Setting: 0

Settings 0: Induction Motor
1: Permanent Magnet Motor
2: IPM Permanent Magnet Motor

05-34 Full-load current of Permanent Magnet Motor

Factory Setting:
Depends on the power
of motor

Settings Depends on the power of motor

↗ **05-35** Rated Power of Permanent Magnet Motor

Factory Setting: 0.00

Settings 0.00~655.35 kW

↗ **05-36** Rated speed of Permanent Magnet Motor

Factory Setting: 2000

Settings 0~65535 rpm

05-37 Pole number of Permanent Magnet Motor

Factory Setting: 10

Settings 0~65535

05-38 Inertia of Permanent Magnet Motor

Factory Setting:
Depends on the power
of motor

Settings 0.0~6553.5 kg.cm² (0.0001kg.m²)

📖 This parameter setting is defined in **kg-cm²** . If this measure is not familiar to you, please refer to the chart below. (Delta's motor inertia chart is for reference purpose only.)

Delta Motor (Low inertia model)								
Rated Power(kW)	0.1	0.2	0.4	0.4	0.75	1	2	
Rotor inertia (kg.m ²)	3.70E-06	1.77E-05	2.77E-05	6.80E-05	1.13E-04	2.65E-04	4.45E-04	

Delta Motor (Mid to High Inertia model)								
Rated Power(kW)	0.5	1	1.5	2	2	0.3	0.6	0.9
Rotor inertia (kg.m ²)	8.17E-04	8.41E-04	1.12E-03	1.46E-03	3.47E-03	8.17E-04	8.41E-04	1.12E-03

※ For more information on motor inertia value, please refer to Pr.11-01.

05-39 Stator Resistance of PM Motor

Factory Setting: 0.000

Settings 0.000~65.535Ω

05-40 Permanent Magnet Motor Ld

Factory Setting: 0.00

Settings 0.00~655.35 mH

05-41 Permanent Magnet Motor Lq

Factory Setting: 0.00

Settings 0.00~655.35 mH

↗ **05-42** PG Offset angle of PM Motor

Factory Setting: 0

Settings 0.0~360.0°

📖 When Pr.05-00 is set to 4, the drive will detect offset angle and write into Pr.05-42.

↗ **05-43** Ke parameter of PM Motor

Unit: V/1000rpm

Factory Setting: 0

Settings 0~65535

06 Protection Parameters

✎ This parameter can be set during operation.

✎ 06-00 Low Voltage Level

Factory Setting:

Settings Frame A to D:

460V Series: 300.0~440.0V

360.0

Frame E and frames above E: 380.0~440.0V

400.0

📖 It is used to set the Lv level. When the drive is in the low voltage, it will stop output and free to stop.

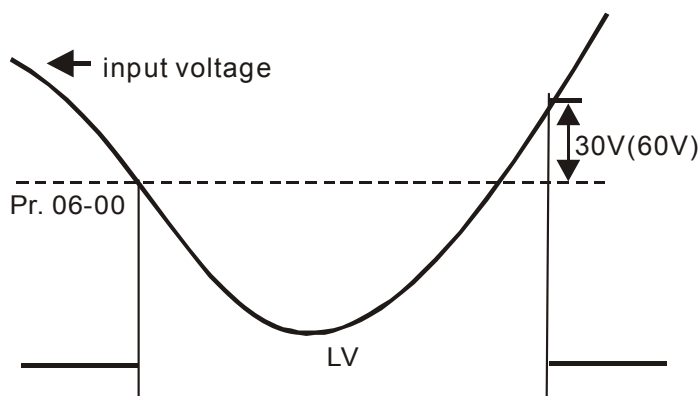

✎ 06-01 Over-voltage Stall Prevention

Factory Setting: 760.0

Settings 460V Series: 0.0~900.0V

0: Disabled

- 📖 When Pr.06-01 is set to 0.0, the over-voltage stall prevention function is disabled.
- 📖 During deceleration, the DC bus voltage may exceed its Maximum Allowable Value due to motor regeneration. When this function is enabled, the AC motor drive will not decelerate further and keep the output frequency constant until the voltage drops below the preset value again.
- 📖 This function is used for the occasion that the load inertia is unsure. When it stops in the normal load, the over-voltage won't occur during deceleration and fulfill the setting of deceleration time. Sometimes, it may not stop due to over-voltage during decelerating to stop when increasing the load regenerative inertia. At this moment, the AC drive will auto add the deceleration time until drive stop.
- 📖 When the over-voltage stall prevention is enabled, drive deceleration time will be larger than the setting.
- 📖 When there is any problem as using deceleration time, refer to the following items to solve it.
 1. Add the suitable deceleration time.
 2. Add brake resistor (refer to appendix B-1 for details) to consume the electrical energy that regenerated from the motor with heat type.
- Related parameters: Pr.01-13, 01-15, 01-17, 01-19 (settings of decel. time 1~4), Pr.02-13~02-14 (Multi-function Output 1 RY1, RY2), Pr. 02-16~02-17 Multi-function Output (MO1, 2)

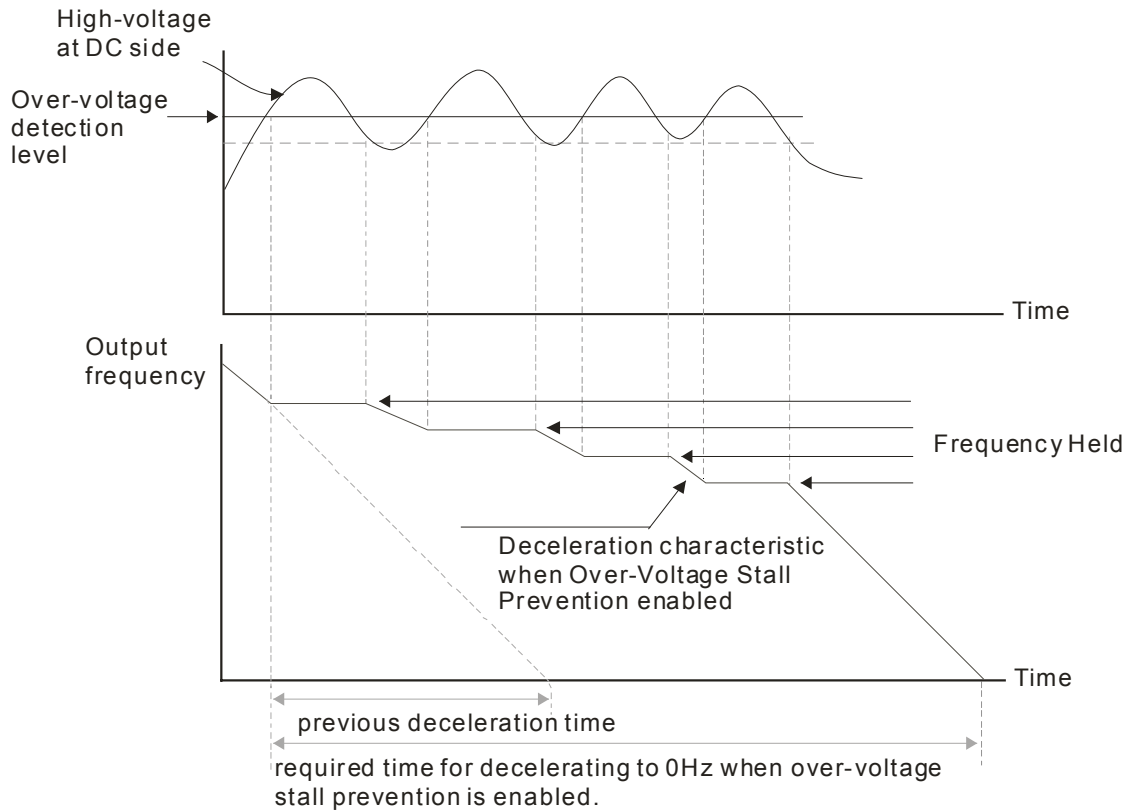

✎ **06-02** Selection for Over-voltage Stall Prevention

Factory Setting: 0

Settings 0: Traditional over-voltage stall prevention

1: Smart over-voltage prevention

📖 When Pr.06-02 is set to 1, the drive will maintain DCbus voltage when decelerating and prevent OV.

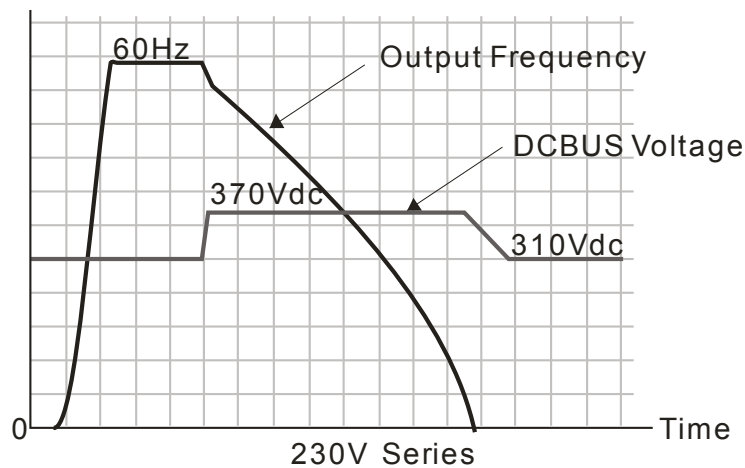

✎ **06-03** Over-current Stall Prevention during Acceleration

Settings Light duty: 0~160% (100%: drive's rated current)

Factory Setting: 120

Heavy duty: 0~180% (100%: drive's rated current)

Factory Setting: 150

📖 If the motor load is too large or drive acceleration time is too short, the AC drive output current may increase abruptly during acceleration and it may cause motor damage or trigger protection functions (OL or OC). This parameter is used to prevent this situation.

- 📖 During acceleration, the AC drive output current may increase abruptly and exceed the value specified by Pr.06-03 due to rapid acceleration or excessive load on the motor. When this function is enabled, the AC drive will stop accelerating and keep the output frequency constant until the current drops below the maximum value.
- 📖 When the over-current stall prevention is enabled, drive deceleration time will be larger than the setting.
- 📖 When the Over-Current Stall Prevention occurs due to too small motor capacity or in the factory setting, please decrease Pr.06-03 setting.
- 📖 When there is any problem by using acceleration time, refer to the following items to solve it.
- 📖 Related parameters: Pr.01-12, 01-14, 01-16, 01-18 (settings of accel. time 1~4), Pr.01-44
 1. dd the suitable acceleration time.
 2. Setting Pr.01-44 Optimal Acceleration/Deceleration Setting to 1, 3 or 4 (auto accel.)
- 📖 Optimal Acceleration/Deceleration Setting, Pr.02-13~02-14 (Multi-function Output 1 RY1, RY2), Pr. 02-16~02-17 Multi-function Output (MO1, 2)

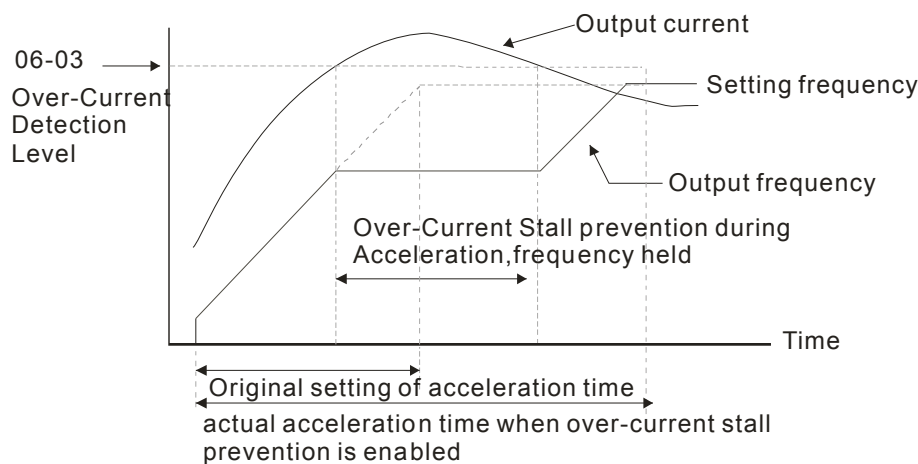

🔪 **06-04** Over-current Stall Prevention during Operation

Settings	Light duty: 0~160% (100%: drive's rated current)	Factory Setting: 120
	Heavy duty: 0~180% (100%: drive's rated current)	Factory Setting: 150

- 📖 It is a protection for drive to auto decrease output frequency when the motor is over-load abruptly during motor constant operation.
- 📖 If the output current exceeds the setting specified in Pr.06-04 when the drive is operating, the drive will decrease its output frequency (according to Pr.06-05) to prevent the motor stall. If the output current is lower than the setting specified in Pr.06-04, the drive will accelerate (according to Pr.06-05) again to catch up with the set frequency command value.

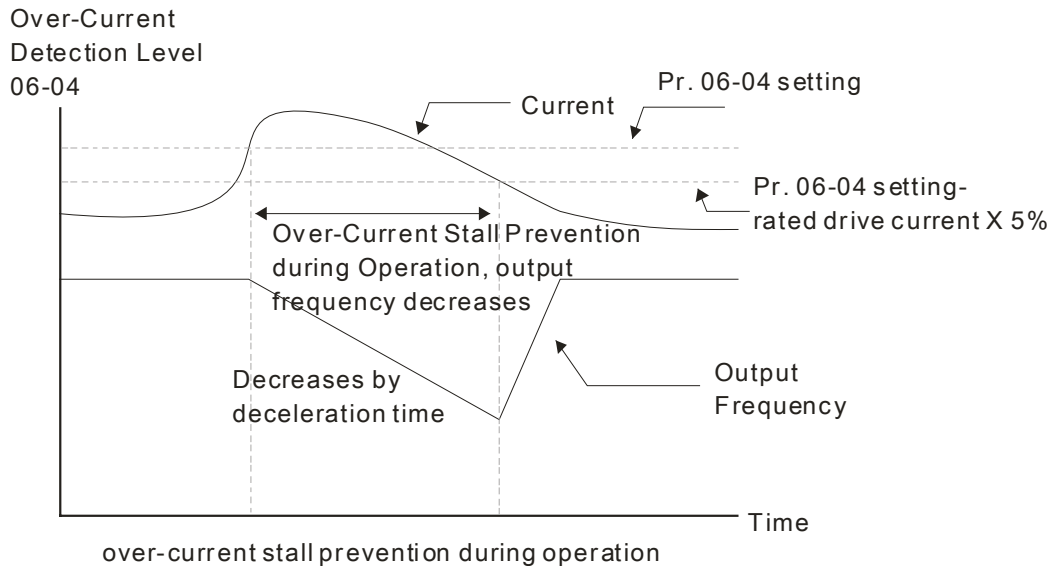

✎ **06-05** Accel./Decel. Time Selection of Stall Prevention at Constant Speed

Factory Setting: 0

- Settings
- 0: by current accel/decel time
 - 1: by the 1st accel/decel time
 - 2: by the 2nd accel/decel time
 - 3: by the 3rd accel/decel time
 - 4: by the 4th accel/decel time
 - 5: by auto accel/decel

📖 It is used to set the accel./decel. time selection when stall prevention occurs at constant speed.

✎ **06-06** Over-torque Detection Selection (OT1)

Factory Setting: 0

- Settings
- 0: Disable
 - 1: Over-torque detection during constant speed operation, continue to operate after detection
 - 2: Over-torque detection during constant speed operation, stop operation after detection
 - 3: Over-torque detection during operation, continue to operate after detection
 - 4: Over-torque detection during operation, stop operation after detection

✎ **06-09** Over-torque Detection Selection (OT2)

Factory Setting: 0

- Settings
- 0: Disable
 - 1: Over-torque detection during constant speed operation, continue to operate after detection
 - 2: Over-torque detection during constant speed operation, stop operation after detection
 - 3: Over-torque detection during operation, continue to operation after detection
 - 4: Over-torque detection during operation, stop operation after detection

- 📖 When Pr.06-06 and Pr.06-09 are set to 1 or 3, it will display a warning message and won't have an abnormal record.
- 📖 When Pr.06-06 and Pr.06-09 are set to 2 or 4, it will display a warning message and will have an abnormal record.

↗ 06-07 Over-torque Detection Level (OT1)	Factory Setting: 120
Settings 10 to 250% (100%: drive's rated current)	
↗ 06-08 Over-torque Detection Level (OT1)	Factory Setting: 0.1
Settings 0.0~60.0 sec	
↗ 06-10 Over-torque Detection Level (OT2)	Factory Setting: 120
Settings 10 to 250% (100%: drive's rated current)	
↗ 06-11 Over-torque Detection Time (OT2)	Factory Setting: 0.1
Settings 0.0~60.0 sec	

- 📖 Over torque detection is determine by the following method: if the output current exceeds the over-torque detection level (Pr.06-07, factory setting: 150%) and also exceeds Pr.06-08 Over-Torque Detection Time, the fault code "ot1/ot2" will appear. If a Multi-Functional Output Terminal is to over-torque detection (setting 7 or 8), the output is on. Please refer to Pr.02-13~02-14 for details.

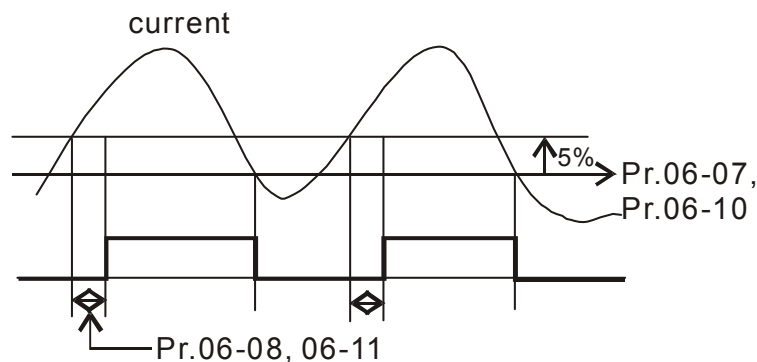

↗ 06-12 Current Limit	Factory Setting: 170
Settings 0~250% (100%: drive's rated current)	
<ul style="list-style-type: none"> 📖 Pr.06-12 sets the maximum output current of the drive. Pr.06-12 and Pr.11-17 ~ Pr.11-20 are used to set the drive's output current limit. When the drive is in VF, SVC or VFPG control mode, output frequency will decreases as the output current reaches current limit. It is a current stall prevention. 	
↗ 06-13 Electronic Thermal Relay Selection (Motor 1)	
↗ 06-27 Electronic Thermal Relay Selection (Motor 2)	Factory Setting: 2
Settings 0: Inverter motor (fan doesn't run with the axel synchronously)	

- 1: Standard motor (fan runs with the axel synchronously)
- 2: Disable

It is used to prevent self-cooled motor overheats under low speed. User can use electronic thermal relay to limit driver's output power.

06-14 Electronic Thermal Characteristic for Motor 1

06-28 Electronic Thermal Characteristic for Motor 2

Factory Setting: 60.0

Settings 30.0~600.0 sec

The parameter is set by the 150% of motor rated current and the setting of Pr.06-14 and Pr.06-28 to prevent the motor damaged from overheating. When it reaches the setting, it will display "EoL1/EoL2" and the motor will be in free running.

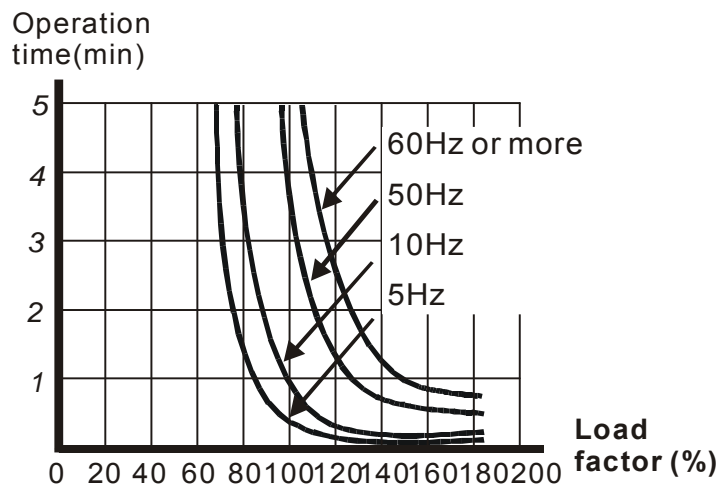

06-15 Heat Sink Over-heat (OH) Warning

Factory Setting: 85.0

Settings 0.0~110.0°C

When this parameter is set as 110.0°C, the drive will trigger error and stop instead of warning once the temperature reaches 110.0°C

For Frame C and above, when IGBT temperature reached (06-15 setting minus 15°C), heatsink fan will accelerate to the highest speed. When IGBT temperature is lower than (06-15 setting minus 35°C), and Cap temperature is lower than (OH2 warning level minus 10°C), heatsink fan will retrieve to its setting speed.

If the setting of this parameter is lower than 35°C, the adjustment level will be still 35°C.

06-16 Stall Prevention Limit Level

Factory Setting: 50

Settings 0~100% (Refer to Pr.06-03, Pr.06-04)

When operation frequency is larger than Pr.01-01; e.g. Pr06-03=150%, Pr. 06-04=100% and Pr. 06-16=80%:

Calculate the Stall Prevention Level during acceleration: $Pr.06-03 * Pr.06-16 = 150 \times 80\% = 120\%$.

Calculate the Stall Prevention Level at constant speed: $Pr.06-04 * Pr.06-16 = 100 \times 80\% = 80\%$.

06-17	Present Fault Record
06-18	Second Most Recent Fault Record
06-19	Third Most Recent Fault Record
06-20	Fourth Most Recent Fault Record
06-21	Fifth Most Recent Fault Record
06-22	Sixth Most Recent Fault Record

Settings

- 0: No fault record
- 1: Over-current during acceleration (ocA)
- 2: Over-current during deceleration (ocd)
- 3: Over-current during constant speed(ocn)
- 4: Ground fault (GFF)
- 5: IGBT short-circuit (occ)
- 6: Over-current at stop (ocS)
- 7: Over-voltage during acceleration (ovA)
- 8: Over-voltage during deceleration (ovd)
- 9: Over-voltage during constant speed (ovn)
- 10: Over-voltage at stop (ovS)
- 11: Low-voltage during acceleration (LvA)
- 12: Low-voltage during deceleration (Lvd)
- 13: Low-voltage during constant speed (Lvn)
- 14: Stop mid-low voltage (LvS)
- 15: Phase loss protection (OrP)
- 16: IGBT over-heat (oH1)
- 17: Capacitance over-heat (oH2) (for 40hp above)
- 18: tH1o (TH1 open: IGBT over-heat protection error)
- 19: tH2o (TH2 open: capacitance over-heat protection error)
- 20: Reserved
- 21: Drive over-load (oL)
- 22: Electronics thermal relay 1 (EoL1)
- 23: Electronics thermal relay 2 (EoL2)
- 24: Motor PTC overheat (oH3) (PTC)
- 25: Reserved
- 26: Over-torque 1 (ot1)
- 27: Over-torque 2 (ot2)
- 28: Low current (uC)
- 29: Home limit error (LMIT)
- 30: Memory write-in error (cF1)
- 31: Memory read-out error (cF2)
- 32: Reserved

- 33: U-phase current detection error (cd1)
- 34: V-phase current detection error (cd2)
- 35: W-phase current detection error (cd3)
- 36: Clamp current detection error (Hd0)
- 37: Over-current detection error (Hd1)
- 38: Over-voltage detection error (Hd2)
- 39: occ IGBT short circuit detection error (Hd3)
- 40: Auto tuning error (AUE)
- 41: PID feedback loss (AFE)
- 42: PG feedback error (PGF1)
- 43: PG feedback loss (PGF2)
- 44: PG feedback stall (PGF3)
- 45: PG slip error (PGF4)
- 46: Reserved
- 47: Reserved
- 48: Analog current input loss (ACE)
- 49: External fault input (EF)
- 50: Emergency stop (EF1)
- 51: External Base Block (bb)
- 52: Password error (PcodE)
- 53: Reserved
- 54: Communication error (CE1)
- 55: Communication error (CE2)
- 56: Communication error (CE3)
- 57: Communication error (CE4)
- 58: Communication Time-out (CE10)
- 59: Reserved
- 60: Brake transistor error (bF)
- 61: Y-connection/ Δ -connection switch error (ydc)
- 62: Decel. Energy Backup Error (dEb)
- 63: Slip error (oSL)
- 64: Electromagnet switch error (ryF)
- 65 : PG Card Error (PGF5)
- 66-67: Reserved
- 68: Sensorless estimated speed have wrong direction
- 69: Sensorless estimated speed is over speed
- 70: Sensorless estimated speed deviated
- 71~72: Reserved
- 73: External safety gate S1
- 74~81: Reserved
- 82: OPHL U phase output phase loss
- 83: OPHL V phase output phase loss

- 84: OPHL W phase output phase loss
- 85: PG-02U ABZ hardware disconnection
- 86: PG-02U UVW hardware disconnection
- 87~88: Reserved
- 89: Initial rotor position detection error
- 90: Inner PLC function is forced to stop
- 91~100: Reserved
- 101: CGdE CANopen software disconnect1
- 102: CHbE CANopen software disconnect2
- 103: Reserved
- 104: CbFE CANopen hardware disconnect
- 105: CIdE CANopen index setting error
- 106: CAdE CANopen slave station number setting error
- 107: CFrE CANopen index setting exceed limit
- 108~110: Reserved
- 111: InrCOM Internal communication overtime error
- 112: PM sensorless shaft lock error
- 113: Reserved

- When the fault occurs and force stopping, it will record in this parameter.
- At stop with low voltage Lv (LvS warn, no record). During operation with mid-low voltage Lv (LvA, Lvd, Lvn error, will record).
- Setting 62: when dEb function is enabled, the drive will execute dEb and record to the Pr.06-17 to Pr.06-22 simultaneously.

	06-23	Fault Output Option 1
	06-24	Fault Output Option 2
	06-25	Fault Output Option 3
	06-26	Fault Output Option 4

Factory Setting: 0

Settings 0 to 65535 sec (refer to bit table for fault code)

- These parameters can be used with multi-function output (set to 35-38) for the specific requirement. When the fault occurs, the corresponding terminals will be activated (It needs to convert binary value to decimal value to fill in Pr.06-23 to Pr.06-26).

Fault Code	Bit0	Bit1	Bit2	Bit3	Bit4	Bit5	Bit6
	current	Volt.	OL	SYS	FBK	EXI	CE
0: No fault							
1: Over-current during acceleration (ocA)	●						
2: Over-current during deceleration (ocd)	●						
3: Over-current during constant speed(ocn)	●						
4: Ground fault (GFF)	●						
5: IGBT short-circuit (occ)	●						
6: Over-current at stop (ocS)	●						

Fault Code	Bit0	Bit1	Bit2	Bit3	Bit4	Bit5	Bit6
	current	Volt.	OL	SYS	FBK	EXI	CE
7: Over-voltage during acceleration (ovA)		●					
8: Over-voltage during deceleration (ovd)		●					
9: Over-voltage during constant speed (ovn)		●					
10: Over-voltage at stop (ovS)		●					
11: Low-voltage during acceleration (LvA)		●					
12: Low-voltage during deceleration (Lvd)		●					
13: Low-voltage during constant speed (Lvn)		●					
14: Stop mid-low voltage (LvS)		●					
15: Phase loss protection (OrP)		●					
16: IGBT over-heat (oH1)			●				
17: Capacitance over-heat (oH2)			●				
18: tH1o (TH1 open)			●				
19: tH2o (TH2 open)			●				
20: Reserved							
21: Drive over-load (oL)			●				
22: Electronics thermal relay 1 (EoL1)			●				
23: Electronics thermal relay 2 (EoL2)			●				
24: Motor PTC overheat (oH3) (PTC)			●				
25: Reserved							
26: Over-torque 1 (ot1)			●				
27: Over-torque 2 (ot2)			●				
28: Low current (uC)	●						
29: Home limit error (LMIT)						●	
30: Memory write-in error (cF1)				●			
31: Memory read-out error (cF2)				●			
32: Reserved							
33: U-phase current detection error (cd1)				●			
34: V-phase current detection error (cd2)				●			
35: W-phase current detection error (cd3)				●			
36: Clamp current detection error (Hd0)				●			
37: Over-current detection error (Hd1)				●			
38: Over-voltage detection error (Hd2)				●			
39: occ IGBT short circuit detection error (Hd3)				●			
40: Auto tuning error (AUE)				●			
41: PID feedback loss (AFE)					●		
42: PG feedback error (PGF1)					●		
43: PG feedback loss (PGF2)					●		
44: PG feedback stall (PGF3)					●		

Fault Code	Bit0	Bit1	Bit2	Bit3	Bit4	Bit5	Bit6
	current	Volt.	OL	SYS	FBK	EXI	CE
45: PG slip error (PGF4)					●		
46: Reserved							
47: Reserved							
48: Analog current input loss (ACE)					●		
49: External fault input (EF)						●	
50: Emergency stop (EF1)						●	
51: External Base Block (bb)						●	
52: Password error (PcodE)				●			
53: Reserved							
54: Communication error (CE1)							●
55: Communication error (CE2)							●
56: Communication error (CE3)							●
57: Communication error (CE4)							●
58: Communication Time-out (CE10)							●
59: Reserved							
60: Brake transistor error (bF)						●	
61: Y-connection/ Δ -connection switch error (ydc)						●	
62: Decel. Energy Backup Error (dEb)		●					
63: Slip error (oSL)						●	
64: Electromagnet switch error (ryF)						●	
65 : PG Card Error (PGF5)						●	
66-67: Reserved							
68: Sensorless estimated speed have wrong direction						●	
69: Sensorless estimated speed is over speed						●	
70: Sensorless estimated speed deviated						●	
71~72: Reserved							
73: External safety gate S1				●			
74~81: Reserved							
82: OPHL U phase output phase loss	●						
83: OPHL V phase output phase loss	●						
84: OPHL W phase output phase loss	●						
85: PG-02U ABZ hardware disconnection					●		
86: PG-02U UVW hardware disconnection					●		
87~88: Reserved							
89: Initial rotor position detection error					●		
90: Inner PLC function is forced to stop				●			
91~100: Reserved							

Fault Code	Bit0	Bit1	Bit2	Bit3	Bit4	Bit5	Bit6
	current	Volt.	OL	SYS	FBK	EXI	CE
101: CGdE CANopen software disconnect1							●
102: CHbE CANopen software disconnect2							●
103: Reserved							
104: CbFE CANopen hardware disconnect							●
105: CIdE CANopen index setting error							●
106: CAdE CANopen slave station number setting error							●
107: CFrE CANopen index setting exceed limit							●
108~110: Reserved							
111: InrCOM Internal communication overtime error							●
112: PM sensorless shaft lock error					●		
113: Reserved							

↗ **06-29** PTC (Positive Temperature Coefficient) Detection Selection

Factory Setting: 0

- Settings
- 0: Warn and keep operating
 - 1: Warn and ramp to stop
 - 2: Warn and coast to stop
 - 3: No warning

📖 Pr.06-29 setting defines how the will drive operate after PTC detection.

↗ **06-30** PTC Level

Factory Setting: 50.0

- Settings 0.0~100.0%

📖 It needs to set AVI/ACI/AUI analog input function Pr.03-00~03-02 to 6 (P.T.C. thermistor input value).

📖 It is used to set the PTC level, and the corresponding value for 100% is max. analog input value.

↗ **06-31** Frequency Command for Malfunction

Factory Setting: Read only

- Settings 0.00~599.00Hz

📖 When malfunction occurs, use can check the frequency command. If it happens again, it will overwrite the previous record.

06-32 Output Frequency at Malfunction

Factory Setting: Read only

- Settings 0.00~599.00Hz

📖 When malfunction occurs, use can check the current frequency command. If it happens again, it will overwrite the previous record.

06-33 Output Voltage at Malfunction

Factory Setting: Read only

Settings 0.0~6553.5V

 When malfunction occurs, user can check current output voltage. If it happens again, it will overwrite the previous record.

06-34 DC Voltage at Malfunction

Factory Setting: Read only

Settings 0.0~6553.5V

 When malfunction occurs, user can check the current DC voltage. If it happens again, it will overwrite the previous record.

06-35 Output Current at Malfunction

Factory Setting: Read only

Settings 0.00~6553.5Amp

 When malfunction occurs, user can check the current output current. If it happens again, it will overwrite the previous record.

06-36 IGBT Temperature at Malfunction

Factory Setting: Read only

Settings -3276.7~3276.7 °C

 When malfunction occurs, user can check the current IGBT temperature. If it happens again, it will overwrite the previous record.

06-37 Capacitance Temperature at Malfunction

Factory Setting: Read only

Settings -3276.7~3276.7 °C

 When malfunction occurs, user can check the current capacitance temperature. If it happens again, it will overwrite the previous record.

06-38 Motor Speed in rpm at Malfunction

Factory Setting: Read only

Settings -32767~32767 rpm

 When malfunction occurs, user can check the current motor speed in rpm. If it happens again, it will overwrite the previous record.

06-39 Torque Command at Malfunction

Factory Setting: Read only

Settings -3276.7~3276.7%

 When malfunction occurs, user can check the current torque command. If it happens again, it will overwrite the previous record.

06-40 Status of Multi-function Input Terminal at Malfunction

Factory Setting: Read only

Settings 0000h~FFFFh

06-41 Status of Multi-function Output Terminal at Malfunction

Factory Setting: Read only

Settings 0000h~FFFFh

📖 When malfunction occurs, user can check the status of multi-function input/output terminals. If it happens again, it will overwrite the previous record.

06-42 Drive Status at Malfunction

Factory Setting: Read only

Settings 0000H~FFFFh

📖 When malfunction occurs, please check the drive status (communication address 2119H). If malfunction happens again, the previous record will be overwritten by this parameter.

06-43 Reserved

06-44 Reserved

↗ **06-45** Treatment to Output Phase Loss Detection (OPHL)

Factory Setting: 3

Settings 0: Warn and keep operating
 1: Warn and ramp to stop
 2: Warn and coast to stop
 3: No warning

📖 Pr.06-45 defines how the drive will operate when output phase loss occurs.

↗ **06-46** Deceleration Time of Output Phase Loss

Factory Setting:0.500

Settings 0.000~65.535 sec

↗ **06-47** Current Bandwidth

Factory Setting:1.00

Settings 0.00~100.00%

↗ **06-48** DC Brake Time of Output Phase Loss

Factory Setting:0.000

Settings 0.000~65.535 sec

↗ **06-49** LvX Auto Reset

Factory Setting: 0

Settings 0: Disable
 1: Enable

↗ **06-50** Time for Input Phase Loss Detection

Factory Setting:0.20

Settings 0.00~600.00 sec

06-51 Reserved

 ↗ **06-52** Ripple of Input Phase Loss

Factory Setting: 60.0

Settings 460V Series: 0.0~320.0 Vdc

 ↗ **06-53** Treatment for the detected Input Phase Loss (OrP)

Factory Setting: 0

Settings 0: warn, ramp to stop

1: warn, coast to stop

 📖 Over ripple protection

06-54 Reserved

 ↗ **06-55** Derating Protection

Factory Setting: 0

Settings 0: constant rated current and limit carrier wave by load current and temperature

1: constant carrier frequency and limit load current by setting carrier wave

2: constant rated current(same as setting 0), but close current limit

 📖 Setting 0:

When the rated current is constant, carrier frequency (Fc) outputted by PWM will auto decrease according to surrounding temperature, overload output current and time. If overload situation is not frequent and only cares the carrier frequency operated with the rated current for a long time and carrier wave changes during short overload, it is recommended to set to 0.

Refer to the following diagram for the level of carrier frequency. Take VFD007C43A in normal duty as example, surrounding temperature 50oC with independent installation and UL open-type.

When the carrier frequency is set to 15kHz, it corresponds to 72% rated output current. When it outputs higher than the value, it will auto decrease the carrier frequency. If the output is 83% rated current and the carrier frequency will decrease to 12kHz. In addition, it will also decrease the carrier frequency when overload. When the carrier frequency is 15kHz and the current is $120\% \times 72\% = 86\%$ for a minute, the carrier frequency will decrease to the factory setting.

 📖 Setting 1:

It is used for the fixed carrier frequency and prevents the carrier wave changes and motor noise caused by the surrounding temperature and frequent overload.

Refer to the following for the derating level of rated current. Take VFD007C43A in normal duty as example, when the carrier frequency keeps in 15kHz and the rated current is decreased to 72%, it will have OL protection when the current is $120\% \times 72\% = 86\%$ for a minute. Therefore, it needs to operate by the curve to keep the carrier frequency.

 📖 Setting 2:

It sets the protection method and action to 0 and disables the current limit for the Ratio*160% of

output current in the normal duty and Ratio*180% of output current in the heavy duty. The advantage is that it can provide higher output current when the setting is higher than the factory setting of carrier frequency. The disadvantage is that it decreases carrier wave easily when overload.

Derating curve diagram in the normal duty (Pr.00-16=0)

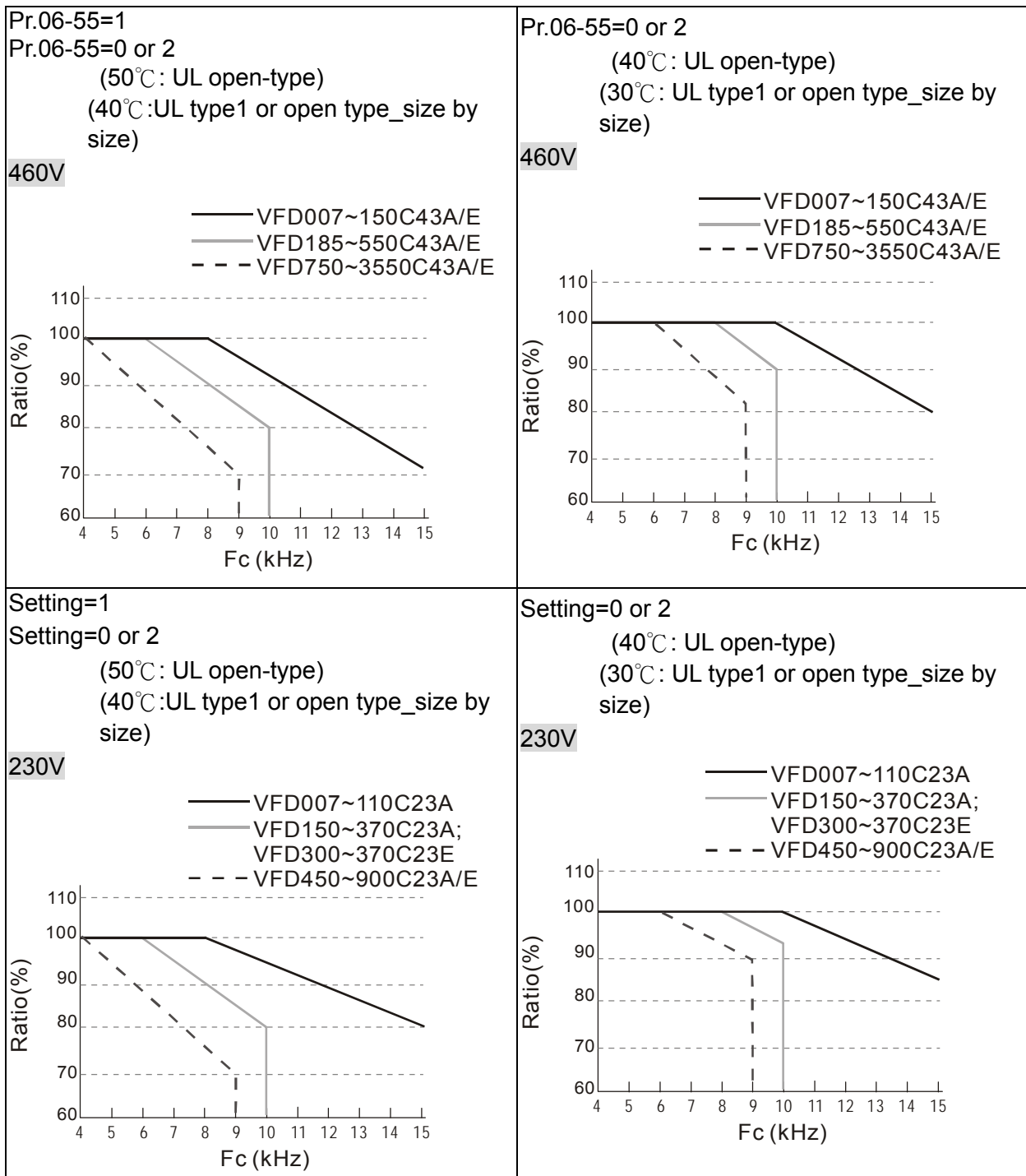

Derating curve diagram in the heavy duty (Pr.00-16=1)

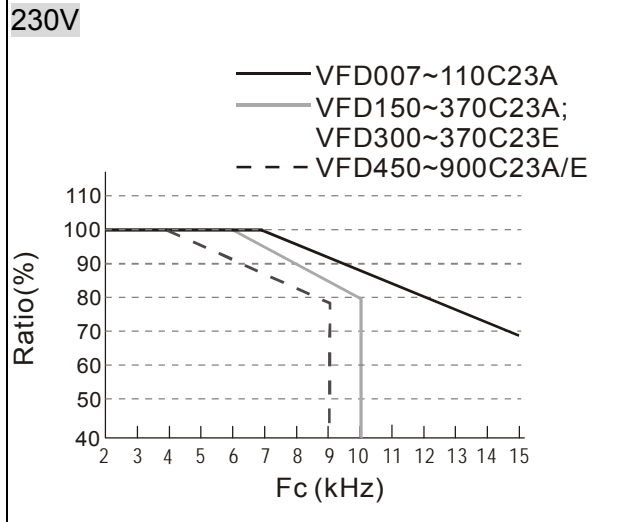
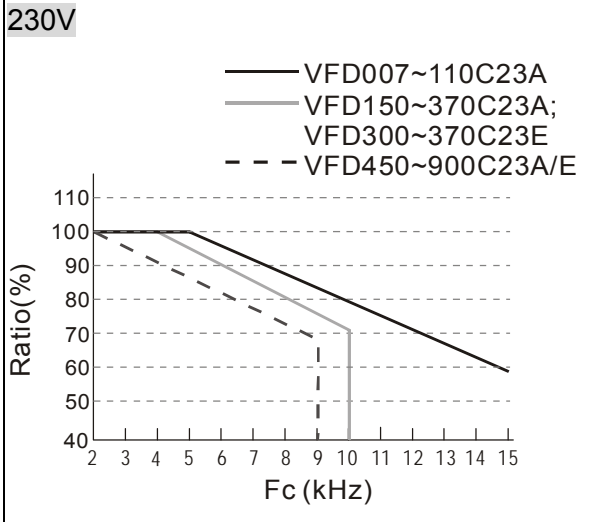
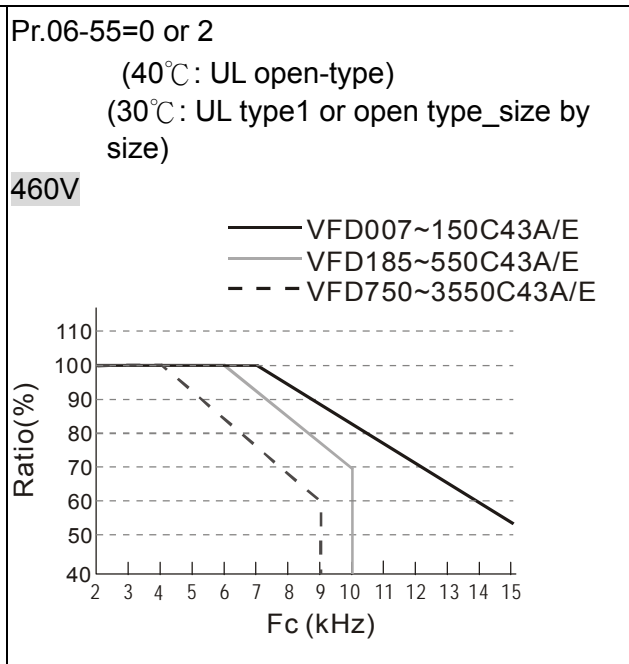
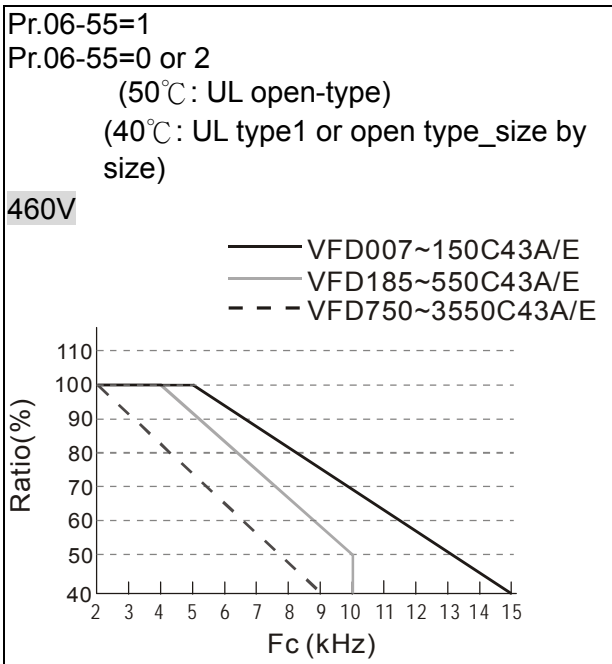

It should be used with Pr. 00-16 and Pr.00-17 for setting.

- 06-56 PT100 Detection Level 1
Factory Setting: 5.000
Settings 0.000~10.000V
- 06-57 PT100 Detection Level 2
Factory Setting: 7.000
Settings 0.000~10.000V
- 06-58 PT100 Level 1 Frequency Protection
Factory Setting: 0.00
Settings 0.00~599.00 Hz

PT100 operation

- (1) Use AVI, AUI or ACI(set to 0-10V) for analog voltage input and select PT100 mode.
- (2) Choose one of the analog voltage input type: (a)AVI (Pr.03-00=11), (b) AUI (Pr.03-02=11), or (c) ACI (Pr.03-01=11 and Pr.03-29=1).

- (3) When using ACI as analog voltage input, set Pr.03-01=11 and Pr.03-29=1. Then switch SW2 to 0-10V on the I/O control terminal block.
- (4) Set Pr.03-23=23 and AFM2 to constant current output. Switch AFM2 (SW2) to 0-20mA on the I/O control terminal block and set constant current output to 9mA by setting Pr.03-33=45. The AFM2 constant output current is $20\text{mA} * 45\% = 9\text{mA}$.
- (5) Pr.03-33 is for adjusting the constant voltage or constant current of AFM2, the setting range is 0~100.00%.
- (6) There are two types of action level for PT100. The diagram of PT protecting action is shown as below:

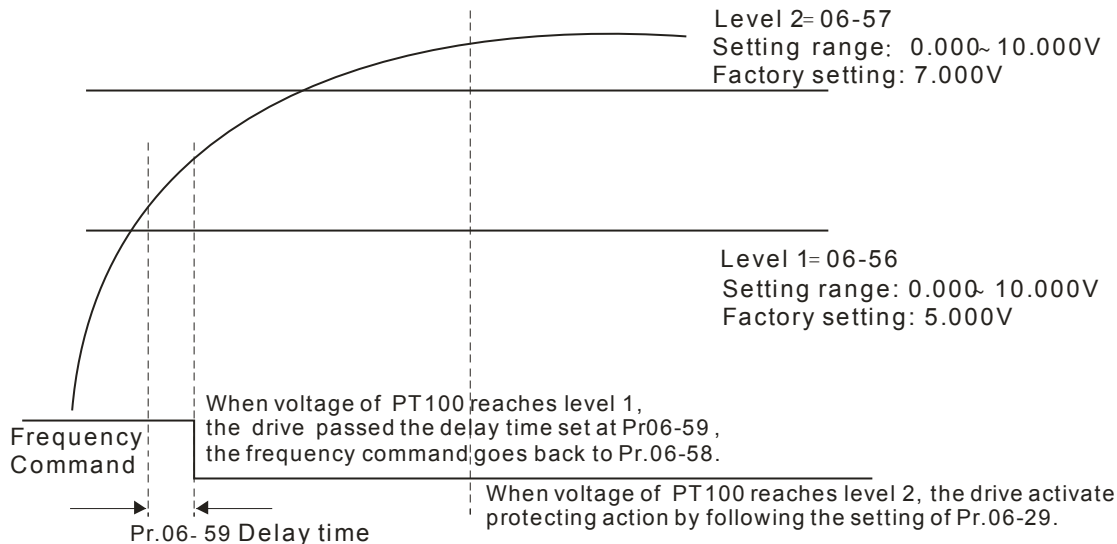

- (7) PT100 wiring diagram:

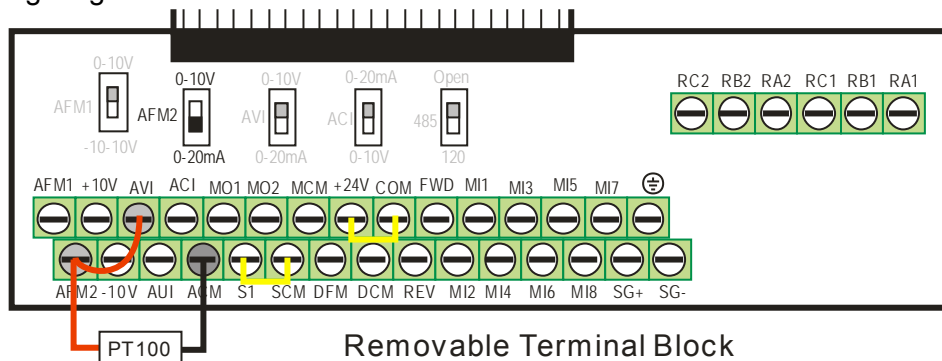

Figure 1

When Pr.06-58=0.00Hz, PT100 function is disabled.

Example:

A PT100 is installed to the drive. If motor temperature reach 135°C (275°F) or higher, the drive will decrease motor frequency to the setting of Pr.06-58. Motor will operate at this frequency (Pr.06-58) till the motor temperature decreases to 135°C (275°F) or lower. If motor temperature raise beyond 150°C (302°F), the motor will decelerate to stop and outputs an 'OH3' warning.

Set up process:

1. Switch AFM2 (SW2) to 0-20mA on the I/O control terminal block. (Refer to Figure 1, PT100 wiring diagram)
2. Wiring (Refer to Figure 1, PT100 wiring diagram):
 Connect external terminal AFM2 to (+)
 Connect external terminal ACM to (-)
 Connect external terminals AFM2 and AVI to short-circuit
3. Set Pr.03-00=11 or Pr.03-23=23 or Pr.03-33=45%(9mA)

4. Refer to RTD temperature and resistance comparison table
Temperature=135°C, current=151.71Ω; Input current: 9mA, Voltage: approximately: 1.37Vdc
Temperature=150°C, current=157.33Ω; Input current: 9mA, Voltage: approximately: 1.42Vdc
5. Set Pr.06=56=1.37 and Pr.06-58=10Hz. When RTD temperature increases to 135°C or higher, the drive will decelerate to the selected frequency. When Pr.06-58=0, the drive will not run.
6. Set Pr.06-57=1.42 and Pr.06-29=1 (warning and decelerate to stop). When RTD temperature increases to 150°C or higher, the drive will decelerate to stop and outputs an 'OH3' warning.

↗ **06-59** PT100 Activation Level Delay Time

Factory Setting: 60

Settings 0~6000 sec.

↗ **06-60** Software Detection GFF Current Level

Factory Setting: 60.0

Settings 0.0~6553.5 %

↗ **06-61** Software Detection GFF Filter Time

Factory Setting: 0.10

Settings 0.00~655.35 sec.

06-62 Reserved

06-63 Fault Record 1 (day)

06-65 Fault Record 2 (day)

06-67 Fault Record 3 (day)

06-69 Fault Record 4 (day)

Factory Setting: Read only

Settings 0~65535 day

06-64 Fault Record 1 (min)

06-66 Fault Record 2 (min)

06-68 Fault Record 3 (min)

06-70 Fault Record 4 (min)

Factory Setting: Read only

Settings 0~1439 minute

📖 When there is any malfunctions in motor drive operation, Pr06-17~22 will record 6 malfunctions recently, and Pr06-63~70 can record the operation time for 4 malfunctions in sequence. It can help to check if there is any wrong with the drive according to the recorded internal time.

For example: The first error: ocA occurs in 1000 minutes after motor drive start operation. The second error: ocd happens after another 1000 minutes. The 4th error: ocA happens after another 1000 minutes. Then, the 5th error is ocd, happening 1000 minutes following 4th error. Last, 6th error ocn happens 1000 minutes after 5th error.

Then Pr06-17~Pr06-22 and Pr06-63~Pr06-70 will be:

	1 st fault	2 nd fault	3 rd fault	4 th fault	5 th fault	6 th fault
06-17	ocA	ocd	ocn	ocA	ocd	ocn
06-18	0	ocA	ocd	ocn	ocA	ocd
06-19	0	0	ocA	ocd	ocn	ocA
06-20	0	0	0	ocA	ocd	ocn
06-21	0	0	0	0	ocA	ocd
06-22	0	0	0	0	0	ocA
06-63	1000	560	120	1120	680	240
06-64	0	1	2	2	3	4
06-65	0	1000	560	120	1120	680
06-66	0	0	1	2	2	3
06-67	0	0	1000	560	120	1120
06-68	0	0	0	1	2	2
06-69	0	0	0	1000	560	120
06-70	0	0	0	0	1	2

※ From time record, it can be known that the last fault (Pr06-17) happened after the drive run for 4days and 240 minutes.

↗ **06-71** Low Current Setting Level

Factory Setting: 0.0

Settings 0.0 ~ 100.0 %

↗ **06-72** Low Current Detection Time

Factory Setting: 0.00

Settings 0.00 ~ 360.00 sec

↗ **06-73** Treatment for low current

Factory Setting: 0

Settings 0 : No function
 1 : warn and coast to stop
 2 : warn and ramp to stop by 2nd deceleration time
 3 : warn and operation continue

📖 The drive will operate as the setting of Pr.06-73 when output current is lower than the setting of Pr.06-71 and when low current continues for a period longer than the setting of Pr.06-72. This parameter can also be used with external multi-function output terminal 44 (MO44) for low current output.

07 Special Parameters

✎ This parameter can be set during operation.

-
- ✎ **07-00** Software Brake Level Factory Setting: 760.0
- Settings 460V series: 700.0~900.0Vdc
-
- 📖 This parameter sets the DC-bus voltage at which the brake chopper is activated. Users can choose the suitable brake resistor to have the best deceleration. Refer to Chapter 7 Accessories for the information of the brake resistor.
- 📖 It is only valid for the models below 30kW of 460 series and 22kW of 230 series.
-
- ✎ **07-01** DC Brake Current Level Factory Setting: 0
- Settings 0~100%
-
- 📖 This parameter sets the level of DC Brake Current output to the motor during start-up and stopping. When setting DC Brake Current, the Rated Current is regarded as 100%. It is recommended to start with a low DC Brake Current Level and then increase until proper holding torque has been attained.
- 📖 When it is in FOCPG/TQCPG mode, DC brake is zero-speed operation. It can enable DC brake function by setting to any value.
-
- ✎ **07-02** DC Brake Time at Start-up Factory Setting: 0.0
- Settings 0.00~60.0 sec
-
- 📖 The motor may be in the rotation status due to external force or itself inertia. If the drive is used with the motor at this moment, it may cause motor damage or drive protection due to over current. This parameter can be used to output DC current before motor operation to stop the motor and get a stable start. This parameter determines the duration of the DC Brake current after a RUN command. When it is set to 0.0, it is invalid.
-
- ✎ **07-03** DC Brake Time at Stop Factory Setting: 0.00
- Settings 0.00~60.00 sec
-
- 📖 The motor may be in the rotation status after drive stop outputting due to external force or itself inertia and can't stop accurately. This parameter can output DC current to force the motor drive stop after drive stops to make sure that the motor is stop.
- 📖 This parameter determines the duration of the DC Brake current during stopping. To DC brake at stop, this function will be valid when Pr.00-22 is set to 0 or 2. When setting to 0.0, it is invalid.
- 📖 Related parameters: Pr.00-22 Stop Method, Pr.07-04 Start-point for DC Brake
-
- ✎ **07-04** Start-Point for DC Brake Factory Setting: 0.00
- Settings 0.00~599.00Hz
-
- 📖 This parameter determines the frequency when DC Brake will begin during deceleration. When

this setting is less than start frequency (Pr.01-09), the start-point for DC brake will start from the min. frequency.

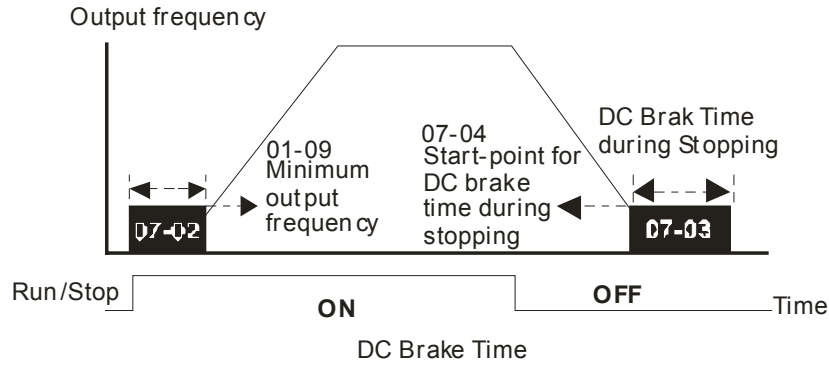

- 📖 DC Brake at Start-up is used for loads that may move before the AC drive starts, such as fans and pumps. Under such circumstances, DC Brake can be used to hold the load in position before setting it in motion.
- 📖 DC Brake at stop is used to shorten the stopping time and also to hold a stopped load in position, such as crane or cutting machine.
- 📖 DC Brake at Start-up is used for loads that may move before the AC drive starts, such as fans and pumps. Under such circumstances, DC Brake can be used to hold the load in position before setting it in motion.
- 📖 DC Brake at stop is used to shorten the stopping time and also to hold a stopped load in position, such as crane or cutting machine.

⚡ **07-05** Voltage Increasing Gain

Factory Setting: 100

Settings 1~200%

- 📖 When the user is using speed tracking, adjust Pr07-05 to slow down the increasing of voltage if there are errors such as oL or ocv. Then the speed tracking time will be longer and the Pr07-09 Pivot Point of the Speed Tracking of the Current 20~200%, factory setting 50. If the pivot point of the user is higher than the Pr06-03 pivot point of the oc stall, then the drive will choose the pivot point of Pr06-03 as the highest pivot point of the speed tracking.

⚡ **07-06** Restart after Momentary Power Loss

Factory Setting: 0

Settings 0: No function

1: Speed search for last frequency command

2: Speed search for the minimum output frequency

- 📖 This parameter determines the operation mode when the AC motor drive restarts from a momentary power loss.
- 📖 The power connected to the drive may power off momentarily due to many reasons. This function allows the drive to keep outputting after power is on again after power off and won't cause drive stops.
- 📖 Setting 1: Operation continues after momentary power loss, speed search starts with the Master Frequency reference value after drive output frequency and motor rotator speed is synchronous. The motor has the characteristics of big inertia and small obstruction. For example, in the

equipment with big inertia wheel, it doesn't need to wait to execute operation command until wheel is complete stop after re-start to save time.

- 📖 Setting 2: Operation continues after momentary power loss, speed search starts with the master frequency after drive output frequency and motor rotator speed is synchronous. The motor has the characteristics of small inertia and bigger obstruction.
- 📖 In PG control mode, the AC motor drive will execute the speed search function automatically by the PG speed when this setting isn't set to 0.

🔪 07-07 Maximum Power Loss Duration

Factory Setting: 2.0

Settings 0.0~20.0 sec

- 📖 If the duration of a power loss is less than this parameter setting, the AC motor drive will resume operation. If it exceeds the Maximum Allowable Power Loss Time, the AC motor drive output is then turned off (coast stop).
- 📖 The selected operation after power loss in Pr.07-06 is only executed when the maximum allowable power loss time is ≤ 5 seconds and the AC motor drive displays "LU".
But if the AC motor drive is powered off due to overload, even if the maximum allowable power loss time is ≤ 5 seconds, the operation mode as set in Pr.07-06 is not executed. In that case it starts up normally.

🔪 07-08 Base block Time

Factory Setting: 0.5

Settings 0.1~5.0 sec

- 📖 When momentary power loss is detected, the AC drive will block its output and then wait for a specified period of time (determined by Pr.07-08, called Base-Block Time) before resuming operation. This parameter should be set at a value to ensure that any residual regeneration voltage from the motor on the output has disappeared before the drive is activated again.

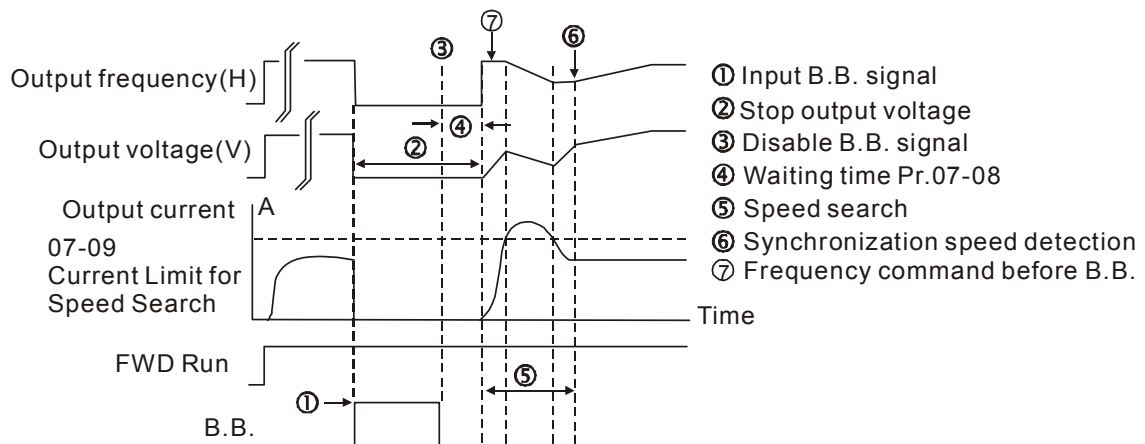

B.B. Search with last output frequency downward timing chart

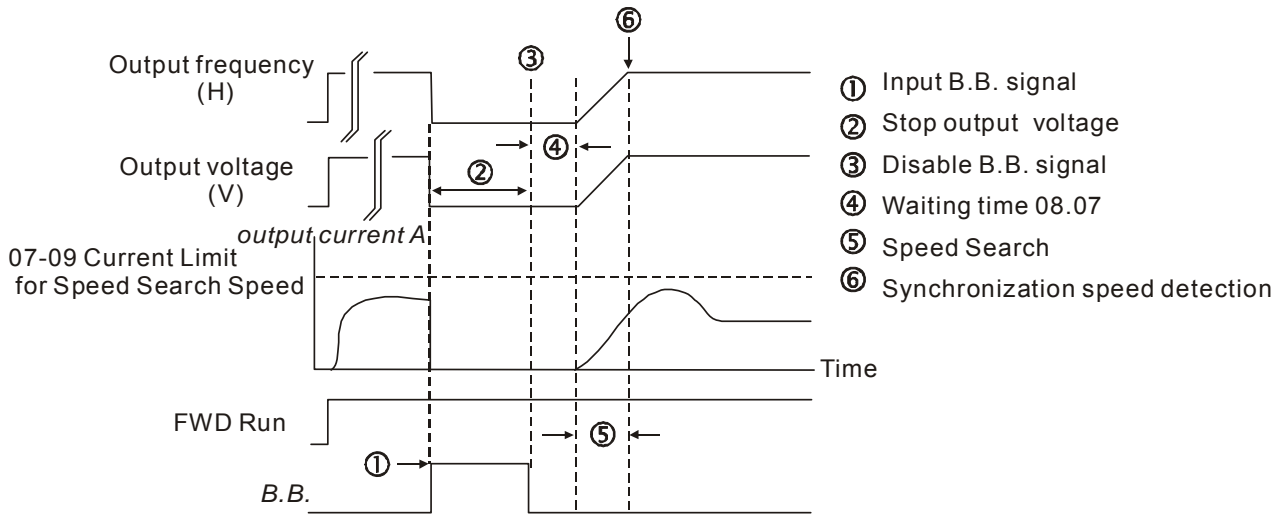

B.B. Search with minimum output frequency upward timing chart

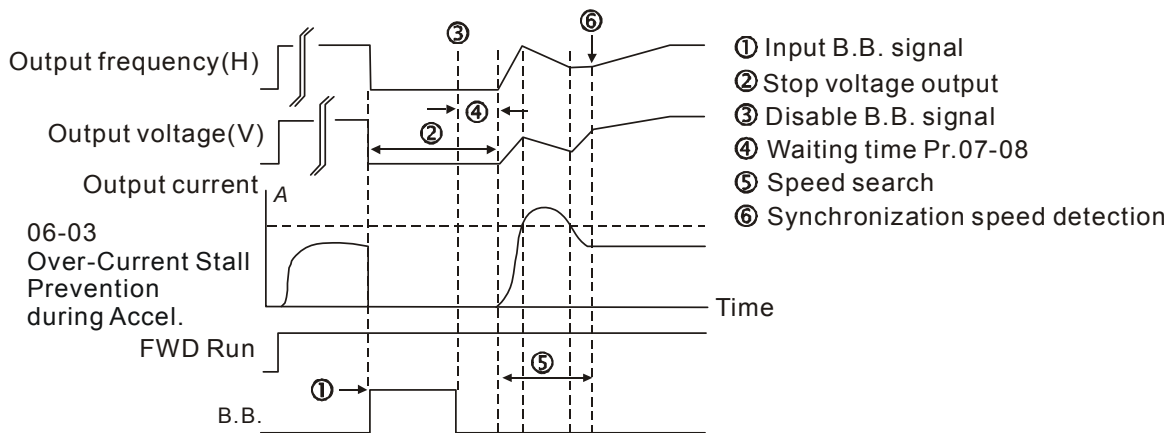

B.B. Search with minimum output frequency upward timing chart

⚡ **07-09** Current Limit for Speed Search

Factory Setting: 100

Settings 20~200%

- 📖 Following a momentary power loss, the AC motor drive will start its speed search operation only if the output current is greater than the value set by Pr.07-09.
- 📖 When executing speed search, the V/f curve is operated by group 1 setting. The maximum current for the optimum accel./decel. and start speed search is set by Pr.07-09.
- 📖 The speed search level will affect the synchronous time. It will get the synchronization faster when this parameter is set to larger value. But too large value may active overload protection.

⚡ **07-10** Treatment to Reboots After Fault

Factory Setting: 0

Settings 0: No function

1: Speed search starts with current speed



2: Speed search starts with minimum output frequency

- 📖 In PG control mode, the AC motor drive will execute the speed search function automatically by the PG speed when this setting isn't set to 0.
- 📖 Fault includes: bb,oc,ov,occ etc. To restart after oc, ov, occ, Pr.07-11 can not be set to 0.

07-11 Auto Restart After Fault

Factory Setting: 0

Settings 0~10



-  After fault (oc, ov, ov), occurs the AC motor drive can be reset/restarted automatically up to 10 times.
-  Setting this parameter to 0 will disable the reset/restart operation after any fault has occurred. When enabled, the AC motor drive will restart with speed search, which starts at the frequency before the fault.
-  If the drive execute reset/restart after fault more than the numbers of time set in Pr.07-11 and the limit is reached within the time period in Pr.07-33, the drive will stop execute reset/restart after fault function. User will be need to input RESET manually for the drive to continue operation.

07-12 Speed Search during Start-up

Factory Setting: 0

Settings 0: Disable

- 1: Speed search from maximum output frequency
- 2: Speed search from start-up motor frequency
- 3: Speed search from minimum output frequency

-  This parameter is used for starting and stopping a motor with a high inertia. A motor with high inertia will take 2-5 minutes or longer to stop completely. By setting this parameter, the user does not need to wait for the motor to come to a complete stop before restarting the AC motor drive. If a PG card and encoder is used on the drive and motor, then the speed search will start from the speed that is detected by the encoder and accelerate quickly to the commanded frequency. The output current is set by the Pr.07-09.
-  In PG control mode, the AC motor drive will execute the speed search function automatically by the PG speed when this setting isn't set to 0.

07-13 dEb Function Selection

Factory Setting: 0

Settings 0: Disable

- 1: dEb with auto accel./decel., the output frequency will not return after power reply.
- 2: dEb with auto accel./decel., the output frequency will return after power reply.

-  This parameter is used for the decel. time selection for momentary power loss.

07-14 Reserved

07-15 Dwell Time at Accel.

Factory Setting: 0.00

Settings 0.00~600.00 sec

⚡ **07-16** Dwell Frequency at Accel.

Factory Setting: 0.00

Settings 0.00~599.00Hz

⚡ **07-17** Dwell Time at Decel.

Factory Setting: 0.00

Settings 0.00~600.00 sec

⚡ **07-18** Dwell Frequency at Decel.

Factory Setting: 0.00

Settings 0.00~599.00Hz

📖 In the heavy load situation, Dwell can make stable output frequency temporarily, such as crane or elevator.

📖 Pr.07-15 to Pr.07-18 is for heavy load to prevent OV or OC occurs.

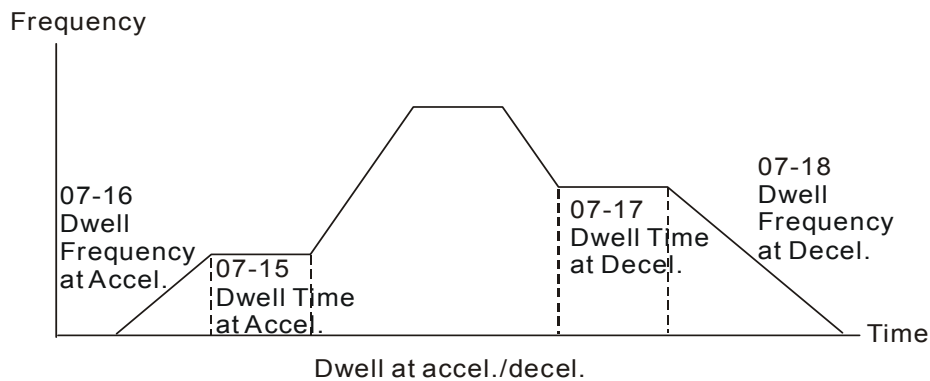

⚡ **07-19** Fan Cooling Control

Factory Setting: 0

Settings 0: Fan always ON

1: 1 minute after the AC motor drive stops, fan will be OFF

2: When the AC motor drive runs, the fan is ON. When the AC motor drive stops, the fan is OFF

3: Fan turns ON when preliminary heat sink temperature (around 60°C) is attained.

4: Fan always OFF

📖 This parameter is used for the fan control.

📖 Setting 0: Fan will be ON as the drive's power is turned ON.

📖 Setting 1: 1 minute after AC motor drive stops, fan will be OFF

📖 Setting 2: AC motor drive runs and fan will be ON. AC motor drive stops and fan will be OFF.

📖 Setting 3: Fan run according to IGBT and capacitance temperature. Fan will be ON when preliminary capacitance temperature is higher than 60oC. Fan will be OFF, when capacitance temperature is lower than 40oC.

📖 Setting 4: Fan is always OFF

⚡ **07-20** Emergency Stop (EF) & Force Stop

Factory Setting: 0

Settings 0: Coast to stop

1: Stop by 1st deceleration time

- 2: Stop by 2nd deceleration time
- 3: Stop by 3rd deceleration time
- 4: Stop by 4th deceleration time
- 5: System Deceleration
- 6: Automatic Deceleration

Pr.07-20 determines AC motor drive stop method. When the multi-function input terminal is set to 10 or 18 and is activated, the drive will stop according to the setting in Pr.07-20.

07-21 Auto Energy-saving Operation

Factory Setting: 0

- Settings 0: Disable
1: Enable

- When Pr.07-21 is set to 1, the acceleration and deceleration will operate with full voltage. During constant speed operation, it will auto calculate the best voltage value by the load power for the load. This function is not suitable for the ever-changing load or near full-load during operation.
- When the output frequency is constant, i.e. constant operation, the output voltage will auto decrease by the load reduction. Therefore, the drive will operate with min. power, multiplication of voltage and current.

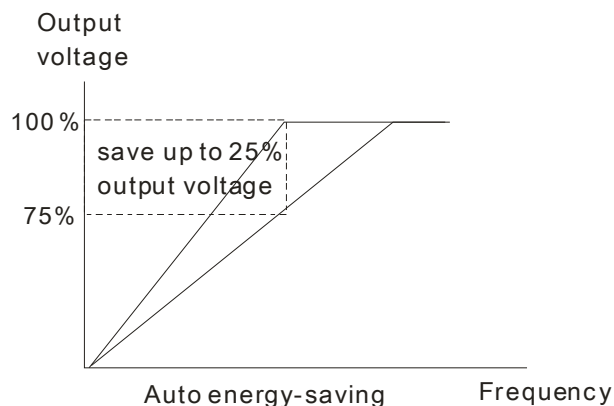

07-22 Energy-saving Gain

Factory Setting: 100

- Settings 10~1000%







- When Pr.00-19 is set to 1, this parameter can be used to adjust the gain of energy-saving. The factory setting is 100%. If the result is not good, it can adjust by decreasing the setting. If the motor oscillates, it should increase the setting.

07-23 Auto Voltage Regulation(AVR) Function

Factory Setting: 0

- Settings 0: Enable AVR
1: Disable AVR
2: Disable AVR during deceleration

- The rated voltage of the motor is usually 220V/200VAC 60Hz/50Hz and the input voltage of the AC motor drive may vary between 180V to 264 VAC 50Hz/60Hz. Therefore, when the AC motor drive is used without AVR function, the output voltage will be the same as the input voltage. When the motor runs at voltages exceeding the rated voltage with 12% - 20%, its lifetime will be shorter and it can be damaged due to higher temperature, failing insulation and unstable torque output.

-  AVR function automatically regulates the AC motor drive output voltage to the motor rated voltage. For instance, if V/f curve is set at 200 VAC/50Hz and the input voltage is at 200V to 264VAC, then the motor Output Voltage will automatically be reduced to a maximum of 200VAC/50Hz. If the input voltage is at 180V to 200VAC, output voltage to motor and input power will be in direct proportion.
-  Setting 0: when AVR function is enabled, the drive will calculate the output voltage by actual DC-bus voltage. The output voltage won't be changed by DC bus voltage.
-  Setting 1: when AVR function is disabled, the drive will calculate the output voltage by DC-bus voltage. The output voltage will be changed by DC bus voltage. It may cause insufficient/over current.
-  Setting 2: the drive will disable the AVR during deceleration, such as operated from high speed to low speed.
-  When the motor ramps to stop, the deceleration time is longer. When setting this parameter to 2 with auto acceleration/deceleration, the deceleration will be quicker.
-  When it is in FOCPG or TQCPG, it is recommended to set to 0 (enable AVR).



 **07-24** Filter Time of Torque Command (V/F and SVC control mode) Factory Setting: 0.500

Settings 0.001~10.000 sec

-  When the setting is too long, the control will be stable but the control response will be delay. When the setting is too short, the response will be quickly but the control may be unstable. User can adjust the setting by the control and response situation.



 **07-25** Filter Time of Slip Compensation (V/F and SVC control mode) Factory Setting: 0.100

Settings 0.001~10.000 sec

-  It can set Pr.05-22 and 05-23 to change the response time of compensation.
-  If Pr.05-22 and 05-23 are set to 10seconds, the response time of compensation is the slowest. But the system may be unstable when the setting is too short.

 **07-26** Torque Compensation Gain (V/F and SVC control mode) Factory Setting: 0





Settings 0~10 (SVC control mode is 1 as the default value)

-  When the motor load is large, a part of drive output voltage is absorbed by the resistor of stator winding and causes insufficient voltage at motor induction and result in over output current and insufficient output torque. It can auto adjust output voltage by the load and keep the air gap magnetic fields stable to get the optimal operation.
-  In the V/F control, the voltage will be decreased in direct proportion when the frequency is decreased. It'll cause decrease torque at low speed due to small AC resistor and the same DC resistor. Therefore, Auto torque compensation function will increase the output voltage in the low frequency to get higher start torque.
-  When Pr.07-26 is set to large, it may cause motor overflux and result in too large output current, motor overheat or triggers protection function.

07-27 Slip Compensation Gain (SVC control mode: the factory value is 1)

Factory Setting: 0.00

Settings 0.00~10.00

-  The induction motor needs the constant slip to produce magnetic torque. It can be ignore in the higher motor speed, such as rated speed or 2-3% slip.
-  In the operation with variable frequency, the slip and the synchronous frequency will be in reverse proportion to produce the same magnetic torque. That is the slip will be larger with the reduction of synchronous frequency. The motor may stop when the synchronous frequency is decreased to a specific value. Therefore, the slip serious affects the accuracy of motor speed at low speed.
-  In another situation, when the drive uses with induction motor, the slip will be increased by the increasing load. It also affects the accuracy of motor speed.
-  This parameter can be used to set compensation frequency and reduce the slip to close the synchronous speed when the motor runs in the rated current to raise the drive accuracy. When the drive output current is larger than Pr.05-05 No-load Current of Induction Motor 1 (A), the drive will compensation the frequency by this parameter.
-  When the control method (Pr.00-11) is changed from V/f mode to vector mode, this parameter will auto be set to 1.00. Otherwise, it will be set to 0.00. Please do the compensation of slip after overload and acceleration. The compensation value should be increased from small to large gradually. That is to add the output frequency with motor rated slip X Pr.07-27 Slip Compensation Gain when the motor is rated load. If the actual speed ratio is slow than expectation, please increase the setting. Otherwise, decrease the setting.

07-28 Reserved

07-29 Slip Deviation Level

Factory Setting: 0

Settings 0~100.0%

0: No detection

07-30 Detection Time of Slip Deviation

Factory Setting:1.0

Settings 0.0~10.0 sec

07-31 Over Slip Treatment

Factory Setting:0

Settings

- 0: Warn and keep operation
- 1: Warn and ramp to stop
- 2: Warn and coast to stop
- 3: No warning

-  Pr.07-29 to Pr.07-31 are used to set allowable slip level/time and over slip treatment when the drive is running.

07-32 Motor Hunting Gain

Factory Setting:1000

Settings 0~10000
0: Disable

-  The motor will have current wave motion in some specific area. It can improve this situation by setting this parameter. (When it is high frequency or run with PG, it can be set to 0. when the current wave motion happens in the low frequency, please increase Pr.05-29.)
-

07-33 Recovery Time to Pr.07-11 (# of automatic reboots after fault)

Factory Setting:60.0

Settings 00~6000.0 sec

-  When a reset/restart after fault occurs, the drive will regards Pr.07-33 as a time boundary and begin counting the numbers of faults occur within this time period. Within the period, if numbers of faults occurred did not exceed the setting in Pr.07-11, the counting will be cleared and starts from 0 when next fault occurs. However, if the numbers of faults occurred within this time period have exceed the setting in Pr.07-11, user will need to press RESET key manually for the drive to operate again.

08 High-function PID Parameters

✎ This parameter can be set during operation.

✎ **08-00** Input Terminal for PID Feedback

Factory Setting:0

Settings 0: No function

1: Negative PID feedback: input from external terminal AVI (Pr.03-00)

2: Negative PID feedback from PG card (Pr.10-15, skip direction)

3: Negative PID feedback from PG card (Pr.10-15)

4: Positive PID feedback from external terminal AVI (Pr.03-00)

5: Positive PID feedback from PG card (Pr.10-15, skip direction)

6: Positive PID feedback from PG card (Pr.10-15)

7: Negative PID feedback from communication protocol

8: Positive PID feedback from communication protocol

📖 Negative feedback means: +target value – feedback. It is used for the detection value will be increased by increasing the output frequency.

📖 Positive feedback means: -target value + feedback. It is used for the detection value will be decreased by increasing the output frequency.

📖 When Pr08-00≠7 neither ≠8, input value is disabled. The value of the setting remain the same after the derive is off.

Common applications for PID control

- ☑ Flow control: A flow sensor is used to feedback the flow data and performs accurate flow control.
- ☑ Pressure control: A pressure sensor is used to feedback the pressure data and performs precise pressure control.
- ☑ Air volume control: An air volume sensor is used to feedback the air volume data to have excellent air volume regulation.
- ☑ Temperature control: A thermocouple or thermistor is used to feedback temperature data for comfortable temperature control.
- ☑ Speed control: A speed sensor or encoder is used to feedback motor shaft speed or input another machines speed as a target value for closed loop speed control of master-slave operation. Pr.10.00 sets the PID set point source (target value).
- ☑ PID control operates with the feedback signal as set by Pr.10.01 either 0~+10V voltage or 4-20mA current.

📖 PID control loop:

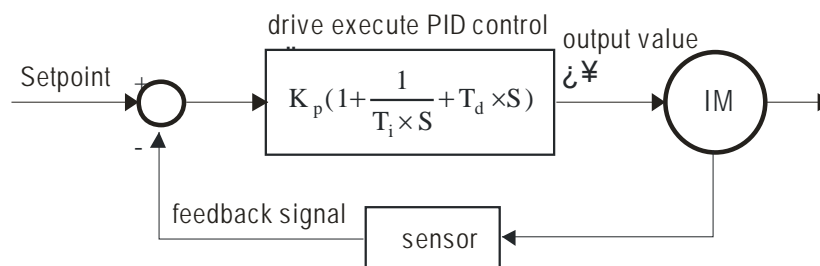

K_p : Proportional gain(P) T_i : Integral time(I) T_d : Derivative control(D) S: Operator

 Concept of PID control

1. Proportional gain(P):
the output is proportional to input. With only proportional gain control, there will always be a steady-state error.
2. Integral time(I):
the controller output is proportional to the integral of the controller input. To eliminate the steady-state error, an “integral part” needs to be added to the controller. The integral time decides the relation between integral part and error. The integral part will be increased by time even if the error is small. It gradually increases the controller output to eliminate the error until it is 0. In this way a system can be stable without steady-state error by proportional gain control and integral time control.
3. Differential control(D):
the controller output is proportional to the differential of the controller input. During elimination of the error, oscillation or instability may occur. The differential control can be used to suppress these effects by acting before the error. That is, when the error is near 0, the differential control should be 0. Proportional gain(P) + differential control(D) can be used to improve the system state during PID adjustment.

 When PID control is used in a constant pressure pump feedback application:

Set the application’s constant pressure value (bar) to be the set point of PID control. The pressure sensor will send the actual value as PID feedback value. After comparing the PID set point and PID feedback, there will be an error. Thus, the PID controller needs to calculate the output by using proportional gain(P), integral time(I) and differential time(D) to control the pump. It controls the drive to have different pump speed and achieves constant pressure control by using a 4-20mA signal corresponding to 0-10 bar as feedback to the drive.

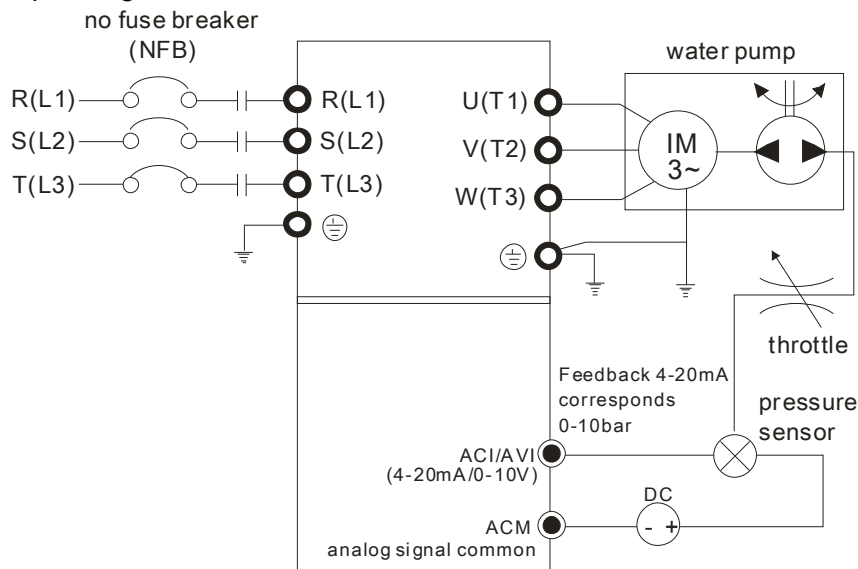

1. Pr.00-04 is set to 10 (Display PID analog feedback signal value (b) (%))
2. Pr.01-12 Acceleration Time will be set as required
3. Pr.01-13 Deceleration Time will be set as required
4. Pr.00-21=0 to operate from the digital keypad
5. Pr.00-20=0, the set point is controlled by the digital keypad
6. Pr.08-00=1 (Negative PID feedback from analog input)
7. ACI analog input Pr. 03-01 set to 5, PID feedback signal.

8. Pr.08-01-08-03 will be set as required

8.1 If there is no vibration in the system, increase Pr.08-01(Proportional Gain (P))

8.2 If there is no vibration in the system, reduce Pr.08-02(Integral Time (I))

8.3 If there is no vibration in the system, increase Pr.08-03(Differential Time(D))

 Refer to Pr.08-00 to 08-21 for PID parameters settings.

08-01 Proportional Gain (P)

Factory Setting:1.0

Settings 0.0~500.0

 It is used to eliminate the system error. It is usually used to decrease the error and get the faster response speed. But if setting too large value in Pr.08-01, it may cause the system oscillation and instability.

 If the other two gains (I and D) are set to zero, proportional control is the only one effective.

08-02 Integral Time (I)

Factory Setting:1.00

Settings 0.00~100.00 sec

0.00: Disable

 The integral controller is used to eliminate the error during stable system. The integral control doesn't stop working until error is 0. The integral is acted by the integral time. The smaller integral time is set, the stronger integral action will be. It is helpful to reduce overshoot and oscillation to make a stable system. At this moment, the decreasing error will be slow. The integral control is often used with other two controls to become PI controller or PID controller.

 This parameter is used to set the integral time of I controller. When the integral time is long, it will have small gain of I controller, the slower response and bad external control. When the integral time is short, it will have large gain of I controller, the faster response and rapid external control.

 When the integral time is too small, it may cause system oscillation.

 If the integral time is set as 0.00, Pr.08-02 will be disabled.

08-03 Derivative Control (D)









Factory Setting:0.00

Settings 0.00~1.00 sec

 The differential controller is used to show the change of system error and it is helpful to preview the change of error. So the differential controller can be used to eliminate the error to improve system state. With the suitable differential time, it can reduce overshoot and shorten adjustment time. However, the differential operation will increase the noise interference. Please note that too large differential will cause big noise interference. Besides, the differential shows the change and the output of the differential will be 0 when there is no change. Therefore, the differential control can't be used independently. It needs to be used with other two controllers to make a PD controller or PID controller.

 This parameter can be used to set the gain of D controller to decide the response of error change. The suitable differential time can reduce the overshoot of P and I controller to decrease the oscillation and have a stable system. But too long differential time may cause system oscillation.

 The differential controller acts for the change of error and can't reduce the interference. It is not recommended to use this function in the serious interference.

-
- ↗ **08-04** Upper limit of Integral Control Factory Setting: 100.0
- Settings 0.0~100.0%
-
-  This parameter defines an upper bound or limit for the integral gain (I) and therefore limits the Master Frequency. The formula is: Integral upper bound = Maximum Output Frequency (Pr.01-00) x (Pr.08-04 %).
 -  Too large integral value will make the slow response due to sudden load change. In this way, it may cause motor stall or machine damage.
-
- ↗ **08-05** PID Output Frequency Limit Factory Setting: 100.0
- Settings 0.0~110.0%
-
-  This parameter defines the percentage of output frequency limit during the PID control. The formula is Output Frequency Limit = Maximum Output Frequency (Pr.01-00) X Pr.08-05 %.
-
- ↗ **08-06** PID feedback value by communication protocol Factory Setting: Read only
- Settings -200.00~200.00%
-
- ↗ **08-07** PID Delay Time Factory Setting: 0.0
- Settings 0.0~35.0 sec
-
- 08-20** PID Mode Selection Factory Setting: 0
- Settings 0: Serial connection
1: Parallel connection
-
-  Pr.08-07 determines the primary low pass filter time when in PID control. Setting a large time constant may slow down the response rate of drive.
 -  Output frequency of PID control will filter by primary low pass function. This function could filtering a mix frequencies. A long primary low pass time means filter degree is high and vice versa.
 -  Inappropriate setting of delay time may cause system error.
 -  PI Control: controlled by the P action only, and thus, the deviation cannot be eliminated entirely. To eliminate residual deviations, the P + I control will generally be utilized. And when the PI control is utilized, it could eliminate the deviation incurred by the targeted value changes and the constant external interferences. However, if the I action is excessively powerful, it will delay the responding toward the swift variation. The P action could be used solely on the loading system that possesses the integral components.
 -  PD Control: when deviation occurred, the system will immediately generate some operation load that is greater than the load generated single handedly by the D action to restrain the increment of the deviation. If the deviation is small, the effectiveness of the P action will be decreasing as well. The control objects include occasions with integral component loads, which are controlled by the P action only, and sometimes, if the integral component is functioning, the whole system will be vibrating. On such occasions, in order to make the P action's vibration subsiding and the system

stabilizing, the PD control could be utilized. In other words, this control is good for use with loadings of no brake functions over the processes.

 PID Control: Utilize the I action to eliminate the deviation and the D action to restrain the vibration, thereafter, combine with the P action to construct the PID control. Use of the PID method could obtain a control process with no deviations, high accuracies and a stable system.

 Serial connection

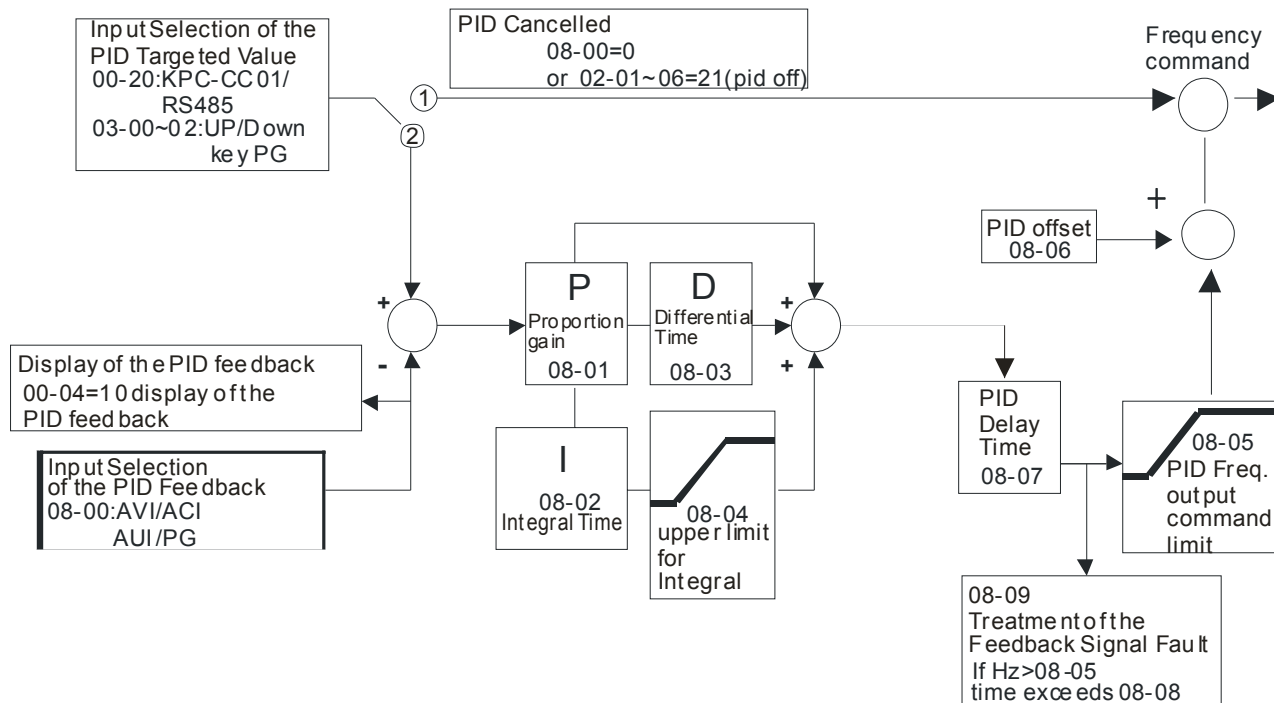

 Parallel connection

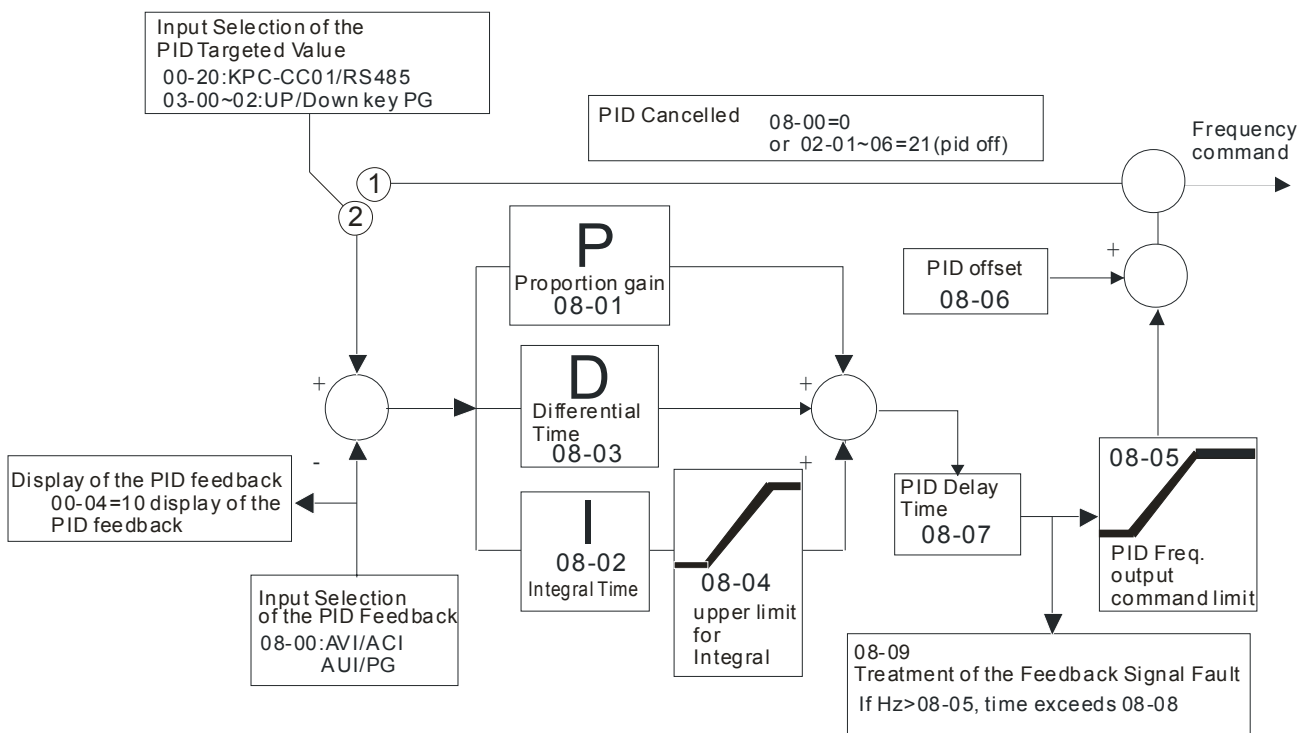

⚡ **08-08** Feedback Signal Detection Time

Factory Setting: 0.0

Settings 0.0~3600.0 sec

- 📖 Pr.08-08 is valid only if the feedback signal is ACI.
- 📖 This parameter sets the detection time of abnormal PID derivate. If detection time is set to 0.0, detection function is disabled.

08-09 Feedback Signal Fault Treatment

Factory Setting: 0

Settings 0: Warn and keep operation
 1: Warn and ramp to stop
 2: Warn and coast to stop
 3: Warn and operate at last frequency

- 📖 This parameter is valid only when the feedback signal is ACI.
- 📖 AC motor drive acts when the feedback signals (analog PID feedback or PG (encoder) feedback) are abnormal.

⚡ **08-10** Sleep Frequency

Factory Setting: 0.00

Settings 0.00~599.00Hz

⚡ **08-11** Wake-up Frequency

Factory Setting: 0.00

Settings 0.00~599.00Hz

⚡ **08-12** Sleep Time

Factory Setting: 0.0

Settings 0.00~6000.0 sec

- 📖 If the command frequency falls below the sleep frequency, for the specified time in Pr. 08-12, then the drive will shut off the output and wait until the command frequency rises above Pr.08-11.

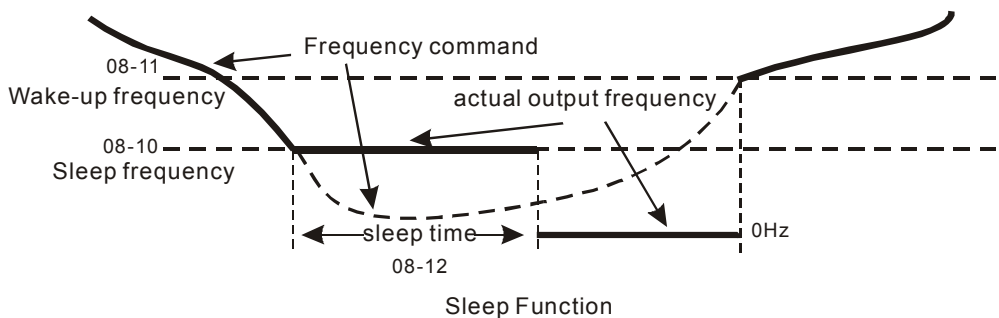

⚡ **08-13** PID Deviation Level

Factory Setting: 10.0

Settings 1.0~50.0%

⚡ **08-14** PID Deviation Time

Factory Setting: 5.0

Settings 0.1~300.0 sec

↗	08-15	Filter Time for PID Feedback	Factory Setting: 5.0
		Settings 0.1~300.0 sec	
		<p>When the PID control function is normal, it should calculate within a period of time and close to the setpoint value.</p> <p>Refer to the PID control diagram for details. When executing PID feedback control, if $\text{PID reference target value} - \text{detection value} > \text{Pr.08-13 PID Deviation Level}$ and exceeds Pr.08-14 setting, the PID control fault occurs. The treatment will be done as Pr.08-09 setting.</p>	
↗	08-16	PID Compensation Selection	Factory Setting: 0
		Settings 0: Parameter setting 1: Analog input	
↗	08-17	PID Compensation	Factory Setting: 0
		Settings -100.0~+100.0%	
	08-18	Setting of Sleep Mode Function	Factory Setting: 0
		Settings 0: Follow PID output command 1: Follow PID feedback signal	
↗	08-19	Wake-up Integral Limit	Factory Setting: 50.0
		Settings 0.0~200.0%	
	08-21	Enable PID to Change the Operation Direction	Factory Setting: 0
		Settings 0: Disable change of direction 1: Enable change of direction	
↗	08-22	Wakeup Delay Time	Factory Setting: 0.00
		Settings 0.00~600.00 sec.	
↗	08-23	PID Control Flag	Factory Setting: 0
		Settings Bit 0 = 1, PID reverse running must follow the setting of Pr00-23. Bit 0 = 0, PID reverse running follow PID's calculated value.	

09 Communication Parameters

✎ The parameter can be set during the operation.

When using communication devices, connects AC drive with PC by using Delta IFD6530 or IFD6500.

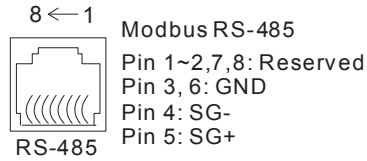

✎ 09-00 COM1 Communication Address

Factory Setting: 1

Settings 1~254

📖 If the AC motor drive is controlled by RS-485 serial communication, the communication address for this drive must be set via this parameter. And the communication address for each AC motor drive must be different and unique.

✎ 09-01 COM1 Transmission Speed

Factory Setting: 9.6

Settings 4.8~115.2 Kbps

📖 This parameter is used to set the transmission speed between the RS485 master (PLC, PC, etc.) and AC motor drive.

✎ 09-02 COM1 Transmission Fault Treatment

Factory Setting: 3

Settings 0: Warn and keep operation
1: Warn and ramp to stop
2: Warn and coast to stop
3: No warning and continue operation

📖 This parameter is set to how to react if transmission errors occur.

✎ 09-03 COM1 Time-out Detection

Factory Setting: 0.0

Settings 0.0~100.0 sec
0.0: Disable



📖 It is used to set the transmission time between communication and keypad.

✎ 09-04 COM1 Communication Protocol

Factory Setting: 1

Settings 1: 7, N, 2 for ASCII
2: 7, E, 1 for ASCII
3: 7, O, 1 for ASCII
4: 7, E, 2 for ASCII
5: 7, O, 2 for ASCII
6: 8, N, 1 for ASCII
7: 8, N, 2 for ASCII
8: 8, E, 1 for ASCII

- 9: 8, O, 1 for ASCII
- 10: 8, E, 2 for ASCII
- 11: 8, O, 2 for ASCII
- 12: 8, N, 1 for RTU
- 13: 8, N, 2 for RTU
- 14: 8, E, 1 for RTU
- 15: 8, O, 1 for RTU
- 16: 8, E, 2 for RTU
- 17: 8, O, 2 for RTU

-  Control by PC or PLC (Computer Link)
-  A VFD-C2000 can be set up to communicate on Modbus networks using one of the following modes: ASCII (American Standard Code for Information Interchange) or RTU (Remote Terminal Unit). Users can select the desired mode along with the RS-485 serial port communication protocol in Pr.09-00.
-  MODBUS ASCII (American Standard Code for Information Interchange) : Each byte data is the combination of two ASCII characters. For example, a 1-byte data: 64 Hex, shown as '64' in ASCII, consists of '6' (36Hex) and '4' (34Hex).

1. Code Description

Communication protocol is in hexadecimal, ASCII: "0", "9", "A", "F", every 16 hexadecimal represent ASCII code. For example:

Character	'0'	'1'	'2'	'3'	'4'	'5'	'6'	'7'
ASCII code	30H	31H 32H	33H	34H 35H 36H 37H				

Character	'8'	'9'	'A'	'B'	'C'	'D'	'E'	'F'
ASCII code	38H	39H 40H	41H 42H	43H 44H 45H 46H				

 Data Format

10-bit character frame (For ASCII):

(7 , N , 2)

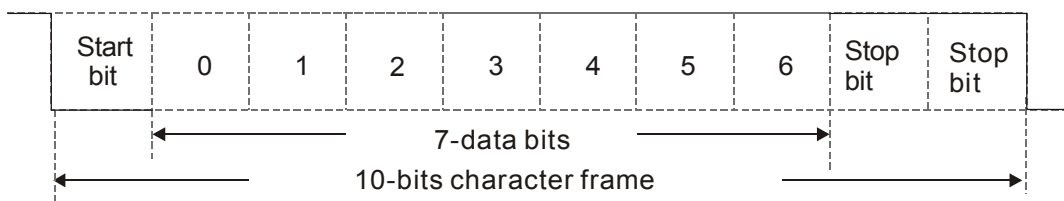

(7 , E , 1)

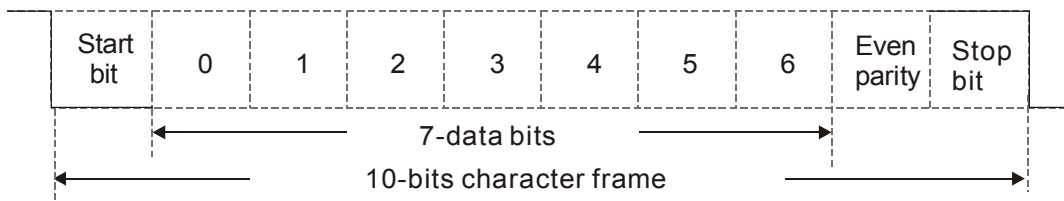

(7, 0, 1)

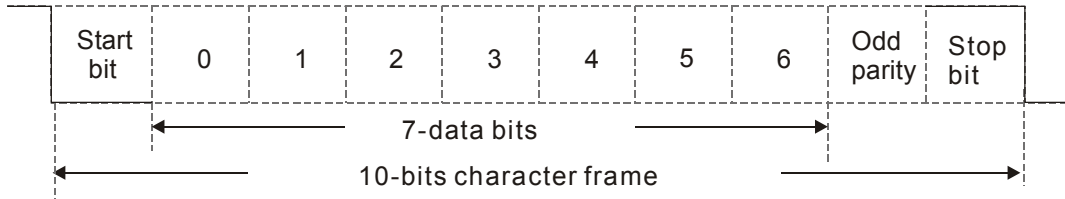

11-bit character frame (For RTU):

(8, N, 2)

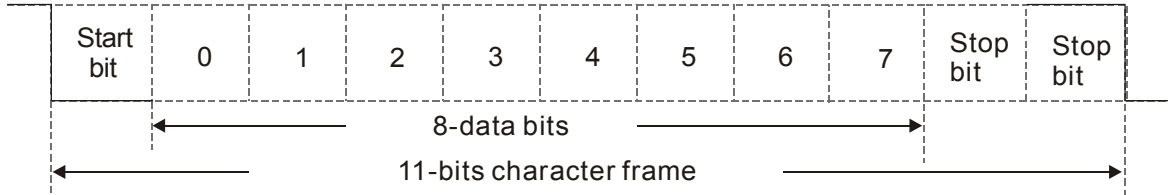

(8, E, 1)

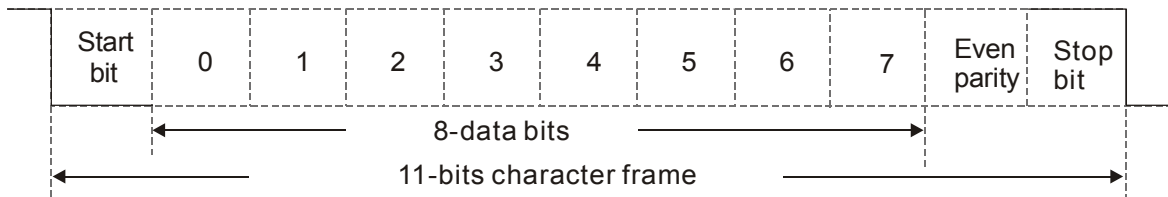

(8, O, 1)

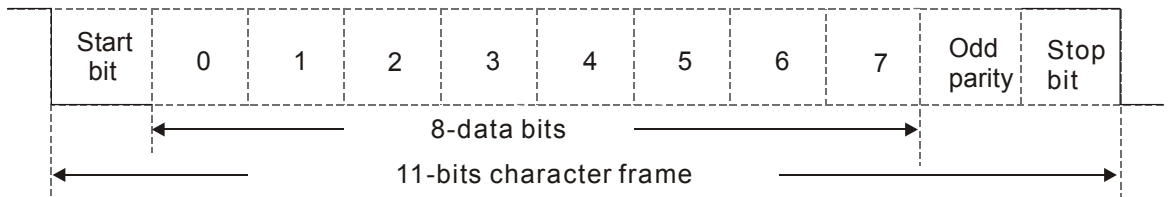

2. Communication Protocol

Communication Data Frame: **ASCII mode**

STX	Start character = ':' (3AH)
Address Hi	Communication address: 8-bit address consists of 2 ASCII codes
Address Lo	
Function Hi	Command code: 8-bit command consists of 2 ASCII codes
Function Lo	
DATA (n-1)	Contents of data: Nx8-bit data consist of 2n ASCII codes n<=16, maximum of 32 ASCII codes
.....	
DATA 0	
LRC CHK Hi	LRC check sum: 8-bit check sum consists of 2 ASCII codes
LRC CHK Lo	
END Hi	End characters: END1= CR (0DH), END0= LF(0AH)
END Lo	

Communication Data Frame: **RTU mode**

START	A silent interval of more than 10 ms
Address	Communication address: 8-bit address
Function	Command code: 8-bit command

DATA (n-1)	Contents of data: n×8-bit data, n≤16
.....	
DATA 0	
CRC CHK Low	CRC check sum: 16-bit check sum consists of 2 8-bit characters
CRC CHK High	
END	A silent interval of more than 10 ms

Address (Communication Address)

Valid communication addresses are in the range of 0 to 254. A communication address equal to 0, means broadcast to all AC drives (AMD). In this case, the AMD will not reply any message to the master device.

00H: broadcast to all AC drives

01H: AC drive of address 01

0FH: AC drive of address 15

10H: AC drive of address 16

:

FEH: AC drive of address 254

Function (Function code) and DATA (data characters)

The format of data characters depends on the function code.

03H: read data from register

06H: write single register

Example: reading continuous 2 data from register address 2102H, AMD address is 01H.

ASCII mode:

Command Message:		Response Message	
STX	‘.’	STX	‘.’
Address	‘0’	Address	‘0’
	‘1’		‘1’
Function	‘0’	Function	‘0’
	‘3’		‘3’
Starting address	‘2’	Number of data (count by byte)	‘0’
	‘1’		‘4’
	‘0’	Content of starting address 2102H	‘1’
	‘2’		‘7’
Number of data (count by word)	‘0’	Content of address 2103H	‘7’
	‘0’		‘0’
	‘2’		‘0’
	‘D’		‘0’
LRC Check	‘7’	LRC Check	‘0’
	CR		‘7’
END	LF	END	‘1’
			CR
			LF

RTU mode:

Command Message:		Response Message	
Address	01H	Address	01H
Function	03H	Function	03H
Starting data address	21H	Number of data (count by byte)	04H
	02H		
Number of data (count by world)	00H	Content of data address 2102H	17H
	02H		70H

CRC CHK Low	6FH	Content of data address 2103H	00H
CRC CHK High	F7H	CRC CHK Low	FEH
		CRC CHK High	5CH

06H: single write, write single data to register.

Example: writing data 6000(1770H) to register 0100H. AMD address is 01H.

ASCII mode:

Command Message:		Response Message	
STX	‘.’	STX	‘.’
Address	‘0’	Address	‘0’
	‘1’		‘1’
Function	‘0’	Function	‘0’
	‘6’		‘6’
Data address	‘0’	Data address	‘0’
	‘1’		‘1’
	‘0’		‘0’
	‘0’		‘0’
Data content	‘1’	Data content	‘1’
	‘7’		‘7’
	‘7’		‘7’
	‘0’		‘0’
LRC Check	‘7’	LRC Check	‘7’
	‘1’		‘1’
END	CR	END	CR
	LF		LF

RTU mode:

Command Message:		Response Message	
Address	01H	Address	01H
Function	06H	Function	06H
Data address	01H	Data address	01H
	00H		00H
Data content	17H	Data content	17H
	70H		70H
CRC CHK Low	86H	CRC CHK Low	86H
CRC CHK High	22H	CRC CHK High	22H

10H: write multiple registers (write multiple data to registers)

Example: Set the multi-step speed,

Pr.04-00=50.00 (1388H), Pr.04-01=40.00 (0FA0H). AC drive address is 01H.

ASCII Mode

Command Message:		Response Message	
STX	‘.’	STX	‘.’
ADR 1	‘0’	ADR 1	‘0’
ADR 0	‘1’	ADR 0	‘1’
CMD 1	‘1’	CMD 1	‘1’
CMD 0	‘0’	CMD 0	‘0’
Starting data address	‘0’	Starting data address	‘0’
	‘5’		‘5’
	‘0’		‘0’
	‘0’		‘0’
Number of data (count by word)	‘0’	Number of data (count by word)	‘0’
	‘0’		‘0’
	‘0’		‘0’
	‘2’		‘2’

Number of data (count by byte)	'0'	LRC Check	'E'
	'4'		'8'
The first data content	'1'	END	CR
	'3'		LF
	'8'		
	'8'		
The second data content	'0'		
	'F'		
	'A'		
	'0'		
LRC Check	'9'		
	'A'		
END	CR		
	LF		

RTU mode:

Command Message:		Response Message	
ADR	01H	ADR	01H
CMD	10H	CMD 1	10H
Starting data address	05H	Starting data address	05H
Number of data (count by word)	00H	Number of data (count by word)	00H
Number of data (count by byte)	04	CRC Check Low	41H
The first data content	13H	CRC Check High	04H
	88H		
The second data content	0FH		
	A0H		
CRC Check Low	'9'		
CRC Check High	'A'		

Check sum

ASCII mode:

LRC (Longitudinal Redundancy Check) is calculated by summing up, module 256, and the values of the bytes from ADR1 to last data character then calculating the hexadecimal representation of the 2's-complement negation of the sum.

For example,

$01H+03H+21H+02H+00H+02H=29H$, the 2's-complement negation of 29H is **D7H**.

RTU mode:

CRC (Cyclical Redundancy Check) is calculated by the following steps:

Step 1:

Load a 16-bit register (called CRC register) with FFFFH.

Step 2:

Exclusive OR the first 8-bit byte of the command message with the low order byte of the 16-bit CRC register, putting the result in the CRC register.

Step 3:

Examine the LSB of CRC register.

Step 4:

If the LSB of CRC register is 0, shift the CRC register one bit to the right with MSB zero filling, then repeat step 3. If the LSB of CRC register is 1, shift the CRC register one bit to the right with MSB zero filling, Exclusive OR the CRC register with the polynomial value A001H, then repeat step 3.

Step 5:

Repeat step 3 and 4 until eight shifts have been performed. When this is done, a complete 8-bit byte will have been processed.

Step 6:

Repeat step 2 to 5 for the next 8-bit byte of the command message. Continue doing this until all bytes have been processed. The final contents of the CRC register are the CRC value. When transmitting the CRC value in the message, the upper and lower bytes of the CRC value must be swapped, i.e. the lower order byte will be transmitted first.

The following is an example of CRC generation using C language. The function takes two arguments:

Unsigned char* data ← a pointer to the message buffer

Unsigned char length ← the quantity of bytes in the message buffer

The function returns the CRC value as a type of unsigned integer.

Unsigned int crc_chk(unsigned char* data, unsigned char length)

```

{
  int j;
  unsigned int reg_crc=0Xffff;
  while(length--){
    reg_crc ^= *data++;
    for(j=0;j<8;j++){
      if(reg_crc & 0x01){ /* LSB(b0)=1 */
        reg_crc=(reg_crc>>1) ^ 0Xa001;
      }else{
        reg_crc=reg_crc >>1;
      }
    }
  }
}

return reg_crc;          //          return register CRC

```

3. Address list

Content	Address	Function	
AC drive Parameters	GGnnH	GG means parameter group, nn means parameter number, for example, the address of Pr 4-01 is 0401H.	
Command Write only	2000H	Bit 0-3	0: No function 1: Stop 2: Run 3: Jog + Run
		Bit 4-5	00B: No function 01B: FWD 10B: REV 11B: Change direction
		Bit 6-7	00B: 1st accel/decel 01B: 2nd accel/decel 10B: 3rd accel/decel 11B: 4th accel/decel
		Bit 8-11	000B: master speed
			0001B: 1st accel/decel.
			0010B: 2nd accel/decel
			0011B: 3rd accel/decel
			0100B: 4th accel/decel
			0101B: 5th accel/decel
			0110B: 6th accel/decel
			0111B: 7th accel/decel
			1000B: 8th accel/decel
			1001B: 9th accel/decel
			1010B: 10th accel/decel
			1011B: 11th accel/decel
1100B: 12th accel/decel			
1101B: 13th accel/decel			
1110B: 14th accel/decel			
1111B: 15th accel/decel			
Bit 12	1: enable bit06-11 function		
Bit 13~14	00B: No function 01B: operated by digital keypad 10B: operated by Pr.00-21 setting 11B: change operation source		
	Bit 15	Reserved	
Command Write only	2001H	Frequency command	
	2002H	Bit 0	1: EF (external fault) on
		Bit 1	1: Reset
		Bit 2	1: B.B. ON
	Bit 3-15	Reserved	
Status monitor Read only	2100H	Error code: refer to Pr.06-17 to Pr.06-22	
	2101H	Bit0	AC Drive Operation Status 00b: Drive stops 01b: Drive decelerating
		Bit1	10b: Drive standby 11b: Drive operating
		Bit2	1: JOG Command
		Bit3	Operation Direction 00b: FWD run 01b: from REV run to FWD run
		Bit4	10b: REV run 11b: from FWD run to REV run
Bit8	1: Master frequency controlled by communication interface		

Content	Address	Function
	Bit9	1: Master frequency controlled by analog signal
	Bit10	1: Operation command controlled by communication interface
	Bit11	1: Parameter locked
	Bit12	1: Enable to copy parameters from keypad
	Bit13~15	Reserved
	2102H	Frequency command (F)
	2103H	Output frequency (H)
	2104H	Output current (AXX.X.X)
	2105H	DC-BUS Voltage (UXXX.X)
	2106H	Output voltage (EXXX.X)
	2107H	Current step number of Multi-Step Speed Operation
	2108H	Reserved
	2109H	Counter value
	201AH	Power Factor Angle (XXX.X)
	201BH	Output Torque (%)
	201CH	Actual motor speed (rpm)
	201DH	Number of PG feed back pulses
	201EH	Number of PG2 pulse commands
	201FH	Power output (X.XXX)
	2116H	Multi-function display (Pr.00-04)
	211BH	Max. operation frequency (Pr.01-00) or Max. user defined value (Pr.00-26)
	2200H	Display output current (A)
	2201H	Display counter value of TRG terminal (c)
	2202H	Display actual output frequency (H)
	2203H	Display DC-BUS voltage (u)
	2204H	Display output voltage of U, V, W (E)
	2205H	Display output power angle of U, V, W (n)
	2206H	Display actual motor speed kW of U, V, W (P)
	2207H	Display motor speed in rpm estimated by the drive or encoder feedback (r00: positive speed, -00: negative speed)
	2208H	Display positive/negative output torque in %, estimated by the drive (t0.0: positive torque, -0.0: negative torque)
	2209H	Display PG feedback (as NOTE 1)
	220AH	Display PID feedback value after enabling PID function in % (b)
	220BH	Display signal of AVI analog input terminal, 0-10V corresponds to 0-100% (1.) (as NOTE 2)
	220CH	Display signal of ACI analog input terminal, 4-20mA/0-10V corresponds to 0-100% (2.) (as NOTE 2)
	220DH	Display signal of AUI analog input terminal, -10V~10V corresponds to -100~100% (3.) (as NOTE 2)
	220EH	Display the IGBT temperature of drive power module in °C (c.)
	220FH	Display the temperature of capacitance in °C (i.)
	2210H	The status of digital input (ON/OFF), refer to Pr.02-12 (as NOTE 3)
	2211H	The status of digital output (ON/OFF), refer to Pr.02-18 (as NOTE 4)
	2212H	Display the multi-step speed that is executing (S)
	2213H	The corresponding CPU pin status of digital input (d.) (as NOTE 3)
	2214H	The corresponding CPU pin status of digital output (O.) (as NOTE 4)
	2215H	Number of actual motor revolution (PG1 of PG card) (P.) it will start from 9 when the actual operation direction is changed or keypad display at stop is 0. Max. is 65535 (P.)
	2216H	Pulse input frequency (PG2 of PG card)(S.)

Content	Address	Function
	2217H	Pulse input position (PG card PG2), maximum setting is 65535.
	2218H	Position command tracing error (P.)
	2219H	Display times of counter overload (0.00~100.00%)
	221AH	Display GFF in % (G.)
	221BH	Display DCbus voltage ripples (Unit: Vdc) (r.)
	221CH	Display PLC register D1043 data (C)
	221DH	Display Pole of Permanent Magnet Motor
	221EH	User page displays the value in physical measure
	221FH	Output Value of Pr.00-05
	2220H	Number of motor turns when drive operates
	2221H	Operation position of motor
	2222H	Fan speed of the drive
	2223H	Control mode of the drive 0: speed mode 1: torque mode
	2224H	Carrier frequency of the drive

4. Exception response:

The AC motor drive is expected to return a normal response after receiving command messages from the master device. The following depicts the conditions when no normal response is replied to the master device.

The AC motor drive does not receive the messages due to a communication error; thus, the AC motor drive has no response. The master device will eventually process a timeout condition.

The AC motor drive receives the messages without a communication error, but cannot handle them. An exception response will be returned to the master device and an error message "CExx" will be displayed on the keypad of AC motor drive. The xx of "CExx" is a decimal code equal to the exception code that is described below.

In the exception response, the most significant bit of the original command code is set to 1, and an exception code which explains the condition that caused the exception is returned.

Example:

ASCII mode:		RTU mode:	
STX	‘.’	Address	01H
Address	‘0’	Function	86H
	‘1’	Exception code	02H
Function	‘8’	CRC CHK Low	C3H
	‘6’	CRC CHK High	A1H
Exception code	‘0’		
	‘2’		
LRC CHK	‘7’		
	‘7’		
END	CR		
	LF		

The explanation of exception codes:

Exception code	Explanation
1	Illegal data value: The data value received in the command message is not available for the AC drive.
2	Illegal data address: The data address received in the command message is not available for the AC motor drive.
3	Parameters are locked: parameters can't be changed
4	Parameters can't be changed during operation
10	Communication time-out.

↗ **09-05** ~ Reserved
09-08

↗ **09-09** Response Delay Time

Factory Setting: 2.0

Settings 0.0~200.0ms

📖 This parameter is the response delay time after AC drive receives communication command as shown in the following.

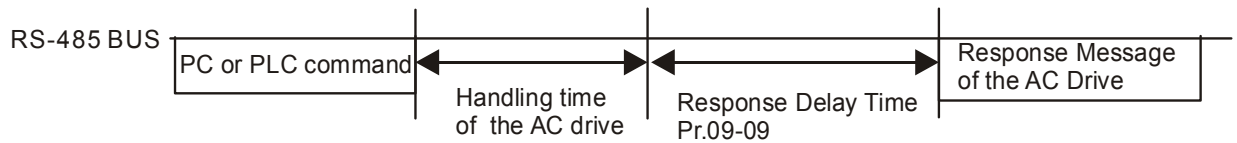

↗ **09-10** Main Frequency of the Communication

Factory Setting: 60.00

Settings 0.00~599.00Hz

📖 When Pr.00-20 is set to 1 (RS485 communication). The AC motor drive will save the last frequency command into Pr.09-10 when abnormal turn-off or momentary power loss. After reboots the power, it will regards the frequency set in Pr.09-10 if no new frequency command is inputted.

- ↗ **09-11** Block Transfer 1
- ↗ **09-12** Block Transfer 2
- ↗ **09-13** Block Transfer 3
- ↗ **09-14** Block Transfer 4
- ↗ **09-15** Block Transfer 5
- ↗ **09-16** Block Transfer 6
- ↗ **09-17** Block Transfer 7
- ↗ **09-18** Block Transfer 8
- ↗ **09-19** Block Transfer 9
- ↗ **09-20** Block Transfer 10
- ↗ **09-21** Block Transfer 11
- ↗ **09-22** Block Transfer 12
- ↗ **09-23** Block Transfer 13
- ↗ **09-24** Block Transfer 14
- ↗ **09-25** Block Transfer 15
- ↗ **09-26** Block Transfer 16

Factory Setting: 0

Settings 0~65535

📖 There is a group of block transfer parameter available in the AC motor drive (Pr.09-11 to Pr.09-20). User can use them (Pr.09-11 to Pr.09-20) to save those parameters that you want to read.

09-27 ~ Reserved
09-29

09-30 Communication Decoding Method

Factory Setting: 1

- Settings 0: Decoding Method 1 (20xx)
 1: Decoding Method 2 (60xx)

		Decoding Method 1	Decoding Method 2
Source of Operation Control	Digital Keypd	Digital keypad controls the drive action regardless decoding method 1 or 2.	
	External Terminal	External terminal controls the drive action regardless decoding method 1 or 2.	
	RS-485	Refer to address: 2000h~20FFh	Refer to address: 6000h ~ 60FFh
	CANopen	Refer to index: 2020-01h~2020-FFh	Refer to index:2060-01h ~ 2060-FFh
	Communication Card	Refer to address: 2000h ~ 20FFh	Refer to address: 6000h ~ 60FFh
	PLC	PLC commands the drive action regardless decoding method 1 or 2.	

09-31 Internal Communication Protocol

Factory Setting: 0

- Settings 0: Modbus 485
 -1: Internal Communication Slave 1
 -2: Internal Communication Slave 2
 -3: Internal Communication Slave 3
 -4: Internal Communication Slave 4
 -5: Internal Communication Slave 5
 -6: Internal Communication Slave 6
 -7: Internal Communication Slave 7
 -8: Internal Communication Slave 8
 -9: Reserve
 -10: Internal Communication Master
 -11: Reserve
 -12: Internal PLC Control

09-32 Reserved

09-33 PLC command force to 0

Factory Setting: 0

- Settings 0~65535

09-34 Reserved

09-35 PLC Address

Factory Setting: 2

Settings 1~254

09-36 CANopen Slave Address

Factory Setting: 0

Settings 0: Disable
1~127

09-37 CANopen Speed

Factory Setting: 0

Settings 0: 1M bps
1: 500K bps
2: 250K bps
3: 125K bps
4: 100K bps (Delta only)
5: 50K bps

09-38 Reserved

09-39 CANopen Warning Record

Factory Setting: 0

Settings bit 0: CANopen Guarding Time out
bit 1: CANopen Heartbeat Time out
bit 2: CANopen SYNC Time out
bit 3: CANopen SDO Time out
bit 4: CANopen SDO buffer overflow
bit 5: Can Bus Off
bit 6: Error protocol of CANOPEN

09-40 CANopen Decoding Method

Factory Setting: 1

Settings 0: Delta defined decoding method
1: CANopen Standard DS402 protocol

09-41 CANopen Status

Factory Setting: 0

Settings 0: Node Reset State
1: Com Reset State
2: Boot up State
3: Pre Operation State
4: Operation State
5: Stop State

09-42 CANopen Control Status

Factory Setting: Read Only

- Settings
- 0: Not ready for use state
 - 1: Inhibit start state
 - 2: Ready to switch on state
 - 3: Switched on state
 - 4: Enable operation state
 - 7: Quick stop active state
 - 13: Err reaction activation state
 - 14: Error state

09-43 Reserved**09-44** Reserved**09-45** CANopen Master Function

Factory Setting: 0

- Settings
- 0: Disable
 - 1: Enable

09-46 CANopen Master Address

Factory Setting: 100

- Settings 0~127

09-47

~

Reserved

09-59**09-60** Identifications for Communication Card

Factory Setting: ##

- Settings
- 0: No communication card
 - 1: DeviceNet Slave
 - 2: Profibus-DP Slave
 - 3: CANopen Slave/Master
 - 4: Modbus-TCP Slave
 - 5: EtherNet/IP Slave
 - 6~8: Reserved

09-61 Firmware Version of Communication Card

Factory Setting: ##

- Settings Read only

09-62 Product Code

Factory Setting: ##

Settings Read only

09-63 Error Code

Factory Setting: ##

Settings Read only

09-64
~ Reserved
09-69

✓ **09-70** Address of Communication Card
(Special parameter for DeviceNet card and PROFIBUS card)

Factory Setting: 1

Settings DeviceNet: 0-63
Profibus-DP: 1-125

✓ **09-71** Setting of DeviceNet Speed (according to Pr.09-72)
(Special parameter for DeviceNet card and PROFIBUS card)



Factory Setting: 2

Settings Standard DeviceNet:
0: 125Kbps
1: 250Kbps
2: 500Kbps
3: 1Mbps (Delta only)
Non standard DeviceNet: (Delta only)
0: 10Kbps
1: 20Kbps
2: 50Kbps
3: 100Kbps
4: 125Kbps
5: 250Kbps
6: 500Kbps
7: 800Kbps
8: 1Mbps

✓ **09-72** Other Setting of DeviceNet Speed
(Special parameter for DeviceNet card and PROFIBUS card)

Factory Setting: 0

Settings 0: Disable
1: Enable

-  It needs to use with Pr.09-71.
-  Setting 0: the baud rate can only be set to 125K bps, 250K bps, 500K bps.
-  Setting 1: setting of DeviceNet baud rate can be the same as CANopen (setting 0-8).

09-73 Reserved**09-74** Reserved

- ✎ **09-75** IP Configuration of the Communication Card
(Special parameter for MODBUS TCP card)

Factory Setting: 0

Settings 0: Static IP
1: DynamicIP (DHCP)

 Setting 0: it needs to set IP address manually.

 Setting 1: IP address will be auto set by host controller.

- ✎ **09-76** IP Address 1 of the Communication Card
(Special parameter for MODBUS TCP card)

- ✎ **09-77** IP Address 2 of the Communication Card
(Special parameter for MODBUS TCP card)

- ✎ **09-78** IP Address 3 of the Communication Card
(Special parameter for MODBUS TCP card)

- ✎ **09-79** IP Address 4 of the Communication Card
(Special parameter for MODBUS TCP card)

Factory Setting: 0

Settings 0~65535

- ✎ **09-80** Address Mask 1 of the Communication Card
(Special parameter for MODBUS TCP card)

- ✎ **09-81** Address Mask 2 of the Communication Card
(Special parameter for MODBUS TCP card)

- ✎ **09-82** Address Mask 3 of the Communication Card
(Special parameter for MODBUS TCP card)

- ✎ **09-83** Address Mask 4 of the Communication Card
(Special parameter for MODBUS TCP card)

Factory Setting: 0

Settings 0~65535

- ✎ **09-84** Getway Address 1 of the Communication Card
(Special parameter for MODBUS TCP card)

- ✎ **09-85** Getway Address 2 of the Communication Card
(Special parameter for MODBUS TCP card)

- ✎ **09-86** Getway Address 3 of the Communication Card
(Special parameter for MODBUS TCP card)

- ✎ **09-87** Getway Address 4 of the Communication Card
(Special parameter for MODBUS TCP card)

Factory Setting: 0

Settings 0~65535

<p>✎ 09-88 Password for Communication Card (Low word) (Special parameter for MODBUS TCP card)</p>	
<p>✎ 09-89 Password for Communication Card (High word) (Special parameter for MODBUS TCP card)</p>	
	Factory Setting: 0
	Settings 0~99
<p>✎ 09-90 Reset Communication Card (Special parameter for MODBUS TCP card)</p>	
	Factory Setting: 0
	Settings 0: Disable 1: Reset, return to factory setting
<p>✎ 09-91 Additional Setting for Communication Card (Special parameter for MODBUS TCP card)</p>	
	Factory Setting: 1
	Settings Bit 0: Enable IP Filter Bit 1: Internet parameters enable(1bit) Enable to write internet parameters (1bit). This bit will change to disable when it finishes saving the update of internet parameters. Bit 2: Login password enable(1bit) Enable login password (1bit). This bit will be changed to disable when it finishes saving the update of internet parameters.
<p>09-92 Status of Communication Card (Special parameter for MODBUS TCP card)</p>	
	Factory Setting: 0
	Settings Bit 0: password enable When the communication card is set with password, this bit is enabled. When the password is clear, this bit is disabled.





10 Speed Feedback Control Parameters ↗ This parameter can be set during operation.

In this parameter group, ASR is the abbreviation for Adjust Speed Regulator and PG is the abbreviation for Pulse Generator.

10-00 Encoder Type Selection

Factory Setting: 0



- Settings
- 0: Disable
 - 1: ABZ
 - 2: ABZ (Delta encoder for PM motor)
 - 3: Resolver (Standard encoder for PM motor)
 - 4: ABZ/UVW (Standard encoder for PM motor)
 - 5: MI8 single phase pulse input

-  For PG extension card EMC-PG01L and EMC-PG01O, set Pr.10-00=1. These extension cards are for IM motor only.
-  For EMC-PG01U, when setting Pr.10-00=2 (Delta encoder) make sure SW1 is switched to D (Delta type). If the setting for Pr.10-00, 10-01 and 10-02 has changed, please turn off the drive's power and reboots to prevent PM motor stall. This mode is suggested for PM motor.
-  For EMC-PG01R, when setting Pr.10-00=3 please also input 1024 ppr.
-  For EMC-PG01U, when setting Pr.10-00=4 (Standard ABZ/UVW Encoder) make sure SW1 is switched to S (Standard Type). This mode is applicable for both IM and PM motor.

10-01 Encoder Pulse

Factory Setting: 600

Settings 1~20000

-  A Pulse Generator (PG) or encoder is used as a sensor that provides a feedback signal of the motor speed. This parameter defines the number of pulses for each cycle of the PG control, i.e. the number of pulses for a cycle of A phase/B phase.
-  This setting is also the encoder resolution. With the higher resolution, the speed control will be more accurate.
-  An errotic input to Pr.10-00 may result drive over current, motor stall, PM motor magnetic pole origin detection error. If Pr.10-00 setting has changed, please trace the magnetic pole again, set Pr.05-00=4 (static test for PM motor magnetic pole and PG origin again).

10-02 Encoder Input Type Setting

Factory Setting: 0

- Settings
- 0: Disable
 - 1: Phase A leads in a forward run command and phase B leads in a reverse run command

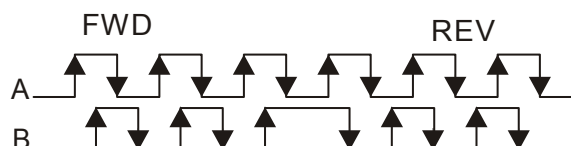

2: Phase B leads in a forward run command and phase A leads in a reverse run command

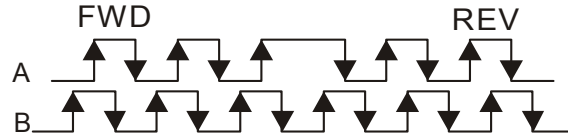

3: Phase A is a pulse input and phase B is a direction input. (L =reverse direction, H=forward direction)

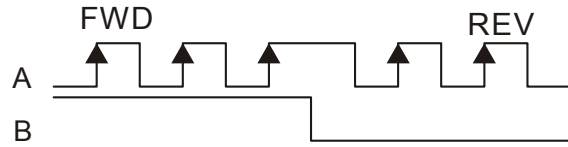

4: Phase A is a pulse input and phase B is a direction input. (L=forward direction, H=reverse direction)

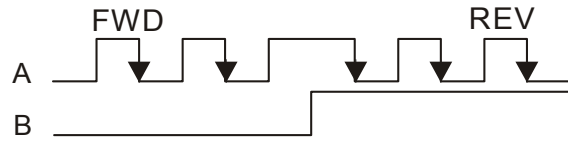

5: Single-phase input

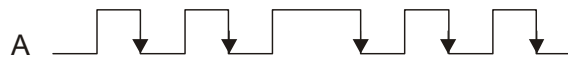

10-03 Output Setting for Frequency Division (denominator)

Factory Setting: 1

Settings 1~255

This parameter is used to set the denominator for frequency division (for PG card EMC-PG01L or EMC-PG01O). For example, when it is set to 2 with feedback 1024ppr, PG output will be $1024/2=512$ ppr.

10-04 Electrical Gear at Load Side A1

10-05 Electrical Gear at Motor Side B1

10-06 Electrical Gear at Load Side A2



10-07 Electrical Gear at Motor Side B2

Factory Setting: 100

Settings 1~65535

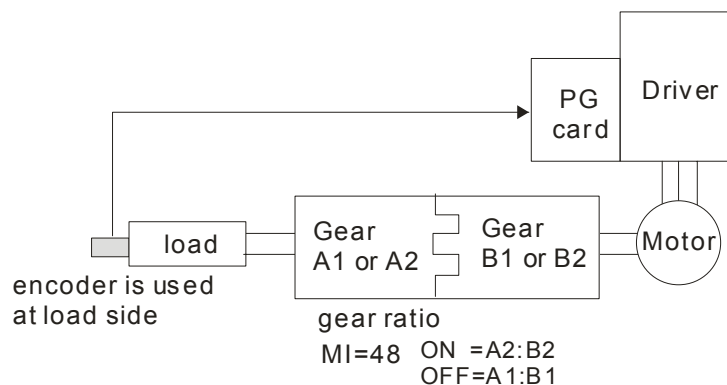
Parameters 10-04 to 10-07 can be used with the multi-function input terminal (set to 48) to switch to Pr.10-04~10-05 or Pr.10-06~10-07 as shown as follows



- ↗ **10-08** Treatment for Encoder Feedback Fault
- Factory Setting: 2
- Settings 0: Warn and keep operating
1: Warn and RAMP to stop
2: Warn and COAST to stop
-
- ↗ **10-09** Detection Time of Encoder Feedback Fault
- Factory Setting: 1.0
- Settings 0.0~10.0 sec
0: No function
-  When encoder loss, encoder signal error, pulse signal setting error or signal error, if time exceeds the detection time for encoder feedback fault (Pr.10-09), the encoder signal error will occur. Refer to the Pr.10-08 for encoder feedback fault treatment.
-
- ↗ **10-10** Encoder Stall Level
- Factory Setting: 115
- Settings 0~120%
0: No function
-  This parameter determines the maximum encoder feedback signal allowed before a fault occurs. (Max. output frequency Pr.01-00 =100%)
-
- ↗ **10-11** Detection Time of Encoder Stall
- Factory Setting: 0.1
- Settings 0.0~2.0 sec
-
- ↗ **10-12** Treatment for Encoder Stall
- Factory Setting: 2
- Settings 0: Warn and keep operation
1: Warn and ramp to stop
2: Warn and coast to stop
-  When the motor frequency exceeds Pr.10-10 setting and detection time exceeds Pr.10-11, it will operate as Pr.10-12 setting.
-
- ↗ **10-13** Encoder Slip Range
- Factory Setting: 50
- Settings 0~50%
0: Disable
-
- ↗ **10-14** Detection Time of Encoder Slip
- Factory Setting: 0.5
- Settings 0.0~10.0 sec
-
- ↗ **10-15** Treatment for Encoder Stall and Slip Error
- Factory Setting: 2
- Settings 0: Warn and keep operation
1: Warn and ramp to stop
2: Warn and coast to stop

When the value of (rotation speed – motor frequency) exceeds Pr.10-13 setting, detection time exceeds Pr.10-14; it will start to accumulate time. If detection time exceeds Pr.10-14, the encoder feedback signal error will occur. Refer to Pr.10-15 encoder stall and slip error treatment.

10-16 Pulse Input Type Setting (PG card: PG2)

Factory Setting: 0

Settings 0: Disable

1: Phase A leads in a forward run command and phase B leads in a reverse run command

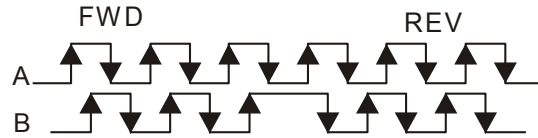

2: Phase B leads in a forward run command and phase A leads in a reverse run command

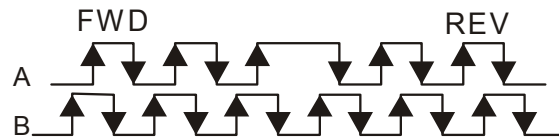

3: Phase A is a pulse input and phase B is a direction input. (L=reverse direction, H=forward direction)

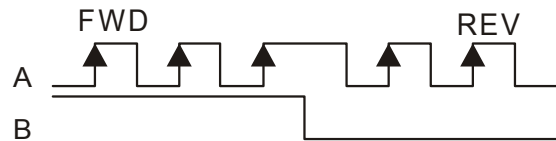

4: Phase A is a pulse input and phase B is a direction input. (L=forward direction, H=reverse direction)

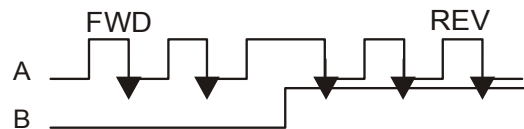

When this setting is different from Pr.10-01 setting and the source of the frequency command is pulse input (Pr.00-20 is set to 4 or 5), it may have 4 times frequency problem.

Example: Assume that Pr.10-01=1024, Pr.10-02=1, Pr.10-16=3, Pr.00-20=5, MI=37 and ON, it needs 4096 pulses to rotate the motor a revolution.

Assume that Pr.10-01=1024, Pr.10-02=1, Pr.10-16=1, Pr.00-20=5, MI=37 and ON, it needs 1024 pulses to rotate the motor a revolution.

Position control diagram

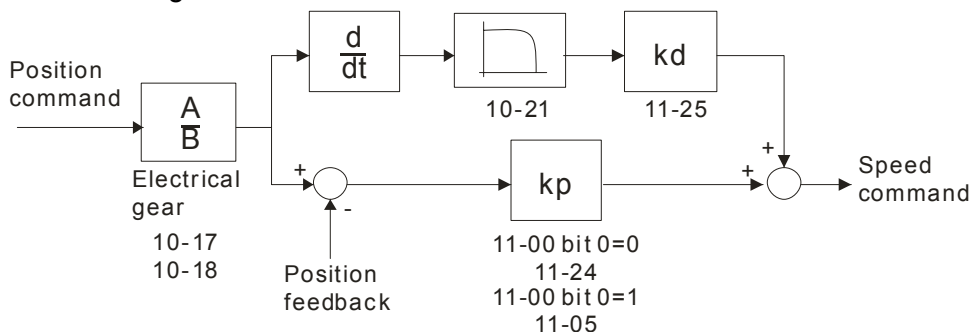

↗ **10-17** Electrical Gear A

↗ **10-18** Electrical Gear B

Factory Setting: 100

Settings 1~65535

📖 Rotation speed = pulse frequency/encoder pulse (Pr.10-00) * PG Electrical Gear A / PG Electrical Gear B.

↗ **10-19** Positioning for Encoder Position

Factory Setting: 0

Settings -32767~2400

📖 This parameter determines the internal position in the position mode.

📖 It needs to be used with multi-function input terminal setting =35 (enable position control).

📖 When it is set to 0, it is the Z-phase position of encoder.

↗ **10-20** Range for Encoder Position Attained

Factory Setting: 10

Settings 0~65535 pulse

📖 This parameter determines the range for internal positioning position attained.

For example:

When the position is set by Pr.10-19 Positioning for Encoder Position and Pr.10-20 is set to 1000, it reaches the position if the position is within 990-1010 after finishing the positioning.

↗ **10-21** Filter Time (PG2)

Factory Setting: 0.100

Settings 0.000~65.535 sec

📖 When Pr.00-20 is set to 5 and multi-function input terminal is set to 37 (OFF), the pulse command will be regarded as frequency command. This parameter can be used to suppress the jump of speed command.

10-22 Speed Mode (PG2)

Factory Setting: 0

Settings 0: Electronic Frequency

1: Mechanical Frequency (base on pole pair)

10-23 Reserved

↗ **10-24** FOC&TQC Function Control

Factory Setting: 0

Settings 0~65535

Bit#	Description
0	ASR control at sensorless torque 0:use PI as ASR; 1:use P as ASR

1~10	NA
11	Activate DC braking when executing zero torque command 0:ON , 1:OFF
12	FOC Sensorless mode, cross zero means speed goes from negative to positive or positive to negative (forward to reverse direction or reverse to forward direction). 0: determine by stator frequency , 1: determine by speed command
13	NA
14	NA
15	Direction control at open loop status 0: Switch ON direction control 1: Switch OFF direction control

10-25 FOC Bandwidth of Speed Observer

Factory Setting:40.0

Settings 20.0~100.0Hz

 Setting speed observer to higher bandwidth could shorten the speed response time but will create greater noise interference during the speed observation.

10-26 FOC Minimum Stator Frequency

Factory Setting:2.0

Settings 0.0~10.0%fN

 This parameter is used to set the minimum level of stator frequency at operation status. This setting ensures the stability and accuracy of observer and avoid interferences from voltage, current and motor parameter.

10-27 FOC Low-pass Filter Time Constant

Factory Setting:50

Settings 1~1000ms

 This parameter sets the low-pass filter time constant of a flux observer at start up. If the motor can not be activated during the high-speed operation, please lower the setting in this parameter.

10-28 FOC Gain of Excitation Current Rise Time

Factory Setting:100

Settings 33~100% Tr (Tr: rotor time constant)

 This parameter sets the drive's excitation current rise time when activates at sensorless torque mode. When the drive's activation time is too long at torque mode, please adjust this parameter to a shorter time constant.

10-29 Top Limit of Frequency Deviation

Factory Setting: 20.00

Settings 0.00~200.00Hz

 Pr.10-29 is for setting the maximum of frequency deviation.

10-30 Resolver Pole Pair

Factory Setting: 1

Settings 1~50

 To use Pr.10-30 function, user must set Pr.10-00=3(Resolver Encoder) first.

↗	10-31	I/F Mode, current command	Factory Setting: 40																											
		Settings 0~150%I _{rated} (Rated current % of the drive)																												
↗	10-32	PM Sensorless Observer Bandwidth for High Speed Zone	Factory Setting: 5.00																											
		Settings 0.00~600.00Hz																												
	10-33	Reserved																												
↗	10-34	PM Sensorless Observer Low-pass Filter Gain	Factory Setting: 1.00																											
		Settings 0.00~655.35Hz																												
↗	10-35	I/F Mode, current command	Factory Setting: 1.00																											
		Settings 0.00~3.00																												
↗	10-36	I/F Mode, current command	Factory Setting: 0.20																											
		Settings 0.00~3.00																												
↗	10-37	PM Sensorless Control Word	Factory Setting: 0000																											
		Settings 0000~FFFFh																												
		<table border="1"> <thead> <tr> <th>Bit No.</th> <th>Function</th> <th>Description</th> </tr> </thead> <tbody> <tr> <td>0</td> <td>Reserved</td> <td></td> </tr> <tr> <td>1</td> <td>Reserved</td> <td></td> </tr> <tr> <td>2</td> <td>Choose a control mode to start.</td> <td>0 : Start by IF mode 1: Start by VF mode</td> </tr> <tr> <td>3</td> <td>Choose a mode to stop .</td> <td>0 : Stop by IF mode 1 : Stop by VF mode</td> </tr> <tr> <td>4</td> <td>Reserved</td> <td></td> </tr> <tr> <td>5</td> <td>Choose a control mode to stop</td> <td>0 : When lower than Pr10-40, coast to stop If lower than Pr10-40, decelerate to stop by VF mode.</td> </tr> <tr> <td>6</td> <td>Reserved</td> <td></td> </tr> <tr> <td>7</td> <td>Reserved</td> <td></td> </tr> </tbody> </table>	Bit No.	Function	Description	0	Reserved		1	Reserved		2	Choose a control mode to start.	0 : Start by IF mode 1: Start by VF mode	3	Choose a mode to stop .	0 : Stop by IF mode 1 : Stop by VF mode	4	Reserved		5	Choose a control mode to stop	0 : When lower than Pr10-40, coast to stop If lower than Pr10-40, decelerate to stop by VF mode.	6	Reserved		7	Reserved		
Bit No.	Function	Description																												
0	Reserved																													
1	Reserved																													
2	Choose a control mode to start.	0 : Start by IF mode 1: Start by VF mode																												
3	Choose a mode to stop .	0 : Stop by IF mode 1 : Stop by VF mode																												
4	Reserved																													
5	Choose a control mode to stop	0 : When lower than Pr10-40, coast to stop If lower than Pr10-40, decelerate to stop by VF mode.																												
6	Reserved																													
7	Reserved																													
	10-38	Reserved																												
↗	10-39	Frequency Point when switch from I/F mode to PM Sensorless mode	Factory Setting: 20.00																											
		Settings 0.00~599.00Hz																												
↗	10-40	Frequency Point when switch from PM Sensorless Observation mode to I/F mode	Factory Setting: 20.00																											
		Settings 0.00~599.00Hz																												

↗	10-41	I/F mode, low pass-filter time	Factory Setting: 0.2
		Settings 0.0~6.0 sec	

↗	10-42	Voltage pulse width	Factory Setting: 10
		Settings 0~50 ms	

PM Sensorless Adjustment Procedure

1. When using high frequency standstill VFD parameter tuning, use VFD software v1.45 to monitor adjustment procedure. To download VFD Software v1.45, go to:

http://www.delta.com.tw/product/em/drive/ac_motor/download/software/VFDSoft%20v1.45.zip

2. Testing PM High Frequency Standstill VFD (calculation of Rs, Ld, Lg)

Procedures:

- A. Set control mode as VF mode (Pr00-10=0, Pr00-11=0)
- B. Output Frequency of Motor 1 (Pr01-01)
- C. Output Voltage of Motor 1 (Pr01-02)
- D. Induction Motor and Permanent Magnet Motor Selection (Pr05-33=1)
- E. Full-load current of Permanent Magnet Motor (Pr05-34)
- F. Set Motor Auto Tuning Pr 05-00 =13; High frequency and blocked rotor test for PM motor.

Then run the drive.

3. Set control mode as PM sensorless Mode (Parameters 00-10=0, 00-11=6)

4. Set VFD Parameters

- Pr05-35 Rated Power of Permanent Magnet Motor
- Pr05-36 Rated speed of Permanent Magnet Motor
- Pr05-37 Pole number of Permanent Magnet Motor
- Pr05-38 Inertia of Permanent Magnet Motor

5. Set ASR Parameters

- Pr11-00 bit0=1: Auto tuning for ASR and APR
- Pr11-02 : ASR1/ASR2 Switch Frequency, it is recommended to set Pr10-39 higher than 10Hz.
- Pr11-03: ASR1 Low-speed Bandwidth and Pr11-03, ASR2 High-speed Bandwidth. Do not set Low-speed Bandwidth too high to avoid dissipation of the estimator.

6. Set speed estimator and speed control's parameter.

- Pr10-39 Frequency when switch from I/F Mode to PM sensorless mode.
- Pr10-32 PM Sensorless Observer Bandwidth for High Speed Zone

7. Zero-load test

- Refer to switch point procedure of I/F and FOC as shown in the image below.

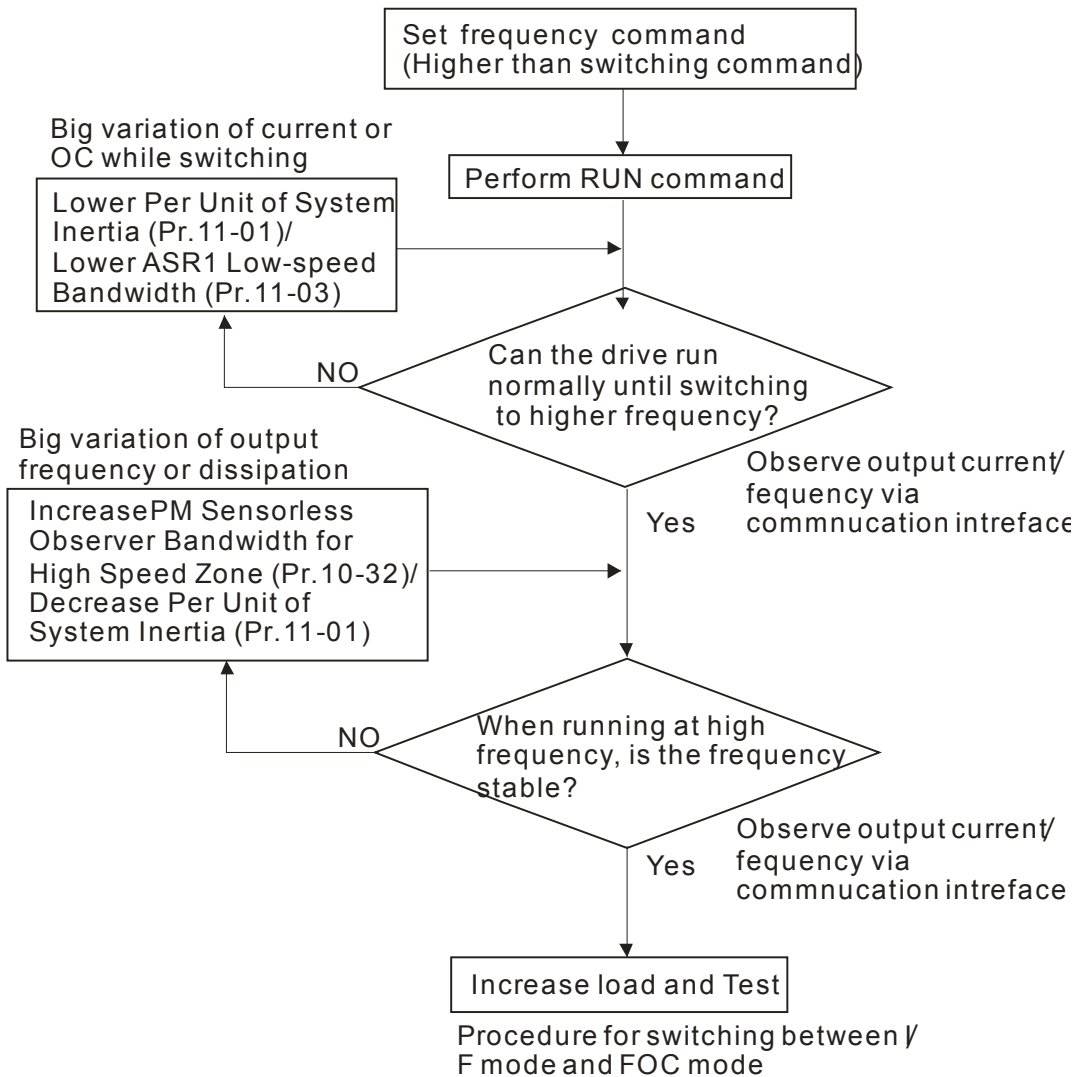

10-43 PG Card Version

Factory Setting: Read only

Settings 0~655.35

Version reference:

PG02U	21.XX
PG01U	31.XX
PG01O/PG01L	11.XX
PG02O/PG02L	14.XX
PG01R	41.XX



10-44 ~ **10-48** Reserved

10-49 Zero voltage time while start up

Factory Setting: 0.000

Settings 00.000~60.000 sec



When the motor is in static status at the startup, the accuracy to estimate angles will be increased. In order to make the motor in "static status", the drive 3 phase U, V, W output 0V to motor to reach this goal. The Pr10-49 setting time is the length of time when three-phase output 0V.

-  It is possible that even when this parameter is being applied but the motor at the installation site cannot go in to the “static status” caused by the inertia or by any external force. So, if the motor doesn’t go into a complete “static status” in 0.2 sec, increase appropriately this setting value.
-  This parameter is functional only when the setting of Pr07-12 Speed Search during Startup ≠0.

10-50 Reverse angle limit (Electrical angle)

Factory Setting: 10.00

Settings 0.00~30.00 degree

-  While forward run is starting, if there is a sudden reverse run and the reverse angle is bigger than the Pr10-50 setting, then, drive will has a ScRv error.
-  This parameter is valid only when Pr07-28 =11 Enable textile machine’s function.

10-51 Injection Frequency

Factory Setting: 500 Hz



Settings 0~2000Hz

-  This parameter is a High Frequency Injection Command when the motor drive is under IPM HFI sensor-less control mode and it doesn’t often need to be adjusted. But, if a motor’s rated frequency (i.e. 400Hz) is too close to the frequency setting of this parameter (i.e. 500Hz), the accuracy of angles detected will be affected. Therefore, refer to the setting of Pr01-01 before adjusting this parameter.

10-52 Injection Magnitude

Factory Setting:15/30V

Settings 0.0~200.0V

-  This parameter is the High Frequency Injection Command’s amplitude when the motor drive is under IPM HFI sensor-less control mode.
-  By increase the setting value of this parameter, the accuracy of angles detected will also be increased. However, if the setting value is too big, it will cause a louder electromagnetic noise.

10-53 PM Motor Initial Rotor Position Detection Method

Factory Setting: 0

- Settings
- 0: No function
 - 1: DC injection
 - 2: High frequency injection
 - 3: Pulse injection
 - 4~5: Reserved

11 Advanced Parameters

✎ This parameter can be set during operation.

In this parameter group, ASR is the abbreviation for Adjust Speed Regulator

11-00 System Control

Factory Setting: 0

- Settings
- 0: Auto tuning for ASR and APR
 - 1: Inertia estimate (only in FOCPG mode)
 - 2: Zero servo
 - 3: Dead time compensation closed
 - 7: Selection to save or not save the frequency
 - 8: Maximum speed of point to point position control

- 📖 Bit 0=0: Pr.11-06 to 11-11 will be valid and Pr.11-03~11-05 are invalid.
 Bit 0=1: system will generate an ASR setting. At this moment, Pr.11-06~11-11 will be invalid and Pr.11-03~11-05 are valid.
- Bit 1=0: no function.
 Bit 1=1: Inertia estimate function is enabled. (Bit 1 setting would not activate the estimation process, please set Pr.05-00=12 to begin FOC/TQC Sensorless inertia estimating)
- Bit 2=0: no function.
 Bit 2=1: when frequency command is less than Fmin (Pr.01-07), it will use zero servo function.

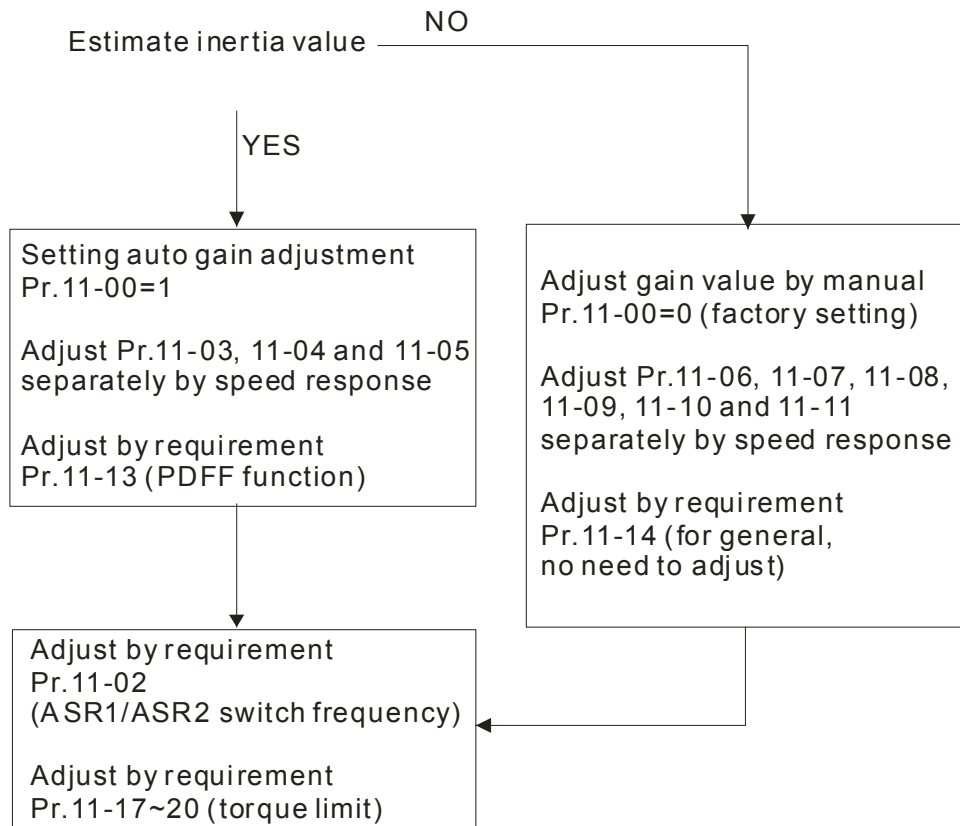

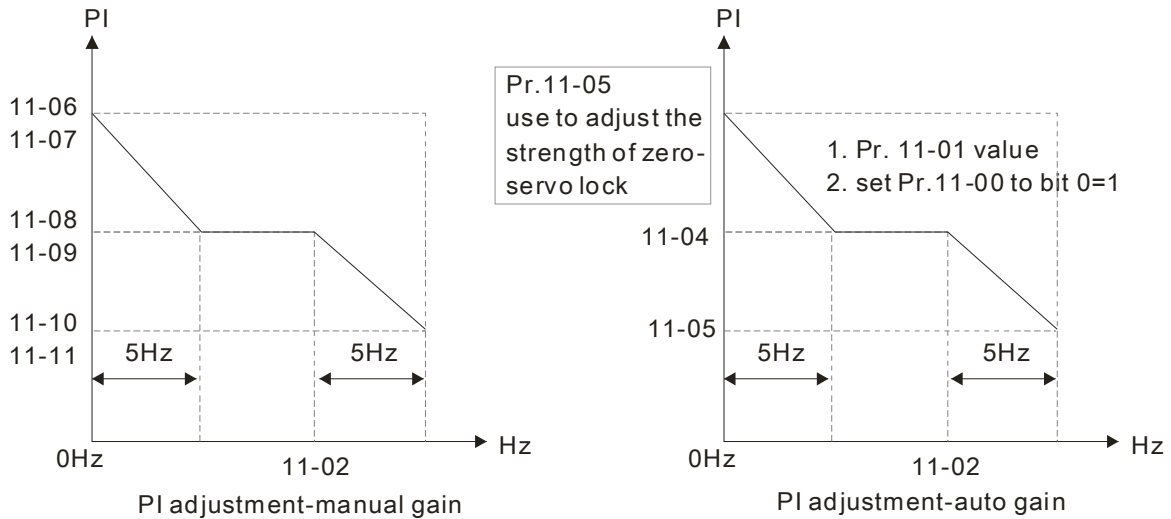

- 📖 Bit 7=0: frequency is saved before power turns off. When power turns on again, the display frequency will be the memorized frequency.
- Bit 7=1: frequency is not saved before power turns off. When power turns ON again, the display frequency will be 0.00Hz.
- Bit 8=0: maximum speed for point-to-point position control is control by the setting of Pr.11-43.
- Bit 8=1: maximum speed for point-to-point position control is control by the multi-step speed setting of the external terminal device. When multi-step speed of the external device is set to 0, the maximum operation speed will bet the setting of Pr.11-43.

11-01 Per Unit of System Inertia Factory Setting: 256

Settings 1~65535 (256=1PU)

📖 To get the system inertia from Pr.11-01, user needs to set Pr.11-00 to bit1=1 and execute continuous forward/reverse running.

Unit of induction motor system inertia is 0.001kg·m²:

Power	Setting	Power	Setting
11kW	35.8	37 kW	202.5
15 kW	74.3	45 kW	355.5
18.5 kW	95.3	55 kW	410.8
22 kW	142.8	75 kW	494.8
30 kW	176.5	90 kW	1056.5

The base value for induction motor system inertia is set by Pr.05-38 and the unit is in 0.001kg·m².

11-02 ASR1/ASR2 Switch Frequency Factory Setting: 7.00

Settings 5.00~599.00Hz

11-03 ASR1 Low-speed Bandwidth Factory Setting: 10

Settings 1~40Hz (IM)/ 1~100Hz (PM)

- ↗ **11-04** ASR2 High-speed Bandwidth Factory Setting: 10
 Settings 1~40Hz (IM)/ 1~100Hz (PM)
- ↗ **11-05** Zero-speed Bandwidth Factory Setting: 10
 Settings 1~40Hz (IM)/ 1~100Hz (PM)
- 📖 After estimating inertia and set Pr.11-00 to bit 0=1 (auto tuning), user can adjust parameters Pr.11-03, 11-04 and 11-05 separately by speed response. The larger number you set, the faster response you will get. Pr.11-02 is the switch frequency for low-speed/high-speed bandwidth.
- ↗ **11-06** ASR (Auto Speed Regulation) control (P) 1 Factory Setting: 10
 Settings 0~40 Hz (IM)/ 1~100Hz (PM)
- ↗ **11-07** ASR (Auto Speed Regulation) control (I) 1 Factory Setting: 0.100
 Settings 0.000~10.000 sec
- ↗ **11-08** ASR (Auto Speed Regulation) control (PI) 2 Factory Setting: 10
 Settings 0~40 Hz (IM)/ 0~100Hz (PM)
- ↗ **11-09** ASR (Auto Speed Regulation) control (I) 2 Factory Setting: 0.100
 Settings 0.000~10.000 sec
- ↗ **11-10** ASR(Auto Speed Regulation) Control (P) of Zero Speed Factory Setting: 10
 Settings 0~40 Hz (IM)/ 0~100Hz (PM)
- ↗ **11-11** ASR(Auto Speed Regulation) Control (I) of Zero Speed Factory Setting: 0.100
 Settings 0.000~10.000 sec
- ↗ **11-12** Gain for ASR Speed Feed Forward Factory Setting: 0
 Settings 0~100%

📖 This parameter is used to improve speed response.

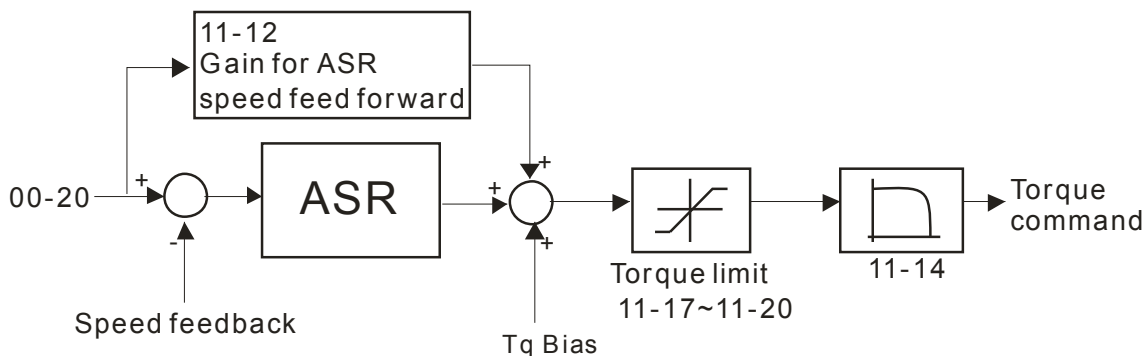

⚡ **11-13** PDFF Gain Value

Factory Setting: 30

Settings 0~200%

📖 After finishing estimating and set Pr.11-00 to bit 0=1 (auto tuning), using Pr.11-13 to reduce overshoot. Please adjust PDFF gain value by actual situation.

📖 This parameter will be invalid when Pr.05-24 is set to 1.

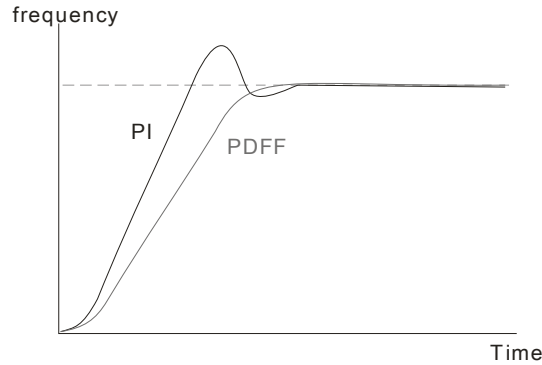

⚡ **11-14** Low-pass Filter Time of ASR Output

Factory Setting: 0.008

Settings 0.000~0.350 sec

📖 It is used to set the filter time of ASR command.

⚡ **11-15** Notch Filter Depth

Factory Setting: 0

Settings 0~20db

⚡ **11-16** Notch Filter Frequency

Factory Setting: 0.00

Settings 0.00~200.00Hz

📖 This parameter is used to set resonance frequency of mechanical system. It can be used to suppress the resonance of mechanical system.

📖 The larger number you set Pr.11-15, the better suppression resonance function you will get.

📖 The notch filter frequency is the resonance of mechanical frequency.

⚡ **11-17** Forward Motor Torque Limit

⚡ **11-18** Forward Regenerative Torque Limit

⚡ **11-19** Reverse Motor Torque Limit

⚡ **11-20** Reverse Regenerative Torque Limit

Factory Setting: 500

Settings 0~500%

📖 The motor rated torque is 100%. The settings for Pr.11-17 to Pr.11-20 will compare with Pr.03-00=7, 8, 9, 10. The minimum of the comparison result will be torque limit.

📖 Calculation equation for motor rated torque:

$$T(N.M) = \frac{P(W)}{\omega(rad/s)} ; P(W) \text{ value} = \text{Pr.05-02};$$

Motor rated torque=

$$\omega(\text{rad/s}) \text{ value} = \text{Pr.05-03} \cdot \frac{\text{RPM} \times 2\pi}{60} = \text{rad/s}$$

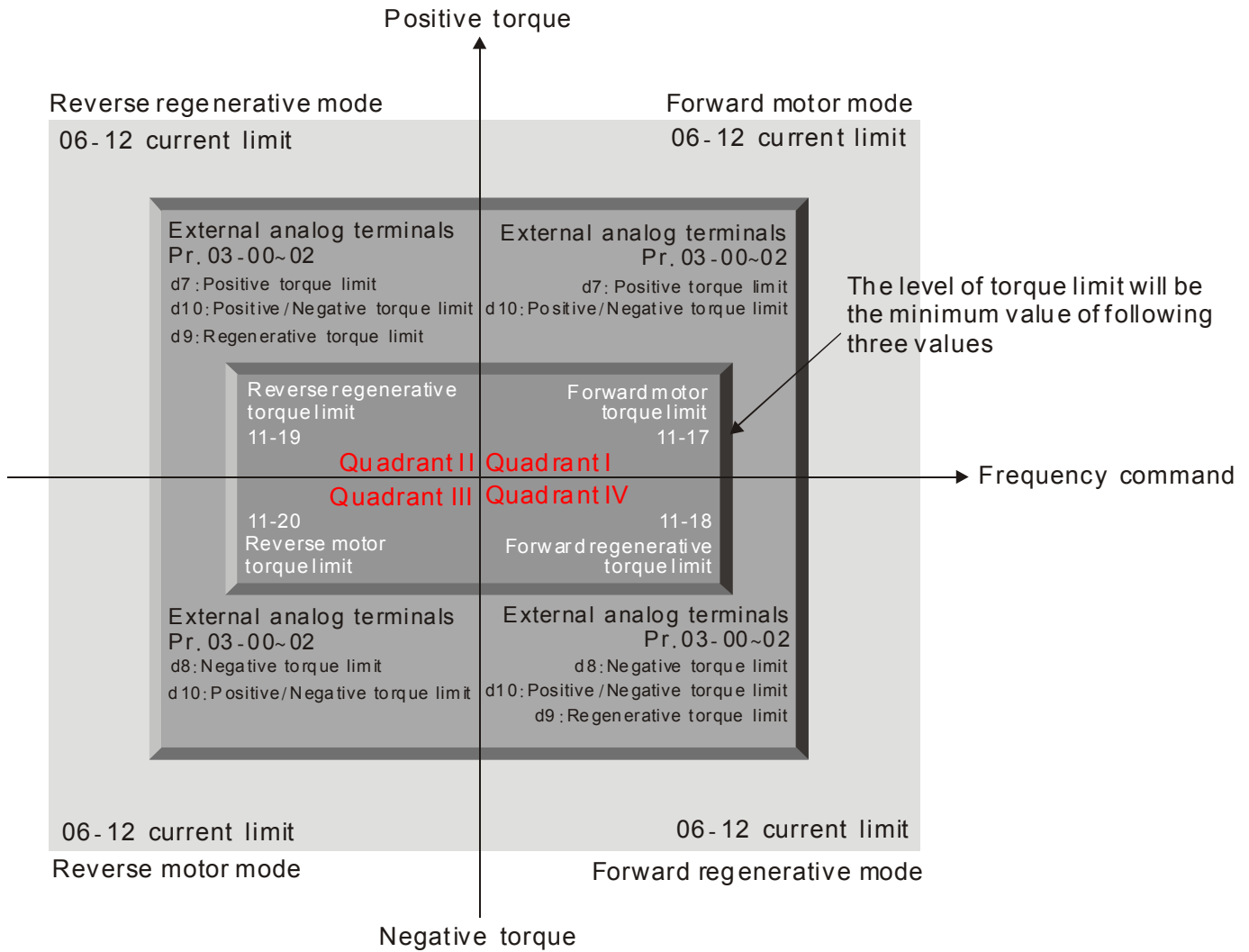

⚡ **11-21** Gain Value of Flux Weakening Curve for Motor 1

Factory Setting: 90

Settings 0~200%

⚡ **11-22** Gain Value of Flux Weakening Curve for Motor 2

Factory Setting: 90

Settings 0~200%

- 📖 Pr.11-21 and 11-22 are used to adjust the output voltage of flux weakening curve.
- 📖 For the spindle application, the adjustment method is
 1. It is used to adjust the output voltage when exceeding rated frequency.
 2. Monitor the output voltage
 3. Adjust Pr.11-21 (motor 1) or Pr.11-22 (motor 2) setting to make the output voltage reach motor rated voltage.
 4. The larger number it is set, the larger output voltage you will get.

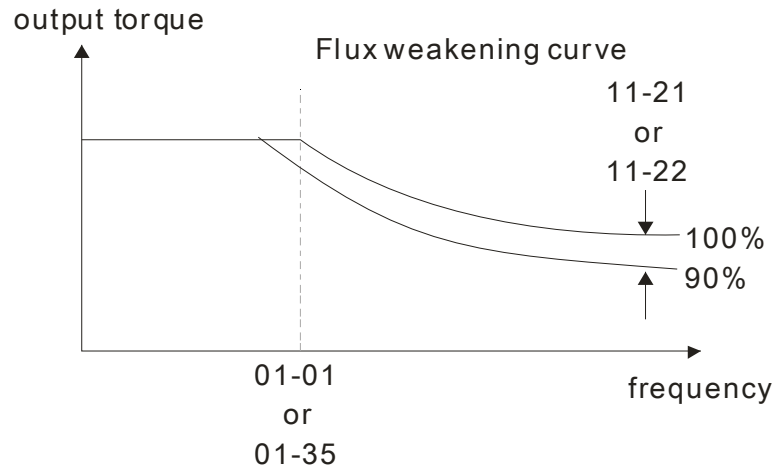

⚡ **11-23** Speed Response of Flux Weakening Area

Factory Setting: 65

Settings 0: Disable
0~150%

📖 It is used to control the speed in the flux weakening area. The larger value is set in Pr.11-23, the faster acceleration/deceleration will generate. In general, it is not necessary to adjust this parameter.

⚡ **11-24** APR Gain

Factory Setting: 10.00

Settings 0.00~40.00 (IM)/ 0~100.00Hz (PM)

📖 Kip gain of internal position is determined by Pr.11-05.

⚡ **11-25** Gain Value of APR Feed Forward

Factory Setting: 30

Settings 0~100

📖 For the position control, if it set a larger value in Pr.11-25, it can shorten the pulse differential and speed up the position response. But it may overshoot.

📖 When the multi-function input terminal is set to 37(ON), this parameter can be set as required. If this parameter is set to a non zero value and adjust Pr.10-21 (PG2 Filter Time) to reduce the position overshoot and pulse differential. If it is set to 0, it won't have overshoot problem in position control but the pulse differential is decided by Pr.11-05 (KP gain).

⚡ **11-26** APR Curve Time

Factory Setting: 3.00

Settings 0.00~655.35 sec

📖 It is valid when the multi-function input terminal is set to 35(ON). The larger it is set, the longer the position time will be.

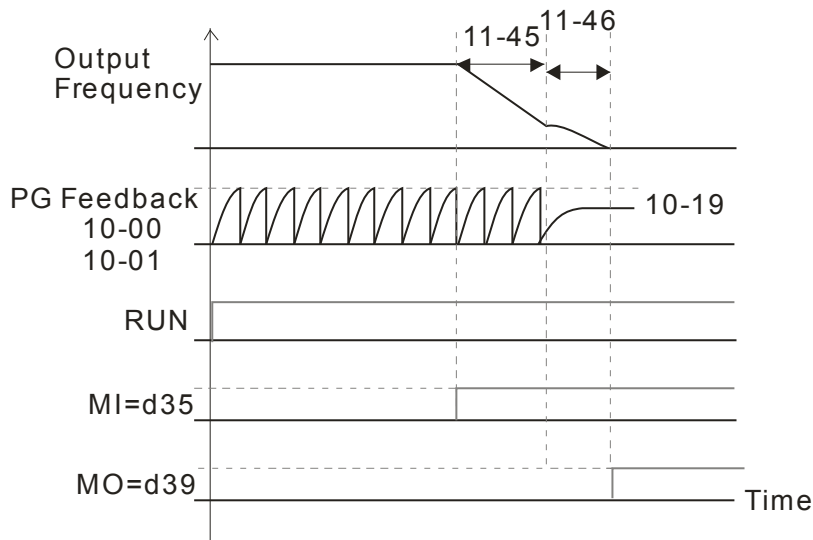

11-27 Max. Torque Command

Factory Setting: 100

Settings 0~500%

- 📖 The upper limit of torque command is 100%.
- 📖 Calculation equation for motor rated torque:

$$\text{motor rated torque: } T(N.M) = \frac{P(W)}{\omega(rad/s)}; P(W) \text{ value} = \text{Pr.05-02};$$

$$\omega(rad/s) \text{ value} = \text{Pr.05-03} \cdot \frac{RPM \times 2\pi}{60} = rad/s$$

11-28 Source of Torque Offset

Factory Setting: 0

- Settings
- 0: Disable
 - 1: Analog input (Pr.03-00)
 - 2: Torque offset setting (Pr.11-29)
 - 3: Control by external terminal (by Pr.11-30 to Pr.11-32)

- 📖 This parameter is the source of torque offset.
- 📖 When it is set to 3, source of torque offset would determine Pr.11-30 to Pr.11-32 by
- 📖 When it is set to 3, the source of torque offset will regard Pr.11-30~11-32 by the multi-function input terminals (MI) setting (31, 32 or 33).

N.O. switch status: ON= contact closed, OFF= contact open

Pr. 11-32	Pr. 11-31	Pr. 11-30	Torque Offset
MI=33(High)	MI=32(Mid)	MI=31(Low)	
OFF	OFF	OFF	None
OFF	OFF	ON	11-30
OFF	ON	OFF	11-31
OFF	ON	ON	11-30+11-31
ON	OFF	OFF	11-32
ON	OFF	ON	11-30+11-32
ON	ON	OFF	11-31+11-32
ON	ON	ON	11-30+11-31+11-32

11-29 Torque Offset Setting

Factory Setting: 0.0

Settings -100.0~100.0%

 This parameter is torque offset. The motor rated torque is 100%.

 Calculation equation for motor rated torque:

$$\text{motor rated torque: } T(N.M) = \frac{P(W)}{\omega(rad/s)}; P(W) \text{ value} = \text{Pr.05-02};$$

$$\omega(rad/s) \text{ value} = \text{Pr.05-03} \cdot \frac{RPM \times 2\pi}{60} = rad/s$$

11-30 High Torque Offset

Factory Setting: 30.0

Settings -100.0~100.0%

11-31 Middle Torque Offset

Factory Setting: 20.0

Settings -100.0~100.0%

11-32 Low Torque Offset

Factory Setting: 10.0

Settings -100.0~100.0%

 When it is set to 3, the source of torque offset will regard Pr.11-30, Pr.11-31 and Pr.11-32 by the multi-function input terminals setting (31, 32 or 33). The motor rated torque is 100%.

 Calculation equation for motor rated torque:

$$\text{motor rated torque: } T(N.M) = \frac{P(W)}{\omega(rad/s)}; P(W) \text{ value} = \text{Pr.05-02};$$

$$\omega(rad/s) \text{ value} = \text{Pr.05-03} \cdot \frac{RPM \times 2\pi}{60} = rad/s$$

11-33 Source of Torque Command

Factory Setting: 0

Settings

- 0: Digital Keypad (Pr.11-34)
- 1: RS485 serial communication
- 2: Analog signal (Pr.03-00)
- 3: CANopen
- 4: Reserved
- 5: Communication card

 When Pr.11-33 is set to 0, torque command can be set in Pr.11-34.

 When Pr.11-33 is set to 1 or 2, Pr.11-34 would only display the torque command

11-34 Torque Command

Factory Setting: 0.0

Settings -100.0~100.0% (Pr.11-27=100%)

- This parameter is for the torque command. When Pr.11-27 is set to 250% and Pr.11-34 is set to 100%, actual torque command=250X100%=250% motor rated torque.
- The drive will save the setting to the record before power turns off.

11-35 Low-pass Filter Time of Torque Command

Factory Setting: 0.000

Settings 0.000~1.000 sec

- When the setting is too long, the control will be stable but the control response will be delay. When the setting is too short, the response will be quickly but the control maybe unstable. User can adjust the setting by the control and response situation.

11-36 Speed Limit Selection

Factory Setting: 0

Settings 0: Set by Pr.11-37 (Forward speed limit) and Pr.11-38 (Reverse speed limit)
 1: Set by Pr.11-37,11-38 and Pr.00-20 (Source of Master Frequency Command)
 2: Set by Pr.00-20 (Source of Master Frequency Command).

- Speed limit function: in TQCPG, when the motor speed is accelerated to speed limit value (Pr.11-36, 11-37 and 11-38), it will switch to speed control mode to stop acceleration.
- When the torque is positive direction, speed limit is positive direction. When the torque is negative direction, speed limit is negative direction.

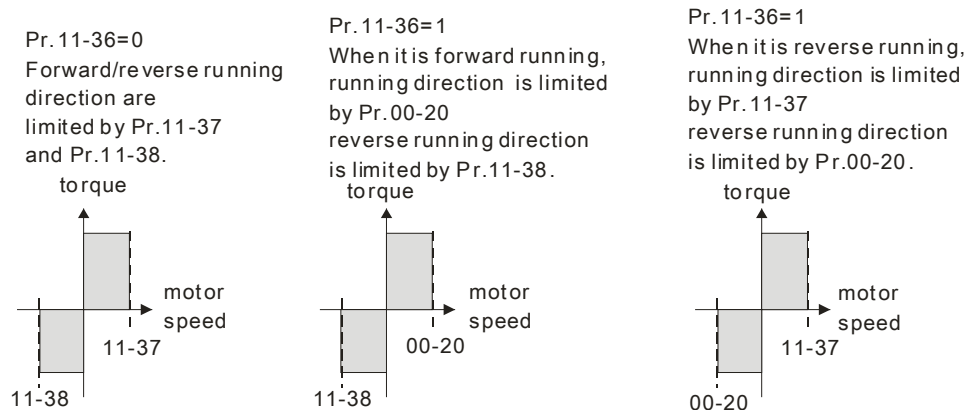

11-37 Forward Speed Limit (torque mode)

Factory Setting: 10

Settings 0~120%

11-38 Reverse Speed Limit (torque mode)

Factory Setting: 10

Settings 0~120%

- These parameters are used in the torque mode to limit the running direction and opposite direction. (Pr.01-00 max. output frequency=100%)

11-39 Zero Torque Command Mode

Factory Setting: 0

Settings 0: Torque mode
1: Speed mode

 This parameter defines the torque command mode at 0% of torque output. When Pr.11-39 is set as 0 (the torque mode), if torque command is 0%, the motor will produce excitation current but no torque current. When Pr.11-39 is set as 1 (the speed mode), if torque command is 0%, the AC motor drive can still produce torque current through speed controller to prevent motor race and the drive will also automatically adjust the speed to 0 when the speed command is not equal to 0.

11-40 Command Source of Point-to-Point Position Control

Factory Settings:0

Settings 0: External terminal
1: Reserved
2: RS485
3: CAN
4: Reserved
5: Communication card

11-41 Reserved

11-42 System Control Flags

Factory Settings: 0000

Settings 0000~FFFFh

Bit No.	Function	Description
0	At torque mode, selection between speed control and current control.	0:Speed control at torque mode, the largest current limit is the torque command. 1: Speed control at torque mode, P06-12 the largest current limit is Pr06-12
1	FWD/REV direction control	0: FWD/REV cannot be controlled by 02-12 bit 0 & 1 1: FWD/REV can be controlled by 02-12 bit 0&1
2	Fuzzy PID selection control	0: Fuzzy PID enabled 1: Fuzzy PID disabled
3~15	Reserved	

11-43 Max. Frequency of Point- to-Point Position Control

Factory Settings:10.00

Settings 0.00~599.00Hz

11-44 Accel. Time of Point-to Point Position Control

Factory Settings:1.00

Settings 0.00~655.35sec

11-45 Decel. Time of Point-to Point Position Control

Factory Settings:3.00

Settings 0.00~655.35sec

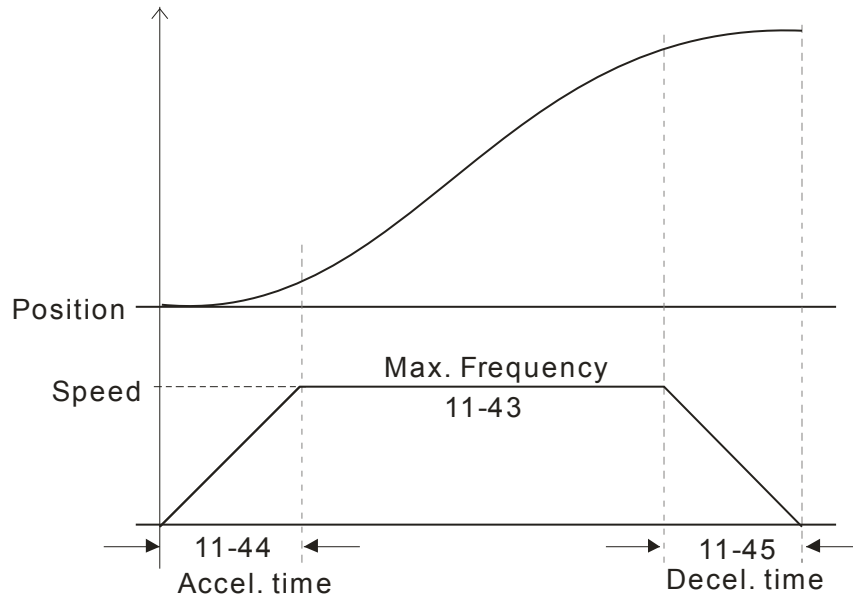

12-2 Adjustment & Application

12-2-1 Standard PM Motor Adjustment Procedure

- Pr00-11=2 SVC (Pr05-33=1 or 2)

Flow chart of adjustment when starting up WITHOUT load

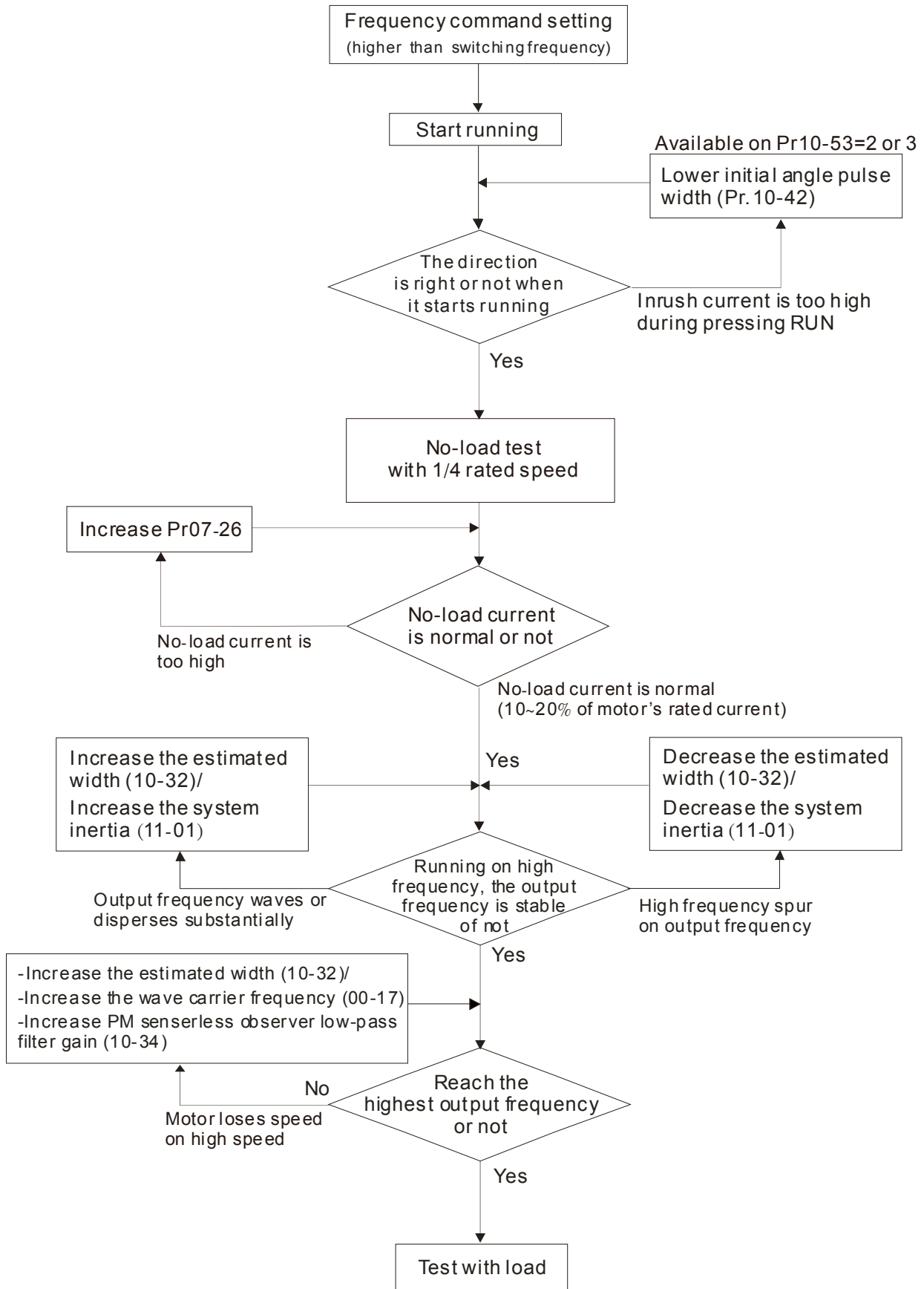

Flow chart of adjustment when starting up WITH load

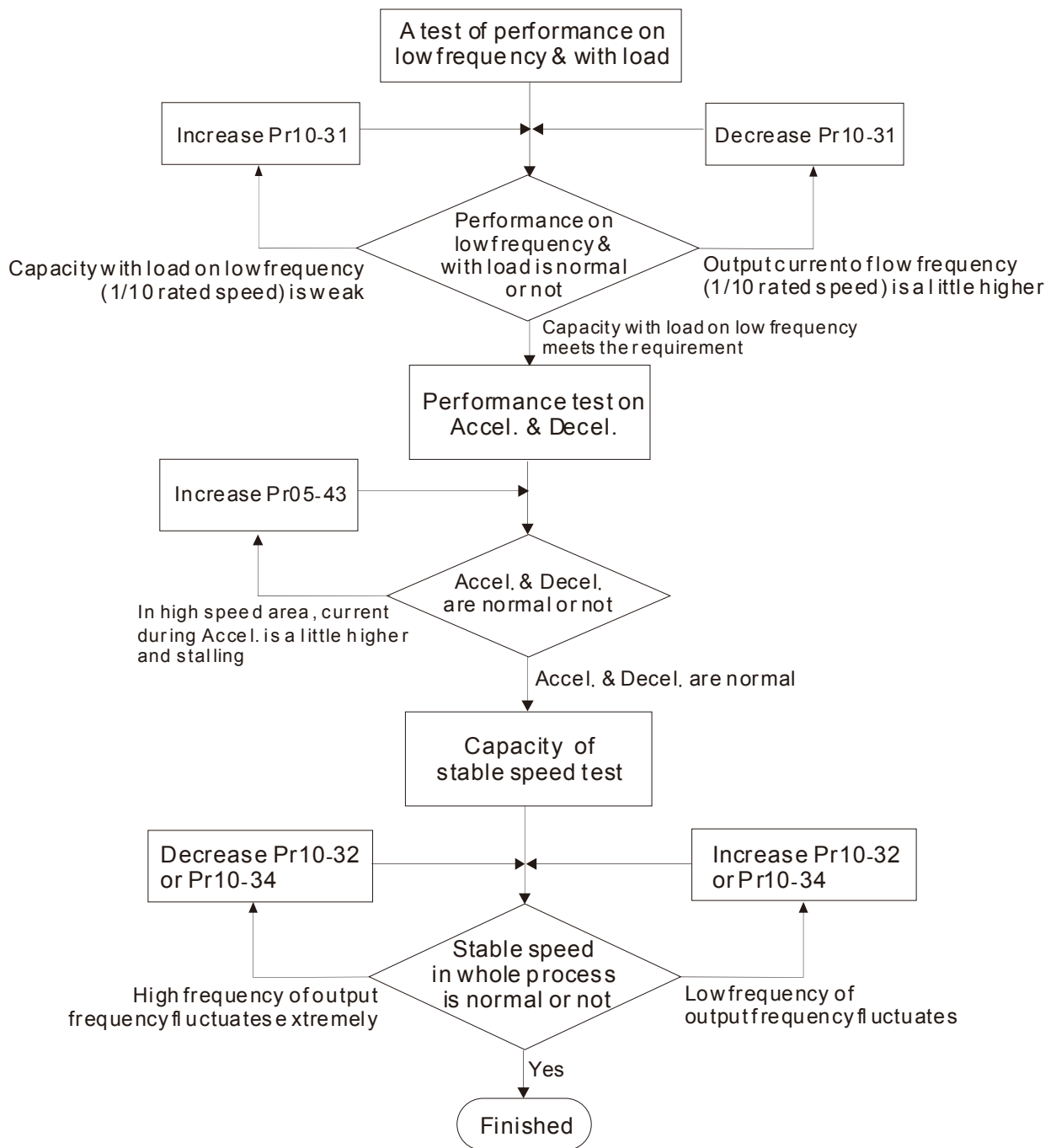

PMSVC control diagram

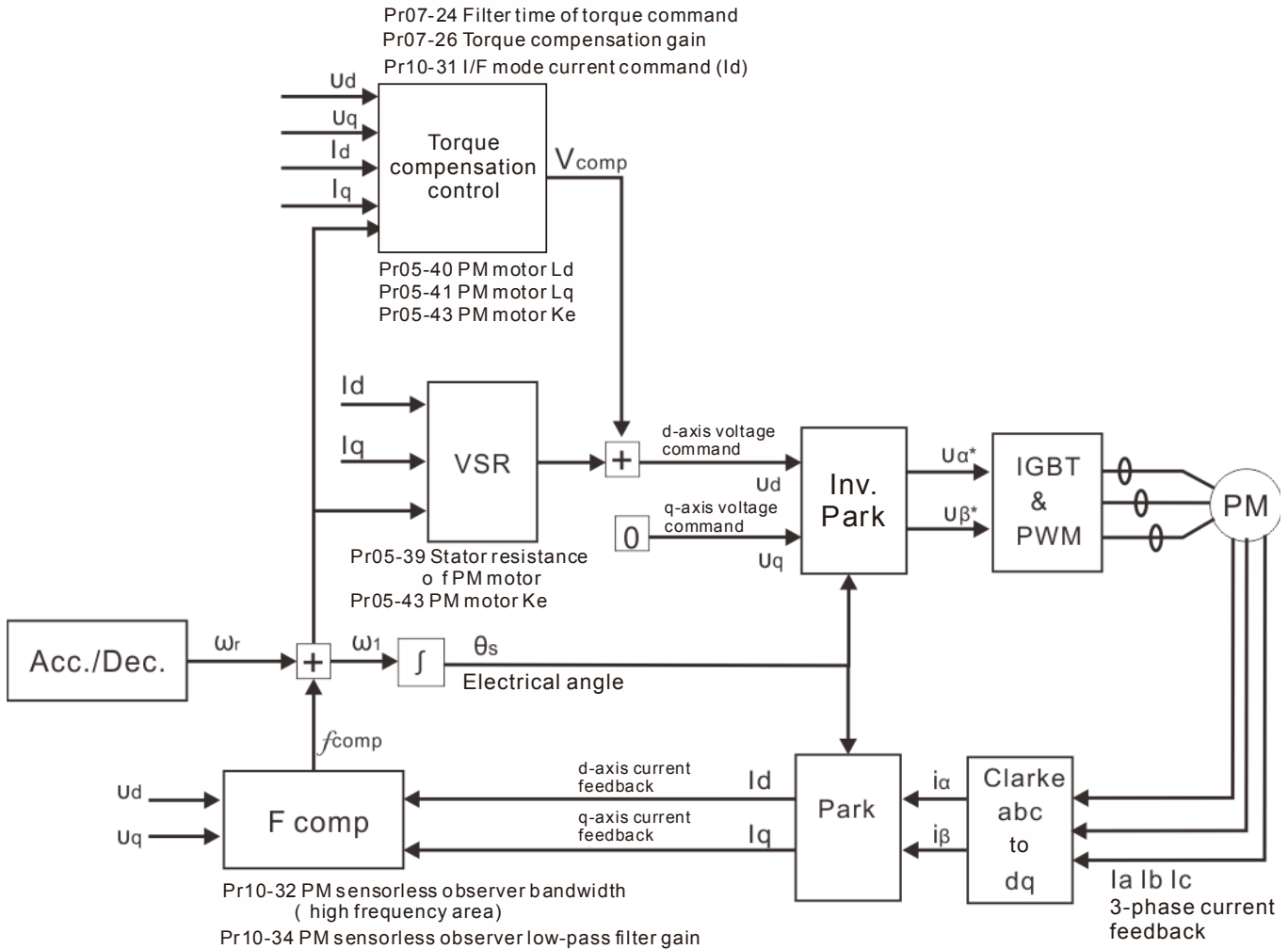

Adjustment procedure

1. Set up PM motor control

Pr05-33=1 or 2

2. Set up motor parameter according to the nameplate on the motor

Pr01-01 Output Frequency of Motor 1 (base frequency and motor rated frequency)

Pr01-02 Output Voltage of Motor 1 (base frequency and motor rated frequency)

Pr05-34 Full-load current of Permanent Magnet Motor

Pr05-35 Rated Power of Permanent Magnet Motor

Pr05-36 Rated speed of Permanent Magnet Motor

Pr05-37 Pole number of Permanent Magnet Motor

3. Execute Auto-tuning

Set up Pr05-00=13 for IPM motor tuning and press Run(static-tuning). When the tuning is done, the following parameters will be obtained.

Pr05-39 Stator Resistance of PM Motor

Pr05-40 Permanent Magnet Motor L_d

Pr05-41 Permanent Magnet Motor L_q



Pr05-43 (V/1000rpm), the K_e parameter of PM motor (this can be calculated automatically according to power, current and speed of motor).

Pr10-52 Injection magnitude

10-52 Injection Magnitude

Factory Setting:15/30V



Settings 0.0~200.0V

-  The parameter can be got while motor parameter executes auto-tuning. The parameter will influence the accuracy of angle detection.
 -  When the ratio of salient pole (L_q/L_d) is lower, increase Pr10-52 to make angle detection be accurate.
4. Set up speed control mode: Pr00-10=0, Pr00-11=2 SVC.
 5. It is suggested that cutting off the power after finishing tuning, and then re-power on.
 6. The ration of PMSVC control mode is 1:20.
 7. When PMSVC control mode is under 1/20 rated speed, load bearing capacity=100% motor rated torque.
 8. PMSVC control mode is not applicable for zero speed control.
 9. Start-up with load and forward/reverse load bearing capacity of PMSVC control mode=100% rated torque of motor.
 10. Set up the speed estimators related parameters

10-31 I/F Mode Current Command / Low-speed Current Command under PMSVC Control

Factory Setting:40



Settings 0~150% of motor's rated current

-  The parameter is the current command of the drive in low-speed area (low-speed area: frequency command < Pr10-39).
-  When it is stalling on heavy duty start-up or forward/reverse with load, adjust the parameter (to increase it). If inrush current too higher to cause oc stall, then decrease it.

10-32 PM FOC Sensorless Speed Estimator Bandwidth

Factory Setting:5.00



Settings 0.00~600.00Hz

-  The parameter is speed estimator bandwidth. Adjust the parameter will influence the stability and the accuracy of speed for motor.
-  If there is low frequency vibrates (the waveform is similar to sine wave) during the process, then increase the bandwidth. If there is high frequency vibrates (the waveform vibrates extremely and is like spur), then decrease the bandwidth.

10-34 PM Sensorless Observer Low-pass Filter Gain

Factory Setting:1.00



Settings 0.00~655.35

-  Adjust the parameter will influence the speed estimator's speed of response.
-  If there is low frequency vibrates (the waveform is similar to sine wave) during the process, then increase the gain. If there is high frequency vibrates (the waveform vibrates extremely and is like spur), then decrease the gain.

10-39 Frequency Point when switch from I/F Mode to PM Sensorless Mode

Factory Setting:20.00



Settings 0.00~599.00Hz

-  The parameter is the switch point which is from low frequency to high frequency. It will influence high/low frequency area of speed observer.
-  If the switch point is too low, motor will generate not enough back emf to let the speed estimator measure the right rotator's position and speed, and cause stall and oc when the frequency of switch point is running.
-  If the switch point is too high, the active area of I/F will too wide, and then it will generate larger current to make it cannot save energy. (The reason is that if the current of Pr10-31 sets too high, and the high switch point will make the drive keeps outputting with the setting value of Pr10-31)

10-42 Voltage pulse width

Factory Setting:10





Settings 0~50 ms

-  The angle detection is 3:6-pulse. The parameter influences the value of pulse during the angle detection. The larger the pulse is, the higher of the accuracy of rotator's position. But it might cause oc easily.
-  Increase the parameter when the running direction and the command are opposite while start-up. If oc occurs in the start-up moment, then decrease the parameter.

10-49 Zero voltage time while start up

Factory Setting: 0.000

Settings 0.000~60.000 sec.

-  When the motor is in static status at the startup, the accuracy to estimate angles will be increased. In order to make the motor in "static status", the drive 3 phase U, V, W output 0V to motor to reach this goal. The Pr10-49 setting time is the length of time when three-phase output 0V.
-  It is possible that even when this parameter is being applied but the motor at the installation site cannot go in to the "static status" caused by the inertia or by any external force. So, if the motor doesn't go into a completer "static status" in 0.2 sec, increase appropriately this setting value.
-  This parameter is functional only when the setting of Pr07-12 Speed Search during Startup $\neq 0$.
-  If Pr10-49 sets too high, the start-up time will be longer obviously. If is too low, then the braking performance will be weak.

10-51 Injection Frequency

Factory Setting: 500Hz

Settings 0~1200Hz

-  This parameter is a High Frequency Injection Command when the motor drive is under IPM HFI sensor-less control mode and it doesn't often need to be adjusted. But, if a motor's rated frequency (i.e. 400Hz) is too close to the frequency setting of this parameter (i.e. 500Hz),

the accuracy of angles detected will be affected. Therefore, refer to the setting of Pr01-01 before adjusting this parameter.

- 📖 If the setting value of Pr00-17 is lower $Pr10-51 \times 10$, then increase the frequency of carrier wave.

↖ **10-52** Injection Magnitude

Factory Setting: 15/30V

Settings 0.0~200.0V

- 📖 The parameter is magnitude command of high frequency injection signal when IPM HFI sensorless control mode.
- 📖 Increase the parameter can get the more accurate estimated value of angle. But the noise of electromagnetic might be louder if the setting value is too high.
- 📖 To get the parameter when motor's parameter is "Auto". And the parameter will influence the accuracy of angel's estimation.
- 📖 When the ratio of salient pole (Lq/Ld) is lower, increase Pr10-52 to make angle detection be accurate.

↖ **10-53** PM Motor Initial Rotor Position Detection Method

Factory Setting: 0

Settings 0: No function
 1: DC injection
 2: High frequency injection
 3: Pulse injection
 4~5: Reserved

- 📖 It is suggested to set as "2" if it's IPM; set as "3" if it's SPM. If there is bad effect when set as "2" or "3", then set as "1".

11. Parameters for speed adjustment

↖ **07-26** Torque Compensation Gain (V/F and SVC control mode)

Factory Setting: 0

Settings 0~10

- 📖 The parameter influences the output current during the running process. There will be less effect on the low speed area.
- 📖 Increase the setting value if the current with no-load is too high. But it might also cause the motor to vibrate. If the motor vibrates during the operation, decrease the setting value.

● Pr00-11=6 PM Sensorless (I/F + FOC)

Flow chart of speed estimator performance adjustment

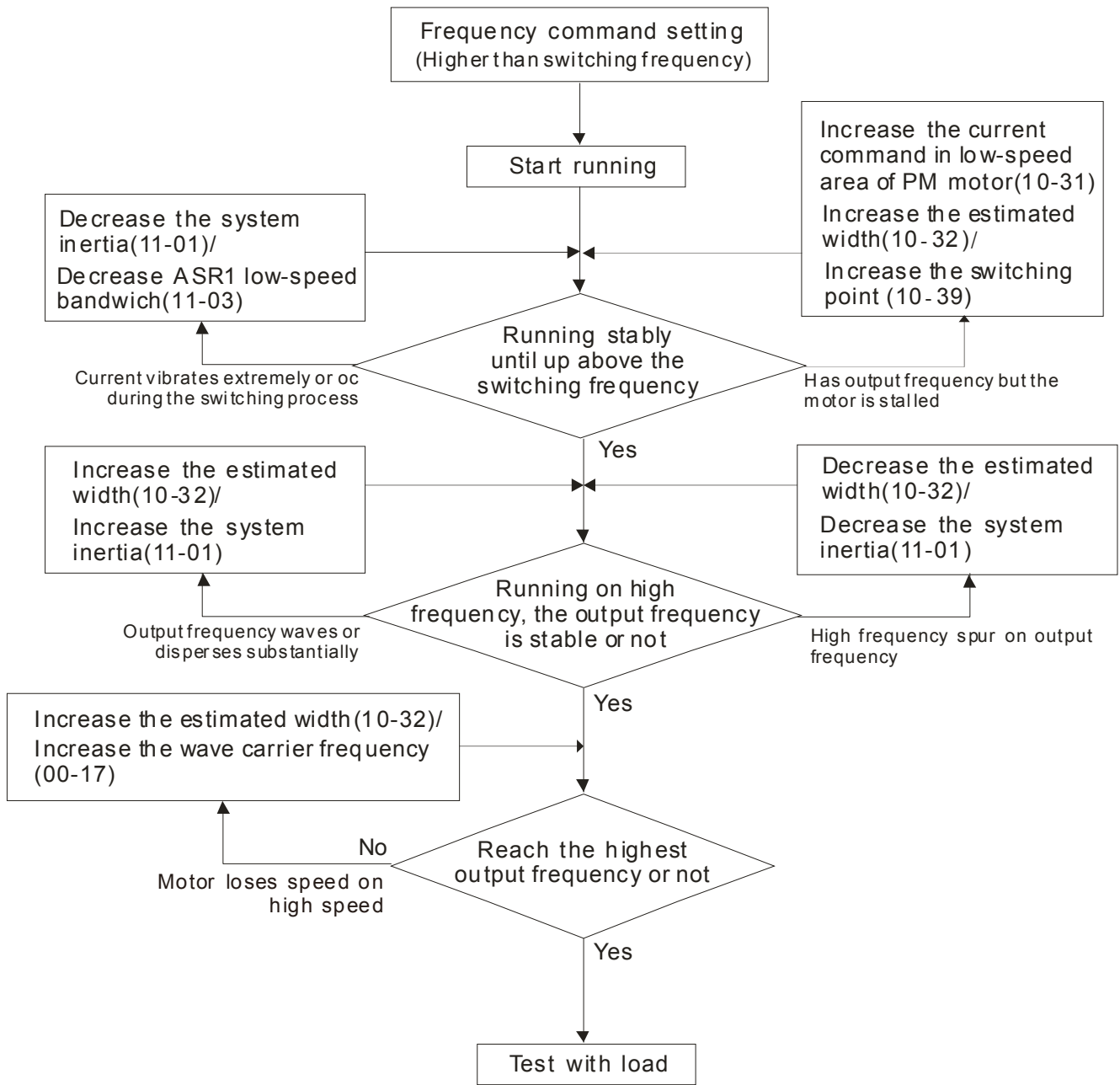

PM FOC sensorless control diagram

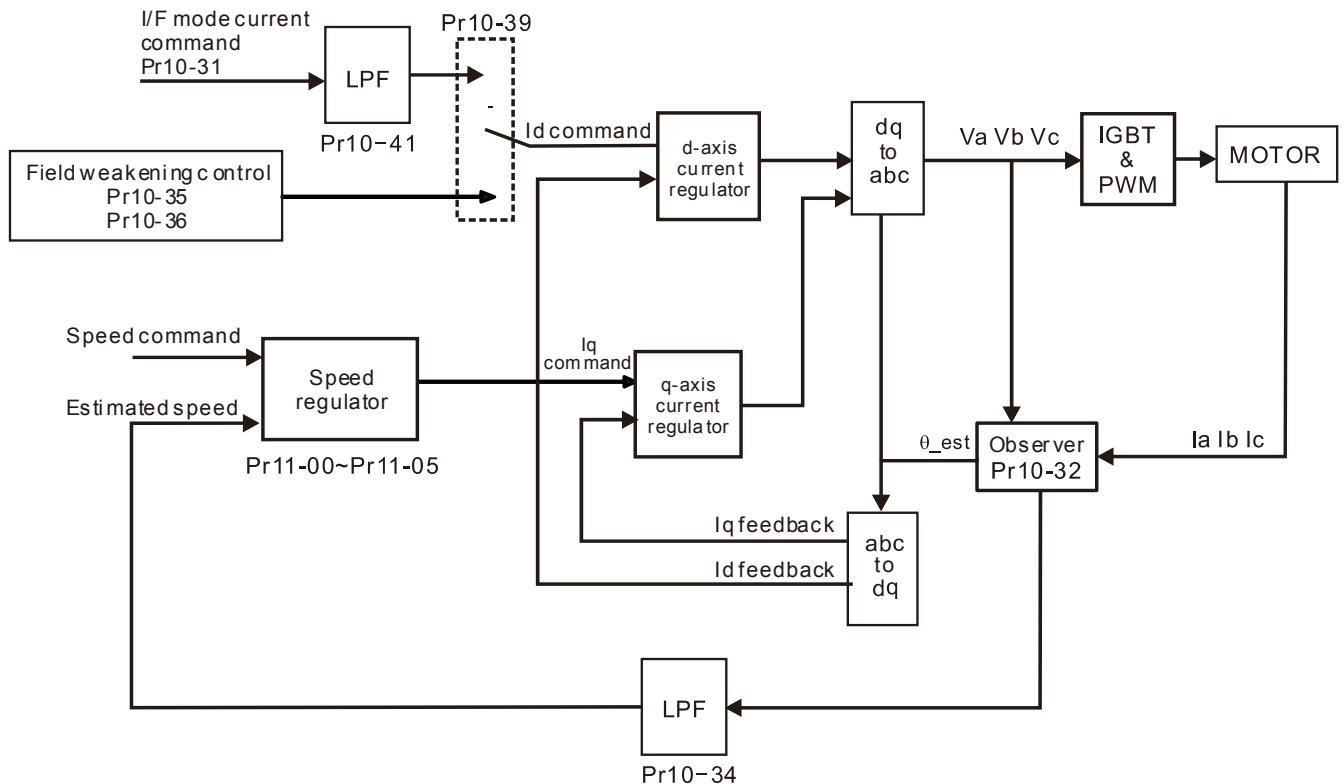

Adjustment procedure

1. Sep up PM motor control
Pr05-33=1 or 2
2. Set up motor parameter according to the nameplate on the motor
 - Pr01-01 Output Frequency of Motor 1 (base frequency and motor rated frequency)
 - Pr01-02 Output Voltage of Motor 1 (base frequency and motor rated frequency)
 - Pr05-34 Full-load current of Permanent Magnet Motor
 - Pr05-35 Rated Power of Permanent Magnet Motor
 - Pr05-36 Rated speed of Permanent Magnet Motor
 - Pr05-37 Pole number of Permanent Magnet Motor
3. Execute Auto-tuning
Set up Pr05-00=13 for IPM motor tuning and press Run(static-tuning). When the tuning is done, the following parameters will be obtained.
 - Pr05-39 Stator Resistance of PM Motor
 - Pr05-40 Permanent Magnet Motor Ld
 - Pr05-41 Permanent Magnet Motor Lq
4. Set up Pr00-11=6 for PM sensorless control (I/F+FOC)
5. Adjust the parameters which are related to speed estimator and ASR to make the best operational performance.

6. Set up the speed estimator related parameters

↗ **10-31** I/F Mode Current Command / Low-speed Current Command under PMSVC Control

Factory Setting: 40

Settings 0~150% of motor's rated current

📖 The parameter is the current command of the drive in low-speed area (low-speed area: frequency command < Pr10-39).

📖 When it is stalling on heavy duty start-up or forward/reverse with load, adjust the parameter (to increase it). If inrush current too higher to cause oc stall, then decrease it.

↗ **10-32** PM FOC Sensorless Speed Estimator Bandwidth

Factory Setting: 5.00

Settings 0.00~600.00Hz

📖 The parameter is speed estimator bandwidth. Adjust the parameter will influence the stability and the accuracy of speed for motor.

📖 If there is low frequency vibrates (the waveform is similar to sine wave) during the process, then increase the bandwidth. If there is high frequency vibrates (the waveform vibrates extremely and is like spur), then decrease the bandwidth.

↗ **10-34** PM Sensorless Observer Low-pass Filter Gain

Factory Setting: 1.00

Settings 0.00~655.35

📖 Adjust the parameter will influence the speed estimator's speed of response.

📖 If there is low frequency vibrates (the waveform is similar to sine wave) during the process, then increase the gain. If there is high frequency vibrates (the waveform vibrates extremely and is like spur), then decrease the gain.

↗ **10-35** AMR (Kp)

Factory Setting: 1.00

Settings 0.00~3.00

↗ **10-36** AMR (Ki)

Factory Setting: 0.20

Settings 0.00~3.00



📖 Active Magnetic regulator--- Kp and Ki. These two parameters will influence magnetic flux control of field weakening region.

📖 Increase the parameter if the input power has rapid change (ex. unstable electrical grid makes voltage be insufficient in a sudden) while enter the field weakening region, and ACR diverges to cause oc (ex. during the application of Press, there are other Press is working, and DC BUS decreases extremely in a sudden). If Id has spur and cause high frequency noise of output current to be too big, then decrease the parameter to lower the noise, but this also might cause a slow response.

10-39 Frequency Point when switch from I/F Mode to PM Sensorless Mode

Factory Setting: 20.00



Settings 0.00~599.00Hz

-  The parameter is the switch point which is from low frequency to high frequency. It will influence high/low frequency area of speed observer.
-  If the switch point is too low, motor will generate not enough back emf to let the speed estimator measure the right rotator's position and speed, and cause stall and oc when the frequency of switch point is running.
-  If the switch point is too high, the active area of I/F will too wide, and then it will generate larger current to make it cannot save energy. (The reason is that if the current of Pr10-31 sets too high, and the high switch point will make the drive keeps outputting with the setting value of Pr10-31)

10-40 Frequency Point when Switch from PM Sensorless Observation to I/F Mode

Factory Setting: 20.00



Settings 0.00~599.00Hz

-  The parameter is the switch point which is from high frequency to low frequency. It will influence high/low frequency area of speed observer.
-  If the switch point is too low, motor will generate not enough back emf to let the speed estimator measure the right rotator's position and speed, and cause stall and oc when the frequency of switch point is running.
-  If the switch point is too high, the active area of I/F will too wide, and then it will generate larger current to make it cannot save energy. (The reason is that if the current of Pr10-31 sets too high, and the high switch point will make the drive keeps outputting with the setting value of Pr10-31)

10-41 I/F Mode and Low Pass-filter time of Id

Factory Setting: 0.2



Settings 0.0~6.0 sec

-  The parameter is the filter time of Pr10-31. This can make the magnetic field of I/F increases to current command value progressively and smoothly.
-  If Id has to be higher slowly, then increase the parameter to avoid Step of current occurring on start-up. If decrease (the minimum is 0) it, the speed of current to rise will be fast, and occurs Step.

10-42 Voltage pulse width

Factory Setting: 10

Settings 0~50 ms

-  The angle detection is 3:6-pulse. The parameter influences the value of pulse during the angle detection. The larger the pulse is, the higher of the accuracy of rotator's position. But it might cause oc easily.
-  Increase the parameter when the running direction and the command are opposite while start-up. If oc occurs in the start-up moment, then decrease the parameter.

7. ASR parameters

11-00 System Control

Factory Setting: 0

Settings bit 0: Auto tuning for ASR and APR
bit 1: Inertia estimation (only in FOCPG mode)

-  bit 0=0: Pr.11-06 to 11-11 will be valid and Pr.11-03~11-05 are invalid.
bit 0=1: system will generate an ASR setting. At this moment, Pr.11-06~11-11 will be invalid and Pr.11-03~11-05 are valid.

11-01 Per-unit of System Inertia

Factory Setting: 256



Settings 1~65535 (256=1PU)

-  Decrease the setting value if there is high frequency spur which occurs on Iq current command of ASR. If the response of sudden load is too slow, then increase the setting value.

 **11-02** ASR1/ASR2 Switch Frequency

Factory Setting: 7.00

Settings 5.00~599.00Hz

-  Low-speed/ high speed switch point of ASR in FOC area. This provides higher response in high speed area and lower response in low speed area to meet customers demand. It is suggested that the switch point should >Pr10-39.
-  If the setting value is too low, it will not cover Pr10-39. If it's too high, the range of high speed will be too narrow.

 **11-03** ASR1 Low-speed Bandwidth

Factory Setting: 10

Settings 1~40Hz (IM)/ 1~100Hz (PM)

 **11-04** ASR2 High-speed Bandwidth



Factory Setting: 10

Settings 1~40Hz (IM)/ 1~100Hz (PM)

 **11-05** Zero-speed Bandwidth

Factory Setting: 10

Settings 1~40Hz (IM)/ 1~100Hz (PM)

-  After estimating inertia and set Pr.11-00 to bit 0=1 (auto tuning), user can adjust parameters Pr.11-03, 11-04 and 11-05 separately by speed response. The larger number you set, the faster response you will get. Pr.11-02 is the switch frequency for low-speed/high-speed bandwidth.
-  Position control pulse command (Mlx=37) and P2P position control Kp gain can adjust Pr11-05. The higher the value, the lower the steady-state error.

↘	11-06	ASR (Auto Speed Regulation) control (P) 1	Factory Setting: 10
		Settings 0~40 Hz (IM)/ 0~100Hz (PM)	
↘	11-07	ASR (Auto Speed Regulation) control (I) 1	Factory Setting: 0.100
		Settings 0.000~10.000 sec.	
↘	11-08	ASR (Auto Speed Regulation) control (P) 2	Factory Setting: 10
		Settings 0~40 Hz (IM)/ 0~100Hz (PM)	
↘	11-09	ASR (Auto Speed Regulation) control (I) 2	Factory Setting: 0.100
		Settings 0.000~10.000 sec.	
↘	11-10	ASR (Auto Speed Regulation) Control (P) of Zero Speed	Factory Setting: 10
		Settings 0~40 Hz (IM)/ 0~100Hz (PM)	
↘	11-11	ASR (Auto Speed Regulation) Control (I) of Zero Speed	Factory Setting: 0.100
		Settings 0.000~10.000 sec.	

● Pr00-11=7 IPM Sensorless

Flow chart of adjustment when starting up with light duty

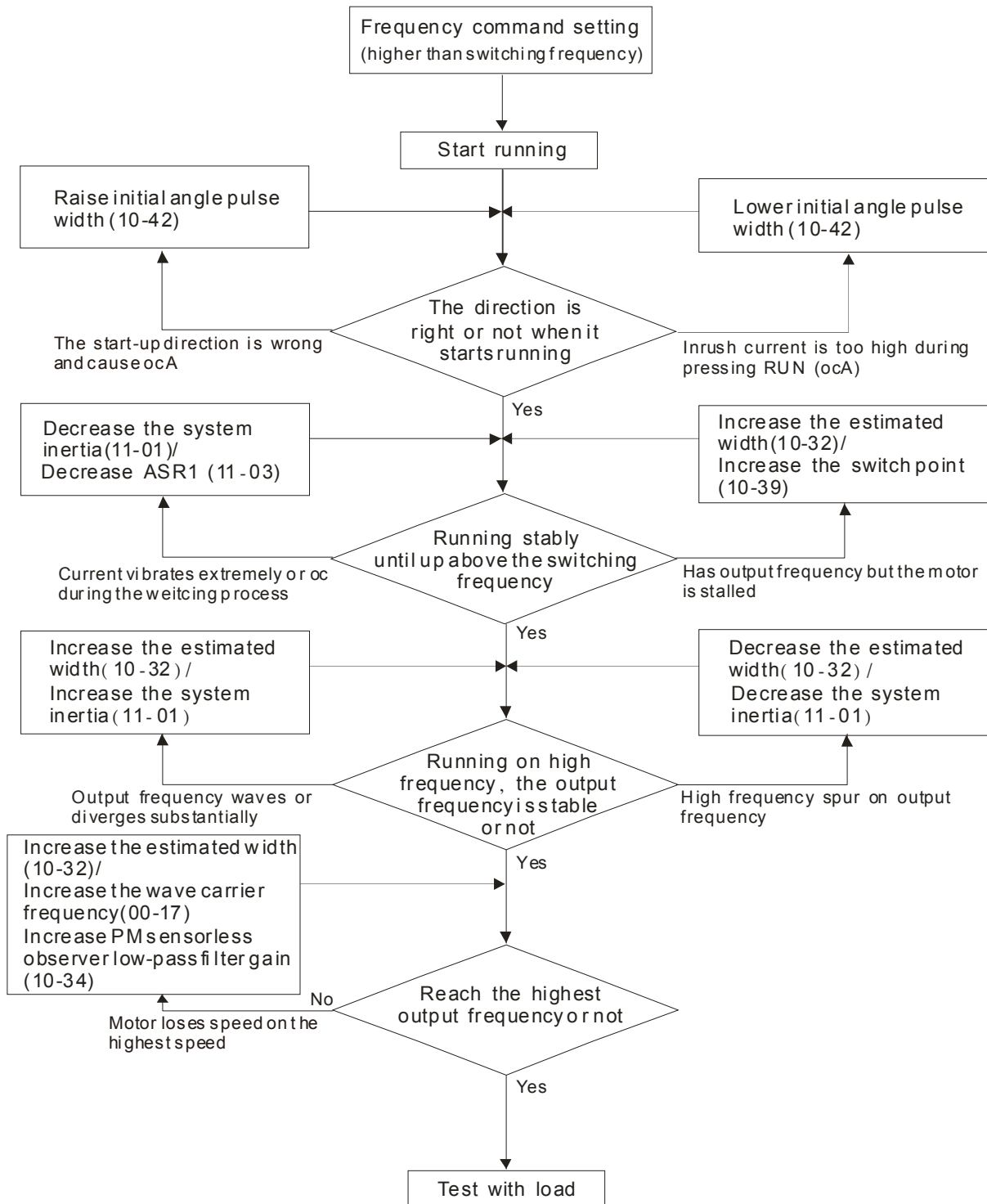

IPM sensorless control diagram

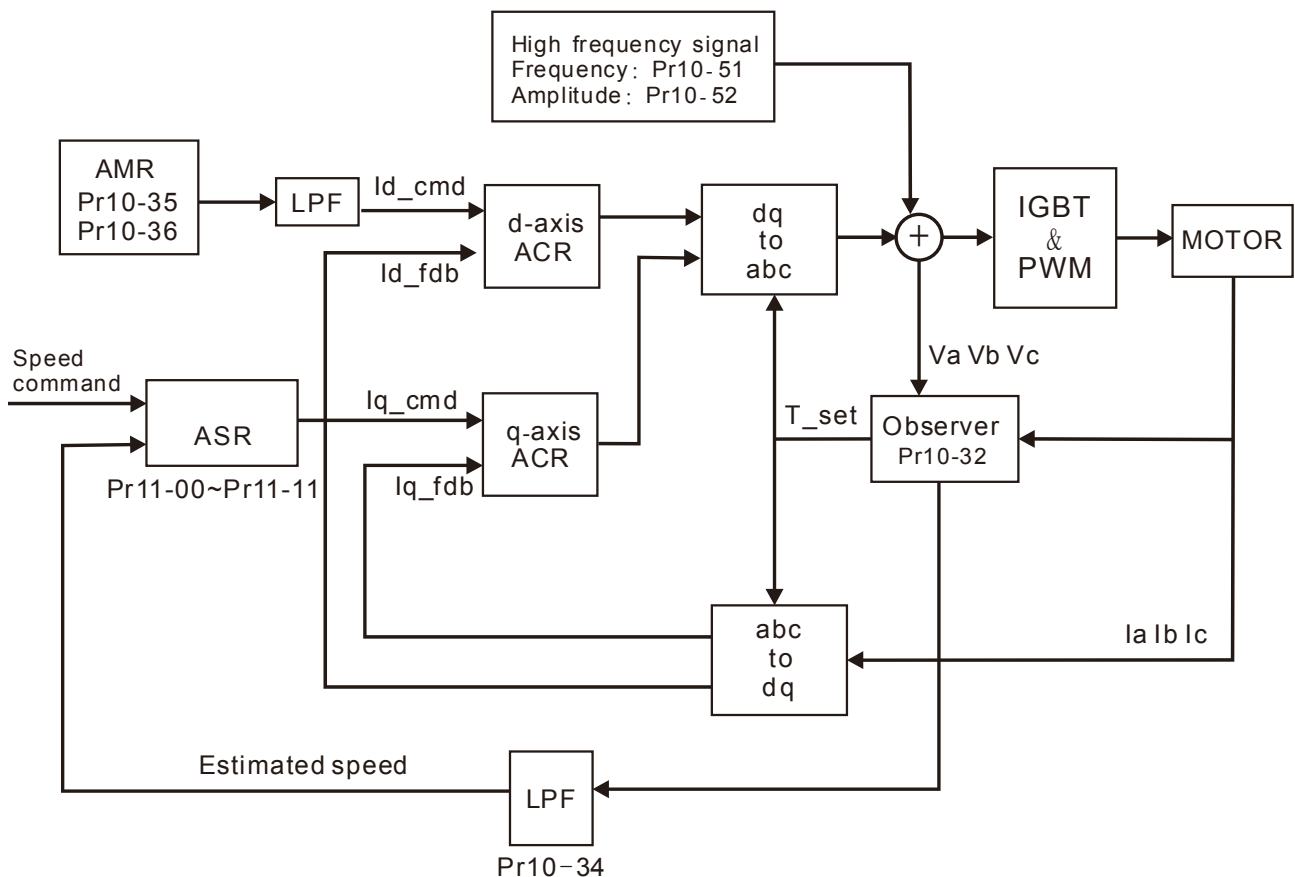





Adjustment procedure

1. Sep up PM motor control
Pr05-33=1 or 2
2. Set up motor parameter according to the nameplate on the motor
 - Pr01-01 Output Frequency of Motor 1 (base frequency and motor rated frequency)
 - Pr01-02 Output Voltage of Motor 1 (base frequency and motor rated frequency)
 - Pr05-34 Full-load current of Permanent Magnet Motor
 - Pr05-35 Rated Power of Permanent Magnet Motor
 - Pr05-36 Rated speed of Permanent Magnet Motor
 - Pr05-37 Pole number of Permanent Magnet Motor
3. Execute Auto-tuning
Set up Pr05-00=13 for IPM motor tuning and press Run(static-tuning). When the tuning is done, the following parameters will be obtained.
 - Pr05-39 Stator Resistance of PM Motor
 - Pr05-40 Permanent Magnet Motor Ld
 - Pr05-41 Permanent Magnet Motor Lq
 - PM motor inertia (E-4 kg-m²) Pr05-38 (power, current and speed of motor auto calculates to get this value)
 - PM motor Ke (V/1000rpm) Pr05-43 (power, current and speed of motor auto calculates to get this value)

10-52 Injection Magnitude

Factory Setting: 15/30V



Settings 0.0~200.0V

-  The parameter is magnitude command of high frequency injection signal when IPM HFI sensorless control mode.
 -  Increase the parameter can get the more accurate estimated value of angle. But the noise of electromagnetic might be louder if the setting value is too high.
 -  To get the parameter when motor's parameter is "Auto". And the parameter will influence the accuracy of angel's estimation.
 -  When the ratio of salient pole (L_q/L_d) is lower, increase Pr10-52 to make angle detection be accurate.
1. Set speed control mode: Pr00-10=0, Pr00-11-7 (IPM Sensorless).
 2. It is suggested that cutting off the power after finishing tuning, and then re-power on.
 3. Start-up with load should adjust the appropriate inertia value Pr11-01 first, and adjust the suitable high/low speed ASR K_p , K_i according to speed response of system.
 4. Light-duty start-up related parameters

10-32 PM FOC Sensorless Speed Estimator Bandwidth

Factory Setting: 5.00



Settings 0.00~600.00Hz

-  The parameter is speed estimator bandwidth. Adjust the parameter will influence the stability and the accuracy of speed for motor.
-  If there is low frequency vibrates (the waveform is similar to sine wave) during the process, then increase the bandwidth. If there is high frequency vibrates (the waveform vibrates extremely and is like spur), then decrease the bandwidth.

10-34 PM Sensorless Observer Low-pass Filter Gain

Factory Setting: 1.00

Settings 0.00~655.35

-  Adjust the parameter will influence the speed estimator's speed of response.
-  If there is low frequency vibrates (the waveform is similar to sine wave) during the process, then increase the gain. If there is high frequency vibrates (the waveform vibrates extremely and is like spur), then decrease the gain.

10-35 AMR (K_p)

Factory Setting: 1.00

Settings 0.00~3.00

10-36 AMR (K_i)

Factory Setting: 0.20

Settings 0.00~3.00



-  Active Magnetic regulator--- K_p and K_i . These two parameters will influence magnetic flux control of field weakening region.

-  Increase the parameter if the input power has rapid change (ex. unstable electrical grid makes voltage be insufficient in a sudden) while enter the field weakening region, and ACR diverges to cause oc (ex. during the application of Press, there are other Press is working, and DC BUS decreases extremely in a sudden). If Id has spur and cause high frequency noise of output current to be too big, then decrease the parameter to lower the noise, but this also might cause a slow response.

10-39 Frequency Point when switch from I/F Mode to PM Sensorless Mode

Factory Setting:20.00



Settings 0.00~599.00Hz

-  The parameter is the switch point which is from low frequency to high frequency. It will influence high/low frequency area of speed observer.
-  If the switch point is too low, motor will generate not enough back emf to let the speed estimator measure the right rotator's position and speed, and cause stall and oc when the frequency of switch point is running.
-  If the switch point is too high, the active area of I/F will too wide, and then it will generate larger current to make it cannot save energy. (The reason is that if the current of Pr10-31 sets too high, and the high switch point will make the drive keeps outputting with the setting value of Pr10-31)

10-40 Frequency Point when Switch from PM Sensorless Observation Mode to I/F Mode

Factory Setting: 20.00



Settings 0.00~599.00Hz

-  The parameter is the switch point which is from high frequency to low frequency. It will influence high/low frequency area of speed observer.
-  If the switch point is too low, motor will generate not enough back emf to let the speed estimator measure the right rotator's position and speed, and cause stall and oc when the frequency of switch point is running.
-  If the switch point is too high, the active area of I/F will too wide, and then it will generate larger current to make it cannot save energy. (The reason is that if the current of Pr10-31 sets too high, and the high switch point will make the drive keeps outputting with the setting value of Pr10-31)

10-42 Voltage pulse width

Factory Setting:10

Settings 0~50 ms

-  The angle detection is 3:6-pulse. The parameter influences the value of pulse during the angle detection. The larger the pulse is, the higher of the accuracy of rotator's position. But it might cause oc easily.
-  Increase the parameter when the running direction and the command are opposite while start-up. If oc occurs in the start-up moment, then decrease the parameter.

↖ **10-49** Zero voltage time while start up

Factory Setting: 0.000

Settings 0.000~60.000 sec.

- 📖 When the motor is in static status at the startup, the accuracy to estimate angles will be increased. In order to make the motor in “static status”, the drive 3 phase U, V, W output 0V to motor to reach this goal. The Pr10-49 setting time is the length of time when three-phase output 0V.
- 📖 It is possible that even when this parameter is being applied but the motor at the installation site cannot go in to the “static status” caused by the inertia or by any external force. So, if the motor doesn’t go into a complete “static status” in 0.2 sec, increase appropriately this setting value.
- 📖 This parameter is functional only when the setting of Pr07-12 ≠0.
- 📖 If Pr10-49 sets too high, the start-up time will be longer obviously. If is too low, then the braking performance will be weak.

↖ **10-50** Reverse Angle Limit (Electrical angle)

Factory Setting: 10.00

Settings 0.00~30.00 degree

- 📖 While forward run is starting, if there is a sudden reverse run and the reverse angle is larger than the Pr10-50 setting, then drive will has a ScRv error.
- 📖 This parameter is valid only when Pr07-28 =11 Enable textile machine’s function.
- 📖 If the estimated angle error of start-up is too large to cause the motor reverse, the parameter can limit the degree of the reverse.
- 📖 Decrease the setting value to let the reverse angle not to be large; or increase it for high error tolerance, but it might cause oc easily if there is large load.

↖ **10-51** Injection Frequency

Factory Setting: 500Hz

Settings 0~1200Hz

- 📖 This parameter is a High Frequency Injection Command when the motor drive is under IPM HFI sensor-less control mode and it doesn’t often need to be adjusted. But, if a motor’s rated frequency (i.e. 400Hz) is too close to the frequency setting of this parameter (i.e. 500Hz), the accuracy of angles detected will be affected. Therefore, refer to the setting of Pr01-01 before adjusting this parameter.
- 📖 If the setting value of Pr00-17 is lower Pr10-51*10, then increase the frequency of carrier wave.

5. ASR parameters

11-00 System Control

Factory Setting: 0

Settings bit 0: Auto tuning for ASR and APR
 bit 1: Inertia estimation (only in FOCPG mode)

- 📖 bit 0=0: Pr.11-06 to 11-11 will be valid and Pr.11-03~11-05 are invalid.
 bit 0=1: system will generate an ASR setting. At this moment, Pr.11-06~11-11 will be invalid and Pr.11-03~11-05 are valid.

11-01 Per-unit of System Inertia

Factory Setting: 256

Settings 1~65535 (256=1PU)

- 📖 Decrease the setting value if there is high frequency spur which occurs on Iq current command of ASR. If the response of sudden load is too slow, then increase the setting value.

11-02 ASR1/ASR2 Switch Frequency

Factory Setting: 7.00

Settings 5.00~599.00Hz

- 📖 Low-speed/ high speed switch point of ASR in FOC area. This provides higher response in high speed area and lower response in low speed area to meet customers demand. It is suggested that the switch point should >Pr10-39.
- 📖 If the setting value is too low, it will not cover Pr10-39. If it's too high, the range of high speed will be too narrow.

11-03 ASR1 Low-speed Bandwidth

Factory Setting: 10

Settings 1~40Hz (IM)/ 1~100Hz (PM)

11-04 ASR2 High-speed Bandwidth

Factory Setting: 10

Settings 1~40Hz (IM)/ 1~100Hz (PM)

11-05 Zero-speed Bandwidth

Factory Setting: 10

Settings 1~40Hz (IM)/ 1~100Hz (PM)

- 📖 After estimating inertia and set Pr.11-00 to bit 0=1 (auto tuning), user can adjust parameters Pr.11-03, 11-04 and 11-05 separately by speed response. The larger number you set, the faster response you will get. Pr.11-02 is the switch frequency for low-speed/high-speed bandwidth.
- 📖 Position control pulse command (Mlx=37) and P2P position control Kp gain can adjust Pr11-05. The higher the value, the lower the steady-state error.

11-06 ASR (Auto Speed Regulation) control (P) 1

Factory Setting: 10

Settings 0~40 Hz (IM)/ 0~100Hz (PM)

11-07 ASR (Auto Speed Regulation) control (I) 1

Factory Setting: 0.100

Settings 0.000~10.000 sec.

11-08 ASR (Auto Speed Regulation) control (P) 2

Factory Setting: 10

Settings 0~40 Hz (IM)/ 0~100Hz (PM)

↗	11-09	ASR (Auto Speed Regulation) control (I) 2	Factory Setting: 0.100
		Settings 0.000~10.000 sec.	
↗	11-10	ASR (Auto Speed Regulation) Control (P) of Zero Speed	Factory Setting: 10
		Settings 0~40 Hz (IM)/ 0~100Hz (PM)	
↗	11-11	ASR (Auto Speed Regulation) Control (I) of Zero Speed	Factory Setting: 0.100
		Settings 0.000~10.000 sec.	

12-2-2 Standard IM Motor Adjustment Procedure

Flow chart

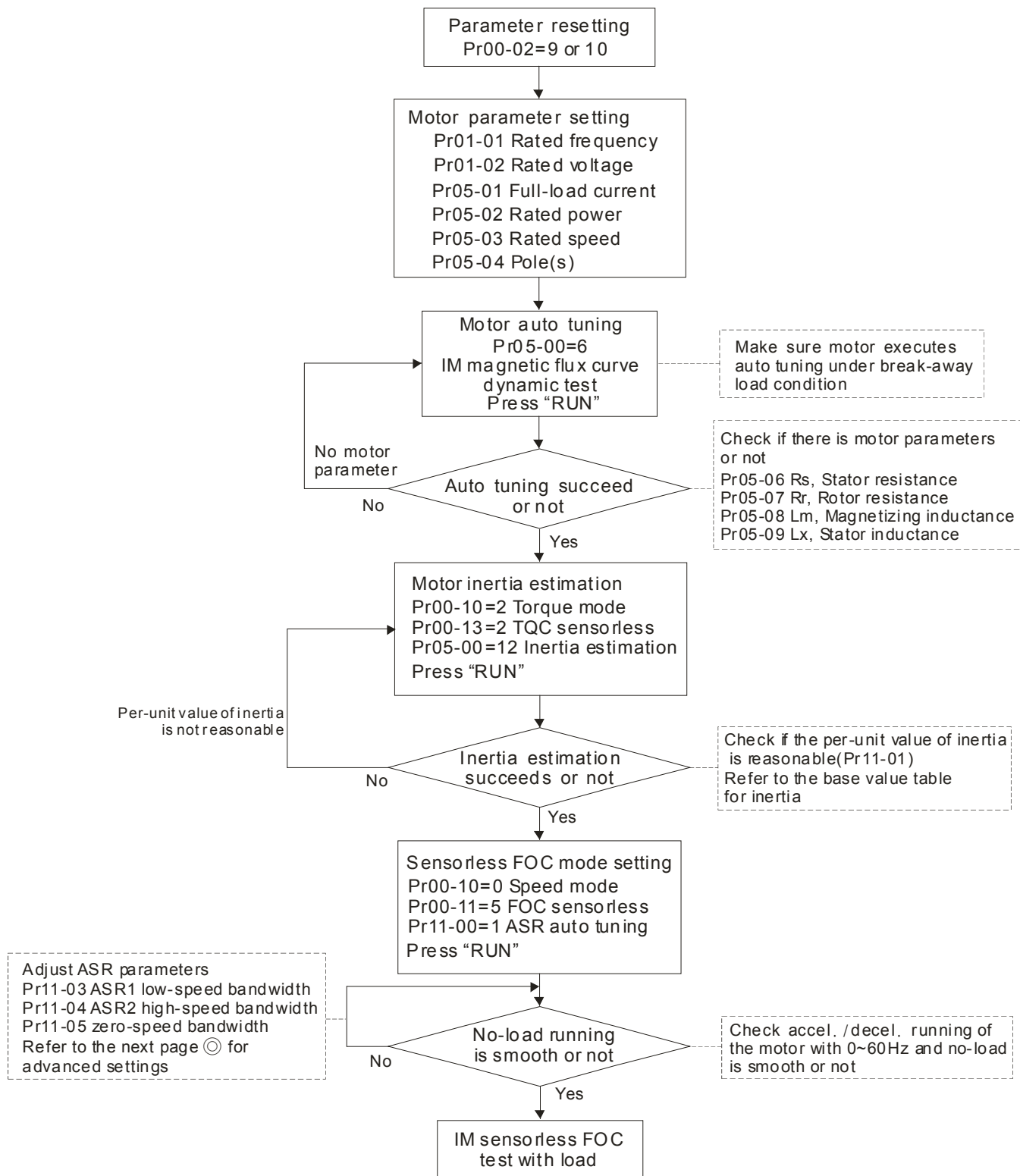

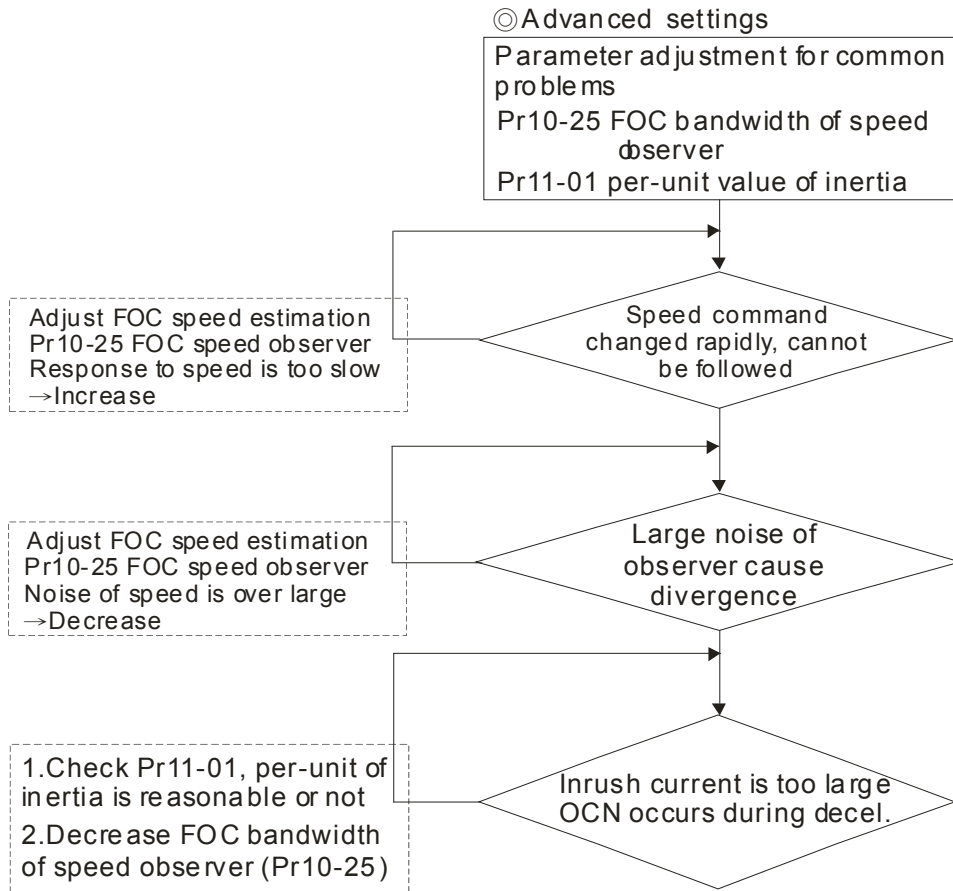

FOC sensorless control diagram

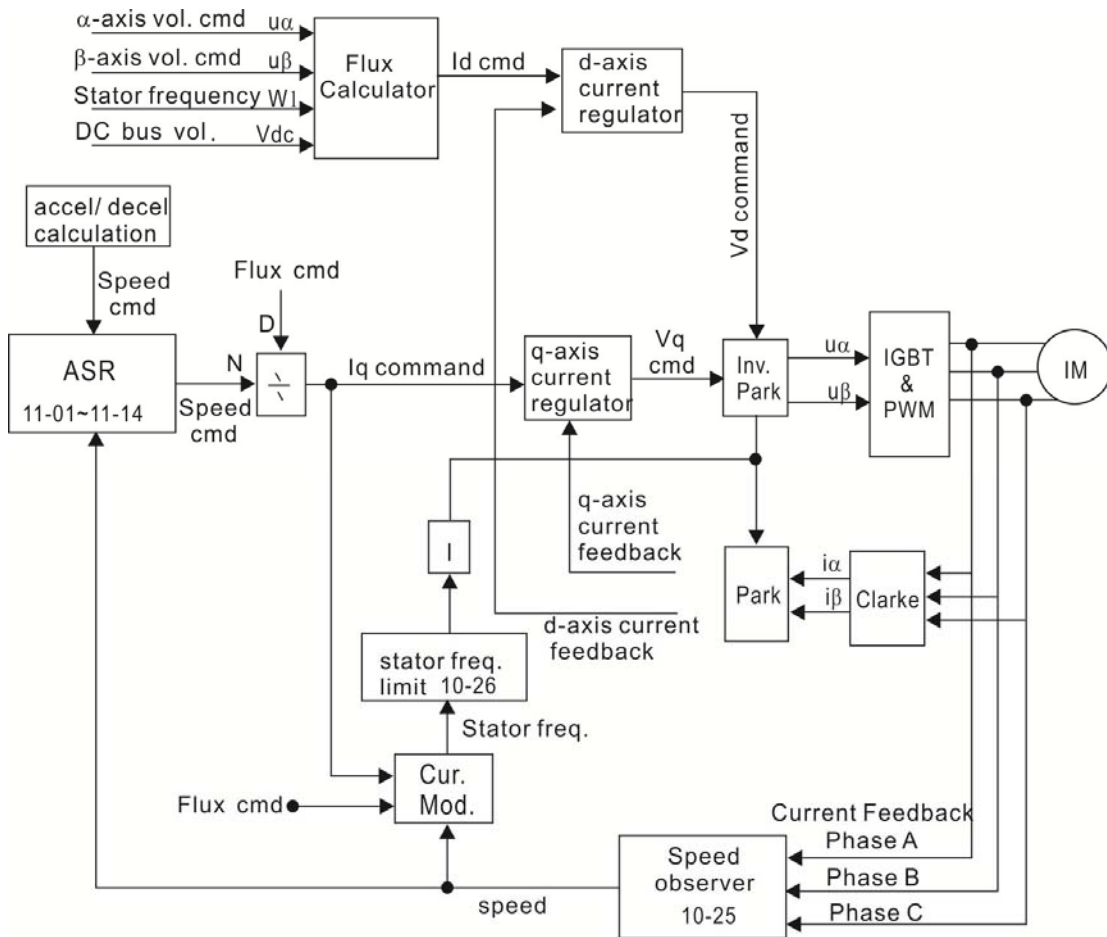

Adjustment procedure

1. Parameter reset **Pr00-02=10 or 9**
(By doing this, avoid other parameters which are not related to influence motor)
2. Set up motor parameter according to the nameplate on the motor
 - Pr01-01 Output Frequency of Motor 1 (base frequency and motor rated frequency)
 - Pr01-02 Output Voltage of Motor 1 (base frequency and motor rated frequency)
 - Pr05-01 Full-lad current
 - Pr05-02 Rated power
 - Pr05-03 Rated speed
 - Pr05-04 Poles
3. Press “RUN” to start auto tuning of IM magnetic flux curve dynamic test for Pr05-00=1 or 6 (motor is running). Make sure the motor executes auto tuning under break-away load condition. And check if there are motor parameters after auto tuning.
 - Pr05-06 Rs Stator resistance
 - Pr05-07 Rr Rotor resistance
 - Pr05-08 Lm Magnetizing inductance
 - Pr05-09 Lx Stator inductance
4. Execute motor inertia estimation (optional). Press “RUN” to start it after finishing the setting of the parameters mentioned below.
 - Pr00-10=2 Torque mode
 - Pr00-13=2 TQC sensorless
 - Pr05-00=12 FOC sensorless inertia estimation (motor is running)

➤ After inertia estimation is finished, check Pr11-01 whether the value is reasonable or not according to the base value table below. (Unit: 0.001kg-m²)

Power	Setting	Power	Setting	Power	Setting	Power	Setting
1Hp	2.3	15Hp	74.3	60HP	410.8	215HP	2800.0
2Hp	4.3	20Hp	95.3	75HP	494.8	300HP	3550.0
3Hp	8.3	25Hp	142.8	100HP	1056.5		
5Hp	14.8	30Hp	176.5	125HP	1275.3		
7.5Hp	26.0	40Hp	202.5	150HP	1900.0		
10Hp	35.8	50Hp	355.5	175HP	2150.0		

5. Execute running with IM sensorless FOC mode, set up the following parameter,
 - Pr00-10 = 0, set as speed mode
 - Pr00-11 = 5, set as FOC sensorless mode
 - Pr11-00-bit0 =1, ASR gain auto tuning

Press “RUN” and start the **test with no-load**. Speed up the motor to the rated speed, and then lower the speed to stop, check the motor runs smoothly or not. **The setting of IM**

sensorless FOC is successful if the motor runs smoothly. But if the motor runs unsmoothly or low-frequency start up is failed, then refer to the following steps.

6. Set up Pr11-00-bit0=1, and adjust ASR parameter according to speed response.
 - Pr11-00-bit0 =1, ASR gain will auto adjust
 - Pr11-03 ASR1 low-speed bandwidth (When speed up in low speed cannot follow the accel. command, increase the low-speed bandwidth)
 - Pr11-04 ASR2 high-speed bandwidth (When speed up in high speed cause vibration or cannot follow the accel. Command, increase high-speed bandwidth)
 - Pr11-05 Zero-speed bandwidth (If the response of start-up is slow or incapable, increase zero-speed bandwidth)
 - The bigger setting value of ASR bandwidth is, the faster response is.
 - It is suggested that low-speed bandwidth cannot be set too high, or the observer will diverge.

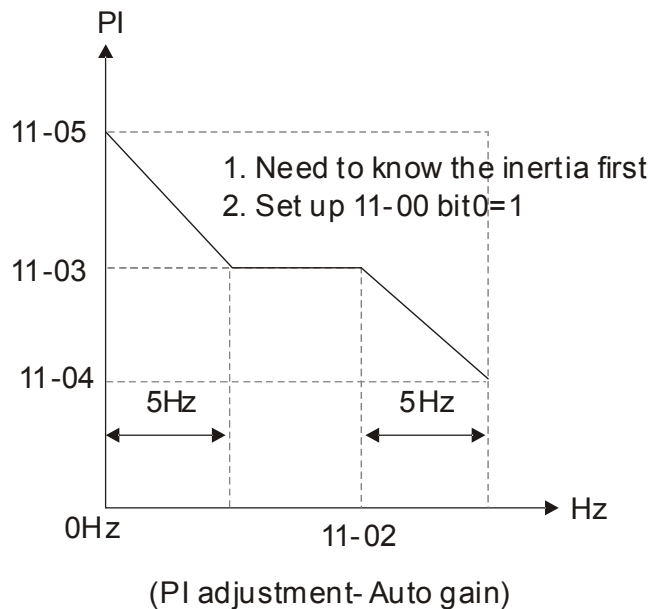

7. Adjust the setting of FOC speed observer and per-unit value of inertia (common problems)
 - Pr10-25: Set up FOC bandwidth of speed observer
 - Situation 1. Speed command changed rapidly, but speed response cannot follow. (Speed response is too slow→ Increase the setting value)
 - Situation 2. The noise of observer is too large, and the running is diverged. (Speed noise is too large→Decrease)
 - Pr11-01: Set up per-unit value of inertia
 - Situation 1. When start- up, inrush current is too high in a sudden, and cause oc.
 - Situation 2. During the running or stop, OCN occurs and the motor runs randomly.
 - ◆ Check Pr11-01 whether the per-unit of inertia is too large.
 - ◆ Decrease Pr10-25 or Pr11-05.

8. Related parameters

00-11 Control of Speed Mode

Factory Setting: 0

- Settings
- 0: VF (IM V/f control)
 - 1: VFPG (IM V/f control+ Encoder)
 - 2: SVC(IM sensorless vector control)
 - 3: FOCPG (IM FOC vector control+ encoder)
 - 4: FOCPG (PM FOC vector control + Encoder)
 - 5: FOC Sensorless (IM field oriented sensorless vector control)
 - 6 : PM Sensorless (PM field oriented sensorless vector control)
 - 7: IPM Sensorless (IPM field oriented sensorless vector control)

01-01 Output Frequency of Motor 1 (base frequency and motor rated frequency)Factory Setting:
60.00/50.00

Settings 0.00~599.00Hz

 This value should be set according to the rated frequency of the motor as indicated on the motor nameplate. If the motor is 60Hz, the setting should be 60Hz. If the motor is 50Hz, it should be set to 50Hz.

01-02 Output Voltage of Motor 1 (base frequency and motor rated frequency)

Factory Setting: 400.0

Settings 460V series: 0.0~510.0V

 This value should be set according to the rated voltage of the motor as indicated on the motor nameplate. If the motor is 440V, the setting should be 440.0. If the motor is 400V, it should be set to 400.0.

 There are many motor types in the market and the power system for each country is also difference. The economic and convenience method to solve this problem is to install the AC motor drive. There is no problem to use with the different voltage and frequency and also can amplify the original characteristic and life of the motor.

05-00 Motor Auto Tuning

Factory Setting: 0

- Settings
- 0: No function
 - 1: Rolling test for induction motor (Rs, Rr, Lm, Lx, no-load current)
 - 2: Rolling test for induction motor
 - 3: No function
 - 4: Rolling test for PM motor magnetic pole
 - 5: Rolling test for PM(SPM) motor
 - 6: Rolling test for IM motor flux curve
 - 12: FOC Sensorless inertia estimation
 - 13: High frequency and blocked rotor test for IPM/SPM motor parameter

05-02 Rated Power of Induction Motor 1(kW)

Factory Setting: ###

Settings 0~655.35 kW

It is used to set rated power of the motor 1. The factory setting is the power of the drive.

05-04 Pole Number of Induction Motor 1

Factory Setting: 4

Settings 2~64

It is used to set the number of motor poles (must be an even number).

05-05 No-load Current of Induction Motor 1 (A)

Unit: Amper

Factory Setting: ###

Settings 0 to the factory setting in Pr.05-01

The factory setting is 40% of rated current.

To make sure the motor runs properly, set up Pr01-01 and 05-03 before setting Pr05-04.

The maximum number of poles to be set depends on Pr01-01 and 05-03.

Example: When Pr01-01=20Hz, Pr05-03=39rpm. According to formula, $120 \times 20\text{Hz} / 30\text{rpm} = 61.5$, chop off the digits in units to let it be even number, 60. Thus the maximum of Pr05-04 can be 60 poles.

05-05 No-load Current of Induction Motor 1 (A)

Unit: Amper

Factory Setting: ###

Settings 0 to the factory setting in Pr.05-01

The factory setting is 40% of rated current.

05-06 Stator Resistance(Rs) of Induction Motor 1

05-07 Rotor Resistance(Rr) of Induction Motor 1

Factory Setting: ####

Settings 0~65.535Ω

05-08 Magnetizing Inductance(Lm) of Induction Motor 1

05-09 Stator inductance(Lx) of Induction Motor 1

Factory Setting: ##

Settings 0~6553.5mH

10-25 FOC Bandwidth of Speed Observer

Factory Setting:40.0

Settings 20.0~100.0Hz

Setting speed observer to higher bandwidth could shorten the speed response time but will create greater noise interference during the speed observation.

11-00 System Control

Factory Setting: 0

- Settings 0: Auto tuning for ASR and APR
 1: Inertia estimate (only in FOCPG mode)
 2: Zero servo
 3: Dead time compensation closed
 7: Selection to save or not save the frequency
 8: Maximum speed of point to point position control

bit 0=0: Pr.11-06 to 11-11 will be valid and Pr.11-03~11-05 are invalid.

bit 0=1: System will generate an ASR setting. At this moment, Pr.11-06~11-11 will be invalid and Pr.11-03~11-05 are valid.

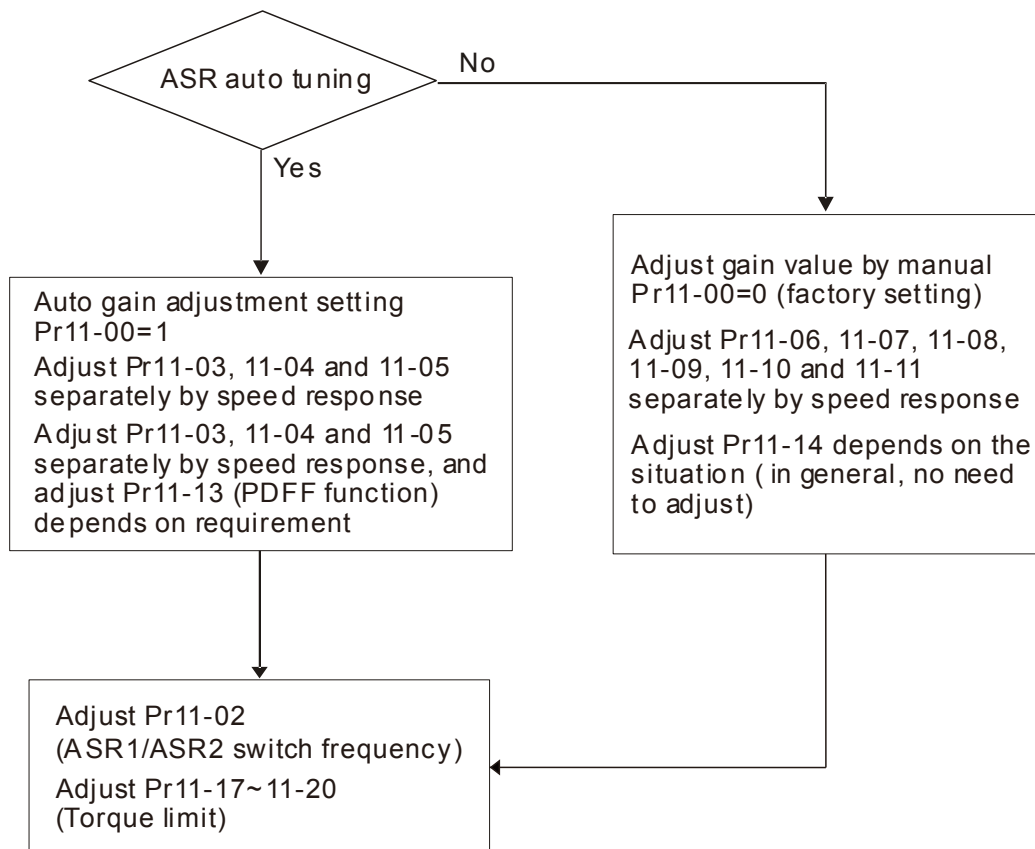
**11-01** Per Unit of System Inertia

Factory Setting: 256

Settings 1~65535 (256=1PU)

To get the system inertia from Pr.11-01, user needs to set Pr.11-00 to bit1=1 and execute continuous forward/reverse running.

Unit of induction motor system inertia is 0.001kg-m²:

Power	Setting	Power	Setting
11kW	35.8	37 kW	202.5
15 kW	74.3	45 kW	355.5
18.5 kW	95.3	55 kW	410.8
22 kW	142.8	75 kW	494.8
30 kW	176.5	90 kW	1056.5

The base value for induction motor system inertia is set by Pr.05-38 and the unit is in 0.001kg-m².

↗	11-02 ASR1/ASR2 Switch Frequency	Factory Setting: 7.00
	Settings 5.00~599.00Hz	
↗	11-03 ASR1 Low-speed Bandwidth	Factory Setting: 10
	Settings 1~40Hz (IM)/ 1~100Hz (PM)	
↗	11-04 ASR2 High-speed Bandwidth	Factory Setting: 10
	Settings 1~40Hz (IM)/ 1~100Hz (PM)	
↗	11-05 Zero-speed Bandwidth	Factory Setting: 10
	Settings 1~40Hz (IM)/ 1~100Hz (PM)	

📖 After estimating inertia and set Pr.11-00 to bit 0=1 (auto tuning), user can adjust parameters Pr.11-03, 11-04 and 11-05 separately by speed response. The larger number you set, the faster response you will get. Pr.11-02 is the switch frequency for low-speed/high-speed bandwidth.

Chapter 13 Warning Codes

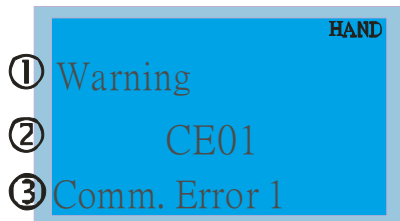

① Warning

② CE01

③ Comm. Error 1



① Display error signal

② Abbreviate error code
The code is displayed as shown on KPC-CE01.

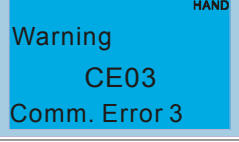
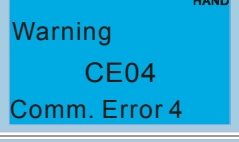
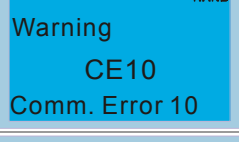
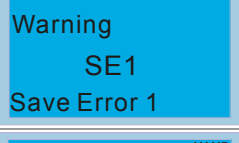
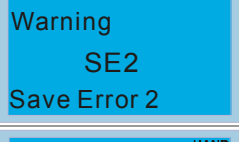
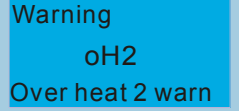
③ Display error description

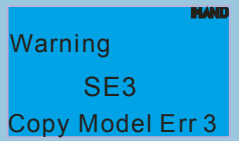
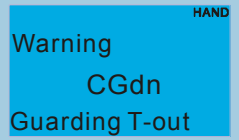
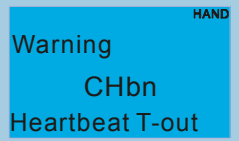
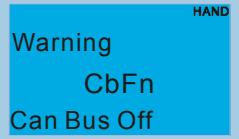
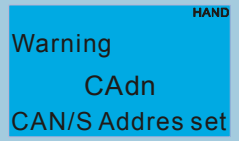

ID No.	Display on LCM Keypad	Descriptions
1		Modbus function code error
2		Address of Modbus data is error
3		Modbus data error
4		Modbus communication error
5		Modbus transmission time-out
7		Keypad COPY error 1 Keypad simulation error, including communication delays, communication error (keypad received error FF86) and parameter value error.
8		Keypad COPY error 2 Keypad simulation done, parameter write error
9		IGBT over-heating warning
10		Capacity over-heating warning

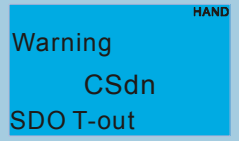
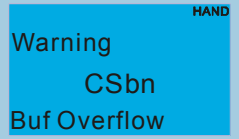
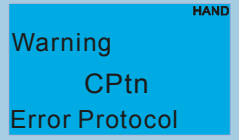
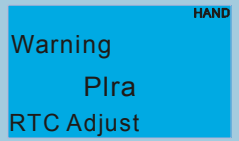

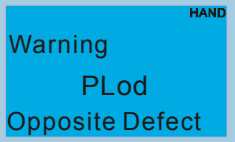
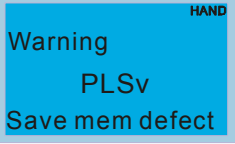
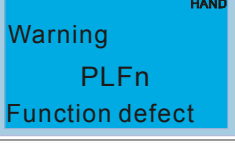
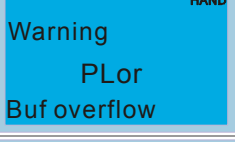
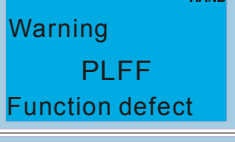
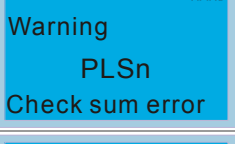
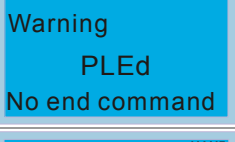
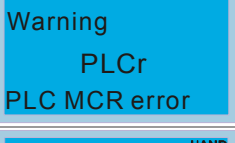
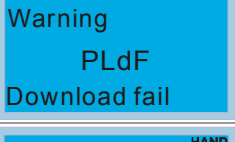
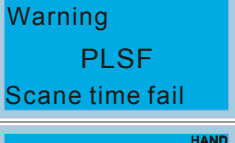
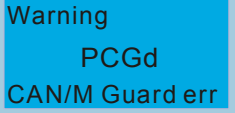

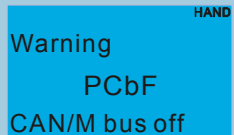
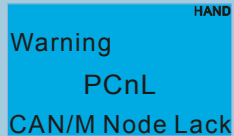
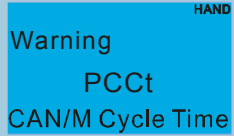
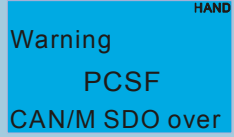
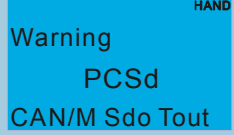
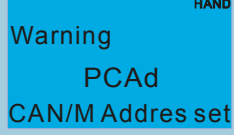
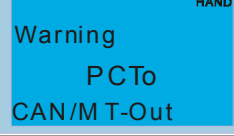
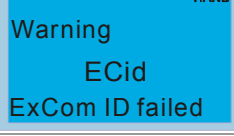
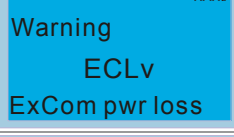
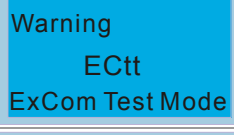
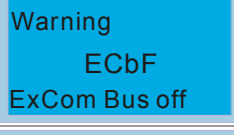
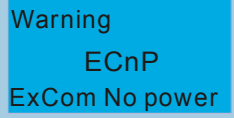
ID No.	Display on LCM Keypad	Descriptions
11		PID feedback error
12		ACI signal error When Pr03-19 is set to 1 and 2.
13		Low current
15		PG feedback error
17		Over-speed warning
18		Over speed deviation warning
19		Phase loss
20		Over torque 1
21		Over torque 2
22		Motor over-heating
24		Over slip
25		Auto tuning processing

ID No.	Display on LCM Keypad	Descriptions
28	 <p>Warning OPHL Output PHL Warn</p>	Output phase loss
30	 <p>Warning SE3 Copy Model Err 3</p>	Keypad COPY error 3 Keypad copy between different power range drive
36	 <p>Warning CGdn Guarding T-out</p>	CAN guarding time-out 1
37	 <p>Warning CHbn Heartbeat T-out</p>	CAN heartbeat time-out 2
39	 <p>Warning CbFn Can Bus Off</p>	CAN bus off
40	 <p>Warning Cldn CAN/S Idx exceed</p>	CAN index error
41	 <p>Warning CAdn CAN/S Adres set</p>	CAN station address error
42	 <p>Warning CFrn CAN/S FRAM fail</p>	CAN memory error
43	 <p>Warning CSdn SDO T-out</p>	CAN SDO transmission time-out
44	 <p>Warning CSbn Buf Overflow</p>	CAN SDO received register overflow
46	 <p>Warning CPtn Error Protocol</p>	CAN format error
47	 <p>Warning Plra RTC Adjust</p>	Adjust RTC

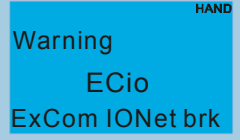
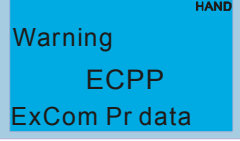
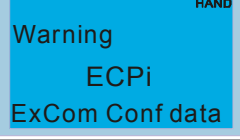
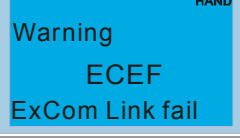
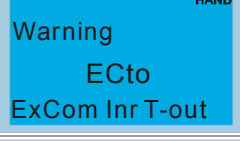
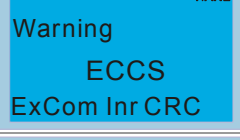
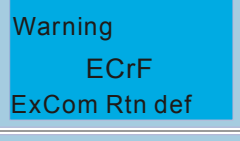
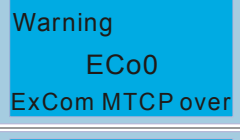
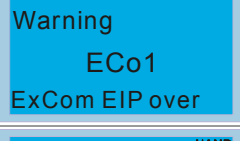
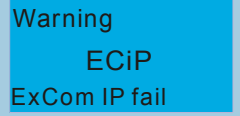
ID No.	Display on LCM Keypad	Descriptions
50		PLC download error
51		Save error of PLC download
52		Data error during PLC operation
53		Function code of PLC download error
54		PLC register overflow
55		Function code of PLC operation error
56		PLC checksum error
57		PLC end command is missing
58		PLC MCR command error
59		PLC download fail
60		PLC scan time exceed
61		CAN Master guarding error

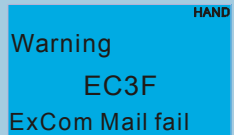
ID No.	Display on LCM Keypad	Descriptions
62	 <p>Warning PCbF CAN/M bus off</p>	CAN Master bus off
63	 <p>Warning PCnL CAN/M Node Lack</p>	CAN Master node error
64	 <p>Warning PCct CAN/M Cycle Time</p>	CAN/M cycle time-out
65	 <p>Warning PCSF CAN/M SDO over</p>	CAN/M SDOover
66	 <p>Warning PCsd CAN/M Sdo Tout</p>	CAN/M SDO time-out
67	 <p>Warning PCAd CAN/M Adres set</p>	CAN/M station address error
68	 <p>Warning PCTo CAN/M T-Out</p>	PLC/CAN Master Slave communication time out
70	 <p>Warning ECid ExCom ID failed</p>	Duplicate MAC ID error Node address setting error
71	 <p>Warning ECLv ExCom pwr loss</p>	Low voltage of communication card
72	 <p>Warning ECtt ExCom Test Mode</p>	Communication card in test mode
73	 <p>Warning ECbF ExCom Bus off</p>	DeviceNet bus-off
74	 <p>Warning ECnP ExCom No power</p>	DeviceNet no power

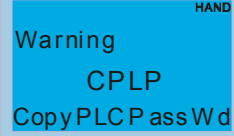
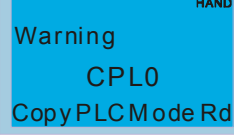
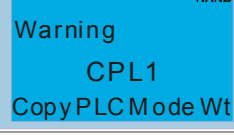
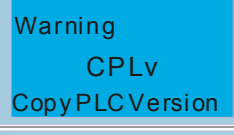
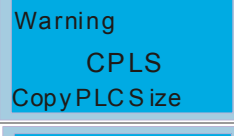
ID No.	Display on LCM Keypad	Descriptions
75	 <p>Warning ECFF ExCom Factly def</p>	Factory default setting error
76	 <p>Warning ECiF ExCom Inner err</p>	Serious internal error
77	 <p>Warning ECio ExCom IONet brk</p>	IO connection break off
78	 <p>Warning ECPP ExCom Pr data</p>	Profibus parameter data error
79	 <p>Warning ECPi ExCom Conf data</p>	Profibus configuration data error
80	 <p>Warning ECEF ExCom Link fail</p>	Ethernet Link fail
81	 <p>Warning ECto ExCom Inr T-out</p>	Communication time-out for communication card and drive
82	 <p>Warning ECCS ExCom Inr CRC</p>	Check sum error for Communication card and drive
83	 <p>Warning ECrF ExCom Rtn def</p>	Communication card returns to default setting
84	 <p>Warning ECo0 ExCom MTCP over</p>	Modbus TCP exceed maximum communication value
85	 <p>Warning ECo1 ExCom EIP over</p>	EtherNet/IP exceed maximum communication value
86	 <p>Warning ECiP ExCom IP fail</p>	IP fail

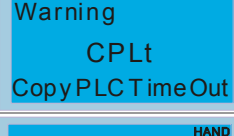
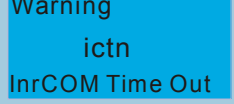
ID No.	Display on LCM Keypad	Descriptions
87	 <p>Warning EC3F ExCom Mail fail</p>	Mail fail
88	 <p>Warning Ecby ExCom Busy</p>	Communication card busy
90	 <p>Warning CPLP CopyPLCP assWd</p>	Copy PLC password error
91	 <p>Warning CPL0 CopyPLCMode Rd</p>	Copy PLC Read mode error
92	 <p>Warning CPL1 CopyPLCMode Wt</p>	Copy PLC Write mode error
93	 <p>Warning CPLv CopyPLCVersion</p>	Copy PLC Version error
94	 <p>Warning CPLS CopyPLCSize</p>	Copy PLC Capacity size error
95	 <p>Warning CPLF CopyPLCFunc</p>	Copy PLC and the PLC function must be disable
96	 <p>Warning CPLt CopyPLCTimeOut</p>	Copy PLC time out
101	 <p>Warning ictn InrCOM Time Out</p>	Internal communication is off

[This page intentionally left blank]

Chapter 14 Fault Codes and Descriptions

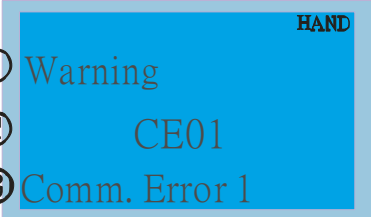
	① Warning	① Display error signal
	② CE01	② Abbreviate error code The code is displayed as shown on KPC-CE01.
	③ Comm. Error 1	③ Display error description

* Refer to setting of Pr06-17~Pr06~22.

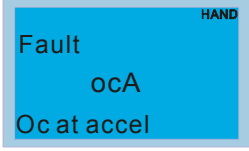
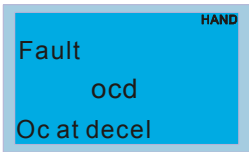
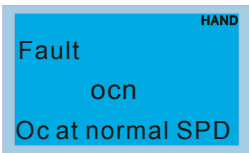
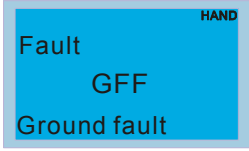
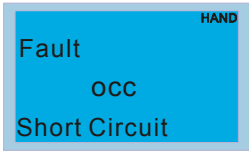
ID*	Fault Name	Fault Descriptions	Corrective Actions
1		Over-current during acceleration (Output current exceeds triple rated current during acceleration.)	<ol style="list-style-type: none"> 1. Short-circuit at motor output: Check for possible poor insulation at the output. 2. Acceleration Time too short: Increase the Acceleration Time. 3. AC motor drive output power is too small: Replace the AC motor drive with the next higher power model.
2		Over-current during deceleration (Output current exceeds triple rated current during deceleration.)	<ol style="list-style-type: none"> 1. Short-circuit at motor output: Check for possible poor insulation at the output. 2. Deceleration Time too short: Increase the Deceleration Time. 3. AC motor drive output power is too small: Replace the AC motor drive with the next higher power model.
3		Over-current during steady state operation (Output current exceeds triple rated current during constant speed.)	<ol style="list-style-type: none"> 1. Short-circuit at motor output: Check for possible poor insulation at the output. 2. Sudden increase in motor loading: Check for possible motor stall. 3. AC motor drive output power is too small: Replace the AC motor drive with the next higher power model.
4		Ground fault	<p>When (one of) the output terminal(s) is grounded, short circuit current is more than 50% of AC motor drive rated current, the AC motor drive power module may be damaged.</p> <p>NOTE: The short circuit protection is provided for AC motor drive protection, not for protecting the user.</p> <ol style="list-style-type: none"> 1. Check the wiring connections between the AC motor drive and motor for possible short circuits, also to ground. 2. Check whether the IGBT power module is damaged. 3. Check for possible poor insulation at the output.
5		Short-circuit is detected between upper bridge and lower bridge of the IGBT module	Return to the factory

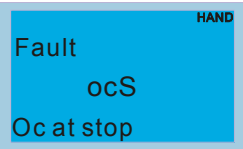
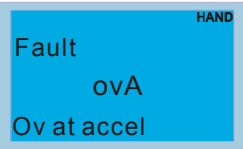
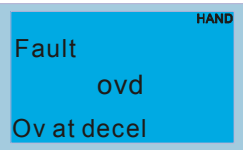
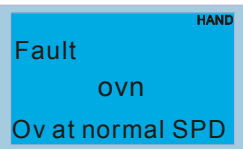
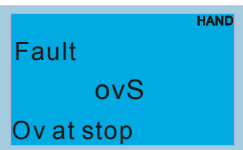
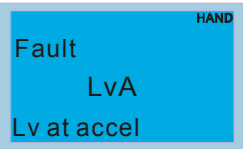
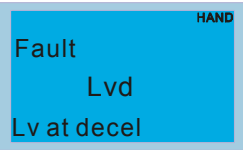
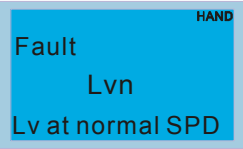
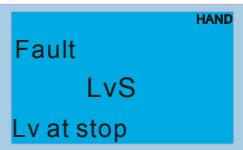

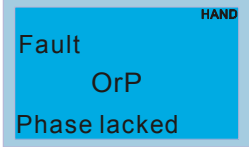
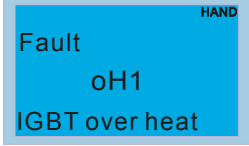
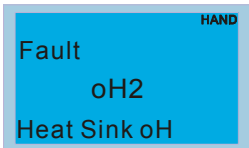
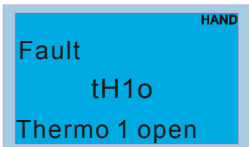
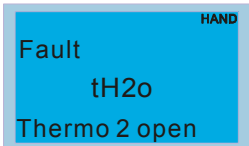
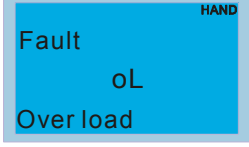
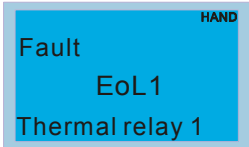
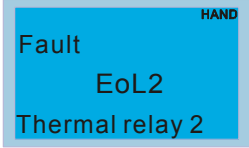
ID*	Fault Name	Fault Descriptions	Corrective Actions
6		Hardware failure in current detection	Return to the factory
7		DC BUS over-voltage during acceleration (230V: DC 450V; 460V: DC 900V)	<ol style="list-style-type: none"> 1. Check if the input voltage falls within the rated AC motor drive input voltage range. 2. Check for possible voltage transients. 3. If DC BUS over-voltage due to regenerative voltage, please increase the acceleration time or add an optional brake resistor.
8		DC BUS over-voltage during deceleration (230V: DC 450V; 460V: DC 900V)	<ol style="list-style-type: none"> 1. Check if the input voltage falls within the rated AC motor drive input voltage range. 2. Check for possible voltage transients. 3. If DC BUS over-voltage due to regenerative voltage, please increase the Deceleration Time or add an optional brake resistor.
9		DC BUS over-voltage at constant speed (230V: DC 450V; 460V: DC 900V)	<ol style="list-style-type: none"> 1. Check if the input voltage falls within the rated AC motor drive input voltage range. 2. Check for possible voltage transients. 3. If DC BUS over-voltage due to regenerative voltage, please increase the Deceleration Time or add an optional brake resistor.
10		Hardware failure in voltage detection	<ol style="list-style-type: none"> 1. Check if the input voltage falls within the rated AC motor drive input voltage range. 2. Check for possible voltage transients.
11		DC BUS voltage is less than Pr.06-00 during acceleration	<ol style="list-style-type: none"> 1. Check if the input voltage is normal 2. Check for possible sudden load
12		DC BUS voltage is less than Pr.06-00 during deceleration	<ol style="list-style-type: none"> 1. Check if the input voltage is normal 2. Check for possible sudden load
13		DC BUS voltage is less than Pr.06-00 in constant speed	<ol style="list-style-type: none"> 1. Check if the input voltage is normal 2. Check for possible sudden load
14		DC BUS voltage is less than Pr.06-00 at stop	<ol style="list-style-type: none"> 1. Check if the input voltage is normal 2. Check for possible sudden load

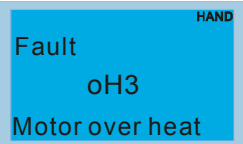
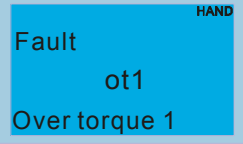
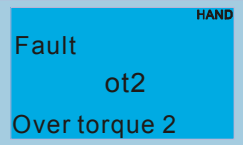
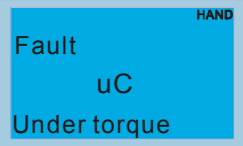
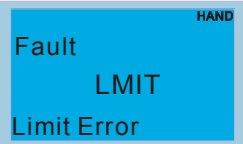
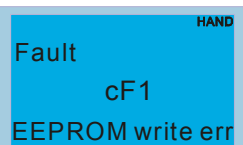
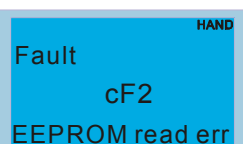
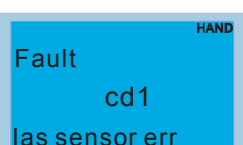
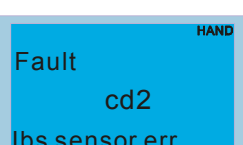
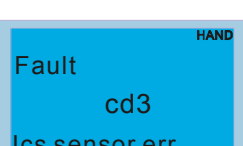
ID*	Fault Name	Fault Descriptions	Corrective Actions
15	 Fault OrP Phase lacked	Phase Loss	Check Power Source Input if all 3 input phases are connected without loose contacts. For models 40hp and above, please check if the fuse for the AC input circuit is blown.
16	 Fault oH1 IGBT over heat	IGBT overheating IGBT temperature exceeds protection level	<ol style="list-style-type: none"> 1. Ensure that the ambient temperature falls within the specified temperature range. 2. Make sure that the ventilation holes are not obstructed. 3. Remove any foreign objects from the heatsinks and check for possible dirty heat sink fins. 4. Check the fan and clean it. 5. Provide enough spacing for adequate ventilation.
17	 Fault oH2 Heat Sink oH	Heatsink overheating Capacitance temperature exceeds cause heatsink overheating.	<ol style="list-style-type: none"> 1. Ensure that the ambient temperature falls within the specified temperature range. 2. Make sure heat sink is not obstructed. Check if the fan is operating 3. Check if there is enough ventilation clearance for AC motor drive.
18	 Fault tH1o Thermo 1 open	IGBT Hardware Error	Return to the factory
19	 Fault tH2o Thermo 2 open	Capacitor Hardware Error	Return to the factory
21	 Fault oL Over load	Overload The AC motor drive detects excessive drive output current.	<ol style="list-style-type: none"> 1. Check if the motor is overloaded. 2. Take the next higher power AC motor drive model.
22	 Fault EoL1 Thermal relay 1	Electronics thermal relay 1 protection	<ol style="list-style-type: none"> 1. Check the setting of electronics thermal relay (Pr.06-14) Take the next higher power AC motor drive model
23	 Fault EoL2 Thermal relay 2	Electronics thermal relay 2 protection	<ol style="list-style-type: none"> 1. Check the setting of electronics thermal relay (Pr.06-28) Take the next higher power AC motor drive model 2. Take the next higher power AC motor drive model

ID*	Fault Name	Fault Descriptions	Corrective Actions
24	 Fault oH3 Motor over heat	Motor overheating The AC motor drive detecting internal temperature exceeds the setting of Pr.06-30 (PTC level) or Pr.06-57 (PT100 level 2).	<ol style="list-style-type: none"> 1. Make sure that the motor is not obstructed. 2. Ensure that the ambient temperature falls within the specified temperature range. 3. Change to a higher power motor.
26	 Fault ot1 Over torque 1	These two fault codes will be displayed when output current exceeds the over-torque detection level (Pr.06-07 or Pr.06-10) and exceeds over-torque detection (Pr.06-08 or Pr.06-11) and it is set to 2 or 4 in Pr.06-06 or Pr.06-09.	<ol style="list-style-type: none"> 1. Check whether the motor is overloaded. 2. Check whether motor rated current setting (Pr.05-01) is suitable 3. Take the next higher power AC motor drive model.
27	 Fault ot2 Over torque 2		
28	 Fault uC Under torque	Low current detection	Check Pr.06-71, Pr.06-72, Pr.06-73.
29	 Fault LMIT Limit Error	Limit error	
30	 Fault cF1 EEPROM write err	Internal EEPROM can not be programmed.	<ol style="list-style-type: none"> 1. Press "RESET" key to the factory setting 2. Return to the factory.
31	 Fault cF2 EEPROM read err	Internal EEPROM can not be read.	<ol style="list-style-type: none"> 1. Press "RESET" key to the factory setting 2. Return to the factory.
33	 Fault cd1 las sensor err	U-phase error	Reboots the power. If fault code is still displayed on the keypad please return to the factory
34	 Fault cd2 lbs sensor err	V-phase error	Reboots the power. If fault code is still displayed on the keypad please return to the factory
35	 Fault cd3 lcs sensor err	W-phase error	Reboots the power. If fault code is still displayed on the keypad please return to the factory

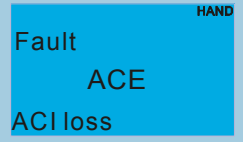
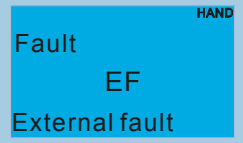
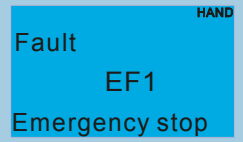
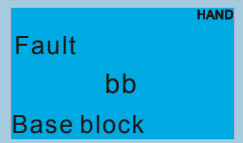
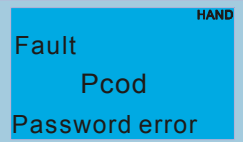
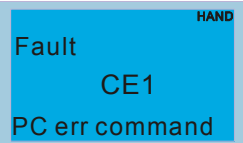
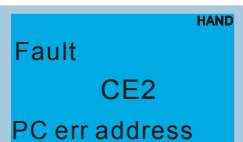
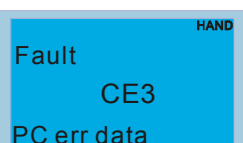
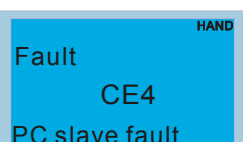
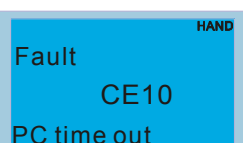
ID*	Fault Name	Fault Descriptions	Corrective Actions
36	Fault Hd0 cc HW error	CC (current clamp)	Reboots the power. If fault code is still displayed on the keypad please return to the factory
37	Fault Hd1 Oc HW error	OC hardware error	Reboots the power. If fault code is still displayed on the keypad please return to the factory
38	Fault Hd2 Ov HW error	OV hardware error	Reboots the power. If fault code is still displayed on the keypad please return to the factory
39	Fault Hd3 occ HW error	Occ hardware error	Reboots the power. If fault code is still displayed on the keypad please return to the factory
40	Fault AUE Auto tuning err	Auto tuning error	<ol style="list-style-type: none"> 1. Check cabling between drive and motor 2. Try again.
41	Fault AFE PID Fbk error	PID loss (ACI)	<ol style="list-style-type: none"> 1. Check the wiring of the PID feedback 2. Check the PID parameters settings
42	Fault PGF1 PG Fbk error	PG feedback error	Check if encoder parameter setting is accurate when it is PG feedback control.
43	Fault PGF2 PG Fbk loss	PG feedback loss	Check the wiring of the PG feedback
44	Fault PGF3 PG Fbk over SPD	PG feedback stall	<ol style="list-style-type: none"> 1. Check the wiring of the PG feedback 2. Check if the setting of PI gain and deceleration is suitable 3. Return to the factory
45	Fault PGF4 PG Fbk deviate	PG slip error	<ol style="list-style-type: none"> 1. Check the wiring of the PG feedback 2. Check if the setting of PI gain and deceleration is suitable 3. Return to the factory

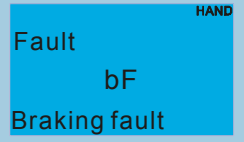
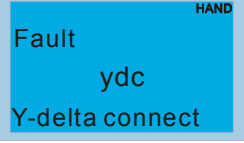
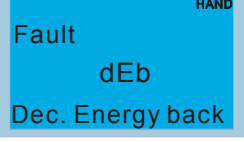
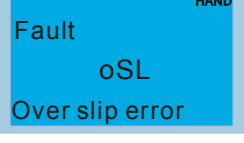
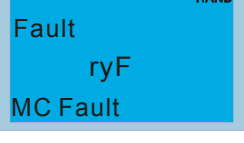
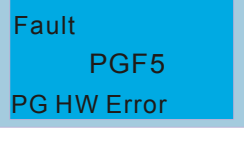
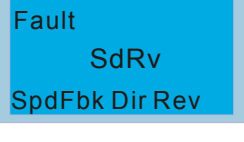
ID*	Fault Name	Fault Descriptions	Corrective Actions
48	 Fault ACE ACI loss	ACI loss	<ol style="list-style-type: none"> 1. Check the ACI wiring 2. Check if the ACI signal is less than 4mA
49	 Fault EF External fault	External Fault	<ol style="list-style-type: none"> 1. Input EF (N.O.) on external terminal is closed to GND. Output U, V, W will be turned off. 2. Give RESET command after fault has been cleared.
50	 Fault EF1 Emergency stop	Emergency stop	<ol style="list-style-type: none"> 1. When the multi-function input terminals MI1 to MI6 are set to emergency stop, the AC motor drive stops output U, V, W and the motor coasts to stop. 2. Press RESET after fault has been cleared.
51	 Fault bb Base block	External Base Block	<ol style="list-style-type: none"> 1. When the external input terminal (B.B) is active, the AC motor drive output will be turned off. 2. Deactivate the external input terminal (B.B) to operate the AC motor drive again.
52	 Fault Pcod Password error	Password is locked.	Keypad will be locked. Turn the power ON after power OFF to re-enter the correct password. See Pr.00-07 and 00-08.
54	 Fault CE1 PC err command	Illegal function code	Check if the function code is correct (function code must be 03, 06, 10, 63)
55	 Fault CE2 PC err address	Illegal data address (00H to 254H)	Check if the communication address is correct
56	 Fault CE3 PC err data	Illegal data value	Check if the data value exceeds max./min. value
57	 Fault CE4 PC slave fault	Data is written to read-only address	Check if the communication address is correct
58	 Fault CE10 PC time out	Modbus transmission time-out	

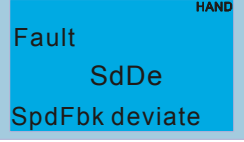
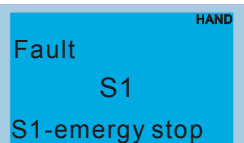
ID*	Fault Name	Fault Descriptions	Corrective Actions
60	 Fault bF Braking fault	Brake resistor fault	If the fault code is still displayed on the keypad after pressing "RESET" key, please return to the factory.
61	 Fault ydc Y-delta connect	Y-connection/ Δ -connection switch error	<ol style="list-style-type: none"> 1. Check the wiring of the Y-connection/Δ-connection 2. Check the parameters settings
62	 Fault dEb Dec. Energy back	When Pr.07-13 is not set to 0 and momentary power off or power cut, it will display dEb during accel./decel. stop.	<ol style="list-style-type: none"> 1. Set Pr.07-13 to 0 2. Check if input power is stable
63	 Fault oSL Over slip error	It will be displayed when slip exceeds Pr.05-26 setting and time exceeds Pr.05-27 setting.	<ol style="list-style-type: none"> 1. Check if motor parameter is correct (please decrease the load if overload) 2. Check the settings of Pr.05-26 and Pr.05-27
64	 Fault ryF MC Fault	Electric valve switch error when executing Soft Start. (This warning is for frame E and higher frame of AC drives) Do not disconnect RST when drive is still operating.	
65	 Fault PGF5 PG HW Error	Hardware error of PG Card Check if PG Card is insert to the right slot and parameter settings for encoder are accurate.	
68	 Fault SdRv SpdFbk Dir Rev	Rotating direction is different from the commanding direction detected by the sensorless. Solution Verify if the parameter setting of the motor drive is correct Increase the estimator's bandwidth and verify if parameters relating to the sensorless are correct.	
69	 Fault SdOr SpdFbk over SPD	Overspeed rotation detected by the sensorless Solution Verify if the parameter setting of the motor drive is correct Increase the estimator's bandwidth and verify if parameters relating to the sensorless are correct. Verify if the gains of the speed circuit is reasonable.	
70	 Fault SdDe SpdFbk deviate	Big difference between the rotating speed and the command detected by the sensorless Solution Verify if the parameter setting of the motor drive is correct Increase the estimator's bandwidth and verify if parameters relating to the sensorless are correct. Verify if the gains of the speed circuit is reasonable.	
73	 Fault S1 S1-emergency stop	Emergency stop for external safety	

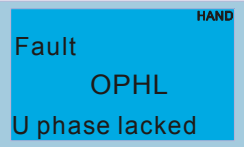
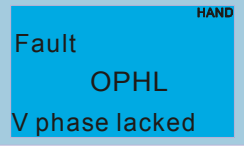
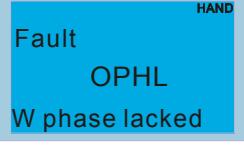
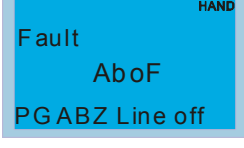
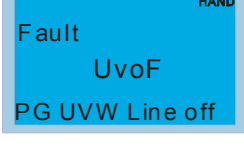
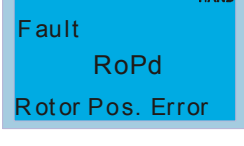
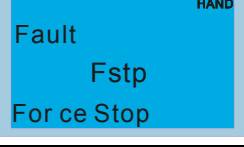
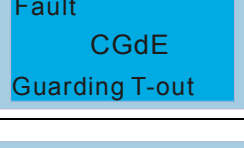
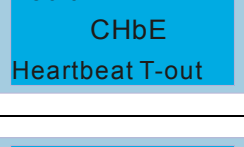
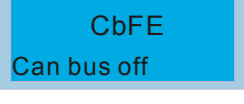
ID*	Fault Name	Fault Descriptions	Corrective Actions
82	 <p>Fault OPHL U phase lacked</p>	Output phase loss (Phase U)	
83	 <p>Fault OPHL V phase lacked</p>	Output phase loss (Phase V)	
84	 <p>Fault OPHL W phase lacked</p>	Output phase loss (Phase W)	
85	 <p>Fault AboF PG ABZ Line off</p>	PG card ABZ signal loss Solution Verify if the parameter setting of PG card and PG card cable is correct.	
86	 <p>Fault UvoF PG UVW Line off</p>	PG card UVW signal loss Solution Verify if the parameter setting of PG card and PG card cable is correct.	
89	 <p>Fault RoPd Rotor Pos. Error</p>	Rotor position detection error Solution Verify if the UVW output cable are loss. Verify if the motor internal coil is broken. Verify if the drive UVW output are normal.	
90	 <p>Fault Fstp Force Stop</p>	Internal PLC forced to stop Verify the setting of Pr.00-32	
101	 <p>Fault CGdE Guarding T-out</p>	CANopen guarding error	
102	 <p>Fault CHbE Heartbeat T-out</p>	CANopen heartbeat error	
104	 <p>Fault CbFE Can bus off</p>	CANopen bus off error	

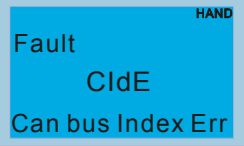
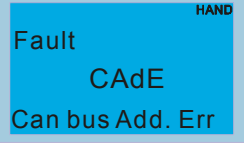
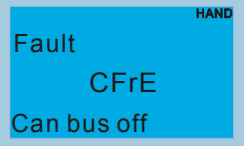
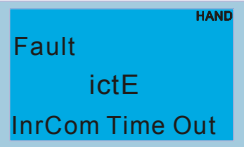
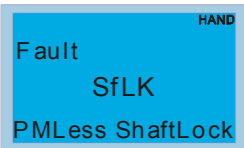
ID*	Fault Name	Fault Descriptions	Corrective Actions
105		CANopen index error	
106		CANopen station address error	
107		CANopen memory error	
111		Internal communication time-out	
112		<p>Motor Shaft lock error(Motor does not turn but the output frequency is not zero)</p> <p>Solution</p> <p>Verify if the motor parameter setting is correct.</p>	

[This page intentionally left blank]

Chapter 15 CANopen Overview

- 15.1 CANopen Overview
- 15.2 Wiring for CANopen
- 15.3 How to control by CANopen
 - 15.3.1 CANopen Control Mode Selection
 - 15.3.2 Delta Defined Control Mode (There are two modes available)
 - 15.3.3 DS402 Standard Control Mode
 - 15.3.4 Remarks to Control Modes
- 15.4 CANopen Supporting Index
- 15.5 CANopen Fault Code
- 15.6 CANopen LED Function

The built-in CANopen function is a kind of remote control. Master can control the AC motor drive by using CANopen protocol. CANopen is a CAN-based higher layer protocol. It provides standardized communication objects, including real-time data (Process Data Objects, PDO), configuration data (Service Data Objects, SDO), and special functions (Time Stamp, Sync message, and Emergency message). And it also has network management data, including Boot-up message, NMT message, and Error Control message. Refer to CiA website <http://www.can-cia.org/> for details. The content of this instruction sheet may be revised without prior notice. Please consult our distributors or download the most updated version at <http://www.delta.com.tw/industrialautomation>

Delta CANopen supporting functions:

- Support CAN2.0A Protocol;
- Support CANopen DS301 V4.02;
- Support DSP-402 V2.0.

Delta CANopen supporting services:

- PDO (Process Data Objects): PDO1~ PDO4
- SDO (Service Data Object):
 - Initiate SDO Download;
 - Initiate SDO Upload;
 - Abort SDO;
 - SDO message can be used to configure the slave node and access the Object Dictionary in every node.
- SOP (Special Object Protocol):
 - Support default COB-ID in Predefined Master/Slave Connection Set in DS301 V4.02;
 - Support SYNC service;
 - Support Emergency service.
- NMT (Network Management):
 - Support NMT module control;
 - Support NMT Error control;
 - Support Boot-up.

Delta CANopen not supporting service:

- Time Stamp service

15.1 CANopen Overview

CANopen Protocol

CANopen is a CAN-based higher layer protocol, and was designed for motion-oriented machine control networks, such as handling systems. Version 4 of CANopen (CiA DS301) is standardized as EN50325-4. The CANopen specifications cover application layer and communication profile (CiA DS301), as well as a framework for programmable devices (CiA 302), recommendations for cables and connectors (CiA 303-1) and SI units and prefix representations (CiA 303-2).

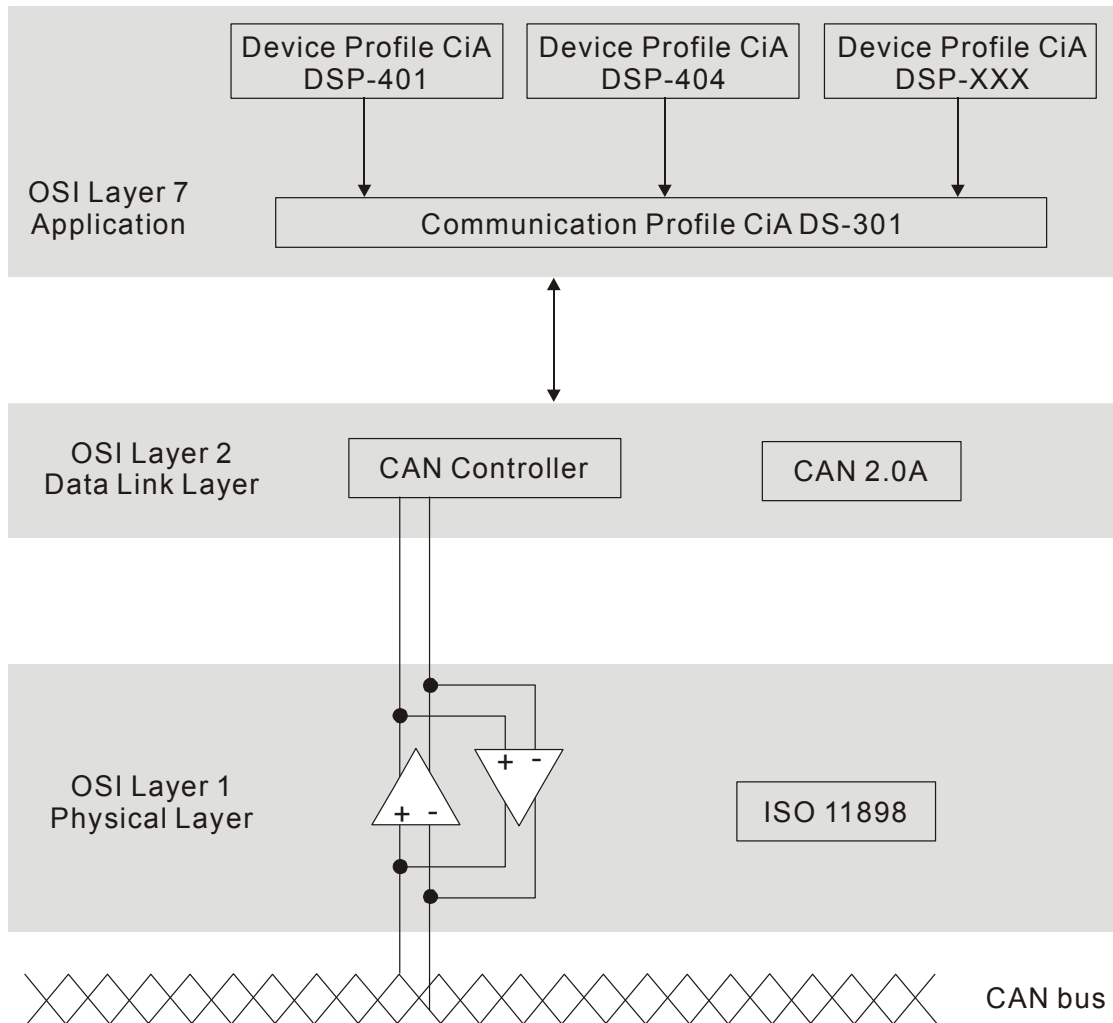

RJ-45 Pin Definition

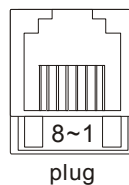

PIN	Signal	Description
1	CAN_H	CAN_H bus line (dominant high)
2	CAN_L	CAN_L bus line (dominant low)
3	CAN_GND	Ground / 0V /V-
6	CAN_GND	Ground / 0V /V-

CANopen Communication Protocol

It has services as follows:

- NMT (Network Management Object)
- SDO (Service Data Objects)
- PDO (Process Data Object)
- EMCY (Emergency Object)

NMT (Network Management Object)

The Network Management (NMT) follows a Master/Slave structure for executing NMT service. Only one NMT master is in a network, and other nodes are regarded as slaves. All CANopen nodes have a present NMT state, and NMT master can control the state of the slave nodes. The state diagram of a node is shown as follows:

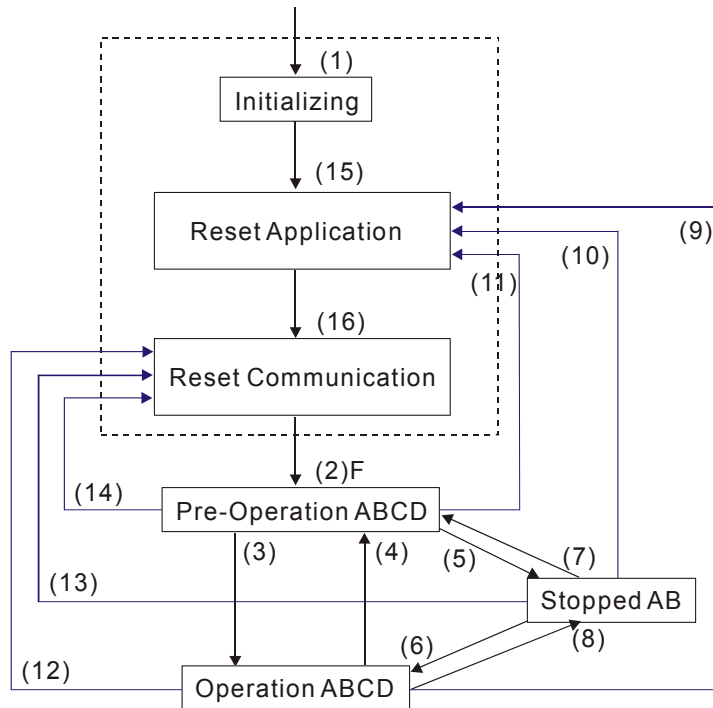

- (1) After power is applied, it is auto in initialization state
- (2) Enter pre-operational state automatically
- (3) (6) Start remote node
- (4) (7) Enter pre-operational state
- (5) (8) Stop remote node
- (9) (10) (11) Reset node
- (12) (13) (14) Reset communication
- (15) Enter reset application state automatically
- (16) Enter reset communication state automatically

- A: NMT
- B: Node Guard
- C: SDO
- D: Emergency
- E: PDO
- F: Boot-up

	Initializing	Pre-Operational	Operational	Stopped
PDO			○	
SDO		○	○	
SYNC		○	○	
Time Stamp		○	○	
EMCY		○	○	
Boot-up	○			
NMT		○	○	○

SDO (Service Data Objects)

SDO is used to access the Object Dictionary in every CANopen node by Client/Server model. One SDO has two COB-ID (request SDO and response SDO) to upload or download data between two nodes. No data limit for SDOs to transfer data. But it needs to transfer by segment when data exceeds 4 bytes with an end signal in the last segment.

The Object Dictionary (OD) is a group of objects in CANopen node. Every node has an OD in the system, and OD contains all parameters describing the device and its network behavior. The access path of OD is the index and sub-index, each object has a unique index in OD, and has sub-index if necessary. The request and response frame structure of SDO communication is shown as follows:

PDO (Process Data Object)

PDO communication can be described by the producer/consumer model. Each node of the network will listen to the messages of the transmission node and distinguish if the message has to be processed or not after receiving the message. PDO can be transmitted from one device to one another device or to many other devices. Every PDO has two PDO services: a TxPDO and a RxPDO. PDOs are transmitted in a non-confirmed mode.

PDO Transmission type is defined in the PDO communication parameter index (1400h for the 1st RxPDO or 1800h for the 1st TxPDO), and all transmission types are listed in the following table:

Type Number	PDO				
	Cyclic	Acyclic	Synchronous	Asynchronous	RTR only
0		○	○		
1-240	○		○		
241-251	Reserved				
252			○		○
253				○	○
254				○	
255				○	

Type number 1-240 indicates the number of SYNC message between two PDO transmissions.
 Type number 252 indicates the data is updated (but not sent) immediately after receiving SYNC.
 Type number 253 indicates the data is updated immediately after receiving RTR.
 Type number 254: Delta CANopen doesn't support this transmission format.
 Type number 255 indicates the data is asynchronous transmission.
 All PDO transmission data must be mapped to index via Object Dictionary.

EMCY (Emergency Object)

When errors occurred inside the hardware, an emergency object will be triggered an emergency object will only be sent when an error is occurred. As long as there is nothing wrong with the hardware, there will be no emergency object to be served as a warning of an error message.

15.2 Wiring for CANopen

An external adapter card: EMC-COP01 is used for CANopen wiring; establish CANopen to VFD CT2000 connection. The link is enabled by using RJ45 cable. The two farthest ends must be terminated with 120Ω terminating resistors.

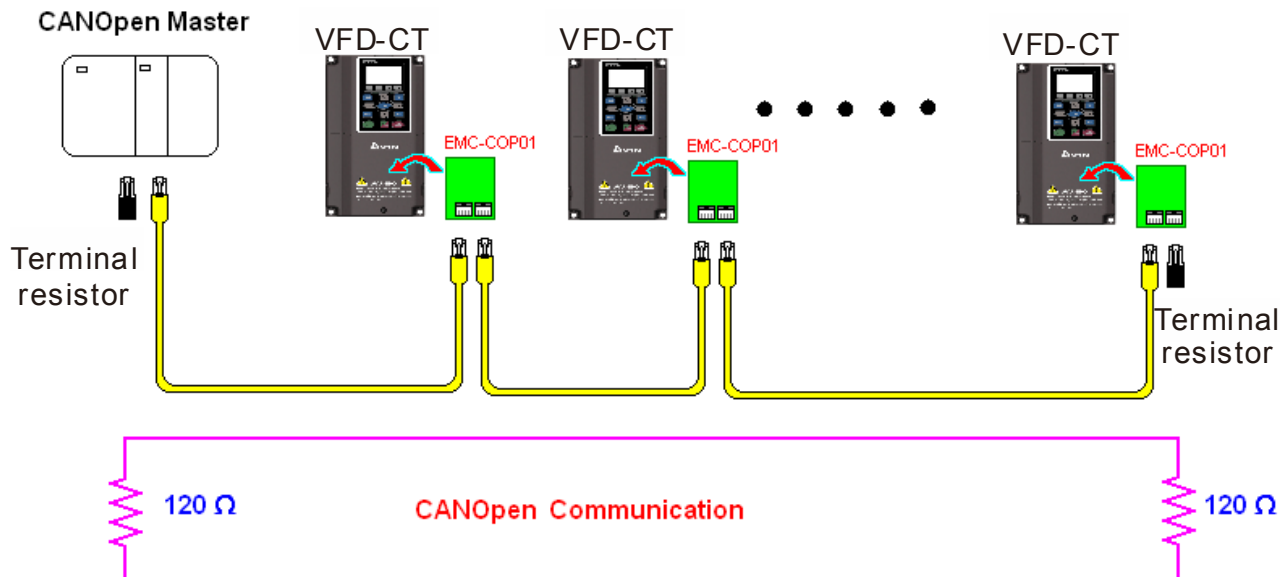

15.3 CANopen Communication Interface

Description

15.3.1 CANopen Control Mode Selection

There are two control modes for CANopen; Pr.09-40 set to 1 is the factory setting mode DS402 standard and Pr.09-40 set to 0 is Delta's standard setting mode.

Actually, there are two control modes according to Delta's standard, one is the old control mode (Pr09-30=0).

This control mode can only control the motor drive under frequency control. Another mode is a new standard (Pr09-30=1)

This new control mode allows the motor drive to be controlled under all sorts of mode. Currently, C2000 support speed, torque, position and home mode.

The definition of relating control mode are:

CANopen Control Mode Selection	Control Mode							
	Speed		Torque		Position		Home	
	Index	Description	Index	Description	Index	Description	Index	Description
DS402 standard Pr. 09-40=1	6042-00	Target rotating speed (RPM)	6071-00	Target Torque (%)	607A-00	Target Position	-----	-----
	-----	-----	6072-00	Max. Torque Limit(%)	-----	-----	-----	-----
Delta Standard (Old definition) P09-40=0, P09-30=0	2020-02	Target rotating speed (Hz)	-----	-----	-----	-----	-----	-----
Delta Standard (New definition) P09-40=0, P09-30=1	2060-03	Target rotating speed (Hz)	2060-07	Target Torque (%)	2060-05	Target Position	-----	-----
	2060-04	Torque Limit (%)	2060-08	Speed Limit (Hz)	-----	-----	-----	-----

CANopen Control Mode Selection	Operation Control	
	Index	Description
DS402 standard Pr. 09-40=1	6040-00	Operation Command
	-----	-----
Delta Standard (Old definition) P09-40=0, P09-30=0	2020-01	Operation Command
Delta Standard (New definition) P09-40=0, P09-30=1	2060-01	Operation Command
	-----	-----

CANopen Control Mode Selection	Other	
	Index	Description
DS402 standard Pr. 09-40=1	605A-00	Quick stop processing mode
	605C-00	Disable operation processing mode
Delta Standard (Old definition) P09-40=0, P09-30=0	-----	-----
Delta Standard (New definition) P09-40=0, P09-30=1	-----	-----
	-----	-----

However, you can use some index regardless DS402 or Delta's standard.

For example:

1. Index which are defined as RO attributes.
2. Index correspond to parameters such as (2000 ~200B-XX)
3. Accelerating/Decelerating Index: 604F 6050

15.3.2 DS402 Standard Control Mode

15.3.2.1 Related set up of ac motor drive (by following DS402 standard)

If you want to use DS402 standard to control the motor drive, please follow the steps below:

1. Wiring for hardware (refer to chapter 15-2 Wiring for CANopen)
2. Operation source setting: set Pr.00-21 to 3 for CANopen communication card control.
3. Frequency source setting: set Pr.00.20 to 6. (Choose source of frequency command from CANopen setting.)
4. Source of torque setting is set by Pr.11-33. (Choose source of torque command from CANopen setting.)
5. CANopen station setting: set Pr.09-36 (Choose source of position command from CANopen setting.)
6. Set DS402 as control mode: Pr09-40=1
7. CANopen station setting: set Pr.09-36 (Range of setting is 1~127. When Pr.09-36=0, CANopen slave function is disabled.) (Note: If error arise (CAde or CANopen memory error) as station setting is completed, press Pr.00-02=7 for reset.)
8. CANopen baud rate setting: set Pr.09.37 (CANBUS Baud Rate: 1M(0), 500K(1), 250K(2), 125K(3), 100K(4) and 50K(5))
9. Set multiple input functions to Quick Stop (it can also be enable or disable, default setting is disable). If it is necessary to enable the function, set MI terminal to 53 in one of the following parameter: Pr.02.01 ~Pr.02.08 or Pr.02.26 ~ Pr.02.31. (Note: This function is available in DS402 only.)

15.3.2.2 The status of the motor drive (by following DS402 standard)

According to the DS402 definition, the motor drive is divided into 3 blocks and 9 status as described below.

3 blocks

Power Disable: That means without PWM output

Power Enable: That means with PWM output

Fault: One or more than one error has occurred.

9 statuses

Start: Power On

Not ready to switch on: The motor drive is initiating.

Switch On Disable: When the motor drive finishes the initiation, it will be at this mode.

Ready to switch on: Warming up before running.

Switch On: The motor drive has the PWM output now, but the reference command is not effective.

Operate Enable: Able to control normally.

Quick Stop Active: When there is a Quick Stop request, you have to stop running the motor drive.

Fault Reaction Active: The motor drive detects conditions which might trigger error(s).

Fault: One or more than errors has occurred to the motor drive.

Therefore, when the motor drive is turned on and finishes the initiation, it will remain at Ready to Switch on status. To control the operation of the motor drive, you need to change this status to Operate Enable status. The way to change it is to commend the control word's bit0 ~ bit3 and bit7 of the Index 6040H and to pair with Index Status Word (Status Word 0X6041). The control steps and index definition are described as below:

Index 6040

15~9	8	7	6~4	3	2	1	0
Reserved	Halt	Fault Reset	Operation	Enable operation	Quick Stop	Enable Voltage	Switch On

Index 6041

15~14	13~12	11	10	9	8	7	6	5	4	3	2	1	0
Reserved	Operation	Internal limit active	Target reached	Remote	Reserved	Warning	Switch on disabled	Quick stop	Voltage enabled	Fault	Operation enable	Switch on	Ready to switch on

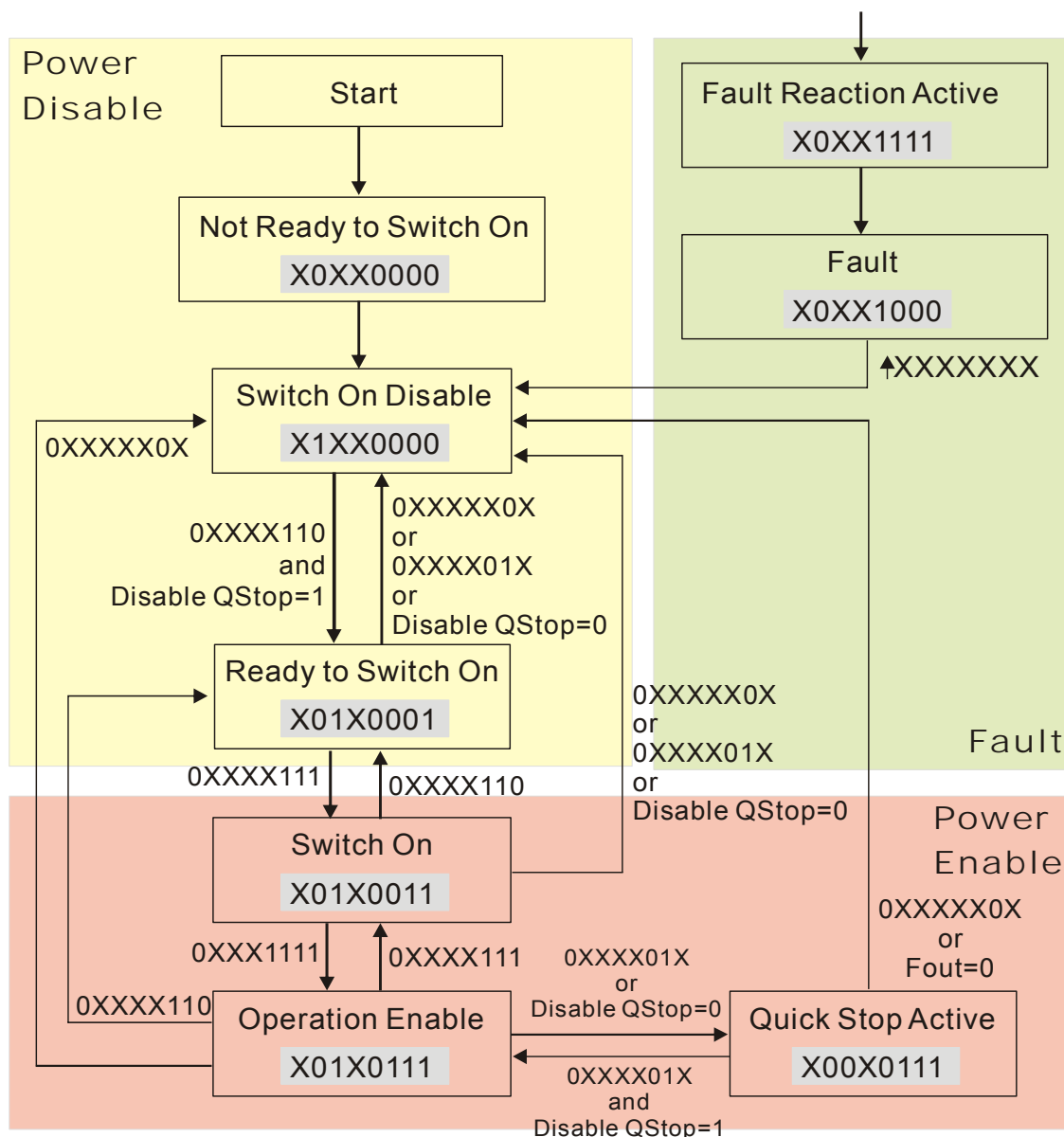

Set command 6040 =0xE, then set another command 6040 =0xF. Then the motor drive can be switched to Operation Enable. The Index 605A decides the dashed line of Operation Enable when

the control mode changes from Quick Stop Active. (When the setting value is 1~3, this dashed line is active. But when the setting value of 605A is not 1~3, once the motor drive is switched to Quick Stop Active, it will not be able to switch back to Operation Enable.)

Index	Sub	Definition	Factory Setting	R/W	Size	Unit	PDO Map	Mode	note
605Ah	0	Quick stop option code	2	RW	S16		No		0 : disable drive function 1 :slow down on slow down ramp 2: slow down on quick stop ramp 5 slow down on slow down ramp and stay in QUICK STOP 6 slow down on quick stop ramp and stay in QUICK STOP 7 slow down on the current limit and stay in Quick stop

Besides, when the control section switches from Power Enable to Power Disable, use 605C to define parking method.

Index	Sub	Definition	Factory Setting	R/W	Size	Unit	PDO Map	Mode	note
605Ch	0	Disable operation option code	1	RW	S16		No		0: Disable drive function 1: Slow down with slow down ramp; disable of the drive function

15-3-2-3 Various mode control method (by following DS402 standard)

Control mode of C2000, supporting speed, torque, position and home control are described as below:

Speed mode

1. Let Ac Motor Drive be at the speed control mode: Set Index6060 to 2.
2. Switch to Operation Enable mode: Set 6040=0xE, then set 6040 = 0xF.
3. To set target frequency: Set target frequency of 6042, since the operation unit of 6042 is rpm, there is a transformation:

$$n = f \times \frac{120}{p}$$

n: rotation speed (rpm) (rounds/minute) P: motor's pole number (Pole)
 f: rotation frequency (Hz)

For example:

Set 6042H = 1500 (rpm), if the motor drive's pole number is 4 (Pr05-04 or Pr05-16), then the motor drive's operation frequency is 1500(120/4)=50Hz.

Besides, the 6042 is defined as a signed operation. The plus or minus sign means to rotate clockwise or counter clockwise

4. To set acceleration and deceleration: Use 604F(Acceleration) and 6050(Deceleration).
5. Trigger an ACK signal: In the speed control mode, the bit 6~4 of Index 6040 needs to be controlled. It is defined as below:

Speed mode (Index 6060=2)	Index 6040			SUM
	Bit 6	Bit 5	Bit 4	
	1	0	1	Locked at the current signal.
	1	1	1	Run to reach targeting signal.
	Other			Decelerate to 0Hz.

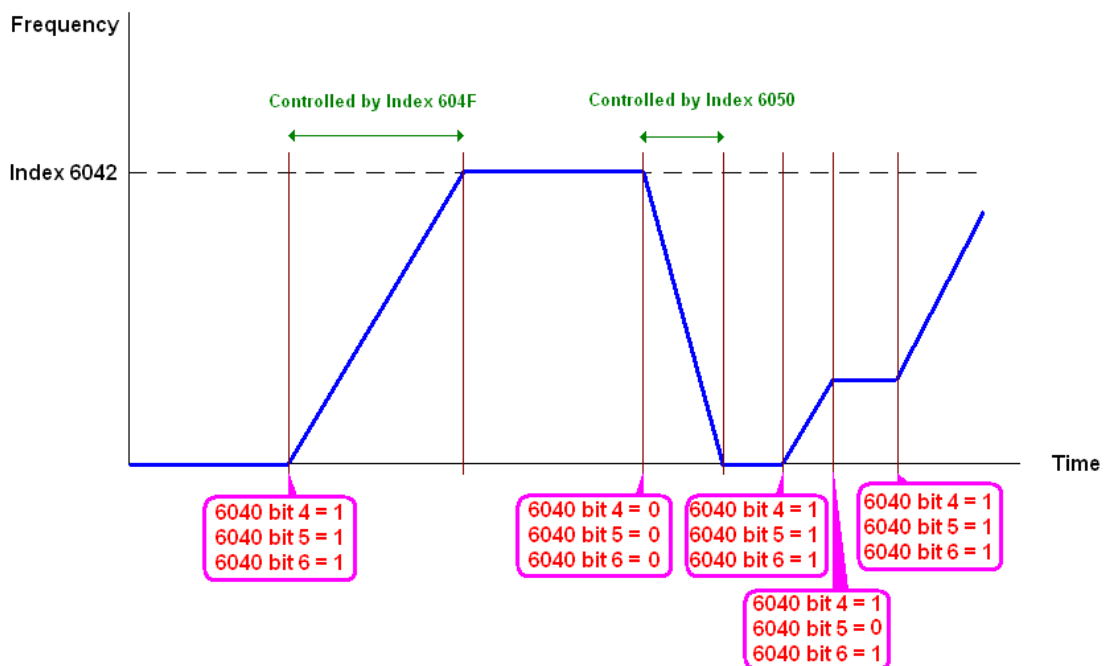

NOTE 01: To know the current rotation speed, read 6043. (unit: rpm)

NOTE 02: To know if the rotation speed can reach the targeting value; read bit 10 of 6041. (0: Not reached; 1: Reached)

Torque mode

1. Let Ac Motor Drive be at the torque control mode: Set Index6060 = 4.
2. Switch the current mode to Operation Enable, set 6040 = 0xE, then set 6040 = 0xF.
3. To set targeting torque: Set 6071 as targeting torque and 6072 as the largest output torque.

Torque mode (Index 6060=4)	Index 6040			SUM
	Bit 6	Bit 5	Bit 4	
	X	X	X	RUN to reach the targeting torque.

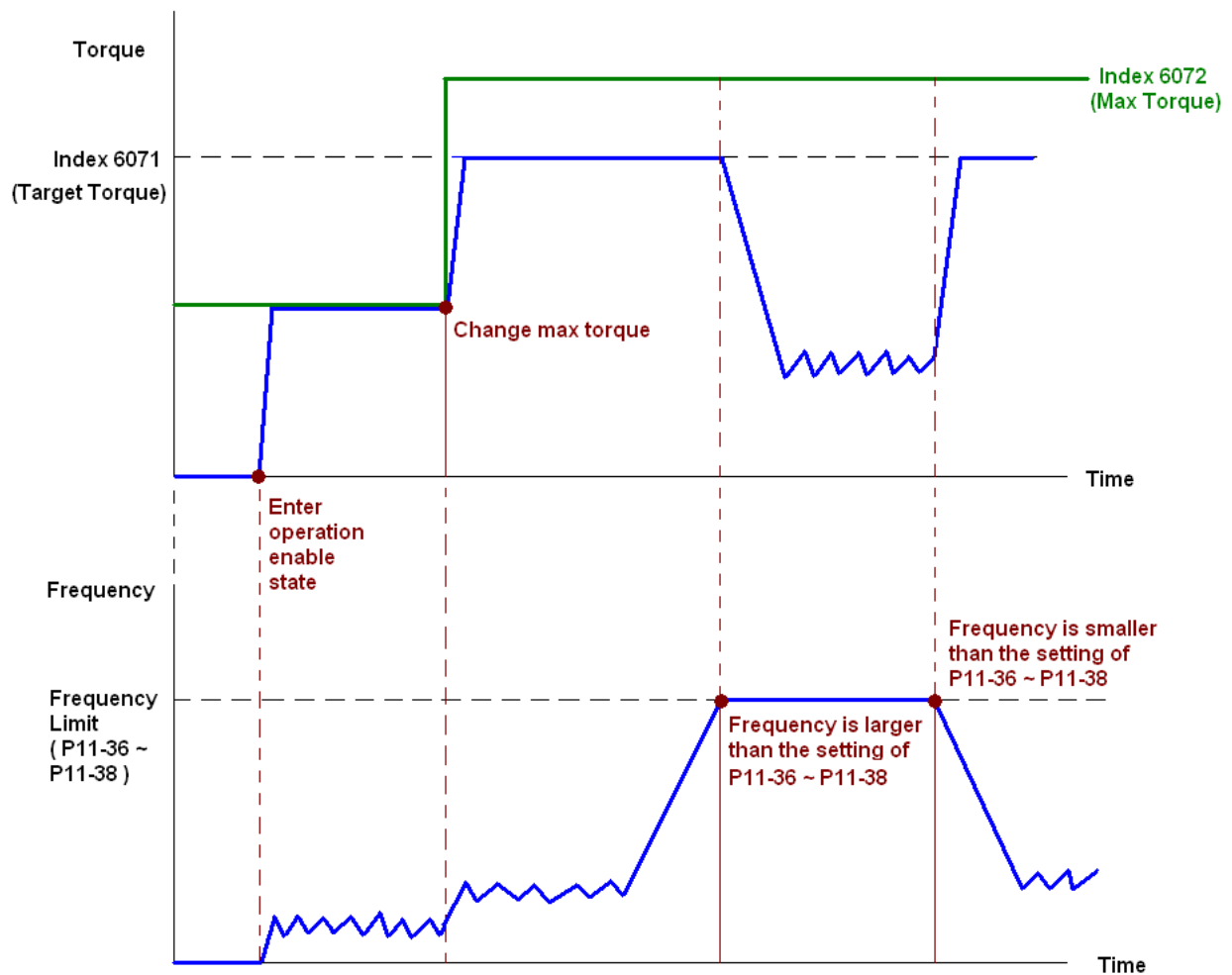

NOTE: The standard DS402 doesn't regulate the highest speed limit. Therefore if the motor drive defines the control mode of DS402, the highest speed will go with the setting of Pr11-36 to Pr11-38.

NOTE 01: To know the current torque, read 6077 (unit: 0.1%).

NOTE02: To know if reaching the targeting torque, read bit 10 of 6041. (0: Not reached; 1: Reached)

Position mode

1. Set the parameter of a trapezium curve to define position control (Pr11-43 Max. Frequency of Point- to-Point Position Control, Pr11-44 Accel. Time of Point-to Point Position Control and Pr11-45 Decel. Time of Point-to Point Position Control)
2. Let Ac Motor Drive be at the position control mode: Then set Index 6060 = 1.
3. Switch the current mode to Operation Enable, set 6040 = 0xE and then set 6040 = 0xF.
4. To set targeting position: set 607A as the targeting position.
5. Trigger an ACK signal: Set 6040 = 0x0F then set 6040 = 0x1F. (Bit4 changes from 0 to 1).

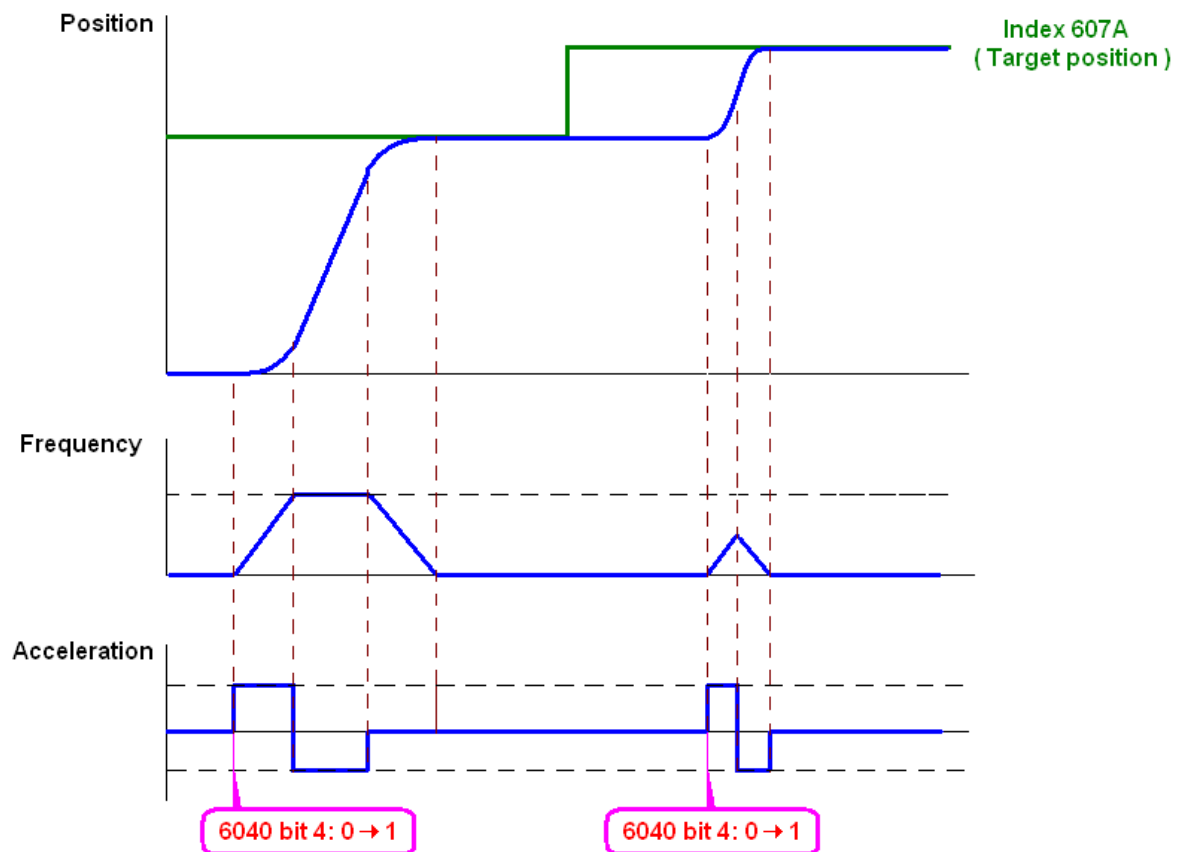

NOTE 01: To know the current position, read 6064.

NOTE 02: To know if the position reaches the targeting position, read bit 10 of 6041. (0: reached, 1: Not reached)

NOTE 03: To know if the position is over the limited area, read bit 11 of 6041 (0: in the limit, 1: over the limit)

Home mode

1. Set Pr00-12 to choose a home method.
2. Set the left and right limits correspond to the position of MI terminal.
3. To switch Ac Motor Drive control mode to Home mode: Set Index 6060 = 6.
4. To switch from current mode to Operation Enable: Set 6040 = 0xE, then set 6040 = 0xF.
5. To trigger an ACK signal: Set 6040 = 0x0F, then set 6040 = 0x1F (Bit4 changes from 0 to 1 and the motor drive will be back to home.)

Note 01: To know if the home mode is completed, read bit 12 of 6041. (0: reached, 1: Not reached)

15.3.3 By using Delta Standard (Old definition, only support speed mode)

15-3.3.1 Various mode control method (by following DS402 standard)

If you want to use DS402 standard to control the motor drive, please follow the steps below:

1. Wiring for hardware (Refer to chapter 15.2 Wiring for CANopen)
2. Operation source setting: set Pr.00-21 to 3 for CANopen communication card control.
3. Frequency source setting: set Pr.00.20 to 6. (Choose source of frequency command from CANopen setting.)

4. Set Delta Standard (Old definition, only support speed mode) as control mode: Pr. 09-40 = 0 and 09-30 = 0.
CANopen station setting: set Pr.09-36 (Range of setting is 1~127. When Pr.09-36=0, CANopen slave function is disabled.) (Note: If error arised (CAAdE or CANopen memory error) as station setting is completed, press Pr.00-02=7 for reset.)
5. CANopen baud rate setting: set Pr.09.37 (CANBUS Baud Rate: 1M(0), 500K(1), 250K(2), 125K(3), 100K(4) and50K(5))

15-3-3-2 By speed mode

1. Set the target frequency: Set 2020-02, the unit is Hz, with a number of 2 decimal places. For example 1000 is 10.00.
2. Operation control: Set 2020-01 = 0002H for Running, and set 2020-01 = 0001H for Stopping.

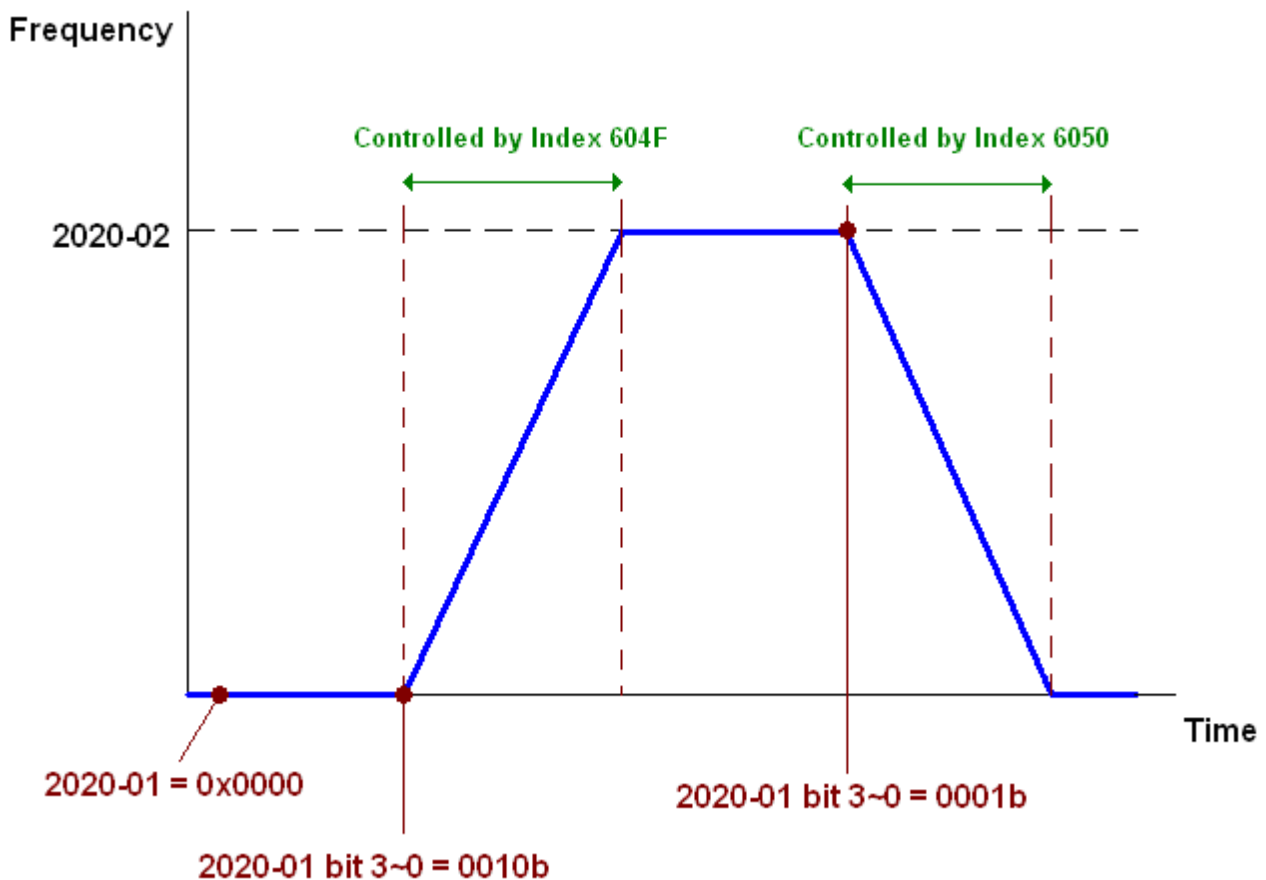

15.3.4 By using Delta Standard (New definition)

15-3-4-1 Related set up of ac motor drive (Delta New Standard)

If you want to use DS402 standard to control the motor drive, please follow the steps below:

1. Wiring for hardware (Refer to chapter 15.2 Wiring for CANopen)
2. Operation source setting: set Pr.00-21 to 3 for CANopen communication card control.
3. Frequency source setting: set Pr.00.20 to 6. (Choose source of frequency commend from CANopen setting.)
4. Source of torque setting is set by Pr.11-33. (Choose source of torque commend from CANopen setting.)

5. CANopen station setting: set Pr.09-36 (Choose source of position command from CANopen setting.)
6. Set Delta Standard (Old definition, only support speed mode) as control mode: Pr. 09-40 = 0 and 09-30 = 0.
7. CANopen station setting: set Pr.09-36 (Range of setting is 1~127. When Pr.09-36=0, CANopen slave function is disabled.) (Note: If error arised (CAE or CANopen memory error) as station setting is completed, press Pr.00-02=7 for reset.)
8. CANopen baud rate setting: set Pr.09.37 (CANBUS Baud Rate: 1M(0), 500K(1), 250K(2), 125K(3), 100K(4) and50K(5))

15-3-4-2 Various mode control method (Delta New Standard)

Speed Mode

1. Let Ac Motor Drive be at the speed control mode: Set Index6060 = 2.
2. Set the target frequency: set 2060-03, unit is Hz, with a number of 2 decimal places. For example 1000 is 10.00Hz.
3. Operation control: set 2060-01 = 008H for Server on, and set 2060-01 = 0081H for Running.

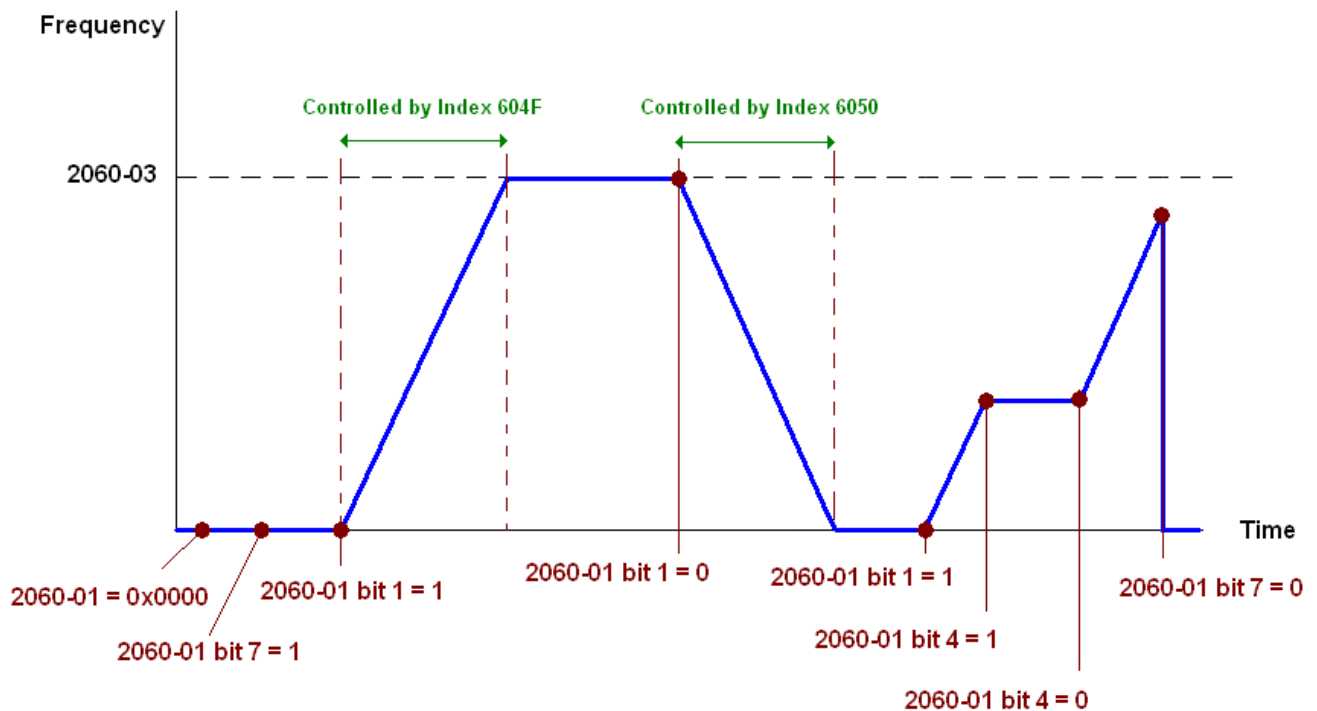

Torque Mode

1. Let Ac Motor Drive be at torque control mode: set Index 6060 = 4.
2. Set target torque: set 2060-07, unit is %, a number of 1 decimal place. For example 100 is 10.0%.
3. Operation control: Set 2060-01 = 0080H for Server on, then the motor drive will start to run to reach target torque.

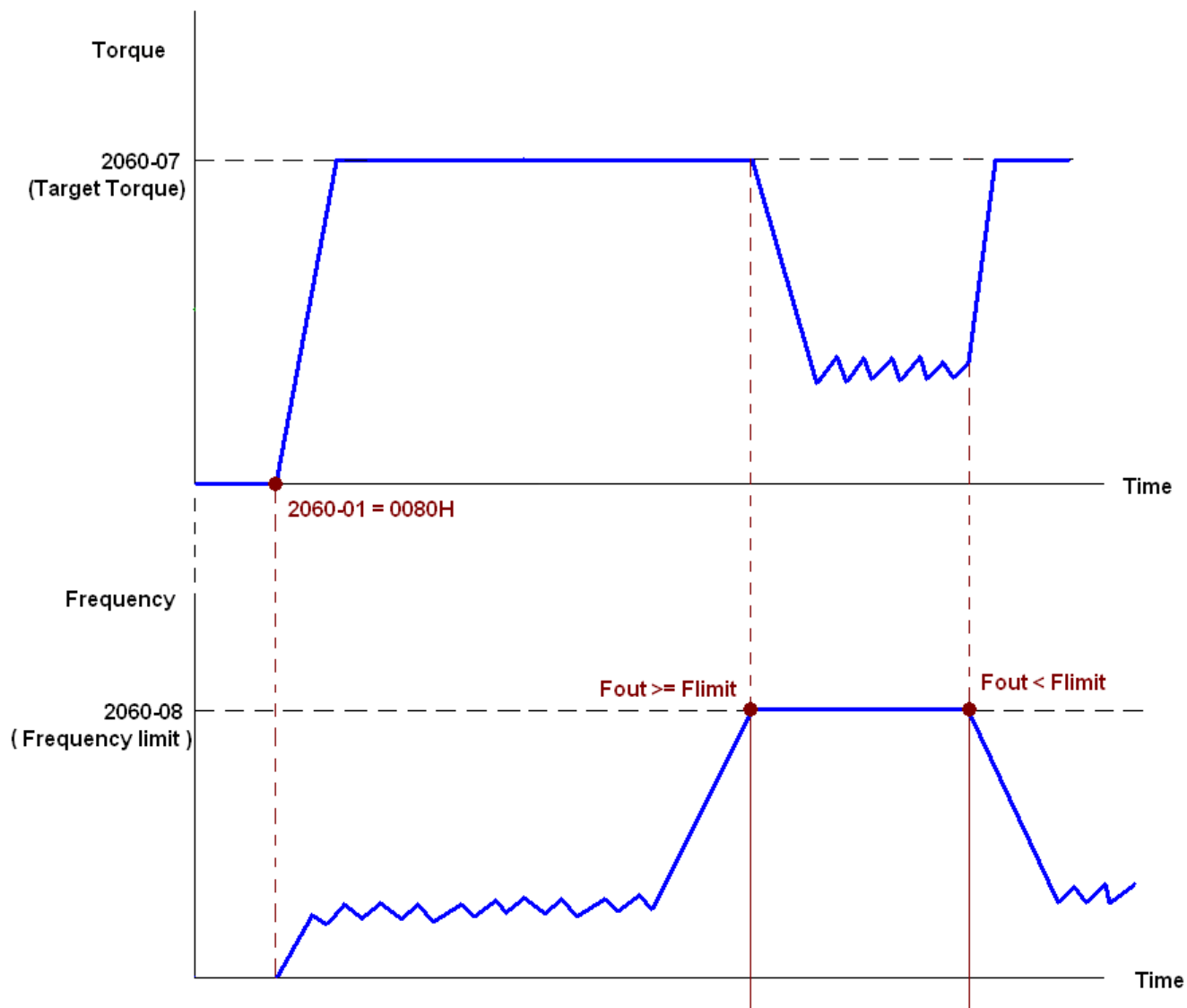

Note01 To know what the current torque is, read 2061-07 (unit is 0.1%).

Note02 To know if the torque can reach the setting value, read the bit 0 of 2061-01 (0: Not reached, 1: Reached).

Note 03: When doing torque output and if the motor drive's speed reaches the speed limit, the output torque will decrease to ensure the speed is under the limit.

Position Mode

1. Set the parameter of a trapezium curve to define position control (Pr11-43 Max. Position Control Frequency), Pr11-44 Accel. Time of Position Control, Pr11-45 Decel. Time of Position Control)
2. Let Ac motor drive be at the position control mode, set Index 6060 = 1.
3. Set 2060-01 = 0080h, then motor drive will have server on.
4. Set target position: set 2060-05 = target position.
5. Set 2060-01 =0081h to trigger the motor drive to run to the target position.
6. To move to another position, simply repeat step 3 to 5.

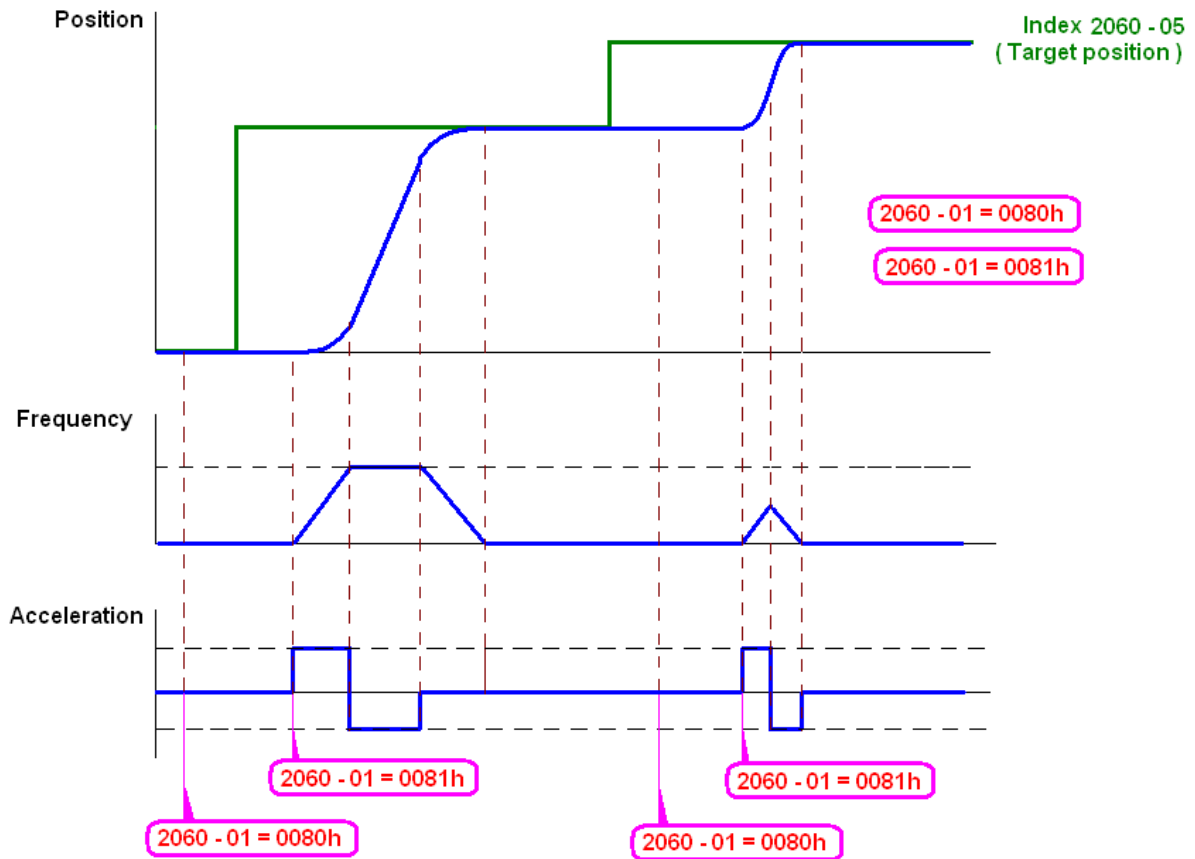

NOTE01: To know the current position, read 2061-05.

NOTE02: To know if reaching the target position, read bit 0 of 2061 (0: Not reached, 1: Reached).

Home Mode

1. Set Pr00-12 to choose how to return home.
2. Set the left and right limits correspond to the position of MI terminal.
3. To switch C2000 control mode to Home mode: Set Index 6060 = 6.
4. Set 2060-01 = 0080h, then motor drive will have server on.
5. Set the ACK signal: set 2060-01 = 0081h, then the motor drive will start to go back home.

NOTE 01: To know if returning home is completed, read bit12 of 6041 (0: Not reached, 1: Reached).

15-3-5 DI/DO AI AO are controlled via CANopen

To control the DO AO of the motor drive through CANopen, follow the steps below:

1. To set the DO to be controlled, define this DO to be controlled by CANopen. For example, set Pr02-14 to control RY2.
2. To set the DO to be controlled, define this AO to be controlled by CANopen. For example, set Pr03-23 to control AFM2.
3. To control the mapping index of CANopen. If you want to control DO, then you will need to control Index2026-41. If you want to control AO, then you will need to control 2026-AX. If you want to set RY2 as ON, set the bit 1 of Index 2026-41 =1, then RY2 will output 1. If you want to control AFM2 output = 50.00%, then you will need to set Index 2026-A2 =5000, then AFM2 will output 50%.

Mapping table of CANopen DI DO AI AO:

DI:

Terminal	Related Parameters	R/W	Mapping Index
FWD	==	RO	2026-01 bit 0
REV	==	RO	2026-01 bit 1
MI 1	==	RO	2026-01 bit 2
MI 2	==	RO	2026-01 bit 3
MI 3	==	RO	2026-01 bit 4
MI 4	==	RO	2026-01 bit 5
MI 5	==	RO	2026-01 bit 6
MI 6	==	RO	2026-01 bit 7
MI 7	==	RO	2026-01 bit 8
MI 8	==	RO	2026-01 bit 9
MI 10	==	RO	2026-01 bit 10
MI 11	==	RO	2026-01 bit 11
MI 12	==	RO	2026-01 bit 12
MI 13	==	RO	2026-01 bit 13
MI 14	==	RO	2026-01 bit 14
MI 15	==	RO	2026-01 bit 15

DO :

Terminal	Related Parameters	R/W	Mapping Index
RY1	P2-13 = 50	RW	2026-41 bit 0
RY2	P2-14 = 50	RW	2026-41 bit 1
	P2-15 = 50	RW	2026-41 bit 2
MO1	P2-16 = 50	RW	2026-41 bit 3
MO2	P2-17 = 50	RW	2026-41 bit 4
MO3	P2-18 = 50	RW	2026-41 bit 5
MO4	P2-19 = 50	RW	2026-41 bit 6

MO5	P2-20 = 50	RW	2026-41 bit 7
MO6	P2-21 = 50	RW	2026-41 bit 8
MO7	P2-22 = 50	RW	2026-41 bit 9
MO8	P2-23 = 50	RW	2026-41 bit 10

AI :

Terminal	Related Parameters	R/W	Mapping Index
AVI	==	RO	Value of 2026-61
ACI	==	RO	Value of 2026-62
AUI	==	RO	Value of 2026-63

AO :

Terminal	Related Parameters	R/W	Mapping Index
AFM1	P3-20 = 20	RW	Value of 2026-A1
AFM2	P3-23 = 20	RW	Value of 2026-A2

15.4 CANopen Supporting Index

C2000 Index:

Parameter index corresponds to each other as following:

Index	sub-Index
2000H + Group	member+1

For example:

Pr.10.15 (Encoder Slip Error Treatment)

Group	member
10(0AH)	15(0FH)

Index = 2000H + 0AH = 200A

Sub Index = 0FH + 1H = 10H

C2000 Control Index:

Delta Standard Mode (Old definition)

Index	Sub	Definition	Factory Setting	R/W	Size	Note
2020H	0	Number	3	R	U8	Bit 1~0 00B:disable 01B:stop 10B:disable 11B: JOG Enable
	1	Control word	0	RW	U16	Bit3~2 Reserved
						Bit5~4 00B:disable 01B: Direction forward 10B: Reverse 11B: Switch Direction
						Bit7~6 00B: 1 st step Accel. /Decel. 01B: 2 nd step Accel. /Decel. 10B: 3 rd step Accel. /Decel. 11B: 4 th step Accel. /Decel.
						Bit11~8 0000B: Master speed 0001B: 1 st step speed 0010B: 2 nd step speed 0011B: 3 rd step speed 0100B: 4 th step speed 0101B: 5 th step speed 0110B: 6 th step speed 0111B: 7 th step speed 1000B: 8 th step speed 1001B: 9 th step speed 1010B: 10 th step speed 1011B: 11 th step speed 1100B: 12 th step speed 1101B: 13 th step speed 1110B: 14 th step speed 1111B: 15 th step speed
						Bit12 1: Enable the function of Bit6-11
						Bit14~13 00B: no function 01B: Operation command by the digital keypad

Index	Sub	Definition	Factory Setting	R/W	Size	Note	
							10B: Operation command by Pr. 00-21 setting
							11B: Switch the source of operation command
						Bit 15	Reserved
	2	Freq. command (XXX.XXHz)	0	RW	U16		
	3	Other trigger	0	RW	U16	Bit0	1: E.F. ON
						Bit1	1: Reset
						Bit15~2	Reserved
2021H	0	Number	DH	R	U8		
	1	Error code	0	R	U16		
	2	AC motor drive status	0	R	U16	Bit 1~0	00B: stop
							01B: decelerate to stop
							10B: waiting for operation command
							11B: in operation
						Bit 2	1: JOG command
						Bit 4~3	00B: forward running
							01B: switch from reverse running to forward running
							10B: switch from forward running to reverse running
							11B: reverse running
						Bit 7~5	Reserved
						Bit 8	1: master frequency command controlled by communication interface
						Bit 9	1: master frequency command controlled by analog signal input
						Bit 10	1: operation command controlled by communication interface
						Bit 15~11	Reserved
	3	Freq. command (XXX.XXHz)	0	R	U16		
	4	Output freq. (XXX.XXHz)	0	R	U16		
	5	Output current (XX.XA)	0	R	U16		
	6	DC bus voltage (XXX.XV)	0	R	U16		
	7	Output voltage (XXX.XV)	0	R	U16		
	8	the current segment run by the multi-segment speed command	0	R	U16		
	9	Reserved	0	R	U16		
	A	Display counter value (c)	0	R	U16		
	B	Display output power angle (XX.X°)	0	R	U16		
	C	Display output torque (XXX.X%)	0	R	U16		
	D	Display actual motor speed (rpm)	0	R	U16		
	E	Number of PG feed back pulses (0~65535)	0	R	U16		
	F	Number of PG2 pulse commands (0~65535)	0	R	U16		
	10	power output (X.XXXKWH)	0	R	U16		
2022H	0	Reserved	0	R	U16		
	1	Display output current	0	R	U16		

Index	Sub	Definition	Factory Setting	R/W	Size	Note
	2	Display counter value	0	R	U16	
	3	Display actual output frequency (XXX.XXHz)	0	R	U16	
	4	Display DC-BUS voltage (XXX.XV)	0	R	U16	
	5	Display output voltage (XXX.XV)	0	R	U16	
	6	Display output power angle (XX.X°)	0	R	U16	
	7	Display output power in kW	0	R	U16	
	8	Display actual motor speed (rpm)	0	R	U16	
	9	Display estimate output torque (XXX.X%)	0	R	U16	
	A	Display PG feedback	0	R	U16	
	B	Display PID feedback value after enabling PID function in % (To 2 decimal places)	0	R	U16	
	C	Display signal of AVI analog input terminal, 0-10V corresponds to 0-100% (To 2 decimal places)	0	R	U16	
	D	Display signal of ACI analog input terminal, 4-20mA/0-10V corresponds to 0-100% (To 2 decimal places)	0	R	U16	
	E	Display signal of AUI analog input terminal, -10V~10V corresponds to -100~100% (To 2 decimal places)	0	R	U16	
	F	Display the IGBT temperature of drive power module in °C	0	R	U16	
	10	Display the temperature of capacitance in °C	0	R	U16	
	11	The status of digital input (ON/OFF), refer to Pr.02-12	0	R	U16	
	12	The status of digital output (ON/OFF), refer to Pr.02-18	0	R	U16	
	13	Display the multi-step speed that is executing	0	R	U16	
	14	The corresponding CPU pin status of digital input	0	R	U16	
	15	The corresponding CPU pin status of digital output	0	R	U16	
	16	Number of actual motor revolution (PG1 of PG card). it will start from 9 when the actual operation direction is changed or keypad display at stop is 0. Max. is 65535	0	R	U16	
	17	Pulse input frequency (PG2 of PG card)	0	R	U16	
	18	Pulse input position (PG card PG2), maximum setting is 65535.	0	R	U16	
	19	Position command tracing error	0	R	U16	
	1A	Display times of counter overload (0.00~100.00%)	0	R	U16	

Index	Sub	Definition	Factory Setting	R/W	Size	Note
	1B	Display GFF in %	0	R	U16	
	1C	Display DCbus voltage ripples (Unit: Vdc)	0	R	U16	
	1D	Display PLC register D1043 data	0	R	U16	
	1E	Display Pole of Permanent Magnet Motor	0	R	U16	
	1F	User page displays the value in physical measure	0	R	U16	
	20	Output Value of Pr.00-05	0	R	U16	
	21	Number of motor turns when drive operates	0	R	U16	
	22	Operation position of motor	0	R	U16	
	23	Fan speed of the drive	0	R	U16	
	24	Control mode of the drive 0: speed mode 1: torque mode	0	R	U16	
	25	Carrier frequency of the drive	0	R	U16	

CANopen Remote IO mapping

Index	Sub	R/W	Definition
2026H	01h	R	Each bit corresponds to the different input terminals
	02h	R	Each bit corresponds to the different input terminals
	03h~40h	R	Reserved
	41h	RW	Each bit corresponds to the different output terminals
	42h~60h	R	Reserved
	61h	R	AVI (%)
	62h	R	ACI (%)
	63h	R	AUI (%)
	64h~A0h	R	Reserved
	A1h	RW	AFM1 (%)
	A2h	RW	AFM2 (%)

Delta Standard Mode (New definition)

Index	sub	R/W	Size	Descriptions			Speed Mode	Position Mode	Home Mode	Torque Mode	
				bit	Definition	Priority					
2060h	00h	R	U8								
	01h	RW	U16	0	Ack	4	0:fcmd =0 1:fcmd = Fset(Fpid)	Pulse 1: Position control	Pulse 1: Return to home		
				1	Dir	4	0: FWD run command 1: REV run command				
				2							
				3	Halt		0: drive run till target speed is attained 1: drive stop by declaration setting				
				4	Hold		0: drive run till target speed is attained 1: frequency stop at current frequency				
				5	JOG		0:JOG OFF Pulse 1:JOG RUN				
				6	QStop		Quick Stop				

Index	sub	R/W	Size	Descriptions			Speed Mode	Position Mode	Home Mode	Torque Mode
				bit	Definition	Priority				
				7	Power		0:Power OFF 1:Power ON	0:Power OFF 1:Power ON	0:Power OFF 1:Power ON	0:Power OFF 1:Power ON
				14~8	Cmd SW		Multi-step frequency switching	Multi-step position switching		
				15			Pulse 1: Fault code cleared	Pulse 1: Fault code cleared	Pulse 1: Fault code cleared	Pulse 1: Fault code cleared
	02h	RW	U16							
	03h	RW	U16				Speed command (unsigned decimal)			
	04h	RW	U16							
	05h	RW	S32					Position command		
	06h	RW								
	07h	RW	U16							Torque command (signed decimal)
08h	RW	U16							Speed limit (unsigned decimal)	
2061h	01h	R	U16	0	Arrive		Frequency attained	Position attained	Homing complete	Torque attained
				1	Dir		0: Motor FWD run 1: Motor REV run	0: Motor FWD run 1: Motor REV run	0: Motor FWD run 1: Motor REV run	0: Motor FWD run 1: Motor REV run
				2	Warn		Warning	Warning	Warning	Warning
				3	Error		Error detected	Error detected	Error detected	Error detected
				4						
				5	JOG		JOG	JOG	JOG	JOG
				6	QStop		Quick stop	Quick stop	Quick stop	Quick stop
				7	Power On		Switch ON	Switch ON	Switch ON	Switch ON
	15~8									
	02h	R								
	03h	R	U16				Actual output frequency	Actual output frequency	Actual output frequency	Actual output frequency
	04h	R								
	05h	R	S32				Actual position (absolute)	Actual position (absolute)	Actual position (absolute)	Actual position (absolute)
06h	R									
07h	R	S16				Actual torque	Actual torque	Actual torque	Actual torque	

DS402 Standard

Index	Sub	Definition	Factory Setting	R/W	Size	Unit	PDO Map	Mode	Note
6007h	0	Abort connection option code	2	RW	S16		Yes		0: No action 2: Disable Voltage, 3: quick stop
603Fh	0	Error code	0	R0	U16		Yes		
6040h	0	Control word	0	RW	U16		Yes		
6041h	0	Status word	0	R0	U16		Yes		
6042h	0	vl target velocity	0	RW	S16	rpm	Yes	vl	
6043h	0	vl velocity demand	0	RO	S16	rpm	Yes	vl	
6044h	0	vl control effort	0	RO	S16	rpm	Yes	vl	
604Fh	0	vl ramp function time	10000	RW	U32	1ms	Yes	vl	Unit must be: 100ms, and check if the setting is set to 0.
6050h	0	vl slow down time	10000	RW	U32	1ms	Yes	vl	
6051h	0	vl quick stop time	1000	RW	U32	1ms	Yes	vl	
605Ah	0	Quick stop option code	2	RW	S16		No		0 : disable drive function 1 :slow down on slow down ramp 2: slow down on quick stop ramp

Index	Sub	Definition	Factory Setting	R/W	Size	Unit	PDO Map	Mode	Note
									5 slow down on slow down ramp and stay in QUICK STOP
									6 slow down on quick stop ramp and stay in QUICK STOP
605Ch	0	Disable operation option code	1	RW	S16		No		0: Disable drive function 1: Slow down with slow down ramp; disable of the drive function
6060h	0	Mode of operation	2	RW	S8		Yes		1: Profile Position Mode 2: Velocity Mode 4: Torque Profile Mode 6: Homing Mode
6061h	0	Mode of operation display	2	RO	S8		Yes		Same as above
6064h	0	pp Position actual value	0	RO	S32		Yes	pp	
6071h	0	tq Target torque	0	RW	S16	0.1%	Yes	tq	Valid unit: 1%
6072h	0	tq Max torque	150	RW	U16	0.1%	No	tq	Valid unit: 1%
6075h	0	tq Motor rated current	0	RO	U32	mA	No	tq	
6077h	0	tq torque actual value	0	RO	S16	0.1%	Yes	tq	
6078h	0	tq current actual value	0	RO	S16	0.1%	Yes	tq	
6079h	0	tq DC link circuit voltage	0	RO	U32	mV	Yes	tq	
607Ah	0	pp Target position	0	RW	S32	1	Yes	pp	

15.5 CANopen Fault Code

Setting *	Display	Fault code	Description	CANopen fault code (bit 0~7)	CANopen fault register
1	Fault ocA Oc at accel	0001H	Over-current during acceleration	1	2213H
2	Fault ocd Oc at decel	0002H	Over-current during deceleration	1	2213H
3	Fault ocn Oc at normal SPD	0003H	Over-current during steady status operation	1	2214H
4	Fault GFF Ground fault	0004H	Ground fault. When (one of) the output terminal(s) is grounded, short circuit current is more than 50% of AC motor drive rated current. NOTE: The short circuit protection is provided for AC motor drive protection, not for protection of the user.	1	2240H
5	Fault occ Short Circuit	0005H	Short-circuit is detected between upper bridge and lower bridge of the IGBT module.	1	2250H
6	Fault ocS Oc at stop	0006H	Over-current at stop. Hardware failure in current detection	1	2214H
7	Fault ovA Ov at accel	0007H	Over-current during acceleration. Hardware failure in current detection	2	3210H
8	Fault ovd Ov at decel	0008H	Over-current during deceleration. Hardware failure in current detection.	2	3210H
9	Fault ovn Ov at normal SPD	0009H	Over-current during steady speed. Hardware failure in current detection.	2	3210H
10	Fault ovS Ov at stop	000AH	Over-voltage at stop. Hardware failure in current detection	2	3210H

Setting *	Display	Fault code	Description	CANopen fault code (bit 0~7)	CANopen fault register
11	Fault LvA Lv at accel	000BH	DC BUS voltage is less than Pr.06.00 during acceleration.	2	3220H
12	Fault Lvd Lv at decel	000CH	DC BUS voltage is less than Pr.06.00 during deceleration.	2	3220H
13	Fault Lvn Lv at normal SPD	000DH	DC BUS voltage is less than Pr.06.00 in constant speed.	2	3220H
14	Fault LvS Lv at stop	000EH	DC BUS voltage is less than Pr.06-00 at stop	2	3220H
15	Fault OrP Phase Lacked	000FH	Phase Loss Protection	2	3130H
16	Fault oH1 IGBT over heat	0010H	IGBT overheat IGBT temperature exceeds protection level. 1~15HP: 90°C 20~100HP: 100°C	3	4310H
17	Fault oH2 Hear Sink oH	0011H	Heat sink overheat Heat sink temperature exceeds 90oC	3	4310H
18	Fault tH1o Thermo 1 open	0012H	Temperature detection circuit error (IGBT) IGBT NTC	3	FF00H
19	Fault tH2o Thermo 2 open	0013H	Temperature detection circuit error (capacity module) CAP NTC	3	FF01H
21	Fault oL Inverter oL	0015H	Overload. The AC motor drive detects excessive drive output current. NOTE: The AC motor drive can withstand up to 150% of the rated current for a maximum of 60 seconds.	1	2310H
22	Fault EoL1 Thermal relay 1	0016H	Electronics thermal relay 1 protection	1	2310H

Setting *	Display	Fault code	Description	CANopen fault code (bit 0~7)	CANopen fault register
23	Fault EoL2 Thermal relay 2	0017H	Electronics thermal relay 2 protection	1	2310H
24	Fault oH3 Motor over heat	0018H	Motor overheating The AC motor drive detecting internal temperature exceeds the setting of Pr.06-30 (PTC level) or Pr.06-57 (PT100 level 2).	3	FF20H
26	Fault ot1 Over torque 1	001AH	These two fault codes will be displayed when output current exceeds the over-torque detection level (Pr.06.07 or Pr.06.10) and exceeds over-torque detection (Pr.06.08 or Pr.06.11) and it is set 2 or 4 in Pr.06-06 or Pr.06-09.	3	8311H
27	Fault ot2 Over torque 2	001BH		3	8311H
28	Fault uC Under torque 1	001CH	Low current	1	8321H
29	Fault LMIT Limit Error	001DH	Limit error	1	7320H
30	Fault cF1 EEPROM write Err	001EH	Internal EEPROM can not be programmed.	5	5530H
31	Fault cF2 EEPROM read Err	001FH	Internal EEPROM can not be read.	5	5530H
33	Fault cd1 Ias sensor Err	0021H	U-phase error	1	FF04H
34	Fault cd2 Ibs sensor Err	0022H	V-phase error	1	FF05H
35	Fault cd3 Ics sensor Err	0023H	W-phase error	1	FF06H

Setting *	Display	Fault code	Description	CANopen fault code (bit 0~7)	CANopen fault register
36	Fault Hd0 cc HW Error	0024H	cc (current clamp) hardware error	5	FF07H
37	Fault Hd1 oc HW Error	0025H	oc hardware error	5	FF08H
38	Fault Hd2 ov HW Error	0026H	ov hardware error	5	FF09H
39	Fault Hd3 GFF HW Error	0027H	GFF hardware error	5	FF0AH
40	Fault AUE Auto tuning Err	0028H	Auto tuning error	1	FF21H
41	Fault AFE PID Fbk Error	0029H	PID loss (ACI)	7	FF22H
42	Fault PGF1 PG Fbk Error	002AH	PG feedback error	7	7301H
43	Fault PGF2 PG Fbk Loss	002BH	PG feedback loss	7	7301H
44	Fault PGF3 PG Fbk Over SPD	002CH	PG feedback stall	7	7301H
45	Fault PGF4 PG Fbk deviate	002DH	PG slip error	7	7301H
48	Fault ACE ACI loss	0030H	ACI loss	1	FF25H

Setting *	Display	Fault code	Description	CANopen fault code (bit 0~7)	CANopen fault register
49	Fault EF External Fault	0031H	External Fault When input EF (N.O.) on external terminal is closed to GND, AC motor drive stops output U, V, and W.	5	9000H
50	Fault EF1 Emergency stop	0032H	Emergency stop When the multi-function input terminals MI1 to MI6 are set to emergency stop, the AC motor drive stops output U, V, W and the motor coasts to stop.	5	9000H
51	Fault bb Base block	0033H	External Base Block When the external input terminals MI1 to MI16 are set as bb and active, the AC motor drive output will be turned off	5	9000H
52	Fault Pcod Password Error	0034H	Password will be locked if three fault passwords are entered	5	FF26H
54	Fault cE1 Modbus CMD err	0036H	Illegal function code	4	7500H
55	Fault cE2 Modbus ADDR err	0037H	Illegal data address (00H to 254H)	4	7500H
56	Fault cE3 Modbus DATA err	0038H	Illegal data value	4	7500H
57	Fault cE4 Modbus slave FLT	0039H	Data is written to read-only address	4	7500H
58	Fault cE10 Modbus time out	003AH	Modbus transmission timeout.	4	7500H
60	Fault bF Braking fault	003CH	Brake resistor fault	5	7110H

Setting *	Display	Fault code	Description	CANopen fault code (bit 0~7)	CANopen fault register
61	Fault ydc Y-delta connect	003DH	Motor Y-Δ switch error	2	3330H
62	Fault dEb Dec. Energy back	003EH	Energy regeneration when decelerating	2	FF27H
63	Fault oSL Over slip Error	003FH	Over slip error. Slip exceeds Pr.05.26 limit and slip duration exceeds Pr.05.27 setting.	7	FF28H
64	Fault ryF MC Fault	0040H	Electric valve switch error when executing Soft Start. (This warning is for frame E and higher frame of AC drives) Do not disconnect RST when drive is still operating.	5	7110H
65	Fault PGF5 PG HW Error	0041H	PG Card Error	5	FF29H
68	Fault SdRv SpdFbk Dir Rev	0044H	Rotating direction is different from the commanding direction detected by the sensorless. Solution Verify if the parameter setting of the motor drive is correct Increase the estimator's bandwidth and verify if parameters relating to the sensorless are correct.	7	8400H
69	Fault SdOr SpdFbk over SPD	0045H	Overspeed rotation detected by the sensorless Solution Verify if the parameter setting of the motor drive is correct Increase the estimator's bandwidth and verify if parameters relating to the sensorless are correct. Verify if the gains of the speed circuit is reasonable.	7	8400H
70	Fault SdDe SpdFbk deviate	0046H	Big difference between the rotating speed and the command detected by the sensorless Solution Verify if the parameter setting of the motor drive is correct Increase the estimator's bandwidth and verify if parameters relating to the sensorless are correct. Verify if the gains of the speed circuit is reasonable.	7	8400H
73	Fault S1 S1-Emergy stop	0049H	external safety emergency stop	5	FF2AH

Setting *	Display	Fault code	Description	CANopen fault code (bit 0~7)	CANopen fault register
82	Fault OPHL U phase lacked	0052H	U phase output phase loss	2	2331H
83	Fault OPHL U phase lacked	0053H	V phase output phase loss	2	2332H
84	Fault OPHL U phase lacked	0054H	W phase output phase loss	2	2333H
85	Fault AboF PG ABZ Line off	0055H	PG card ABZ signal loss Solution Verify if the parameter setting of PG card and PG card cable is correct.	5	7301H
86	Fault UvoF PG UVW Line off	0056H	PG card UVW signal loss Solution Verify if the parameter setting of PG card and PG card cable is correct.	5	7301H
89	Fault RoPd Rotor Pos. Error	0059H	Rotor position detection error Solution Verify if the UVW output cable are loss. Verify if the motor internal coil is broken. Verify if the drive UVW output are normal.	7	FF30H
90	Fault Fstp Force Stop	005AH	Internal PLC forced to stop Verify the setting of Pr.00-32	7	FF2EH
101	Fault CGdE Guarding T-out	0065H	Guarding time-out 1	4	8130H
102	Fault CHbE Heartbeat T-out	0066H	Heartbeat time-out	4	8130H
104	Fault CbFE CAN/S bus off	0068H	CAN bus off	4	8140H
105	Fault CIdE CAN/S Idx exceed	0069H	CAN index exceed	4	8100H

Setting *	Display	Fault code	Description	CANopen fault code (bit 0~7)	CANopen fault register
106	Fault CADE CAN/S add. set	006AH	CAN address error	4	8100H
107	Fault CFrE Can bus off	006BH	CAN frame fail	4	8100H
111	Fault ictE InrCom Time Out	006FH	Internal communication time-out	4	7500H
112	Fault SfLK PMLess ShaftLock	0070H	Motor Shaft lock error(Motor does not turn but the output frequency is not zero) Solution Verify if the motor parameter setting is correct.	7	FF31H

15.6 CANopen LED Function

There are two CANopen flash signs: RUN and ERR.

RUN LED:

LED status	Condition	CANopen State
OFF		Initial
Blinking		Pre-Operation
Single flash		Stopped
ON		Operation

ERR LED:

LED status	Condition/ State
OFF	No Error
Single flash	One Message fail
Double flash	Guarding fail or heartbeat fail
Triple flash	SYNC fail
ON	Bus off

Chapter 16 PLC Function

- 16-1 PLC Summary
- 16-2 Notes before PLC use
- 16-3 Turn on
 - 16-3-1 Connect to PC
 - 16-3-2 I/O device explanation
 - 16-3-3 Installation WPLSoft
 - 16-3-4 Program writing
 - 16-3-5 Program download
 - 16-3-6 Program monitoring
- 16-4 Basic principles of PLC ladder diagrams
 - 16-4-1 Schematic diagram of PLC ladder diagram program scanning
 - 16-4-2 Introduction to ladder diagrams
 - 16-4-3 Overview of PLC ladder diagram editing
 - 16-4-4 Commonly-used basic program design examples
- 16-5 Various PLC device functions
 - 16-5-1 Introduction to device functions
 - 16-5-2 Introduction to special relay functions (special M)
 - 16-5-3 Introduction to special register functions (special D)
 - 16-5-4 PLC Communication address
- 16-6 Introduction to the Command Window
 - 16-6-1 Overview of basic commands
 - 16-6-2 Detailed explanation of basic commands
 - 16-6-3 Overview of application commands
 - 16-6-4 Detailed explanation of applications commands
 - 16-6-5 Detailed explanation of driver special applications commands
- 16-7 Error display and handling
- 16-8 CANopen Master control applications
- 16-9 Explanation of various PLC mode controls (speed, torque, homing, and position)
- 16-10 Internal communications main node control
- 16-11 Count function using MI8
 - 16-11-1 High-speed count function
 - 16-11-2 Frequency calculation function
- 16-12 Modbus remote IO control applications (use MODRW)
- 16-13 Calendar

16-1 PLC Summary

16-1-1 Introduction

The commands provided by the CT2000's built-in PLC functions, including the ladder diagram editing tool WPLSoft, as well as the usage of basic commands and applications commands, chiefly retain the operating methods of Delta's PLC DVP series.

16-1-2 WPLSoft ladder diagram editing tool

WPLSoft is Delta's program editing software for the DVP and CT2000 programmable controllers in the Windows operating system environment. Apart from general PLC program design general Windows editing functions (such as cut, paste, copy, multiple windows, etc.), WPLSoft also provides many Chinese/English annotation editing and other convenience functions (such as registry editing, settings, file reading, saving, and contact graphic monitoring and settings, etc.).

The following basic requirements that need to install WPLSoft editing software:

Item	System requirements
Operating system	Windows 95/98/2000/NT/ME/XP
CPU	At least Pentium 90
Memory	At least 16MB (we recommend at least 32MB)
Hard drive	Hard drive capacity: at least 100MB free space One optical drive (for use in installing this software)
Display	Resolution: 640×480, at least 16 colors; it is recommended that the screen area be set at 800×600 pixels
Mouse	Ordinary mouse or Windows-compatible device
Printer	Printer with a Windows driver program
RS-485 port	Must have at least an RS-485 port to link to the PLC
Suitable PLC models	Delta's full DVP-PLC series, VFD-CT2000 series

16-2 Notes before PLC use

1. The PLC has a preset communications format of 7,N,2,9600, with node 2; the PLC node can be changed in parameter 09-35, but this address may not be the same as the converter's address setting of 09-00.
2. The CT2000 provides 2 communications serial ports that can be used to download PLC programs (see figure below). Channel 1 has a fixed communications format of 19200,8,N,2 RTU.

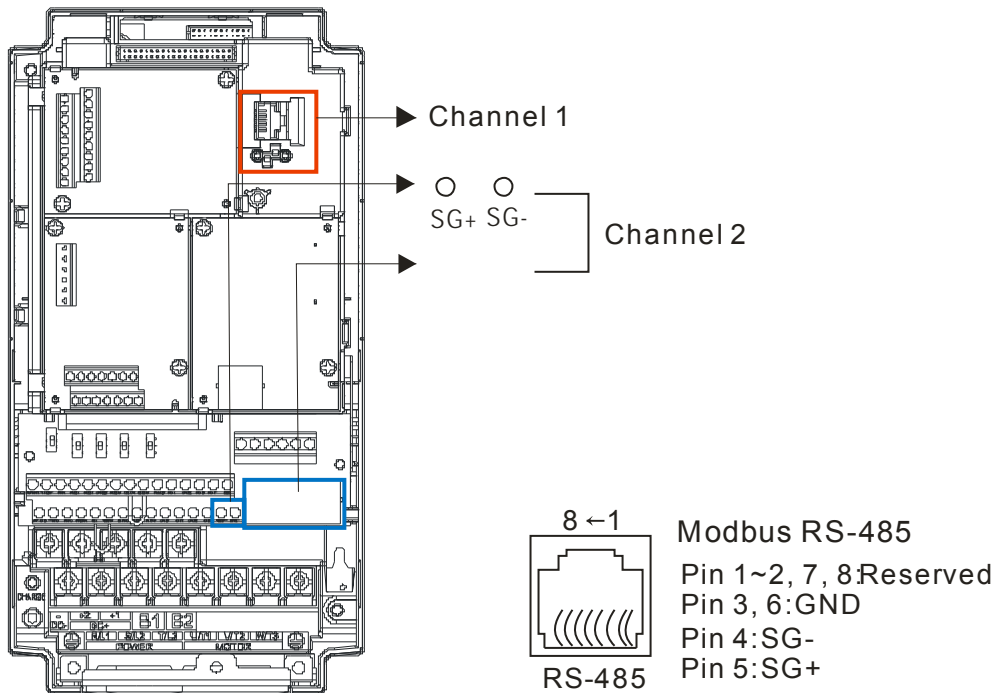

3. The client can simultaneously access data from the converter and internal PLC, which is performed through identification of the node. For instance, if the converter node is 1 and the internal PLC node is 2, then the client command will be
01 (node) 03 (read) 0400 (address) 0001 (1 data item), indicating that it must read the data in converter parameter 04-00
02 (node) 03 (read) 0400 (address) 0001 (1 data item), indicating that it must read the data in internal PLC X0
4. The PLC program will be disabled when uploading/downloading programs.
5. Please note when using WPR commands to write in parameters, values may be modified up to a maximum of 10^9 times, otherwise a memory write error will occur. The calculation of modifications is based on whether the entered value has been changed. If the entered value is left unchanged, the modifications will not increase afterwards. But if the entered value is different from before, the number of modifications will increase by one.
6. When parameter 00-04 is set as 28, the displayed value will be the value of PLC register D1043 (see figure below):

Digital Keypad KPC-CC01 Can display 0~65535	Digital Keypad KPC-CE01 0~9999
--	-----------------------------------

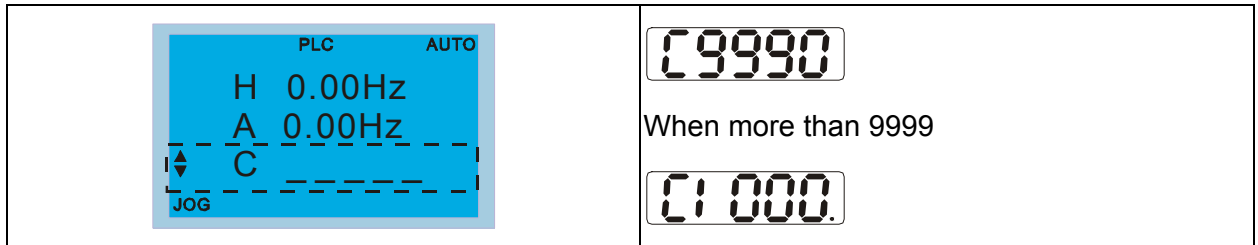

7. In the PLC Run and PLC Stop mode, the content 9 and 10 of parameter 00-02 cannot be set and cannot be reset to the default value.
8. The PLC can be reset to the default value when parameter 00-02 is set as 6.
9. The corresponding MI function will be disabled when the PLC writes to input contact X.
10. When the PLC controls converter operation, control commands will be entirely controlled by the PLC and will not be affected by the setting of parameter 00-21.
11. When the PLC controls converter frequency commands (FREQ commands), frequency commands will be entirely controlled by the PLC, and will not be affected by the setting of parameter 00-20 or the Hand ON/OFF configuration.
12. When the PLC controls converter frequency (TORQ commands), torque commands will be entirely controlled by the PLC, and will not be affected by the setting of parameter 11-33 or the Hand ON/OFF configuration.
13. When the PLC controls converter frequency (POS commands), position commands will be entirely controlled by the PLC, and will not be affected by the setting of parameter 11-40 or the Hand ON/OFF configuration.
14. When the PLC controls converter operation, if the keypad Stop setting is valid, this will trigger an FStP error and cause stoppage.

16-3 Turn on

16-3-1 Connect to PC

Start operation of PLC functions in accordance with the following four steps

1. After pressing the Menu key and selecting **4: PLC** on the KPC-CC01 digital keypad, press the Enter key (see figure below).

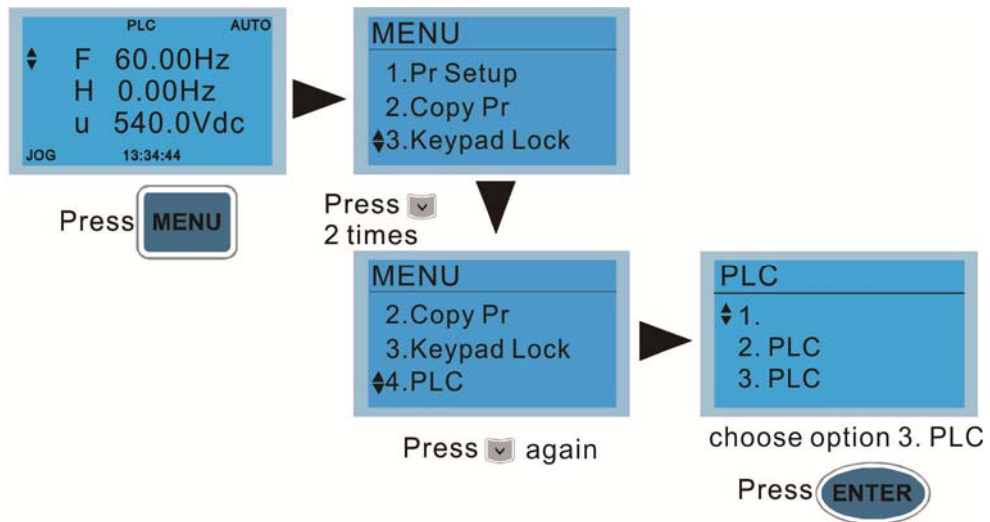

NOTE

If the optional KPC-CE01 digital keypad is used, employ the following method:

Switch to the main PLC2 screen: After powering up the drivers, press the key on the KPC-CE01 once to

switch to the function screen, which will then display "PrSET." After using the up or down button to switch to the

"PLC" screen, and then press to enter PLC function settings. Afterwards, press the Up key to switch to the

"PLC2," and then press . The screen will now display "PLSn" and flash, indicating that the internal PLC currently has no program, and this error message can be ignored. If the PLC has an editing program, the screen will display "End," and will jump back to "PLC2" after 1 to 2 seconds. When no program has been downloaded to the drivers, the program can continue to run even if a PLC warning message appears.



2. Wiring: Connect the driver's RJ-45 communications interface to a PC via the RS485



3. PLC function usage

<div style="border: 1px solid black; background-color: #00AEEF; color: white; padding: 5px;"> <p style="margin: 0;">PLC</p> <p style="margin: 0;">◆ 1.Disable</p> <p style="margin: 0;">2.PLC Run</p> <p style="margin: 0;">3.PLC Stop</p> </div>	<ul style="list-style-type: none"> ■ PLC functions are as shown in the figure on the left; select item 2 and implement PLC functions. 1: No function (Disable) 2: Enable PLC (PLC Run) 3: Stop PLC functions (PLC Stop)
Optional product: PLC function display method on KPC-CE01 digital keypad	PLC 0 : Do not implement PLC functions PLC 1 : Initiate PLC Run PLC 2 : Initiate PLC Stop

- When the external multifunctional input terminals (MI1 to MI8) are in PLC Mode select bit0 (51) or PLC Mode select bit1 (52), and the terminal contact is closed or open, it will compulsorily switch to the PLC mode, and keypad switching will be ineffective. Corresponding actions are as follows:

PLC mode		PLC Mode select bit1(52)	PLC Mode select bit0 (51)
Using KPC-CC01	Using KPC-CE01		
Disable	PLC 0	OFF	OFF
PLC Run	PLC 1	OFF	ON
PLC Stop	PLC 2	ON	OFF
Maintain previous state	Maintain previous state	ON	ON

Use of KPC-CE01 digital keypad to implement PLC functions

- ☑ When the PLC screen switches to the PLC1 screen, this will trigger one PLC action, and the PLC program start/stop can be controlled by communications via the WPL.
- ☑ When the PLC screen switches to the PLC2 screen, this will trigger one PLC stop, and the PLC program start/stop can be controlled by communications via the WPL.
- ☑ The external terminal control method is the same as shown in the table above.

NOTE

- When input/output terminals (FWD REV MI1 to MI8 MI10 to 15, Relay1, Relay2 RY10 to RY15, MO1 to MO2 MO10 to MO11,) are included in the PLC program, these input/output terminals will only be used by the PLC. As an example, when the PLC program controls Y0 during PLC operation (PLC1 or PLC2), the corresponding output terminal relay(RA/RB/RC) will operate in accordance with the program. At this time, the multifunctional input/output terminal setting will be ineffective. Because these terminal functions are already being used by the PLC, the DI DO AO in use by the PLC can be determined by looking at parameter 02-52, 02-53, and 03-30.
- When the PLC's procedures use special register D1040, the corresponding AO contact AFM1 will be occupied, and AFM2 corresponding to special register D1045 will have the same situation.
- Parameter 03-30 monitors the state of action of the PLC function analog output terminal; Bit0 corresponds to the AFM1 action state, and Bit1 corresponds to the AFM2 action state.

16-3-2 I/O device explanation

Input devices:

Serial No.	X0	X1	X2	X3	X4	X5	X6	X7	X10	X11	X12	X13	X14	X15	X16	X17
1	FWD	REV	MI1	MI2	MI3	MI4	MI5	MI6	MI7	MI8						
2											MI10	MI11	MI12	MI13	MI14	MI15
3											MI10	MI11	MI12	MI13		

1: Control I/O |

2: Expansion card EMC-D611A (D1022=4)

3: Expansion card EMC-D42A (D1022=5)

Output devices:

Serial No.	Y0	Y1	Y2	Y3	Y4	Y5	Y6	Y7	Y10	Y11	Y12	Y13	Y14	Y15	Y16	Y17
1	RY1	RY2		MO1	MO2											
2						MO10	MO11									
3						RY10	RY11	RY12	RY13	RY14	RY15					

1: Control I/O |

2: Expansion card EMC-D42A (D1022=5)

3: Expansion card EMC-R6AA (D1022=6)

16-3-3 Installation WPLSoft

See Delta's website for WPLSoft editing software:

<http://www.delta.com.tw/industrialautomation/download>.

16-3-4 Program writing

After completing installation, the WPLSoft program will be installed in the designated subfolder "C:\Program Files\Delta Industrial Automation\WPLSoft x.xx." The editing software can now be run by clicking on the WPL icon using the mouse.



The WPL editing window will appear after 3 seconds (see figure below). When running WPLSoft for the first time, before "New file" has been used, only the "File (F)," "Communications (C)," View (V)," "Options (O)," and "Help (H)" columns will appear on the function toolbar.

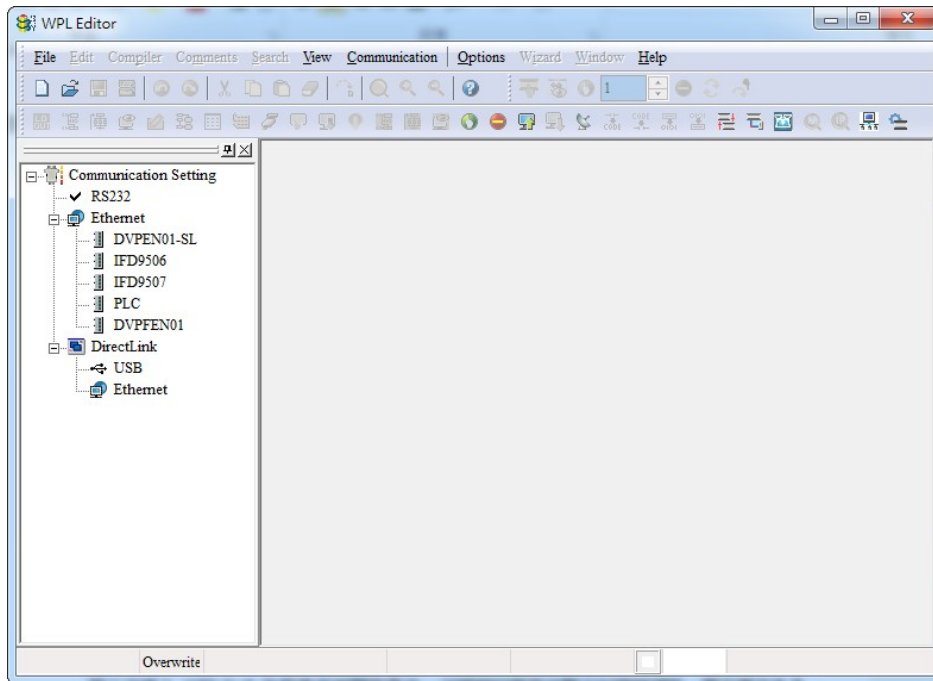

After running WPLSoft for the second time, the last file edited will open and be displayed in the editing window. The following figure provides an explanation of the WPLSoft editing software window:

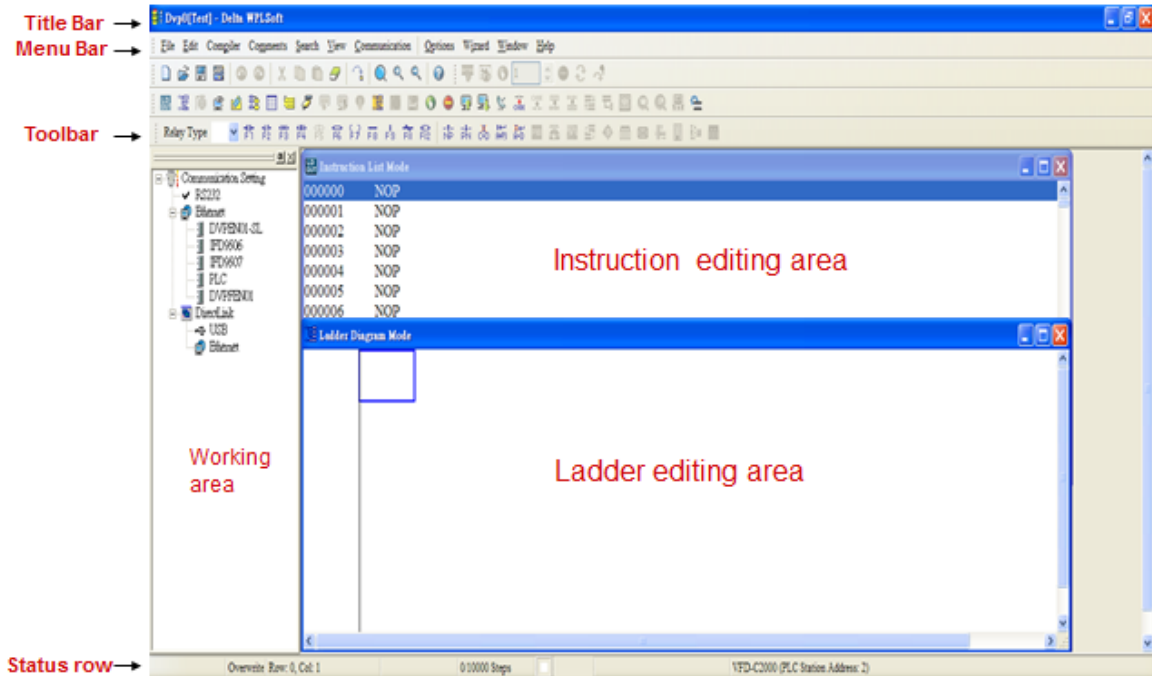

Click on the  icon on the toolbar in the upper left part of the screen: opens new file (Ctrl+N)



You can also use "File (F)"=> New file (N) (Ctrl+N)

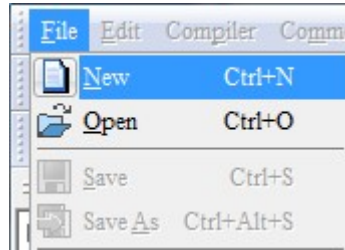

The "Device settings" window will appear after clicking. You can now enter the project title and filename, and select the device and communication settings to be used

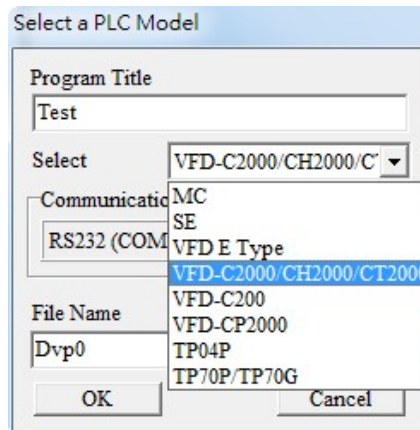

Communications settings: Perform settings in accordance with the desired communications method

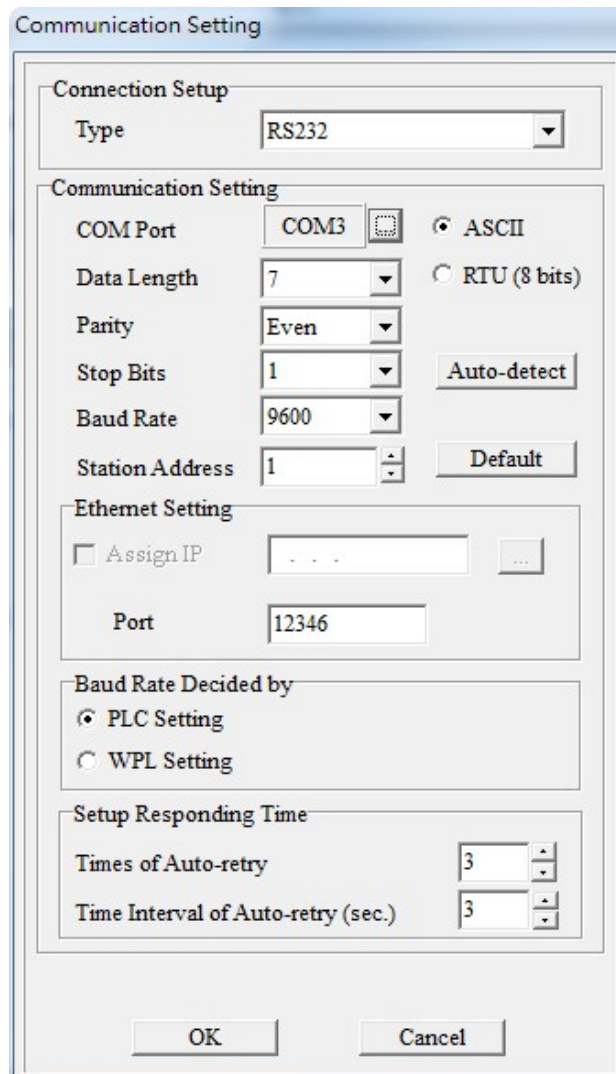

Press Confirm after completing settings and begin program editing. There are two program editing methods; you can choose whether to perform editing in the command mode or the ladder diagram mode.

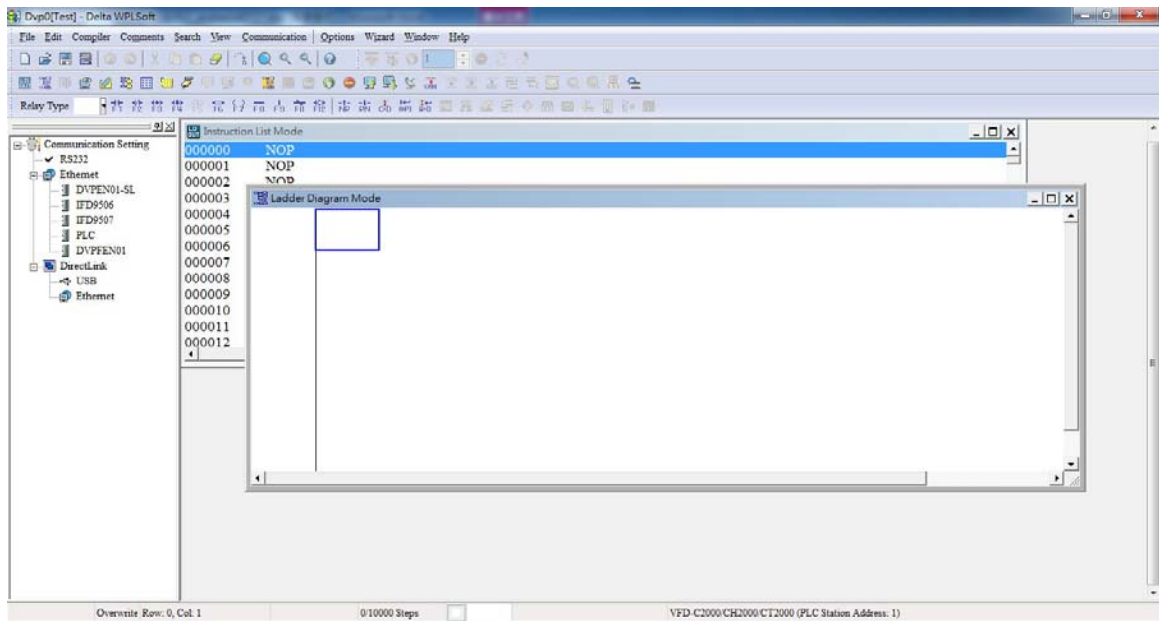

In ladder diagram mode, you can perform program editing using the buttons on the function icon row

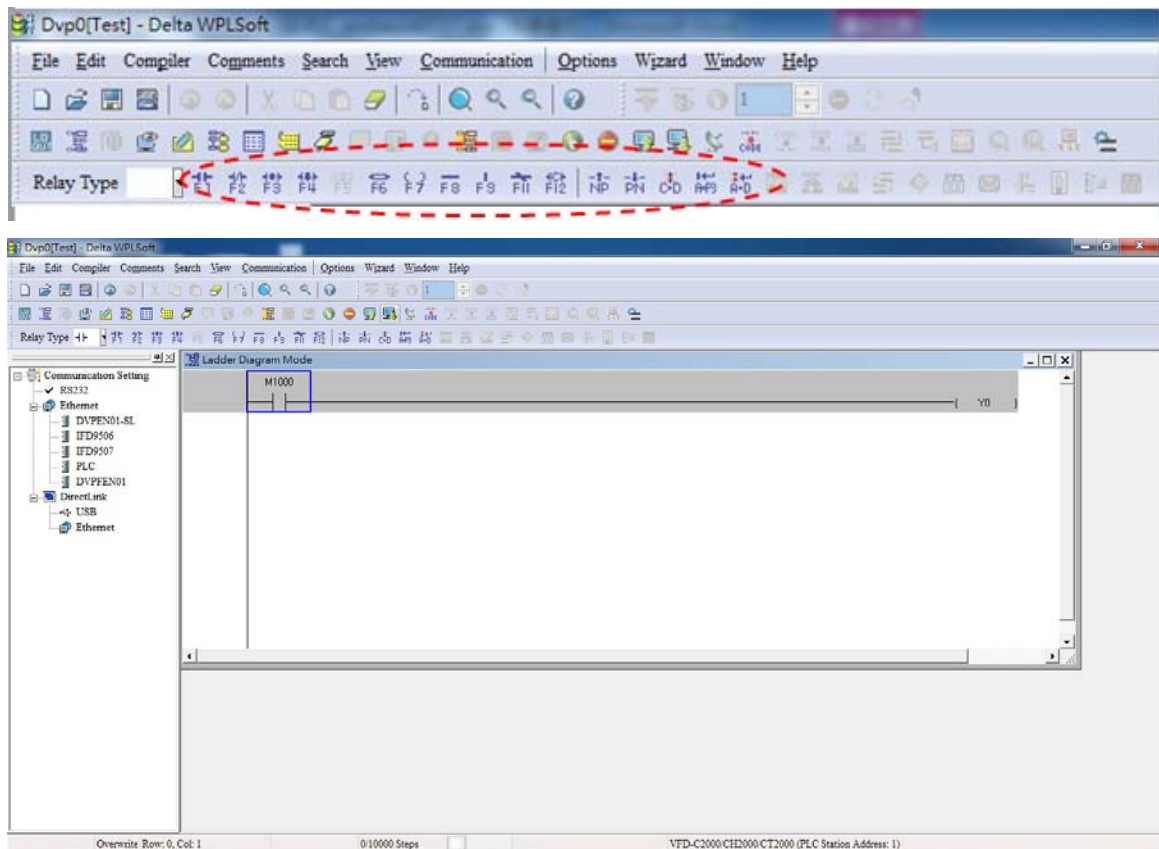

Basic Operation

Example: Input the ladder diagram in the following figure

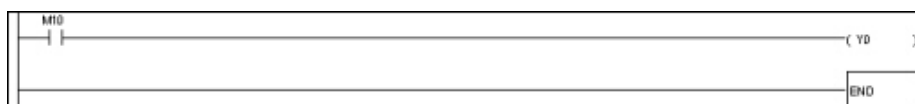

Mouse operation and keyboard function key (F1 to F12) operation

1. The following screen will appear after a new file has been established:

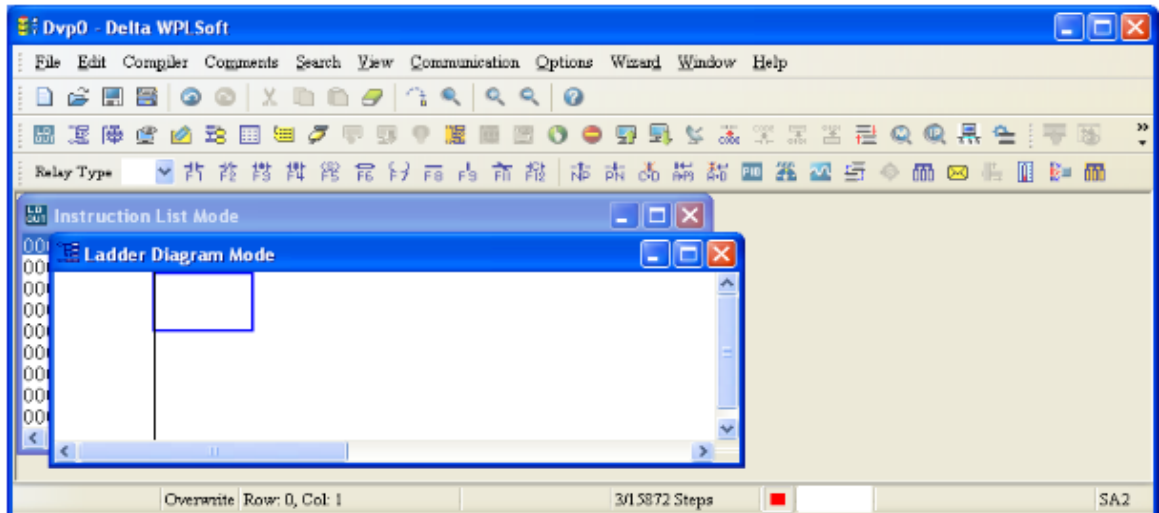

2. Use the mouse to click on the always-open switch icon  or press the function key F1:

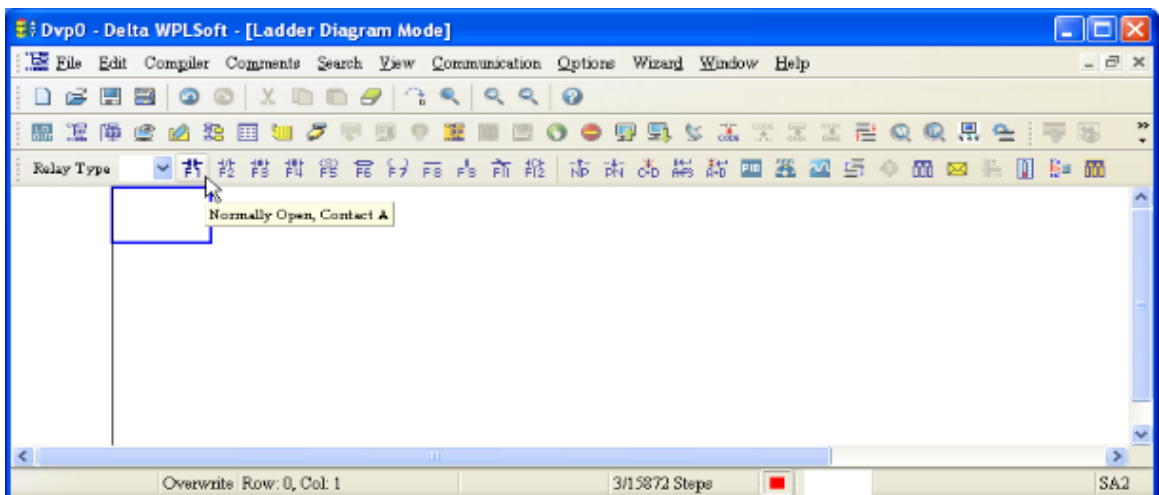

3. After the name of the input device and the comment dialog box have appeared, the device name (such as "M"), device number (such as "10"), and input comments (such as "auxiliary contact") can be selected; press the Confirm button when finished.

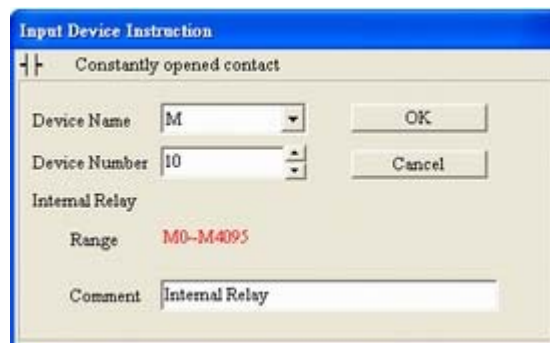

- Click on the output coil icon  or press function key F7. After the name of the input device and the comment dialog box have appeared, the device name (such as "Y"), device number (such as "0"), and input comments (such as "output coil") can be selected; press the Confirm button when finished.

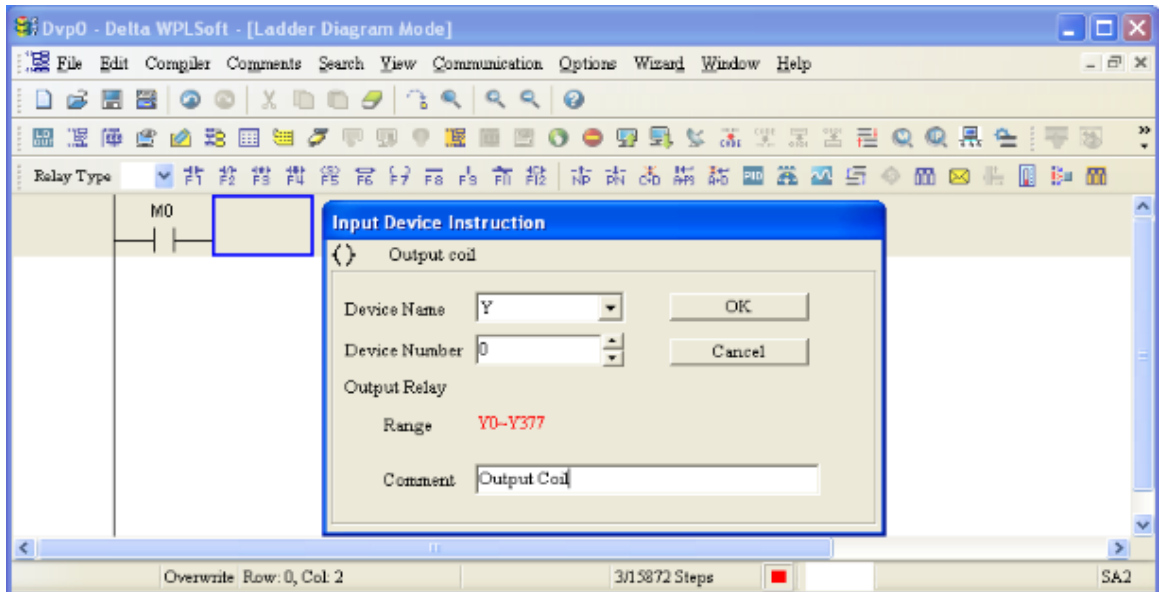

- Click on application command icon  or press function key F6. Click on "All application commands" in the function classification field, and click on the End command in the application command pull-down menu, or use the keyboard to key in "End" in that field, and press the confirm button.

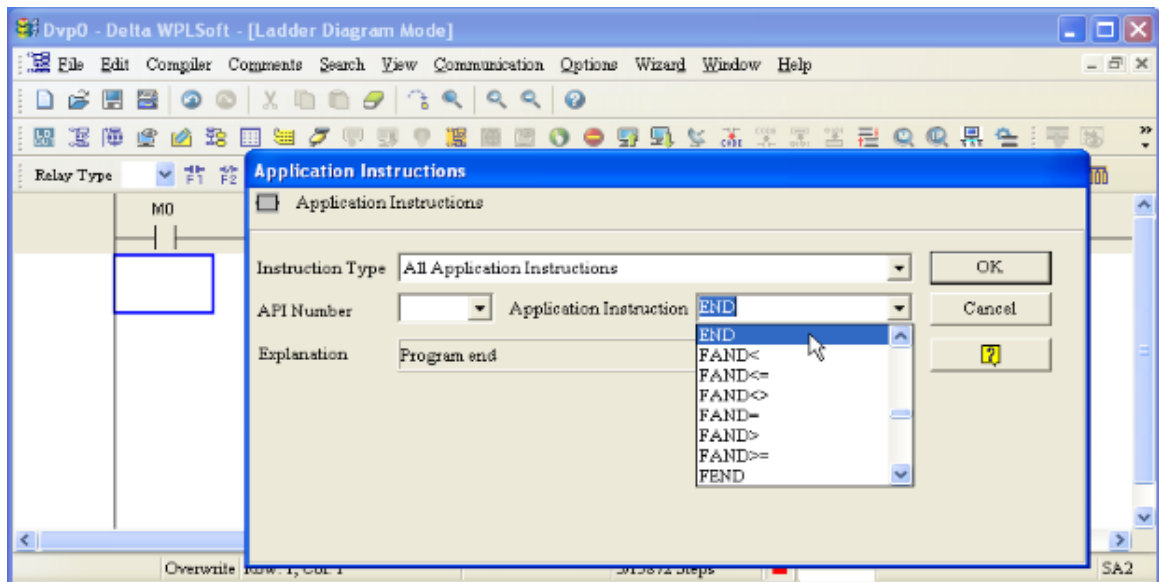

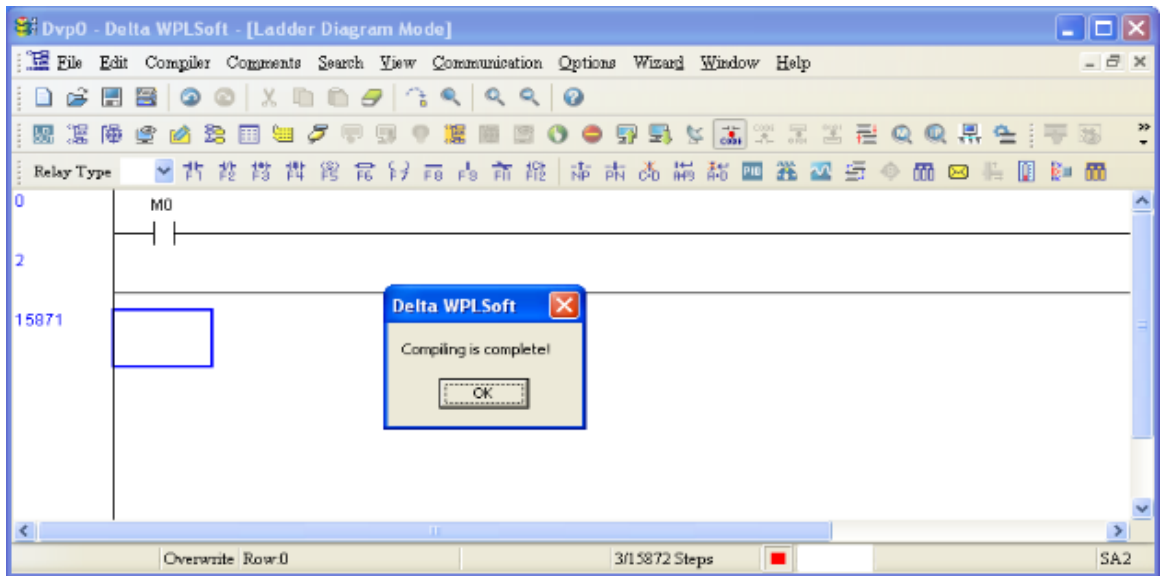

6. Click on the  icon, which will compile the edited ladder diagram as a command program.

After compiling, the number of steps will appear on the left side of the busbar.



16-3-5 Program download

After inputting a program using WPLSoft, select compile . After completing compilation, select the  to download a program. WPLSoft will perform program download with the online PLC in the communications format specified in communications settings.

16-3-6 Program monitoring

While confirming that the PLC is in the Run mode, after downloading a program, click on  in the communications menu and select start ladder diagram control (see figure below)

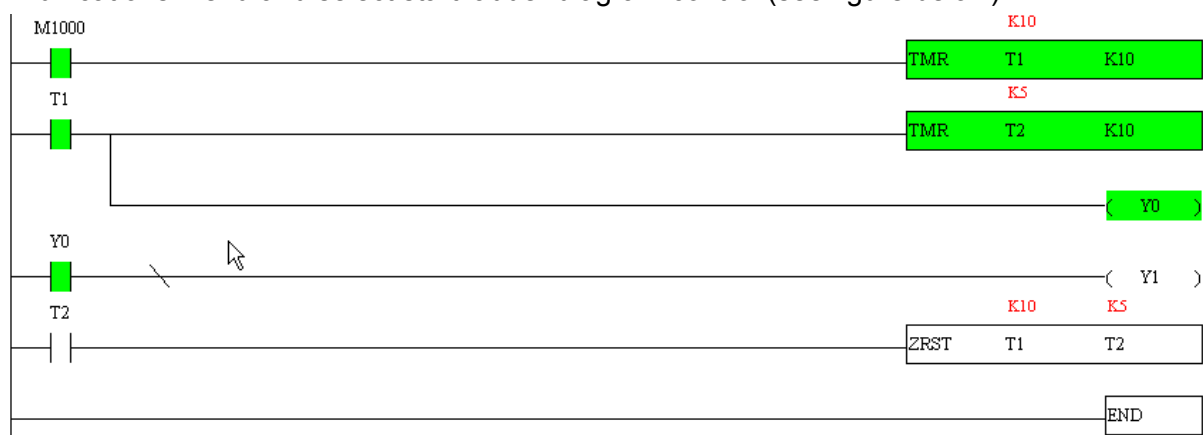

16-4 Basic principles of PLC ladder diagrams

16-4-1 Schematic diagram of PLC ladder diagram program scanning

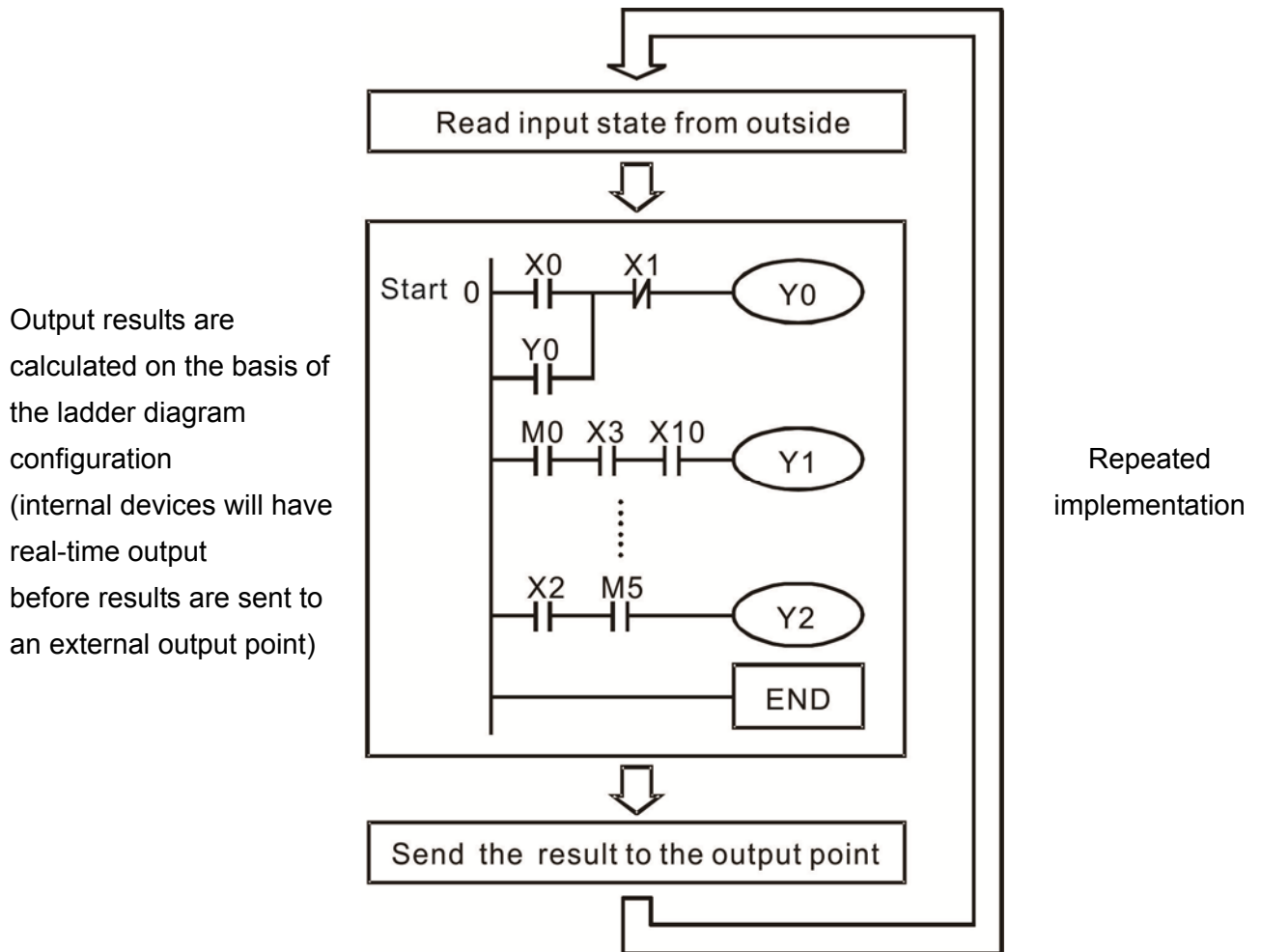

16-4-2 Introduction to ladder diagrams

Ladder diagrams comprise a graphic language widely applied in automatic control, and employs common electrical control circuit symbols. After a ladder diagram editor has been used to create a ladder pattern, PLC program designed is completed. The use of a graphic format to control processes is very intuitive, and is readily accepted by personnel who are familiar with electrical control circuit technology. Many of the basic symbols and actions in a ladder diagram comprise commonly-seen electrical devices in conventional automatic control power distribution panels, such as buttons, switches, relays, timers, and counters.

Internal PLC devices: The types and quantities of internal PLC devices vary in different brands of products. Although these internal devices use the same names as conventional electrical control circuit elements such as relays, coils, and contacts, a PLC does not actually contain these physical devices, and they instead correspond to basic elements in the PLC's internal memory (bits). For instance, if a bit is 1, this may indicate that a coil is electrified, and if that bit is 0, it will indicate that the coil is not electrified. An NO contact (Normal Open, or contact a) can be used to directly read the value of the corresponding bit, and an NC contact (Normal Close, or contact b) can be used to obtain the inverse of the bit's value. Multiple relays occupy multiple bits, and 8 bits comprise one byte; two

bytes comprise one word, and two words comprise a double word. When multiple relays are processing at the same time (such as addition/subtraction or displacement, etc.), a byte, word, or double word can be used. Furthermore, a PLC contains two types of internal devices: a timer and a counter. It not only has a coil, but can count time and numerical values. Because of this, when it is necessary to process some numerical values, these values are usually in the form of bytes, words, or double words.







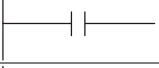
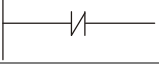
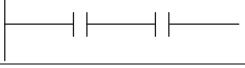

The various internal devices in a PLC all account for a certain quantity of storage units in the PLC's storage area. When these devices are used, the content of the corresponding storage area is read in the form of bits, bytes, or words.

Introduction to the basic internal devices in a PLC

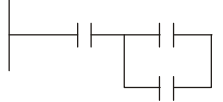
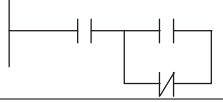
Device type	Description of Function
Input Relay	<p>An input relay constitutes the basic unit of storage in a PLC's internal memory corresponding to an external input point (which serves as a terminal connecting with an external input switch and receiving external input signals). It is driven by external input signals, to which it assigns values of 0 or 1. A program design method cannot change the input relay status, and therefore cannot rewrite the corresponding basic units of an input relay, and WPLSoft cannot be used to perform compulsory On/Off actions. A relay's contacts (contacts a and b) can be used an unlimited number of times. An input relay with no input signal must be left idle and cannot be used for some other purpose.</p> <p><input checked="" type="checkbox"/> Device indicated as: X0, X1, X7, X10, X11, etc. This device is expressed with the symbol "X," and a device's order is indicated with an octal number. Input point numbers are indicated in the main computer and in expansion devices.</p>
Output Relay	<p>An output relay constitutes the basic unit of storage in a PLC's internal memory corresponding to an external output point (which connects with an external load). It may be driven by an input relay contact, a contact on another internal device, or its own contacts. It uses one NO contact to connect with external loads or other contacts, and, like input contacts, can use the contact an unlimited number of times. An output relay with no input signal will be idle, but may be used an internal relay if needed.</p> <p><input checked="" type="checkbox"/> Device indicated as: Y0, Y1, Y7, Y10, Y11, etc. This device is expressed with the symbol "Y," and a device's order is indicated with an octal number. Output point numbers are indicated in the main computer and in expansion devices.</p>
Internal Relay	<p>Internal relays have no direct connection with the outside. These relays are auxiliary relays inside a PLC. Their function is the same as that of an auxiliary (central) relay in an electrical control circuit: Each auxiliary relay corresponding to a basic unit of internal storage; they can be driven by input relay contacts, output relay contacts, and the contacts of other internal devices. An internal auxiliary relay's contact can also be used an unlimited number of times. Internal relays have no outputs to outside, and must output via an output point.</p> <p><input checked="" type="checkbox"/> Device indicated as: M0, M1 to M799, etc. This device is expressed as the symbol "M," expressed, and its order is expressed as a decimal number.</p>
Counter	<p>A counter is used to perform counting operations. A count setting value (such as the number of pulses to be counted) must be assigned when a counter is used. A counter contains a coil, contact, and a counting storage device. When the coil goes from Off →to On, this indicates that the counter has an input pulse, and one is added to its count. There are 16 bits that can be employed by the user.</p> <p><input checked="" type="checkbox"/> Device indicated as: C0, C1 to C79, etc. This device is expressed as the symbol "C," expressed, and its order is expressed as a decimal number.</p>

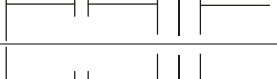
Device type	Description of Function
Timer	<p>A timer is used to complete control of timing. The timer contains a coil, contact, and a time value register. When the coil is electrified, if the preset time is reached, the contact will be actuated (contact a will close, contact b will open), and the timer's fixed value be given by the set value. Timer has a regulated clock cycle (timing units: 100 ms). As soon as power to the coil is cut off, the contact will no longer be actuated (contact a will open, contact b will close), and the original timing value will return to zero.</p> <p><input checked="" type="checkbox"/> Device indicated as: T0, T1 to T159, etc. The device is expressed as the symbol "T," and its order is expressed as a decimal number.</p>
Data register	<p>When a PLC is used to perform various types of sequence control and set time value and count value control, it most commonly perform data processing and numerical operations, and data registers are used exclusively for storage of data and various parameters. Each data register contains 16 bits of binary data, which means that it can store one word. Two data registers with adjacent numbers can be used to process double words.</p> <p><input checked="" type="checkbox"/> Device indicated as: D0, D1 to D399, etc. The device is expressed as the symbol "D," and its order is expressed as a decimal number.</p>

Ladder diagram images and their explanation

Ladder diagram structures	Explanation of commands	Command	Using Device
	NO switch, contact a	LD	X、Y、M、T、C
	NC switch, contact b	LDI	X、Y、M、T、C
	Series NO	AND	X、Y、M、T、C
	Series NC	ANI	X、Y、M、T、C
	Parallel NO	OR	X、Y、M、T、C
	Parallel NC	ORI	X、Y、M、T、C
	Positive edge-triggered switch	LDP	X、Y、M、T、C
	Negative edge-triggered switch	LDF	X、Y、M、T、C
	Positive edge-triggered series	ANDP	X、Y、M、T、C
	Negative edge-triggered series	ANDF	X、Y、M、T、C
	Positive edge-triggered parallel	ORP	X、Y、M、T、C
	Negative edge-triggered parallel	ORF	X、Y、M、T、C
	Block series	ANB	N/A

Ladder diagram structures	Explanation of commands	Command	Using Device
	Block parallel	ORB	N/A
	Multiple outputs	MPS MRD MPP	N/A
	Coil driven output commands	OUT	Y · M
	Some basic commands, applications commands	Some basic commands Applications commands	
	Inverted logic	INV	N/A

16-4-3 Overview of PLC ladder diagram editing

The program editing method begins from the left busbar and proceeds to the right busbar (the right busbar is omitted when editing using WPLSoft). Continue to the next row after completing each row; there is a maximum of 11 contacts on each row. If this is not sufficient, a continuous line will be generated to indicate the continued connection and more devices can be added. A continuous series of numbers will be generated automatically and identical input points can be used repeatedly. See figure below:

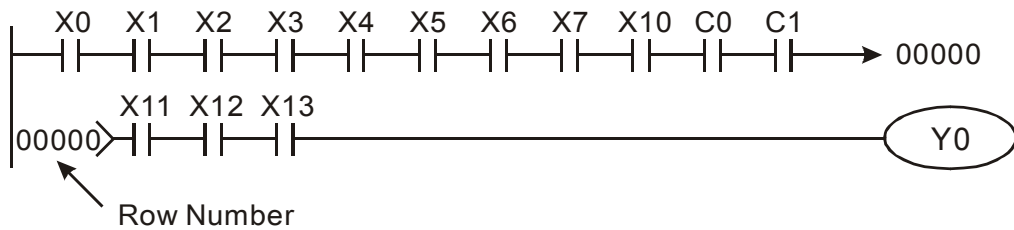

The ladder diagram programming method involves scanning from the upper left corner to the lower right corner. The coils and applications command computing box are handled in the output, and the ladder diagram is placed on the farthest right. Taking the figure below as an example, we can gradually analyze the procedural sequence of the ladder diagram. The number in the upper right corner gives the sequential order.

- Explanation of command sequence
- 1 LD X0
 - 2 OR M0
 - 3 AND X1
 - 4 LD X3
 - 5 AND M1
 - 6 ORB
 - 7 LD Y1
 - 8 AND X4
 - 9 LD T0
 - 10 AND M3
 - 11 ORB
 - 12 ANB
 - 13 OUT Y1
 - 14 TMR T0 K10

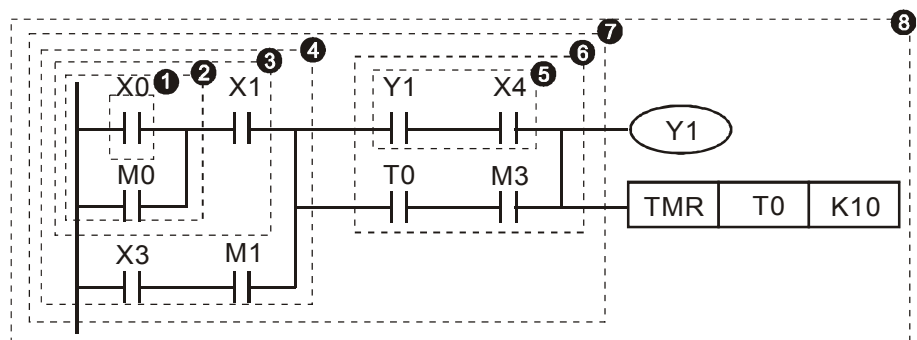

Explanation of basic structure of ladder diagrams

LD (LDI) command: An LD or LDI command is given at the start of a block.

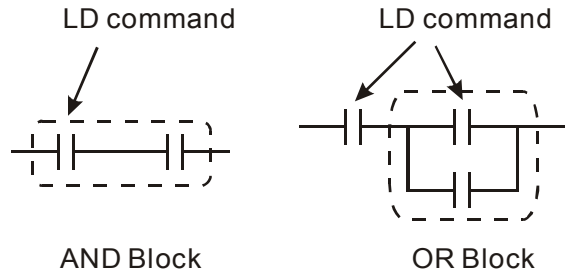

LDP and LDF have this command structure, but there are differences in their action state. LDP, LDF only act at the rising or falling edge of a conducting contact. (see figure below):

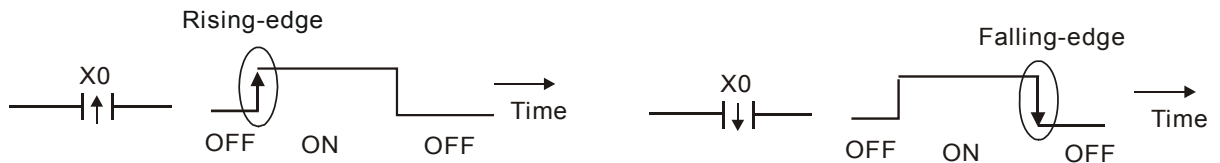

AND (ANI) command: A series configuration in which a single device is connected with one device or a block.

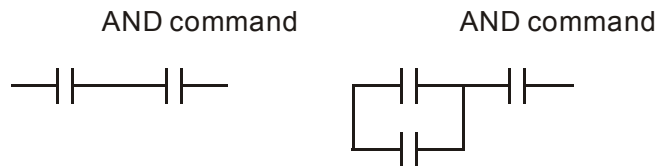

ANDP, ANDF also have structures like this, but their action occurs at the rising and falling edge.

OR (ORI) command: A single device is connected with one device or a block.

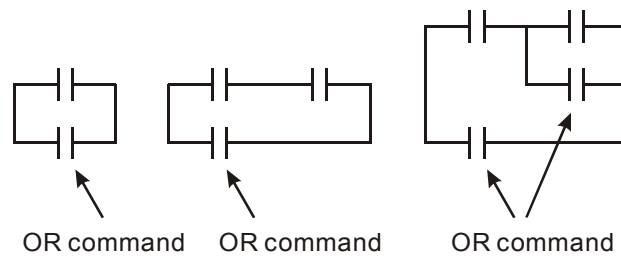

ORP, ORF also have identical structures, but their action occurs at the rising and falling edge.

ANB command: A configuration in which one block is in series with one device or block.

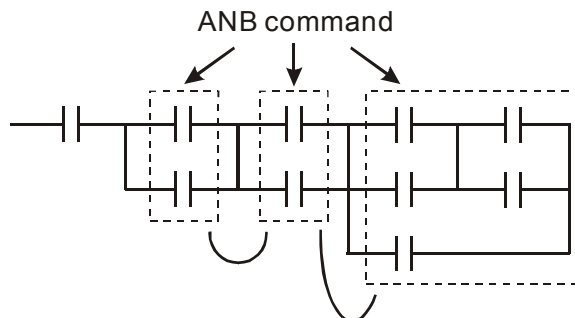

ORB command: A configuration in which one block is in parallel with one device or block.

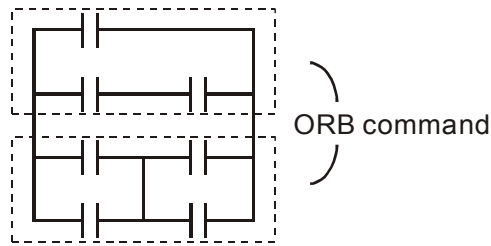

In the case of ANB and ORB operations, if a number of blocks are connected, they should be combined to form a block or network from the top down or from left to right.

MPS, MRD, MPP commands: Branching point memory for multiple outputs, enabling multiple, different outputs. The MPS command begins at a branching point, where the so-called branching point refers to the intersection of horizontal and vertical lines. We have to rely on the contact status along a single vertical line to determine whether the next contact can give a memory command. While each contact is basically able to give memory commands, in view of convenience and the PLC's capacity restrictions, this can be omitted from some places when converting a ladder diagram. The structure of the ladder diagram can be used to judge what kinds of contact memory commands are used.

MPS can be distinguished by use of the "┣" symbol; this command can be used consecutively for up to 8 times. The MRD command is read from branching point memory; because logic states along any one vertical line must be the same, in order to continue analysis of other ladder diagrams, the original contact status must be read.

MRD can be distinguished by use of the "┤" symbol. The MPP command is read from the starting state of the uppermost branching point, and it is read from the stack (pop); because it is the final command along a vertical line, it indicates that the state of the vertical line can be concluded.

MPP can be distinguished by use of the "┘" symbol. Although there should basically be no errors when using the foregoing analytical approach, the compiling program may sometimes omit identical state output, as shown in the following figure:

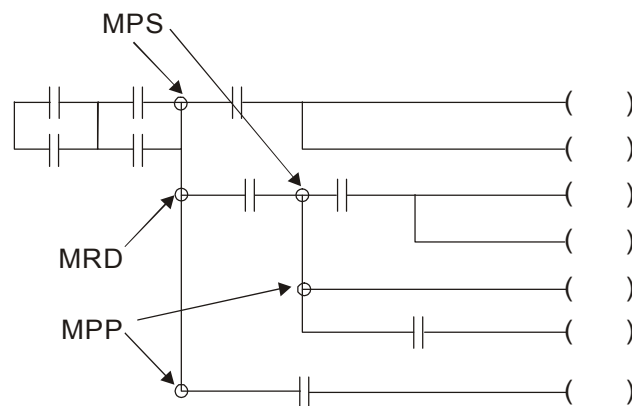

16-4-4 Commonly-used basic program design examples

Start, stop, and protection

Some applications may require a brief close or brief break using the buttons to start and stop equipment. A protective circuit must therefore be designed to maintain continued operation in these situations; this protective circuit may employ one of the following methods:

Example 1: Priority stop protective circuit

When the start NO contact X1=On, and the stop NC contact X2=Off, Y1=On; if X2=On at this time, coil Y1 will no longer be electrified, and this is therefore referred to as priority stop.

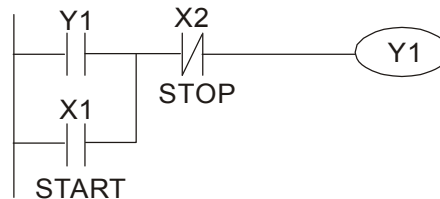

Example 2: Priority start protective circuit

When start NO contact X1=On, and the stop NC contact X2=Off, Y1=On, and coil Y1 will be electrified and protected. At this time, if X2=On, coil Y1 will still protect the contact and continue to be electrified, and this is therefore priority start.

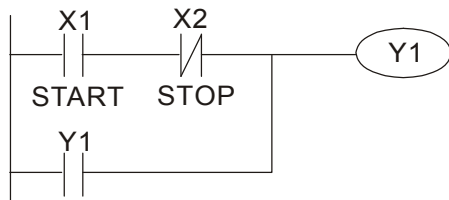

Example 3: Setting (SET) and reset (RST) command protective circuit

The following figure shows a protective circuit composed of RST and SET commands.

Priority stop occurs when the RST command is placed after the SET command. Because the PLC executes programs from the top down, at the end of the program, the state of Y1 will indicate whether coil Y1 is electrified. When X1 and X2 are both actuated, Y1 will lose power, and this is therefore priority stop.

Priority start occurs when the SET command is placed after the RST command. When X1 and X2 are both actuated, Y1 will be electrified, and this is therefore priority start.

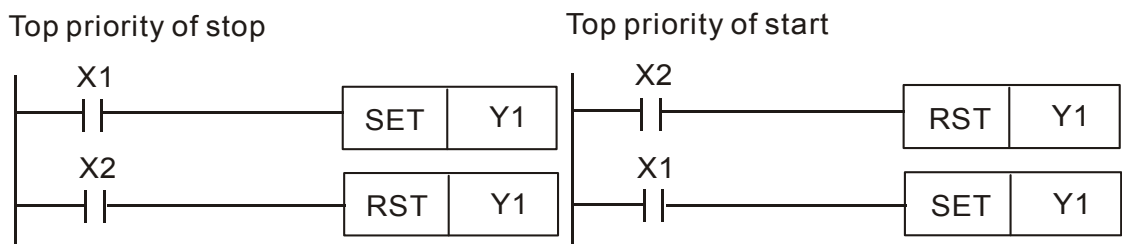

Commonly-used control circuits

Example 4: Conditional control

X1, X3 are respectively start/stop Y1, and X2, X4 are respectively start/stop Y2; all have protective circuits. Because Y1's NO contact is in series with Y2's circuit, it becomes an AND condition for the actuation of Y2. The action of Y1 is therefore a condition for the action of Y2, and Y1 must be actuated before Y2 can be actuated.

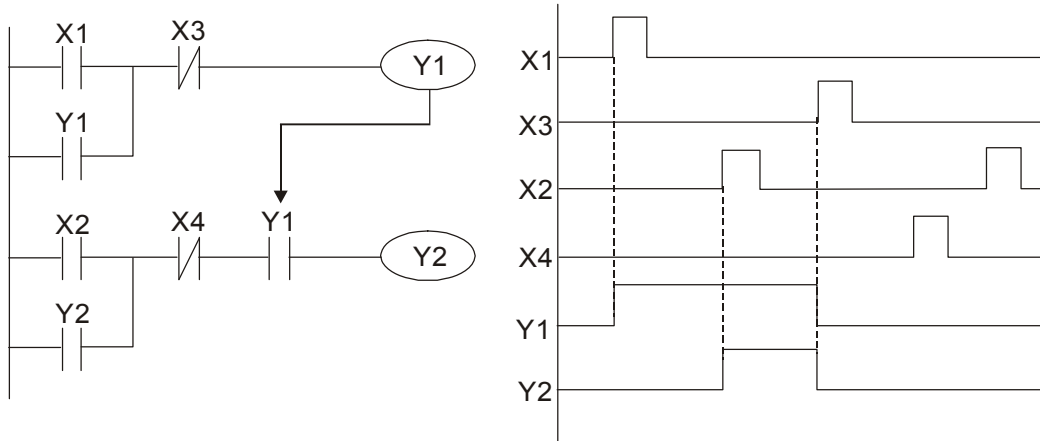

Example 5: Interlocking control

The figure below shows an interlocking control circuit. Depending on which of the start contacts X1, X2 is valid first, the corresponding output Y1 or Y2 will be actuated, and when one is actuated, the other will not be actuated. This implies that Y1 and Y2 cannot be actuated at the same time (interlocking effect). Even if both X1 and X2 are valid at the same time, because the ladder diagram program is scanned from the top down, it is impossible for Y1 and Y2 to be actuated at same time. This ladder diagram assigns priority only to Y1.

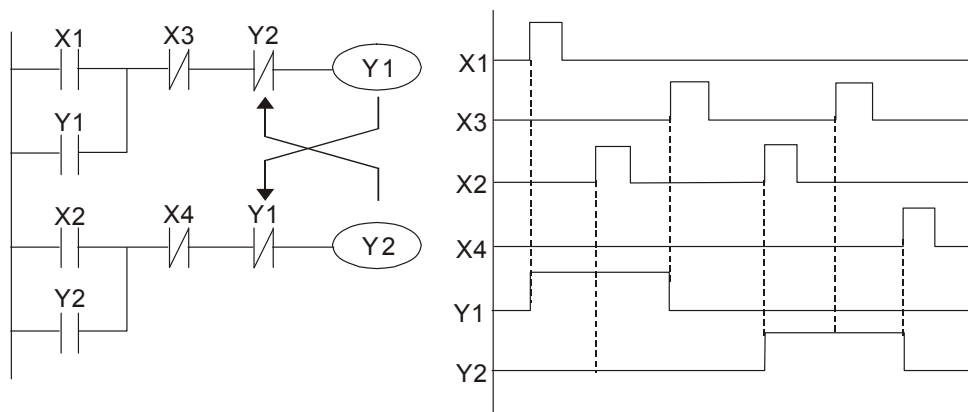

Example 6: Sequence control

If the NC contact of Y2 in the interlocking control configuration of example 5 is put in series with the Y1 circuit, so that it is an AND condition for actuation of Y1 (see figure below), not only is Y1 a condition for the actuation of Y2 in this circuit, the actuation of Y2 will also stop the actuation of Y1. This configuration confirms the actuation order of Y1 and Y2.

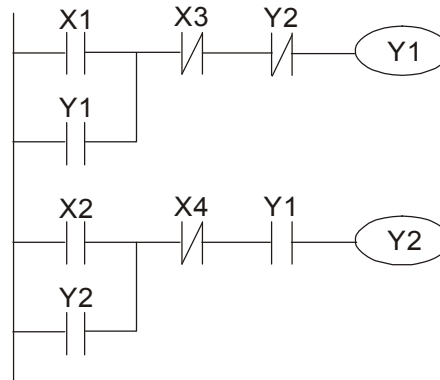

Example 7: Oscillating circuit

Oscillating circuit with a period of $\Delta T + \Delta T$

The figure below shows a very simple ladder diagram. When starting to scan the Y1 NC contact, because the Y1 coil has lost power, the Y1 NC contact will be closed. When the Y1 coil is then scanned, it will be electrified, and the output will be 1. When the Y1 NC contact is scanned in the scanning cycle, because Y1 coil is electrified, the Y1 NC contact will be open, the Y1 coil will then lose power, and the output will be 0. Following repeated scanning, the output of Y1 coil will have an oscillating waveform with a period of $\Delta T(\text{On}) + \Delta T(\text{Off})$.

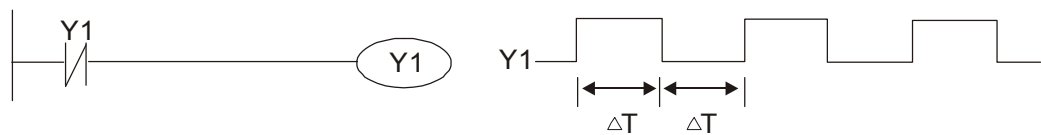

Oscillating circuit with a period of $nT + \Delta T$

The program of the ladder diagram shown below uses timer T0 to control coil Y1's electrified time. After Y1 is electrified, it causes timer T0 to close during the next scanning cycle, which will cause the output from Y1 to have the oscillating waveform shown in the figure below. Here n is the timer's decimal setting value, and T is the clock cycle of the timer.

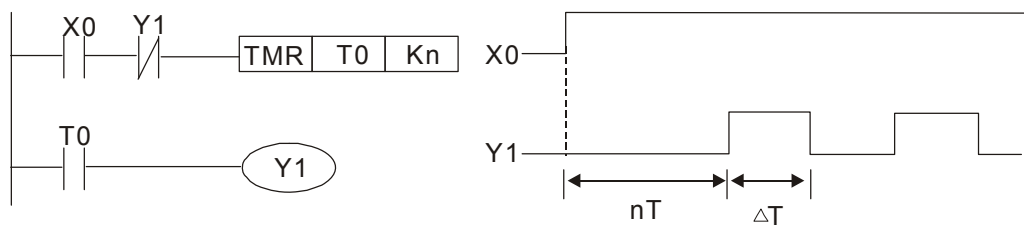

Example 8: Flashing circuit

The following figure shows an oscillating circuit of a type commonly used to cause an indicator light to flash or a buzzers to buzz. It uses two timers to control the On and Off time of Y1 coil. Here n1, n2 are the timing set values of T1 and T2, and T is the clock cycle of the timer.

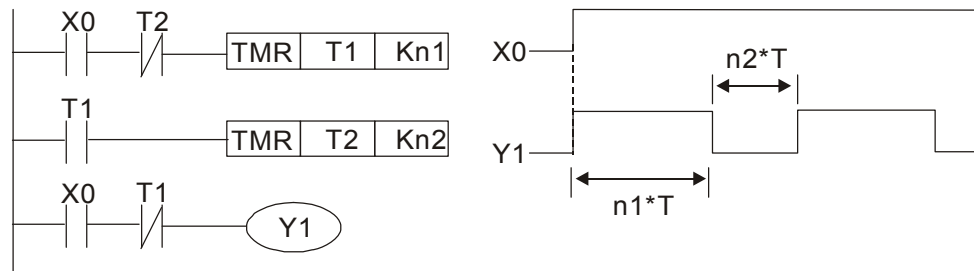

Example 9: Triggering circuit

In the figure below, a command consisting of the differential of the rising edge of X0 causes coil M0 to generate a single pulse for ΔT (length of one scanning cycle), and coil Y1 is electrified during this scanning cycle. Coil M0 loses power during the next scanning cycle, and NC contact M0 and NC contact Y1 are both closed. This causes coil Y1 to stay in an electrified state until there is another rising edge in input X0, which again causes the electrification of coil M0 and the start of another scanning cycle, while also causing coil Y1 to lose power, etc. The sequence of these actions can be seen in the figure below. This type of circuit is commonly used to enable one input to perform two actions in alternation. It can be seen from the time sequence in the figure below that when input X0 is a square wave signal with a period of T, the output of coil Y1 will be a square wave signal with a period of 2T.

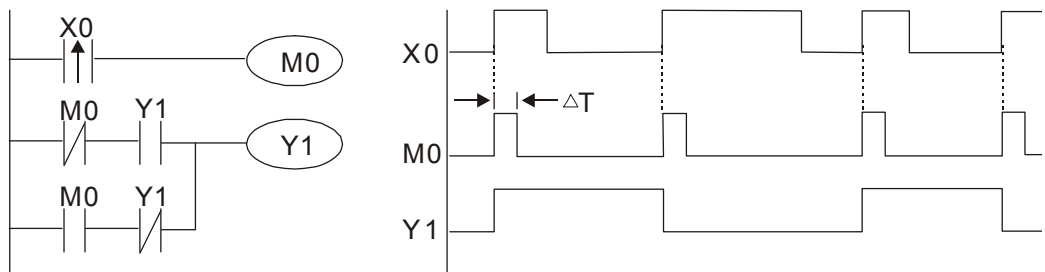

Example 10: Delay circuit

When input X0 is On, because the corresponding NC contact will be Off, the timer T10 will be in no power status, and output coil Y1 will be electrified. T10 will receive power and begin timing only after input X0 is Off, and output coil Y1 will be delayed for 100 sec. (K1000*0.1 sec. =100 sec.) before losing power; please refer to the sequence of actions in the figure below.

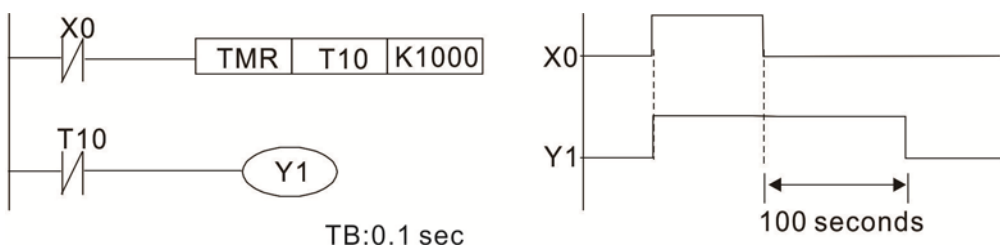

Example 11: The open/close delay circuit is composed of two timers; output Y4 will have a delay whether input X0 is On or Off.

Example 12: Extended timing circuit

In the circuit in the figure on the left, the total delay time from the moment input X0 closes to the time output Y1 is electrified is $(n1+n2)*T$, where T is the clock cycle. Timers: T11, T12; clock cycle: T.

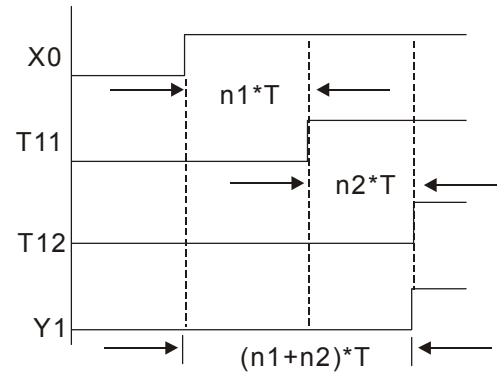
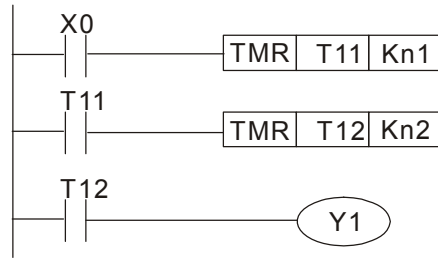

16-5 Various PLC device functions

Item	Specifications	Notes
Algorithmic control method	Program stored internally, alternating back-and-forth scanning method	
Input/output control method	When it starts again after ending (after execution to the END command), the input/output has an immediate refresh command	
Algorithmic processing speed	Basic commands (several us);	Applications command (1-several tens of us)
Programming language	Command + ladder diagram	
Program capacity	10000 steps	
Input/output terminal	Input (X): 10, output (Y): 4	This number of contacts constitutes CT2000 input/output contacts; other devices have different correspondences

Type	Device	Item	Range	Function	
Relay bit form	X	External input relay	X0~X17, 16 points, octal number	Total 32 points Corresponds to external input point	
	Y	External output relay	Y0~Y17, 16 points, octal number		Corresponds to external output point
	M	Auxiliary Relay	General Use	M0~M799, 800 points	Total 880 points Contact can switch On/Off within the program
			Special purpose	M1000~M1079, 80 points	
	T	Timer	100ms timer	T0~T159, 160 points	Total 160 points Timers referred to by the TMR command; contact of the T with the same number will go On when the time is reached
C	Counter	16-bit counter, general use	C0~C79, 80 points	Total 80 points Counter referred to by the CNT command; contact of the C with the same number will go On when the count is reached	
Register word data	T	Current timer value	T0~T159, 160 points	The contact will be On when the time is reached	
	C	Current counter value	C0~C79, 16-bit counter	80 points The counter contact will come On when the count is reached	
	D	Data Register	Used to maintain power Off	D0~D399, 400 points	Total 1400 points Used as data storage memory area
Special purpose			D1000~D1199, 200 points D2000~D2799, 800 points		
Constant	K	Decimal	Single-byte	Setting Range: K-32,768 ~ K32,767	
			Double-byte	Setting Range: K-2,147,483,648~K2,147,483,647	
	H	Hexadecimal	Single-byte	Setting Range: H0000 ~ HFFFF	
			Double-byte	Setting Range: H00000000 ~ HFFFFFFFF	
Serial communications port (program write/read)			RS-485/keypad port		

Input/output		Built-in three analog inputs and two analog outputs
Function expansion module	Optional Accessories	EMC-D42A; EMC-R6AA; EMCD611A
Communication Expansion Module	Optional Accessories	EMC-COP01,(CANopen)

16-5-1 Introduction to device functions

Input/output contact functions

Input contact X functions: Input contact X is connected with an input device, and reads input signals entering the PLC. The number of times that contact a or b of input contact X is used in the program is not subject to restrictions. The On/Off state of input contact X will change as the input device switches On and Off; a peripheral device (WPLSoft) cannot be used to force contact X On or Off.

Output contact Y functions

The job of output contact Y is to send an On/Off signal to drive the load connected with output contact Y. Output contacts consist of two types: relays and transistors. While number of times that contact a or b of each output contact Y is used in the program is not subject to restrictions, it is recommended that the number of output coil Y be used only once in a program, otherwise the right to determine the output state when the PLC performs program scanning will be assigned to the program's final output Y circuit.

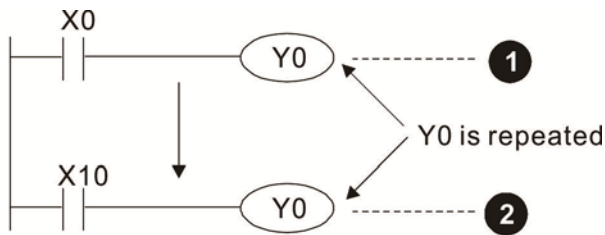

The output of Y0 will be decided by circuit ② , i.e. decided by On/Off of X10.

Numerical value, constant [K]/[H]

Constant	Single-byte	K	Decimal	K-32,768 ~ K32,767
	Double-byte			K-2,147,483,648~K2,147,483,647
	Single-byte	H	Hexadecimal	H0000 ~ HFFFF
	Double-byte			H00000000 ~ HFFFFFFFF

The PLC can use five types of numerical values to implement calculations based on its control tasks; the following is an explanation of the missions and functions of different numerical values.

Binary Number, BIN

The PLC's numerical operations and memory employ binary numbers. Binary nibbles and relevant terms are explained as follows:

Bit	Bits are the fundamental units of binary values, and have a state of either 1 or 0
Nibble	Comprised of a series of 4 bits (such as b3-b0); can be used to express a one-nibble decimal number 0-9 or hexadecimal number: 0-F.
Byte	Comprised of a series of two nibbles (i.e. 8 bits, b7-b0); can express a hexadecimal number: 00-FF.
Word	Comprised of a series of two bytes (i.e. 16 bits, b15-b0); can express a hexadecimal number with four nibbles: 0000-FFFF.
Double Word	Comprised of a series of two words (i.e. 32 bits, b31-b0); can express a hexadecimal number with eight nibbles: 00000000-FFFFFFFF

Relationship between bits, digits, nibbles, words, and double words in a binary system (see figure below):

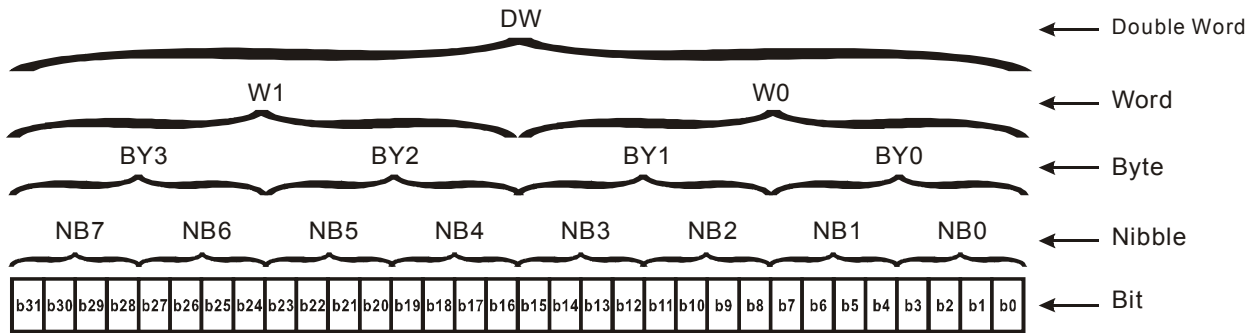

Octal Number, OCT

The external input and output terminals of a DVP-PLC are numbered using octal numbers

Example: External input: X0~X7 , X10~X17...(Device number table);

External output: Y0~Y7 , Y10~Y17...(Device number table)

Decimal Number, DEC

Decimal numbers are used for the following purposes in a PLC system:

- The setting values of timer T or counter C, such as TMR C0 K50. (K constant)
- The numbers of devices including M, T, C, or D, such as M10 or T30. (device number)
- Used as an operand in an application command, such as MOV K123 D0. (K constant)

Binary Code Decimal, BCD

Uses one nibble or 4 bits to express the data in a decimal number; a series of 16 bits can therefore express a decimal number with 4 nibbles. Chiefly used to read the input value of a fingerwheel numerical switch input or output a numerical value to a seven-segment display driver.

Hexadecimal Number, HEX

Applications of hexadecimal numbers in a PLC system: Used as operands in application commands, such as MOV H1A2B D0. (H constant)

Constant K

Decimal numbers are usually prefixed with a "K" in a PLC system, such as K100. This indicates that it is a decimal number with a numerical value of 100.

Exceptions: K can be combined with bit device X, Y, M, or S to produce data in the form of a nibble, byte, word, or double word, such as in the case of K2Y10 or K4M100. Here K1 represents a 4-bit combination, and K2-K4 variously represent 8-, 12-, and 16-bit combinations.

Constant H

Hexadecimal numbers are usually prefixed with the letter "H" in a PLC system, such as in the case of H100, which indicates a hexadecimal number with a numerical value of 100.

Functions of auxiliary relays

Like an output relay Y, an auxiliary relay M has an output coil and contacts a and b, and the number of times they can be used in a program is unrestricted. Users can use an auxiliary relay M to configure the control circuit, but cannot use it to directly drive an external load. Auxiliary relays have

the following two types of characteristics:

Ordinary auxiliary relays: Ordinary auxiliary relays will all revert to the Off state if a power outage occurs while the PLC is running, and will remain in the Off state if power is again turned down.

Special purpose auxiliary relays: Each special purpose auxiliary relay has its own specific use. Do not use any undefined special purpose auxiliary relays.

Timer functions

Timers take 100 ms as their timing units. When the timing method is an upper time limit, when the current timer value = set value, power will be sent to the output coil. Timer setting values consist of decimal K values, and the data register D can also serve as a setting value.

Actual timer setting time = timing units * set value

Counter features

Item	16-bit counter
Type	General Type
CT Direction:	Score:
Setting	0~32,767
Designation of set value	Constant K or data register D
Change in current value	When the count reaches the set value, there is no longer a count
Output contact	When the count reaches the set value, the contact comes On and stays On
Reset	The current value reverts to 0 when an RST command is executed, and the contact reverts to Off
Contact actuation	All are actuated after the end of scanning

Counter functions

When a counter's counting pulse input signal goes Off→On, if the counter's current value is equal to the set value, the output coil will come On. The setting value will be a decimal K values, and the data register D can also serve as a setting value.

16-bit counter C0-C79:

- ☑ 16-bit counter setting range: K0-K32,767. (when K0 and K1 are identical, the output contact will immediately be On during the first count.)
- ☑ The current counter value will be cleared from an ordinary counter when power is shut off to the PLC.
- ☑ If the MOV command or WPLSoft is used to transmit a value greater than the set value to the C0 current value register, when the next X1 goes from Off→On, the C0 counter contact will change to On, and the current value will change to the set value.
- ☑ A counter's setting value may be directly set using a constant K or indirectly set using the value in register D (not including special data registers D1000- D1199 或 D2000 ~ D2799).
- ☑ If the set value employs a constant K, it may only be a positive number; the set value may be either a positive or negative number if the value in data register D is used. The current counter value will change from 32,767 to -32,768 as the count continues to accumulate.

Example

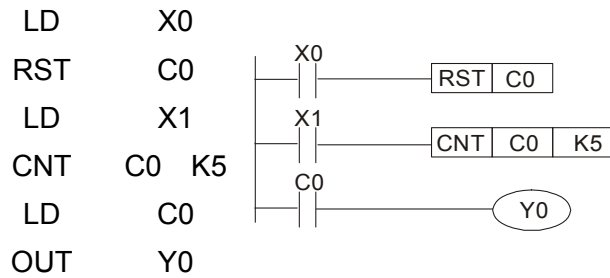

1. When X0=On and the RST command is executed, the current value of C0 will revert to 0, and the output contact will revert to Off.
2. When X1 changes from Off→On, the current value of the counter will execute an increase (add one).
3. When the count of counter C0 reaches the set value K5, the contact C0 will come On, and the current value of C0= set value =K5. Afterwards, signal C0 triggered by X1 cannot be received, and the current value of C0 will remain K5.

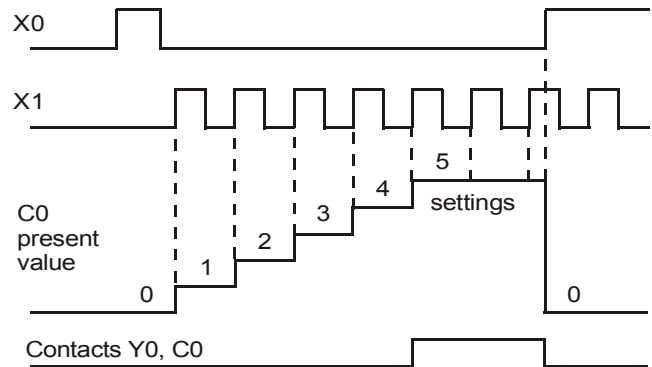

16-5-2 Introduction to special relay functions (special M)

R/W items: RO: read only function; RW: read and write function

Special M	Description of Function	R/W *
M1000	Operates monitor NO contact (contact a). NO while RUN, contact a. This contact is On while in the RUN state.	RO
M1001	Operates monitor NC contact (contact b). NC while RUN, contact b. This contact is Off while in the RUN state.	RO
M1002	Initiates a forward (the instant RUN is On) pulse. Initial pulse, contact a. Produces a forward pulse the moment RUN begins; its width = scan cycle	RO
M1003	Initiates a reverse (the instant RUN is Off) pulse. Initial pulse, contact a. Produces a reverse pulse the moment RUN ends; the pulse width = scan cycle	RO
M1004	Reserved	RO
M1005	Driver malfunction instructions	RO
M1006	Converter has no output	RO
M1007	Driver direction FWD(0)/REV(1)	RO
M1008 ~ M1010	--	--
M1011	10 ms clock pulse › 5ms On/5ms Off	RO
M1012	100 ms clock pulse › 50ms On / 50ms Off	RO
M1013	1 sec. clock pulse › 0.5s On / 0.5s Off	RO
M1014	1 min. clock pulse › 30s On / 30s Off	RO
M1015	Frequency attained (when used together with M1025)	RO

Special M	Description of Function	R/W *
M1016	Parameter read/write error	RO
M1017	Parameter write successful	RO
M1018	--	--
M1019	--	--
M1020	Zero flag	RO
M1021	Borrow flag	RO
M1022	Carry flag	RO
M1023	Divisor is 0	RO
M1024	--	--
M1025	Driver frequency = set frequency (ON) Driver frequency =0(OFF)	RW
M1026	Driver operating direction FWD(OFF)/REV(ON)	RW
M1027	Driver Reset	RW
M1028	--	--
M1029	--	--
M1030	--	--
M1031	Compulsory setting of the current PID integral value equal to D1019 (0 change, 1 valid)	RW
M1032	Compulsory definition of FREQ command after PID control	RW
M1033	--	--
M1034	Initiates CANopen real-time control	RW
M1035	Initiates internal communications control	RW
M1036	Ignore calendar error	RW
M1037	--	--
M1038	MI8 count begins	RW
M1039	Reset MI8 count value	RW
M1040	Hardware power (Servo On)	RW
M1041	--	--
M1042	Quick stop	RW
M1043	--	--
M1044	Pause	RW
M1045	--	--
~		
M1047	--	--
M1048	Move to new position	RW
M1049	--	--
M1050	Absolute position/relative position (0: relative/1: absolute)	RW
M1051	--	--
M1052	Lock frequency (lock, frequency locked at the current operating frequency)	RW
M1053	--	--
M1054	Compulsory reset of absolute position	RW
M1055	Search Origin	RW
M1056	Hardware already has power (Servo On Ready)	RO
M1057	--	--
M1058	On Quick Stopping	RO
M1059	CANopen Master setting complete	RO
M1060	CANopen Currently initializing slave station	RO
M1061	CANopen Slave station initialization failure	RO
M1062	--	--
M1063	Torque attained	RO
M1064	Target reached	RO
M1065	Read/write CANopen data time out	RO
M1066	Read/write CANopen data complete	RO
M1067	Read/write CANopen data successful	RO
M1068	Calendar calculation error	RO

Special M	Description of Function	R/W *
M1069	--	--
M1070	Return home complete	RO
M1071	Homing error	RO
M1072 ~ M1075	--	--
M1076	Calendar time error or refresh time out	RO
M1077	485 Read/write complete	RO
M1078	485 Read-write error	RO
M1079	485 Communications time out	RO

16-5-3 Introduction to special register functions (special D)

Special D	Description of Function	R/W *
D1000	--	--
D1001	Device system program version	RO
D1002	Program capacity	RO
D1003	Total program memory content	RO
D1004 ~ D1009	--	--
D1010	Current scan time (units: 0.1 ms)	RO
D1011	Minimum scan time (units: 0.1 ms)	RO
D1012	Maximum scan time (units: 0.1 ms)	RO
D1013 ~ D1017	--	--
D1018	Current integral value	RO
D1019	Compulsory setting of PID I integral	RW
D1020	Output frequency (0.000~600.00Hz)	RO
D1021	Output current (####.#A)	RO
D1022	AI AO DI DO Expansion card number 0 : No expansion card 4 : AC input card (6 in) (EMC-D611A) 5 : I/O Card (4 in 2 out) (EMC-D42A) 6 : Relay card(6 out) (EMC-R6AA)	RO
D1023	Communication expansion card number 0 : No expansion card 1 : DeviceNet Slave 2 : Profibus-DP Slave 3 : CANopen Slave 4 : Modbus-TCP Slave 5 : EtherNet/IP Slave	RO
D1024 ~ D1026	--	--
D1027	PID calculation frequency command (frequency command after PID calculation)	RO
D1028	AVI value (0.00~100.00%)	RO
D1029	ACI value (0.0~100.00%)	RO
D1030	AUI value (-100.0~100.00%)	RO
D1031	--	--

Special D	Description of Function	R/W *
~ D1035		
D1036	Servo error bit	RO
D1037	Driver output frequency	RO
D1038	DC BUS voltage	RO
D1039	Output voltage	RO
D1040	Analog output value AFM1(-100.00~100.00%)	RW
D1041 ~ D1042	--	--
D1043	Can be user-defined (will be displayed on panel when parameter 00-04 is set as 28; display method is C xxx)	RW
D1044	--	-
D1045	Analog output value AFM2(-100.00~100.00%)	RW
D1046 ~ D1049	--	--
D1050	Actual Operation Mode 0 : Speed 1 : Position 2 : Torque 3 : Homing Origin	RO
D1051	Actual position (Low word)	RO
D1052	Actual position (High word)	RO
D1053	Actual torque	RO
D1054	MI8 current calculated count value (L Word)	RO
D1055	MI8 current calculated count value (H Word)	RO
D1056	Rotational speed corresponding to MI8	RO
D1057	MI8's rotational speed ratio	RW
D1058	MI8 refresh rate (ms) corresponding to rotational speed	RW
D1059	Number of nibbles of rotational speed corresponding to MI8 (0-3)	RW
D1060	Operation Mode setting 0 : Speed 1 : Position 2 : Torque 3 : Homing Origin	RW
D1061	485 COM1 communications time out time (ms)	RW
D1062	Torque command (torque limit in speed mode)	RW
D1063	Year (Western calendar) (display range 2000-2099) (must use KPC-CC01)	RO
D1064	Week (display range 1-7) (must use KPC-CC01)	RO
D1065	Month (display range 1-12) (must use KPC-CC01)	RO
D1066	Day (display range 1-31) (must use KPC-CC01)	RO
D1067	Hour (display range 0-23) (must use KPC-CC01)	RO
D1068	Minute (display range 0-59) (must use KPC-CC01)	RO
D1069	Second (display range 0-59) (must use KPC-CC01)	RO
D1100	Target frequency	RO
D1101	Target frequency (must be operating)	RO
D1102	Reference frequency	RO
D1103	Target L	RO
D1104	Target H	RO
D1105	Target torque	RO
D1106	--	--
D1107	π (Pi) Low word	RO
D1108	π (Pi) High word	RO

Special D	Description of Function	R/W *
D1109	Random number	RO
D1110	Internal node communications number (set number of slave stations to be controlled)	RW
D1111	Encoder Pulses L	RO
D1112	Encoder Pulses H	RO
D1113	--	RO
D1114	--	--
D1115	Internal node synchronizing cycle (ms)	RO
D1116	Internal node error (bit0 = Node 0, bit1 = Node 1,...bit7 = Node 7)	RO
D1117	Internal node online correspondence (bit0 = Node 0, bit1 = Node 1,...bit7 = Node 7)	RO
D1118	--	--
D1119	--	--
D1120	Internal node 0 control command	RW
D1121	Internal node 0 mode	RW
D1122	Internal node 0 reference command L	RW
D1123	Internal node 0 reference command H	RW
D1124	--	--
D1125	--	--
D1126	Internal node 0 status	RO
D1127	Internal node 0 reference status L	RO
D1128	Internal node 0 reference status H	RO
D1129	--	--
D1130	Internal node 1 control command	RW
D1131	Internal node 1 mode	RW
D1132	Internal node 1 reference command L	RW
D1133	Internal node 1 reference command H	RW
D1134	--	--
D1135	--	--
D1136	Internal node 1 status	RO
D1137	Internal node 1 reference status L	RO
D1138	Internal node 1 reference status H	RO
D1139	--	--
D1140	Internal node 2 control command	RW
D1141	Internal node 2 mode	RW
D1142	Internal node 2 reference command L	RW
D1143	Internal node 2 reference command H	RW
D1144	--	--
D1145	--	--
D1146	Internal node 2 status	RO
D1147	Internal node 2 reference status L	RO
D1148	Internal node 2 reference status H	RO
D1149	--	--
D1150	Internal node 3 control command	RW
D1151	Internal node 3 mode	RW
D1152	Internal node 3 reference command L	RW
D1153	Internal node 3 reference command H	RW
D1154	--	--
D1155	--	--
D1156	Internal node 3 status	RO
D1157	Internal node 3 reference status L	RO
D1158	Internal node 3 reference status H	RO
D1159	--	--
D1160	Internal node 4 control command	RW

Special D	Description of Function	R/W *
D1161	Internal node 4 mode	RW
D1162	Internal node 4 reference command L	RW
D1163	Internal node 4 reference command H	RW
D1164	--	--
D1165	--	--
D1166	Internal node 4 status	RO
D1167	Internal node 4 reference status L	RO
D1168	Internal node 4 reference status H	RO
D1169	--	--
D1170	Internal node 5 control command	RW
D1171	Internal node 5 mode	RW
D1172	Internal node 5 reference command L	RW
D1173	Internal node 5 reference command H	RW
D1174	--	RW
D1175	--	--
D1176	Internal node 5 status	--
D1177	Internal node 5 reference status L	RO
D1178	Internal node 5 reference status H	RO
D1179	--	--
D1180	Internal node 6 control command	RW
D1181	Internal node 6 mode	RW
D1182	Internal node 6 reference command L	RW
D1183	Internal node 6 reference command H	RW
D1184	--	--
D1185	--	--
D1186	Internal node 6 status	RO
D1187	Internal node 6 reference status L	RO
D1188	Internal node 6 reference status H	RO
D1189	--	--
D1190	Internal node 7 control command	RW
D1191	Internal node 7 mode	RW
D1192	Internal node 7 reference command L	RW
D1193	Internal node 7 reference command H	RW
D1194	--	--
D1195	--	--
D1196	Internal node 7 status	RO
D1197	Internal node 7 reference status L	RO
D1198	Internal node 7 reference status H	RO
D1199	--	--

The following is CANopen Master's special D (can be written in only with PLC in Stop state)

n = 0 ~ 7

Special D	Description of Function	PDO Map	Power off Memory	Default:	R/W
D1070	Channel opened by CANopen initialization (bit0=Machine code0	NO	NO	0	R
D1071	Error channel occurring in CANopen initialization process (bit0=Machine code0	NO	NO	0	R
D1072	Reserved	-	-		-
D1073	CANopen break channel (bit0=Machine code0	NO	NO		R

Special D	Description of Function	PDO Map	Power off Memory	Default:	R/W
D1074	Error code of master error 0: No error 1: Slave station setting error 2: Synchronizing cycle setting error (too small)	NO	NO	0	R
D1075	Reserved	-	-		-
D1076	SDO error message (main index value)	NO	NO		R
D1077	SDO error message (secondary index value)	NO	NO		R
D1078	SDO error message (error code)	NO	NO		R
D1079	SDO error message (error code)	NO	NO		R
D1080	Reserved	-	-		-
D1081 ~ D1086	Reserved	-	-		-
D1087 ~ D1089	Reserved	-	-		-
D1090	Synchronizing cycle setting	NO	YES	4	RW
D1091	Sets slave station On or Off (bit 0-bit 7 correspond to slave stations number 0-7)	NO	YES	FFFFH	RW
D1092	Delay before start of initialization	NO	YES	0	RW
D1093	Break time detection	NO	YES	1000ms	RW
D1094	Break number detection	NO	YES	3	RW
D1095 ~ D1096	Reserved	-	-		-
D1097	Corresponding real-time transmission type (PDO) Setting range: 1~240	NO	YES	1	RW
D1098	Corresponding real-time receiving type (PDO) Setting range: 1~240	NO	YES	1	RW
D1099	Initialization completion delay time Setting range: 1 to 60000 sec	NO	YES	15 sec.	RW
D2000+100*n	Station number n of slave station Setting range: 0~127 0: No CANopen function	NO	YES	0	RW

The CT2000 supports 8 slave stations under the CANopen protocol; each slave station occupies 100 special D locations; stations are numbered 1-8, total of 8 stations.

Explanation of slave station number and

Slave station no. 1	D2000 D2001 ~ D2099	Node ID Slave station no. 1 torque restrictions ~ Address 4(H) corresponding to receiving channel 4
Slave station no. 2	D2100 D2101 ~ D2199	Node ID Slave station no. 2 torque restrictions ~ Address 4(H) corresponding to receiving channel 4
Slave station no. 3	D2200 D2201 ~ D2299	Node ID Slave station no. 3 torque restrictions ~ Address 4(H) corresponding to receiving channel 4
	↓	
Slave station no. 8	D2700 D2701 ~ D2799	Node ID Slave station no. 8 torque restrictions ~ Address 4(H) corresponding to receiving channel 4

1. The range of n is 0-7
2. ●Indicates PDOTX, ▲Indicates PDORX; unmarked special D can be refreshed using the CANFLS command

Special D	Description of Function	Default:	R/W
D2000+100*n	Station number n of slave station Setting range: 0~127 0: No CANopen function	0	RW
D2002+100*n	Manufacturer code of slave station number n (L)	0	R
D2003+100*n	Manufacturer code of slave station number n (H)	0	R
D2004+100*n	Manufacturer's product code of slave station number n (L)	0	R
D2005+100*n	Manufacturer's product code of slave station number n (H)	0	R

Basic definitions

Special D	Description of Function	Default:	CAN Index	PDO Default:				R/W
				1	2	3	4	
D2006+100*n	Communications break handling method of slave station number n	0	6007H-0010H					RW
D2007+100*n	Error code of slave station number n error	0	603FH-0010H					R
D2008+100*n	Control word of slave station number n	0	6040H-0010H	●		●	●	RW
D2009+100*n	Status word of slave station number n	0	6041H-0010H	▲		▲	▲	R
D2010+100*n	Control mode of slave station number n	2	6060H-0008H					RW
D2011+100*n	Actual mode of slave station number n	2	6061H-0008H					R

Velocity Control

Slave station number n=0-7

Special D	Description of Function	Default:	CAN Index	PDO Default:				R/W
				1	2	3	4	
D2001+100*n	Torque restriction on slave station number n	0	6072H-0010H					RW
D2012+100*n	Target speed of slave station number n	0	6042H-0010H	●				RW
D2013+100*n	Actual speed of slave station number n	0	6043H-0010H	▲				R
D2014+100*n	Error speed of slave station number n	0	6044H-0010H					R
D2015+100*n	Acceleration time of slave station number n	1000	604FH-0020H					R
D2016+100*n	Deceleration time of slave station number n	1000	6050H-0020H					RW

Torque control

Slave station number n=0-7

Special D	Description of Function	Default:	CAN Index	PDO Default:				R/W
				1	2	3	4	
D2017+100*n	Target torque of slave station number n	0	6071H-0010H				●	RW
D2018+100*n	Actual torque of slave station number n	0	6077H-0010H				▲	R
D2019+100*n	Actual current of slave station number n	0	6078H-0010H					R

Position control

Slave station number n=0-7

Special D	Description of Function	Default:	CAN Index	PDO Default:				R/W
				1	2	3	4	
D2020+100*n	Target of slave station number n (L)	0	607AH-0020H			●		RW
D2021+100*n	Target of slave station number n (H)	0						RW
D2022+100*n	Actual position of slave station number n (L)	0	6064H-0020H					R
D2023+100*n	Actual position of slave station number n (H)	0				▲		R
D2024+100*n	Speed chart of slave station number n (L)	10000	6081H-0020H					RW
D2025+100*n	Speed chart of slave station number n (H)	0						RW

20XXH correspondences: MI MO AI AO

Slave station number n=0-7

Special D	Description of Function	Default:	CAN Index	PDO Default:				R/W
				1	2	3	4	
D2026+100*n	MI status of slave station number n	0	2026H-0110H	▲				RW
D2027+100*n	MO setting of slave station number n	0	2026H-4110H	●				RW
D2028+100*n	AI1 status of slave station number n	0	2026H-6110H	▲				RW
D2029+100*n	AI2 status of slave station number n	0	2026H-6210H	▲				RW
D2030+100*n	AI3 status of slave station number n	0	2026H-6310H	▲				RW
D2031+100*n	AO1 status of slave station number n	0	2026H-A110H	●				RW
D2032+100*n	AO2 status of slave station number n	0	2026H-A210H	●				RW
D2033+100*n	AO3 status of slave station number n	0	2026H-A310H	●				RW

PDO reflection length setting:

Special D	Description of Function	Default:	R/W
D2034+100*n	Real-time transmission setting of slave station number n	000AH	RW
D2067+100*n	Real-time reception setting of slave station number n	0000H	RW

16-5-4 PLC Communication address

Device	Range	Type	Address (Hex)
X	00~37 (Octal)	bit	0400~041F
Y	00~37 (Octal)	bit	0500~051F
T	00~159	bit/word	0600~069F
M	000~799	bit	0800~0B1F
M	1000~1079	bit	0BE8~0C37
C	0~79	bit/word	0E00~0E47
D	00~399	word	1000~118F
D	1000~1099	word	13E8~144B
D	2000~2799	word	17D0~1AEF

Command code that can be used

Function Code	Description of Function	Function target
01	Coil status read	Y,M,T,C
02	Input status read	X,Y,M,T,C
03	Read single unit of data	T,C,D
05	Compulsory single coil status change	Y,M,T,C
06	Write single unit of data	T,C,D
0F	Compulsory multiple coil status change	Y,M,T,C
10	Write multiple units of data	T,C,D

NOTE

When PLC functions have been activated, the CT2000 can match PLC and driver parameters; this method employs different addresses, drivers (default station number is 1, PLC sets station number as 2)

16-6 Introduction to the Command Window

16-6-1 Overview of basic commands

Ordinary commands

Command code	Function	OPERAND	Execution speed (us)
LD	Load contact a	X、Y、M、T、C	0.8
LDI	Load contact b	X、Y、M、T、C	0.8
AND	Connect contact a in series	X、Y、M、T、C	0.8
ANI	Connect contact b in series	X、Y、M、T、C	0.8
OR	Connect contact a in parallel	X、Y、M、T、C	0.8
ORI	Connect contact b in parallel	X、Y、M、T、C	0.8
ANB	Series circuit block	N/A	0.3
ORB	Parallel circuit block	N/A	0.3
MPS	Save to stack	N/A	0.3
MRD	Stack read (pointer does not change)	N/A	0.3
MPP	Read stack	N/A	0.3

Output command

Command code	Function	OPERAND	Execution speed (us)
OUT	Drive coil	Y、M	1
SET	Action continues (ON)	Y、M	1
RST	Clear contact or register	Y、M、T、C、D	1.2

Timer, counter

Command code	Function	OPERAND	Execution speed (us)
TMR	16-bit timer	T-K or T-D commands	1.1
CNT	16-bit counter	C-K or C-D (16-bit)	0.5

Main control command

Command code	Function	OPERAND	Execution speed (us)
MC	Common series contact connection	N0~N7	0.4
MCR	Common series contact release	N0~N7	0.4

Contact rising edge/falling edge detection command

Command code	Function	OPERAND	Execution speed (us)
LDP	Start of forward edge detection action	X、Y、M、T、C	1.1
LDF	Start of reverse edge detection action	X、Y、M、T、C	1.1
ANDP	Forward edge detection series connection	X、Y、M、T、C	1.1
ANDF	Reverse edge detection series connection	X、Y、M、T、C	1.1
ORP	Forward edge detection parallel connection	X、Y、M、T、C	1.1
ORF	Reverse edge detection parallel connection	X、Y、M、T、C	1.1

Upper/lower differential output commands

Command code	Function	OPERAND	Execution speed (us)
PLS	Upper differential output	Y · M	1.2
PLF	Lower differential output	Y · M	1.2

Stop command

Command code	Function	OPERAND	Execution speed (us)
END	Program conclusion	N/A	0.2

Other commands

Command code	Function	OPERAND	Execution speed (us)
NOP	No action	N/A	0.2
INV	Inverse of operation results	N/A	0.2
P	Index	P	0.3

16-6-2 Detailed explanation of basic commands

Command	Function					
LD	Load contact a					
Operand	X0~X17	Y0~Y17	M0~M799	T0~159	C0~C79	D0~D399
	✓	✓	✓	✓	✓	—

Explanation

The LD command is used for contact a starting at the left busbar or contact a starting at a contact circuit block; its function is to save current content and save the acquired contact status in the cumulative register.

Example

Ladder diagram:



Command code:

Description:

LD	X0	Load Contact a of X0
AND	X1	Create series connection to contact a of X1
OUT	Y1	Drive Y1 coil

Command	Function					
LDI	Load contact b					
Operand	X0~X17	Y0~Y17	M0~M799	T0~159	C0~C79	D0~D399
	✓	✓	✓	✓	✓	—

Explanation

The LDI command is used for contact b starting at the left busbar or contact b starting at a contact circuit block; its function is to save current content and save the acquired contact status in the cumulative register.

Example

Ladder diagram:

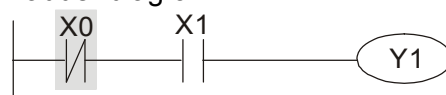

Command code:

Description:

LDI	X0	Load Contact b of X0
AND	X1	Create series connection to contact a of X1
OUT	Y1	Drive Y1 coil

Command	Function					
AND	Connect contact a in series					
Operand	X0~X17	Y0~Y17	M0~M799	T0~159	C0~C79	D0~D399
	✓	✓	✓	✓	✓	—

Explanation The AND command is used to create a series connection to contact a; first reads current status of the designated series contact and logical operation results before contact in order to perform "AND" operation; saves results in cumulative register.

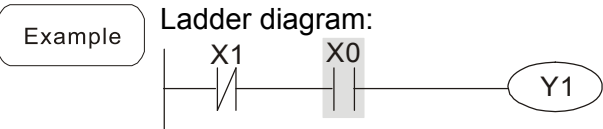

Command code:	Description:
LDI X1	Load Contact b of X1
AND X0	Create series connection to contact a of X0
OUT Y1	Drive Y1 coil

Command	Function					
ANI	Connect contact b in series					
Operand	X0~X17	Y0~Y17	M0~M799	T0~159	C0~C79	D0~D399
	✓	✓	✓	✓	✓	—

Explanation The ANI command is used to create a series connection to contact b; its function is to first read current status of the designated series contact and logical operation results before contact in order to perform "AND" operation; saves results in cumulative register.

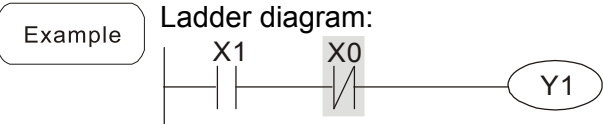

Command code:	Description:
LD X1	Load Contact a of X1
ANI X0	Create series connection to contact b of X0
OUT Y1	Drive Y1 coil

Command	Function					
OR	Connect contact a in parallel					
Operand	X0~X17	Y0~Y17	M0~M799	T0~159	C0~C79	D0~D399
	✓	✓	✓	✓	✓	—

Explanation The OR command is used to establish a parallel connection to contact a; its function is to first read current status of the designated series contact and logical operation results before contact in order to perform "OR" operation; saves results in cumulative register.

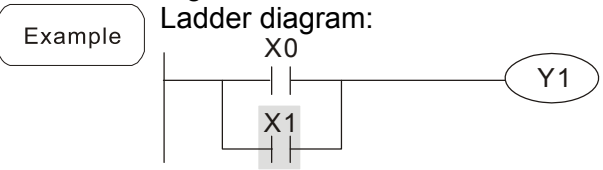

Command code:	Description:
LD X0	Load Contact a of X0
OR X1	Create series connection to contact a of X1
OUT Y1	Drive Y1 coil

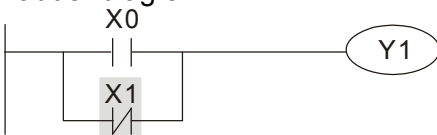
Command	Function					
ORI	Connect contact b in parallel					
Operand	X0~X17	Y0~Y17	M0~M799	T0~159	C0~C79	D0~D399
	✓	✓	✓	✓	✓	—
Explanation	The ORI command is used to establish a parallel connection to contact a; its function is to first read current status of the designated series contact and logical operation results before contact in order to perform "OR" operation; saves results in cumulative register.					
Example	Ladder diagram:			Command code: Description:		
				LD X0 Load Contact a of X0		
				ORI X1 Create series connection to contact b of X1		
				OUT Y1 Drive Y1 coil		

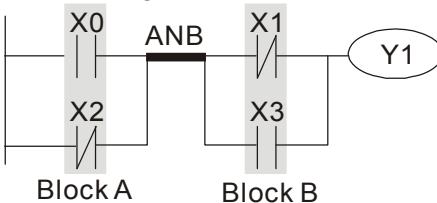
Command	Function					
ANB	Series circuit block					
Operand	N/A					
Explanation	ANB performs an "AND" operation on the previously saved logic results and the current cumulative register content.					
Example	Ladder diagram:			Command code: Description:		
				LD X0 Load Contact a of X0		
				ORI X2 Establish parallel connection to contact b of X2		
				LDI X1 Load Contact b of X1		
				OR X3 Establish parallel connection to contact a of X3		
				ANB Series circuit block		
				OUT Y1 Drive Y1 coil		

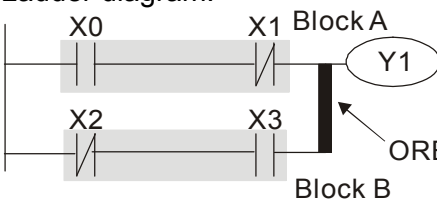
Command	Function					
ORB	Parallel circuit block					
Operand	N/A					
Explanation	ORB performs an "OR" operation on the previously saved logic results and the current cumulative register content.					
Example	Ladder diagram:			Command code: Description:		
				LD X0 Load Contact a of X0		
				ANI X1 Establish parallel connection to contact b of X1		
				LDI X2 Load Contact b of X2		
				AND X3 Establish parallel connection to contact a of X3		
				ORB Parallel circuit block		
				OUT Y1 Drive Y1 coil		

Command	Function					
MPS	Save to stack					
Operand	N/A					
Explanation	Save current content of cumulative register to the stack. (Add one to stack pointer)					

Command	Function
MRD	Read stack (pointer does not change)
Operand	N/A
Explanation	Reads stack content and saves to cumulative register. (Stack pointer does not change)

Command	Function
MPP	Read stack
Operand	N/A

Retrieves result of previously-save logical operation from the stack, and saves to cumulative register. (Subtract one from stack pointer)

Example Ladder diagram:

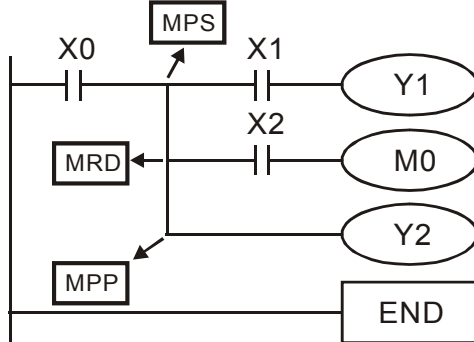

Command code:	Description:
LD X0	Load Contact a of X0
MPS	Save to stack
AND X1	Create series connection to contact a of X1
OUT Y1	Drive Y1 coil
MRD	Read stack (pointer does not change)
AND X2	Create series connection to contact a of X2
OUT M0	Drive M0 coil
MPP	Read stack
OUT Y2	Drive Y2 coil
END	Program conclusion

Command	Function
OUT	Drive coil
Operand	X0~X17 Y0~Y17 M0~M799 T0~159 C0~C79 D0~D399
	— ✓ ✓ — — —

Explanation Outputs result of logical operation before OUT command to the designated element. Coil contact action:

Result:	Out command		
	Coil	Access Point:	
		Contact a (NO)	Contact b (NC)
FALSE	Off	Not conducting	Conducting
TRUE	On	Conducting	Not conducting

Example Ladder diagram:



Command code:	Description:
LD X0	Load Contact b of X0
AND X1	Establish parallel connection to contact a of X1
OUT Y1	Drive Y1 coil

Command	Function
SET	Action continues (ON)
Operand	X0~X17 Y0~Y17 M0~M799 T0~159 C0~C79 D0~D399
	— ✓ ✓ — — —

Explanation When the SET command is driven, the designated element will be set as On, and will be maintained in an On state, regardless of whether the SET command is still driven. The RST command can be used to set the element as Off.

Example Ladder diagram:

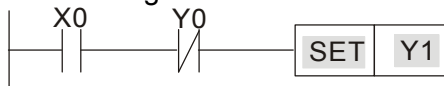

Command code:	Description:
LD X0	Load Contact a of X0
AN Y0	Establish parallel connection to contact b of Y0
SET Y1	Action continues (ON)

Command	Function					
RST	Clear contact or register					
Operand	X0~X17	Y0~Y17	M0~M799	T0~159	C0~C79	D0~D399
	—	✓	✓	✓	✓	✓

Explanation When the RST command is driven, the action of the designated element will be as follows:

Element	Mode
Y, M	Both coil and contact will be set as Off.
T, C	The current timing or count value will be set as 0, and both the coil and contact will be set as Off.
D	The content value will be set as 0.

If the RST command has not been executed, the status of the designated element will remain unchanged.

Example

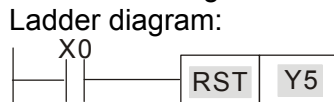

Command code:	Description:
LD X0	Load Contact a of X0
RST Y5	Clear contact or register

Command	Function	
TMR	16-bit timer	
Operand	T-K	T0~T159 , K0~K32,767
	T-D	T0~T159 , D0~D399

Explanation When the TMR command is executed, the designated timer coil will be electrified, and the timer will begin timing. The contact's action will be as follows when the timing value reaches the designated set value (timing value \geq set value):

NO (Normally Open) contact	Closed
NC (Normally Close) contact	Open

If the RST command has not been executed, the status of the designated element will remain unchanged.

Example

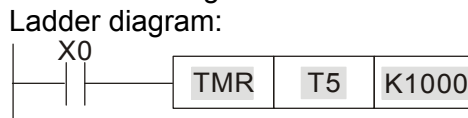

Command code:	Description:
LD X0	Load Contact a of X0
TMR T5 K1000	T5 timer Set value as K1000

Command	Function	
CNT	16-bit counter	
Operand	C-K	C0~C79 , K0~K32,767
	C-D	C0~C79 , D0~D399

Explanation When the CNT command is executed from Off→On, this indicates that the designated counter coil goes from no power → electrified, and 1 will be added to the counter's count value; when the count reaches the designated value (count value = set value), the contact will have the following action:

NO (Normally Open) contact	Closed
NC (Normally Close) contact	Open

After the count value has been reached, the contact and count value will both remain unchanged even if there is continued count pulse input. Please use the RST command if you wish to restart or clear the count.

Example

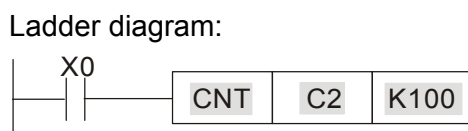

Command code:	Description:
LD X0	Load Contact a of X0
CNT C2 K100	C2counter Set value as K100

Command	Function
MC/MCR	Connect/release a common series contact
Operand	N0~N7

Explanation MC is the main control initiation command, and any commands between MC and MCR will be executed normally. When the MC command is Off, any commands between MC and MCR will act as follows:

Determination of commands	Description
Ordinary timer	The timing value will revert to 0, the coil will lose power, and the contact will not operate
Counter	The coil will lose power, and the count value and contact will stay in their current state
Coil driven by OUT command	None receive power
Elements driven by SET, RST commands	Will remain in their current state
Applications commands	None are actuated

MCR is the main control stop command, and is placed at the end of the main control program. There may not be any contact commands before the MCR command. The MC-MCR main control program commands support a nested program structure with a maximum only 8 levels; use in the order N0-N7, please refer to the following program:

Example Ladder diagram:

Command code:

Command	Code	Description:
LD	X0	Load Contact a of X0
MC	N0	Connection of N0 common series contact
LD	X1	Load Contact a of X1
OUT	Y0	Drive Y0 coil
:	:	:
LD	X2	Load Contact a of X2
MC	N1	Connection of N1 common series contact
LD	X3	Load Contact a of X3
OUT	Y1	Drive Y1 coil
:	:	:
MCR	N1	Release N1 common series contact
:	:	:
MCR	N0	Release N0 common series contact
:	:	:
LD	X10	Load Contact a of X10
MC	N0	Connection of N0 common series contact
LD	X11	Load Contact a of X11
OUT	Y10	Drive Y10 coil
:	:	:
MCR	N0	Release N0 common series contact

Command	Function					
LDP	Start of forward edge detection action					
Operand	X0~X17	Y0~Y17	M0~M799	T0~159	C0~C79	D0~D399
	✓	✓	✓	✓	✓	—

Explanation The LDP command has the same usage as LD, but its action is different; its function is to save current content, while also saving the detected state of the rising edge of the contact to the cumulative register.

Example Ladder diagram:

Command code:

Command	Code	Description:
LDP	X0	Start of X0 forward edge detection action
AND	X1	Create series connection to contact a of X1

OUT Y1 Drive Y1 coil

Remark

Please refer to the function specifications table for each device in series for the scope of usage of each operand.

A rising edge contact will be TRUE after power is turned on if the rising edge contact is On before power is turned on to the PLC.

Command	Function					
LDF	Start of reverse edge detection action					
Operand	X0~X17	Y0~Y17	M0~M799	T0~159	C0~C79	D0~D399
	✓	✓	✓	✓	✓	—

Explanation

The LDF command has the same usage as LD, but its action is different; its function is to save current content while also saving the detected state of the falling edge of the contact to the cumulative register.

Example

Ladder diagram:

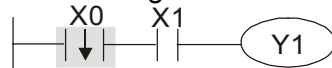

Command code: Description:

LDF	X0	Start of X0 reverse edge detection action
AND	X1	Create series connection to contact a of X1
OUT	Y1	Drive Y1 coil

Command	Function					
ANDP	Forward edge detection series connection					
Operand	X0~X17	Y0~Y17	M0~M799	T0~159	C0~C79	D0~D399
	✓	✓	✓	✓	✓	—

Explanation

The ANDP command used for a contact rising edge detection series connection.

Example

Ladder diagram:

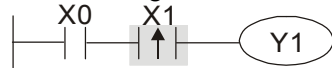

Command code: Description:

LD	X0	Load Contact a of X0
ANDP	X1	X1 Forward edge detection series connection
OUT	Y1	Drive Y1 coil

Command	Function					
ANDF	Reverse edge detection series connection					
Operand	X0~X17	Y0~Y17	M0~M799	T0~159	C0~C79	D0~D399
	✓	✓	✓	✓	✓	—

Explanation

The ANDF command is used for a contact falling edge detection series connection.

Example

Ladder diagram:

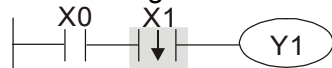

Command code: Description:

LD	X0	Load Contact a of X0
ANDF	X1	X1 Reverse edge detection series connection
OUT	Y1	Drive Y1 coil

Command	Function					
ORP	Forward edge detection parallel connection					
Operand	X0~X17	Y0~Y17	M0~M799	T0~159	C0~C79	D0~D399
	✓	✓	✓	✓	✓	—

Explanation

The ORP command is used for a contact rising edge detection parallel connection.

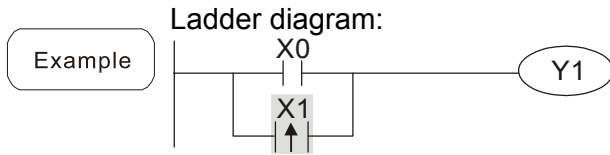

Command code:		Description:
LD	X0	Load Contact a of X0
ORP	X1	X1 Forward edge detection parallel connection
OUT	Y1	Drive Y1 coil

Command	Function					
ORF	Reverse edge detection parallel connection					
Operand	X0~X17	Y0~Y17	M0~M799	T0~159	C0~C79	D0~D399
	✓	✓	✓	✓	✓	—

Explanation The ORF command is used for contact falling edge detection parallel connection.

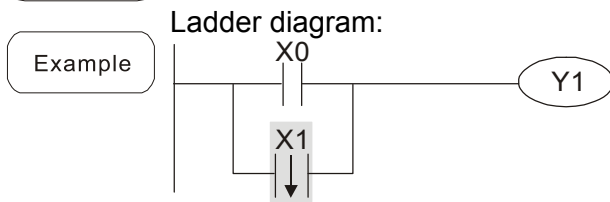

Command code:		Description:
LD	X0	Load Contact a of X0
ORF	X1	X1 Reverse edge detection parallel connection
OUT	Y1	Drive Y1 coil

Command	Function					
PLS	Upper differential output					
Operand	X0~X17	Y0~Y17	M0~M799	T0~159	C0~C79	D0~D399
	—	✓	✓	—	—	—

Explanation Upper differential output commands. When X0=Off→On (positive edge-triggered), the PLS command will be executed, and M0 will send one pulse, with a pulse length consisting of one scanning period.

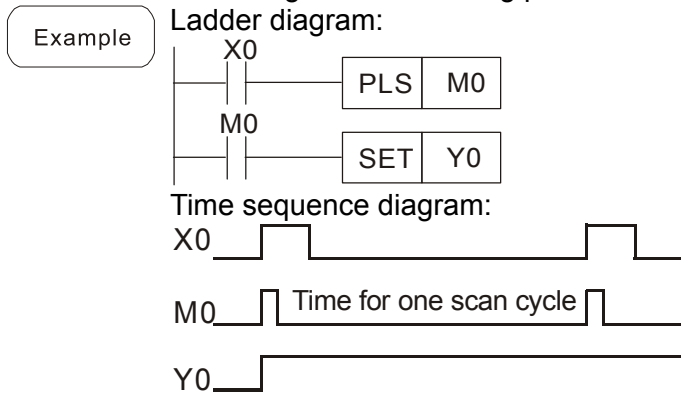

Command code:		Description:
LD	X0	Load Contact a of X0
PLS	M0	M0 Upper differential output
LD	M0	Load Contact a of M0
SET	Y0	Y0 Action continues (ON)

Command	Function					
PLF	Lower differential output					
Operand	X0~X17	Y0~Y17	M0~M799	T0~159	C0~C79	D0~D399
	—	✓	✓	—	—	—

Explanation Lower differential output command. When X0= On→Off (negative edge-triggered), the PLF command will be executed, and M0 will send one pulse, with pulse length consisting of one scanning period.

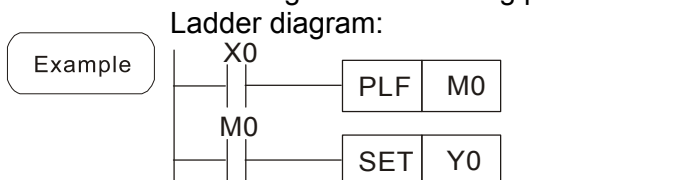

Command code:		Description:
LD	X0	Load Contact a of X0
PLF	M0	M0 Lower differential output
LD	M0	Load Contact a of M0

Time sequence diagram:

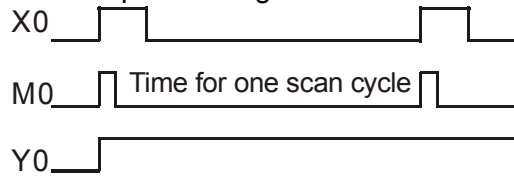

SET Y0 Y0 Action continues (ON)

Command	Function
END	Program conclusion
Operand	N/A

Explanation

An END command must be added to the end of a ladder diagram program or command program. The PLC will scan from address 0 to the END command, and will return to address 0 and begins scanning again after execution.

Command	Function
NOP	No action
Operand	N/A

Explanation

The command NOP does not perform any operation in the program. Because execution of this command will retain the original logical operation results, it can be used in the following situation: the NOP command can be used instead of a command that is deleted without changing the program length.

Example

Ladder diagram:

NOP command will be simplified and not displayed when the ladder diagram is displayed.

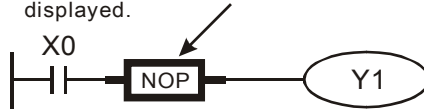

Command code:

Description:

LD	X0	Load Contact b of X0
NOP		No action
OUT	Y1	Drive Y1 coil

Command	Function
INV	Inverse of operation results
Operand	N/A

Explanation

Saves the result of the logic inversion operation prior to the INV command in the cumulative register.

Example

Ladder diagram:



Command code:

Description:

LD	X0	Load Contact a of X0
INV		Inverse of operation results
OUT	Y1	Drive Y1 coil

Command	Function
P	Index
Operand	P0~P255

Explanation

Pointer P is used to subprogram call command API 01 CALL. Use does not require starting from zero, but the number cannot be used repeatedly, otherwise an unpredictable error will occur.

Example

Ladder diagram:

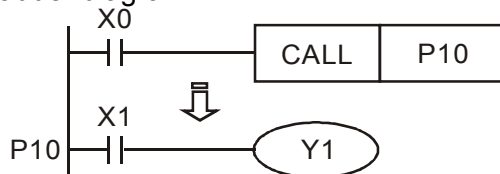

Command code:

Description:

LD	X0	Load Contact a of X0
CALL	P10	Call command CALL to P10
:		
P10		Pointer P10

LD	X1	Load Contact a of X1
OUT	Y1	Drive Y1 coil

16-6-3 Overview of application commands

Classification	API	Command code		P command	Function	STEPS	
		16 bit	32 bit			16bit	32bit
Circuit control	01	CALL	-	✓	Call subprogram	3	-
	2	SRET	-	-	Conclusion of subprogram	1	-
	06	FEND	-	-	Conclusion a main program	1	-
Send comparison	10	CMP	DCMP	✓	Compares set output	7	13
	11	ZCP	DZCP	✓	Range comparison	9	17
	12	MOV	DMOV	✓	Data movement	5	9
	15	BMOV	-	✓	Send all	7	-
Four logical operations	20	ADD	DADD	✓	BIN addition	7	13
	21	SUB	DSUB	✓	BIN subtraction	7	13
	22	MUL	DMUL	✓	BIN multiplication	7	13
	23	DIV	DDIV	✓	BIN division	7	13
	24	INC	DINC	✓	BIN add one	3	5
	25	DEC	DDEC	✓	BIN subtract one	3	5
Rotational displacement	30	ROR	DROR	✓	Right rotation	5	-
	31	ROL	DROL	✓	Left rotation	5	-
Data Process	40	ZRST	-	✓	Clear range	5	-
	49	-	DFLT	✓	BIN whole number → binary floating point number transformation	-	9
communication	150	MODRW	-	✓	MODBUS read/write	7	-
Floating point operation	110	-	DECMP	✓	Comparison of binary floating point numbers	-	13
	111	-	DEZCP	✓	Comparison of binary floating point number range	-	17
	116	-	DRAD	✓	Angle → Diameter	-	9
	117	-	DDEG	✓	Diameter → angle	-	9
	120	-	DEADD	✓	Binary floating point number addition	-	13
	121	-	DESUB	✓	Binary floating point number subtraction	-	13
	122	-	DEMUL	✓	Binary floating point number multiplication	-	13
	123	-	DEDIV	✓	Binary floating point number division	-	13
	124	-	DEXP	✓	Binary floating point number obtain exponent	-	9
	125	-	DLN	✓	Binary floating point number obtain logarithm	-	9
	127	-	DESQR	✓	Binary floating point number find square root	-	9
	129	-	DINT	✓	Binary floating point number → BIN whole number transformation	-	9
	130	-	DSIN	✓	Binary floating point number SIN operation	-	9
	131	-	DCOS	✓	Binary floating point number COS operation	-	9
	132	-	DTAN	✓	Binary floating point number TAN operation	-	9
	133	-	DASIN	✓	Binary floating point number ASIN operation	-	9
134	-	DACOS	✓	Binary floating point number ACOS operation	-	9	

Classification	API	Command code		P command	Function	STEPS	
		16 bit	32 bit			16bit	32bit
	135	-	DATAN	✓	Binary floating point number ATAN operation	-	9
Floating point operation	136	-	DSINH	✓	Binary floating point number SINH operation	-	9
	137	-	DCOSH	✓	Binary floating point number COSH operation	-	9
	138	-	DTANH	✓	Binary floating point number TANH operation	-	9
	160	TCMP	-	✓	Compare calendar data	11	-
Calendar	161	TZCP	-	✓	Compare calendar data range	9	-
	162	TADD	-	✓	Calendar data addition	7	-
	163	TSUB	-	✓	Calendar data subtraction	7	-
	166	TRD	-	✓	Calendar data read	3	-
	170	GRY	DGRY	✓	BIN→GRY code transformation	5	9
GRAY code	171	GBIN	DGBIN	✓	GRY code →BIN transformation	5	9
Contact form logical operation	215	LD&	DLD&	-	Contact form logical operation LD#	5	9
	216	LD	DLD	-	Contact form logical operation LD#	5	9
	217	LD^	DLD^	-	Contact form logical operation LD#	5	9
	218	AND&	DAND&	-	Contact form logical operation AND#	5	9
	219	ANDI	DANDI	-	Contact form logical operation AND#	5	9
	220	AND^	DAND^	-	Contact form logical operation AND#	5	9
	221	OR&	DOR&	-	Contact form logical operation OR#	5	9
	222	OR	DOR	-	Contact form logical operation OR#	5	9
	223	OR^	DOR^	-	Contact form logical operation OR#	5	9
Contact form compare command	224	LD=	DLD=	-	Contact form compare LD*	5	9
	225	LD>	DLD>	-	Contact form compare LD*	5	9
	226	LD<	DLD<	-	Contact form compare LD*	5	9
	228	LD<>	DLD<>	-	Contact form compare LD*	5	9
	229	LD<=	DLD<=	-	Contact form compare LD*	5	9
	230	LD>=	DLD>=	-	Contact form compare LD*	5	9
	232	AND=	DAND=	-	Contact form compare AND*	5	9
	233	AND>	DAND>	-	Contact form compare AND*	5	9
	234	AND<	DAND<	-	Contact form compare AND*	5	9
	236	AND<>	DAND<>	-	Contact form compare AND*	5	9
	237	AND<=	DAND<=	-	Contact form compare AND*	5	9
	238	AND>=	DAND>=	-	Contact form compare AND*	5	9
	240	OR=	DOR=	-	Contact form compare OR*	5	9
	241	OR>	DOR>	-	Contact form compare OR*	5	9
	242	OR<	DOR<	-	Contact form compare OR*	5	9
	244	OR<>	DOR<>	-	Contact form compare OR*	5	9
245	OR<=	DOR<=	-	Contact form compare OR*	5	9	
246	OR>=	DOR>=	-	Contact form compare OR*	5	9	

Classification	API	Command code		P command	Function	STEPS	
		16 bit	32 bit			16bit	32bit
Floating point contact form	275	-	FLD=	-	Floating point number contact form compare LD*	-	9
	276	-	FLD>	-	Floating point number contact form compare LD*	-	9
	277	-	FLD<	-	Floating point number contact form compare LD*	-	9
Compare command	278	-	FLD<>	-	Floating point number contact form compare LD*	-	9
	279	-	FLD<=	-	Floating point number contact form compare LD*	-	9
	280	-	FLD>=	-	Floating point number contact form compare LD*	-	9
	281	-	FAND=	-	Floating point number contact form compare AND*	-	9
	282	-	FAND>	-	Floating point number contact form compare AND*	-	9
	283	-	FAND<	-	Floating point number contact form compare AND*	-	9
	284	-	FAND<>	-	Floating point number contact form compare AND*	-	9
	285	-	FAND<=	-	Floating point number contact form compare AND*	-	9
	286	-	FAND>=	-	Floating point number contact form compare AND*	-	9
	287	-	FOR=	-	Floating point number contact form compare OR*	-	9
	288	-	FOR>	-	Floating point number contact form compare OR*	-	9
	289	-	FOR<	-	Floating point number contact form compare OR*	-	9
	290	-	FOR<>	-	Floating point number contact form compare OR*	-	9
	291	-	FOR<=	-	Floating point number contact form compare OR*	-	9
	292	-	FOR>=	-	Floating point number contact form compare OR*	-	9
Driver special command	139	RPR	-	✓	Read servo parameter	5	-
	140	WPR	-	✓	Write servo parameter	5	-
	141	FPID	-	✓	Driver PID control mode	9	-
	142	FREQ	-	✓	Driver torque control mode	7	-
	262	-	DPOS	✓	Set target	-	5
	263	TORQ	-	✓	Set target torque	5	-
	261	CANRX	-	✓	Read CANopen slave station data	9	-
	264	CANTX	-	✓	Write CANopen slave station data	9	-
	265	CANFLS	-	✓	Refresh special D corresponding to CANopen	3	-
	320	ICOMR	DICOMR	✓	Internal communications read	9	17
321	ICOMW	DICOMW	✓	Internal communications write	9	17	

16-6-4 Detailed explanation of applications commands

API 01		CALL															(S)	Call subprogram		
		Bit device			Word device										16-bit command (3 STEP)					
		X	Y	M	K	H	KnX	KnY	KnM	T	C	D	CALL	Continuous execution type	CALLP	Pulse execution type				
Notes on operand usage: The S operand can designate P CT2000 series device: The S operand can designate P0-P63																	32-bit command			
																	Flag signal: none			

Explanation

- **S** : Call subprogram pointer.
- Write the subprogram after the FEND command.
- The subprogram must end after the SRET command.
- Refer to the FEND command explanation and sample content for detailed command functions.

API 02		SRET																–	Conclusion of subprogram	
		Bit device			Word device										16-bit command (1 STEP)					
		X	Y	M	K	H	KnX	KnY	KnM	T	C	D	FEND	Continuous execution type	–	–				
Notes on operand usage: No operand A contact-driven command is not needed																	32-bit command			
																	Flag signal: none			

Explanation

- A contact-driven command is not needed. Automatically returns next command after CALL command
- Indicates end of subprogram. After end of subprogram, SRET returns to main program, and executes next command after the original call subprogram CALL command.
- Refer to the FEND command explanation and sample content for detailed command functions.

API 06	FEND	—	Conclusion a main program
-----------	-------------	---	---------------------------

	Bit device			Word device								16-bit command (1 STEP)			
	X	Y	M	K	H	KnX	KnY	KnM	T	C	D	FEND	Continuous execution type	—	—
Notes on operand usage: No operand A contact-driven command is not needed												32-bit command			
												— — — —			
												Flag signal: none			

Explanation

- This command indicates the end of the main program. It is the same as the END command when the PLC executes this command.
- The CALL command program must be written after the FEND command, and the SRET command added to the end of the subprogram.
- When using the FEND command, an END command is also needed. However, the END command must be placed at the end, after the main program and subprogram.

CALL command process

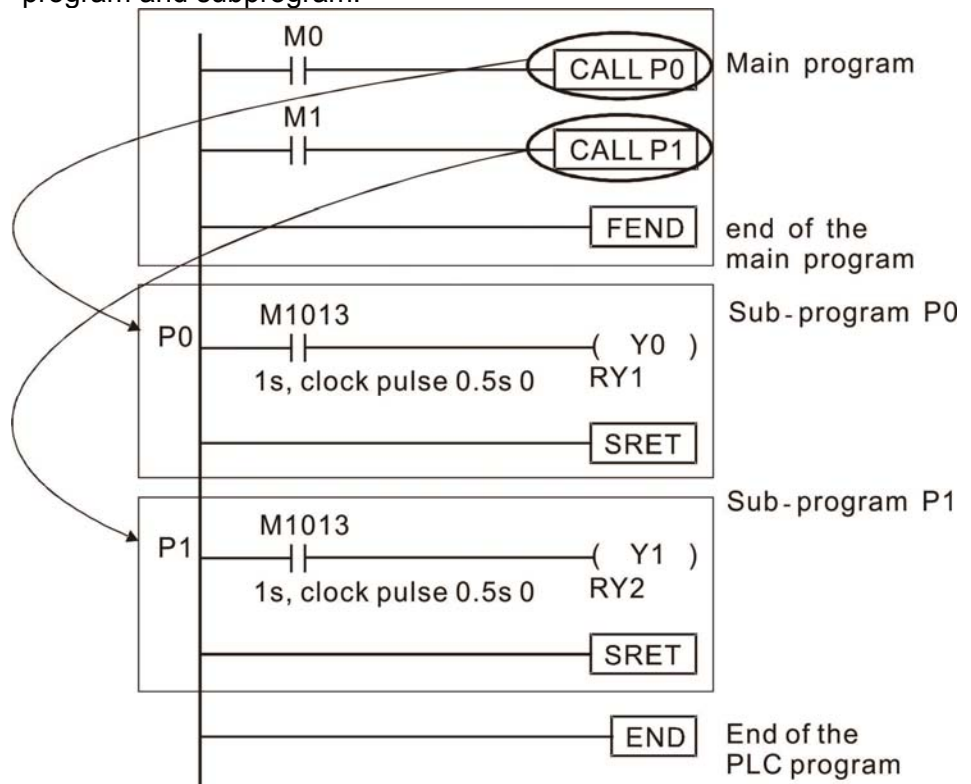

API 10	D	CMP	P	(S1)	(S2)	(D)	Compares set output							
Bit device			Word device								16-bit command (7 STEP)			
X	Y	M	K	H	KnX	KnY	KnM	T	C	D	CMP	Continuous execution type	CMPP	Pulse execution type
S1			*	*	*	*	*	*	*	*				
S2			*	*	*	*	*	*	*	*				
D		*	*											
Notes on operand usage: The operand D occupies three consecutive points											32-bit command (13 STEP)			
											DCMP	Continuous execution type	DCMPP	Pulse execution type
											Flag signal: none			

Explanation

- (S1): Compare value 1. (S2): Compare value 2. (D): Results of comparison.
- Compares the size of the content of operand (S1) and (S2); the results of comparison are expressed in (D).
- Size comparison is performed algebraically. All data is compared in the form of numerical binary values. Because this is a 16-bit command, when b15 is 1, this indicates a negative number.

Example

- When the designated device is Y0, it automatically occupies Y0, Y1 and Y2.
- When X10=On, the CMP command executes, and Y0, Y1 or Y2 will be On. When X10=Off, the CMP command will not execute, and the state of Y0, Y1 and Y2 will remain in the state prior to X10=Off.
- If ≥, ≤, or ≠ results are needed, they can be obtained via series/parallel connections of Y0-Y2.

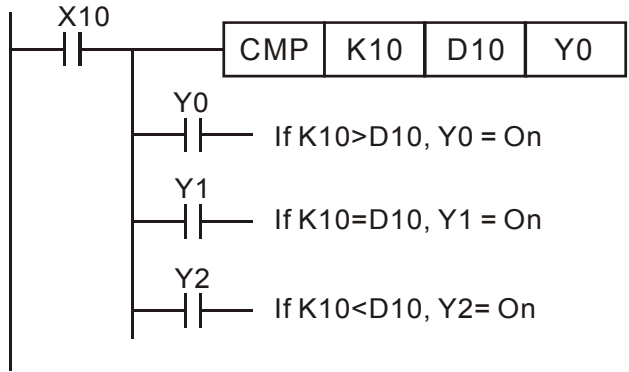

- To clear results of comparison, use the RST or ZRST command.

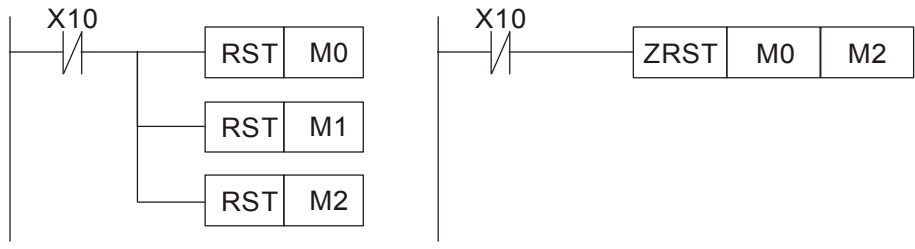

API 11	D	ZCP	P	(S1)	(S2)	(S)	(D)	Range comparison						
Bit device			Word device								16-bit command (9 STEP)			
X	Y	M	K	H	KnX	KnY	KnM	T	C	D	ZCP	Continuous execution type	ZCPP	Pulse execution type
S1			*	*	*	*	*	*	*	*				
S2			*	*	*	*	*	*	*	*				
S			*	*	*	*	*	*	*	*				
D		*	*											
Notes on operand usage: The content value of operand S1 is less than the content value of S2 operand The operand D occupies three consecutive points											32-bit command (17 STEP)			
											DZCP	Continuous execution type	DZCPP	Pulse execution type
											Flag signal: none			

Explanation

- (S1): Lower limit of range comparison. (S2): Upper limit of range comparison. (S): Comparative value. (D): Results of comparison.
- When the comparative value (S) is compared with the lower limit (S1) and upper limit (S2), the results of comparison are expressed in (D).
- When lower limit (S1) > upper limit (S2), the command will use the lower limit (S1) to perform comparison with the upper and lower limit.
- Size comparison is performed algebraically. All data is compared in the form of numerical binary values. Because this is a 16-bit command, when b15 is 1, this indicates a negative number.

Example

- When the designated device is M0, it automatically occupies M0, M1 and M2.
- When X0=On, the ZCP command executes, and M0, M1 or M2 will be On. When X0=Off, the ZCP command will not execute, and the state of M0, M1 or M2 will remain in the state prior to X0=Off.
- If ≥, ≤, or ≠ results are needed, they can be obtained via series/parallel connections of M0-M2.

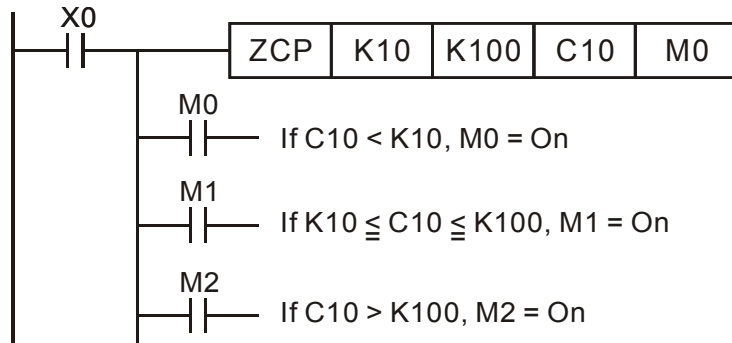

- To clear results of comparison, use the RST or ZRST command.

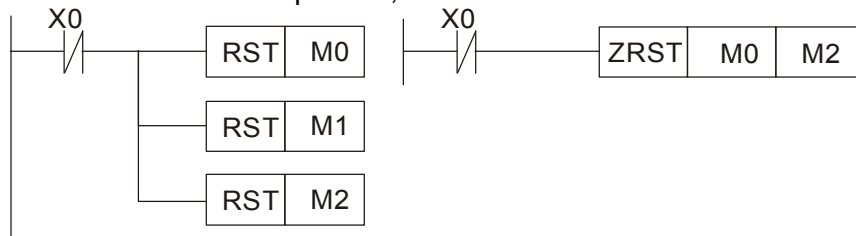

API 12	D	MOV	P	(S)	(D)	Data movement								
Bit device		Word device									16-bit command (5 STEP)			
X	Y	M	K	H	KnX	KnY	KnM	T	C	D	MOV	Continuous execution type	MOV P	Pulse execution type
S			*	*	*	*	*	*	*	*				
D						*	*	*	*	*				
Notes on operand usage: none											32-bit command (9 STEP)			
											DMOV	Continuous execution type	DMOV P	Pulse execution type
											Flag signal:			

Explanation

- (S) : Data source. (D) : Destination of data movement.
- When this command is executed, the content of (S) content will be directly moved to (D). When the command is not executed, the content of (D) will not change.

Example

1. When X0=Off, the content of D10 will not change; if X0=On, the value K10 will be sent to data register D10.
2. When X1=Off, the content of D10 will not change; if X1=On, the current value of T0 will be sent to data register D10.

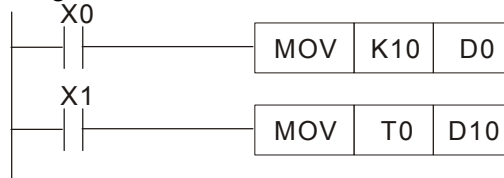

API 15	BMOV		P	(S) (D) (n)	Send all									
Bit device			Word device								16-bit command (7 STEP)			
X	Y	M	K	H	KnX	KnY	KnM	T	C	D	BMOV	Continuous execution type	BMOV P	Pulse execution type
S					*	*	*	*	*	*	32-bit command			
D						*	*	*	*	*	-			
n			*	*				*	*		-			
Notes on operand usage: n operand scope n = 1 to 512											Flag signal: none			

- Explanation**
- (S): Initiate source device. (D): Initiate destination device. (n): Send block length.
 - The content of n registers starting from the initial number of the device designated by (S) will be sent to the n registers starting from the initial number of the device designated by (D); if the number of points referred to by n exceeds the range used by that device, only points within the valid range will be sent.

Example 1 3. When X10=On, the content of registers D0-D3 will be sent to the four registers D20 to D23.

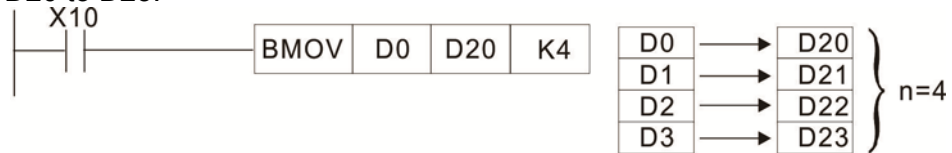

Example 2 4. If the designated bit devices KnX, KnY, and KnM are sent, (S) and (D) must have the same number of nibbles, which implies that n must be identical.

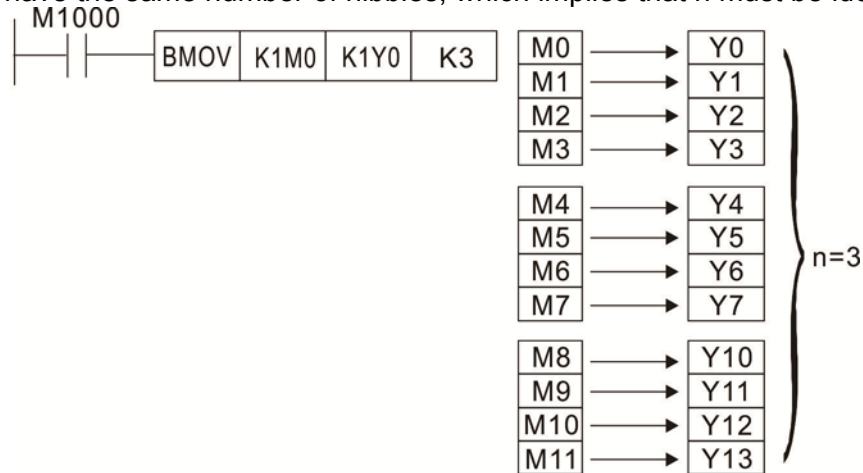

Example 3 5. In order to prevent overlap between the transmission addresses of two operands, which would cause confusion, make sure that the addresses designated by the two operands have different sizes, as shown below:

When (S) > (D), send in the order ① → ② → ③.

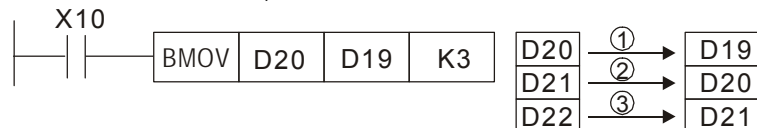

When (S) < (D), send in the order ③ → ② → ①.

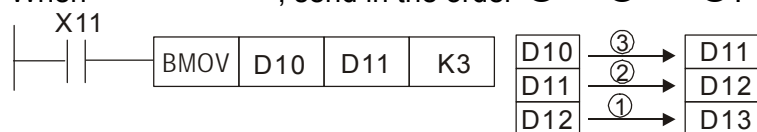

API 20	D	ADD	P	(S1)	(S2)	(D)	BIN addition							
Bit device			Word device								16-bit command (7 STEP)			
X	Y	M	K	H	KnX	KnY	KnM	T	C	D	ADD	Continuous execution type	ADDP	Pulse execution type
S1			*	*	*	*	*	*	*	*				
S2			*	*	*	*	*	*	*	*				
D						*	*	*	*	*				
Notes on operand usage: none											32-bit command (13 STEP)			
											DADD	Continuous execution type	DADDP	Pulse execution type
											Flag signal: M1020 Zero flag M1021 Borrow flag M1022 Carry flag Please refer to the following supplementary explanation			

Explanation

- (S1): Augend. (S2): Addend. (D): Sum.
- Using two data sources: The result of adding (S1) and (S2) using the BIN method will be stored in (D).
- The highest bit of any data is symbolized as bit 0 indicating (positive) 1 indicating (negative), enabling the use of algebraic addition operations. (for instance: 3+(-9)=-6)
- Flag changes connected with the addition.
 1. When calculation results are 0, the zero flag M1020 will be On.
 2. When calculation results are less than -32,768, the borrow flag M1021 will be On.
 3. When calculation results are greater than 32,767, the carry flag M1022 will be On.

Example

6. 16-bit BIN addition: When X0=On, the result of the content of addend D0 plus the content of augend D10 will exist in the content of D20.



Remark

7. Relationship between flag actions and negative/positive numbers:

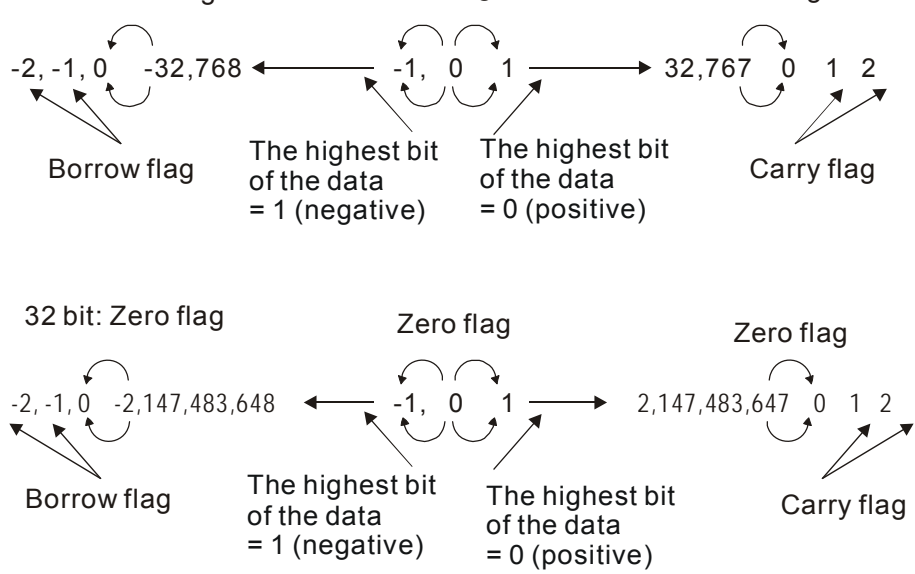

API 21	D	SUB	P	(S1)	(S2)	(D)	BIN subtraction							
Bit device			Word device								16-bit command (7 STEP)			
X	Y	M	K	H	KnX	KnY	KnM	T	C	D	SUB	Continuous execution type	SUBP	Pulse execution type
S1			*	*	*	*	*	*	*	*				
S2			*	*	*	*	*	*	*	*				
D						*	*	*	*	*				
Notes on operand usage: none											32-bit command (13 STEP)			
											DSUB	Continuous execution type	DSUBP	Pulse execution type
											Flag signal: M1020 Zero flag M1021 Borrow flag M1022 Carry flag Please refer to the following supplementary explanation			

Explanation

- (S1): Minuend. (S2): Subtrahend. (D): Difference.
- Using two data sources: The result of subtraction of (S1) and (S2) using the BIN method is stored in (D).
- The highest bit of any data is symbolized as bit 0 indicating (positive) 1 indicating (negative), enabling the use of algebraic subtraction operations.
- Flag changes connected with subtraction.
 1. When calculation results are 0, the zero flag M1020 will be On.
 2. When calculation results are less than -32,768, the borrow flag M1021 will be On.
 3. When calculation results are greater than 32,767, the carry flag M1022 will be On.

Example

8. 16-bit BIN subtraction: When X0=On, the content of D0 is subtracted from the content of D10, and the difference is stored in D20.



API 22		D	MUL	P	(S1) (S2) (D)	BIN multiplication									
Bit device				Word device								16-bit command (7 STEP)			
X Y M				K	H	KnX	KnY	KnM	T	C	D	MUL	Continuous execution type	MULP	Pulse execution type
S1				*	*	*	*	*	*	*	*				
S2				*	*	*	*	*	*	*	*				
D							*	*	*	*	*				
Notes on operand usage: The 16-bit command operand D will occupy 2 consecutive points												32-bit command (13 STEP)			
												DMUL	Continuous execution type	DMULP	Pulse execution type
												Flag signal: none			

Explanation

- (S1): Multiplicand. (S2): Multiplier. (D): Product.
- Using two data sources: When (S1) and (S2) are multiplied using the BIN method, the product is stored in (D).

16-bit BIN multiplication operation:

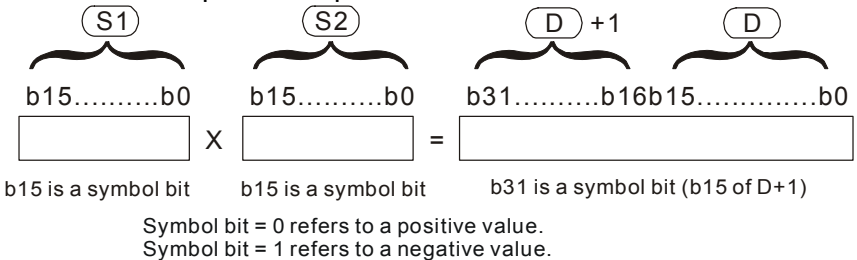

When (D) is a bit device, K1-K4 can be designated as a hexadecimal number, which will occupy 2 consecutive units.

Example

- When 16-bit D0 is multiplied by 16-bit D10, the result will be a 32-bit product; the upper 16 bits will be stored in D21, and the lower 16 bits will be stored in D20. Whether the bit at the farthest left is Off or On will indicate the sign of the result.

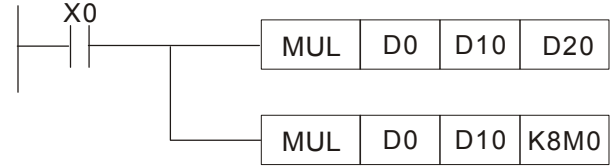

API 23	D	DIV	P	(S1)	(S2)	(D)	BIN division								
Bit device			Word device									16-bit command (7 STEP)			
X	Y	M	K	H	KnX	KnY	KnM	T	C	D	DIV	Continuous execution type	DIVP	Pulse execution type	
S1			*	*	*	*	*	*	*	*	32-bit command (13 STEP)				
S2			*	*	*	*	*	*	*	*	DDIV	Continuous execution type	DDIVP	Pulse execution type	
D						*	*	*	*	*	Flag signal: none				

Notes on operand usage:
The 16-bit command operand D will occupy 2 consecutive points

Explanation

- (S1): Dividend. (S2): Divisor. (D): Quotient and remainder.
- Using two data sources: The quotient and remainder will be stored in (D) when (S1) and (S2) are subjected to division using the BIN method. The sign bit for (S1), (S2) and (D) must be kept in mind when performing a 16-bit operation.

16-bit BIN division:

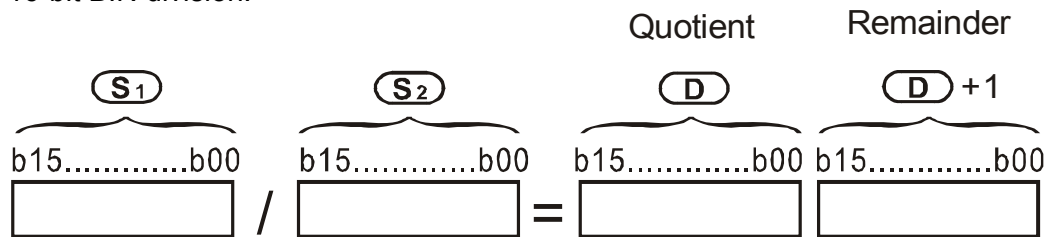

If (D) is a bit device, K1-K4 can be designated 16 bits, which will occupy 2 consecutive units and yield the quotient and remainder.

Example

- When X0=On, the quotient resulting from division of dividend D0 by divisor D10 will be placed in D20, and the remainder will be placed in D21. Whether the highest bit is Off or On will indicate the sign of the result.

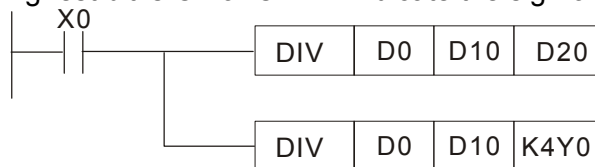

API 24	D	INC	P	(D)	BIN add one										
Bit device			Word device									16-bit command (3 STEP)			
X	Y	M	K	H	KnX	KnY	KnM	T	C	D	INC	Continuous execution type	INCP	Pulse execution type	
D						*	*	*	*	*					
Notes on operand usage: none											32-bit command (5 STEP)				
											DINC	Continuous execution type	DINCP	Pulse execution type	
											Flag signal: none				

Explanation

- (D) : Destination device.
- If a command is not the pulse execution type, when the command is executed, the program will add 1 to the content of device (D) for each scanning cycle.
- This command is ordinarily used as a pulse execution type command (INCP).
- During 16-bit operation, 32,767 +1 will change the value to -32,768. During 32 bit operation, 2,147,483,647 +1 will change the value to -2,147,483,648.

Example

11. When X0=Off→On, 1 is automatically added to the content of D0.

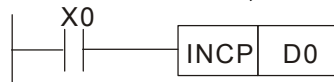

API 25	D	DEC	P	(D)	BIN subtract one									
Bit device			Word device								16-bit command (3 STEP)			
X	Y	M	K	H	KnX	KnY	KnM	T	C	D	DEC	Continuous execution type	DECP	Pulse execution type
D			*	*	*	*	*							
Notes on operand usage: none											32-bit command (5 STEP)			
											DDEC	Continuous execution type	DDECP	Pulse execution type
											Flag signal: none			

Explanation

- (D): Destination device.
- If a command is not the pulse execution type, when the command is executed, the program will add 1 to the content of device (D) for each scanning cycle.
- This command is ordinarily used as a pulse execution type command (DECP).
- During 16-bit operation, -32,768 -1 will change the value to 32,767. During 32 bit operation, -2,147,483,648 -1 will change the value to -2,147,483,647.

Example

12. When X0=Off→On, 1 is automatically subtracted from the content of D0.



API 30	D	ROR	P	(D)	(n)	Right rotation									
Bit device		Word device										16-bit command (5 STEP)			
X	Y	M	K	H	KnX	KnY	KnM	T	C	D	ROR	Continuous execution type	RORP	Pulse execution type	
D						*	*	*	*	*					
n			*	*							32-bit command (9 STEP)				
Notes on operand usage: Only K4 (16-bit) will be valid if the operand D is designated as KnY or KnM. n operand n=K1-K16 (16-bit)											DROR	Continuous execution type	DRORP	Pulse execution type	
											Flag signal: M1022 Carry flag				

Explanation

- (D): Device to be rotated. (n): Number of bits for one rotation.
- Rotates the device designated by (D) to the right (n) bits.
- This command is ordinarily used as a pulse execution type command (RORP).

Example

13. When X0=Off→On, 4 of the 16 bits in D10 specify a right rotation; the content of the bit indicated with * (see figure below) will be sent to the carry flag signal M1022.

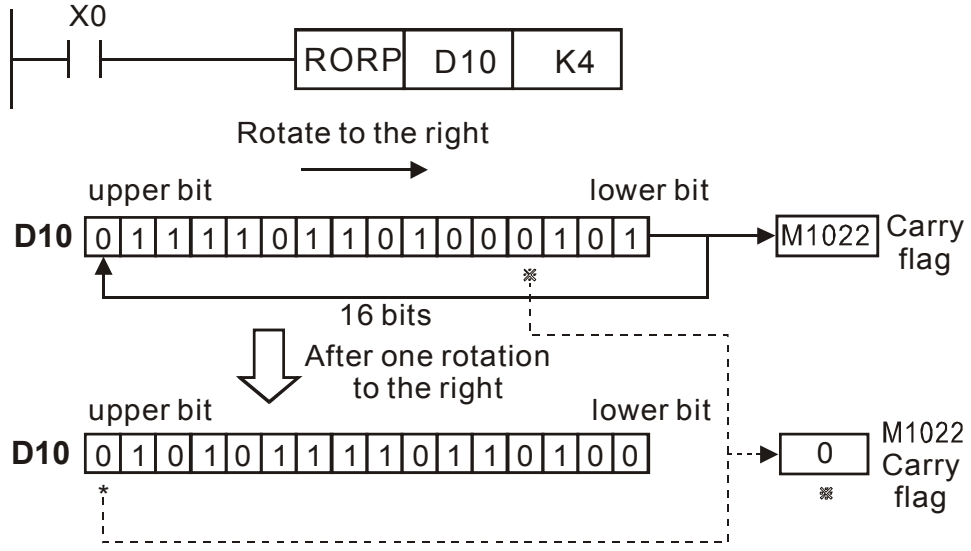

API 31	D	ROL	P	(D)	(n)	Left rotation									
Bit device		Word device										16-bit command (5 STEP)			
X	Y	M	K	H	KnX	KnY	KnM	T	C	D	ROL	Continuous execution type	ROLP	Pulse execution type	
D						*	*	*	*	*					
n			*	*							32-bit command (9 STEP)				
Notes on operand usage: Only K4 (16-bit) will be valid if the operand D is designated as KnY or KnM. n operand n=1 to 16 (16-bit)											DROL	Continuous execution type	DROLP	Pulse execution type	
											Flag signal: M1022			Carry flag	

Explanation

- (D): Device to be rotated. (n): Number of bits for one rotation.
- Rotates the device designated by (D) to the left (n) bits.
- This command is ordinarily used as a pulse execution type command (ROLP).

Example

14. When X0=Off→On, 4 of the 16 bits in D10 specify a left rotation; the content of the bit indicated with * (see figure below) will be sent to the carry flag signal M1022.

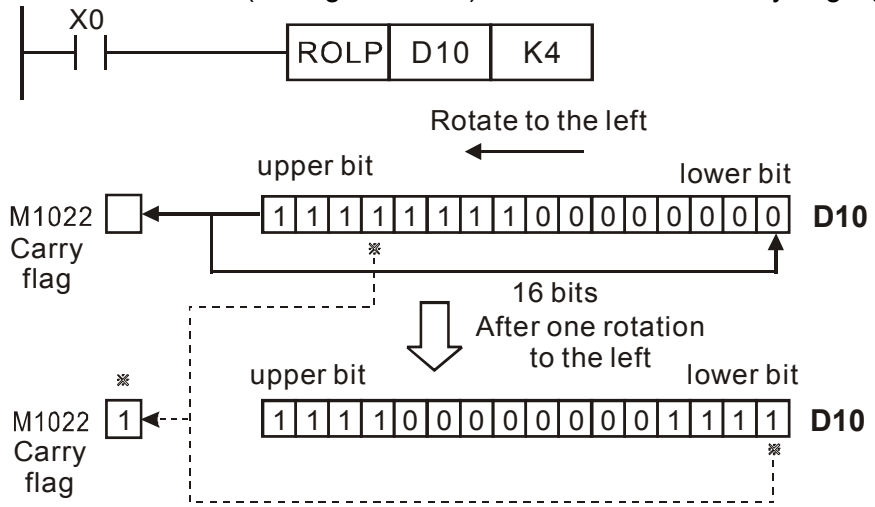

API 40	ZRST		P	(D1) (D2)	Clear range										
	Bit device			Word device								16-bit command (5 STEP)			
	X	Y	M	K	H	KnX	KnY	KnM	T	C	D	ZRST	Continuous execution type	ZRSTP	Pulse execution type
D1		*	*						*	*	*				
D2		*	*						*	*	*				
Notes on operand usage: Number of operand D ₁ operand ≤ number of operand D ₂ Operands D ₁ , D ₂ must designate the same type of device Please refer to the function specifications table for each device in series for the scope of device usage											32-bit command				
											Flag signal: none				

Explanation

- **D₁**: Clear range's initial device. **D₂**: Clear range's final device.
- When the number of operand D₁ > number of operand D₂, only the operand designated by D₂ will be cleared.

Example

- When X0 is On, auxiliary relays M300 - M399 will be cleared and changed to Off.
- When X1 is On, 16-bit counters C0 - C127 will all be cleared. (Writes 0, and clears and changes contact and coil to Off).
- When X10 is On, timer T0 - T127 will all be cleared. (Writes 0, and clears and changes contact and coil to Off).
- When X3 is On, the data in data registers D0 - D100 will be cleared and set as 0.

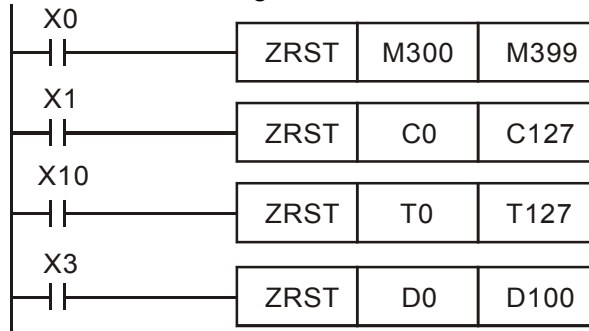

Remark

- Devices can independently use the clear command (RST), such as bit device Y, M and word device T, C, D.

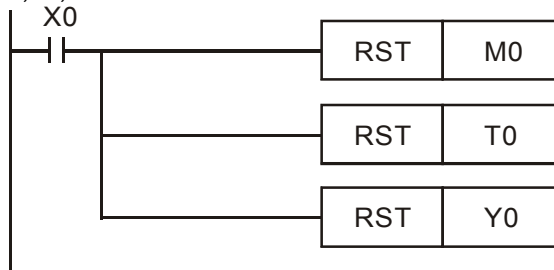

API 49	D	FLT	P	(S)	(D)	BIN whole number → binary decimal transformation									
Bit device			Word device									16-bit command			
X	Y	M	K	H	KnX	KnY	KnM	T	C	D	- - - -				
S	*	*						*	*	*	32-bit command (9steps)				
D	*	*						*	*	*	DFLT	Continuous	DFLTP	Pulse	
Notes on operand usage: Please refer to the function specifications table for each device in series for the scope of device usage The operand D will occupy 2 consecutive points											execution type		execution type		
											Flag signal: none				

- Explanation
- **S**: Transformation source device. **D**: Device storing transformation results.
 - Transforms BIN whole number into a binary decimal value.

Example 20. When X11 is On, converts the whole number of values corresponding to D0 and D1 into floating point numbers, which are placed in D20 and D21.

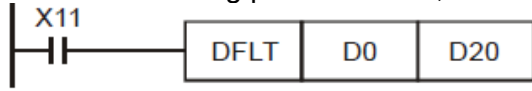

API 150	MODRW	P	S₁	S₂	S₃	S	n	MODBUS data read/write					
	Bit device		Word device								16-bit command (5 STEP)		
	X	Y	M	K	H	KnX	KnY	KnM	T	C	D	MODRW: Continuous execution type	MODRW: Pulse execution type
S1				*	*						*		
S2				*	*						*		
S3				*	*						*		
S											*		
n				*	*						*		
												32-bit command	
												Flag signal: M1077 M1078 M1079	

Explanation

- S1: online device address. S2: communications function code. S3: address of data to read/write. S: register for data to be read/written is stored. N: length of data to be read/written.
- COM1 must be defined as controlled by the PLC (set P9-31 = -12) before using this command, and the corresponding communications speed and format must also be set (set P09-01 and P09-04). S2: communications function code. Currently only supports the following function code; the remaining function code cannot be executed.

Function	Description
H 02	Input read
H 03	Read word
H 06	Write single word
H 0F	Write multiple coils
H10	Write single word

- After executing this command, M1077, M1078 and M1079 will be immediately changed to 0.
- As an example, when CT2000 must control another converter and PLC, if the converter has a station number of 10 and the PLC has a station number of 20, see the following example:

Control slave device converter

Serial No.	Example	MODRW command				
		S1	S2	S3	S4	n
		Node ID	Function code	Addresses	Register	Length:
1	Reads 4 sets of data comprising the converter slave device parameters P01-00 to P01-03, and saves the read data in D0 to D3	K10	H3	H100	D0	K4
2	Reads 3 sets of data comprising the converter slave device addresses H2100 to H2102, and saves the read data in D5 to D7	K10	H3	H2100	D5	K3
3	Reads 3 sets of data comprising the converter slave device parameters P05-00 to P05-03, and writes the values as D10 to D12	K10	H10	H500	D10	K3
4	Writes 2 sets of data comprising the converter slave device addresses H2000 to H2001, and writes the values as D15 to D16	K10	H10	H2000	D15	K2

PLC controlling slave device

Serial No.	Example	MODRW command				
		S1	S2	S3	S4	n
		Node ID	Function code	Addresses	Register	Length:
1	Reads 4 sets of data comprising the PLC slave device's X0 to X3 state, and saves the read data in bits 0 to 3 of D0	K20	H2	H400	D0	K4
2	Reads 4 sets of data comprising the PLC slave device's Y0 to Y3 state, and saves the read data in bits 0 to 3 of D1	K20	H2	H500	D1	K4
3	Reads 4 sets of data comprising the PLC slave device's M0 to M3 state, and saves the read data in bits 0 to 3 of D2	K20	H2	H800	D2	K4
4	Reads 4 sets of data comprising the PLC slave device's T0 to T3 state, and saves the read data in bits 0 to 3 of D3	K20	H2	H600	D3	K4
5	Reads 4 sets of data comprising the PLC slave device's C0 to C3 state, and saves the read data in bits 0 to 3 of D4	K20	H2	HE00	D4	K4
6	Reads 4 sets of data comprising the PLC slave device's T0 to T3 count value, and saves the read data of D10 to D13	K20	H3	H600	D10	K4
7	Reads 4 sets of data comprising the PLC slave device's C0 to C3 count value, and saves the read data of D20 to D23	K20	H3	HE00	D20	K4
8	Reads 4 sets of data comprising the PLC slave device's D0 to D3 count value, and saves the read data of D30 to D33	K20	H3	H1000	D30	K4
9	Writes 4 sets of the PLC slave device's Y0 to Y3 state, and writes the values as bits 0 to 3 of D1	K20	HF	H500	D1	K4
10	Writes 4 sets of the PLC slave device's M0 to M3 state, and writes the values as bits 0 to 3 of D2	K20	HF	H800	D2	K4
11	Writes 4 sets of the PLC slave device's T0 to T3 state, and writes the values as bits 0 to 3 of D3	K20	HF	H600	D3	K4
12	Writes 4 sets of the PLC slave device's C0 to C3 state, and writes the values as bits 0 to 3 of D4	K20	HF	HE00	D4	K4
13	Writes 4 sets of the PLC slave device's T0 to T3 state, and writes the values of D10 to D13	K20	H10	H600	D10	K4
14	Writes 4 sets of the PLC slave device's C0 to C3 state, and writes the values of D20 to D23	K20	H10	HE00	D20	K4
15	Writes 4 sets of the PLC slave device's D0 to D3 state, and writes the values of D30 to D33	K20	H10	H1000	D30	K4

Example

- Will trigger M0 On when the PLC begins to operate, and sends instruction to execute one MODRW command.
- After receiving the slave device's response, if the command is correct, it will execute one ROL command, which will cause M1 to be On.
- After receiving the slave device's response, will trigger M50 = 1 after a delay of 10 PLC scanning cycles, and then execute one MODRW command.
- After again receiving the slave device's response, if the command is correct, it will execute one ROL command, and M2 will change to On at this time (and M2 can be defined as a repeat of M); K4M0 will change to K1, and only M0 will remain 1. Transmission can proceed in a continuous cycle. If you wish to add a command, merely add the desired command in the empty frame, and change repeat M to Mn+1.

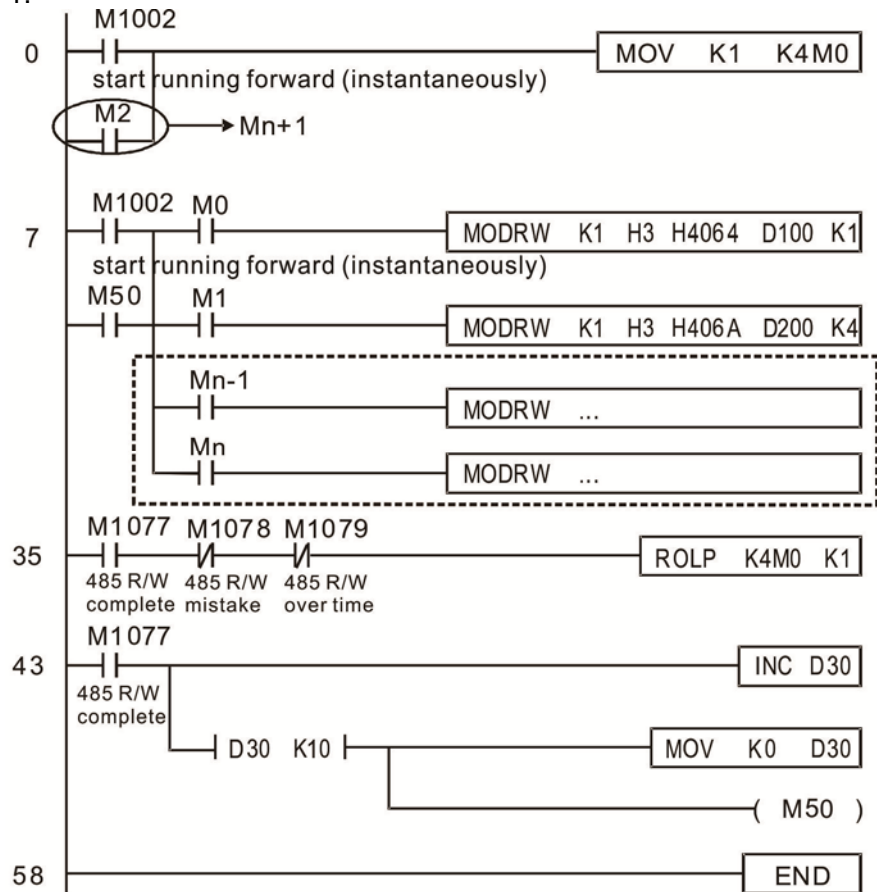

API 110	D	ECMP	P	(S ₁)	(S ₂)	(D)	Comparison of binary floating point numbers
------------	---	------	---	-------------------	-------------------	-----	---

	Bit device			Word device								16-bit command			
	X	Y	M	K	H	KnX	KnY	KnM	T	C	D				
S1				*	*						*				
S2				*	*						*	32-bit command (13 STEP)			
D				*	*						*	DECMP	Continuous execution type	DECMP	Pulse execution type

Notes on operand usage:
 The operand D occupies three consecutive points
 Please refer to the function specifications table for each device in series for the scope of device usage

Flag signal: none

Explanation

- **S₁**: Comparison of binary floating point numbers value 1. **S₂**: Comparison of binary floating point numbers value 2. **D**: Results of comparison, occupies 3 consecutive points.
- When binary floating point number 1 is compared with comparative binary floating point number 2, the result of comparison (>, =, <) will be expressed in **D**.
- **If the source operand S₁ or S₂ designates a constant K or H, the command will transform the constant to a binary floating-point number for the purpose of comparison.**

Example

- When the designated device is M10, it will automatically occupy M10-M12.
- When X0=On, the DECMP command executes, and one of M10-M12 will be On. When X0=Off, the DECMP command will not execute, and M10-M12 will remain in the X0=Off state.
- If results in the form of ≥, ≤, or ≠ are needed, they can be obtained by series and parallel connection of M10-M12.
- Please use the RST or ZRST command to clear the result.

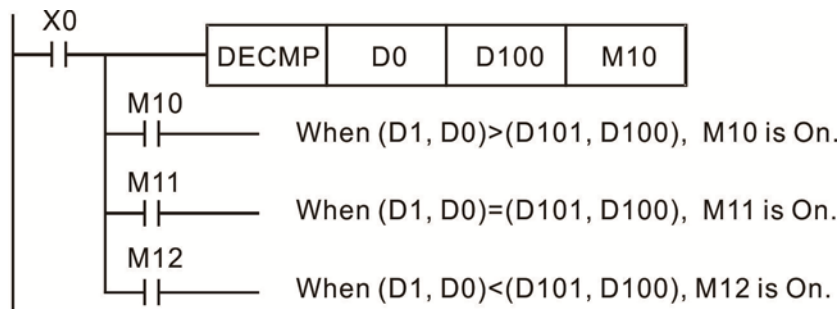

API 111	D	EZCP	P	S ₁	S ₂	S	D	Comparison of binary floating point number range				
Bit device		Word device										
	X	Y	M	K	H	KnX	KnY	KnM	T	C	D	16-bit command
S1				*	*						*	— — — — —
S2				*	*						*	— — — — —
S				*	*						*	32-bit command (17 STEP)
D		*	*									DEZCP : Continuous execution type
Notes on operand usage: The operand D occupies three consecutive points Please refer to the function specifications table for each device in series for the scope of device usage											DEZCPP : Pulse execution type	
											Flag signal: none	

Explanation

- **S₁**: Lower limit of binary floating point number in range comparison. **S₂**: Upper limit of binary floating point number in range comparison. **S**: Comparison of binary floating point numerical values. **D**: Results of comparison, occupies 3 consecutive points.
- Comparison of binary floating point numerical value **S** with binary floating point number lower limit value **S₁** and binary floating point number upper limit value **S₂**; the results of comparison are expressed in **D**.
- **If the source operand S₁ or S₂ designates a constant K or H, the command will transform the constant to a binary floating-point number for the purpose of comparison.**
- When the lower limit binary floating point number **S₁** is greater than the upper limit binary floating point number **S₂**, a command will be issued to perform comparison with the upper and lower limits using the binary floating point number lower limit value **S₁**.

Example

- When the designated device is M0, it will automatically occupy M0- M2.
- When X0=On, the DEZCP command will be executed, and one of M0-M2 will be On. When X0=Off, the EZCP command will not execute, and M0-M2 will continue in the X0=Off state.
- Please use the RST or ZRST command to clear the result.

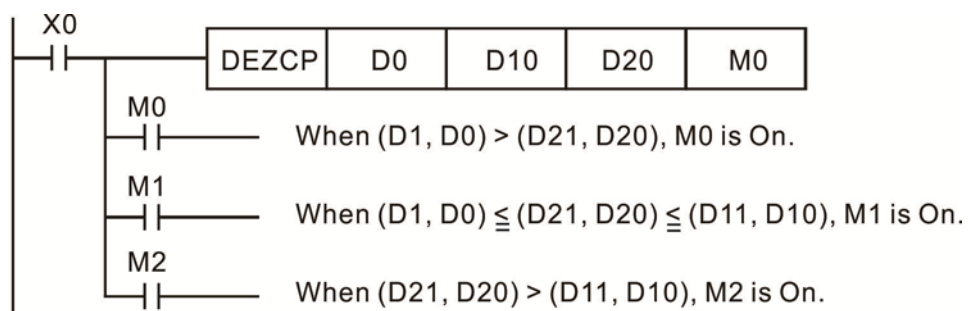

API 116	D	RAD	P	(S) (D)	Angle → Diameter									
Bit device			Word device								16-bit command			
X	Y	M	K	H	KnX	KnY	KnM	T	C	D	-	-	-	-
S			*	*						*	32-bit command (9 STEP)			
D										*	DRAD	Continuous	DRADP	脈波執行型
Notes on operand usage: Please refer to the function specifications table for each device in series for the scope of device usage											execution type			
											Flag signal: none			

Explanation

- **S**: data source (angle). **D**: result of transformation (diameter).
- Uses the following formula to convert angles to radians.
- $\text{Diameter} = \text{Angle} \times (\pi/180)$

Example

- When X0=On, the angle of the designated binary floating point number (D1, D0) will be converted to radians and stored in (D11, D10), with the content consisting of a binary floating point number.

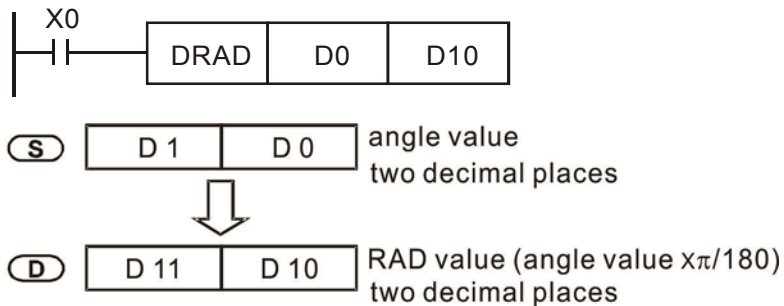

API 117	D	DEG	P	(S) (D)	Diameter → angle									
Bit device			Word device								16-bit command			
X	Y	M	K	H	KnX	KnY	KnM	T	C	D	-	-	-	-
S			*	*						*	32-bit command (9 STEP)			
D										*	DDEG	Continuous execution type	DDEGP	Pulse execution type
Notes on operand usage: Please refer to the function specifications table for each device in series for the scope of device usage											Flag signal: none			

Explanation

- **S**: data source (diameter). **D**: results of transformation (angle).
- Uses the following formula to convert radians to an angle.
- $Angle = Diameter \times (180/\pi)$

Example

- When X0=On, angle of the designated binary floating point number (D1, D0) in radians will be converted to an angle and stored in (D11, D10), with the content consisting of a binary floating point number.

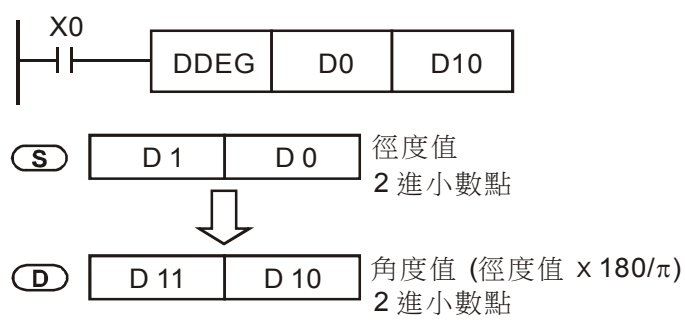

API 120	D	EADD	P	(S ₁)	(S ₂)	(D)	Adding binary floating point numbers								
	Bit device			Word device								16-bit command			
	X	Y	M	K	H	KnX	KnY	KnM	T	C	D	- - - -			
S1				*	*						*	32-bit command (9 STEP)			
S2				*	*						*	DEADD : Continuous execution type DEADDP : Pulse execution type			
D											*	Flag signal: none			
Notes on operand usage: Please refer to the function specifications table for each device in series for the scope of device usage															

Explanation

- **S₁**: addend. **S₂**: augend. **D**: sum.
- When the content of the register designated by **S₂** is added to the content of the register designated by **S₁**, and the result is stored in the register designated by **D**. Addition is performed entirely using binary floating-point numbers.
- **If the source operand S₁ or S₂ designates a constant K or H, the command will transform that constant into a binary floating point number for use in addition.**
- **In the situation when S₁ and S₂ designate identical register numbers, if a "continuous execution" command is employed, when conditional contact is On, the register will perform addition once during each scan. Pulse execution type commands (DEADDP) are generally used under ordinary circumstances.**

Example

- When X0=On, a binary floating point number (D1, D0) will be added to a binary floating point number (D3, D2), and the results stored in (D11, D10).

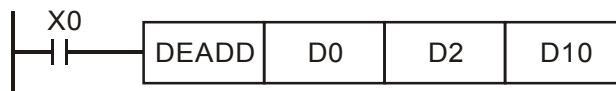

- When X2 =On, a binary floating point number (D11, D10) will be added to K1234 (which has been automatically converted to a binary floating-point number), and the results stored in (D21, D20).

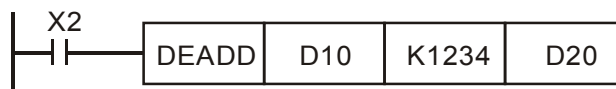

API 121	D	ESUB	P	(S ₁)	(S ₂)	(D)	Subtraction of binary floating point numbers								
	Bit device			Word device								16-bit command			
	X	Y	M	K	H	KnX	KnY	KnM	T	C	D	- - - -			
S1				*	*						*	32-bit command (13 STEP)			
S2				*	*						*	DESUB : Continuous : DESUBP : Pulse execution type : execution type			
D											*	Flag signal: none			
Notes on operand usage: Please refer to the function specifications table for each device in series for the scope of device usage															

Explanation

- **S₁**: minuend. **S₂**: subtrahend. **D**: difference.
- When the content of the register designated by **S₂** is subtracted from the content of the register designated by **S₁**, the difference will be stored in the register designated by **D**; subtraction is performed entirely using binary floating-point numbers.
- **If the source operand S₁ or S₂ designates a constant K or H, the command will transform that constant into a binary floating point number for use in subtraction.**
- **In the situation when S₁ and S₂ designate identical register numbers, if a "continuous execution" command is employed, when conditional contact is On, the register will perform addition once during each scan. Pulse execution type commands (DESUBP) are generally used under ordinary circumstances.**

Example

- When X0=On, a binary floating point number (D1, D0) will be subtracted to a binary floating point number (D3, D2), and the results stored in (D11, D10).

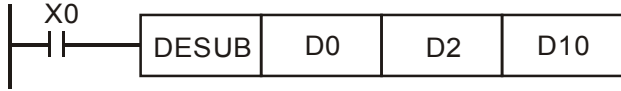

- When X2 =On, the binary floating point number (D1, D0) will be subtracted from K1234 (which has been automatically converted to a binary floating-point number), and the results stored in (D11, D10).

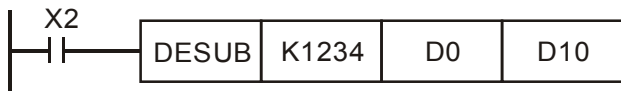

API 122	D	EMUL	P	(S ₁)	(S ₂)	(D)	Multiplication of binary floating point numbers								
	Bit device			Word device								16-bit command			
	X	Y	M	K	H	KnX	KnY	KnM	T	C	D	- - - -			
S1				*	*						*	32-bit command (13 STEP)			
S2				*	*						*	DEMUL : Continuous : DEMULP : Pulse			
D											*	execution type : execution type			
Notes on operand usage: Please refer to the function specifications table for each device in series for the scope of device usage												Flag signal: none			

Explanation

- **S₁**: multiplicand. **S₂**: multiplier. **D**: product.
- When the content of the register designated by **S₁** is multiplied by the content of the register designated by **S₂**, the product will be stored in the register designated by **D**; multiplication is performed entirely using binary floating-point numbers.
- **If the source operand S₁ or S₂ designates a constant K or H, the command will transform that constant into a binary floating point number for use in multiplication.**
- **In the situation when S₁ and S₂ designate identical register numbers, if a "continuous execution" command is employed, when conditional contact is On, the register will perform multiplication once during each scan. Pulse execution type commands (DEMULP) are generally used under ordinary circumstances.**

Example

- When X1=On, the binary floating point number (D1, D0) will be multiplied by the binary floating point number (D11, D10), and the product will be stored in the register designated by (D21, D20).

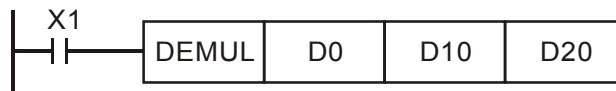

- When X2 =On, the binary floating point number (D1, D0) will be multiplied from K1234 (which has been automatically converted to a binary floating-point number), and the results stored in (D11, D10).

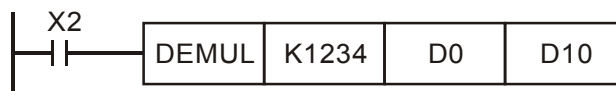

API 123	D	EDIV	P	(S ₁)	(S ₂)	(D)	Division of binary floating point numbers							
Bit device			Word device								16-bit command			
X	Y	M	K	H	KnX	KnY	KnM	T	C	D	-	-	-	-
S1			*	*						*	32-bit command (13 STEP)			
S2			*	*						*	DEDIV	Continuous execution type	DEDIVP	Pulse execution type
D										*	Flag signal: none			
Notes on operand usage: Please refer to the function specifications table for each device in series for the scope of device usage														

Explanation

- ◆ S₁: dividend. S₂: divisor. D: quotient and remainder.
- ◆ When the content of the register designated by S₁ is divided by the content of the register designated by S₂, the quotient will be stored in the register designated by D; division is performed entirely using binary floating-point numbers.
- If the source operand S₁ or S₂ designates a constant K or H, the command will transform that constant into a binary floating point number for use in division.

Example

- ◆ When X1=On, the binary floating point number (D1, D0) will be divided by the binary floating point number (D11, D10), and the quotient stored in the register designated by (D21, D20).

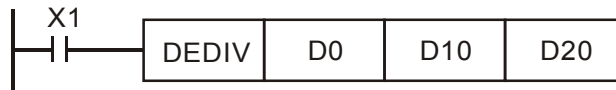

- ◆ When X2 =On, the binary floating point number (D1, D0) will be divided by K1,234 (which has been automatically converted to a binary floating-point number), and the results stored in (D11, D10).

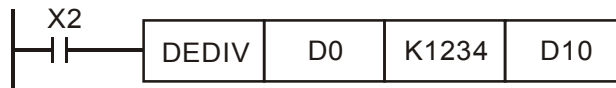

API 124	D	EXP	P	(S) (D)	Binary floating point number obtain exponent														
Bit device		Word device										16-bit command							
X	Y	M	K	H	KnX	KnY	KnM	T	C	D	-		-		-		-		
S			*	*							*	32-bit command (9 STEP)							
D											*	DEXP		Continuous execution type		DEXPP		Pulse execution type	
Notes on operand usage: Please refer to the function specifications table for each device in series for the scope of device usage												Flag signal: none							

Explanation

- **S**: operation source device. **D**: operation results device.
- Taking $e = 2.71828$ as a base, **S** is the exponent in the EXP operation.
- $[D + 1, D] = \text{EXP}[S + 1, S]$
- Valid regardless of whether the content of **S** has a positive or negative value. The designated register D must have a 32-bit data format. This operation is performed using floating-point numbers, and **S** must therefore be converted to a floating point number.
- Content of operand $D = e^S$; $e = 2.71828$, **S** is the designated source data

Example

- When M0 is On, the value of (D1, D0) will be converted to a binary floating point number, which will be stored in register (D11, D10).
- When M1 is On, the EXP operation is performed on the exponent of (D11, D10); its value is a binary floating point number stored in register (D21, D20).

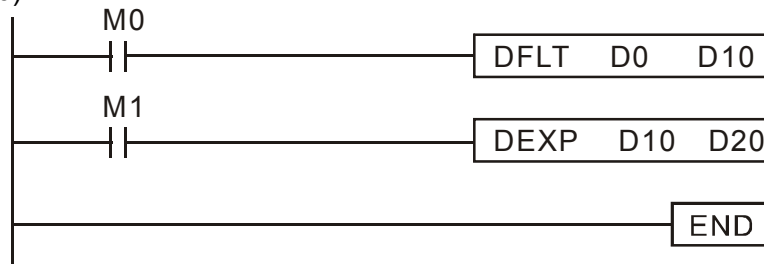

API 125	D	LN	P	<div style="display: flex; justify-content: space-around;"> (S) (D) </div>								Binary floating point number obtain logarithm			
Bit device			Word device									16-bit command			
	X	Y	M	K	H	KnX	KnY	KnM	T	C	D	- - - -			
S				*	*						*	-			
D											*	-			
Notes on operand usage: Please refer to the function specifications table for each device in series for the scope of device usage												DLN Continuous DLNP Pulse execution type execution type			
												Flag signal: none			

Explanation

- **S**: operation source device. **D**: operation results device.
- Taking $e = 2.71828$ as a base, **S** is the exponent in the EXP operation.
- $[D + 1, D] = \text{EXP}[S + 1, S]$
- Valid regardless of whether the content of **S** has a positive or negative value. The designated register D must have a 32-bit data format. This operation is performed using floating-point numbers, and **S** must therefore be converted to a floating point number.
- Content of operand $D = e^S$; $e = 2.71828$, **S** is the designated source data

Example

- When M0 is On, the value of (D1, D0) will be converted to a binary floating point number, which will be stored in register (D11, D10).
- When M1 is On, the EXP operation is performed on the exponent of (D11, D10); its value is a binary floating point number stored in register (D21, D20).

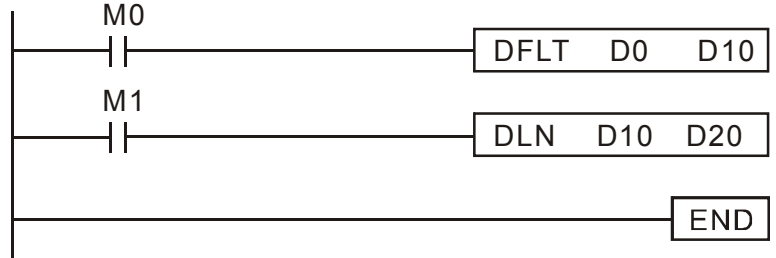

API 127	D	ESQR	P	(S) (D)	Binary floating point number find square root										
Bit device		Word device										16-bit command			
X	Y	M	K	H	KnX	KnY	KnM	T	C	D	-	-	-	-	
S			*	*						*	32-bit command (9 STEP)				
D										*	DESQR	Continuous	DESQR	Pulse	
Notes on operand usage: Please refer to the function specifications table for each device in series for the scope of device usage											execution type	P	execution type		
											Flag signal: none				

Explanation

- **S**: source device for which square root is desired **D**: result of finding square root.
- When the square root is taken of the content of the register designated by **S**, the result is temporarily stored in the register designated by **D**. Taking square roots is performed entirely using binary floating-point numbers.
- If the source operand **S** refers to a constant K or H, the command will transform that constant into a binary floating point number for use in the operation.

Example

- When X0=On, the square root is taken of the binary floating point number (D1, D0), and the result is stored in the register designated by (D11, D10).

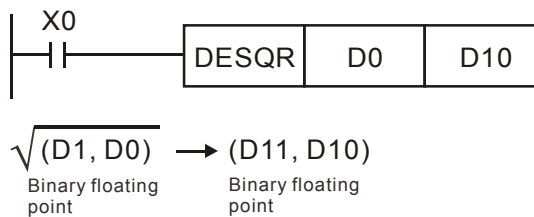

- When X2 =On, the square root is taken of K1,234 (which has been automatically converted to a binary floating-point number), and the results stored in (D11, D10).

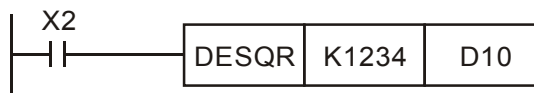

API 129		D	INT	P		S	D	Binary floating point number → BIN whole number transformation								
		Bit device			Word device							16-bit command				
		X	Y	M	K	H	KnX	KnY	KnM	T	C	D	- - - -			
S												*	-			
D												*	32-bit command (9 STEP)			
Notes on operand usage: Please refer to the function specifications table for each device in series for the scope of device usage												DINT	Continuous execution type	DINTP	Pulse execution type	
												Flag signal: none				

Explanation

- **S**: the source device to be transformed. **D**: results of transformation.
- The content of the register designated by **S** is transformed from a binary floating point number format into a BIN whole number, and is temporarily stored in **D**. The BIN whole number floating point number will be discarded.
- The action of this command is the opposite of that of command API 49 (FLT).

Example

- When X0=On, the binary floating point number (D1, D0) is transformed into a BIN whole number, and the result is stored in (D10); the BIN whole number floating point number will be discarded.

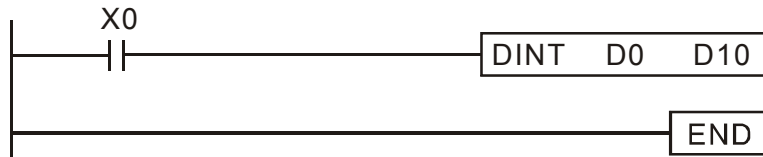

API 130	D	SIN	P	S D	Binary floating point number SIN operation										
	Bit device			Word device							16-bit command				
	X	Y	M	K	H	KnX	KnY	KnM	T	C	D	-			
S				*	*						*	-			
D											*	-			
Notes on operand usage: Please refer to the function specifications table for each device in series for the scope of device usage												DSIN	Continuous execution type	DSINP	Pulse execution type
												Flag signal: none			

Explanation

- ◆ **S**: the designated source value. **D**: the SIN value result.
- ◆ **S** is the designated source in radians.
- ◆ The value in radians (RAD) is equal to (angle × π/180).
- ◆ The SIN obtained from the source value designated by **S** is stored in **D**.

The following figure displays the relationship between the arc and SIN results:

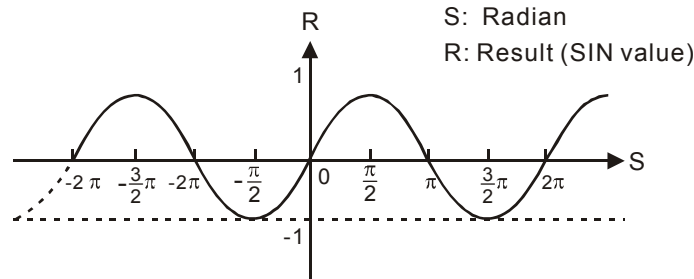

Example

- ◆ When X0=On, the SIN value of the designated binary floating point number (D1, D0) in radians (RAD) will be stored in (D11, D10), with the content consisting of a binary floating point number.

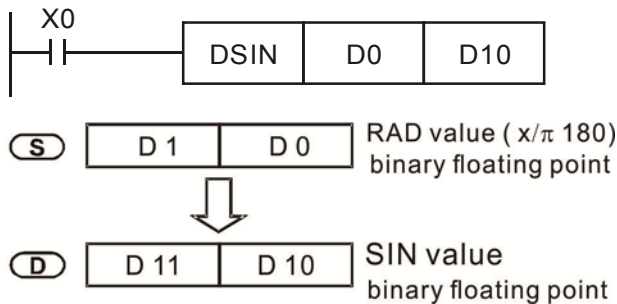

API 131	D	COS	P	(S) (D)	Binary floating point number COS operation									
Bit device		Word device								16-bit command				
X	Y	M	K	H	KnX	KnY	KnM	T	C	D	- - - -			
S			*	*						*	32-bit command (9 STEP)			
D										*	DCOS	Continuous execution type	DCOSP	Pulse execution type
Notes on operand usage: Please refer to the function specifications table for each device in series for the scope of device usage											Flag signal: none			

- Explanation**
- **S**: the designated source value. **D**: the COS value result.
 - **The source designated by S can be given as radians or an angle; this is decided by flag M1018.**
 - When M1018=Off, the operation is in radians mode, where the radians (RAD) value is equal to (angle × π/180).
 - When M1018=On, the operation is in the angle mode, where the angular range is 0° ≤ angle < 360°.
 - When calculation results yield 0, M1020=On.
 - The COS obtained from the source value designated by **S** is stored in **D**.

The following figure displays the relationship between the arc and SIN results:

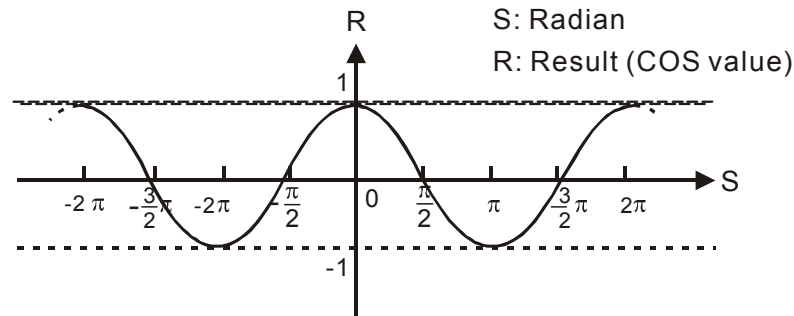

- Example**
- When X0=On, the COS value of the designated binary floating point number (D1, D0) in radians will be stored in (D11, D10), with the content consisting of a binary floating point number.

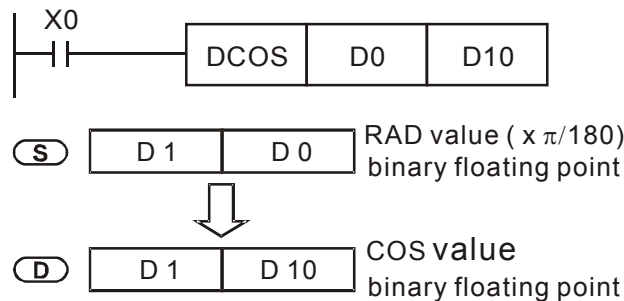

API 132	D	TAN	P	(S) (D)	Binary floating point number TAN operation													
Bit device			Word device								16-bit command							
X	Y	M	K	H	KnX	KnY	KnM	T	C	D	-							
S			*	*						*	-							
D										*	-							
Notes on operand usage: Please refer to the function specifications table for each device in series for the scope of device usage											DTAN : Continuous execution type				DTANP : Pulse execution type			
											Flag signal: none							

Explanation

- **S**: the designated source value. **D**: the TAN value result.
- The source designated by **S** can be given as radians or an angle; this is decided by flag M1018.
- When M1018=Off, the operation is in radians mode, where the radians (RAD) value is equal to (angle $\times \pi / 180$).
- When M1018=On, the operation is in the angle mode, where the angular range is $0^\circ \leq \text{angle} < 360^\circ$.
- When calculation results yield 0, M1020=On.
- The TAN obtained from the source value designated by **S** is stored in **D**.

The following figure displays the relationship between the arc and SIN results:

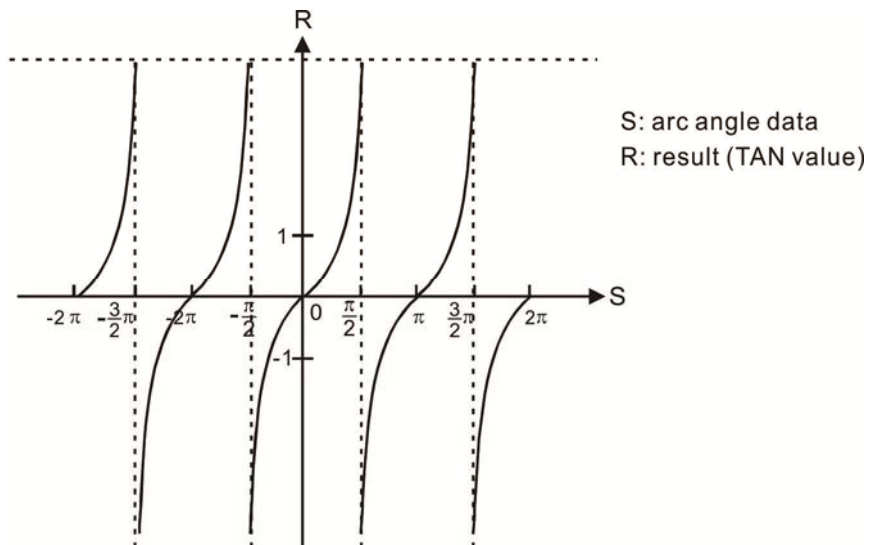

Example

- ◆ When X0=On, the TAN value of the designated binary floating point number (D1, D0) in radians (RAD) will be stored in (D11, D10), with the content consisting of a binary floating point number.

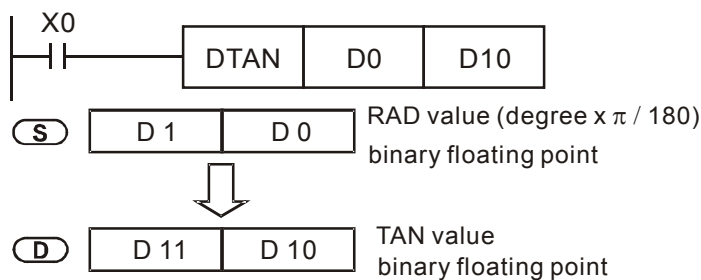

API 133	D	ASIN	P	(S) (D)	Binary floating point number ASIN operation														
Bit device		Word device								16-bit command									
	X	Y	M	K	H	KnX	KnY	KnM	T	C	D	-							
S				*	*						*	-							
D											*	-							
Notes on operand usage: Please refer to the function specifications table for each device in series for the scope of device usage												32-bit command (9 STEP)							
												DASIN		Continuous execution type		DASINP		Pulse execution type	
Flag signal: none																			

- Explanation
- **S**: the designated source (binary floating point number). **D**: the ASIN value result.
 - ASIN value = \sin^{-1}

The figure below shows the relationship between input data and result:

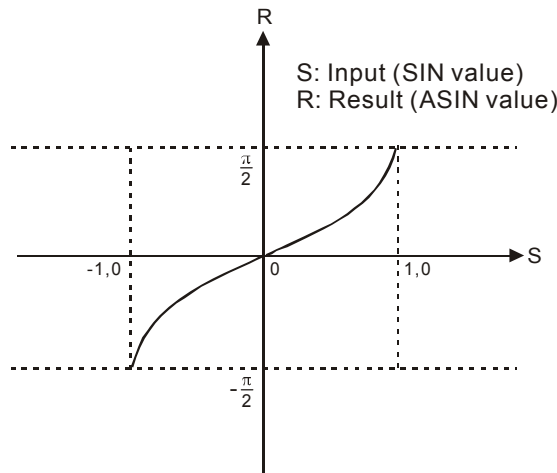

- Example
- ◆ When X0=On, the ASIN value obtained from the designated binary floating point number (D1, D0) will be stored in (D11, D10), with the content consisting of a binary floating point number.

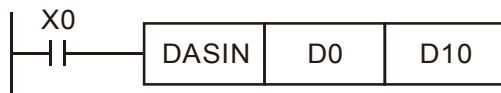

(S) D 1 D 0 Binary floating point



(D) D 11 D 10 ASIN value binary floating point

API 134	D	ACOS	P	(S) (D)								Binary floating point number ACOS operation		
Bit device		Word device										16-bit command		
X	Y	M	K	H	KnX	KnY	KnM	T	C	D	-	-	-	-
S			*	*						*	32-bit command (9 STEP)			
D										*	DACOS	Continuous	DACOS	Pulse
Notes on operand usage: Please refer to the function specifications table for each device in series for the scope of device usage											execution type	P	execution type	
											Flag signal: none			

Explanation

- **S**: the designated source (binary floating point number). **D**: the ACOS value result.
- ACOS value = \cos^{-1}

The figure below shows the relationship between input data and result:

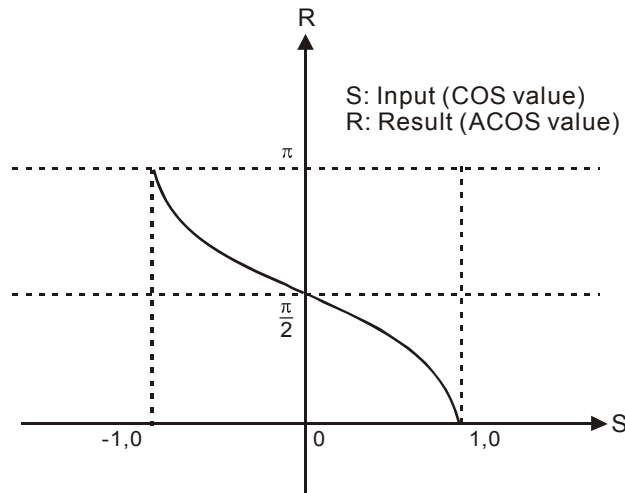

Example

- ◆ When X0=On, the ACOS value obtained from the designated binary floating point number (D1, D0) will be stored in (D11, D10), with the content consisting of a binary floating point number.

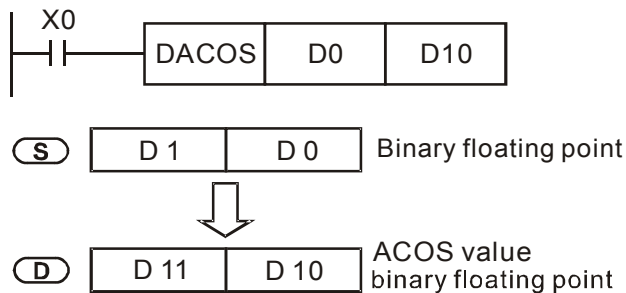

API 135		D	ATAN	P	(S) (D)	Binary floating point number ATAN operation									
	Bit device			Word device								16-bit command			
	X	Y	M	K	H	KnX	KnY	KnM	T	C	D	- - - -			
S				*	*						*	32-bit command (9 STEP)			
D											*	DATAN : Continuous execution type DATANP : Pulse execution type			
Notes on operand usage: Please refer to the function specifications table for each device in series for the scope of device usage												Flag signal: none			

- Explanation**
- **S**: the designated source (binary floating point number). **D**: the ATAN value result.
 - ATAN value = \tan^{-1}

The figure below shows the relationship between input data and result:

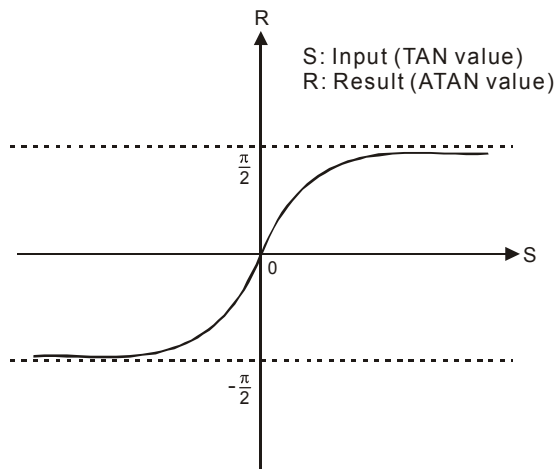

- Example**
- ◆ When X0=On, the TAN value obtained from the designated binary floating point number (D1, D0) will be stored in (D11, D10), with the content consisting of a binary floating point number.

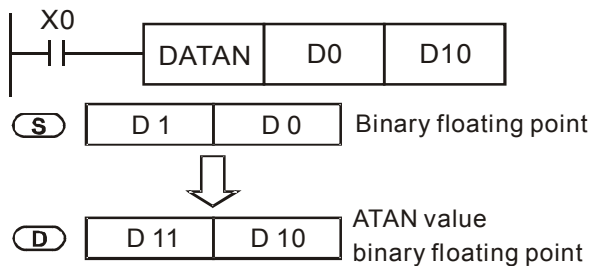

API 136	D	SINH	P	(S) (D)								Binary floating point number SINH operation		
Bit device		Word device										16-bit command		
X	Y	M	K	H	KnX	KnY	KnM	T	C	D	-	-	-	-
S			*	*						*	32-bit command (9 STEP)			
D										*	DSINH	Continuous execution type	DSINH P	Pulse execution type
Notes on operand usage: Please refer to the function specifications table for each device in series for the scope of device usage											Flag signal: none			

Explanation

- **S**: the designated source (binary floating point number). **D**: the SINH value result.
- $SINH\ value = (e^S - e^{-S}) / 2$

Example

- When X0=On, the SINH value obtained from the designated binary floating point number (D1, D0) will be stored in (D11, D10), with the content consisting of a binary floating point number.

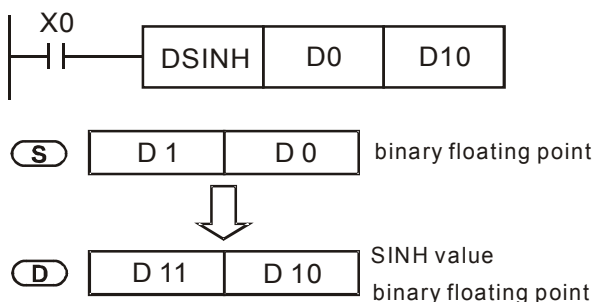

API 137	D	COSH	P	(S)	(D)	Binary floating point number COSH operation						
Bit device		Word device										16-bit command
X	Y	M	K	H	KnX	KnY	KnM	T	C	D		
S			*	*							*	
D											*	
Notes on operand usage: Please refer to the function specifications table for each device in series for the scope of device usage											32-bit command (9 STEP)	
											DCOSH : Continuous execution type	
											DCOSH P : Pulse execution type	
											Flag signal: none	

Explanation

- **S**: the designated source (binary floating point number). **D**: the COSH value result.
- $\text{COSH value} = (e^s + e^{-s}) / 2$

Example

- When X0=On, the COSH value obtained from the designated binary floating point number (D1, D0) will be stored in (D11, D10), with the content consisting of a binary floating point number.

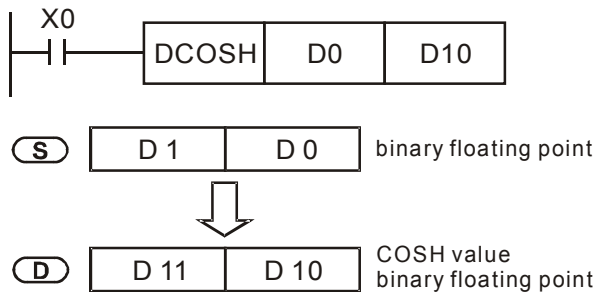

API 138	D	TANH	P	(S)	(D)	Binary floating point number TANH operation								
Bit device			Word device								16-bit command			
X	Y	M	K	H	KnX	KnY	KnM	T	C	D	- - - -			
S			*	*						*	32-bit command (9 STEP)			
D										*	DTANH : Continuous : DTANHP : Pulse execution type : execution type			
Notes on operand usage: Please refer to the function specifications table for each device in series for the scope of device usage											Flag signal: none			

Explanation

- **S**: the designated source (binary floating point number). **D**: the TANH value result.
- $\tanh \text{ value} = (e^s - e^{-s}) / (e^s + e^{-s})$

Example

- When X0=On, the TANH value obtained from the designated binary floating point number (D1, D0) will be stored in (D11, D10), with the content consisting of a binary floating point number.

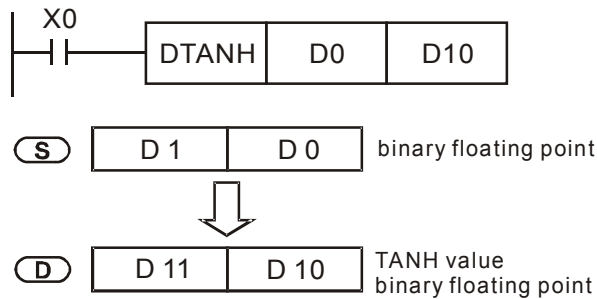

API 160	TCMP	P	(S ₁)	(S ₂)	(S ₃)	(S)	(D)	Comparison of calendar data							
	Bit device			Word device								16-bit command (11 STEP)			
	X	Y	M	K	H	KnX	KnY	KnM	T	C	D	TCMP	Continuous execution type	TCMPP	Pulse execution type
S1				*	*	*	*	*	*	*	*				
S2				*	*	*	*	*	*	*	*				
S3				*	*	*	*	*	*	*	*				
S									*	*	*				
D		*	*												
Notes on operand usage: Please refer to the function specifications table for each device in series for the scope of device usage											Flag signal: none				

Explanation

- **S₁**: Sets the hours of the comparison time, setting range is "K0-K23." **S₂**: Sets the minutes of the comparison time, setting range is "K0-K59." **S₃**: Sets the seconds of the comparison time, setting range is "K0-K59." **S**: current calendar time. **D**: Results of comparison.
- Compares the time in hours, minutes, and seconds set in **S₁ - S₃** with the current calendar time in hours, minutes, and seconds, with the results of comparison expressed in **D**.
- **S** The hour content of the current calendar time is "K0-K23." **S + 1** comprises the minutes of the current calendar time, and consists of "K0-K59." **S + 2** comprises the seconds of the current calendar time, and consists of "K0-K59."
- The current calendar time designated by **S** is usually compared using the TCMP command after using the TRD command to read the current calendar time. If the content value of **S** exceeds the range, this is considered an operating error, the command will not execute, and M1068=On.

Example

- When X10=On, the command will execute, and the current calendar time in D20-D22 will be compared with the preset value of 12:20:45; the results will be displayed in M10-M12. When X10 On→Off, the command will not be executed, but the On/Off status prior to M10-M12 will be maintained.
- If results in the form of \geq , \leq , or \neq are needed, they can be obtained by series and parallel connection of M10-M12.

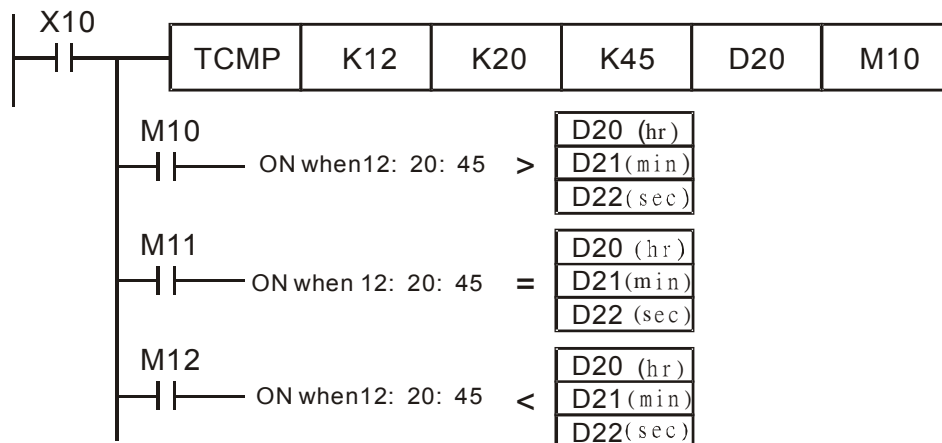

API 161	TZCP	P	(S ₁) (S ₂) (S) (D)	Comparison of calendar data
------------	------	---	---	-----------------------------

	Bit device			Word device								16-bit command (9 STEP)			
	X	Y	M	K	H	KnX	KnY	KnM	T	C	D	TZCP	Continuous execution type	TZCPP	Pulse execution type
S1									*	*	*				
S2									*	*	*				
S									*	*	*				
D		*	*												

Notes on operand usage:
Please refer to the function specifications table for each device in series for the scope of device usage

Flag signal: none

Explanation

- **S₁**: Sets the lower limit of the comparison time. **S₂**: Sets the upper limit of the comparison time. **S**: current calendar time. **D**: Results of comparison.
- Performs range comparison by comparing the hours, minutes, and seconds of the current calendar time designated by **S** with the lower limit of the comparison time set as **S₁** and the upper limit of the comparison time set as **S₂**, and expresses the results of comparison in **D**.
- **S₁ · S₁ +1 · S₁ +2**: Sets the hours, minutes, and seconds of the lower limit of the comparison time.
- **S₂ · S₂ +1 · S₂ +2**: Sets the hours, minutes, and seconds of the upper limit of the comparison time.
- **S · S +1 · S +2**: The hours, minutes, and seconds of the current calendar time
- The D0 designated by the **S** listed in this program is usually obtained by comparison using the TZCP command after using the TRD command in advance to read the current calendar time. If the value of **S₁**, **S₂**, or **S** exceeds the range, this is considered an operating error, the command will not execute, and M1068=On.
- When the current time **S** is less than the lower limit value **S₁** and **S** is less than the upper limit value **S₂**, **D** will be On. When the current time **S** is greater than the lower limit value **S₁** and **S** is greater than the upper limit value **S₂**, **D +2** will be On; **D +1** will be On under other conditions.

Example

- When X10=On, the TZCP command executes, and one of M10-M12 will be On. When X10=Off, the TZCP command will not execute, and M10-M12 will remain in the X10=Off state.

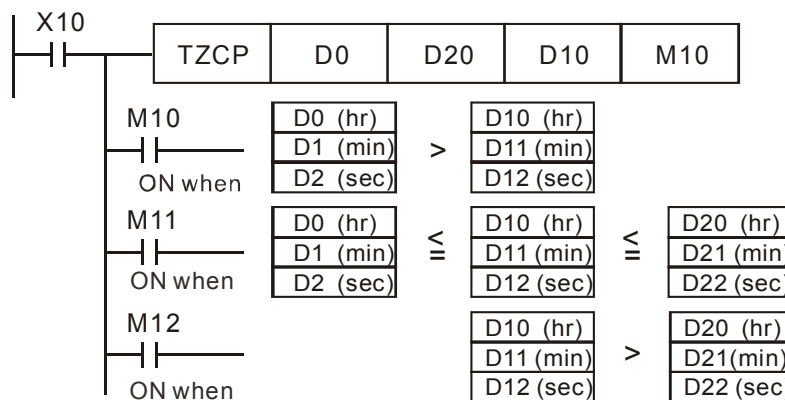

API 162	TADD	P	(S ₁) (S ₂) (D)	Calendar data addition											
	Bit device			Word device			16-bit command (7 STEP)								
	X	Y	M	K	H	KnX	KnY	KnM	T	C	D	TADD	Continuous execution type	TADDP	Pulse execution type
S1									*	*	*				
S2									*	*	*				
D									*	*	*				
Notes on operand usage: Please refer to the function specifications table for each device in series for the scope of device usage												32-bit command			
												<ul style="list-style-type: none"> Flag signal: M1020 Zero flag M1022 Carry flag M1068 Calendar error 			

Explanation

- **S₁**: time addend. **S₂**: time augend. **D**: time sum.
- The calendar data in hours, minutes, and seconds designated by **S₂** is added to the calendar data in hours, minutes, and seconds designated by **S₁**, and the result is stored as hours, minutes, and seconds in the register designated by **D**.
- If the value of **S₁** or **S₂** exceeds the range, this is considered an operating error, the command will not execute, M1067, M1068=On, and D1067 will record the error code 0E1A(HEX).
- If the results of addition are greater than or equal to 24 hours, carry flag M1022=On, and **D** will display the results of addition minus 24 hours.
- If the results of addition are equal to 0 (0 hours, 0 minutes, 0 seconds), zero flag M1020=On.

Example

- When X10=On, the TADD command will be executed, and the calendar data in hours, minutes, and seconds designated by D0 to D2 will be added to the calendar data in hours, minutes, and seconds designated by D10 to D12, and the results are stored as a total number of hours, minutes, and seconds in the registers designated by D20 to D22.

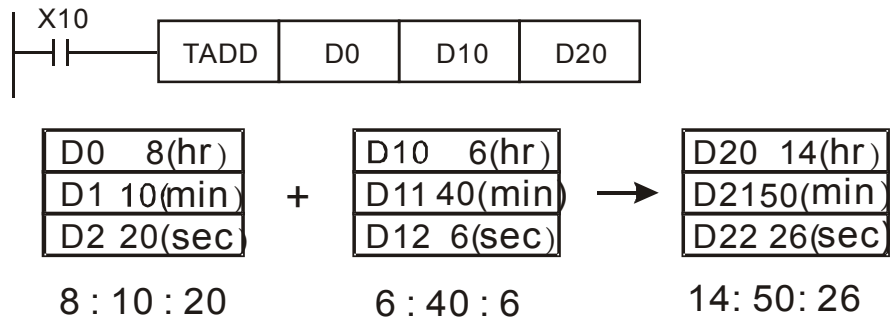

API 163	TSUB		P	<div style="display: flex; justify-content: space-around;"> (S1) (S2) (D) </div>								Calendar data subtraction			
Bit device			Word device									16-bit command (7 STEP)			
X	Y	M	K	H	KnX	KnY	KnM	T	C	D	TSUB	Continuous execution type	TSUBP	Pulse execution type	
S1								*	*	*	32-bit command				
S2								*	*	*	-				
D								*	*	*	-				
Notes on operand usage: Please refer to the function specifications table for each device in series for the scope of device usage											<ul style="list-style-type: none"> Flag signal: M1020 Zero flag M1022 Carry flag M1068 Calendar error 				

Explanation

- **S₁**: time minuend. **S₂**: time augend. **D**: time sum.
- Subtracts the calendar data in hours, minutes, and seconds designated by **S₂** from the calendar data in hours, minutes, and seconds designated by **S₁**, and the result is temporarily stored as hours, minutes, and seconds in the register designated by **D**.
- If the value of **S₁** or **S₂** exceeds the range, this is considered an operating error, the command will not execute, M1067, M1068=On, and D1067 will record the error code 0E1A(HEX).
- If subtraction results in a negative number, borrow flag M1021=On, and the result of that negative number plus 24 hours will be displayed in the register designated by **D**.
- If the results of subtraction are equal to 0 (0 hours, 0 minutes, 0 seconds), zero flag M1020=On.

Example

- When X10=On, the TADD command will be executed, and the calendar data in hours, minutes, and seconds designated by D10 to D12 will be subtracted from the calendar data in hours, minutes, and seconds designated by D0 to D2, and the results are stored as a total number of hours, minutes, and seconds in the registers designated by D20 to D22.

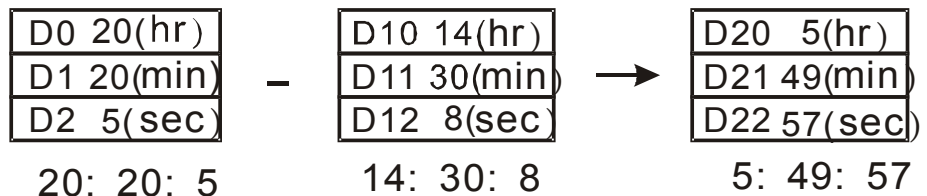
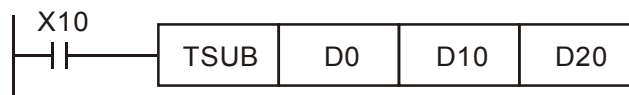

API 166	TRD		P									Calendar data read			
Bit device			Word device									16-bit command (3 STEP)			
X	Y	M	K	H	KnX	KnY	KnM	T	C	D	TRD	Continuous execution type	120	Pulse execution type	
D								*	*	*	32-bit command				
Notes on operand usage: Please refer to the function specifications table for each device in series for the scope of device usage											• Flag signal: none				

Explanation

- **S₁**: time minuend. **S₂**: time augend. **D**: time sum.
- **D**: device used to store the current calendar time after reading.
- The EH/EH2/SV/EH3/SV2/SA/SX/SC main units have a built-in calendar clock, and the clock provides seven sets of data comprising year, week, month, day, hour, minute, and second stored in D1063 to D1069. The TRD command function allows program designers to directly read the current calendar time into the designated seven registers.
- D1063 only reads the two right digits of the Western calendar year.

Example

- When X0=On, the current calendar time is read into the designated registers D0 to D6.
- In D1064, 1 indicates Monday, 2 indicates Tuesday, and so on, with and 7 indicating Sunday.

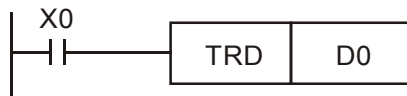

Special D	Item	Content		General D	Item
D1063	Year (Western)	00~99	→	D0	Year (Western)
D1064	Weeks	1~7	→	D1	Weeks
D1065	Month	1~12	→	D2	Month
D1066	Day	1~31	→	D3	Day
D1067	Hour	0~23	→	D4	Hour
D1068	Minute	0~59	→	D5	Minute
D1069	Second	0~59	→	D6	Second

API 170	D	GRY	P	(S) (D)	BIN→GRAY code transformation										
	Bit device			Word device								16-bit command (5 STEP)			
	X	Y	M	K	H	KnX	KnY	KnM	T	C	D	GRY	Continuous execution type	GRYP	Pulse execution type
S				*	*	*	*	*	*	*	*				
D							*	*	*	*	*				
Notes on operand usage: Please refer to the function specifications table for each device in series for the scope of device usage												32-bit command (9 STEP)			
												DGRY	Continuous execution type	DGRYP	Pulse execution type
• Flag signal: none															

Explanation

- **S**: source device. **D**: device storing GRAY code.
- Transforms the content value (BIN value) of the device designated by **S** to GRAY code, which is stored in the device designated by **D**.
- The valid range of **S** is as shown below; if this range is exceeded, it will be considered an error, and the command will not execute.

16-bit command: 0~32,767

- 32-bit command: 0~2,147,483,647

Example

- ◆ When X0=On, the constant K6513 will be transformed to GRAY code and stored in D0.

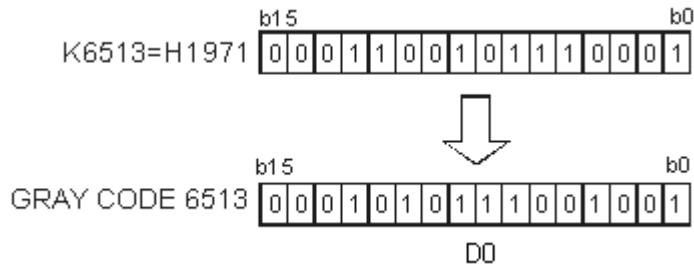
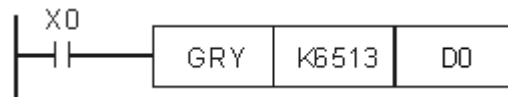

API 171	D	GBIN	P	(S) (D)								GRAY code →BIN transformation			
	Bit device			Word device								16-bit command (5 STEP)			
	X	Y	M	K	H	KnX	KnY	KnM	T	C	D	GBIN	Continuous execution type	GBINP	Pulse execution type
S				*	*	*	*	*	*	*	*				
D							*	*	*	*	*				
Notes on operand usage: Please refer to the function specifications table for each device in series for the scope of device usage												32-bit command (9 STEP)			
												DGBIN	Continuous execution type	DGBINP	Pulse execution type
• Flag signal: none															

Explanation

- **S**: source device used to store GRAY code. **D**: device used to store BIN value after transformation.
- The GRAY code corresponding to the value of the device designated by **S** is transformed into a BIN value, which is stored in the device designated by **D**.
- This command will transform the value of the absolute position encoder connected with the PLC's input and (this encoder usually has an output value in the form of GRAY code) into a BIN value, which is stored in the designated register.
- The valid range of **S** is as shown below; if this range is exceeded, it will be considered an error, and the command will not execute.
16-bit command: 0~32,767
32-bit command: 0~2,147,483,647

Example

- ◆ When X20=On, the GRAY code of the absolute position encoder connected with input points X0 to X17 will be transformed into BIN value and stored in D10.

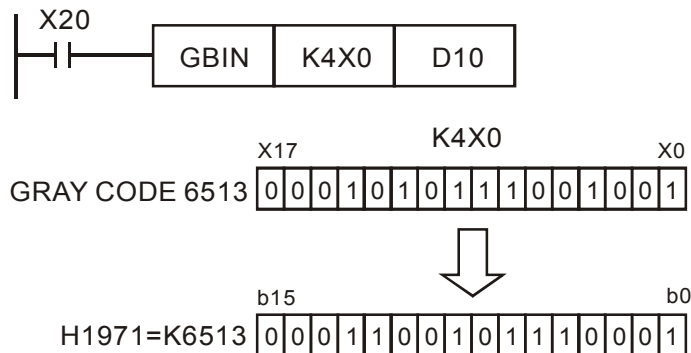

API 215~ 217	D	LD#	(S1)	(S2)	Contact form logical operation LD#										
Bit device			Word device									16-bit command (5 STEP)			
X	Y	M	K	H	KnX	KnY	KnM	T	C	D	LD#	Continuous execution type	—	—	
S1			*	*	*	*	*	*	*	*					
S2			*	*	*	*	*	*	*	*					
Notes on operand usage: # : & \ · ^											32-bit command (9 STEP)				
Please refer to the function specifications table for each device in series for the range of device usage											DLD#	Continuous execution type	—	—	
Flag signal: none															

Explanation

- **S₁**: data source device 1. **S₂**: data source device 2.
- This command performs comparison of the content of **S₁** and **S₂**; when the result of comparison is not 0, this command will be activated, but this command will not be activated when the result of comparison is 0.
- The LD#This command can be used while directly connected with the busbar

API No.	16-bit commands	32-bit commands	Conditions for activation				Conditions for inactivation			
			S ₁	&	S ₂	≠ 0	S ₁	&	S ₂	= 0
215	LD&	DLD&	S ₁	&	S ₂	≠ 0	S ₁	&	S ₂	= 0
216	LD	DLD	S ₁		S ₂	≠ 0	S ₁		S ₂	= 0
217	LD^	DLD^	S ₁	^	S ₂	≠ 0	S ₁	^	S ₂	= 0

&: logical AND operation.

|: logical OR operation.

^: logical XOR operation.

Example

21. When the content of C0 and C10 is subjected to the logical AND operation, and the result is not equal to 0, Y10=On.
22. When the content of D200 and D300 is subjected to the logical OR operation, and the result is not equal to 0, and X1=On, Y11=On and remains in that state.

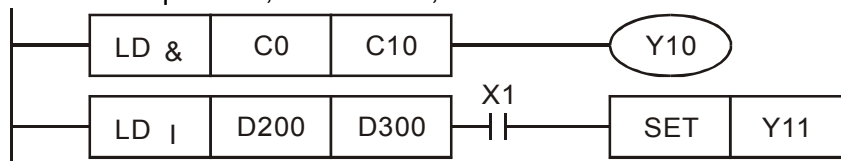

API 218~ 220	D	AND#	(S1)	(S2)	Contact form logical operation AND#										
Bit device		Word device										16-bit command (5 STEP)			
X	Y	M	K	H	KnX	KnY	KnM	T	C	D	AND#	Continuous execution type	—	—	
S1			*	*	*	*	*	*	*	*	*				
S2			*	*	*	*	*	*	*	*	*				
Notes on operand usage: # : & · · ^ Please refer to the function specifications table for each device in series for the scope of device usage											32-bit command (9 STEP)				
											DAND#	Continuous execution type	—	—	
											Flag signal: none				

Explanation

- **S₁**: data source device 1. **S₂**: data source device 2.
- This command performs comparison of the content of **S₁** and **S₂**; when the result of comparison is not 0, this command will be activated, but this command will not be activated when the result of comparison is 0.
- The AND# command is an operation command in series with the contact.

API No.	16-bit commands	32-bit commands	Conditions for activation				Conditions for inactivation			
218	AND&	DAND&	S ₁	&	S ₂	≠ 0	S ₁	&	S ₂	= 0
219	AND	DAND	S ₁		S ₂	≠ 0	S ₁		S ₂	= 0
220	AND^	DAND^	S ₁	^	S ₂	≠ 0	S ₁	^	S ₂	= 0

&: logical AND operation.

|: logical OR operation.

^: logical XOR operation.

Example

- When X0=On and the content of C0 and C10 is subjected to the logical AND operation, and the result is not equal to 0, Y10=On.
- When X1=Off and D10 and D0 is subjected to the logical OR operation, and the result is not equal to 0, Y11=On and remains in that state.
- When X2 =On and the content of the 32-bit register D200(D201) and 32-bit register D100(D101) is subjected to the logical XOR operation, and the result is not equal to 0 or M3=On, M50=On.

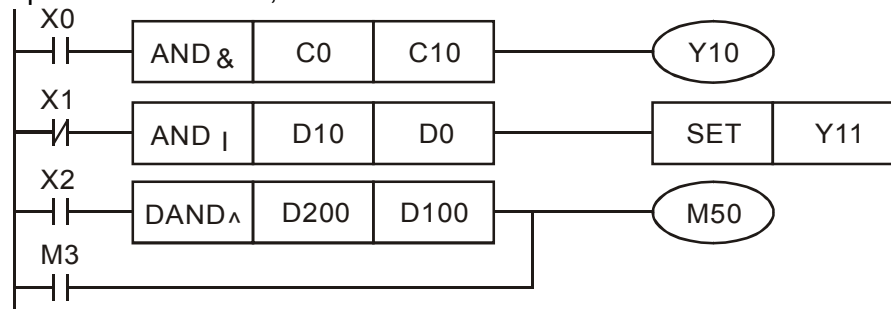

API 221~ 223	D	OR#	(S1)	(S2)	Contact form logical operation OR#									
Bit device			Word device								16-bit command (5 STEP)			
X	Y	M	K	H	KnX	KnY	KnM	T	C	D	OR#	Continuous execution type	—	—
S1			*	*	*	*	*	*	*	*				
S2			*	*	*	*	*	*	*	*				
Notes on operand usage: # : & · · ^											32-bit command (9 STEP)			
Please refer to the function specifications table for each device in series for the scope of device usage											DOR#	Continuous execution type	—	—
Flag signal: none														

Explanation

- **S₁**: data source device 1. **S₂**: data source device 2.
- This command performs comparison of the content of **S₁** and **S₂**; when the result of comparison is not 0, this command will be activated, but this command will not be activated when the result of comparison is 0.
- The OR# command is an operation command in series with the contact.

API No.	16-bit commands	32-bit commands	Conditions for activation				Conditions for inactivation			
221	OR&	DOR&	S₁	&	S₂	≠ 0	S₁	&	S₂	= 0
222	OR	DOR	S₁		S₂	≠ 0	S₁		S₂	= 0
223	OR^	DOR^	S₁	^	S₂	≠ 0	S₁	^	S₂	= 0

&: logical AND operation.

|: logical OR operation.

^: logical XOR operation.

Example

26. When X1=On or the content of C0 and C10 is subjected to the logical AND operation, and the result is not equal to 0, Y0=On.
27. When X2 and M30 are both equal to On, or the content of 32-bit register D10 (D11) and 32-bit register D20 (D21) is subjected to the logical OR operation, and the result is not equal to 0, or the content of the 32-bit counter C235 and the 32-bit register D200 (D201) is subjected to the logical XOR operation, and the result is not equal to 0, M60=On.

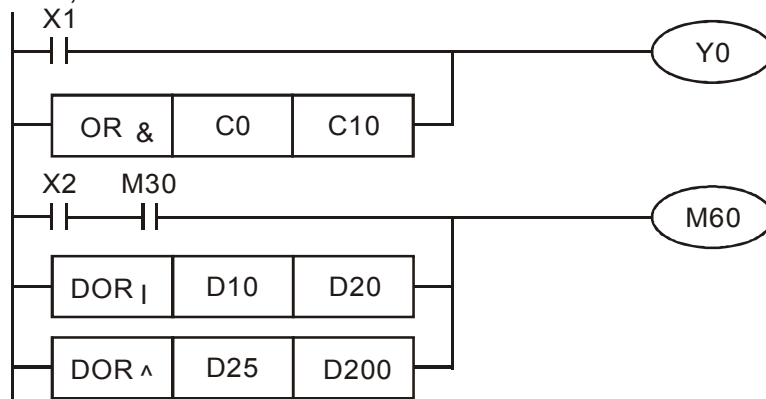

API 224~ 230	D	LD※	(S1)	(S2)	Contact form compare LD*									
Bit device			Word device								16-bit command (5 STEP)			
X	Y	M	K	H	KnX	KnY	KnM	T	C	D	LD※	Continuous execution type	—	—
S1			*	*	*	*	*	*	*	*				
S2			*	*	*	*	*	*	*	*				
Notes on operand usage: ※ : = > < <> ≤ ≥											32-bit command (9 STEP)			
Please refer to the function specifications table for each device in series for the scope of device usage											DLD※	Continuous execution type	—	—
Flag signal: none														

Explanation

- **S₁**: data source device 1. **S₂**: data source device 2.
- This command compares the content of **S₁** and **S₂**. Taking API 224 (LD=) as an example, this command will be activated when the result of comparison is "equal," and will not be activated when the result is "unequal."
- The LD* can be used while directly connected with the busbar

API No.	16-bit commands	32-bit commands	Conditions for activation	Conditions for inactivation
224	LD=	DLD=	S₁ = S₂	S₁ ≠ S₂
225	LD>	DLD>	S₁ > S₂	S₁ ≤ S₂
226	LD<	DLD<	S₁ < S₂	S₁ ≥ S₂
228	LD<>	DLD<>	S₁ ≠ S₂	S₁ = S₂
229	LD≤	DLD≤	S₁ ≤ S₂	S₁ > S₂
230	LD≥	DLD≥	S₁ ≥ S₂	S₁ < S₂

Example

28. When the content of C10 is equal to K200, Y10=On.
 29. When the content of D200 is greater than K-30, and X1=On, Y11=On and remains in that state.

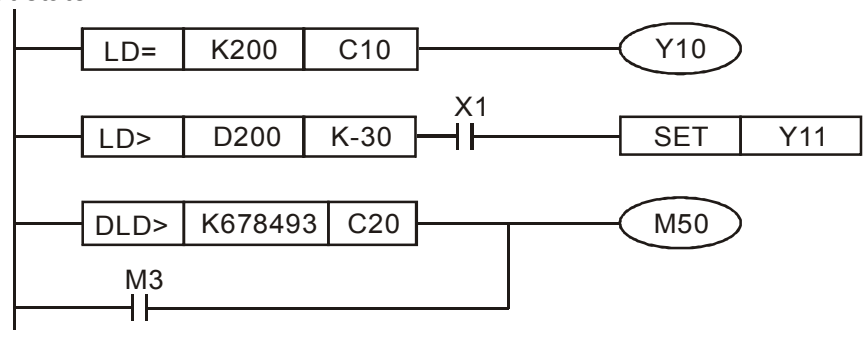

API 232~ 238	D	AND※	(S1)	(S2)	Contact form compare AND*												
Bit device		Word device										16-bit command (5 STEP)					
X	Y	M	K	H	KnX	KnY	KnM	T	C	D	AND※		Continuous execution type	—	—		
S1			*	*	*	*	*	*	*	*	*	DAND※		Continuous execution type	—	—	
S2			*	*	*	*	*	*	*	*	*						
Notes on operand usage: ※ : = , > , < , <> , ≤ , ≥											32-bit command (9 STEP)						
Please refer to the function specifications table for each device in series for the scope of device usage											DAND※				Continuous execution type	—	—
											Flag signal: none						

Explanation

- **S₁**: data source device 1. **S₂**: data source device 2.
- This command compares the content of **S₁** and **S₂**. Taking API 232 (AND=) as an example, when the result of comparison is equal, this command will be activated; when the result of comparison is unequal, this command will not be activated.
- The AND* command is a comparison command in series with a contact.

API No.	16-bit commands	32-bit commands	Conditions for activation	Conditions for inactivation
232	AND=	DAND=	S₁ = S₂	S₁ ≠ S₂
233	AND>	DAND>	S₁ > S₂	S₁ ≤ S₂
234	AND<	DAND<	S₁ < S₂	S₁ ≥ S₂
236	AND<>	DAND<>	S₁ ≠ S₂	S₁ = S₂
237	AND≤	DAND≤	S₁ ≤ S₂	S₁ > S₂
238	AND≥	DAND≥	S₁ ≥ S₂	S₁ < S₂

Example

30. When X0=On and the current value of C10 is also equal to K200, Y10=On.
31. When X1=Off and the content of register D0 is not equal to K-10, Y11=On and remains in that state.
32. When X2 =On and the content of the 32-bit register D0(D11)is less than 678,493, or M3=On, M50=On.

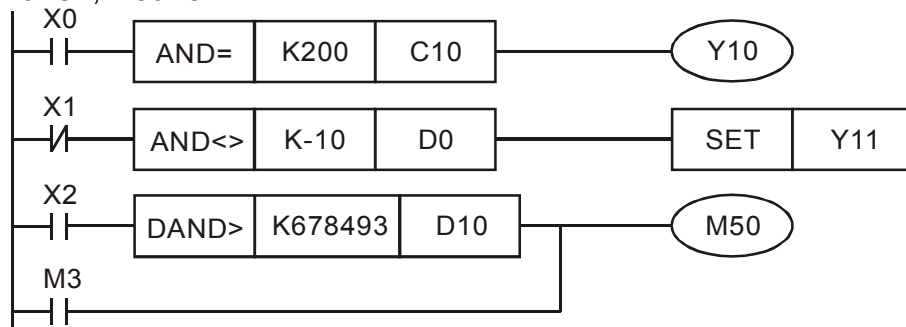

API 240~ 246	D	OR※	(S1)	(S2)	Contact form compare OR*										
Bit device		Word device										16-bit command (5 STEP)			
X	Y	M	K	H	KnX	KnY	KnM	T	C	D	OR※	Continuous execution type	—	—	
S1			*	*	*	*	*	*	*	*	*				
S2			*	*	*	*	*	*	*	*	*				
Notes on operand usage: ※ : = , > , < , <> , ≤ , ≥											32-bit command (9 STEP)				
Please refer to the function specifications table for each device in series for the scope of device usage											DOR※	Continuous execution type	—	—	
											Flag signal: none				

Explanation

- **S₁**: data source device 1. **S₂**: data source device 2.
- This command compares the content of **S₁** and **S₂**. Taking API 240 (OR=) as an example, when the result of comparison is equal, this command will be activated; when the result of comparison is unequal, this command will not be activated.
- The OR* command is a compare command in parallel with a contact.

API No.	16-bit commands	32-bit commands	Conditions for activation	Conditions for inactivation
240	OR=	DOR=	S₁ = S₂	S₁ ≠ S₂
241	OR>	DOR>	S₁ > S₂	S₁ ≤ S₂
242	OR<	DOR<	S₁ < S₂	S₁ ≥ S₂
244	OR<>	DOR<>	S₁ ≠ S₂	S₁ = S₂
245	OR≤	DOR≤	S₁ ≤ S₂	S₁ > S₂
246	OR≥	DOR≥	S₁ ≥ S₂	S₁ < S₂

Example

33. When X0=On and the current value of C10 is also equal to K200, Y10=On.
34. When X1=Off and the content of register D0 is not equal to K-10, Y11=On and remains in that state.
35. When X2 =On and the content of the 32-bit register D0(D11)is less than 678,493, or M3=On, M50=On.

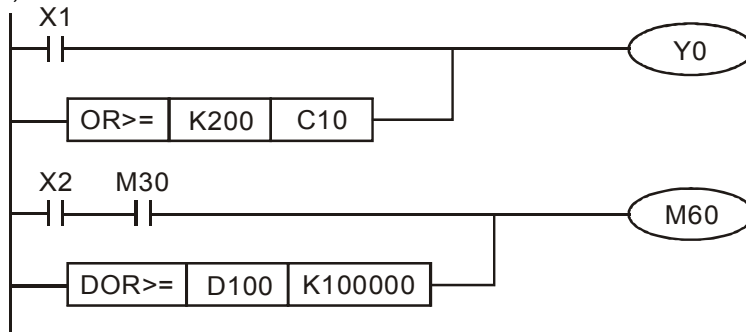

API 275~ 280	FLD*		(S1) (S2)		Floating point number contact form compare LD*								
Bit device			Word device									:16-bit command	
X	Y	M	K	H	KnX	KnY	KnM	T	C	D	-		
S1								*	*	*	-		
S2								*	*	*	-		
Notes on operand usage: # : & \ \ ^											FLD* : Continuous execution type		
Please refer to the function specifications table for each device in series for the scope of device usage											Flag signal: none		

Explanation

- ◆ **S₁**: data source device 1. **S₂**: data source device 2.
- ◆ This command compares the content of **S₁** and **S₂**. Taking "FLD=" as an example, if the result of comparison is "equal," this command will be activated; but it will not be activated when the result is "unequal."
- ◆ The FLD* command can directly input floating point numerical values (for instance: F1.2) to the **S₁**, **S₂** operands, or store floating-point numbers in register D for use in operations.
- ◆ This command can be used while directly connected with the busbar

API No.	32-bit commands	Conditions for activation	Conditions for inactivation
275	FLD=	S₁ = S₂	S₁ ≠ S₂
276	FLD>	S₁ > S₂	S₁ ≤ S₂
277	FLD<	S₁ < S₂	S₁ ≥ S₂
278	FLD<>	S₁ ≠ S₂	S₁ = S₂
279	FLD≤	S₁ ≤ S₂	S₁ > S₂
280	FLD≥	S₁ ≥ S₂	S₁ < S₂

Example

- ◆ When the floating point number of register D200 (D201) is less than or equal to F1.2, and X1 activated, contact Y21 will be activated and remain in that state.

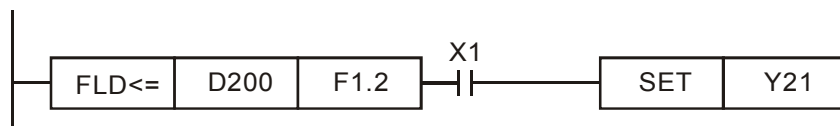

API 281~ 286	FAND※		(S1) (S2)		Floating point number contact form compare AND*									
Bit device			Word device									16-bit command		
X	Y	M	K	H	KnX	KnY	KnM	T	C	D	-			
S1								*	*	*	-			
S2								*	*	*	-			
Notes on operand usage: # : & · · ^ Please refer to the function specifications table for each device in series for the scope of device usage											32-bit command (9 STEP)			
											FAND※ : Continuous execution type			
											Flag signal: none			

Explanation

- ◆ **S₁**: data source device 1. **S₂**: data source device 2.
- ◆ This command compares the content of **S₁** and **S₂**. Taking "FAND=" as an example, if the result of comparison is "equal," this command will be activated; but it will not be activated when the result is "unequal."
- ◆ The FAND* command can directly input floating point numerical values (for instance: F1.2) to the **S₁**, **S₂** operands, or store floating-point numbers in register D for use in operations.
- ◆ This command can be used while directly connected with the busbar

API No.	32-bit commands	Conditions for activation	Conditions for inactivation
281	FAND	S₁ = S₂	S₁ ≠ S₂
282	FAND >	S₁ > S₂	S₁ ≤ S₂
283	FAND <	S₁ < S₂	S₁ ≥ S₂
284	FAND < >	S₁ ≠ S₂	S₁ = S₂
285	FAND < =	S₁ ≤ S₂	S₁ > S₂
286	FAND > =	S₁ ≥ S₂	S₁ < S₂

Example

- ◆ When X1=Off, and the floating point number in register D100 (D101) is not equal to F1.2, Y21=On and remains in that state.

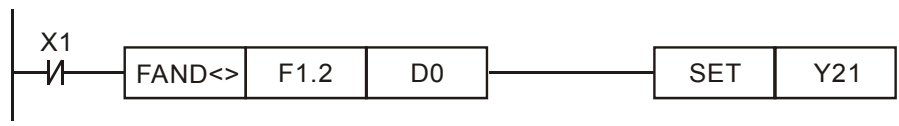

API 287~ 292	FOR*		(S1) (S2)		Floating point number contact form compare OR*							
Bit device			Word device								:16-bit command	
X	Y	M	K	H	KnX	KnY	KnM	T	C	D	-	-
S1								*	*	*	-	-
S2								*	*	*	:32-bit command (9 STEP)	
Notes on operand usage: # : & \ \ ^											FOR* Continuous execution type	
Please refer to the function specifications table for each device in series for the scope of device usage											Flag signal: none	

Explanation

- ◆ **S₁**: data source device 1. **S₂**: data source device 2.
- ◆ This command compares the content of **S₁** and **S₂**. Taking "FOR=" as an example, if the result of comparison is "equal," this command will be activated; but it will not be activated when the result is "unequal."
- ◆ The FOR* command can directly input floating point numerical values (for instance: F1.2) to the **S₁**, **S₂** operands, or store floating-point numbers in register D for use in operations.
- ◆ This command can be used while directly connected with the busbar

API No.	32-bit commands	Conditions for activation	Conditions for inactivation
287	FOR=	S₁ = S₂	S₁ ≠ S₂
288	FOR>	S₁ > S₂	S₁ ≤ S₂
289	FOR<	S₁ < S₂	S₁ ≥ S₂
290	FOR<>	S₁ ≠ S₂	S₁ = S₂
291	FOR≤	S₁ ≤ S₂	S₁ > S₂
292	FOR≥	S₁ ≥ S₂	S₁ < S₂

Example

- ◆ When X2 and M30 are both equal to "On," or the floating point number in register D100 (D101) is greater than or equal to F1.234, M60=On.

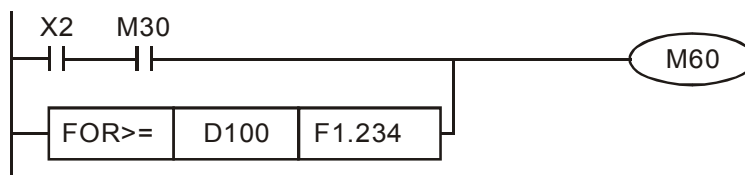

16-6-5 Detailed explanation of drive special applications commands

API 139	RPR		P		(S1) (S2)							Read servo parameter		
Bit device			Word device								16-bit command (5 STEP)			
X Y M			K	H	KnX	KnY	KnM	T	C	D	RPR	Continuous execution type	RPRP	Pulse execution type
S1			*	*						*				
S2										*				
Notes on operand usage: none											32-bit command			
											Flag signal: none			

Explanation ■ (S1): Parameter address of data to be read. (S2): Register where data to be read is stored.

API 140	WPR		P		(S1) (S2)							Write servo parameter		
Bit device			Word device								16-bit command (5 STEP)			
X Y M			K	H	KnX	KnY	KnM	T	C	D	WPR	Continuous execution type	WPRP	Pulse execution type
S1			*	*						*				
S2			*	*						*				
Notes on operand usage: none											32-bit command			
											Flag signal: none			

Explanation ■ (S1): Data to write to specified page. (S2): Parameter address of data to be written.

Example

36. When the data in the CT2000 driver's parameter H01.00 is read and written to D0, data from H01.01 will be read and written to D1.
37. When M0=On, the content of D10 will be written to the CT2000 driver parameter 04.00 (first speed of multiple speed levels).
38. When the parameter has been written successfully, M1017=On.
39. The CT2000's WPR command does not support writing to the 20XX address, but the RPR command supports reading of 21XX, 22XX.

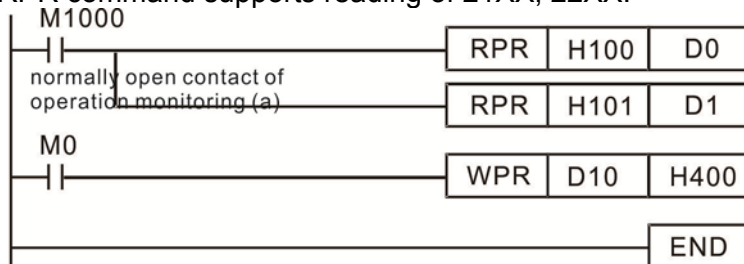

Recommendation Take care when using the WPR command. When writing parameters, because most parameters are recorded as they are written, these parameters may only be revised 109 times; a memory write error may occur if parameters are written more than 10⁹ times.

Because the following commonly-used parameters have special processing, there are **no** restrictions on the number of times they may be written.

- P00-10: Control method
- P00-11: Speed mode selection
- P00-12: P2P position mode
- P00-13: Torque mode select
- P00-27: User-defined value

P01-12: Acceleration time 1

P01-13: Deceleration time 1

P01-14: Acceleration time 2

P01-15: Deceleration time 2

P01-16: Acceleration time 3

P01-17: Deceleration time 3

P01-18: Acceleration time 4

P01-19: Deceleration time 4

P02-12: Select MI Conversion Time mode:

P02-18: Select MO Conversion Time mode:

P04-50 ~ P04-69: PLC register parameter 0 - 19

P08-04: Upper limit of integral

P08-05: PID output upper limit

P10-17: Electronic gear A

P10-18: Electronic gear B

P11-34: Torque command

P11-43: P2P highest frequency

P11-44: Position control acceleration time

P11-45: Position control deceleration time

Calculation of the number of times written is based on whether the written value is modified. For instance, writing the same value 100 times at the same time counts as writing only once.

When writing a PLC program, if unsure of usage of the WPR command, we recommend that you use the WPRP command.

API 141	FPID		P	(S1) (S2) (S3) (S4)	Driver PID control mode										
	Bit device			Word device								16-bit command (9 STEP)			
	X	Y	M	K	H	KnX	KnY	KnM	T	C	D	FPID	Continuous execution type	FPIDP	Pulse execution type
S1				*	*						*				
S2				*	*						*				
S3				*	*						*				
S4				*	*						*				
Notes on operand usage: none												Flag signal: none			

Explanation

- (S1): PID reference target value input terminal select. (S2): PID function proportional gain P. (S3): PID function integral time I. (S4): PID function differential time D.
- The FPID command can directly control the driver's feedback control of PID parameter 08-00 PID reference target value input terminal selection, 08-01 proposal gain P, 08-02 integral time I, and 08-03 differential time D.

Example

- When M0=On, the set PID reference target value input terminal selection is 0 (no PID function), the PID function proportional gain P is 0, the PID function integral time I is 1 (units: 0.01 sec.), and the PID function differential time D is 1 (units: 0.01 sec.).
- When M1=On, the set PID reference target value input terminal selection is 0 (no PID function), the PID function proportional gain P is 1 (units: 0.01), the PID function integral time I is 0, and the PID function differential time D is 0.
- When M2=On, the set PID reference target value input terminal selection is 1 (target frequency input is controlled from the digital keypad), the PID function proportional gain P is 1 (units: 0.01), the PID function integral time I is 0, and the PID function differential time D is 0.
- D1027: Frequency command after PID operation.

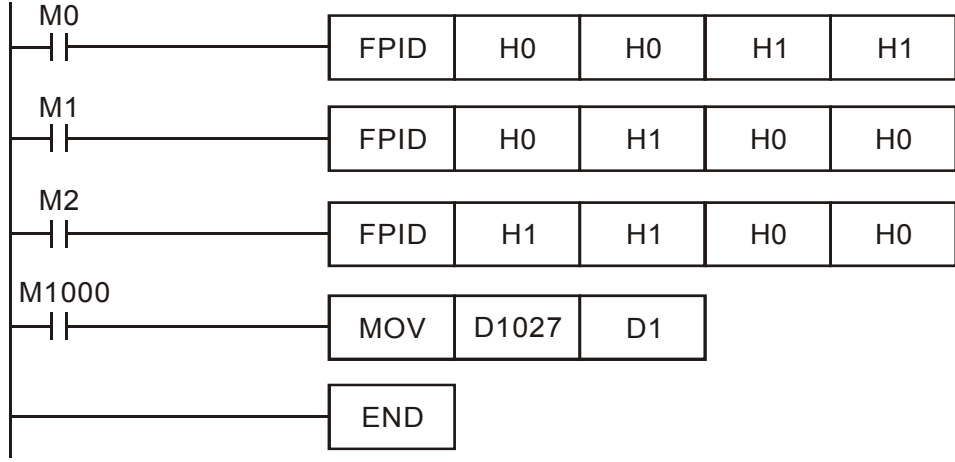

API 142	FREQ		P	(S1)	(S2)	(S3)	Driver speed control mode								
Bit device			Word device								16-bit command (7 STEP)				
	X	Y	M	K	H	KnX	KnY	KnM	T	C	D	FREQ	Continuous execution type	FREQP	Pulse execution type
S1				*	*						*				
S2				*	*						*				
S3				*	*						*				
Notes on operand usage: none												32-bit command			
												Flag signal: M1015			

- Explanation
- (S1): Frequency command. (S2): Acceleration time. (S3): Deceleration time
 - S2,S3: In acceleration/deceleration time settings, the number of decimal places is determined by the definitions of Pr01-45.

Example

When 01-45=0: units of 0.01 sec.

The setting of 50 for S2 (acceleration time) in the ladder diagram below implies 0.5 sec, and the S3 (deceleration time) setting of 60 implies 0.6 sec

- The FREQ command can control driver frequency commands, and acceleration and deceleration time; it also uses special register control actions, such as:
M1025: Control driver RUN(On)/STOP(Off) (RUN requires Servo On (M1040 On) to be effective)
M1026: Control driver operating direction FWD(Off)/REV(On)
M1040: Control Servo On/Servo Off.
M1042: Trigger quick stop (ON)/does not trigger quick stop (Off).
M1044: Pause (On)/release pause (Off)
M1052: Lock frequency (On)/release lock frequency (Off)

Example

- M1025: Driver RUN(On)/STOP(Off), M1026: driver operating direction FWD(Off)/REV(On). M1015: frequency reached.
- When M10=On, sets the driver frequency command K300(3.00Hz), with an acceleration/deceleration time of 0.
When M11=On, sets the driver frequency command K3000 (30.00Hz), with an acceleration time of 50 (0.5 sec.) and deceleration time of 60 (0.6 sec.). (When 01-45=0)
- When M11=Off, the driver frequency command will now change to 0

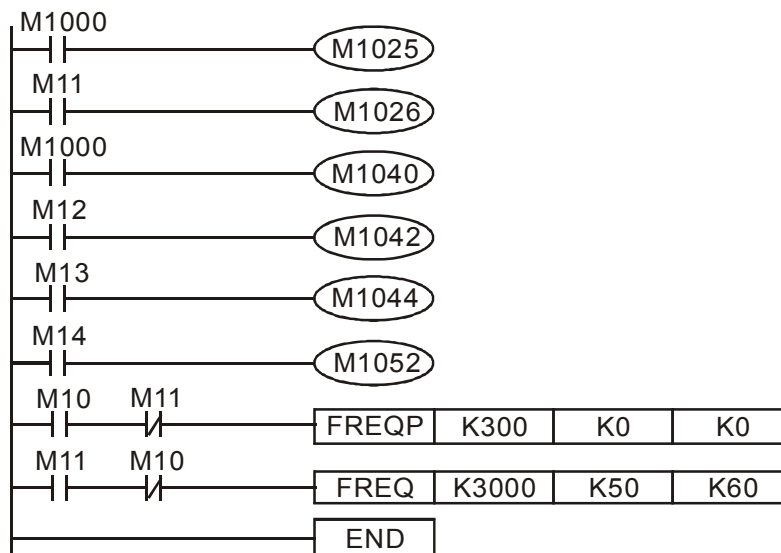

- Parameter 09-33 are defined on the basis of whether reference commands have been cleared before PLC operation
Bit 0 : Prior to PLC scanning procedures, whether the target frequency has been cleared is 0. (This will be written to the FREQ command when the PLC is On)

Bit 1 : Prior to PLC scanning procedures, whether the target torque has been cleared is 0. (This will be written to the TORQ command when the PLC is On)

Bit 2 : Prior to PLC scanning procedures, whether speed limits in the torque mode have been cleared is 0. (This will be written to the TORQ command when the PLC is On)

Example: When using r to write a program,

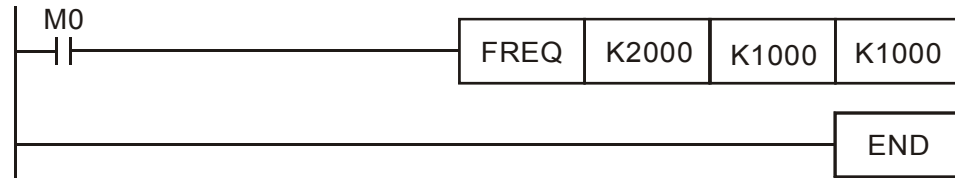

if we force M0 to be 1, the frequency command will be 20.00 Hz; but when M0 is set as 0, there will be a different situation.

Case 1: When the 09-33 bit 0 is 0, and M0 is set as 0, the frequency command will remain at 20.00Hz.

Case 2: When the 09-33 bit 0 is 1, and M0 is set as 0, the frequency command will change to 0.00Hz

The reason for this is that when the 09-33 bit 0 is 1 prior to PLC scanning procedures, the frequency will first revert to 0.

When the 09-33 bit 0 is 0, the frequency will not revert to 0.

API 263	TORQ	P	(S1) (S2)	Driver torque control mode											
	Bit device		Word device								16-bit command (5 STEP)				
	X	Y	M	K	H	KnX	KnY	KnM	T	C	D	TORQ	Continuous execution type	TORQ P	Pulse execution type
S1				*	*						*				
S2				*	*						*				
Notes on operand usage: none												32-bit command			
												Flag signal: M1063			

Explanation

- (S1): Torque command (numbered, no more than one digit). (S2): Speed limit.
- The TORQ command can control the driver torque command and speed limits; it also uses special register control actions, such as:
M1040: Controls Servo On/Servo Off. When Servo is ON, if a TORQ command is executed, the torque will output the torque defined by the TORQ command, and the frequency restrictions will similarly be controlled by the TORQ command.

Example

- M1040: Control Servo On/Servo Off. M1063: set torque attained. D1060 is the mode controls. D1053 is the actual torque.
- When M0=Off, set the driver torque command K+500 (+50.0%), rotational speed restrictions is 3000 (30Hz).
- When M0=On, sets the driver torque command K-300 (-30.0%), rotational speed restrictions is 3000 (30Hz).
- When M10=On, driver began output torque command.
- When set torque is attained, M1063 will go On; this flag usually jumps continuously, however.

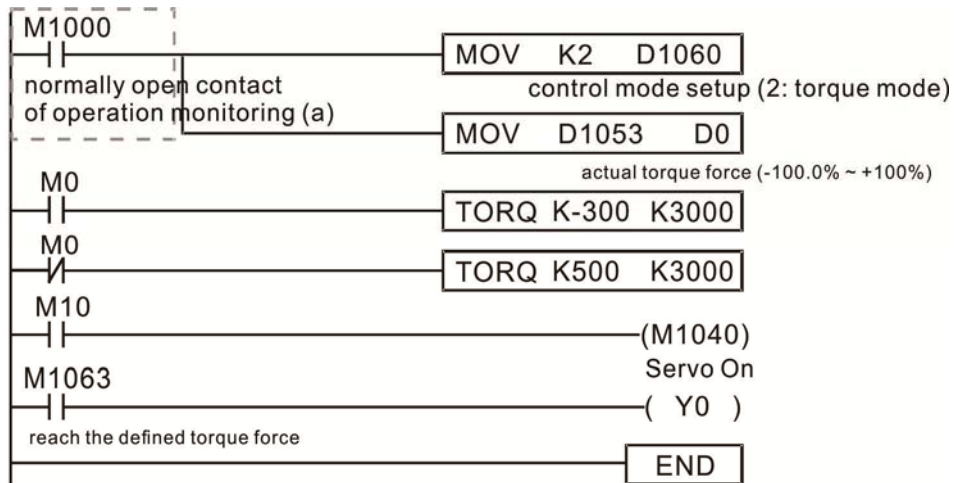

- Parameter 09-33 are defined on the basis of whether reference commands have been cleared before PLC operation
 Bit 0: Prior to PLC scanning procedures, whether the target frequency has been cleared is 0. (This will be written to the FREQ command when the PLC is On)
 Bit 1: Prior to PLC scanning procedures, whether the target torque has been cleared is 0. (This will be written to the TORQ command when the PLC is On)
 Bit 2: Prior to PLC scanning procedures, whether speed limits in the torque mode have been cleared is 0. (This will be written to the TORQ command when the PLC is On)

Example:

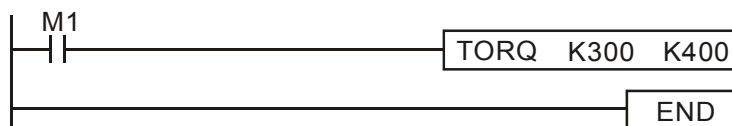

If we now force M1 to be 1, the torque command will be K+300 (+30%), and the speed limit will be 400 (40Hz). But when M1 is set as 0, there will be a different situation

Case 1: When bit 1 and bit 2 of 09-33 are both set as 0, and M1 is set as 0, the torque command will remain at +30%, and the speed limit will be set as 40Hz.

Case 2: When bit 1 and bit 2 of 09-33 are both 1, and M1 is set as 0, the torque command will revert 0%, and the speed limit will be set as 0Hz.

API 262	DPOS		P	(S1)								Driver point-to-point control			
Bit device			Word device									16-bit command			
X	Y	M	K	H	KnX	KnY	KnM	T	C	D	-	-	-	-	
			*	*						*	32-bit command (5 STEP)				
Notes on operand usage: none											DPOS	Continuous	DPOSP	Pulse	
											execution type		execution type		
											Flag signal: M1064, M1070				

Explanation

- **(S1)**: Target (must have a number).
- The DPOS command can control the driver's position commands, and employs special register control actions, such as:
 M1040: Control Servo On/Servo Off. M1055 search for origin. M1048 move to new position. If the control mode is position mode (D1060 = 1), and the converter is in the Servo ON state (M1040 = 1), if the DPOS command is executed, the driver will move to a new position in conjunction with activation of M1048 once (OFF to ON).

Example

52. M1040: Control Servo On/Servo Off. M1064: set position attained. D1060 is the mode control. D1051(L) and D1052(H) are the actual position points.
53. When X0=On, M1040 will be On (Servo On).
54. When X1=On, sets DPOS position as +300000, and M1048 will change to On (move to new position) after a delay of 1 sec. Check whether the value of D1051 has changed at this time; after the set position point has been reached, M1064 will go On, and Y0 will output On.

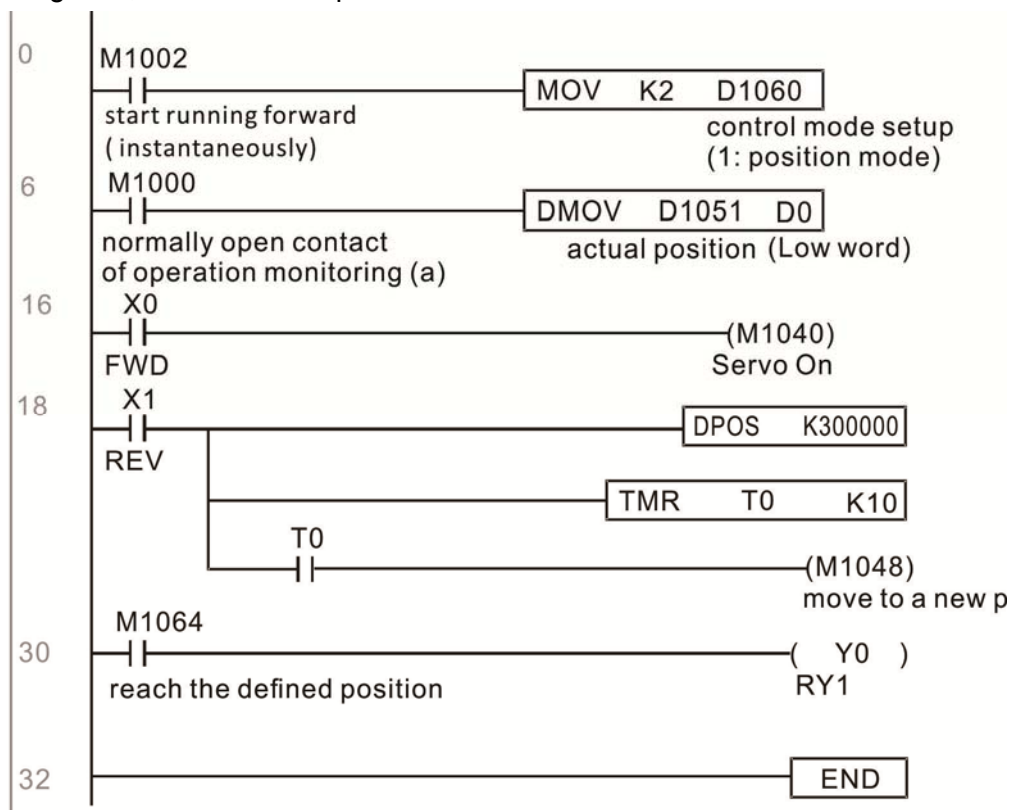

API 261	CANRX		P	(S1)	(S2)	(S3)	(D)	Read CANopen slave station data							
	Bit device			Word device							16-bit command (9 STEP)				
	X	Y	M	K	H	KnX	KnY	KnM	T	C	D	CANRX	Continuous execution type	CANRXP	Pulse execution type
S1				*	*										
S2				*	*										
S3				*	*										
D									*	*	*				
Notes on operand usage: none												Flag signal			

Explanation

- (S1): Slave station number. (S2): Main index.. (S3): Subindex+bit length. (D): Preset address.
- The CANRX command can read the index of the corresponding slave station. When it is executed, it will send the SDO message format to the slave station. M1066 and M1067 will both be 0 at that time, and M1066 will be set as 1 after reading. If the slave station gives the correct response, it will write the value to the preset register, and set M1067 as 1. If the slave station has a response error, M1067 will be set as 0, and an error message will be recorded to D1076 to D1079.

Example

M1002: When the PLC runs, the command will be triggered once and will set K4M400 = K1
 Afterwards, each time M1066 is 1, it will switch to a different message.

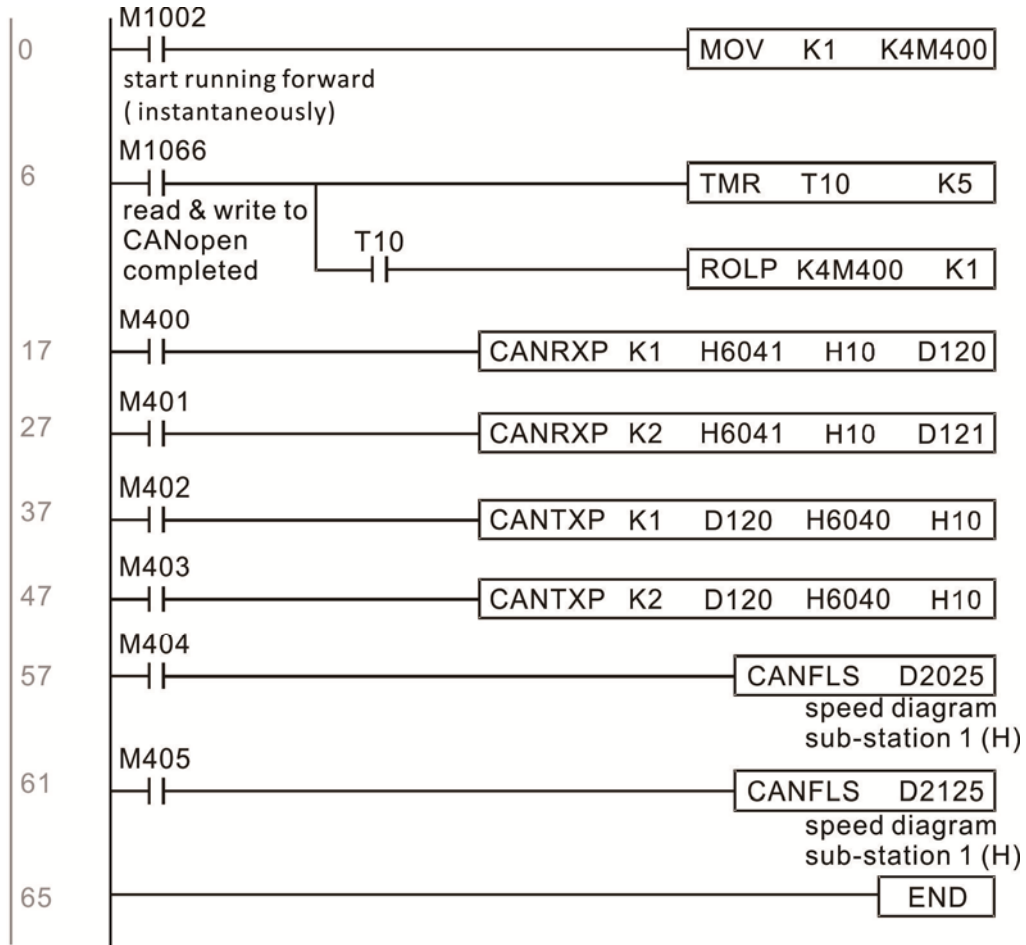

API 264	CANTX		P	(S1) (S2) (S3) (S4)	Write CANopen slave station data										
	Bit device			Word device								16-bit command (9 STEP)			
	X	Y	M	K	H	KnX	KnY	KnM	T	C	D	CANTX	Continuous execution type	CANTXP	Pulse execution type
S1				*	*										
S2				*	*				*	*	*				
S3				*	*										
S4				*	*										
Notes on operand usage: none												Flag signal			

- Explanation
- (S1): Slave station number. (S2): Address to be written. (S3): Main index. (S4): Subindex+bit length.
 - The CANTX command can write a value to the index of the corresponding slave station. When it is executed, it will send the SDO message format to the slave station. M1066 and M1067 will both be 0 at that time, and M1066 will be set as 1 after reading. If the slave station gives the correct response, it will write the value to the preset register, and set M1067 as 1. If the slave station has a response error, M1067 will be set as 0, and an error message will be recorded to D1076 to D1079.

API 265	CANFLS		P	(D)								Refresh special D corresponding to CANopen	
Bit device			Word device								16-bit command (3 STEP)		
X	Y	M	K	H	KnX	KnY	KnM	T	C	D	CANFLS: Continuous execution type	CANFLSP: Pulse execution type	
D			*	*									
Notes on operand usage: none											32-bit command		
											Flag signal		

- Explanation**
- **(D)**: Special D to be refreshed.
 - The CANFLS command can refresh special D commands. When is a read only attribute, executing this command will send a message equivalent to that of CANRX to the slave station, and the number of the slave station will be transmitted back and refreshed to this special D. When there is a read/write attribute, executing this command will send a message equivalent to that of CANTX to the slave station, and the value of this special D will be written to the corresponding slave station.
 - When M1066 and M1067 are both 0, and M1066 is set as 1 after reading, if the slave station gives a correct response, the value will be written to the designated register, and M1067 will be set as 1. If the slave station's response contains an error, then M1067 will be set as 0, and an error message will be recorded to D1076-D1079.

API 320	D	ICOMR		P	(S1) (S2) (S3) (D)						Internal communications read		
Bit device			Word device								16-bit command (9 STEP)		
X	Y	M	K	H	KnX	KnY	KnM	T	C	D	ICOMR: Continuous execution type	ICOMRP: Pulse execution type	
S1			*	*						*			
S2			*	*						*			
S3			*	*						*	32-bit command (17 STEP)		
D			*	*						*	DICOMR: Continuous execution type	DICOMRP: Pulse execution type	
Notes on operand usage: none											Flag signal: M1077 M1078 M1079		

- Explanation**
- (S1)**: Selection of slave device. **(S2)**: Device selection (0: converter, 1: internal PLC). **(S3)**: Read address. **(D)**: Saving target.
- The ICOMR command can obtain the slave station's converter and the internal PLC's register value.

API 321	D	ICOMW	P	(S1) (S2) (S3) (D)	Internal communications write								
Bit device		Word device								16-bit command (9 STEP)			
X	Y	M	K	H	KnX	KnY	KnM	T	C	D	ICOMW: Continuous execution type	ICOMWP: Pulse execution type	
S1			*	*						*	32-bit command (17 STEP)		
S2			*	*						*	DICOMW: Continuous execution type	DICOMWP: Pulse execution type	
S3			*	*						*			
D			*	*						*			
Notes on operand usage: none											Flag signal: M1077 M1078 M1079		

Explanation

(S1): Selection of slave device. (S2): Device selection (0: converter, 1: internal PLC). (S3): Read address. (D): Saving target.

- The ICOMW command write a value to the slave station's converter and the internal PLC's register.

Example

Please refer to the following example:

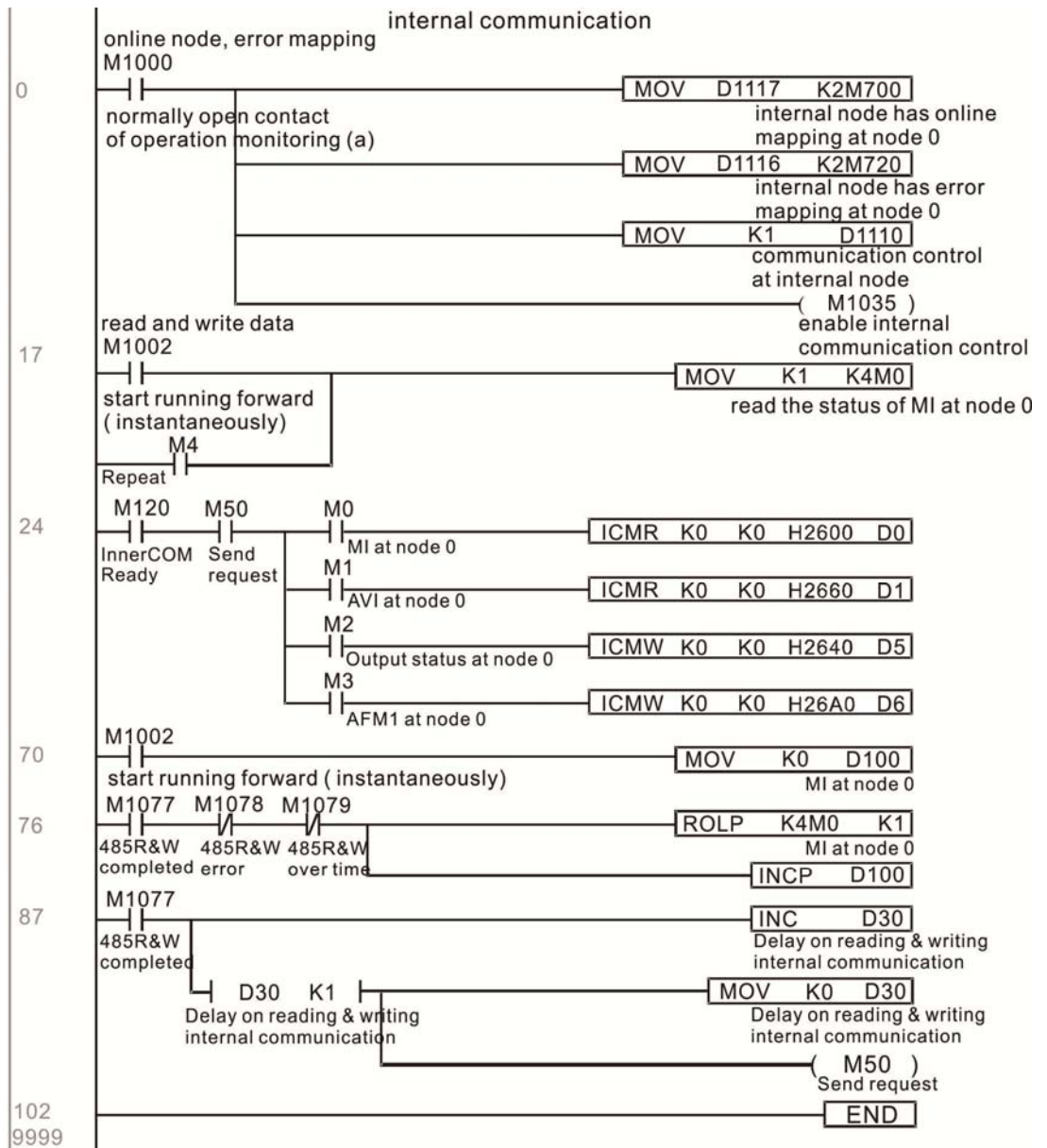

16-7 Error display and handling

Code	ID	Descript	Recommended handling approach
PLrA	47	RTC time check	Turn power on and off when resetting the keypad time
PLrt	49	(incorrect RTC mode)	Turn power on and off after making sure that the keypad is securely connected
PLod	50	Data writing memory error	Check whether the program has an error and download the program again
PLSv	51	Data write memory error during program execution	Restart power and download the program again
PLdA	52	Program transmission error	Try uploading again; if the error persists, sent to the manufacturer for service
PLFn	53	Command error while downloading program	Check whether the program has an error and download the program again
PLor	54	Program exceeds memory capacity or no program	Restart power and download the program again
PLFF	55	Command error during program execution	Check whether the program has an error and download the program again
PLSn	56	Check code error	Check whether the program has an error and download the program again
PLEd	57	Program has no END stop command	Check whether the program has an error and download the program again
PLCr	58	MC command has been used continuously more than nine times	Check whether the program has an error and download the program again
PLdF	59	Download program error	Check whether the program has an error and download again
PLSF	60	PLC scan time excessively long	Check whether the program code has a writing error and download again

16- 8 CANopen Master control applications

Control of a simple multi-axis application is required in certain situations. If the device supports the CANopen protocol, a CT2000 can serve as the master in implementing simple control (position, speed, homing, and torque control). The setting method comprises the following seven steps:

Step 1: Activating CANopen Master functions

1. Parameter 09-45=1 (initiates Master functions); restart power after completing setting, the status bar on the KPC-CC01 digital keypad will display "CAN Master".
2. Parameter 00-02=6 reset PLC (please note that this action will reset the program and PLC registers to the default values)
3. Turn power off and on again.
4. Use the KPC-CC01 digital keypad to set the PLC control mode as "**PLC Stop**" (if the KPC-CE01 digital keypad is used, set as "PLC 2"; if a newly-introduced driver is used, the blank internal PLC program will cause a PLFF warning code to be issued).

Step 2: Master memory settings

1. After connecting the 485 communications cable, use WPL Soft to set the PLC **status** as Stop (if the PLC mode has been switched to the "**PLC Stop**" mode, the PLC **status** should already be Stop)
2. Set the address and corresponding station number of the slave station to be controlled. For instance, if it is wished to control two slave stations (a maximum of 8 stations can be controlled simultaneously), and the station numbers are 21 and 22, it is only necessary to set D2000 and D2100 as 20 and 21, and then set D2200, D2300, D2400, D2500, D2600, and D2700 as 0. The setting method involves use of the PLC's WPL editing software WPL as follows:

- Open WPL and implement **communications > register edit (T C D)** function

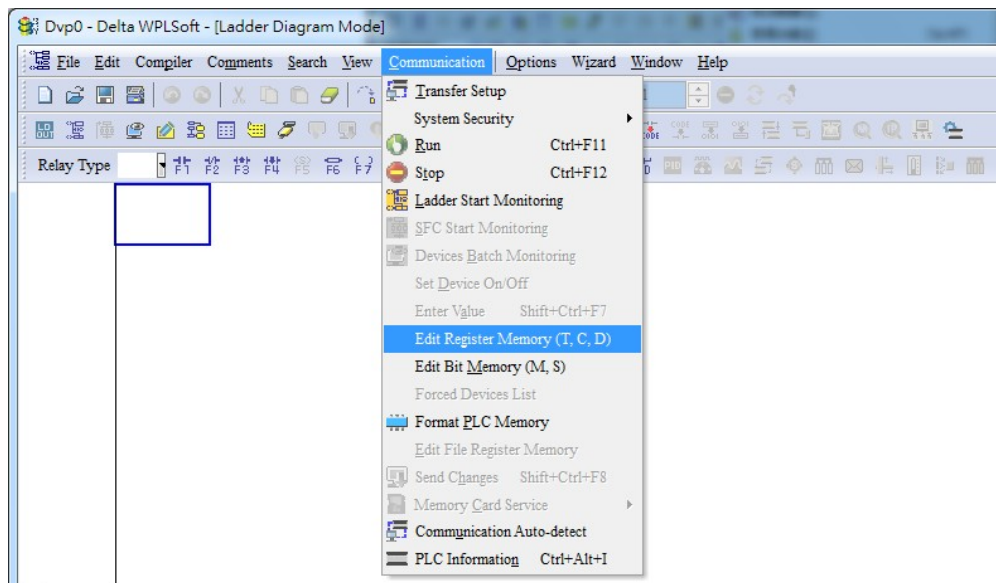

- After leaving the PLC register window, the register setting screen will appear, as shown below:

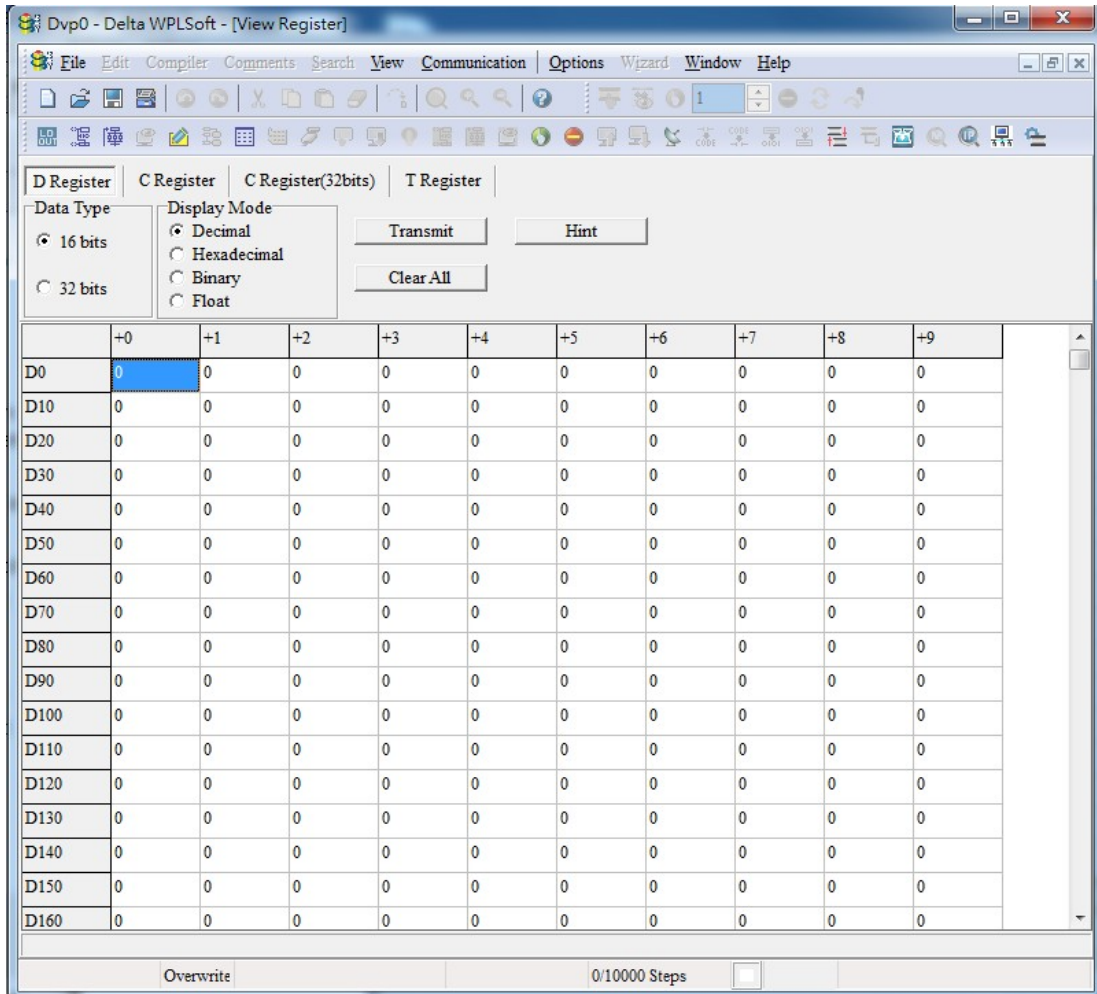

If there is a new PLC program and no settings have yet been made, you can read default data from the converter, and merely edit it to suit the current application. If settings have already been made, however, the special D in the CANopen area will display the saved status (the CANopen D area is located at D1090 to D1099 and D2000 to D2799). Assuming it is a new program, we will first read the default data from the converter; check the communications format if there is no communications link (the default PLC station number is 2, 9600, 7N2, ASCII). Perform the following steps: 1. Switch the PLC to Stop status; 2. Press the transmit button; 3. click on read memory after exiting the window; 4. Ignore D0-D399; and 5. click on the confirm button.)

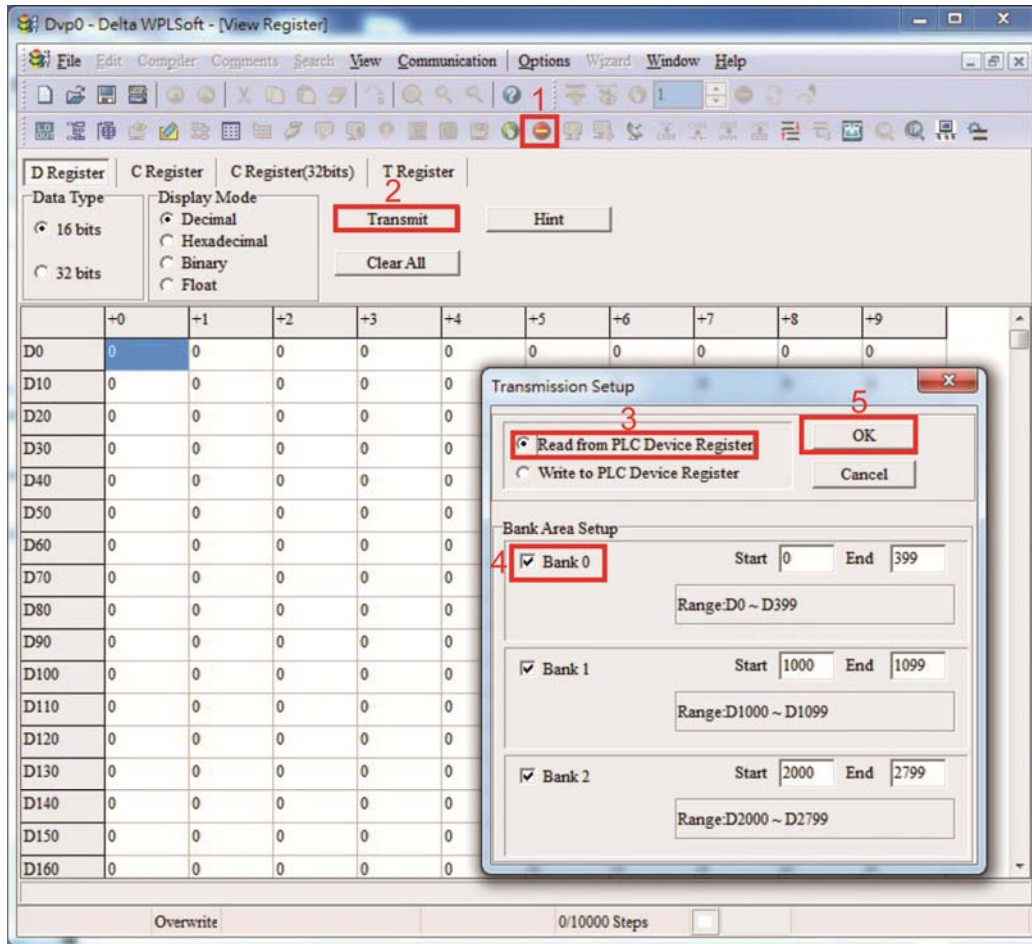

After reading the data, it is necessary to perform some special D settings. Before proceeding, we will first introduce the special D implications and setting range. The CANopen Master's special D range is currently D1070 to D1099 and D2000 to D2799; this range is divided into 3 blocks:

The first block is used to display CANopen's current status, and has a range of D1070 to D1089;

the second block is used for CANopen's basic settings, and has a range of D1090 to D1099;

the third block is the slave station mapping and control area, and has a range of D2000 to D2799;

These areas are therefore introduced as follows:

The first contains the current CANopen status display:

When the master initializes a slave station, we can find out from D1070 whether configuration of the slave device has been completed; we can find out whether an error occurred in the configuration process from D1071 and whether the configuration is inappropriate from D1074.

After entering normal control, we can find out whether the slave device is offline from D1073. In addition, we can check the slave device's read/write information using the CANRX, CANTX, and CANFLS commands; error information can be obtained from D1076 to D1079 if there has been a read/write failure.

Special D	Description of Function	R/W
D1070	Channel opened by CANopen initialization (bit0=Machine code0	R
D1071	Error channel occurring in CANopen initialization process (bit0=Machine code0	R
D1072	Reserved	-
D1073	CANopen break channel (bit0=Machine code0	R

Special D	Description of Function	R/W
D1074	Error code of master error 0: No error 1: Slave station setting error 2: Synchronizing cycle setting error (too small)	R
D1075	Reserved	-
D1076	SDO error message (main index value)	R
D1077	SDO error message (secondary index value)	R
D1078	SDO error message (error code L)	R
D1079	SDO error message (error code H)	R

The second area is for basic CANopen settings: (the PLC must have **stopped** when this area is used to make settings)

We must set the information exchange time for the master and slave station,

Special D	Description of Function	Default:	R/W
D1090	Synchronizing cycle setting	4	RW

Use D1090 to perform settings; setting time relationships include:

$$\text{Sync time} \geq \frac{1M}{\text{Rate}} * \frac{N}{4}$$

N: TXPDO + RXPDO

For instance, when communications speed is 500K, TXPDO + RXPDO have 8 sets, and synchronizing time will require more than 4 ms

We must also define how many slave stations will be open. D1091 is the channel for defining station opening, and D2000+100*n is the station number defining this channel. See the detailed explanation below.

Slave station number n=0-7

Special D	Description of Function	R/W
D1091	Sets slave station On or Off (bit 0-bit 7 correspond to slave stations number 0-7)	RW
D2000+100*n	Slave station number	RW

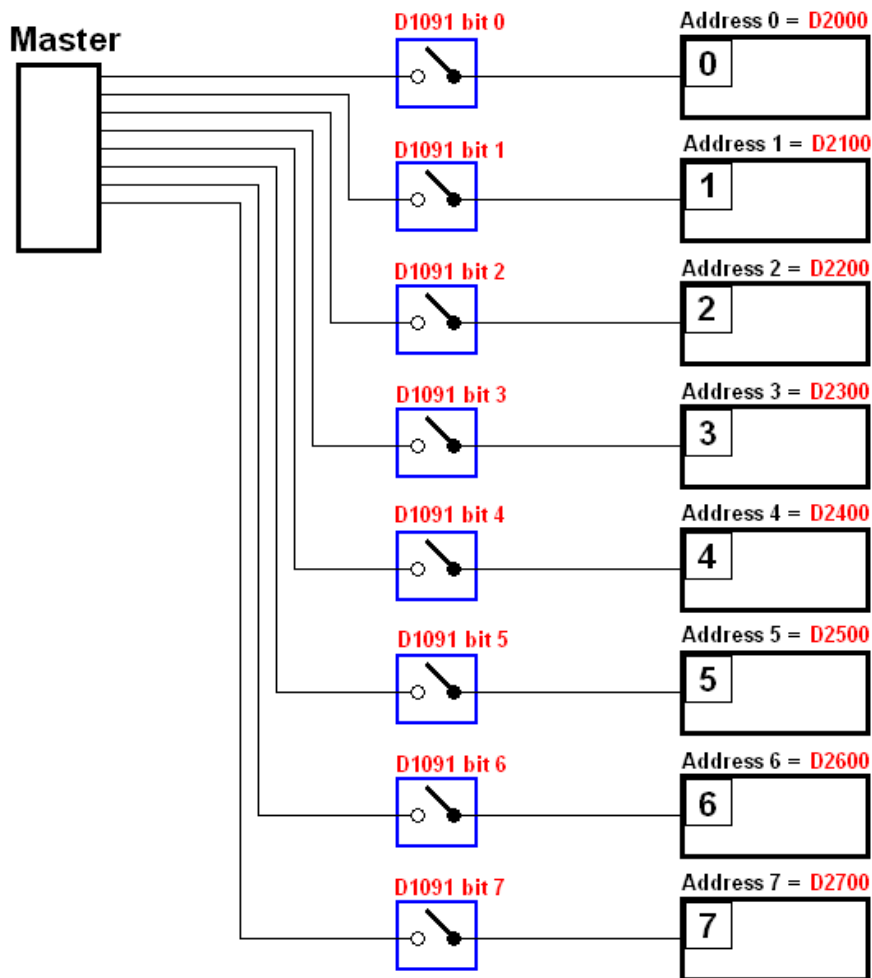

If slave devices have a slow start-up, the master can delay for a short time before performing slave station configuration; this time delay can be set via D1092.

Special D	Description of Function	Default:	R/W
D1092	Delay before start of initialization	0	RW

With regard to slave device initialization, a delay time can be set to judge whether failure has occurred. If the communications speed is relatively slow, the delay time can be adjusted to judge whether initialization has been completed, which will ensure that there is time to perform slave device initialization.

Special D	Description of Function	Default:	R/W
D1099	Initialization completion delay time Setting range: 1 to 60000 sec	15 sec.	RW

After communication is successful, the system must detect whether there is a break in communications with the slave station. D1093 is used to set detection time, and D1094 sets the number of consecutive errors that will trigger a break error.

Special D	Description of Function	Default:	R/W
D1093	Break time detection	1000ms	RW
D1094	Break number detection	3	RW

The packet type transmitted by PDO is set before establishing normal communications and generally does not require adjustment.

Special D	Description of Function	Default:	R/W
-----------	-------------------------	----------	-----

Special D	Description of Function	Default:	R/W
D1097	Corresponding real-time transmission type (PDO) Setting range: 1~240	1	RW
D1098	Corresponding real-time receiving type (PDO) Setting range: 1~240	1	RW

The third block is the slave station mapping and control area.

CANopen provides a PDO method to perform mapping of the master and slave station memory, and enables the master to directly access read/write data in a certain memory area. The master will automatically perform data exchange with the corresponding slave device, and the read/write values can be seen directly from the special D area after real-time exchange (M1034 = 1 time) has been established. The CT2000 currently supports real-time mapping of four PDOs, and there are two types of PDO RXPDO (reads slave device information) and TXPDO (writes to slave device). In addition, in order to facilitate control, the CT2000 cannot perform mapping of commonly-used registers; the following is an overview of the current PDO mapping situation:

TX PDO							
PDO4 (Torque)		PDO3 (Position)		PDO2 (Remote I/O)		PDO1 (Speed)	
Description	Special D	Description	Special D	Description	Special D	Description	Special D
Controller Word	D2008+1 00*n	Controller Word	D2008+1 00*n	Slave device DO	D2027+1 00*n	Controller Word	D2008+1 00*n
Target torque	D2017+1 00*n	Target	D2020+1 00*n	Slave device AO1	D2031+1 00*n	Target speed	D2012+1 00*n
Control method	D2010+1 00*n	Control method	D2010+1 00*n	Slave device AO2	D2032+1 00*n		
				Slave device AO3	D2033+100*n		

RXPDO							
PDO4 (Torque)		PDO3 (Position)		PDO2 (Remote I/O)		PDO1 (Speed)	
Description	Special D	Description	Special D	Description	Special D	Description	Special D
Mode word	D2009+100*n	Mode word	D2009+100*n	Slave device DI	D2026+100*n	Mode word	D2009+100*n
Actual torque	D2018+100*n	Actual position	D2022+100*n D2023+100*n	Slave device AI1	D2028+100*n	Actual frequency	D2013+100*n
Actual mode	D2011+100*n	Actual mode	D2011+100*n	Slave device AI2	D2029+100*n		
				Slave device AI3	D2030+100*n		

Because usage requires only simple to open the corresponding PDO, where TXPDO employs D2034+100*n settings and RXPDO employs D2067+100*n settings.

These two special D areas are defined as follows:

	PDO4		PDO3		PDO2		PDO1	
Default definition	Torque		Position		Remote I/O		Speed	
bit	15	14 ~ 12	11	10 ~ 8	7	6 ~ 4	3	2 ~ 0
Definition	En	Length:	En	Length:	En	Length:	En	Length:

En: indicates whether PDO is used

Length: indicates mapping of several variables

In a simple example, if we wish to control a CT2000 slave device and cause it to operate in speed mode, we only have to make the following settings:

D2034+100*n =000Ah

Length:	TX PDO							
	PDO4		PDO3		PDO2		PDO1	
	Description	Special D	Description	Special D	Description	Special D	Description	Special D
1	Controller Word	D2008+100*n	Controller Word	D2008+100*n	Slave device DO	D2027+100*n	Controller Word	D2008+100*n
2	Target torque	D2017+100*n	Target	D2020+100*n	Slave device AO1	D2031+100*n	Target speed	D2012+100*n
3	Control method	D2010+100*n	Control method	D2010+100*n	Slave device AO2	D2032+100*n		
4					Slave device AO3	D2033+100*n		

	PDO4		PDO3		PDO2		PDO1	
Definition	Torque		Position		Remote I/O		Speed	
bit	15	14 ~ 12	11	10 ~ 8	7	6 ~ 4	3	2 ~ 0
Definition	0	0	0	0	0	0	1	2

D2067+100*n =000Ah

Length:	TX PDO							
	PDO4		PDO3		PDO2		PDO1	
	Description	Special D	Description	Special D	Description	Special D	Description	Special D
1	Controller Word	D2009+100*n	Controller Word	D2009+100*n	Slave device DI	D2026+100*n	Controller Word	D2009+100*n
2	Actual torque	D2018+100*n	Actual position	D2022+100*n	Slave device AI1	D2028+100*n	Actual frequency	D2013+100*n
3	Actual mode	D2011+100*n	Actual mode	D2011+100*n	Slave device AI2	D2029+100*n		
4					Slave device AI3	D2030+100*n		

	PDO4		PDO3		PDO2		PDO1	
Definition	Torque		Position		Remote I/O		Speed	
bit	15	14 ~ 12	11	10 ~ 8	7	6 ~ 4	3	2 ~ 0
Definition	0	0	0	0	0	0	1	2

Switch the PLC to Run after completing settings. Now wait for successful initialization of CANopen (M1059 = 1 and M1061 = 0), and then initiate CANopen memory mapping (M1034 = 1). The control word and frequency command will now automatically refresh to the corresponding slave device (D2008+n*100 and D2012+n*100), and the slave device's status word and currently frequency will also be automatically sent back to the master station (D2009+n*100 and D2013+n*100). This also illustrates how the master can handle these tasks through read/write operations in the special D area.

Furthermore, it should be noted that the remote I/O of PDO2 can obtain the slave device's current DI and AI status, and can also control the slave device's DO and AO status. Nevertheless, after introducing a fully automatic mapping special D, the CT2000 CANopen master also provides additional information refreshes. For instance, while in speed mode, acceleration/deceleration settings may have been refreshed. The special D therefore also stores some seldom-used real-time information, and these commands can be refreshed using the CANFLS command. The following is the CT2000's current CANopen master data conversion area, which has a range of D2001+100*n - D2033+100*n, as shown below:

1. The range of n is 0-7
2. ●Indicates PDOTX, ▲Indicates PDORX; unmarked special D can be refreshed using the CANFLS command

Special D	Description of Function	Default	PDO Default:				R/W
			1	2	3	4	
		:					

D2000+100*n	Station number n of slave station Setting range: 0~127 0: No CANopen function	0						RW
D2002+100*n	Manufacturer code of slave station number n (L)	0						R
D2003+100*n	Manufacturer code of slave station number n (H)	0						R
D2004+100*n	Manufacturer's product code of slave station number n (L)	0						R
D2005+100*n	Manufacturer's product code of slave station number n (H)	0						R

Basic definitions

Special D	Description of Function	Default:	PDO Default:				R/W
			1	2	3	4	
D2006+100*n	Communications break handling method of slave station number n	0					RW
D2007+100*n	Error code of slave station number n error	0					R
D2008+100*n	Control word of slave station number n	0	●		●	●	RW
D2009+100*n	Status word of slave station number n	0	▲		▲	▲	R
D2010+100*n	Control mode of slave station number n	2					RW
D2011+100*n	Actual mode of slave station number n	2					R

Velocity Control

Special D	Description of Function	Default :	PDO Default:				R/W
			1	2	3	4	
D2001+100*n	Torque restriction on slave station number n	0					RW
D2012+100*n	Target speed of slave station number n (rpm)	0	●				RW
D2013+100*n	Actual speed of slave station number n (rpm)	0	▲				R
D2014+100*n	Error speed of slave station number n (rpm)	0					R
D2015+100*n	Acceleration time of slave station number n (ms)	1000					RW
D2016+100*n	Deceleration time of slave station number n (ms)	1000					RW

Torque control

Special D	Description of Function	Default:	PDO Default:				R/W
			1	2	3	4	
D2017+100*n	Target torque of slave station number n(-100.0%~+100.0%)	0				●	RW
D2018+100*n	Actual torque of slave station number n(XX.X%)	0				▲	R
D2019+100*n	Actual current of slave station number n(XX.XA)	0					R

Position control

Special D	Description of Function	Default:	PDO Default:				R/W
			1	2	3	4	
D2020+100*n	Target of slave station number n (L)	0					RW
D2021+100*n	Target of slave station number n (H)	0			●		RW
D2022+100*n	Actual position of slave station number n (L)	0					R
D2023+100*n	Actual position of slave station number n (H)	0			▲		R

D2024+100*n	Speed chart of slave station number n (L)	10000					RW
D2025+100*n	Speed chart of slave station number n (H)	0					RW

Remote I/O

Special D	Description of Function	Default:	PDO Default:				R/W
			1	2	3	4	
D2026+100*n	MI status of slave station number n	0		▲			R
D2027+100*n	MO setting of slave station number n	0		●			RW
D2028+100*n	AI1 status of slave station number n	0		▲			R
D2029+100*n	AI2 status of slave station number n	0		▲			R
D2030+100*n	AI3 status of slave station number n	0		▲			R
D2031+100*n	AO1 setting of slave station number n	0		●			RW
D2032+100*n	AO2 setting of slave station number n	0		●			RW
D2033+100*n	AO3 setting of slave station number n	0		●			RW

After gaining an understanding of special D definitions, we return to setting steps. After entering the values corresponding to D1090 to D1099, D2000+100*n, D2034+100*n and D2067+100*n, we cannot begin to perform downloading, which is performed in accordance with the following steps: (1. D2000 and D2100 are set as 20 and 21, and D2200, D2300, D2400, D2500, D2600, and D2700 are set as 0; if a setting of 0 causes problems, D1091 can be set as 3, and slave stations 2 to 7 can be closed. 2. Switch PLC to Stop status. 3. Press the transmit button. 4. click on write memory after exiting the window. 5. Ignore D0-D399. 6. Change the second range to D1090-D1099. 7. Click on Confirm.)

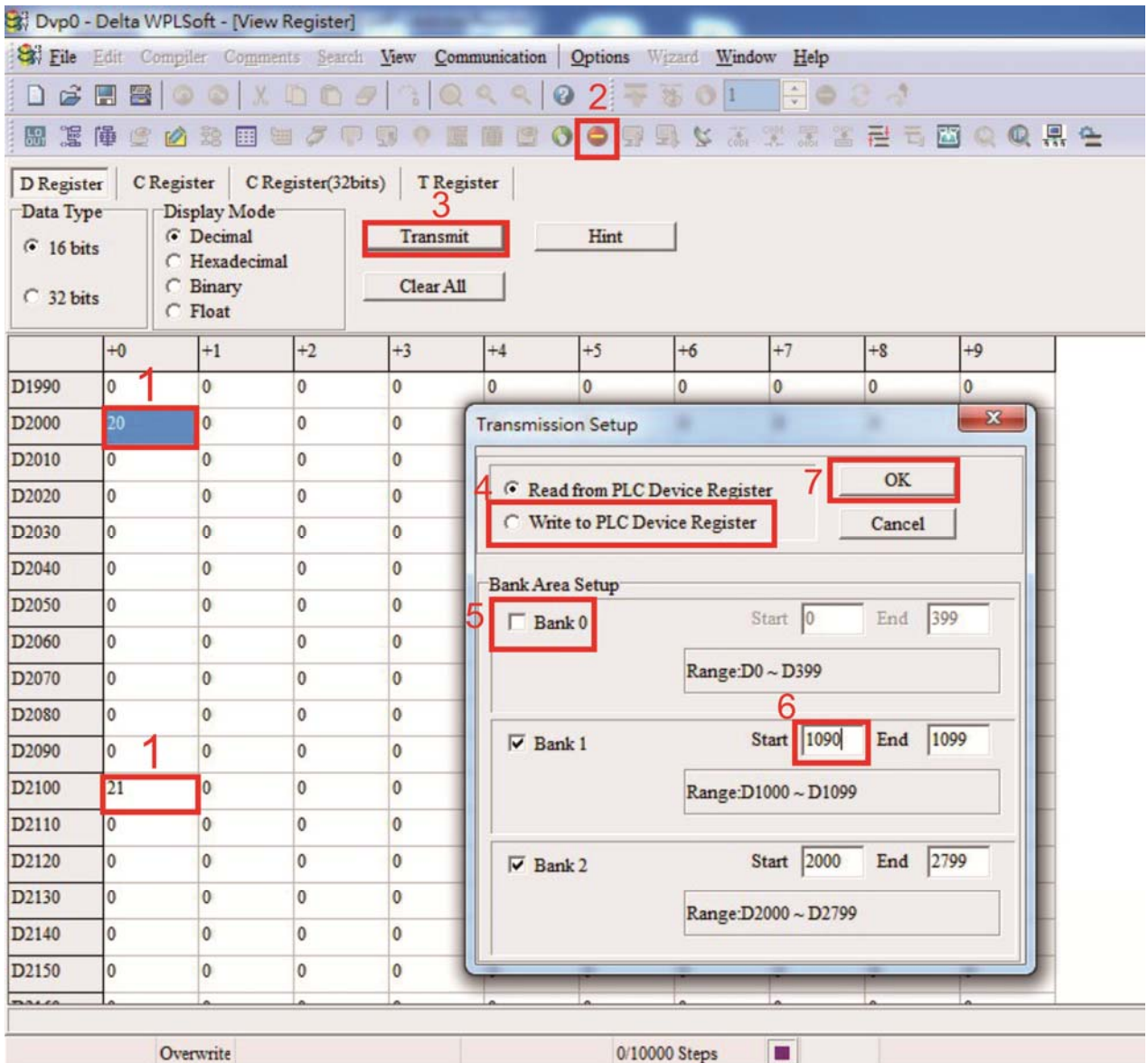

- Another method can be used to set D1091: Determine which of slave stations 0 to 7 will not be needed, and set the corresponding bits to 0. For instance, if it is not necessary to control slave stations 2, 6 and 7, merely set D1091 = 003B, and the setting method is the same as described above: Use WPL to initiate **communications > use register edit (T C D)** function to perform settings.

Step 3: Set the master's communications station number and communications speed

- ☑ When setting the master's station number (parameter 09-46, default is set as 100), make sure not to use the same number as a slave station.
- ☑ Set the CANopen communications speed (parameter 09-37); regardless of whether the driver is defined as a master or slave station, the communications speed is set via this parameter.

Step 4: Write program code

Real-time access: Can directly read/write to or from the corresponding D area.

Non real-time access:

Read command: Use the CANRX command for reading. M1066 will be 1 when reading is complete; M1067 will be 1 if reading is successful, and M1067 will be 0 if an error has occurred.

Write command: Use the CANTX command for writing. M1066 will be 1 when writing is complete; M1067 will be 1 if writing is successful, and M1067 will be 0 if an error has occurred.

Refresh command: Use CANFLS command to refresh (if there are RW attributes, the master will write to the slave station; if there are RO attributes, the slave station will return the read values to the master); M1066 will be 1 if refresh has been completed; M1067 will be 1 if refresh is successful, and M1067 will be 0 if an error has occurred.

 **NOTE**

When using CANRX, CANTX or CANFLS, internal implementation commands will wait until M1066 is completed before executing the next CANRX, CANTX or CANFLS.

Afterwards, download program to the driver (Please note that the PLC's default communications format is ASCII 7N2 9600, and the station number is 2. The WPL must therefore be modified, and the WPL setting pathway is **settings > communications settings**)

Step 5: Set the slave stations' station numbers, communications speed, control source, and command source

Delta's CT2000 and EC series devices currently support the CANopen communications interface driver, and the corresponding slave station numbers and communications speed parameters are as follows:

	Corresponding device parameters		Value	Definition
	CT2000	E-C		
Slave station address	09-36	09-20	0	Disable CANopen hardware interface
			1~127	CANopen Communication address
Communication speed	09-37	09-21	0	1M
			1	500K
			2	250K
			3	125K
			4	100K
			5	50K
Control source	00-21	-	3	
	-	02-01	5	
Frequency source	00-20	-	6	
	-	02-00	5	
Torque source	11-33	-	3	
	-	-	-	
Position source	11-40	-	3	
	-	-	-	

Delta's A2 Servo currently supports the CANopen communications interface, and the corresponding slave station numbers and communications speed parameters are as follows:

	Corresponding device parameters		Value	Definition
	A2			
Slave station address	03-00		1~127	CANopen Communication address
Communication speed	03-01 bit 8-11 XRXX		R= 0	125K
			R= 1	250K
			R= 2	500K

		R= 3	750K
		R= 4	1M
Control/command source	01-01	B	

Step 6: Connect hardware wiring

When performing wiring, note the head and tail terminal resistance; connection methods are as follows:

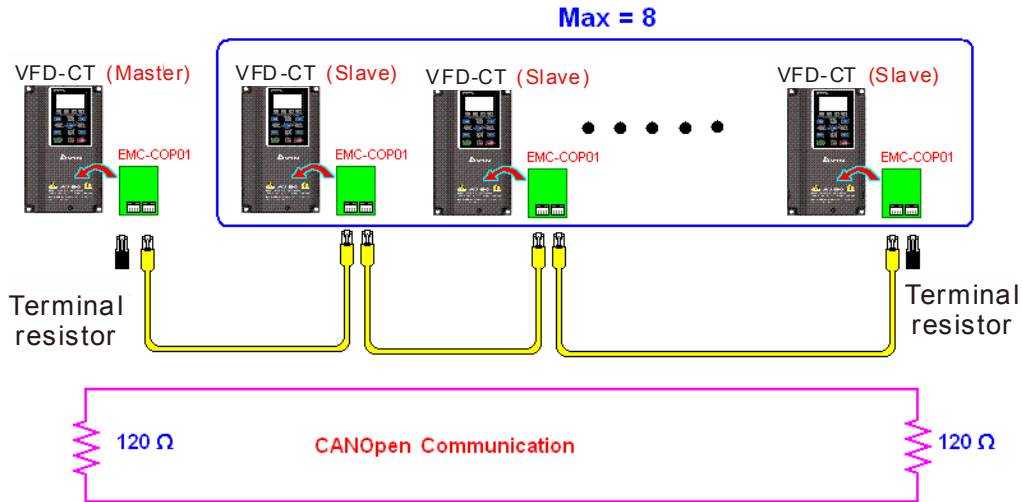

Step 7: Initiate control

After a program has been written and downloaded, switch the PLC mode to Run. Merely turn power to master and slave stations off and then on again.

Refer to CANMasterTest 1 vs. 2 driver.dvp

Example

CT2000 driver one-to-two control

Step 1: Activating CANOpen Master functions

- ☑ Parameter 09-45=1 (initiates Master functions); restart power after completing setting, the status bar on the KPC-CC01 digital keypad will display "CAN Master".
- ☑ Parameter 00-02=6 reset PLC (please note that this action will reset the program and PLC registers to the default values)
- ☑ Turn power off and on again.
- ☑ **Use the KPC-CC01 digital keypad to set the PLC control mode as "PLC Stop"** (if the KPC-CE01 digital keypad is used, set as "PLC 2"; if a newly-introduced driver is used, the blank internal PLC program will cause a PLFF warning code to be issued).

Step 2: Master memory correspondences

- ☑ Enable WPL
- ☑ Use keypad set PLC mode as Stop (PLC 2)
- ☑ WPL read D1070 to D1099 D2000 to D2799
- ☑ Set D2000=10 D2100=11

- ☑ Set D2100 2200 2300 2400 2500 2600 2700=0
- ☑ Download D2000 to D2799 settings

Step 3: Set the master's communications station number and communications speed

- ☑ When setting the master's station number (parameter 09-46, default is set as 100), make sure not to use the same number as a slave station.
- ☑ Set the CANopen communications speed as 1M (parameter 09-37=0); regardless of whether the driver is defined as a master or slave station, the communications speed is set via this parameter.

Step 4: Write program code

Real-time access: Can directly read/write to or from the corresponding D area.

Non real-time access:

Read command: Use the CANRX command for reading. M1066 will be 1 when reading is complete; M1067 will be 1 if reading is successful, and M1067 will be 0 if an error has occurred.

Write command: Use the CANTX command for writing. M1066 will be 1 when writing is complete; M1067 will be 1 if writing is successful, and M1067 will be 0 if an error has occurred.

Refresh command: Use CANFLS command to refresh (if there are RW attributes, the master will write to the slave station; if there are RO attributes, the slave station will return the read values to the master); M1066 will be 1 if refresh has been completed; M1067 will be 1 if refresh is successful, and M1067 will be 0 if an error has occurred.

NOTE

When using CANRX, CANTX or CANFLS, internal implementation commands will wait until M1066 is completed before executing the next CANRX, CANTX or CANFLS.

Afterwards, download program to the driver (Please note that the PLC's default communications format is ASCII 7N2 9600, and the station number is 2. The WPL must therefore be modified, and the WPL setting pathway is **settings > communications settings**)

Step 5: Set the slave stations' station numbers and communications speed

- | | |
|--|-----------------------|
| Slave station no. 1: 09-37 = 0(Speed 1M) | 09-36=10(Node ID 10) |
| Slave station no. 2: 09-37 = 0(Speed 1M) | 09-36=10(Node ID 11) |

Step 6: Connect hardware wiring

When performing wiring, note the head and tail terminal resistance; connection methods are as follows:

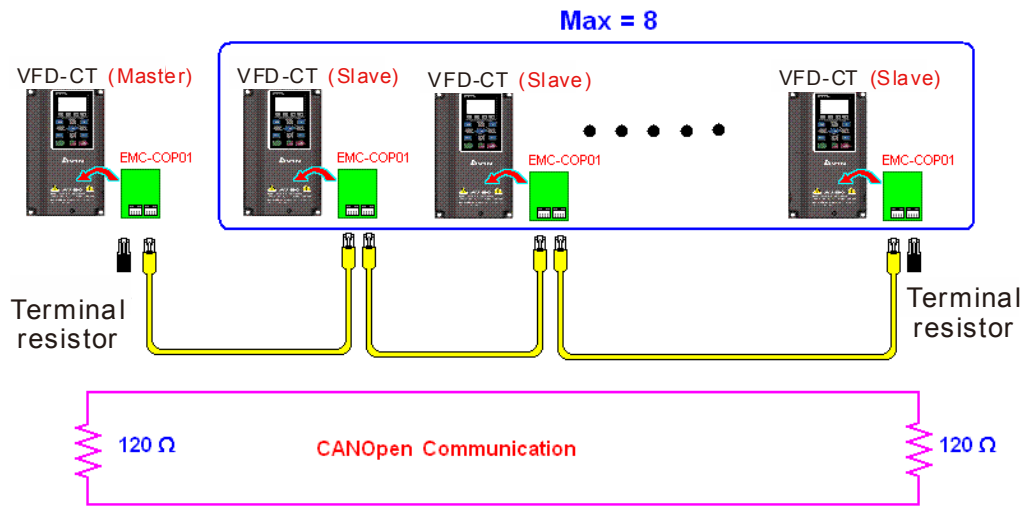

Step 7: Initiate control

After a program has been written and downloaded, switch the PLC mode to Run. Merely turn power to master and slave stations off and then on again.

Refer to CANMasterTest 1 vs. 2 driver.dvp

16-9 Explanation of various PLC mode controls (speed, torque, homing, and position)

The torque mode and position mode are based on FOC vector control and speed mode also supports FOC vector control. Control therefore cannot be performed successfully unless you study motor parameters ahead of time for the torque mode and position mode, and the speed mode based on FOC.

In addition, motors are classified as two types: IM and PM. You therefore need to study IM motor parameters. For PM motors, after completing motor parameter study, you must also complete study of motor origin angle of deviation. Please refer to parameters 12-58 Pr. 05-00 detailed explanation.

※ If a PM motor belongs to Delta's ECMA series, motor parameters can be directly input from data in the servo motor catalog, and parameter study will not be needed.

Control methods and settings are explained as follows:

Speed control:

Register table for speed mode:

Control special M

Special M	Description of Function	Attributes
M1025	Driver frequency = set frequency (ON)/driver frequency =0 (OFF)	RW
M1026	Driver operating direction FWD(OFF)/REV(ON)	RW
M1040	Hardware power (Servo On)	RW
M1042	Quick stop	RW
M1044	Pause (Halt)	RW
M1052	Lock frequency (lock, frequency locked at the current operating frequency)	RW

Status special M

Special M	Description of Function	Attributes
M1015	Frequency attained (when used together with M1025)	RO
M1056	Servo On Ready	RO
M1058	On Quick Stopping	RO

Control special D

Special D	Description of Function	Attributes
D1060	Mode setting (speed mode is 0)	RW

Status special D

Special D	Description of Function	Attributes
D1037	Converter output frequency (0.00~600.00)	RO
D1050	Actual operating mode (speed mode is 0)	RO

Speed mode control commands:

FREQ(P)	S1	S2	S3
	Target speed	The first acceleration time setting	The first deceleration time setting

Example of speed mode control:

Before performing speed control, if the FOC (magnetic field orientation) control method is used, setting of electromechanical parameters must first be completed.

1. Setting D1060 = 0 will shift the converter to the speed mode (default).
2. Use the FREQ command to control frequency, acceleration time, and deceleration time.
3. Set M1040 = 1, the driver will now be excited, but the frequency will be 0.
4. Set M1025 = 1, the driver frequency command will now jump to the frequency designated by FREQ, and acceleration/deceleration will be controlled on the basis of the acceleration time and deceleration time specified by FREQ.
5. M1052 can be used to lock the current operating frequency.
6. M1044 can be used to temporarily pause operation, and the deceleration method will comply with deceleration settings.
7. M1042 can be used to perform quick stop, and deceleration will be as quick as possible without giving rise to an error. (There may still be a jump error if the load is too large.)
8. Control user rights: M1040(Servo ON) > M1042(Quick Stop) > M1044(Halt) > M1052(LOCK)

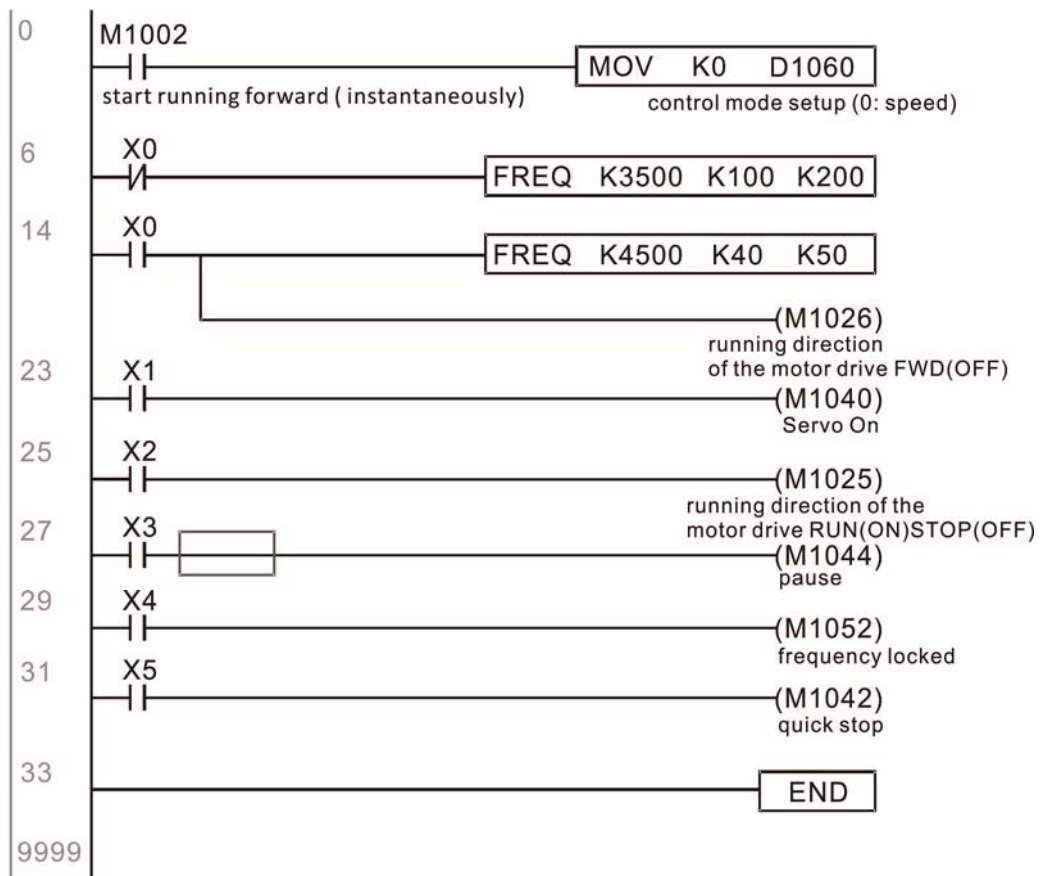

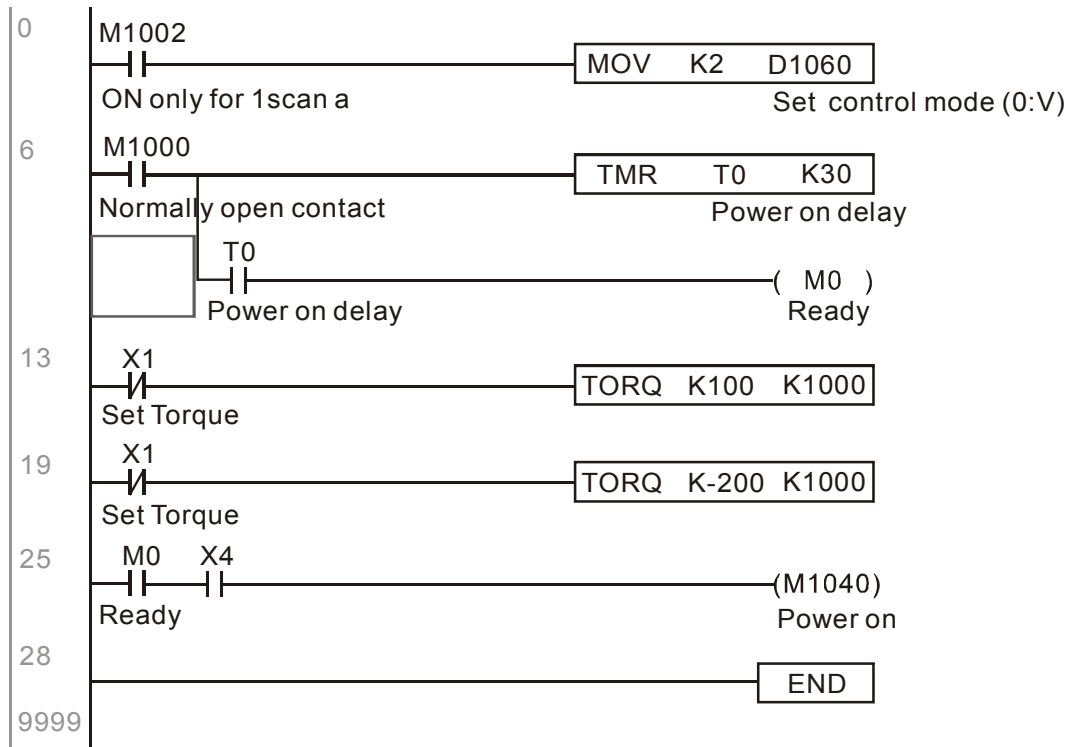

Homing control/position control:

Register table in homing mode/position mode:

Control special M

Special M	Description of Function	Attributes
M1040	Servo On	RW
M1048	Move to new position, must use control mode as position mode (D1060 = 1) and M1040 = 1	RW
M1050	Absolute position/relative position (0: relative/1: absolute)	RW
M1055	Search for origin (home start), must use control mode as position mode (D1060 = 3) and M1040 = 1	RW

Status special M

Special M	Description of Function	Attributes
M1064	Target reached	RO
M1070	Return home complete	RO
M1071	Homing error	RO

Control special D

Special D	Description of Function	Attributes
D1060	Operating mode setting (position mode is 1, homing mode is 3)	RW

Status special D

Special D	Description of Function	Attributes
D1050	Actual operating mode (speed mode is 0)	RO
D1051	Actual position (Low word)	RO
D1052	Actual position (High word)	RO

※ D1051 and D1052 must be combined to give the actual location, and it has a serial number.

Position mode control commands:

DPOS(P) S1
 Target (with numbers)

Example of homing mode/position mode control:

First complete setting of electromechanical parameters connected with position before implementing homing control or position control.

1. Set 00-40 to select the homing method and the corresponding limit sensors and origin. (Setting the MI function gives a reverse rotation limit of 44, a forward rotation limit of 45, and an origin proximity of 46. Because the CT2000 current only supports a Z-phase origin, the encoder card must provide Z-phase.)
2. Set D1060 = 3 to change the converter to the homing mode.

3. Set M1040 = 1
 In the VF/SVC/VFPG mode, will enter the STANDBY mode (01-34 can be used to access the STANDBY mode's action options).
 In the FOC+PG mode, zero speed holding will occur
4. Set M1055 = 1, and the driver will now start to search for the origin.
5. When homing is complete, M1070 will change to ON. If you now set D1060 = 1, the control mode will switch to position mode (please note that M1040 will not change to off; this mechanical origin move).
6. The DPOS command can now be used to designate the driver's target location. M1050 or parameter 00-12 can be used to set a change in absolute or relative position.
7. Implement M1048 Pulse ON once (must be more than 1 ms in duration), and the converter will begin to move toward the target (M1040 must be 1 to be effective). The current position can be obtained from D1051 and D1052.

Part 1: The initialization mode is defined as the "homing" mode from the beginning (set D1060 = 3). X2 is used to implement converter excitation.

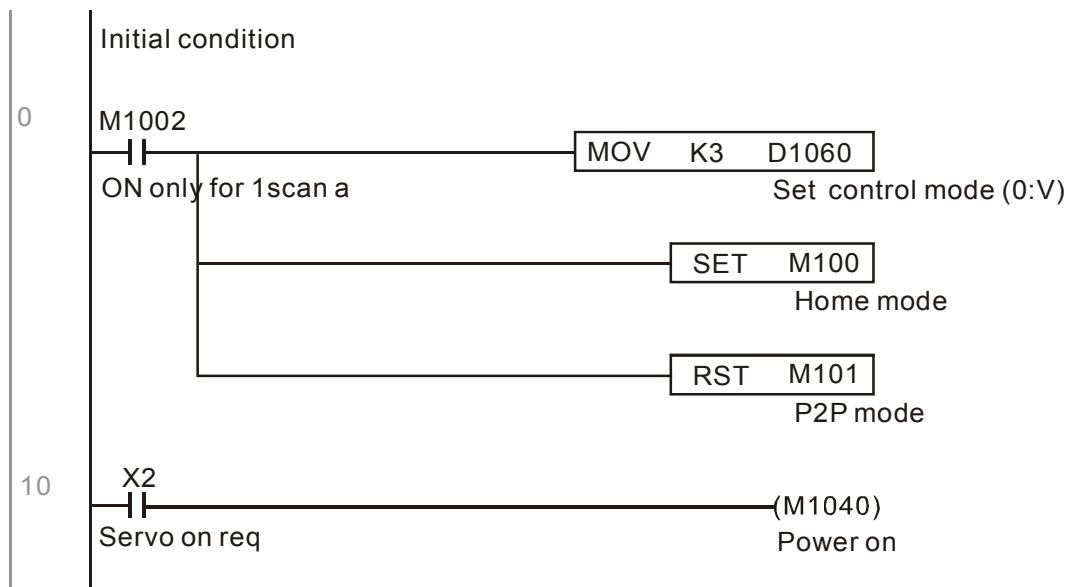

Part 2—homing: Use X3 to trigger homing action; will automatically switch to position mode after completion.

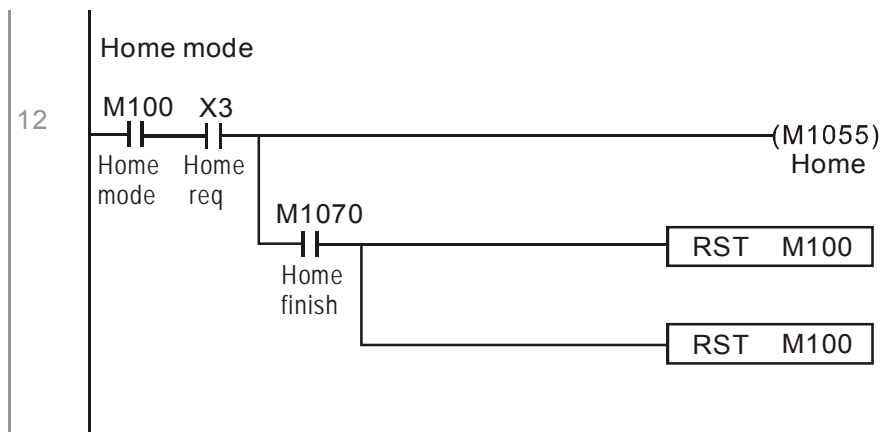

Part 3—point-to-point movement: Switch to position mode (set D1060 = 1), and move back and forth between position points. (+300000 ~ -300000)

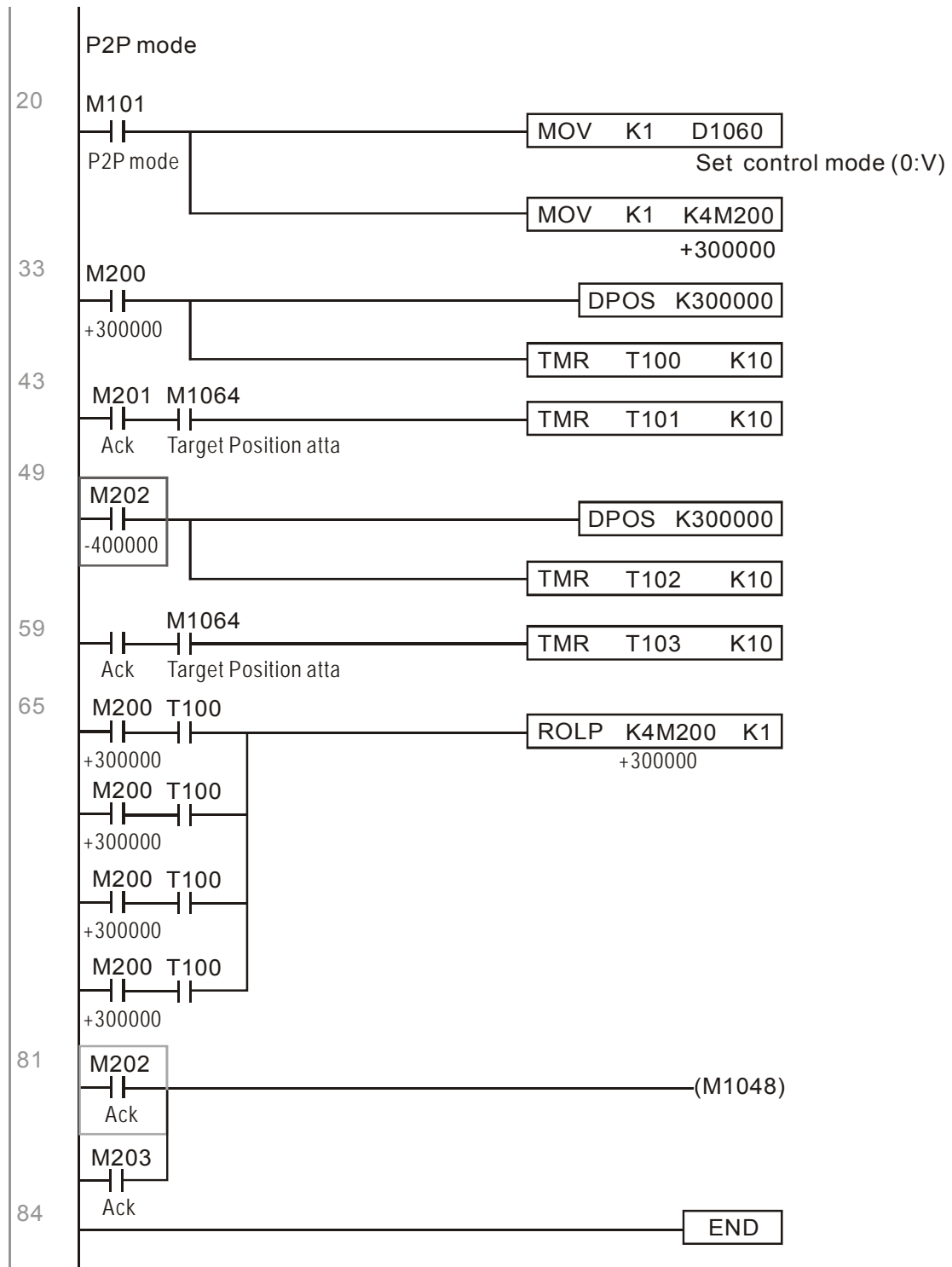

※ If homing is not needed in an application, the first and second parts can be skipped. However, the M1040 condition from Part 1 must be included, and the writing method in Part 1 involve the use of X2 to achieve direct access. In addition, when M101 is used at the beginning of Part 3 to set the control mode, it can be rewritten as M1002, which will put the PLC immediately into the position mode when it starts running.

16-10 Internal communications main node control

The protocol has been developed in order to facilitate the use of 485 instead of CANopen in certain application situations. The 485 protocol offers similar real-time characteristics as CANopen; this protocol can only be used on the C2000 and CT2000 devices. The maximum number of slave devices is 8.

Internal communications have a master-slave structure. The initiation method is very simple:

Slave device:

Set parameter 09-31 = -1 to -8 in order to access 8 nodes, and set parameter 00-20 = 1 to define the control source as 485 and access the reference sources that must be controlled, namely speed command (00-21 = 2), torque command (11-33 = 1), and position command (11-40=2). This will complete slave device settings. (PLC functions do not need to be activated)

System

Setting the master is even simpler; it is only necessary to set parameter 09-31 = -10, and enable the PLC.

Hardware wiring: The master and slave stations are connected via the 485 serial port. The CT2000 provide two types of 485 serial port interfaces, see the figure below: (please refer to 06 Control terminals concerning detailed terminal connections)

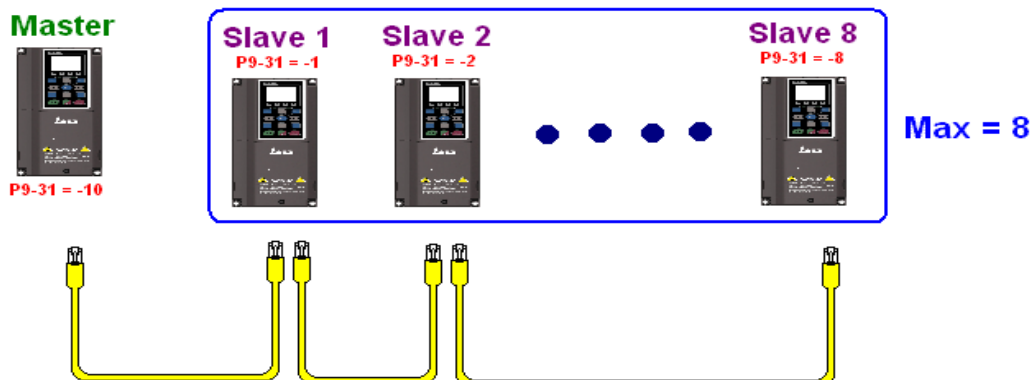
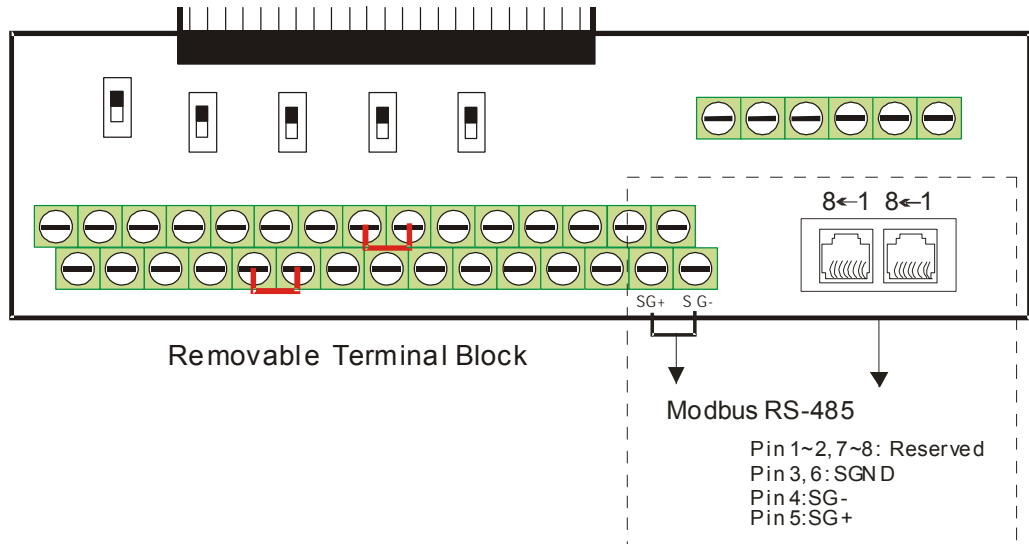

Master programming: In a program, D1110 can be used to define a slave station to be controlled (1-8, if set as 0, can jump between 8 stations). Afterwards, M1035 is set as 1, and the memory positions of the master and slave stations will correspond. At this time, it is only necessary to send commands to the correlation slave station address to control that station. The following is a register table connected with internal communications:

Control special M

Special M	Description of Function	Attributes
M1035	Initiates internal communications control	RW

Control special D

Special D	Description of Function	Attributes
D1110	Internal node communications number 1-8 (set the station number of the slave station to be controlled)	RW

Special D	Description of Function							Attributes
	Definition	bit	User rights	Speed mode	Location mode	Torque mode	Homing mode	
D1120 + 10*N	Internal node N control command	0	4	Command functions	-	-	Homing Origin	RW
		1	4	Reverse rotation requirements	Immediate change	-	-	
		2	4	-	-	-	-	
		3	3	Temporary pause	Temporary pause	-	-	
		4	4	Frequency locking	-	-	Temporary pause	
		5	4	JOG	-	-	-	
		6	2	Quick Stop	Quick Stop	Quick Stop	Quick Stop	
		7	1	Servo ON	Servo ON	Servo ON	Servo ON	
		11~8	4	Speed interval switching	Speed interval switching	-	-	
		13~12	4	Deceleration time change	-	-	-	
14	4	Enable Bit 13 ~ 8	Enable Bit 13 ~ 8	-	-			
15	4	Clear error code	Clear error code	Clear error code	Clear error code			
D1121 + 10*N	Internal node N control mode			0	1	2	3	RW
D1122 + 10*N	Internal node N reference command L			Speed command (no number)	Position command (with numbers)	Torque command (with numbers)	-	RW
D1123 + 10*N	Internal node N reference command H			-		Speed limit	-	RW

※ N = 0 ~ 7

Status special D

Special D	Description of Function	Attributes
D1115	Internal node synchronizing cycle (ms)	RO
D1116	Internal node error (bit0 = slave device 1, bit1 = slave device 2, ... bit7 = slave device 8)	RO
D1117	Internal node online correspondence (bit0 = slave device 1, bit1 = slave device 2, ... bit7 = slave device 8)	RO

Special D	Description of Function					Attributes
	bit	Speed mode	Location mode	Torque mode	Homing mode	
D1126 + 10*N	0	Frequency command arrival	Position command attained	Torque command attained	Zero command completed	RO
	1	Clockwise	Clockwise	Clockwise	Clockwise	
		Counterclockwise:	Counterclockwise:	Counterclockwise:	Counterclockwise:	
	2	Warning	Warning	Warning	Warning	
	3	Error	Error	Error	Error	
	5	JOG				
	6	Quick Stop	Quick Stop	Quick Stop	Quick Stop	
7	Servo ON	Servo ON	Servo ON	Servo ON		
D1127 + 10*N		Actual frequency	Actual position (with numbers)	Actual torque (with numbers)	-	RO
D1128 + 10*N		-		-	-	

※ N = 0 ~ 7

Example: Assume it is desired to control slave station 1 operation at frequencies of 30.00Hz and 60.00 Hz, status, and online node correspondences:

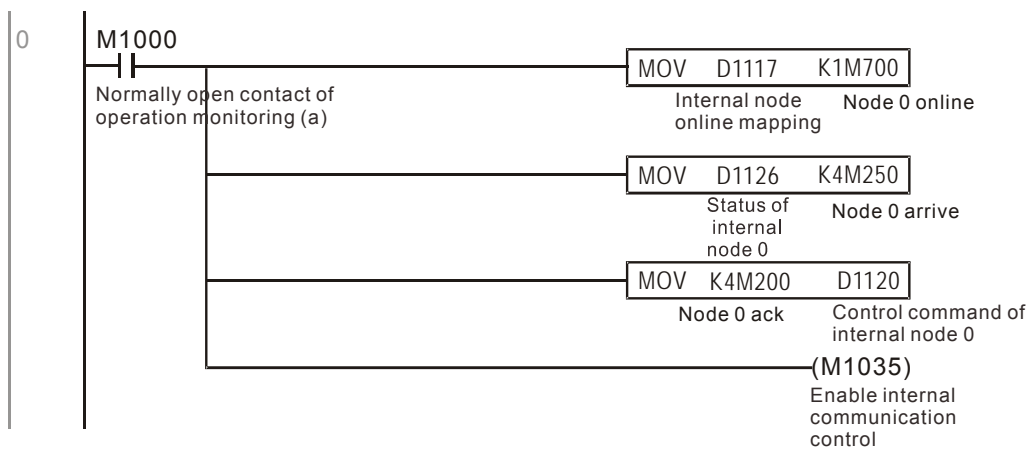

When it is judged that slave station 1 is online, delay 3 sec. and begin control

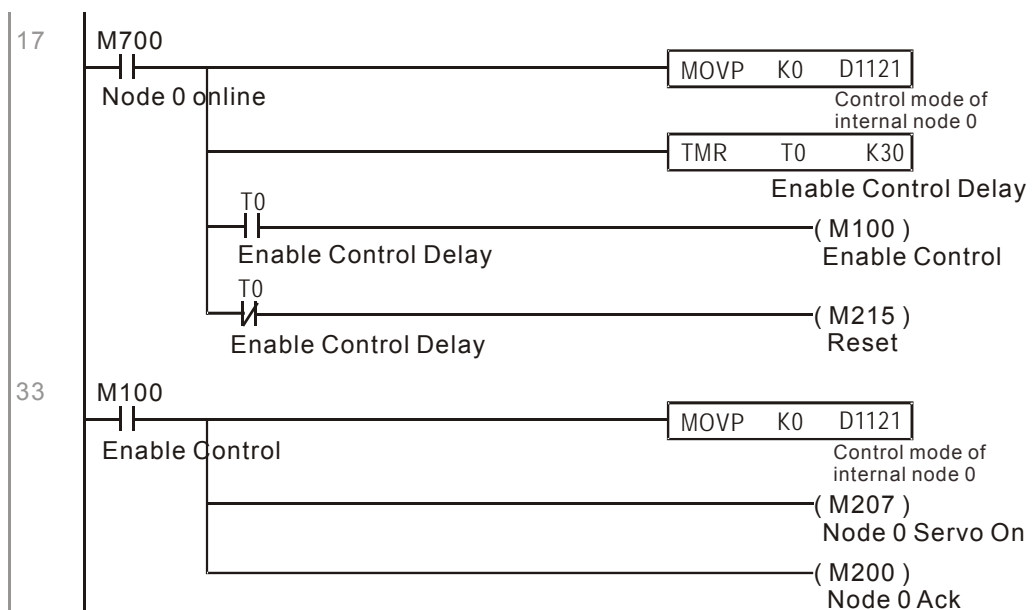

It is required slave station 1 maintain forward rotation at 30.00Hz for 1 sec., and maintain reverse rotation at 60.00 Hz for 1 sec., and repeat this cycle continuously.

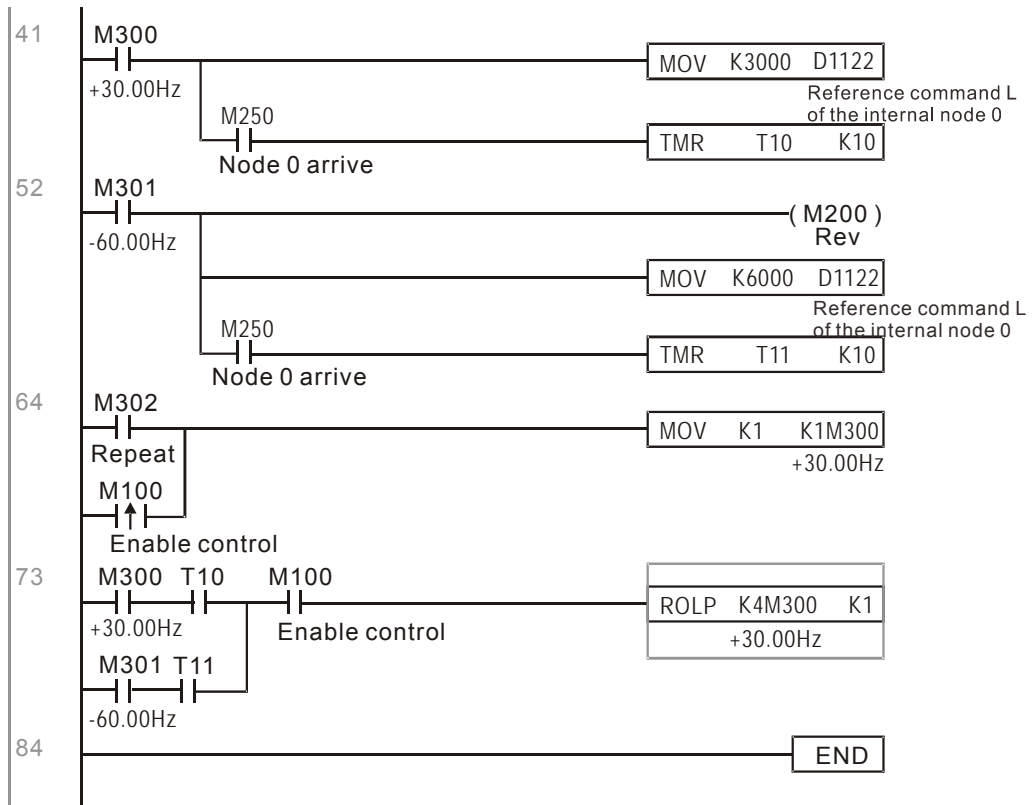

16-11 Count function using MI8

16-11-1 High-speed count function

The CT2000's MI8 supports one-way pulse counting, and the maximum speed is 100K. The starting method is very simple, and only requires setting M1038 to begin counting. The 32 bit count value is stored on D1054 and D1055 in non-numerical form. M1039 can reset the count value to 0.

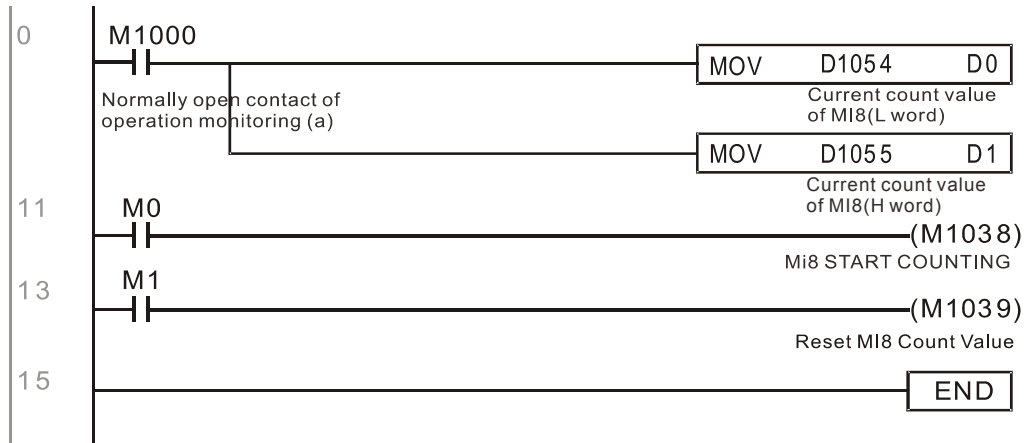

※ When the PLC program defines MI8 for use as a high-speed counter, and also for use in PLC procedures, it must be written to M1038 or M1039, and the original MI8 functions will be disabled.

16-11-2 Frequency calculation function

Apart from high-speed counting, the CT2000's MI8 can also convert a received pulse to frequency. The following figure shows that there is no conflict between frequency conversion and count calculations, which can be performed simultaneously.

PLC speed calculation formula

D1057 Speed

D1058 Interval between calculations

D1059 Decimal places

Assuming that there are 5 input pulses each second, (see figure below) we set D1058=1000ms=1.0 sec. as the calculation interval. This enables five pulses to be sent to the converter each second.



Assuming that each 5 pulses correspond to 1Hz, we set D1057=5.

Assuming that we wish to display numbers to two decimal places, we set D1059=2, which is also 1.00Hz. The numerical value displayed at D1056 is 100. For simplicity, the D1059 conversion formula can be expressed as in the following table:

$$D1058 = \frac{\text{Pulses per second}}{D1057} \times \frac{1000}{D1057} \times 10^{D1059}$$

16-12 Modbus remote IO control applications (use MODRW)

The CT2000's internal PLC supports 485 read/write functions, which can be realized using the MODRW command. However, the 485 serial port must be defined as available for the PLC's 485 use before writing a program, and the parameter 09-31 must be set as -12. After completing settings, the standard functions defined by 485 can be used to implement read/write commands at other stations. Communications speed is defined by parameter 09-01, the communications format is defined by parameter 09-04, and the PLC's current station number is defined by parameter 09-35. The CT2000 currently supports the functions

read coil (0x01), read input (0x02), read register (0x03), write to single register (0x06), write to several coils (0x0F), and write to several registers (0x10). Explanations and the usage of these functions are provided as follows:

MODRW command					General meaning	Slave device is Delta's PLC meaning	Slave device is Delta's converter meaning
S1	S2	S3	S4	S5			
Node ID	Command	Address	Return: D area	Length :			
K3	H01	H500	D0	K18	Read coil (Bit)	Read 18 bits of data corresponding to slave station 3 PLC Y0 to Y21. This data is stored by bit 0 to 15 of the this station's D0 and bit 0 to bit 3 of D1.	Does not support this function
K3	H02	H400	D10	K10	Read input (Bit)	Read 10 bits of data corresponding to slave station 3 PLC X0 to X11. This data is stored by bit 0 to 9 of this station's D10.	Does not support this function
K3	H03	H600	D20	K3	Read register (word)	Read 3 words of data corresponding to slave station 3 PLC T0 to T2. This data is stored by D20 to D22.	Read 3 words of data corresponding to slave station 3 converter parameters 06-00 to 06-02. This data is stored by D20 to D22
K3	H06	H610	D30	XX	Write to single register (word)	Write slave station 3 PLC's T16 to this station's D30 value	Write slave station 3 converter 06 to 16 parameter to this station's D30 value
K3	H0F	H509	D40	K10	Write to multiple coils (Bit)	Write slave station 3 PLC's Y11 to Y22 to bit 0 to 9 of D40.	Does not support this function
K3	H10	H602	D50	K4	Write to multiple registers (word)	Write slave station 3 PLC's T2 to T5 to D50 to D53	Write slave station 3 converter 06-02 to 06-05 parameters to this station's D50 to D53

※ XX indicates doesn't matter

After implementing MODRW, the status will be displayed in M1077 (485 read/write complete), M1078 (485 read/write error), and M1079 (485 read/write time out). M1077 is defined so as to immediately revert to 0 after the MODRW command has been implemented. However, any of three situations—a report of no error, a data error report, or time out with no report—will cause the status of M1077 to change to On.

Example program: Testing of various functions

At the start, will cause the transmitted time sequence to switch to the first data unit.

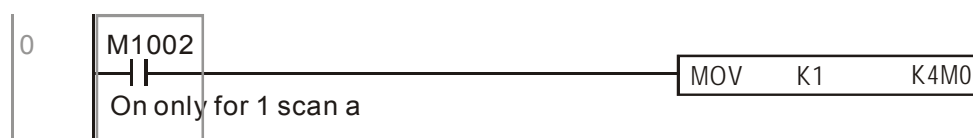

When the reported message indicates no error, it will switch to the next transmitted command



If time out occurs or an error is reported, the M1077 will change to On. At this time, after a delay of 30 scanning cycles, it will re-issue the original command once

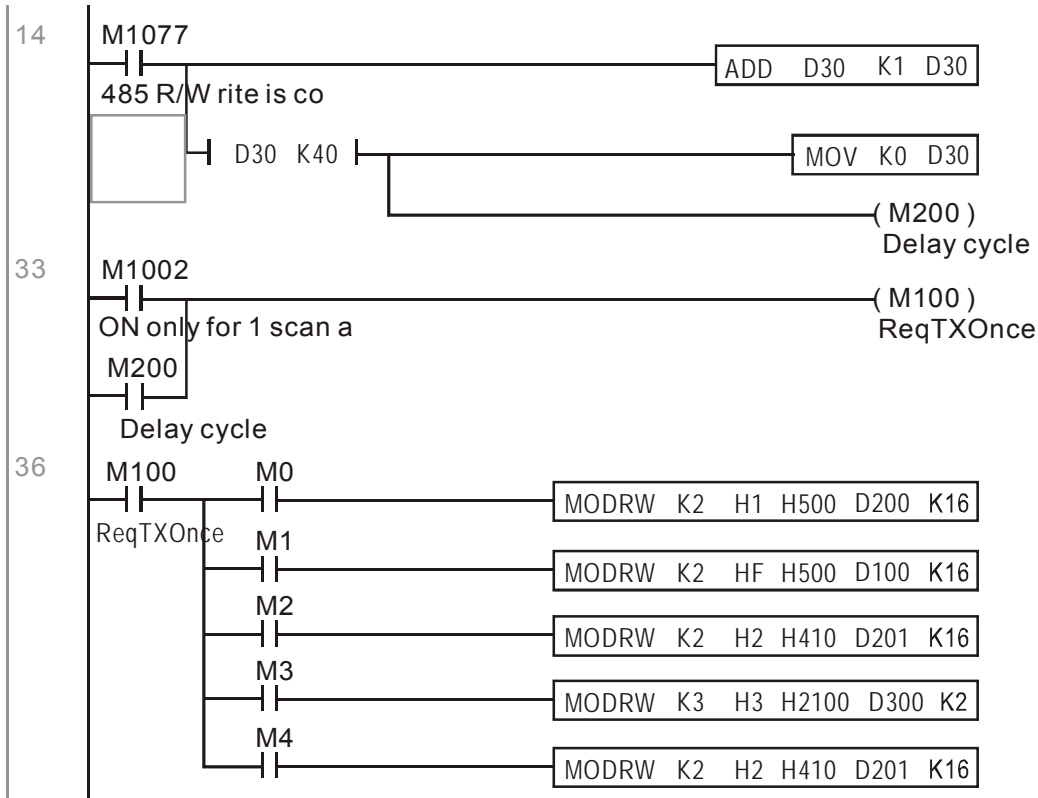

It will repeat after sending all commands

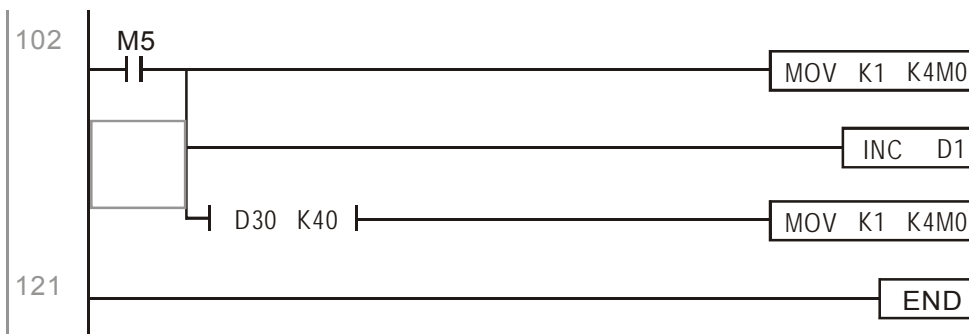

Practical applications:

Actual use to control the RTU-485 module.

Step 1: Set the communications format. Assume that the communications format is 115200, 8,N,2, RTU

CT2000 : The default PLC station number is set as 2 (09-35)

09-31=-12(COM1 is controlled by the PLC), 09-01=115.2(The communications speed is 115200)

09-04=13(The format is 8,N,2, RTU)

RTU485: The station number = 8 (give example)

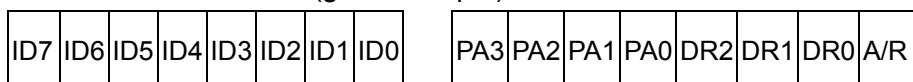

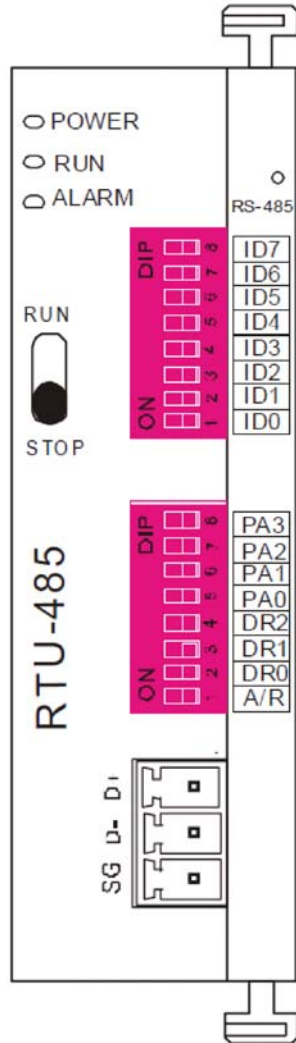
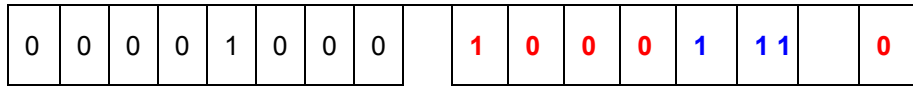

Communication station #:
ID0~ ID7 are defined as $2^0, 2^1, 2^2 \dots 2^6, 2^7$

Communication protocol

PA3	PA2	PA1	PA0	A/R	Communication Protocol
OFF	OFF	OFF	OFF	ON	7,E,1 · ASCII
OFF	OFF	OFF	ON	ON	7,O,1 · ASCII
OFF	OFF	ON	OFF	ON	7,E,2 · ASCII
OFF	OFF	ON	ON	ON	7,O,2 · ASCII
OFF	ON	OFF	OFF	ON	7,N,2 · ASCII
OFF	ON	OFF	ON	ON	8,E,1 · ASCII
OFF	ON	ON	OFF	ON	8,O,1 · ASCII
OFF	ON	ON	ON	ON	8,N,1 · ASCII
ON	OFF	OFF	OFF	ON	8,N,2 · ASCII
OFF	ON	OFF	ON	OFF	8,E,1 · RTU
OFF	ON	ON	OFF	OFF	8,O,1 · RTU
OFF	ON	ON	ON	OFF	8,N,1 · RTU
ON	OFF	OFF	OFF	OFF	8,N,2 · RTU

DR2	DR1	DR0	Communication Speed
OFF	OFF	OFF	1,200 bps
OFF	OFF	ON	2,400 bps
OFF	ON	OFF	4,800 bps
OFF	ON	ON	9,600 bps
ON	OFF	OFF	19,200 bps
ON	OFF	ON	38,400 bps
ON	ON	OFF	57,600 bps
ON	ON	ON	115,200 bps

Step 2: Install control equipment. We sequentially connect a DVP16-SP (8 IN 8 OUT), DVP-04AD (4 channels AD), DVP02DA (2 channels DA), and DVP-08ST (8 switches) to the RTU485.

The following corresponding locations can be obtained from the RTU485's configuration definitions:

Module	Terminals	485 Address
DVP16-SP	X0 ~ X7	0400H ~ 0407H
	Y0 ~ Y7	0500H ~ 0507H
DVP-04AD	AD0 ~ AD3	1600H ~ 1603H
DVP02DA	DA0 ~ DA1	1640H ~ 1641H
DVP-08ST	Switch 0 ~ 7	0408H ~ 040FH

Step 3: Physical configuration

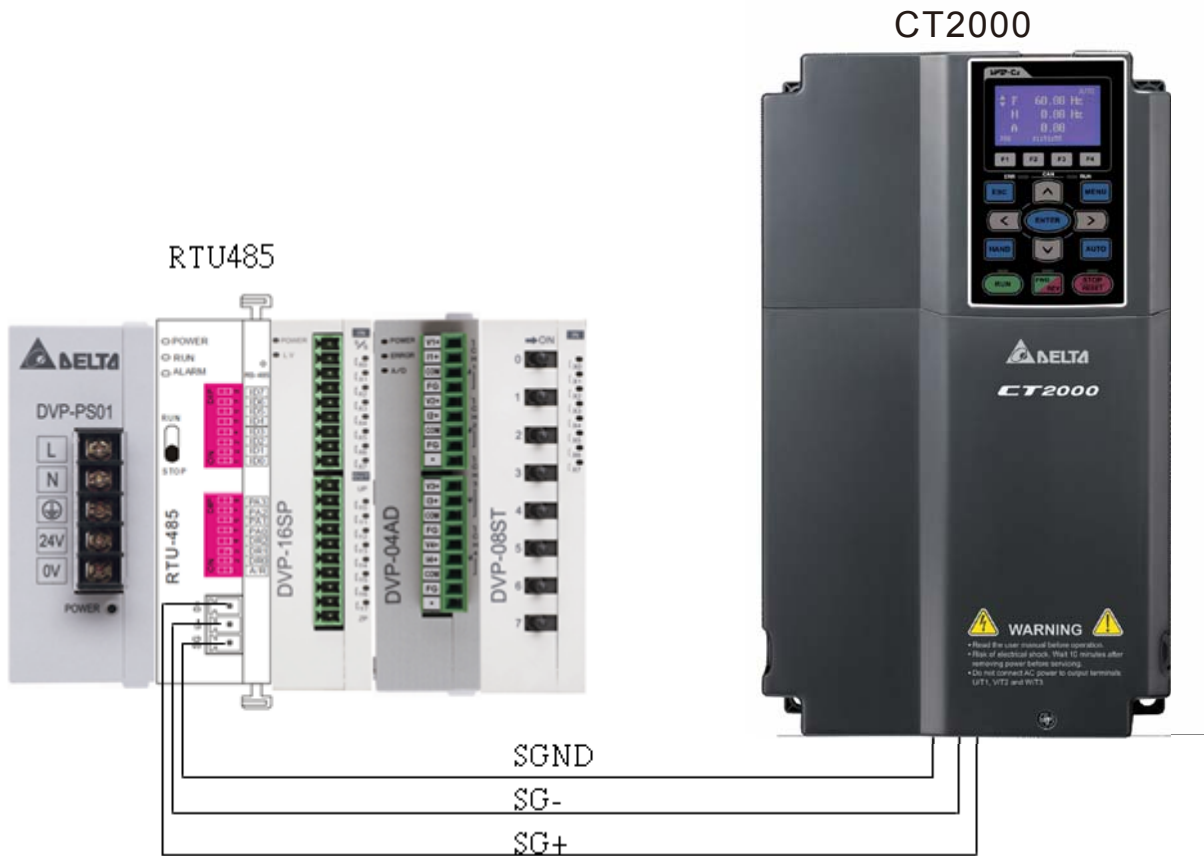

Step 4: Write to PLC program

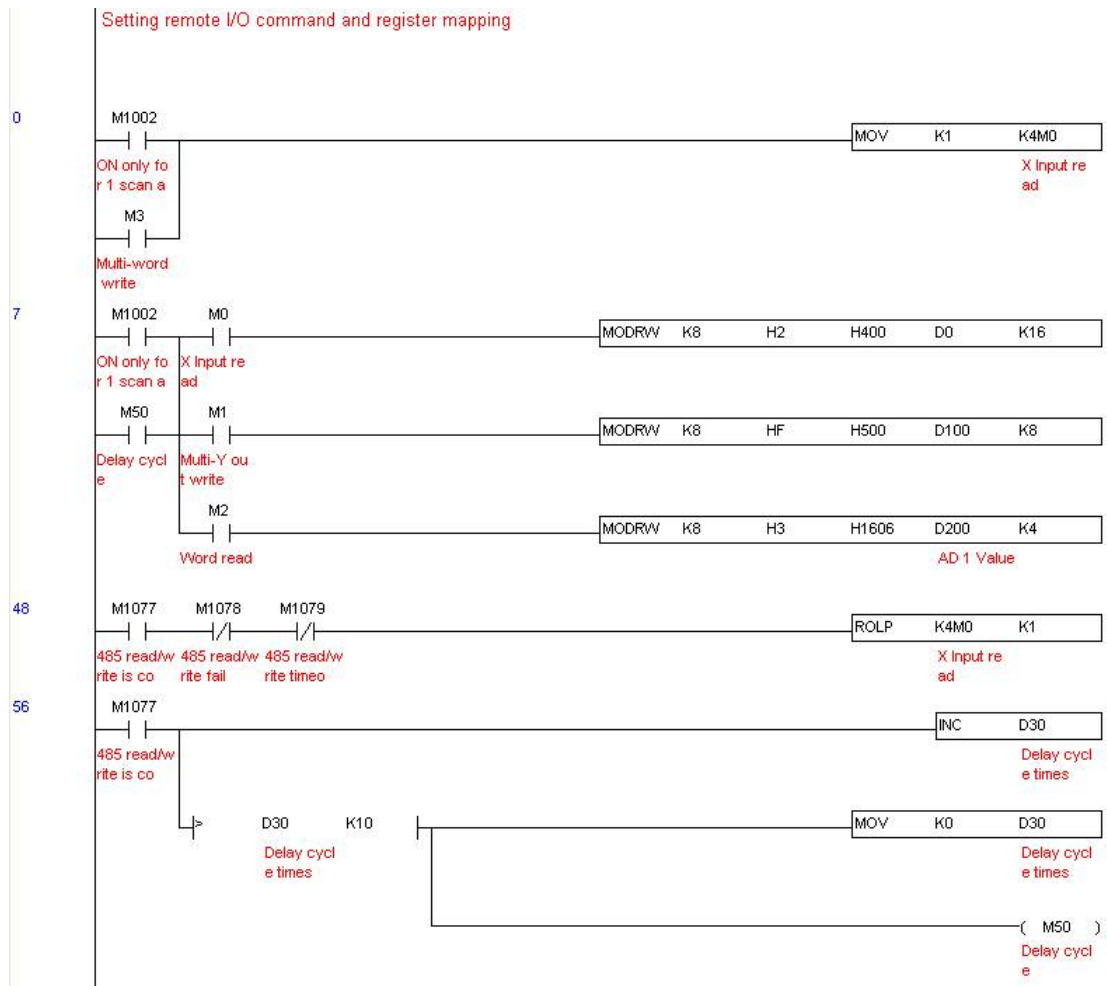

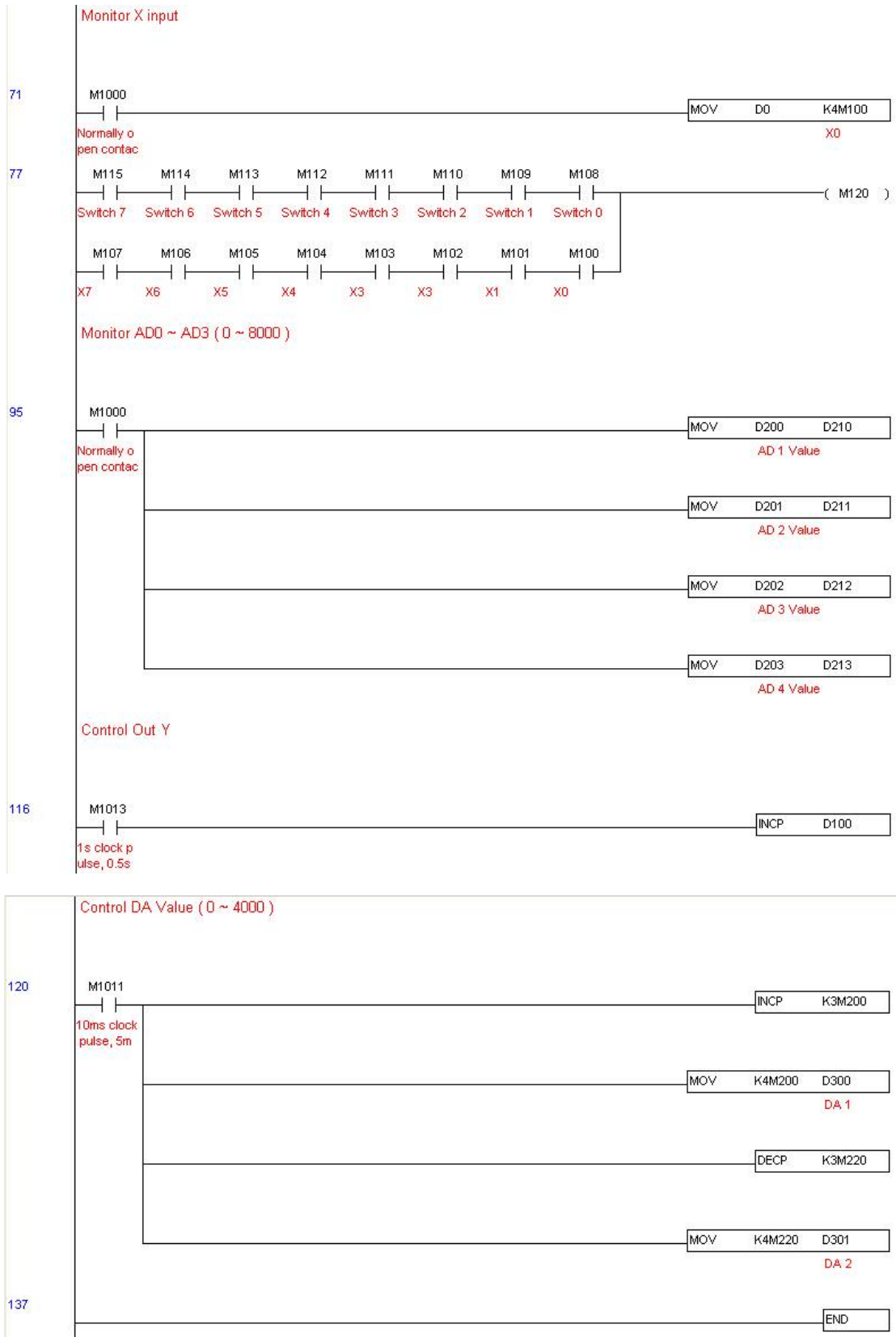

Step 5: Actual testing situation:

I/O testing: When the switch is activated, it can be discovered that the display corresponds to M115 - M108. Furthermore, it can be seen that one output point light is added every 1 sec. (the display uses a binary format)

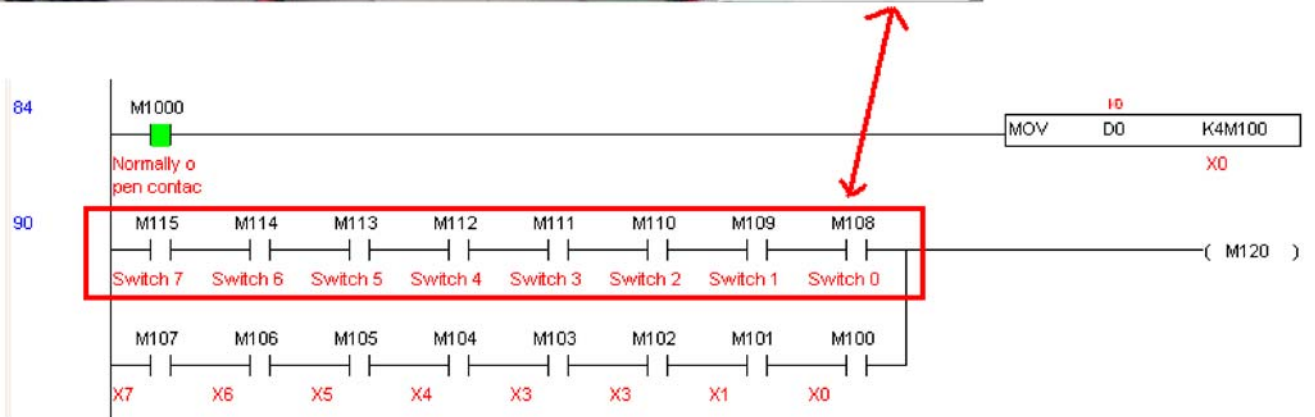
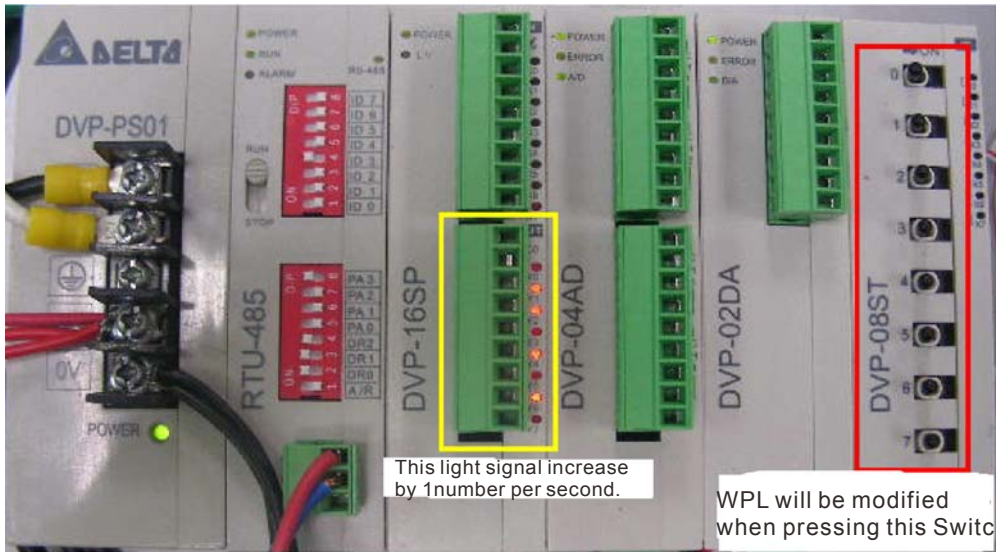

AD DA testing: It can be discovered that D200 and D201 are roughly twice the D300, and continue to increase progressively. For their part, the D202 and D203 are roughly twice the D301, and continue to decrease progressively.

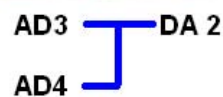
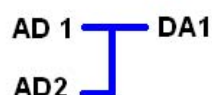
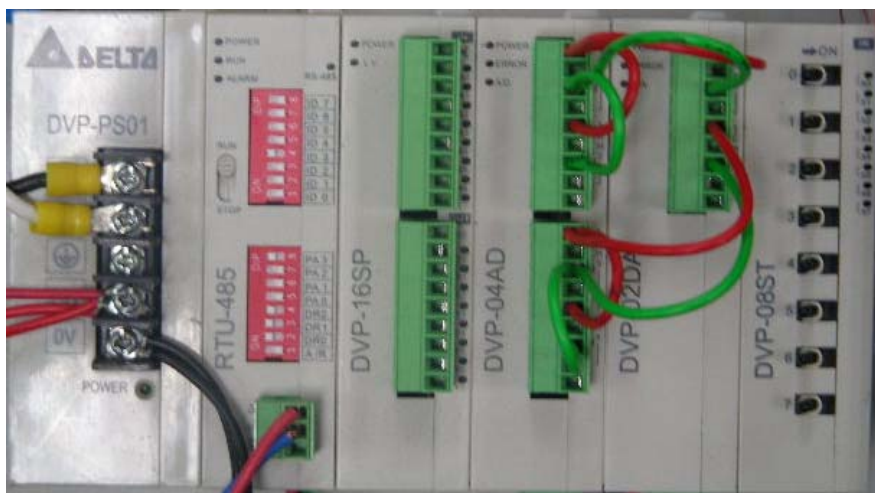

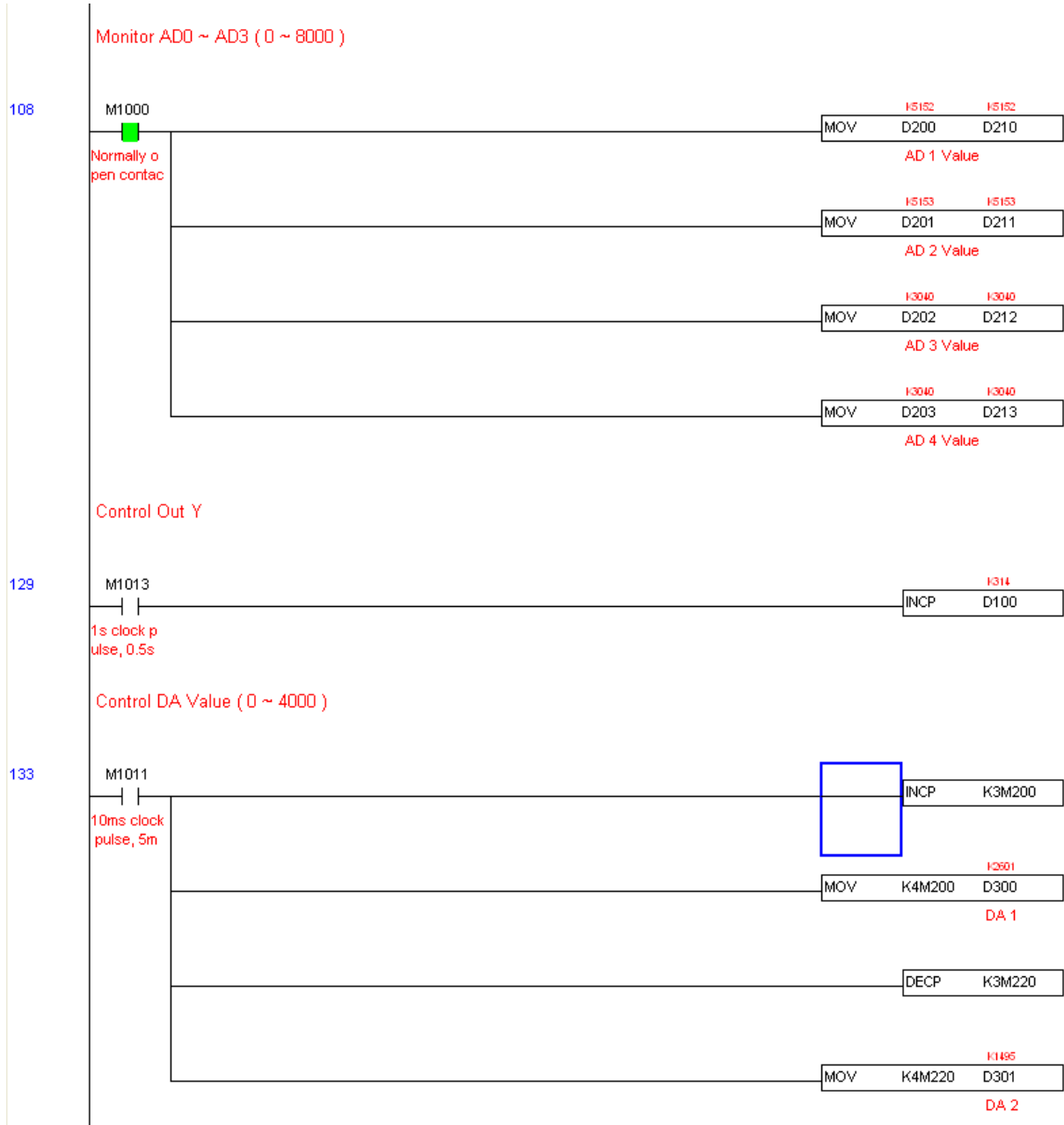

16-13 Calendar functions

The CT2000's internal PLC includes calendar functions, but these may only be used when a keypad (KPC-CC01) is connected, and otherwise cannot be used. Currently-supported commands include TCMP (comparison of calendar data), TZCP (calendar data range comparison), TADD (calendar data addition), TSUB (calendar data subtraction), and TRD (calendar reading). Please refer to the explanation of relevant commands and functions for the usage of these commands.

In real applications, the internal PLC can judge whether calendar function have been activated; if they have been activated, calendar warning codes may be displayed in some situations. The basis for whether a calendar function has been activated is whether the program has written the calendar time (D1063 to D1069) in connection with the foregoing calendar commands or programs.

The calendar's time display is currently assigned to D1063 to D1069, and is defined as follows:

Special D	Item	Content	Attributes
D1063	Year (Western)	20xx (2000~2099)	RO
D1064	Weeks	1~7	RO
D1065	Month	1~12	RO
D1066	Day	1~31	RO
D1067	Hour	0~23	RO
D1068	Minute	0~59	RO
D1069	Second	0~59	RO

Calendar-related special M items are defined as follows:

Special D	Item	Attributes
M1068	Calendar time error	RO
M1076	Calendar time error or refresh time out	RO
M1036	Ignore calendar warning	RW

*When a program writes to the commands TCMP, TZCP, TADD, or TSUB, if it is discovered that a value exceeds the reasonable range, M1026 will be 1.

*When the keypad display is PLra (RTC correction warning) or PLrt (RTC time out warning), M1076 will be ON.

*When M1036 is 1, the PLC will ignore the calendar warning.

Calendar trigger warning code is defined as follows:

Warning	Description	Reset approach	Whether it affects PLC operation
PLra	Calendar time correction	Requires power restart	Will not have any effect
PLrt	Calendar time refresh time out	Requires power restart	Will not have any effect

*When the PLC's calendar functions are operating, if the keypad is replaced with another keypad, it will jump to PLra.

*When it is discovered at startup that the keypad has not been powered for more than 7 days, or the time is wrong, PLra will be triggered.

*When it is discovered that the CT2000 has no keypad 10 sec. after startup, PLrT will be triggered.

*If the keypad is suddenly pulled out while the calendar is operating normally, and is not reconnected for more than 1 minute, PLrT will be triggered.

Practical applications:

We will perform a demo of simple applications.

We first correct the keypad time. After pressing Menu on the keypad, select the 9th time setting option. After selection, set the current time.

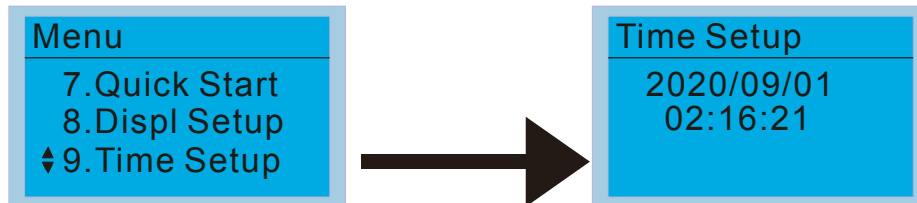

We set converter on during the period of 8:00-17:20, which allows us to write the following example

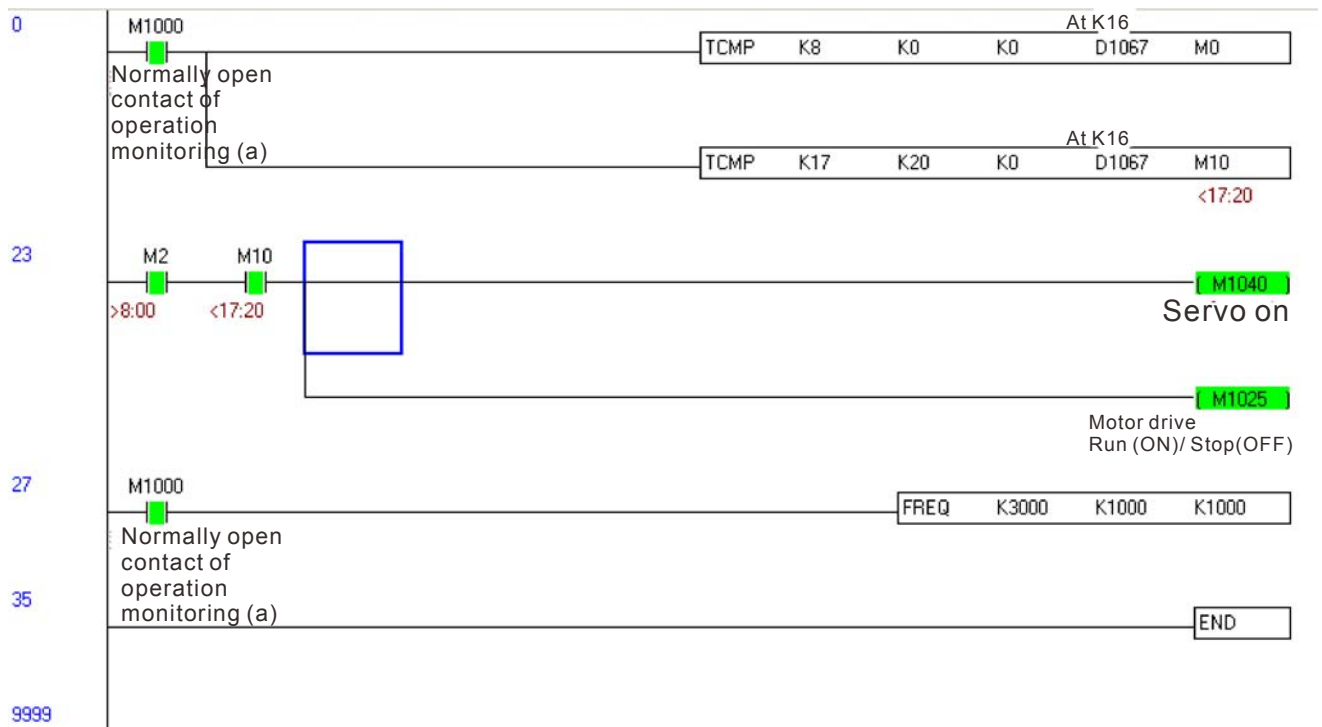

[This page intentionally left blank]

Chapter 17 How to Select the Right AC Motor Drive

17-1 Capacity formula

17-2 General Precautions

17-3 How to choose a suitable motor

The choice of the right AC motor drive for the application is very important and has great influence on its lifetime. If the capacity of AC motor drive is too large, it cannot offer complete protection to the motor and motor maybe damaged. If the capacity of AC motor drive is too small, it cannot offer the required performance and the AC motor drive maybe damaged due to overloading.

But by simply selecting the AC motor drive of the same capacity as the motor, user application requirements cannot be met completely. Therefore, a designer should consider all the conditions, including load type, load speed, load characteristic, operation method, rated output, rated speed, power and the change of load capacity. The following table lists the factors you need to consider, depending on your requirements.

Item		Related Specification			
		Speed and torque characteristics	Time ratings	Overload capacity	Starting torque
Load type	Friction load and weight load				
	Liquid (viscous) load	●			●
	Inertia load				
	Load with power transmission				
Load speed and torque characteristics	Constant torque				
	Constant output	●	●		
	Decreasing torque				
	Decreasing output				
Load characteristics	Constant load				
	Shock load	●	●	●	●
	Repetitive load				
	High starting torque				
	Low starting torque				
Continuous operation, Short-time operation			●	●	
Long-time operation at medium/low speeds					
Maximum output current (instantaneous)		●		●	
Constant output current (continuous)					
Maximum frequency, Base frequency		●			
Power supply transformer capacity or percentage impedance					
Voltage fluctuations and unbalance				●	●
Number of phases, single phase protection					
Frequency					
Mechanical friction, losses in wiring				●	●
Duty cycle modification			●		

17-1 Capacity Formulas

1. When one AC motor drive operates one motor

The starting capacity should be less than 1.5x rated capacity of AC motor drive

The starting capacity=

$$\frac{k \times N}{973 \times \eta \times \cos \varphi} \left(T_L + \frac{GD^2}{375} \times \frac{N}{t_A} \right) \leq 1.5 \times \text{the_capacity_of_AC_motor_drive(kVA)}$$

2. When one AC motor drive operates more than one motor

2.1 The starting capacity should be less than the rated capacity of AC motor drive

- Acceleration time ≤ 60 seconds

The starting capacity=

$$\frac{k \times N}{\eta \times \cos \varphi} [n_r + n_s(k_s - 1)] = P_{C1} \left[1 + \frac{n_s}{n_r} (k_s - 1) \right] \leq 1.5 \times \text{the_capacity_of_AC_motor_drive(kVA)}$$

- Acceleration time ≥ 60 seconds

The starting capacity=

$$\frac{k \times N}{\eta \times \cos \varphi} [n_r + n_s(k_s - 1)] = P_{C1} \left[1 + \frac{n_s}{n_r} (k_s - 1) \right] \leq \text{the_capacity_of_AC_motor_drive(kVA)}$$

2.2 The current should be less than the rated current of AC motor drive(A)

- Acceleration time ≤ 60 seconds

$$n_r + I_M \left[1 + \frac{n_s}{n_r} (k_s - 1) \right] \leq 1.5 \times \text{the_rated_current_of_AC_motor_drive(A)}$$

- Acceleration time ≥ 60 seconds

$$n_r + I_M \left[1 + \frac{n_s}{n_r} (k_s - 1) \right] \leq \text{the_rated_current_of_AC_motor_drive(A)}$$

2.3 When it is running continuously

- The requirement of load capacity should be less than the capacity of AC motor drive(kVA)

The requirement of load capacity=

$$\frac{k \times P_M}{\eta \times \cos \varphi} \leq \text{the_capacity_of_AC_motor_drive(kVA)}$$

- The motor capacity should be less than the capacity of AC motor drive

$$k \times \sqrt{3} \times V_M \times I_M \times 10^{-3} \leq \text{the_capacity_of_AC_motor_drive(kVA)}$$

- The current should be less than the rated current of AC motor drive(A)

$$k \times I_M \leq \text{the_rated_current_of_AC_motor_drive(A)}$$

Symbol explanation

P_M : Motor shaft output for load (kW)

η : Motor efficiency (normally, approx. 0.85)

$\cos \varphi$: Motor power factor (normally, approx. 0.75)

V_M : Motor rated voltage(V)

I_M : Motor rated current(A), for commercial power

k : Correction factor calculated from current distortion factor (1.05-1.1, depending on PWM method)

P_{C1} : Continuous motor capacity (kVA)

k_S : Starting current/rated current of motor

n_r : Number of motors in parallel

n_s : Number of simultaneously started motors

GD^2 : Total inertia (GD^2) calculated back to motor shaft (kg m^2)

T_L : Load torque

t_A : Motor acceleration time

N : Motor speed

17-2 General Precaution

Selection Note

1. When the AC Motor Drive is connected directly to a large-capacity power transformer (600kVA or above) or when a phase lead capacitor is switched, excess peak currents may occur in the power input circuit and the converter section may be damaged. To avoid this, use an AC input reactor (optional) before AC Motor Drive mains input to reduce the current and improve the input power efficiency.
2. When a special motor is used or more than one motor is driven in parallel with a single AC Motor Drive, select the AC Motor Drive current $\geq 1.25 \times$ (Sum of the motor rated currents).
3. The starting and accel./decel. characteristics of a motor are limited by the rated current and the overload protection of the AC Motor Drive. Compared to running the motor D.O.L. (Direct On-Line), a lower starting torque output with AC Motor Drive can be expected. If higher starting torque is required (such as for elevators, mixers, tooling machines, etc.) use an AC Motor Drive of higher capacity or increase the capacities for both the motor and the AC Motor Drive.
4. When an error occurs on the drive, a protective circuit will be activated and the AC Motor Drive output is turned off. Then the motor will coast to stop. For an emergency stop, an external mechanical brake is needed to quickly stop the motor.

Parameter Settings Note

1. The AC Motor Drive can be driven at an output frequency up to 400Hz (less for some models) with the digital keypad. Setting errors may create a dangerous situation. For safety, the use of the upper limit frequency function is strongly recommended.
2. High DC brake operating voltages and long operation time (at low frequencies) may cause overheating of the motor. In that case, forced external motor cooling is recommended.
3. Motor accel./decel. time is determined by motor rated torque, load torque, and load inertia.
4. If the stall prevention function is activated, the accel./decel. time is automatically extended to a length that the AC Motor Drive can handle. If the motor needs to decelerate within a certain time with high load inertia that can't be handled by the AC Motor Drive in the required time, either use an external brake resistor and/or brake unit, depending on the model, (to shorten deceleration time only) or increase the capacity for both the motor and the AC Motor Drive.

17-3 How to Choose a Suitable Motor

Standard motor

When using the AC Motor Drive to operate a standard 3-phase induction motor, take the following precautions:

1. The energy loss is greater than for an inverter duty motor.
2. Avoid running motor at low speed for a long time. Under this condition, the motor temperature may rise above the motor rating due to limited airflow produced by the motor's fan. Consider external forced motor cooling.
3. When the standard motor operates at low speed for long time, the output load must be decreased.
4. The load tolerance of a standard motor is as follows:

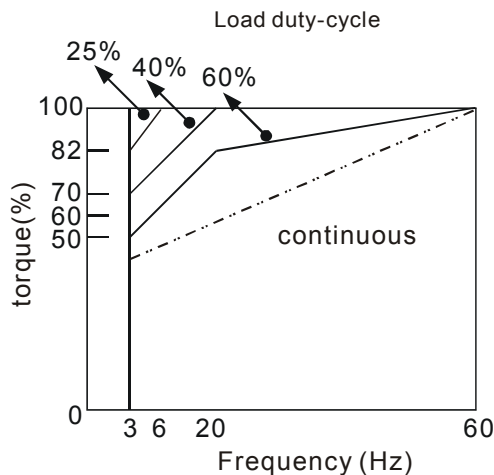

5. If 100% continuous torque is required at low speed, it may be necessary to use a special inverter duty motor.
6. Motor dynamic balance and rotor endurance should be considered once the operating speed exceeds the rated speed (60Hz) of a standard motor.
7. Motor torque characteristics vary when an AC Motor Drive instead of commercial power supply drives the motor. Check the load torque characteristics of the machine to be connected.
8. Because of the high carrier frequency PWM control of the VFD series, pay attention to the following motor vibration problems:
 - Resonant mechanical vibration: anti-vibration (damping) rubbers should be used to mount equipment that runs at varying speed.
 - Motor imbalance: special care is required for operation at 50 or 60 Hz and higher frequency.
 - To avoid resonances, use the Skip frequencies.
9. The motor fan will be very noisy when the motor speed exceeds 50 or 60Hz.

Special motors:

1. Pole-changing (Dahlander) motor:

The rated current is differs from that of a standard motor. Please check before operation and select the capacity of the AC motor drive carefully. When changing the pole number the motor needs to be stopped first. If over current occurs during operation or regenerative voltage is too high, please let the motor free run to stop (coast).

2. Submersible motor:

The rated current is higher than that of a standard motor. Please check before operation and choose the capacity of the AC motor drive carefully. With long motor cable between AC motor drive and motor, available motor torque is reduced.

3. Explosion-proof (Ex) motor:

Needs to be installed in a safe place and the wiring should comply with the (Ex) requirements. Delta AC Motor Drives are not suitable for (Ex) areas with special precautions.

4. Gear reduction motor:

The lubricating method of reduction gearbox and speed range for continuous operation will be different and depending on brand. The lubricating function for operating long time at low speed and for high-speed operation needs to be considered carefully.

5. Synchronous motor:

The rated current and starting current are higher than for standard motors. Please check before operation and choose the capacity of the AC motor drive carefully. When the AC motor drive operates more than one motor, please pay attention to starting and changing the motor.

Power Transmission Mechanism

Pay attention to reduced lubrication when operating gear reduction motors, gearboxes, belts and chains, etc. over longer periods at low speeds. At high speeds of 50/60Hz and above, lifetime reducing noises and vibrations may occur.

Motor torque

The torque characteristics of a motor operated by an AC motor drive and commercial mains power are different.

Below you'll find the torque-speed characteristics of a standard motor (4-pole, 15kW):

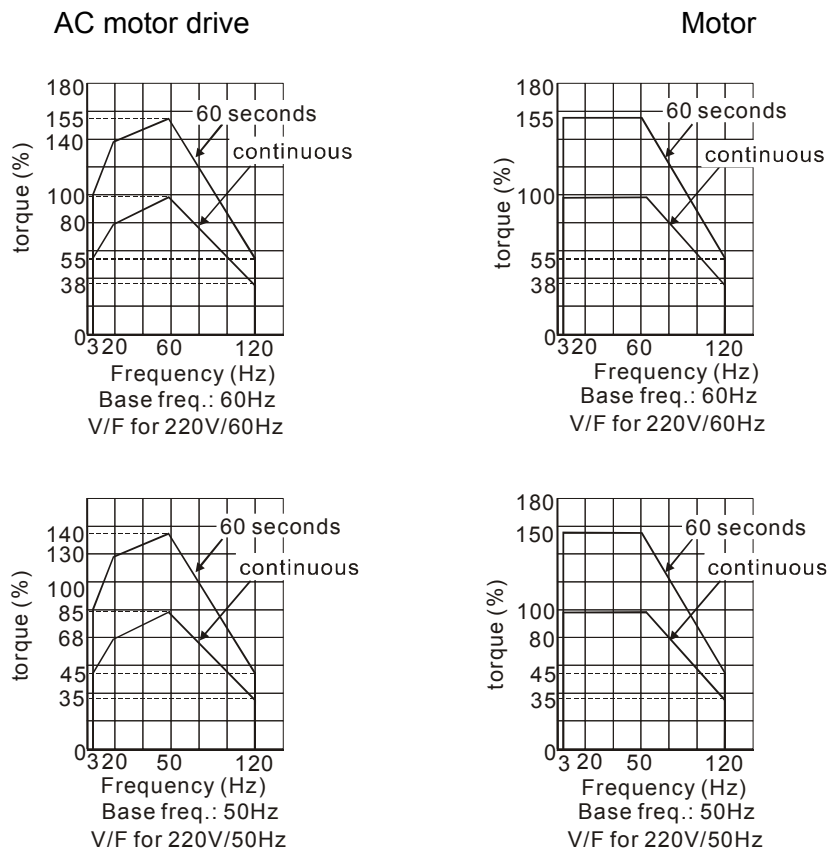

Chapter 18 Suggestions and Error Corrections for Standard AC Motor Drives

18-1 Maintenance and Inspections

18-2 Greasy Dirt Problem

18-3 Fiber Dust Problem

18-4 Erosion Problem

18-5 Industrial Dust Problem

18-6 Wiring and Installation Problem

18-7 Multi-function Input/Output Terminals Problem

The AC motor drive has a comprehensive fault diagnostic system that includes several different alarms and fault messages. Once a fault is detected, the corresponding protective functions will be activated. The following faults are displayed as shown on the AC motor drive digital keypad display. The six most recent faults can be read from the digital keypad or communication.

The AC motor drive is made up by numerous components, such as electronic components, including IC, resistor, capacitor, transistor, and cooling fan, relay, etc. These components can't be used permanently. They have limited-life even under normal operation. Preventive maintenance is required to operate this AC motor drive in its optimal condition, and to ensure a long life.

Check your AC motor drive regularly to ensure there are no abnormalities during operation and follows the precautions:



- ☑ Wait 5 seconds after a fault has been cleared before performing reset via keypad of input terminal.
- ☑ When the power is off after 5 minutes for $\leq 22\text{kW}$ models and 10 minutes for $\geq 30\text{kW}$ models, please confirm that the capacitors have fully discharged by measuring the voltage between + and -. The voltage between + and - should be less than 25VDC.
- ☑ Only qualified personnel can install, wire and maintain drives. Please take off any metal objects, such as watches and rings, before operation. And only insulated tools are allowed.
- ☑ Never reassemble internal components or wiring.
- ☑ Make sure that installation environment comply with regulations without abnormal noise, vibration and smell.

18-1 Maintenance and Inspections

Before the check-up, always turn off the AC input power and remove the cover. Wait at least 10 minutes after all display lamps have gone out, and then confirm that the capacitors have fully discharged by measuring the voltage between DC+ and DC-. The voltage between DC+ and DC- should be less than 25VDC.

Ambient environment

Check Items	Methods and Criterion	Maintenance Period		
		Daily	Half Year	One Year
Check the ambient temperature, humidity, vibration and see if there are any dust, gas, oil or water drops	Visual inspection and measurement with equipment with standard specification	<input type="radio"/>		
If there are any dangerous objects	Visual inspection	<input type="radio"/>		

Voltage

Check Items	Methods and Criterion	Maintenance Period		
		Daily	Half Year	One Year
Check if the voltage of main circuit and control circuit is correct	Measure with multimeter with standard specification	<input type="radio"/>		

Digital Keypad Display

Check Items	Methods and Criterion	Maintenance Period		
		Daily	Half Year	One Year
Is the display clear for reading	Visual inspection	<input type="radio"/>		
Any missing characters	Visual inspection	<input type="radio"/>		

Mechanical parts

Check Items	Methods and Criterion	Maintenance Period		
		Daily	Half Year	One Year
If there is any abnormal sound or vibration	Visual and aural inspection		<input type="radio"/>	
If there are any loose screws	Tighten the screws		<input type="radio"/>	
If any part is deformed or damaged	Visual inspection		<input type="radio"/>	
If there is any color change by overheating	Visual inspection		<input type="radio"/>	
If there is any dust or dirt	Visual inspection		<input type="radio"/>	

Main circuit

Check Items	Methods and Criterion	Maintenance Period		
		Daily	Half Year	One Year
If there are any loose or missing screws	Tighten or replace the screw	<input type="radio"/>		
If machine or insulator is deformed, cracked, damaged or with color change due to overheating or ageing	Visual inspection NOTE: Please ignore the color change of copper plate		<input type="radio"/>	
If there is any dust or dirt	Visual inspection		<input type="radio"/>	

Terminals and wiring of main circuit

Check Items	Methods and Criterion	Maintenance Period		
		Daily	Half Year	One Year
If the terminal or the plate is color change or deformation due to overheat	Visual inspection		<input type="radio"/>	
If the insulator of wiring is damaged or color change	Visual inspection		<input type="radio"/>	
If there is any damage	Visual inspection	<input type="radio"/>		

DC capacity of main circuit

Check Items	Methods and Criterion	Maintenance Period		
		Daily	Half Year	One Year
If there is any leak of liquid, color change, crack or deformation	Visual inspection	<input type="radio"/>		
If the safety valve is not removed? If valve is inflated?	Visual inspection	<input type="radio"/>		
Measure static capacity when required		<input type="radio"/>		

Resistor of main circuit

Check Items	Methods and Criterion	Maintenance Period		
		Daily	Half Year	One Year
If there is any peculiar smell or insulator cracks due to overheat	Visual inspection, smell	<input type="radio"/>		
If there is any disconnection	Visual inspection	<input type="radio"/>		
If connection is damaged?	Measure with multimeter with standard specification	<input type="radio"/>		

Transformer and reactor of main circuit

Check Items	Methods and Criterion	Maintenance Period		
		Daily	Half Year	One Year
If there is any abnormal vibration or peculiar smell	Visual, aural inspection and smell	<input type="radio"/>		

Magnetic contactor and relay of main circuit

Check Items	Methods and Criterion	Maintenance Period		
		Daily	Half Year	One Year
If there are any loose screws	Visual and aural inspection	<input type="radio"/>		
If the contact works correctly	Visual inspection	<input type="radio"/>		

Printed circuit board and connector of main circuit

Check Items	Methods and Criterion	Maintenance Period		
		Daily	Half Year	One Year
If there are any loose screws and connectors	Tighten the screws and press the connectors firmly in place.		<input type="radio"/>	
If there is any peculiar smell and color change	Visual and smell inspection		<input type="radio"/>	
If there is any crack, damage, deformation or corrosion	Visual inspection		<input type="radio"/>	
If there is any liquid is leaked or deformation in capacity	Visual inspection		<input type="radio"/>	

Cooling fan of cooling system

Check Items	Methods and Criterion	Maintenance Period		
		Daily	Half Year	One Year
If there is any abnormal sound or vibration	Visual, aural inspection and turn the fan with hand (turn off the power before operation) to see if it rotates smoothly		<input type="radio"/>	
If there is any loose screw	Tighten the screw		<input type="radio"/>	
If there is any color change due to overheat	Change fan		<input type="radio"/>	

Ventilation channel of cooling system

Check Items	Methods and Criterion	Maintenance Period		
		Daily	Half Year	One Year
If there is any obstruction in the heat sink, air intake or air outlet	Visual inspection		○	

 **NOTE**

Please use the neutral cloth for clean and use dust cleaner to remove dust when necessary.

18-2 Greasy Dirt Problem

Serious greasy dirt problems generally occur in processing industries such as machine tools, punching machines and so on. Please be aware of the possible damages that greasy oil may cause to your drive:

1. Electronic components that silt up with greasy oil may cause the drive to burn out or even explode.
2. Most greasy dirt contains corrosive substances that may damage the drive.

Solution:

Install the AC motor drive in a standard cabinet to keep it away from dirt. Clean and remove greasy dirt regularly to prevent damage of the drive.

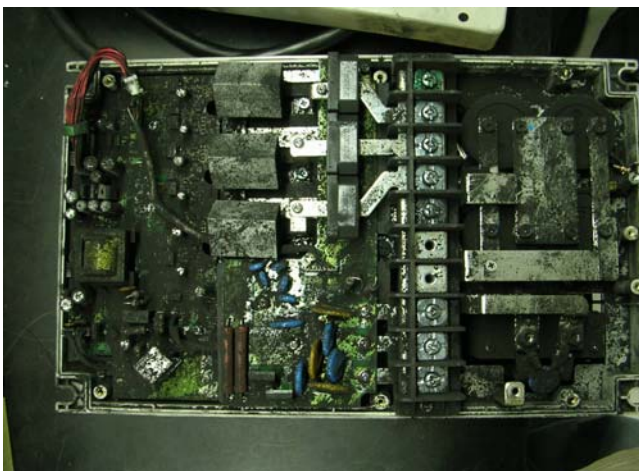

18-3 Fiber Dust Problem

Serious fiber dust problems generally occur in the textile industry. Please be aware of the possible damages that fiber may cause to your drives:

1. Fiber that accumulates or adheres to the fans will lead to poor ventilation and cause overheating problems.
2. Plant environments in the textile industry have higher degrees of humidity that may cause the drive to burn out, become damaged or explode due to wet fiber dust adhering to the devices.

Solution:

Install the AC motor drive in a standard cabinet to keep it away from fiber dust. Clean and remove fiber dust regularly to prevent damage to the drive.



18-4 Erosion Problem

Erosion problems may occur if any fluids flow into the drives. Please be aware of the damages that erosion may cause to your drive.

1. Erosion of internal components may cause the drive to malfunction and possibility to explode.

Solution:

Install the AC motor drive in a standard cabinet to keep it away from fluids. Clean the drive regularly to prevent erosion.

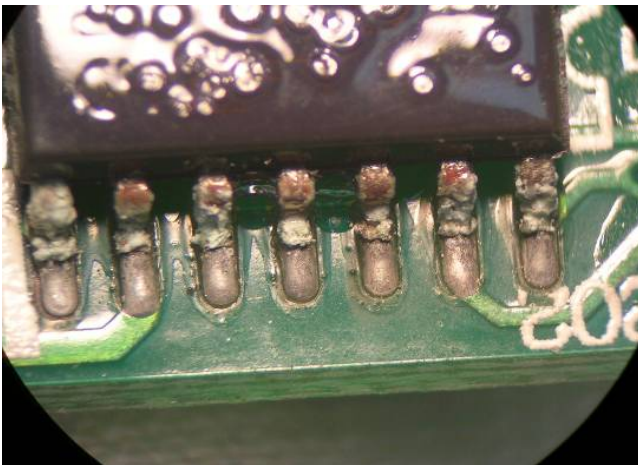
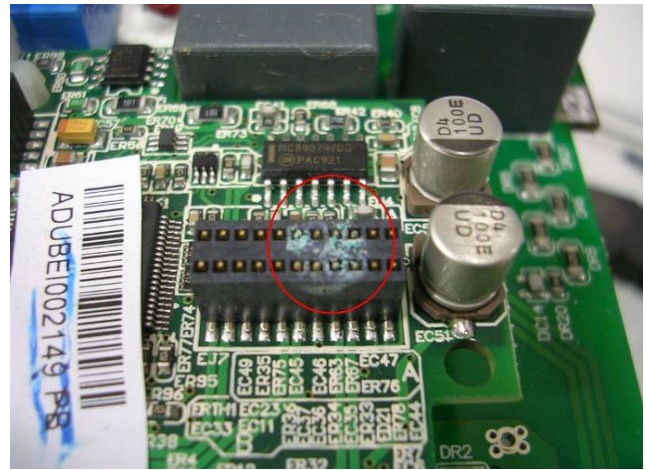
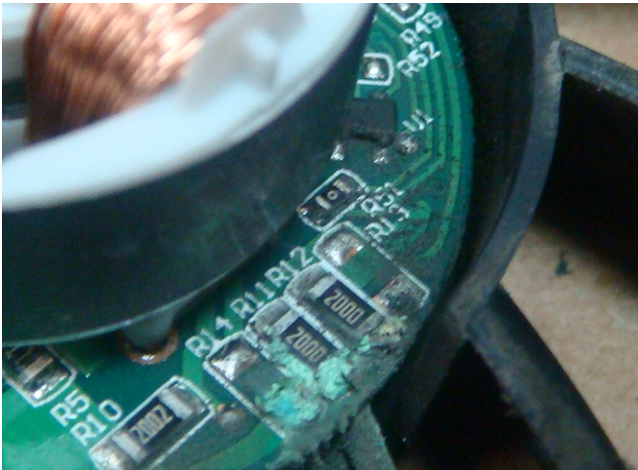

18-5 Industrial Dust Problem

Serious industrial dust pollution frequently occurs in stone processing plants, flour mills, cement plants, and so on. Please be aware of the possible damage that industrial dust may cause to your drives:

1. Dust accumulating on electronic components may cause overheating problem and shorten the service life of the drive.
2. Conductive dust may damage the circuit board and may even cause the drive to explode.

Solution:

Install the AC motor drive in a standard cabinet and cover the drive with a dust cover. Clean the cabinet and ventilation hole regularly for good ventilation.

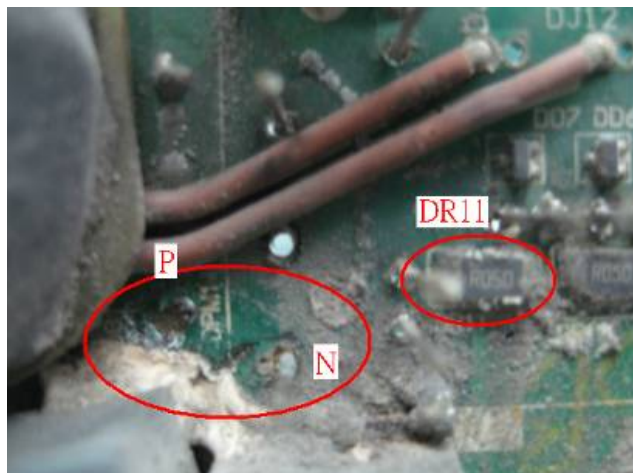
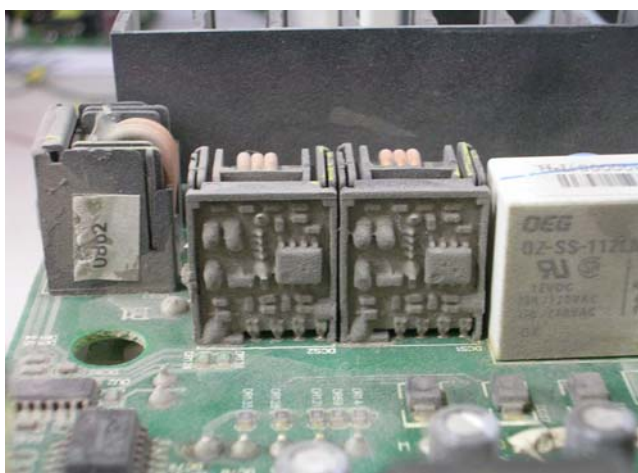

18-6 Wiring and Installation Problem

When wiring the drive, the most common problem is wrong wire installation or poor wiring. Please be aware of the possible damages that poor wiring may cause to your drives:

1. Screws are not fully fastened. Occurrence of sparks as impedance increases.
2. If a customer has opened the drive and modified the internal circuit board, the internal components may have been damaged.

Solution:

Ensure all screws are fastened when installing the AC motor drive. If the AC motor drive functions abnormally, send it back to the repair station. DO NOT try to reassemble the internal components or wire.

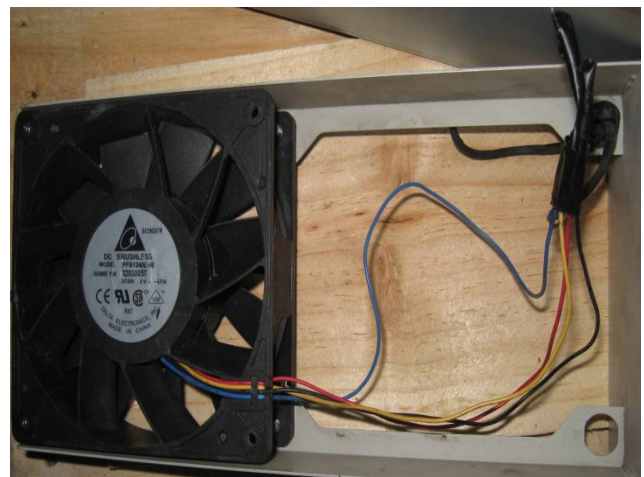
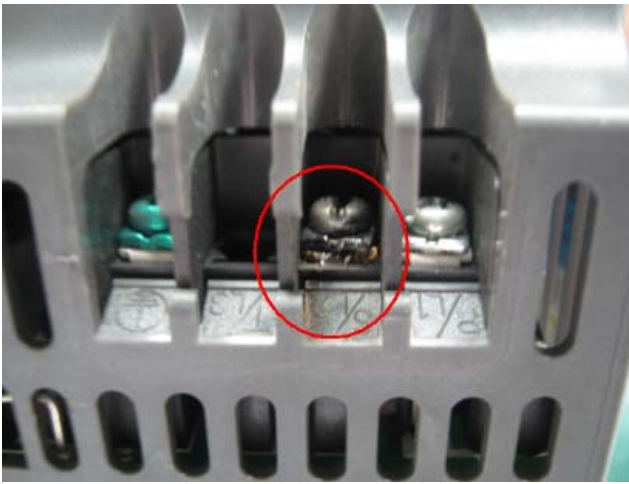

18-7 Multi-function Input/Output Terminals Problem

Multi-function input/output terminal errors are generally caused by over usage of terminals and not following specifications. Please be aware of the possible damages that errors on multi-function input/output terminals may cause to your drives:

1. Input/output circuit may burn out when the terminal usage exceeds its limit.

Solution:

Refer to the user manual for multi-function input output terminals usage and follow the specified voltage and current. DO NOT exceed the specification limits.

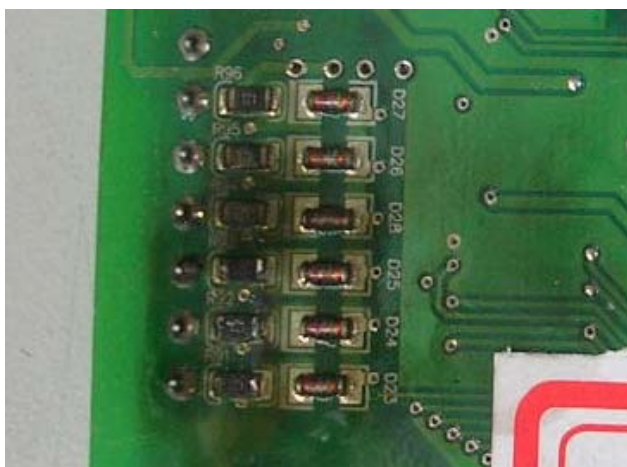
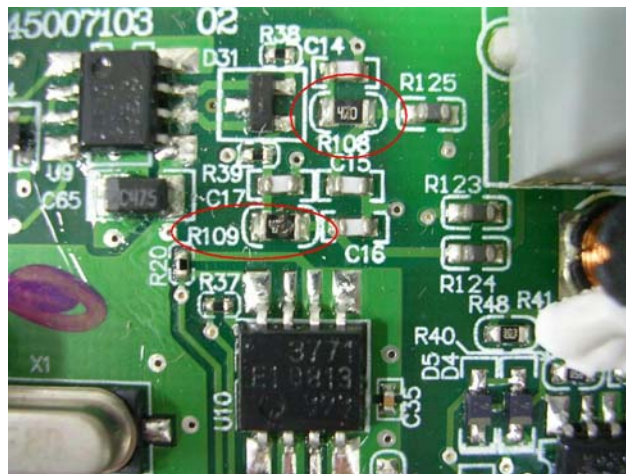
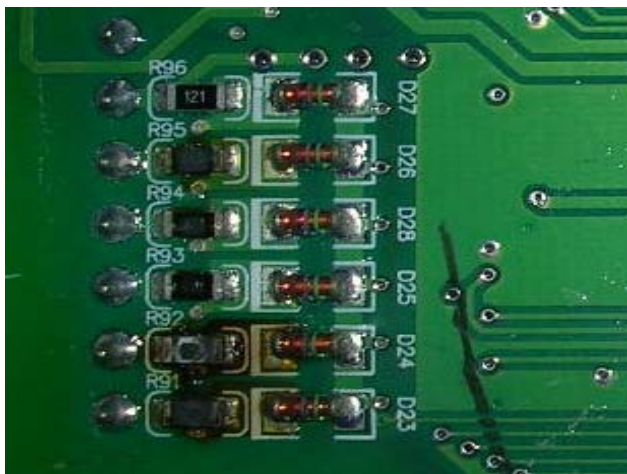

[This page intentionally left blank]

Chapter 19 EMC Standard Installation Guide

Preface
Table of Contents
19-1 Introduction
19-1.1 What is EMC
19-1.2 EMC for AC Motor Drive
19-2 How to prevent EMI
19-2.1 Types of EMI: common-mode and differential mode noise
19-2.2 How does EMI transmit? (Noise transmission)
19-3 Solution to EMI: Grounding
19-3.1 Protective Grounding & Functional Grounding
19-3.2 Ground Loops
19-3.3 Earthing Systems
19-4 Solution to EMI: Shielding
19-4.1 What is Shielding?
19-4.2 How to Reduce EMI by Shielding?
19-5 Solution to EMI: Filter
19-5.1 Filter
19-5.2 Harmonic Interference

Preface

When an AC motor drive is installed in a noisy environment, radiated and/or conducted noise via signal and power cables can interfere with the correct functioning, cause errors or even damage to the drive. To prevent this, some AC motor drives have an enhanced noise resistance but the results are limited and it is not economical. Therefore, an effective method would be finding the cause of the noise and use the right solution to achieve “no emission, no transmission and no reception of noise”. All three solutions should be applied.

Finding the Noise

- Ascertain whether the error is caused by noise.
- Find the source of the noise and its transmission path.
- Confirm the signal and the source of noise

Solutions

- Grounding
- Shielding
- Filtering

19-1 Introduction

19-1.1 What is EMC?

Electromagnetic Compatibility (EMC) is the ability of an electrical device to function properly in electromagnetic environments. It does not emit electromagnetic noise to surrounding equipment and is immune to interference from surrounding equipment. The goal is to achieve high immunity and low emission; these two properties define the quality of EMC. In general, electrical devices react to high and low frequency phenomena. High frequency phenomena are electrostatic discharge (ESD); pulse interference; radiated electromagnetic field; and conducted high frequency electrical surge. Low frequency phenomena refer to mains power harmonics and imbalance.

The standard emission and immunity levels for compliance depend on the installation location of the drive. A Power Drive System (PDS) is installed in an industrial or domestic environment. A PDS in a domestic environment must have lower emission levels and is allowed to have lower immunity levels. A PDS in an industrial environment is allowed to have higher emission levels but must have more severe immunity levels.

19-1.2 EMC for AC Motor Drive

When an AC motor drive is put into operation, harmonic signal will occur at the AC drive's power input and output side. It creates a certain level of electromagnetic interference to the surrounding electrical devices and the mains power network. An AC motor drive is usually applied in industrial environments with a strong electromagnetic interference. Under such conditions, an AC drive could disturb or be disturbed.

Delta's AC motor drives are designed for EMC and comply with EMC standard EN61800-3 2004. Installing the AC motor drive accurately will decrease EMI influences and ensure long term stability of the electricity system. It is strongly suggested to follow Delta's user manual for wiring and grounding. If any difficulties or problems arise, please follow the instructions and measures as indicated in this EMC Standard Installation Guide.

19-2 How to prevent EMI

19-2.1 Types of EMI: Common-mode and differential-mode noise

The electromagnetic noise of an AC motor drive can be distinguished into common-mode and differential-mode noise. Differential-mode noise is caused by the stray capacitance between the conducting wires and common-mode noise is caused by the common-mode coupling current path created by the stray capacitance between the conducting wires and ground.

Basically, differential-mode noise has a greater impact to the AC motor drive and common-mode noise has a greater impact to high-sensitivity electronic devices. An excessive amount of differential-mode noise may trigger the circuit protection system of the AC motor drive. Common-mode noise affects peripheral electronic devices via the common ground connection.

EMC problems can be more serious when the following conditions apply:

- When a large horsepower AC motor drive is connected to a large horsepower motor.
- The AC motor drive's operation voltage increases.
- Fast switching of the IGBTs.
- When a long cable is used to connect the motor to the AC motor drive.

19-2.2 How does EMI transmit? (Noise transmission path)

Noise disturbs peripheral high-sensitivity electrical devices/systems via conduction and radiation, their transmission paths are shown hereafter:

1. Noise current in the unshielded power cable is conducted to ground via stray capacitances into a common-mode voltage. Whether or not other modules are capable to resist this common-mode noise depends on their Common-Mode Rejection Ratio (CMRR), as shown in the following figure.

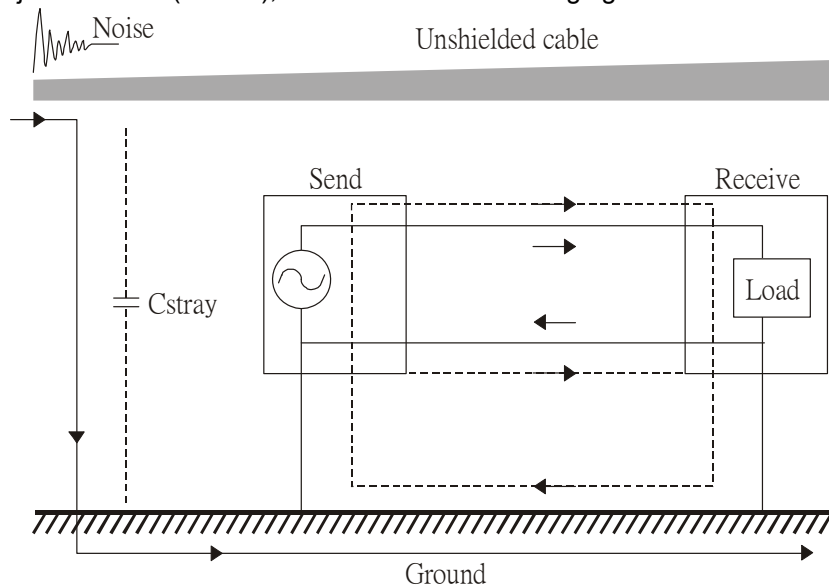

2. Common-mode noise in the power cable is transmitted through the stray capacitance and coupled into the adjacent signal cable, as shown in Figure 2. Several methods can be applied to reduce the effect of this common-mode noise; for example, shield the power cable and/or the signal cables, separate the power and signal cables, take the input and output side of the signal cable and twist them together to balance out the stray capacitance, let power cables and signal cables cross at 90° , etc.

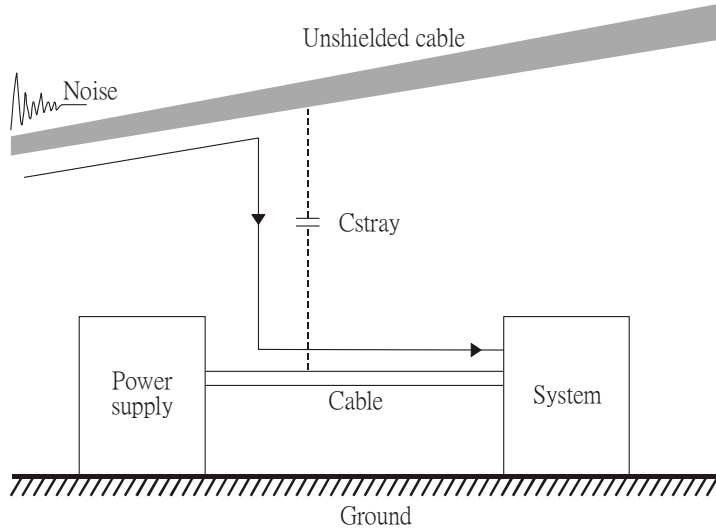

3. Common-mode noise is coupled via the power cable to other power systems then the cable of such a power system is coupled to the transmission system, as shown in Figure 3.

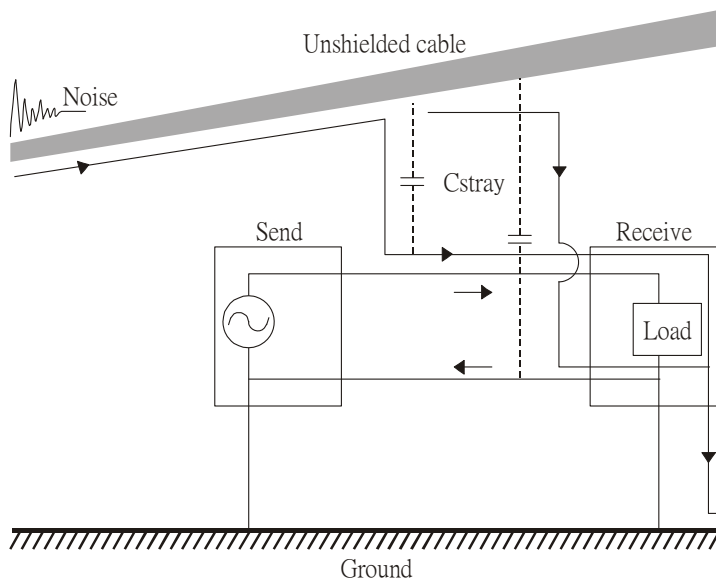

4. The common-mode noise of an unshielded power cable is transmitted to the ground via the stray capacitance. Since both shielded wire and unshielded wire are connected to a common ground, other systems can be interfered with by the common-mode noise that is transmitted from the ground back to the system via the shield. See Figure 4.

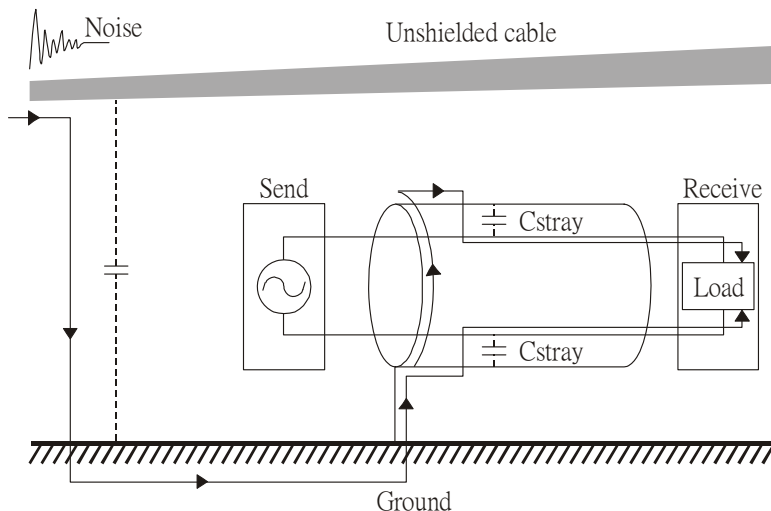

5. When excessive pulse modulated currents pass through an un-grounded AC drive cable, it acts as an antenna and creates radiated interference.

19-3 Solution to EMI: Grounding

The leakage current of an electronic equipment is conducted to ground via the grounding wire and the ground electrode. According to Ohm's law, potential differences may arise when the electrode's ground and the ground's ground resistance are different.

According to Ohm's law, the earth resistance for electrode and the ground are different, in this case potential differences may arise.

19-3.1 Protective Grounding & Functional Grounding

Please carefully read the following instruction if two types of grounding are applied at the same time.

Protective grounding is applied outside buildings and must have low resistance. On the other hand, functional grounding can be applied inside buildings and must have low impedance.

The goal of EMC is to avoid any interference effects. Grounding for EMC can be distinguished by frequency. For frequencies lower than 10kHz, a *single-point ground* system should be used and for frequencies higher than 10 kHz, a *multiple point ground* system should be used.

- *Single Point Grounding*: all signal grounds of all IT equipment are connected in series to form a single reference point. This point can be grounded directly to earth; to the designated grounding point or to the safety point that is already grounded.
- *Multiple Point Grounding*: all signals of all IT equipment are grounded independently.
- *Hybrid Grounding*: this type of grounding behaves differently for low and high frequencies. When two pieces of IT equipment (A and B) are connected via a shielded cable, one end is connected directly to ground while the other end is connected to ground via a capacitor. This type of grounding system fulfils the criteria for high and low frequency grounding.
- *Floating grounding*: the signals of all IT equipment are isolated from each other and are not grounded.

DC current flows evenly throughout the conductor section. But AC current flows towards the conductor's surface as frequency increases; this is called the "skin effect". It causes the effective cross-section area to be reduced with increasing frequency. Therefore it is suggested to increase the effective ground cross-section area for high frequencies by replacing pigtail grounding by braided conductors or strip conductors. Refer to the following figure.

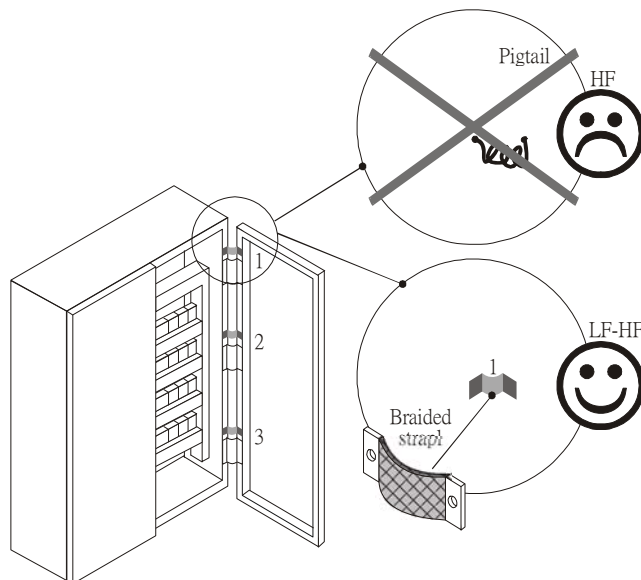

This is why a thick short ground wire must be implemented for connecting to the common grounding path or the ground busbar. Especially when a controller (e.g. PLC) is connected to an AC motor drive, it must be grounded by a short and thick conducting wire. It is suggested to use a flat braided conductor (ex: metal mesh) with a lower impedance at high frequencies.

If the grounding wire is too long, its inductance may interfere structure of the building or the control cabinet and form mutual inductance and stray capacitance. As shown in the following figure, a long grounding wire could become a vertical antenna and turn into a source of noise.

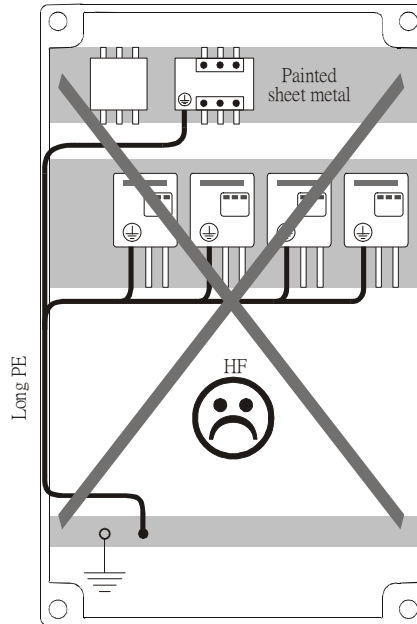

19-3.2 Ground Loops

A *ground loop* occurs when the pieces of equipment are connected to more than one grounding path. In this case, the ground current may return to the grounding electrode via more than one path. There are three methods to prevent ground loops

1. Use a common power circuit
2. Single point grounding
3. Isolate signals, e.g. by photocouplers

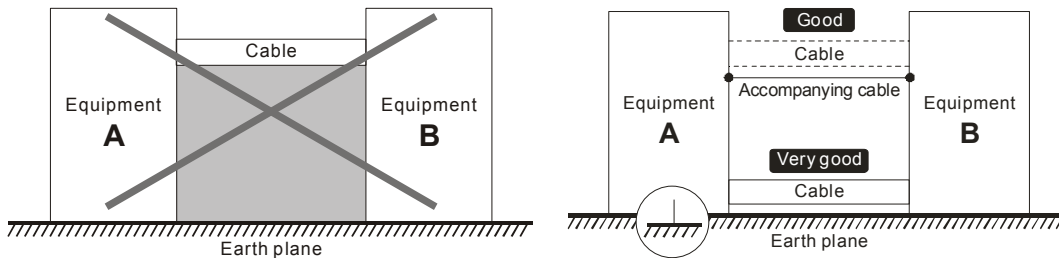

In order to avoid “Common Mode Noise”, please use parallel wires or twisted pair wiring. Follow this rule and also avoid long wires, it is suggested to place the two wires as close to each other as possible.

19-3.3 Earthing Systems

The international standard IEC60364 distinguishes three different earthing system categories, using the two-letter codes TN, TT, IT.

- The **first letter** indicates the type of earthing for the power supply equipment (generator or transformer).
 - T**: One or more points of the power supply equipment are connected directly to the same earthing point.
 - I**: Either no point is connected to earth (isolated) or it is connected to earth via a high impedance.
- The **second letter** indicates the connection between earth and the power supply equipment.
 - T**: Connected directly to earth (This earthing point is separate from other earthing points in the power supply system.)
 - N**: Connected to earth via the conductor that is provided by the power supply system
- The **third and fourth letter** indicate the location of the earth conductor.
 - S**: Neutral and earth conductors are separate
 - C**: Neutral and earth are combined into a single conductor

TN system

TN: The neutral point of the low voltage transformer or generator is earthed, usually the star point in a three-phase system. The body of the electrical device is connected to earth via this earth connection at the transformer.

protective earth (PE): The conductor that connects the exposed metallic parts of the consumer.

neutral (N): The conductor that connects to the start point in a 3-phase system or that carries the return current in a single phase system.

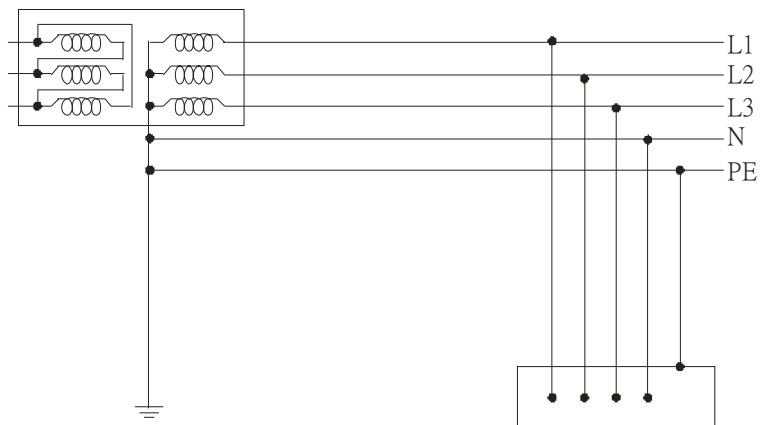

TN-S system

TN-S: PE and N are two separate conductors that are combined together only near the power source (transformer or generator). It is the same as a three-phase 5-wire system.

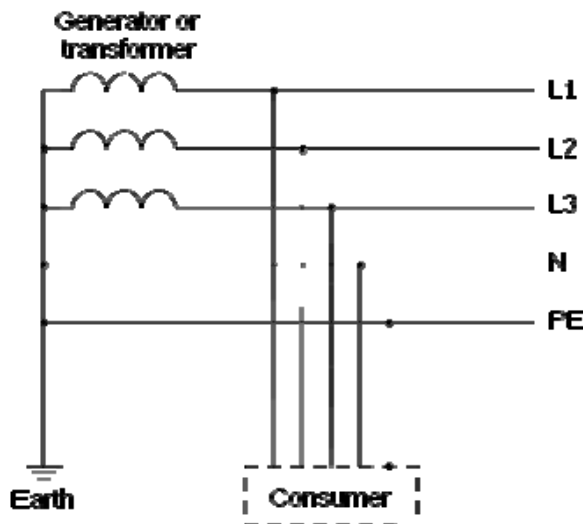

TN-C system

TN-C: PE and N are two separate conductors in an electrical installation similar to a three-phase 5wire system, but near the power side, PE and N are combined into a PEN conductor similar to a three-phase 4 wire system.

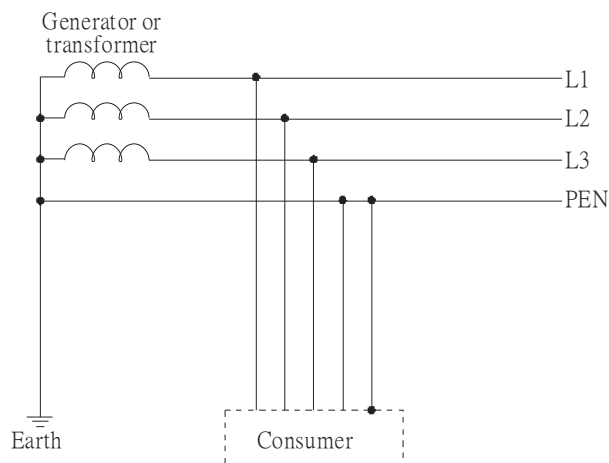

TN-C-S system

TN-C-S: A combined earth and neutral system (PEN conductor) is used in certain systems but eventually split up into two separate conductors PE and N. A typical application of combined PEN conductor is from the substation to the building but within the building PEN is separated into the PE and N conductors. Direct connection of PE and N conductors to many earthing points at different locations in the field will reduce the risk of broken neutrals. Therefore this application is also known as *protective multiple earthing (PME)* in the UK or as *multiple earthed neutral (MEN)* in Australia

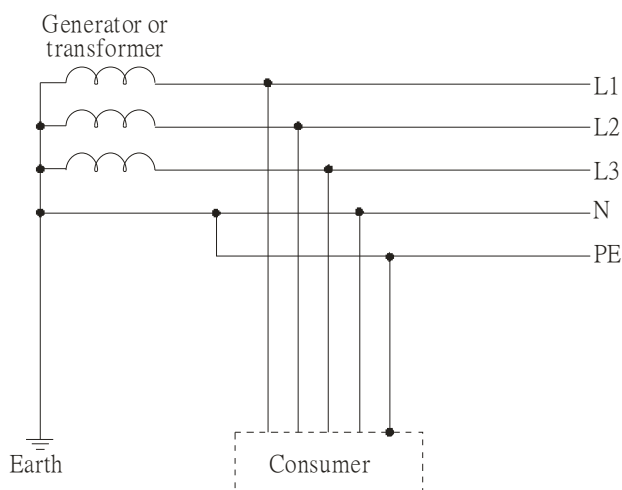

TT system

TT: The neutral point (N) of the low voltage transformer and the equipment frames (PE) are connected to a separate earthing point. The Neutral (N) of the transformer and electrical equipment are connected.

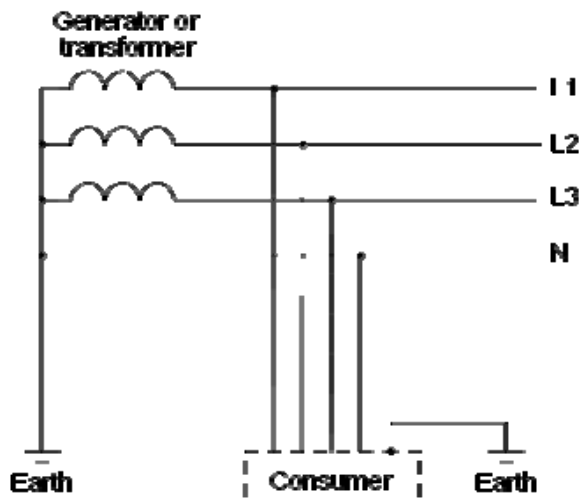

IT system

IT: The neutral point of the transformer and electrical equipment are not earthed, only the equipment frames PE are earthed.

In the IT network, the power distribution system Neutral is either not connected to earth or is earthed via a high impedance. In such a system, an insulated monitoring device is used for impedance monitoring.

A built-in filter should be disconnected by the RFI-jumper and an external filter should not be installed when the AC

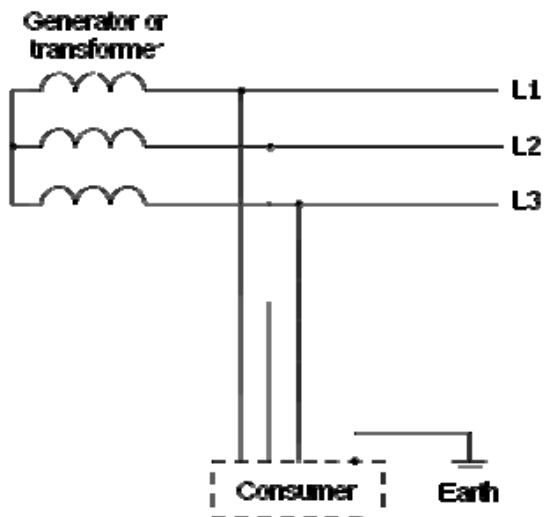

motor drive or the AC servo motor drive is connected to an IT system.

Criteria for earthing system and EMC

	TN-S	TN-C	TT	IT
Safety of Personnel	Good Continuity of the PE conductor must be ensured throughout the installation	Good Continuity of the PE conductor must be ensured throughout the installation	Good RCD is mandatory	Good Continuity of the PE conductor must be ensured throughout the installation
Safety of property	Poor High fault current (around 1kA)	Poor High fault current (around 1kA)	Good Medium fault current (< a few dozen amperes)	Good Low current at the first fault (< a few dozen mA) but high current at the second fault
Availability of energy	Good	Good	Good	Excellent
EMC behavior	Excellent Few equipotential Problems: - Need to handle the high leaking currents problem of the device - High fault current (transient disturbances)	Poor (prohibited) - Neutral and PE are the same - Circulation of disturbance currents in exposed conductive parts (high magnetic-field radiation) - High fault currents (transient disturbances)	Good - Over-voltage risk - Equipotential Problems: - Need to handle the high leaking currents problem of the device - RCD (Residual-current device)	Poor (should be avoided) - Over-voltage risk - Common-mode filters and surge arrestors must handle the phase to phase voltage. - RCDs subject to nuisance tripping when common-mode capacitors are present - Equivalent to TN system for second fault

19-4 Solution to EMI: Shielding

19-4.1 What is Shielding?

Electrostatic shielding is used to isolate equipment so that it will not create electromagnetic field interference or be influenced by an external electromagnetic field. A conductive material is used for electrostatic shielding to achieve this isolation.

A *Faraday cage* can be made from a mesh of metal or a conductive material.

One characteristic of metal is that it is highly conductive and not electrostatic, which offers shielding and prevents interference by external electrical fields. Metal with its high conductivity protects the internal devices from high voltages—no voltage will enter the cage even when the cage is experiencing a high current. In addition, electromagnetic fields can also pass through the Faraday cage without causing any disturbance.

Electromagnetic shielding is applied to some electrical devices and measurement equipment for the purpose of blocking interference. Examples of shielding include:

- earth high-voltage indoor equipment using a metal frame or a high-density metal mesh
- shielding a power transformer is achieved by wrapping a metal sheet between the primary and secondary windings or by adding an enamel wire to the winding wire which is then earthed.
- a shielding coating, which is made of metal mesh or conductive fibres to provide effective protection for the workers who work in a high-voltage environment.

In the picture below, the radio appears to be not fully covered by metal but if the conductivity of the metal is high, radio waves are completely blocked and the radio will not receive any signal.

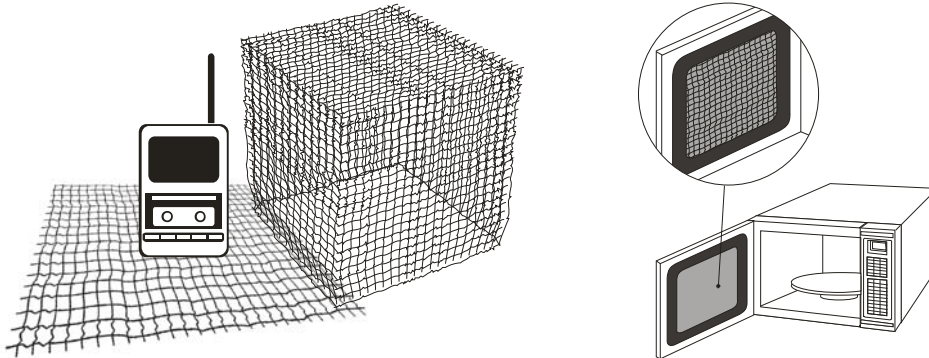

Mobile phone connections are also established through the transmission of radio waves. This is why the mobile phone reception is often cut off when we walk into an elevator. The metal walls of the elevator create the same shielding effect just as if we had entered a metal cage. Another example is a microwave oven. The microwave door may seem transparent in visible light, but the density of the metal mesh in the microwave door blocks the electromagnetic waves. A higher density of the metal mesh offers better shielding.

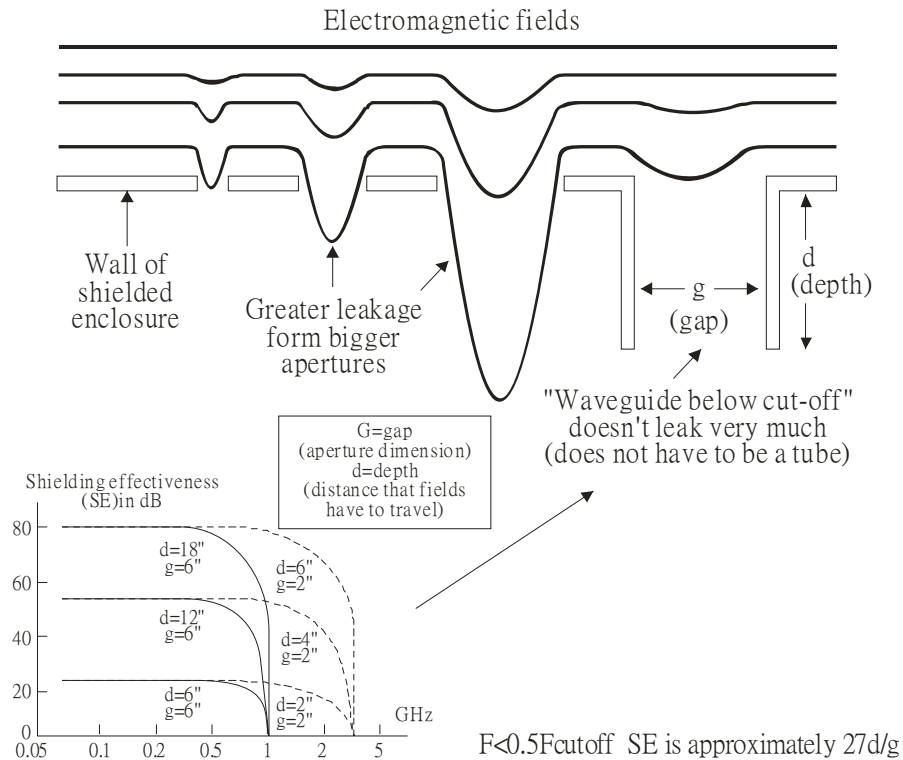

19-4.2 How to reduce EMI by Shielding?

Iron and other metals are high conductivity materials that provide effective shielding at extremely low frequencies. But conductivity will decrease as:

1. High frequency signals are applied to the conductor.
2. Equipment is located in a strong magnetic field
3. The shielding frame is forced into a specific form by machines.

It is difficult to select a suitable high-conductivity material for shielding without the help from a shielding material supplier or a related EMI institution.

Metallic Shielding Effectiveness

Shielding Effectiveness (SE) is used to assess the applicability of the shielding shell. The formula is:

$$SE_{dB} = A + R + B \quad (\text{Measures in dB}) \quad \text{where } \begin{aligned} A &= \text{Absorption loss (dB)} \\ R &= \text{Reflection loss (dB)} \\ B &= \text{Correction factor (dB) (for multiple reflections in thin shields)} \end{aligned}$$

The absorption loss refers to the amount of energy loss as the electromagnetic wave travels through the shield. The formula is:

$$AdB = 1.314(f\sigma\mu)^{1/2}t \quad \text{where } \begin{aligned} f &= \text{frequency (MHz)} \\ \mu &= \text{permeability relative to copper} \\ \sigma &= \text{conductivity relative to copper} \\ t &= \text{thickness of the shield in centimetres} \end{aligned}$$

The reflection loss depends on the source of the electromagnetic wave and the distance from that source. For a rod or straight wire antenna, the wave impedance increases as it moves closer to the source and decreases as it moves away from the source until it reaches the plane wave impedance (377) and shows no change. If the wave source is a small wire loop, the magnetic field is dominant and the wave impedance decreases as it moves closer to the source and increases as it moves away from the source; but it levels out at 377 when the distance exceeds one-sixth of the wavelength.

Electrical Cabinet Design

In a high frequency electric field, shielding can be achieved by painting a thin layer of conductive metal on the enclosure or on the internal lining material. However, the coating must be thorough and all parts should be properly covered without any seams or gaps (just like a Faraday cage). That is only the ideal. Making a seamless shielding shell is practically impossible since the cage is composed of metal parts. In some conditions, it is necessary to drill holes in the shielding enclosure for installation of accessories (like optional cards and other devices).

1. If the metallic components are properly welded using sophisticated welding technology to form an electrical cabinet, deformation during usage is unlikely to occur. But if the electrical cabinet is assembled with screws, the protective insulating layer under the screw must be properly removed before assembly to achieve the greatest conductivity and best shielding.
2. Drilling holes for the installation of wires in the electrical cabinet lowers the shielding effectiveness and increases the chance of electric waves leaking through the openings and emitting interference. We recommend that the drilled holes are as narrow as possible. When the wiring holes are not used, properly cover the holes with metal plates or metal covers. The paint or the coating of the metal plate and metal cover should be thoroughly removed to ensure a metal-to-metal contact or a conductive gasket should be installed.
3. Install industrial conductive gaskets to completely seal the electrical cabinet and the cabinet door without gaps. If conductive gaskets are too costly, please screw the cabinet door to the electrical cabinet with a short distance between the screws.
4. Reserve a grounding terminal on the electrical cabinet door. This grounding terminal shall not be painted. If the paint already exists, please remove the paint before grounding.

Electrical wires and cables

Shielded Twisted Pair (STP) is a type of cable where two insulated copper wires are twisted together with a metal mesh surrounding the twisted pair that forms the electromagnetic shielding and can also be used for grounding.

The individual electrical wires and complete cable are surrounded by (synthetic) rubber, that provides insulation and also protects against damage.

There are two types of electrical cables: high voltage and low voltage. The high voltage cable differs from the low voltage cable in that it has an additional insulation layer called the dielectric insulator within the plastic sleeve. The dielectric insulator is the most important component in insulation. The low voltage cable is usually only filled with a soft polymer material for keeping the internal copper wire in place.

The shield has two functions.

1. To shield the electrical wire and cable.
 - A. Electric currents increase as power flows through the power cable and generate an electrical field. Such interference can be suppressed inside the cable by shielding the power cables or the electrical wires.
 - B. To form a protective earthing. When the cable core is damaged, the leakage current will flow via the shield to ground
2. To protect the cable. A power cable used for the computer control purpose generates only relatively low amount of current inside the cable. Such power cable will not become the source of interferences but has great possibility to be interfered by the surrounding electrical devices.

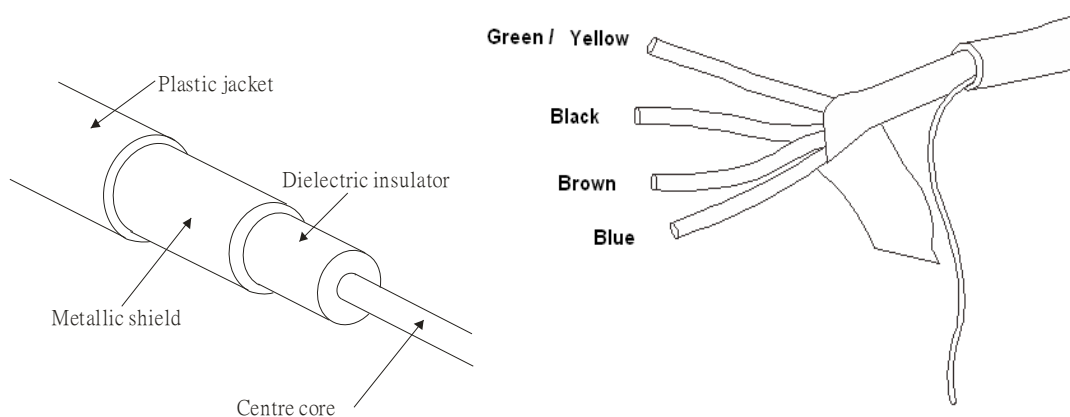

19-5 Solution to EMI: Filter

19-5.1 Filter

Electromagnetic interference is transmitted in two ways, by radiation and by conduction. The most effective and economical method of reducing radiated interference is to use shielding and of reducing conducted interference is to use an electromagnetic filter.

Noise interference can be divided into two categories: high frequency (150kHz~300MHz) and low frequency (100Hz~3000Hz). High-frequency noise fades more over distance and has a shorter wave-length, while low-frequency noise fades less over distance and has a longer wave-length.. Both types of interference are transmitted through power cables and power leads, affecting the power supply side.

High-frequency interference at the power side can be eliminated or attenuated by mounting a filter. The filter consists of coils and capacitors. Some drives do not have a built-in filter, in which case the installation of an external option filter is required. The drawing below shows a standard filter diagram:

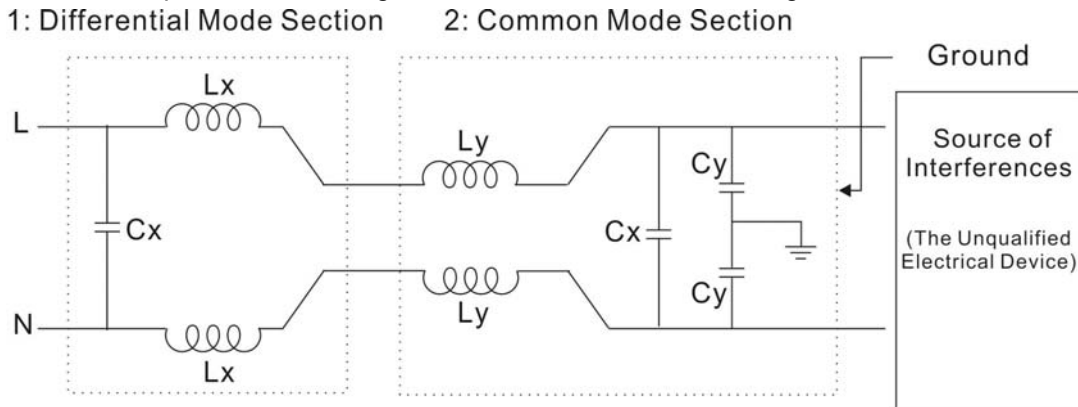

A filter is composed of a Differential Mode section (to eliminate noise below 150kHz) and a Common Mode section (to eliminate noise above 150kHz). For high-frequency noise, the inductor acts as a high impedance to form an open circuit and the capacitor acts as a low impedance to form a short circuit. Proper design and dimensioning of inductors and capacitors give a resonant circuit to absorb harmonic currents. Capacitor C_y is earthed to lead the harmonic currents to the ground.

External Filter

The filter and the AC drive should be installed in the control cabinet or on the mounting plate that is earthed to ground. The motor cable must be shielded and as short as possible. Please use the filters recommended by Delta to ensure compliance with EMC standards.

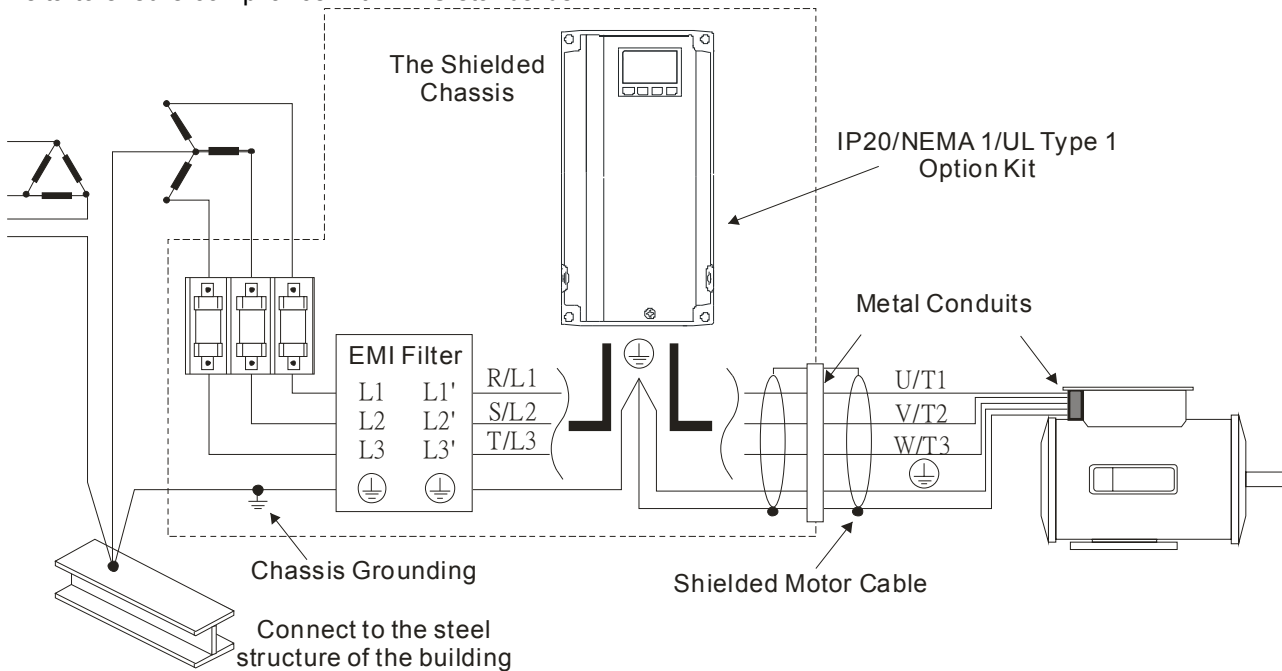

AC Motor Drives with Built-in Filter

1. Since interferences are suppressed by installing an earthed capacitor in the filter, the amount of current to ground (leakage current) could result in electric shocks to personnel or the power system. Please be aware of this problem.
2. Since the leakage current to ground can be high, it is crucial to implement protective earthing to prevent electrical shocks.

Filter Installation (With and Without)

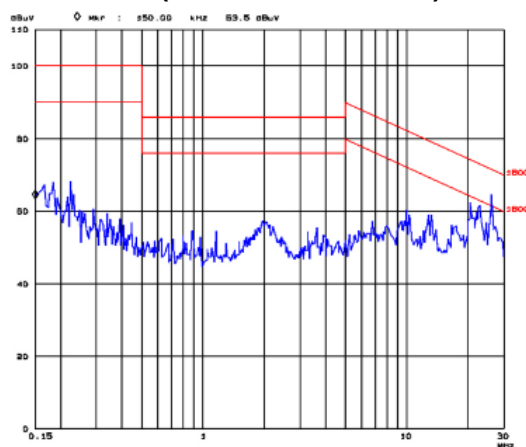

<15m@60Hz with EMI Filter>

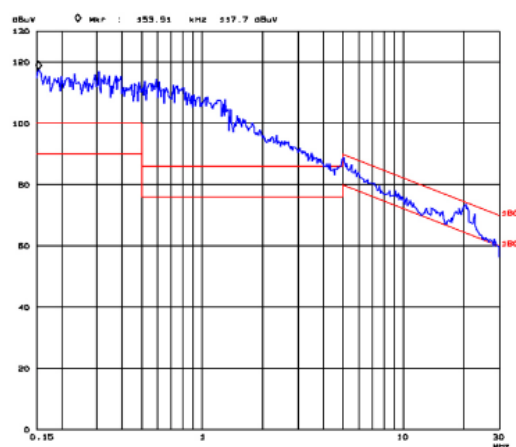

<15m@60Hz without EMI Filter>

Zero Phase Reactor (Choke)

Interferences can also be suppressed by installing a zero phase reactor at the power supply side and/or the AC Motor Drive's output, depending on where the interference is. Since currents are large at the power input and the AC Motor Drive's output, please carefully select the magnetic core with suitable current handling capability. An ideal magnetic material for large currents is compound magnetic powder. It has a higher current handling capability and higher impedance compared to pure metallic magnetic cores. It is therefore suitable to implement in a high frequency environment. The impedance can also be enhanced by increasing the turn ratio.

Zero Phase Reactor Installation

There are two installation methods, depending on the size of the zero phase reactor and the motor cable length.

1. Wind the motor cable through the middle of a zero-phase reactor 4 times. Place the reactor and the AC Motor Drive as close to each other as possible.

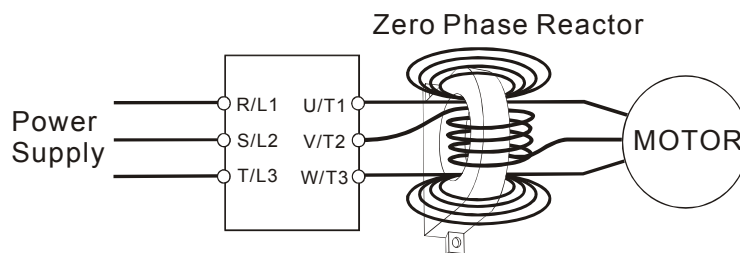

2. Place all wires through the middle of four zero-phase reactors without winding.

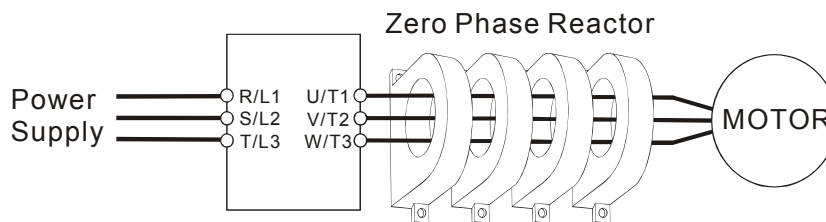

Analog Input Signals

If the analog input signals are affected by noise from the AC motor drive, please connect a capacitor and a ferrite core as indicated in the following diagram.

Wind the wires around the core in same direction for 3 times or more.

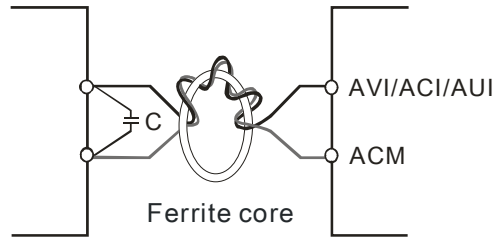

19-5.2 Harmonic Interference

The AC motor drive's input current is non-linear, the input rectifier generates harmonics. Harmonics must be limited to within a certain range to avoid impact the mains power and to avoid current distortion to ensure surrounding devices are not influenced. An AC Motor Drive with built-in DC reactor suppresses harmonic currents (Total Harmonic Current Distortion THID) effectively and therefore reduces the harmonic voltage peaks (Total Harmonic Voltage Distortion).

Harmonic Current at the Power Supply Side

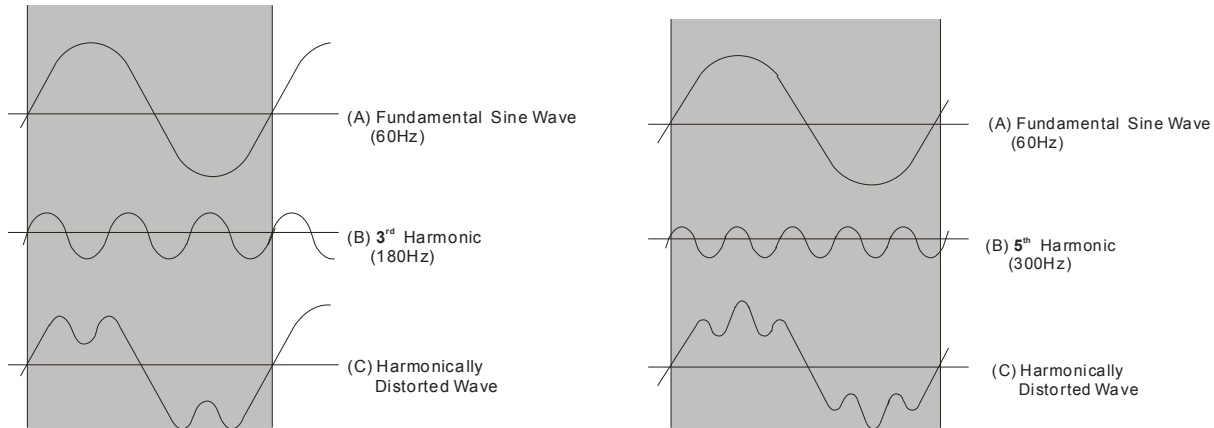

Suppression of Harmonic Currents

When a large portion of lower order harmonic currents (5th, 7th, 11th, etc) occur at the power input, surrounding devices will be disturbed and the power factor will be low as a result of reactive power. Installing a reactor at the AC Motor Drive's input effectively suppresses lower order harmonic currents.

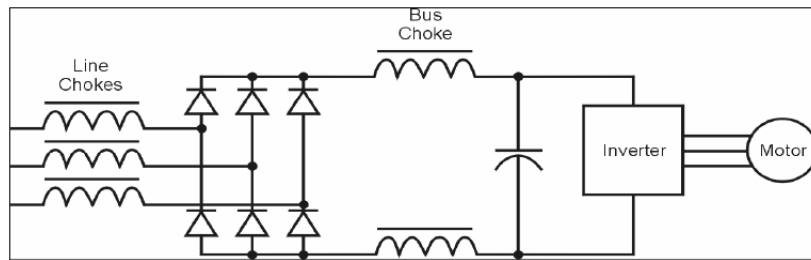

AC Reactor

Installed in series with the power supply and is effective in reducing low order current harmonics.

Features of an AC reactor include:

1. Reduces the harmonic currents to the AC Motor Drive and increases the impedance of the power supply.
2. Absorbs interferences generated by surrounding devices (such as surge voltages, currents, and mains surge voltages) and reduce their effect on the AC Motor Drive.
3. Increases the power factor.

DC Reactor

A DC-Reactor is installed between the rectifier and the DC-bus capacitor to suppress harmonic currents and to achieve a higher power factor.

Current Wave Diagrams

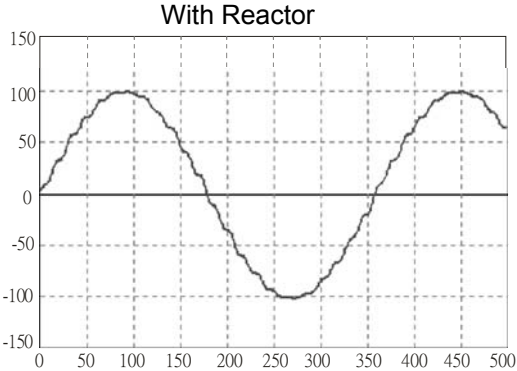
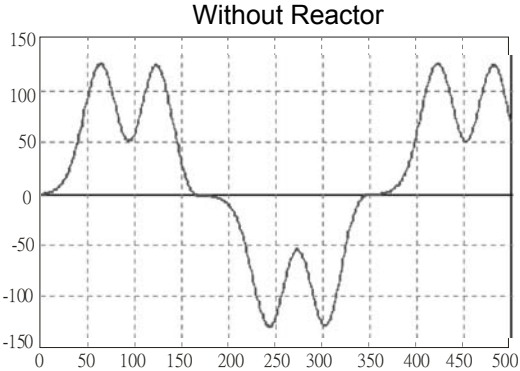

[This page intentionally left blank]

Appendix A. Publication History

V1.3	
Explanations	Affected Chapters
New	
Introduction of modified models (air force cooling) and new models (fan cooling)	Chapter 1, Chapter 2, Chapter 3, Chapter 5, Chapter 6, Chapter 7, Chapter 8, Chapter 9
Standard Adjustment Procedure of IM/PM motor	Chapter 12
Revised	
Operation of digital keypad	Chapter 10
Settings and descriptions of parameters	Chapter 11, Chapter 12