



Automation for a Changing World

# Delta SCADA System DIAView

[www.deltaww.com](http://www.deltaww.com)

 **DELTA**  
Smarter. Greener. Together.

## Delta SCADA System DIAView

### Your Best Choice for Data Collection, Factory Visualization, Real-Time Monitoring and Management

To succeed in a highly competitive marketplace, your plants, machines, systems and facilities all require more efficient management to reduce energy consumption, and increase plant energy efficiency and capacity.

Delta's SCADA (Supervisory Control And Data Acquisition) System DIAView is a computer system for gathering information, monitoring real time data, and carrying out necessary analysis and control to satisfy the needs of acquiring data from remote devices and managing plant operations. It offers a user-friendly and versatile software interface for facilities management and remote monitoring and control. The SCADA System DIAView can be widely applied in industries such as machinery, metallurgy, water treatment, HVAC, packaging, central heating control, environmental monitoring, textiles, energy management, transportation, smart buildings and others. It can significantly reduce energy consumption for customers, increase overall plant efficiency and capacity, and provide management interfaces for system management and production line visualization.

When combined with Delta's industrial automation products, DIAView can help customers in a variety of industries establish a complete automation solution to easily monitor and effectively manage their factories and every subsystem situation. For the factory owner DIAView helps reduce onsite management and lower operation costs while improving production quality with traceable production records through factory visualization and intelligent management.

Delta's SCADA System DIAView is the best choice for meeting your needs and challenges with "Automation for a Changing World" !

- Stable industrial communication, seamless integration with Delta PLC products
- WPF technology for intuitive displays and easy-to-navigate interfaces
- Flexible variables dictionary and batch editing parameters
- A variety of data visualization tools: reports, alarms, charts and trend graphs
- Robust and efficient alarm management
- Easy-to-learn VBScript language
- Reliable user authority management



## Features

Delta SCADA System DIAView	1
SCADA System DIAView for Efficient Facility Monitoring and Management	3
Stable Industrial Communication Design	5
Excellent Graphical Demo Platform	6
Flexible Variables Dictionary	7
A Variety of Data Visualization Tools	8
Robust and Efficient Alarm Management	10
Easy-to-Learn VBScript Language	11
Efficient Recipe Management	11
Reliable User Authority Management	12
Open Software Structure	12

## Applications and Software Licensing

Applications	13
Minimum System Requirements of DIAView	15
Software Licensing (Single Version)	15
DIAView IPC/PPC	16
<ul style="list-style-type: none"> <li>• DIAVH-IPC003100/ DIAVH-IPC005100</li> <li>• DIAVH-PPC153100/ DIAVH-PPC155100</li> <li>• DIAVH-PPC193100/ DIAVH-PPC195100</li> </ul>	
Ordering Information	22



# SCADA System DIAView for Efficient Facility Monitoring and Management

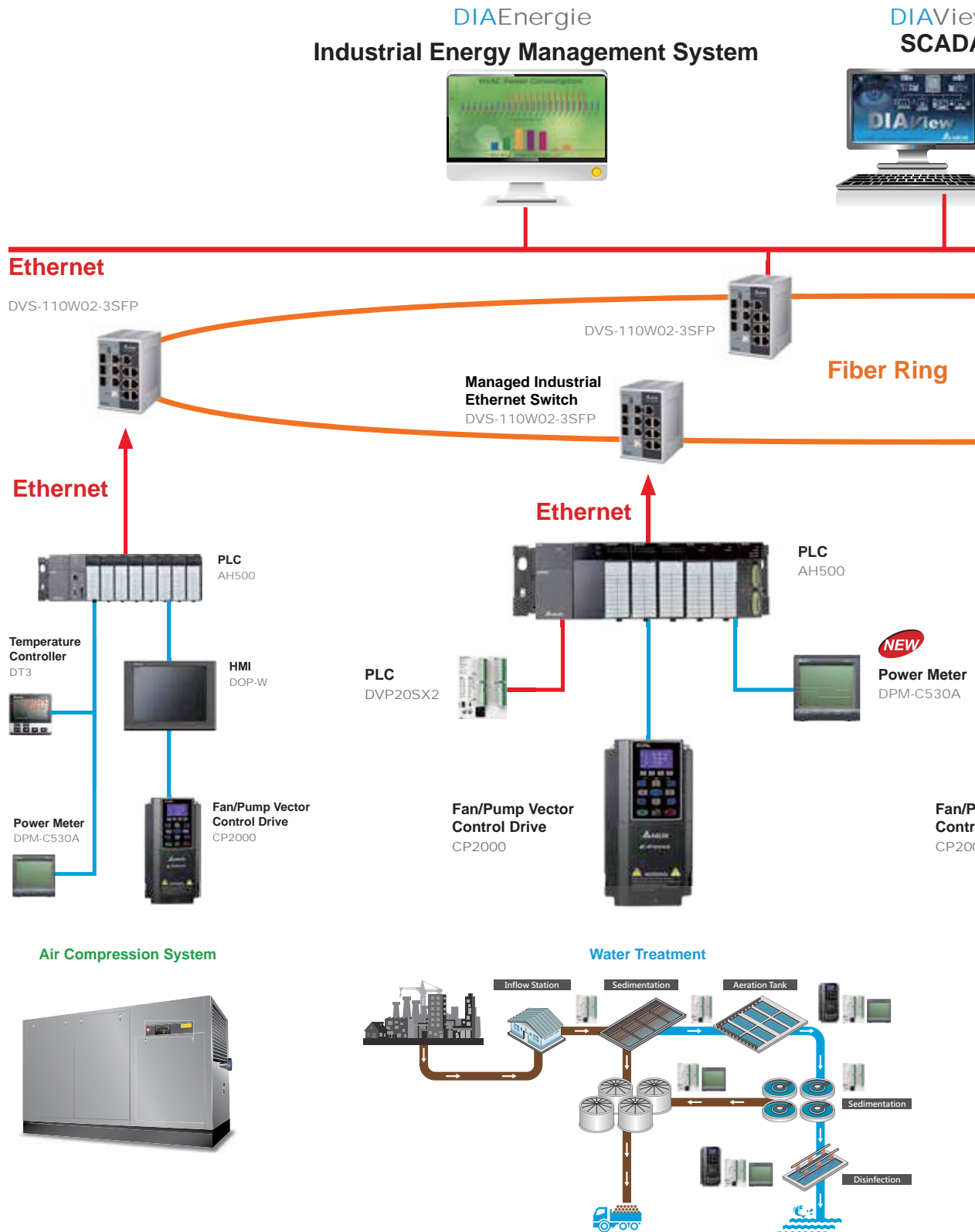

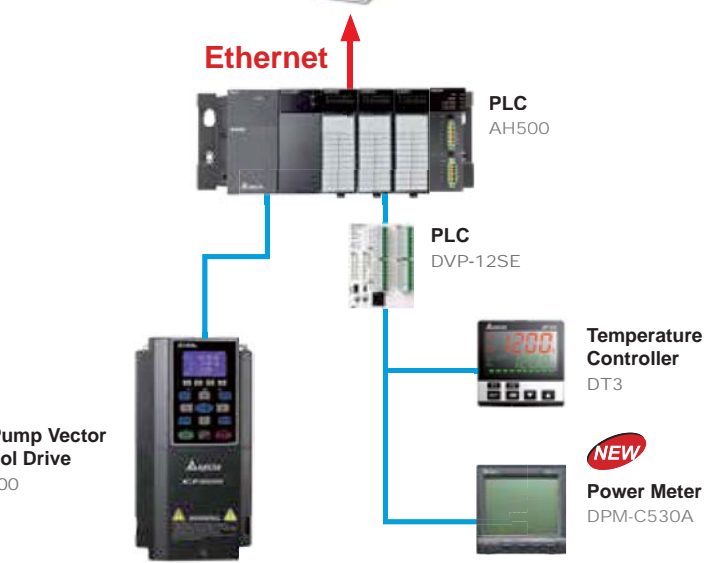

**HVAC System**

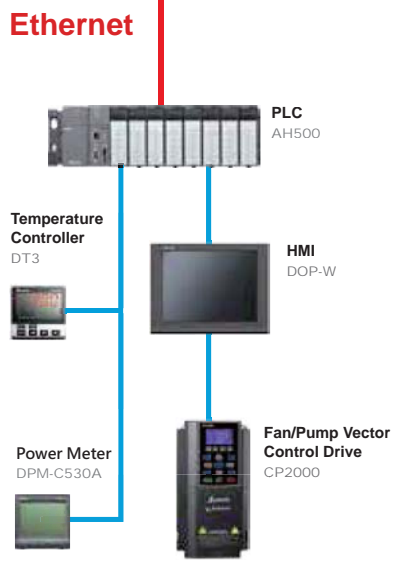

**Production Line & Environment**

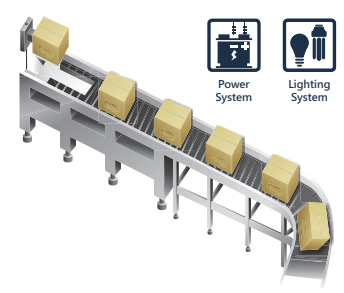
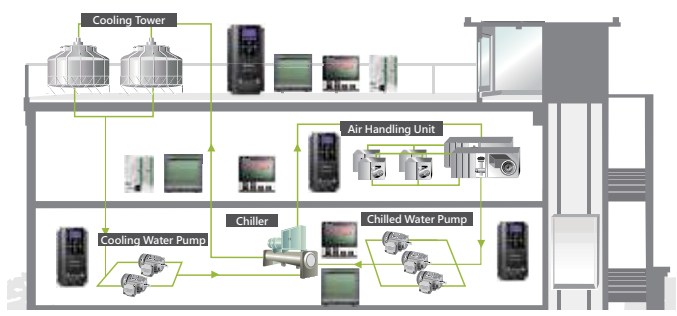

# Features

- Stable Industrial Communication Design
- Excellent Graphical Demo Platform
- Flexible Variables Dictionary
- A Variety of Data Visualization Tools
- Robust and Efficient Alarm Management
- Easy-to-Learn VBScript Language
- Efficient Recipe Management
- Reliable User Authority Management
- Open Software Structure



## Stable Industrial Communication Design Communication Functions

- ▶ Equipment auto turn on and off functions
- ▶ Sampling and data acquisition optimization
- ▶ Communication retry function
- ▶ Supports MODBUS communication
- ▶ Supports OPC Server and Client
- ▶ Seamless integration with Delta PLC products



### DIAView Monitoring and Management

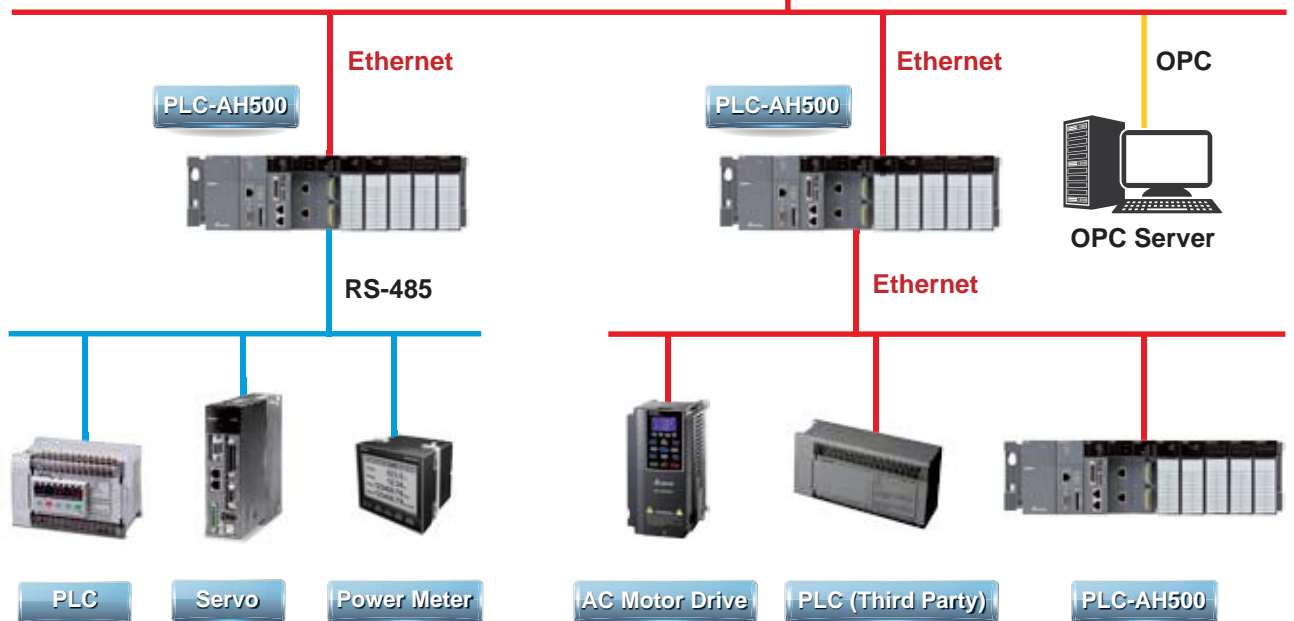

# Excellent Graphical Demo Platform

## Graphical Operator Interface

Graphical interface development is a critical factor for the SCADA system. DIAView provides an intelligent graphical symbol library that allows users to quickly create graphical elements and true color objects. It is easy to design an intuitive and easy-to-navigate operator interface for system configuration.

- ▶ WPF technology, superb display
- ▶ Complex animation, lifelike images
- ▶ Rich animation, high-quality graphics
- ▶ Easy-to-use intelligent graphical symbol library



- ▶ Easy cross-platform development with .net control platform

### Intelligent Graphical Symbol Library

- ▶ Over 1,000 kinds of commonly used industrial graphics
- ▶ Multi-level animation and operational attributes
- ▶ User-defined graphics editing available

## Customizable Engineering Components

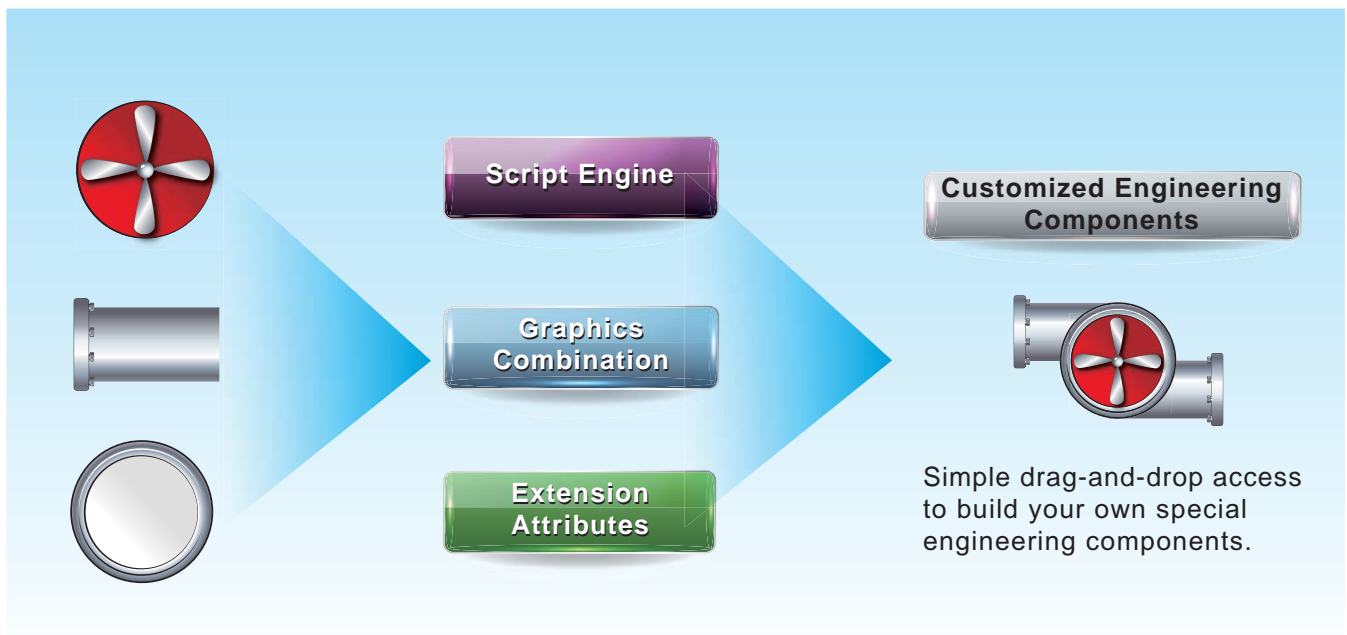

# Flexible Variables Dictionary

## Variables Dictionary

The variables dictionary is a collection of variables in a project and the variable group is a unit for grouping and managing variables.

- ▶ Add, delete and modify variables controlled through the DIAView system
- ▶ Classification and sorting by different variable groups
- ▶ Variables branching and management via a tree structure
- ▶ Batch editing parameters for improving development efficiency
- ▶ Handles large numbers of variables based on customer requirements

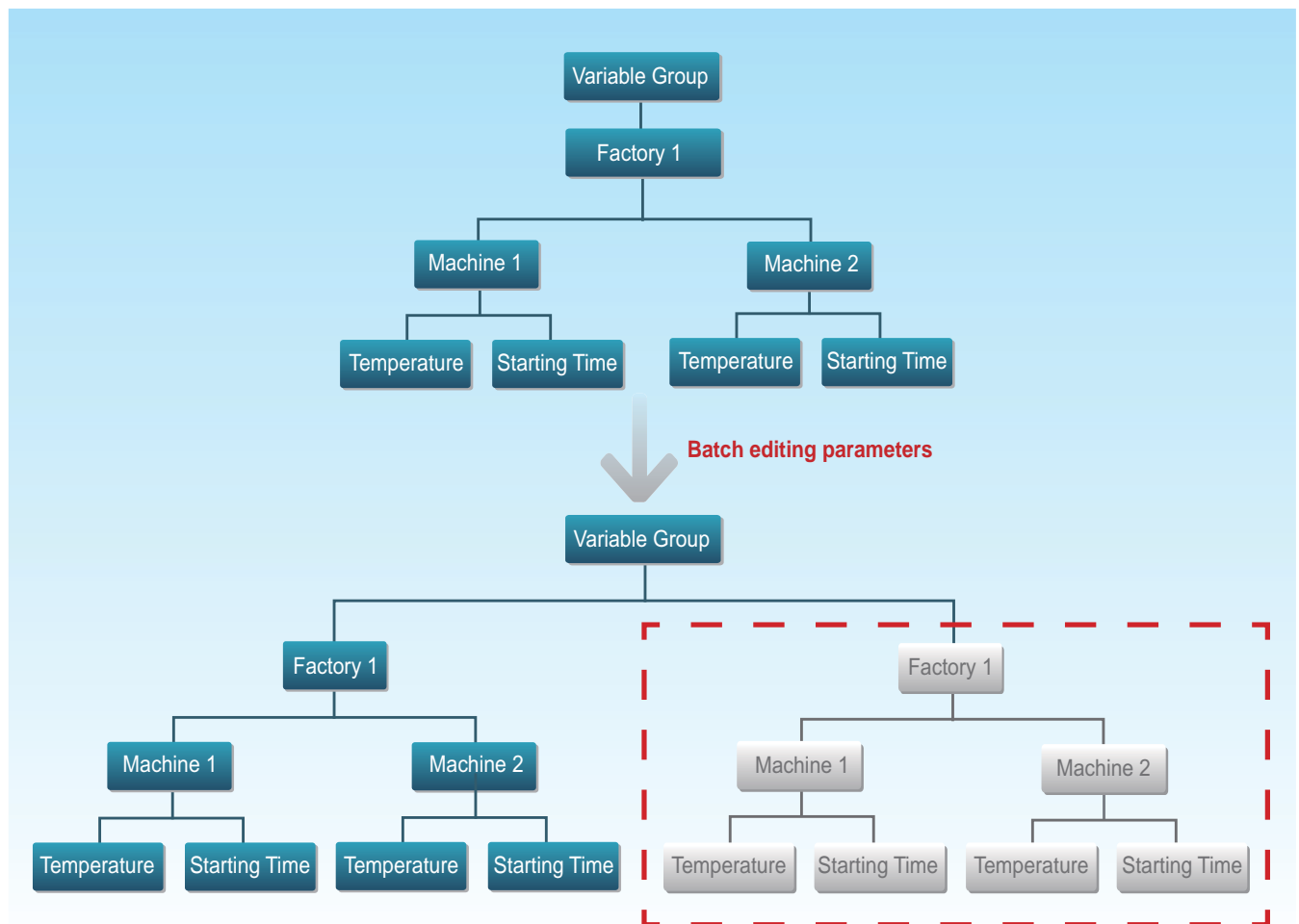
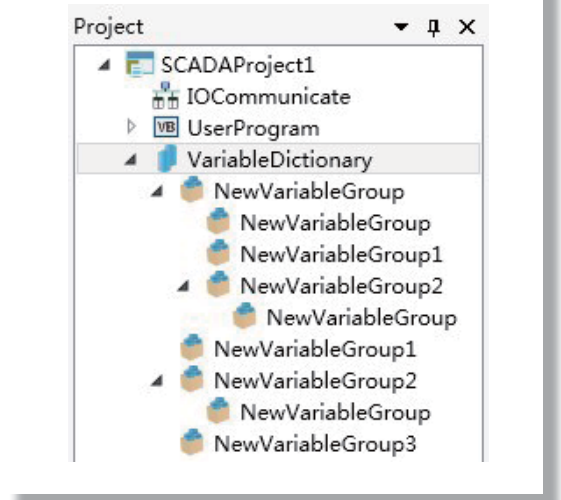



# A Variety of Data Visualization Tools

## Reports and Templates

- ▶ Microsoft Office Excel editing interface
- ▶ Processes various reports in a variety of formats
- ▶ Offers more flexible template functions for creating customizable templates
- ▶ Reports import and export functions for information and analysis



Variables and parameters configuration

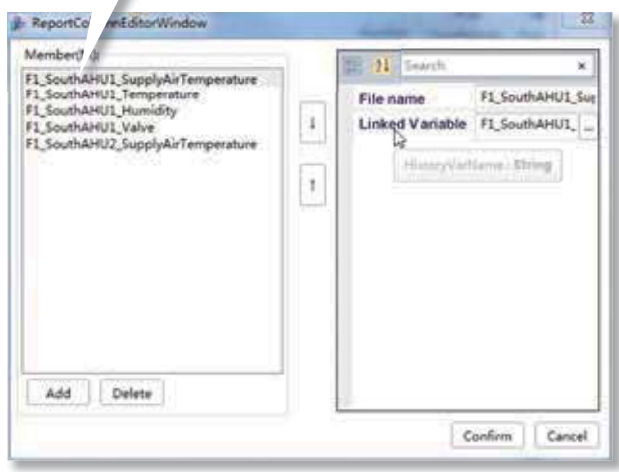

Reports Import and Export

Temperature Reports			Temperature Reports of HVAC System				
Time	Supply Air Temperature ( °C )	Temp	Time	Supply Air Temperature ( °C )	Return Air Temperature ( °C )	Fresh Air Temperature ( °C )	Supply Air Temperature ( °C )
2015/06/11 10:00:00	24		2015/06/11 10:00:00	24	23	18	24
2015/06/11 10:01:00	24		2015/06/11 10:01:00	24	23	18	24
2015/06/11 10:02:00	24		2015/06/11 10:02:00	24	23	18	24
2015/06/11 10:03:00	25		2015/06/11 10:03:00	25	24	19	25
2015/06/11 10:04:00	25		2015/06/11 10:04:00	25	24	19	25
2015/06/11 10:05:00	26		2015/06/11 10:05:00	26	25	20	26
2015/06/11 10:06:00	26		2015/06/11 10:06:00	26	25	20	26
2015/06/11 10:07:00	26		2015/06/11 10:07:00	26	25	20	26
2015/06/11 10:08:00	26		2015/06/11 10:08:00	26	25	20	26
2015/06/11 10:09:00	26		2015/06/11 10:09:00	26	25	20	26
2015/06/11 10:10:00	27		2015/06/11 10:10:00	27	26	21	27
2015/06/11 10:11:00	27		2015/06/11 10:11:00	27	26	21	27
2015/06/11 10:12:00	27		2015/06/11 10:12:00	27	26	21	27

# A Variety of Data Visualization Tools

## Trends and Charts

- ▶ Trend graphs, pie charts, and bar charts
- ▶ Create online graphs and charts of real-time and historical data
- ▶ Data exchange in relational databases

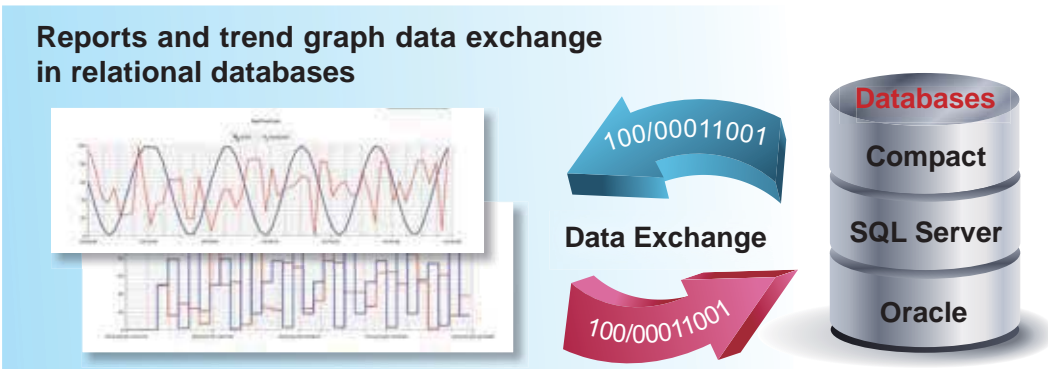
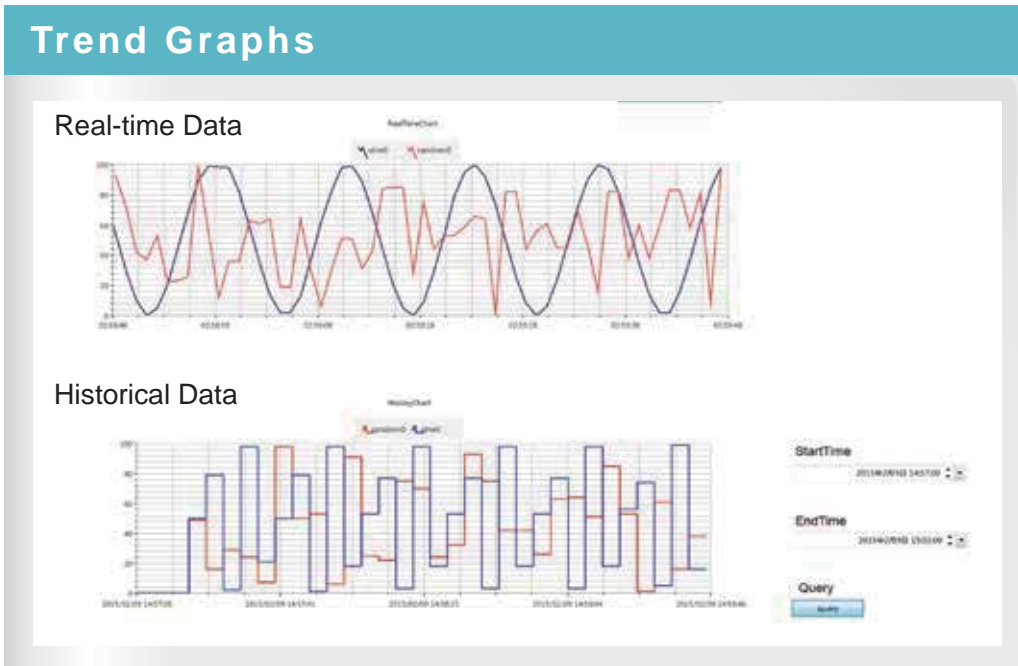

Pie Chart

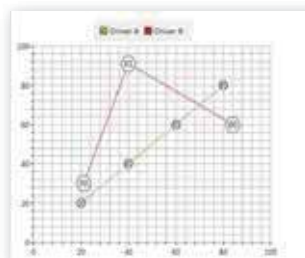

XY Chart

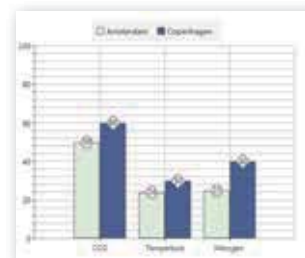

Bar Chart

# Robust and Efficient Alarm Management

## Alarm Functions

The DIAView system provides realtime alarm and early warning capabilities for faster response to critical situations. This prevents damage to equipment, ensures a safer working environment, and meets other operational needs.

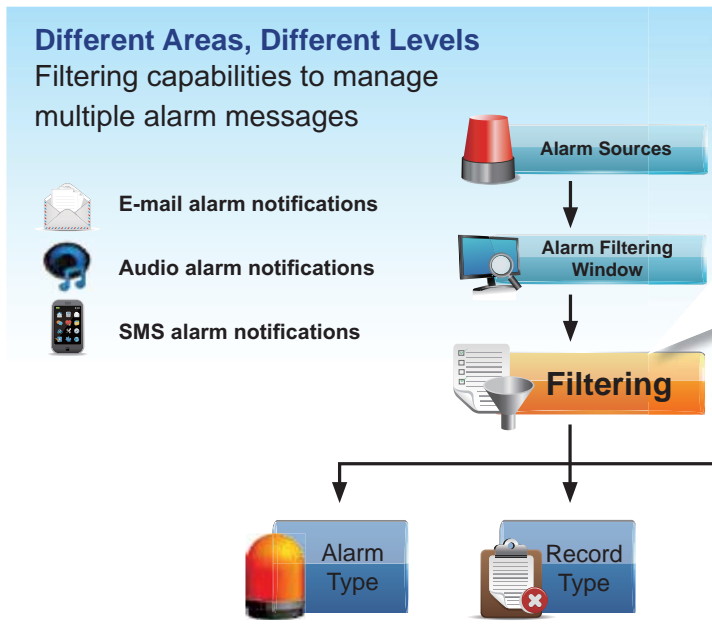

### Alarm Filtering:

Users can easily see the alarm status of the connected equipment, display alarm records and define the alarm levels simply by checking the boxes of different options in the alarm filtering window.



Alarm Filtering Window

## Support 3rd Party Software Database



DIAView SCADA



**Easy to expand data types**

- ▶ Easily Data Exchange
- ▶ Support SQL Server, SQL Compact, Oracle Database
- ▶ Integrate with 3<sup>rd</sup> Party SW

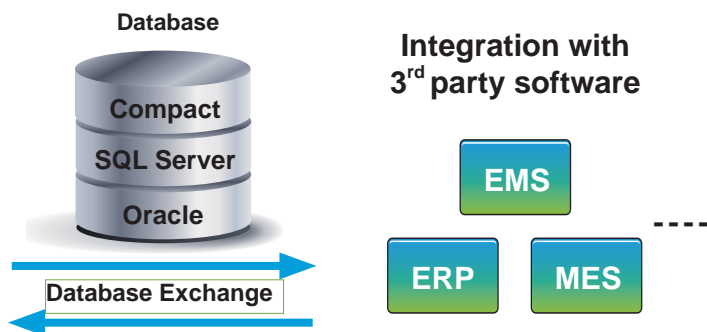

# Easy-to-Learn VBScript Language

## VBScript Language

VBScript stands for Visual Basic Scripting. It offers a lightning fast interpreter that is widely used among system administrators in the Microsoft environment for IE Browsers that does not increase the burden on your server.

VBScript language has a very simple syntax, and is easy to learn and implement. It can be configured to execute visual programming, smart sensing, automatic alerts, grammar checking, and error prompts.

- ▶ Read and write protection
- ▶ Supports Chinese characters
- ▶ Three kinds of scripts indexing
- ▶ Default value reading and writing
- ▶ Case insensitive
- ▶ Error script codes for precise positioning

```

1 Dim objUserList, objUserArray, strUser, i
2 objUserList = UserCmd.GetAllUserNames()
3 objUserArray = Split(objUserList, ",")
4 For i = 0 To UBound(objUserArray)
5     strUser = objUserArray(i)
6     user.Items.Add(strUser)
7 Next
    
```

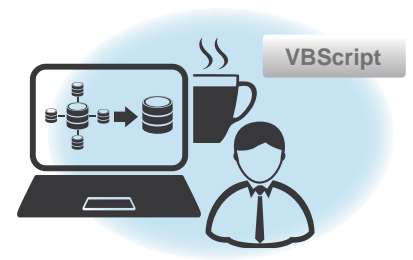

# Efficient Recipe Management

## Recipe Management

This function allows users to create their own special recipes to suit their manufacturing and development requirements and improve production speed and accuracy for a wide range of industries such as food, pharmaceuticals, and more.



## Bread Recipe

Recipe Configuration				
Ingredients	Variable	Sweet	Salty	Coffee Flavor
Sugar	Variable1	85	10	30
Cream	Variable2	10	10	10
Salt	Variable3	5	80	10
Coffee Powder	Variable4	0	0	50



# Reliable User Authority Management

## User Authority

This function allows users to assign authority levels and register passwords to set permissions for different users for security control.

User authority management includes: login, logout, change password, add and delete users.

- ▶ System administrators can operate all security areas and manage all users.
- ▶ An administrator has the authority to add and delete users, and modify user information.
- ▶ Operators can specify the security area and perform operations.

### User Authority Table

Users	Permission	Remarks
Administrator	Add and remove users, manage security areas, associated security areas and operator's authority	System default is for a one system administrator
Operator	Login, logout, and edit relevant screens and variables	Objects can only be edited in relevant security areas

### Security Area

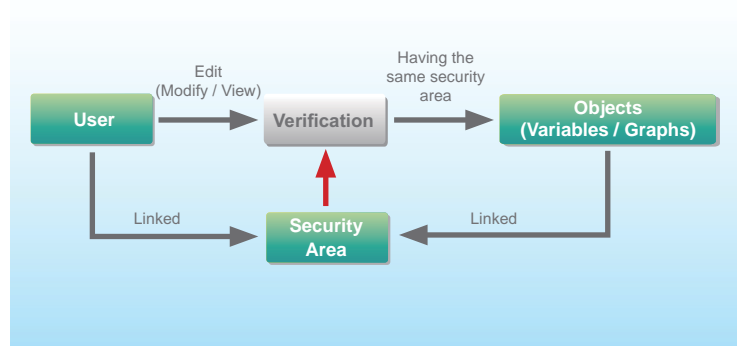

# Remote Monitoring - Client Server

DIAView SCADA

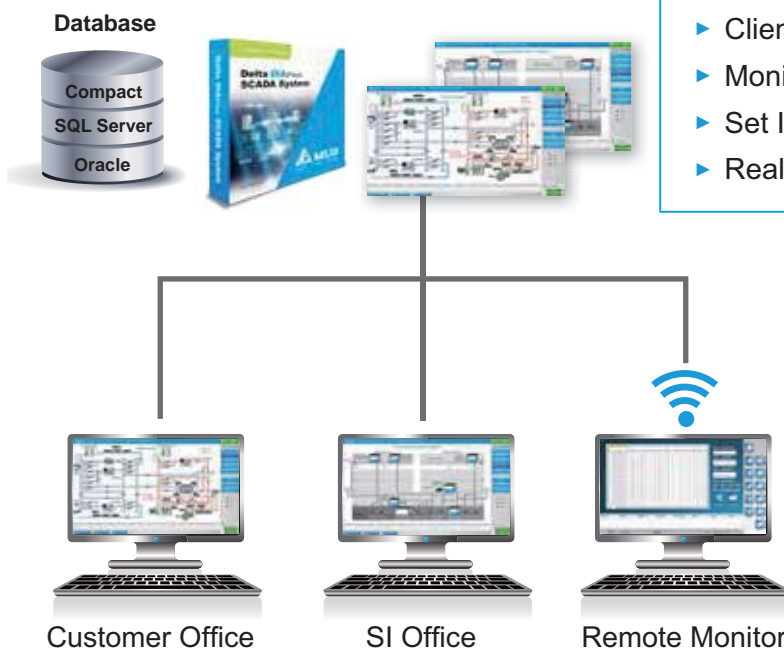

### Remote Monitoring

- ▶ Client/Server support connect Server remotely
- ▶ Monitor the real-time data anytime and anywhere
- ▶ Set IP address to connect server
- ▶ Real-time get the alarm information and debug



- ▶ Easily IP Setting
- ▶ Set password for security Protection

# Minimum System Requirements of DIAView

Hardware / Software	System Requirements
CPU	Pentium 2.0GHz or greater is recommended (Intel's Core I3 and higher processors are recommended)
Memory	2G MB and above is recommended
Hard Disk	Capacity: 10GB and above
Monitor	Supports resolution: 1024 x 768 or higher full-color display
Operating System	Windows 7 Professional / Ultimate (32 bit & 64 bit); Windows 8 Professional / Ultimate (32 bit & 64 bit); Windows Server 2003/2008/2012 (32 bit & 64 bit)
Web Installer	Microsoft NET Framework 4.0 should be installed

## Software Licensing (Single Version)



### Licensing

- ▶ DIAView licensing is calculated based on the I/O points of a customer's connected devices, and the software itself is free of charge, making it one of the most cost-efficient SCADA systems available.
- ▶ When licensing is authorized, users can use a USB hardware key to enable and carry out all authorizations. If the licensing is not authorized, the trial can be performed for only 2 hours.



### I/O Points

- ▶ Eight standard options: 64, 128, 256, 512, 1000, 1500, 3000 and unlimited.
- ▶ The point limit is the maximum number of a customer's connected I/O device addresses that can be read.



### Cost of I/O Points

- ▶ Based on purchased I/O points (external), users are allowed to use that number of external I/O points and support unlimited internal tags

## Industrial PCs IPC/PPC

Together with DIAView SCADA system software, Delta also provides the DIAView IPC (Industrial PC) and PPC (Panel PC) two series of industrial PC products that offer excellent scalability and flexibility and meet the needs of a variety of industrial applications and facility requirements.

### DIAPH-IPC003100/ DIAPH-IPC005100



### Introduction

The IPC series DIAPH-IPC003100 and DIAPH-IPC005100 models are low power consumption, high reliability, and fully-sealed fanless industrial control PCs which integrate with an Intel® Processor I3 4030U / Intel® Processor I5-4200U, 4GB DDRIII and are equipped with abundant I/O interfaces. The DIAView IPC series supports Windows XP, Windows 7, Linux and other operating systems.

Delta's IPC series has an elegant design with a dark printed metallic finish, and features a rugged, fully-sealed fanless and compact aluminum alloy metal shell for anti-interference, good heat dissipation, long-life, and low power consumption. Highly durable, this product is resistant to harsh environments, vibration and impact, and adapted for high pollution levels and high temperature applications. The IPC series complies with the relevant safety standards for harsh environments and meets customer needs for a wide range of industrial applications, such as machinery equipment, intelligent transportation, industrial automation and other industries.

### Features

- ▶ Intel® Core I3 4030U / I5-4200U
- ▶ 4GB DDRIII memory equipped as standard
- ▶ 4x USB ports / 6x Serial COM ports (5x RS-232, 1x RS-485 / RS-422)
- ▶ 1x VGA, 1x HDMI display port
- ▶ 2x RJ45 Gigabit Ethernet LAN
- ▶ 1x Audio port
- ▶ Fully-sealed fanless design, suitable for harsh industrial environment applications
- ▶ Color: Black

# DIAVH-IPC003100/ DIAVH-IPC005100

## Dimensions

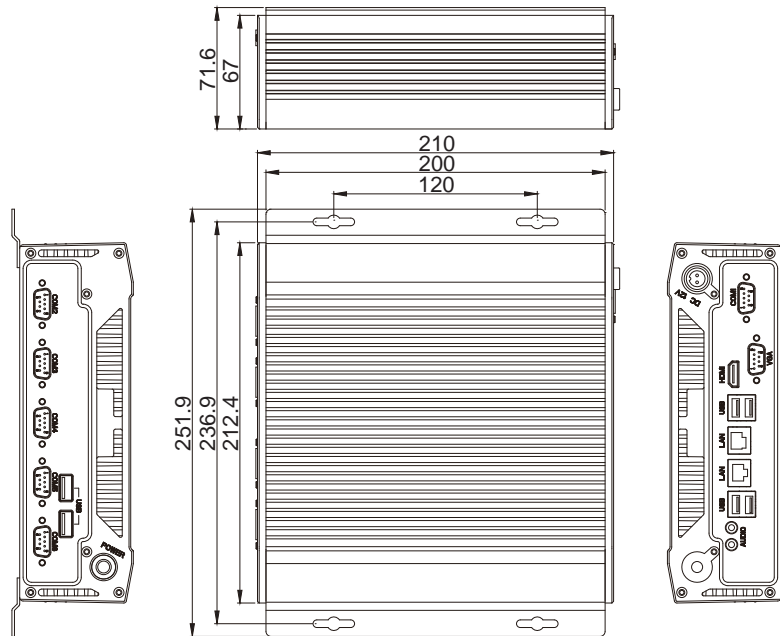

Units: mm

## Specifications

Model Name	DIAVH-IPC003100/ DIAVH-IPC005100	
Performance	CPU	Intel® Core I3 4030U Intel® Core I5 4200U
	Chipset	Cores Dual Core Processor
	Frequency	1.9Hz / 2.6GHz
	Memory	DDRIII 4GB / DDRIII 1333MHz
	Storage	512G SSD
Power Characteristics	Power Supply	100 ~ 240 VAC / 50 ~ 60 Hz (with power adapter) 12 VDC / 5 A (without power adapter)
	Power Consumption	16 W (Standby mode) 20.4 W (Running Max. Power 100%)
I/O Interface	USB	4x USB 2.0 ports
	Serial COM Port	6x Serial COM ports (5x RS-232, 1x RS-485 / RS-422)
	Ethernet Port	2x RTL8111E RJ45 Gigabit Ethernet LAN
	Audio Output	1x Audio output
	Display	1x VGA, 1x HDMI
Operating System	Operating System	Windows 7
Environmental Test	Anti-Vibration	5 ~ 19 Hz/1.0 mm amplitude; 19 ~ 200 Hz/1.0 g acceleration
	Anti-Shock	10 g acceleration, 11 ms duration
	Reliability	MTBF ≥ 50000 h; MTTR ≤ 0.5 h
	Operating Temperature	-10°C ~ 50°C (with air flow)
	Storage Temperature	-20°C ~ 60°C
Mechanical Properties	Operating Humidity	95 % @40°C, non-condensing
	Dimensions	212.4mm(L)×206mm(W)×67 mm(H)
	Material	Aluminum alloy metal shell, fully-sealed fanless design
	Weight	2.8 kg / 3.5 kg (net weight / gross weight)
	Color	Black



# DIAVH-PPC153100/ DIAVH-PPC155100



## Introduction

The PPC series DIAVH-PPC153100 and DIAVH-PPC155100 models are low power consumption, high performance, high reliability, and fully-sealed fanless industrial panel PCs combined with aluminum alloy die cast technology on front and rear panels for improved heat dissipation.

These two models integrate with an Intel® Core I3 4030U / Intel® Processor I5-4200U dual-core processor, 4GB DDRIII memory, and are equipped with abundant I/O interfaces. The PPC series adopts a slim panel PC design and allows fanless operations. This series also supports Windows XP, Windows 7, Linux and other operating systems.

Delta's DIAView PPC series is suitable for the plastic & rubber machinery, solar photovoltaic, automotive control and other industrial automation applications and industries.

## Features

- ▶ Intel® Core I3 4030U / I5-4200U
- ▶ 15-inch TFT LCD resistive touch screen
- ▶ 4GB DDRIII memory equipped as standard
- ▶ 4x USB ports / 4x Serial COM ports ( 3 \* RS232, 1\* RS422/485 )
- ▶ 1x VGA, 1x HDMI display port
- ▶ 2x RJ45 Gigabit Ethernet LAN
- ▶ 1x Audio port
- ▶ Fully-sealed fanless design, suitable for harsh industrial environment applications
- ▶ Color: Silver

# DIAVH-PPC153100/ DIAVH-PPC155100

## Dimensions

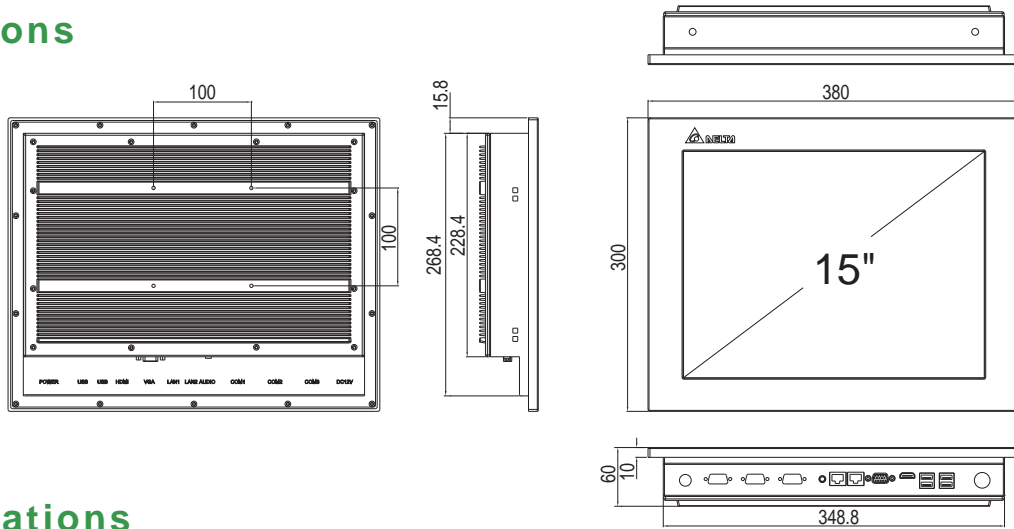

Units: mm

## Specifications

Model Name	DIAVH-PPC153100/ DIAVH-PPC155100	
Display Features	Display	15-inch TFT LCD
	Resolution	1024 x 768
	Brightness	350 cd/m <sup>2</sup>
	Contrast Ratio	400 : 1
	Touch Screen	Resistive touch screen
Performance	CPU	Intel® Core I3 4030U Intel® Core I5 4200U
	Chipset	Cores Dual Core Processor
	Frequency	1.9Hz / 2.6GHz
	Memory	DDRIII 4GB / DDRIII 1333MHz
	Storage	512G SSD
Power Characteristics	Power Supply	100 ~ 240 VAC / 50 ~ 60 Hz (with power adapter) 12 VDC / 5 A or 9 ~ 36 VDC Optional (without power adapter)
	Power Consumption	16 W (Standby mode) 30.6 W (Running Max. Power 100%)
I/O Interface	USB	4x USB 2.0 ports
	Serial COM Port	4 * Serial COM Port ( 3 * RS232, 1* RS422/485 )
	Ethernet Port	2x RTL8111E RJ45 Gigabit Ethernet LAN
	Audio Output	1x Audio output
	Display	1x VGA, 1x HDMI
Operating System	Operating System	Windows 7
Environmental Test	Anti-Vibration	5 ~ 19 Hz/1.0 mm amplitude;19 ~ 200 Hz/1.0 g acceleration
	Anti-Shock	10 g acceleration, 11 ms duration
	IP Rating	Front Panel IP65 (Optional)
	Reliability	MTBF ≥ 50000 h; MTTR ≤ 0.5 h
	Operating Temperature	-10°C ~ 50°C (with air flow)
	Storage Temperature	-20°C ~ 60°C
Mechanical Properties	Operating Humidity	95 % @40°C, non-condensing
	Dimensions	380 mm (L) x 300 mm (W) x 60 mm (H)
	Material	Aluminum alloy metal shell, fully-sealed fanless design
	Weight	5.6 kg / 7.6 kg (net weight / gross weight)
	Color	Silver

# DI AVH-PPC193100/ DI AVH-PPC195100



## Introduction

The PPC series DI AVH-PPC193100 and DI AVH-PPC195100 models are low power consumption, high performance, high reliability, and fully-sealed fanless industrial panel PCs combined with aluminum alloy die cast technology on front and rear panels for improved heat dissipation.

These two models integrate with an Intel® Core I3 4030U /I5-4200U dual-core processor, 4GB DDRIII memory, and are equipped with abundant I/O interfaces. The PPC series adopts a slim panel PC design and allows fanless operations. This series also supports Windows XP, Windows 7, Linux and other operating systems.

Delta's PPC series is suitable for the plastic & rubber machinery, solar photovoltaic, automotive control and other industrial automation applications and industries.

## Features

- ▶ Intel® Core I3 4030U /I5-4200U dual-core processor
- ▶ 19-inch TFT LCD resistive touch screen
- ▶ 4GB DDRIII memory equipped as standard
- ▶ 4x USB ports / 4x Serial COM ports (3x RS-232, 1x RS-485 / RS-422)
- ▶ 1x VGA, 1x HDMI display port
- ▶ 2x RJ45 Gigabit Ethernet LAN
- ▶ 1x Audio port
- ▶ Fully-sealed fanless design, suitable for harsh industrial environment applications
- ▶ Color: Silver

# DIAVH-PPC193100/ DIAVH-PPC195100

## Dimensions

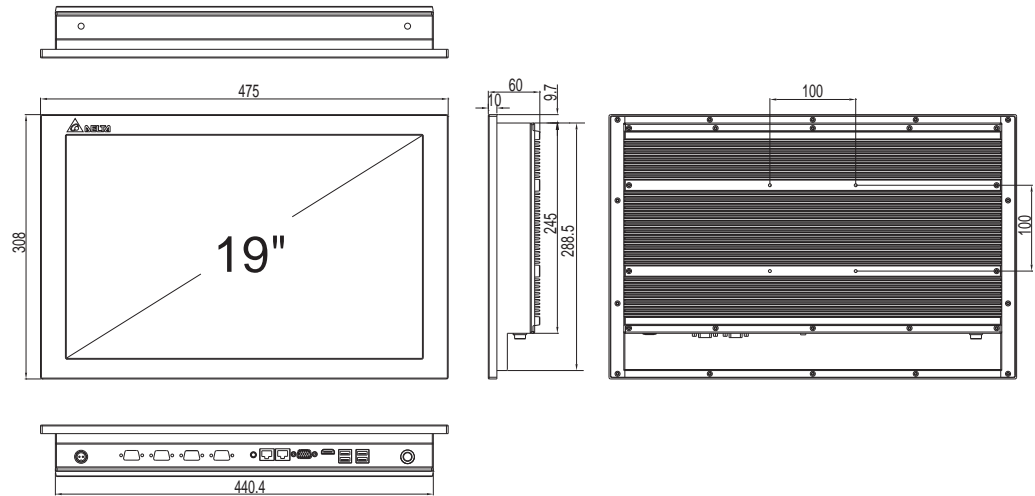

Units: mm

## Specifications

Model Name	DIAVH-PPC193100/ DIAVH-PPC195100	
Display Features	Display	19-inch TFT LCD
	Resolution	1440 x 900
	Brightness	250 cd/m <sup>2</sup>
	Contrast Ratio	1000:1
	Touch Screen	Resistive touch screen
Performance	CPU	Intel® Core I3 4030U Intel® Core I5-4200U
	Chipset	Cores Dual Core Processor
	Frequency	1.9Hz / 2.6GHz
	Memory	DDRIII 4GB / DDRIII 1333MHz
	Storage	512G SSD
Power Characteristics	Power Supply	100 ~ 240 VAC / 50 ~ 60 Hz (with power adapter)
	Power Consumption	17 W (Standby mode) 31 W (Running Max. Power 100%)
I/O Interface	USB	4x USB 3.0 ports
	Serial COM Port	4x Serial COM ports (3x RS-232, 1x RS-485 / RS-422)
	Ethernet Port	2x RTL8111E RJ45 Gigabit Ethernet LAN
	Audio Output	1x Audio output
	Display	1x VGA, 1x HDMI
Operating System	Operating System	Windows 7
Environmental Test	Anti-Vibration	5 ~ 19 Hz /1.0 mm amplitude;19 ~ 200 Hz /1.0 g acceleration
	Anti-Shock	10 g acceleration, 11 ms duration
	IP Rating	Front Panel IP65 (Optional)
	Reliability	MTBF ≥ 50000 h; MTTR ≤ 0.5 h
	Operating Temperature	-10°C ~ 50°C (with air flow)
	Storage Temperature	-20°C ~ 60°C
	Operating Humidity	95 % @40°C, non-condensing
Mechanical Properties	Dimensions	475 mm(L)× 308 mm(W)× 57 mm(H)
	Material	Aluminum alloy metal shell, fully-sealed fanless design
	Weight	6.1 kg / 8.0 kg (net weight / gross weight)
	Color	Silver



# Applications

## Wastewater Treatment Monitoring & Control System

- With DIAView, control and process monitoring of wastewater plants can be easily managed from the central control room. All process data and historical alarm / events can also be viewed and recorded for enhanced monitoring.
- DIAView offers analysis and calculation functions, enabling various aspects of flow analysis and sophisticated water quality analysis and calculation. This helps to properly control chemical feed systems and automatically adjusts the chemical feed pump or valve, reducing associated risks and operation costs.



Wastewater Treatment Plants

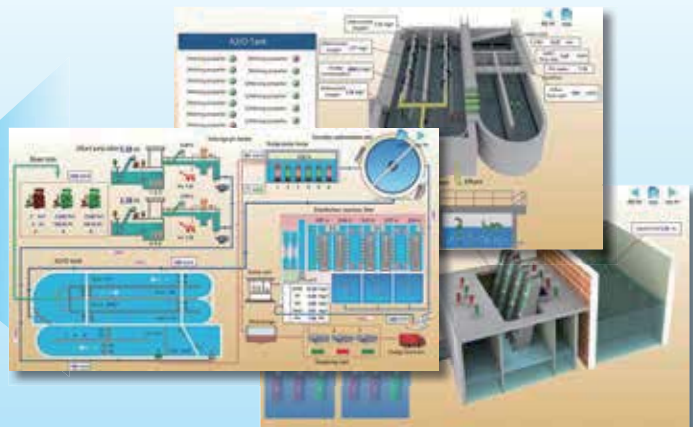

Control and Process Monitoring of Wastewater Treatment Plants

## HVAC Energy-Saving Monitoring & Control System

- Integrates DIAView, PLC and AC motor drives to fulfill requirements for constructing an HVAC intelligent monitoring and control system, providing energy savings of 20% ~ 60%.
- DIAView helps to automatically adjust fan frequency and chiller load according to the indoor temperature and monitor the status of the air conditioning system in real-time for excellent HVAC control and monitoring.
- Comparing indoor and outdoor conditions, it also monitors the density of indoor CO<sub>2</sub>, and then lets in fresh outside air to reduce reliance on the air conditioning system, save more energy, and create a comfortable indoor environment for users.



HVAC System Structure



HVAC System Intelligent Monitoring and Control

# Applications

## Inspection & Monitoring of Electronic Equipment

- DIAView helps to coordinate PLCs, schedule the equipment to perform inspection step by step, and provide group control functions.
- With DIAView, the system can record daily production conditions, identify qualified and unqualified products, and provide data acquisition and inquiry functions.



Electronic Inspection Equipment



Inspection and Monitoring of Electronic Equipment

## Remote Control & Monitoring of 4-Color Printing Machines

- DIAView provides remote and real-time monitoring and control of printing processes and the entire operation.
- Suppliers can use the remote lock function of DIAView to lock machines remotely and protect data that might be lost to manage their own receivables.



Actual Printing Machine



Remote Control & Monitoring of 4-Color Printing Machine

## Ordering Information

Product	Model Name	Descriptions
DIAView	DIAV-010640000C	DIAView SCADA Standalone Vision, 64 I/O points, Watchdog USB Key
	DIAV-011280000C	DIAView SCADA Standalone Vision, 128 I/O points, Watchdog USB Key
	DIAV-012560000C	DIAView SCADA Standalone Vision, 256 I/O points, Watchdog USB Key
	DIAV-015120000C	DIAView SCADA Standalone Vision, 512 I/O points, Watchdog USB Key
	DIAV-0101K0000C	DIAView SCADA Standalone Vision, 1000 I/O points, Watchdog USB Key
	DIAV-011K50000C	DIAView SCADA Standalone Vision, 1500 I/O points, Watchdog USB Key
	DIAV-0103K0000C	DIAView SCADA Standalone Vision, 3000 I/O points, Watchdog USB Key
	DIAV-0199K0000C	DIAView SCADA Standalone Vision, Unlimited I/O points, Watchdog USB Key
	DIAV-020640500C	DIAView SCADA C/S version, 64 tags & 5 C/S , Watchdog USB Key
	DIAV-021280500C	DIAView SCADA C/S version, 128 tags & 5 C/S , Watchdog USB Key
	DIAV-022560500C	DIAView SCADA C/S version, 256 tags & 5 C/S , Watchdog USB Key
	DIAV-025120500C	DIAView SCADA C/S version, 512 tags & 5 C/S , Watchdog USB Key
	DIAV-0201K0500C	DIAView SCADA C/S version, 1000 tags & 5 C/S , Watchdog USB Key
	DIAV-021K50500C	DIAView SCADA C/S version, 1500 tags & 5 C/S , Watchdog USB Key
	DIAV-0203K0500C	DIAView SCADA C/S version, 3000 tags & 5 C/S , Watchdog USB Key
	DIAV-0299K0500C	DIAView SCADA C/S version, Unlimited I/O tags & 5 C/S , Watchdog USB Key
	DIAV-020641000C	DIAView SCADA C/S version, 64 tags & 10 C/S , Watchdog USB Key
	DIAV-021281000C	DIAView SCADA C/S version, 128 tags & 10 C/S , Watchdog USB Key
	DIAV-022561000C	DIAView SCADA C/S version, 256 tags & 10 C/S , Watchdog USB Key
	DIAV-025121000C	DIAView SCADA C/S version, 512 tags & 10 C/S , Watchdog USB Key
	DIAV-0201K1000C	DIAView SCADA C/S version, 1000 tags & 10 C/S , Watchdog USB Key
	DIAV-021K51000C	DIAView SCADA C/S version, 1500 tags & 10 C/S , Watchdog USB Key
	DIAV-0203K1000C	DIAView SCADA C/S version, 3000 tags & 10 C/S , Watchdog USB Key
	DIAV-0299K1000C	DIAView SCADA C/S version, Unlimited I/O tags & 10 C/S , Watchdog USB Key

Product	Model Name	Descriptions
Industrial PCs	DIAVH-IPC003104	Industrial Box PC, Intel Core i3 4030U Processor, with Windows 7 Professional 32 bit
	DIAVH-IPC003105	Industrial Box PC, Intel Core i3 4030U Processor
	DIAVH-IPC005104	Industrial Box PC, Intel Core i5 4200U Processor, with Windows 7 Professional 32 bit
	DIAVH-IPC005105	Industrial Box PC, Intel Core i5 4200U Processor
	DIAVH-PPC153104	15-inch Industrial Panel PC, Intel® Core i3 4030U Processor, with Windows 7 Professional 32 bit
	DIAVH-PPC153105	15-inch Industrial Panel PC, Intel® Core i3 4030U Processor
	DIAVH-PPC155104	15-inch Industrial Panel PC, Intel® Core i5 4200U Processor, with Windows 7 Professional 32 bit
	DIAVH-PPC155105	15-inch Industrial Panel PC, Intel® Core i5 4200U Processor
	DIAVH-PPC193104	19-inch Industrial Panel PC, Intel® Core i3 4030U Processor, with Windows 7 Professional 32 bit
	DIAVH-PPC193105	19-inch Industrial Panel PC, Intel® Core i3 4030U Processor
	DIAVH-PPC195104	19-inch Industrial Panel PC, Intel® Core i5 4200U Processor, with Windows 7 Professional 32 bit
	DIAVH-PPC195105	19-inch Industrial Panel PC, Intel® Core i5 4200U Processor



Smarter. Greener. Together.

## Industrial Automation Headquarters

### Delta Electronics, Inc.

Taoyuan Technology Center  
18 Xinglong Road, Taoyuan District,  
Taoyuan City 33068, Taiwan (R.O.C.)  
TEL: 886-3-362-6301 / FAX: 886-3-371-6301

## Asia

### Delta Electronics (Jiangsu) Ltd.

Wujiang Plant 3  
1688 Jiangxing East Road,  
Wujiang Economic Development Zone  
Wujiang City, Jiang Su Province, P.R.C. 215200  
TEL: 86-512-6340-3008 / FAX: 86-769-6340-7290

### Delta Greentech (China) Co., Ltd.

238 Min-Xia Road, Pudong District,  
ShangHai, P.R.C. 201209  
TEL: 86-21-58635678 / FAX: 86-21-58630003

### Delta Electronics (Japan), Inc.

Tokyo Office  
2-1-14 Minato-ku Shibadaimon,  
Tokyo 105-0012, Japan  
TEL: 81-3-5733-1111 / FAX: 81-3-5733-1211

### Delta Electronics (Korea), Inc.

1511, Byucksan Digital Valley 6-cha, Gasan-dong,  
Geumcheon-gu, Seoul, Korea, 153-704  
TEL: 82-2-515-5303 / FAX: 82-2-515-5302

### Delta Electronics Int'l (S) Pte Ltd.

4 Kaki Bukit Ave 1, #05-05, Singapore 417939  
TEL: 65-6747-5155 / FAX: 65-6744-9228

### Delta Electronics (India) Pvt. Ltd.

Plot No 43 Sector 35, HSIIDC  
Gurgaon, PIN 122001, Haryana, India  
TEL : 91-124-4874900 / FAX : 91-124-4874945

## Americas

### Delta Products Corporation (USA)

Raleigh Office  
P.O. Box 12173, 5101 Davis Drive,  
Research Triangle Park, NC 27709, U.S.A.  
TEL: 1-919-767-3800 / FAX: 1-919-767-8080

### Delta Greentech (Brasil) S.A.

Sao Paulo Office  
Rua Itapeva, 26 - 3° andar Edificio Itapeva One-Bela Vista  
01332-000-São Paulo-SP-Brazil  
TEL: 55 11 3568-3855 / FAX: 55 11 3568-3865

## Europe

### Delta Electronice (Netherlands) B.V.

Eindhoven Office  
De Witbogt 20, 5652 AG Eindhoven, The Netherlands  
TEL: +31 (0)40-8003800 / FAX: +31 (0)40-8003898

\*We reserve the right to change the information in this catalogue without prior notice.