

安全上的要点

- 为了确保您的安全，请务必遵守以下内容：
- 请勿在有易燃、易爆气体的环境下使用。
 - 请勿在有水、油、化学药品飞溅的环境、及接触到蒸汽的环境下使用。
 - 请勿擅自拆卸、修理、改造本产品。
 - 使用时请勿超出额定电压、电流的范围。
 - 请注意工作电源的极性，勿接错线。
 - 请正确连接负载。
 - 请勿让负载短路。
 - 请不要在外壳破损的状态下使用。
 - 废弃时，请作为工业废弃物处理。

使用上的注意

- 传感器导线和动力线或电力线装在同一配管中使用时，会受到干扰，有误动作甚至被破坏。
- 延长导线必须使用截面积0.3mm²以上、长度100m以下的导线。将韩国S-mark认证机型作为认定品使用时，导线的长度要在10m以下（不含10m）。
- 加在导线上的力请按下列值。
拉力80N以下，扭矩0.1N·m以下，压力20N以下，弯曲3kg以下
- 接通电源后，200ms以内本产品处于可以检测的状态。所以如果负载和产品连接在不同的电源上时，必须先接通产品的电源。
- 导线引出型产品连接使用时，请同时投入电源。连接的传感器之间、电源投入的时间差在30ms以上的时候，相互干涉防止功能将无法正常工作。另外，也会出现不能使用遥控器的情况。
- 请务必在安装保护盖的状态下使用。
- 关于连接器部的短路保护（使用连接器型时）
为了防止触电和短路，请将保护用贴纸（连接器：属于E3X-CN系列）贴在不使用的连接用电源端子上。

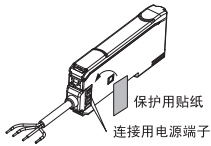

- 拆除或者增加放大器时，请务必先切断电源。
- 由于电源切断或者静电等干扰发生写入错误时（ERR/EEP闪烁），请通过本体上的设定键进行初始化处理。
- 使用手持式控制器操作时请使用E3X-MC11-SV2手持式控制器。不能使用E3X-MC11。
- 不能与E3X-DA-N系列进行光通信。
- 有时在接通电源后，需要花费一定的时间，使放大器通过适应使用环境来使受光量达到安定状态。
- 切断电源时，可能会发生输出脉冲，所以请先切断负载或者是负载线的电源。
- 请勿使用稀释剂、汽油、丙酮、及煤油类来清扫本产品。
- 请勿强行对光纤单元施加拉伸、压缩的力。光纤单元只能承受9.8N·m以内的力。

包装内容确认

·放大器单元 1台 ·使用说明书（本说明书） 1份

1. 额定/性能

型号	高功能双输出型		高功能外部输入型		
	连接方式	导线引出型	连接器型*1	导线引出型	连接器型*1
型号 (E3X-)	NPN	DA11TW-S	DA6TW-S	DA11RM-S	DA6RM-S
	PNP	DA41TW-S	DA8TW-S	DA41RM-S	DA8RM-S
电源电压	DC12~24V±10% 波动10%以下				
消费功率	消费功率 1080mW以下 (24V时45mA)				
控制输出	集电极开路 (DC26.4V以下)				
定时功能	负载电流: 50mA以下、残留电压: 1V以下、漏电流10μA以下				
定时时间	无效/OFF 延时/ON 延时/单触发 1ms~5s				
微分检测模式	有				
光量调整功能	有				
APC功能	有				
防相互干扰功能	有<光通信同期式>*2 10台*3				
输入输出设定	输出设定 (2CH输出/Area输出/自我诊断输出)		外部输入设定 (各种示教/光量调整/归零/投光OFF/计数归零)		

*1: 作为单品或者作为母机使用时，请使用连接器E3X-CN21（母连接器4芯）；作为子机使用时，请另外使用E3X-CN22（子连接器2芯）。无论哪种连接器都可以使用。
*2: 当「检测功能」设定为高速模式「SHS」时，通信功能无效，防相互干扰功能以及手持式控制器的通信功能不能使用。
*3: 光量调整功能有效时，防相互干扰功能最多可连接8台。

2. 各部分的名称及其功能

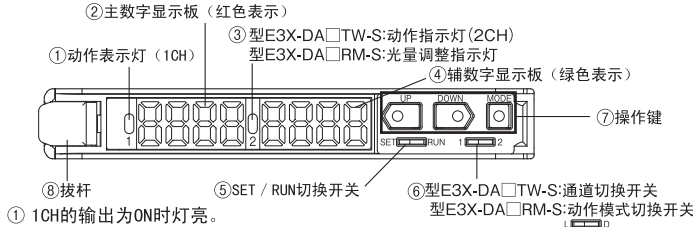

- 1CH的输出为ON时点亮。
- 显示受光量或者功能的名称。
- E3X-DA□TW-S: 2CH的输出为ON时点亮。E3X-DA□RM-S: 设定为光量调整时灯亮
- 显示检测时的辅助性情报和功能的设定值。
- 进行模式的切换。
- E3X-DA□TW-S: 进行通道的选择。E3X-DA□RM-S: 进行动作模式的切换。
- 进行显示的切换和功能的操作。
- 插拔光纤时使用。

3. 操作的基础知识

模式的切换

用「SET/RUN切换开关」进行模式切换。请切换为目标模式进行操作。

模式	内 容
SET	设定检测条件以及设定示教阈值时选择。
RUN	实际进行检测时或者进行以下设定时选择。 手动调整阈值、示教、光量调整、归零、按键锁定

按键操作

切换显示和检测条件的设定操作，用操作键进行。按键的作用，根据当前正在选择的模式不同而变化。

按键的种类	按键的作用	
	RUN模式	SET模式
UP键 ◀	调高阈值	设定以下功能 •实行示教 •顺方向变更设定值
DOWN键 ▶	调低阈值	设定以下功能 •实行示教 •逆方向变更设定值
MODE键 ■	通过MODE按键设定以下功能。 •示教 •实行光量调整 •实行归零	切换成需要设定的功能

显示内容的阅读方法

在主数字显示和辅数字显示上显示的内容，根据当前选择的模式而不同。出厂后初次接通电源时，默认显示为RUN模式的内容。

模式	主数字显示 (红色显示)	辅数字显示 (绿色显示)
SET	通过按键操作，依次显示受光量*和功能名称 *即使「检测功能」设定为「DIFF」（微分动作），也会显示受光量。	通过按键操作，会依次显示阈值*以及主数字显示板上显示的功能的设定值。 *「检测功能」设定为「DIFF」（微分动作）时，显示相对受光量变化的阈值。
RUN※	显示当前的受光量。「检测功能」上设定为「DIFF」（微分动作）时，显示受光变化量。	显示当前的阈值。「检测功能」上设定为「DIFF」（微分动作）时，显示相对受光量变化的阈值。

※显示内容可以通过「显示切换」功能进行变更。请参照「5. 详细设定」

4. 基本设定

1. 动作模式的设定

E3Z-DA□RM-S选择入光时ON还是遮光时ON，使用动作模式开关进行切换。请参照下图：E3Z-DA□TM-S用SET模式的「动作模式」进行设定。请参照「5. 详细设定」

动作模式	LON (入光时ON)	DON (遮光时ON)
设定		

2. 光量调整 (根据需要)

需要将当前检测中的受光量调整到光量调整的目标值（出厂时设定：2000）左右时进行的操作。光量调整一定要在检测物体与头部固定、受光量安定的状态下实行。

■设定方法

请事先确认「MODE键设定」的功能设定为「PTUN」（光量调整）的位置上。出厂时是设定在「PTUN」上的。请参照「5. 详细设定」

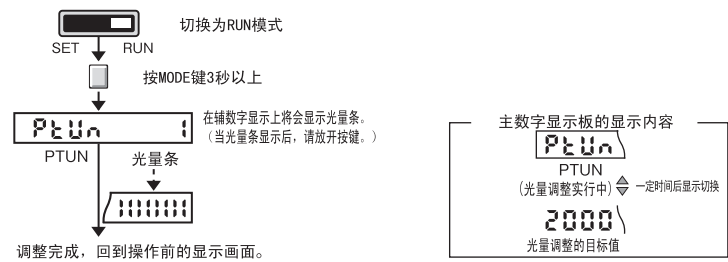

可以进行「光量调整目标值」的变更。请参照「5. 详细设定」

当检测功能选择为「SHS」下实行光量调整时，一定要设定在最小光量上。（这时「光量调整目标值」无效。）

切换检测功能后，受光量会发生变化，所以这时请在检测功能切换后再度实行光量调整。

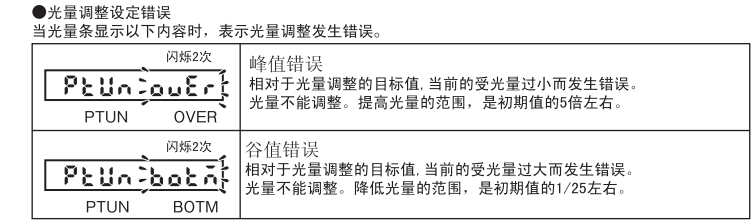

■解除方法



3. 设定阈值

1) 手动设定 手动设定阈值。

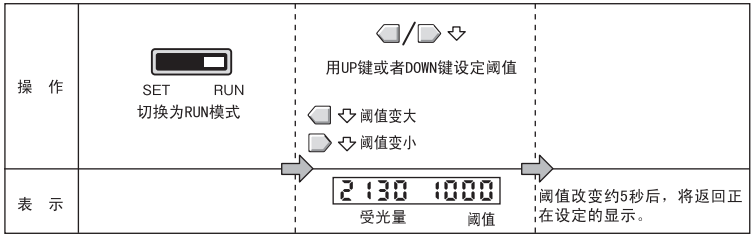

2) 示教设定

① 工件有无示教
分别检测有工件和无工件时的光量值，将两者光量值的中间值设定为阈值。RUN模式、SET模式的任何一个都可以设定。RUN模式下设定时，请预先确认「MODE键设定」功能的设定为「2PNT」。出厂时，设定为「PTUN」。请参照「5. 详细设定」

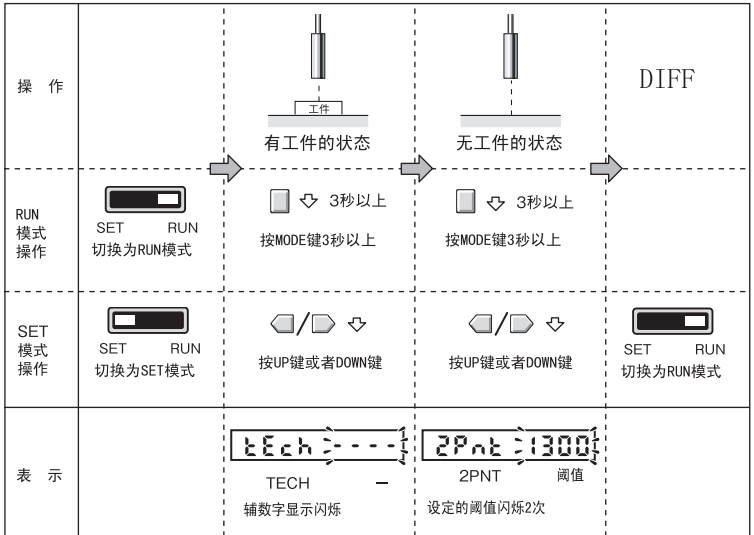

「检测功能」上设定为「DIFF」（微分动作）时，有无工件的2点的受光量之差的一半的值作为阈值。

② 自动示教 (通过移动工件设定)
在连续按键的过程中检测微小光量，可以设定其最大值和最小值的中间值为阈值。请预先确认「MODE键设定」功能的设定为「AUTO」。出厂时，设定为「PTUN」。请参照「5. 详细设定」

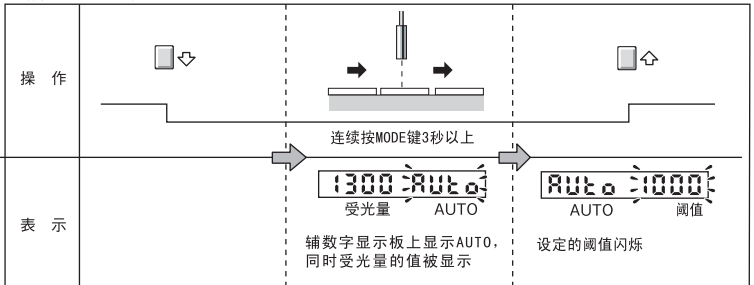

「检测功能」选择为「DIFF」（微分动作）时，自动示教变为无效。

③ 对射型无工件示教
使用对射型光纤时，以无工件的状态进行设定的方法。（没有工件状态）将受光量的约-6%的值作为阈值设定，能够检测微小的光量差。

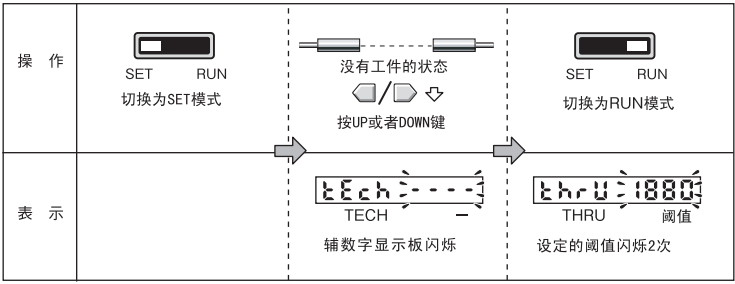

「检测功能」上设定为「DIFF」（微分动作）时，会被设定为（没有工件状态）受光量的下侧，能够安定检测的最小位置的阈值。

④ 反射型无工件示教

使用反射型光纤时，以无工件的状态进行设定的方法。（没有工件状态）将受光量的约+6%的值作为阈值设定，能够检测微小的光量差。

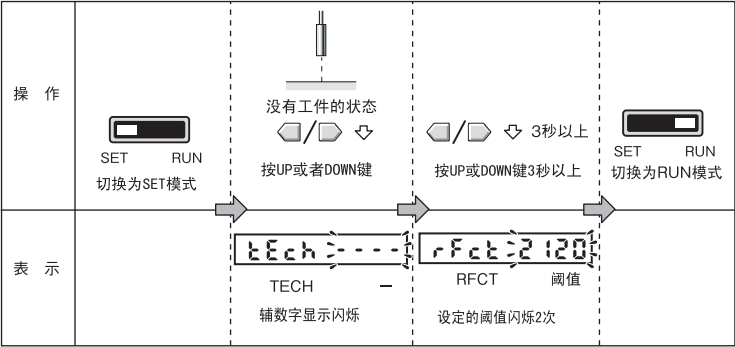

「检测功能」上设定为「DIFF」（微分动作）时，会被设定为（没有工件状态）受光量的上侧，能够安定检测的最小位置的阈值。

⑤ 最大感度设定

用最大感度设定阈值。这是想将检测距离设定到最长时非常便利的方法。

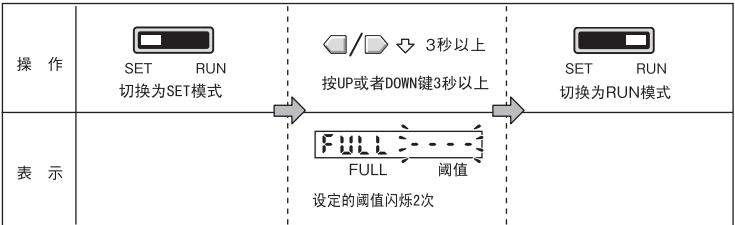

有/无工件与设定无关。设定的值，根据「检测功能」和「光量调整」而变化。「检测功能」上设定为「DIFF」（微分动作）时，无法使用这个方法进行阈值设定。

·示教错误

实行示教后，辅数字显示上显示下列内容是表示发生错误。只是，虽然会设定在阈值可能的范围，但有时也会无法正确检测。

	OVER ERROR 受光量过大。 请在进行以下任意一个内容之后，再实行示教。 •调整头部，使受光量变小 •实行光量调整
	LOW ERROR 受光量过小。 请在进行以下任意一个内容之后，再实行示教。 •调整头部，使受光量变大 •实行光量调整
	NEAR ERROR 受光量的变化过小。 请调整头部，使受光量的变化变大后，再度实行示教

5.详细设定

在SET模式中，能够进行以下的功能设定。
功能迁移上显示的内容，是出厂时的内容。
「动作模式」和「定时器」以外的功能是两个通道共通的设定。

*:阈值、受光量、百分比等数值的显示内容只是一个例子，与实际显示不同。

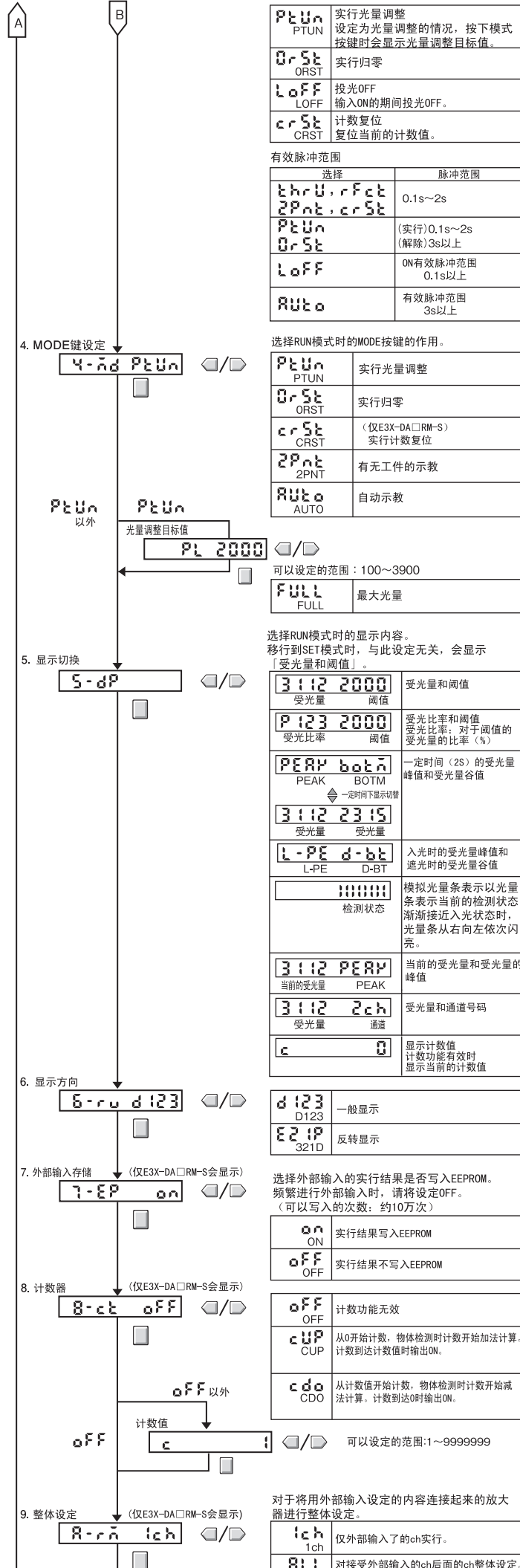
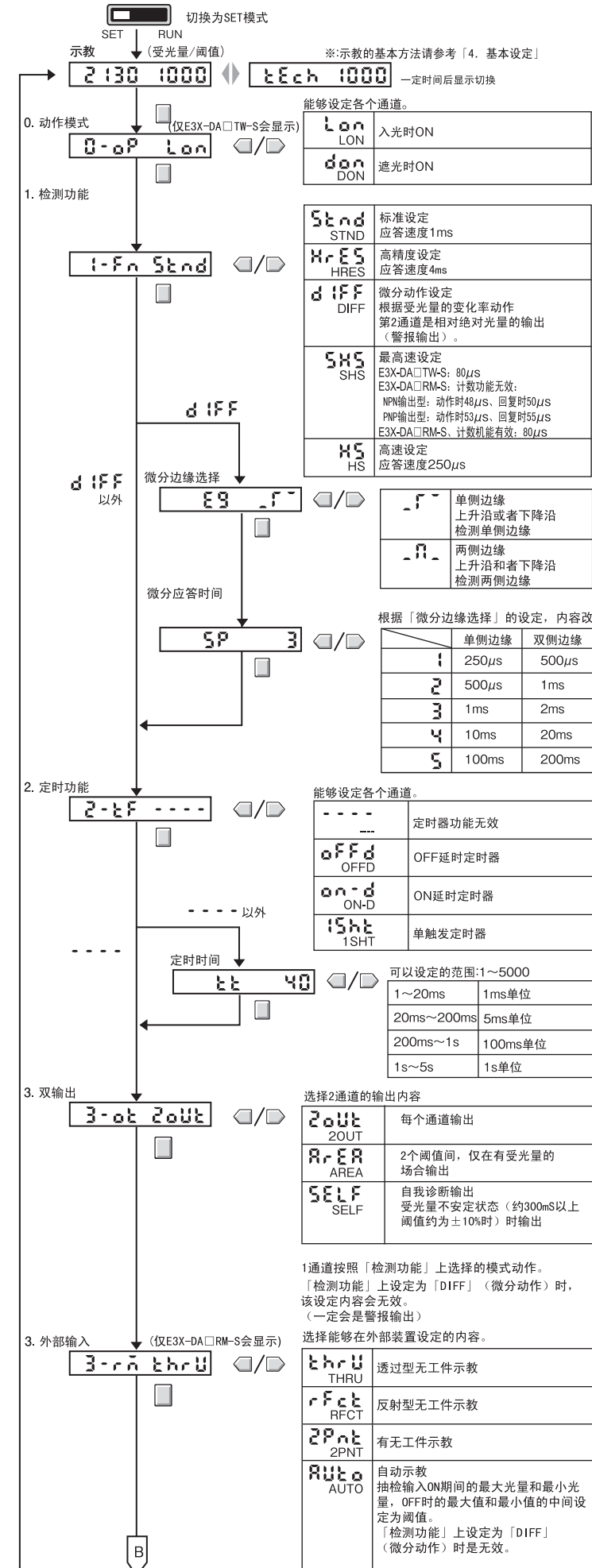

6.方便的功能

将数字显示设为零 (归零)

将主数字显示上显示的受光量表示为「0」。辅数字显示上显示的阈值也会因受光量变为「0」而转换。请预先将「MODE键设定」功能的设定变更为「ORST」(归零)。出厂时的设定为「PTUN」。请参考「5.详细设定」

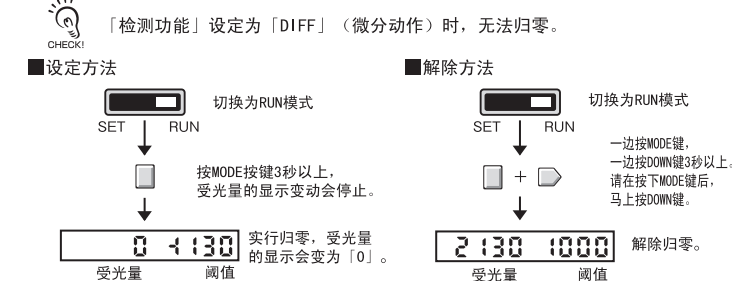

按键锁定

使按键操作全部无效, 起到防止按键误操作的作用。无效的仅是操作按键, 无法使各切换开关无效。

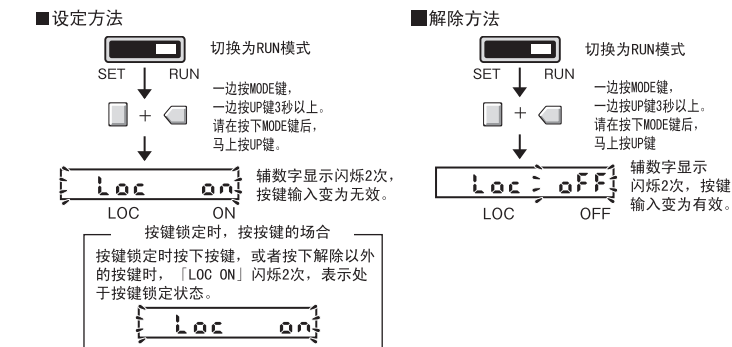

设定数据初始化 (设定初始化处理)

设定内容全部初始化, 回到出厂时的状态。



7.放大器单元的设置

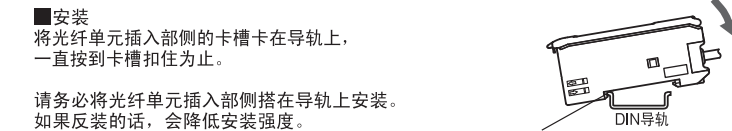

拆卸

朝方向1按住, 光纤单元朝方向2提起。

连接使用时 (连接器型)
 可以连接最多16台。

1. 放大器单元各自安装在DIN导轨上。
 2. 在导轨上滑动放大器单元, 将连接器插入放大器单元, 插紧到发出“咔”的一声为止。
 因振动等原因导致放大器移动时, 请安装另售的边缘导轨进行固定 (型号PFP-M)。

拆卸时请按照相反的顺序进行。请务必先拆开放大器单元间的连接后, 再从DIN导轨上拆卸。

8.光纤单元的安装

1. 打开保护盖。
 2. 提起Lock拉杆。
 3. 将光纤牢牢插入光纤单元插入口。
 4. 将Lock拉杆拉回原来的方向, 固定光纤。
 拆除时请按照相反的顺序进行。

9.输出段回路图

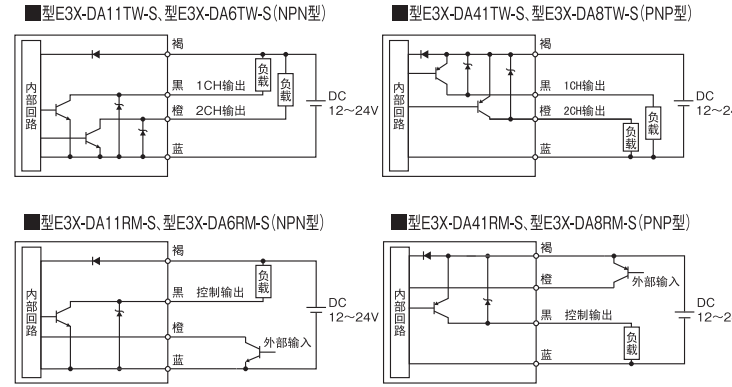

10.外形尺寸图

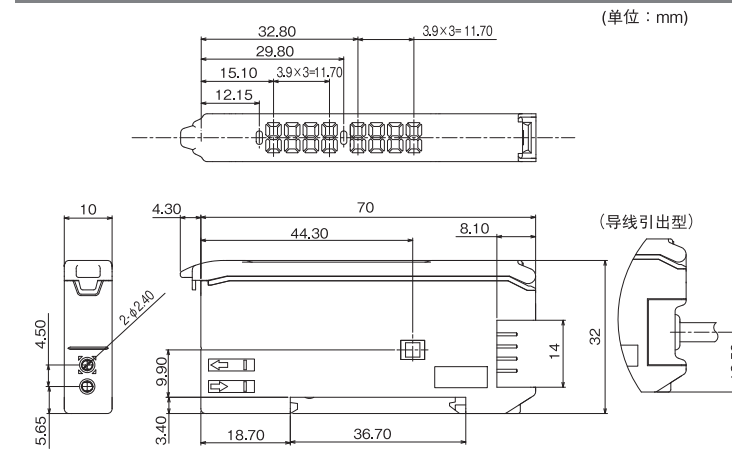

使用时的承诺事项

- ①为了确保安全, 直接或间接用于人体检测时, 请勿使用本产品。需使用该用途时, 请选用本公司传感器综合样本中刊登的安全传感器。
 - ②使用于下列用途时, 与本公司营业担当者商谈之后, 根据规格书等确认的同时, 对额定性能方面请想出有充裕的使用方法并采取即使万一出现故障也能使危险降低到最小的安全回路等的安全对策。
 - a) 屋外的用途、潜在化学污染或者受到电气的妨害的用途或者在商品目录、使用说明书中没有记载的条件及环境下使用。
 - b) 原子力控制设备、焚烧设备、铁道·航空·车辆设备、医用设备、娱乐机械、安全装置及行政机关及根据个别业界的规定制造的设备。
 - c) 可能危及生命、财产的系统·机械·装置
 - d) 煤气、水道、电气的供给系统记24小时连续运转系统等需要高信赖的设备。
 - e) 其他, 以上述的 a) ~ d) 为基准, 需要高度安全性的用途。
- * 上述内容是适用条件的一部分。仔细阅读本公司的综合商品目录、数据表等最新版商品目录、手册中记载的保证免费事项的内容后再使用。

联络处所在地

■技术支持
 欧姆龙 (中国) 有限公司
 地址: 中国上海浦东新区银城中路200号
 中银大厦2211室
 电话: 86-21-5037-2222
 技术咨询热线: 800-820-4535
 网址: www.fa.omron.com.cn

■制造
 欧姆龙 (上海) 有限公司
 地址: 中国上海浦东新区金桥
 出口加工区金吉路789号
 电话: 86-21-5050-9988
 邮编: 201206

Digital Fiber Sensor
E3X-DA□□TW-S / E3X-DA□□RM-S
INSTRUCTION SHEET

Thank you for selecting an OMRON product. This sheet primarily describes precautions required in installing and operating the product.

- The specialist who has the knowledge of electricity must treat.
• Please often read this manual, and use it correctly after it understands enough.
• Please keep this manual importantly to refer at any time.

TRACEABILITY INFORMATION:
Representative in EU: OMRON Europe B.V.
Manufacturer: Omron Corporation,
Shiokoji Horikawa, Shimogyo-ku,
Kyoto 600-8530 JAPAN

The following notice applies only to products that carry the CE mark:
This is a class A product. In residential areas it may cause radio interference, in which case the user may be required to take adequate measures to reduce interference.

PRECAUTIONS FOR SAFE USE

- Please observe the following precautions for safe use of the product.
1) Do not use the Amplifier Unit in environments subject to flammable or explosive gases.
2) Do not use the Amplifier Unit in environments subject to exposure to water, oil, chemicals, etc.
3) Do not attempt to disassemble, repair, or modify the Amplifier Unit in any way.
4) Do not apply voltages or currents that exceed the rated ranges.
5) Wire the Amplifier Unit correctly, e.g., do not reverse the polarity of the power supply.
6) Connect the load correctly.
7) Do not short both ends of the load.
8) Do not use the Amplifier Unit if the case is damaged.
9) When disposing of the Amplifier Unit, treat it as industrial waste.

PRECAUTIONS FOR CORRECT USE

- Please observe the following precautions to prevent failure to operate, malfunction, or undesirable effects on product performance.
1) The optical fibers are made out of methacrylic resin. Do not use them in atmospheres where organic solvents are present.
2) Wire the Amplifier Unit separately from power supply or high-voltage lines.
3) For extending wires, use a cable 0.3mm² min. and 100m max. in length.
4) Do not exceed the following force values applied to the cable.
5) The Amplifier Unit is ready to operate 200 ms after the power supply is turned ON.
6) Please turn on the power supply at the same time when you connecting use the amplifier units with cables.
7) Always keep the protective cover in place when using the Amplifier Unit.
8) Connector Short-circuit Protection (for Amplifier Units with Connectors)
9) Always turn OFF the power supply before connecting, separating, or adding Amplifier Units.
10) If the data is not written to the EEPROM correctly due to a power failure or static-electric noise, initialize the settings using the keys on the Amplifier Unit.
11) Using a Mobile Console
Use the E3X-MC11-SV2 Mobile Console for the E3X-DA-S series Amplifier Units.
12) Optical communications are not possible with an E3X-DA-N Amplifier Unit.
13) Depending on the application environment, time may be required for the incident light level to stabilize after the power supply is turned ON.
14) Do not use thinners, benzene, acetone, or kerosene for cleaning the Amplifier Unit.
15) Do not pull or apply excessive pressure or force (exceeding 9.8 N·m) on the Fiber Unit when it is mounted to the Amplifier Unit.
16) Output pulses may occur when the power is interrupted and so turn OFF the power to the load or load line before turning OFF the power to the Sensor.

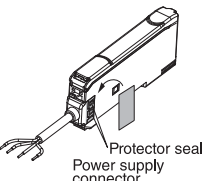

Confirming the Package Contents
• Amplifier Unit: 1 • Instruction Sheet (this sheet): 1

1. Ratings and Specifications

Table with columns for Type, Connection method, Model number, Supply voltage, Power consumption, Control output, Timer, Differential detection mode, Power tuning, APC function, Mutual interference prevention, and I/O settings.

*1: When using individually or as a master, obtain the E3X-CN21 Master Connector (4-conductor), and when using as a slave, obtain the E3X-CN22 Slave Connector (2-conductor).
*2: Communications are disabled if SHS is selected for the detection mode, and the communications functions for mutual interference prevention and the Mobile Console will not function.
*3: Mutual interference prevention can be used for only up to 6 Units if power tuning is enabled.

2. Nomenclature

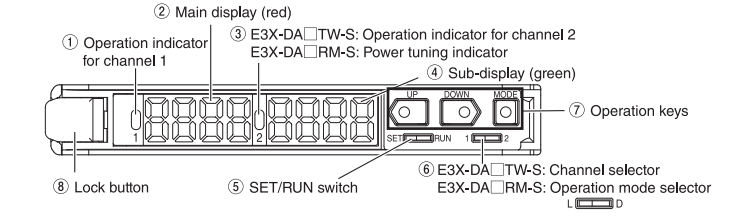

- ① Lit when the output is ON.
E3X-DA□TW-S: Lit when the output for channel 1 is ON.
E3X-DA□RM-S: Lit when power tuning is set.
② Displays supplemental detection information, the setting of a function, etc.
③ E3X-DA□TW-S: Lit when the output for channel 2 is ON.
E3X-DA□RM-S: Lit when power tuning is set.
④ Displays supplemental detection information, the setting of a function, etc.
⑤ Used to switch the mode.
⑥ E3X-DA□TW-S: Used to select the channel to display or set.
E3X-DA□RM-S: Used to select dark-ON or light-ON operation.
⑦ Used to change the display, set functions, etc.
⑧ Used to connect and disconnect the Fiber Unit.

3. Basic Operating Information

Setting the Mode
The mode is set using the SET/RUN switch. Set this switch according to the operation to be performed.

Table with 2 columns: Mode (SET, RUN) and Description (Select to set detection conditions, Select for actual detection operation or to set the following: Manual adjustment of threshold value, teaching power adjustment, zero reset, or key lock).

Key Operations

The operation keys are used to switch the displays and set detection conditions. The functions of the keys depend on the current mode.

Table with 3 columns: Key (UP key, DOWN key, MODE key), RUN mode, and SET mode. Describes functions like increasing/decreasing threshold value, teaching, and setting functions.

Time to Press Keys
If a specific time for pressing a key is not given in a procedure, press the key for approximately 1 second. For example, if the procedure says 'press the UP key,' then press the UP key for approximately 1 second and then release it.

Reading Displays

The information displayed on the main display and sub-display depends on the current mode. For the default settings, the RUN mode displays will appear when the power supply is turned ON for the first time.

Table with 3 columns: Mode (SET, RUN), Main display (red), and Sub-display (green). Describes what is shown on each display for different modes.

Note: The information that appears on the displays can be set using the display switch function. Refer to 5. Detailed Settings.

4. Basic Settings

1. Setting the Operation Mode

E3X-DA□RW-S: Select either Light-ON or Dark-ON operation with the operation mode selector. As shown below:
E3X-DA□TW-S: Set the 'operation mode' under SET MODE. Refer to 5. Detailed Settings.

Table with 3 columns: Operation mode (LON, DON), Setting, and the corresponding indicator status (L and D).

2. Adjusting the Power (as Required)

Power tuning can be used to adjust the incident light level that is currently being received to the power tuning target value (default: 2,000). Before tuning ON the power, always secure the detection object and Head and be sure that the incident light level is stable.

Setting Method

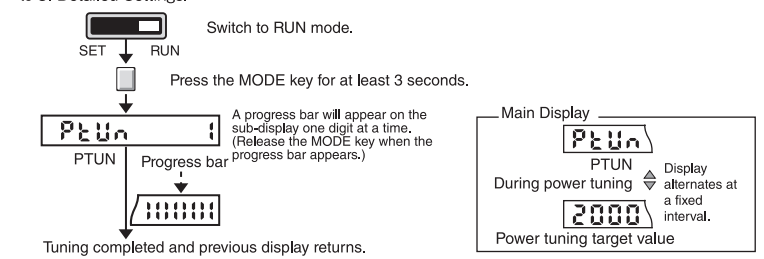

- The power tuning target value can be changed. Refer to 5. Detailed Settings.
If power is tuned when SHS is selected for the detection method, the power will be set to the minimum value.
Power tuning will be cleared whenever the detection method is changed from STND, HRES, or SHS.

Power tuning Errors

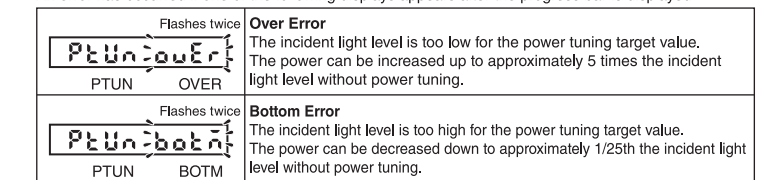

Clearing Method

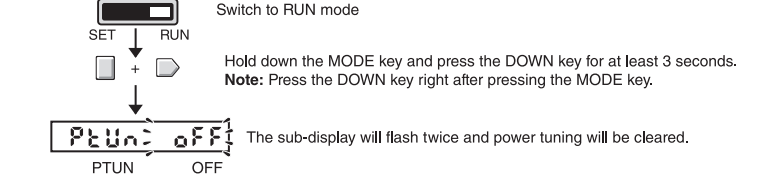

3. Setting Thresholds

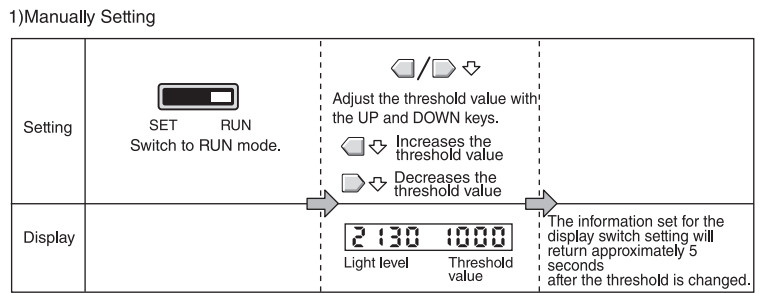

Teaching

Teaching With and Without a Workpiece
Teaching can be performed twice, once with and once without a workpiece, and the value between the two measured values is set as the threshold. RUN mode and SET mode - each mode can be set up. PTUN is the default setting. Refer to 5. Detailed Settings.

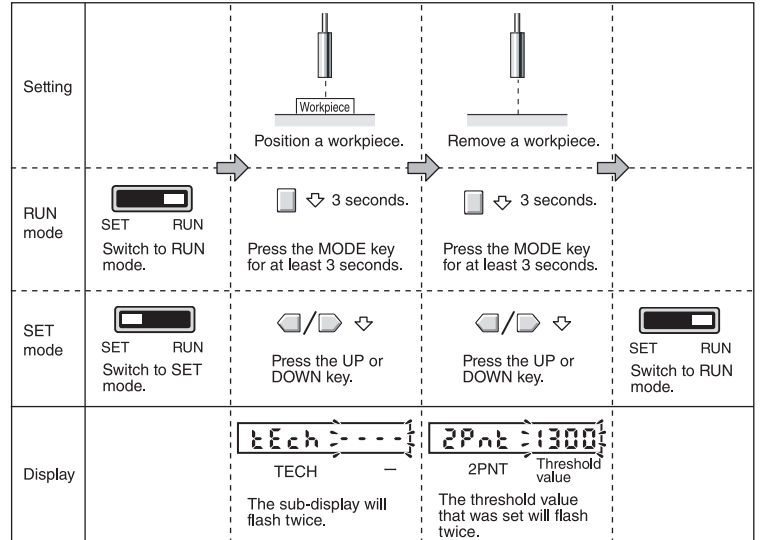

If DIFF (differential operation) is set for the detection method, the threshold value will be set to half of the difference between the two measured values.

Automatic-teaching (It sets up at move work.)

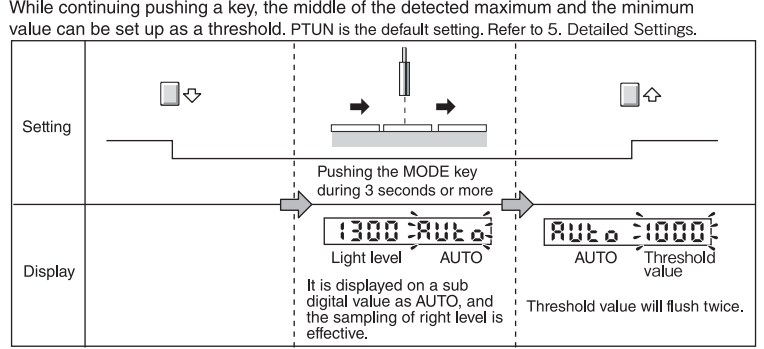

This method cannot be used to set the threshold when the detection method has been set to DIFF (differential operation).

Teaching for Through-beam Sensor Heads
Teaching for a Through-beam Sensor Head is performed without a workpiece. A value about 6% less than the incident light level with no workpiece is set as the threshold value. This method is ideal to stably detect very small differences in light level.

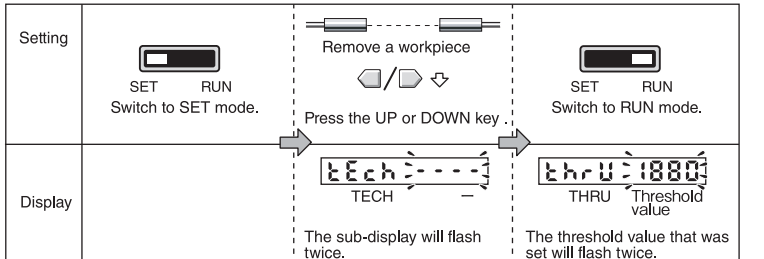

If DIFF (differential operation) is set for the detection method, the threshold value will be set to the minimum value below the incident light level without a workpiece that will enable stable detection.

Teaching for Reflective Sensor Heads
Teaching for a Reflective Sensor Head is performed without a workpiece (i.e., for the background). A value about 6% greater than the incident light level is set as the threshold value. This method is ideal to stably detect very small differences in light level.

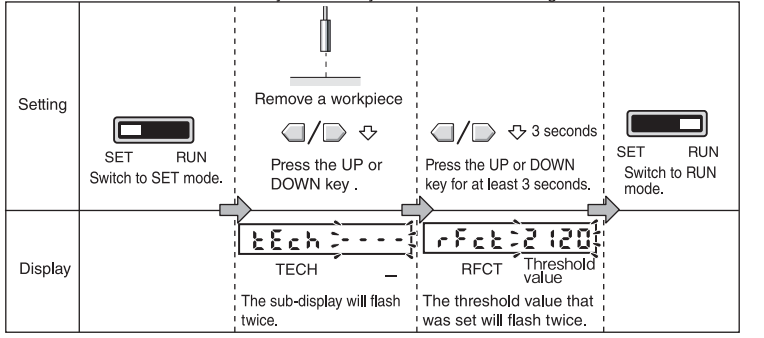

If DIFF (differential operation) is set for the detection method, the threshold value will be set to the minimum value above the incident light level without a workpiece that will enable stable detection.

Setting the Threshold at the Maximum Sensitivity
The threshold can be set at the maximum sensitivity. This is convenient when using the longest sensing distance.

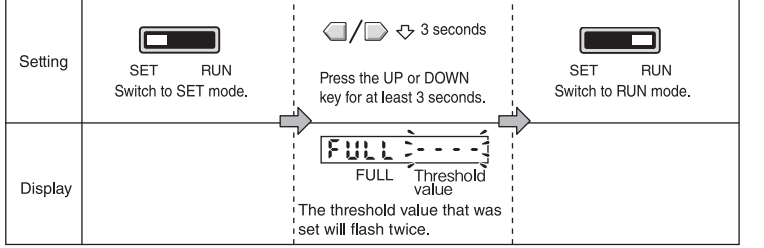

It does not matter whether or not there is a workpiece. The value that is set will depend on the detection method and power adjustment settings. This method cannot be used to set the threshold when the detection method has been set to DIFF (differential operation).

Teaching Error

Table with 2 columns: Error type (Over error, Low error, Near error) and description of the error and how to resolve it.

5. Detailed Settings

The following functions can be set in SET mode. The default settings are shown in the transition boxes between functions.

All settings except for the operation mode and timer settings are the same for both channels.

*: The values shown for thresholds, incident light levels, percentages, etc., are examples only. Actual displays may vary.

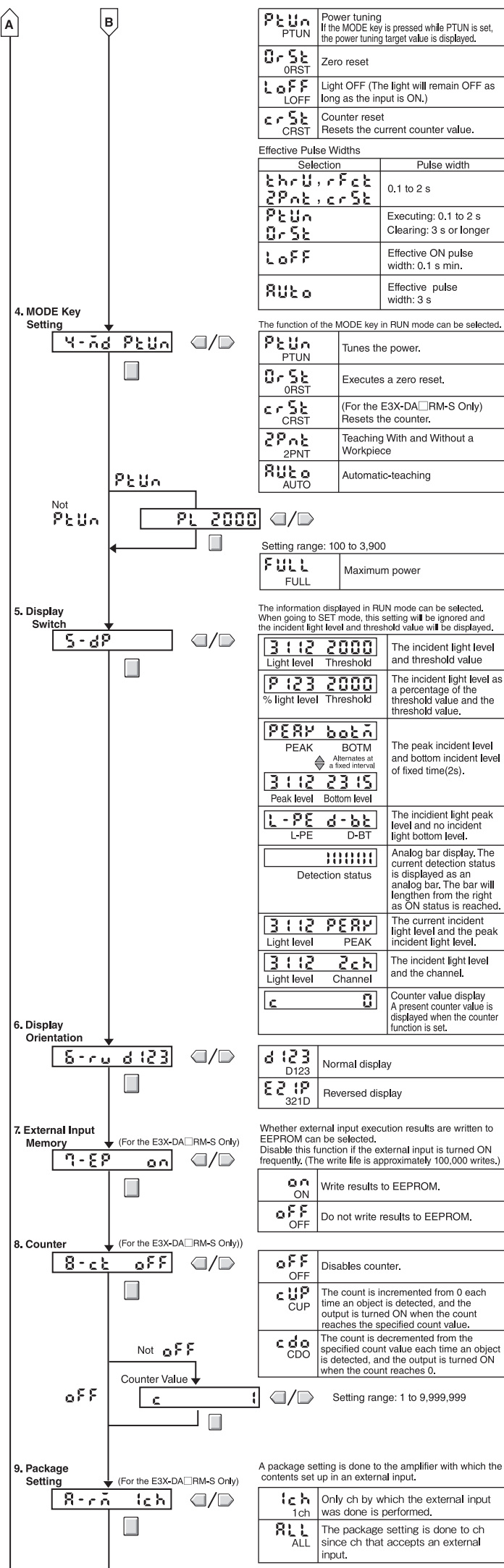
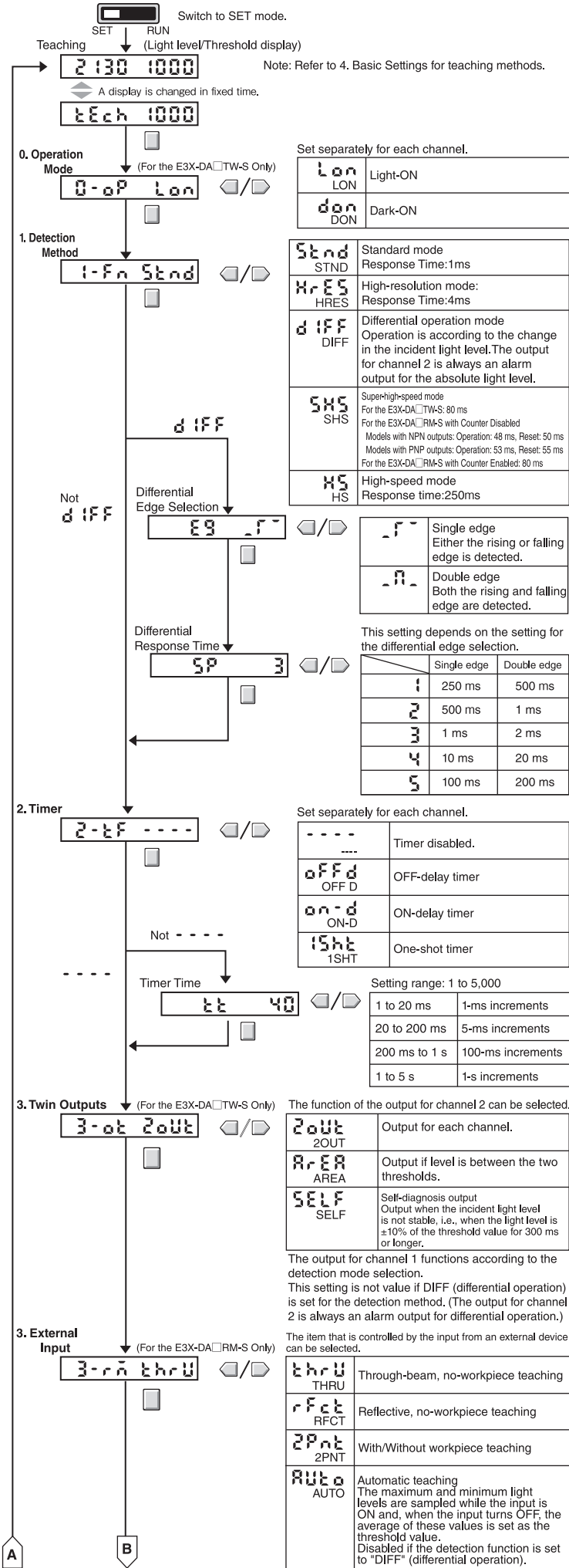

6. Convenient Functions

Zeroing the Main Display

The incident light level displayed on the main display can be zeroed. The threshold displayed in the sub-display is shifted by an amount corresponding to the amount the incident light level was changed.

Confirm that the MODE key setting is ORST (zero reset) in advance. PTUN (power tuning) is the default setting. Refer to 5. Detailed Settings.

Zero-reset is not possible if the detection function is set to "DIFF" (differential operation).

Setting Method

Switch to RUN mode.

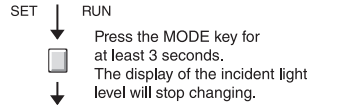

The display will be zeroed, i.e., the incident light level will be displayed as 0.

Clearing Method

Switch to RUN mode.

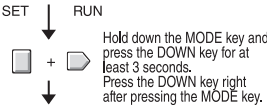

The zero reset function will be cleared.

Key Lock

All key operations can be disabled to help prevent key operating errors.

Only the operation keys are disabled. The switches and selectors will still function.

Setting Method

Switch to RUN mode.

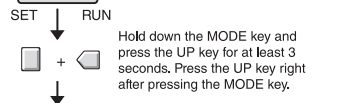

The sub-display will flash twice and key input will be disabled.

Clearing Method

Switch to RUN mode.

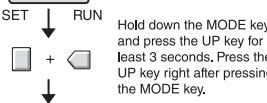

The sub-display will flash twice and key input will be enabled.

If a key is pressed while key operations are locked, "LOC ON" will flash twice on the display to indicate that key operations have been disabled.

Initializing Settings

This procedure can be used to return all the settings to the original default values.

Setting Method

Switch to SET mode.



The sub-display will flash twice and key input will be enabled.

Settings not initialized.

Settings initialized.

Initialization has been completed.

7. Installing the Amplifier Unit

Mounting Units

Catch the hook on the Fiber Unit connector end of the Unit on the DIN Track and then press down on the other end of the Unit until it locks into place.

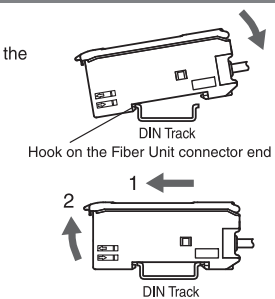

Always attach the Fiber Unit connector end first. If the incorrect end is attached first, the mounting strength will be reduced.

Removing Units

Press the Unit in the direction indicated by "1" and then lift up on the Fiber Unit connector end of the Unit in the direction indicated by "2."

Joining Amplifier Units (for Units with Connectors)

Up to 16 Units can be joined.

- Mount the Amplifier Units one at a time onto the DIN Track.
- Slide the Amplifier Units together and press the Amplifier Units together until they click into place.

Secure the Units with an End Plate (PFP-M) if there is a possibility of the Amplifier Units moving, e.g., due to vibration.

Reverse the above procedure to separate and remove the Units. Do not attempt to remove Amplifier Units from the DIN Track without separating them first.

8. Connecting the Fiber Unit

- Open the protective cover
- Press up the lock button.
- Insert the fibers all the way to the back of the connector insertion opening.
- Return the lock button to its original position to secure the fibers.

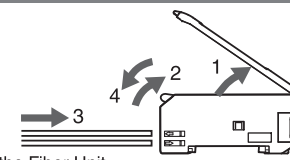

Reverse the above procedure to disconnect the Fiber Unit.

9. I/O Circuits

E3X-DA11TW-S and E3X-DA6TW-S (NPN Models)

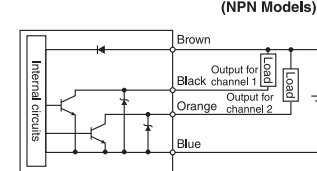

E3X-DA41TW-S and E3X-DA8TW-S (PNP Models)

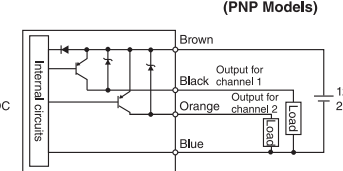

E3X-DA11RM-S and E3X-DA6RM-S (NPN Models)

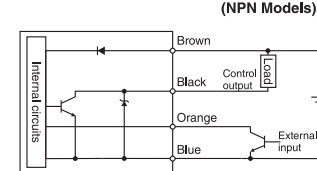

E3X-DA41RM-S and E3X-DA8RM-S (PNP Models)

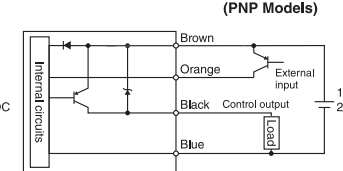

10. Dimensions

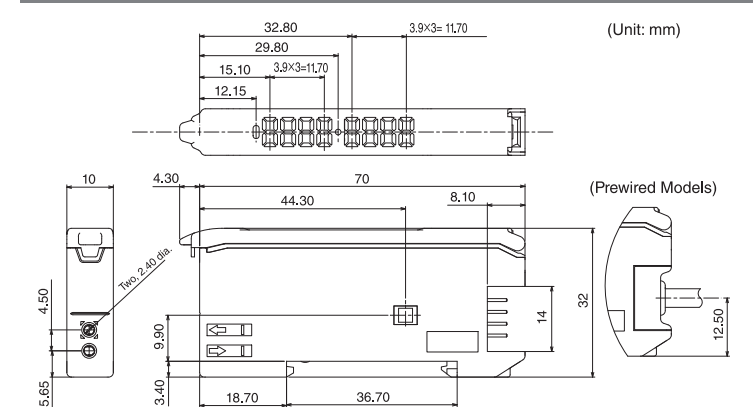

Suitability for Use

THE PRODUCTS CONTAINED IN THIS SHEET ARE NOT SAFETY RATED. THEY ARE NOT DESIGNED OR RATED FOR ENSURING SAFETY OF PERSONS, AND SHOULD NOT BE RELIED UPON AS A SAFETY COMPONENT OR PROTECTIVE DEVICE FOR SUCH PURPOSES. Please refer to separate catalogs for OMRON's safety rated products.

OMRON shall not be responsible for conformity with any standards, codes, or regulations that apply to the combination of the products in the customer's application or use of the product.

Take all necessary steps to determine the suitability of the product for the systems, machines, and equipment with which it will be used. Know and observe all prohibitions of use applicable to this product.

NEVER USE THE PRODUCTS FOR AN APPLICATION INVOLVING SERIOUS RISK TO LIFE OR PROPERTY WITHOUT ENSURING THAT THE SYSTEM AS A WHOLE HAS BEEN DESIGNED TO ADDRESS THE RISKS, AND THAT THE OMRON PRODUCT IS PROPERLY RATED AND INSTALLED FOR THE INTENDED USE WITHIN THE OVERALL EQUIPMENT OR SYSTEM. See also Product catalog for Warranty and Limitation of Liability.

- EUROPE**
OMRON EUROPE B.V. Sensor Business Unit
Carl-Benz Str.4, D-71154 Nufringen Germany
Phone: 49-7032-811-0 Fax: 49-7032-811-199
- NORTH AMERICA**
OMRON ELECTRONICS LLC
One Commerce Drive Schaumburg, IL 60173-5302 U.S.A.
Phone: 1-847-843-7900 Fax: 1-847-843-7787
- ASIA-PACIFIC**
OMRON ASIA PACIFIC PTE. LTD.
No. 438A Alexandra Road #05-05-08(Lobby 2),
Alexandra Technopark, Singapore 119967
Phone : 65-6835-3011 Fax : 1-847-843-7787
- CHINA**
OMRON(CHINA) CO., LTD.
Room 2211, Bank of China Tower,
200 Yin Cheng Zhong Road,
PuDong New Area, Shanghai, 200120, China
Phone : 86-21-5037-2222 Fax : 86-21-5037-2200

OMRON Corporation

© OCT, 2009