

IO-Link Series

IO-Link Makes Communication Down to the Sensor Level Visible



Using IoT to enhance the value of manufacturing

- "Abnormality detection" for shortest recovery
- "Condition monitoring" for predictive maintenance
- "Individual identification" for reduction of man hours



Toward the Factory of the Future with **Onsite IoT**

Today's manufacturing industry is facing the need for high-mix low-volume production and advanced manufacturing. On the other hand, with the technology of digital fields, ICT and analysis technology are advancing by leaps and bounds. We aim to achieve the Factory of the Future through the use of the IoT (Internet of Things) in order to respond to such changes in the environment.

What we are aiming for is

the Factory of the Future in which human intention and equipment converge

Using the IoT to connect things at the manufacturing site with each other and with people from equipment down to the individual components incorporated into devices makes it possible to detect signs that may indicate problems before the equipment stops and for the equipment to handle this autonomously and analyze the causes of defects.

The result is that machines and equipment move and stop as people intend.

This allows personnel to concentrate on higher added-value work without the need for emergency maintenance or for going back over work already completed.

Attaining this Factory of the Future means onsite IoT.



Onsite IoT from OMRON

Automation in Manufacturing with Intelligence

With OMRON, you can collect a wide variety of data at the manufacturing site level simply and without omission or excess effort.

The implicit knowledge of proficient skills and manufacturing know-how is turned into explicit knowledge and fed back to the manufacturing site to improve productivity.

We are aiming to further use data for automation in manufacturing with intelligent equipment, including achieving production lines that do not stop and equipment that learns and evolves.

The Strength of the Manufacturing Site Developed by OMRON

Three Forms of Know-how Moving IoT Forward

At OMRON, we have the product know-how of a manufacturer who has produced control components for decades, the manufacturing know-how of a user who uses these control components on its own lines, and the know-how to handle open network environments.

With these three types of know-how, nurtured with the strength of manufacturing sites as only OMRON can, the customer's application is achieved and onsite IoT is moved forward powerfully.

Attaining the Factory of the Future Makes

Manufacturing More Enjoyable

Maintenance	From emergency maintenance to planned maintenance, which generates improvements
Production Technology	Predictive control of the production line as a whole
Development	Concentrating on work that creates innovative products



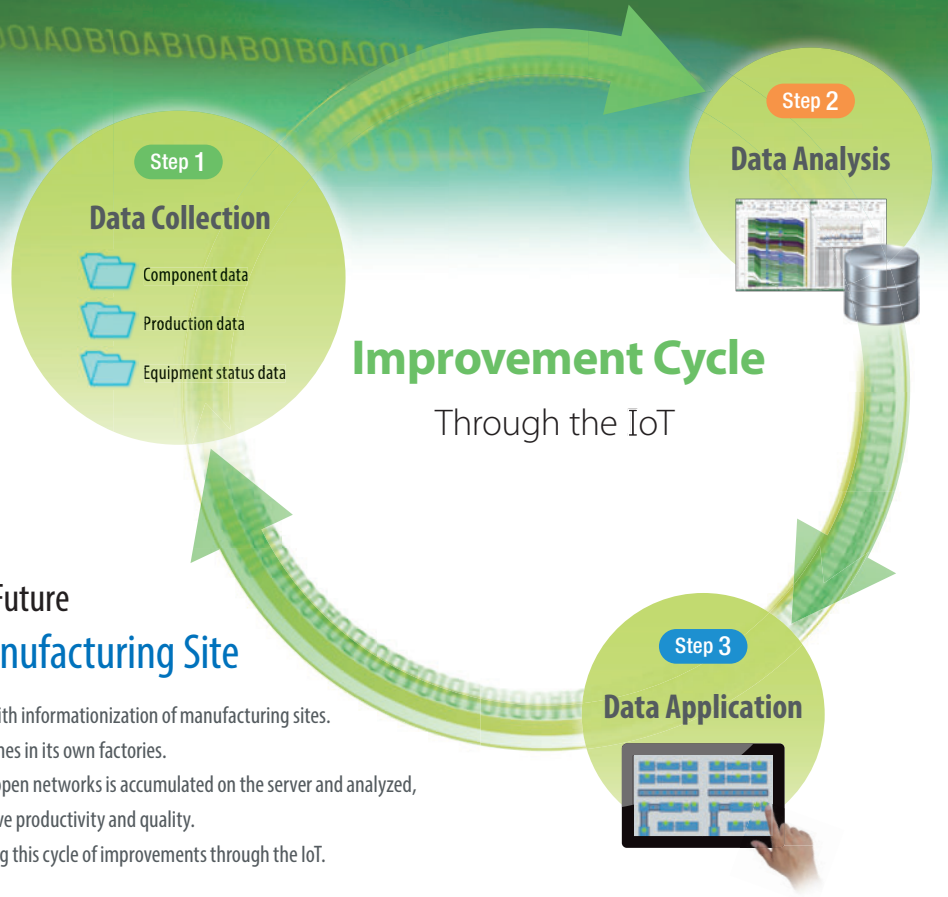

The First Step to the Factory of the Future Informationization of the Manufacturing Site

Attaining the Factory of the Future through the IoT starts with informationization of manufacturing sites. OMRON itself started with visualization of the production lines in its own factories. Data collected through EtherNet/IP™, EtherCAT, and other open networks is accumulated on the server and analyzed, and the results are used at the manufacturing site to improve productivity and quality. We have already achieved major improvements by repeating this cycle of improvements through the IoT.



The Cycle of Improvements Through the IoT Has Been Verified in OMRON's Own Factories

We provide our customers with the know-how to achieve this and the results.

Productivity Improvement

Examples from Kusatsu Factory and Shanghai Factory

Through High-Speed Collection of Big Data
Improved Operating Rates

Improvement Results

- Time to identify areas for improvement reduced to 1/6 or less*
- Productivity improved by 30%*

*In-house comparison.

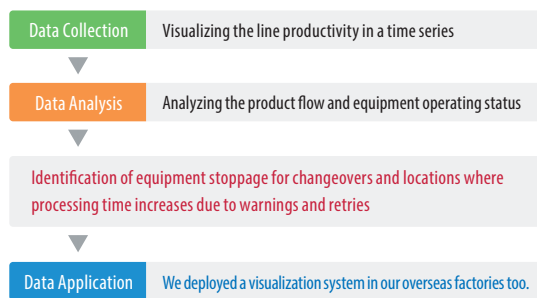

Predictive Maintenance

Example from Ayabe Factory

Through Application of Big Data
Improved Equipment Maintenance with Less Waste

Improvement Results

- Productivity improved by avoiding intermittent stops
- Costs reduced through accurate parts replacement

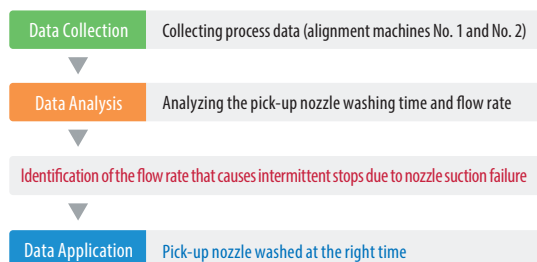



The IoT at the Component Level Is Necessary for Manufacturing Site Informationization

At many manufacturing sites, the adoption of the IoT is being promoted at the controller and HMI levels through EtherNet/IP or EtherCAT, but not at the component level.

Therefore, at OMRON, we early on created a lineup of devices for IO-Link, which is a sensor-level open network to promote sensor-level informationization.

Using IO-Link to Make Communications Down to the Sensor Level Visible

As our first round of IO-Link products, we now provide IO-Link Photoelectric Sensors, IO-Link Color Mark Photoelectric Sensors, IO-Link Proximity Sensors, and IO-Link Masters. By connecting Sensors and Controllers to an IO-Link Master, not only ON/OFF signals but also information required for stable operation, such as incident light levels, are made visible. We are making it possible to monitor the conditions of sensors and detect any abnormalities to shorten the recovery time for devices and equipment, to enable predictive maintenance, and to reduce commissioning time.

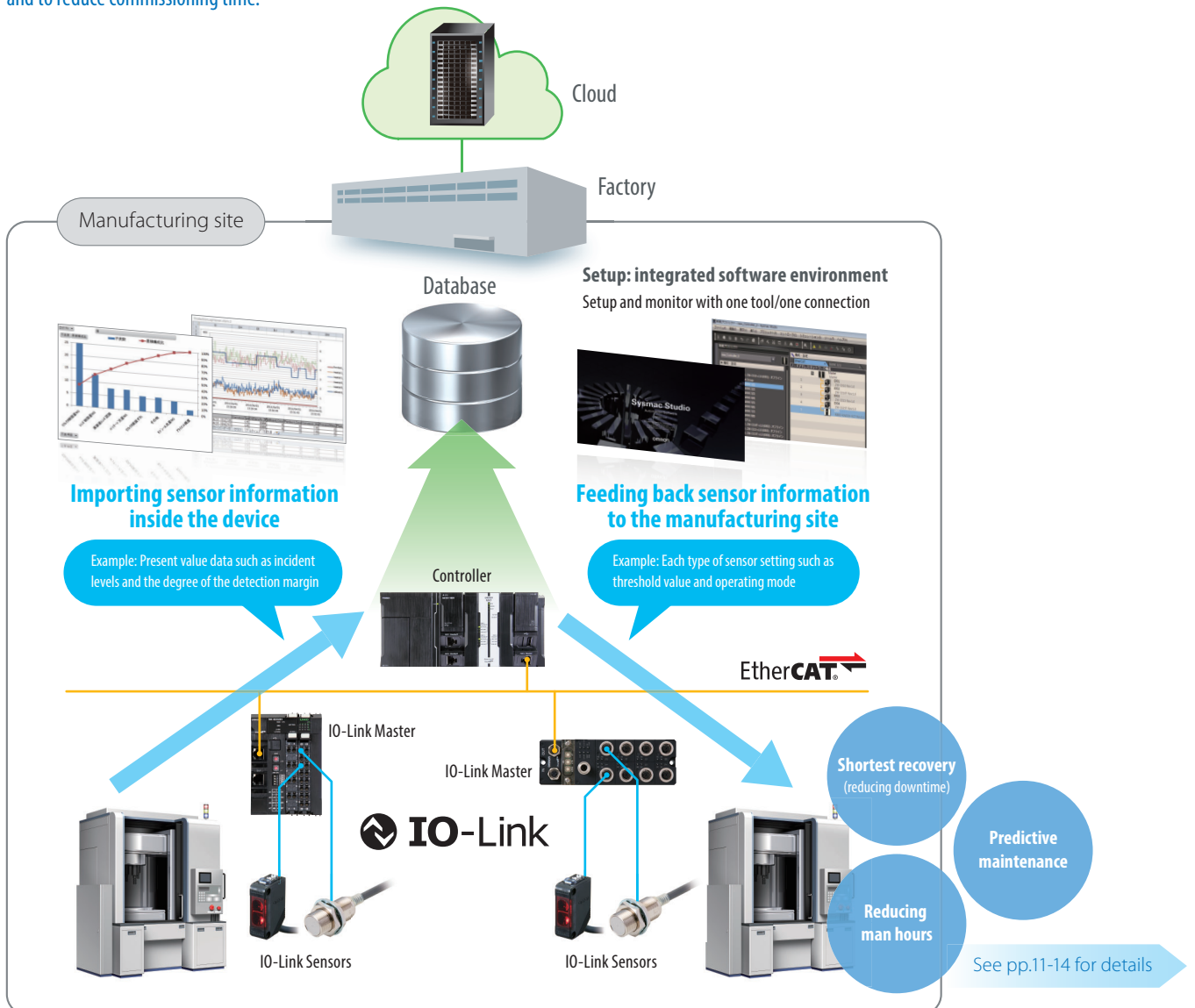

IO-Link Is

Communication Technology That Realizes the Informationization of Sensor Levels

IO-Link

IO-Link, which is specified as international standard IEC 61131-9, is an open information technology (interface technology) between the Sensor/Actuator and the I/O Terminal. It collects information held by the sensor/actuator through the IO-Link Master and via a fieldbus network into the host controller. The IO-Link enables communication within the whole system and reduce time required for commissioning and maintenance.

An Open International Standard

As of December 2015, over 100 companies, including major sensor manufacturers, have joined the IO-Link Consortium.

Responding to Global Development

All IO-Link Sensors have an IODD (IO Data Description) file that lists what kind of instrument they are and what parameters need to be set for them. IODD files are globally common, so IO-Link Sensors can be used in the same way with any manufacturer.



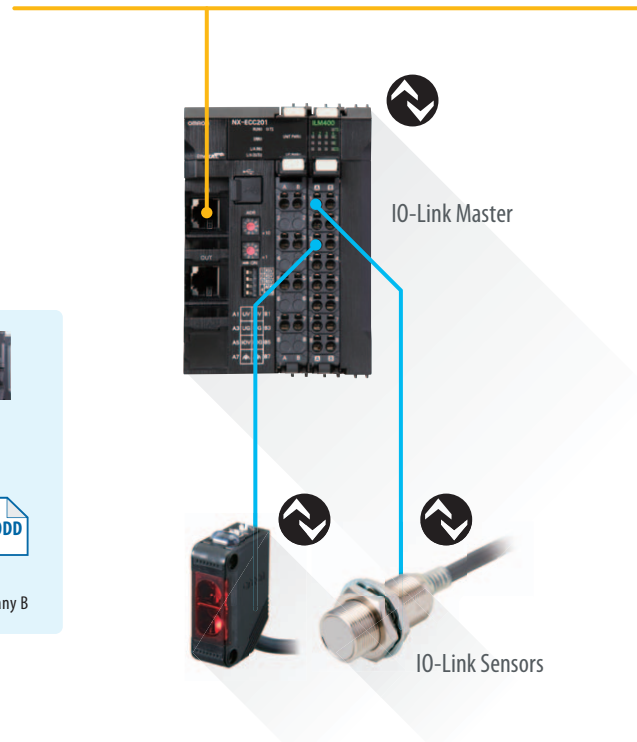

Communications of the ON/OFF Signals and Sensor Information

IO-Link can send and receive in both directions not just ON/OFF signals but also sensor information. The IO-Link baud rates*1 of COM 1, 2, and 3 are specified in the IO-Link specifications. Omron's IO-Link components are compatible with COM 2 and COM 3, and are capable of high speed communications.

Condition Monitoring/Batch Data Input is Available

The IO-Link master has multiple ports and an IO-Link Sensor is connected to each port. Unlike a fieldbus network, communication is one-to-one.

Without IO-Link support

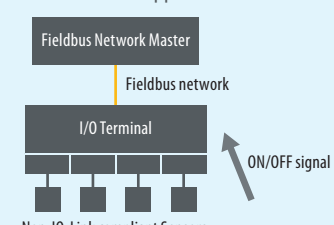

With IO-Link

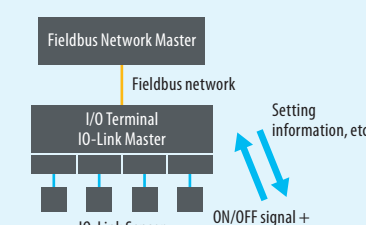

*1. Baud rates are as follows. COM 1: 4.8 kbps, COM 2: 38.4 kbps, COM 3: 230.4 kbps

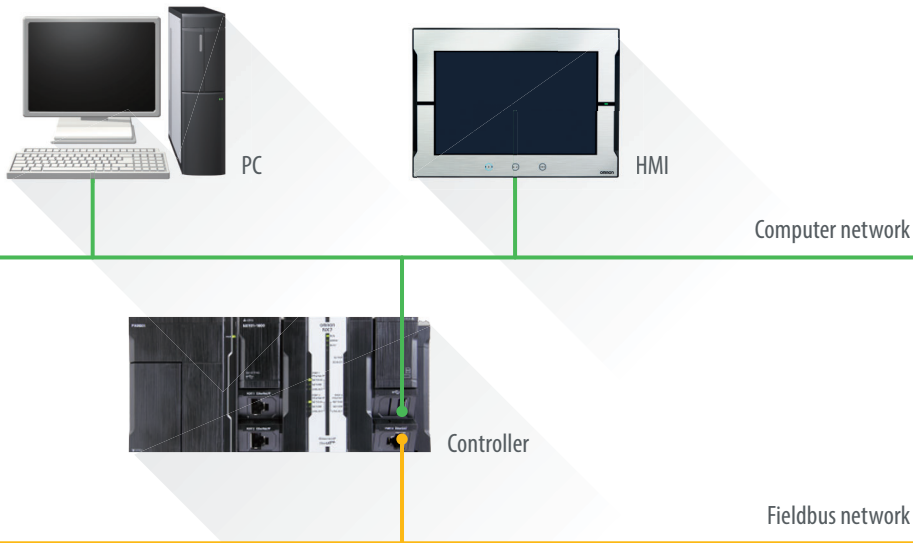

Uses 3-wire Unshielded Cable

No dedicated communication cable required. A communication system that can be used both as an ON/OFF line and a communication line.

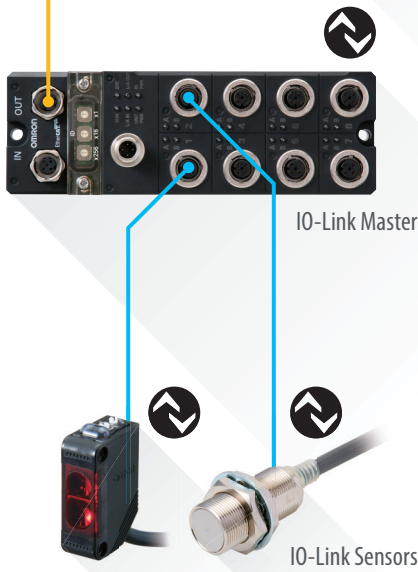

Can Be Used with a Conventional 3-wire Unshielded Cable or Integrated I/F Connector

3-wire unshielded cable
Maximum length 20 m

A dedicated communication cable is unnecessary and a conventional 3-wire unshielded cable can be used for the IO-Link, because the IO-Link has both an IO-Link Mode which performs a digital communication and Standard I/O (SIO) Mode which uses conventional contact input/output.

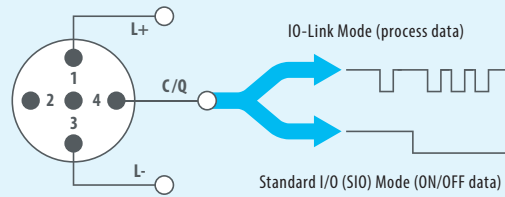

Capable of Intermixing IO-Link Sensors and Sensors That Are Not Compliant with IO-Link

You can connect an IO-Link Sensor and a Sensor/Actuator that is not compliant with IO-Link to a single IO-Link Master.

A Part of the Existing Equipment Can Be Replaced with the IO-Link

In situations where you want to improve only one part of your existing equipment, such as when "errors often occur" or "I want to import sensor information," IO-Link Sensors can be mixed with non-supported sensors.

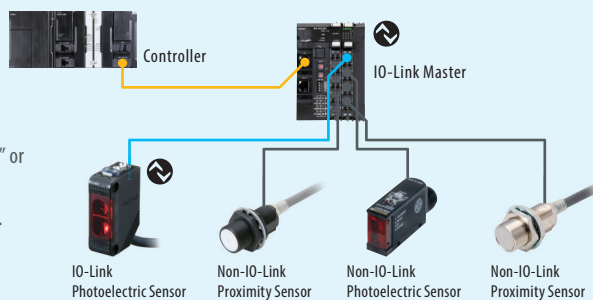

Omron's IO-Link Compliant Equipment

Masters and Sensors Can Be Chosen to Match Your Setup Situation

Omron provides two types of Masters, a Master Unit with screw-less clamp terminal blocks and a Master Unit for M12 Smartclick connectors, as IO-Link compliant devices and Sensors for connecting to the screw-less clamp terminals or to the M12 connector terminals that support each Master.



Corresponding to our shared Value Design for Panel concept for the specifications of products.

IO-Link Masters

The Unit with Screw-less Clamp Terminal Blocks Allows Wiring Man-hours to be Reduced

NX-series IO-Link Master Unit
NX-ILM400
4-port/screw-less clamp terminal block
Note: Four sensors can be connected to one device.



IO-Link Sensors

Screw-less Clamp Terminals Connection Devices

Photoelectric Sensor
E3Z-□-IL□
Pre-wired Models

Proximity Sensor
E2E-□-IL□
Pre-wired Models

Color Mark
Photoelectric Sensor
E3S-DCP21-IL□
Models for M12 Connector

Note: When using a connector with a cable (M12 two-sided connector), the connector can also be connected to environment-resistant unit type GX-ILM08C

Spatter-resistant
Proximity Sensor
E2EQ-□-IL□
Pre-wired Models

Photoelectric Sensor
E3Z-□-IL□
Models for M8 Connector

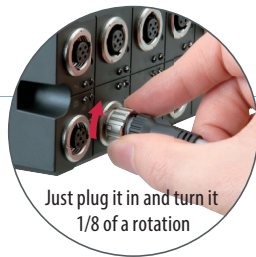

Smartclick

Note: Smartclick is a registered trademark of Omron.



The Unit for M12 Smartclick Connector Can Be Used in Watery, and Dusty Environments

Environment-resistant Unit **IP67 Type**
 GX-ILM08C
 8-port/M12 Smartclick connector

Note: Eight sensors can be connected to one device.

IO-Link

M12 Connector Connection Devices



Photoelectric Sensor
 E3Z-□-IL□
 Models with M12 Pre-wired
 Smartclick Connector



Proximity Sensor
 E2E-□-IL□
 Models with M12 Pre-wired
 Smartclick Connector

Spatter-resistant
 Proximity Sensor
 E3Z-□-IL□
 Models with M12 Pre-wired
 Smartclick Connector

Value Provided by IO-Link

Supporting Solutions to Management Issues in the Manufacturing Industry Through Abnormality Detection/Condition Monitoring/Individual Identification

“Improving an equipment operation rate” is a universal management issue at manufacturing sites. As the calculation formula below shows, an overall equipment operation rate is determined by how stops, drops in speed and defects are avoided.

$$\text{Overall Equipment Effectiveness}^{*1} = \text{Availability (stop loss)} \times \text{speed performance (performance loss)} \times \text{quality (defect loss)}$$

*1. OEE: overall equipment effectiveness. An index that stratifies the effectiveness of production equipment developed and advocated by the Japan Institute of Plant Maintenance.

These three loss occurrence factors are divided into the following (1) to (4). Of these, the occurrence factors for stop loss are the same as for the three major issues (right diagram) at the manufacturing sites, and it can be seen that the issue happening at a site becomes a stop loss factor.

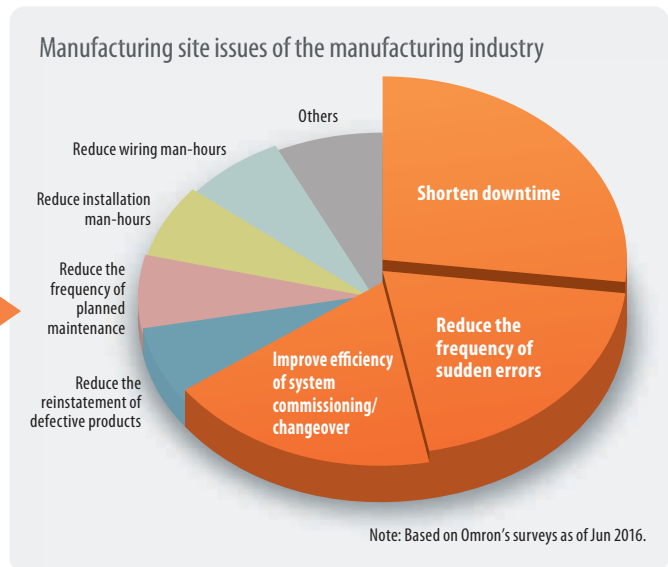
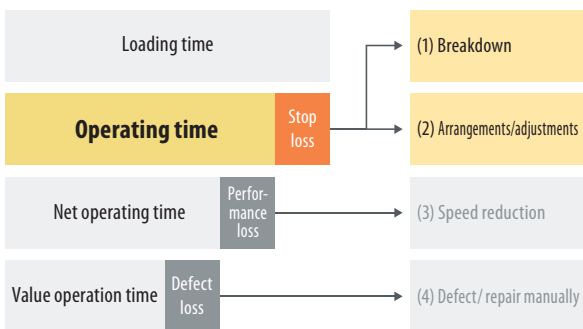

Omron's IO-Link Compliant Components Solve “Stop Loss” Issues and Improve Equipment Operation Rate



What makes the shortening of downtime possible is...
 “Abnormality detection” for the shortest recovery

P. 11

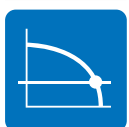

What makes the reduction of the frequency of sudden errors possible is...
 “Condition monitoring” for predictive maintenance

P. 12



What makes the improvement of changeover efficiency possible is...
 “Individual identification” for the reduction of man-hours

P. 14



To those in charge of maintenance “Abnormality detection” for the shortest recovery

Detects Wiring Cable Disconnections and Errors and Improves Equipment Operation Rate Through Quick Maintenance

Past problems

- An abnormality was displayed on the abnormality display screen, but upon going to look at the equipment, no external error was detected and the cause of the stop was not understood...
- Those responsible for maintenance investigated the cause of the abnormality from the activity of the stopped equipment, but because the maintenance person relied on the skill he or she has to identify the abnormality and replace the failed sensor, stoppages from 2 hours to several days occur...



With an IO-Link Photoelectric Sensor/Proximity Sensor

Abnormal area and phenomenon of sensors are reported in real time

When an abnormality occurs in a sensor, because you can see where the abnormality occurred and the factors estimated for it, you can go to where the abnormality occurred and recover the equipment in the shortest amount of time.

Also with wire disconnection detection, not only output wires, but also power lines can be detected unconditionally.

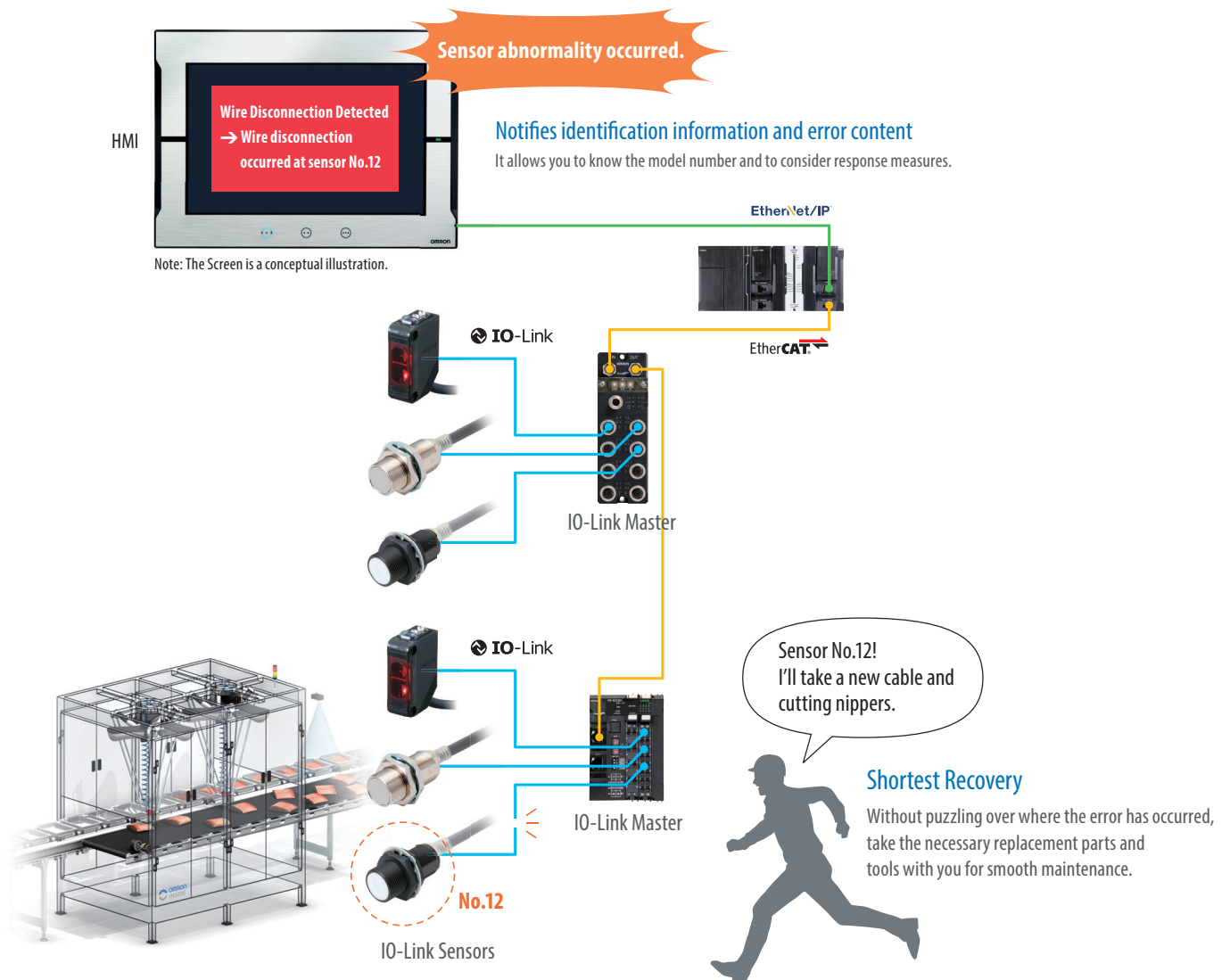

To those in charge of maintenance **“Condition monitoring” for predictive maintenance (1)**



The Proximity Sensor Indicates an Excessive Proximity to the Sensing Object.
Understand the Changes in Device Condition in Advance and Reduce Sudden Stops

Existing problems

The detection position changes due to wear and vibration in the device's mechanical parts and as a result, false detection and collision with the sensor have a negative impact on the device...



With an IO-Link Proximity Sensor

You are notified of excessive remoteness or proximity, and the occurrence of sudden defects is greatly reduced

Constantly monitoring the position of the sensing object and notifying of excessive remoteness or proximity can be used for predictive maintenance of the device.

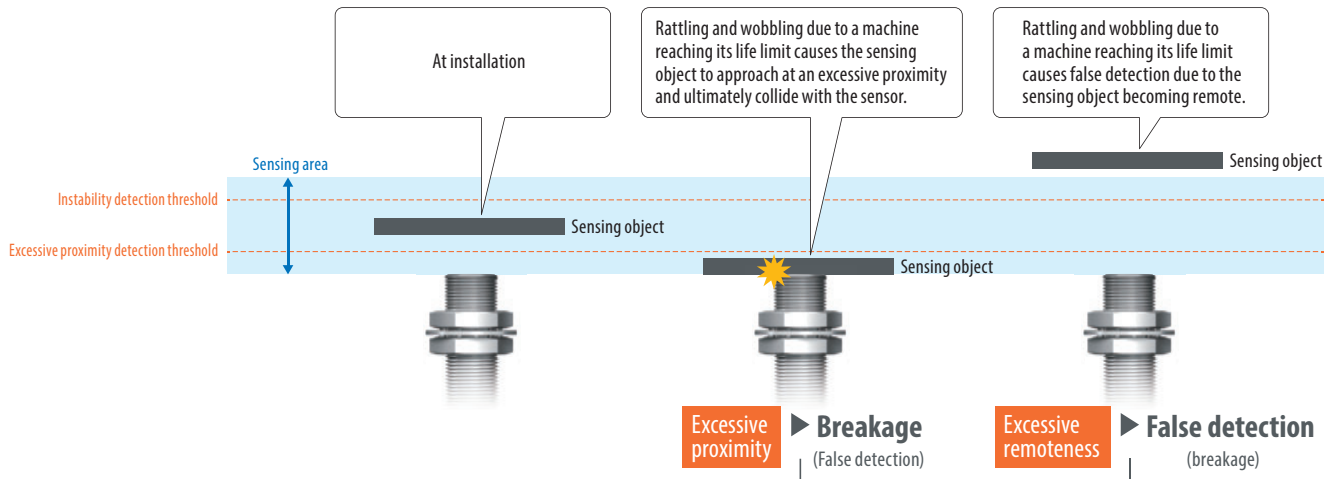
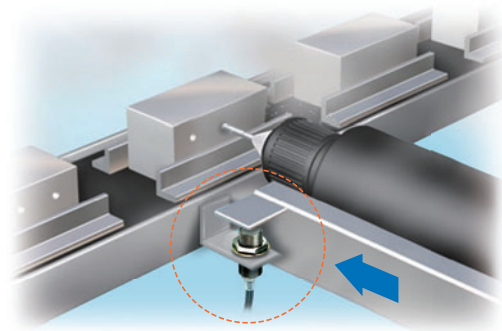

Sensing object becomes excessively proximate

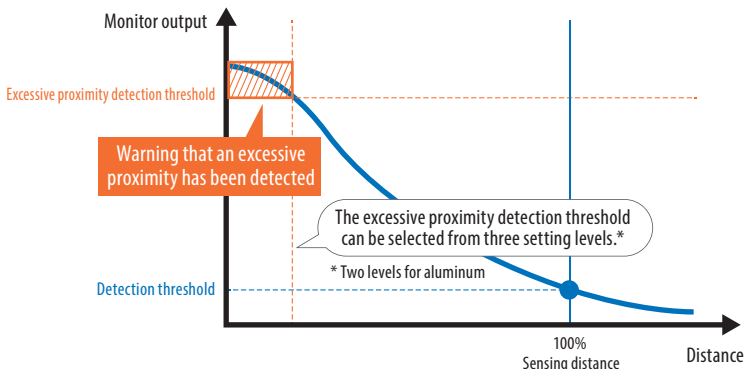

Sensing object becomes excessively remote

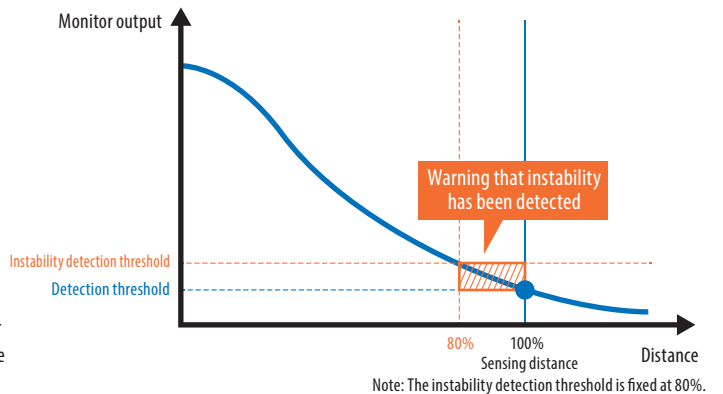

To those in charge of maintenance "Condition monitoring" for predictive maintenance (2)



Understand Unstable Situations in the Incident Level of the Photoelectric Sensor in Advance and Reduce Sudden Stops

Existing problems

- In a conveyance process operating for 24 hours, dust or dirt accumulated on the detection surface of the photoelectric sensor, leading to a decline in the light incident level that causes the sensor to make false detection and the device to stop...
- Water drops stick to the sensing surface of the reflective sensor causing reflected light to enter...

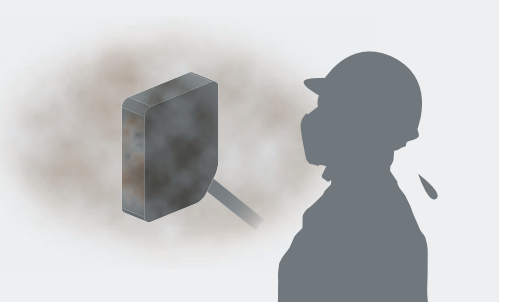

With an IO-Link Photoelectric Sensor

A light incident level monitor prevents false detection

With a response time of 1 ms, Photoelectric Sensor's light incident level is output for monitoring. It is output when the light incident level exceeds the instability detection threshold, so you can check the site before false detection occurs and perform predictive maintenance.

Debris and dust accumulate on the sensing surface (Through-beam)

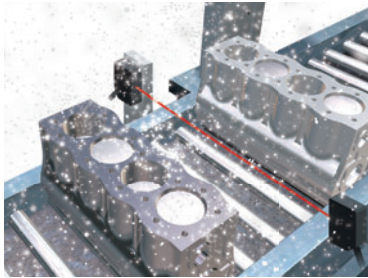

Paint adhered to the sensing surface (Through-beam)

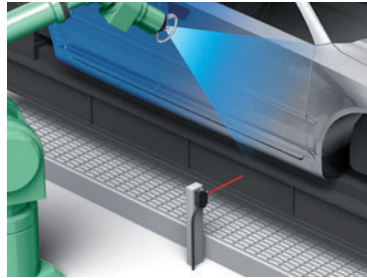

Water drops adhered to the sensing surface (Through-beam)

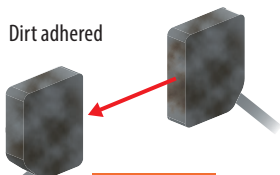

Incident level decrease when the level is higher than the detection threshold

Incident level reduces → **False detection**

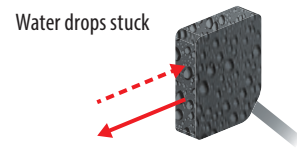
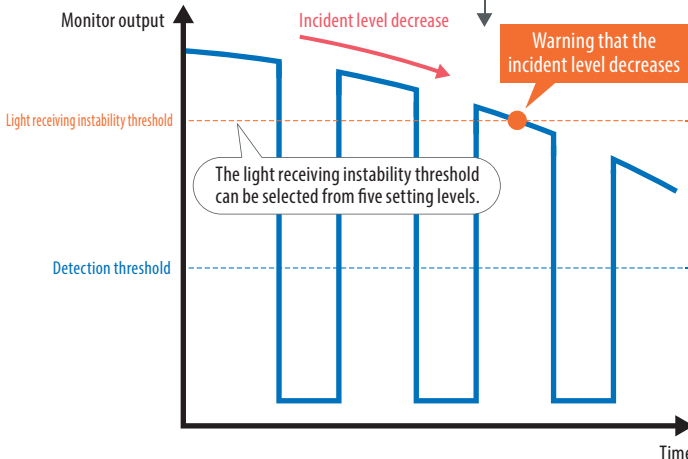

Incident level increase when the level is lower than the detection threshold

Incident level increases → **False detection**

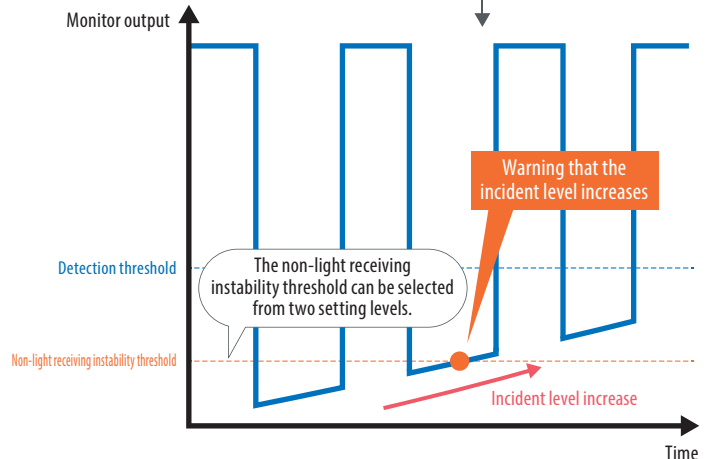

To those in charge of production engineering "Individual identification" for the reduction of man-hours



Improving System Commissioning and Changeover Efficiency by Checking Identifications in Batches

Existing problems

- During system start-up or changeover, operators had to perform the I/O check for each of the thousands of sensors installed on the line, and it took an enormous amount of time...
- When a sensor is installed wrong or an error occurs, wasteful work occurred that would normally be unnecessary...



With an IO-Link Photoelectric Sensor/Proximity Sensor

Without going to the site, you can check individual sensor identifications in batches, resulting in a sharp reduction of commissioning time

By checking the sensor identification (manufacturer/sensor type/model number), you can easily check mistakes such as misconnected or unconnected sensors and installation mistakes. Also, because it is possible to program multiple sensors at once using the command language used only for the controller, it is also possible to reduce commissioning time sharply.

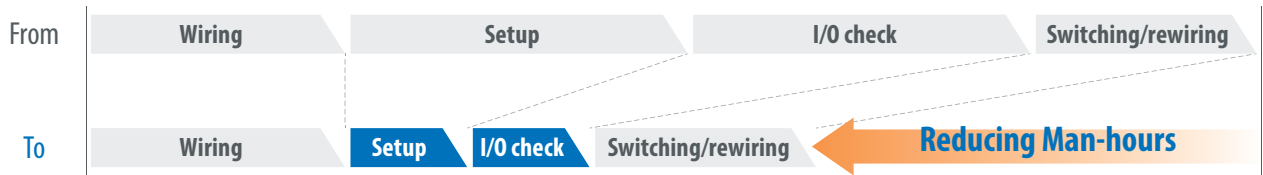

Note: The graph above is a conceptual illustration.

Setup

Setting all sensors from a host device at the same time

Program all at once to reduce commissioning time and inconsistent settings

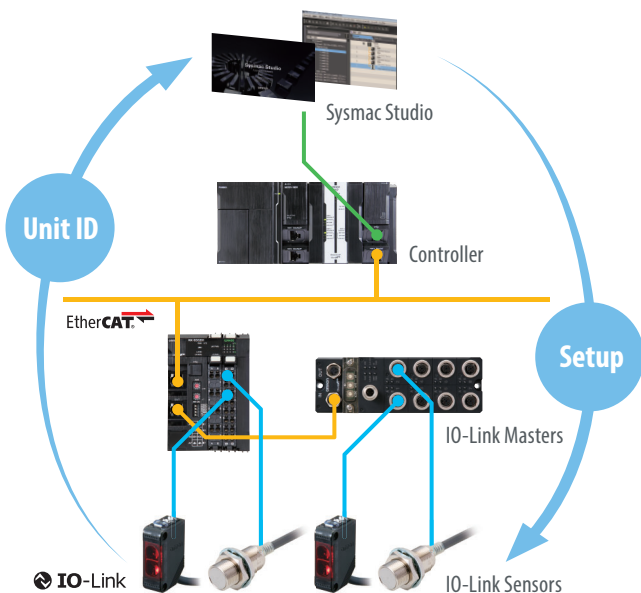

I/O check

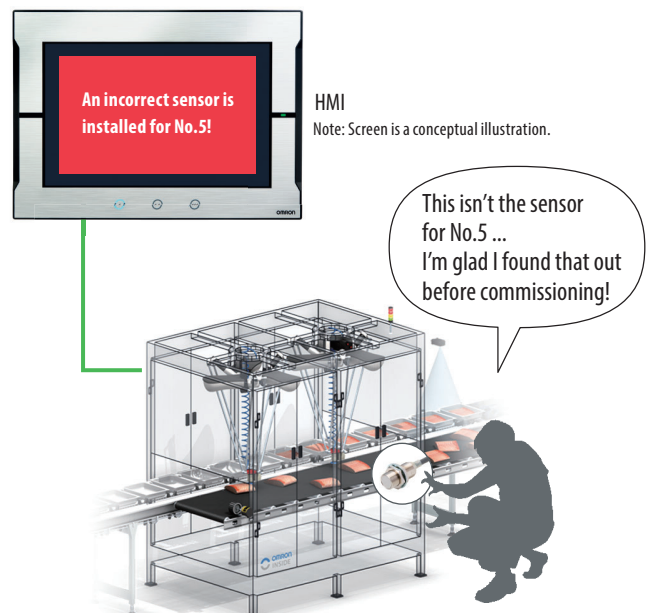

Use identification checks with HMI to prevent installation mistakes

Makes it possible to check for sensor installation mistakes before commissioning



Note: Screen is a conceptual illustration.

IO-Link Masters

Product name	Number of IO-Link ports	External connection terminal	Environment tolerance	Model
NX Series IO-Link Master Unit *1 	4	Screw-less clamp terminals	IP20	NX-ILM400
GX Series IO-Link Master Unit 	8	M12 Smartclick Connector	IP67	GX-ILM08C

*1. EtherCAT Communication Coupler Unit NX-ECC□□□ or EtherNet/IP Communication Coupler Unit NX-EIC202 is necessary for the system configuration.

IO-Link Sensors

Photoelectric Sensor

Product name	Sensing method	Connection method	Model
	Through-beam	Pre-wired Models (2m)	E3Z-T81-IL□ 2M
		M12 Pre-wired Smartclick Connector Models (0.3m)	E3Z-T81-M1TJ-IL□ 0.3M
		Standard M8 Connector Models	E3Z-T86-IL□
	Retro-reflective	Pre-wired Models (2m)	E3Z-R81-IL□ 2M
		M12 Pre-wired Smartclick Connector Models (0.3m)	E3Z-R81-M1TJ-IL□ 0.3M
		Standard M8 Connector Models	E3Z-R86-IL□
	Diffuse-reflective	Pre-wired Models (2m)	E3Z-D82-IL□ 2M
		M12 Pre-wired Smartclick Connector Models (0.3m)	E3Z-D82-M1TJ-IL□ 0.3M
		Standard M8 Connector Models	E3Z-D87-IL□
	Diffuse-reflective Narrow-beam	Pre-wired Models (2m)	E3Z-L81-IL□ 2M
		M12 Pre-wired Smartclick Connector Models (0.3m)	E3Z-L81-M1TJ-IL□ 0.3M
		Standard M8 Connector Models	E3Z-L86-IL□

Color Mark Photoelectric Sensor

Product name	Sensing method	Connection method	Model
E3S-DCP21-IL□ 	Diffuse-reflective	M12 Connector Models	E3S-DCP21-IL□

Standard Proximity Sensor (DC 3-wire Shielded Model)

Product name	Size	Connection method	Model
	M12	Pre-wired Models (2m)	E2E-X3B4-IL□ 2M
		M12 Pre-wired Smartclick Connector Models (0.3m)	E2E-X3B4-M1TJ-IL□ 0.3M
	M18	Pre-wired Models (2m)	E2E-X7B4-IL□ 2M
		M12 Pre-wired Smartclick Connector Models (0.3m)	E2E-X7B4-M1TJ-IL□ 0.3M
	M30	Pre-wired Models (2m)	E2E-X10B4-IL□ 2M
		M12 Pre-wired Smartclick Connector Models (0.3m)	E2E-X10B4-M1TJ-IL□ 0.3M

Spatter-resistant Proximity Sensor (DC 3-wire Shielded Model)

Product name	Size	Connection method	Model
	M12	Pre-wired Models (2m)	E2EQ-X3B4-IL□ 2M
		M12 Pre-wired Smartclick Connector Models (0.3m)	E2EQ-X3B4-M1TJ-IL□ 0.3M
	M18	Pre-wired Models (2m)	E2EQ-X7B4-IL□ 2M
		M12 Pre-wired Smartclick Connector Models (0.3m)	E2EQ-X7B4-M1TJ-IL□ 0.3M
	M30	Pre-wired Models (2m)	E2EQ-X10B4-IL□ 2M
		M12 Pre-wired Smartclick Connector Models (0.3m)	E2EQ-X10B4-M1TJ-IL□ 0.3M

Software

Product name	Model
Sysmac Studio *2	SYSMAC-SE2□□□

*2. CX-ConfiguratorFDT for IO-Link sensor setup is included in Sysmac Studio.

INDEX

Communications Specifications	18
Masters Unit	
NX-series IO-Link Master Unit	
NX-ILM400	19
GX-series IO-Link Master Unit	
GX-ILM08C	31
Slave Unit	
IO-Link Photoelectric Sensor	
E3Z-□-IL□	43
IO-Link Color Mark Photoelectric Sensors	
E3S-DCP21-IL□	55
IO-Link Proximity Sensor (Standard Models)	
E2E-□-IL□	63
IO-Link Proximity Sensor (Spatter-resistant Models)	
E2EQ-□-IL□	69

Communications Specifications

Item	Specification
Communications protocol	IO-Link protocol
Baud rate	COM1 (4.8 kbps), COM2 (38.4 kbps), or COM3 (230.4 kbps)
Topology	1:1
Communications media	Unshielded cable
Communications distance	20 m max.
Compliant standards	<ul style="list-style-type: none">• IO-Link Interface and System Specification Version1.1.2 *• IO-Link Test Specification Version1.1.2

* OMRON IO-Link products do not support the IO-Link preoperate state.

NX-series IO-Link Master Unit

NX-ILM400

IO-Link makes sensor level information visible and solves the three major issues at manufacturing sites!
The screwless clamping terminal block reduces wiring work.

- Downtime can be reduced.
Notifies you of faulty parts and such phenomena in the Sensor in real time.
- The frequency of sudden failure can be decreased.
Condition monitoring of sensors and equipment to prevent troubles.
- The efficiency of changeover can be improved.
The batch check for individual sensor IDs significantly decreases commissioning time.



Corresponding to our shared **Value Design for Panel** concept for the specifications of products

Features

- The host controller can cyclically read control signals, status*1, wiring, and power supply status of IO-Link sensors. Because an IO-Link System can cyclically read analog data such as the amount of incident light in addition to ON/OFF information, it can be used for predictive maintenance based on detection of such things as decreases in the amount of light.
- User-specified data in IO-Link devices can be read and written from the host controller when necessary.
- Digital signals can be input rapidly from IO-Link sensors*2 during IO-Link communications.
- IO-Link sensors can be combined with non-IO-Link sensors.
- Incorrect connections of IO-Link sensors can be checked when IO-Link communications start.
- Backup and restoration of IO-Link device parameters make replacement of IO-Link sensors easier.
- IO-Link sensors can be easily replaced with non-IO-Link sensors without changing the data address settings.*3
- Sensors can report their errors to the master, which facilitates locating errors from the host.
- The total number of retries in cyclic communications can be recorded. You can use this value to check for the influences of noise and other problems.
(When EtherCAT is used as the host communication interface)
- Up to four sensors can be connected.

*1. Examples for Photoelectric Sensors: Instability detection and sensor errors

*2. IO-Link sensors that support digital inputs that use pin 2 of IO-Link Master Unit ports

*3. Bit data of IO-Link sensor can be reflected in the address of the digital input data by using digital input collection.
This function is supported with the unit version 1.1 or later.

Sysmac is a trademark or registered trademark of OMRON Corporation in Japan and other countries for OMRON factory automation products.

EtherCAT® is a registered trademark of Beckhoff Automation GmbH for their patented technology.

EtherNet/IP™ is the trademarks of ODVA.

Other company names and product names in this document are the trademarks or registered trademarks of their respective companies.

System Configuration

Controller Communications with NX Bus

NX bus communications can be used only when the controller is an NX1P2 CPU Unit.

Support Software:

- IO-Link Master Unit settings: Use the Sysmac Studio.
- IO-Link device settings: Use CX-ConfiguratorFDT.

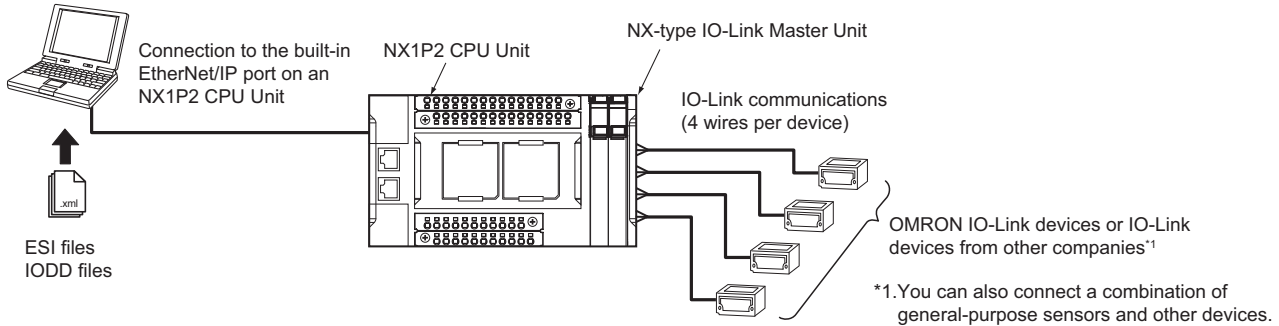

Applicable Support Software

Function	IO-Link Master Unit type	Applicable Support Software		
		NX Unit settings	IO-Link Master Unit settings	Setting and monitoring the connected IO-Link devices
Applicable Support Software	NX	Sysmac Studio *1	Sysmac Studio *1	CX-ConfiguratorFDT *2
	GX	Sysmac Studio *1	Sysmac Studio *1	CX-ConfiguratorFDT *2

*1. Sysmac Studio version 1.17 or higher is required.

*2. CX-ConfiguratorFDT version 2.2 or higher is required.

Controller Communications with EtherNet/IP

Support Software:

- IO-Link Master Unit settings: Use the Sysmac Studio or NX-IO Configurator.*1
- IO-Link device settings: Use CX-ConfiguratorFDT.*2

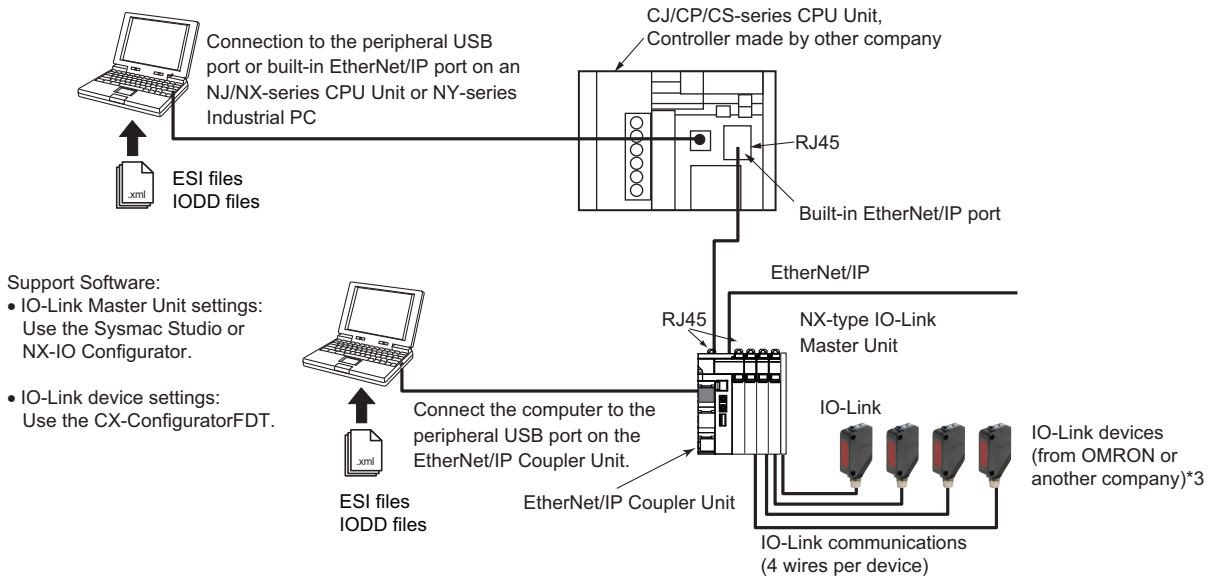

*1. When a host controller from another company is used with EtherNet/IP host communications connect the Sysmac Studio or NX-IO Configurator to the EtherNet/IP Coupler Unit, for IO-Link Master Unit settings.

*2. When a host controller from another company is used with EtherNet/IP host communications connect CX-ConfiguratorFDT to the EtherNet/IP Coupler Unit, for IO-Link device settings.

*3. You can also connect a combination of general-purpose sensors and other devices.

Applicable Support Software

IO-Link Master Unit type	Applicable Support Software		
	Tag data link setting	IO-Link Master Unit settings *1	Setting and monitoring the IO-Link devices
NX	Use the Network Configurator or the EtherNet/IP software application from the other company.	IO-Link Master Unit Configuration Tool • Sysmac Studio*2 • NX-IO Configurator*3	CX-ConfiguratorFDT

*1. The IO-Link device connection configuration information settings are included in the IO-Link Master Unit settings.

*2. The settings from the Sysmac Studio are required when you use the Safety Control Unit on the Slave Terminal. The Safety Control Unit is not supported with the NX-IO Configurator.

*3. The connectable paths of NX-IO Configurator differ depending on the unit version of the EtherNet/IP Coupler Unit.

Controller Communications with EtherCAT

Support Software:

- IO-Link Master Unit settings: Use the Sysmac Studio.*1
- IO-Link device settings: Use CX-ConfiguratorFDT.*2

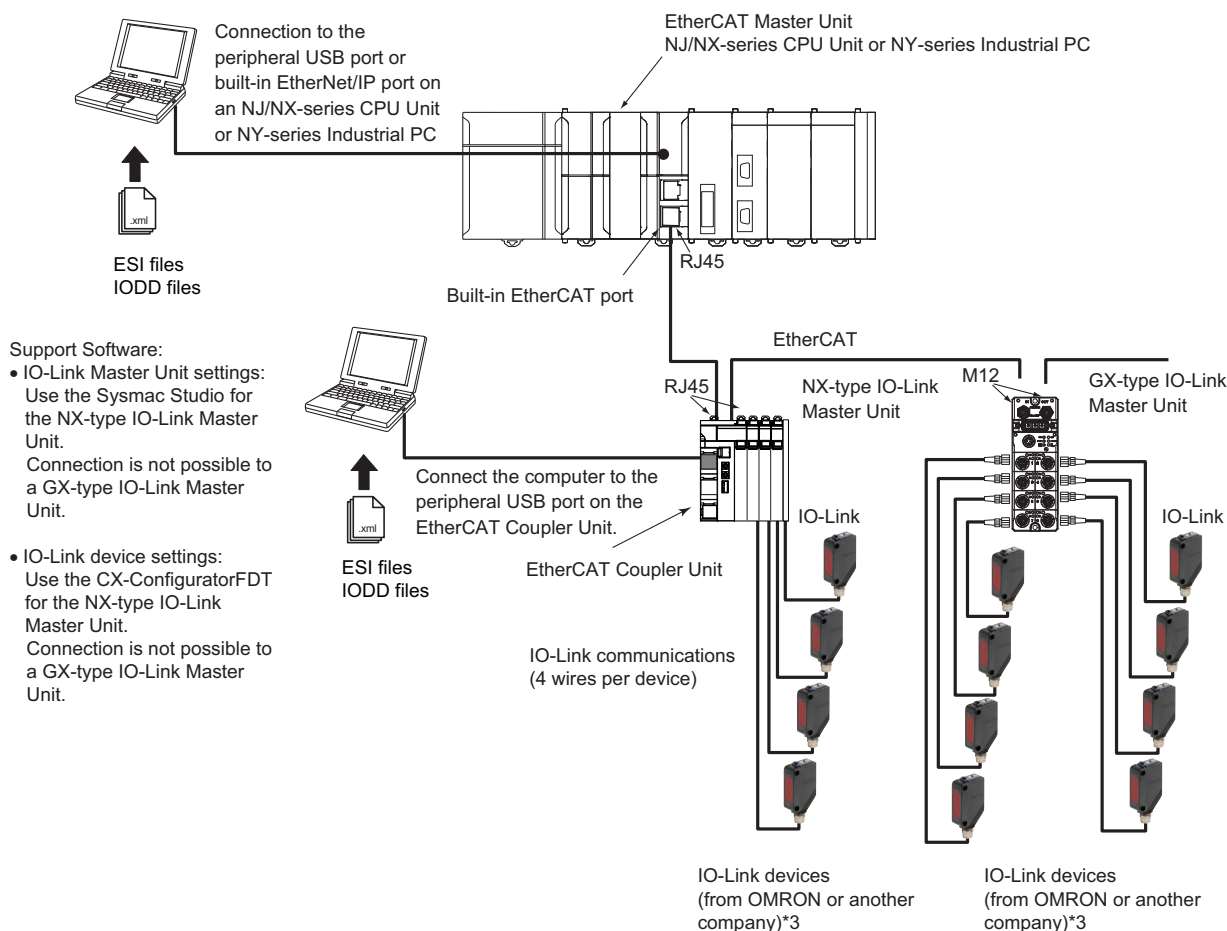

- *1. When a host controller from another company is used with EtherCAT host communications, use the EtherCAT software application from the other company for a GX-type IO-Link Master Unit.
Note. For an NX-type IO-Link Master Unit, connect the Sysmac Studio to the EtherCAT Coupler Unit, as shown above.
- *2. When a host controller from another company is used with EtherCAT host communications, for a GX-type IO-Link Master Unit, make the IO-Link device settings with message communications from the host controller from the other company.
Note. For an NX-type IO-Link Master Unit, connect CX-ConfiguratorFDT to the EtherCAT Coupler Unit, as shown above.
- *3. You can also connect a combination of general-purpose sensors and other devices.

Applicable Support Software

IO-Link Master Unit type	Applicable Support Software		
	PDO allocation settings (GX) I/O allocation settings (NX)	IO-Link Master Unit settings (IO-Link device connection configuration settings) *1	Setting and monitoring the IO-Link devices
NX	Sysmac Studio *1	Sysmac Studio *1	CX-ConfiguratorFDT *2
GX	Sysmac Studio *1	Sysmac Studio *1	CX-ConfiguratorFDT *2

*1. The device configuration settings are included in the IO-Link Master Unit settings.

*2. CX-ConfiguratorFDT version 2.2 or higher is required.

NX-ILM400

Ordering Information

International Standards

- The standards are abbreviated as follows: U: UL, U1: UL(Class I Division 2 Products for Hazardous Locations), C: CSA, UC: cULus, UC1: cULus (Class I Division 2 Products for Hazardous Locations), CU: cUL, N: NK, L: Lloyd, CE: EU Directives, RCM: Regulatory Compliance Mark, and KC: KC Registration.
- Contact your OMRON representative for further details and applicable conditions for these standards.

NX-series IO-Link Master Unit

Product name	Specification			Model	Standards
	Number of IO-Link ports	I/O refreshing method	I/O connection terminals		
NX-series IO-Link Master Unit	4	Free-Run refreshing	Screwless clamping terminal block	NX-ILM400	UC1, CE, N, RCM, KC

Peripheral Devices

Sensor I/O Connectors

Order a cable with a connector on one end to connect a sensor of connector type. Refer to the *Ordering Information* in the catalog of the sensor to connect or the *Sensor I/O Connectors/Sensor Controllers* on your local OMRON website for recommended products.

Optional Products

Product name	Specification	Model	Standards
Unit/Terminal Block Coding Pins	Pins for 10 Units (30 terminal block pins and 30 Unit pins)	NX-AUX02	---

Product name	Specification				Model	Standards
	No. of terminals	Terminal number indications	Ground terminal mark	Terminal current capacity		
Terminal Block	16	A/B	Not provided	10 A	NX-TBA162	---

Software

Automation Software Sysmac Studio

Please purchase a DVD and required number of licenses the first time you purchase the Sysmac Studio. DVDs and licenses are available individually. Each model of licenses does not include any DVD.

Product name	Specification	Specification		Model	Standards
		Number of licenses	Media		
Sysmac Studio Standard Edition Ver.1.□□	The Sysmac Studio is the software that provides an integrated environment for setting, programming, debugging and maintenance of machine automation controllers including the NJ/NX-series CPU Units, NY-series Industrial PC, EtherCAT Slave, and the HMI.	--- (Media only)	DVD	SYSMAC-SE200D	---
	Sysmac Studio runs on the following OS. Windows 7(32-bit/64-bit version)/Windows 8(32-bit/64-bit version)/Windows 8.1(32-bit/64-bit version)/Windows 10(32-bit/64-bit version)	1 license *	---	SYSMAC-SE201L	

* Multi licenses are available for the Sysmac Studio (3, 10, 30, or 50 licenses).

General Specification

Item	Specification	
Enclosure	Must be built into a panel.	
Grounding methods	Ground to 100 Ω or less.	
Operating environment	Ambient operating temperature	0 to 55°C
	Ambient operating humidity	10% to 95% (with no condensation or icing)
	Atmosphere	Must be free from corrosive gases.
	Ambient storage temperature	-25 to 70°C (with no condensation or icing)
	Altitude	2,000 m max.
	Pollution degree	Pollution degree 2 or less: Conforms to JIS B3502 and IEC 61131-2.
	Noise immunity	Conforms to IEC 61000-4-4, 2 kV (power line).
	Overvoltage category	Category: Conforms to JIS B3502 and IEC 61131-2.
	EMC immunity level	Zone B
	Vibration resistance	Conforms to IEC 60068-2-6. 5 to 8.4 Hz with amplitude of 3.5 mm, 8.4 to 150 Hz, acceleration of 9.8 m/s ² 100 min each in X, Y, and Z directions (10 sweeps of 10 min each = 100 min total)
Shock resistance	Conforms to IEC 60068-2-27. 147 m/s ² , 3 times each in X, Y, and Z directions	
Applicable standards *	UL 61010-2-201, ANSI/ISA 12.12.01, EU: EN 61131-2, RCM, KC, and IO-Link conformance	

* Refer to the OMRON website (www.ia.omron.com) or ask your OMRON representative for the most recent applicable standards for each model.

NX-ILM400

Unit Specification

Item		Specification
Unit name		IO-Link Master Unit
Model		NX-ILM400
Number of ports		4
Communications specifications	Communications protocol	IO-Link protocol
	Baud rate	COM1: 4.8kbps COM2: 38.4kbps COM3: 230.4kbps
	Topology	1:1
	Compliant standards	<ul style="list-style-type: none"> IO-Link Interface and System Specification Version1.1.2 IO-Link Test Specification Version1.1.2
Power supply to devices* in IO-Link Mode or SIO (DI) Mode	Rated voltage	24 VDC (20.4 to 28.8 VDC)
	Maximum load current	0.2 A/port
	Short-circuit protection	Provided.
Digital inputs (in SIO (DI) Mode)	Internal I/O common	PNP
	Rated voltage	24 VDC (20.4 to 28.8 VDC)
	Input current	5 mA typical (24 VDC)
	ON voltage/ON current	15 VDC min., 2 mA min.
	OFF voltage	5 VDC max.
	Input filter time	No filter, 0.25 ms, 0.5 ms, 1 ms (default), 2 ms, 4 ms, 8 ms, 16 ms, 32 ms, 64 ms, 128 ms, 256 ms
Digital outputs (in SIO (DO) Mode)	Internal I/O common	PNP
	Output type	Push-pull
	Rated voltage	24 VDC (20.4 to 28.8 VDC)
	Maximum load current	0.1 A/port
	Short-circuit protection	Provided.
	Leakage current	0.1 mA max.
	Residual voltage	1.5 V max.
Digital inputs for pin 2 (in IO-Link Mode)	Internal I/O common	PNP
	Rated voltage	24 VDC (20.4 to 28.8 VDC)
	Input current	2 mA typical (24 VDC)
	ON voltage/ON current	15 VDC min., 2 mA min.
	OFF voltage	5 VDC max.
	Input filter time	No filter, 0.25 ms, 0.5 ms, 1 ms (default), 2 ms, 4 ms, 8 ms, 16 ms, 32 ms, 64 ms, 128 ms, 256 ms
Cable specifications	Cable type	Unshielded
	Length	20 m max.
	Electrostatic capacity between lines	3 nF max.
	Loop resistance	6 Ω max.
External connection terminals		Screwless Clamping Terminal Block (16 terminals)
I/O refreshing method		Free-Run refreshing
Dimensions		12 × 100 × 71 mm (W×H×D)
Isolation method		Photocoupler isolation
Insulation resistance		20 MΩ min. at 100 VDC (between isolated circuits)
Dielectric strength		510 VAC for 1 min, leakage current: 5 mA max. (between isolated circuits)
I/O power supply method		Supply from the NX bus
NX Unit power consumption		<ul style="list-style-type: none"> Connected to a CPU Unit 1.05 W max. Connected to a Communications Coupler Unit 0.80 W max.
Current consumption from I/O power supply		50 mA
Weight		67 g

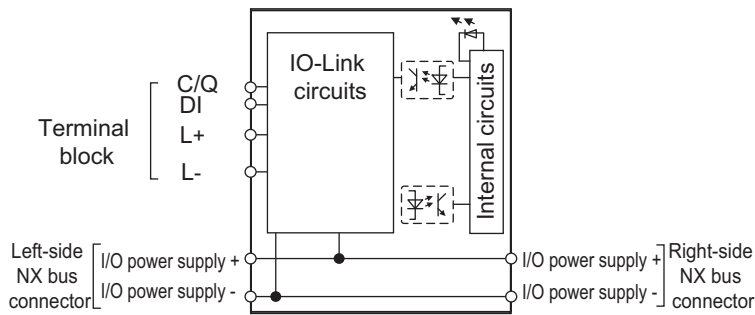
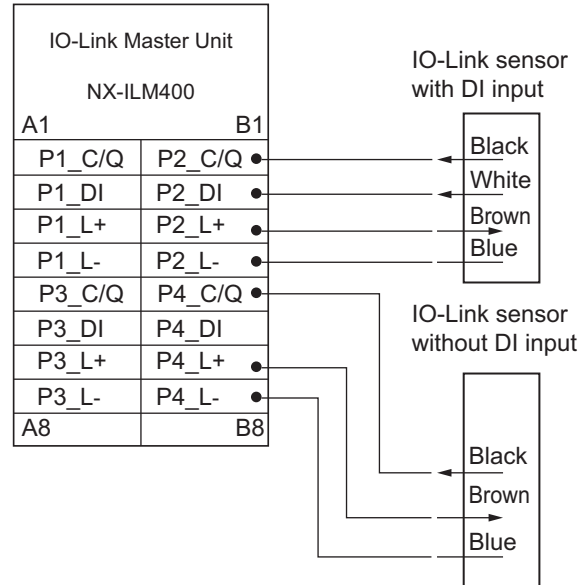
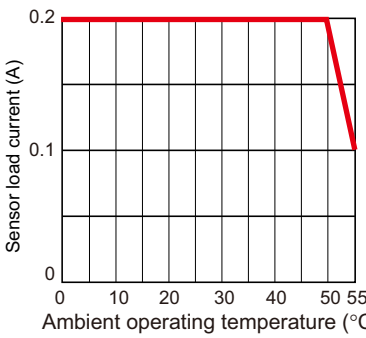
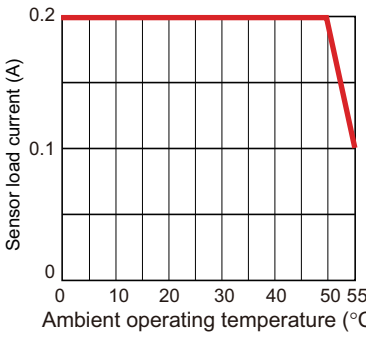
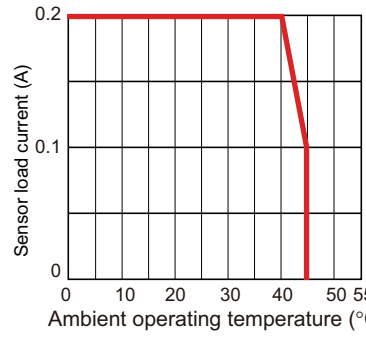
Item	Specification
<p>Circuit configuration</p>	
<p>Terminal connection diagram</p>	
<p>Installation orientation and restrictions</p>	<ul style="list-style-type: none"> • Connected to a CPU Unit The Unit can be in the upright installation orientation. Upright Installation  <ul style="list-style-type: none"> • Connected to a Communications Coupler Unit The Unit can be installed in any of six possible orientations. There are restrictions on mounting orientations other than upright. <div style="display: flex; justify-content: space-around;"> <div style="text-align: center;"> <p>Upright Installation</p>  </div> <div style="text-align: center;"> <p>Any Installation Other Than Upright</p>  </div> </div>
<p>Protective functions</p>	<p>L+ terminal short-circuit protection C/Q terminal short-circuit protection</p>

Function Specifications

Function		Description
Communications	Cyclic communications	I/O data (process data) in the IO-Link devices is cyclically exchanged with the IO-Link Master Unit as the IO-Link communications master. At the same time, this data and the status of the IO-Link Master Unit is cyclically exchanged with the controller, with the IO-Link Master Unit operating as a slave of the controller. Cyclic communications can be used to check the amount of detection performance deterioration in devices, and to check changes in usage conditions, such as the amount of incident light for photoelectric sensors, stability detection margins, and excessive proximity for proximity sensors.
	Message communications	The controller can send messages (commands) to the IO-Link Master Unit and receive the response from the IO-Link Master Unit. The IO-Link Master Unit can also function as a gateway to send messages (commands and responses) between the controller and the IO-Link devices. During operation, you can change and adjust device parameters, such as threshold settings, tuning execution, and ON-delay time changes, from a program. Or, during operation, you can check the internal status, such as the operating times of devices.
Communications mode settings		You can select any of the following modes for each port: IO-Link Mode, SIO (DI) Mode, SIO (DO) Mode, and Disable Port This allows you to combine IO-Link communications and digital I/O in a single unit.
Digital inputs for pin 2		In IO-Link Mode, you can perform digital input with pin 2 while performing IO-Link communications.
Automatic baud rate setting for IO-Link communications		The IO-Link Master Unit automatically matches the specific baud rates (COM1, COM2, or COM3) of the IO-Link devices to communicate with the IO-Link devices. Therefore, it is not necessary to set the baud rate of the connected device for each port.
Connected device verification		This function is used to verify the configuration of IO-Link devices that are connected to the IO-Link Master Unit against the registered IO-Link device configuration settings when the power supply is turned ON. The user can enable or disable connected device verification.
IO-Link communications error detection		This function detects I/O cable breaks, disconnections from IO-Link device ports, error-level device events, device configuration verification errors, and IO-Link device malfunctions.
Detection of short-circuits in I/O cables		This function detects short-circuits in I/O cables
Notification of input data validity		The controller can use the Input Data Enabled Flags to determine whether the process input data for IO-Link communications is valid.
Load rejection for controller communications error		This function turns OFF outputs from the IO-Link Master Unit when a communications error occurs in communications with the controller in IO-Link Mode or in an SIO mode. This prevents incorrect output operations when communications error occurs.
IO-Link total communications lost frames		The IO-Link total communications lost frames can be read from the CX-ConfiguratorFDT. You can use this function to determine communications status as affected by I/O cable noise or other factors.
Digital input filter		This function is used to eliminate chattering and noise of the input signal for digital inputs in SIO(DI) Mode or for digital inputs for pin 2 in IO-Link Mode. It prevents data change and stabilizes the input signal even in situations where the input data changes due to chattering or noise and the bit status is unstable.
Digital input collection*		In IO-Link Mode, this function reflects the specified bit data in the input data from the IO-Link device on the digital input data of the IO-Link Master Unit. As a result, the bit data in the input data from the IO-Link device can be aggregated into the digital input data of the IO-Link Master Unit. One bit for each IO-Link port can be aggregated. This function cannot be used in SIO (DI) Mode and SIO (DO) Mode. If you use this function, digital inputs with pin 2 cannot be used.
Backup and restoration of parameter settings in IO-Link devices		This function is used to back up parameter settings in IO-Link devices in the IO-Link Master Unit or restore them to IO-Link devices. This eliminates the need to set parameters again after replacing an IO-Link device.
Event log		This function records events, such as errors and status changes, that occur in the IO-Link Master Unit and the IO-Link devices. This enables partial troubleshooting for NJ/NX-series Controllers and NY-series Industrial PCs.

* This function is supported with the unit version 1.1 or later.

Version Information

Connecting with CPU Units

Refer to the user's manual for the CPU Unit for the CPU Unit to which NX Units can be connected.

NX Unit		Corresponding versions *		
Model	Unit version	CPU Unit	Sysmac Studio	CX-ConfiguratorFDT
NX-ILM400	Ver.1.1	Ver1.13 or later	Ver1.20 or higher	Ver2.3 or higher
	Ver.1.0	Ver.1.13 or later	Ver.1.17 or higher	Ver.2.3 or higher

* Some Units do not have all of the versions given in the above table. If a Unit does not have the specified version, support is provided by the oldest available version after the specified version. Refer to the user's manuals for the specific Units for the relation between models and versions.

Connecting with Coupler Units

NX Unit		Corresponding versions *						
Model	Unit version	EtherCAT				EtherNet/IP		
		Communications Coupler Unit	NJ/NX-series CPU Units or NY-series Industrial PCs	Sysmac Studio	CX-Configurator FDT	Communications Coupler Unit	Sysmac Studio	CX-Configurator FDT
NX-ILM400	Ver.1.1	Ver.1.0 or later	Ver.1.12 or later	Ver.1.20 or higher	Ver.2.2 or higher	Ver.1.0 or later	Ver.1.20 or higher	Ver.2.2 or higher
	Ver.1.0	Ver.1.0 or later	Ver.1.12 or later	Ver.1.16 or higher	Ver.2.2 or higher	Ver.1.0 or later	Ver.1.16 or higher	Ver.2.2 or higher

* Some Units do not have all of the versions given in the above table. If a Unit does not have the specified version, support is provided by the oldest available version after the specified version. Refer to the user's manuals for the specific Units for the relation between models and versions.

External Interface

NXILM-400

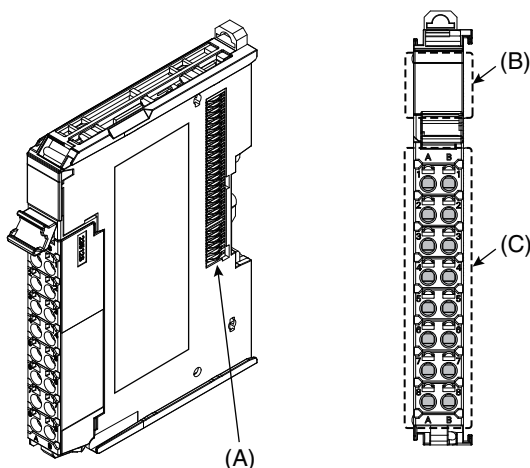

Letter	Name	Function
(A)	NX bus connector	This connector is used to connect each Unit.
(B)	Indicators	The indicators show the current operating status of the Unit.
(C)	Terminal block	The terminal block is used to connect external devices. The number of terminals depends on the type of Unit.

Terminal Blocks

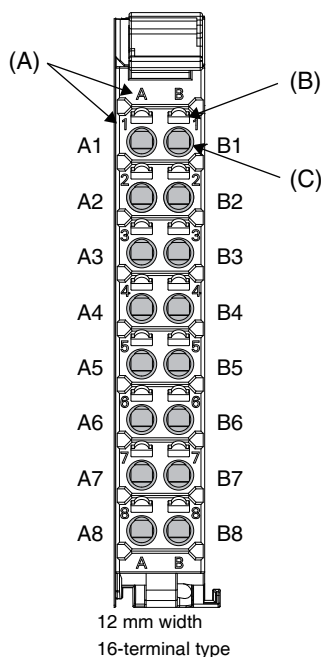

Letter	Name	Function
(A)	Terminal number indications	Terminal numbers for which A and B indicate the column, and 1 to 8 indicate the line are displayed. The terminal number is a combination of column and line, i.e. A1 to A8 and B1 to B8. The terminal number indications are the same regardless of the number of terminals on the terminal block.
(B)	Release holes	Insert a flat-blade screwdriver into these holes to connect and remove the wires.
(C)	Terminal holes	The wires are inserted into these holes.

Applicable Terminal Blocks for Each Unit Model

Unit model	Terminal Blocks				
	Model	No. of terminals	Terminal number indications	Ground terminal mark	Terminal current capacity
NX-ILM400	NX-TBA162	16	A/B	Not provided	10A

Applicable Wires

Using Ferrules

If you use ferrules, attach the twisted wires to them.

Observe the application instructions for your ferrules for the wire stripping length when attaching ferrules.

Always use plated one-pin ferrules. Do not use unplated ferrules or two-pin ferrules.

The applicable ferrules, wires, and crimping tool are given in the following table.

Terminal types	Manufacturer	Ferrule model	Applicable wire (mm ² (AWG))	Crimping tool
Terminals other than ground terminals	Phoenix Contact	AI0,34-8	0.34 (#22)	Phoenix Contact (The figure in parentheses is the applicable wire size.) CRIMPFOX 6 (0.25 to 6 mm ² , AWG 24 to 10)
		AI0,5-8	0.5 (#20)	
		AI0,5-10		
		AI0,75-8	0.75 (#18)	
		AI0,75-10		
		AI1,0-8	1.0 (#18)	
		AI1,0-10		
		AI1,5-8	1.5 (#16)	
		AI1,5-10		
Ground terminals		AI2,5-10	2.0 ^{*1}	
Terminals other than ground terminals	Weidmuller	H0.14/12	0.14 (#26)	Weidmuller (The figure in parentheses is the applicable wire size.) PZ6 Roto (0.14 to 6 mm ² , AWG 26 to 10)
		H0.25/12	0.25 (#24)	
		H0.34/12	0.34 (#22)	
		H0.5/14	0.5 (#20)	
		H0.5/16		
		H0.75/14	0.75 (#18)	
		H0.75/16		
		H1.0/14	1.0 (#18)	
		H1.0/16		
		H1.5/14	1.5 (#16)	
		H1.5/16		

*1. Some AWG 14 wires exceed 2.0 mm² and cannot be used in the screwless clamping terminal block.

When you use any ferrules other than those in the above table, crimp them to the twisted wires so that the following processed dimensions are achieved.

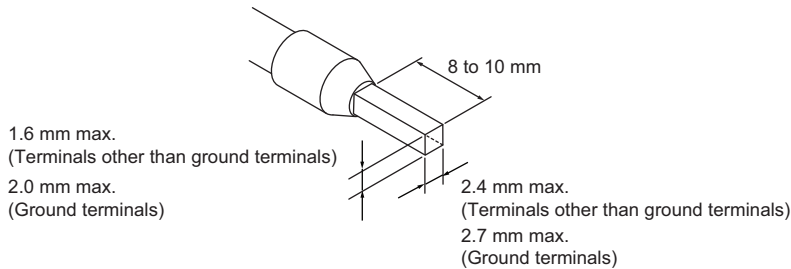

Using Twisted Wires/Solid Wires

If you use the twisted wires or the solid wires, use the following table to determine the correct wire specifications.

Terminals		Wire type				Wire size	Conductor length (stripping length)
		Twisted wires		Solid wire			
Classification	Current capacity	Plated	Unplated	Plated	Unplated		
All terminals except ground terminals	2 A max.	Possible	Possible	Possible	Possible	0.08 to 1.5 mm ² AWG28 to 16	8 to 10 mm
	Greater than 2 A and 4 A or less		Not Possible	Possible ^{*1}	Not Possible		
	Greater than 4 A		Possible ^{*1}	Not Possible	Not Possible		
Ground terminals	---	Possible	Possible	Possible ^{*2}	Possible ^{*2}	2.0 mm ²	9 to 10 mm

*1. Secure wires to the screwless clamping terminal block. Refer to the Securing Wires in the USER'S MANUAL for how to secure wires.

*2. With the NX-TB□□□1 Terminal Block, use twisted wires to connect the ground terminal. Do not use a solid wire.

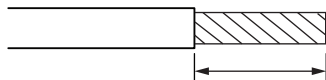

Conductor length (stripping length)

<Additional Information> If more than 2 A will flow on the wires, use plated wires or use ferrules.

Dimensions

NX-ILM400
12 mm Width

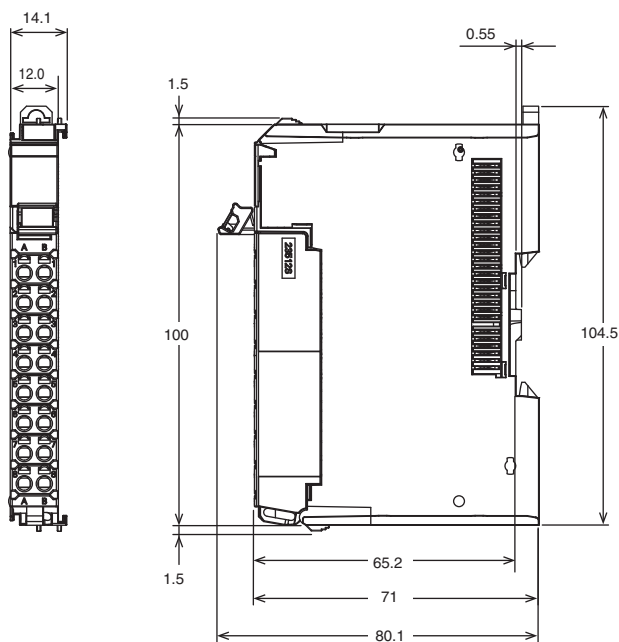

NX-ILM400

Related Manuals

Man.No	Model	Manual	Application	Description
W567	NX-ILM400	IO-Link Master Unit User's Manual	Learning hardware information, wiring, and specifications for the NX-series IO-Link Master Unit and checking a list of NX objects.	Describes detailed part specifications, installation, and wiring and also provides tables of specifications and NX objects for the NX-series IO-Link Master Unit.
W570	NX-ILM400 GX-ILM08C	IO-Link System User's Manual	Learning everything from an introduction to details about IO-Link Systems, including mainly software information common to all IO-Link masters, Support Software operating methods, and troubleshooting.	Provides an overview of IO-Link Systems and explains the system configuration, communications specifications, communications methods, I/O data, parameters, models, Support Software, and troubleshooting. Refer to the following manuals for the individual IO-Link Master Units for hardware information and specifications specific to each Master Unit and a list of the objects for each Master Unit. NX-series IO-Link Master Unit: W568 GX-series IO-Link Master Unit: W488-E1-05 or later
W488	GX-ID □□□□ GX-OD □□□□ GX-OC □□□□ GX-MD □□□□ GX-AD □□□□ GX-DA □□□□ GX-EC □□□□ GX-ILM □□□ XWT-ID □□ XWT-OD □□	EtherCAT Slave Units User's Manual	Learning hardware information on the GX-series IO-Link Master Unit and checking a list of objects (W488-E1-05 or later). Or, learning how to use GX-series EtherCAT Slave Terminals.	Describes part names, functions, installation, and wiring and also provides tables of specifications and objects for the GX-series IO-Link Master Unit (W488-E1-05 or later). Also describes the hardware, setup methods, and functions of the EtherCAT Remote I/O Terminals.
W502	NX701-□□□□ NJ501-□□□□ NJ301-□□□□ NJ101-□□□□ NX1P2-□□□□	NJ/NX-series Instructions Reference Manual	Learning detailed specifications on the basic instructions of an NJ/NXseries CPU Unit.	The instructions in the instruction set (IEC 61131-3 specifications) are described. When programming, use this manual together with the <i>NX-series CPU Unit Hardware User's Manual</i> (Cat. No. W535) or <i>NJ-series CPU Unit Hardware User's Manual</i> (Cat. No. W500) and <i>NJ/NX-series CPU Unit Software User's Manual</i> (Cat. No. W501).
W505	NX701-□□□□ NJ501-□□□□ NJ301-□□□□ NJ101-□□□□ NX1P2-□□□□	NJ/NX-series CPU Unit Built-in EtherCAT® Port User's Manual	Using the built-in EtherCAT port on an NJ/NX-series CPU Unit.	Information on the built-in EtherCAT port is provided. This manual provides an introduction and provides information on the configuration, features, and setup.
W503	NX701-□□□□ NJ501-□□□□ NJ301-□□□□ NJ101-□□□□ NX1P2-□□□□	NJ/NX-series Troubleshooting Manual	Learning about the errors that may be detected in an NJ/NX-series Controller.	Concepts on managing errors that may be detected in an NJ/NX-series Controller and information on individual errors are described.
W525	NX- □□□□□□	NX-series Data Reference Manual	Referencing lists of the data that is required to configure systems with NX-series Units	Lists of the power consumptions, weights, and other NX Unit data that is required to configure systems with NX-series Units are provided.
W519	NX-ECC□□□	NX-series EtherCAT® Coupler Unit User's Manual	Learning how to use an NX-series EtherCAT Coupler Unit and EtherCAT Slave Terminals	The system and configuration of EtherCAT Slave Terminals, which consist of an NX-series EtherCAT Coupler Unit and NX Units, are described along with the hardware, setup, and functions of the EtherCAT Coupler Unit that are required to configure, control, and monitor NX Units through EtherCAT.
W536	NX-EIC202	NX-series EtherNet/IP™ Coupler Unit User's Manual	Learning how to use an NX-series EtherNet/IP Coupler Unit and EtherNet/IP Slave Terminals.	The following items are described: the overall system and configuration methods of an EtherNet/IP Slave Terminal (which consists of an NX-series EtherNet/IP Coupler Unit and NX Units), and information on hardware, setup, and functions to set up, control, and monitor NX Units.
W504	SYSMAC-SE2□□□	Sysmac Studio Version 1 Operation Manual	Learning about the operating procedures and functions of the Sysmac Studio.	Describes the operating procedures of the Sysmac Studio.
W578	NX1P2-□□□□	NX-series NX1P2 CPU Unit Hardware User's manual	Learning the basic specifications of the NX-series NX1P2 CPU Units, including introductory information, designing, installation, and maintenance. Mainly hardware information is provided.	An introduction to the entire NX1P system is provided along with the following information on the NX1P2 CPU Unit. <ul style="list-style-type: none"> • Features and system configuration • Introduction • Part names and functions • General specifications • Installation and wiring • Maintenance and inspection
W562	NY532-1□□□ NY512-1□□□	NY-series IPC Machine Controller Industrial Panel PC / Industrial Box PC Built-in Ether-CAT® Port User's Manual	Using the built-in EtherCAT port in an NY-series Industrial PC.	Information on the built-in EtherCAT port is provided. This manual provides an introduction and provides information on the configuration, features, and setup.
W560	NY532-1□□□ NY512-1□□□	NY-series Instructions Reference Manual	Learning detailed specifications on the basic instructions of an NY-series Industrial PC.	The instructions in the instruction set (IEC 61131-3 specifications) are described.

Note: Refer to the instructions for the individual Sensors for information on IO-Link Sensors.

IO-Link makes sensor level information visible and solves the three major issues at manufacturing sites!

The unit for M12 Smartclick connector can be used in watery, and dusty environments.



- Downtime can be reduced.
Notifies you of faulty parts and such phenomena in the Sensor in real time.
- The frequency of sudden failure can be decreased.
Condition monitoring of sensors and equipment to prevent troubles.
- The efficiency of changeover can be improved.
The batch check for individual sensor IDs significantly decreases commissioning time.

Features

- The host controller can cyclically read control signals, status*1, wiring, and power supply status of IO-Link sensors. Because an IO-Link System can cyclically read analog data such as the amount of incident light in addition to ON/OFF information, it can be used for predictive maintenance based on detection of such things as decreases in the amount of light.
- User-specified data in IO-Link devices can be read and written from the host controller when necessary.
- Digital signals can be input rapidly from IO-Link sensors*2 during IO-Link communications.
- IO-Link sensors can be combined with non-IO-Link sensors.
- Incorrect connections of IO-Link sensors can be checked when IO-Link communications start.
- Backup and restoration of IO-Link device parameters make replacement of IO-Link sensors easier.
- IO-Link sensors can be easily replaced with non-IO-Link sensors without changing the data address settings.*3
- Sensors can report their errors to the master, which facilitates locating errors from the host.
- The total number of retries in cyclic communications can be recorded. You can use this value to check for the influences of noise and other problems.
(When EtherCAT is used as the host communication interface)
- Up to eight sensors can be connected. IP67 protection.

*1. Examples for Photoelectric Sensors: Instability detection and sensor errors

*2. IO-Link sensors that support digital inputs that use pin 2 of IO-Link Master Unit ports

*3. Bit data of IO-Link sensor can be reflected in the address of the digital input data by using digital input collection.
This function is supported with the unit version 1.1 or later.

Sysmac is a trademark or registered trademark of OMRON Corporation in Japan and other countries for OMRON factory automation products.

EtherCAT® is a registered trademark of Beckhoff Automation GmbH for their patented technology.

EtherNet/IP™ is the trademarks of ODVA.

Other company names and product names in this document are the trademarks or registered trademarks of their respective companies.

System Configuration

Support Software:

- IO-Link Master Unit settings: Use the Sysmac Studio.*1
- IO-Link device settings: Use CX-ConfiguratorFDT.*2

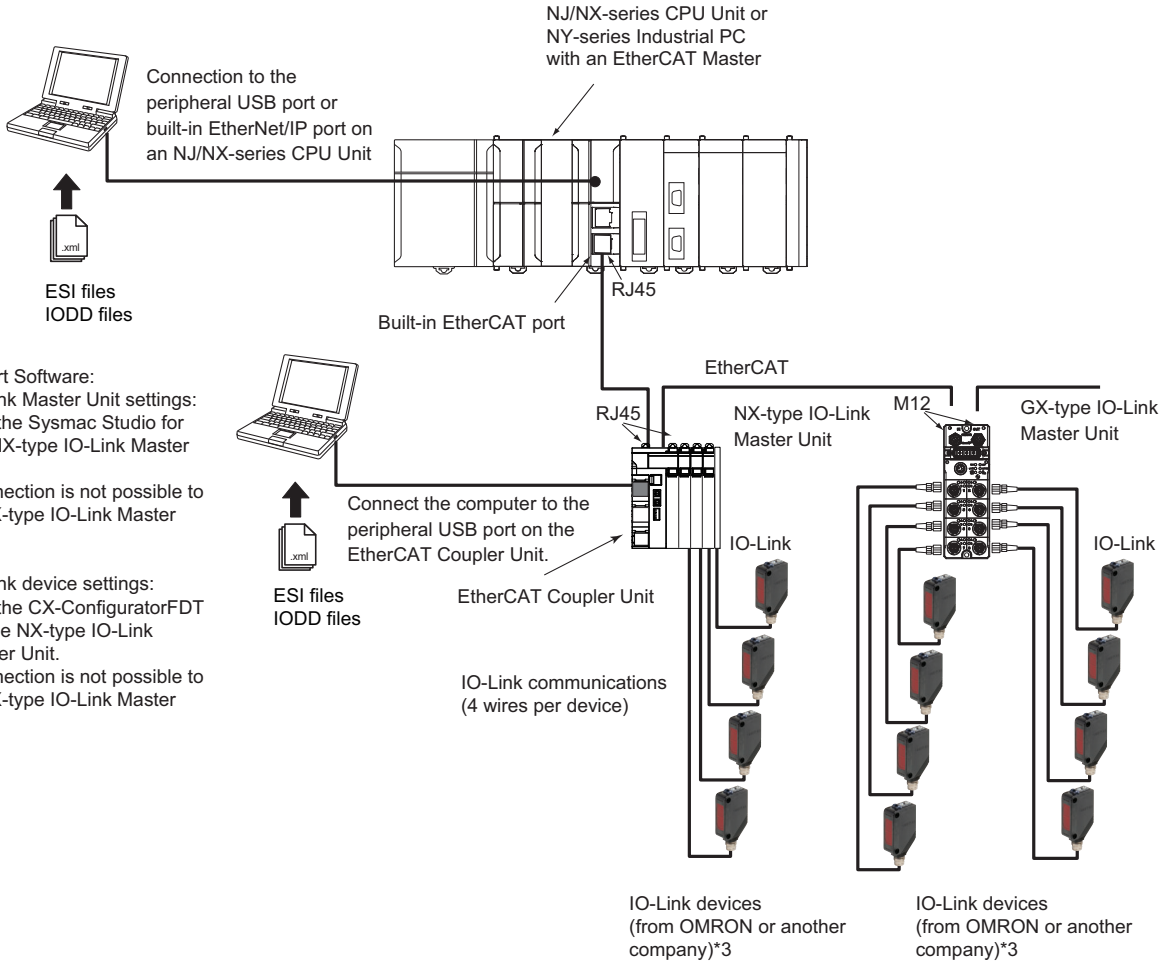

*1. When a host controller from another company is used with EtherCAT host communications, use the EtherCAT software application from the other company for a GX-type IO-Link Master Unit.

Note. For an NX-type IO-Link Master Unit, connect the Sysmac Studio to the EtherCAT Coupler Unit, as shown above.

*2. When a host controller from another company is used with EtherCAT host communications, for a GX-type IO-Link Master Unit, make the IO-Link device settings with message communications from the host controller from the other company.

Note. For an NX-type IO-Link Master Unit, connect CX-ConfiguratorFDT to the EtherCAT Coupler Unit, as shown above.

*3. You can also connect a combination of general-purpose sensors and other devices.

Ordering Information

International Standards

- The standards are abbreviated as follows: U: UL, U1: UL(Class I Division 2 Products for Hazardous Locations), C: CSA, UC: cULus, UC1: cULus (Class I Division 2 Products for Hazardous Locations), CU: cUL, N: NK, L: Lloyd, CE: EU Directives, RCM: RCM mark, and KC: KC Registration.
- Contact your OMRON representative for further details and applicable conditions for these standards.



EtherCAT Slave Terminals IO-Link Master Unit

Product Name	Specification			Model	Standards
	Environmental resistance	Number of IO-Link ports	I/O connection terminals		
GX-series IO-Link Master Unit	IP67	8	M12 connector (A-cording, female)	GX-ILM08C	CE, RCM, KC

Peripheral Devices

Recommended EtherCAT Communications Cables

Use Straight STP (shielded twisted-pair) cable of category 5 or higher with double shielding (braiding and aluminum foil tape) for EtherCAT.

Item	Appearance	Recommended manufacturer	Cable length (m)	Model
Cable with Connectors on Both Ends Shield Strengthening cable Wire Gauge and Number of Pairs: AWG22, 2-pair Cable Cable color: Black	 NEW	OMRON	0.5	XS5W-T421-BM2-SS
			1	XS5W-T421-CM2-SS
			2	XS5W-T421-DM2-SS
			3	XS5W-T421-EM2-SS
			5	XS5W-T421-GM2-SS
			10	XS5W-T421-JM2-SS
Cable with Connectors on Both Ends Rugged type Shield Strengthening cable Wire Gauge and Number of Pairs: AWG22, 2-pair Cable Cable color: Black	 NEW	OMRON	0.5	XS5W-T421-BMC-SS
			1	XS5W-T421-CMC-SS
			2	XS5W-T421-DMC-SS
			3	XS5W-T421-EMC-SS
			5	XS5W-T421-GMC-SS
			10	XS5W-T421-JMC-SS

Note: For details, Contact your OMRON representative.

Power Supply Cables

Item	Appearance	Recommended manufacturer	Cable length (m)	Model
Connector connected to cable, socket on one cable end Fire-retardant, Robot cable	Smartclick (M12 Straight)	OMRON	1	XS5F-D421-C80-F
			2	XS5F-D421-D80-F
			3	XS5F-D421-E80-F
			5	XS5F-D421-G80-F
			10	XS5F-D421-J80-F
Connectors connected to cable, socket and plug on cable ends Fire-retardant, Robot cable	Smartclick (M12 Straight/M12 straight)	OMRON	1	XS5W-D421-C81-F
			2	XS5W-D421-D81-F
			3	XS5W-D421-E81-F
			5	XS5W-D421-G81-F
			10	XS5W-D421-J81-F

Note: Refer to the *Round Water-resistant Connectors* in the category of *Sensor I/O Connector/Sensor Controller* on your local OMRON website for details.

Sensor I/O Connectors

Order a cable with a connector on both ends to connect a sensor of connector type.

Item	Appearance	Recommended manufacturer	Cable length (m)	Model
Connectors connected to cable, M8 socket and M12 plug on cable ends Fire-retardant, Robot cable	M8 screw- M12 Smartclick (M8 Straight/M12 straight)	OMRON	0.2	XS3W-M42C-4C2-A
Connectors connected to cable, socket and plug on cable ends Fire-retardant, Robot cable	Smartclick (M12 Straight/M12 straight)	OMRON	1	XS5W-D421-C81-F
			2	XS5W-D421-D81-F
			3	XS5W-D421-E81-F
			5	XS5W-D421-G81-F
			10	XS5W-D421-J81-F

Note: Refer to the *Ordering Information* in the catalog of the sensor to connect or the *Sensor I/O Connectors/Sensor Controllers* on your local OMRON website for details.

GX-ILM08C

Power Supply T-Joint Connector

This connector is used when branching a GX-type Unit power supply.

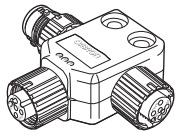
Item	Appearance	Specification	Connector type	Model
XS5R Plug/Socket T-Joint Connector		M12	Smartclick connector	XS5R-D427-5

Waterproof Cover for Connectors

This is a waterproof cover for unused M12 GX connectors (female).

When you use this waterproof cover, you can maintain the IP67 protective structure.

The following two types of covers are available. Either one can be mounted on an EtherCAT communications connector or I/O connector.

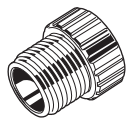
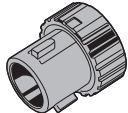
Item	Appearance	Specification	Connector type	Materials	Model
M12 Threaded Waterproof Cover *1		M12	Screw-type connector	Brass/nickel plated	XS2Z-22
Smartclick Waterproof Cover *2		M12	Smartclick connector	PBT	XS5Z-11

*1. When mounting the M12 Threaded Waterproof Cover on a connector, always tighten it to a torque of 0.39 to 0.49 N·m.

*2. When mounting a Smartclick Waterproof Cover on a connector, torque management is not required.

Tool for M12 Threaded Connectors

The tool for tightening M12 Threaded Connectors is used when tightening to a specified torque.

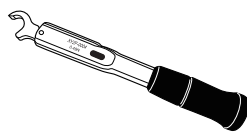
Item	Appearance	Model
Torque Wrench		XY2F-0004

Software

Automation Software Sysmac Studio

Please purchase a DVD and required number of licenses the first time you purchase the Sysmac Studio. DVDs and licenses are available individually. Each model of licenses does not include any DVD.

Product name	Specification			Model	Standards
		Number of licenses	Media		
Sysmac Studio Standard Edition Ver.1.□□	The Sysmac Studio is the software that provides an integrated environment for setting, programming, debugging and maintenance of machine automation controllers including the NJ/NX-series CPU Units, NY-series Industrial PC, EtherCAT Slave, and the HMI.	--- (Media only)	DVD	SYSMAC-SE200D	---
	Sysmac Studio runs on the following OS. Windows 7(32-bit/64-bit version)/Windows 8(32-bit/64-bit version)/Windows 8.1(32-bit/64-bit version)/Windows 10(32-bit/64-bit version)	1 license *	---	SYSMAC-SE201L	

* Multi licenses are available for the Sysmac Studio (3, 10, 30, or 50 licenses).

General Specification

Item	Specification
Unit power supply voltage	20.4 to 26.4 VDC (24 VDC -15%/+10%)
I/O power supply	20.4 to 26.4 VDC (24 VDC -15%/+10%)
Noise resistance	Conforms to IEC 61000-4-4, 2 kV (power line).
Vibration resistance	Malfunction: 10 to 60 Hz with amplitude of 0.7 mm, 60 to 150 Hz and 50 m/s ² for 80 minutes each in X, Y, and Z directions
Shock resistance	150 m/s ² with amplitude of 0.7 mm
Dielectric strength	600 VAC (between isolated circuits)
Insulation resistance	20 MΩ min. (between isolated circuits)
Ambient operating temperature	-10 to 55°C
Ambient operating humidity	25% to 85% (with no condensation)
Ambient operating atmosphere	No corrosive gases
Altitude	2,000 m max.
Storage temperature	-25 to 65°C
Storage humidity	25% to 85% (with no condensation)
Degree of protection	IP67
Mounting	M5 screw mounting
Mounting strength	100 N
Communications connector strength	30 N
Connector types	Connectors for EtherCAT communications: M12 (D-coding, female) × 2 Power supply connector: M12 (A-coding, male) × 1 I/O connectors: M12 (A-coding, female)*1 × 8
Screw tightening torque *2	Round connectors (communications connector, power supply, and I/O): 0.39 to 0.49 N·m M5 (Unit mounted from the front): 1.47 to 1.96 N·m Cover for node address setting switches: 0.4 to 0.6 N·m
Applicable standards *3	EU: EN 61131-2, RCM, KC, IO-Link conformance, and EtherCAT conformance

*1. Confirms to Class A when used as an IO-Link connector.

*2. For SmartClick Connectors, insert the Connector all the way and turn it approx. 1/8 of a turn. Torque management is not required.

*3. Refer to the OMRON website (www.ia.omron.com) or ask your OMRON representative for the most recent applicable standards for each model.

GX-ILM08C

Unit Specification

Item	Specification	
Unit name	IO-Link Master Unit	
Model	GX-ILM08C	
Number of IO-Link ports	8	
Communications specifications	Communications protocol	IO-Link protocol
	Baud rate	COM1: 4.8 kbps COM2: 38.4 kbps COM3: 230.4 kbps
	Topology	1:1
	Compliant standards	<ul style="list-style-type: none"> IO-Link Interface and System Specification Version 1.1.2 IO-Link Test Specification Version 1.1.2
Device power supply* in IO-Link Mode or SIO (DI) Mode	Rated voltage	24 VDC (20.4 to 26.4 VDC)
	Maximum load current	0.2 A/port
	Short-circuit protection	Yes
Digital inputs (in SIO (DI) Mode)	Internal I/O common	PNP
	Rated voltage	24 VDC (20.4 to 26.4 VDC)
	Input current	5 mA typical (at 24 VDC)
	ON voltage/ON current	15 VDC min., 5 mA min.
	OFF voltage	5 VDC max.
	Input filter time	No filter, 0.25 ms, 0.5 ms, 1 ms (default), 2 ms, 4 ms, 8 ms, 16 ms, 32 ms, 64 ms, 128 ms, or 256 ms
Digital outputs (in SIO (DIO) Mode)	Internal I/O common	PNP
	Output type	Push-pull
	Rated voltage	24 VDC (20.4 to 26.4 VDC)
	Maximum load current	0.3 A/port
	Short-circuit protection	Provided.
	Leakage current	0.1 mA max.
	Residual voltage	1.5 V max.
Digital inputs for pin 2 (in IO-Link Mode)	Internal I/O common	PNP
	Rated voltage	24 VDC (20.4 to 26.4 VDC)
	Input current	2 mA (24 VDC)
	ON voltage/ON current	15 VDC min., 2 mA min.
	OFF voltage	5 VDC max.
	Input filter time	No filter, 0.25 ms, 0.5 ms, 1 ms (default), 2 ms, 4 ms, 8 ms, 16 ms, 32 ms, 64 ms, 128 ms, or 256 ms
Cable specifications	Cable type	Unshielded
	Cable length	20 m max.
	Electrostatic capacity between lines	3 nF max.
	Loop resistance	6 Ω max.
Dimensions	175 × 33 × 60 mm (W×H×D) (The height is 49.1 mm when the connectors are included.)	
Isolation method	Photocoupler isolation	
I/O power supply method	Supplied from the power supply connector.	
Unit power supply current consumption	60 mA	
I/O power supply current consumption	100 mA	
Weight	430 g	
Circuit layout	<p>The diagram illustrates the internal circuitry of the GX-ILM08C unit. It shows the power supply connector on the left, which provides Unit power supply (24V and 0V) and I/O power supply (24V and 0V). The internal circuits include Internal circuits, Isolation circuit, IO-LINK circuits, and Non-isolated power supply circuits. The IO-LINK circuits are connected to I/O connectors 1 and 8, which have terminals L+, C/Q, DI, and L-.</p>	
Installation orientation and restrictions	Installation orientation: 6 possible orientations Restrictions: No restrictions	
Protective functions	L+ terminal short-circuit protection C/Q terminal short-circuit protection	

Function Specifications

Function		Description
Communications	Cyclic communications	I/O data (process data) in the IO-Link devices is cyclically exchanged with the IO-Link Master Unit as the IO-Link communications master. At the same time, this data and the status of the IO-Link Master Unit is cyclically exchanged with the controller, with the IO-Link Master Unit operating as a slave of the controller. Cyclic communications can be used to check the amount of detection performance deterioration in devices, and to check changes in usage conditions, such as the amount of incident light for photoelectric sensors, stability detection margins, and excessive proximity for proximity sensors.
	Message communications	The controller can send messages (commands) to the IO-Link Master Unit and receive the response from the IO-Link Master Unit. The IO-Link Master Unit can also function as a gateway to send messages (commands and responses) between the controller and the IO-Link devices. During operation, you can change and adjust device parameters, such as threshold settings, tuning execution, and ON-delay time changes, from a program. Or, during operation, you can check the internal status, such as the operating times of devices.
Communications mode settings		You can select any of the following modes for each port: IO-Link Mode, SIO (DI) Mode, SIO (DO) Mode, and Disable Port This allows you to combine IO-Link communications and digital I/O in a single unit.
Digital inputs for pin 2		In IO-Link Mode, you can perform digital input with pin 2 while performing IO-Link communications.
Automatic baud rate setting for IO-Link communications		The IO-Link Master Unit automatically matches the specific baud rates (COM1, COM2, or COM3) of the IO-Link devices to communicate with the IO-Link devices. Therefore, it is not necessary to set the baud rate of the connected device for each port.
Connected device verification		This function is used to verify the configuration of IO-Link devices that are connected to the IO-Link Master Unit against the registered IO-Link device configuration settings when the power supply is turned ON. The user can enable or disable connected device verification.
IO-Link communications error detection		This function detects I/O cable breaks, disconnections from IO-Link device ports, error-level device events, device configuration verification errors, and IO-Link device malfunctions.
Detection of short-circuits in I/O cables		This function detects short-circuits in I/O cables
Notification of input data validity		The controller can use the Input Data Enabled Flags to determine whether the process input data for IO-Link communications is valid.
Load rejection for controller communications error		This function turns OFF outputs from the IO-Link Master Unit when a communications error occurs in communications with the controller in IO-Link Mode or in an SIO mode. This prevents incorrect output operations when communications error occurs.
IO-Link total communications lost frames		The IO-Link total communications lost frames can be read from the CX-ConfiguratorFDT. You can use this function to determine communications status as affected by I/O cable noise or other factors.
Digital input filter		This function is used to eliminate chattering and noise of the input signal for digital inputs in SIO(DI) Mode or for digital inputs for pin 2 in IO-Link Mode. It prevents data change and stabilizes the input signal even in situations where the input data changes due to chattering or noise and the bit status is unstable.
Digital input collection*		In IO-Link Mode, this function reflects the specified bit data in the input data from the IO-Link device on the digital input data of the IO-Link Master Unit. As a result, the bit data in the input data from the IO-Link device can be aggregated into the digital input data of the IO-Link Master Unit. One bit for each IO-Link port can be aggregated. This function cannot be used in SIO (DI) Mode and SIO (DO) Mode. If you use this function, digital inputs with pin 2 cannot be used.
Backup and restoration of parameter settings in IO-Link devices		This function is used to back up parameter settings in IO-Link devices in the IO-Link Master Unit or restore them to IO-Link devices. This eliminates the need to set parameters again after replacing an IO-Link device.
Event log		This function records events, such as errors and status changes, that occur in the IO-Link Master Unit and the IO-Link devices.

* This function is supported with the unit version 1.1 or later.

GX-ILM08C

EtherCAT Communications Specifications

Item	Specification
Communications protocol	EtherCAT protocol
Modulation	Baseband
Baud rate	100 Mbps
Physical layer	100BASE-TX (IEEE 802.3)
Connectors	M12 (D-coding, female) × 2 (shielded) CN IN: EtherCAT input CN OUT: EtherCAT output
Communications media	Category 5 or higher (cable with double, aluminum tape and braided shielding is recommended.)
Communications distance	Distance between nodes (Slave Units): 100 m max.
Noise resistance	Conforms to IEC 61000-4-4, 1 kV or higher.
Node address setting method	Set on hexadecimal node address switches or with a Configuration Tool.
Node address range	000 to FFF hex (0 to 4,095 decimal): Set on node address switches or with a Configuration Tool.
Indicators	UNIT PWR × 1 IO PWR × 1 L/A IN (Link/Activity IN) × 1 L/A OUT (Link/Activity OUT) × 1 RUN × 1 ERR × 1
Process data	Variable PDO mapping
PDO size/node	2 to 270 bytes
Mailbox	Emergency messages, SDO requests, SDO responses, and SDO information
Synchronization mode	Free Run Mode (asynchronous)

Version Information

GX Unit		Corresponding versions *		
		EtherCAT		
Model	Unit version	CPU Units	Sysmac Studio	CX-ConfiguratorFDT
GX-ILM08C	Ver.1.1	Ver.1.12 or later	Ver.1.20 or higher	Ver.2.2 or higher
	Ver.1.0	Ver.1.12 or later	Ver.1.16 or higher	Ver.2.2 or higher

* Some Units do not have all of the versions given in the above table. If a Unit does not have the specified version, support is provided by the oldest available version after the specified version. Refer to the user's manuals for the specific Units for the relation between models and versions.

Component Names and Functions

GX-ILM08C

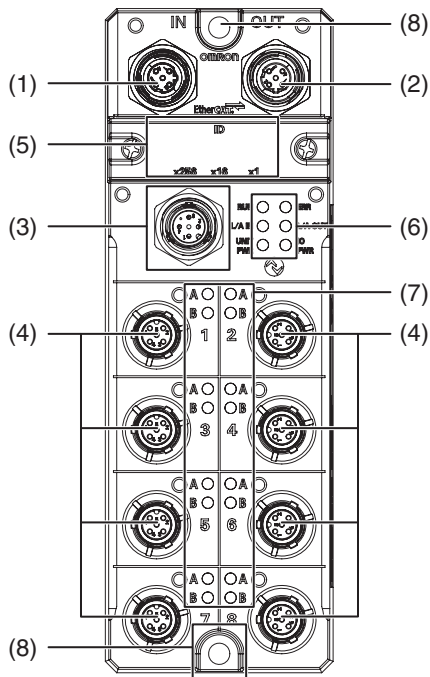

No.	Name	Function
(1)	EtherCAT communications connector, IN	EtherCAT cable connection: IN side M12 connector (D-coding, female)
(2)	EtherCAT communications connector, OUT	EtherCAT cable connection: OUT side M12 connector (D-coding, female)
(3)	Power supply connector	Connects to Unit power supply and I/O power supply cable. M12 connector (A-coding, male)
(4)	I/O connectors	Connect to IO-Link sensor cables (IO-Link connector type: Class A) M12 connectors (A-coding, female)
(5)	Node address setting switches	Used to set the EtherCAT node address.
(6)	Status indicators	Indicate the current status of the EtherCAT Slave Unit. (RUN, ERR, L/A IN, L/A OUT, UNIT PWR, and I/O PWR)
(7)	I/O indicators	Indicate the I/O status. (C/E and C/Q)
(8)	Mounting holes	Used to mount the Unit with M5 screws.

GX-ILM08C

Wiring

IO-Link Mode

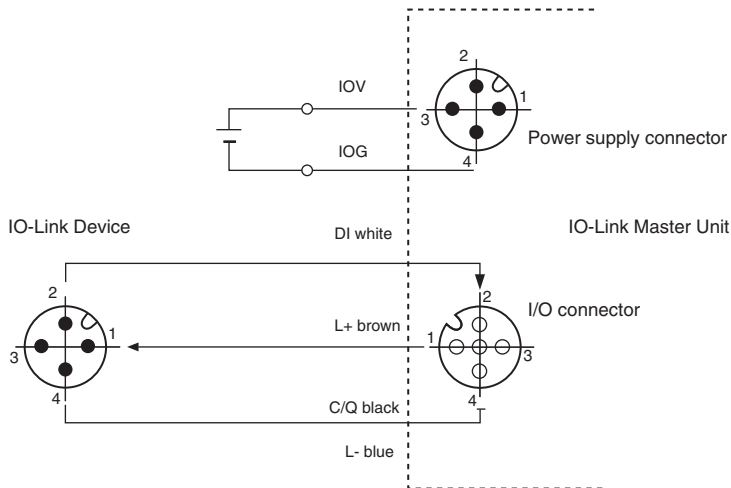

Note: Even if you connect to IO-Link devices without digital inputs for pin 2, connect pin 2 as shown in the above figure. This is because connectors on the IO-Link devices and the cable with connectors on both ends connect pin 2. However, because no data enters pin 2 of the IO-Link Master Unit, digital IO-Link input data is always OFF.

SIO (DI) Mode

Wiring Three-wire Sensors

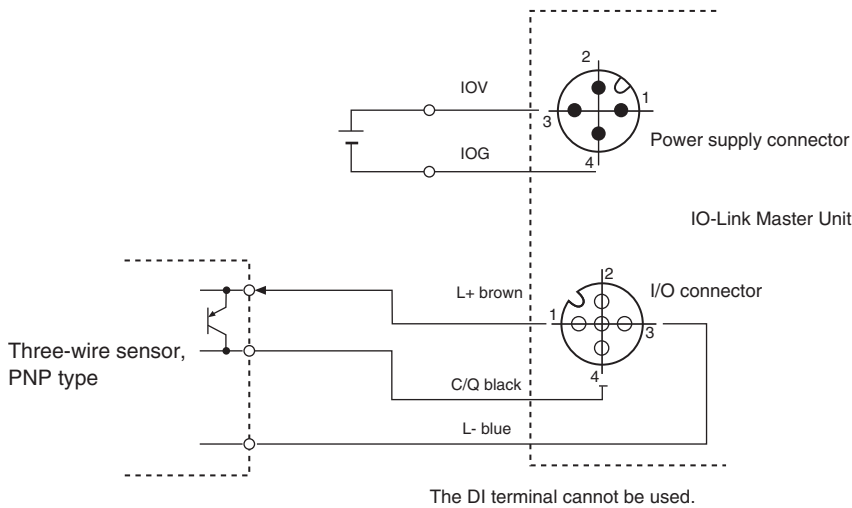

Wiring Two-wire Sensors

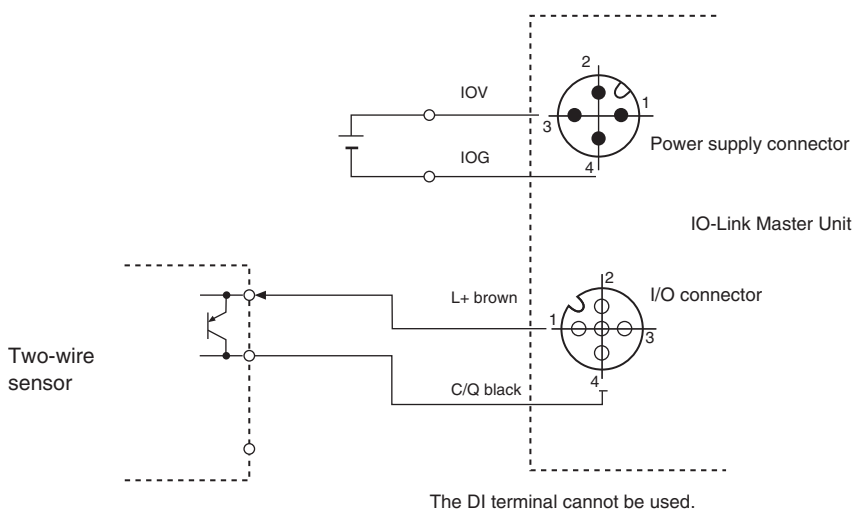

SIO (DO) Mode
Wiring Output Devices

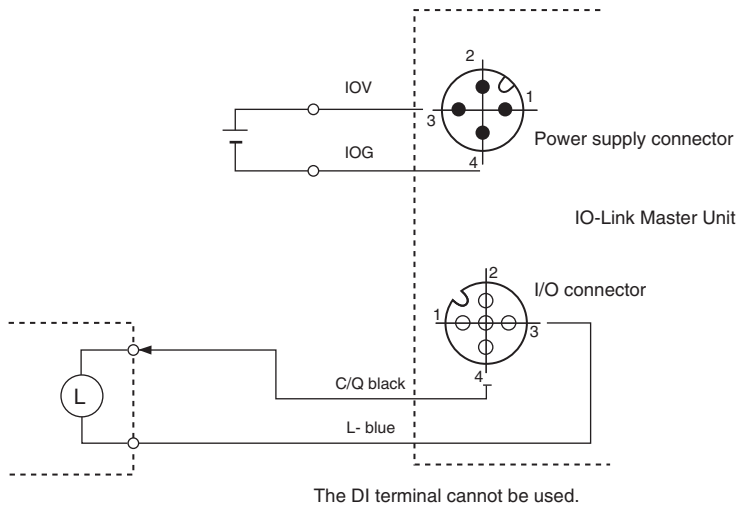

Dimensions

(Unit: mm)

GX-ILM08C

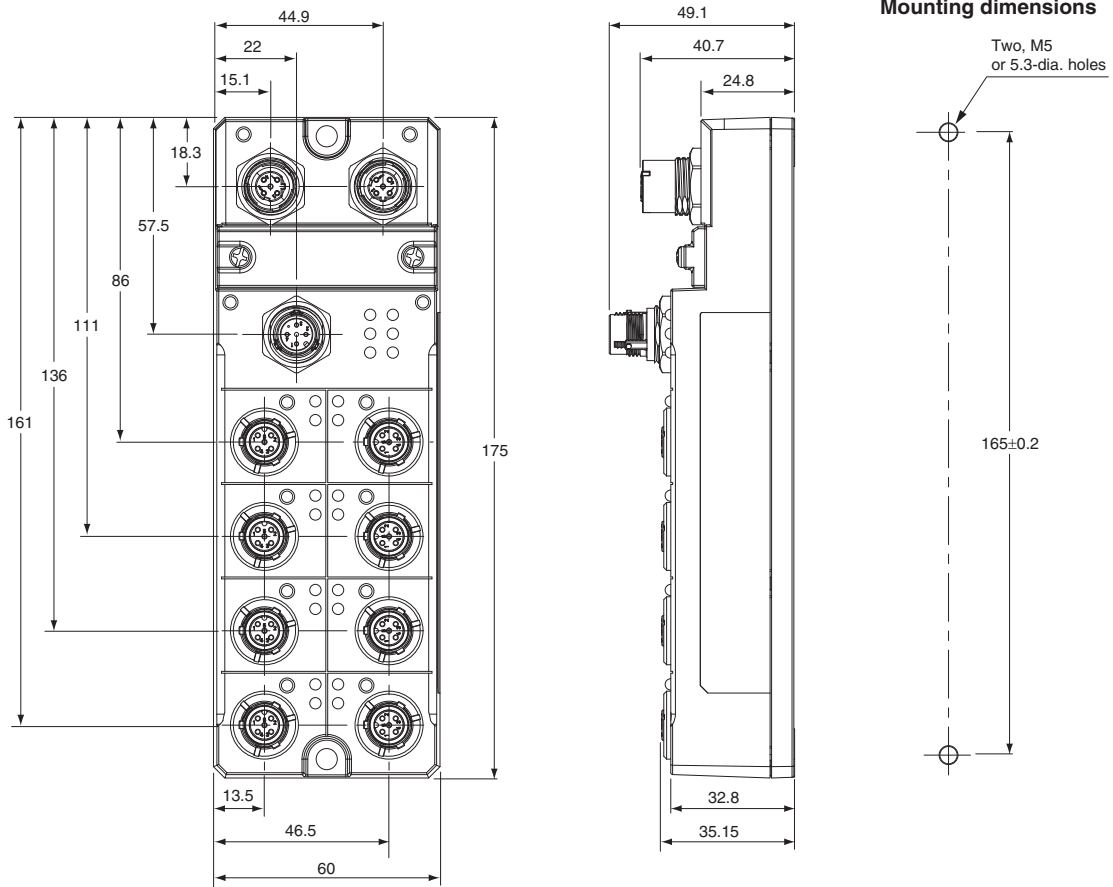

GX-ILM08C

Related Manuals

Man.No	Model	Manual	Application	Description
W488	GX-ID □□□□ GX-OD □□□□ GX-OC □□□□ GX-MD □□□□ GX-AD □□□□ GX-DA □□□□ GX-EC □□□□ GX-ILM □□□ XWT-ID □□ XWT-OD □□	EtherCAT Slave Units User's Manual	Learning hardware information on the GX-series IO-Link Master Unit and checking a list of objects. (W488-E1-05 or later). Or, learning how to use GX-series EtherCAT Slave Terminals.	Describes part names, functions, installation, and wiring and also provides tables of specifications and objects for the GX-series IO-Link Master Unit (W488-E1-05 or later). Also describes the hardware, setup methods, and functions of the EtherCAT Remote I/O Terminals.
W570	NX-ILM400 GX-ILM08C	IO-Link System User's Manual	Learning everything from an introduction to details about IO-Link Systems, including mainly software information common to all IO-Link masters, Support Software operating methods, and troubleshooting.	Provides an overview of IO-Link Systems and explains the system configuration, communications specifications, communications methods, I/O data, parameters, models, Support Software, and troubleshooting. Refer to the following manuals for the individual IO-Link Master Units for hardware information and specifications specific to each Master Unit and a list of the objects for each Master Unit. NX-series IO-Link Master Unit: W568 GX-series IO-Link Master Unit: W488-E1-05 or later
W567	NX-ILM400	IO-Link Master Unit User's Manual	Learning hardware information, wiring, and specifications for the NX-series IO-Link Master Unit and checking a list of NX objects.	Describes detailed part specifications, installation, and wiring and also provides tables of specifications and NX objects for the NX-series IO-Link Master Unit.
W502	NX701-□□□□ NJ501-□□□□ NJ301-□□□□ NJ101-□□□□ NX1P2-□□□□	NJ/NX-series Instructions Reference Manual	Learning detailed specifications on the basic instructions of an NJ/NXseries CPU Unit.	The instructions in the instruction set (IEC 61131-3 specifications) are described. When programming, use this manual together with the <i>NX-series CPU Unit Hardware User's Manual</i> (Cat. No. W535) or <i>NJ-series CPU Unit Hardware User's Manual</i> (Cat. No. W500) and <i>NJ/NX-series CPU Unit Software User's Manual</i> (Cat. No. W501).
W505	NX701-□□□□ NJ501-□□□□ NJ301-□□□□ NJ101-□□□□ NX1P2-□□□□	NJ/NX-series CPU Unit Built-in EtherCAT® Port User's Manual	Using the built-in EtherCAT port on an NJ/NX-series CPU Unit.	Information on the built-in EtherCAT port is provided. This manual provides an introduction and provides information on the configuration, features, and setup.
W503	NX701-□□□□ NJ501-□□□□ NJ301-□□□□ NJ101-□□□□ NX1P2-□□□□	NJ/NX-series Troubleshooting Manual	Learning about the errors that may be detected in an NJ/NX-series Controller.	Concepts on managing errors that may be detected in an NJ/NX-series Controller and information on individual errors are described.
W519	NX-ECC□□□	NX-series EtherCAT® Coupler Unit User's Manual	Learning how to use an NX-series EtherCAT Coupler Unit and EtherCAT Slave Terminals.	The system and configuration of EtherCAT Slave Terminals, which consist of an NX-series EtherCAT Coupler Unit and NX Units, are described along with the hardware, setup, and functions of the EtherCAT Coupler Unit that are required to configure, control, and monitor NX Units through EtherCAT.
W504	SYSMAC-SE2□□□	Sysmac Studio Version 1 Operation Manual	Learning about the operating procedures and functions of the Sysmac Studio.	Describes the operating procedures of the Sysmac Studio.
W562	NY532-1□□□ NY512-1□□□	NY-series IPC Machine Controller Industrial Panel PC / Industrial Box PC Built-in Ether-CAT® Port User's Manual	Using the built-in EtherCAT port in an NY-series Industrial PC.	Information on the built-in EtherCAT port is provided. This manual provides an introduction and provides information on the configuration, features, and setup.
W560	NY532-1□□□ NY512-1□□□	NY-series Instructions Reference Manual	Learning detailed specifications on the basic instructions of an NY-series Industrial PC.	The instructions in the instruction set (IEC 61131-3 specifications) are described.



IO-Link Makes Sensor Level Information Visible and Solves the Three Major Issues at Manufacturing Sites! Standard Photoelectric Sensor.

- Downtime can be reduced.
Notifies you of faulty parts and such phenomena in the Sensor in real time.
- The frequency of sudden failure can be decreased.
The light incident level monitor prevents false detection before it happens.
- The efficiency of changeover can be improved.
The batch check for individual sensor IDs significantly decreases commissioning time.
- Three types of sensing methods and three types of connection methods are available.



For the most recent information on models that have been certified for safety standards, refer to your OMRON website.

Be sure to read *Safety Precautions* on page 51.

Ordering Information

IO-Link Model / Sensors [Refer to Dimensions on page 52.]

Red light Infrared light

Sensing method	Appearance	Connection method	Sensing distance	IO-Link baud rate	Model						
					PNP						
Through-beam (Emitter + Receiver) *3		Pre-wired (2 m)		COM2 (38.4 kbps)	E3Z-T81-IL2 2M Emitter E3Z-T81-L-IL2 2M Receiver E3Z-T81-D-IL2 2M						
		Pre-wired M12 connector			E3Z-T81-M1TJ-IL2 0.3M Emitter E3Z-T81-L-M1TJ-IL2 0.3M Receiver E3Z-T81-D-M1TJ-IL2 0.3M						
		Standard M8 connector			E3Z-T86-IL2 Emitter E3Z-T86-L-IL2 Receiver E3Z-T86-D-IL2						
		Pre-wired (2 m)			COM3 (230.4 kbps)	E3Z-T81-IL3 2M Emitter E3Z-T81-L-IL3 2M Receiver E3Z-T81-D-IL3 2M					
		Pre-wired M12 connector				E3Z-T81-M1TJ-IL3 0.3M Emitter E3Z-T81-L-M1TJ-IL3 0.3M Receiver E3Z-T81-D-M1TJ-IL3 0.3M					
		Standard M8 connector				E3Z-T86-IL3 Emitter E3Z-T86-L-IL3 Receiver E3Z-T86-D-IL3					
		Retro-reflective with MSR function					Pre-wired (2 m)		COM2 (38.4 kbps)	E3Z-R81-IL2 2M	
							Pre-wired M12 connector			E3Z-R81-M1TJ-IL2 0.3M	
							Standard M8 connector			E3Z-R86-IL2	
Pre-wired (2 m)	COM3 (230.4 kbps)		E3Z-R81-IL3 2M								
Pre-wired M12 connector			E3Z-R81-M1TJ-IL3 0.3M								
Standard M8 connector			E3Z-R86-IL3								

Note: Please contact your OMRON sales representative regarding the IO-Link setup file (IODD file).

*1. The Reflector is sold separately. Select the Reflector model most suited to the application.

*2. The sensing distance specified is possible when the E39-R1S is used. Values in parentheses indicate the minimum required distance between the Sensor and Reflector.

*3. Through-beam Sensors are normally sold in sets that include both the Emitter and Receiver.

Red light Infrared light

Sensing method	Appearance	Connection method	Sensing distance			IO-Link baud rate	Model
							PNP
Diffuse-reflective		Pre-wired (2 m)	1 m			COM2 (38.4 kbps)	E3Z-D82-IL2 2M
		Pre-wired M12 connector					E3Z-D82-M1TJ-IL2 0.3M
		Standard M8 connector					E3Z-D87-IL2
		Pre-wired (2 m)					E3Z-D82-IL3 2M
		Pre-wired M12 connector					E3Z-D82-M1TJ-IL3 0.3M
		Standard M8 connector					E3Z-D87-IL3
		Pre-wired (2 m)	90 mm (narrow beam)			COM2 (38.4 kbps)	E3Z-L81-IL2 2M
		Pre-wired M12 connector					E3Z-L81-M1TJ-IL2 0.3M
		Standard M8 connector					E3Z-L86-IL2
		Pre-wired (2 m)					E3Z-L81-IL3 2M
		Pre-wired M12 connector					E3Z-L81-M1TJ-IL3 0.3M
		Standard M8 connector					E3Z-L86-IL3

Note: Please contact your OMRON sales representative regarding the IO-Link setup file (IODD file).

Accessories (Sold Separately)

Slit (A Slit is not provided with Through-beam Sensors) Order a Slit separately if required.

Slit width	Sensing distance	Minimum detectable object (Reference value)	Model	Contents
	E3Z-T□□			
0.5-mm dia.	50 mm	0.2-mm dia.	E39-S65A	One set (contains Slits for both the Emitter and Receiver)
1-mm dia.	200 mm	0.4-mm dia.	E39-S65B	
2-mm dia.	800 mm	0.7-mm dia.	E39-S65C	
0.5 × 10 mm	1 m	0.2-mm dia.	E39-S65D	
1 × 10 mm	2.2 m	0.5-mm dia.	E39-S65E	
2 × 10 mm	5 m	0.8-mm dia.	E39-S65F	

Reflectors (Reflector required for Retroreflective Sensors) A Reflector is not provided with the Sensor. Be sure to order a Reflector separately.

Name	Sensing distance *		Model	Quantity	Remarks
	E3Z-R				
	Rated value	Reference value			
Reflector	3 m (100 mm)	---	E39-R1	1	<ul style="list-style-type: none"> Reflectors are not provided with Retro-reflective models. The MSR function of the E3Z-R□ is enabled.
	4 m (100 mm)	---	E39-R1S	1	
	---	5 m (100 mm)	E39-R2	1	
	---	2.5 m (100 mm)	E39-R9	1	
	---	3.5 m (100 mm)	E39-R10	1	
Fog Preventive Coating	---	3 m (100 mm)	E39-R1K	1	
Small Reflector	---	1.5 m (50 mm)	E39-R3	1	
Tape Reflector	---	700 mm (150 mm)	E39-RS1	1	
	---	1.1 m (150 mm)	E39-RS2	1	
	---	1.4 m (150 mm)	E39-RS3	1	









Note:1. If you use the Reflector at any distance other than the rated distance, make sure that the stability indicator lights properly when you install the Sensor.

2. Refer to *Reflectors on E39-L/E39-S/E39-R* on your OMRON website for details.

* Values in parentheses indicate the minimum required distance between the Sensor and Reflector.

Mounting Brackets

A Mounting Bracket is not enclosed with the Sensor. Order a Mounting Bracket separately if required.

Appearance	Model (material)	Quantity	Remarks	Appearance	Model (material)	Quantity	Remarks
	E39-L153 (SUS304) *1	1	Mounting Brackets		E39-L98 (SUS304) *2	1	Metal Protective Cover Bracket
	E39-L104 (SUS304) *1	1			E39-L150 (SUS304)	1	(Sensor adjuster)
	E39-L43 (SUS304) *2	1	Horizontal Mounting Brackets		E39-L151 (SUS304)	1	Easily mounted to the aluminum frame rails of conveyors and easily adjusted.
	E39-L142 (SUS304) *2	1	Horizontal Protective Cover Bracket				For left to right adjustment
	E39-L44 (SUS304)	1	Rear Mounting Bracket		E39-L144 (SUS304) *2	1	Compact Protective Cover Bracket (For E3Z only)

Note: 1. When using Through-beam models, order one bracket for the Receiver and one for the Emitter.







2. Refer to *Mounting Brackets on E39-L/E39-S/E39-R* on your OMRON website for details.

*1. Cannot be used for Standard Connector models with mounting surface on the bottom. In that case, use Pre-wired Connector models.

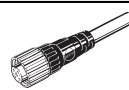
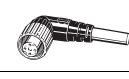
*2. Cannot be used for Standard Connector models.

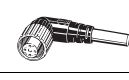
Sensor I/O Connectors

(Models for Connectors and Pre-wired Connectors: A Connector is not provided with the Sensor. Be sure to order a Connector separately.)

Size	Type	Appearance	Cable length	Model
M12	Socket on one cable end	Smartclick connector Straight *2 	2 m	XS5F-D421-D80-F
			5 m	XS5F-D421-G80-F
		Smartclick connector L-shape *2 *3 	2 m	XS5F-D422-D80-F
			5 m	XS5F-D422-G80-F
	Socket and plug on cable ends *1	Smartclick connector Straight/ Straight *2 	2 m	XS5W-D421-D81-F
			5 m	XS5W-D421-G81-F
Smartclick connector L-shape/L-shape *2 *3 		2 m	XS5W-D422-D81-F	
		5 m	XS5W-D422-G81-F	
M8	Socket on one cable end	Straight *3 	2 m	XS3F-M421-402-A
			5 m	XS3F-M421-405-A
		L-shape *3 *4 	2 m	XS3F-M422-402-A
			5 m	XS3F-M422-405-A
M8 socket/ M12 plug	Socket and plug on cable ends	M8-M12 (Smartclick) conversion cable *2 	0.2 m	XS3W-M42C-4C2-A

Note: 1. When using Through-beam models, order one connector for the Receiver and one for the Emitter.

2. Refer to *Sensor I/O Connectors/Sensor Controllers* on your OMRON website for details.

*1. Straight type/L-shape type combinations are also available.

*2. The connectors will not rotate after they are connected.

*3. The cable is fixed at an angle of 180° from the sensor emitter/receiver surface.

Ratings and Specifications

IO-Link Model

		Sensing method	Through-beam	Retro-reflective with MSR function	Diffuse-reflective	Narrow-beam Models
Model	PNP output	Pre-wired	E3Z-T81-IL□	E3Z-R81-IL□	E3Z-D82-IL□	E3Z-L81-IL□
		Pre-wired connector (M12)	E3Z-T81-M1TJ-IL□	E3Z-R81-M1TJ-IL□	E3Z-D82-M1TJ-IL□	E3Z-L81-M1TJ-IL□
Item		Connector (M8)	E3Z-T86-IL□	E3Z-R86-IL□	E3Z-D87-IL□	E3Z-L86-IL□
Sensing distance		15 m	4 m (100 mm) * (when using E39-R1S) 3 m (100 mm) * (when using E39-R1)	1 m (white paper: 300 × 300 mm)	90 + 30 mm (white paper: 100 × 100 mm)	
Spot diameter (reference value)		---				2.5 dia. and sensing distance of 90 mm
Standard sensing object		Opaque: 12-mm dia. min.	Opaque: 75-mm dia. min.	---		
Minimum detectable object (reference value)		---				0.1 mm (copper wire)
Differential travel (representative example)		---	---	20% max. of setting distance	Refer to <i>Engineering data</i> on page 48.	
Directional angle		Both emitter and receiver: 3 to 15°	2 to 10°	---		
Light source (wavelength)		Infrared LED (870 nm)	Red LED (660 nm)	Infrared LED (860 nm)	Red LED (650 nm)	
Power supply voltage		10 to 30 VDC (including 10% ripple (p-p))				
Current consumption		50 mA max. (Emitter: 25 mA max., Receiver: 25 mA max.)	30 mA max.			
Control output		Load power supply voltage: 30 VDC max., Load current: 100 mA max. Residual voltage: Load current of less than 10 mA: 1 V max. Load current of 10 to 100 mA: 2 V max. PNP open collector output Light-ON/Dark-ON selectable				
Indicators		In the Standard I/O mode (SIO mode): Operation indicator (orange, lit) and stability indicator (green, lit) In the IO-Link Mode: Operation indicator (orange, lit) and communication indicator (green, blinking at 1 s intervals)				
Protection circuits		Reversed power supply polarity protection, output short-circuit protection, and reversed output polarity protection	Reversed power supply polarity protection, output short-circuit protection, reversed output polarity protection, and mutual interference prevention			
Response time		Operate or reset: 1 ms max.				
Sensitivity adjustment		Sensitivity adjuster / IO-Link communications				
Ambient illumination (Receiver side)		Incandescent lamp: 3,000 lx max. Sunlight: 10,000 lx max.				
Ambient temperature range		Operating: -25 to 55°C (with no icing or condensation) Storage: -40 to 70°C (with no icing or condensation)				
Ambient humidity range		Operating: 35% to 85%, Storage: 35% to 95% (with no condensation)				
Insulation resistance		20 MΩ min. at 500 VDC				
Dielectric strength		1,000 VAC, 50/60 Hz for 1 min				
Vibration resistance		Destruction: 10 to 55 Hz, 1.5 mm double amplitude for 2 hours each in X, Y, and Z directions				
Shock resistance		Destruction: 500 m/s ² 3 times each in X, Y, and Z directions				
Degree of protection		IEC 60529 IP67				
Connection method		Pre-wired cable (standard cable length 2 m), M12 pre-wired connector (standard cable length 0.3 m), M8 connector				
Weight (packed state)	Pre-wired cable (2 m)	Approx. 120 g	Approx. 65 g			
	Pre-wired connector (M12)	Approx. 60 g	Approx. 30 g			
	Connector (M8)	Approx. 30 g	Approx. 20 g			
Material	Case	Polybutylene terephthalate (PBT)				
	Display	Modified polyarylate				
	Lens	Modified polyarylate	Methacrylate resin (PMMA)	Modified polyarylate		
Main IO-Link functions		Operation mode switching between Light ON and Dark ON, setup of the instability detection level for light receiving and non-light receiving, timer function of the control output and timer time selecting, instability output (IO-Link mode) ON delay timer time selecting, setup of a teaching level and execution of teaching, setup of light receiving sensitivity level, monitor output, operating hours read-out, and initial reset				
Communication specifications	IO-Link specification	Ver 1.1				
	Baud rate	-IL3: COM3 (230.4 kbps), -IL2: COM2 (38.4 kbps)				
	Data length	PD size: 2 bytes, OD size: 1 byte (M-sequence type: TYPE_2_2)				
	Minimum cycle time	-IL3 (COM3): 1 ms, -IL2 (COM2): 2.3 ms				
Accessories		Instruction manual (Neither Reflectors nor Mounting Brackets are provided with any of the above models.)				

* Values in parentheses indicate the minimum required distance between the Sensor and Reflector.

Engineering Data (Reference Value)

Parallel Operating Range

Through-beam Models

E3Z-T8□-IL□

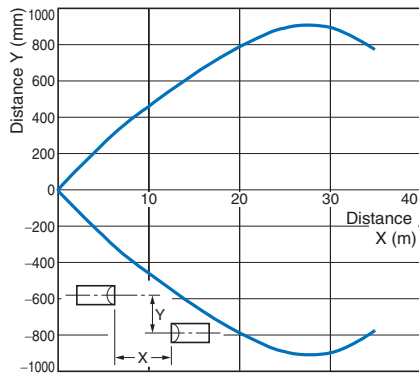

Through-beam Models

E3Z-T8□-IL□ and Slit

(A Slit is mounted to the Emitter and Receiver.)

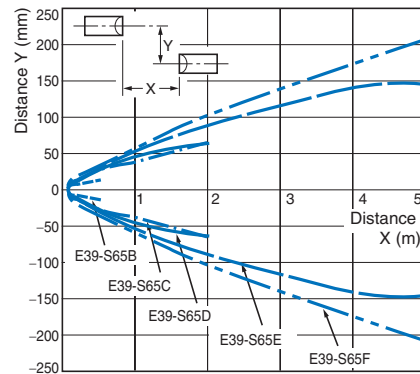

Retro-reflective Models

E3Z-R8□-IL□ and Reflector

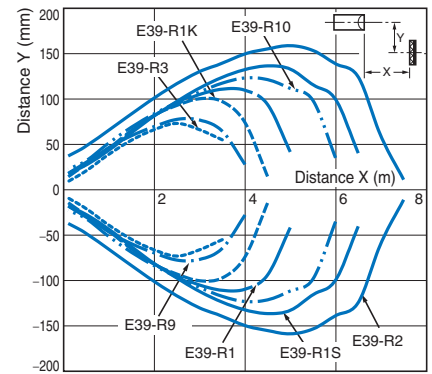

Operating Range

Diffuse-reflective Models

E3Z-D8□-IL□

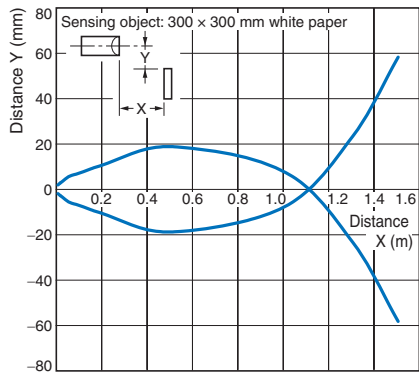

Narrow-beam Reflective Models

E3Z-L8□-IL□

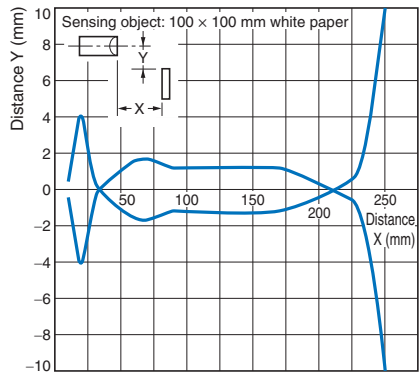

Monitor Output vs. Sensing Distance

Through-beam Models

E3Z-T8□-IL□

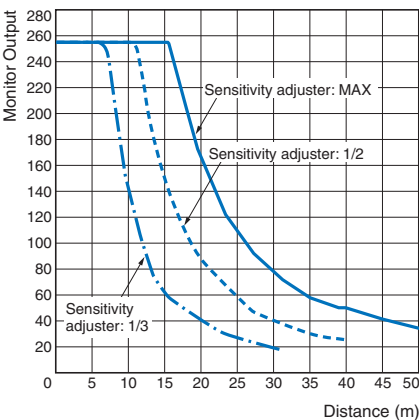

Retro-reflective Models

E3Z-R8□-IL□ and E39-R1 Reflector

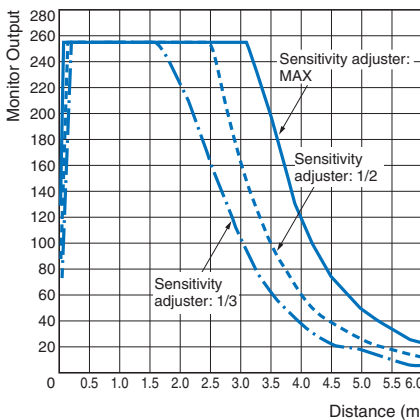

Monitor Output vs. Sensing Distance

Diffuse-reflective Models

E3Z-D8□-IL□

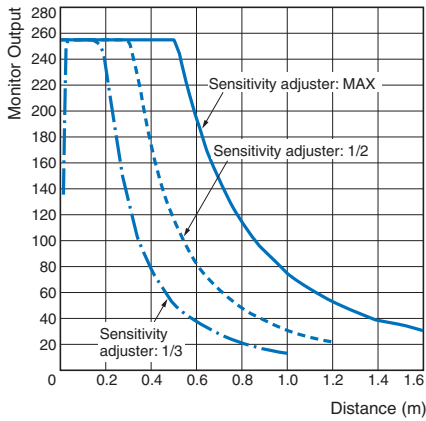

Narrow-beam Reflective Models

E3Z-L8□-IL□

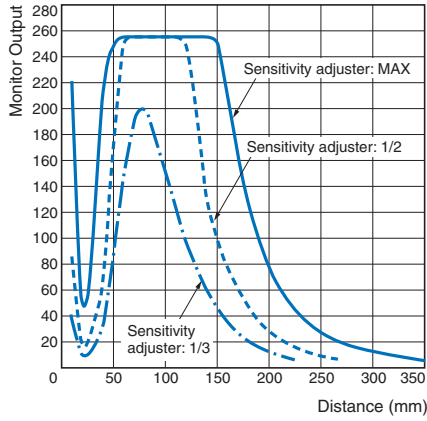

Sensing Object Size vs. Sensing Distance

Diffuse-reflective Models

E3Z-D8□-IL□

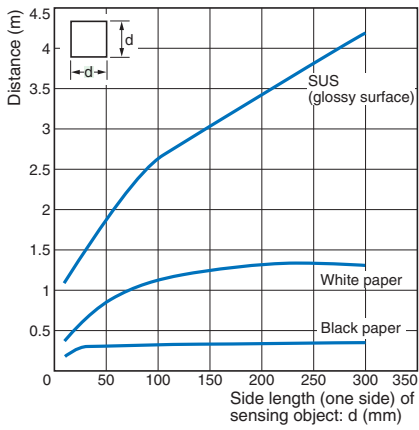

Narrow-beam Reflective Models

E3Z-L8□-IL□

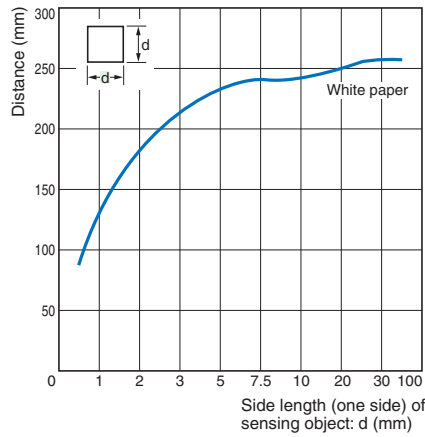

Spot Diameter vs. Sensing Distance

Narrow-beam Reflective Models

E3Z-L8□-IL□

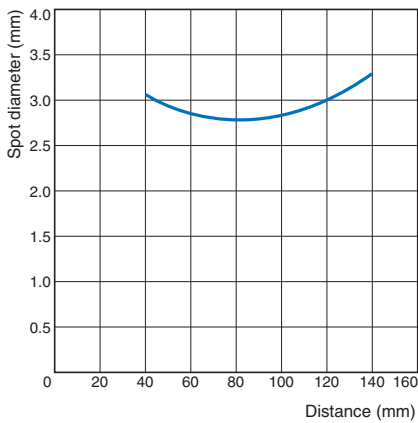

Differential Travel vs. Sensing Distance

Narrow-beam Reflective Models

E3Z-L8□-IL□

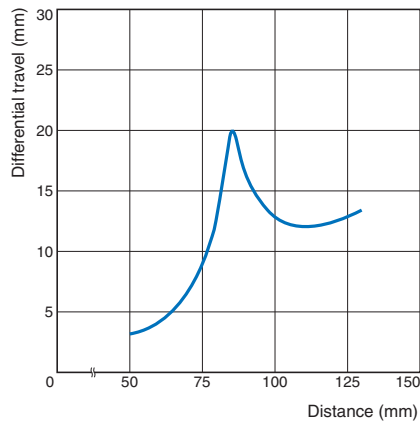

I/O Circuit Diagrams

Communications Specifications

Masters

Photoelectric Sensor

Color Mark Photoelectric Sensors

Proximity Sensor

Timing Chart

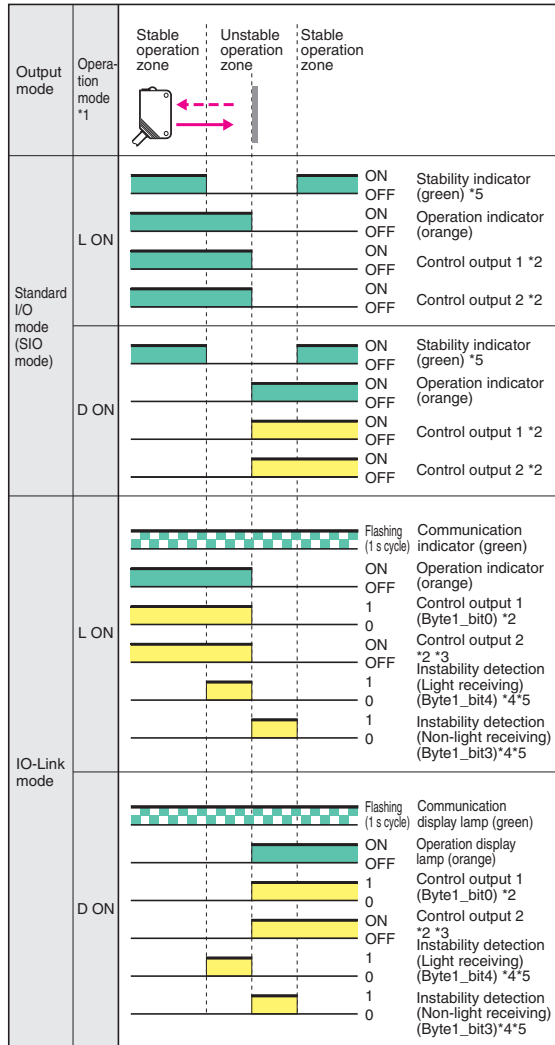

Note: Please contact your OMRON sales representative regarding assignment of data.

- *1. The operation mode can be changed by the IO-Link communications.
- *2. The timer function can be set up using the IO-Link communications for control output 1 and 2 separately. (It is able to select ON delay, OFF delay, or one-shot function and select a timer time of 1 to 4000 ms (T).)
- *3. In the IO-Link mode, if the ON/OFF speed of the sensor is slow, high-speed response of 1 ms or less can be realized using control output 2 as a sensor.
- *4. The judgment time for the instability detection diagnosis can be selected using the IO-Link communications. (For the ON delay timer function to detect instability, the setting can be selected from 0 (invalid), 10, 50, 100, 300, 500, or 1000 ms.
- *5. The judgment condition for the light receiving/non-light receiving instability detection function can be selected using the IO-Link communications. (Setting of light receiving instability detection threshold: 500%/400%/300%/200%/140%, setting of non-light receiving instability detection threshold: 70%/50%)

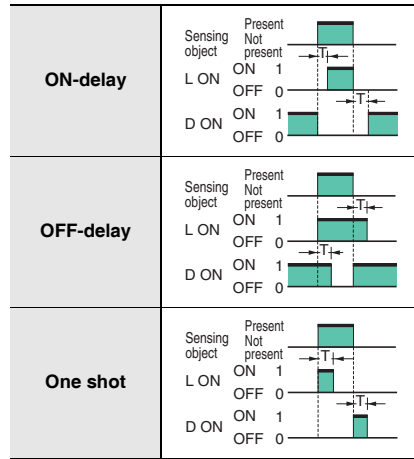

Output circuit

Reflective / Receiver of Through-beam Model

E3Z-□8□-IL□

When using as a general sensor

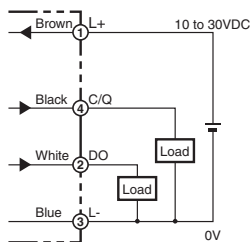

When using the Sensor connected to IO-Link Master Unit

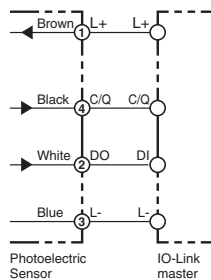

Connector Pin Arrangement

Pre-wired M12 connector
E3Z-□81-M1TJ-IL□
E3Z-□82-M1TJ-IL□
E3Z-T81-D-M1TJ-IL□

Standard M8 connector
E3Z-□86-IL□
E3Z-□87-IL□
E3Z-T86-D-IL□



Emitter of Through-beam Model

E3Z-T8□-L-IL□

When using as a general sensor

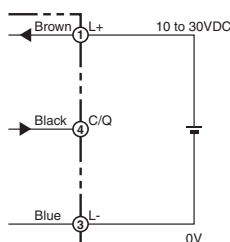

When using the Sensor connected to IO-Link Master Unit

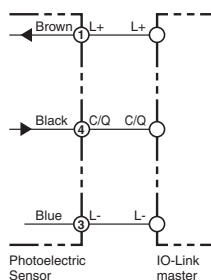

Connector Pin Arrangement

E3Z-T81-L-M1TJ-IL□

E3Z-T86-L-IL□



Note: Pins 2 is not used.

Note: Pins 2 is not used.

Plugs (Sensor I/O Connectors)

M8 connector

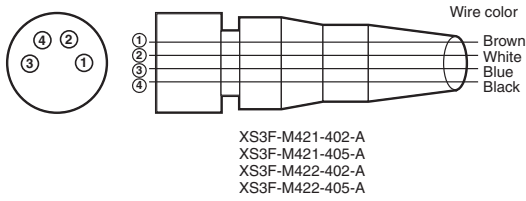

M12 connector

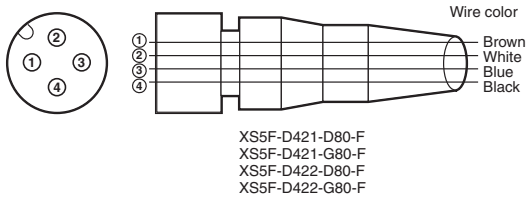

M8-M12 (Smartclick) conversion cable

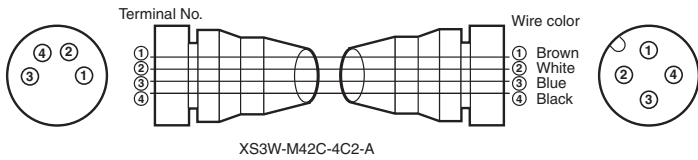

Through-beam Models (Emitter)

Pin arrangement

Classification	Wire color	Connector pin No.	Application
DC	Brown	1	Power supply (+V)
	White	2	-
	Blue	3	Power supply (0 V)
	Black	4	Output C/Q

Note: Pins 2 is not used.

Through-beam Models (Receiver)

Retro-reflective Models

Diffuse-reflective Models

Pin arrangement

Classification	Wire color	Connector pin No.	Application
DC	Brown	1	Power supply (+V)
	White	2	Output DO
	Blue	3	Power supply (0 V)
	Black	4	Output C/Q

Nomenclature

Through-beam Models

E3Z-T8□-IL□ (Receiver)

Retro-reflective Models

E3Z-R8□-IL□

Diffuse-reflective Models

E3Z-D8□-IL□

E3Z-L8□-IL□

In the Standard I/O mode (SIO mode):

- Stability indicator (green)
- IO-Link communication indicator (green)

In the IO-Link mode:

- Operation selector
- Operation indicator (orange)
- Sensitivity adjuster

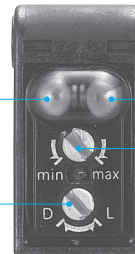



Safety Precautions

Be sure to read the precautions for all models in the website at: <http://www.ia.omron.com/>.

Warning Indications

 WARNING	Warning level Indicates a potentially hazardous situation which, if not avoided, will result in minor or moderate injury, or may result in serious injury or death. Additionally there may be significant property damage.
Precautions for Safe Use	Supplementary comments on what to do or avoid doing, to use the product safely.
Precautions for Correct Use	Supplementary comments on what to do or avoid doing, to prevent failure to operate, malfunction or undesirable effect on product performance.

Meaning of Product Safety Symbols

	General prohibition Indicates the instructions of unspecified prohibited action.
	Caution, explosion Indicates the possibility of explosion under specific conditions.
	Caution, fire Indicates the possibility of fires under specific conditions.

WARNING

This product is not designed or rated for ensuring safety of persons either directly or indirectly. Do not use it for such purposes.



The maximum power supply voltage is 30 VDC. Before turning the power ON, make sure that the power supply voltage does not exceed the maximum voltage.



Never use the product with an AC power supply. Otherwise, explosion may result.



Do not use the product with voltage in excess of the rated voltage. Excess voltage may result in malfunction or fire.



Do not use the product above rated load.



Precautions for Safe Use

Be sure to follow the safety precautions below for added safety.

1. Do not use the sensor under the environment with explosive or ignition gas.
2. Never disassemble, repair nor tamper with the product.

Precautions for Correct Use

1. Do not use the product under the following conditions.
 - (1) In the place exposed to the direct sunlight.
 - (2) In the place where humidity is high and condensation may occur.
 - (3) In the place where vibration or shock is directly transmitted to the product.
2. Connection and Mounting
 - (1) If the sensor wiring is placed in the same conduits or ducts as high-voltage or high-power lines, inductive noise may cause malfunction or damage. Wire the cables separately or use a shielded cable.
 - (2) Use an extension cable less than 100 m long for Standard I/O mode and less than 20 m for IO-Link mode.
 - (3) Do not exceed the following force values applied to the cable. Tensile: 80 N max., torque: 0.1 Nm max., pressure: 20 N max., flexure: 3 kg max.

M8 metal connectors

- (4) Fasten a fixed implement by hand. If you use pliers, it may cause malfunction or damage to it.
3. Cleaning
Do not use thinner, alcohol, or other organic solvents. Otherwise, the optical properties and degree of protection may be degraded.
4. Power supply
When using a commercially available switching regulator, be sure to ground the FG (Frame Ground) terminals.
5. Power supply reset time
The photoelectric sensor will begin sensing no later than 100 ms after the power is turned on. If the load and the photoelectric sensor is connected to different power supply, the photoelectric sensor must be always turned on first.
6. Turning off the power supply
When turning off the power, output pulse may be generated. We recommend turning off the power supply of the load or load line first.
7. Water resistance
Though this is type IP67, do not use in the water, rain or outdoors.
8. Please process it as industrial waste.

E3Z-□-IL□

Dimensions

(Unit: mm)
Tolerance class IT16 applies to dimensions in this data sheet unless otherwise specified.

Sensors

Through-beam Models *

Pre-wired Models

E3Z-T81-IL□

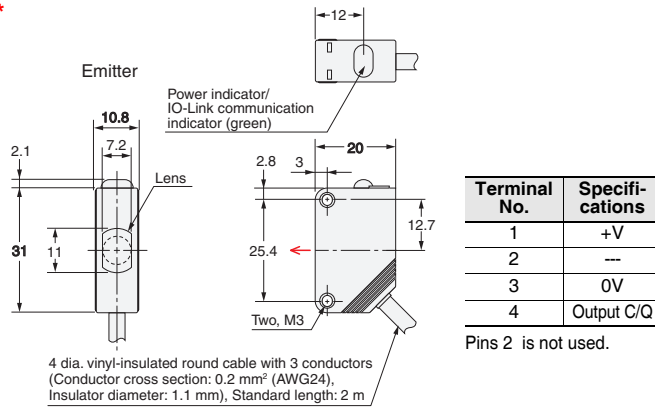

Pre-wired M12 connector (E3Z-T□□-M1TJ)

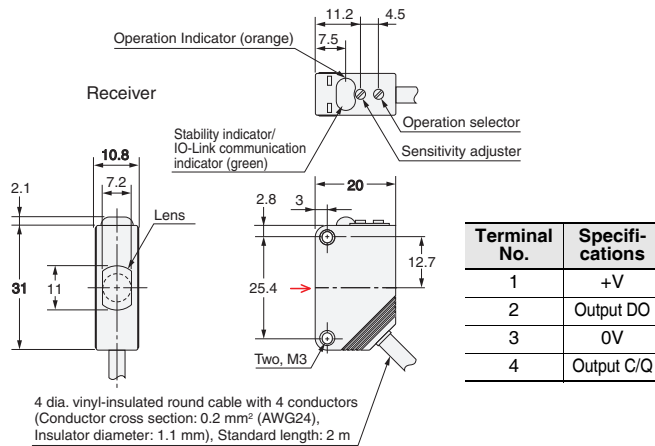
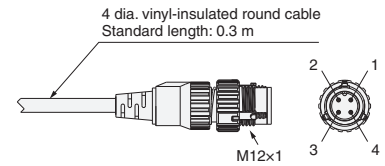

Through-beam Models *

Connector Models

E3Z-T86-IL□

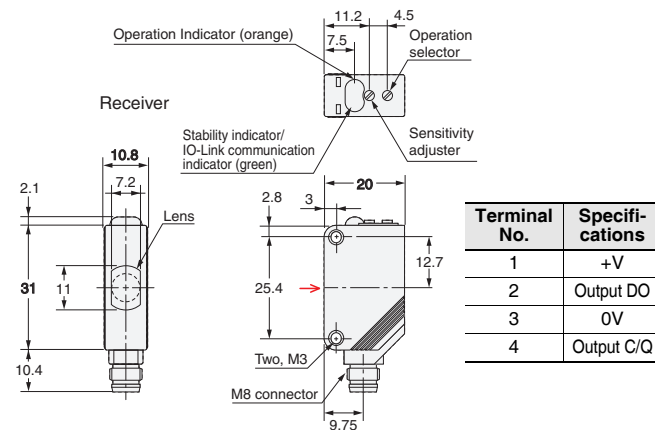
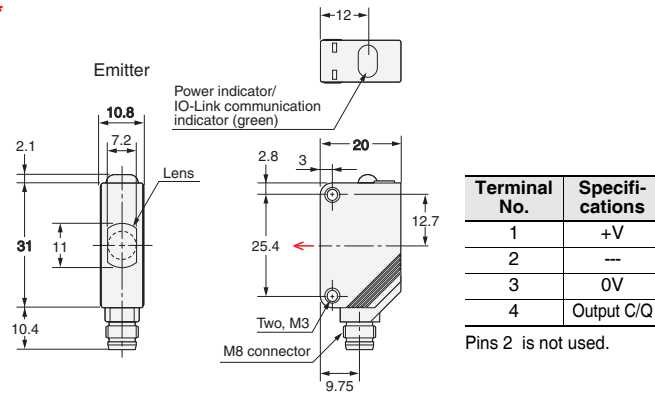

* Models numbers for Through-beam Sensors (E3Z-T□□) are for sets that include both the Emitter and Receiver.
The model number of the Emitter is expressed by adding "-L" to the set model number (example: E3Z-T81-IL□-L 2M), the model number of the Receiver, by adding "-D" (example: E3Z-T81-IL□-D 2M). Refer to *Ordering Information* to confirm model numbers for Emitter and Receivers.

Retro-reflective Models

Pre-wired Models

- E3Z-R81-IL□
- E3Z-D82-IL□
- E3Z-L81-IL□

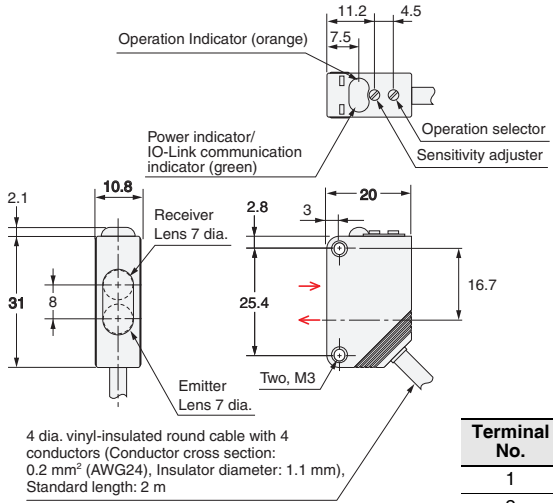

Pre-wired M12 connector (E3Z-□8□-M1TJ)

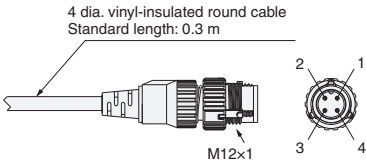

Terminal No.	Specifications
1	+V
2	Output DO
3	0V
4	Output C/Q

Retro-reflective Models

Connector Models

- E3Z-R86-IL□
- E3Z-D87-IL□
- E3Z-L86-IL□

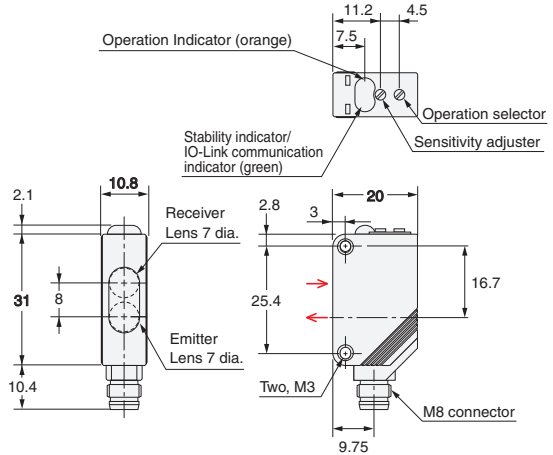

Terminal No.	Specifications
1	+V
2	Output DO
3	0V
4	Output C/Q

Note: The lens for the E3Z-D□2/D□7 is black.

Accessories (Order Separately)

Slits

E39-S65A
E39-S65B
E39-S65C

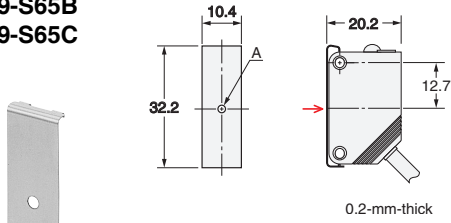

Model	Size A	Material
E39-S65A	0.5 dia.	SUS301 stainless steel
E39-S65B	1.0 dia.	
E39-S65C	2.0 dia.	

Slits

E39-S65D
E39-S65E
E39-S65F

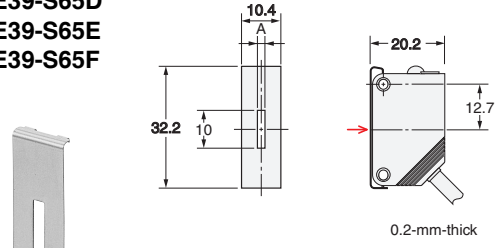

Model	Size A	Material
E39-S65D	0.5	SUS301 stainless steel
E39-S65E	1.0	
E39-S65F	2.0	

Mounting Bracket

E39-L44

(Mounting dimensions)

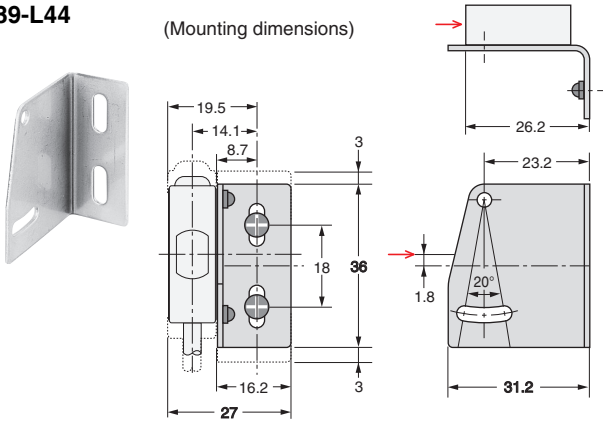

Mounting Bracket

E39-L104

(Mounting dimensions)

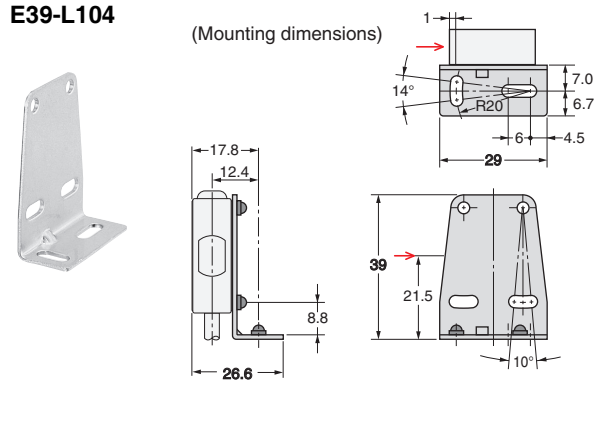

Reflectors

Refer to E39-R on your OMRON website for details.

Sensor I/O Connectors

Refer to XS3 or XS5 on your OMRON website for details.

E3S-DCP21-IL□



Color Mark Detection on Any Type of Packaging.

Narrow Beam and Large Lens for Stable Detection of Workpieces Tilted at Various Angles.

- Detects subtle color differences.
High luminance, three-element (RGB) LED light source for greater light intensity. Highly efficient optics technology provides high power and enables stable detection even of subtle color differences.
- Handles glossy workpieces.
Thorough noise reduction.
High dynamic range covers everything from black to mirror surfaces.
- IoT compatible.
Sends RGB information to host with high-speed IO-Link communications.
Optimum threshold set to reduce false detection.



For the most recent information on models that have been certified for safety standards, refer to your OMRON website.

Refer to *Safety Precautions* on page 60.

Ordering Information

Sensors (Refer to *Dimensions* on page 61.)

Red light, Green light, Blue light

Sensing method	Appearance	Connection method	Sensing distance	Output	Model	IO-Link baud rate
Diffuse-reflective (mark detection)		M12 connector		Push-pull	E3S-DCP21-IL2	COM2 (38.4 kbps)
					E3S-DCP21-IL3	COM3 (230.4 kbps)

Note: Please contact your OMRON sales representative regarding the IO-Link setup file (IODD file).

Accessories (Sold Separately)

Sensor I/O Connectors (Required for a Sensor with a connector.)

Connectors are not provided with the Sensors. Be sure to order a Connector separately.

Size	Type	Appearance	Cable length	Model
M12	Socket on one cable end	Straight	2 m	XS2F-D421-D80-F
			5 m	XS2F-D421-G80-F
		L-shape *2	2 m	XS2F-D422-D80-F
			5 m	XS2F-D422-G80-F
	Socket and plug on cable ends *1	Smartclick connector Straight/straight	2 m	XS5W-D421-D81-F
			5 m	XS5W-D421-G81-F
Smartclick connector L-shape/L-shape *2		2 m	XS5W-D422-D81-F	
		5 m	XS5W-D422-G81-F	

Note: 1. Refer to *Sensor I/O Connectors/Sensor Controllers* on your OMRON website for details.

The XS2W (Socket and Plug on Cable Ends) and XS5F (Socket on One Cable End) are also available.

2. The connectors will not rotate after they are connected.

*1. There are also straight type/L-shape type combinations available.

*2. The cable is fixed at an angle of 180° from the sensor emitter/receiver surface.

Ratings and Specifications

Item	Sensing method Output Model	Diffuse-reflective (mark detection)	
		Push-pull	
		E3S-DCP21-IL2	E3S-DCP21-IL3
Sensing distance	10 ±3 mm (White paper 10 ×10 mm)		
Spot size (reference value)	1 × 4 mm		
Light source (wavelength)	Red LED (635 nm), Green LED (525 nm), Blue LED (465 nm)		
Power supply voltage	10 to 30 VDC±10% (Ripple (p-p) 10% max.)		
Power consumption	960 mW max. (Reference: Power supply voltage 24 V, Current consumption 40 mA max.)		
Control output	Load current: 100 mA max. (30 VDC max.)		
Indications	Operation indicator (orange), RUN indicator (green), 7-segment indicator (white), Key lock indicator (white), Timer indicator (white), 1-point teaching mode indicator (white)		
Operation mode	High when mark is detected.		
Protection circuits	Power supply reverse polarity protection, output short-circuit protection and output incorrect connection protection		
Response time	Operate or reset: 50 μs max. for each (2-point teaching mode) Operate or reset: 150 μs max. for each (1-point teaching mode)		
Sensitivity adjustment	Teaching method		
Ambient illumination	Incandescent lamp: 3,000 lx max.		
Ambient temperature range	Operating: -10 to 55°C; Storage: -25 to 70°C (with no icing or condensation)		
Ambient humidity range	Operation: 35% to 85%, Storage: 35% to 95% (with no condensation)		
Insulation resistance	20 MΩ min. (at 500 VDC)		
Dielectric strength	1,000 VAC, 50/60 Hz for 1 min		
Vibration resistance	Destruction: 10 to 55 Hz with double amplitude of 1.5 mm for 2 hours each in X, Y, and Z directions		
Shock resistance	Destruction: 500 m/s ² 3 times each in X, Y, and Z directions		
Degree of protection	IEC 60529 IP67		
Connection method	M12, 4-pin connector		
Weight (packed state/Sensor only)	Model with connector	Approx. 370 g/approx. 320 g	
	Case	Diecast zinc (nickel-plated brass)	
Materials	Lens	Methacrylic resin (PMMA)	
	Indicators	ABS	
	Buttons	Elastomers	
	Connector	Diecast zinc (nickel-plated brass)	
Main IO-Link functions	<ul style="list-style-type: none"> • Operation mode switching between NO and NC • Timer function of the control output and timer time selecting function (Select a function from disabled, ON delay, OFF delay, one-shot or ON/OFF delay.) (Select a timer time of 1-5000 ms.) • Selecting function of ON delay timer time for instability (0 (disabled)-1000 ms) • Monitor output function (PD output indicating a relative detection quantity) • Energizing time read-out function (unit: h) • Initialize the settings function "Restore the factory settings" 		
Communication specifications	IO-Link specification	Version 1.1	
	Baud rate	E3S-DCP21-IL3: COM3 (230.4 kbps), E3S-DCP21-IL2: COM2 (38.4 kbps)	
	Data length	PD size: 8 bytes, OD size: 1 byte (M-sequence type: TYPE_2_2)	
	Minimum cycle time	E3S-DCP21-IL3 (COM3): 1.5 ms, E3S-DCP21-IL2 (COM2): 4.8 ms	
Accessories	Instruction manual		

* Standard Sensing Object for the Mark Sensor

Color	Munsell code
White	N9.5
Red	4R 4.5/12.0
Yellow-red	4YR 6.0/11.5
Yellow	5Y 8.5/11.0
Yellow-green	3GY 6.5/10.0
Green	3G 6.5/9.0
Blue-green	5BG 4.5/10.0
Blue	3PB 5.0/10.0
Blue-purple	9PB 5.0/10.0
Purple	7P 5.0/10.0
Red-purple	6RP 4.5/12.5
(Black)	(N2.0)

Engineering Data (Reference Value)

Color vs. Detection Capability E3S-DC

Teaching Capabilities

	White	Red	Yellow-red	Yellow	Yellow-green	Green	Blue-green	Blue	Blue-purple	Purple	Red-purple	Black
White	○	○	○	○	○	○	○	○	○	○	○	○
Red	○	○	○	○	○	○	○	○	○	○	○	○
Yellow-red	○	○	○	○	○	○	○	○	○	○	○	○
Yellow	○	○	○	○	○	○	○	○	○	○	○	○
Yellow-green	○	○	○	○	○	○	○	○	○	○	○	○
Green	○	○	○	○	○	○	○	○	○	○	○	○
Blue-green	○	○	○	○	○	○	○	○	○	○	○	○
Blue	○	○	○	○	○	○	○	○	○	○	○	○
Blue-purple	○	○	○	○	○	○	○	○	○	○	○	○
Purple	○	○	○	○	○	○	○	○	○	○	○	○
Red-purple	○	○	○	○	○	○	○	○	○	○	○	○
Black	○	○	○	○	○	○	○	○	○	○	○	○

Note: The above chart shows the combinations of colors for which teaching is possible at a sensing distance of 10 mm.

Detectable Ranges E3S-DC

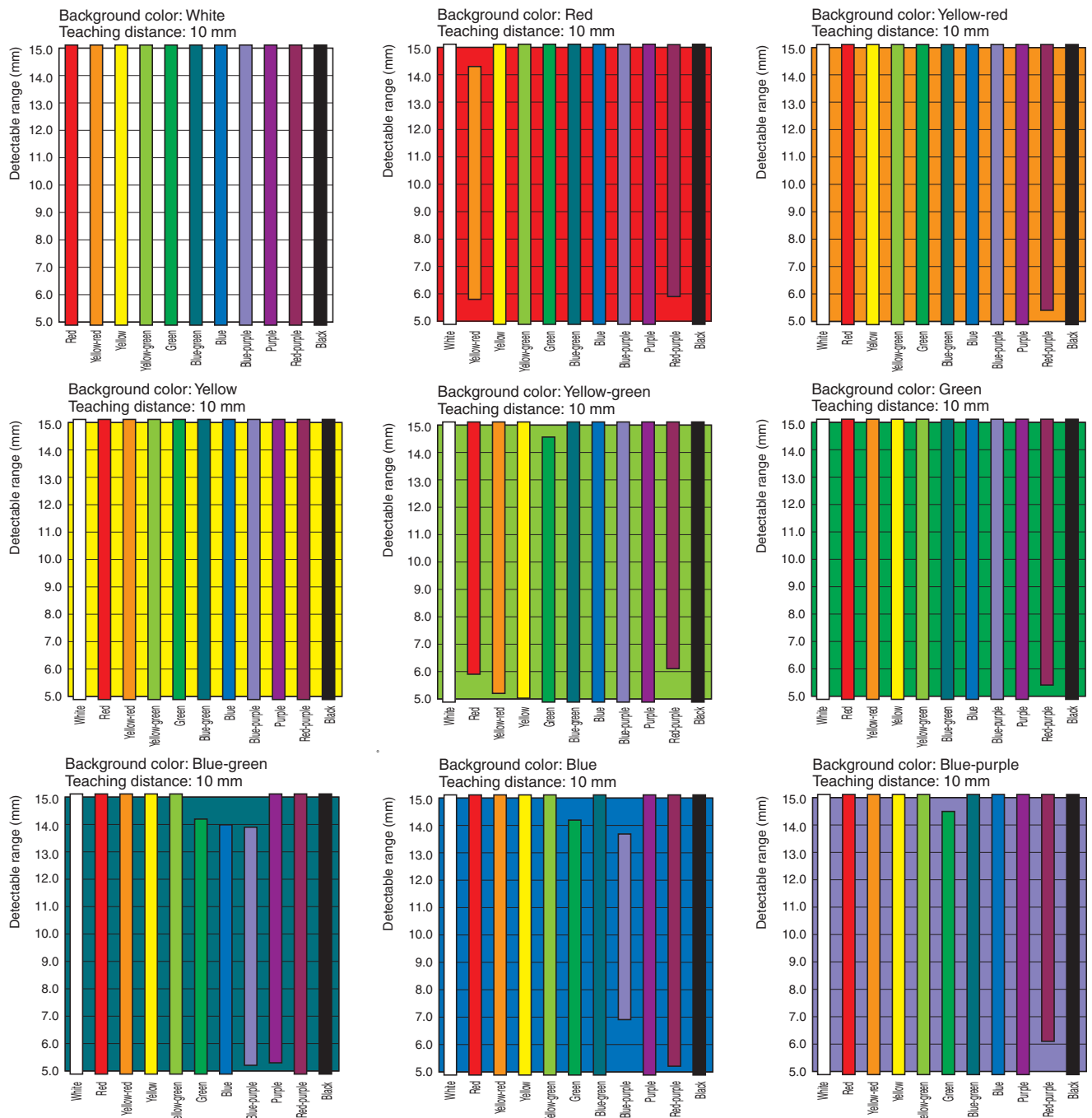

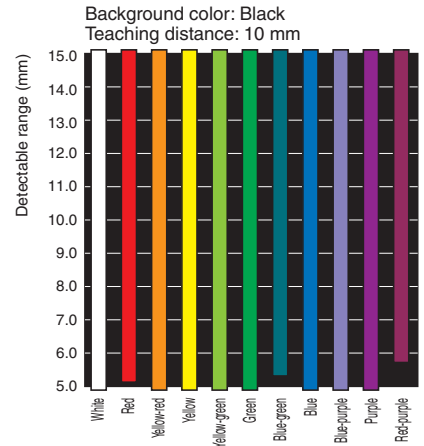
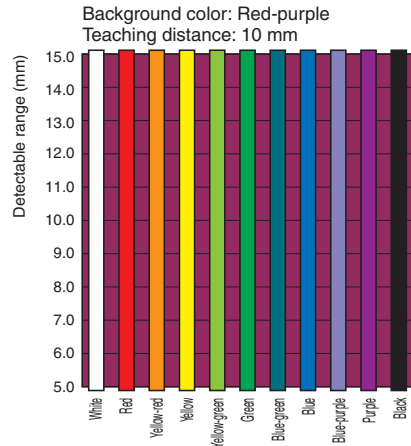
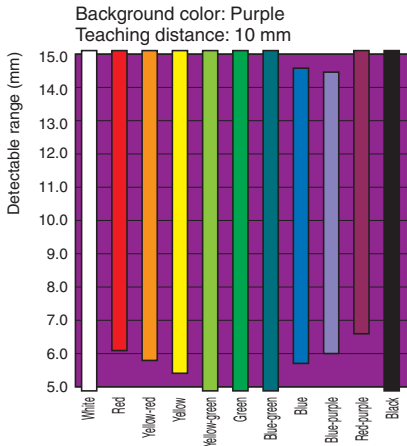

Excess Gain vs. Distance

E3S-DC

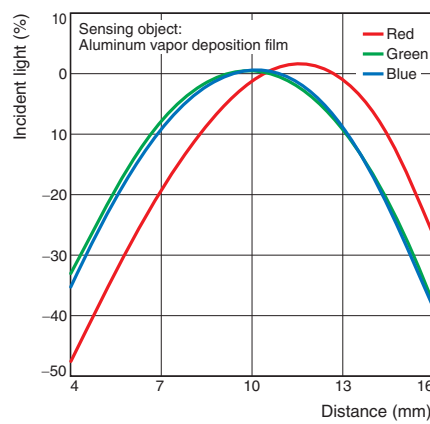
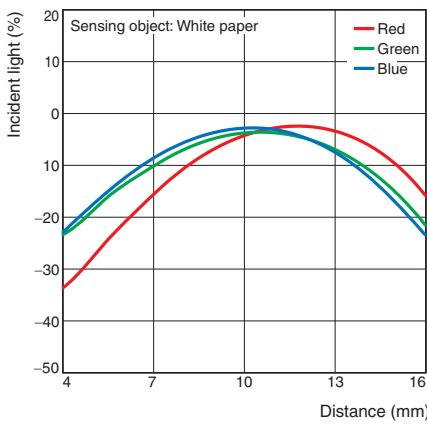

Angle vs. Incident Characteristics

E3S-DC

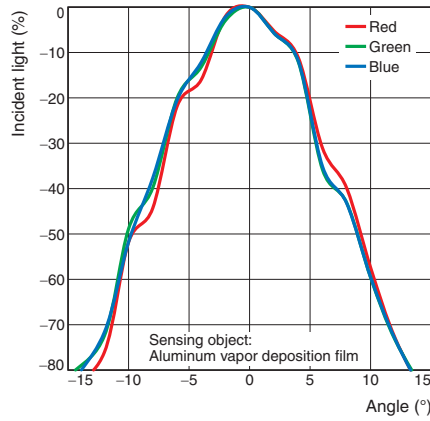
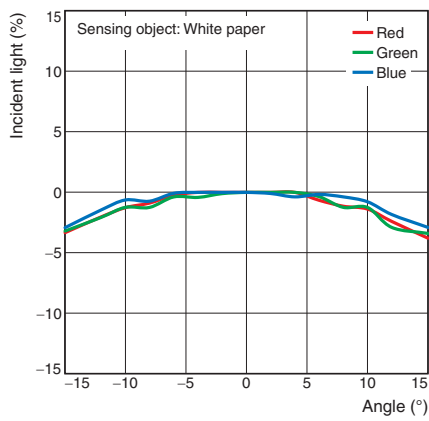

I/O Circuit Diagrams

Push-Pull Output

Model	Output mode	NO/NC setting *4	Timing chart	Output circuit
E3S-DCP21-IL2 E3S-DCP21-IL3	Standard I/O mode (SIO mode) (Pin 2 Output Settings)	NO *5	<p>Sensing object: Background (Green), Mark (Lighting)</p> <p>RUN indicator (Green): Lighting</p> <p>Operation indicator (Orange): Not Lighting, Lighting</p> <p>Pin 4 output (NO): LOW, HIGH</p> <p>Pin 2 output (NO): LOW, HIGH</p> <p>Load current (PNP connection): OFF, ON</p> <p>Load current (NPN connection): ON, OFF</p>	<p>Using Pin 2 as an external input *1 (enabled by default)</p>
		NC	<p>Sensing object: Background (Green), Mark (Lighting)</p> <p>RUN indicator (Green): Lighting</p> <p>Operation indicator (Orange): Lighting, Not Lighting</p> <p>Pin 4 output (NC): HIGH, LOW</p> <p>Pin 2 output (NC): HIGH, LOW</p> <p>Load current (PNP connection): ON, OFF</p> <p>Load current (NPN connection): OFF, ON</p>	<p>Using Pin 2 with a control output *1 (set for IO-Link)</p>
	IO-Link mode (Pin 2 Output Settings)	NO *5	<p>Sensing object: Background (Green), Mark (Lighting)</p> <p>RUN indicator (Green) (1 sec cycles Flashing): [Flashing bar]</p> <p>Operation indicator (Orange): Not Lighting, Lighting</p> <p>Pin 4 output (NO) (IO-Link communications): [Flashing bar]</p> <p>Pin 2 output (NO): LOW, HIGH</p>	
		NC	<p>Sensing object: Background (Green), Mark (Lighting)</p> <p>RUN indicator (Green) (1 sec cycles Flashing): [Flashing bar]</p> <p>Operation indicator (Orange): Lighting, Not Lighting</p> <p>Pin 4 output (NC) (IO-Link communications): [Flashing bar]</p> <p>Pin 2 output (NC): HIGH, LOW</p>	

*1. Pin 2 input/output can be switched with the IO-Link communication command "Switchpoint Pin 2".

*2. In case of NPN connection, please connect the load between Pin 1 and Pin 4.

*3. In case of PNP connection, please connect the load between Pin 3 and Pin 4.

*4. It can be switched in IO-Link.

*5. Factory default

Note: 1. You can use IO-Link communications to reverse the operation logic, set an output delay, and change between an input and output.
2. Please contact your OMRON sales representative regarding assignment of data.

Plugs (Sensor I/O Connectors)

M12, 4-pin Connector

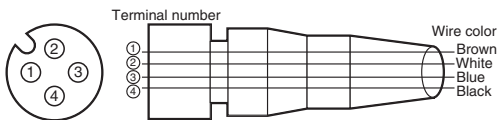

Classification	Wire color	Connector pin No.	Application
			E3S-DCP21-IL2 E3S-DCP21-IL3
DC	Brown	①	Power supply (+V)
	White	②	External input *
	Blue	③	Power supply (0 V)
	Black	④	Output C/Q

* It can be set as the control output with IO-Link.

Nomenclature

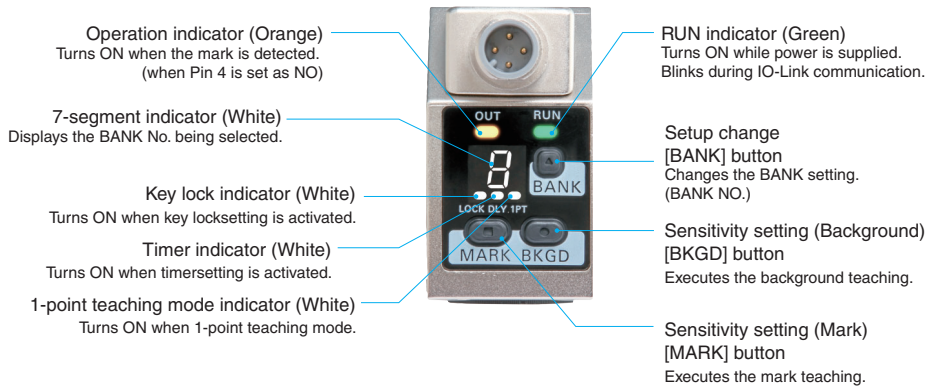





Safety Precautions

Be sure to read the precautions for all models in the website at: <http://www.ia.omron.com/>.

Warning Indications

 WARNING	Warning level Indicates a potentially hazardous situation which, if not avoided, will result in minor or moderate injury, or may result in serious injury or death. Additionally, there may be significant property damage.
Precautions for Safe Use	Supplementary comments on what to do or avoid doing, to use the product safely.
Precautions for Correct Use	Supplementary comments on what to do or avoid doing, to prevent failure to operate, malfunction or undesirable effect on product performance.

Meaning of Product Safety Symbols

	General prohibition Indicates the instructions of unspecified prohibited action.
	Caution, explosion Indicates the possibility of explosion under specific conditions.
	Caution, fire Indicates the possibility of fire under specific conditions.
	General caution Indicates unspecified general alert.

WARNING

This product is not designed or rated for ensuring safety of persons either directly or indirectly. Do not use it for such purpose. 

Never use the product with an AC power supply. Otherwise, explosion may result. 

Do not use the product with voltage in excess of the rated voltage. Excess voltage may result in malfunction or fire. 

Be sure to tighten the external lens until it reaches the chassis. 

Precautions for Safe Use

The following precautions must be observed to ensure safe operation of the product.

1. Do not install the product in the following locations.
 - Locations subject to direct sunlight
 - Locations subject to condensation due to high humidity
 - Locations subject to corrosive gas
 - In the place where vibration or shock is directly transmitted to the product.
2. Do not use the product in environments subject to flammable or explosive gases.
3. Do not use the product in any atmosphere or environment that exceeds the ratings.
4. Do not pull on the cable with excessive strength.
5. Do not attempt to disassemble, repair, or modify the product in any way.
6. Do not use the product with the main unit damaged.
7. Be sure that before making supply the supply voltage is less than the maximum rated supply voltage (30 VDC).
8. Do not apply any load exceeding the ratings.
9. Do not short the load. Otherwise damage or fire may result.
10. Connect the load correctly.
11. Do not use the product under a chemical or an oil environment without prior evaluation.
12. Though this is type IP67, do not use in the water, rain or outdoors.
13. Do not use thinner, alcohol, or other organic solvents. Otherwise, the optical properties and degree of protection may be degraded.
14. When disposing of the product, treat it as industrial waste.
15. These Sensors are certificated for the UL standard on the assumption of usage in a Class 2 circuit. Use them with Class 2 power supplies in the United States or Canada. Use the OMRON XS2F-D4-series or XS5F-D4-series Cables. Cables that have wires less than AWG24 (0.2 mm²) are for connection to terminal blocks and are not for field splicing. External overcurrent protection of 1 A for AWG26, 2 A for AWG24, or 3 A for AWG22 wire must be provided for cable protection.

Precautions for Correct Use

- Note that the water-resistant function is impaired if installing the Photoelectric Sensor by hitting it with a hammer and so on.
- Be sure to tighten the external lens until it reaches the chassis.
- If the Sensor wiring is placed in the same conduits or ducts as high-voltage or high-power lines, inductive noise may cause malfunction or damage. Wire the cables separately or use a shielded cable.
- To extend a cable in the standard I/O mode, use a cable of 0.3 mm² or more and keep the length 100 m or less. Keep the length 20 m or less if using the Sensor in the IO-Link mode.
- Apply a screw tightening torque of 2.0 N·m or less.
- If a commercial switching regulator is used, ground the FG (frame ground) terminal.
- The Sensor will be able to detect objects 100 ms after the power supply is tuned ON. Start using the Sensor 100 ms or more after turning ON the power supply. If the load and the Sensor are connected to separate power supplies, be sure to turn ON the Sensor first.
- Do not press the button with anything sharp such as a screwdriver because it might be damaged.
- Output pulses may occur when the power supply is turned OFF. We recommend that you turn OFF the power supply to the load or load line first.

Dimensions

(Unit: mm)
Tolerance class IT16 applies to dimensions in this data sheet unless otherwise specified.

Sensors

Diffuse-reflective Models

E3S-DCP21-IL2

E3S-DCP21-IL3

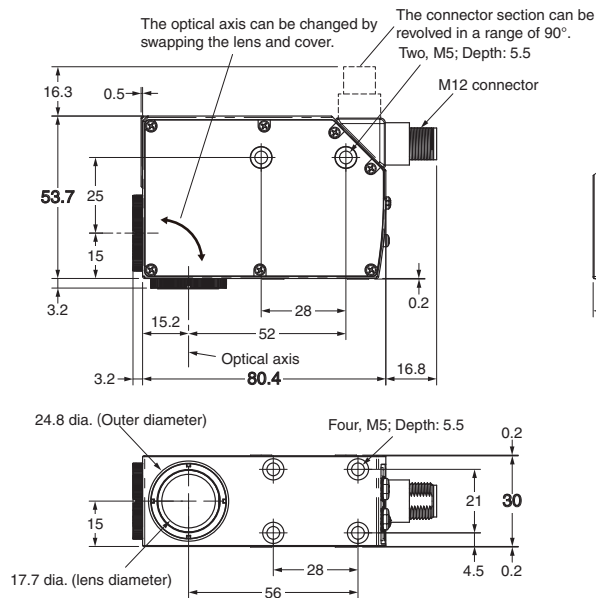
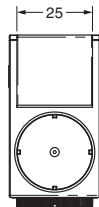

- Note:**
- Apply a screw tightening torque of 2.0 N·m or less.
 - Be sure to tighten the external lens or cover until it reaches the chassis.



IO-Link Makes Sensor Level Information Visible and Solves the Three Major Issues at Manufacturing Sites! Standard Proximity Sensor.

- Downtime can be reduced.
Notifies you of faulty parts and such phenomena in the Sensor in real time.
- The frequency of sudden failure can be decreased.
Notifies you of objects being too far or too close.
- The efficiency of changeover can be improved.
The batch check for individual sensor IDs significantly decreases commissioning time.
- Standard Sensor for detecting ferrous metals.



For the most recent information on models that have been certified for safety standards, refer to your OMRON website.

Be sure to read *Safety Precautions* on page 67.

Ordering Information

Sensors [Refer to *Dimensions* on page 68.]

DC 3-wire IO-Link Models

Appearance	Sensing distance	Connection method	Pin arrangement	IO-Link baud rate	Model
					PNP
Shielded 	M12 3 mm	Pre-wired Models (2 m)	—	COM2 (38.4 kbps)	E2E-X3B4-IL2 2M
		M12 Pre-wired Smartclick Connector Models (0.3 m)	1: +V 3: 0 V 4: C/Q output	COM3 (230.4 kbps)	E2E-X3B4-IL3 2M
	M18 7 mm	Pre-wired Models (2 m)	—	COM2 (38.4 kbps)	E2E-X7B4-IL2 2M
		M12 Pre-wired Smartclick Connector Models (0.3 m)	1: +V 3: 0 V 4: C/Q output	COM3 (230.4 kbps)	E2E-X7B4-IL3 2M
	M30 10 mm	Pre-wired Models (2 m)	—	COM2 (38.4 kbps)	E2E-X10B4-IL2 2M
		M12 Pre-wired Smartclick Connector Models (0.3 m)	1: +V 3: 0 V 4: C/Q output	COM3 (230.4 kbps)	E2E-X10B4-IL3 2M
				COM2 (38.4 kbps)	E2E-X10B4-M1TJ-IL2 0.3M
				COM3 (230.4 kbps)	E2E-X10B4-M1TJ-IL3 0.3M

Note: Please contact your OMRON sales representative regarding the IO-Link setup file (IODD file).

Accessories (Sold Separately)

Sensor I/O Connectors

(Models with Pre-wired Connectors: A Connector is not provided with the Sensor. Be sure to order a Connector separately.)

Type	Appearance	Cable length	Sensor I/O Connector model number	Applicable Proximity Sensor model number
Socket on one cable end	Straight 	2 m	XS5F-D421-D80-F	E2E-X□B4-M1TJ-IL□
		5 m	XS5F-D421-G80-F	
	L-shape 	2 m	XS5F-D422-D80-F	
		5 m	XS5F-D422-G80-F	
Socket and plug on cable ends *	Straight/straight 	2 m	XS5W-D421-D81-F	
		5 m	XS5W-D421-G81-F	
	L-shape/L-shape 	2 m	XS5W-D422-D81-F	
		5 m	XS5W-D422-G81-F	

Note: Refer to *Sensor I/O Connector/Sensor Controller* on your OMRON website for details.

* There are also straight type/L-shape type combinations available.

Ratings and Specifications

DC 3-wire IO-Link Models (E2E-X□B4-IL□)

Item	Size Shielded Model	M12	M18	M30
		Shielded		
		E2E-X3B4-IL□	E2E-X7B4-IL□	E2E-X10B4-IL□
Sensing distance		3 mm ±10%	7 mm ±10%	10 mm ±10%
Set distance *1		0 to 2.4 mm	0 to 5.6 mm	0 to 8 mm
Differential travel		10% max. of sensing distance		
Detectable object		Ferrous metal (The sensing distance decreases with non-ferrous metal. Refer to <i>Engineering Data</i> on pages 65.)		
Standard sensing object		Iron, 12 × 12 × 1 mm	Iron, 18 × 18 × 1 mm	Iron, 30 × 30 × 1 mm
Response frequency *2		1 kHz	0.5 kHz	0.4 kHz
Power supply voltage		10 to 30 VDC (including 10% ripple (p-p))		
Current consumption		20 mA max.		
Control output	Load current	100 mA max.		
	Residual voltage	2 V max. (Load current: 100 mA, Cable length: 2 m)		
Indicators *1		In the Standard I/O mode (SIO mode): Operation indicator (orange, lit) and stability indicator (green, lit) In the IO-Link mode: Operation indicator (orange, lit) and communication indicator (green, blinking at 1 s intervals)		
Operation mode		PNP NO/NC switching type (Factory setting: NO) Refer to the timing charts under <i>I/O Circuit Diagrams</i> on page 66 for details.		
Protection circuits		Power supply reverse polarity protection, output reverse polarity protection, surge suppressor, and output short-circuit protection		
Ambient temperature range		Operating/Storage: -25 to 70°C (with no icing or condensation)		
Ambient humidity range		Operating/Storage: 35% to 95% (with no condensation)		
Temperature influence		±10% max. of sensing distance at 23°C in the temperature range of -25 to 70°C		
Voltage influence		±1% max. of sensing distance at rated voltage in the rated voltage ±15% range		
Insulation resistance		50 MΩ min. (at 500 VDC) between current-carrying parts and case		
Dielectric strength		1,000 VAC, 50/60 Hz for 1 minute between current-carrying parts and case		
Vibration resistance		Destruction: 10 to 55 Hz, 1.5-mm double amplitude for 2 hours each in X, Y, and Z directions		
Shock resistance		Destruction: 1,000 m/s ² 10 times each in X, Y, and Z directions		
Degree of protection		IEC 60529 IP67, in-house standards: oil-resistant *3		
Connection method		Pre-wired Models (Standard cable length: 2 m), Pre-wired Connector Models (Standard cable length: 0.3 m)		
Materials	Case	Nickel-plated brass		
	Sensing surface	PBT		
	Clamping nuts	Nickel-plated brass		
	Toothed washer	Zinc-plated iron		
Main IO-Link functions		Operation mode switching between NO and NC, self diagnosis enabling, excessive proximity judgment distance selecting, timer function of the control output and timer time selecting, instability output (IO-Link mode) ON delay timer time selecting function, monitor output, operating hours read-out, and initial reset		
Communication specifications	IO-Link specification	Ver 1.1		
	Baud rate	-IL3: COM3 (230.4 kbps), -IL2: COM2 (38.4 kbps)		
	Data length	PD size: 2 bytes, OD size: 1 byte (M-sequence type: TYPE_2_2)		
	Minimum cycle time	-IL3 (COM3): 1 ms, -IL2 (COM2): 2.3 ms		
Accessories		Instruction manual		

Note: Please contact your OMRON sales representative regarding the IO-Link setup file (IODD file).

*1. In the Standard I/O mode (SIO mode), use the product in a range that the green stability indication lamp is lit. (Although the lamp is turned off when the object detected has approached excessively, the detection performance is stable.)

In the IO-Link mode, use the product in a range that the Byte1_bit4 for instability detection is zero. (Although the Byte1_bit5 for excessive proximity detection is one if the object detected has approached excessively, the detection performance is stable.)

Please contact your OMRON sales representative regarding assignment of data.

*2. The response frequency is an average value. Measurement conditions are as follows: standard sensing object, a distance of twice the standard sensing object, and a set distance of half the sensing distance.

*3. Oil resistance in-house standard: Performance with respect to water insoluble oil.
(Test at right)

Oil resistance test

After the test time elapses, the characteristics below are checked for problems.

- (1) Visual appearance (no damage that affects product characteristics)
- (2) Operation check (ON/OFF)
- (3) Insulation resistance (50 MΩ min. at 500 VDC)
- (4) Dielectric strength (500 VAC, 1 min.)
- (5) Water resistance (IP67)

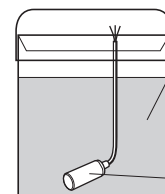

Test oil: Water insoluble oil
Velocite No. 3
(manufactured by
Exxon Mobil)
50°C x 250 hours
Depth 10 cm

Sensor

Engineering Data (Reference Value)

Sensing Area

E2E-X□B4 (-M1TJ) -IL□

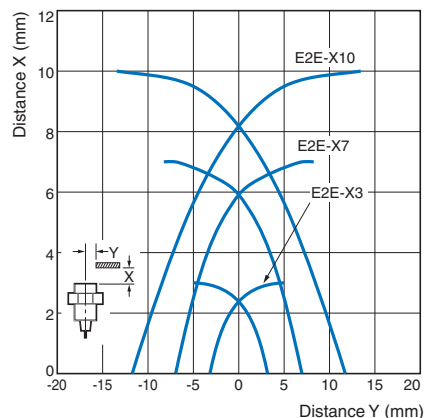

Influence of Sensing Object Size and Material

E2E-X3B4 (-M1TJ) -IL□

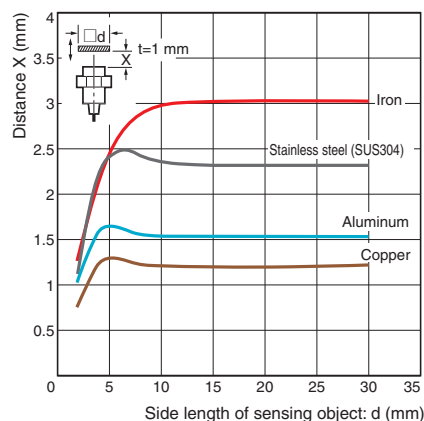

E2E-X7B4 (-M1TJ) -IL□

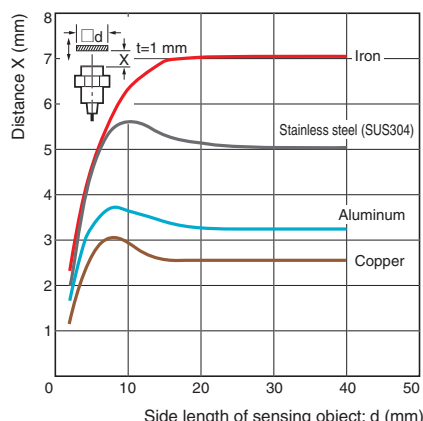

E2E-X10B4 (-M1TJ) -IL□

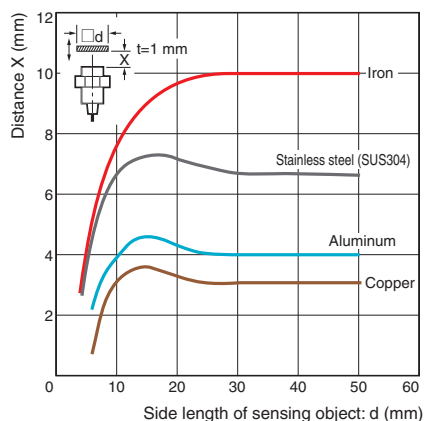

Monitor Output

E2E-X3B4 (-M1TJ) -IL□

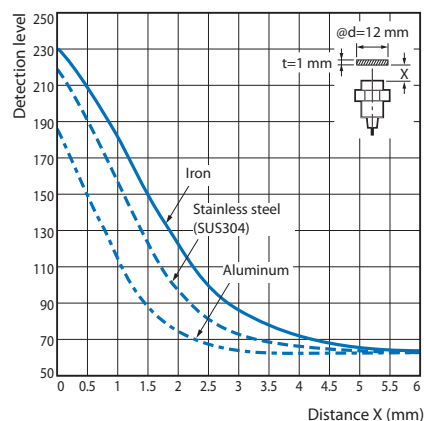

E2E-X7B4 (-M1TJ) -IL□

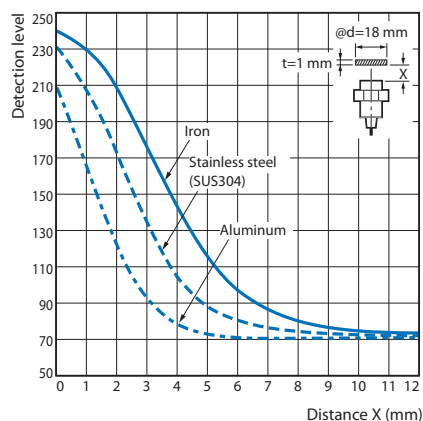

E2E-X10B4 (-M1TJ) -IL□

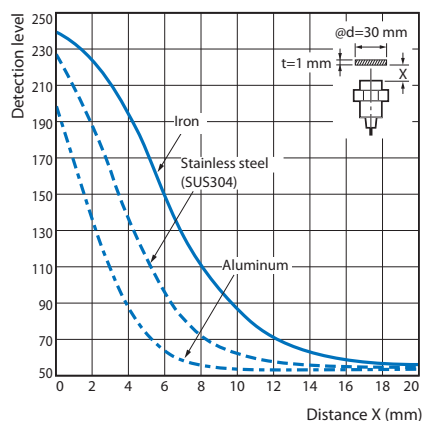

I/O Circuit Diagrams

Timing Chart

Standard I/O mode (SIO mode) *8

Mode	Stability indicator (green)	Operation indicator (orange)	Control output *5
NO	ON	ON	ON
NC	OFF	OFF	OFF

IO-Link mode

Mode	Flashing (1 s cycle) Communication indicator (green)	Operation indicator (orange)	Control output *5 (Byte1_bit0)	Instability detection *6 (Byte1_bit4)	Excessive proximity detection (Byte1_bit5)
NO	ON	OFF	1	0	0
NC	OFF	ON	0	1	1

*1. The operation mode can be changed by the IO-Link communications.

*2. If the excessive proximity diagnosis function using the IO-Link communications is disabled, the lamp is lit in this zone, too, in the Standard I/O mode (SIO mode). In the IO-Link mode, diagnosis is disabled (fixed to zero).

*3. If the instability detection diagnosis function using the IO-Link communications is disabled, the lamp is lit in this zone, too, in the Standard I/O mode (SIO mode). In the IO-Link mode, diagnosis is disabled (fixed to zero).

*4. If both the diagnosis functions of excessive proximity and instability detection using the IO-Link communications are disabled, the lamp is not lit in all the zones.

*5. The timer function of the control output can be set up by the IO-Link communications. (It is able to select ON delay, OFF delay, or one-shot function and select a timer time of 1 to 4000 ms (T).)

ON-delay	OFF-delay	One Shot

*6. The judgment time for the instability detection diagnosis can be selected by the IO-Link communications. (For the ON delay timer function, the setting can be selected from 0 (invalid), 10, 50, 100, 300, 500, or 1000 ms.)

*7. The judgment distance of the excessive proximity diagnosis function can be selected by the IO-Link communications. (The distance can be selected as a combination of the material of the object detected, such as iron, aluminum, or SUS and the judgment distance of approximately 10, 20, or 30%. However, it is not allowed to select a combination of aluminum and 30%.)

*8. If using the product as a general sensor, it operates in the Standard I/O mode (SIO mode).

Note: Please contact your OMRON sales representative regarding assignment of data.

Output circuit

When using as a general sensor

When using the Sensor connected to IO-Link Master Unit

Pre-wired Connector Model Connections

Model	Connections
E2EQ-XB4-M1TJ-IL	<div style="display: flex; justify-content: space-around; align-items: flex-start;"> <div style="text-align: center;"> <p>E2E</p> </div> <div style="text-align: center;"> <p>XS5F</p> </div> </div> <p style="font-size: small; margin-top: 10px;">* ① Brown (+V) ② White (not used) ③ Blue (0V) ④ Black (Output)</p>

* If the XS5W-D42-81-F Connector which has a socket and plug on the cable ends is connected to the Sensor, this part will be a plug.



Safety Precautions

Be sure to read the precautions for all models in the website at: <http://www.ia.omron.com/>.

Warning Indications

 Warning	Warning level Indicates a potentially hazardous situation which, if not avoided, will result in minor or moderate injury, or may result in serious injury or death. Additionally there may be significant property damage.
Precautions for Safe Use	Supplementary comments on what to do or avoid doing, to use the product safely.
Precautions for Correct Use	Supplementary comments on what to do or avoid doing, to prevent failure to operate, malfunction or undesirable effect on product performance.

Meaning of Product Safety Symbols

	General prohibition Indicates the instructions of unspecified prohibited action.
	Caution, explosion Indicates the possibility of explosion under specific conditions.

Warning

This product is not designed or rated for ensuring safety of persons either directly or indirectly. Do not use it for such purposes.



Risk of explosion.

Do not connect sensor to AC power supply.



Precautions for Safe Use

The following precautions must be observed to ensure safe operation.

- Do not use the product in an environment where flammable or explosive gas is present.
- Do not attempt to disassemble, repair, or modify the product.
- Power Supply Voltage**
Do not use a voltage that exceeds the rated operating voltage range. Applying a voltage that is higher than the operating voltage range may result in damage or burnout.
- Incorrect Wiring**
Be sure that the power supply polarity and other wiring is correct. Incorrect wiring may cause explosion or burnout.
- Connection without a Load**
If the power supply is connected directly without a load, the internal elements may explode or burn. Be sure to insert a load when connecting the power supply.
- Dispose of this product as industrial waste.

Precautions for Correct Use

Do not use this product under ambient conditions that exceed the ratings.

● Operating Environment

- Do not install the product in the following locations. Doing so may result in product failure or malfunction.
 - Outdoor locations directly subject to sunlight, rain, snow, water droplets, or oil.
 - Locations subject to atmospheres with chemical vapors, in particular solvents and acids.
 - Locations subject to corrosive gases.
- The Sensor may malfunction if used near ultrasonic cleaning equipment, high-frequency equipment, transceivers, cellular phones, inverters, or other devices that generate a high-frequency electric field. Please refer to the Precautions for Correct Use on the OMRON website (www.ia.omron.com) for typical measures.
- Laying the Proximity Sensor wiring in the same conduit or duct as high-voltage wires or power lines may result in incorrect operation and damage due to induction. Wire the Sensor using a separate conduit or independent conduit.

- Never use thinner or other solvents. Otherwise, the Sensor surface may be dissolved.

● Design

Influence of Surrounding Metal

When mounting the Sensor within a metal panel, ensure that the clearances given in the following table are maintained. Failure to maintain these distances may cause deterioration in the performance of the Sensor.

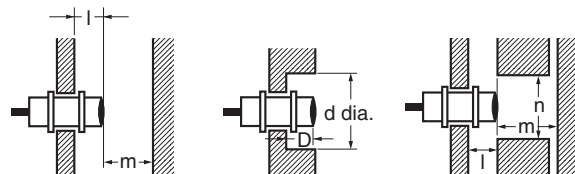

(Unit: mm)

Model	Item	l	d	D	m	n
E2E-X3B4 (-M1TJ) -IL□	0		12		8	18
E2E-X7B4 (-M1TJ) -IL□			18	0	20	27
E2E-X10B4 (-M1TJ) -IL□			30		40	45

Mutual Interference

When installing Sensors face-to-face or side-by-side, ensure that the minimum distances given in the following table are maintained.

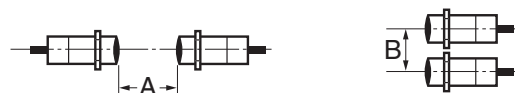

(Unit: mm)

Model	Item	A	B
E2E-X3B4 (-M1TJ) -IL□		30	20
E2E-X7B4 (-M1TJ) -IL□		50	35
E2E-X10B4 (-M1TJ) -IL□		100	70

● Mounting

Tightening Force

Do not tighten the nut with excessive force. A washer must be used with the nut. Do not use tightening force that exceeds the values in the following table.



Model	Item	Torque
E2E-X3B4 (-M1TJ) -IL□		30 N·m
E2E-X7B4 (-M1TJ) -IL□		70 N·m
E2E-X10B4 (-M1TJ) -IL□		180 N·m

● Wiring

In the IO-Link mode, the cable between the IO-link Master and Sensor must have a length of 20m or less.

E2E-□-IL□

Dimensions

(Unit: mm)
Tolerance class IT16 applies to dimensions in this data sheet unless otherwise specified.

Pre-wired Models

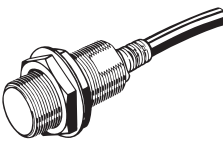
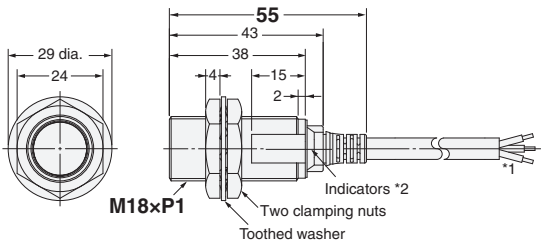
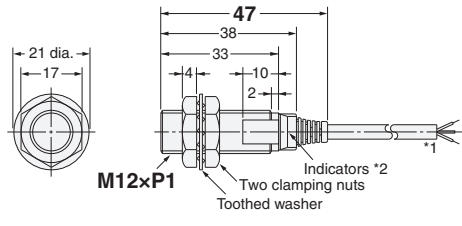
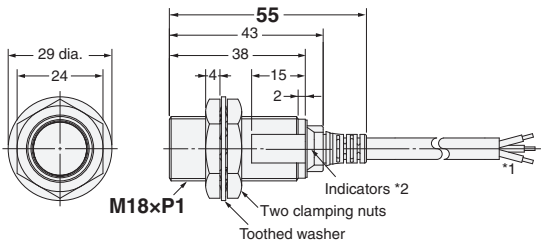
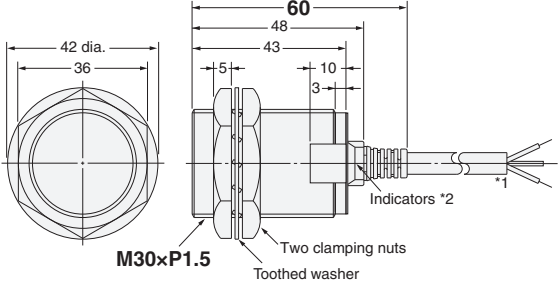
 <p>E2E-X7B4-IL□</p>  <p>*1. 6-dia. vinyl-insulated round cable with 3 conductors (Conductor cross section: 0.5 mm², Insulator diameter: 1.9 mm), Standard length: 2 m *2. Operation indicator (orange), stability indicator/communication indicator (green)</p>	<p>E2E-X3B4-IL□</p>  <p>*1. 4-dia. vinyl-insulated round cable with 3 conductors (Conductor cross section: 0.3 mm², Insulator diameter: 1.3 mm), Standard length: 2 m *2. Operation indicator (orange), stability indicator/communication indicator (green)</p>
<p>E2E-X7B4-IL□</p>  <p>*1. 6-dia. vinyl-insulated round cable with 3 conductors (Conductor cross section: 0.5 mm², Insulator diameter: 1.9 mm), Standard length: 2 m *2. Operation indicator (orange), stability indicator/communication indicator (green)</p>	<p>E2E-X10B4-IL□</p>  <p>*1. 6-dia. vinyl-insulated round cable with 3 conductors (Conductor cross section: 0.5 mm², Insulator diameter: 1.9 mm), Standard length: 2 m *2. Operation indicator (orange), stability indicator/communication indicator (green)</p>

Pre-wired Connector Models

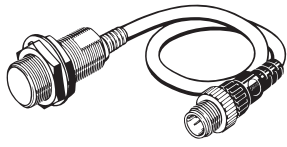
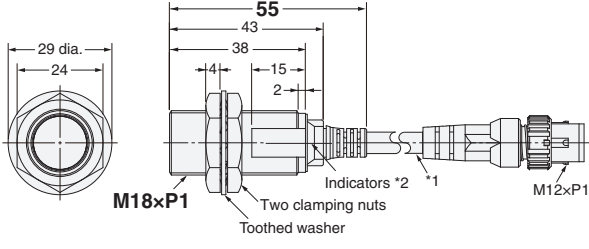
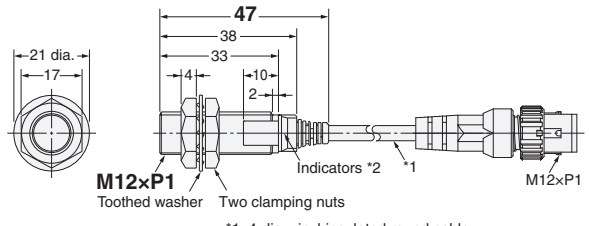
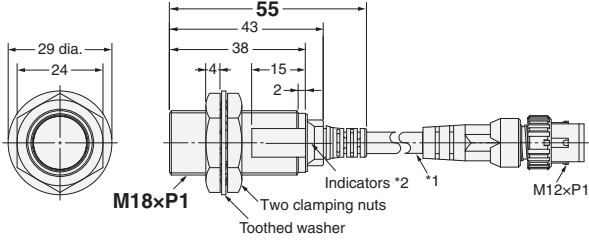
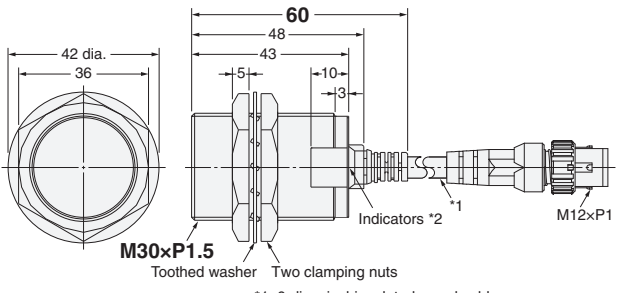
 <p>E2E-X7B4-M1TJ-IL□</p>  <p>*1. 6-dia. vinyl-insulated round cable Standard length: 0.3 m *2. Operation indicator (orange), stability indicator/communication indicator (green)</p>	<p>E2E-X3B4-M1TJ-IL□</p>  <p>*1. 4-dia. vinyl-insulated round cable Standard length: 0.3 m *2. Operation indicator (orange), stability indicator/communication indicator (green)</p>
<p>E2E-X7B4-M1TJ-IL□</p>  <p>*1. 6-dia. vinyl-insulated round cable Standard length: 0.3 m *2. Operation indicator (orange), stability indicator/communication indicator (green)</p>	<p>E2E-X10B4-M1TJ-IL□</p>  <p>*1. 6-dia. vinyl-insulated round cable Standard length: 0.3 m *2. Operation indicator (orange), stability indicator/communication indicator (green)</p>

Mounting Hole Dimensions

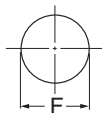

Dimension	M12	M18	M30
F (mm)	12.5 ^{+0.5} ₀ dia.	18.5 ^{+0.5} ₀ dia.	30.5 ^{+0.5} ₀ dia.

E2EQ-□-IL□



IO-Link Makes Sensor Level Information Visible and Solves the Three Major Issues at Manufacturing Sites! A Proximity Sensor That Can Be Used in a Spatter Environment.

- Downtime can be reduced.
Notifies you of faulty parts and such phenomena in the Sensor in real time.
- The frequency of sudden failure can be decreased.
Notifies you of objects being too far or too close.
- The efficiency of changeover can be improved.
The batch check for individual sensor IDs significantly decreases commissioning time.
- The fluororesin coating provides exceptional spatter resistance.



For the most recent information on models that have been certified for safety standards, refer to your OMRON website.

Be sure to read *Safety Precautions* on page 73.

Ordering Information

Sensors [Refer to *Dimensions* on page 74.]

DC 3-wire IO-Link Models

Appearance	Sensing distance	Connection method	Pin arrangement	IO-Link baud rate	Model
Shielded 	M12 3 mm	Pre-wired Models (2 m)	—	COM2 (38.4 kbps)	E2EQ-X3B4-IL2 2M
		M12 Pre-wired Smartclick Connector Models (0.3 m)	1: +V 3: 0 V 4: C/Q output	COM2 (38.4 kbps)	E2EQ-X3B4-M1TJ-IL2 0.3M
	M18 7 mm	Pre-wired Models (2 m)	—	COM2 (38.4 kbps)	E2EQ-X7B4-IL2 2M
		M12 Pre-wired Smartclick Connector Models (0.3 m)	1: +V 3: 0 V 4: C/Q output	COM2 (38.4 kbps)	E2EQ-X7B4-M1TJ-IL2 0.3M
	M30 10 mm	Pre-wired Models (2 m)	—	COM2 (38.4 kbps)	E2EQ-X10B4-IL2 2M
		M12 Pre-wired Smartclick Connector Models (0.3 m)	1: +V 3: 0 V 4: C/Q output	COM2 (38.4 kbps)	E2EQ-X10B4-M1TJ-IL2 0.3M
				COM3 (230.4 kbps)	E2EQ-X10B4-IL3 2M
				COM3 (230.4 kbps)	E2EQ-X10B4-M1TJ-IL3 0.3M

Note: Please contact your OMRON sales representative regarding the IO-Link setup file (IODD file).

Accessories (Sold Separately)

Sensor I/O Connectors

(Models with Pre-wired Connectors: A Connector is not provided with the Sensor. Be sure to order a Connector separately.)

Type	Appearance	Cable length	Sensor I/O Connector model number	Applicable Proximity Sensor model number
Socket on one cable end	Straight 	2 m	XS5F-D421-D80-F	E2EQ-X□B4-M1TJ-IL□
		5 m	XS5F-D421-G80-F	
	L-shape 	2 m	XS5F-D422-D80-F	
		5 m	XS5F-D422-G80-F	
Socket and plug on cable ends *	Straight/straight 	2 m	XS5W-D421-D81-F	
		5 m	XS5W-D421-G81-F	
	L-shape/L-shape 	2 m	XS5W-D422-D81-F	
		5 m	XS5W-D422-G81-F	

Note: Refer to *Sensor I/O Connector/Sensor Controller* on your OMRON website for details.

* There are also straight type/L-shape type combinations available.

Ratings and Specifications

DC 3-wire IO-Link Models

Item	Size Shielded Model	M12	M18	M30
		Shielded		
		E2EQ-X3B4-IL□	E2EQ-X7B4-IL□	E2EQ-X10B4-IL□
Sensing distance		3 mm ±10%	7 mm ±10%	10 mm ±10%
Set distance *1		0 to 2.4 mm	0 to 5.6 mm	0 to 8 mm
Differential travel		10% max. of sensing distance		
Detectable object		Ferrous metal (The sensing distance decreases with non-ferrous metal. Refer to <i>Engineering Data</i> on pages 71.)		
Standard sensing object		Iron, 12 × 12 × 1 mm	Iron, 18 × 18 × 1 mm	Iron, 30 × 30 × 1 mm
Response frequency *2		1 kHz	0.5 kHz	0.4 kHz
Power supply voltage		10 to 30 VDC (including 10% ripple (p-p))		
Current consumption		20 mA max.		
Control output	Load current	100 mA max.		
	Residual voltage	2 V max. (Load current: 100 mA, Cable length: 2 m)		
Indicators *1		In the Standard I/O mode (SIO mode): Operation indicator (orange, lit) and stability indicator (green, lit) In the IO-Link mode: Operation indicator (orange, lit) and communication indicator (green, blinking at 1 s intervals)		
Operation mode		PNP NO/NC switching type (Factory setting: NO) Refer to the timing charts under <i>I/O Circuit Diagrams</i> on page 72 for details.		
Protection circuits		Power supply reverse polarity protection, output reverse polarity protection, surge suppressor, and output short-circuit protection		
Ambient temperature range		Operating/Storage: -25 to 70°C (with no icing or condensation)		
Ambient humidity range		Operating/Storage: 35% to 95% (with no condensation)		
Temperature influence		±10% max. of sensing distance at 23°C in the temperature range of -25 to 70°C		
Voltage influence		±1% max. of sensing distance at rated voltage in the rated voltage ±15% range		
Insulation resistance		50 MΩ min. (at 500 VDC) between current-carrying parts and case		
Dielectric strength		1,000 VAC, 50/60 Hz for 1 minute between current-carrying parts and case		
Vibration resistance		Destruction: 10 to 55 Hz, 1.5-mm double amplitude for 2 hours each in X, Y, and Z directions		
Shock resistance		Destruction: 1,000 m/s ² 10 times each in X, Y, and Z directions		
Degree of protection		IEC 60529 IP67, in-house standards: oil-resistant		
Connection method		Pre-wired Models (Standard cable length: 2 m), Pre-wired Connector Models (Standard cable length: 0.3 m)		
Materials	Case	Fluororesin coating (Base material: brass)		
	Sensing surface	Fluororesin		
	Clamping nuts	Fluororesin coating (Base material: brass)		
	Toothed washer	Zinc-plated iron		
Main IO-Link functions		Operation mode switching between NO and NC, self diagnosis enabling, excessive proximity judgment distance selecting, timer function of the control output and timer time selecting, instability output (IO-Link mode) ON delay timer time selecting function, monitor output, operating hours read-out, and initial reset		
Communication specifications	IO-Link specification	Ver 1.1		
	Baud rate	-IL3: COM3 (230.4 kbps), -IL2: COM2 (38.4 kbps)		
	Data length	PD size: 2 bytes, OD size: 1 byte (M-sequence type: TYPE_2_2)		
	Minimum cycle time	-IL3 (COM3): 1 ms, -IL2 (COM2): 2.3 ms		
Accessories		Instruction manual		

Note: Please contact your OMRON sales representative regarding the IO-Link setup file (IODD file).

*1. In the Standard I/O mode (SIO mode), use the product in a range that the green stability indication lamp is lit. (Although the lamp is turned off when the object detected has approached excessively, the detection performance is stable.)

In the IO-Link mode, use the product in a range that the Byte1_bit4 for instability detection is zero. (Although the Byte1_bit5 for excessive proximity detection is one if the object detected has approached excessively, the detection performance is stable.)

Please contact your OMRON sales representative regarding assignment of data.

*2. The response frequency is an average value. Measurement conditions are as follows: standard sensing object, a distance of twice the standard sensing object, and a set distance of half the sensing distance.

Engineering Data (Reference Value)

Sensing Area

E2EQ-X□B4 (-M1TJ) -IL□

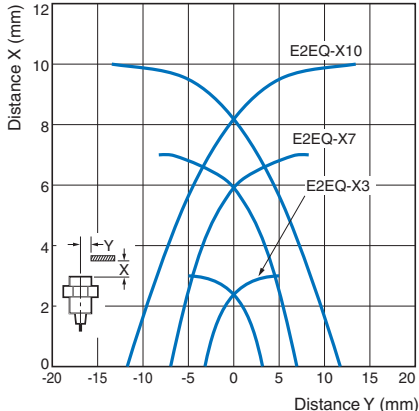

Influence of Sensing Object Size and Material

E2EQ-X3B4 (-M1TJ) -IL□

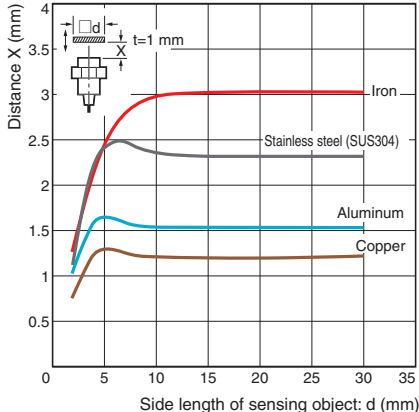

E2EQ-X7B4 (-M1TJ) -IL□

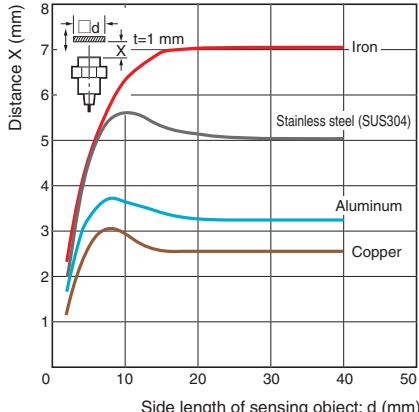

E2EQ-X10B4 (-M1TJ) -IL□

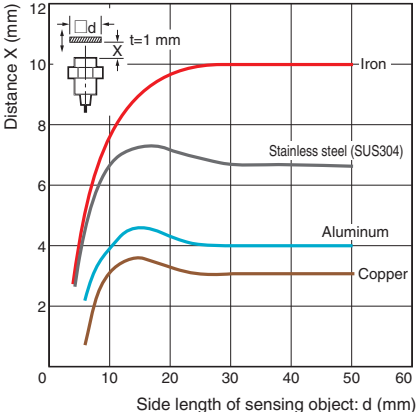

Monitor Output

E2EQ-X3B4 (-M1TJ) -IL□

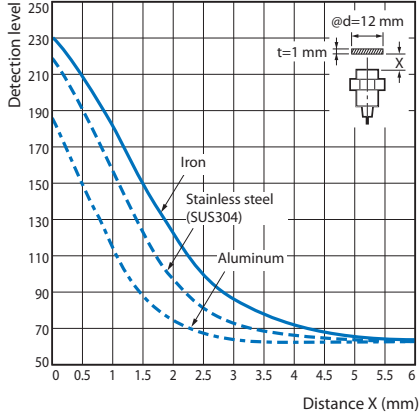

E2EQ-X7B4 (-M1TJ) -IL□

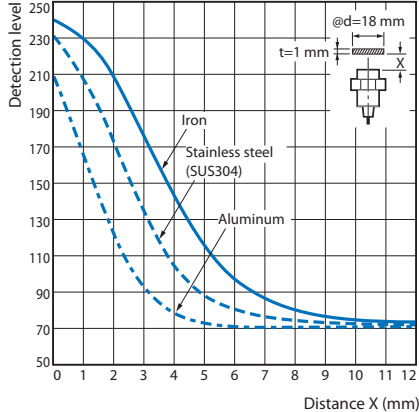

E2EQ-X10B4 (-M1TJ) -IL□

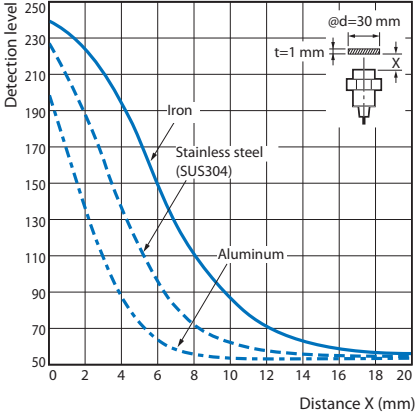

Communications Specifications

Masters

Photoelectric Sensor

Color Mark Photoelectric Sensors

Proximity Sensor

I/O Circuit Diagrams

Timing Chart

The timing chart illustrates the sensor's response to a sensing object moving through different zones. The x-axis represents the rated sensing distance in percent (100%, 80%, 20%, 0%). Key zones include Non-sensing, Unstable, Set position, Stable, and Excessive proximity judgment distance. The chart shows the state of various indicators: Stability indicator (green), Operation indicator (orange), and Control output (yellow) for both NO and NC configurations in Standard I/O mode and IO-Link mode. IO-Link mode includes additional signals like Communication indicator (flashing green), Instability detection (Byte1_bit4), and Excessive proximity detection (Byte1_bit5).

*1. The operation mode can be changed by the IO-Link communications.

*2. If the excessive proximity diagnosis function using the IO-Link communications is disabled, the lamp is lit in this zone, too, in the Standard I/O mode (SIO mode). In the IO-Link mode, diagnosis is disabled (fixed to zero).

*3. If the instability detection diagnosis function using the IO-Link communications is disabled, the lamp is lit in this zone, too, in the Standard I/O mode (SIO mode). In the IO-Link mode, diagnosis is disabled (fixed to zero).

*4. If both the diagnosis functions of excessive proximity and instability detection using the IO-Link communications are disabled, the lamp is not lit in all the zones.

*5. The timer function of the control output can be set up by the IO-Link communications. (It is able to select ON delay, OFF delay, or one-shot function and select a timer time of 1 to 4000 ms (T).)

ON-delay	OFF-delay	One Shot

*6. The judgment time for the instability detection diagnosis can be selected by the IO-Link communications. (For the ON delay timer function, the setting can be selected from 0 (invalid), 10, 50, 100, 300, 500, or 1000 ms.)

*7. The judgment distance of the excessive proximity diagnosis function can be selected by the IO-Link communications. (The distance can be selected as a combination of the material of the object detected, such as iron, aluminum, or SUS and the judgment distance of approximately 10, 20, or 30%. However, it is not allowed to select a combination of aluminum and 30%.)

*8. If using the product as a general sensor, it operates in the Standard I/O mode (SIO mode).

Note: Please contact your OMRON sales representative regarding assignment of data.

Output circuit

When using as a general sensor

When using the Sensor connected to IO-Link Master Unit

Pre-wired Connector Model Connections

Model	Connections
E2EQ-X□B4-M1TJ-IL□	<div style="display: flex; justify-content: space-around; align-items: flex-start;"> <div style="text-align: center;"> <p>E2EQ</p> </div> <div style="text-align: center;"> <p>XS5F</p> </div> <div style="font-size: x-small;"> <p>* ○ Brown (+V) ○ White (not used) ○ Blue (0V) ○ Black (Output)</p> </div> </div>

* If the XS5W-D42□-□81-F Connector which has a socket and plug on the cable ends is connected to the Sensor, this part will be a plug.

Safety Precautions

Be sure to read the precautions for all models in the website at: <http://www.ia.omron.com/>.

Warning Indications

	Warning level Indicates a potentially hazardous situation which, if not avoided, will result in minor or moderate injury, or may result in serious injury or death. Additionally there may be significant property damage.
Precautions for Safe Use	Supplementary comments on what to do or avoid doing, to use the product safely.
Precautions for Correct Use	Supplementary comments on what to do or avoid doing, to prevent failure to operate, malfunction or undesirable effect on product performance.

Meaning of Product Safety Symbols

	General prohibition Indicates the instructions of unspecified prohibited action.
	Caution, explosion Indicates the possibility of explosion under specific conditions.

Warning

This product is not designed or rated for ensuring safety of persons either directly or indirectly. Do not use it for such purposes.



Risk of explosion. Do not connect sensor to AC power supply.



Precautions for Safe Use

The following precautions must be observed to ensure safe operation.

- Do not use the product in an environment where flammable or explosive gas is present.
- Do not attempt to disassemble, repair, or modify the product.
- Power Supply Voltage**
Do not use a voltage that exceeds the rated operating voltage range. Applying a voltage that is higher than the operating voltage range may result in damage or burnout.
- Incorrect Wiring**
Be sure that the power supply polarity and other wiring is correct. Incorrect wiring may cause explosion or burnout.
- Connection without a Load**
If the power supply is connected directly without a load, the internal elements may explode or burn. Be sure to insert a load when connecting the power supply.
- Dispose of this product as industrial waste.

Precautions for Correct Use

Do not use this product under ambient conditions that exceed the ratings.

● Operating Environment

- Do not install the product in the following locations. Doing so may result in product failure or malfunction.
 - Outdoor locations directly subject to sunlight, rain, snow, water droplets, or oil.
 - Locations subject to atmospheres with chemical vapors, in particular solvents and acids.
 - Locations subject to corrosive gases.
- The Sensor may malfunction if used near ultrasonic cleaning equipment, high-frequency equipment, transceivers, cellular phones, inverters, or other devices that generate a high-frequency electric field. Please refer to the Precautions for Correct Use on the OMRON website (www.ia.omron.com) for typical measures.
- Laying the Proximity Sensor wiring in the same conduit or duct as high-voltage wires or power lines may result in incorrect operation and damage due to induction. Wire the Sensor using a separate conduit or independent conduit.

- Never use thinner or other solvents. Otherwise, the Sensor surface may be dissolved.

● Design

Influence of Surrounding Metal

When mounting the Sensor within a metal panel, ensure that the clearances given in the following table are maintained. Failure to maintain these distances may cause deterioration in the performance of the Sensor.

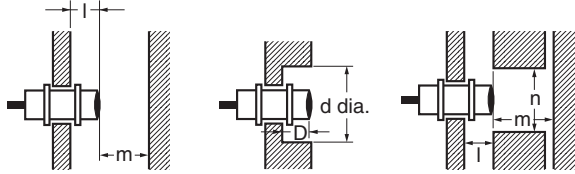

(Unit: mm)

Model	Item	l	d	D	m	n
E2EQ-X3B4 (-M1TJ) -IL□	0		12		8	18
E2EQ-X7B4 (-M1TJ) -IL□			18	0	20	27
E2EQ-X10B4 (-M1TJ) -IL□			30		40	45

Mutual Interference

When installing Sensors face-to-face or side-by-side, ensure that the minimum distances given in the following table are maintained.

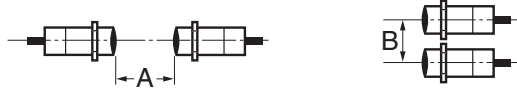

(Unit: mm)

Model	Item	A	B
E2EQ-X3B4 (-M1TJ) -IL□		30	20
E2EQ-X7B4 (-M1TJ) -IL□		50	35
E2EQ-X10B4 (-M1TJ) -IL□		100	70

● Mounting

Tightening Force

Do not tighten the nut with excessive force. A washer must be used with the nut. Do not use tightening force that exceeds the values in the following table.



Model	Item	Torque
E2EQ-X3B4 (-M1TJ) -IL□		30 N·m
E2EQ-X7B4 (-M1TJ) -IL□		70 N·m
E2EQ-X10B4 (-M1TJ) -IL□		180 N·m

● Wiring

In the IO-Link mode, the cable between the IO-link Master and Sensor must have a length of 20m or less.

E2EQ-□-IL□

Dimensions

(Unit: mm)
Tolerance class IT16 applies to dimensions in this data sheet unless otherwise specified.

Pre-wired Models

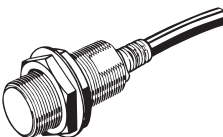

E2EQ-X3B4-IL□

Technical drawing showing dimensions: 21 dia., 17, 47, 38, 33, 4, 10, 2, 4, 15, 2, 1, 1, 1. Components: M12xP1, Indicators *2, Two clamping nuts, Toothed washer.

*1. 4-dia. vinyl-insulated round cable with 3 conductors (Flame-resistant, Conductor cross section: 0.3 mm², Insulator diameter: 1.3 mm, Standard length: 2 m)
*2. Operation indicator (orange), stability indicator/communication indicator (green)

E2EQ-X7B4-IL□

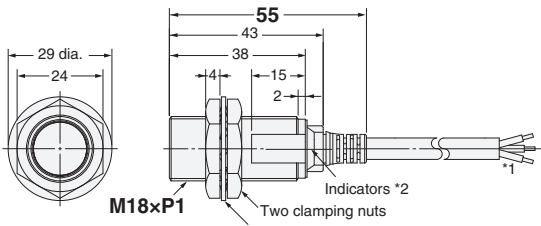

Technical drawing showing dimensions: 29 dia., 24, 55, 43, 38, 4, 15, 2, 1, 1, 1. Components: M18xP1, Indicators *2, Two clamping nuts, Toothed washer.

*1. 6-dia. vinyl-insulated round cable with 3 conductors (Flame-resistant, Conductor cross section: 0.5 mm², Insulator diameter: 1.9 mm, Standard length: 2 m)
*2. Operation indicator (orange), stability indicator/communication indicator (green)

E2EQ-X10B4-IL□

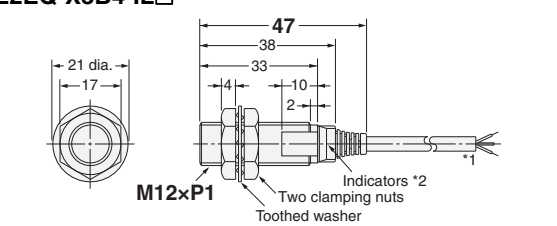

Technical drawing showing dimensions: 42 dia., 36, 60, 48, 43, 5, 10, 3, 1, 1, 1. Components: M30xP1.5, Indicators *2, Two clamping nuts, Toothed washer.

*1. 6-dia. vinyl-insulated round cable with 3 conductors (Flame-resistant, Conductor cross section: 0.5 mm², Insulator diameter: 1.9 mm, Standard length: 2 m)
*2. Operation indicator (orange), stability indicator/communication indicator (green)

Pre-wired Connector Models

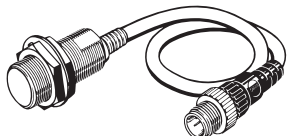

E2EQ-X3B4-M1TJ-IL□

Technical drawing showing dimensions: 21 dia., 17, 47, 38, 33, 4, 10, 2, 4, 15, 2, 1, 1, 1, 1, 1. Components: M12xP1, Toothed washer, Two clamping nuts, Indicators *2, M12xP1.

*1. 4-dia. vinyl-insulated round cable (Flame-resistant), Standard length: 0.3 m
*2. Operation indicator (orange), stability indicator/communication indicator (green)

E2EQ-X7B4-M1TJ-IL□

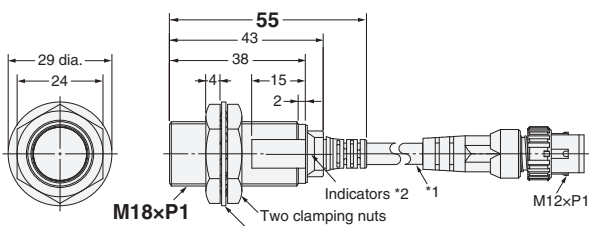

Technical drawing showing dimensions: 29 dia., 24, 55, 43, 38, 4, 15, 2, 1, 1, 1, 1, 1, 1. Components: M18xP1, Two clamping nuts, Toothed washer, Indicators *2, *1, M12xP1.

*1. 6-dia. vinyl-insulated round cable (Flame-resistant), Standard length: 0.3 m
*2. Operation indicator (orange), stability indicator/communication indicator (green)

E2EQ-X10B4-M1TJ-IL□

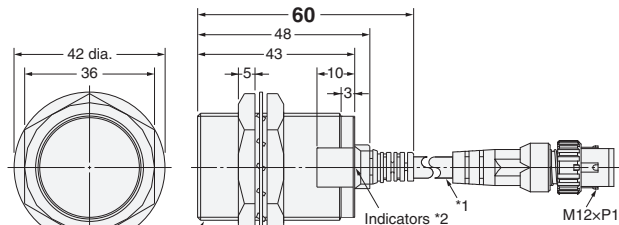

Technical drawing showing dimensions: 42 dia., 36, 60, 48, 43, 5, 10, 3, 1, 1, 1, 1, 1, 1. Components: M30xP1.5, Toothed washer, Two clamping nuts, Indicators *2, *1, M12xP1.

*1. 6-dia. vinyl-insulated round cable (Flame-resistant), Standard length: 0.3 m
*2. Operation indicator (orange), stability indicator/communication indicator (green)

Mounting Hole Dimensions



Model	E2EQ-X3B4	E2EQ-X7B4	E2EQ-X10B4
F (mm)	12.5 ^{+0.5} ₀ dia.	18.5 ^{+0.5} ₀ dia.	30.5 ^{+0.5} ₀ dia.

Terms and Conditions Agreement

Read and understand this catalog.

Please read and understand this catalog before purchasing the products. Please consult your OMRON representative if you have any questions or comments.

Warranties.

- (a) Exclusive Warranty. Omron's exclusive warranty is that the Products will be free from defects in materials and workmanship for a period of twelve months from the date of sale by Omron (or such other period expressed in writing by Omron). Omron disclaims all other warranties, express or implied.
- (b) Limitations. OMRON MAKES NO WARRANTY OR REPRESENTATION, EXPRESS OR IMPLIED, ABOUT NON-INFRINGEMENT, MERCHANTABILITY OR FITNESS FOR A PARTICULAR PURPOSE OF THE PRODUCTS. BUYER ACKNOWLEDGES THAT IT ALONE HAS DETERMINED THAT THE PRODUCTS WILL SUITABLY MEET THE REQUIREMENTS OF THEIR INTENDED USE.

Omron further disclaims all warranties and responsibility of any type for claims or expenses based on infringement by the Products or otherwise of any intellectual property right. (c) Buyer Remedy. Omron's sole obligation hereunder shall be, at Omron's election, to (i) replace (in the form originally shipped with Buyer responsible for labor charges for removal or replacement thereof) the non-complying Product, (ii) repair the non-complying Product, or (iii) repay or credit Buyer an amount equal to the purchase price of the non-complying Product; provided that in no event shall Omron be responsible for warranty, repair, indemnity or any other claims or expenses regarding the Products unless Omron's analysis confirms that the Products were properly handled, stored, installed and maintained and not subject to contamination, abuse, misuse or inappropriate modification. Return of any Products by Buyer must be approved in writing by Omron before shipment. Omron Companies shall not be liable for the suitability or unsuitability or the results from the use of Products in combination with any electrical or electronic components, circuits, system assemblies or any other materials or substances or environments. Any advice, recommendations or information given orally or in writing, are not to be construed as an amendment or addition to the above warranty.

See <http://www.omron.com/global/> or contact your Omron representative for published information.

Limitation on Liability; Etc.

OMRON COMPANIES SHALL NOT BE LIABLE FOR SPECIAL, INDIRECT, INCIDENTAL, OR CONSEQUENTIAL DAMAGES, LOSS OF PROFITS OR PRODUCTION OR COMMERCIAL LOSS IN ANY WAY CONNECTED WITH THE PRODUCTS, WHETHER SUCH CLAIM IS BASED IN CONTRACT, WARRANTY, NEGLIGENCE OR STRICT LIABILITY.

Further, in no event shall liability of Omron Companies exceed the individual price of the Product on which liability is asserted.

Suitability of Use.

Omron Companies shall not be responsible for conformity with any standards, codes or regulations which apply to the combination of the Product in the Buyer's application or use of the Product. At Buyer's request, Omron will provide applicable third party certification documents identifying ratings and limitations of use which apply to the Product. This information by itself is not sufficient for a complete determination of the suitability of the Product in combination with the end product, machine, system, or other application or use. Buyer shall be solely responsible for determining appropriateness of the particular Product with respect to Buyer's application, product or system. Buyer shall take application responsibility in all cases.

NEVER USE THE PRODUCT FOR AN APPLICATION INVOLVING SERIOUS RISK TO LIFE OR PROPERTY OR IN LARGE QUANTITIES WITHOUT ENSURING THAT THE SYSTEM AS A WHOLE HAS BEEN DESIGNED TO ADDRESS THE RISKS, AND THAT THE OMRON PRODUCT(S) IS PROPERLY RATED AND INSTALLED FOR THE INTENDED USE WITHIN THE OVERALL EQUIPMENT OR SYSTEM.

Programmable Products.

Omron Companies shall not be responsible for the user's programming of a programmable Product, or any consequence thereof.

Performance Data.

Data presented in Omron Company websites, catalogs and other materials is provided as a guide for the user in determining suitability and does not constitute a warranty. It may represent the result of Omron's test conditions, and the user must correlate it to actual application requirements. Actual performance is subject to the Omron's Warranty and Limitations of Liability.

Change in Specifications.

Product specifications and accessories may be changed at any time based on improvements and other reasons. It is our practice to change part numbers when published ratings or features are changed, or when significant construction changes are made. However, some specifications of the Product may be changed without any notice. When in doubt, special part numbers may be assigned to fix or establish key specifications for your application. Please consult with your Omron's representative at any time to confirm actual specifications of purchased Product.

Errors and Omissions.

Information presented by Omron Companies has been checked and is believed to be accurate; however, no responsibility is assumed for clerical, typographical or proofreading errors or omissions.

EtherCAT® is a registered trademark and patented technology, licensed by Beckhoff Automation GmbH, Germany.

EtherNet/IP™ is the trademarks of ODVA.

Other company names and product names in this document are the trademarks or registered trademarks of their respective companies.

The product photographs and figures that are used in this catalog may vary somewhat from the actual products.

OMRON Corporation Industrial Automation Company

Kyoto, JAPAN

Contact: www.ia.omron.com

Regional Headquarters

OMRON EUROPE B.V.

Wegalaan 67-69, 2132 JD Hoofddorp
The Netherlands
Tel: (31)2356-81-300/Fax: (31)2356-81-388

OMRON ELECTRONICS LLC

2895 Greenspoint Parkway, Suite 200
Hoffman Estates, IL 60169 U.S.A.
Tel: (1) 847-843-7900/Fax: (1) 847-843-7787

OMRON ASIA PACIFIC PTE. LTD.

No. 438A Alexandra Road # 05-05/08 (Lobby 2),
Alexandra Technopark,
Singapore 119967
Tel: (65) 6835-3011/Fax: (65) 6835-2711

OMRON (CHINA) CO., LTD.

Room 2211, Bank of China Tower,
200 Yin Cheng Zhong Road,
PuDong New Area, Shanghai, 200120, China
Tel: (86) 21-5037-2222/Fax: (86) 21-5037-2200

Authorized Distributor:

© OMRON Corporation 2016-2017 All Rights Reserved.
In the interest of product improvement,
specifications are subject to change without notice.

CSM_5_3_0917

Cat. No. Y229-E1-01

0917 (0616)