

LASER **OMRON**

# 型 E3Z-L□□□

光电传感器  
激光型

## 使用说明书

感谢您选择欧姆龙产品。  
使用时，请务必遵守以下内容。

- 由具备一定电气知识的人员使用。
- 使用本品前，请仔细阅读本说明书，充分了解产品。
- 为了您的方便，请妥善保管好本说明书。

The following notice applies only to products that carry the CE mark Notice:  
This is a class A product. In residential areas it may cause radio interference, in which case the user may be required to take adequate measures to reduce interference.



© OMRON Corporation 2005-2010 All Rights Reserved.

## 安全上的注意

●警告表示的意思

**注意** 如果不正确使用，有可能导致死亡或重大伤害。

●警告表示

**注意** 不可将传感器连接交流电源。有爆裂的危险。



## 安全上的要点

- 以下项目在安全确保方面非常重要，请务必遵守。
- 请不要在具有可燃性、爆炸性气体的环境下使用。
  - 请勿拆卸、修理、改造本产品。
  - 电源电压必须在额定值内（DC12~24V±10%）。
  - 请使用额定值以下的负载。

## 使用上的注意

- 请勿在以下场所使用。
  - 日光直射场所
  - 湿度高或易结露场所
  - 含腐蚀性气体场所
  - 振动或冲击能直接传送到传感器场所
- 连接和安装
  - 传感器最大允许电压是DC26.4V。通电前请确认供电电压小于最大允许电压。
  - 传感器导线和动力线或电力线装在同一配管中使用时，会受到干扰，有误动作甚至被损坏。原上传感器导线必须单独放置或者屏蔽。
  - 延长导线必须使用截面积0.3mm<sup>2</sup>以上、长度100m以下导线。
  - 导线请勿用力拉扯。
  - 安装传感器时，请勿使传感器受剧烈外力（如用锤击打等），这样就有可能破坏传感器防水保护性能。安装时请使用M3螺栓固定。
- M8连接器方面
  - 连接器的插拔必须在传感器电源切断情况下进行。
  - 插拔连接头时请握住传感器的外壳部位。
  - 一定要用手作为固定工具，如果用钳子拧会破坏产品。
  - 合适的扭矩为0.3~0.4N·m。如果扭矩不够，会失去防水保护功能，且会在有振动情况下容易松动。
- 清扫
 

因为稀释剂类会溶化产品表面，所以请避免使用。
- 电源
 

使用市场上销售的开关整流器时，请将FG（Frame・Ground端子）接地。
- 电源重置时间
 

从接通电源到传感器可正常进行检出的时间是100ms，所以请在通电100ms后再使用。负载和传感器接不同电源时，一定要先接通传感器的电源。
- 电源关闭
 

电源关闭时，可能会出现输出脉冲，所以我们建议先关闭负载或负载线的电源。
- 负载短路保护
 

本类传感器具有负载短路保护功能，请勿将负载短路。勿使超过额定的电流通过负载。发生负载短路时，输出会变成OFF。请对回路进行修正后再接通电源。短路保护回路也会重新调整。另外，当回路中通过1.8倍以上的额定负载电流时，负载短路保护功能也会动作。所以接L负载时确保通过的电流小于额定负载电流的1.8倍。
- 耐水性
 

虽然防水等级为IP67，但最好避免在水中、雨中和室外使用。
- 废弃时，请作为工业废弃物处理。

## 有关激光安全

- 使用上的注意
- 使用上的注意
 

型号E3Z-L□□□放射的是可视激光。请勿直视。请将激光束的光路作为终端使用。终端材料请考虑使用反射少的抛光涂面，以使激光不影响到肉眼。如光路中有镜面反射体的话，则对于反射光路，请将光束圈在内。必须将激光开放出来使用时，其光路请务必避开肉眼的高度。
  - 对于激光机器，国内外激光安全对策有所规定。以下分在国内使用和在国内组装出口海外两种情况进行简单说明。

- 国内
 

为了防止由于激光产品不同而导致有时会对使用者造成伤害，根据国际电气基准(IEC)，JIS C 6802规定了「激光产品的放射安全规格」。型号E3Z-L□□□划分在该规格中的JIS规格CLASS I里。有关激光的标签标识在传感器侧面粘贴下图的说明标签。如安装配件等的标签标识面从外面看不到的话，则请在安装配件或该产品附近粘贴附属的标签粘纸。

- 美国除外的其他国家
 

有关出口欧洲的情况，适用EN60825-1:2007。型号E3Z-L□□□划分在该规格中的CLASS I里。有关激光的标签标识在传感器侧面粘贴下图的说明标签。如安装配件等的标签标识面从外面看不到的话，则请在安装配件或该产品附近粘贴附属的标签粘纸。



- 美国
 

搭载在机器上出口美国时，受到美国的安全规格FDA (Food and Drug Administration) 所规定。型号E3Z-L□□□划分在该规格中的I里。请参考下图，再贴上本体标签

警告/证明标签



This laser product complies with 21 CFR 1040.10 and 1040.11 except for deviations pursuant to Laser Notice No.50, dated June 24, 2007  
OMRON Corporation  
735-5 higashiokoji-cho, karasuma-shichijo, shimogyo-ku, Kyoto 660-8216 JAPAN  
Place of manufacture: Shanghai Factory, OMRON Corp.  
Manufactured in

激光放出开口标签



AVOID EXPOSURE LASER LIGHT RADIATION EMITTED FROM THIS APERTURE

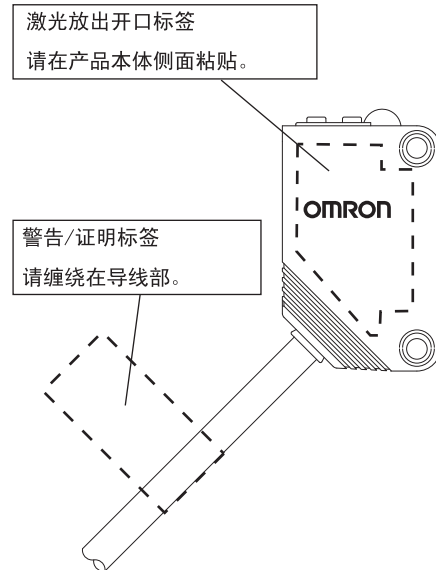

## 规格性能

检出方式	对射型		回归反射型		距离设定型	
型号	NPN 型E3Z-LT61/-LT66	PNP 型E3Z-LT81/-LT86	型E3Z-LR61/-LR66	型E3Z-LR81/-LR86	型E3Z-LL61/-LL66	型E3Z-LL81/-LL86
检出距离	60m		0.3~15m (型E39-R1使用时) 0.2~7m (型E39-R12使用时) 0.2~7m (型E39-R6使用时)	20~300mm (白纸□100mm) 20~160mm (黑纸□100mm)	25~300mm (白纸□100mm) 25~100mm (黑纸□100mm)	25~300mm (白纸□100mm) 25~100mm (黑纸□100mm)
设定距离范围	—		—	40~300mm (白纸□100mm) 40~160mm (黑纸□100mm)	40~300mm (白纸□100mm) 40~100mm (黑纸□100mm)	40~300mm (白纸□100mm) 40~100mm (黑纸□100mm)
应差距离	—		—	额定检出距离的5%以下		
黑白误差	—		—	5% (距离160mm)		5% (距离100mm)
光源 (发光波长)	红色LD (655nm)					
光源 (JIS/IEC CLASS1, FDA CLASS I)	2mW以下		1mW以下		4.5mW以下	
电源电压	DC12~24V±10% 波动 (P-P) 10%以下					
消费电流	投光器: 15mA以下 受光器: 20mA以下		30mA以下			
控制输出	负载电源电压DC26.4V以下, 负载电流100mA以下 集电极开路输出 入光时ON/遮光时ON开关切换式					
输出残留电压	残留电压1V以下 (负载电流小于10mA); 残留电压2V以下 (负载电流小于10~100mA)					
保护回路	电源逆接保护/负载短路保护/输出逆接保护		电源逆接保护/负载短路保护/相互干涉防止功能/输出逆接保护			
响应时间	动作·复归: 各1ms以下				动作·复归: 各0.5ms以下	
周围温度	动作时: -10~+55℃, 保存时: -25~+70℃ (但不结冰、结露)					
使用周围湿度	动作时: 湿度35~85%RH, 保存时: 湿度35~95%RH (但不结冰、结露)					
保护构造	IEC60529规格 IP67					
材质	聚对苯二甲酸丁二醇酯 (PBT)					
外壳	聚酯合橡胶					
显示部	聚甲基丙烯酸甲酯 (PMMA)					
镜头部	聚酯合橡胶		聚甲基丙烯酸甲酯 (PMMA)		聚酯合橡胶	

## 输出回路图

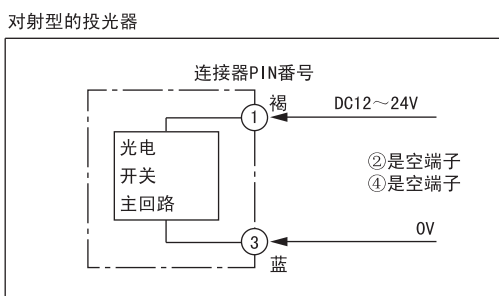
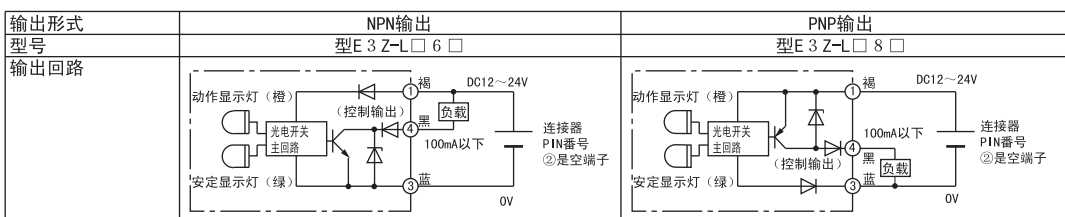

## 外形尺寸图

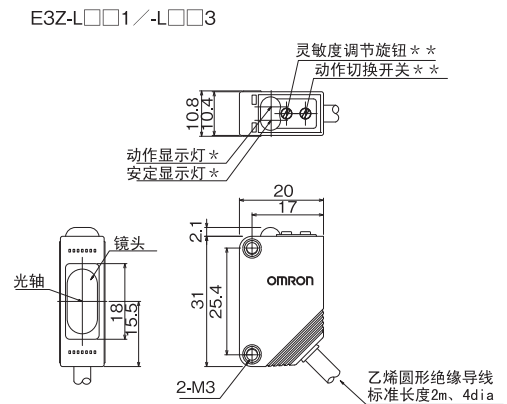

- \* 对射型投光器仅有电源表示灯
- \*\* 对射型投光器没有感度调节旋钮和动作切换开关，所以外形有所不同。

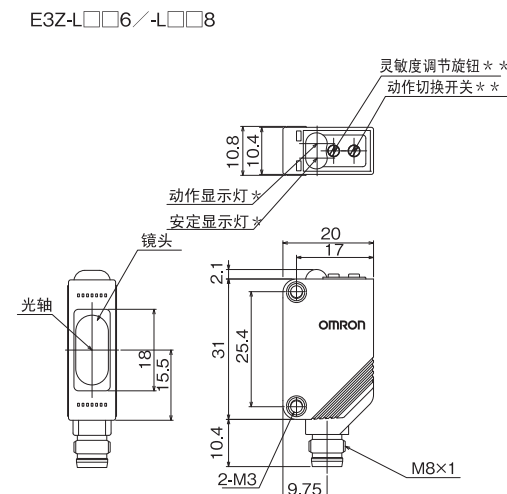

- \* 对射型投光器仅有电源表示灯
- \*\* 对射型投光器没有感度调节旋钮和动作切换开关，所以外形有所不同。

## 安装图

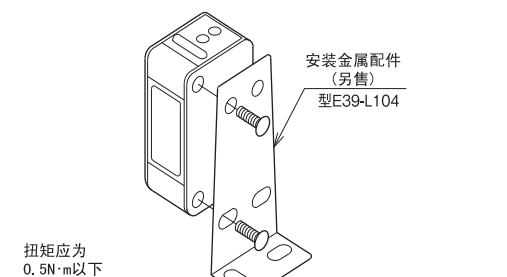

## 使用时的承诺事项

- 为了确保安全，直接或间接用于人体检测时，请勿使用本产品。需使用该用途时，请选用本公司传感器综合样本中刊登的安全传感器。
- 用于下列用途时，与本公司营业担当者商谈之后，根据规格书等确认的同时，对额定性能方面请想出有裕度的使用方法及采取即使万一出现故障也能使危险降低到最小的安全回路等的安全对策。
  - 屋外的用途、潜在化学污染或者受到电气的妨害的用途或者在商品目录、使用说明等中没有记载的条件及环境下使用。
  - 原子力控制设备、焚烧设备、铁道·航空·车辆设备、医疗设备、娱乐机械、安全装置及行政机关及根据个别业界的规定制造的设备。
  - 可能危及生命、财产的系统·机械·装置
  - 煤气、水道、电气的供给系统记24小时连续运转系统等需要高信赖的设备。
  - 其他，以上述的 a) ~ d) 为基准，需要高度安全性的用途。
- 上述内容是适用条件的一部分。仔细阅读本公司的综合商品目录、数据表等最新版商品目录、手册中记载的保证免费事项的内容后再使用。

■制造商  
欧姆龙 (上海) 有限公司  
地址: 中国上海市浦东新区金桥出口加工区金吉路789号  
电话: (86) 21-5050-9988

■技术咨询  
欧姆龙 (中国) 有限公司  
地址: 中国上海市浦东新区银城中路200号中银大厦2211室  
电话: (86) 21-5037-2222  
技术咨询热线: 800-820-4535  
网址: <http://www.fa.omron.com.cn>

OMRON Corporation

OMRON

# Model E3Z-L

PHOTOELECTRIC SENSOR  
LASERTYPE

## INSTRUCTION SHEET

Thank you for selecting OMRON product. This sheet primarily describes precautions required in installing and operating the product. Before operating the product, read the sheet thoroughly to acquire sufficient knowledge of the product. For your convenience, keep the sheet at your disposal.

### TRACEABILITY INFORMATION:

Representative in EU: OMRON EUROPE B.V. Wegalaan 67-69 2132 JD Hoofddorp, The Netherlands  
Manufacturer: OMRON CORPORATION, Shiockoji Horikawa, Shimogyo-ku, Kyoto 600-8530 JAPAN  
Shanghai Factory No.789 Jinji Road, Jinqiao Export Processing District, Pudong New Area, Shanghai, 201206 CHINA

The following notice applies only to products that carry the CE mark:  
Notice: This is a class A product. In residential areas it may cause radio interference, in which case the user may be required to take adequate measures to reduce interference.  
© OMRON Corporation 2005-2010 All Rights Reserved.

## Precautions on Safety

### Meaning of Signal Words

**CAUTION** Indicates a potentially hazardous situation which, if not avoided, may result in minor or moderate injury or in property damage.

### Warnings

**CAUTION**  
Do not connect sensor to AC power supply.  
Risk of explosion.

## Laser Safety

### Handling Precautions

**Handling precaution**  
The E3Z-L emits a visible laser beam. Never stare into the beam. Be sure that the end of the beam path is terminated. The best material for terminating the beam is a surface painted with matt paint. If there are refractive surface in the beam path, be sure that the reflected beam path is contained. If containment is not possible for the application, do not allow the beam to travel at eye level.  
**Laser safety measures for laser devices** are stipulated both in Japan and overseas. Here, two cases are described: Application in Japan and Application in a device to be shipped overseas.

#### (1) Application in Japan

According to JIS C6802, the safety measures required of the user are stipulated according to the class of the laser device. The E3Z-L is classified as a class-1 laser according to JIS C6802.

#### Laser stickers

The following stickers are attached to the side of the sensor.



#### (2) USA

When a laser device is exported to the USA, it falls the laser regulations of the FDA (Food and Drug Administration). The E3Z-L is classified as a class-1 laser by the FDA, and it has already been registered with the CDRH (Center for Devices and Radiological Health). Ask your OMRON representative for details.

#### Laser Labels

Technical standards have been provided with the product. When exporting to the USA, refer to the following illustration and replace the label with the caution label.

It is assumed that the E3Z-L will be incorporated into a final system device.

When incorporating the E3Z-L, comply with the following technical standard: US Federal Low 21 CFR 1040.10 and 1040.11 except for deviations pursuant to Laser Notice No.50, dated June 24, 2007

### Caution / Certification and Identification labels



#### Aperture labels

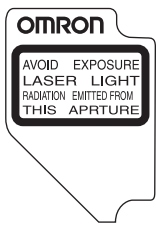

#### (3) Regions except the USA

When exporting to countries other than the USA, the E3Z-L is classified as a class-1 laser according to EN60825-1:2007.

#### Laser stickers

The following stickers are attached to the side of the sensor.



## DIMENSIONS

E3Z-L / -L

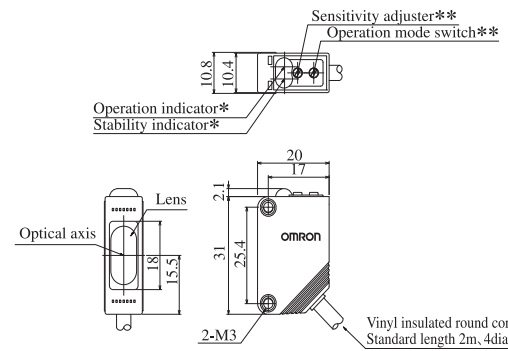

\*Only power indicator is on a light source of Separate type.  
\*\*The form differs because a light source of Separate type does not have it.

E3Z-L / -L

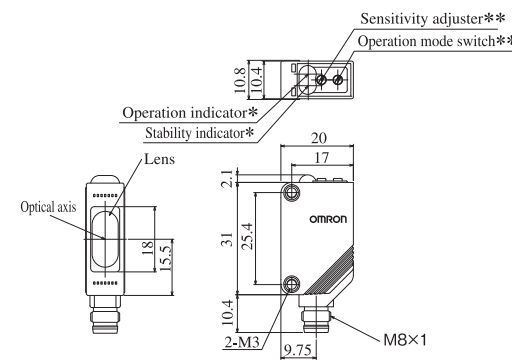

\*Only power indicator is on a light source of Separate type.  
\*\*The form differs because a light source of Separate type does not have it.

## Precautions for Safe Use

- Be sure to follow the safety precautions below for added safety.
- Do not use the sensor under the environment with explosive or ignition gas.
- Never disassemble, repair nor tamper with the product.
- Keep the supply voltage within the specified range. (12 to 24V DC ± 10%)
- Do not use the sensor over the rated values.

## Precautions for Correct Use

- Do not use the product under the following conditions.
  - In the place exposed to the direct sunlight.
  - In the place where humidity is high and condensation may occur.
  - In the place where corrosive gas exists.
  - In the place where vibration or shock is directly transmitted to the product.
- Connection and Mounting
  - Be sure that before making supply the supply voltage is less than the maximum rated supply voltage. (26.4V DC)
  - There are some cases where the photoelectric switch cable is unavoidably laid in a tube or duct together with a high-tension or power line.
  - This causes an induction, possibly resulting in malfunction or damage. In principal, the cable should be separately laid or shielded. For extending wires, use a cable 0.3mm<sup>2</sup> min. and 100m max. in length.
  - Do not pull the wire strongly.
  - Excessive force (hitting by hammer, etc.) should not be put on the photoelectric switch because it may damage its water-resistance characteristic. Use M3 screws to mount the photoelectric switch.
- M8 metal connector
  - Plug in or out the connector after surely turning off a power supply.
  - Plug in or out the connector with a cover part of it.
  - Fasten a fixed implement by hand. If you use a plier, it may be cause of malfunction or damage to it.
  - Proper bolting torque is 0.3 to 0.4N·m to keep water-resistance.
- Cleaning  
Do not use thinner such as alcohol and benzene because it may melt a surface of a product.
- Power supply  
When using a commercially available switching regulator, be sure to ground the FG (Frame Ground) terminals.
- Power supply reset time  
The photoelectric switch will begin sensing no later than 100ms after the power is turned on. If the load and the photoelectric switch is connected to different power supply, the photoelectric switch must be always turned on first.
- Turning off the power supply  
When turning off the power, output pulse may be generated. We recommend turning off the power supply of the load or load line first.
- Load short circuit protection  
This product is provided with function of load short circuit protection. However, be never short-circuited of the load. Please do not throw the current that exceeds ratings into the load. Control output is turned off when this function operates. After checking of wiring and load current, make power supply again. Then the circuit is reset. Load short circuit protection operates when the current is 1.8 times over than the rated load current. The inrush current should be 1.8 times less than the rated load current when L load is used.
- Water resistance  
Though this is type IP67, do not use in the water, rain or outdoors.
- Please process it as industrial waste.

Detection system	Separate type		Retroreflective type		Distance-setting type	
	NPN	PNP	E3Z-LR61/LR66	E3Z-LR81/LR86	E3Z-LL61/LL66	E3Z-LL83/LL88
Type	E3Z-LT61/LT66	E3Z-LT81/LT86	E3Z-LR61/LR66	E3Z-LR81/LR86	E3Z-LL61/LL66	E3Z-LL83/LL88
Detecting distance	60m	60m	0.3 to 15m (with E39-R1) 0.2 to 7m (with E39-R12) 0.2 to 7m (with E39-R6)	0.3 to 15m (with E39-R1) 0.2 to 7m (with E39-R12) 0.2 to 7m (with E39-R6)	20 to 300mm (white paper 100X100mm) 20 to 160mm (Black paper 100X100mm)	25 to 300mm (white paper 100X100mm) 25 to 100mm (Black paper 100X100mm)
Setting distance					40 to 300mm (white paper 100X100mm) 40 to 160mm (Black paper 100X100mm)	40 to 300mm (white paper 100X100mm) 40 to 100mm (Black paper 100X100mm)
Hysteresis					5% of setting distance max	5% of setting distance max
Black/white error					5% (of 160mm)	5% (of 100mm)
Light source	Visible wavelength for the semiconductor laser: 655 nm					
	JIS/IEC Class1, FDA CLASS I 2mW max.	JIS/IEC Class1, FDA CLASS I 1mW max.	JIS/IEC Class1, FDA CLASS I 1mW max.	JIS/IEC Class1, FDA CLASS I 1mW max.	JIS/IEC Class1, FDA CLASS I 4.5mW max.	JIS/IEC Class1, FDA CLASS I 4.5mW max.
Supply voltage	12 to 24 V DC +/- 10%, ripple (p-p): 10% max.					
Current consumption	Light source: 15mA max. Receiver: 20mA max.		30mA max.			
Control output	Load power supply voltage 26.4 VDC max., load current 100mA max. Open collector output Light-ON/Dark-ON switch selectable					
Residual voltage	1 V or less: Load current less than 10mA. 2 V or less: Load current less than 10 to 100mA.					
Response time	1ms max.				0.5ms max.	
Ambient Temperature	Operating -10 to +55°C, Storage -25 to +70°C (no freezing and condensation)					
Ambient humidity	Operating 35 to 85%, Storage 35 to 95% (no freezing and condensation)					
Protection structure	IEC60529 : IP67					
Material	Polybutylene Terephthalate resin (PBT)					
Case	Denatured Polyarylate resin					
Display	Denatured Polyarylate resin					
Lens	Denatured Polyarylate resin		Acrylic resin		Denatured Polyarylate resin	

## OUTPUT CIRCUIT DIAGRAM

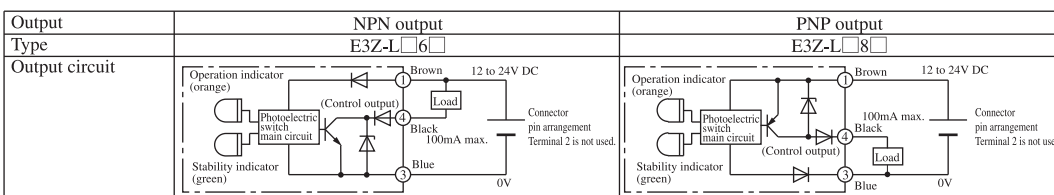

### Light source of Separate type

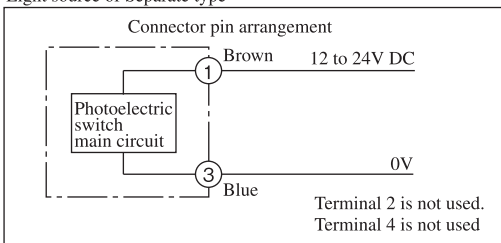

### CONNECTOR PIN ARRANGEMENT

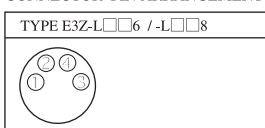

## MOUNTING

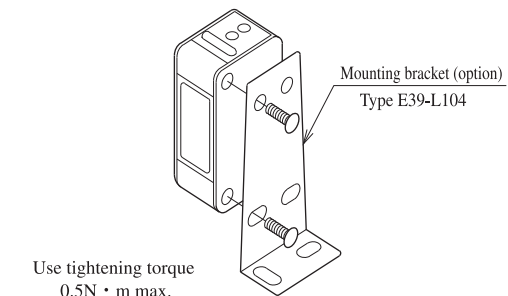

Use tightening torque  
0.5N · m max.

## SUITABILITY FOR USE

THE PRODUCTS CONTAINED IN THIS SHEET ARE NOT SAFETY RATED. THEY ARE NOT DESIGNED OR RATED FOR ENSURING SAFETY OF PERSONS, AND SHOULD NOT BE RELIED UPON AS A SAFETY COMPONENT OR PROTECTIVE DEVICE FOR SUCH PURPOSES. Please refer to separate catalogs for OMRON's safety rated products. OMRON shall not be responsible for conformity with any standards, codes, or regulations that apply to the combination of the products in the customer's application or use of the product. Take all necessary steps to determine the suitability of the product for the systems, machines, and equipment with which it will be used. Know and observe all prohibitions of use applicable to this product. NEVER USE THE PRODUCTS FOR AN APPLICATION INVOLVING SERIOUS RISK TO LIFE OR PROPERTY WITHOUT ENSURING THAT THE SYSTEM AS A WHOLE HAS BEEN DESIGNED TO ADDRESS THE RISKS, AND THAT THE OMRON PRODUCT IS PROPERLY RATED AND INSTALLED FOR THE INTENDED USE WITHIN THE OVERALL EQUIPMENT OR SYSTEM. See also Product catalog for Warranty and limitation of Liability.

- EUROPE  
OMRON EUROPE B.V. Sensor Business Unit  
Carl-Benz Str.4, D-71154 Nufringen Germany  
Phone: 49-7032-811-0 Fax: 49-7032-811-199
- NORTH AMERICA  
OMRON ELECTRONICS LLC  
One Commerce Drive Schaumburg, IL 60173-5302 U.S.A.  
Phone: 1-847-843-7900 Fax: 1-847-843-7787
- ASIA-PACIFIC  
OMRON ASIA PACIFIC PTE. LTD.  
No. 438A Alexandra Road #05-05 (Lobby 2),  
Alexandra Technopark, Singapore 119967  
Phone: 65-6835-3011 Fax: 65-6835-2711
- CHINA  
OMRON(CHINA) CO., LTD.  
Room 2211, Bank of China Tower,  
200 Yin Cheng Zhong Road,  
PuDong New Area, Shanghai, 200120, China  
Phone: 86-21-5037-2222 Fax: 86-21-5037-2200

OMRON Corporation

© OCT, 2009