

■ Fiber Optic Sensors Overview

Fiber optic sensor applies for mark, and small object detection with fiber optic cable instead of photo sensor lens. With flexible characteristics of fiber optic cable, fiber optic sensor is able to install in the limited space. Because of this, demand of fiber optic sensor is increasing these days.

■ Fiber Optic Cable Detection Principle And Configuration

◎ Fiber optic cable configuration

As shown the below figure, one optical fiber is composed of core which is high refractive index and clad. The incident light from the one side of the fiber will be projected and go ahead to other side section during repeating total reflection at the boundary of core and clad. In this case, the angel of reflection is 60° and is spared like a cone. This optical fiber bundle with exterior coating such as silicon rubber or vinyl chloride is called optical fiber cable.

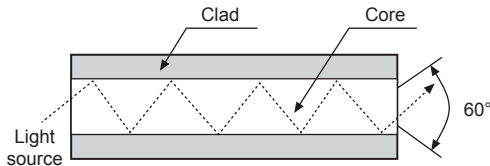

■ Classification Of Optical Fiber Cable

◎ The material list of optical fiber cable

Plastic type and glass type are used for optical fiber sensor.

| | Plastic optical fiber | Glass optical fiber |
|------------------|---|---|
| Material | Ø0.5 to 1mm single or dual wire made by synthetic resins of poly acrylics | Make a stainless cable by several number of 30 to 50µ glass fiber |
| Exterior coating | Polyethylene or vinyl chloride | Silicon rubber tube, stainless spiral tube, heat stress tube |
| Advantage | Light weight and economical | High light penetration ratio, strong heat |
| Dis-advantage | Low light penetration ratio and weak heat | Heavy, expansive, easy to be cut |

◎ The shape list of optical fiber cable

| Type | Shape | Characteristic |
|-------------------|-------|--|
| Parallel (normal) | | Use for only plastic optical fiber cable. Floodlight and light interception are structured in parallel. It is the type of transferring |
| Coaxial | | The center area and the surrounding area are separated. This type has the same detecting ability which is the operating position even though the object passes from any direction. |
| Split | | Floodlight and light interception are separate, suitable to detect mark, usually used for glass optical fiber. |

◎ The characteristic list of optical fiber cable

● Standard optical fiber (single core)

High efficiency of light transmission (long sensing distance)

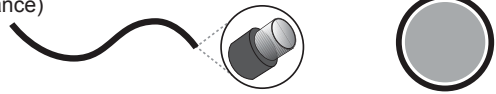

● Flexible optical fiber (multi core)

A large number of ultra-fine cores are all surrounded by cladding. Easy to install in the many places where are bending areas because in the change of the intensity of radiation by bending is small.

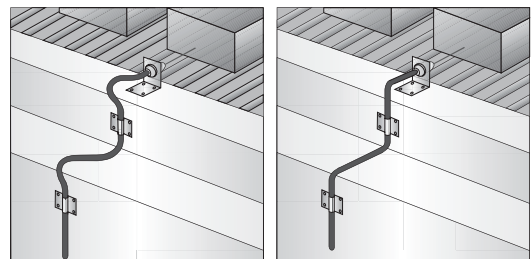

● Break-resistant optical fiber

The fiber units contain a large number of independent fine fibers, ensuring a high degree of flexibility. It can be used for moving parts (robot hand) and it is not easily broken.

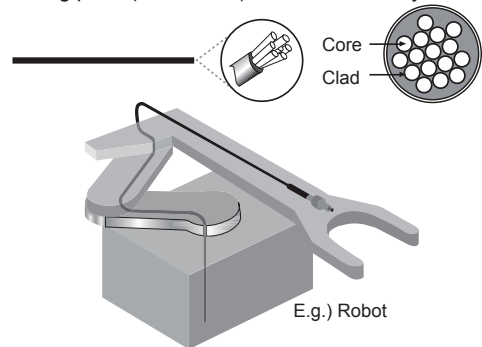

■ The Feature Of Optical Fiber Cable

◎ The radius of allowable stress for bending

The optical fiber cable is able to be used in bend condition as much as user wants, but as the rate bend is increasing, the optical transmission rate is also decreased. And if the radius of bending is less than the radius of allowable stress for bending, the optical transmission rate is decreased rapidly. Please caution that the cable is not bent less than the radius of the allowable stress for bending.

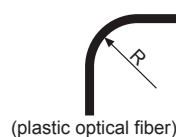

- Flexible type: R1
- Break-resistant type: R5
- Standard, Coaxial type: R30 or R15
- Heat-resistant type: R30 or R50

| | |
|-----|--|
| (A) | Photoelectric Sensors |
| (B) | Fiber Optic Sensors |
| (C) | Door/Area Sensors |
| (D) | Proximity Sensors |
| (E) | Pressure Sensors |
| (F) | Rotary Encoders |
| (G) | Connectors/ Connector Cables/ Sensor Distribution Boxes/ Sockets |
| (H) | Temperature Controllers |
| (I) | SSRs / Power Controllers |
| (J) | Counters |
| (K) | Timers |
| (L) | Panel Meters |
| (M) | Tacho / Speed / Pulse Meters |
| (N) | Display Units |
| (O) | Sensor Controllers |
| (P) | Switching Mode Power Supplies |
| (Q) | Stepper Motors & Drivers & Controllers |
| (R) | Graphic/ Logic Panels |
| (S) | Field Network Devices |
| (T) | Software |

Technical Description

◎ The optical transmission rate

The optical transmission rate is decided by the wave length, the material, length of the optical fiber, and the using source of light for the optical fiber cable. The optical transmission rate of the optical wavelength decided by the wavelength and the material of the optical fiber is the same as below picture. Especially the difference of the optical transmission rate of plastic optical fiber cable is bigger than glass optical fiber cable, and the efficiency of the red light source is higher than the efficiency of the infrared light source.

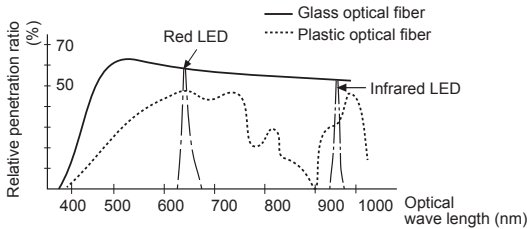

For the length of optical fiber cable and the optical transmission rate by the optical penetration ratio, when the length of optical fiber cable is long, the penetration rate is decreased, and the rate of diminution is changed by the light source.

◎ The Characteristic of sensing distance by the length of the optical fiber cable

The sensing distance is changed by the length of the optical fiber cable. And by the cutting condition of the end of the optical fiber cable, more than 20% of the sensing distance can be declined, and it can be changed by the types of the optical fiber cable.

- Optical fiber cable: FD-620-10
Sensing target: White mat paper

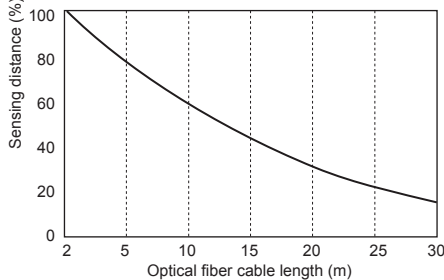

■ Optical Fiber Sensor

The optical fiber sensor uses the optical fiber cable instead of lens which is the absolute item for the traditional photo sensor. It is able to be attached on any places by flexibility of the optical fiber.

◎ The Characteristic of optical fiber sensor

• Flexibility

- Easy to install at the narrow or difficult place
- It does not need to install the fiber amplifier toward the sensing targets.

• Subminiature sensing front end

- It is able to detect a small object (∅ is small and the microscopic objects)
- It is able to attach close to the detected object.
- No space constraints because of small size

• The property of cable (heat-resisting property, exterior)

- It is able to detect in high temperature. (use heat-resisting optical fiber cable)
- It is able to use as explosion proof type because current does not flow on the fiber cable include front end sensing part.
- It is able to get stable detecting operating because it is not affected by noise.

◎ The sensing method of the optical fiber sensor

The optical fiber sensor is classified as the through-beam type and the diffuse reflective type by the sensing method, and can be selected by purpose.

- There are two kinds of optical fiber sensors for through-beam type. One is using two separate fiber cables as shown (Figure 1). Another is using a parallel optical fiber cable as shown (Figure 2).

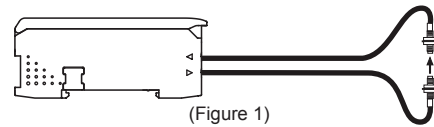

(Figure 1)

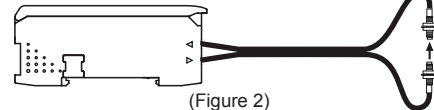

(Figure 2)

- For the diffuse reflective type, two parallel fiber cables are connected at one hood. Please caution that the sensing distance is changed by the surrounding color of the sensing target because this way detects the reflected light of the sensing target.

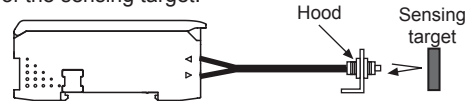

■ Proper Usage

◎ The insertion depth of optical fiber cable

Please insert the optical fiber cable as following way. The sensing distance is decreased if the insertion depth is not enough.

- The external diameter ∅2.2mm optical fiber cable

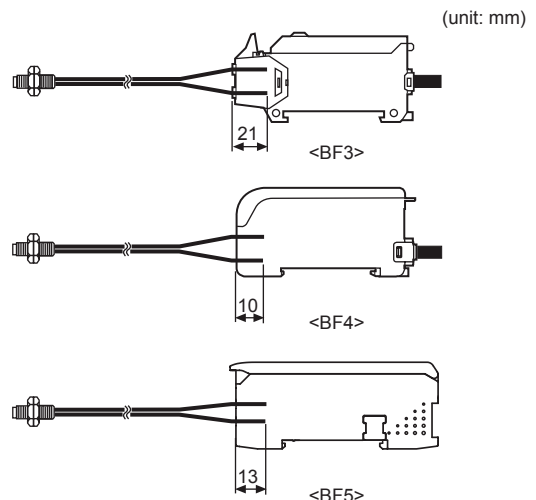

Technical Description

● The external diameter Ø1.0mm optical fiber cable

Please use the attached adapter when inserting the external diameter Ø1mm optical fiber cable.

(unit: mm)

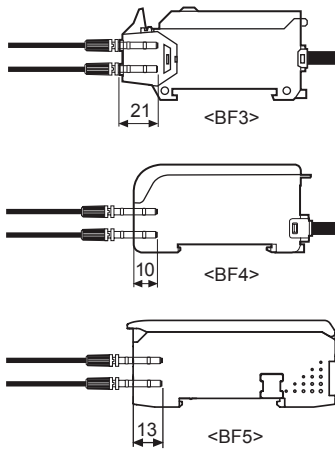

● Coaxial type optical fiber cable

For the model FD-320-F1 of coaxial type fiber cable, the external diameters are Ø1mm for emitter and Ø1.3mm for receiver. Caution that the insertion position of the emitter cable (Ø1) and the receiver cable (Ø1.3) should not be changed each other. (also BF3 and BF4 series)

(unit: mm)

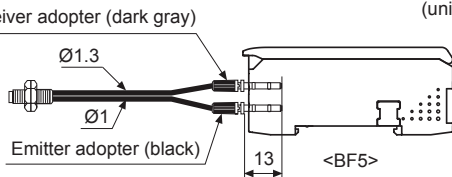

◎ Install optical fiber sensor

- If the wire of the optical fiber sensor is set with high-tension wire or power line, it may cause malfunction or trouble. Please use separate wiring or single pipe to escape them.
- Please locate the optical fiber hood of the optical fiber sensor at the dangerous place, and locate fiber amplifier at the safe place.

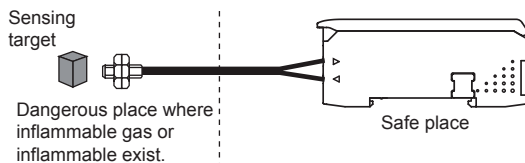

- The optical fiber sensor needs to be installed close to the sensing target as you can, because the receiver level can be low when the sensing distance is long. The light transmitted from the optical fiber wires spreads of about 60° columnar.
- Please block strong light sources (sunlight, spotlight) with the shading plate. The strong light sources should not be at the angel of directivity of the receiver face of the optical fiber cable.

- When the optical fiber sensor is installed by through-beam type, it should be within 5mm from the center of the optical axis.

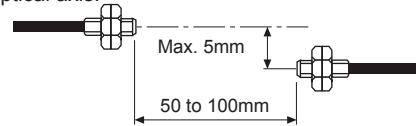

- When the side of the optical fiber cable is dirty, clean it with dry cloth. Do not use the organic solvent based thinner.
- Do not potentiate excessively such as compress or pull at the hood part of the optical fiber cable.

| Tension of the optical fiber cable | |
|------------------------------------|------------------|
| Diameter of the optical cable | Tensile strength |
| Ø0.5mm | Max. 1kgf |
| Ø1.0mm | Max. 3kgf |

※Caution: When more than allowable force is potentiated at the optical fiber cable, the cable can get damage.

- Do not bend within 20mm from amplifier and fiber hood.

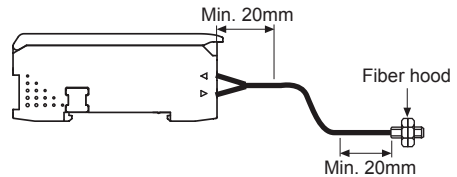

- After installing the optical fiber sensor, please keep the remained cable as following way. (When cable is folded by vibration, the rate of light is reduced.)

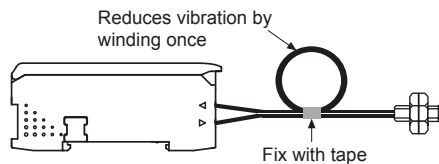

- Do not potentiate excessively at the nut to close when fixing the hood of the optical fiber cable. (Refer tightening torque of the type of the optical fiber cable)

< Bolt type >

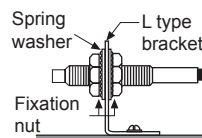

| Tightening torque of fiber hood bolt | |
|--------------------------------------|-------------------|
| Diameter | Tightening torque |
| M3 | Max. 3kgf-cm |
| M4 | Max. 8kgf-cm |
| M6 | Max. 10kgf-cm |

※Caution: When more than allowable torque is applied at the bolt of the fiber hood, the fiber hood can get damage.

< Cylinder type >

- Set bolt (max. M3)
- Tightening torque (max. 2kgf-cm)

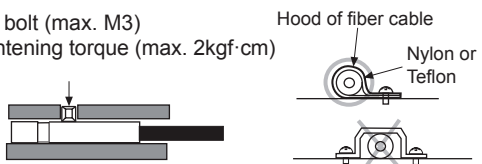

(A) Photoelectric Sensors

(B) Fiber Optic Sensors

(C) Door/Area Sensors

(D) Proximity Sensors

(E) Pressure Sensors

(F) Rotary Encoders

(G) Connectors/ Connector Cables/ Sensor Distribution Boxes/ Sockets

(H) Temperature Controllers

(I) SSRs / Power Controllers

(J) Counters

(K) Timers

(L) Panel Meters

(M) Tacho / Speed / Pulse Meters

(N) Display Units

(O) Sensor Controllers

(P) Switching Mode Power Supplies

(Q) Stepper Motors & Drivers & Controllers

(R) Graphic/ Logic Panels

(S) Field Network Devices

(T) Software

Technical Description

◎ Install optical fiber sensor

- If the wire of the optical fiber sensor is set in a pipe with high-tension wire or power line, it may cause malfunction or trouble. Please use separate wiring or single pipe to escape them.
- Please cut the cable at once. If the surface of the cut is broken, or gets grooves, the sensing distance is short.
- Do not use the hole which had used at once. The cutting surface is not good. The sensing distance is short. Please use another hole.
- Please use our given cutter (FC-3). Do not cut the cable with a cutting nipper or stationery (cutter, scissors).

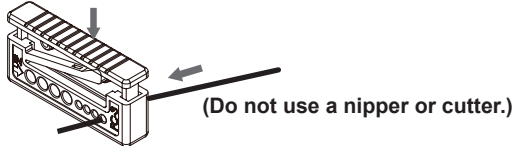

- The external diameter $\varnothing 1\text{mm}$ ($\varnothing 1.3\text{mm}$) optical fiber cable should be cut according to the following order..

| | | |
|---|---|--|
| ① | Shipment in the pre-tightening condition as shown on the right. | |
| ② | Unscrew to the arrow direction and move it. | |
| ③ | Insert the cable into the cutter (FC-3). | |
| ④ | After locating the adopter like picture on the right, screw it. | |

- Fiber cable cutter (FC-3)

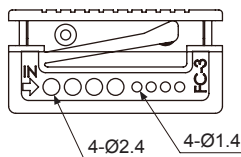

◎ The bending radius of SUS type fiber cable

The bending radius (R) of the stainless pipe (SUS) should be as big as possible. If the bending radius is small, the sensing distance is also short.

< Bend the end of the SUS >

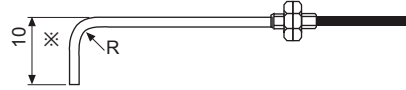

< Bend SUS in front of the hood >

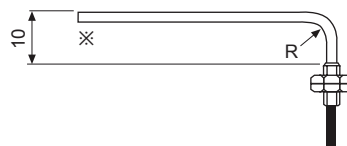

※Caution 1: When bending SUS, do not bend it less than 10mm.

※Caution 2: The length of SUS for FTS-230-05 type is 35mm. Please do not bend SUS as user can.

◎ Service temperature of fiber cable

- The service temperature of standard type of fiber cable is -40 to 70°C . If the surrounding temperature is high, the penetration ratio of the light becomes low. If user wants to use in the high temperature, please use the heat-resisting type optical fiber cable.

- Heat-resisting optical fiber cable

| Detection method | Fiber material | Model | Ambient temperature |
|-------------------------|----------------|-------------|--------------------------------|
| Diffuse reflective type | Plastic | FD-620-10H | -40 to 105°C |
| | | FD-620-15H1 | -40 to 150°C |
| | Glass | GD-420-20H2 | -40 to 250°C |
| | | GD-620-20H2 | -40 to 250°C |
| Through-beam type | Plastic | FT-420-10H | -40 to 105°C |
| | | FT-420-10H1 | -40 to 150°C |
| | Glass | GT-420-14H2 | -40 to 250°C |