

# All-in-One Vision System

- PC-based, flexible image processing system
- A variety of ready-to-use image processing parts
- Customized samples to quickly build ideal machine vision
- Highly robust, advanced measurement algorithm
- Lineup of connection-guaranteed peripheral devices, including Windows Embedded Standard-based FJ Controller



## System configuration

### Standard Configuration

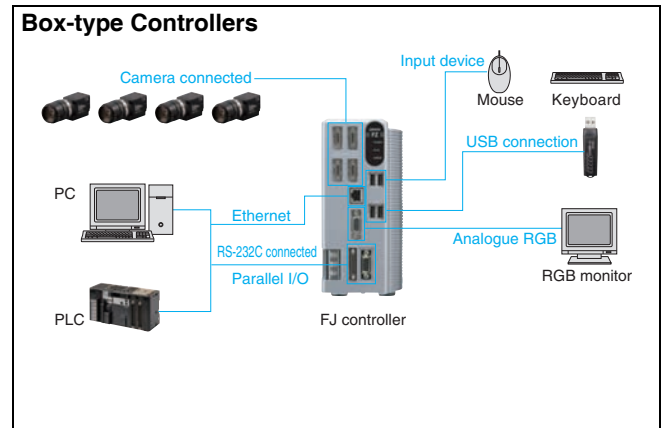
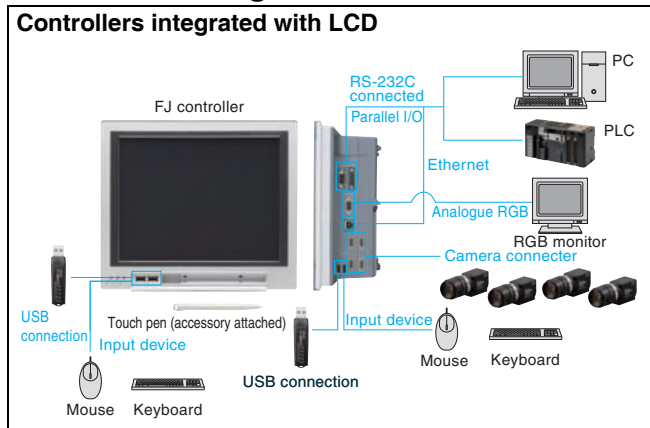

### For Customization

Development environment Application producer



Sample codes and Development Wizard for easy customization are available.

## Ordering Information

### Controller







CPU	Type	Dual-task	HALCON installed (See note 1)	No. of Cameras	Output	Model
Core i5 2.4 GHz	Controller integrated with LCD	Yes	No	2	NPN	FJ-3000 (See note 4)
		Yes	No	4	NPN	FJ-3000-10 (See note 4)
		Yes	No	2	PNP	FJ-3005 (See note 4)
		Yes	No	4	PNP	FJ-3005-10 (See note 4)
		Yes	Yes	2	NPN	FJ-H3000 (See note 4)
		Yes	Yes	4	NPN	FJ-H3000-10 (See note 4)
		Yes	Yes	2	PNP	FJ-H3005 (See note 4)
	Box-type Controller	Yes	Yes	4	PNP	FJ-H3005-10 (See note 4)
		Yes	No	2	NPN	FJ-3050 (See note 2)
		Yes	No	4	NPN	FJ-3050-10 (See note 2)
		Yes	No	2	PNP	FJ-3055 (See note 2)
		Yes	No	4	PNP	FJ-3055-10 (See note 2)
		Yes	Yes	2	NPN	FJ-H3050 (See note 3)
		Yes	Yes	4	NPN	FJ-H3050-10 (See note 3)
Atom 1.6 GHz	Box-type Controller	Yes	Yes	2	PNP	FJ-H3055 (See note 3)
		Yes	Yes	4	PNP	FJ-H3055-10 (See note 3)
		Yes	Yes	4	PNP	FJ-H3055-10 (See note 3)
		No	No	2	NPN	FJ-350 (See note 4)
		No	No	4	NPN	FJ-350-10 (See note 4)
		No	No	2	PNP	FJ-355 (See note 4)
		No	No	4	PNP	FJ-355-10 (See note 4)

- Note:**
1. HALCON runtime license has been installed. The development of HALCON requires HDevelop.
  2. The production of the FJ-series Controllers FJ-305□/-305□-10 were discontinued at the end of October 2015.
  3. The production of the FJ-series Controllers FJ-H305□/-H305□-10 were discontinued at the end of September 2016.
  4. The production of the FJ-series Controllers FJ-300□/-300□-10/-H300□/-H300□-10/-35□/-35□-10 will be discontinued at the end of March 2018.





## Development Environment

Type	Model	Operating environment
Application Producer 	FJ-AP1	<ul style="list-style-type: none"> <li>· CPU: Intel Pentium Processor (SSE2 or higher)</li> <li>· OS: Windows XP Professional (32bit) Service pack 3 or later, or Windows 7 Professional (32bit) or Enterprise (32bit) or Ultimate (32bit)</li> <li>· .NET Framework: .NET Framework 3.5 or higher</li> <li>· Memory: At least 2 GB RAM</li> <li>· Available disk space: At least 2 GB</li> <li>· Browser: Microsoft® Internet Explorer 6.0 or later</li> <li>· Display: XGA (1024×768), True Color (32-bit) or higher</li> <li>· Optical drive: CD/DVD drive</li> <li>· The following software is required to customize the software: Microsoft® Visual Studio® 2010 Professional</li> </ul>

## Cameras

Appearance	Type	Model	Remarks		
	Digital Cameras	300,000-pixels	Color	FZ-SC	Lens required
			Monochrome	FZ-S	
	Digital Cameras	2 million pixels	Color	FZ-SC2M	
			Monochrome	FZ-S2M	
	Small Digital Cameras	300,000-pixel flat type	Color	FZ-SFC	Lens for small cameras required
			Monochrome	FZ-SF	
	Small Digital Cameras	300,000-pixel pen type	Color	FZ-SPC	
			Monochrome	FZ-SP	
	High-speed Cameras	300,000-pixels	Color	FZ-SHC	Lens required
			Monochrome	FZ-SH	
	Intelligent Compact Cameras	Wide View (Long-distance)	Color	FZ-SQ100F	Camera + Lens + High-power Lighting
		Wide View (Short-distance)	Color	FZ-SQ100N	
		Standard	Color	FZ-SQ050F	
		Narrow View	Color	FZ-SQ010F	

## Cameras Peripheral Devices





Appearance	Type	Model	Remarks
	CCTV Lenses	3Z4S-LE Series	—
	Extension Tubes		
	Low-distortion Lenses	3Z4S-LE SV-0614H/ SV-0814H/SV-1214H/ SV-1614H/SV-2514H/ SV-3514H/SV-5014H/ SV-7525H/SV-10028H	Low distortion lens for 2-million and 5-million Pixel Cameras
	Lenses for Small Camera	FZ-LES3/LES6/LES16/LES30	Lens for 300,000-pixel Small Cameras
	Extension Tubes for Small Camera	FZ-LESR	Extension Tubes for 300,000-pixel Small Cameras
	For Intelligent Compact Camera	Mounting brackets	—
		Polarizing Filter Attachment	

## Cables

Appearance	Type	Cable length:	Model
	Camera Cable	2m	FZ-VS3 2M
		3m	FZ-VS3 3M
		5m	FZ-VS3 5M
		10m (See note 2)	FZ-VS3 10M
	Bend resistant Camera Cable	2m	FZ-VSB3 2M
		3m	FZ-VSB3 3M
		5m	FZ-VSB3 5M
		10m (See note 2)	FZ-VSB3 10M
	Right-angle Camera Cable (See note 1)	2m	FZ-VSL3 2M
		3m	FZ-VSL3 3M
		5m	FZ-VSL3 5M
		10m (See note 2)	FZ-VSL3 10M
	Bend resistant Right-angle Camera Cable (See note 1)	2m	FZ-VSLB3 2M
		3m	FZ-VSLB3 3M
		5m	FZ-VSLB3 5M
		10m (See note 2)	FZ-VSLB3 10M
	Long-distance Camera Cable	15m (See note 3)	FZ-VS4 15M
	Long-distance Right-angle Camera Cable (See note 1)	15m (See note 3)	FZ-VSL4 15M
	Cable Extension Unit Up to two Extension Units and threecables can be connected. (Maximum cable length: 45 m) (See note 4)	—	FZ-VSJ
	Monitor Cable	2m	FZ-VM 2M
		5m	FZ-VM 5M
	Parallel Cable	2m	FZ-VP 2M
		5m	FZ-VP 5M
	Parallel I/O Cable for Connector-terminal Conversion Unit (See note 5)	2m	FZ-VPX 2M
		5m	FZ-VPX 5M









- Note:**
- This Cable has an L-shaped connector on the Camera end.
  - The 10-m Cable cannot be used for the 5-million pixel camera.
  - The 15-m Cable cannot be used for the 5-million pixel camera.
  - Maximum cable length depends on type of camera and cable length to connect. For details, refer to "Cameras / Cables Connection Table" on page 7.
  - Connector-Terminal Block Conversion Units can be connected (Recommended Products: OMRON XW2R-J50G-T, XW2R-E50G-T, XW2R-P50G-T).

## Peripheral Devices

Appearance	Type	Model	Remarks
	LCD Monitor	<b>FZ-M08</b>	For box-type controller
	USB Memory	<b>FZ-MEM2G</b>	Capacity: 2 GB
		<b>FZ-MEM8G</b>	Capacity: 8 GB
	VESA attachment	<b>FZ-VESA</b>	For installing the controller integrated with LCD
	Desktop controller stand	<b>FZ-DS</b>	For installing the controller integrated with LCD
	Lighting Controller	For FL-Series	<b>FL-TCC1</b> Required to control external lighting from a Controller
—	External Lighting	<b>FL-Series</b>	—

## Lenses

### High-resolution, Low-distortion Lenses

Model	3Z4S-LE SV-0614H	3Z4S-LE SV-0814H	3Z4S-LE SV-1214H	3Z4S-LE SV-1614H	3Z4S-LE SV-2514H	3Z4S-LE SV-3514H	3Z4S-LE SV-5014H	3Z4S-LE SV-7525H	3Z4S-LE SV-10028H
Appearance/ Dimensions (mm)									
Focal length	6mm	8mm	12mm	16mm	25mm	35mm	50mm	75mm	100mm
Brightness	F1.4	F1.4	F1.4	F1.4	F1.4	F1.4	F1.4	F2.5	F2.8
Filter size	M40.5 P0.5	M35.5 P0.5	M27.0 P0.5	M27.0 P0.5	M27.0 P0.5	M35.5 P0.5	M40.5 P0.5	M34.0 P0.5	M37.5 P0.5

### CCTV Lenses

Model	3Z4S-LE SV-03514V	3Z4S-LE SV-04514V	3Z4S-LE SV-0614V	3Z4S-LE SV-0813V	3Z4S-LE SV-1214V	3Z4S-LE SV-1614V	3Z4S-LE SV-2514V	3Z4S-LE SV-3518V	3Z4S-LE SV-5018V	3Z4S-LE SV-7527V	3Z4S-LE SV-10035V
Appearance/ Dimensions (mm)											
Focal length	3.5mm	4.5mm	6mm	8mm	12mm	16mm	25mm	35mm	50mm	75mm	100mm
Brightness	F1.4	F1.4	F1.4	F1.3	F1.4	F1.4	F1.4	F1.8	F1.8	F2.7	F3.5
Filter size	—	—	M27 P0.5	M25.5 P0.5	M27 P0.5	M27 P0.5	M27 P0.5	M27 P0.5	M30.5 P0.5	M30.5 P0.5	M30.5 P0.5

### Lenses for small camera

Model	FZ-LES3	FZ-LES6	FZ-LES16	FZ-LES30
Appearance/ Dimensions (mm)				
Focal length	3mm	6mm	16mm	30mm
Brightness	F2.0	F2.0	F3.4	F3.4

### Extension Tubes

Model	3Z4S-LE SV-EXR
Contents	Set of 7 tubes (40 mm, 20 mm, 10 mm, 5 mm, 2.0 mm, 1.0 mm, and 0.5 mm) Maximum outer diameter: 30 mm dia.

### Extension Tubes for small camera

Model	FZ-LESR
Contents	Set of 3 tubes (15 mm, 10 mm, 5 mm) Maximum outer diameter: 12 mm dia.

- Do not use the 0.5-mm, 1.0-mm, and 2.0-mm Extension Tubes attached to each other. Since these Extension Tubes are placed over the threaded section of the Lens or other Extension Tube, the connection may loosen when more than one 0.5-mm, 1.0-mm or 2.0-mm Extension Tube are used together.
- Reinforcement is required to protect against vibration when Extension Tubes exceeding 30 mm are used.

## Ratings and Performance

## Controller

Model		NPN Output	FJ-3000	FJ-3000-10	FJ-3050	FJ-3050-10	FJ-H3000	FJ-H3000-10	FJ-H3050	FJ-H3050-10	FJ-350	FJ-350-10	
		PNP Output	FJ-3005	FJ-3005-10	FJ-3055	FJ-3055-10	FJ-H3005	FJ-H3005-10	FJ-H3055	FJ-H3055-10	FJ-355	FJ-355-10	
<b>Controller type</b>		Controller integrated with LCD			Box-type controller		Controller integrated with LCD			Box-type controller		Box-type controller	
<b>No. of cameras</b>		2	4	2	4	2	4	2	4	2	4		
<b>CPU</b>		Intel Core i5-520E Processor 2.40 GHz											
<b>Main memory</b>		3 GB											
<b>Storage</b>		Compact Flash 2 GB											
<b>OS</b>		Windows Embedded Standard 2009											
<b>Dual-task</b>		Yes											
<b>HALCON installed</b>		No					Yes					No	
<b>Connected camera</b>		Can be connected to all cameras.											
<b>Operation</b>		Controller integrated with LCD: touch pen, mouse, etc. Box-type controller: mouse, etc.											
<b>Processing resolution</b>		Intelligent Compact Camera: 752 (H) × 480 (V) 300,000-pixel camera: 640 (H) × 480 (V) 2-million pixel camera: 1600 (H) × 1200 (V), 5-million pixel camera: 2488 (H) × 2044 (V)											
<b>No. of scenes</b>		32											
<b>Number of logged images</b>	<b>When connected to an Intelligent Compact Camera</b>	Connected to 1 camera	214										
		Connected to 2 cameras	107										
		Connected to 3 cameras	71										
		Connected to 4 cameras	53										
	<b>When connected to a 300,000-pixel camera</b>	Connected to 1 camera	Color camera: 250, Monochrome Camera: 252										
		Connected to 2 cameras	Color camera: 125, Monochrome Camera: 126										
		Connected to 3 cameras	Color camera: 83, Monochrome Camera: 84										
		Connected to 4 cameras	Color camera: 62, Monochrome Camera: 63										
	<b>When connected to a 2 million-pixel camera</b>	Connected to 1 camera	Color camera: 40, Monochrome Camera: 40										
		Connected to 2 cameras	Color camera: 20, Monochrome Camera: 20										
		Connected to 3 cameras	Color camera: 13, Monochrome Camera: 13										
		Connected to 4 cameras	Color camera: 10, Monochrome Camera: 10										
	<b>When connected to a 5 million-pixel camera</b>	Connected to 1 camera	Color camera: 15, Monochrome Camera: 15										
		Connected to 2 cameras	Color camera: 7, Monochrome Camera: 7										
		Connected to 3 cameras	Color camera: 5, Monochrome Camera: 5										
		Connected to 4 cameras	Color camera: 3, Monochrome Camera: 3										
<b>Serial communications</b>		RS-232C/422A: 1CH											
<b>Network communications</b>		Ethernet 100BASE-TX/10BASE-T											
<b>EtherNet/IP</b>		Ethernet port baud rate: 100 Mbps (100BASE-TX)											
<b>Parallel I/O</b>		17 inputs (RESET, STEP0/ENCTRIG_Z0, STEP1/ENCTRIG_Z1, DSA0 to 1, ENCTRIG_A0 to 1, ENCTRIG_B0 to 1, DI0 to 7) 29 outputs (RUN/BUSY1, BUSY0, GATE0 to 1, OR0 to 1, READY0 to 1, ERROR, STGOUT0 to 3*, DO0 to 15)											
<b>Monitor interface</b>		Controller integrated with LCD: integrated controller and LCD 12.1 inch TFT color LCD (Resolution: XGA 1,024 × 768 dots) Box-type controller: Analog RGB video output, 1 channel (Resolution: XGA 1,024 × 768 dots)											
<b>USB interface</b>		4 channels (supports USB 1.1 and 2.0)											
<b>Power supply voltage</b>		20.4 to 26.4 VDC											
<b>Current consumption (at 24.0 VDC)</b>	<b>When connected to an Intelligent Compact Camera</b>	5.0 A max.	7.5 A max.	5.0 A max.	7.5 A max.	5.0 A max.	7.5 A max.	5.0 A max.	7.5 A max.	4.0 A max.	5.5 A max.		
	<b>When connected to a 300,000-pixel, 2 million-pixel, or 5 million-pixel camera</b>	3.7 A max.	4.9 A max.	3.7 A max.	4.9 A max.	3.7 A max.	4.9 A max.	3.7 A max.	4.9 A max.	2.6 A max.	2.9 A max.		
<b>Ambient temperature range</b>		Operating: 0 to +45°C for low cooling fan speeds 0 to +50°C for high cooling fan speeds Storage: -20 to 65°C (with no icing or condensation)											
<b>Ambient humidity range</b>		Operating and storage: 35 to 85°C (with no condensation)											
<b>Weight</b>		Approx. 3.4 kg			Approx. 1.9 kg			Approx. 3.4 kg			Approx. 1.8 kg		
<b>Accessories</b>		Controller integrated with LCD: touch pen (one, inside the front panel), Instruction Manual, 6 mounting brackets, Member registration sheet Box-type controller: Instruction Manual, Member registration sheet											

\* STGOUT 2 to 3 only for camera 4ch type

## Digital Cameras

	FZ-S	FZ-SC	FZ-S2M	FZ-SC2M
<b>Image elements</b>	Interline transfer reading all pixels, 1/3-inch CCD image elements		Interline transfer reading all pixels, 1/1.8-inch CCD image elements	
<b>Color/Monochrome</b>	Monochrome	Color	Monochrome	Color
<b>Effective pixels</b>	640 (H) × 480 (V)		1600 (H) × 1200 (V)	
<b>Pixel size</b>	7.4 (μm) × 7.4 (μm)		4.4 (μm) × 4.4 (μm)	
<b>Shutter function</b>	Electronic shutter; select shutter speeds from 1/10 to 1/50,000 s		Electronic shutter; select shutter speeds from 1/10 to 1/50,000 s	
<b>Partial function</b>	12 to 480 lines		12 to 1200 lines	
<b>Frame rate (image read time)</b>	80 fps (12.5 ms)		30 fps (33.3 ms)	
<b>Field of vision, installation distance</b>	Selecting a lens according to the field of vision and installation distance			
<b>Ambient temperature range</b>	Operating: 0 to 50°C Storage: -25 to 65°C (with no icing or condensation)		Operating: 0 to 40°C Storage: -25 to 65°C (with no icing or condensation)	
<b>Ambient humidity range</b>	Operating and storage: 35% to 85% (with no condensation)			
<b>Weight</b>	Approx. 55 g		Approx. 76 g	
<b>Accessories</b>	Instruction manual			

## Small Digital Cameras

	FZ-SF	FZ-SFC	FZ-SP	FZ-SPC
<b>Image elements</b>	Interline transfer reading all pixels, 1/3-inch CCD image elements			
<b>Color/Monochrome</b>	Monochrome	Color	Monochrome	Color
<b>Effective pixels</b>	640 (H) × 480 (V)			
<b>Pixel size</b>	7.4 (μm) × 7.4 (μm)			
<b>Shutter function</b>	Electronic shutter; select shutter speeds from 1/10 to 1/50,000 s			
<b>Partial function</b>	12 to 480 lines			
<b>Frame rate (image read time)</b>	80 fps (12.5 ms)			
<b>Field of vision, installation distance</b>	Selecting a lens according to the field of vision and installation distance			
<b>Ambient temperature range</b>	Operating: 0 to 50°C (camera amp) 0 to 45°C (camera head) Storage: -25 to 65°C (with no icing or condensation)		Operating: 0 to 50°C (camera amp) 0 to 45°C (camera head) Storage: -25 to 65°C (with no icing or condensation)	
<b>Ambient humidity range</b>	Operating and storage: 35% to 85% (with no condensation)		Operating and storage: 35% to 85% (with no condensation)	
<b>Weight</b>	Approx. 150 g		Approx. 150 g	
<b>Accessories</b>	Instruction manual, installation bracket, Four mounting brackets(M2)		Instruction manual	

## High-speed Cameras

	FZ-SH	FZ-SHC
<b>Image elements</b>	Interline transfer reading all pixels, 1/3-inch CCD image elements	
<b>Color/Monochrome</b>	Monochrome	Color
<b>Effective pixels</b>	640 (H) × 480 (V)	
<b>Pixel size</b>	7.4 (μm) × 7.4 (μm)	
<b>Shutter function</b>	Electronic shutter; select shutter speeds from 1/10 to 1/50,000 s	
<b>Partial function</b>	12 to 480 lines	
<b>Frame rate (image read time)</b>	204 fps (4.9 ms)	
<b>Field of vision, installation distance</b>	Selecting a lens according to the field of vision and installation distance	
<b>Ambient temperature range</b>	Operating: 0 to 40°C Storage: -25 to 65°C (with no icing or condensation)	
<b>Ambient humidity range</b>	Operating and storage: 35% to 85% (with no condensation)	
<b>Weight</b>	Approx. 105 g	
<b>Accessories</b>	Instruction manual	

## Intelligent Compact Cameras

	FZ-SQ010F	FZ-SQ050F	FZ-SQ100F	FZ-SQ100N
<b>Image elements</b>	1/3-inch CMOS image elements			
<b>Color/Monochrome</b>	Color			
<b>Effective pixels</b>	752 (H) × 480 (V)			
<b>Pixel size</b>	6.0 (μm) × 6.0 (μm)			
<b>Shutter function</b>	1/250 to 1/32,258			
<b>Partial function</b>	8 to 480 lines			
<b>Frame rate (image read time)</b>	60 fps			
<b>Field of vision</b>	7.5 × 4.7 to 13 × 8.2 mm	13 × 8.2 to 53 × 33 mm	53 × 33 to 240 × 153 mm	29 × 18 to 300 × 191 mm
<b>Installation distance</b>	38 to 60 mm	56 to 215 mm	220 to 970 mm	32 to 380 mm
<b>LED class *</b>	Risk Group 2			
<b>Ambient temperature range</b>	Operating: 0 to 50°C Storage: -25 to 65°C			
<b>Ambient humidity range</b>	Operating and storage: 35% to 85% (with no condensation)			
<b>Weight</b>	Approx. 150 g		Approx. 140 g	
<b>Accessories</b>	Mounting bracket (FQ-XL), polarizing filter attachment (FQ-XF1), instruction manual and warning label			

\* Applicable standards : IEC62471-2

## LCD Monitor

	FZ-M08
Size	8.4 inches
Type	Liquid crystal color TFT
Resolution	1,024 × 768 dots
Input signal	Analog RGB video input, 1 channel
Power supply voltage	21.6 to 26.4 VDC
Current consumption	Approx. 0.7 A max.
Ambient temperature range	Operating: 0 to 50°C Storage: -25 to 65°C (with no icing or condensation)
Ambient humidity range	Operating and storage: 35 to 85% (with no condensation)
Weight	Approx. 1.2 kg
Accessories	Instruction Sheet and 4 mounting brackets

## Camera Cables

	FZ-VS3 (2 m)	FZ-VSB3 (2 m)	FZ-VSL3 (2 m)	FZ-VSLB3 (2 m)
Type	Standard	Bend resistant	Right-angle	Bend resistant Right-angle
Shock resistiveness (durability)	10 to 150 Hz single amplitude 0.15 mm 3 directions, 8 strokes, 4 times			
Ambient temperature range	Operation and storage: 0 to 65 °C (with no icing or condensation)			
Ambient humidity range	Operation and storage: 40 to 70%RH (with no condensation)			
Ambient atmosphere	No corrosive gases			
Material	Cable sheath, connector: PVC			
Minimum bending radius	69mm	69mm	69mm	69mm
Weight	Approx. 170 g	Approx. 180 g	Approx. 170 g	Approx. 180 g

## Monitor Cable

	FZ-VM
Vibration resistiveness	10 to 150 Hz single amplitude 0.15 mm 3 directions, 8 strokes, 4 times
Ambient temperature range	Operation: 0 to +50°C; Storage: -20 to +65°C (with no icing or condensation)
Ambient humidity range	Operation and storage: 35 to 85%RH (with no condensation)
Ambient atmosphere	No corrosive gases
Material	Cable sheath: heat-resistant PVC Connector: PVC
Minimum bending radius	75 mm
Weight	approx. 170 g

## Cable Extension Unit

	FZ-VSJ
Power supply voltage (See note 1.)	11.5 to 13.5 VDC
Current consumption (See note 2.)	1.5 A max.
Ambient temperature range	Operating: 0 to 50°C Storage: -25 to 65°C (with no icing or condensation)
Ambient humidity range	Operating and storage: 35 to 85% (with no condensation)
Maximum Units connectable	2 Units per Camera
Weight	Approx. 240 g
Accessories	Instruction Sheet and 4 mounting screws

- Note:**
1. A 12-VDC power supply must be provided to the Cable Extension Unit when connecting the Intelligent camera, the Intelligent Compact Camera, the Strobe controller, or the Lighting Controller.
  2. The current consumption shows when connecting the Cable Extension Unit to an external power supply.

## Long-distance Camera Cables

	FZ-VS4 (15 m)	FZ-VSL4 (15 m)
Type	Standard	Right-angle
Shock resistiveness (durability)	10 to 150 Hz single amplitude 0.15 mm 3 directions, 8 strokes, 4 times	
Ambient temperature range	Operation and storage: 0 to 65 °C (with no icing or condensation)	
Ambient humidity range	Operation and storage: 40 to 70%RH (with no condensation)	
Ambient atmosphere	No corrosive gases	
Material	Cable sheath, connector: PVC	
Minimum bending radius	78 mm	
Weight	Approx. 1400 g	

## Parallel Cable

	FZ-VP	FZ-VPX
Vibration resistiveness	10 to 150 Hz single amplitude 0.15 mm 3 directions, 8 strokes, 4 times	
Ambient temperature range	Operation: 0 to +50°C; Storage: -20 to +65°C (with no icing or condensation)	
Ambient humidity range	Operation and storage: 35 to 85%RH (with no condensation)	
Ambient atmosphere	No corrosive gases	
Material	Cable sheath: heat-resistant PVC Connector: resin	
Minimum bending radius	75 mm	
Weight	approx.160 g	approx.180 g

## Cameras / Cables Connection Table

Type of camera	Model	Cable length	High-speed cameras	Digital cameras			Small digital cameras	Intelligent compact cameras
				300,000-pixel	2 million-pixel	5 million-pixel	Pen type / flat type	
Camera Cables Right-angle camera cables	FZ-VS3 FZ-VSL3	2m	Yes	Yes	Yes	Yes	Yes	Yes
		3m	Yes	Yes	Yes	Yes	Yes	Yes
		5m	Yes	Yes	Yes	Yes	Yes	Yes
		10m	Yes	Yes	Yes	No	Yes	Yes
Bend resistant camera cables Bend resistant Right-angle Camera Cable	FZ-VSB3 FZ-VSLB3	2m	Yes	Yes	Yes	Yes	Yes	Yes
		3m	Yes	Yes	Yes	Yes	Yes	Yes
		5m	Yes	Yes	Yes	Yes	Yes	Yes
		10m	Yes	Yes	Yes	No	Yes	Yes
Long-distance camera cable Long-distance right-angle camera cable	FZ-VS4 FZ-VSL4	15m	Yes	Yes	Yes	No	Yes	Yes



## Processing Items



































\*The red items are available only with controllers with HALCON.

Group	Icon	Processing Item	
Inspections / Measurement		Search	Used to identify the shapes and calculate the position of measurement objects.
		Flexible Search	Recognizing the shapes of workpieces with variation and detecting their positions.
		Sensitive Search	Search a small difference by dividing the search model in detail, and calculating the correlation.
		ECM Search	Used to search the similar part of model form input image. Detect the evaluation value and position.
		Ec Circle Search	Extract circles using "round " shape information and get position, radius and quantity in high preciseness.
		Shape Search+	Used to Search the similar part of models from input image. Detect the evaluation value and position.
		Classification	Used when various kinds of products on the assembly line need to be sorted and identified.
		Edge Position	Measure position of measurement objects according to the color change in measurement area.
		Edge Pitch	Detect edges by color change in measurement area. Used for calculating number of pins of IC and connectors.
		Scan Edge Position	Measure peak/bottom edge position of workpieces according to the color change in separated measurement area.
		Scan Edge Width	Measure max/min/average width of workpieces according to the color change in separated measurement area.
		Color Data	Used for detecting presence and mixed varieties of products by using color average and deviation.
		Gravity and Area	Used to measure area, center of gravity of workpieces by extracting the color to be measured.
		Labeling	Used to measure number, area and gravity of workpieces by extracting registered color.
		Label Data	Selecting one region of extracted Labeling, and get that measurement. Area and Gravity position can be got and judged.
		Labeling+	Extract objects of registered color, and measure many features such as number and circularity.
		Defect	Used for appearance measurement of plain-color measurement objects such as defects, stains and burrs.
		PreciseDefect	Check the defect on the object. Parameters for extraction defect can be set precisely.
		Fine Matching	Difference can be detected by overlapping and comparing(matching) registered fine images with input images.
		Character Inspection	Recognize character according correlation search with model image registered in [Model Dictionary].
		Date Verification	Reading character string is verified with internal date.
		Model Dictionary	Register character pattern as dictionary. The pattern is used in [Character Inspection].
		Barcode+ (See note 1)	Recognize barcode, verify and output decoded characters.
		2DCode+ (See note 2)	Recognize 2D code, verify and output decoded characters.
		Circle Angle	Used for calculating angle of inclination of circular measurement objects.
Image Capturing		Camera Image Input	To input images from cameras. And set up the conditions to input images from cameras.
		Camera Image Input HDR	Create high-dynamic range images by acquiring several images with different conditions.
		Camera Image Input HDR Lite	HDR function for FZ-SQ□ Intelligent Compact Cameras.
		Camera Switching	To switch the cameras used for measurement. Not input images from cameras again.
		Measurement Image Switching	To switch the images used for measurement. Not input images from camera again.
Correcting images		Position Compensation	Used when positions are differed. Correct measurement is performed by correcting position of input images.
		Trapezoidal Correction+	Rectify the trapezoidal deformed image.
		Filtering	Used for processing images input from cameras in order to make them easier to be measured.

- Note: 1.** Bar Codes that can be read : JAN/EAN/UPC (including add-on codes), Code 39, Codabar (NW-7), ITF (Interleaved 2 of 5), Code 93, Code 128, GS1-128, GS1 DataBar (RSS-14 / RSS Limited / RSS Expanded), Pharmacode  
**2.** 2D Codes that can be read : Data Matrix (ECC200), QR Code



\*The red items are available only with controllers with HALCON.

Group	Icon	Processing Item	
Correcting images		Background Suppression	To enhance contrast of images by extracting color in specified brightness.
		Color Gray Filter	Color image is converted into monochrome images to emphasize specific color.
		Extract Color Filter	Convert color image to color extracted image or binary image.
		Anti Color Shading	To remove the irregular color/pattern by uniformizing max.2 specified colors.
		Stripes Removal Filter+	Remove the background pattern of stripes.
		Halation Cut+	Remove halation from input image.
		Panorama+	Combine multiple image to create one big image.
		Polar Transformation	Rectify the image by polar transformation. Useful for OCR or pattern inspection printed on circle.
Assisting inspections / measurement		Macro	Advanced arithmetic processing can be easily incorporated into workflow as macro processing items.
		Calculation	Used when using the judge results and measured values of Procltem which are registered in processing units.
		Line Regression	Used for calculating regression line from plural measurement coordinate.
		Circle Regression	Used for calculating regression circle from plural measurement coordinate.
		Calibration+	Transform (X,Y) position to the real coordinate system.
		Set Unit Data	Used to change the Procltem data (setting parameters,etc.) that has been set up in a scene.
		Get Unit Data	Used to get one data (measured results, setting parameters,etc.) of Procltem that has been set up in a scene.
		Set Unit Figure	Used for re-setting the figure data (model, measurement area) registered in an unit.
		Get Unit Figure	Used for get the figure data (model, measurement area) registered in an unit.
		Trend Monitor	Used for displaying the information about results on the monitor, facilitating to avoid NG and analyze causes.
		Image Logging	Used for saving the measurement images to the memory and USB memory.
		Data Logging	Used for saving the measurement data to the memory and USB memory.
		Elapsed Time	Used for calculating the elapsed time since the measurement trigger input.
		Wait	Processing is stopped only at the set time. The standby time is set by the unit of [ms].
		Focus	Focus setting is supported.
	Iris	Focus and aperture setting is supported.	
Branching processing		Conditional Branch	Used where more than two kinds of products on the production line need to detected separately.
		End	This Procltem must be set up as the last processing unit of a branch.
		DI Branch	Same as Procltem "Branch". But you can change the targets of conditional branching via external inputs.
Outputting results		Data Output	Used when you need to output data to the external devices such as PLC or PC via serial ports.
		Parallel Data Output	Used when you need to output data to the external devices such as PLC or PC via parallel ports.
		Parallel Judgement Output	Used when you need to output judgement results to the external devices such as PLC or PC via parallel ports.
		Fieldbus Data Output	Outputs data to an external device, such as a Programmable Controller, through a fieldbus interface.
Displaying results on the monitor		Result Display	Used for displaying the texts or the figures in the camera image .
		Display Image File	Display selected image file.
		Display Last NG Image	Display the last NG images.

## External Dimensions

### Controllers

#### ■ LCD-integrated type

FJ-300□/FJ-300□-10

FJ-H300□/FJ-H300□-10

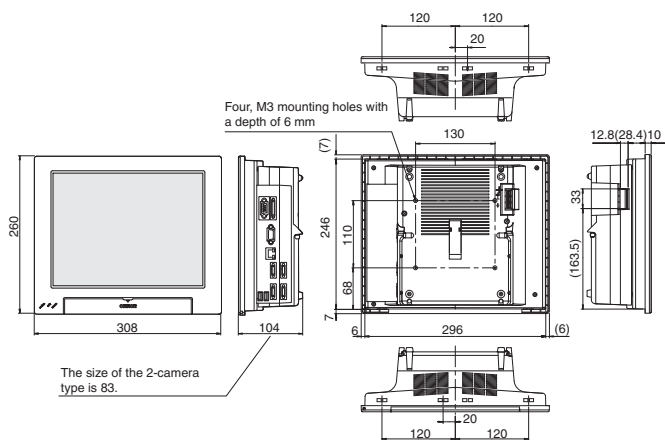

#### ■ Box-type

FJ-305□/FJ-305□-10

FJ-H305□/FJ-H305□-10

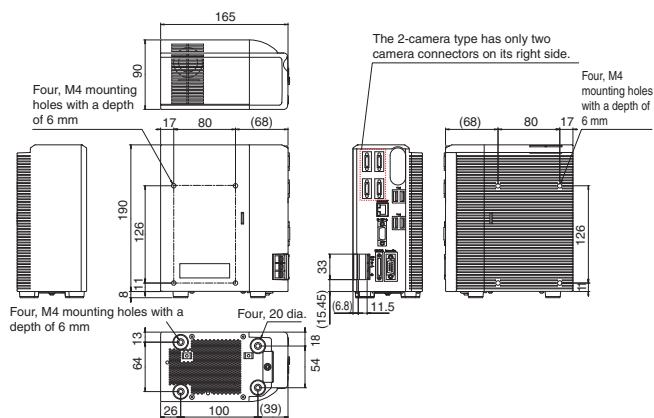

#### FJ-35□/FJ-35□-10

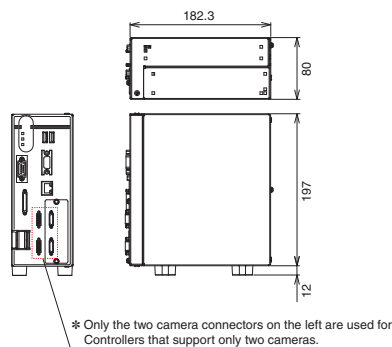

# Cable Camera Cable

## Camera Cable

Camera Cable  
FZ-VS3

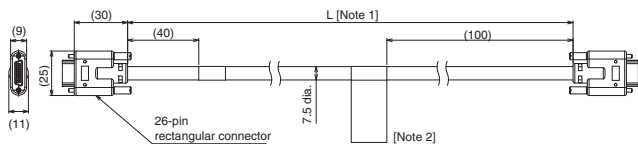

Bend resistant Camera Cable  
FZ-VSB3

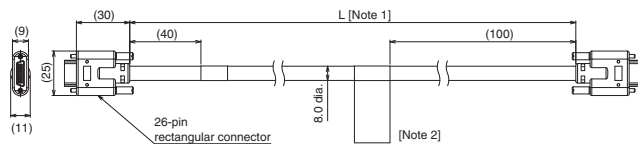

Right-angle Camera Cable  
FZ-VSL3

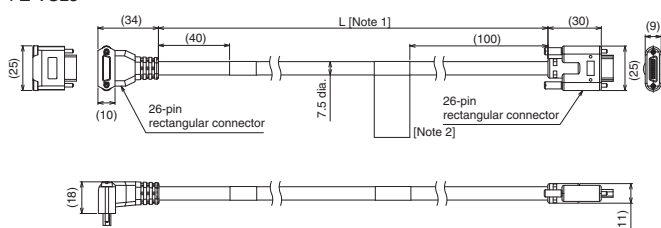

Bend resistant Right-angle Camera Cable  
FZ-VSLB3

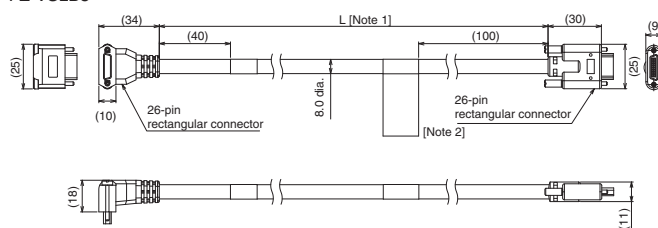

Long-distance Camera Cable  
FZ-VS4

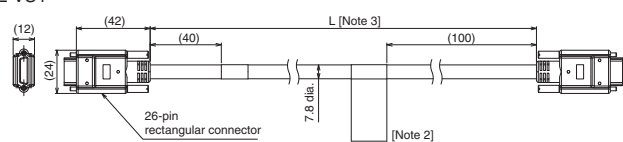

Long-distance Right-angle Camera Cable  
FZ-VSL4

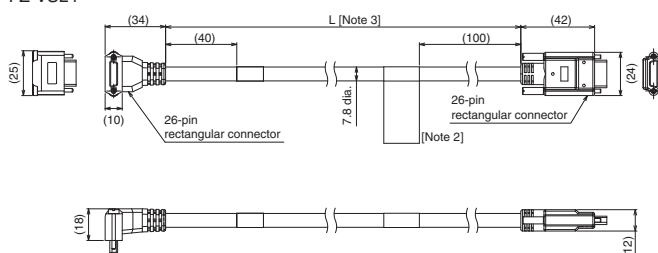

Note1. Cable is available in 2m/3m/5m/10m.  
Note2. Each camera cables has polarity.  
Please ensure that the name plate side of the cable is connected to the controller.  
Note3. Cable is available in 15m.

## Parallel Cable

FZ-VP

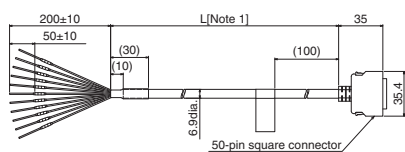

[Note1]: cable is available in 2m/5m.

FZ-VPX

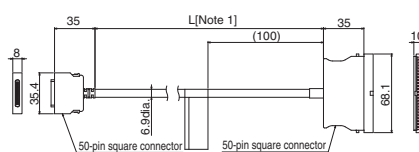

[Note1]: cable is available in 2m/5m.

## Monitor Cable

FZ-VM

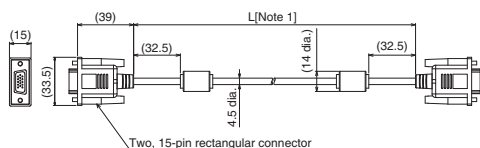

[Note1]: cable is available in 2m/5m.

**Cameras**

**■ Digital cameras**

**300,000-pixel camera**

**FZ-S**  
**FZ-SC**

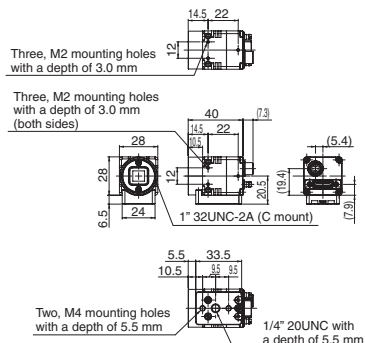

**2 million-pixel camera**

**FZ-S2M**  
**FZ-SC2M**

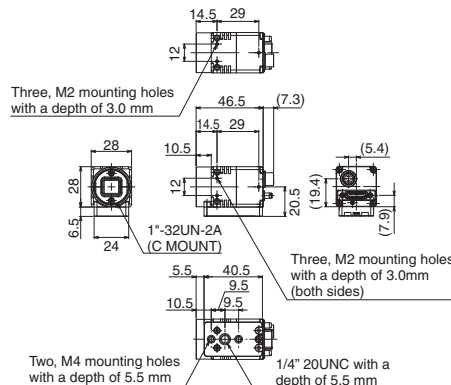

**■ Small digital cameras**

**Camera head**

**Flat camera**

**FZ-SF**  
**FZ-SFC**

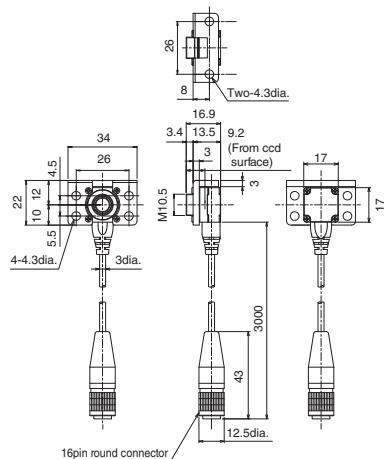

**Pen-shaped camera**

**FZ-SP**  
**FZ-SPC**

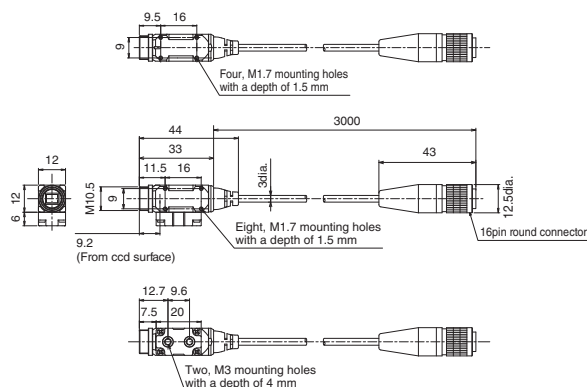

**Camera amplifier**

Can be used for both flat cameras and pen-shaped cameras

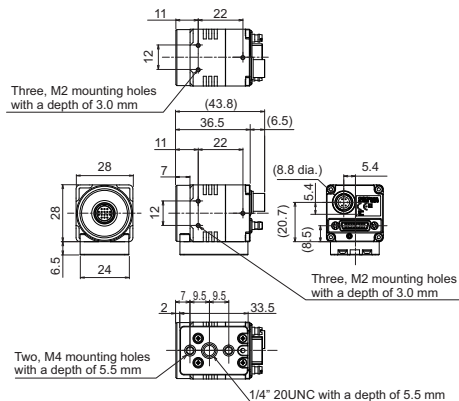

**■ High speed camera**

**FZ-SHC**

**FZ-SH**

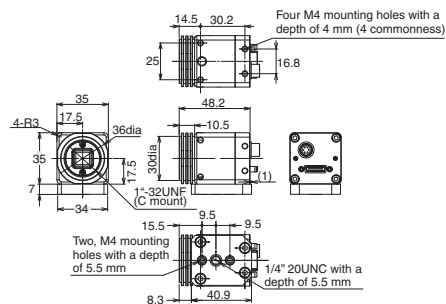

## Intelligent Compact Cameras

(Dimensional drawings are provided here only for the products that have undergone design changes as of Dec. 2012.)

### Narrow view / Standard FZ-SQ010F FZ-SQ050F

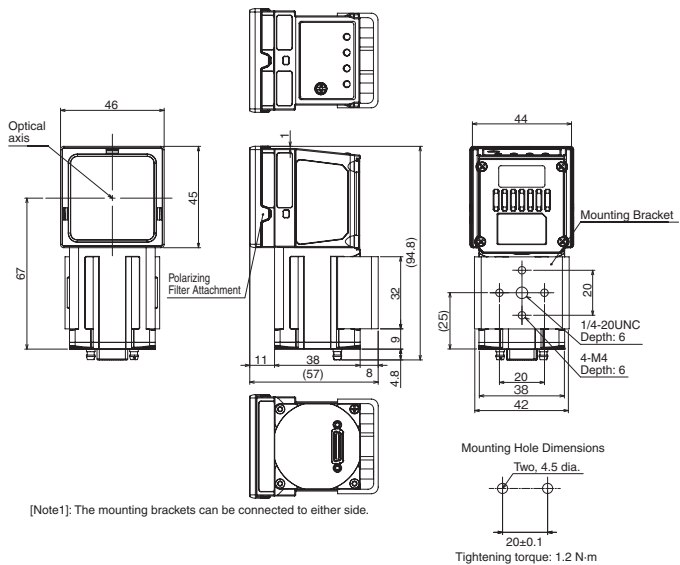

### Wide View FZ-SQ100F (long-distance) FZ-SQ100N (short-distance)

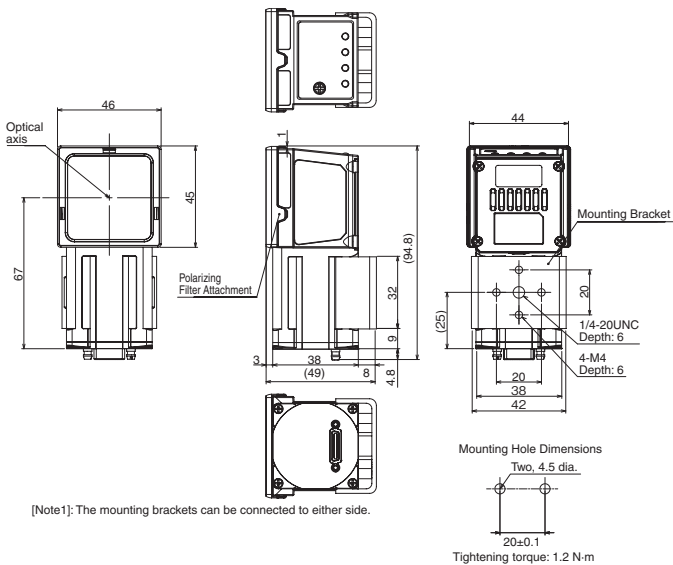

See the diagram below when mounting bracket FQ-XL2 is attached.

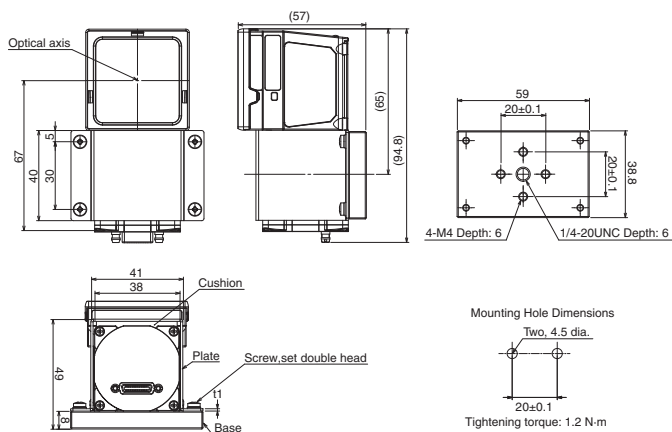

**Lens for small camera**  
FZ-LES Series

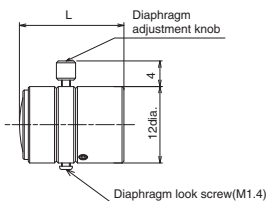

LensesModel	Focal length	Brightness	Maximum outside diameter	Overall length
FZ-LES3	3mm	F2.0	12 dia.	16.4mm
FZ-LES6	6mm	F2.0	12 dia.	19.7mm
FZ-LES16	16mm	F3.4	12 dia.	23.1mm
FZ-LES30	30mm	F3.4	12 dia.	25.5mm

**Extension Tubes for small camera**  
FZ-LESR

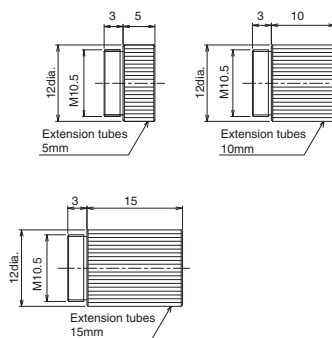

**Camera Cable Extension Unit**  
FZ-VSJ

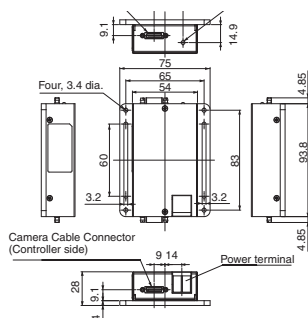

**LCD Monitor**  
FZ-M08

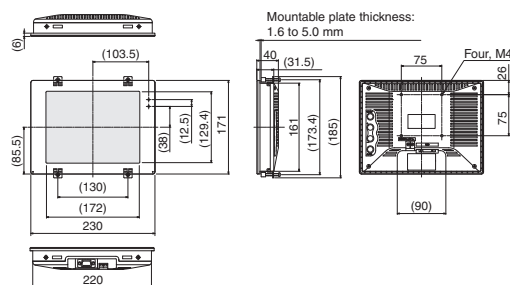

# Optical Chart

## 2 million-pixel digital camera FZ-S□2M

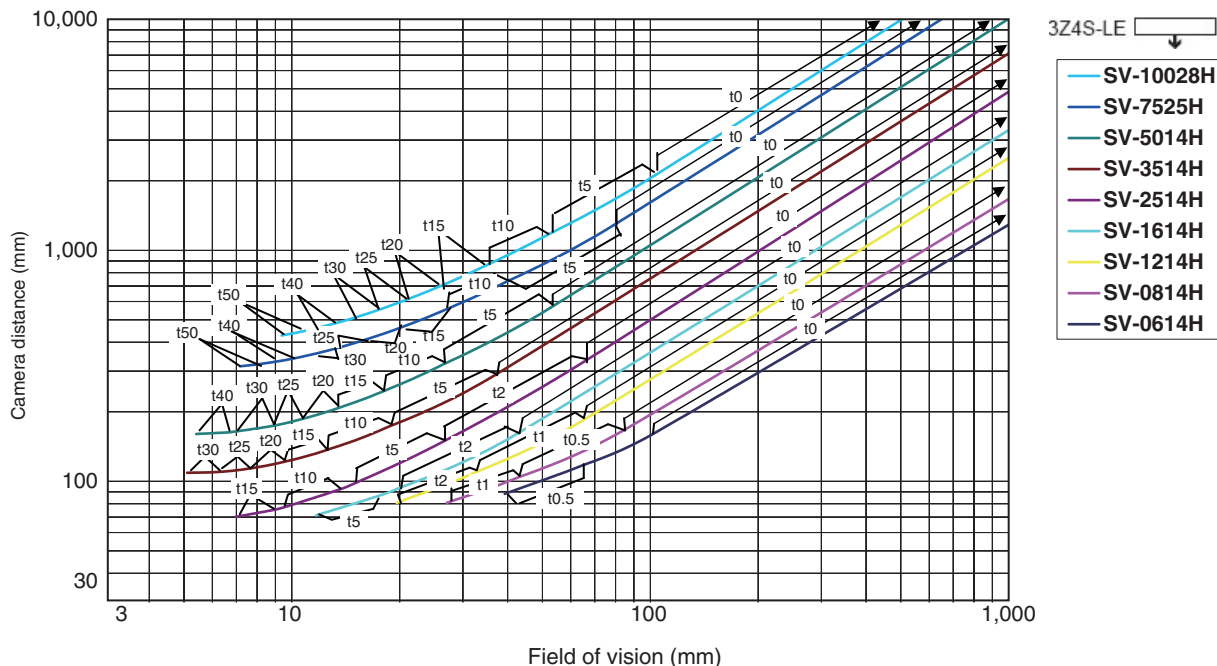

## 300,000-pixel High-speed camera FZ-SH□, and Digital camera FZ-S□

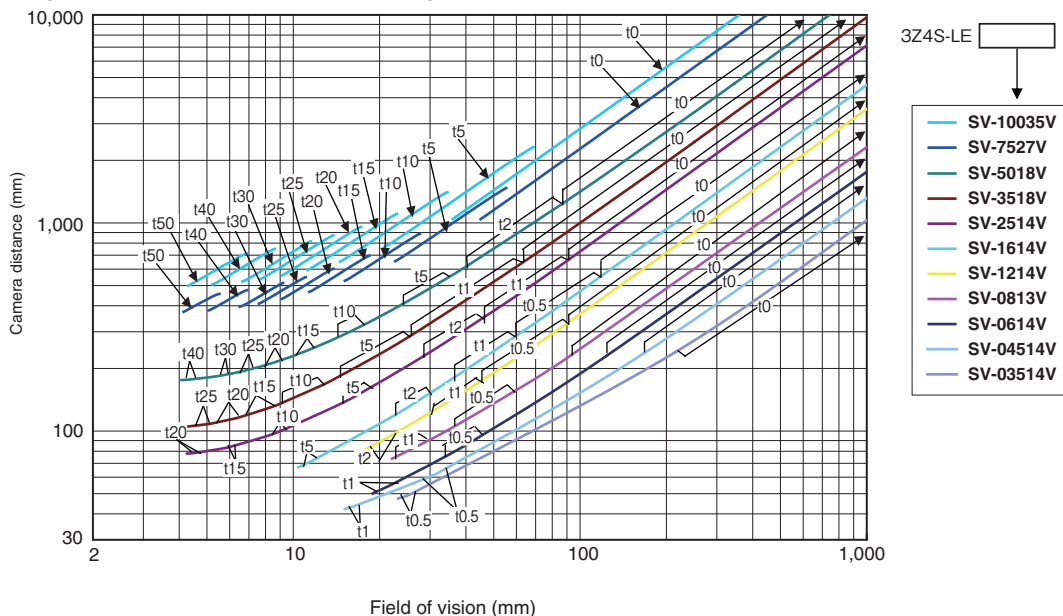



300,000-pixel small digital cameras FZ-SF□, FZ-SP□

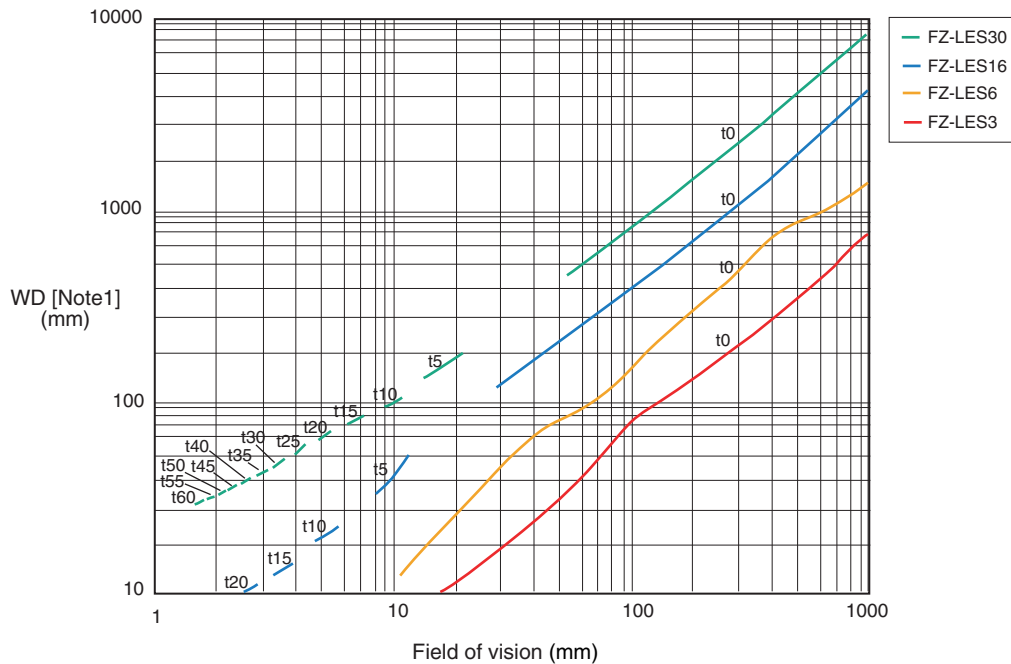

**Note: 1.** The vertical axis represents WD, not installation distance.

**Meaning of Optical Chart**

The X axis of the optical chart shows the field of vision (mm)(Note1), and the Y axis of the optical chart shows the camera installation distance (mm)(Note2).

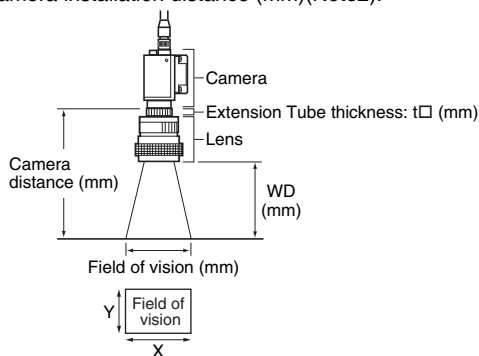

**Note: 1.** The lengths of the fields of vision given in the optical charts are the lengths of the Y axis.  
**2.** The vertical axis represents WD for small cameras.

**Intelligent Compact Cameras**

■ **Narrow View**  
FZ-SQ010F

■ **Standard**  
FZ-SQ050F

■ **Wide View (Long-distance)**  
FZ-SQ100F

■ **Wide View (Short-distance)**  
FZ-SQ100N

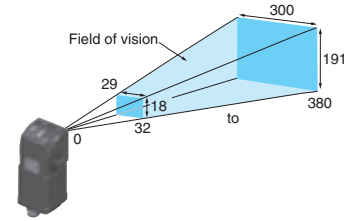
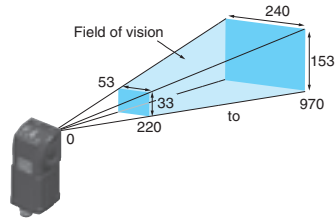
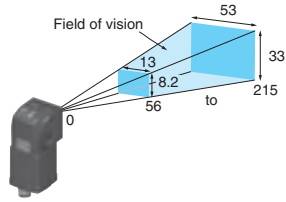
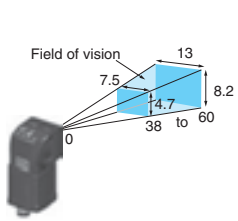





## **READ AND UNDERSTAND THIS DOCUMENT**

Please read and understand this document before using the products. Please consult your OMRON representative if you have any questions or comments.

## **WARRANTY**

OMRON's exclusive warranty is that the products are free from defects in materials and workmanship for a period of one year (or other period if specified) from date of sale by OMRON.

OMRON MAKES NO WARRANTY OR REPRESENTATION, EXPRESS OR IMPLIED, REGARDING NON-INFRINGEMENT, MERCHANTABILITY, OR FITNESS FOR PARTICULAR PURPOSE OF THE PRODUCTS. ANY BUYER OR USER ACKNOWLEDGES THAT THE BUYER OR USER ALONE HAS DETERMINED THAT THE PRODUCTS WILL SUITABLY MEET THE REQUIREMENTS OF THEIR INTENDED USE. OMRON DISCLAIMS ALL OTHER WARRANTIES, EXPRESS OR IMPLIED.

## **LIMITATIONS OF LIABILITY**

OMRON SHALL NOT BE RESPONSIBLE FOR SPECIAL, INDIRECT, OR CONSEQUENTIAL DAMAGES, LOSS OF PROFITS OR COMMERCIAL LOSS IN ANY WAY CONNECTED WITH THE PRODUCTS, WHETHER SUCH CLAIM IS BASED ON CONTRACT, WARRANTY, NEGLIGENCE, OR STRICT LIABILITY.

In no event shall responsibility of OMRON for any act exceed the individual price of the product on which liability is asserted.

IN NO EVENT SHALL OMRON BE RESPONSIBLE FOR WARRANTY, REPAIR, OR OTHER CLAIMS REGARDING THE PRODUCTS UNLESS OMRON'S ANALYSIS CONFIRMS THAT THE PRODUCTS WERE PROPERLY HANDLED, STORED, INSTALLED, AND MAINTAINED AND NOT SUBJECT TO CONTAMINATION, ABUSE, MISUSE, OR INAPPROPRIATE MODIFICATION OR REPAIR.

## **SUITABILITY FOR USE**

THE PRODUCTS CONTAINED IN THIS DOCUMENT ARE NOT SAFETY RATED. THEY ARE NOT DESIGNED OR RATED FOR ENSURING SAFETY OF PERSONS, AND SHOULD NOT BE RELIED UPON AS A SAFETY COMPONENT OR PROTECTIVE DEVICE FOR SUCH PURPOSES. Please refer to separate catalogs for OMRON's safety rated products.

OMRON shall not be responsible for conformity with any standards, codes, or regulations that apply to the combination of products in the customer's application or use of the product.

At the customer's request, OMRON will provide applicable third party certification documents identifying ratings and limitations of use that apply to the products. This information by itself is not sufficient for a complete determination of the suitability of the products in combination with the end product, machine, system, or other application or use.

The following are some examples of applications for which particular attention must be given. This is not intended to be an exhaustive list of all possible uses of the products, nor is it intended to imply that the uses listed may be suitable for the products:

- Outdoor use, uses involving potential chemical contamination or electrical interference, or conditions or uses not described in this document.
- Nuclear energy control systems, combustion systems, railroad systems, aviation systems, medical equipment, amusement machines, vehicles, safety equipment, and installations subject to separate industry or government regulations.
- Systems, machines, and equipment that could present a risk to life or property.

Please know and observe all prohibitions of use applicable to the products.

NEVER USE THE PRODUCTS FOR AN APPLICATION INVOLVING SERIOUS RISK TO LIFE OR PROPERTY WITHOUT ENSURING THAT THE SYSTEM AS A WHOLE HAS BEEN DESIGNED TO ADDRESS THE RISKS, AND THAT THE OMRON PRODUCT IS PROPERLY RATED AND INSTALLED FOR THE INTENDED USE WITHIN THE OVERALL EQUIPMENT OR SYSTEM.

## **PERFORMANCE DATA**

Performance data given in this document is provided as a guide for the user in determining suitability and does not constitute a warranty. It may represent the result of OMRON's test conditions, and the users must correlate it to actual application requirements. Actual performance is subject to the OMRON Warranty and Limitations of Liability.

## **CHANGE IN SPECIFICATIONS**

Product specifications and accessories may be changed at any time based on improvements and other reasons.

It is our practice to change model numbers when published ratings or features are changed, or when significant construction changes are made. However, some specifications of the product may be changed without any notice. When in doubt, special model numbers may be assigned to fix or establish key specifications for your application on your request. Please consult with your OMRON representative at any time to confirm actual specifications of purchased products.

## **DIMENSIONS AND WEIGHTS**

Dimensions and weights are nominal and are not to be used for manufacturing purposes, even when tolerances are shown.

## **ERRORS AND OMISSIONS**

The information in this document has been carefully checked and is believed to be accurate; however, no responsibility is assumed for clerical, typographical, or proofreading errors, or omissions.

## **PROGRAMMABLE PRODUCTS**

OMRON shall not be responsible for the user's programming of a programmable product, or any consequence thereof.

## **COPYRIGHT AND COPY PERMISSION**

This document shall not be copied for sales or promotions without permission.

This document is protected by copyright and is intended solely for use in conjunction with the product. Please notify us before copying or reproducing this document in any manner, for any other purpose. If copying or transmitting this document to another, please copy or transmit it in its entirety.

## **LED Safety**

### **WARNING**

The lighting of Intelligent Compact Cameras emits visible light, which may adversely affect the eyes in rare instances.  
Do not look directly into the light emitted from the lighting. When the subject is a specular reflective object, protect your eyes from reflected light.



### Displaying LED Labels

Attached the enclosed warning label in a readily visible location near the product, such as on the cable.



**Note: Do not use this document to operate the Unit.**

**OMRON Corporation** Industrial Automation Company  
Tokyo, JAPAN

Contact: [www.ia.omron.com](http://www.ia.omron.com)

#### **Regional Headquarters**

**OMRON EUROPE B.V.**  
Sensor Business Unit  
Carl-Benz-Str. 4, D-71154 Nufringen, Germany  
Tel: (49) 7032-811-0/Fax: (49) 7032-811-199

**OMRON ASIA PACIFIC PTE. LTD.**  
No. 438A Alexandra Road # 05-05/08 (Lobby 2),  
Alexandra Technopark,  
Singapore 119967  
Tel: (65) 6835-3011/Fax: (65) 6835-2711

**OMRON ELECTRONICS LLC**  
One Commerce Drive Schaumburg,  
IL 60173-5302 U.S.A.  
Tel: (1) 847-843-7900/Fax: (1) 847-843-7787

**OMRON (CHINA) CO., LTD.**  
Room 2211, Bank of China Tower,  
200 Yin Cheng Zhong Road,  
PuDong New Area, Shanghai, 200120, China  
Tel: (86) 21-5037-2222/Fax: (86) 21-5037-2200

Authorized Distributor:

© OMRON Corporation 2011 All Rights Reserved.  
In the interest of product improvement,  
specifications are subject to change without notice.  
CSM\_1\_24\_0118

Cat. No. **Q187-E1-01**

0811(0811)