

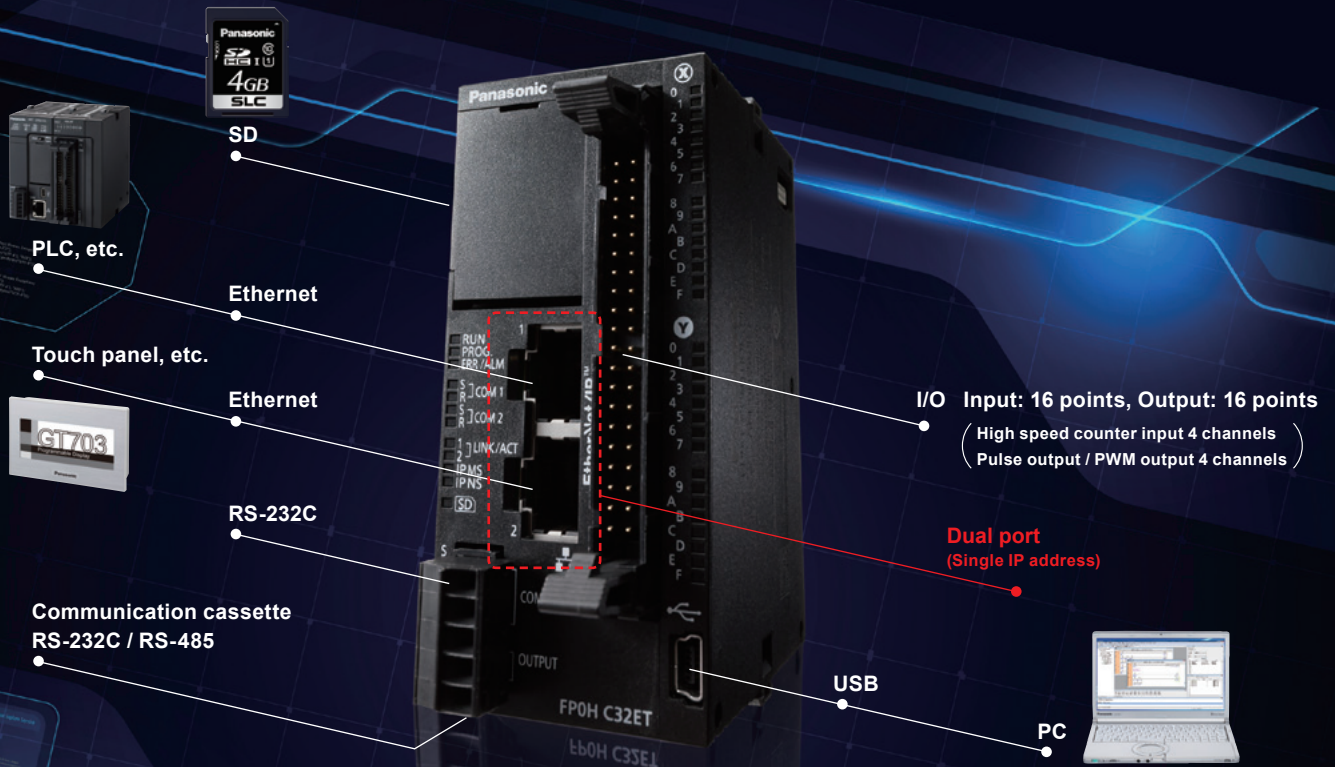

Built-in dual Ethernet ports

Multiple interfaces that connect with various devices



Ultra-compact PLC

FP0H collects information from field level

The ultra-compact PLC “FP0H” collects information (open network supported) and achieves distributed control (no hub required with serial wiring)!

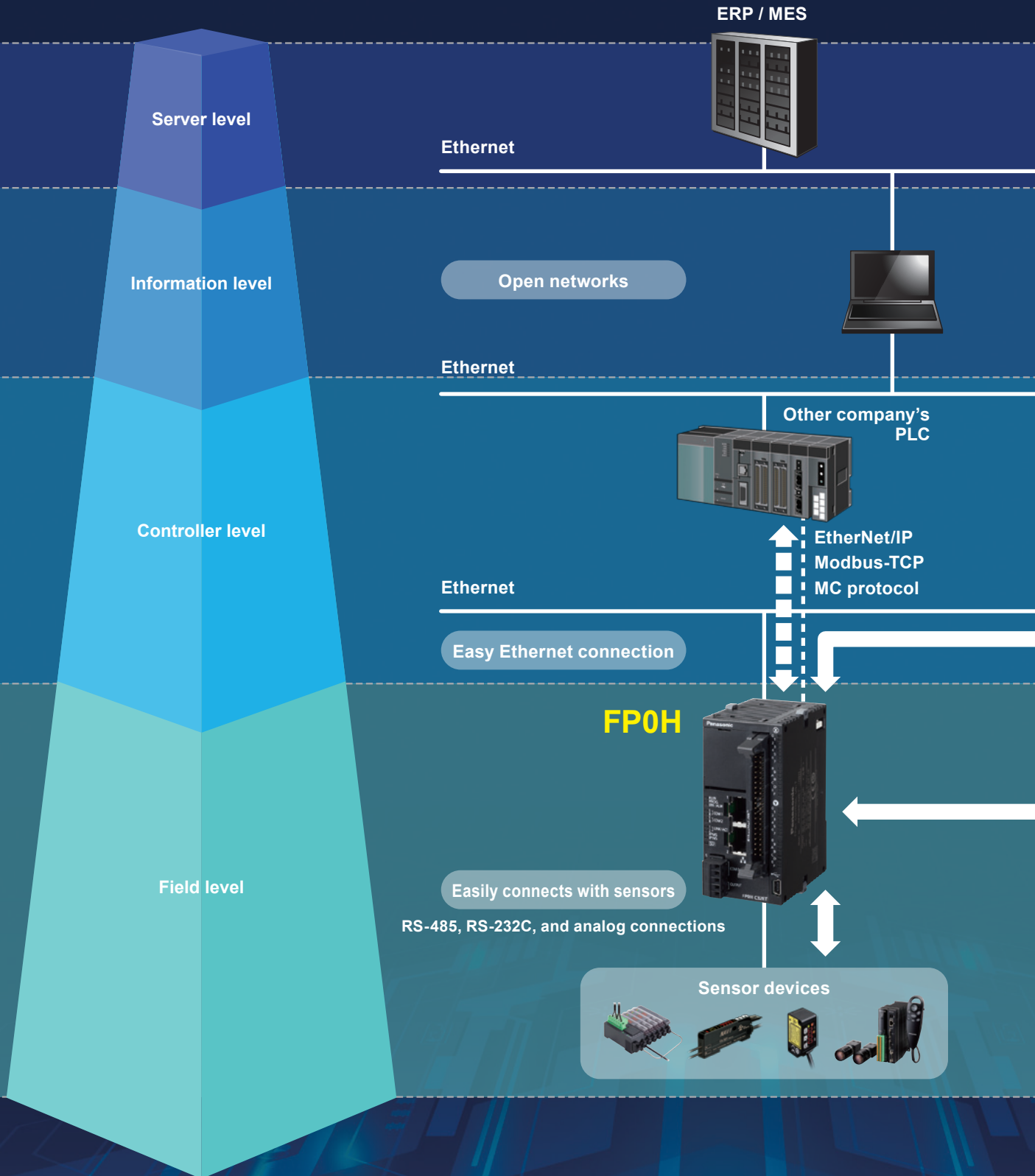

Network hierarchy

devices.

Information visualization using FP7's Web server function



Basic performance

New functions

FP0H can transmit information to PC or server, etc.

FTP server function **NEW**

Allows the PC to read the logging data in the SD memory card and to write setting values and other parameters.

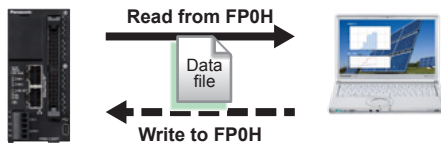

FTP client function **NEW**

The FP0H can generate and write data files to an FTP server on a PC as well as read data files from the FTP server.

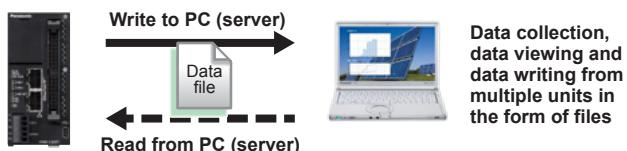

Transfer electric power data from factories and offices to an FTP server on a regular basis.

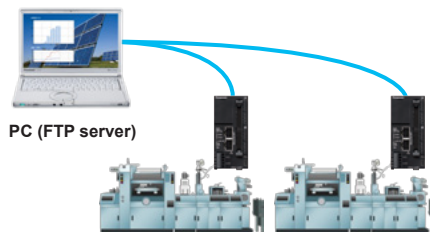

Users can access the accumulating production information in the server at any time.

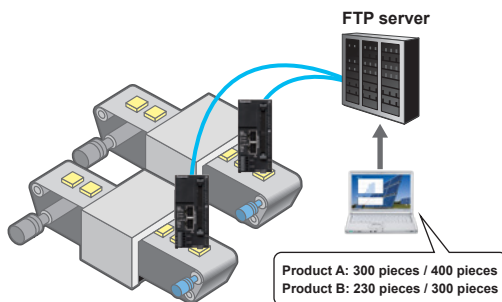

Basic performance

Significantly improved basic performance in an ultra-compact body!

- High-speed operation processing** 8 x faster than conventional models!
 Basic instruction: 10 ns to (up to 10 k steps)
- High capacity Max. 64 k steps** 2 x larger than conventional models!
 Program capacity: 64 k / 40 k / 32 k / 24 k Step variable
- Data capacity: 12 k / 24 k / 32 k / 64 k Step variable**

To improve productivity in an advanced small device!

Food processing machine Packaging equipment Inspection equipment

- Faster Reduce production costs
- Higher capacity Support multiple types

I/O: 16 input points, 16 output points, Transistor output (NPN / PNP)
 Built-in I/F: Ethernet × 2 ports, RS-232C × 1 channel, USB × 1 channel
 Expansion I/F: **FP0H** / **FPΣ** expansion bus × 1, **FP0R** expansion bus × 1
 Cassette slot × 1 (RS-232C, RS-232C × 2, RS-485, RS-232C and RS-485)
 Tool: **FPWIN GR7** / **FPWIN Pro7**

Up to 384 I/O points FP0H / FPΣ / FP0R units can be added.

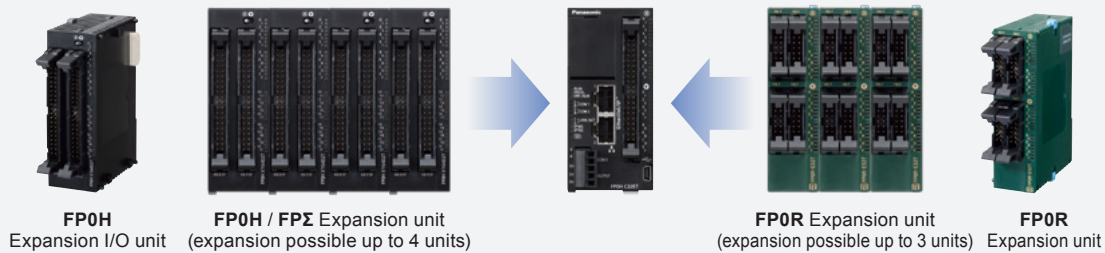

Can select required functions to control various devices!

Built-in 4-axis pulse outputs

Built-in 4-axis pulse output, so simultaneous control of 2-axis linear interpolation is possible for two sets. For example, two X-Y tables can be controlled.

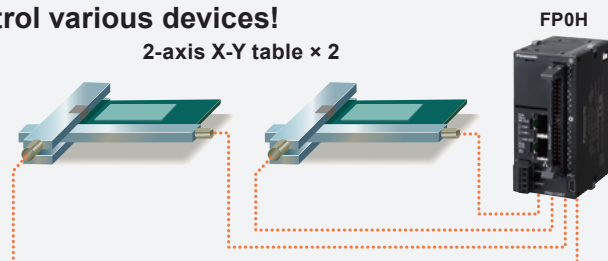

High-speed counter input and pulse output

Ladder programs can be combined to create an application for counting pulse signals from the encoder through the high speed counter input and adjusting the pulse output frequency based on the count to synchronize the slave axis speed with the master axis speed.

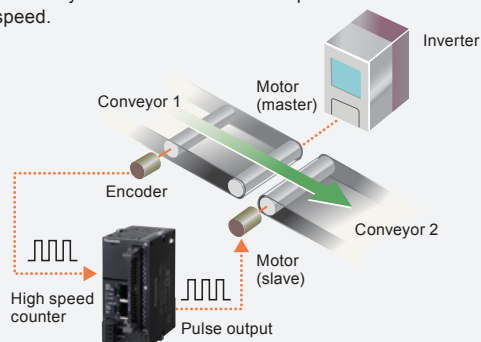

In the upper figure, the speed of conveyor 1, which is inverter controlled, is measured based on the encoder pulse count, and pulses are output (for jog operation) to the motor (slave) according to the measured speed in order to synchronize the speed of conveyor 2.

Built-in multipoint PWM outputs (4 channels)

The pulse output port of **FP0H** can also serve as a PWM output port. One of the application examples is an analog voltage output, which can be used for inverter speed control.

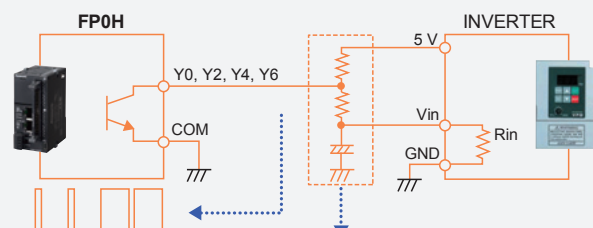

The speed can be controlled by changing the ON width of the PWM output.

The unit can also serve as an analog voltage output when a smoothing capacitor is inserted in the circuit.

Connection to various devices

- EtherNet/IP, Modbus-TCP and MC protocol compatibility*
- Easy connection with all kinds of robots and PLCs*
- Cassette system reduces unit cost and installation space

*Only for Ethernet type

EtherNet/IP compatibility

An Ethernet type control unit supports EtherNet/IP. Easy connection with all kinds of robots and PLCs enables control and communication.

Note: EtherNet/IP is a trademark of ODVA, Inc.

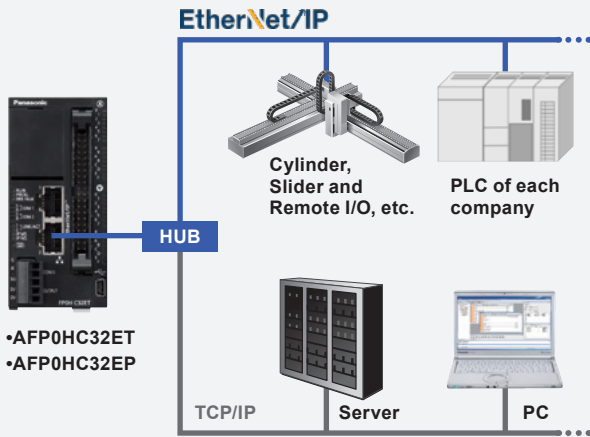

Cassette system reduces unit cost and installation space

With ease and at low cost, extend the serial communication functionality of control unit.

Communication cassettes

- RS-232C
- RS-232C × 2
- RS-485
- RS-232C and RS-485

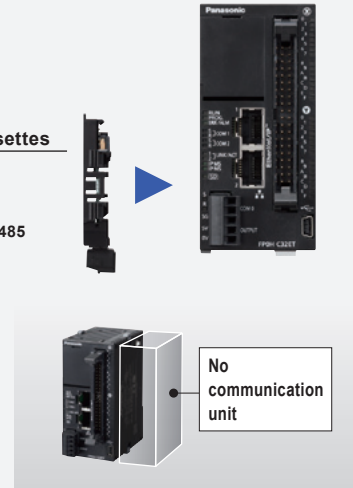

Logs collected information

- An SD memory card slot and a logging trace function are provided.*
- A project copy function can copy ladder data without a PC.* (Only when a programmable display is used)
- Variable data capacity handles capacity shortage.
- Program capacity: Max. 64 k steps*

* Only for Ethernet type

Easy multiple concurrent logging

Logging set up is done via the configuration screen. Moreover, it is possible to keep up to 4 files concurrently active.

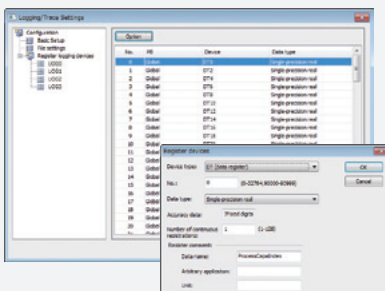

•Various triggers: periodic, cycle, bit, startup, etc.

Use program and data register sharing to resolve data space shortage.

No need repurchase expensive upgrade models.

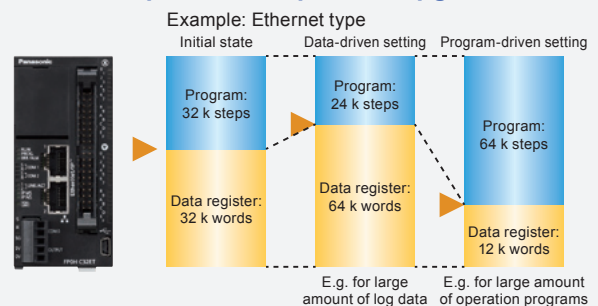

Can update programs with an SD memory card

Can save programs in and read them from an SD memory card. Programs can be updated easily via an SD memory card.



Reference value: for Ethernet type

Program	64 k steps	40 k steps	32 k steps	24 k steps
Data register	12 k words	24 k words	32 k words	64 k words

Motor control

■ The control unit controls four axes with pulse output (up to 100 kHz per axis).

Control unit

You can achieve position control easily only by starting a positioning action pattern configured with a dedicated setting tool.

Positioning control configuration

The positioning table (Note 1) and parameters for each axis (Note 2) are set.

Table number	Operation pattern	Control method	X-axis (CH0)	Acceleration/d	Acceleration	Deceleration	Target	Dwell t
1	E End point	Increment	3	0000	L: Linear	100	2	1000
2	E End point	Increment	3	0000	L: Linear	100	100	1000
3	E End point	Increment	3	10000	L: Linear	100	100	1000
4	E End point	Increment	3	10000	L: Linear	100	100	1000
5	E End point	Increment	3	0000	L: Linear	100	100	1000
6	E End point	Increment	3	0	L: Linear	100	100	1000
7	E End point	Increment	3	0	L: Linear	100	100	1000
8	E End point	Increment	3	0	L: Linear	100	100	1000

Basic	Channel 0 (Axis)	Channel 1 (Axis)	Channel 2 (Axis)	Channel 3 (Axis)
Pulse output method	Pulse Sign	Pulse Sign	Pulse Sign	Pulse Sign
Pulse output motor direction	Off direction +	Off direction +	Off direction +	Off direction +
Speed speed	100	100	100	100
Positioning speed return	0	0	0	0
Home position type	Normal Open	Normal Open	Normal Open	Normal Open
Home position search high	Normal Open	Normal Open	Normal Open	Normal Open
Limit + switch type	Normal Open	Normal Open	Normal Open	Normal Open
Limit - switch type	Normal Open	Normal Open	Normal Open	Normal Open
Home return method	Not use	Not use	Not use	Not use
Home return direction	Limit (+) direction	Limit (+) direction	Limit (+) direction	Limit (+) direction
Home return acceleration time (ms)	100	100	100	100
Home return deceleration time (ms)	100	100	100	100
Home return target speed	1000	1000	1000	1000
Home return stop speed	100	100	100	100
Disruption counter clear time (ms)	1	1	1	1
Coordinate origin	0	0	0	0
EDU operation	ADD acceleration time (ms)			

- Notes: 1) The positioning table separately shows movement amount, target speed, acceleration and deceleration time, operation mode, and other information for positioning control operations.
2) For each axis parameters are shown for limit input logic, deceleration time to stop, and operation conditions for JOG operation and return to point, etc.

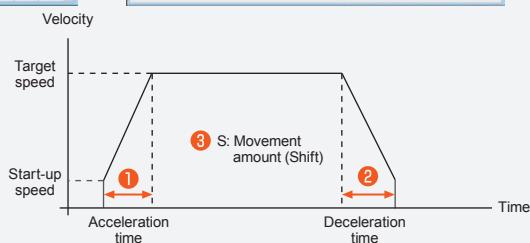

■ The positioning unit (fast start-up in 5 μs) can support ultra-fast linear servos.

Expansion unit

Pulse output of up to 4 Mpps and fast start-up in 5 μs can control linear servos.

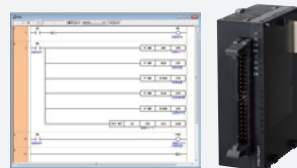

FP0H
Positioning unit

Ideal for applications that repeat short-stroke actions quickly, such as palletizing of electronics parts

A built-in high speed counter can detect abnormalities.



Counting feedback pulses from encoders during positioning can detect accidents such as the abnormalities in the drive system.

- Counts feedback pulses from the encoder to detect abnormalities.

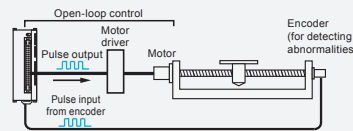

Jog positioning supports fixed feed

Fast start-up and repetitive control can support fixed-feed processing.

■ The supported positioning unit RTEX can control Panasonic motors.

Expansion unit

Support of network servos MINAS A4N / A5IN / A6N significantly reduces the man-hours in wiring.

Commercially available LAN cables can be used as network cables, providing excellent availability, cost efficiency, and flexibility.

High communication speed of 100 Mbps. Precise multi-axis position control is achieved.

Three types (2-axis, 4-axis and 8-axis) are available. Flexible support of control with a small number of axes

The Configurator PM setting software strongly supports from configuration to start-up and to monitoring.

You can start the positioning-dedicated configuration tool Configurator PM, and easily configure parameters and positioning actions. A test run is also supported so that you can check positioning action even when the control unit is in program mode.

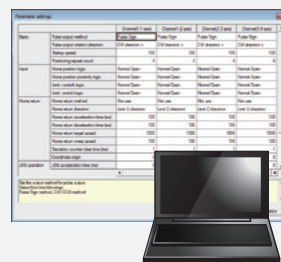

FPZ
Positioning unit
RTEX

Distributed control

- Distributed devices result in a flexible line, reducing man-hours.

Before

Centralized control by a high performance large PLC

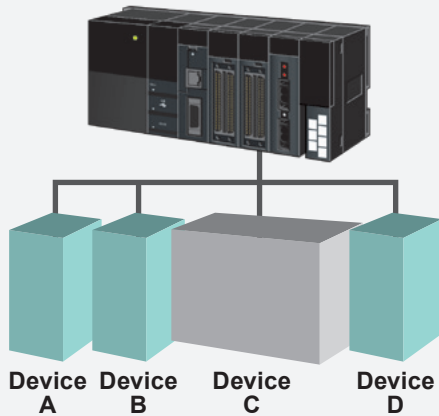

- Control of multiple devices leads to a complicated system design
- When a failure occurs, all the devices are stopped.
- System modification requires more man-hours.
- High risk at start-up and when an error occurs

After

Distributed control where FP0H controls each device.

Data between each controller is shared over Ethernet

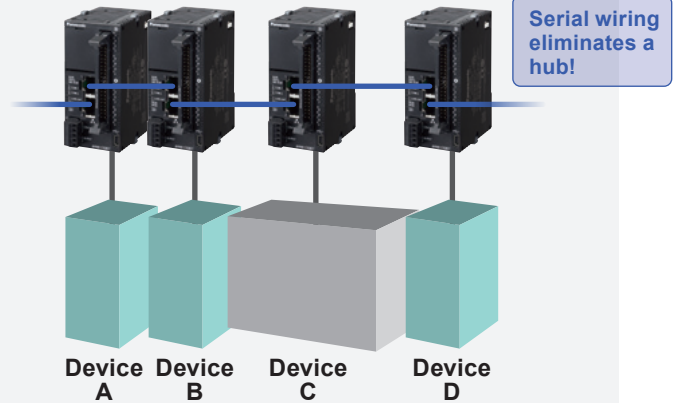

- Distributed control reduces the load on a control unit.
- Recovery of only failed devices reduces man-hours.
- System modification is available per device, which reduces man-hours.
- Lower risk at start-up and when an error occurs

Compatibility

- Ultra-compact size inherited from FPΣ

Ultra-compact size of 90 mm 3.543 in in height contributes to the reduction in size of a device.



FPΣ Control unit
(W 30 × H 90 × D 60 mm)
W 1.181 × H 3.543 × D 2.362 in)

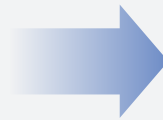

FP0H Control unit (Without Ethernet type)
(W 30.4 × H 90 × D 60 mm)
W 1.197 × H 3.543 × D 2.362 in)

- Ladder programs for FPΣ can be converted for FP0H.

Ladder programs for FPΣ created in Control FPCWIN GR/GR7 can be converted for FP0H. Creating new ladder programs are not required when replacing FPΣ with FP0H.

Note: When an unsupported instruction (F176 SPCH: arc interpolation) is used, convert it before model switching.

FP0H series Lineup

Control units



With Ethernet
NPN type
AFP0HC32ET



With Ethernet
PNP type
AFP0HC32EP



Without Ethernet
NPN type
AFP0HC32T



Without Ethernet
PNP type
AFP0HC32P

Expansion I/O units



32 points input DC
Transistor output
(sink) 32 points
AFP0HXY64D2T



32 points input DC
Transistor output
(source) 32 points
AFP0HXY64D2P

NEW

Communication cassettes



RS-232C, 1 channel
AFP0HCCS1



RS-232C, 2 channels
AFP0HCCS2



RS-485, 1 channel
AFP0HCCM1



RS-232C, 1 channel
RS-485, 1 channel
AFP0HCCS1M1

Positioning units



Transistor output
1 axis
AFP0HPG01T



Line driver output
1 axis
AFP0HPG01L



Transistor output
2 axes
AFP0HPG02T



Line driver output
2 axes
AFP0HPG02L

Expansion units (Common to FPΣ)

Positioning units RTEX



2 axes
FPG-PN2AN
(AFP043610)



4 axes
FPG-PN4AN
(AFP043620)



8 axes
FPG-PN8AN
(AFP043630)

Expansion units (Common to FP0R)

Input and output units

Input units



MIL connector
Input 8 points DC
AFP0RE8X



MIL connector
Input 16 points DC
AFP0RE16X

Output units



MIL connector
Transistor output
(sink) 8 points
AFP0RE8YT



MIL connector
Transistor output
(source) 8 points
AFP0RE8YP



Terminal block
Relay output 8 points
AFP0RE8YRS



MIL connector
Transistor output
(sink) 16 points
AFP0RE16YT



MIL connector
Transistor output
(source) 16 points
AFP0RE16YP

Input and output units



Terminal block
Input 4 points DC
Relay output 4 points
AFP0RE8RS



Terminal block
Input 8 points DC
Relay output 8 points
AFP0RE16RS



Connector
Input 4 points DC
Relay output 4 points
AFP0RE8RM



Connector
Input 8 points DC
Relay output 8 points
AFP0RE16RM



MIL connector
Input 8 points DC
Transistor output
(sink) 8 points
AFP0RE16T



MIL connector
Input 8 points DC
Transistor output
(source) 8 points
AFP0RE16P



MIL connector
Input 16 points DC
Transistor output
(sink) 16 points
AFP0RE32T



MIL connector
Input 16 points DC
Transistor output
(source) 16 points
AFP0RE32P

Analog input and output units

Input units
Output units



Input 4 channels
AFP0RAD4



Input 8 channels
AFP0RAD8



Output 4 channels
AFP0RDA4

Input and output units



Input 2 channels
Output 1 channel
AFP0RA21



Input 4 channels
Output 2 channels
AFP0RA42

Thermocouple units



4 channels
AFP0420
(FP0-TC4)



8 channels
AFP0421
(FP0-TC8)

Link and communication unit

CC-Link
slave unit



AFP07943
(FP0-CCLS)

Control units

Significantly improved basic performance in an ultra-compact body!



Control specifications

Item	Type	Without Ethernet		With Ethernet		
		NPN type	PNP type	NPN type	PNP type	
Part No.		AFP0HC32T	AFP0HC32P	AFP0HC32ET	AFP0HC32EP	
Number of controllable I/O points		32 points (Input: 16, Output: 16). When expanded: Max. 384 points				
Programming method / Control method		Relay symbol / Cyclic operation				
Program memory		Built-in flash ROM (no backup battery required)				
Number of instructions	Basic instructions	120 types approx.				
	High-level instructions	240 types approx.		270 types approx.		
Program capacity		24 k / 32 k steps		24 k / 32 k / 40 k / 64 k steps		
		Can be selected at system register No. 0				
		When the program capacity is changed, the number of words that can be used in the data register (DT) is also changed.				
		Program capacity	DT Number of word			
		24 k steps	65,533 words	32,765 words (initial value)	40 k steps	24,573 words
Operation speed		Basic instruction (NOT / I) : 10 ns/step approx. (Up to 10 k steps), 0.18 μs/step approx. (10 k steps and later)				
		Basic instruction (ST) : 40 ns/step approx. (Up to 10 k steps), 0.65 μs/step approx. (10 k steps and later)				
		High-level instruction (FOMV) : 0.14 μs/step approx. (Up to 10 k steps), 1.2 μs/step approx. (10 k steps and later)				
Base scan time		Control unit: 40 μs or less approx. and FP0 / FP0R expansion unit refresh time (Note 1)		Control unit: 100 μs or less approx. and FP0 / FP0R expansion unit refresh time (Note 1)		
	I/O refresh and base time					
Operation memory	Relay	External input (X) (Note 2, 3)	1,760 points (X0 to X109F)			
		External output (Y) (Note 2, 3)	1,760 points (Y0 to Y109F)			
		Internal relay (R) (Note 3)	4,096 points (R0 to R255F) or 8,192 points (R0 to R511F) (Note 4)		8,192 points (R0 to R511F)	
		Special internal relay (R)	800 points (R9000 to R951F)			
		Timer / Counter (T / C) (Note 5)	1,024 points (initial setting, timer: 1,008 points, counter: 16 points)			
	Memory area	Link relay (L)	2,048 points (L0 to L127F)			
		Data register (DT) (Note 6)	32,765 words or 65,533 words		12,285 words or 24,573 words or 32,765 words or 65,533 words	
		Special data register (DT) (Note 3)	1,000 words (DT90000 to DT90999)			
		Link data register (LD)	256 words (LD0 to LD255)			
		Index register (I)	14 words (I0 to I13)			
Differential points	Points for the program capacity					
Number of master control relay (MCR)	256 points					
Number of labels (JP and LOOP)	256 points					
Number of step ladder	1,000 stages					
Number of subroutines	500 subroutines					
Number of interrupt program		9 programs				
		•Input: 8 programs (INT0 to INT7) •Periodic: 1 program (INT24)				
Sampling trace (Note 7)	Available (Sampling by commands / Sampling at regular time intervals) (For one sampling: 16 bits + 3 words), 1,000 samples					
Comment storage	I/O comments, remarks and block comments can be stored. (no backup battery required, 1 M byte)					
PLC link function (Serial communication)	Max. 16 units, link relays: 1,024 points, link registers: 128 words. (Data transfer and remote programming are not supported)					

Item	Type	Without Ethernet		With Ethernet	
		NPN type	PNP type	NPN type	PNP type
Part No.		AFP0HC32T	AFP0HC32P	AFP0HC32ET	AFP0HC32EP
Constant scan		Available (0 to 600 ms)			
Password		Available (32 digits)			
Program upload protection		Available			
Program protect function		Available			
Self-diagnostic function		Watchdog timer, program syntax check, etc.			
Program edition during RUN		Available			
SD memory card function		—		SD memory card project copy, SD memory card access (instruction), Logging trace function (Note 7)	
Memory transfer		Available [Built-in memory (ROM ⇄ RAM)]			
High speed counter (Note 8)	Main unit input	Single-phase 4 channels (Max. 100 kHz each input) or 2-phase 2 channels (Max. 50 kHz each input)			
Pulse output (Note 8)	Main unit output	4 channels (Max. 100 kHz each axis)			
PWM output (Note 8)	Main unit output	4 channels (1 Hz to 70 kHz: 1,000 resolution / 70.001 kHz to 100 kHz: 100 resolution)			
Pulse catch input	Interrupt input	Total 8 points (with high speed counter)			
Periodical interrupt		0.1 ms to 30 sec.			
Potentiometer (Volume) input (Note 3)		2 channels (0 to 4000)		Not available	
Clock / calendar (Note 9, 10)		Year (last two digits), month, day, hour (24-hour display), minute, second and day of week			
Memory backup (Note 11)	Backup by instruction P13	Data register: all area			
	Auto-backup at power failure	Counter: 16 points Internal relay: 128 points Data register: 315 words			
Battery backup (only when a battery is installed)		Hold areas or non-hold areas can be specified by setting the system registers No.6 to No. 13. (It is also possible to make the setting for hold all points.)			
Battery life		5 years or more under a production condition (operates for 8 hours per day)			

Notes: 1) Refresh times for FP0 / FP0R expansion units	8 points unit	Number of units × 0.8 ms
	16 points unit	Number of units × 1.0 ms
	32 points unit	Number of units × 1.3 ms
	64 points unit	Number of units × 1.9 ms

- The number of points that can be used depends on the combination of hardware.
- Some specifications are compatible with **FPZ**.
- System register No. 1 (internal relay capacity) can be configured to select "0: 4,096 points / 1: 8,192 points".
- An auxiliary timer instruction (F137) can be used to add the number of points.
- System register No. 0 (program capacity) can be configured to select the capacity of the data register (DT).
- Logging trace and sampling trace cannot be used at the same time.
- The specifications are based on the rated input voltage of 24 V DC at +25 °C +77 °F.
- The maximum operation frequency may be lower depending on the applied voltage, ambient temperature, and conditions of use. The maximum operation frequency varies depending on how the unit is used.
- Accuracy of the clock / calendar (within ± 90 seconds per month at +25 °C +77 °F). If an error of the clock / calendar becomes a problem in the system, set an accurate time periodically.
- If the battery is not attached, calendar information is cleared when the power is turned off. It will be necessary to set the date when the power is turned on.
- Data can be rewritten up to 10,000 times. Hold / non-hold areas can be specified in the system registers.

General specifications

Item	Type Part No.	Without Ethernet		With Ethernet	
		NPN type	PNP type	NPN type	PNP type
CE marking directive compliance	AFP0HC32T	AFP0HC32P	AFP0HC32ET	AFP0HC32EP	
		EMC Directive, RoHS Directive			
Rated voltage		24 V DC			
Operating voltage range		20.4 to 28.8 V DC			
Consumption current		140 mA or less		170 mA or less	
Allowed momentary power off time		4 ms (at 20.4 V DC), 10 ms (24 V DC or higher)			
Ambient temperature		0 to +55 °C +32 to +131 °F , At storage: -40 to +70 °C -40 to +158 °F			
Ambient humidity		10 to 95 % RH (at +25 °C +77 °F , no dew condensation allowed), At storage: 10 to 95 % RH (at +25 °C +77 °F , no dew condensation allowed)			
Breakdown voltage (Detection current: 5 mA)		500 V AC for 1 minute Input and output terminals ⇄ power and functional ground terminals Input terminals ⇄ Output terminals			
Insulation resistance (Test voltage: 500 V DC)		100 MΩ or more Input and output terminals ⇄ power and functional ground terminals Input terminals ⇄ Output terminals			
Vibration resistance		5 to 8.4 Hz, single amplitude of 3.5 mm, 8.4 to 150 Hz, constant acceleration of 9.8 m/s ² , for 10 times each in X, Y, and Z directions (1 octave/min.) (JIS B 3502, IEC 61131-2)			
Shock resistance		147 m/s ² , 4 times each in X, Y, and Z directions (JIS B 3502, IEC 61131-2)			
Noise immunity		1,000 V (p-p) with pulse widths 50 ns and 1 μs (using a noise simulator) (Power supply terminal)			
Operating condition		Free from corrosive gasses and excessive dust			
Overvoltage category		Category II			
Degree of pollution		Pollution level 2			
Net weight		110 g approx. each		130 g approx. each	

COM0 port communication specifications

Item	Specifications	
Interface	RS-232C, three-wire system, 1 channel (Not insulated)	
Transmission distance	15 m 49.213 ft	
Communication configuration	1 : 1 communication	
Communication method	Half-duplex system	
Synchronous method	Start-stop synchronization system	
Transmission cable	Multi-conductor shielded wire	
Communication speed (Specified at the system registers)	1,200 (Note 3), 2,400 (Note 3), 4,800, 9,600, 19,200, 38,400, 57,600, 115,200, 230,400 bits/sec.	
Transmission format	Data length	7 bits / 8 bits
	Parity	none / odd / even
	Stop bit	1 bit / 2 bits
	Start code	with STX / without STX
	End code	CR / CR + LF / none / ETX / Time (0 to 100.00 ms)
Data transmission order	Transmit from bit 0 in character units	
Communication mode	MEWTOCOL-COM (Master / Slave) (Computer link) General-purpose communication PLC link MODBUS RTU (Master / Slave)	

Notes: 1) The start and end codes can be used only for general-purpose serial communications.
2) The unit No. (station number) can be selected at system register No. 410.
3) System register no. 415 cannot be used to set the baud rate to 1,200 bps. To set the baud rate to 1,200 bps, use the SYS1 instruction. If the baud rate of any of the COM ports is 2,400 bps or lower, F-ROM access will slow down. Example) F12(ICRD) instruction, P13(ICWT) instruction, etc.

LAN port communication specifications (for only Ethernet type)

Item	Specifications
Communication interface	Ethernet 100BASE-TX / 10BASE-T
Baud rate	100 Mbps, 10 Mbps auto negotiation function
Total cable length	100 m 328.084 ft (500 m 1640.420 ft when a repeater is used)
Number of simultaneous connections	Max. 10 (system connection: 1, user connection: 9)
Communication method	Full duplex / Half-duplex system
Communication protocol (Communication layer)	TCP / IP, UDP
DNS	Supports name servers
DHCP	Automatic IP address acquisition
FTP server / client	Server function: File transmission, No. of users: 1 Client function: Data and file transmission
SNTP	Time adjustment function
General-purpose communication	4 kB / 1 connection (user connection: 1 to 9) (Note 2)
Dedicated communication	EtherNet/IP MEWTOCOL-COM (Master / Slave) (Computer link) MODBUS-TCP (Master / Slave) MEWTOCOL-DAT (Master / Slave) General-purpose communication MC protocol (Note 1) (Master / Slave)

Notes: 1) MC protocol is a short form denoting MELSEC communication protocol; MELSEC is a registered trademark of Mitsubishi Electric Corporation.
QnA compatible 3E frame, only binary (bulk writing and bulk reading) use is available.
2) General-purpose communications can be up to 4 kB (reception) and up to 2 kB (transmission) per connection.

USB port specifications

Item	Specifications
Standard	USB2.0 Full speed (USB mini B type)
Communication function	Computer link (slave)

Dedicated power supply output port specifications for GT series programmable display

Output terminal	Connecting programmable display model
5 V DC	For 5 V DC type GT02 series Programmable Display

Input specifications

Item	Specifications
Rated input voltage	24 V DC
Operating voltage range	21.6 to 26.4 V DC
Rated input current	High-speed part (X0 to X7) : 8 mA approx. Low-speed part (X8 to XF) : 3.5 mA approx.
Input points per common	16 points/common (Either the positive or negative of the input power supply can be connected to the common terminal.)
Min. ON voltage / Min. ON current	High-speed part (X0 to X7) : 19.2 V DC / 6 mA Low-speed part (X8 to XF) : 19.2 V DC / 3 mA
Max. OFF voltage / Max. OFF current	2.4 V DC / 1 mA
Input impedance	High-speed part (X0 to X7) : 3 kΩ approx. Low-speed part (X8 to XF) : 6.8 kΩ approx.
Response time (Note)	OFF → ON <High-speed part (X0 to X7)> 135 μs or less: normal input 5 μs or less: high speed counter, pulse catch, interrupt input settings <Low-speed part (X8 to XF)> 1 ms or less: normal input only
	ON → OFF Same as above
Operating mode indicator	LED display

Note: The input time constant (0.1 to 256 ms) can be specified.

Output specifications

Item	Type Part No.	Without Ethernet	With Ethernet	Without Ethernet	With Ethernet
		AFP0HC32T	AFP0HC32ET	AFP0HC32P	AFP0HC32EP
Output type		Nch open drain		Pch open drain	
Rated load voltage		5 to 24 V DC			
Operating load voltage range		4.75 to 26.4 V DC		21.6 to 26.4 V DC	
Rated load current		0.3 A (For Y0, Y1, Y3, Y4, Y8, Y9, YB, YC), 0.1 A (For Y2, Y5, Y6, Y7, YA, YD, YE, YF)		0.3 A (For Y0 to YF)	
Max. surge current		High-speed part (For Y0, Y1, Y3, Y4, Y8, Y9, YB, YC) : 1.0 A, Low-speed part (For Y2, Y5, Y6, Y7, YA, YD, YE, YF) : 0.5 A			
OFF state leakage current		1 μA or less		2 μA or less	
ON state voltage drop		0.5 V DC or less			
Overcurrent protection		Provided (automatically protected for each 8 points)			
Output points per common		16 points/common (Y0 to YF / 1 common)			
Response time	OFF → ON	High-speed part (For Y0, Y1, Y3, Y4, Y8, Y9, YB, YC) : 2 μs or less, Low-speed part (For Y2, Y5, Y6, Y7, YA, YD, YE, YF) : 1 ms or less			
	ON → OFF	High-speed part (For Y0, Y1, Y3, Y4, Y8, Y9, YB, YC) : 5 μs or less, Low-speed part (For Y2, Y5, Y6, Y7, YA, YD, YE, YF) : 1 ms or less			
Surge absorber		Zener diode			
Operating mode indicator		LED display			

Limitations on simultaneous ON points

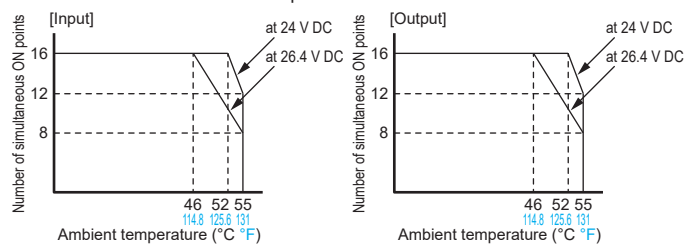

Current consumption

Type of unit	Control unit current consumption (at 24 V DC)	Additional current (at 24 V DC)	Expansion unit current consumption (at 24 V DC)
Control unit alone	AFP0HC32T	—	—
	AFP0HC32P		
	AFP0HC32ET		
	AFP0HC32EP		
Extension unit attached	AFP0HX64D2T	35 mA or less	—
	AFP0HX64D2P		
	AFP0HPG01T	50 mA or less	
	AFP0HPG01L		
	AFP0HPG02T	70 mA or less	
	AFP0HPG02L		
Extension cassette attached	AFP0HCCS1	10 mA or less	—
	AFP0HCCS2		
	AFP0HCCM1		
	AFP0HCCS1M1		

Note: For details about the current consumption of **FPΣ** expansion units and **FP0 / FPOR** expansion units, refer to relevant specifications and manuals.

Expansion I/O units

32 input and 32 output points.



AFP0HXY64D2T
Input 32 points DC
Transistor output (sink)
32 points
AFP0HXY64D2P NEW
Input 32 points DC
Transistor output (source)
32 points

General specifications

Item	Specifications
Ambient temperature	0 to +55 °C +32 to +131 °F, At storage: -20 to +70 °C -4 to +158 °F
Ambient humidity	30 to 85 % RH (at +25 °C +77 °F, no dew condensation allowed), At storage: 30 to 85 % RH (at +25 °C +77 °F, no dew condensation allowed)
Breakdown voltage (Detection current: 5 mA)	500 V AC for 1 minute Input and output terminals ⇄ power and functional ground terminals (at control unit) Input terminals ⇄ Output terminals
Insulation resistance (Test voltage: 500 V DC)	100 MΩ or more Input and output terminals ⇄ power and functional ground terminals (at control unit) Input terminals ⇄ Output terminals
Vibration resistance	10 to 55 Hz, 1 sweep/min., double amplitude of 0.75 mm, 10 minutes each in X, Y, and Z directions
Shock resistance	98 m/s ² , 4 times each in X, Y, and Z directions
Noise immunity	1,000 V (p-p) with pulse widths 50 ns and 1 μs (using a noise simulator)
Operating condition	Free from corrosive gasses and excessive dust
Net weight	100 g approx.
Control unit's additional consumption current	35 mA or less (at 24 V DC) [100 mA or less (internal 5 V DC)]

Communication cassettes

A cassette system reduces the cost and footprint of the unit



AFP0HCCS1 AFP0HCCS2 AFP0HCCM1 AFP0HCCS1M1

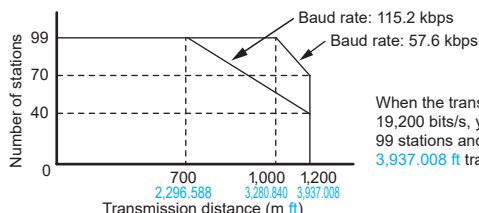

Input specifications

Item	Specifications
Insulation method	Photocoupler
Rated input voltage	24 V DC
Operating voltage range	21.6 to 26.4 V DC
Rated input current	3.5 mA approx.
Input points per common	32 points/common (Either the positive or negative of the input power supply can be connected to the common terminal.)
Min. ON voltage / Min. ON current	19.2 V DC / 3 mA
Max. OFF voltage / Max. OFF current	2.4 V DC / 1.3 mA
Input impedance	6.8 kΩ approx.
Response time	OFF → ON ON → OFF
Operating mode indicator	LED display

Output specifications

Item	Type Part No.	Sink type		Source type	
		AFP0HXY64D2T	AFP0HXY64D2P	AFP0HXY64D2T	AFP0HXY64D2P
Insulation method		Photocoupler			
Output type		Open collector (NPN)		Open collector (PNP)	
Rated load voltage		5 to 24 V DC		24 V DC	
Operating load voltage range		4.75 to 26.4 V DC		21.6 to 26.4 V DC	
Rated load current		0.1 A			
Max. surge current		0.5 A			
Output points per common		32 points/common			
OFF state leakage current		100 μA or less			
ON state voltage drop		0.5 V DC or less			
Response time		OFF → ON		ON → OFF	
		0.2 ms or less		0.5 ms or less	
External power supply (for driving internal circuit)		Voltage 21.6 to 26.4 V DC			
		Current 15 mA or less		30 mA or less	
Surge absorber		Zener diode			
Operating mode indicator		LED display			
Short circuit protection		Short circuit protection, Thermal protection			

Number of simultaneous ON points

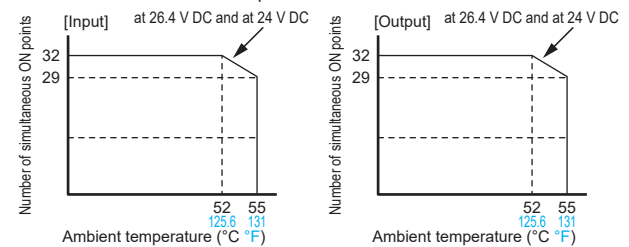

Specifications

Refer to p.11 for the general specifications.

Item	Specifications			
	AFP0HCCS1	AFP0HCCS2	AFP0HCCM1	AFP0HCCS1M1
Interface	RS-232C 1 channel	RS-232C 2 channels	RS-485 1 channel	RS-232C 1 channel and RS-485 1 channel
Transmission distance	Max. 15 m 49.213 ft		Max. 1,200 m 3,937.008 ft	RS-232C Max. 15 m 49.213 ft RS-485 Max. 1,200 m 3,937.008 ft
Communication configuration	1 : 1 communication		1 : N communication	1 : 1 communication 1 : N communication
Communication speed	1,200 (Note 1), 2,400 (Note 1), 4,800, 9,600, 19,200, 38,400, 57,600, 115,200, 230,400 bits/sec.			
Communication method	Half-duplex system			
Synchronous method	Start-stop synchronization system			
Transmission format	Data length	7 bits / 8 bits		
	Parity	none / odd / even		
	Stop bit	1 bit / 2 bits		
	Start code	with STX / without STX		
	End code	CR / CR + LF / none / ETX / Time (0 to 100 ms)		
Data transmission order	Transmit from bit 0 in character units.			
Number of stations	—	—	Max. 99 units	Max. 99 units
Net weight	10 g approx. each			

- Notes: 1) System register no. 415 cannot be used to set the baud rate to 1,200 bps. To set the baud rate to 1,200 bps, use the SYS1 instruction. If the baud rate of any of the COM ports is 2,400 bps or lower, F-ROM access will slow down.
Example) F12(ICRD) instruction, P13(ICWT) instruction, etc.
2) The start and end codes can be used only for general-purpose serial communications.
3) The unit No. (station number) can be selected at system register.
4) Sufficient noise tolerance is provided but it is recommended that a user program be created for retransmission. (To improve the reliability of communications when a communication error occurs due to an excessive noise or when the target device cannot receive data temporarily.)
5) When connecting a commercially available device that has an RS-485 interface, please confirm operation using the actual device. In some cases, the number of station units, transmission distance and communication speed vary depending on the connected device.
6) The transmission distance, transmission speed, and number of stations should be within the range of the graph on the left, depending on each value.

Positioning units

Fast start-up in 5 μ s can support ultra-fast linear servos



AFP0HPG01T

AFP0HPG01L

AFP0HPG02T

AFP0HPG02L

Specifications

Refer to p.11 for the general specifications.

Part No.		AFP0HPG01T	AFP0HPG01L	AFP0HPG02T	AFP0HPG02L
Item	Part No.				
Output type		Transistor	Line driver	Transistor	Line driver
Number of occupied points		Input 16 points, Output 16 points		Input 32 points, Output 32 points	
Number of axes controlled		1 axis		2 axes, independent	
Position command	Command units	Pulse unit (The program specifies whether Increment or Absolute is used.)			
	Max. pulse count	Signed 32 bits (-2,147,483,648 to +2,147,483,647 pulses)			
Speed command	Command range	1 pps to 500 kpps (can set in 1 pps.)	1 pps to 4 Mpps (can set in 1 pps.)	1 pps to 500 kpps (can set in 1 pps.)	1 pps to 4 Mpps (can set in 1 pps.)
	Acceleration / deceleration method	Linear acceleration / deceleration, S acceleration / deceleration			
Acceleration / deceleration command	S-curve type	Can select from Sin curve, Secondary curve, Cycloid curve and Third curve.			
	Acceleration / deceleration time	0 to 32,767 ms (can set in 1 ms)			
Home return	Home return speed	Speed setting possible (changes return speed and search speed)			
	Input signal	Home input, Near home input, Over limit input (+), Over limit input (-)			
	Output signal	Deviation counter clear signal			
Operation mode		E point control (Linear accelerations / decelerations, S accelerations / decelerations) P point control (Linear accelerations / decelerations, S accelerations / decelerations) Home return function (Home search) JOG operation function (Note 1) JOG positioning function Pulser input function (Note 3) • Transfer multiplication ratio ($\times 1, \times 2, \times 5, \times 10, \times 50, \times 100, \times 500, \times 1000$) Real-time frequency change function Infinity output function			
Startup time		0.02 ms or 0.005 ms selectable (Note 2)			
Output interface	Output mode	1 pulse output (Pulse and Sign), 2-pulse output (CW and CCW)			
Feed back counter function (Note 3)	Countable range	Signed 32 bits (-2,147,483,648 to +2,147,483,647 pulses)			
	Input mode	Two-phase input, Direction distinction input, Individual input (transfer multiple available for each.)			
Other functions		The flag to compare the elapsed value is built in. (The timing signal outputs at the optional position during an operation.)			
External power supply	Voltage	21.6 to 26.4 V DC			
	Current consumption	20 mA		30 mA	
Net weight		75 g approx. each		80 g approx. each	

Notes: 1) When selected linear acceleration / deceleration operation, the target speed can be changed during an operation.

2) The startup time can be changed by the control code setting in the shared memory. The factory setting (default setting) is 0.02 ms. The startup time is the time from the start request to the first pulse output.

3) Pulser input function and feedback counter function use the same pulse input terminal, so the both cannot function simultaneously.

Programming software

Control FPCWIN GR7

Save Time on Programming with User-Friendly Software

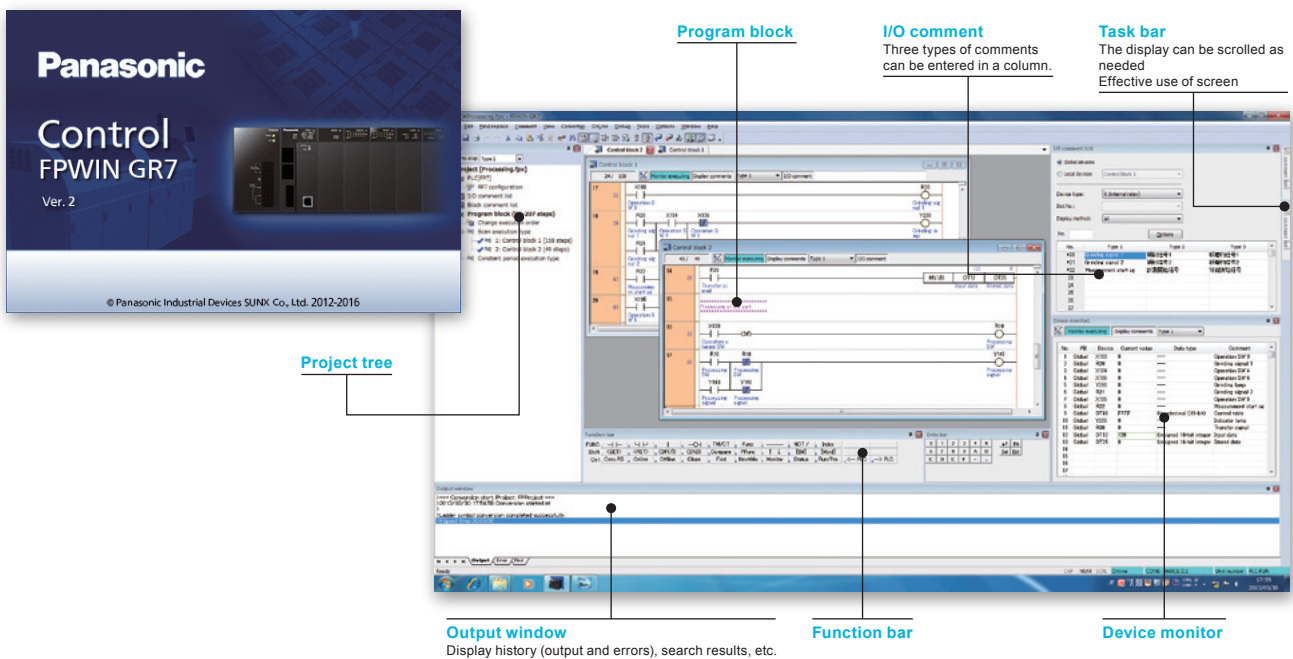

Configuration, editing programming, searching, monitoring, debugging, security, etc.

PLC programming demands a lot of time and effort.

Many programmers get hung up on trying out different configurations, consulting the manual, and re-writing repetitive code blocks.

The **Control FPCWIN GR7** programming software is designed to eliminate these inefficiencies and minimize programming complexity.

Software helps reduce time and effort in various work situations.

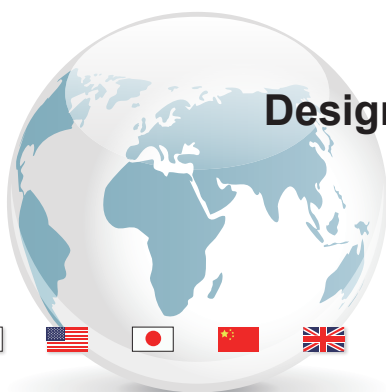

Designed to boost global expansion



Control FPWIN Pro7

Control FPWIN Pro7 (IEC61131-3 compliant Windows version software)

Programming software of PLC open certification corresponds to FP7.

Control FPWIN Pro is the Panasonic programming software developed according to the international standard IEC 61131-3 (for Windows® XP / Vista / 7).

Control FPWIN Pro is the universal software for all Panasonic PLC's

- Programs written in Control FPWIN Pro 6 or earlier versions will run with Control FPWIN Pro 7
- Programs are compatible across FP series PLCs, e.g. FP0R will run with minor adjustments on FPΣ (Sigma) and FP7 PLCs
- FP7 PLCs and Control FPWIN Pro 7 offer the same flexible choice of editors and allow you to select the programming language you are most familiar with.

*Windows, Windows XP, Vista and 7 are trademarks or registered trademarks of Microsoft Corporation in the United States and other countries.

The screenshot displays the Control FPWIN Pro7 software interface with several programming language editors open. On the left, a CD-ROM for 'Control FPWIN Pro7 Ver. 7.0' is shown. The main window is divided into five panes, each representing a different programming language:

- LD Ladder Diagram:** Shows a ladder logic diagram with inputs, timers, and outputs.
- SFC Sequential Function Chart:** Shows a state transition diagram with states and transitions.
- FBD Function Block Diagram:** Shows a diagram with function blocks and their interconnections.
- ST Structured Text:** Shows a text-based program with variables and logic.
- IL Instruction List:** Shows a list of instructions and their parameters.

* 4 languages are fully supported: English, Japanese, Korean, Chinese

• Five programming languages can be used.

Programming can be done using the language most familiar to the developer or using the language most suited to the process to be performed.

High-level (structured text) languages that allow structuring, such as C, are supported.

5 programming languages: IL (Instruction List), LD (Ladder Diagram), FBD (Function Block Diagram), SFC (Sequential Function Chart), ST (Structured Text)

• Easy to reuse well-proven programs

Efficiency when writing programs has been greatly increased by being able to split programming up for each function and process using structured programming.

• Keep know-how from getting out

By "black boxing" a part of a program, you can prevent know-how from leaking out and improve the program's maintainability.

• Source program from PLC can be uploaded.

Serviceability is improved by being able to read programs and comments from a PLC.

• Programming for all models in the FP series possible

Product types

Control units

Product name		Number of I/O points	Rated voltage	Input specifications	Output specifications	Connection method	SD memory card function	Part No.	
FP0H control units	Without Ethernet	Input: 16 points Output: 16 points	24 V DC	24 V DC (Polarity + / - common)	NPN transistor output: 0.3 A / 0.1 A	MIL connector	—	AFP0HC32T	
					PNP transistor output: 0.3 A			AFP0HC32P	
	With Ethernet				NPN transistor output: 0.3 A / 0.1 A			Built-in	AFP0HC32ET
					PNP transistor output: 0.3 A				AFP0HC32EP

Expansion I/O units

Product name		Number of I/O points	Rated voltage	Input specifications	Output specifications	Connection method	Part No.
FP0H expansion unit	Sink type	Input: 32 points Output: 32 points	24 V DC	24 V DC (Polarity + / - common)	NPN transistor output: 0.1 A	MIL connector	AFP0HXY64D2T
	Source type				PNP transistor output: 0.1 A		AFP0HXY64D2P

Communication cassettes

Product name	Specifications	Part No.
FP0H communication cassettes	RS-232C 1 channel	AFP0HCCS1
	RS-232C 2 channel	AFP0HCCS2
	RS-485 1 channel (insulated)	AFP0HCCM1
	RS-232C 1 channel and RS-485 1 channel (insulated)	AFP0HCCS1M1

Positioning units

Product name	Output type	Number of occupied points	Number of axes controlled	Speed command	Part No.
FP0H positioning units	Transistor	Input 16 points, Output 16 points	1 axis	1 pps to 500 kpps	AFP0HPG01T
		Input 32 points, Output 32 points	2 axes		AFP0HPG02T
	Line driver	Input 16 points, Output 16 points	1 axis	1 pps to 4 Mpps	AFP0HPG01L
		Input 32 points, Output 32 points	2 axes		AFP0HPG02L

Expansion units (Common to FPΣ)

Product name	Specifications	Product No.	Part No.
FPΣ positioning unit RTEX	Network type, 2 axes, connected to Panasonic's MINAS A4N / A5IIN / A6N	FPG-PN2AN	AFP0G43610
	Network type, 4 axes, connected to Panasonic's MINAS A4N / A5IIN / A6N	FPG-PN4AN	AFP0G43620
	Network type, 8 axes, connected to Panasonic's MINAS A4N / A5IIN / A6N	FPG-PN8AN	AFP0G43630
Control Configurator PM	Dedicated tool software for positioning unit RTEX, Japanese version		AFP0S66110
	Dedicated tool software for positioning unit RTEX, English version		AFP0S66510

Expansion units (Common to FP0R)

Product name	Number of I/O points	Rated voltage	Input specifications	Output specifications	Connection type	Part No.	
FP0R-E8 expansion units	8 points	Input: 8 points	—	24 V DC ±common	—	MIL connector	AFP0RE8X
	8 points	Input: 4 points Output: 4 points	24 V DC	24 V DC ±common	Relay output: 2 A	Terminal block	AFP0RE8RS
					Molex connector	AFP0RE8RM	
	8 points	Output: 8 points	24 V DC	—	Relay output: 2 A	Terminal block	AFP0RE8YRS
	8 points	Output: 8 points	—	—	NPN transistor output: 0.3 A	MIL connector	AFP0RE8YT
8 points	Output: 8 points	—	—	PNP transistor output: 0.3 A	MIL connector	AFP0RE8YP	
FP0R-E16 expansion units	16 points	Input: 16 points	—	24 V DC ±common	—	MIL connector	AFP0RE16X
	16 points	Input: 8 points Output: 8 points	24 V DC	24 V DC ±common	Relay output: 2 A	Terminal block	AFP0RE16RS
					Molex connector	AFP0RE16RM	
	16 points	Input: 8 points Output: 8 points	—	—	NPN transistor output: 0.3 A	MIL connector	AFP0RE16T
	16 points	Input: 8 points Output: 8 points	—	—	PNP transistor output: 0.3 A	MIL connector	AFP0RE16P
	16 points	Output: 8 points	—	—	NPN transistor output: 0.3 A	MIL connector	AFP0RE16YT
16 points	Output: 16 points	—	—	PNP transistor output: 0.3 A	MIL connector	AFP0RE16YP	
FP0R-E32 expansion units	32 points	Input: 16 points Output: 16 points	—	24 V DC ±common	NPN transistor output: 0.3 A	MIL connector	AFP0RE32T
		Input: 16 points Output: 16 points	—	24 V DC ±common	PNP transistor output: 0.3 A	MIL connector	AFP0RE32P

- Notes: 1) The relay output type expansion units come with a power cable (part number: **AFP0581**). (The transistor output type expansion units need no power cable.)
2) The terminal block type relay output units have two terminal blocks (9 pins) made by Phoenix. Use a 2.5 mm **0.098 in** wide screwdriver. Preferably use the specific terminal block screwdriver (part number: **AFP0806**, Phoenix type code SZS0, 4 × 2.5 mm **0.098 in**) or equivalent.
3) The connector type relay output units have two connectors made by Nihon Molex (Molex type code 51067-0900, 9 pins). Use the specific Molex connector press-fit tool (part number: **AFP0805**, Nihon Molex type code 57189-5000) or equivalent.
4) The transistor output units have a press-fit socket for wire-pressed terminal cable and contacts. Use the press-fit tool (part number: **AXY52000FP**) for wire-pressed terminal cable.

Product types

Expansion units (Common to FP0R)

Product name	Specifications	Product No.	Part No.
FP0R analog input unit	<Input specifications> Number or channels: 4 channels Voltage -10 to +10 V, -5 to +5 V, 0 to +10 V, 0 to +5 V (Resolution: 1/16,000) Current 0 to 20 mA (Resolution: 1/16,000)	—	AFP0RAD4
FP0R analog input unit	<Input specifications> Number or channels: 8 channels Voltage -10 to +10 V, -5 to +5 V, 0 to +10 V, 0 to +5 V (Resolution: 1/16,000) Current 0 to 20 mA (Resolution: 1/16,000)	—	AFP0RAD8
FP0R analog input and output unit	<Input specifications> Number or channels: 2 channels Voltage -10 to +10 V, -5 to +5 V, 0 to +10 V, 0 to +5 V (Resolution: 1/16,000) Current 0 to 20 mA (Resolution: 1/16,000)	—	AFP0RA21
	<Output specifications> Number or channels: 1 channel Voltage -10 to +10 V, -5 to +5 V, 0 to +10 V, 0 to +5 V (Resolution: 1/16,000) Current 0 to 20 mA (Resolution: 1/16,000)		
FP0R analog input and output unit	<Input specifications> Number or channels: 4 channels Voltage -10 to +10 V, -5 to +5 V, 0 to +10 V, 0 to +5 V (Resolution: 1/16,000) Current 0 to 20 mA (Resolution: 1/16,000)	—	AFP0RA42
	<Output specifications> Number or channels: 2 channels Voltage -10 to +10 V, -5 to +5 V, 0 to +10 V, 0 to +5 V (Resolution: 1/16,000) Current 0 to 20 mA, 4 to 20 mA (Resolution: 1/16,000)		
FP0R analog output unit	<Output specifications> Number or channels: 4 channels Voltage -10 to +10 V, -5 to +5 V, 0 to +10 V, 0 to +5 V (Resolution: 1/16,000) Current 0 to 20 mA, 4 to 20 mA (Resolution: 1/16,000)	—	AFP0RDA4
FP0 thermocouple units	K, J, T and R thermocouple, 4 channels, Resolution: 0.1 °C	FP0-TC4	AFP0420
	K, J, T and R thermocouple, 8 channels, Resolution: 0.1 °C	FP0-TC8	AFP0421
FP0 CC-Link slave unit	Unit to connect to FP0 CC-link	FP0-CCLS	AFP07943

Programming tools



Product name	Supported version	Supported OS	Part No.
Programming software for Windows® Control FPWIN GR7	Ver. 2.23.0 or later	Windows®10 (32-bit / 64-bit) / Windows®8.1 (32-bit / 64-bit) / Windows®8 (32-bit / 64-bit) / Windows®7 SP1 or later (32-bit / 64-bit) / Windows® Vista SP2 / Windows® XP SP3	AFP0SGR7JP
			AFP0SGR7JPS
			AFP0SGR7EN
			AFP0SGR7ENS
Programming software for Windows® Control FPWIN Pro7	Ver. 7.2.3.0 or later	Windows®10 (32-bit / 64-bit) / Windows®8.1 (32-bit / 64-bit) / Windows®8 (32-bit / 64-bit) / Windows®7 SP1 or later (32-bit / 64-bit)	AFP0SPR7A
			AFP0SPR7AS

Notes: 1) Windows is trademarks or registered trademarks of Microsoft Corporation in the United States and other countries.
2) Please use a commercially available USB2.0 cable (A type mini B) for connecting a control unit with a PC.

Option

Product name	Specifications	Part No.
Backup battery	Required for backup of the data registers and when the calendar timer feature is used.	AFPX-BATT

Others

Product name	Shape	Descriptions	Part No.
Power cable	—	Cable length 1 m 3.281 ft Supplied with FP0H control unit.	AFP0G805
Scattered wire connector set (40 pins)		Supplied with FP0H control unit Supplied with FP0H expansion I/O unit. (including 2 pcs.)	AFP2801
Flat cable connector set (40 pins)		For FP0H control unit and FP0H expansion I/O unit. Used when flat cables are used for bulk wiring. (including 2 pcs.)	AFP2802

GT series Lineup

List of related products Programmable display GT series



Product name	Description						Part No.
	LCD	Screen size	Power supply	Communication port	Color of front panel	SD memory card slot	
Tough GT03M-E	TFT monochrome LCD (white backlight)	3.5 inch	24 V DC	RS-232C	Silver	Not available	AIG03MQ03DE
				RS-422 / RS-485			AIG03MQ05DE
Tough GT03T-E	TFT color LCD (white backlight)	3.5 inch	24 V DC	RS-232C	Silver	Available	AIG03TQ13DE
				RS-422 / RS-485			AIG03TQ15DE
Tough GT32M-E	TFT monochrome LCD (white backlight)	5.7 inch	24 V DC	RS-232C	Silver	Available	AIG32MQ03DE
				RS-422 / RS-485			AIG32MQ05DE
Tough GT32T-E	TFT color LCD (white backlight)	5.7 inch	24 V DC	RS-232C	Silver	Available	AIG32TQ03DE
				RS-422 / RS-485			AIG32TQ05DE
GT02L	STN monochrome LCD (white backlight)	3.7 inch	5 V DC	RS-232C	Black	Not available	AIG02LQ02D
				RS-422 / RS-485			AIG02LQ04D
GT02M	TFT monochrome LCD (white/pink/red backlight)	3.8 inch	5 V DC	RS-232C	Pure black	Not available	AIG02MQ02D
					Hairline silver		AIG02MQ03D
				RS-422 / RS-485	Pure black		AIG02MQ04D
					Hairline silver		AIG02MQ05D
		24 V DC	RS-232C	Pure black	AIG02MQ12D		
				Hairline silver	AIG02MQ13D		
			RS-422 / RS-485	Pure black	AIG02MQ14D		
				Hairline silver	AIG02MQ15D		
			RS-232C	Pure black	Available	AIG02MQ22D	
				Hairline silver	Available	AIG02MQ23D	
RS-422 / RS-485	Pure black	Available	AIG02MQ24D				
	Hairline silver	Available	AIG02MQ25D				
GT02G	TFT monochrome LCD (green/orange/red backlight)	3.8 inch	5 V DC	RS-232C	Pure black	Not available	AIG02GQ02D
					Hairline silver		AIG02GQ03D
				RS-422 / RS-485	Pure black		AIG02GQ04D
					Hairline silver		AIG02GQ05D
		24 V DC	RS-232C	Pure black	AIG02GQ12D		
				Hairline silver	AIG02GQ13D		
			RS-422 / RS-485	Pure black	AIG02GQ14D		
				Hairline silver	AIG02GQ15D		
			RS-232C	Pure black	Available	AIG02GQ22D	
				Hairline silver	Available	AIG02GQ23D	
RS-422 / RS-485	Pure black	Available	AIG02GQ24D				
	Hairline silver	Available	AIG02GQ25D				
GT05M	TFT monochrome LCD (white/pink/red backlight)	3.5 inch	24 V DC	RS-232C	Pure black	Available	AIG05MQ02D
					Hairline silver	Available	AIG05MQ03D
				RS-422 / RS-485	Pure black	Available	AIG05MQ04D
					Hairline silver	Available	AIG05MQ05D
GT05G	TFT monochrome LCD (green/orange/red backlight)	3.5 inch	24 V DC	RS-232C	Pure black	Available	AIG05GQ02D
					Hairline silver	Available	AIG05GQ03D
				RS-422 / RS-485	Pure black	Available	AIG05GQ04D
					Hairline silver	Available	AIG05GQ05D
GT05S	TFT color LCD (white backlight)	3.5 inch	24 V DC	RS-232C	Pure black	Available	AIG05SQ02D
					Hairline silver	Available	AIG05SQ03D
				RS-422 / RS-485	Pure black	Available	AIG05SQ04D
					Hairline silver	Available	AIG05SQ05D
GT703M	TFT monochrome LCD (white/pink/red backlight)	3.8 inch	5 V DC	RS-232C	Pure black	Available	AIG703WMN1B5
					Silver		AIG703WMN1S5
			RS-422 / RS-485	Pure black	Available	AIG703WMNMB5	
				Silver	Available	AIG703WMNMS5	
		24 V DC	RS-232C	Pure black	Available	AIG703WMN1B2	
				Silver	Available	AIG703WMN1S2	
	RS-422 / RS-485	Pure black	Available	AIG703WMNMB2			
		Silver	Available	AIG703WMNMS2			
GT703G	TFT monochrome LCD (green/orange/red backlight)	3.8 inch	5 V DC	RS-232C	Pure black	Available	AIG703WGN1B5
					Silver		AIG703WGN1S5
			RS-422 / RS-485	Pure black	Available	AIG703WGNMB5	
				Silver	Available	AIG703WGNMS5	
		24 V DC	RS-232C	Pure black	Available	AIG703WGN1B2	
				Silver	Available	AIG703WGN1S2	
			RS-422 / RS-485	Pure black	Available	AIG703WGNMB2	
				Silver	Available	AIG703WGNMS2	

GT series Lineup

List of related products Programmable display GT series



Product name	Description						Part No.
	LCD	Screen size	Power supply	Communication port	Color of front panel	SD memory card slot	
GT12M	TFT monochrome LCD (white/pink/red backlight)	4.6 inch	24 V DC	RS-232C	Pure black	Not available	AIG12MQ02D
					Hairline silver		AIG12MQ03D
				RS-422 / RS-485	Pure black	Not available	AIG12MQ04D
					Hairline silver		AIG12MQ05D
				RS-232C	Pure black	Available	AIG12MQ12D
					Hairline silver		AIG12MQ13D
				RS-422 / RS-485	Pure black	Available	AIG12MQ14D
					Hairline silver		AIG12MQ15D
GT12G	TFT monochrome LCD (green/orange/red backlight)	4.6 inch	24 V DC	RS-232C	Pure black	Not available	AIG12GQ02D
					Hairline silver		AIG12GQ03D
				RS-422 / RS-485	Pure black	Not available	AIG12GQ04D
					Hairline silver		AIG12GQ05D
				RS-232C	Pure black	Available	AIG12GQ12D
					Hairline silver		AIG12GQ13D
				RS-422 / RS-485	Pure black	Available	AIG12GQ14D
					Hairline silver		AIG12GQ15D
GT704M	TFT monochrome LCD (white/pink/red backlight)	4.6 inch	24 V DC	RS-232C	Pure black	Available	AIG704WMN1B2
					Silver		AIG704WMN1S2
				RS-422 / RS-485	Pure black	Available	AIG704WMNMB2
					Silver		AIG704WMNMS2
GT704G	TFT monochrome LCD (green/orange/red backlight)	4.6 inch	24 V DC	RS-232C	Pure black	Available	AIG704WGN1B2
					Silver		AIG704WGN1S2
				RS-422 / RS-485	Pure black	Available	AIG704WGNMB2
					Silver		AIG704WGNMS2
GT32M-R	TFT monochrome LCD (white backlight)	5.7 inch	24 V DC	RS-232C	Pure black	Available	AIG32MQ02DR
					Hairline silver		AIG32MQ03DR
				RS-422 / RS-485	Pure black	Available	AIG32MQ04DR
					Hairline silver		AIG32MQ05DR
GT32T-R	TFT color LCD (white backlight)	5.7 inch	24 V DC	RS-232C	Pure black	Available	AIG32TQ02DR
					Hairline silver		AIG32TQ03DR
				RS-422 / RS-485	Pure black	Available	AIG32TQ04DR
					Hairline silver		AIG32TQ05DR
GT707	TFT color LCD (white backlight)	7 inch widescreen	24 V DC	RS-232C	Black	Available	AIG707WCL1G2
Terminal GTWIN Ver.2	Japanese version	Terminal GTWIN CD-ROM					AIGT8000V2
	English version	Terminal GTWIN CD-ROM					AIGT8001V2
Terminal GTWIN Ver.2 Upgrade version (Note)	Japanese version	Terminal GTWIN CD-ROM					AIGT8000V2R
	English version	Terminal GTWIN CD-ROM					AIGT8001V2R
Terminal GTWIN Ver.3	Japanese version	Terminal GTWIN CD-ROM					AIGSGT7JP
	English version	Terminal GTWIN CD-ROM					AIGSGT7EN

Note: It enables to upgrade from Terminal GTWIN Ver. 1 to Ver. 2.

Dimensions (Unit: mm in)

The CAD data can be downloaded from our website.

AFP0HC32T AFP0HC32P Control units

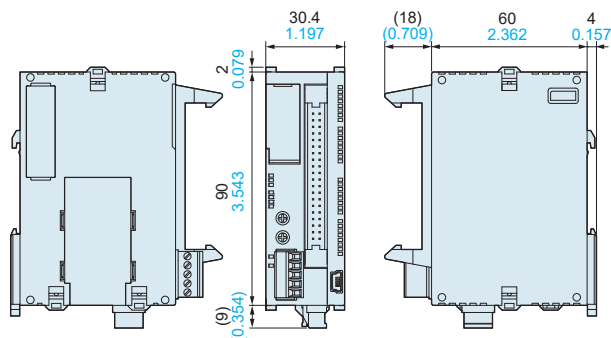

AFP0HC32ET AFP0HC32EP Control units

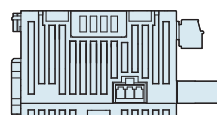
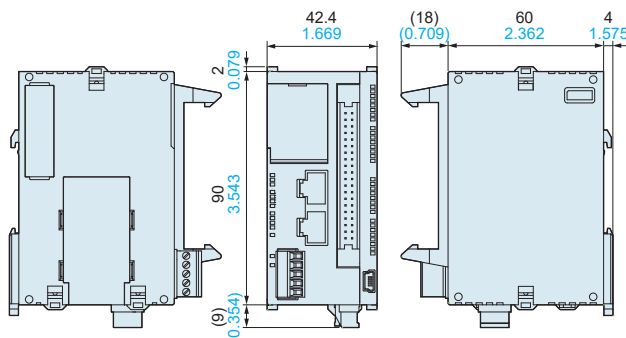

Dimensions (Unit: mm in)

The CAD data can be downloaded from our website.

AFP0HXY64D2T AFP0HXY64D2P Expansion I/O units

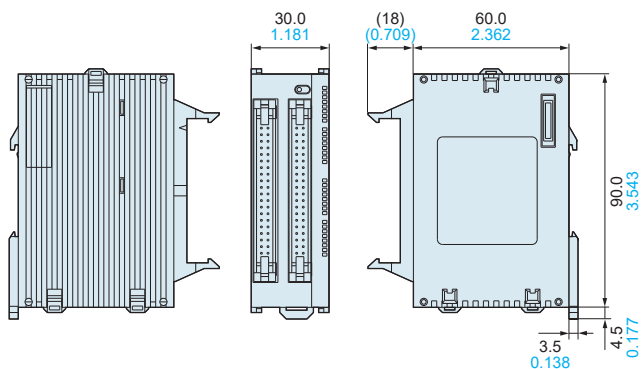

AFP0HPG01T AFP0HPG01L AFP0HPG02T AFP0HPG02L Positioning units

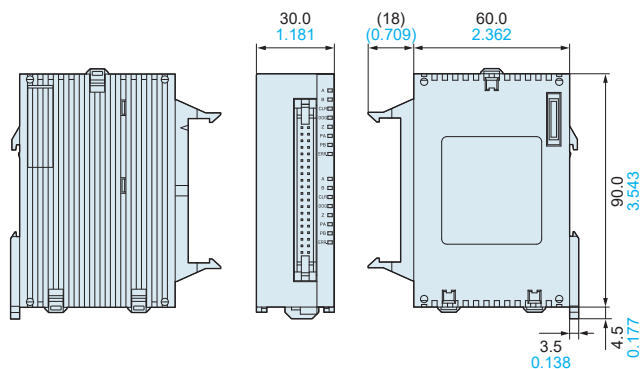

AFP0HCCS1 AFP0HCCS2 AFP0HCCM1 AFP0HCCS1M1 Communication cassettes

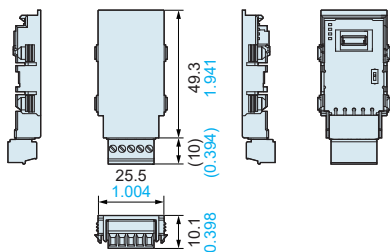

Please contact

Panasonic Corporation

Electromechanical Control Business Division
 ■ 1006, Oaza Kadoma, Kadoma-shi, Osaka 571-8506, Japan
industrial.panasonic.com/ac/e/



©Panasonic Corporation 2018