

**Programmable Controller Unit  
AFPXHC□**

MJE-FPXHCG No.0074-85V

Thank you for purchasing the Panasonic product. Read this installation instructions carefully and follow them to install the product correctly. After installation completes, keep this leaflet in a safe and handy place so that you can refer to it whenever necessary. Refer to the Manual for the detailed explanation.

**SAFETY PRECAUTIONS**

Observe the following notices to ensure personal safety or to prevent accidents.

This leaflet classifies dangers into "⚠ **WARNING**" and "⚠ **CAUTION**" according to the level of danger.

- WARNING** If critical situations that could lead to user's death or serious injury is assumed by mishandling of the product.
- CAUTION** If critical situations that could lead to user's injury or only property damage is assumed by mishandling of the product.

**WARNING**

- Always take precautions to ensure the overall safety of your system, so that the whole system remains safe in the event of failure of this product or other external factor.
- Do not use this product in areas with inflammable gas. It could lead to an explosion.
- Exposing this product to excessive heat or open flames could cause damage to the lithium battery or other electronic parts.
- Battery may explode if mistreated. Do not recharge, disassemble or dispose of fire.

**CAUTION**

- To prevent excessive exothermic heat or smoke generation, use this product at the values less than the maximum of the characteristics and performance that are assured in these specifications.
- Do not dismantle or remodel the product. It could cause excessive exothermic heat or smoke generation.
- Do not touch the terminal while turning on electricity. It could lead to an electric shock.
- Use the external devices to function the emergency stop and interlock circuit.
- Connect the wires or connectors securely. The loose connection could cause excessive exothermic heat or smoke generation.
- Do not allow foreign matters such as liquid, flammable materials, metals to go into the inside of the product. (It could cause excessive exothermic heat or smoke generation.)
- Do not undertake construction (such as connection and disconnection) while the power supply is on. It could lead to an electric shock.
- Be sure to connect the function earth terminal to the ground (Class-D grounding). Failure to do so could lead to an electric shock.
- If the equipment is used in a manner not specified by the Panasonic, the protection provided by the equipment may be impaired.
- This product has been developed / produced for industrial use only.

**1 BEFORE INSTALLATION**

**Environmental requirements**

- Surrounding air temperature 0°C to +55°C
- Surrounding air humidity 10% to 95%RH (at 25°C), no-condensing
- Free from dust, smoke, conducting dust, and/or corrosive or inflammable gas
- Free from water, oil, and/or chemicals
- Free from shock and/or vibration
- Apart from high-voltage line (or device), power wire (or device), wireless transmission device, device with large switching surge, and/or heat-generating device (for 100mm or more)
- Pollution degree 2
- Altitude: 2,000m above sea level or lower
- Equipment class: Class 1
- Overvoltage category: II
- Installation location: In a control panel which has a protective construction IP54 or higher (made from metal that is of adequate strength).

Indoor use.

**Notes on handling**

- Do not directly touch the connector pin to avoid damage due to static electricity.
- Always touch a grounded piece of metal in order to discharge static electricity before handling this product.
- Do not connect a unit other than our FP series to the top connector on the unit.
- Use copper wires with a temperature rating of 80°C or higher.
- Use copper wires with a temperature rating of 105°C or higher for the relay output.

**2 PART NAMES AND DIMENSIONS**

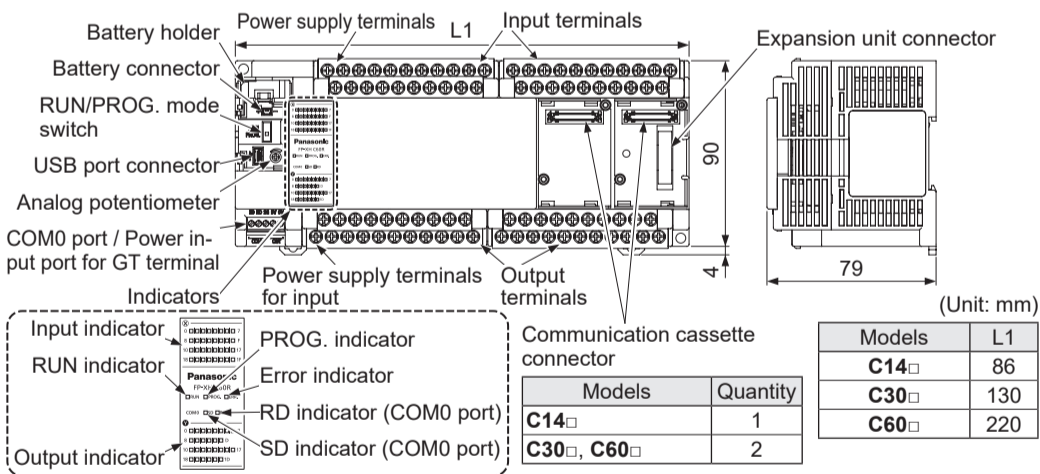

**3 INSTALLATION**

**Installing on DIN rail**

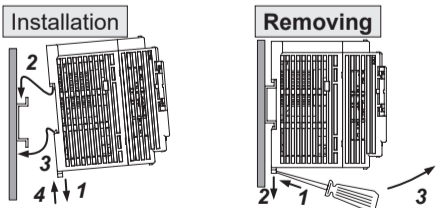

**Installation direction**

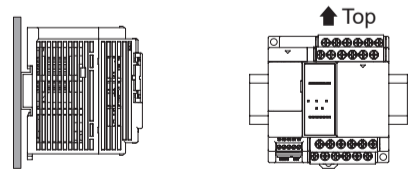

Do not install the unit in other directions than shown above to prevent temperature rise.

**Installing with screws**

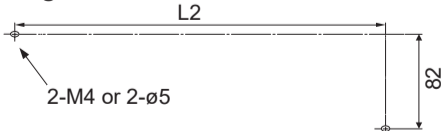

Models	C14□	C30□	C60□
L2	78	122	212

**Installing backup battery**

- The backup battery is optional. Purchase the AFPBAT001 separately.
  - The backup battery can be installed whether the power is ON or OFF.
- Open the operation cover and battery cover.
  - Set the backup battery in the battery holder.
  - Connect the battery connector.
  - Close the card cover.

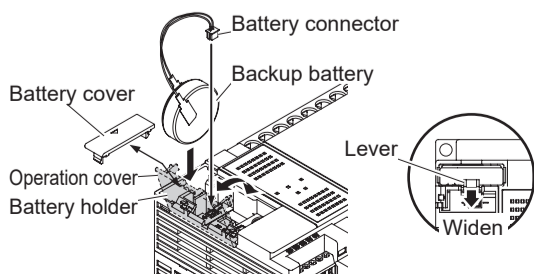

**4 CONNECTION**

**Connecting the expansion unit**

**Note** Connecting/disconnecting the expansion cable must be carried out when the power supply is off. Connecting/disconnecting the expansion cable must be carried out before the add-on cassette is installed.

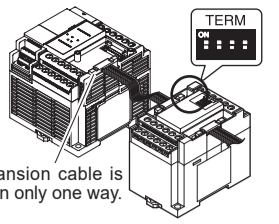

The expansion cable is inserted in only one way.

	TERM switch
Middle expansion unit	All OFF
Terminal expansion unit	All ON

\*: If the terminal unit is an Expansion FP0 Adapter, the TERM switch should be all OFF.

**Connecting the add-on cassette**

**Note** It can be installed in the cassette mounting part of the control unit. For the details on the installation, refer to the installation manual for the add-on cassette.

**5 WIRING**

**Note** Wiring must be carried out when the power supply is off.

**<Power supply terminals, Power supply terminals for input, Input terminals, Output terminals>**

- Appropriate electrical cables (strand wire)**
  - Size: AWG 22 to 14, Tightening torque: 0.5N·m to 0.6N·m
- Solderless terminal**
  - M3 terminal screws are used for the terminal. The following suitable solderless terminals are recommended for the wiring to the terminals.

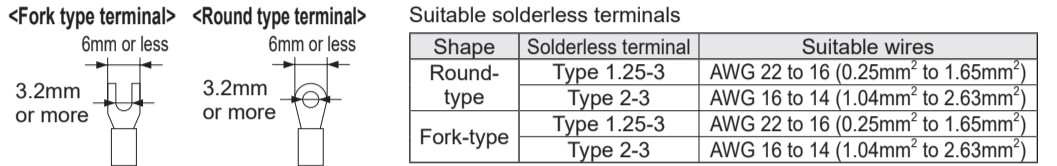

**Connecting the power supply and input / output part**

**<AC power supply>**

Model	Rated voltage	Allowable voltage range	Rated current
C14R	100V to 240V AC	85V to 264V AC	0.35A
C14T			0.3A
C30R			0.6A
C30T			0.55A
C60R			0.7A
C60T			0.65A

**<DC power supply>**

Model	Rated voltage	Allowable voltage range	Rated current
C14RD	24V DC	20.4V to 28.8V DC	0.45A
C14TD			0.35A
C30RD			0.6A
C30TD			0.6A
C60RD			0.8A
C60TD			0.8A

- Connect the same power supply to the COM terminal of the relay output.
- Be sure to ground the function earth terminal to eliminate any effects from noise emission.

The externally connected DC power supply must conform to the SELV (Safety Extra-Low Voltage) and LIM (Limited Energy Circuit).

**Terminal layout**

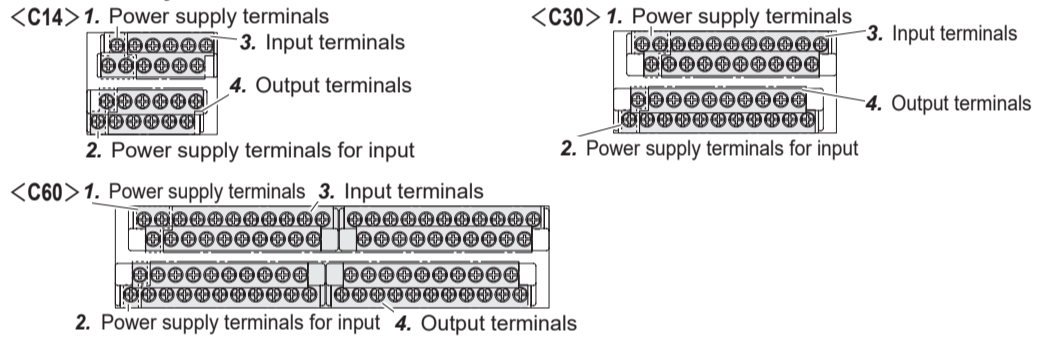

**1. Power supply terminals**

**Note** The power supply for the control unit and the expansion unit should be the same, and should be turned on/off simultaneously. Do not connect the 100-240 V AC to the input terminal or the 24 V DC terminal. (It could lead to a burnout.)

**<AC power supply>**



**2. Power supply terminals for input (AC power supply type only)**

Models	Rated output voltage	Rated max. output current
C14	24V DC±10%	0.15A
C30/C60	24V DC±10%	0.40A

\*: Do not connect this power supply in parallel with other DC power supplies.

**3. Input terminals (24 V DC input)**

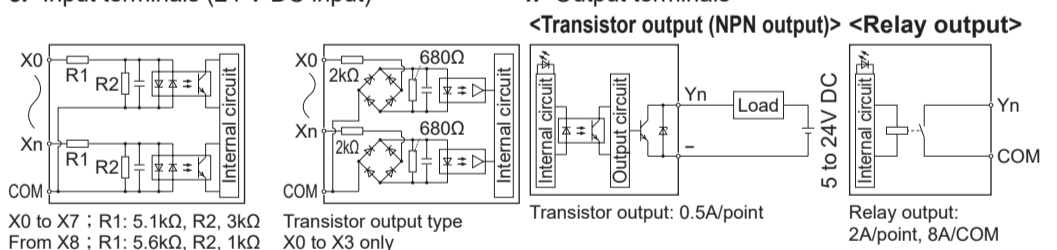

**<COM0 port / Power input port for GT terminal>**

- Appropriate electrical cables (strand wire)**
  - Size: AWG 28 to 18 (0.08mm<sup>2</sup> to 1.00mm<sup>2</sup>)
  - Tightening torque: 0.22N·m to 0.25N·m
- Specialized tool**
  - Blade size: 0.4 × 2.5 (Product No. AFP0806) [Phoenix Contact Co.: SZS0.4×2.5 (1205037)]
- Terminal layout** SD RD SG 5V 0V

**Grounding**

- Be sure to properly ground the unit.
- Do not use the same ground used by other devices. Doing so may cause adverse effects.
- The grounding connection should have a resistance of less than 100Ω.
- Use a 2mm<sup>2</sup> (AWG14) wire for grounding.

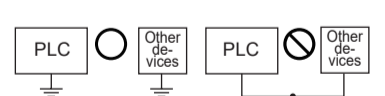

**6 PRE-TRIAL CHECKLIST**

- Is the unit securely fixed to the control panel?
- Are the connectors firmly connected?
- Are the connectors properly connected with respect to their voltage and polarity?

**7 CE Marking**

- The FP-XH series complies with the EMC Directive and Low Voltage Directive.
- EMC Directive (2014/30/EU): EN 61131-2, Low Voltage Directive (2014/35/EU): EN 61131-2
- All work related to transportation, installation, test operation, troubleshooting and maintenance must be performed in accordance with applicable safety regulations and standards by experienced technicians.

Panasonic Corporation  
Panasonic Industrial Devices SUNX Co., Ltd.  
<https://panasonic.net/id/pidsx/global>