

Programmable Controller

FP-XH Control Unit Programming Manual

Domestic version

(MEMO)

Introduction

Thank you for purchasing a Panasonic product. Before you use the product, please carefully read through the user's manual, and understand it in detail to use the product properly.

Types of Manuals

- This manual describes the basic instructions and high-level instructions used by the FP-XH Series Control Unit.
- The following user's manuals are available for the FP-XH series. Please refer to a relevant manual for the unit and purpose of your use.
- The manuals can be downloaded from our Download Center:https://industrial.panasonic.com/ac/e/dl_center/.

Unit name or purpose of use	Manual name	Manual code
FP-XH Control Unit	FP-XH User's Manual (Basic)	WUME-FPXHBASG
	FP-XH Series Programming Manual	WUME-FPXHPGRG
Positioning Function / PWM Output / High-speed Counter Function	FP-XH User's Manual (Positioning / PWM Output / High-speed Counter)	WUME-FPXHPOSG
Communication Functions		
FP-X Extension (Communication) Cassette	FP-XH User's Manual (COM Communication)	WUME-FPXHCOMG
FP-X Expansion Unit	FP-X Series User's Manual	WUME-FPX
FP-X Function Cassettes		

(MEMO)

Table of Contents

1 List of Instruction Words	1-1
1.1 List of Basic Instruction Words.....	1-2
1.2 List of High-level Instructions.....	1-8
2 Sequence Basic Instructions	2-1
2.1 ST, ST/ and OT (Start, Start Not and Out).....	2-2
2.2 DST, DST/ (Direct start, direct start Not).....	2-4
2.3 DOT (direct out).....	2-7
2.4 / (Not).....	2-10
2.5 AN, AN/ (AND, AND Not).....	2-11
2.6 DAN, DAN/ (Direct AND, Direct AND NOT).....	2-13
2.7 OR, OR/ (OR, OR Not).....	2-16
2.8 DOR, DOR/ (Direct OR, Direct OR Not).....	2-18
2.9 ST \uparrow , ST \downarrow , AN \uparrow , AN \downarrow , OR \uparrow , OR \downarrow (Rise Detection and Fall Detection Contact Instructions).....	2-21
2.10 ALT (Alternate out).....	2-23
2.11 ANS (and stack).....	2-25
2.12 ORS (OR Stack).....	2-27
2.13 PSHS, RDS, POPS (Push stack, Read stack, Pop stack).....	2-29
2.14 DF, DF/ (rise differential and fall differential).....	2-33
2.15 DFI [Rise differential (initial execution type)].....	2-38
2.16 SET, RST (Set, Reset).....	2-40
2.17 DSET/DRST (Direct Set/Direct Reset).....	2-43
2.18 KP (Keep).....	2-47
2.19 DKP (Direct Keep).....	2-49
2.20 NOP.....	2-52
3 Basic Function Instructions	3-1
3.1 TML/TMR/TMX/TMY (0.001 s, 0.01 s, 0.1 s, 1 s on-delay timer).....	3-2
3.2 F137 STMR (16-Bit, 0.01-s ON-Delay Timer).....	3-9
3.3 F183 DSTM (32-Bit, 0.01 s ON-Delay Timer).....	3-12
3.4 CT [Counter (Preset Subtraction Expression)].....	3-16
3.5 F118 UDC (Up/Down counter).....	3-23
3.6 SR (Shift Register).....	3-26
3.7 F119 LRSR (Left/Right Shift Register).....	3-29
3.8 F182 FILTR (Time Literal Process).....	3-32
4 Control Instructions	4-1

4.1 MC/MCE (Master Control Relay / Master Control Relay End).....	4-2
4.2 JP/LBL (Jump/Label)	4-7
4.3 LOOP, LBL (Loop, Label).....	4-11
4.4 ED (End).....	4-15
4.5 CNDE (Conditional end)	4-16
4.6 EJECT.....	4-18
5 Step ladder instructions	5-1
5.1 SSTP, NSTL (NSTP), CSTP, STPE (Start Step, Next Step, Clear Step, Step End).....	5-2
5.2 SCLR (Clear Multiple Processes)	5-17
6 Subroutine instructions	6-1
6.1 CALL/SUB/RET (Subroutine call, Subroutine entry, Subroutine return)	6-2
7 Interrupt Instructions.....	7-1
7.1 INT/IRET (Interrupt / Interrupt Return).....	7-2
7.2 ICTL (Interrupt Control).....	7-8
7.2.1 How to start the interrupt program when executing the high-speed counter match ON / match OFF instruction	7-15
8 Special Setting Instructions.....	8-1
8.1 SYS1 (Communication Condition Setting).....	8-2
8.2 SYS1 (Password setting).....	8-8
8.3 SYS1 (Interrupt setting)	8-10
8.4 SYS1 [PC (PLC) Link Time Setting].....	8-12
8.5 SYS1 (MEWTOCOL-COM response control)	8-14
8.6 SYS1 (Change high-speed counter operation mode).....	8-16
8.7 SYS2 [System Register (No.40 to No.48, No.50 to 57) Change]	8-18
9 Compare Contact Instructions	9-1
9.1 ST=, ST <>, ST>, ST>=, ST<, ST<= [16-Bit Data Comparison (Start)].....	9-2
9.2 AN=, AN<>, AN>, AN>=, AN<, AN<= [16-bit data comparison (AND)].....	9-4
9.3 OR= OR <> OR > OR >= OR < OR <= [16-bit data comparison (OR)]	9-6
9.4 STD=, STD<>, STD>, STD>=, STD<, STD<= [32-bit data comparison (start)]	9-8
9.5 AND=, AND<>, AND>, AND>=, AND<, AND<= [32-Bit Data Comparison (AND)].....	9-10
9.6 ORD=, ORD<>, ORD>, ORD>=, ORD<, ORD<= [32-Bit Data Comparison (OR)].....	9-12

9.7	STF=, STF<>, STF>, STF>=, STF< and STF<= [Floating point real number data comparison (start)]	9-14
9.8	ANF=, ANF<>, ANF>, ANF>=, ANF<, ANF<= [Floating point real number data comparison (AND)]	9-16
9.9	ORF=, ORF<>, ORF>, ORF>=, ORF<, ORF<= [floating point real number data comparison (OR)]	9-18
10	Transfer Instructions	10-1
10.1	F0 MV (16-bit data transfer)	10-2
10.2	F0 MV (10 μ sec Ring Counter Read)	10-4
10.3	F1 DMV (32-Bit Data Transfer)	10-5
10.4	F2 MV/ (16-bit data inversion and transfer)	10-7
10.5	F3 DMV/ (32-bit data inversion and transfer)	10-9
10.6	F5 BTM (Bit Data Transfer)	10-11
10.7	F6 DGT (Digit data transfer)	10-16
10.8	F7 MV2 (16-bit 2 Data Transfer)	10-20
10.9	F8 DMV2 (32-bit 2 Data Transfer)	10-22
10.10	F10 BKMV (Block Move)	10-24
10.11	F11 COPY (Block Copy)	10-27
10.12	F12 ICRD (F-ROM Read)	10-29
10.13	P13 ICWT (F-ROM Write)	10-31
10.14	F15 XCH (16-bit data exchange)	10-33
10.15	F16 DXCH (32-bit data exchange)	10-35
10.16	F17 SWAP (Higher/Lower Byte Exchange in 16-Bit Data)	10-37
10.17	F18 BXCH (Block Exchange)	10-39
10.18	F190 MV3 (16-Bit 3-Data Batch Transfer)	10-41
10.19	F191 DMV3 (32-Bit 3-Data Batch Transfer)	10-43
11	Binary Arithmetic Instructions	11-1
11.1	F20 + (16-Bit Addition)	11-2
11.2	F21 D+ (32-bit Addition)	11-4
11.3	F22 + [16-bit addition (storage destination can be specified)]	11-6
11.4	F23 D+ [32-bit addition (storage destination can be specified)]	11-8
11.5	F25 - (16-bit Subtraction)	11-10
11.6	F26 D- (32-bit subtraction)	11-13
11.7	F27 - [16-bit Subtraction (Storage Destination Specifiable)]	11-15
11.8	F28 D- [32-Bit Subtraction (Can Specify Storage Destination)]	11-18
11.9	F30 * (Hexadecimal Multiplication)	11-20
11.10	F31 D* (32-Bit Data Multiplication)	11-22
11.11	F32 % (16-Bit Data Division)	11-24
11.12	F33 D% (32-Bit Data Division)	11-26

11.13	F34 *W [16-bit data multiplication (resulting in one word)]	11-28
11.14	F35 +1 [16-bit increment (+1)]	11-30
11.15	F36 D+1 [32-Bit Increment (+1)]	11-32
11.16	F37 -1 [16-Bit Decrement (-1)]	11-34
11.17	F38 D-1 [32-bit decrement (-1)]	11-36
11.18	F39 D*D [32-Bit Data Multiplication (Result in Two Words)]	11-38
12	BCD Data Arithmetic Instructions	12-1
12.1	F40 B+ (4-Digit Addition)	12-2
12.2	F41 DB+ (8-Digit Addition)	12-4
12.3	F42 B+ [4-digit addition (storage destination specifiable)]	12-6
12.4	F43 DB+ [8-digit addition (storage destination can be specified)]	12-8
12.5	F45 B- (4-Digit Subtraction)	12-10
12.6	F46 DB- (8-Digit Subtraction)	12-12
12.7	F47 B- [4-digit subtraction (storage destination specifiable)]	12-14
12.8	F48 DB- [8-digit subtraction (storage destination can be specified)]	12-16
12.9	F50 B* (4-Digit Multiplication)	12-18
12.10	F51 DB* (8-digit multiplication)	12-20
12.11	F52 B% (4-digit division)	12-22
12.12	F53 DB% (8-Digit Division)	12-24
12.13	F55 B+1 [4-digit BCD increment (+1)]	12-26
12.14	F56 DB+1 [8-digit BCD Increment (+1)]	12-28
12.15	F57 B-1 [4-digit BCD decrement (-1)]	12-30
12.16	F58 DB-1 [8-digit BCD Decrement (-1)]	12-32
13	Data Comparison Instructions	13-1
13.1	F60 CMP (16-bit data comparison)	13-2
13.2	F61 DCMP (32-Bit Data Comparison)	13-8
13.3	F62 WIN (16-Bit Data Band Comparison)	13-12
13.4	F63 DWIN (32-bit data band comparison)	13-14
13.5	F64 BCMP (Block match detection)	13-16
13.6	F373 DTR (16-bit data change detection)	13-19
13.7	F374 DDTR (32-bit data change detection)	13-21
14	Boolean Instructions	14-1
14.1	F65 WAN (Logical Conjunction of 16-Bit Data)	14-2
14.2	F66 WOR (16-bit data OR)	14-4
14.3	F67 XOR (16-bit data exclusive OR)	14-6
14.4	F68 XNR (Exclusive NOR of 16-bit data)	14-8
14.5	F69 WUNI (Word Coupling)	14-10

14.6	F215 DAND (32-bit data logical conjunction)	14-12
14.7	F216 DOR (OR Operation of 32-bit Data)	14-14
14.8	F217 DXOR (32-Bit Data Exclusive OR)	14-16
14.9	F218 DXNR (32-bit Data Exclusive NOR)	14-18
14.10	F219 DUNI (Double word combination)	14-20
15	Data Conversion Instructions	15-1
15.1	F70 BCC (Block Check Code Calculation)	15-3
15.2	F71 HEXA (HEX to Hexadecimal ASCII Conversion)	15-7
15.3	F72 AHEX (Hexadecimal ASCII to Hex conversion)	15-10
15.4	F73 BCDA (BCD to Decimal ASCII conversion)	15-14
15.5	F74 ABCD (Decimal ASCII Code to BCD Conversion)	15-18
15.6	F75 BINA (BIN to Decimal ASCII conversion)	15-22
15.7	F76 ABIN (Decimal ASCII Code to BIN Conversion)	15-25
15.8	F77 DBIA (BIN → Decimal ASCII Conversion)	15-29
15.9	F78 DABI (Decimal ASCII → BIN conversion)	15-32
15.10	F80 BCD (16-bit BIN to 4-digit BCD conversion)	15-36
15.11	F81 BIN (4-digit BCD to 16-bit BIN conversion)	15-38
15.12	F82 DBCD (32-bit BIN → 8-digit BCD conversion)	15-40
15.13	F83 DBIN (8-Digit BCD to 32-Bit BIN Conversion)	15-41
15.14	F84 INV (16-bit data invert)	15-42
15.15	F85 NEG (Hexadecimal Data Complement of 2)	15-43
15.16	F86 DNEG (32-bit Data Complement of 2)	15-44
15.17	F87 ABS (Absolute value of 16-bit data)	15-46
15.18	F88 DABS (Absolute value of 32-bit data)	15-47
15.19	F89 EXT (Sign Extension)	15-48
15.20	F90 DECO (Decode)	15-50
15.21	F91 SEGT (7-segment decode)	15-53
15.22	F92 ENCO (Encode)	15-55
15.23	F93 UNIT (16-bit data combine)	15-58
15.24	F94 DIST (16-Bit Data Distribution)	15-60
15.25	F96 SRC (16-Bit Data Search)	15-62
15.26	F97 DSRC (32-bit Data Search)	15-64
15.27	F230 TMSEC (Time data to second conversion)	15-66
15.28	F231 SECTM (Second to Time Data Conversion)	15-69
15.29	F235 GRY (16-Bit Binary to Gray Code Conversion)	15-72
15.30	F236 DGRY (32-Bit Data to Gray code)	15-73
15.31	F237 GBIN (16-bit gray code to binary conversion)	15-74
15.32	F238 DGBIN (32-bit Gray Code to Binary Conversion)	15-75
15.33	F240 COLM (Bit Line to Bit Column Conversion)	15-77

15.34	F241 LINE (Bit Column to Bit Line Conversion)	15-79
16	Data Shift Instruction	16-1
16.1	F100 SHR (n bit Right Shift of 16-bit Data)	16-2
16.2	F101 SHL (Left Shift of n Bits in 16-Bit Data)	16-4
16.3	F102 DSHR (Right Shift of n Bits in 32-Bit Data)	16-6
16.4	F103 DSHL (Left Shift of n Bits in 32-Bit Data)	16-8
16.5	F105 BSR (One digit shift to the right)	16-10
16.6	F106 BSL (One digit shift to the left)	16-12
16.7	F108 BITR (Right shift of multiple bits of an n-bit range)	16-14
16.8	F109 BITL (Left Shift of Multiple Bits of an n-Bit Range)	16-16
16.9	F110 WSHR (One word shift to the right)	16-18
16.10	F111 WSHL (Bulk Left Shift of Word Unit)	16-20
16.11	F112 WBSR (Bulk right shift of digit unit)	16-22
16.12	F113 WBSL (Digit Bulk Left Shift)	16-24
17	Data Rotation Instructions	17-1
17.1	F120 ROR (16-Bit Data Rotation to the Right)	17-2
17.2	F121 ROL (16-Bit Data Rotation to the Left)	17-4
17.3	F122 RCR [16-bit data rotation to the right (with carry)]	17-6
17.4	F123 RCL [16-Bit Data Left Rotation (with Carry)]	17-8
17.5	F125 DROR [32-Bit Data Right Rotation]	17-10
17.6	F126 DROL (32-bit data left rotation)	17-12
17.7	F127 DROR [32-bit data rotation to the right (with carry)]	17-14
17.8	F128 DRCL [32-bit data rotation to the left (with carry)]	17-16
18	Data Buffer Instruction	18-1
18.1	F98 CMPR (Compress shift read)	18-2
18.2	F99 CMPW (Compress Shift Write)	18-6
18.3	How to Use the FIFO (First-in First-out) Buffer	18-10
18.4	F115 FIFT (FIFO Buffer Definition)	18-11
18.5	F116 FIFR (Reading from FIFO buffer)	18-14
18.6	F117 FIFW (Data write to FIFO buffer)	18-18
19	Bit Manipulation Instructions	19-1
19.1	F130 BTS (16-bit data bit set)	19-2
19.2	F131 BTR (16-Bit Data Reset)	19-4
19.3	F132 BTI (16-bit Data Bit Invert)	19-6
19.4	F133 BTT (16-bit data bit test)	19-8
19.5	F135 BCU [Count of total number of 1 bits in 16-bit data]	19-10
19.6	F136 DBCU [Count of total number of ON bits (1) in 32-bit data]	19-12

20 Special Instructions	20-1
20.1 F138 HMSS (Hours, Minutes, and Seconds Data to Seconds Conversion).....	20-2
20.2 F139 SHMS (Converts Data to Hours, Minutes, and Seconds Data)	20-4
20.3 F140 STC (carry flag set).....	20-6
20.4 F141 CLC (Carry flag reset).....	20-7
20.5 F143 IORF (Partial I/O refresh).....	20-8
20.6 F147 PR (Printout).....	20-10
20.7 F148 ERR (Self-diagnostic Error Set).....	20-15
20.8 F149 MSG (Message Display).....	20-17
20.9 F150 READ (Data read from intelligent unit)	20-18
20.10 F151 WRT (Data Write into Intelligent Unit).....	20-21
20.11 F157 CADD (Date and Time Addition).....	20-24
20.12 F158 CSUB (Date and Time Subtraction).....	20-27
20.13 F160 DSQR (32-bit Data Square Root)	20-32
21 Communication Instruction	21-1
21.1 [F145 SEND] [F146 RECV] Instructions: Common Items.....	21-2
21.2 [F145 SEND] Data Transmission (MEWTOCOL-COM Master).....	21-4
21.3 [F146 RECV] Data Reception (MEWTOCOL-COM Master).....	21-7
21.4 [F145 SEND] Data Transmission (MODBUS Master: Function Code Specification).....	21-10
21.5 [F146 RECV] Data Reception (MODBUS Master: Function Code Specification)	21-12
21.6 [F145 SEND] Data Transmission (MODBUS Master).....	21-14
21.7 [F146 RECV] Data Reception (MODBUS Master).....	21-17
21.8 [F159 MTRN] Serial Data Send / Receive Instruction.....	21-20
22 Sampling Trace Instructions	22-1
22.1 Sampling Trace	22-2
22.2 F155 SMPL (Sampling).....	22-3
22.3 F156 STRG (Sampling trigger)	22-4
23 High-speed Counter Instruction	23-1
23.1 [F0 MV] High-speed Counter Control Instruction	23-2
23.2 [F1 DMV] Elapsed Value Write / Read Instruction	23-4
23.3 [F166 HC1S] High-speed Counter Target Value Match ON Instruction and [F167 HC1R] High-speed Counter Target Value Match OFF Instruction	23-5
23.4 Sample Program (Positioning Operation With Inverter: Single-Speed)	23-7

23.5	Sample Program (Positioning Operation With Inverter: Double-Speed)	23-9
24	High-speed Counter Cam Control Instruction	24-1
24.1	[F165 CAM0] High-speed Counter Cam Control Instruction.....	24-2
24.2	Sample Program (Upper Limit Control, Reset, Addition)	24-7
24.3	Sample Program (Upper Limit Control, Instruction Clear, Addition) ..	24-9
24.4	Sample Program (Upper Limit Control, Subtraction)	24-11
25	PWM Output Instructions	25-1
25.1	[F173 PWMH] PWM Output Instruction (Frequency Specification) ..	25-2
25.2	[F173 PWMH] PWM Output Instruction (Control Code Specification)	25-4
26	Character String Instructions	26-1
26.1	F95 ASC (ASCII code conversion)	26-2
26.2	F250 BTOA (Binary to ASCII Conversion).....	26-5
26.3	F251 ATOB (ASCII to Binary Conversion).....	26-11
26.4	F252 ACHK (ASCII Data Check)	26-19
26.5	F253 SSET (Character Constant → ASCII Code Conversion: with Storage Area Size).....	26-21
26.6	Overview of String Instructions F257 SCMP to F265 SREP.....	26-25
26.7	F257 SCMP (Comparing Character Strings)	26-26
26.8	F258 SADD (Character String Concatenation).....	26-28
26.9	F259 LEN (Number of Characters in a Character String).....	26-30
26.10	F260 SSRC (Search for character string).....	26-32
26.11	F261 RIGHT [Retrieve from Character String (Right)]	26-34
26.12	F262 LEFT [Retrieving data from character strings (left side)]	26-36
26.13	F263 MIDR (Character String From Character String Retrieval) ...	26-38
26.14	F264 MIDW (Writing a Character String to a Character String).....	26-40
26.15	F265 SREP (Replace Character Strings)	26-42
27	Data Manipulation Instructions	27-1
27.1	F270 MAX [maximum value (16-bit)]	27-2
27.2	F271 DMAX [Maximum value (32-bit)].....	27-4
27.3	F272 MIN [Minimum Value (16-bit)]	27-6
27.4	F273 DMIN [Minimum value (32-bit)].....	27-8
27.5	F275 MEAN [Total and Mean Value (16-Bit)]	27-10
27.6	F276 DMEAN [Total and Mean Value (32Bit)].....	27-12
27.7	F277 SORT [Sort (16-bit data)].....	27-14
27.8	F278 DSORT [Sort (32-bit)]	27-16
27.9	F282 SCAL [Scaling (linearization) of 16-bit data].....	27-18

27.10	F283 DSCAL [32-Bit Data Scaling (Linearization)]	27-21
27.11	F284 RAMP (16-bit Data Ramp Output)	27-24
27.12	F285 LIMIT [Upper and lower limit control (word data)]	27-26
27.13	F286 DLIMIT [Upper and Lower Limit Control (Double Word)]	27-28
27.14	F287 BAND [Deadband Control (Word)]	27-30
27.15	F288 DBAND [Deadband Control (Double Word)]	27-32
27.16	F289 ZONE [zone control (word)]	27-34
27.17	F290 DZONE [Zone control (double word)]	27-36
28	Floating-point Instruction	28-1
28.1	F309 FMV (Transfer Floating Point Real Number Data)	28-3
28.2	F310 F+ (Floating point real number data addition)	28-5
28.3	F311 F- (Floating point real number data subtraction)	28-7
28.4	F312 F* (Floating Point Real Number Data Multiplication)	28-9
28.5	F313 F% (Floating point real number data division)	28-11
28.6	F314 SIN (Sine of floating point real number data)	28-13
28.7	F315 COS (Floating Point Real Number Data Cosine)	28-15
28.8	F316 TAN (Floating Point Real Number Data Tangent)	28-17
28.9	F317 ASIN (Arcsine of Floating Point Real Number Data)	28-19
28.10	F318 ACOS (Arccosine of Floating Point Real Number Data)	28-21
28.11	F319 ATAN (Arctangent of floating point real number data)	28-23
28.12	F320 LN (Floating Point Real Number Natural Logarithm)	28-25
28.13	F321 EXP (Floating Point Real Number Data Exponent)	28-27
28.14	F322 LOG (Floating Point Real Number Data Common Logarithm)	28-29
28.15	F323 PWR (Floating point real number data power)	28-31
28.16	F324 FSQR (Floating Point Real Number Square Root)	28-33
28.17	F325 FLT (16-Bit Integer Data to Floating Point Real Number Data Conversion)	28-35
28.18	F326 DFLT (32-Bit Integer to Floating Point Real Number Data Conversion)	28-37
28.19	F327 INT [Floating Point Real Number Data to 16-Bit Data Conversion (Largest Integer not Exceeding Floating Point Real Number Data)]	28-39
28.20	F328 DINT [Floating point real number data to 32-bit integer conversion (largest integer not exceeding floating point real number)]	28-41
28.21	F329 FIX [Floating Point Real Number Data to 16-Bit Integer (Round Down to Nearest Integer) Conversion]	28-43
28.22	F330 DFIX [Convert Floating Point Real Number Data to 32-Bit Integers, (Rounding Down the Decimal Point)]	28-45
28.23	F331 ROFF [Convert Floating Point Real Number Data to a 16- Bit Integer (Rounded Off to the Nearest Integer)]	28-47

28.24	F332 DROFF [Floating point real number Data → 32-bit integer conversion (rounding off at the decimal point)]	28-49
28.25	F333 FINT (Round down floating point real number data at the decimal point).....	28-51
28.26	F334 FRINT (Round off floating point real number data to the first decimal place).....	28-53
28.27	F335 F+/- (Floating Point Real Number Data Sign Conversion).....	28-55
28.28	F336 FABS (Floating Point Real Number Data Absolute Value) ...	28-57
28.29	F337 RAD (Floating Point Real Number Data Degree to Radian)..	28-59
28.30	F338 DEG (Radian to Degree Floating Point Real Number Data Conversion).....	28-61
29	Real number data processing instructions	29-1
29.1	F345 FCMP (Floating Point Real Number Data Real Number Comparison)	29-2
29.2	F346 FWIN (Floating point real number data band comparison).....	29-4
29.3	F347 FLIMIT (Floating point real number data upper/lower limit control).....	29-6
29.4	F348 FBAND (Floating point real number data dead-band control) .	29-8
29.5	F349 FZONE (Floating Point Real Number Data Zone Control)	29-10
29.6	F354 FSCAL (Scaling of real number data).....	29-12
30	Process Control Instructions.....	30-1
30.1	F355 PID (PID Operation).....	30-2
30.2	F356 EZPID (Easy PID).....	30-9
31	Positioning Control Instructions (Table Setting Mode).....	31-1
31.1	[F380 POSST] Positioning Table Start Instruction	31-2
31.2	[F381 JOGST] JOG Operation Start Instruction	31-4
31.3	[F382 ORGST] Home Return Start Instruction	31-6
31.4	[F383 MPOST] Positioning Table Simultaneous Start Instruction.....	31-8
31.5	[F384 PTBLR] Positioning Parameter Read Instruction	31-10
31.6	[F385 PTBLW] Positioning Parameter Write Instruction	31-12
32	Positioning Control Instructions (FP-X Compatible Mode)	32-1
32.1	[F1 DMV] Elapsed Value Write / Read Instruction	32-2
32.2	[F171 (SPDH)] Pulse Output (Trapezoidal Control).....	32-3
32.3	[F171 (SPDH)] Pulse Output (Home Return).....	32-8
32.4	[F172 (PLSH)] Pulse Output (JOG operation)	32-13
32.5	[F174 (SP0H)] Pulse Output (Selectable Data Table Control Operation).....	32-16
32.6	[F175 (SPSH)] Pulse Output (Linear Interpolation)	32-21
33	Precautions for programming	33-1

33.1 Changing the Set Value of Timer/Counter During RUN	33-2
33.1.1 How to Rewrite Constants in the Program	33-2
33.1.2 Methods Used to Rewrite a Value in the Set Value Area	33-2
33.2 Use of Duplicate Output.....	33-5
33.2.1 Duplicate Output	33-5
33.2.2 Processing When Output Is Duplicated with OT, KP, SET, and RST Instructions	33-5
33.3 Rise Detection Method.....	33-7
33.3.1 Rise Detection Instructions	33-7
33.3.2 Operation and Precautions at Run Start Time	33-8
33.3.3 Precautions When Using Control Instructions	33-9
33.4 Operation Errors	33-12
33.4.1 Outline of Operation Errors	33-12
33.4.2 Operation Mode when an Operation Error Occurs	33-12
33.4.3 Handling the Occurrence of Operation Errors.....	33-13
33.4.4 Points to Review in Program.....	33-13
33.5 How to Use the Index Register	33-15
33.5.1 Index Registers	33-15
33.5.2 Index Modification Applicable Areas	33-15
33.5.3 Example of Using an Index Register.....	33-16
33.6 Handling BCD Data.....	33-18
33.7 Precautions for Programming	33-20
33.8 Rewrite Function During RUN.....	33-22
33.8.1 Operation of Rewrite During RUN.....	33-22
33.8.2 When Rewriting During RUN is not Possible	33-22
33.8.3 Method and Operation of Rewriting during RUN	33-24
33.9 Processing During Forced Input/Output	33-25
Appendix Reference Material.....	App-1
Operation Memory Area.....	App-2
List of System Registers	App-4
List of System Registers	App-4
List of Special Relays.....	App-16
List of Special Data Registers.....	App-30
Communication Commands.....	App-47
List of MEWTOCOL Supported Commands	App-47
List of MODBUS Supported Commands.....	App-48
Positioning Memory	App-49
Configuration of Memory Map.....	App-49
Common Area (Memory Area No. 0)	App-50
Axis Information Area (Memory Area No. 1)	App-51
Axis Setting Area (Memory Area No. 2).....	App-52
Positioning Table Area (Memory Area No. 3).....	App-54
List of Error Codes	App-56
List of Syntax Check Errors	App-56
Self-diagnostic Errors.....	App-57
List of MEWTOCOL-COM Communication Error Codes	App-58
List of MODBUS Communication Error Codes	App-59

BIN/HEX/BCD Code Correspondence TableApp-60
ASCII Code Table, JIS8 Code Table.....App-61

1 List of Instruction Words

1.1 List of Basic Instruction Words.....	1-2
1.2 List of High-level Instructions.....	1-8

1.1 List of Basic Instruction Words

1.1 List of Basic Instruction Words

■ Sequence basic instructions

Mnemonic	Name	Steps	Reference page:
ST	Begins a logic operation with a Form A (normally open) contact ^(Note 1)	1 (2)	"P.2-2"
DST	Begins a logic operation with a Form A (normally open) contact: Direct input ^(Note 1)	2	"P.2-4"
ST/	Begins a logic operation with a Form B (normally closed) contact ^(Note 1)	1 (2)	"P.2-2"
DST/	Begins a logic operation with a Form B (normally closed) contact: Direct input ^(Note 1)	2	"P.2-4"
OT	Outputs the operation result ^(Note 1)	1 (2)	"P.2-2"
DOT	Outputs the operation result: Direct input ^(Note 1)	2	"P.2-7"
/	Inverts the operation result	1	"P.2-10"
AN	Connects a Form A (normally open) contact serially ^(Note 2)	1 (2)	"P.2-11"
DAN	Connects a Form A (normally open) contact serially: Direct input ^(Note 1)	2	"P.2-13"
AN/	Connects a Form B (normally closed) contact serially ^(Note 2)	1 (2)	"P.2-11"
DAN/	Connects a Form B (normally closed) contact serially: Direct input ^(Note 1)	2	"P.2-13"
OR	Connects a Form A (normally open) contact in parallel ^(Note 2)	1 (2)	"P.2-16"
DOR	Connects a Form A (normally open) contact in parallel: Direct input ^(Note 1)	2	"P.2-18"
OR/	Connects a Form B (normally closed) contact in parallel ^(Note 2)	1 (2)	"P.2-16"
DOR/	Connects a Form B (normally closed) contact in parallel: Direct input ^(Note 1)	2	"P.2-18"
ST↑	Begins a rise contact logic operation	2	"P.2-21"
ST↓	Begins fall contact logic operation	2	"P.2-21"
AN↑	Connects a contact serially when a rise is detected	2	"P.2-21"
AN↓	Connects a contact serially when a fall is detected	2	"P.2-21"
OR↑	Connects a contact in parallel when a rise is detected	2	"P.2-21"
OR↓	Connects a contact in parallel when a fall is detected	2	"P.2-21"
ALT	Alternate out	3	"P.2-23"
ANS	Connects multiple instruction blocks serially	1	"P.2-25"
ORS	Connects multiple instruction blocks in parallel	1	"P.2-27"
PSHS	Stores the operation result	1	"P.2-29"
RDS	Reads the operation result stored by PSHS	1	"P.2-29"

1.1 List of Basic Instruction Words

Mnemonic	Name	Steps	Reference page:
POPS	Reads and clears the operation result stored by PSHS	1	"P.2-29"
DF	Rise detection	1	"P.2-33"
DF/	Fall detection	1	"P.2-33"
DFI	Rise detection (possible on the first scan)	1	"P.2-38"
SET	Turns ON the output and holds it ON ^(Note 1)	3	"P.2-40"
DSET	Turns ON the output and holds it ON: Direct input ^(Note 1)	3	"P.2-43"
RST	Turns OFF the output and holds it OFF ^(Note 1)	3	"P.2-40"
DRST	Turns OFF the output and holds it OFF: Direct input ^(Note 1)	3	"P.2-43"
KP	Outputs with set and reset inputs	1	"P.2-47"
DKP	Outputs with set and reset inputs: Direct output	2	"P.2-49"
NOP	No operation	1	"P.2-52"

(Note 1) Indicates an instruction for which bit index modification is possible.

(Note 2) Numbers in parentheses in the Steps column indicate the number of steps when index modification is performed or when the device number is large (R1120 or higher, T256 or higher, and C256 or higher).

■ Basic function instructions

Mnemonic	Name	Steps	Reference page:
TML	On-delay timer set in 0.001-s units	3 (4)	"P.3-2"
TMR	On-delay timer set in 0.01-s units	3 (4)	"P.3-2"
TMX	On-delay timer set in 0.1-s units	3 (4)	"P.3-2"
TMY	On-delay timer set in 1-s units	4 (5)	"P.3-2"
F137 STMR	On-delay timer set to 0.01 s	5	"P.3-9"
F183 DSTMR	32-bit on-delay timer set to 0.01 s	7	"P.3-12"
CT	Down counter	3 (4)	"P.3-16"
F118 UDC	Up/down counter	5	"P.3-23"
SR	Shift register	1	"P.3-26"
F119 LRSR	Left/right shift register	5	"P.3-29"
F182 FILTR	Time constant processing instruction S1, S2, S3, D	9	"P.3-32"

(Note 1) Numbers in parentheses in the Steps column indicate the number of steps when index modification is performed or when the device number is large (R1120 or higher, T256 or higher, and C256 or higher).

1.1 List of Basic Instruction Words

■ Control instructions

Mnemonic	Name	Steps	Reference page:
MC	Master control relay	2	"P.4-2"
MCE	Master control relay end	2	"P.4-2"
JP	Jumps to specified label	2	"P.4-7"
LOOP	Jumps to the specified label the number of times specified by D	4	"P.4-11"
LBL	Labels subject to the processing of instructions such as JP and LOOP	1	"P.4-7" "P.4-11"
ED	Main program area end	1	"P.4-15"
CNDE	Conditional program end	1	"P.4-16"
EJECT	Page break when printing	2	"P.4-18"

(Note 1) Numbers in parentheses in the Steps column indicate the number of steps when index modification is performed or when the device number is large (R1120 or higher, T256 or higher, and C256 or higher).

■ Step ladder instructions

Mnemonic	Name	Steps	Reference page:
SSTP	Process start	3	"P.5-2"
NSTL	Specified process start-up (every scan execution type)	3	"P.5-2"
NSTP	Specified process start-up (differential execution type)	3	"P.5-2"
CSTP	Clears the specified process	3	"P.5-2"
STPE	Step ladder area end	1	"P.5-2"
SCLR	Clears multiple processes	5	"P.5-17"

■ Subroutine instructions

Mnemonic	Name	Steps	Reference page:
CALL	Calls the specified subroutine	2	"P.6-2"
SUB	Subroutine definition	1 (2)	"P.6-2"
RET	Ends the subroutine program and returns to the main program	1	"P.6-2"

■ Interrupt instructions

Mnemonic	Name	Steps	Reference page:
INT	Interrupt program definition	1	"P.7-2"
IRET	Ends the interrupt program and returns to the main program	1	"P.7-2"

Mnemonic	Name	Steps	Reference page:
ICTL	Interrupt control specification	5	"P.7-8"

■ Program block control instructions

Mnemonic	Name	Steps	Reference page:
EDPB ^(Note 1)	Final point of PBN program	1	

(Note 1) Cannot be input with a programming tool.

■ Special setting instructions

Mnemonic	Name	Steps	Reference page:
SYS1	Communication conditions setting, end code time setting for setting communication conditions, password setting, interrupt setting, PLC link setting, MEWTOCOL-COM response control, high-speed counter operation mode change, direct station number setting, indirect station number setting, firmware version number read	13	"P.8-2" "P.8-8" "P.8-10" "P.8-12" "P.8-14" "P.8-16"
SYS2	System register change instruction	7	"P.8-18"

■ Compare contact instructions

Mnemonic	Name	Steps	Reference page:
ST=	Begins a logical operation to compare 16-bit data	5	"P.9-2"
ST<>	Begins a logical operation to compare 16-bit data	5	"P.9-2"
ST>	Begins a logical operation to compare 16-bit data	5	"P.9-2"
ST>=	Begins a logical operation to compare 16-bit data	5	"P.9-2"
ST<	Begins a logical operation to compare 16-bit data	5	"P.9-2"
ST<=	Begins a logical operation to compare 16-bit data	5	"P.9-2"
AN =	16-bit data compare serial connection	5	"P.9-4"
AN <>	16-bit data compare serial connection	5	"P.9-4"
AN >	16-bit data compare serial connection	5	"P.9-4"
AN >=	16-bit data compare serial connection	5	"P.9-4"
AN <	16-bit data compare serial connection	5	"P.9-4"
AN <=	16-bit data compare serial connection	5	"P.9-4"
OR=	16-bit data compare parallel connection	5	"P.9-6"
OR<>	16-bit data compare parallel connection	5	"P.9-6"

1.1 List of Basic Instruction Words

Mnemonic	Name	Steps	Reference page:
OR>	16-bit data compare parallel connection	5	"P.9-6"
OR>=	16-bit data compare parallel connection	5	"P.9-6"
OR<	16-bit data compare parallel connection	5	"P.9-6"
OR<=	16-bit data compare parallel connection	5	"P.9-6"
STD=	Begins a logical operation to compare 32-bit data	9	"P.9-8"
STD<>	Begins a logical operation to compare 32-bit data	9	"P.9-8"
STD>	Begins a logical operation to compare 32-bit data	9	"P.9-8"
STD>=	Begins a logical operation to compare 32-bit data	9	"P.9-8"
STD<	Begins a logical operation to compare 32-bit data	9	"P.9-8"
STD<=	Begins a logical operation to compare 32-bit data	9	"P.9-8"
AND=	32-bit data compare serial connection	9	"P.9-10"
AND<>	32-bit data compare serial connection	9	"P.9-10"
AND>	32-bit data compare serial connection	9	"P.9-10"
AND>=	32-bit data compare serial connection	9	"P.9-10"
AND<	32-bit data compare serial connection	9	"P.9-10"
AND<=	32-bit data compare serial connection	9	"P.9-10"
ORD=	32-bit data compare parallel connection	9	"P.9-12"
ORD<>	32-bit data compare parallel connection	9	"P.9-12"
ORD>	32-bit data compare parallel connection	9	"P.9-12"
ORD>=	32-bit data compare parallel connection	9	"P.9-12"
ORD<	32-bit data compare parallel connection	9	"P.9-12"
ORD<=	32-bit data compare parallel connection	9	"P.9-12"

■ Compare contact instructions

Mnemonic	Name	Steps	Reference page:
STF=	Begins a logical operation to compare single-precision floating point data	10	"P.9-14"
STF<>	Begins a logical operation to compare single-precision floating point data	10	"P.9-14"
STF>	Begins a logical operation to compare single-precision floating point data	10	"P.9-14"
STF>=	Begins a logical operation to compare single-precision floating point data	10	"P.9-14"
STF<	Begins a logical operation to compare single-precision floating point data	10	"P.9-14"
STF<=	Begins a logical operation to compare single-precision floating point data	10	"P.9-14"

1.1 List of Basic Instruction Words

Mnemonic	Name	Steps	Reference page:
ANF=	Single-precision floating point data compare serial connection	10	"P.9-16"
ANF<>	Single-precision floating point data compare serial connection	10	"P.9-16"
ANF>	Single-precision floating point data compare serial connection	10	"P.9-16"
ANF>=	Single-precision floating point data compare serial connection	10	"P.9-16"
ANF<	Single-precision floating point data compare serial connection	10	"P.9-16"
ANF<=	Single-precision floating point data compare serial connection	10	"P.9-16"
ORF=	Single-precision floating point data compare parallel connection	10	"P.9-18"
ORF<>	Single-precision floating point data compare parallel connection	10	"P.9-18"
ORF>	Single-precision floating point data compare parallel connection	10	"P.9-18"
ORF>=	Single-precision floating point data compare parallel connection	10	"P.9-18"
ORF<	Single-precision floating point data compare parallel connection	10	"P.9-18"
ORF<=	Single-precision floating point data compare parallel connection	10	"P.9-18"

1.2 List of High-level Instructions

1.2 List of High-level Instructions

■ Transfer instructions

Fun no.	Mnemonic	Operand	Name	Step	Reference page
F0	MV	S, D	16-bit data transfer	5	"P.10-2"
F0	MV	DT90020, D	10 μ sec ring counter read	5	"P.10-4"
F1	DMV	S, D	32-bit data transfer	7	"P.10-5"
F2	MV/	S, D	16-bit data reverse and transfer	5	"P.10-7"
F3	DMV/	S, D	32-bit data reverse and transfer	7	"P.10-9"
F5	BTM	S, n, D	Bit data transfer	7	"P.10-11"
F6	DGT	S, n, D	Digit data transfer	7	"P.10-16"
F7	MV2	S1, S2, D	Two 16-bit data transfer to a single area	7	"P.10-20"
F8	DMV2	S1, S2, D	Two 32-bit data transfer to a single area	11	"P.10-22"
F10	BKMV	S1, S2, D	Data block transfer	7	"P.10-24"
F11	COPY	S, D1, D2	16-bit data block copy	7	"P.10-27"
F12	ICRD	S1, S2, D	F-ROM read	11	"P.10-29"
P13	PICWT	S1, S2, D	F-ROM write	11	"P.10-31"
F15	XCH	D1, D2	16-bit data exchange	5	"P.10-33"
F16	DXCH	D1, D2	32-bit data exchange	5	"P.10-35"
F17	SWAP	D	Higher and lower byte exchange	3	"P.10-37"
F18	BXCH	D1, D2, D3	Data block exchange	7	"P.10-39"
F190	MV3	S1, S2, S3, D	Three 16-bit data transfer to a single area	10	"P.10-41"
F191	DMV3	S1, S2, S3, D	Three 32-bit data transfer to a single area	16	"P.10-43"

■ Binary arithmetic operation instructions

Fun no.	Mnemonic	Operand	Name	Step	Reference page
F20	+	S, D	16-bit data addition [D+S=D]	5	"P.11-2"
F21	D+	S, D	32-bit data addition [D+S=D]	7	"P.11-4"
F22	+	S1, S2, D	16-bit data addition [S1+S2=D]	7	"P.11-6"
F23	D+	S1, S2, D	32-bit data addition [S1+S2=D]	11	"P.11-8"
F25	-	S, D	16-bit data subtraction [D-S=D]	5	"P.11-10"
F26	D-	S, D	32-bit data subtraction [D-S=D]	7	"P.11-13"
F27	-	S1, S2, D	16-bit data subtraction [S1-S2=D]	7	"P.11-15"
F28	D-	S1, S2, D	32-bit data subtraction [S1-S2=D]	11	"P.11-18"
F30	*	S1, S2, D	16-bit data multiplication [S1*S2=D+1,D]	7	"P.11-20"
F31	D*	S1, S2, D	32-bit data multiplication [S1*S2=D+3,D+2,D+1,D]	11	"P.11-22"

1.2 List of High-level Instructions

Fun no.	Mnemonic	Operand	Name	Step	Reference page
F32	%	S1, S2, D	16-bit data division [S1/S2=D]	7	"P.11-24"
F33	D%	S1, S2, D	32-bit data division [S1/S2=D+1,D]	11	"P.11-26"
F34	*W	S1, S2, D	16-bit data multiplication [S1*S2=D]	7	"P.11-28"
F35	+1	D	16-bit data increment	3	"P.11-30"
F36	D+1	D	32-bit data increment	3	"P.11-32"
F37	-1	D	16-bit data decrement	3	"P.11-34"
F38	D-1	D	32-bit data decrement	3	"P.11-36"
F39	D*D	S1, S2, D	32-bit data multiplication [S1*S2=D+1,D]	11	"P.11-38"

■ BCD data arithmetic instructions

Fun no.	Mnemonic	Operand	Name	Step	Reference page
F40	B+	S, D	4-digit BCD data addition [D+S=D]	5	"P.12-2"
F41	DB+	S, D	8-digit BCD data addition [D+S=D]	7	"P.12-4"
F42	B+	S1, S2, D	4-digit BCD data addition [S1+S2=D]	7	"P.12-6"
F43	DB+	S1, S2, D	8-digit BCD data addition [S1+S2=D]	11	"P.12-8"
F45	B-	S, D	4-digit BCD data subtraction [D-S=D]	5	"P.12-10"
F46	DB-	S, D	8-digit BCD data subtraction [D-S=D]	7	"P.12-12"
F47	B-	S1, S2, D	4-digit BCD data subtraction [S1-S2=D]	7	"P.12-14"
F48	DB-	S1, S2, D	8-digit BCD data subtraction [S1-S2=D]	11	"P.12-16"
F50	B*	S1, S2, D	4-digit BCD data multiplication [S1*S2=D+1,D]	7	"P.12-18"
F51	DB*	S1, S2, D	8-digit BCD data multiplication [S1*S2=D+3,D+2,D+1,D]	11	"P.12-20"
F52	B%	S1, S2, D	4-digit BCD data division [S1/S2=D]	7	"P.12-22"
F53	DB%	S1, S2, D	8-digit BCD data division [S1/S2=D+1,D]	11	"P.12-24"
F55	B+1	D	4-digit BCD data increment	3	"P.12-26"
F56	DB+1	D	8-digit BCD data increment	3	"P.12-28"
F57	B-1	D	4-digit BCD data decrement	3	"P.12-30"
F58	DB-1	D	8-digit BCD data decrement	3	"P.12-32"

■ Data comparison instructions

Fun no.	Mnemonic	Operand	Name	Step	Reference page
F60	CMP	S1, S2	16-bit data comparison	5	"P.13-2"
F61	DCMP	S1, S2	32-bit data comparison	9	"P.13-8"
F62	WIN	S1, S2, S3	16-bit data band comparison	7	"P.13-12"
F63	DWIN	S1, S2, S3	32-bit data band comparison	13	"P.13-14"
F64	BCMP	S1, S2, S3	Block data comparison	7	"P.13-16"

1.2 List of High-level Instructions

Fun no.	Mnemonic	Operand	Name	Step	Reference page
F373	DTR	S, D	16-bit data change detection	6	"P.13-19"
F374	DDTR	S, D	32-bit data change detection	6	"P.13-21"

■ Boolean instructions

Fun no.	Mnemonic	Operand	Name	Step	Reference page
F65	WAN	S1, S2, D	16-bit data AND	7	"P.14-2"
F66	WOR	S1, S2, D	16-bit data OR	7	"P.14-4"
F67	XOR	S1, S2, D	16-bit data exclusive OR	7	"P.14-6"
F68	XNR	S1, S2, D	16-bit data exclusive NOR	7	"P.14-8"
F69	WUNI	S1, S2, S3, D	[(S1 AND S3) OR (S2 AND S3)=D](16-bit)	9	"P.14-10"
F215	DAND	S1, S2, D	32-bit data AND	12	"P.14-12"
F216	DOR	S1, S2, D	32-bit data OR	12	"P.14-14"
F217	DXOR	S1, S2, D	32-bit data exclusive OR	12	"P.14-16"
F218	DXNR	S1, S2, D	32-bit data exclusive NOR	12	"P.14-18"
F219	DUNI	S1, S2, S3, D	[(S1 AND S3) OR (S2 AND S3)=D](32-bit)	16	"P.14-20"

■ Data conversion instructions

Fun no.	Mnemonic	Operand	Name	Step	Reference page
F70	BCC	S1, S2, S3, D	Block check code calculation (ADD.SUB, XOR, CRC)	9	"P.15-3"
F71	HEXA	S1, S2, D	Convert hexadecimal data to ASCII code	7	"P.15-7"
F72	AHEX	S1, S2, D	Convert ASCII code to hexadecimal data	7	"P.15-10"
F73	BCDA	S1, S2, D	Convert BCD data to ASCII code	7	"P.15-14"
F74	ABCD	S1, S2, D	Convert ASCII code to BCD data	7	"P.15-18"
F75	BINA	S1, S2, D	Convert 16-bit binary data to ASCII code	7	"P.15-22"
F76	ABIN	S1, S2, D	Convert ASCII code to 16-bit binary data	7	"P.15-25"
F77	DBIA	S1, S2, D	Convert 32-bit binary data to ASCII code	11	"P.15-29"
F78	DABI	S1, S2, D	Convert ASCII code to 32-bit binary data	11	"P.15-32"
F80	BCD	S, D	Convert 16-bit binary data to BCD data	5	"P.15-36"
F81	BIN	S, D	Convert BCD data to 16-bit binary data	5	"P.15-38"
F82	DBCD	S, D	Convert 32-bit binary data to BCD data	7	"P.15-40"
F83	DBIN	S, D	Convert BCD data to 32-bit binary data	7	"P.15-41"
F84	INV	D	16-bit data inversion	3	"P.15-42"
F85	NEG	D	16-bit data sign inversion	3	"P.15-43"
F86	DNEG	D	32-bit data sign inversion	3	"P.15-44"
F87	ABS	D	16-bit data absolute value	3	"P.15-46"

1.2 List of High-level Instructions

Fun no.	Mnemonic	Operand	Name	Step	Reference page
F88	DABS	D	32-bit data absolute value	3	"P.15-47"
F89	EXT	D	Sign extension	3	"P.15-48"
F90	DECO	S, n, D	Decode	7	"P.15-50"
F91	SEGT	S, D	7-segment decode	5	"P.15-53"
F92	ENCO	S, n, D	Encode	7	"P.15-55"
F93	UNIT	S, n, D	Digit combine	7	"P.15-58"
F94	DIST	S, n, D	Digit distribute	7	"P.15-60"
F96	SRC	S1, S2, S3	16-bit data search	7	"P.15-62"
F97	DSRC	S1, S2, S3, S4	32-bit data search	9	"P.15-64"
F230	TMSEC	S, D	Time to second conversion	6	"P.15-66"
F231	SECTM	S, D	Second to time conversion	6	"P.15-69"
F235	GRY	S, D	16-bit data to gray code conversion	6	"P.15-72"
F236	DGRY	S, D	32-bit data to gray code conversion	8	"P.15-73"
F237	GBIN	S, D	Gray code to 16-bit data conversion	6	"P.15-74"
F238	DGBIN	S, D	Gray code to 32-bit data conversion	8	"P.15-75"
F240	COLM	S1, S2, D	Bit line to bit column conversion	8	"P.15-77"
F241	LINE	S1, S2, D	Bit column to bit line conversion	8	"P.15-79"

■ Data shift instructions

Fun no.	Mnemonic	Operand	Name	Step	Reference page
F100	SHR	D, n	16-bit data right shift	5	"P.16-2"
F101	SHL	D, n	16-bit data left shift	5	"P.16-4"
F102	DSHR	D, n	32-bit data right shift	5	"P.16-6"
F103	DSHL	D, n	32-bit data left shift	5	"P.16-8"
F105	BSR	D	16-bit data 1 digit right shift	3	"P.16-10"
F106	BSL	D	16-bit data 1 digit left shift	3	"P.16-12"
F108	BITR	D1, D2, n	Bitwise right shift in block area	7	"P.16-14"
F109	BITL	D1, D2, n	Bitwise left shift in block area	7	"P.16-16"
F110	WSHR	D1, D2	Right shift by one word in block area	5	"P.16-18"
F111	WSHL	D1, D2	Left shift by one word in block area	5	"P.16-20"
F112	WBSR	D1, D2	Right shift by one digit in block area	5	"P.16-22"
F113	WBSL	D1, D2	Left shift by one digit in block area	5	"P.16-24"

■ Data rotate instructions

Fun no.	Mnemonic	Operand	Name	Step	Reference page
F120	ROR	D, n	16-bit data right rotation	5	"P.17-2"

1.2 List of High-level Instructions

Fun no.	Mnemonic	Operand	Name	Step	Reference page
F121	ROL	D, n	16-bit data left rotation	5	"P.17-4"
F122	RCR	D, n	16-bit data right rotation with carry	5	"P.17-6"
F123	RCL	D, n	16-bit data left rotation with carry	5	"P.17-8"
F125	DROR	D, n	32-bit data right rotation	5	"P.17-10"
F126	DROL	D, n	32-bit data left rotation	5	"P.17-12"
F127	DRCR	D, n	32-bit data right rotation with carry	5	"P.17-14"
F128	DRCL	D, n	32-bit data left rotation with carry	5	"P.17-16"

■ Data buffer instructions

Fun no.	Mnemonic	Operand	Name	Step	Reference page
F98	CMPR	D1, D2, D3	Compress shift read	7	"P.18-2"
F99	CMPW	S1, D, S2	Compress shift write	7	"P.18-6"
F115	FIFT	n, D	FIFO buffer definition	5	"P.18-11"
F116	FIFR	S, D	FIFO data read	5	"P.18-14"
F117	FIFW	S, D	FIFO data write	5	"P.18-18"

■ Bit manipulation instructions

Fun no.	Mnemonic	Operand	Name	Step	Reference page
F130	BTS	D, n	Specified bit set	5	"P.19-2"
F131	BTR	D, n	Specified bit reset	5	"P.19-4"
F132	BTI	D, n	Specified bit inversion	5	"P.19-6"
F133	BTT	S, n	Specified bit test	5	"P.19-8"
F135	BCU	S, D	Count ON bits in 16-bit data	5	"P.19-10"
F136	DBCUC	S, D	Count ON bits in 32-bit data	7	"P.19-12"

■ Special instructions

Fun no.	Mnemonic	Operand	Name	Step	Reference page
F138	HMSS	S, D	Hour, minute, second data to second data conversion	5	"P.20-2"
F139	SHMS	S, D	Second data to hour, minute, second data conversion	5	"P.20-4"
F140	STC		Carry flag set	1	"P.20-6"
F141	CLC		Carry flag reset	1	"P.20-7"
F143	IORF	D1, D2	Partial I/O refresh	5	"P.20-8"
F147	PR	S, D	Printout	5	"P.20-10"
F148	ERR	n	Self-diagnostic error code set	3	"P.20-15"

1.2 List of High-level Instructions

Fun no.	Mnemonic	Operand	Name	Step	Reference page
F149	MSG	S	Send characters to programming tool	13	"P.20-17"
F150	READ	S1, S2, n, D	Read shared memory	9	"P.20-18"
F151	WRT	S1, S2, n, D	Write data to shared memory	9	"P.20-21"
F157	CADD	S1, S2, D	Calendar data addition	9	"P.20-24"
F158	CSUB	S1, S2, D	Calendar data subtraction	9	"P.20-27"
F160	DSQR	S, D	32-bit data square root	7	"P.20-32"

■ Serial communication instructions

Fun no.	Mnemonic	Operand	Name	Step	Reference page
F145	SEND	S1, S2, D, N	Data send instruction [MEWTOCOL master]	9	"P.21-4"
F146	RECV	S1, S2, N, D	Data receive instruction [MEWTOCOL master]	9	"P.21-7"
F145	SEND	S1, S2, D, N	Data send instruction [MODBUS master: Function code specification]	9	"P.21-10"
F146	RECV	S1, S2, N, D	Data receive instruction [MODBUS master: Function code specification]	9	"P.21-12"
F145	SEND	S1, S2, D, N	Data send instruction [MODBUS master: No function code specification]	9	"P.21-14"
F146	RECV	S1, S2, N, D	Data receive instruction [MODBUS master: No function code specification]	9	"P.21-17"
F159	MTRN	S, n, D	General-purpose communication instructions	7	"P.21-20"

■ Sampling trace instructions

Fun no.	Mnemonic	Operand	Name	Step	Reference page
F155	SMPL		Sampling	1	"P.22-3"
F156	STRG		Sampling trigger	1	"P.22-4"

■ High-speed counter instructions

Fun no.	Mnemonic	Operand	Name	Step	Reference page
F0	MV	S, DT90052	High-speed counter control instruction	5	"P.23-2"
F1	DMV	S, DT90300	High-speed counter elapsed value read	7	"P.23-4"
F1	DMV	DT90300, D	High-speed counter elapsed value write	7	"P.23-4"
F166	HC1S	n, S, D	Target value match ON (with channel specification)	11	"P.23-5"
F167	HC1R	n, S, D	Target value match OFF (with channel specification)	11	"P.23-5"

1.2 List of High-level Instructions

■ High-speed counter cam control instruction

Fun no.	Mnemonic	Operand	Name	Step	Reference page
F165	CAM0	S	Cam control	3	"P.24-2"

■ PWM output instructions

Fun no.	Mnemonic	Operand	Name	Step	Reference page
F173	PWMH	S, n	PWM output instruction (Frequency specification)	5	"P.25-2"
F173	PWMH	S, n	PWM output instruction (Control code specification)	5	"P.25-4"

■ Character string instructions

Fun no.	Mnemonic	Operand	Name	Step	Reference page
F95	ASC	M, D	Convert character constant to ASCII code	15	"P.26-2"
F250	BTOA	S1, S2, S3, D	Convert multiple binary data to ASCII data string	12	"P.26-5"
F251	ATOB	S1, S2, S3, D	Convert multiple ASCII data strings to binary data	12	"P.26-11"
F252	ACHK	S1, S2, S3	ASCII code check of multiple ASCII data strings	10	"P.26-19"
F253	SSET	S1, S2, D	Character constant to ASCII code conversion (with storage area size)	8 to 264 (Note 1)	"P.26-21"
F257	SCMP	S1, S2, D	Character string comparison	10	"P.26-26"
F258	SADD	S1, S2, D	Character string addition	12	"P.26-28"
F259	LEN	S, D	Character string length	6	"P.26-30"
F260	SSRC	S1, S2, D	Character string search	10	"P.26-32"
F261	RIGHT	S1, S2, D	Right retrieve from character string	8	"P.26-34"
F262	LEFT	S1, S2, D	Left retrieve from character string	8	"P.26-36"
F263	MIDR	S1, S2, S3, D	Read from any position in character string	10	"P.26-38"
F264	MIDW	S1, S2, S3, D	Write to any position in character string	12	"P.26-40"
F265	SREP	S, D, P, n	Replace character string	12	"P.26-42"

(Note 1) For the F253 instruction, the number of steps varies according to the content specified for the operand.

■ Data manipulation instructions

Fun no.	Mnemonic	Operand	Name	Step	Reference page
F270	MAX	S1, S2, D	Search maximum value from 16-bit data block	8	"P.27-2"
F271	DMAX	S1, S2, D	Search maximum value from 32-bit data block	8	"P.27-4"

1.2 List of High-level Instructions

Fun no.	Mnemonic	Operand	Name	Step	Reference page
F272	MIN	S1, S2, D	Search minimum value from 16-bit data block	8	"P.27-6"
F273	DMIN	S1, S2, D	Search minimum value from 32-bit data block	8	"P.27-8"
F275	MEAN	S1, S2, D	Total and mean value calculation in 16-bit data	8	"P.27-10"
F276	DMEAN	S1, S2, D	Total and mean value calculation in 32-bit data	8	"P.27-12"
F277	SORT	S1, S2, S3	Sort data in 16-bit data block	8	"P.27-14"
F278	DSORT	S1, S2, S3	Sort data in 32-bit data block	8	"P.27-16"
F282	SCAL	S1, S2, D	Linearization of 16-bit data	8	"P.27-18"
F283	DSCAL	S1, S2, D	Linearization of 32-bit data	10	"P.27-21"
F284	RAMP	S1, S2, S3, D	16-bit data ramp output	10	"P.27-24"
F285	LIMIT	S1, S2, S3, D	16-bit data upper and lower limit control	10	"P.27-26"
F286	DLIMIT	S1, S2, S3, D	32-bit data upper and lower limit control	16	"P.27-28"
F287	BAND	S1, S2, S3, D	16-bit data deadband control	10	"P.27-30"
F288	DBAND	S1, S2, S3, D	32-bit data deadband control	16	"P.27-32"
F289	ZONE	S1, S2, S3, D	16-bit data zone control	10	"P.27-34"
F290	DZONE	S1, S2, S3, D	32-bit data zone control	16	"P.27-36"

■ Floating point number data instructions

Fun no.	Mnemonic	Operand	Name	Step	Reference page
F309	FMV	S, D	Floating point number data transfer	8	"P.28-3"
F310	F+	S1, S2, D	Floating point number data addition	14	"P.28-5"
F311	F-	S1, S2, D	Floating point number data subtraction	14	"P.28-7"
F312	F*	S1, S2, D	Floating point number data multiplication	14	"P.28-9"
F313	F%	S1, S2, D	Floating point number data division	14	"P.28-11"
F314	SIN	S, D	Sine of floating point number data	10	"P.28-13"
F315	COS	S, D	Cosine of floating point number data	10	"P.28-15"
F316	TAN	S, D	Tangent of floating point number data	10	"P.28-17"
F317	ASIN	S, D	Arcsine of floating point number data	10	"P.28-19"
F318	ACOS	S, D	Arccosine of floating point number data	10	"P.28-21"
F319	ATAN	S, D	Arctangent of floating point number data	10	"P.28-23"
F320	LN	S, D	Natural logarithm of floating point number data	10	"P.28-25"
F321	EXP	S, D	Exponent of floating point number data	10	"P.28-27"
F322	LOG	S, D	Floating point number data common logarithm	10	"P.28-29"
F323	PWR	S1, S2, D	Floating point number data power	14	"P.28-31"
F324	FSQR	S, D	Floating point number data square root	10	"P.28-33"
F325	FLT	S, D	16-bit integer data to floating point number data conversion	6	"P.28-35"

1.2 List of High-level Instructions

Fun no.	Mnemonic	Operand	Name	Step	Reference page
F326	DFLT	S, D	32-bit integer data to floating point number data conversion	8	"P.28-37"
F327	INT	S, D	Floating point number data to 16-bit integer conversion (largest integer not exceeding floating point real number)	8	"P.28-39"
F328	DINT	S, D	Floating point number data to 32-bit integer conversion (largest integer not exceeding floating point real number)	8	"P.28-41"
F329	FIX	S, D	Floating point number data to truncated 16-bit integer conversion	8	"P.28-43"
F330	DFIX	S, D	Floating point number data to truncated 32-bit integer conversion	8	"P.28-45"
F331	ROFF	S, D	Floating point number data to rounded 16-bit integer conversion	8	"P.28-47"
F332	DROFF	S, D	Floating point number data to rounded 32-bit integer conversion	8	"P.28-49"
F333	FINT	S, D	Round down floating point number data at the decimal point	8	"P.28-51"
F334	FRINT	S, D	Round off floating point number data to the first decimal place	8	"P.28-53"
F335	F+/-	S, D	Floating point number data sign conversion	8	"P.28-55"
F336	FABS	S, D	Floating point number data absolute value	8	"P.28-57"
F337	RAD	S, D	Floating point number data degree to radian	8	"P.28-59"
F338	DEG	S, D	Radian to degree floating point number data conversion	8	"P.28-61"

■ Real number data processing instructions

Fun no.	Mnemonic	Operand	Name	Step	Reference page
F345	FCMP	S1, S2	Floating point number data comparison	10	"P.29-2"
F346	FWIN	S1, S2, S3	Floating point number data band comparison	14	"P.29-4"
F347	FLIMIT	S1, S2, S3, D	Floating point number data upper / lower limit control	18	"P.29-6"
F348	FBAND	S1, S2, S3, D	Floating point number data dead-band control	18	"P.29-8"
F349	FZONE	S1, S2, S3, D	Floating point number data zone control	18	"P.29-10"
F354	FSCAL	S1, S2, D	Scaling of real number data	12	"P.29-12"

■ Process control instructions

Fun no.	Mnemonic	Operand	Name	Step	Reference page
F355	PID	S	PID operation	4	"P.30-2"
F356	EZPID	S1, S2, S3, S4	Easy PID (PID operation: PWM output is possible.)	10	"P.30-9"

■ Positioning control instructions (Table setting mode)

Fun no.	Mnemonic	Operand	Name	Step	Reference page
F380	POSST	S1, S2, S3	Positioning table start instruction	8	"P.31-2"
F381	JOGST	S1, S2	JOG operation start instruction	6	"P.31-4"
F382	ORGST	S	Home return start instruction	4	"P.31-6"
F383	MPOST	S	Positioning table simultaneous start instruction	4	"P.31-8"
F384	PTBLR	S1, S2, n, D	Positioning parameter read instruction	10	"P.31-10"
F385	PTBLW	S1, S2, n, D	Positioning parameter write instruction	10	"P.31-12"

■ Positioning control instructions (FP-X compatible mode)

Fun no.	Mnemonic	Operand	Name	Step	Reference page
F1	DMV	S, DT90348	Elapsed value read instruction	7	"P.23-4"
F1	DMV	DT90348, D	Elapsed value write instruction	7	"P.23-4"
F171	SPDH	S, n	Pulse output (Trapezoidal control)	5	"P.32-3"
F171	SPDH	S, n	Pulse output (Home return)	5	"P.32-8"
F172	PLSH	S, n	Pulse output (JOG operation)	5	"P.32-13"
F174	SP0H	S, n	Pulse output (Selectable data table control operation)	5	"P.32-16"
F175	SPSH	S, n	Pulse output (Linear interpolation)	5	"P.32-21"

(MEMO)

2 Sequence Basic Instructions

2.1 ST, ST/ and OT (Start, Start Not and Out).....	2-2
2.2 DST, DST/ (Direct start, direct start Not).....	2-4
2.3 DOT (direct out)	2-7
2.4 / (Not).....	2-10
2.5 AN, AN/ (AND, AND Not).....	2-11
2.6 DAN, DAN/ (Direct AND, Direct AND NOT).....	2-13
2.7 OR, OR/ (OR, OR Not)	2-16
2.8 DOR, DOR/ (Direct OR, Direct OR Not)	2-18
2.9 ST \uparrow , ST \downarrow , AN \uparrow , AN \downarrow , OR \uparrow , OR \downarrow (Rise Detection and Fall Detection Contact Instructions).....	2-21
2.10 ALT (Alternate out).....	2-23
2.11 ANS (and stack).....	2-25
2.12 ORS (OR Stack)	2-27
2.13 PSHS, RDS, POPS (Push stack, Read stack, Pop stack).....	2-29
2.14 DF, DF/ (rise differential and fall differential).....	2-33
2.15 DFI [Rise differential (initial execution type)].....	2-38
2.16 SET, RST (Set, Reset).....	2-40
2.17 DSET/DRST (Direct Set/Direct Reset).....	2-43
2.18 KP (Keep)	2-47
2.19 DKP (Direct Keep)	2-49
2.20 NOP.....	2-52

2.1 ST, ST/ and OT (Start, Start Not and Out)

2.1 ST, ST/ and OT (Start, Start Not and Out)

■ Instruction format

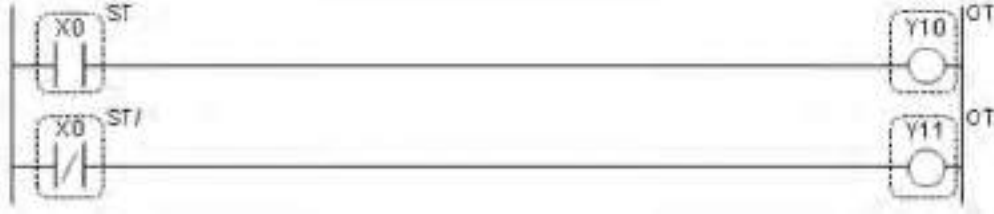

■ Instruction list

Instruction	Description
ST	Input contact starting logical operation as Form A (normally open)
ST/	Input contact starting logical operation as Form B (normally closed)
OT	Coil that outputs logical operation

■ Devices that can be specified (indicated by ●)

Operands	X	Y	R	T	C	L	Index modifier
ST	●	●	●	●	●	●	●
ST/	●	●	●	●	●	●	●
OT		●	●			●	●

■ Outline of operation

Instruction	Operation
ST	Handles input contact as Form A (normally open) and begins a logical operation.
ST/	Handles input contact as Form B (normally closed) and begins a logical operation.
OT	Outputs operation results to the specified coil.

■ Operation example

Operation of instruction format description program

- Execution results are output to Y10 when X0 is ON, and to Y11 when X0 is OFF.

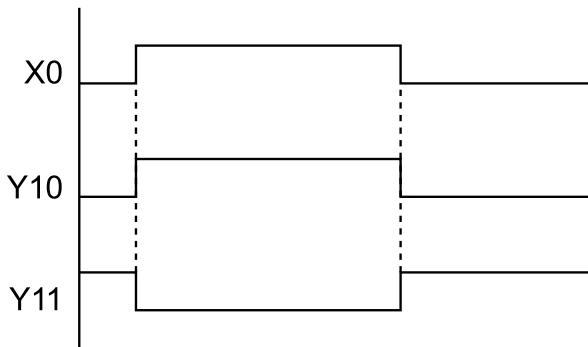

■ Precautions for programming

- **ST** instructions begin from the bus bar. (This is the same for **ST/** instructions)

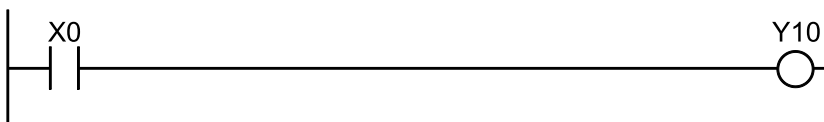

- **OT** instructions cannot begin directly from the bus bar.

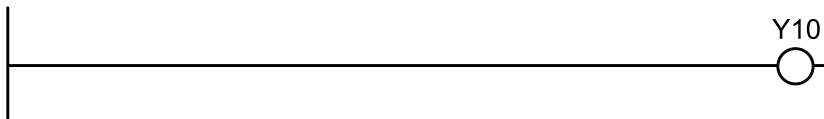

- **OT** instructions can be used consecutively.

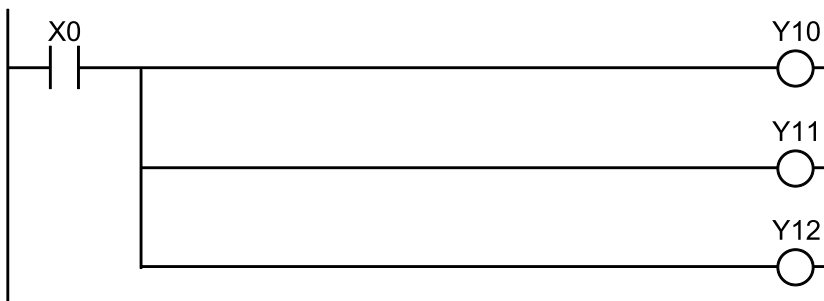

- When an external switch is Form B (normally closed), such as an emergency stop switch, take care to use **ST** instructions in programming.

2.2 DST, DST/ (Direct start, direct start Not)

2.2 DST, DST/ (Direct start, direct start Not)

■ Instruction format

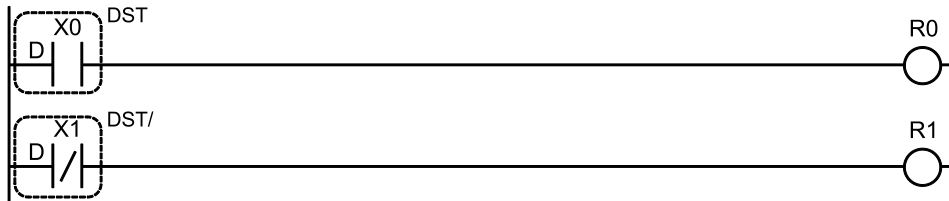

■ Instruction list

Instruction	Description
DST	Input contact starting logical operation as Form A (normally open)
DST/	Input contact starting logical operation as Form B (normally closed)

■ Devices that can be specified (indicated by ●)

Operands	X	Y	R	T	C	L	Index modifier
DST	●						●
DST/	●						●

■ Outline of operation

Instruction	Operation
DST	The specified external contact is read and reflected in the input contact, that input contact is handled as a Form A (normally open) contact, and the logical operation begins.
DST/	The specified external contact is read and reflected in the input contact, that input contact is handled as a Form B (normally closed) contact, and the logical operation begins.

■ Operation example

Operation of instruction format description program

- When external input X0 turns ON, R0 turns ON.
- When external input X1 turns OFF, R1 turns ON.

■ Precautions for programming

- If the contact is outside the permissible range, an operation error will result.
- When the time is set using the controller input time constant setting system register, the time constant is invalid.

■ Comparison of ST instruction and DST instruction

- Compared to the ST instruction, the DST instruction is capable of a high-speed response.

<For ST instruction>

• Ladder diagram

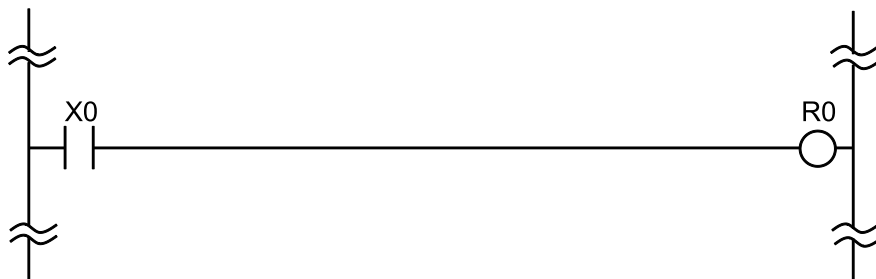

• Timing chart

*Main unit input constant setting: None

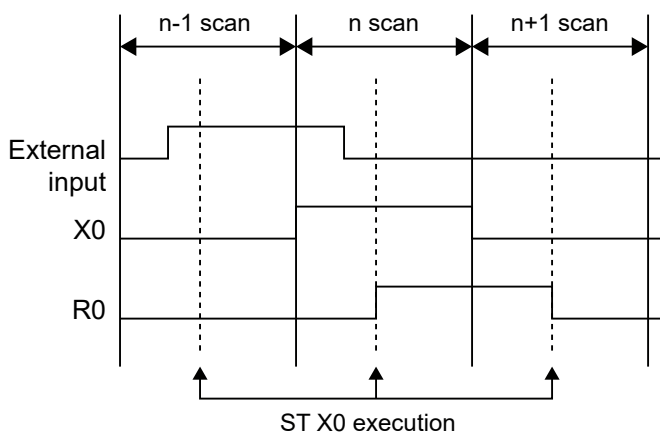

<For DST instruction>

• Ladder diagram

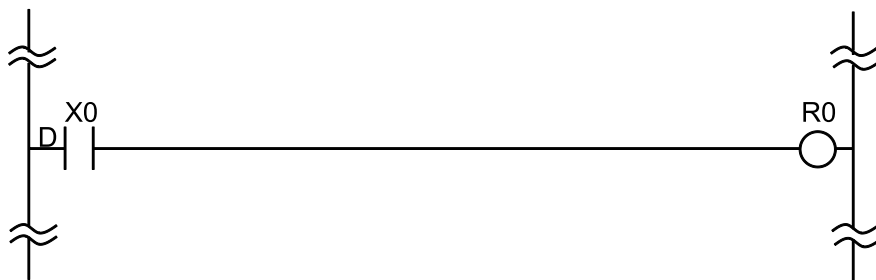

• Timing chart

*Main unit input constant setting: None

2.2 DST, DST/ (Direct start, direct start Not)

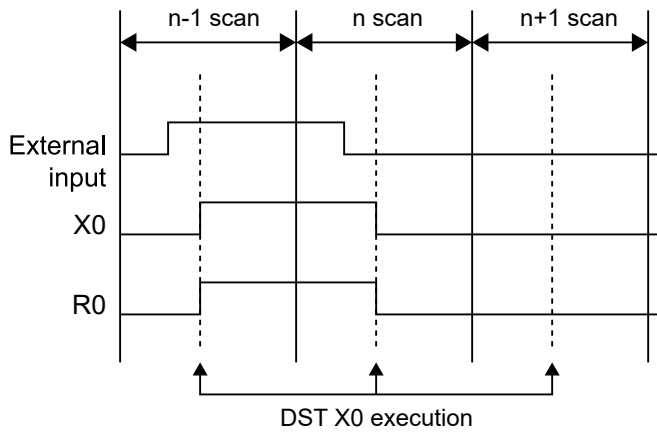

2.3 DOT (direct out)

■ Instruction format

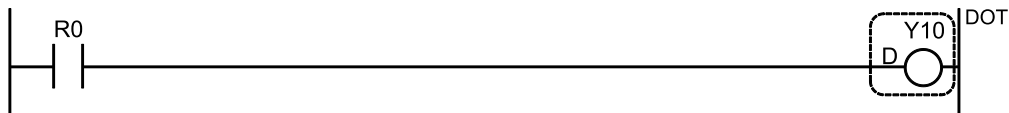

■ Instruction list

Instruction	Description
DOT	Coil that outputs logical operation

■ Devices that can be specified (indicated by ●)

Operands	X	Y	R	T	C	L	Index modifier
DOT		●					●

■ Outline of operation

Instruction	Operation
DOT	Reflects the operation result to the specified output contact, and outputs ON/OFF to the external output.

■ Operation example

Operation of instruction format description program

- If R0 is ON, Y0 turns ON.
- If R0 is OFF, Y0 turns OFF.

■ Precautions for programming

- If the contact is outside the permissible range, an operation error will result.
- If the same output coil is specified, a syntax error (duplicate output) will occur.

■ Comparison of OT instructions and DOT instructions

- Compared to OT instructions, DOT instructions are capable of high-speed responses.

<OT instruction>

2.3 DOT (direct out)

- Ladder diagram

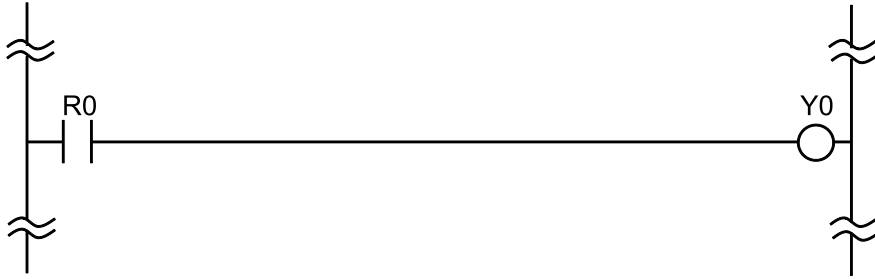

- Timing chart

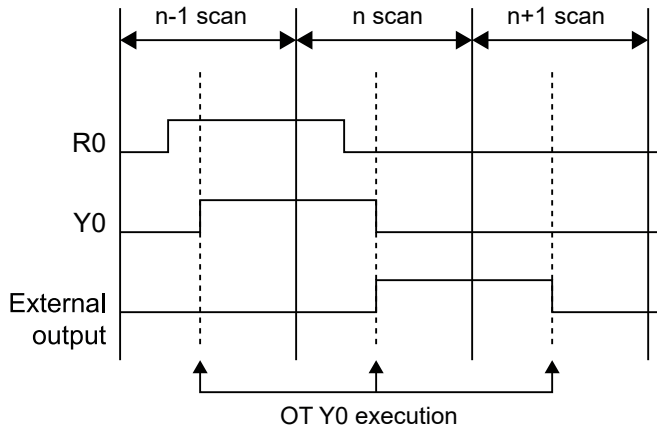

<DOT instruction>

- Ladder diagram

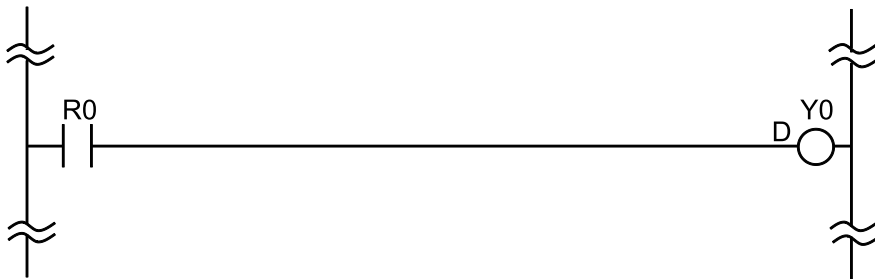

- Timing chart

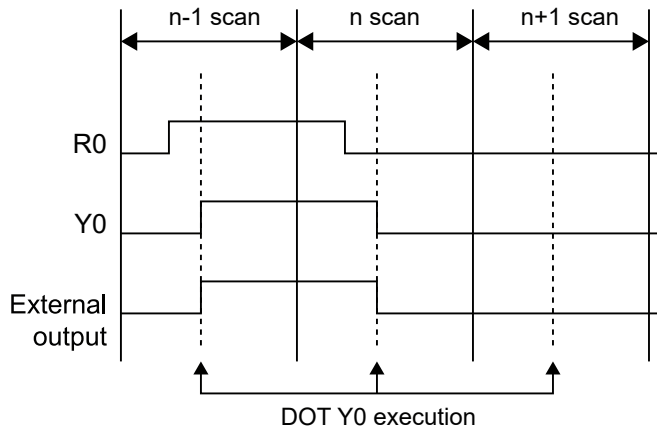

2.4 / (Not)

■ Instruction format

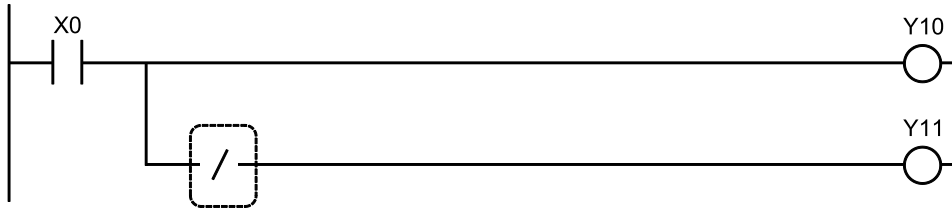

■ Outline of operation

- The **NOT** instruction inverts the operation result up to immediately before this instruction.

■ Operation example

Operation of instruction format description program

- When X0 turns ON, Y10 turns ON and Y11 turns OFF.
- When X0 turns OFF, Y10 turns OFF and Y11 turns ON.

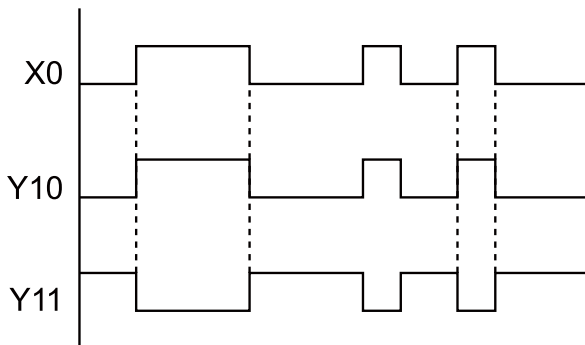

2.5 AN, AN/ (AND, AND Not)

■ Instruction format

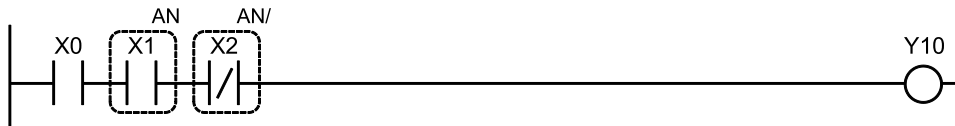

■ Instruction list

Instruction	Description
AN	Form A (normally open) contacts connected in series
AN/	Form B (normally closed) contacts connected in series

■ Devices that can be specified (indicated by ●)

Operands	X	Y	R	T	C	L	Index modifier
AN	●	●	●	●	●	●	●
AN/	●	●	●	●	●	●	●

■ Outline of operation

- A logical conjunction is executed with the immediately preceding serially connected operation result.

■ Operation example

Operation of instruction format description program

- When X0 and X1 turn ON and X2 turns OFF, the result is output to Y10.

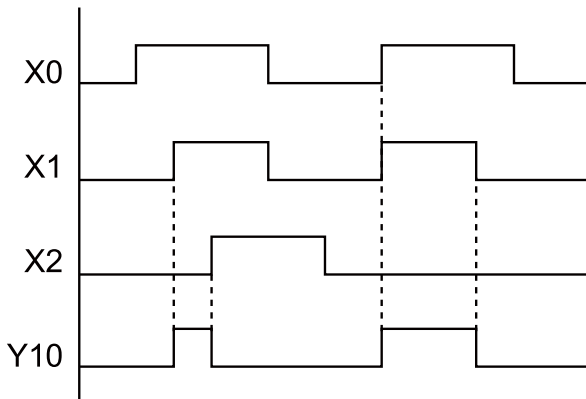

■ Precautions for programming

- Use the **AN** instruction when Form A (normally open) contacts are serially connected.
- Use the **AN/** instruction when Form B (normally closed) contacts are serially connected.

2.5 AN, AN/ (AND, AND Not)

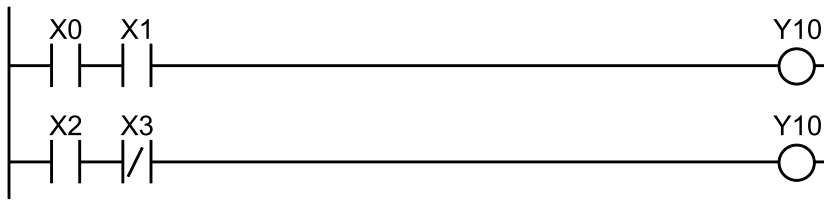

- The **AN** and **AN/** instructions can be used consecutively.

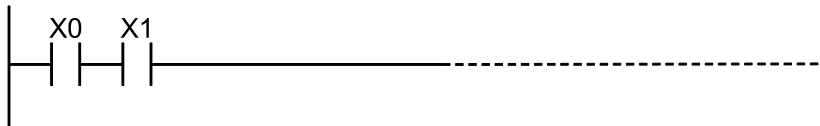

2.6 DAN, DAN/ (Direct AND, Direct AND NOT)

■ Instruction format

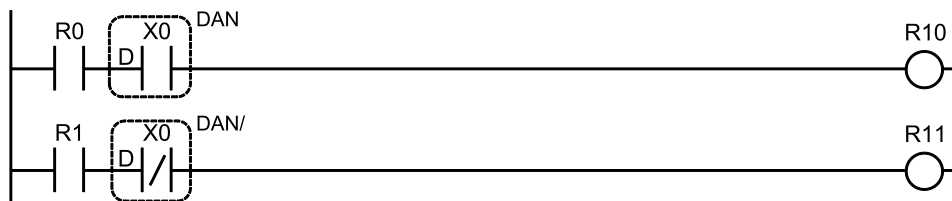

■ Instruction list

Instruction	Description
DAN	Form A (normally open) contacts connected in series
DAN/	Form B (normally closed) contacts connected in series

■ Devices that can be specified (indicated by ●)

Operands	X	Y	R	T	C	L	Index modifier
DAN	●						●
DAN/	●						●

■ Outline of operation

- Reads the specified external input, reflects this in the input contact, and performs a logical conjunction with the calculation results of the immediately preceding operation connected in series.

■ Operation example

Operation of instruction format description program

- R10 turns ON when R0 is ON and external input X0 is ON.
- R11 turns ON when R1 is ON and external input X0 is OFF.

■ Precautions for programming

- If the contact is outside the permissible range, an operation error will result.
- When the time is set using the controller input time constant setting system register, the time constant is invalid.

■ Comparison of AN instructions and DAN instructions

- Compared to AN instructions, DAN instructions are capable of faster response.

<For AN instruction>

2.6 DAN, DAN/ (Direct AND, Direct AND NOT)

- Ladder diagram

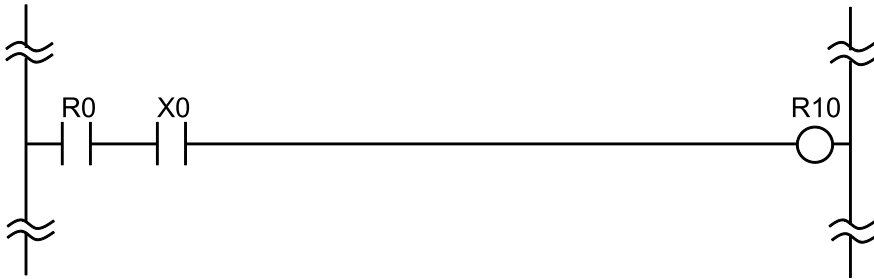

- Timing chart

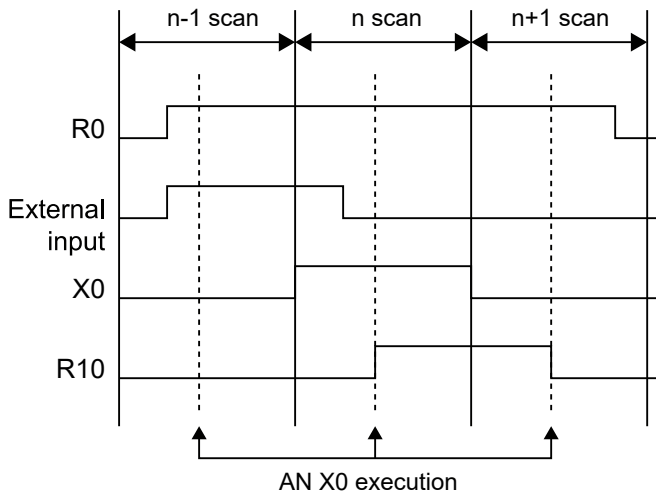

<For DAN instruction>

- Ladder diagram

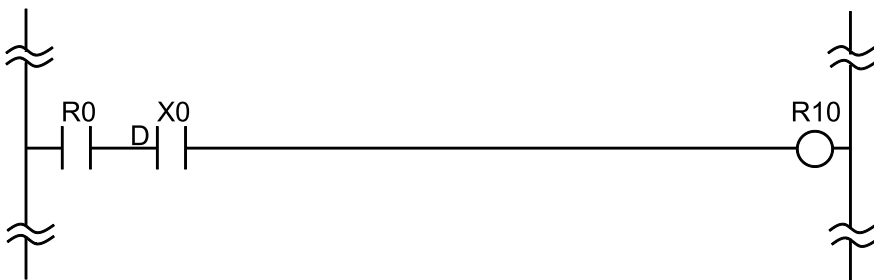

• Timing chart

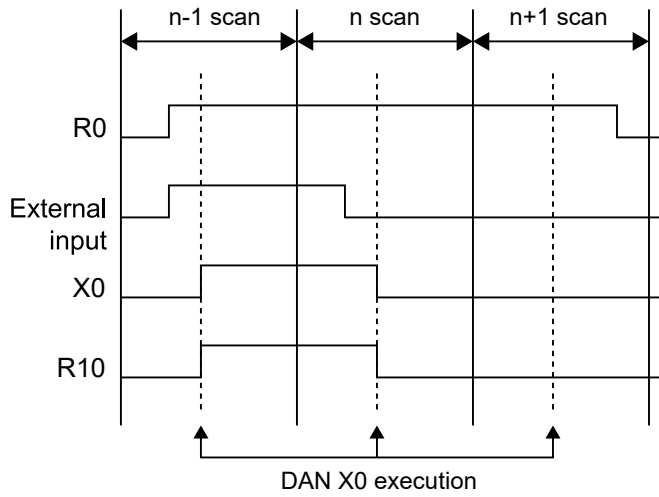

2.7 OR, OR/ (OR, OR Not)

2.7 OR, OR/ (OR, OR Not)

■ Instruction format

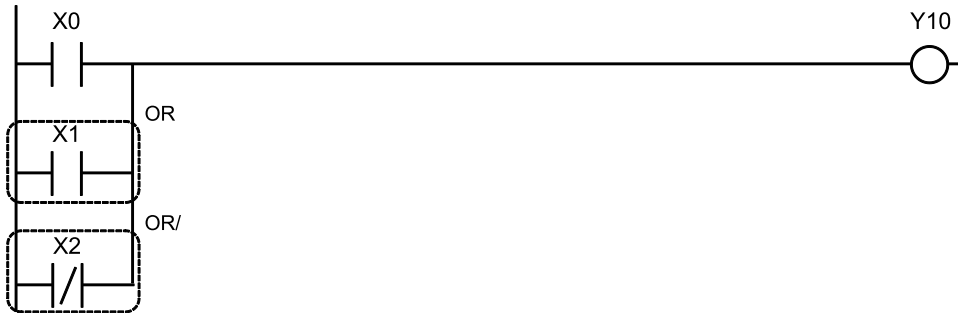

■ Instruction list

Instruction	Description
OR	Form A (normally open) contact connected in parallel
OR/	Form B (normally closed) contact connected in parallel

■ Devices that can be specified (indicated by ●)

Operands	X	Y	R	T	C	L	Index modifier
OR	●	●	●	●	●	●	●
OR/	●	●	●	●	●	●	●

■ Outline of operation

- A logical disjunction is executed with the immediately preceding operation result of the contact connected in parallel.

■ Operation example

Operation of instruction format description program

If any of the conditions of X0 ON, X1 ON, or X2 OFF is satisfied, the result is output to Y10.

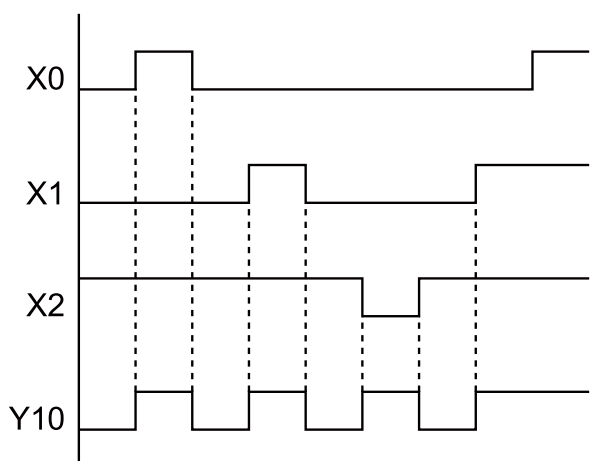

■ Precautions for programming

- Use the **OR** instruction when Form A (normally open) contacts are connected in parallel.
- Use the **OR/** instruction when Form B (normally closed) contacts are connected in parallel.
- The **OR** instruction, like the **ST** instruction, starts from the bus bar.
- The **OR** and **OR/** instructions can be used consecutively.



2.8 DOR, DOR/ (Direct OR, Direct OR Not)

■ **Instruction format**



■ **Instruction list**

Instruction	Description
DOR	Form A (normally open) contact connected in parallel
DOR/	Form B (normally closed) contact connected in parallel

■ **Devices that can be specified (indicated by ●)**

Operands	X	Y	R	T	C	L	Index modifier
DOR	●						●
DOR/	●						●

■ **Outline of operation**

- The specified external input is read and the value is reflected to the input contact. A logical disjunction is executed with the immediately preceding operation result of the contact connected in parallel.

■ **Operation example**

Operation of instruction format description program

- When R0 turns OFF or external input X0 turns ON, R10 turns ON.
- When R1 turns OFF or external input X0 turns OFF, R11 turns ON.

■ **Precautions for programming**

- If the contact is outside the permissible range, an operation error will result.
- When the time is set using the controller input time constant setting system register, the time constant is invalid.

■ Comparing the OR instruction and DOR instruction

- A quicker response is possible with a DOR instruction than with an OR instruction.

<OR instruction>

- Ladder diagram

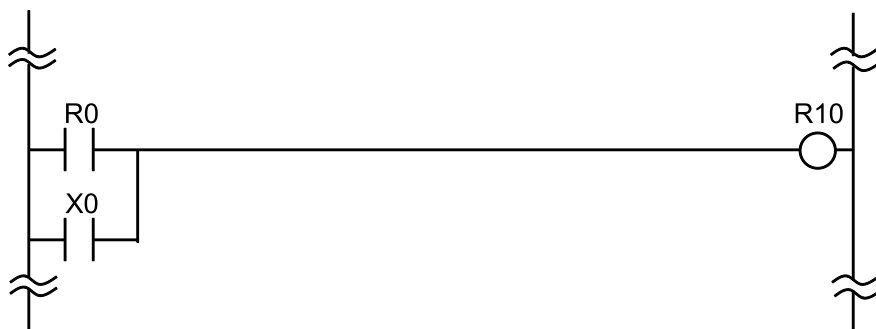

- Timing chart

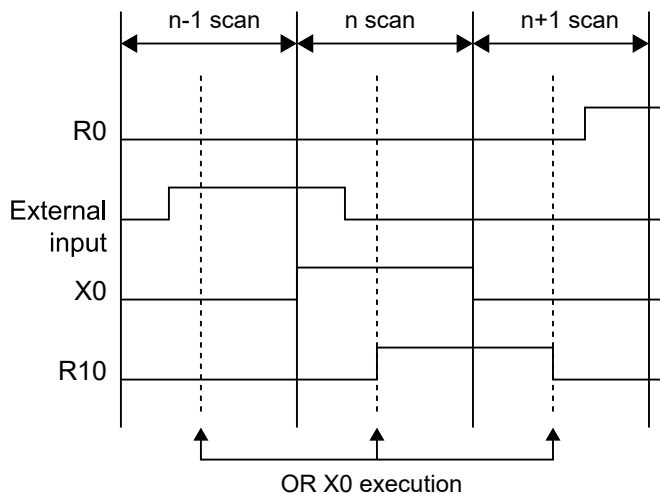

<DOR instruction>

- Ladder diagram

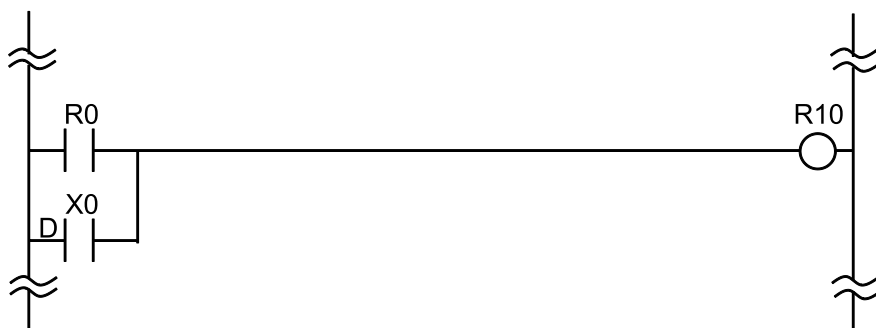

2.8 DOR, DOR/ (Direct OR, Direct OR Not)

- Timing chart

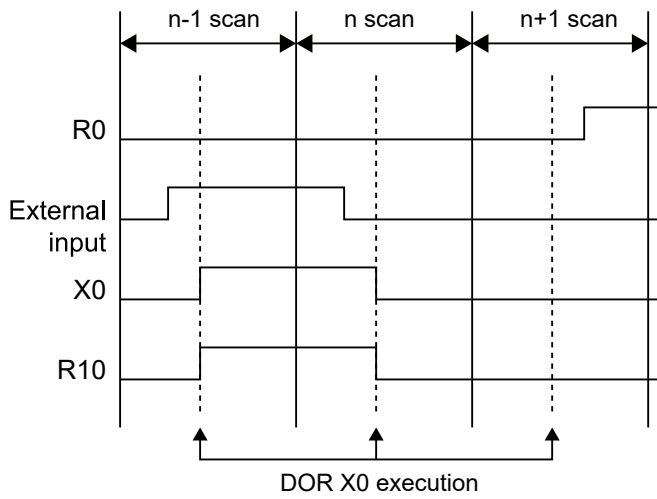

2.9 ST \uparrow , ST \downarrow , AN \uparrow , AN \downarrow , OR \uparrow , OR \downarrow (Rise Detection and Fall Detection Contact Instructions)

■ Instruction format

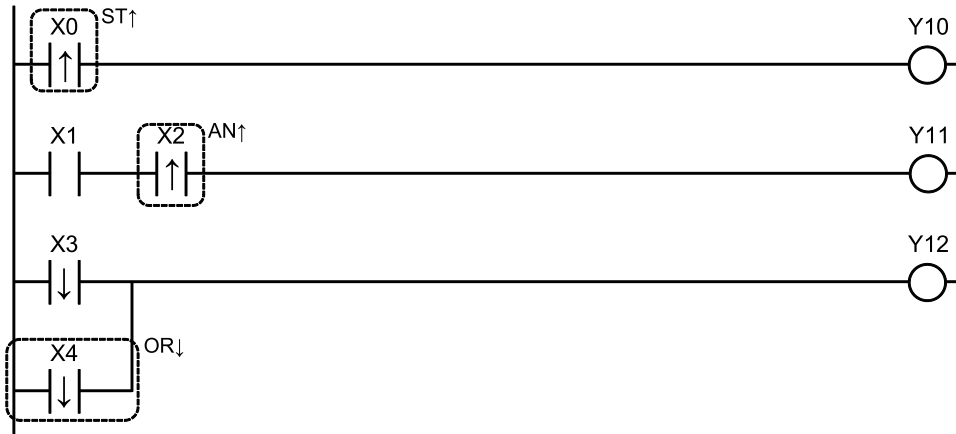

■ Instruction list

Instruction	Description
ST \uparrow , ST \downarrow	Input contact that starts a logical operation at the rise or fall of a signal
AN \uparrow , AN \downarrow	Contacts connected in series at the rise or fall of a signal
OR \uparrow , OR \downarrow	Contacts connected in parallel at the rise or fall of a signal

■ Devices that can be specified (indicated by ●)

Operands	X	Y	R	T	C	L	Index modifier
ST \uparrow , ST \downarrow	●	●	●	●	●	●	
AN \uparrow , AN \downarrow	●	●	●	●	●	●	
OR \uparrow , OR \downarrow	●	●	●	●	●	●	

■ Outline of operation

Instruction	Operation
ST \uparrow , AN \uparrow , OR \uparrow	Conduction takes place for 1 scan only following the change of a signal from the OFF to ON state (rise).
ST \downarrow , AN \downarrow , OR \downarrow	Conduction takes place for 1 scan only following the change of a signal from the ON to OFF state (fall).

■ Operation example

Operation of instruction format description program

1. When X0 changes from OFF to ON (rise), only 1 scan is output to Y10.

2.9 ST \uparrow , ST \downarrow , AN \uparrow , AN \downarrow , OR \uparrow , OR \downarrow (Rise Detection and Fall Detection Contact Instructions)

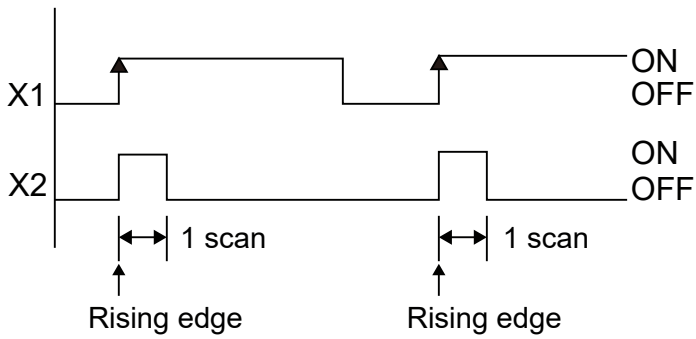

- Output to Y11 takes place for 1 scan only following the change of X2 from the OFF to ON state (rise) when X1 is ON.

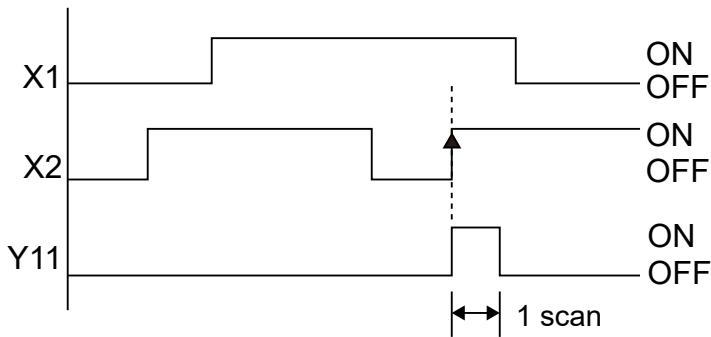

- Output to Y12 takes place for 1 scan only following the change of X3 or X4 from the ON to OFF state (fall).

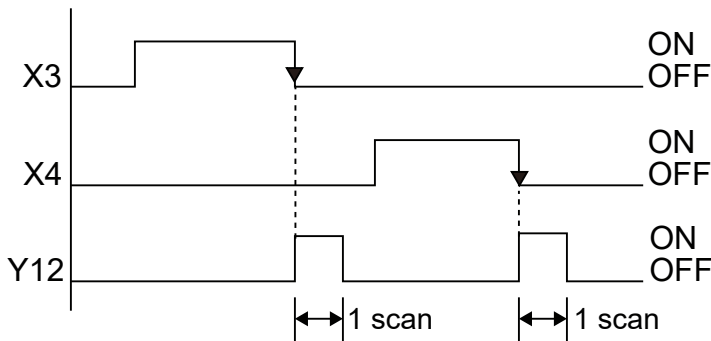

2.10 ALT (Alternate out)

■ Instruction format

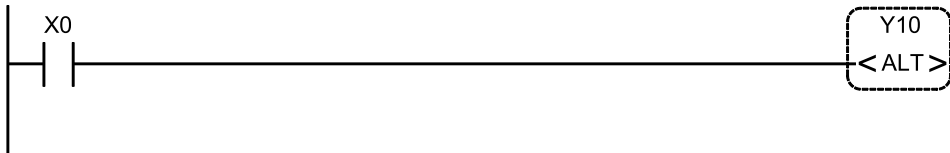

■ Instruction list

Instruction	Description
ALT	Coil that controls flip-flops

■ Devices that can be specified (indicated by ●)

Operands	X	Y	R	T	C	L	Index modifier
ALT		●	●			●	

■ Outline of operation

- When the operation result up to immediately before changes (rises) from OFF to ON, the specified coil ON/OFF is inverted.
- The specified coil ON/OFF status is held until the next rise of the **ALT** instruction that specifies that coil. (Flip-flop control)

■ Operation example

Operation of instruction format description program

Each time X0 changes from OFF to ON (rises), the output Y10 ON/OFF status is inverted.

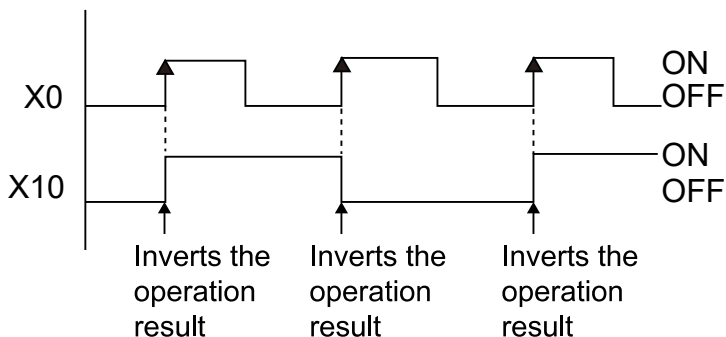

■ Precautions for programming

The **ALT** instruction detects input OFF to ON rise and inverts the output.

- While the input continues to be ON, it is inverted only during rise. After that it is not inverted.
- When switching to RUN or when powering on in "RUN mode", if input is ON from the beginning, inversion is not carried out for the first scan.

2.10 ALT (Alternate out)

- Be aware that, if used with instructions that change the order of execution such as the MC to MCE instructions or the JP to LBL instructions (see 1 to 6 below), the operation of instructions may change depending on the timing of instruction execution and input.
 1. MC to MCE instructions
 2. JP to LBL instructions
 3. LOOP to LBL instructions
 4. CNDE instruction
 5. Step ladder instructions
 6. Subroutine instructions

2.11 ANS (and stack)

■ Instruction format

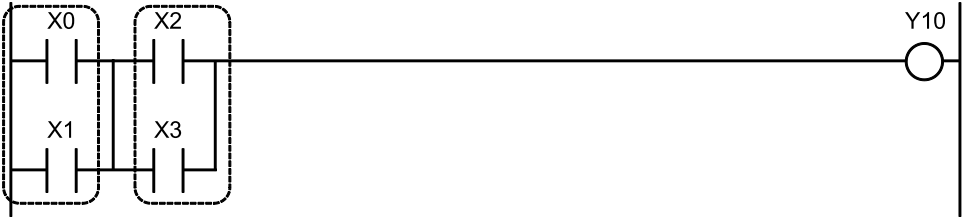

■ Outline of operation

- Blocks that were connected in parallel are connected in series.

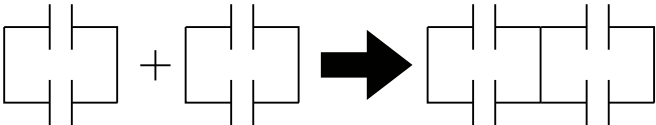

Blocks stack in series

- The start of each block begins with an **ST** instruction.

■ Operation example

Operation of instruction format description program

When X0 or X1 are ON, and X2 or X3 are ON, they are output to Y10.

$$\underbrace{(X0 \text{ OR } X1)}_{\text{Block 1}} \text{ AND } \underbrace{(X2 \text{ OR } X3)}_{\text{Block 2}} \rightarrow Y10$$

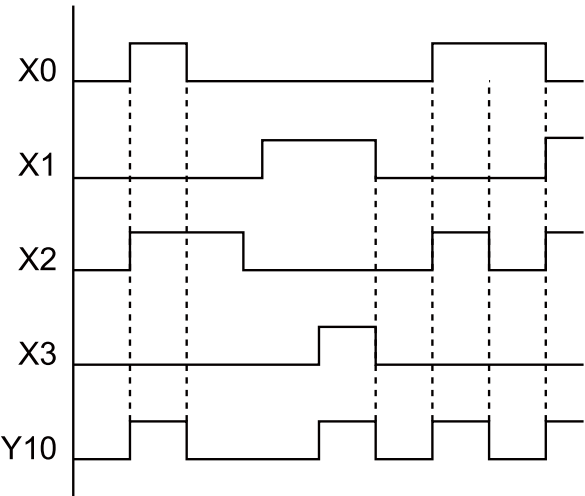

2.11 ANS (and stack)

■ When blocks are consecutive

When blocks are consecutive, consider a block division as follows.

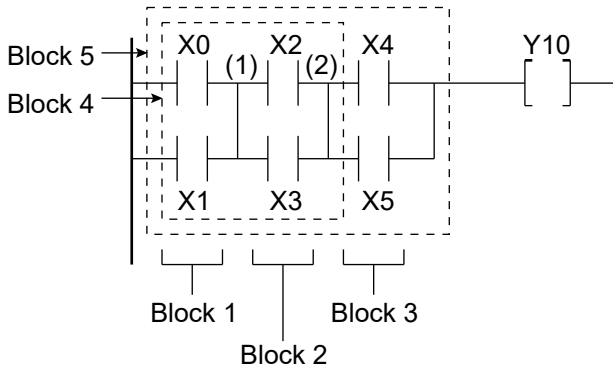

Block 5	Block 4	Block 1	ST X	0
			OR X	1
	Block 2	ST X	2	
		OR X	3	
	ANS.....(1)			
	Block 3	ST X	4	
		OR X	5	
		ANS.....(2)		
		OT Y	10	

2.12 ORS (OR Stack)

■ Instruction format

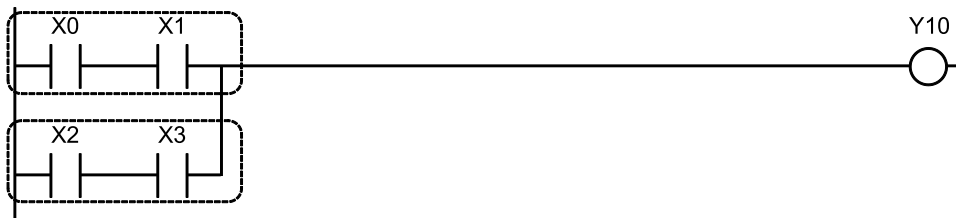

■ Outline of operation

- Serially connected blocks are connected in parallel.

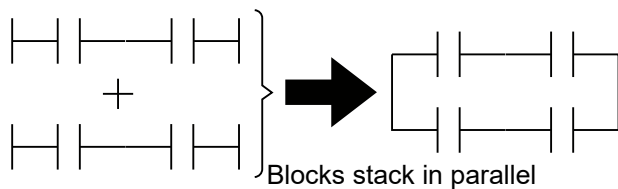

- The start of each block begins with an **ST** instruction.

■ Operation example

Operation of instruction format description program

When both X0 and X1 turn ON, or when both X2 and X3 turn ON, the result is output to Y10.

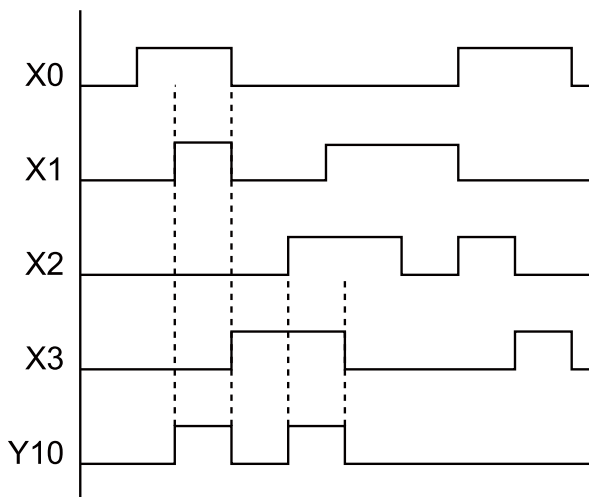
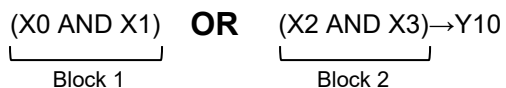

2.12 ORS (OR Stack)

■ When blocks are consecutive

When blocks are consecutive, consider a block division as follows.

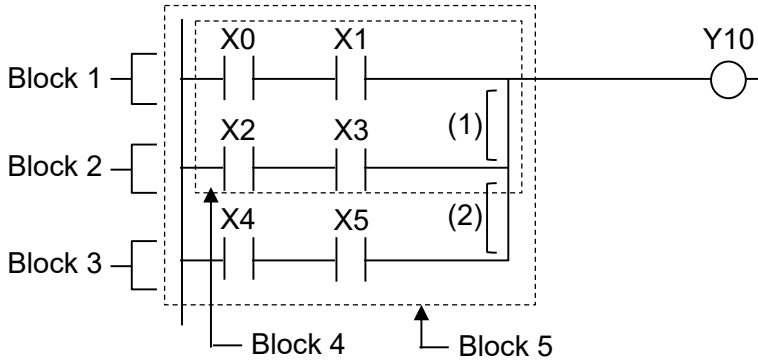

Block 5	Block 4	Block 1	ST	X	0		
			AN	X	1		
	Block 2		ST	X	2		
			AN	X	3		
			ORS			(1)	
	Block 3			ST	X	4	
				AN	X	5	
				ORS			(2)
				OT	Y	10	

2.13 PSHS, RDS, POPS (Push stack, Read stack, Pop stack)

■ Instruction format

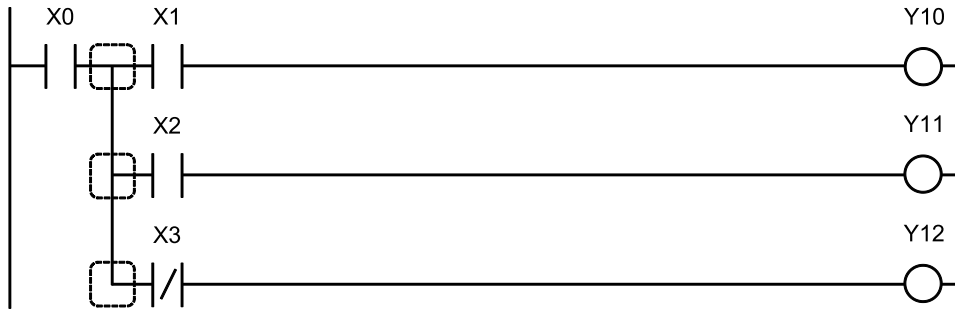

■ Outline of operation

These instructions can be used to store one operation result, read it, and perform multiple processes on it.

Instruction	Operation
PSHS	The operation result immediately before the PSHS instruction is stored and operation continues from the next step.
RDS	The operation result stored by the PSHS instruction is read and operation continues from the next step using this result.
POPS	The operation result stored by the PSHS instruction is read, operation continues from the next step using this result, and the operation result stored by the PSHS instruction is cleared.

This instruction is used when there is branching from a single contact, followed by another contact or contacts.

■ Operation example

Operation of instruction format description program

- 1) When X0 turns ON, the operation result is stored by the **PSHS** instruction, and if X1 is ON, the result is output to Y10.
- 2) The operation result is read by the **RDS** instruction, and if X2 is ON, the result is output to Y11.
- 3) The operation result is read by the **POPS** instruction, output to Y12 if X3 is OFF, and the operation result stored by the **PSHS** instruction is cleared.

2.13 PSHS, RDS, POPS (Push stack, Read stack, Pop stack)

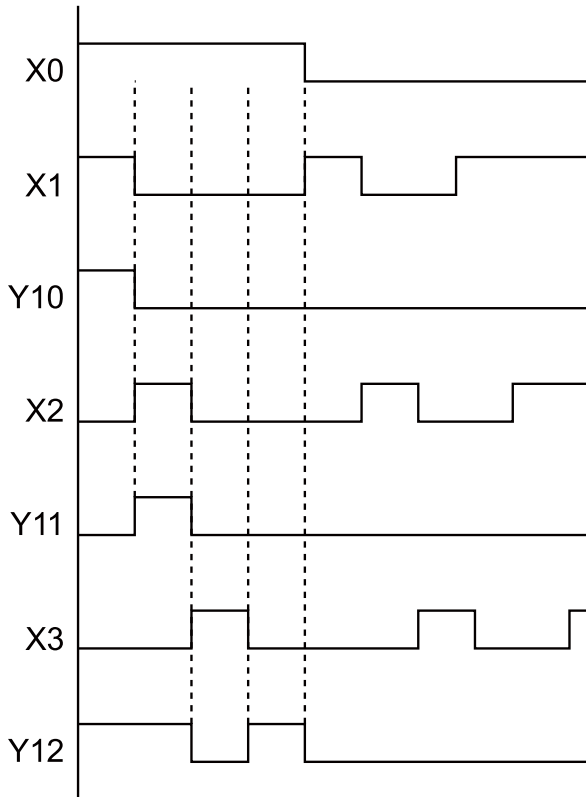

■ Programming precautions

- Use the **RDS** instruction when continuing to use the operation result, and use the **POPS** instruction when finishing. (The **POPS** instruction must be included.)

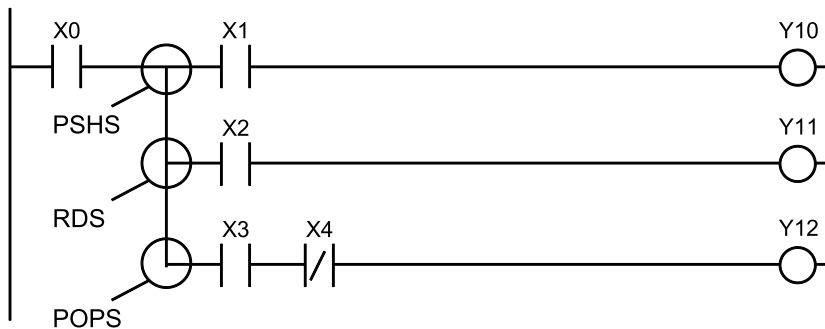

- The **RDS** instruction may be used consecutively as many times as required.

2.13 PSHS, RDS, POPS (Push stack, Read stack, Pop stack)

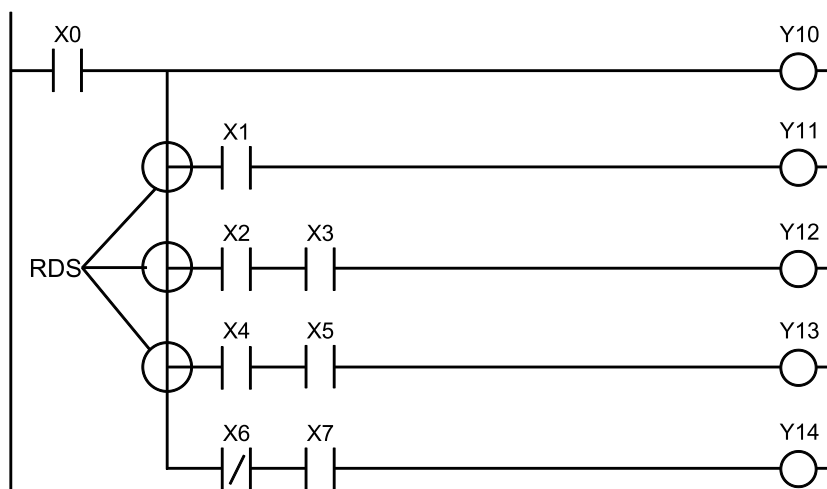

■ Precautions when using the PSHS instruction consecutively

- The **PSHS** instruction is limited to a maximum of eight consecutive uses.
- Please note that the program will not run correctly if this limit is exceeded.

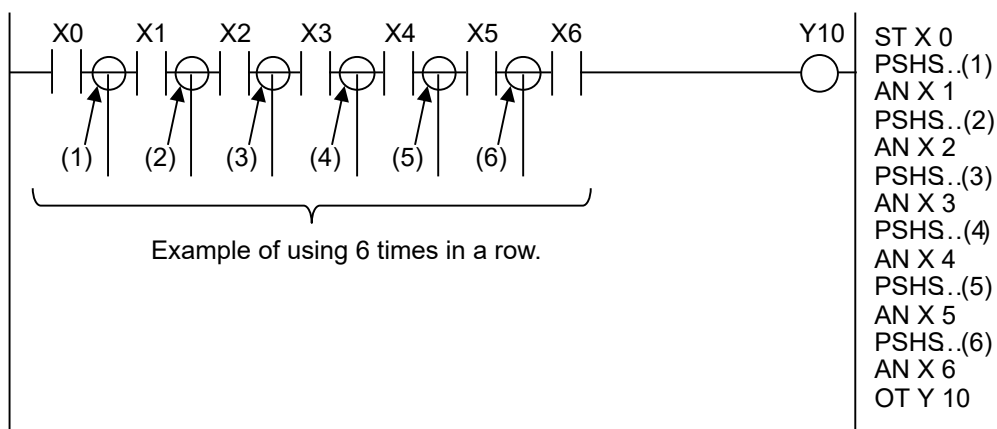

- If the **POPS** instruction is used when using the **PSHS** instruction consecutively, reading will take place in order beginning from the last data stored by the **PSHS** instruction.

2.13 PSHS, RDS, POPS (Push stack, Read stack, Pop stack)

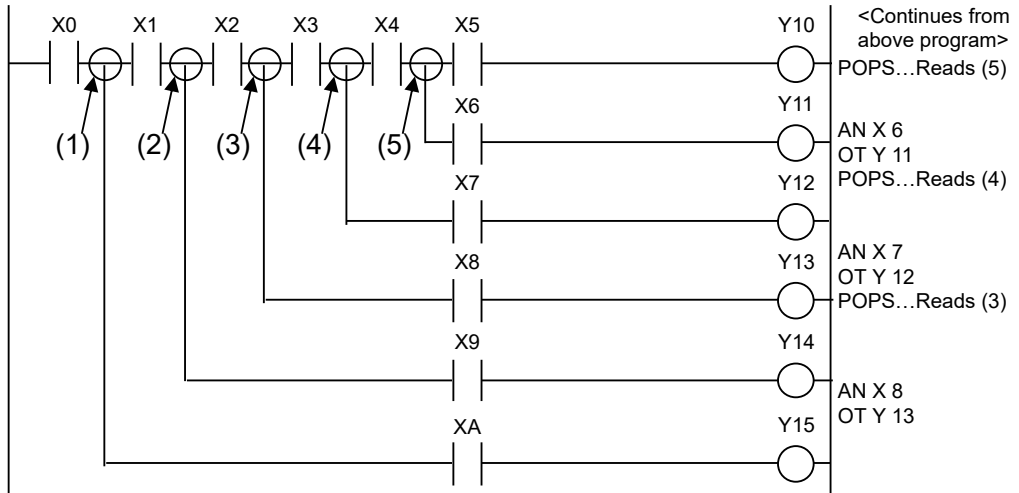

2.14 DF, DF/ (rise differential and fall differential)

■ Instruction format

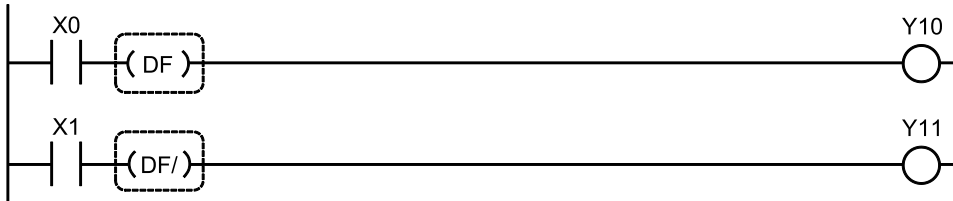

■ Outline of operation

Instruction	Operation
DF	When an execution condition changes from OFF to ON (rise), outputs only that 1 scan (differential output).
DF/	When an execution condition changes from ON to OFF (fall), outputs only that 1 scan (differential output).

- There is no limit to the number of times a differential instruction can be used.
- With a differential instruction, only the changes in the contact's ON/OFF status are detected, so if execution conditions are met (ON) from the start when switching into "RUN mode" or when powering on in "RUN mode", there will be no output.

<Example> Rise differential

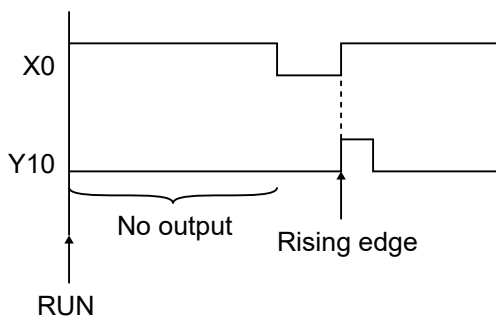

■ Operation example

Operation of instruction format description program

1. When X0 changes from OFF to ON (rise), only 1 scan is output to Y10.
2. When X1 changes from ON to OFF (fall), only 1 scan is output to Y11.

2.14 DF, DF/ (rise differential and fall differential)

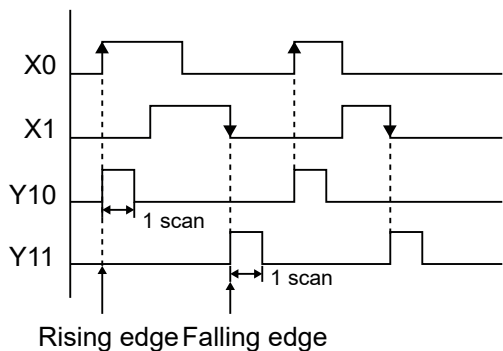

■ Related instructions

- The DFI instruction can be used. Only the first 1 scan is executed.

■ Programming precautions

- For the circuit shown below, the operation is as follows.

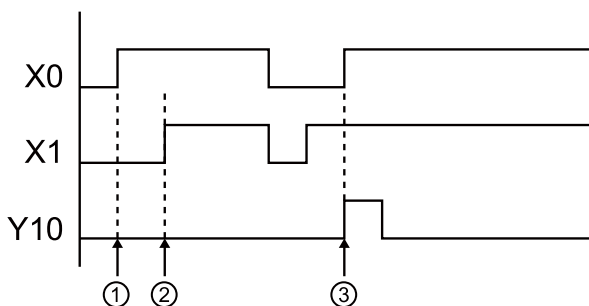
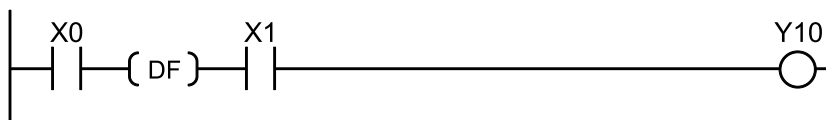

(1)	When X1 is OFF, Y10 remains OFF even if X0 rises.
(2)	When X0 is ON, Y10 remains OFF even if X1 rises.
(3)	When X1 is ON, if X0 rises, then Y10 turns ON for one scan.

- In the following program, the execution condition is ON from the beginning, so output cannot be obtained.



R9013 only turns ON during the first scan after RUN begins.

R9010 is a normally ON relay.

- In the following program, output can be obtained.

2.14 DF, DF/ (rise differential and fall differential)



R9014 turns ON from the second scan after RUN begins.

- Caution is required when using differential instructions in combination with instructions that change the order of execution of instructions (1 to 6 below), such as the **MC/MCE** instructions or the **JP/LBL** instructions.
 1. MC to MCE instructions
 2. JP to LBL instructions
 3. LOOP to LBL instructions
 4. CNDE instruction
 5. Step ladder instructions
 6. Subroutine instructions
- When a differential instruction is combined with an AND stack instruction or a pop stack instruction, take care that the syntax is correct.
- For the circuit shown below, the operation is as follows.



<Time chart>

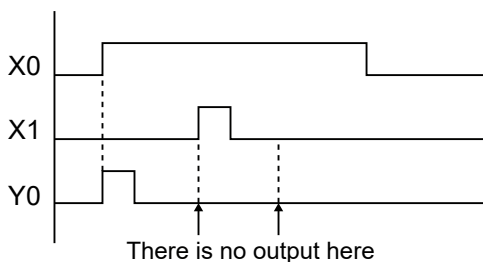

- To turn Y0 ON at the rise of either X0 or X1, program it as follows.

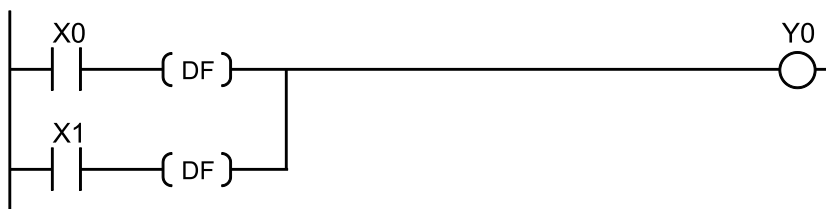

2.14 DF, DF/ (rise differential and fall differential)

<Time chart>

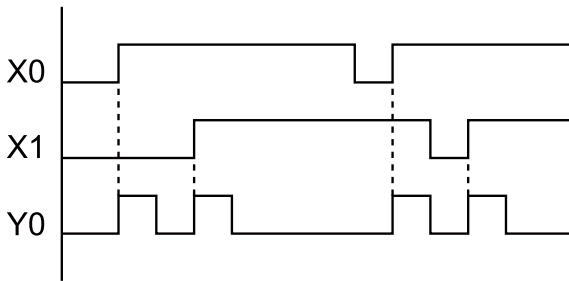

■ Examples of applying differential instructions

- Using differential instructions makes it easy to create and adjust programs.

<Example of application to a self-holding circuit>

- Using a differential instruction allows longer input signals to be supported.

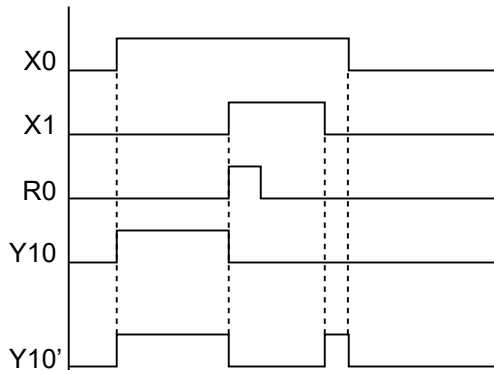
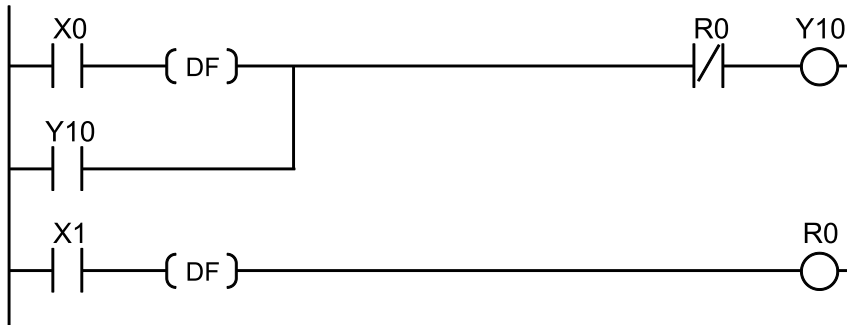

If there are no differential instructions in the above ladder diagram

<Example of application to an alternating circuit>

- It can also be applied to alternating circuits that hold and release with a single signal.

<Example 1>

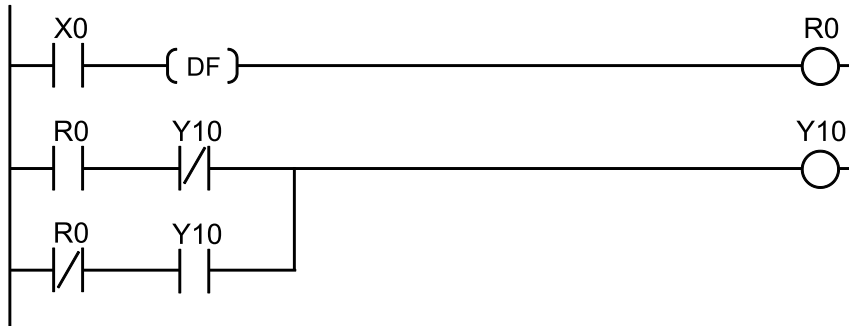

<Example 2>

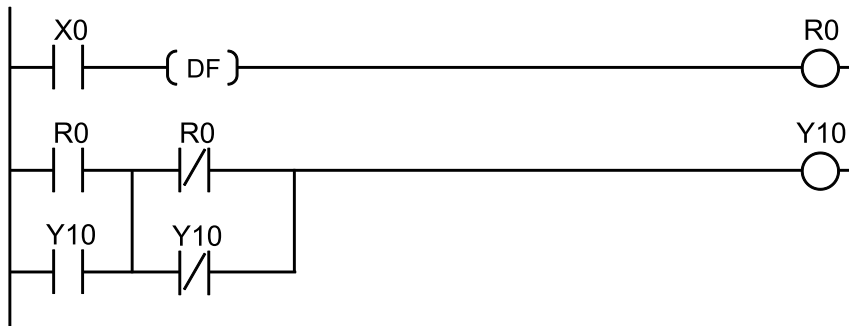

2.15 DFI [Rise differential (initial execution type)]

2.15 DFI [Rise differential (initial execution type)]

■ Instruction format

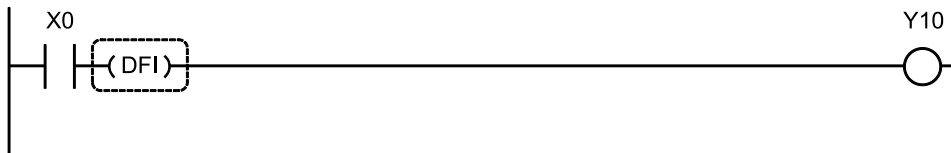

■ Outline of operation

Instruction	Operation
DFI	When an execution condition changes from OFF to ON (rise), outputs only that one scan (differential output).

- If the execution condition is met from before RUN starts, output (differential output) is performed at the first scan.
- There is no limit on the number of times the **DFI** instruction can be used.
- If it is possible for execution conditions to be met when switching into "RUN mode" or when powering on in "RUN mode", with the **DF** instruction, output cannot be obtained with the first scan, so using the **DFI** instruction, blocks that were connected in series are connected in parallel.

■ Operation example

Operation of instruction format description program

When X0 changes from OFF to ON (rise), only 1 scan is output to Y10.

- When execution condition is met after RUN starts

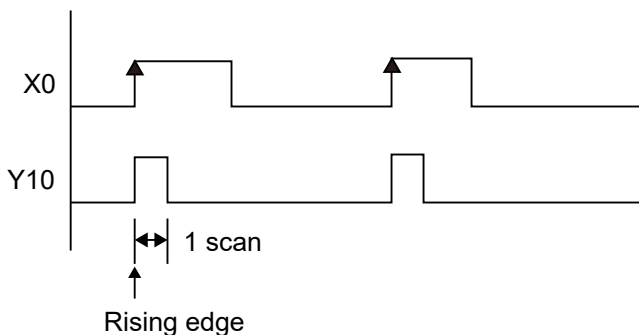

- When execution condition is met from the beginning

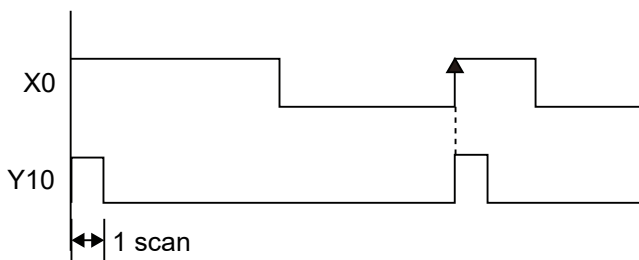

- Caution is required when using differential instructions in combination with instructions that change the order of execution of instructions (1 to 6 below), such as the **MC/MCE** instructions or the **JP/LBL** instructions.
 1. MC to MCE instructions
 2. JP to LBL instructions
 3. LOOP to LBL instructions
 4. CNDE instruction
 5. Step ladder instructions
 6. Subroutine instructions
- When a differential instruction is combined with an AND stack instruction or a pop stack instruction, take care that the syntax is correct.

2.16 SET, RST (Set, Reset)

2.16 SET, RST (Set, Reset)

■ Instruction format

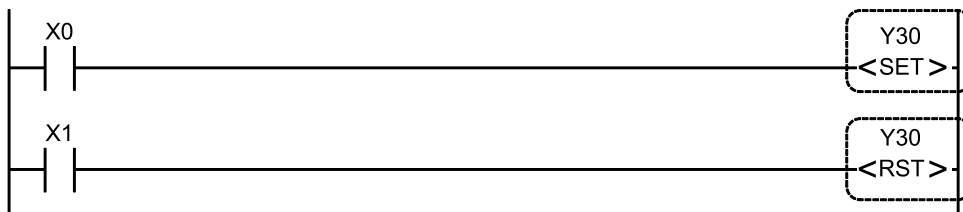

■ Instruction list

Instruction	Description
SET	Output coil
RST	Output coil

■ Devices that can be specified (indicated by ●)

Operands	X	Y	R	T	C	L	Index modifier
SET		●	●			●	●
RST		●	●			●	●

■ Outline of operation

Instruction	Operation
SET	When the execution condition turns ON, the output turns ON and the state is held regardless of a change in the state of the execution condition.
RST	When the execution condition turns ON, the output coil turns OFF and the OFF state is held regardless of a change in the state of the execution condition.

- The same output coil can be specified as many times as desired for the **SET** and **RST** instruction output destinations. (Even if a total check is run, this is not handled as a syntax error.)

■ Operation example

Operation of instruction format description program

1. When X0 turns ON, Y30 turns ON and is held in that state.
2. When X1 turns ON, Y30 turns OFF and is held in that state.

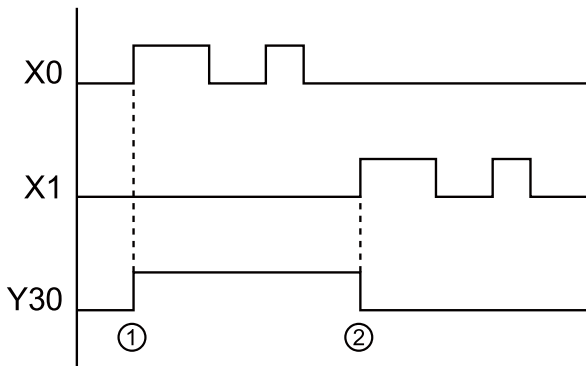

■ Processing mechanisms when the SET and RST instructions are used

- The output content is overwritten with each step during processing of the operation.

e.g. Processing when X0, X1, and X2 are all turned ON

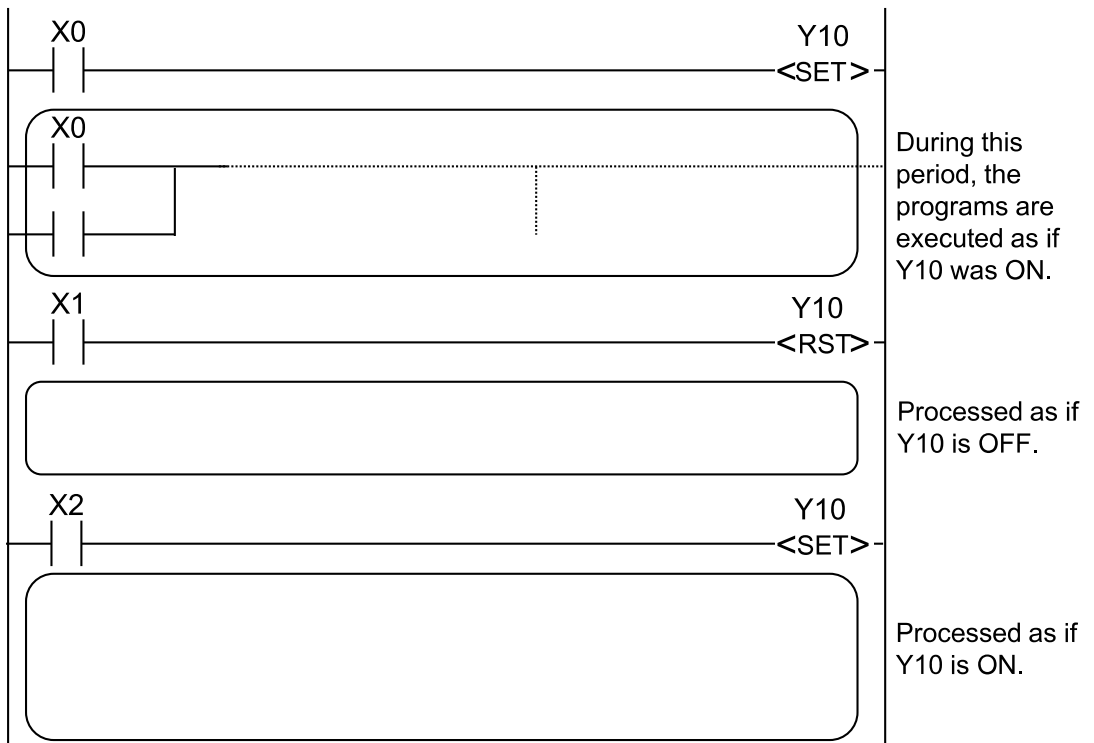

- I/O refresh is performed when an ED instruction is executed; therefore, the data actually output is determined by the final operation result. In the above example, output occurs with Y10 ON.
- To output a result while the operation is still in progress, use the partial I/O refresh instruction (F143).

■ Precautions for programming

- The output destination of a SET instruction retains its state even during the operation of an MC instruction.

2.16 SET, RST (Set, Reset)

- The output destination of a SET instruction is reset when switching from "RUN" to "PROG. mode" and when the power is turned OFF. (However, if an internal relay set as a hold type is specified as the output destination, reset does not take place.)

■ SET and RST instructions used as a set with differential instructions

- Placing a DF differential instruction before the SET and RST instructions makes program development and adjustment easier.
- This is particularly effective when the same output destination is used in several places in the program.

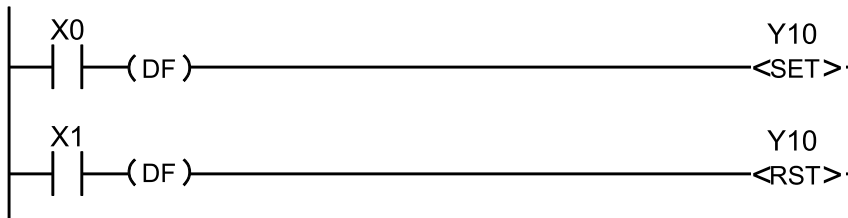

2.17 DSET/DRST (Direct Set/Direct Reset)

■ Instruction format

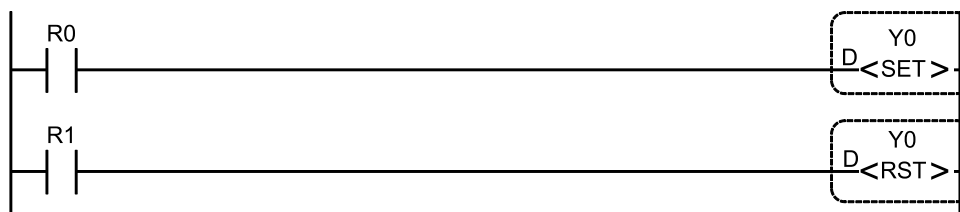

■ Instruction List

Instruction	Description
DSET	Output coil
DRST	Output coil

■ Devices that can be specified (indicated by ●)

Operands	X	Y	R	T	C	L	Index modifier
DSET		●					●
DRST		●					●

■ Outline of operation

Instruction	Operation
DSET	When the execution condition is ON, the specified output contact is turned ON, and ON is output to external output. Regardless of execution condition status changes, the ON status is held.
DRST	When the execution condition is ON, the specified output contact is turned OFF, and OFF is output to external output. Regardless of execution condition status changes, the OFF status is held.

- You can specify the same output coil for the **DSET** and **DRST** instruction output destination as many times as required. Even if Total Check is implemented, it is not treated as a syntax error.

■ Operation Example

Operation of instruction format description program

- When R0 turns ON, external output is turned ON and the ON status is maintained.
- When R1 turns ON, external output is turned OFF and the OFF status is maintained.

■ Precautions for programming

- If the contact is outside the permissible range, an operation error will result.
- Even if the **MC** instruction is in progress, the DSET instruction output destination holds that status.
- The DSET instruction output destination will reset when "RUN MODE" switches to "PROG. MODE" or when the device is powered OFF.

2.17 DSET/DRST (Direct Set/Direct Reset)

■ Comparison of SET instructions and DSET instructions

- Compared to SET instructions, DSET instructions are capable of high-speed responses.

<SET instruction>

- Ladder diagram

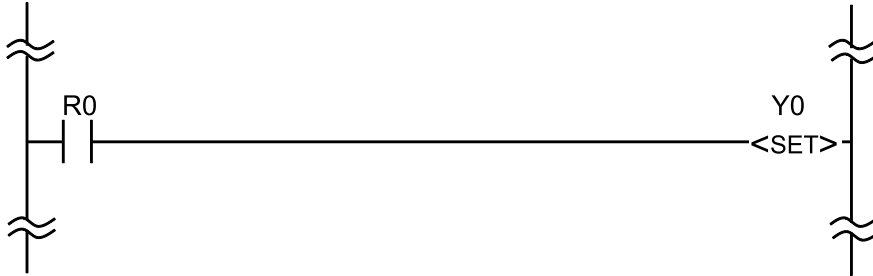

- Timing chart

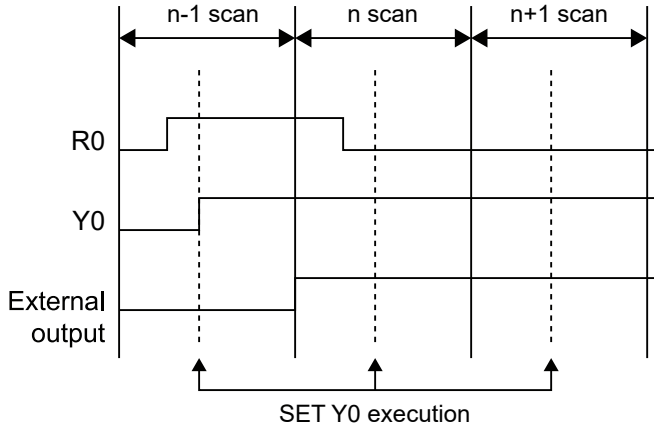

<DSET instruction>

- Ladder diagram

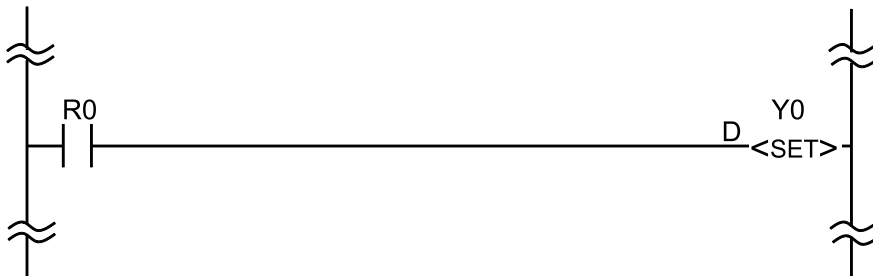

• **Timing chart**

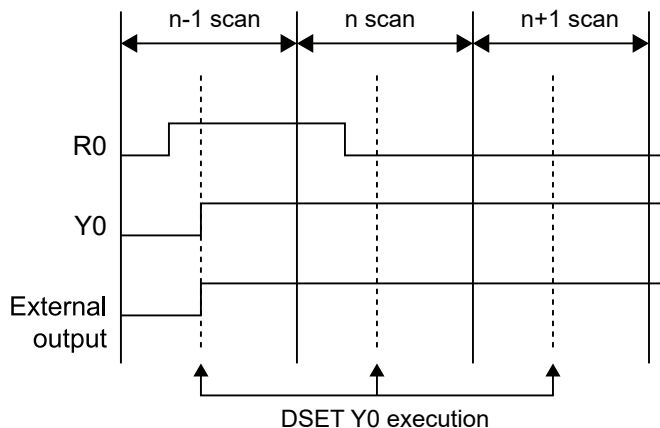

■ **Comparison of RST instructions and DRST instructions**

- Compared to RST instructions, DRST instructions are capable of high-speed responses.

<RST instruction>

• **Ladder diagram**

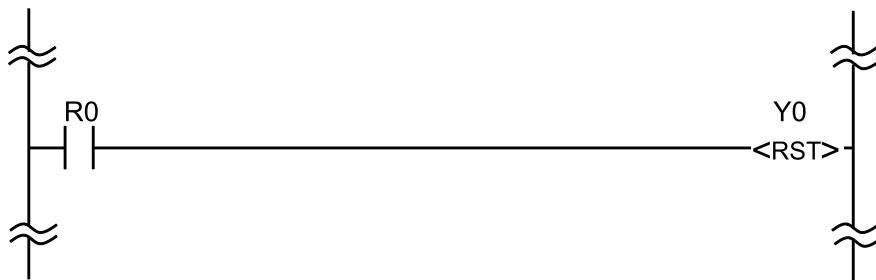

• **Timing chart**

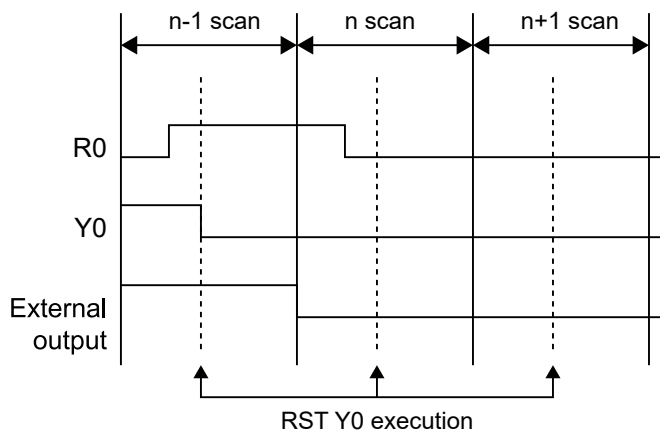

<DRST instruction>

2.17 DSET/DRST (Direct Set/Direct Reset)

- Ladder diagram

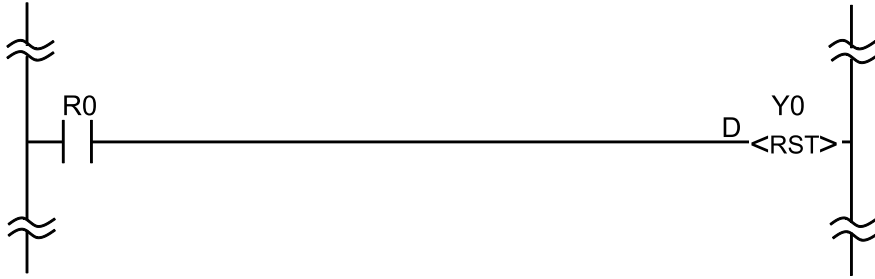

- Timing chart

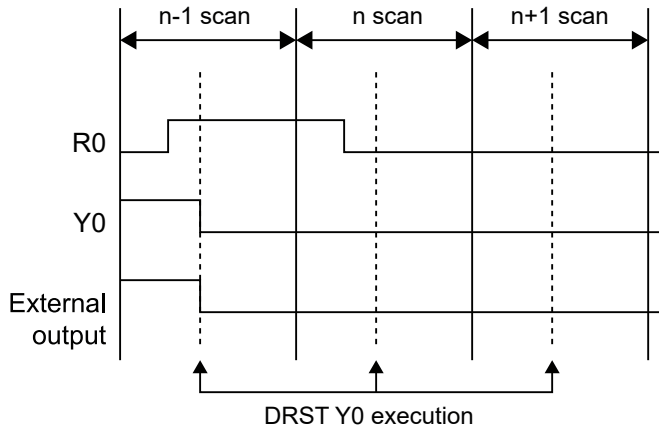

2.18 KP (Keep)

■ Instruction format

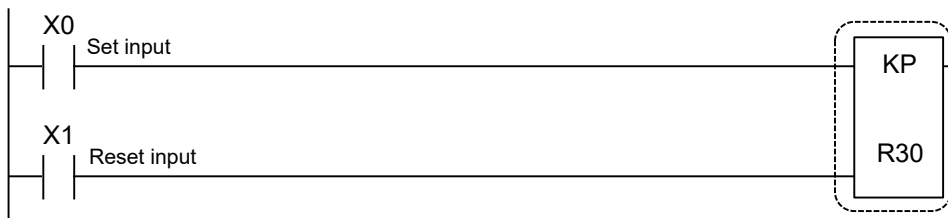

■ Instruction list

Instruction	Description
KP	Output coil

■ Devices that can be specified (indicated by ●)

Operands	X	Y	R	T	C	L	Index modifier
KP		●	●			●	

■ Outline of operation

- When the set input turns ON, output of the specified coil turns ON and is held in that state.
- When the reset input turns ON, the hold state is released.
- The output is held in an ON state until the reset input turns ON, regardless of the ON/OFF state of the set input.
- If the set input and reset input turn ON simultaneously, the reset input takes priority. Serially connected blocks are connected in parallel.

■ Operation example

Operation of instruction format description program

- 1) When X0 turns ON, output of the specified coil turns ON and is held in that state.
- 2) When X1 turns ON, the hold state is released.

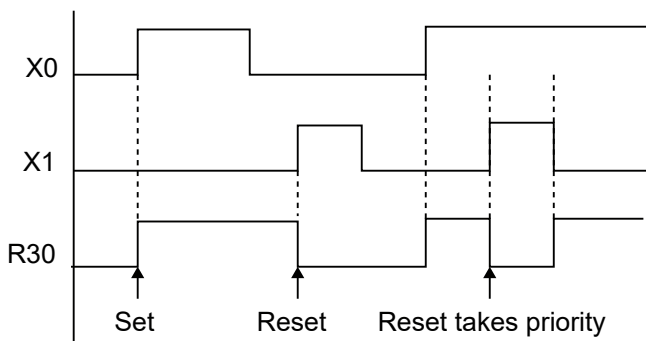

2.18 KP (Keep)

■ Precautions for programming

- The state of the output destination is held even during operation of the **MC** instruction.
- The output is reset when switching from "RUN mode" to "PROG. mode" and when the power is turned OFF. (However, if an internal relay set as a hold type is specified as the output destination, reset does not take place.)

2.19 DKP (Direct Keep)

■ Instruction format

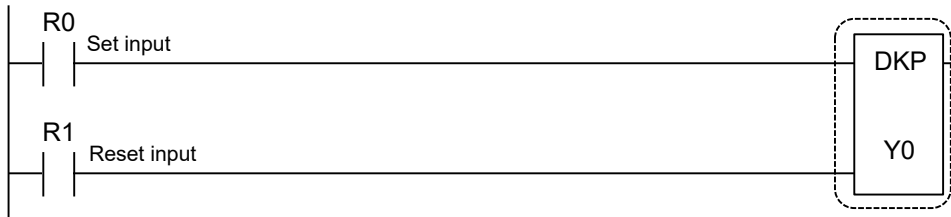

■ Instruction list

Instruction	Description
DKP	Output coil

■ Devices that can be specified (indicated by ●)

Operands	X	Y	R	T	C	L	Index modifier
DKP		●					

■ Outline of operation

- When set input is ON, output from the specified coil is ON, and external output is also ON. Additionally, this status is retained.
- When reset input is ON, output from the specified coil is OFF, and external output is also OFF. Additionally, retention is canceled.
- During retention, regardless of set input ON/OFF status, output is retained until there is reset input.
- If the set input and reset input turn ON simultaneously, the reset input takes priority.

■ Operation example

Operation of instruction format description program

- When R0 turns ON, external output is turned ON and the ON status is maintained.
- When R1 turns ON, external output is turned OFF and the OFF status is maintained.

■ Precautions for programming

- If the contact is outside the permissible range, an operation error will result.
- If the same output coil is specified, a syntax error (duplicate output) will occur.
- The state of the output destination is held even during operation of the **MC** instruction.
- When switching from "RUN mode" to "PROG. mode" and at power OFF, the output destination is reset.

■ Comparison of KP instruction and DKP instruction

- The DKP instruction is capable of faster responsiveness than the KP instruction.

<KP instruction>

2.19 DKP (Direct Keep)

- Ladder diagram

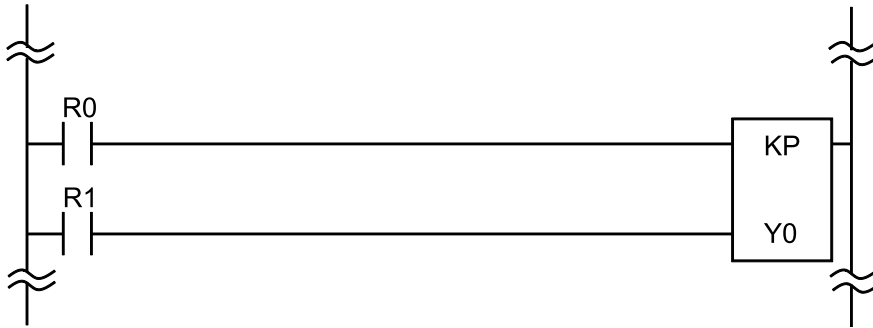

- Timing chart

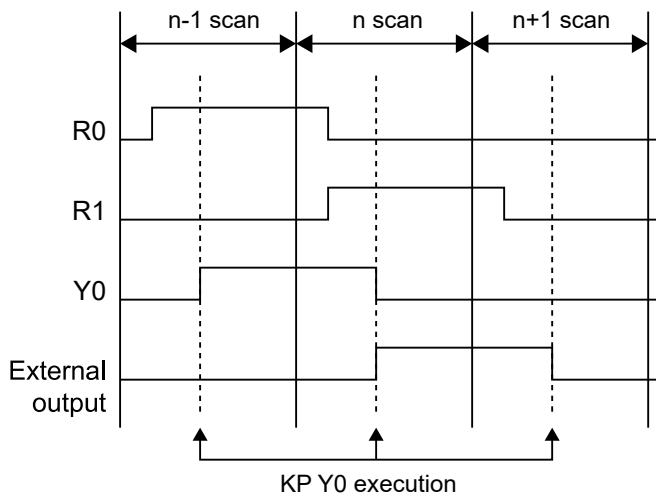

<DKP instruction>

- Ladder diagram

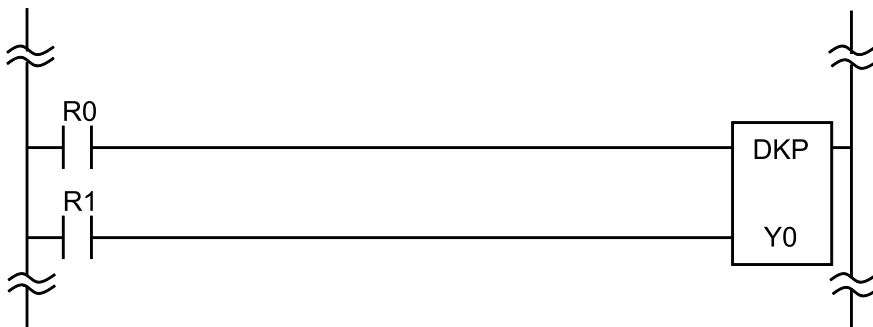

- Timing chart

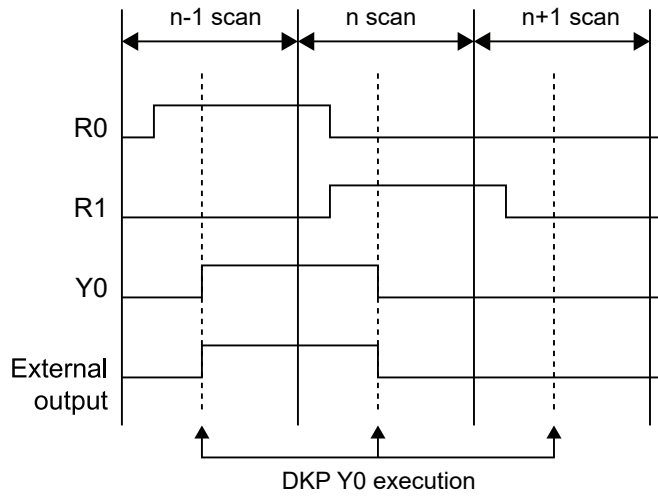

2.20 NOP

2.20 NOP

■ Instruction format

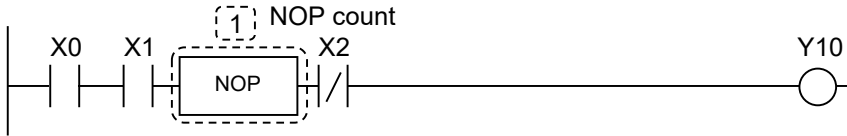

■ Outline of operation

- This instruction has no effect on the operation results to that point. The same operation is performed even without a **NOP** instruction.
- A **NOP** instruction can be used to make the program easier to read when checking or correcting.
- Write a **NOP** instruction (overwrite the previous instruction) when you want to delete an instruction without changing addresses.
- Insert a **NOP** instruction when you want to move the addresses of one part of a program without changing the program.
- For example, this is a convenient means of breaking a long program into several blocks.

e.g.

To move the starting point of a program block from address 39 to address 40, insert a **NOP** instruction at address 39.

Address		Address	
36	ST X0	36	ST X0
	OR X1		OR X1
	OT Y10		OT Y10
39	ST X2	39	NOP
40	AN X3	40	ST X2
41	OT R20	41	AN X3
42	ST R2	42	OT R20
43	DF	43	ST R2
44	ST X3	44	DF
	{	45	ST X3
			}

→ Want to start from address 40
 ← Insert NOP

■ Deleting NOP instructions

After creating a program, it is possible to delete all **NOP** instructions in a program by using the programming tool.

3 Basic Function Instructions

3.1 TML/TMR/TMX/TMY (0.001 s, 0.01 s, 0.1 s, 1 s on-delay timer)	3-2
3.2 F137 STMR (16-Bit, 0.01-s ON-Delay Timer).....	3-9
3.3 F183 DSTM (32-Bit, 0.01 s ON-Delay Timer)	3-12
3.4 CT [Counter (Preset Subtraction Expression)].....	3-16
3.5 F118 UDC (Up/Down counter)	3-23
3.6 SR (Shift Register)	3-26
3.7 F119 LRSR (Left/Right Shift Register)	3-29
3.8 F182 FILTR (Time Literal Process).....	3-32

3.1 TML/TMR/TMX/TMY (0.001 s, 0.01 s, 0.1 s, 1 s on-delay timer)

3.1 TML/TMR/TMX/TMY (0.001 s, 0.01 s, 0.1 s, 1 s on-delay timer)

■ Instruction format

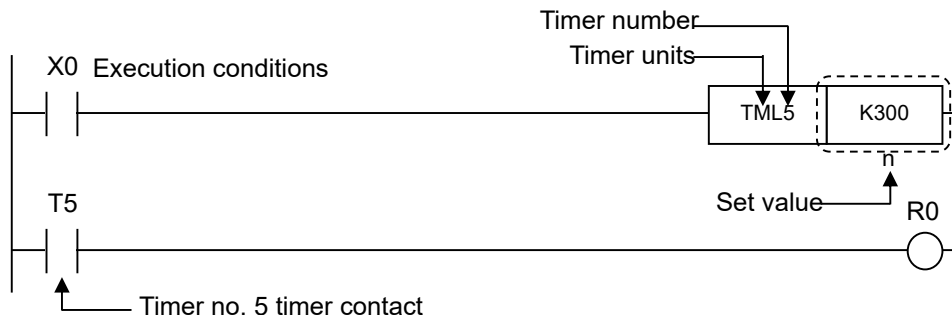

■ Instruction list

Instruction	Description
n	Timer set value

■ Devices that can be specified (indicated by ●)

Operands	WX	WY	WR	WL	SV	EV	DT	LD	I	SWR	SDT	Constant				Index modifier	Integer Device
												K	H	M	f		
n	●	●	●	●	●	●	●	●		●	●	●					

■ Outline of operation

- The timer is a non-hold type that is reset when the power is turned off or when switching from "RUN mode" to "PROG. mode". (If the operating state must be held, set system register No. 6. In that case, be sure to use a battery.)
- When the execution condition turns ON, the set time decrements until the elapsed value becomes 0, at which point timer contact Tn (n is the timer contact number) turns ON.
- If the execution condition turns OFF during while the set time is decrementing, the operation is interrupted and the elapsed value is reset (cleared to 0).
- The OT instruction can also be written immediately after a timer coil.

■ Setting the timer period

1. The timer set time is (timer unit) × (timer set value).
2. The timer set value [n] is set as a decimal constant in the range of K1 to K32767.

TML	0.001 to 32.767 seconds in units of 0.001 second
TMR	0.01 to 327.67 seconds in units of 0.01 second
TMX	0.1 to 3276.7 seconds in units of 0.1 second
TMY	1 to 32,767 seconds in units of 1 second

e.g. When K43 is set by TMX, the set time is $0.1 \times 43 = 4.3$ seconds.
 When K500 is set by TMR, the set time is $0.01 \times 500 = 5$ seconds.

3.1 TML/TMR/TMX/TMY (0.001 s, 0.01 s, 0.1 s, 1 s on-delay timer)

■ Precautions for programming

- As subtraction operations are performed during operation, create the program so that it operates once during one scan. If an operation is performed more than once during one scan or cannot be performed even once due to an interrupt processing program or jump/loop instruction, correct results cannot be obtained.
- When combining a timer instruction with an AND stack instruction or a POP stack instruction, be careful that the programming is correct.

■ Timer operation mechanism

The following are examples of specifying a K constant as the set value. See below for the operation when specifying the set value area.

1. When the mode is switched to "RUN mode" or when the power is turned ON in "RUN mode", the timer set value is transferred to the set value area "SV" of the same number.

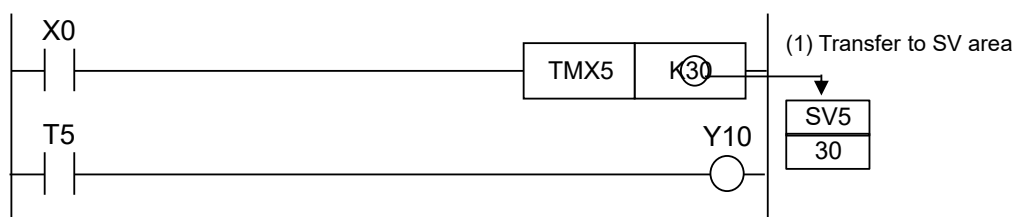

2. When the timer execution condition rises from OFF to ON, the timer set value is transferred from the set value area "SV" to the elapsed value area "EV" of the same number. (The same operation is performed when switching to "RUN mode" while the execution condition is ON.)
3. For each scan, if the execution condition is ON, the timer decrements by the value in the elapsed value area "EV".

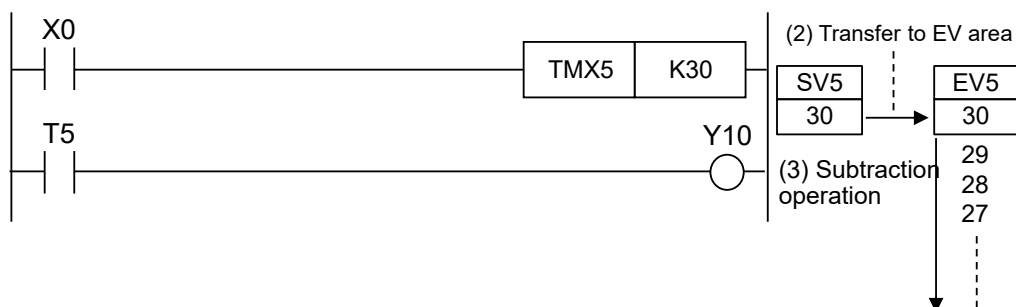

4. When the value of the elapsed value area "EV" becomes 0, the timer contact "T" of the same number turns ON.

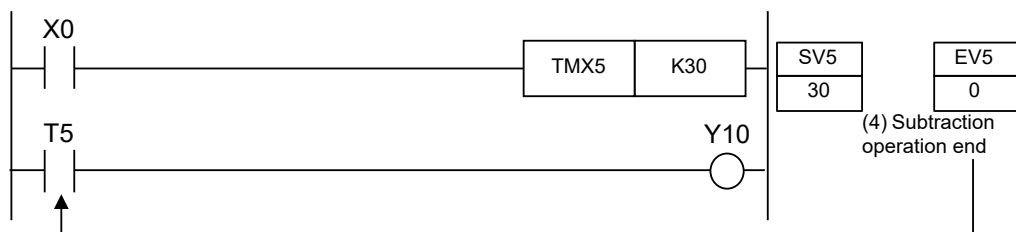

3.1 TML/TMR/TMX/TMY (0.001 s, 0.01 s, 0.1 s, 1 s on-delay timer)

■ Examples of timer instruction application

<Timer series connection>

● Ladder diagram

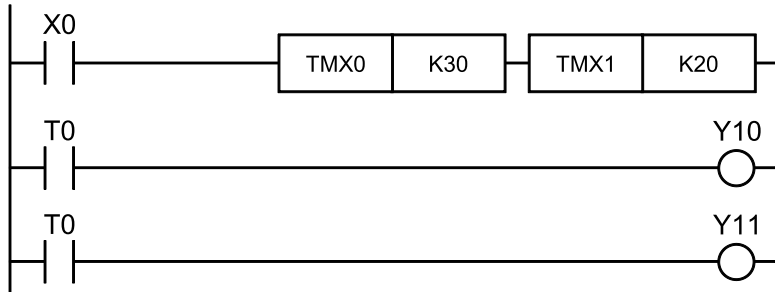

● Timing chart

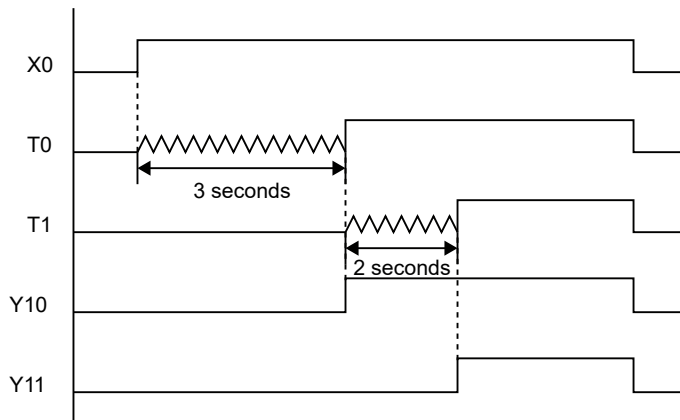

<Timer parallel connection>

● Ladder diagram

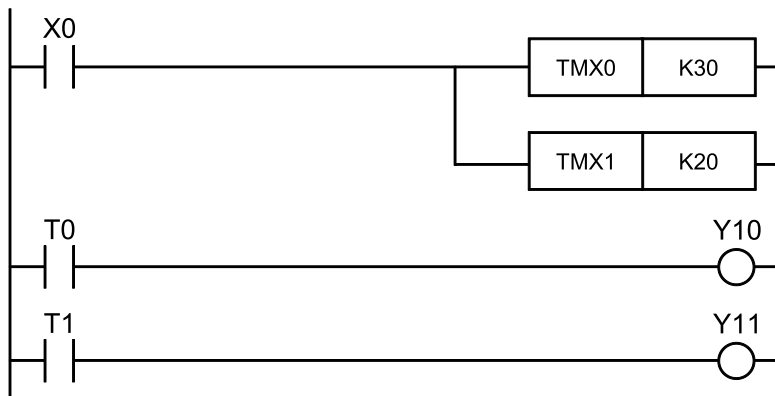

3.1 TML/TMR/TMX/TMY (0.001 s, 0.01 s, 0.1 s, 1 s on-delay timer)

• Timing chart

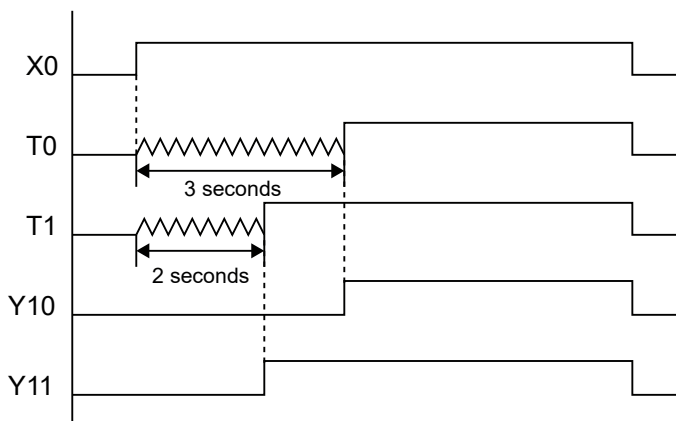

■ How to directly specify the set value area No. for the timer set value

- The set value area number can be specified directly as the set value [n].

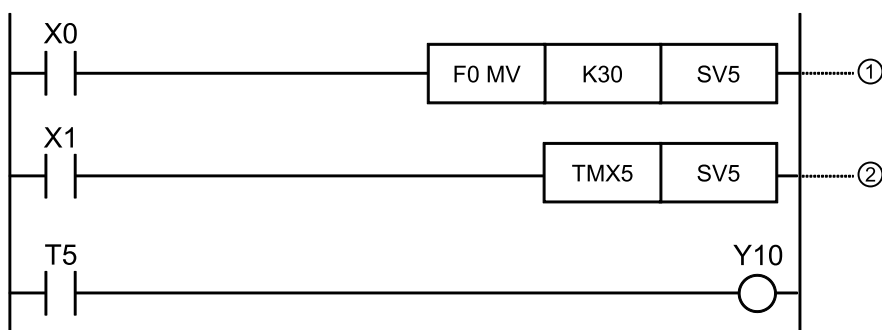

The above program in which SV5 is specified as the set value operates as follows.

1. When execution condition X0 turns ON, the data transfer instruction (F0 MV) is executed and SV5 is set to K30.
2. When execution condition X1 turns ON, the set value is set to 30 and the decrement operation starts.

- Set the number of the set value area "SV" specified in [n] to be the same as the timer number.

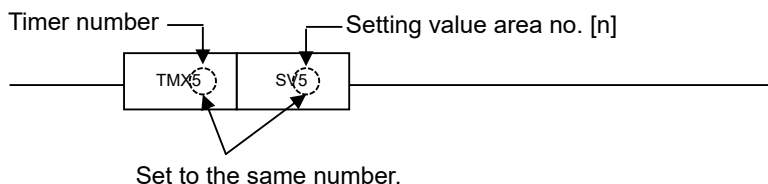

- Even if the value in the set value area "SV" is changed during the subtraction operation, the subtraction operation will continue from the value before the change.
Timer operation starts with the changed value the next time the execution condition changes from OFF to ON after the decrement operation is completed or interrupted.
- The set value area SV is normally a non-hold type that is reset when the power is turned off or when switching from "RUN mode" to "PROG. mode".

3.1 TML/TMR/TMX/TMY (0.001 s, 0.01 s, 0.1 s, 1 s on-delay timer)

If the SV value was changed while in RUN mode and that value is to be used as a set value without being reset the next time the power supply is turned on or when switching from "PROG. Mode" to "RUN mode", set the value to a hold type by using system register no. 6.

■ Timer operation when the set value area number is directly specified

1. When the execution condition for a high-level instruction is ON, the value is set in the set value area "SV".

The following diagram shows an example of using the F0 MV instruction.

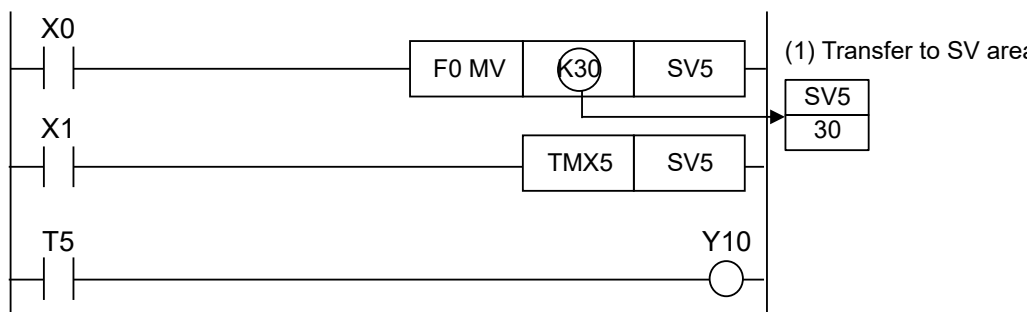

2. When the timer execution condition rises from OFF to ON, the timer set value is transferred from the set value area "SV" to the elapsed value area "EV" of the same number. (The same operation is performed when switching to "RUN mode" while the execution condition is ON.)
3. For each scan, if the execution condition is ON, the timer decrements by the value in the elapsed value area "EV".

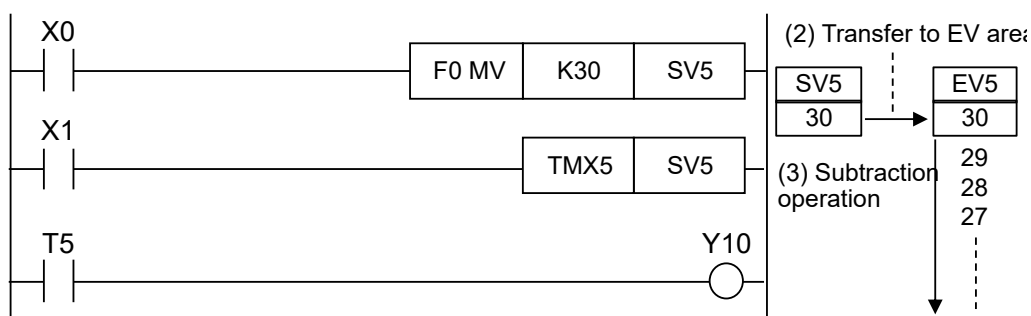

4. When the value of the elapsed value area "EV" becomes 0, the timer contact "T" of the same number turns ON.

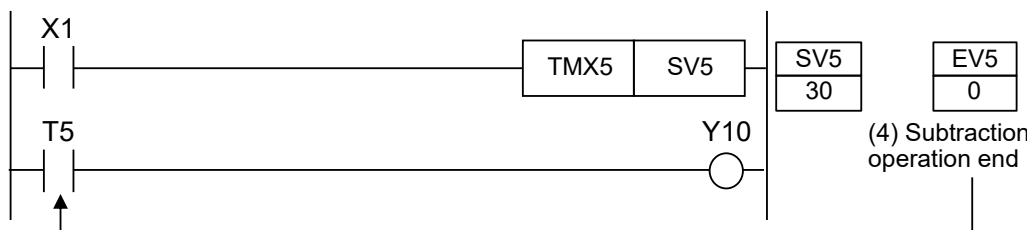

■ Examples of applying direct specification of set value area numbers

Example 1) Changing set values based on specified conditions

The set value is K50 when X0 is ON and K30 when X1 is ON.

3.1 TML/TMR/TMX/TMY (0.001 s, 0.01 s, 0.1 s, 1 s on-delay timer)

- **Ladder diagram**

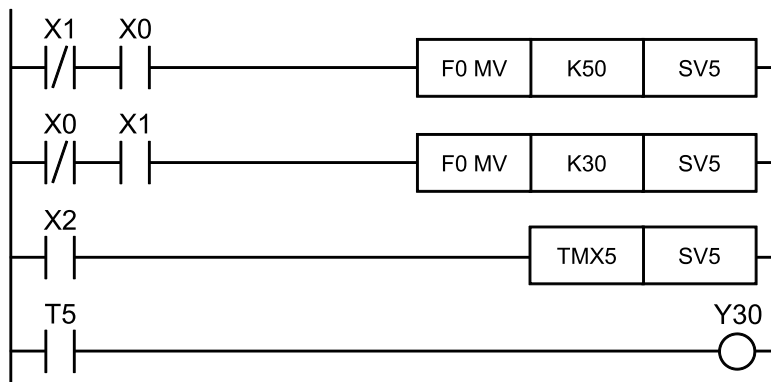

- **Timing chart**

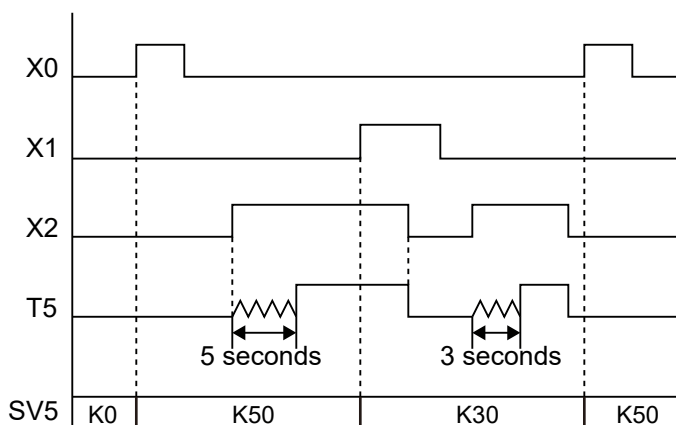

Example 2) Setting a set value from external digital switches

The BCD data of the digital switches connected to X0 through XF is converted and becomes the set value.

- **Connection example**

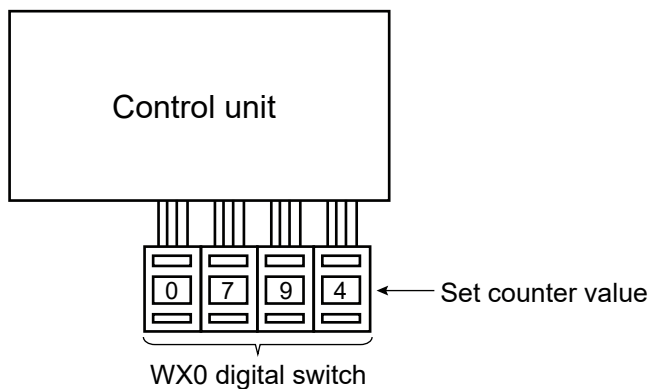

3.1 TML/TMR/TMX/TMY (0.001 s, 0.01 s, 0.1 s, 1 s on-delay timer)

- Ladder diagram

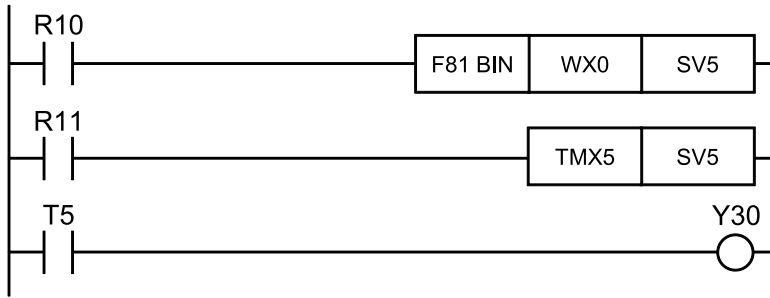

3.2 F137 STMR (16-Bit, 0.01-s ON-Delay Timer)

■ Instruction format

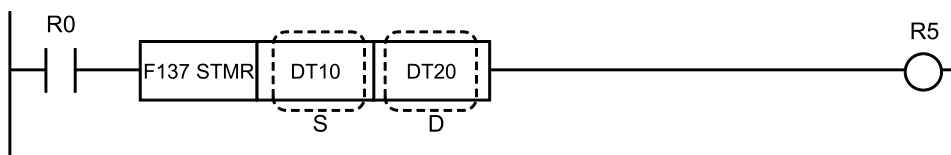

■ Instruction list

Instruction	Description
S	Area storing the setting value, or constant data
D	Process value area

■ Devices that can be specified (indicated by ●)

Operands	WX	WY	WR	WL	SV	EV	DT	LD	I	SWR	SDT	Constant				Index modifier	Integer Device
												K	H	M	f		
S	●	●	●	●	●	●	●	●	●	●	●	●					
D		●	●	●	●	●	●	●	●								

■ Outline of operation

Operates as an ON-delay timer in units of 0.01 seconds. When the internal relay is ON, the setting time is subtracted, and the special internal relay R900D turns ON when the process value [D] becomes 0. (It is OFF when the internal relay is OFF and during subtraction.)

■ Operation example

Operation of instruction format description program

The internal relay is executed, the auxiliary timer is activated, and when a time equal to the value stored in [DT10] × 0.01 seconds has elapsed, R5 turns ON.

- When the internal relay is OFF, the process value area is cleared to 0. The relay in use for the OT instruction turns OFF.
- When the time of the special internal relay R900D is up, it turns ON. It is also possible to use R900D as a timer contact. (It is OFF when the internal relay is OFF and during subtraction.)

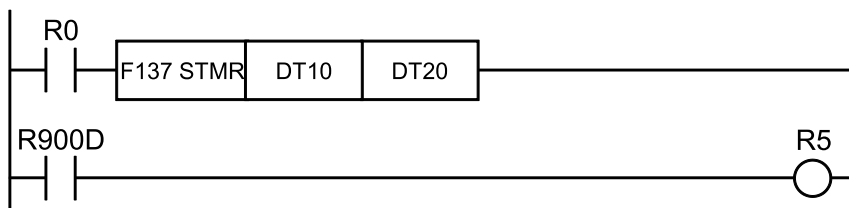

Operation is the same as the above example.

3.2 F137 STMR (16-Bit, 0.01-s ON-Delay Timer)

■ Setting the timer period

1. The timer period is $0.01 \times [\text{timer set value}]$.
2. The timer set value is set with a K constant within the range of K1 to K32767.

"STMR" ranges from 0.01 to 327.67 seconds, in units of 0.01 second.

e.g. If the set value is K500, the set time is $0.01 \times 500 = 5$ seconds.

■ Precautions for programming

- Ensure that the specifications of the area storing the set value and the process value area do not overlap with other timer/counter instructions or operation memory areas of high-level instructions.
- As subtraction operations are performed during operation, create the program so that it operates once during one scan.
(During interrupt processing programs or with jump/loop instructions, a correct result cannot be obtained if there are multiple or no operations during one scan.)

■ How the auxiliary timer works

1. When the internal relay turns from OFF to ON, the set value specified by [S] is transferred to the process value area [D].

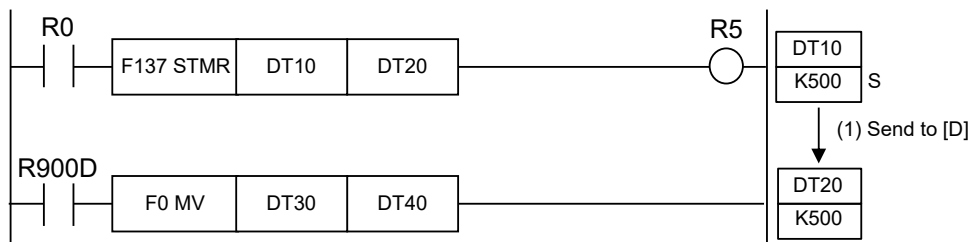

2. With each scan, if the internal relay is ON, the value of the process value area [D] is subtracted.

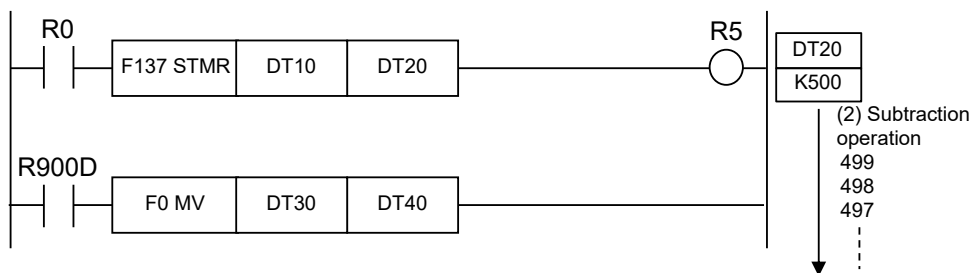

3. If the value of the process value area [D] becomes 0, then the relay in use for the next OT instruction turns ON. The special internal relay R900D also turns ON.

3.2 F137 STMR (16-Bit, 0.01-s ON-Delay Timer)

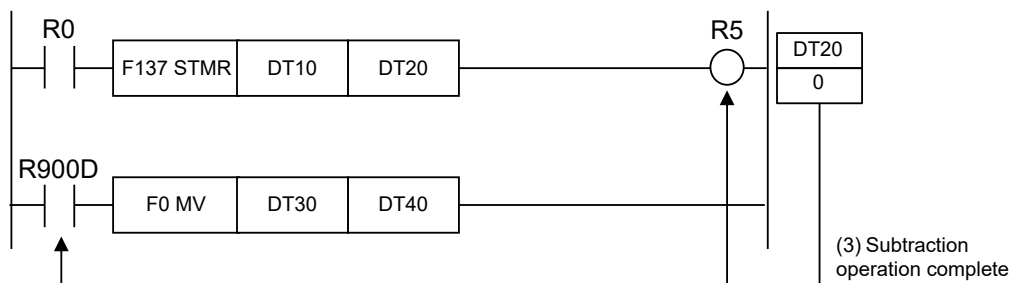

■ Precautions when using R900D

When using multiple auxiliary timers with R900D, ensure that R900D is used on the line after the auxiliary timer instruction.

<Example>

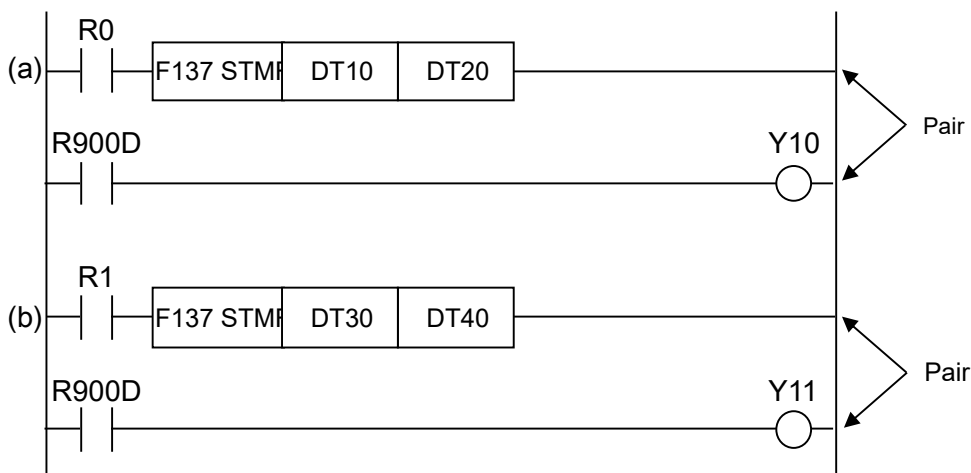

When the time is up for timer (a), activated by R0:ON, Y0 turns ON. When the time is up for timer (b), activated by R1:ON, Y1 turns ON.

- A correct operation cannot be obtained if specified as shown below.

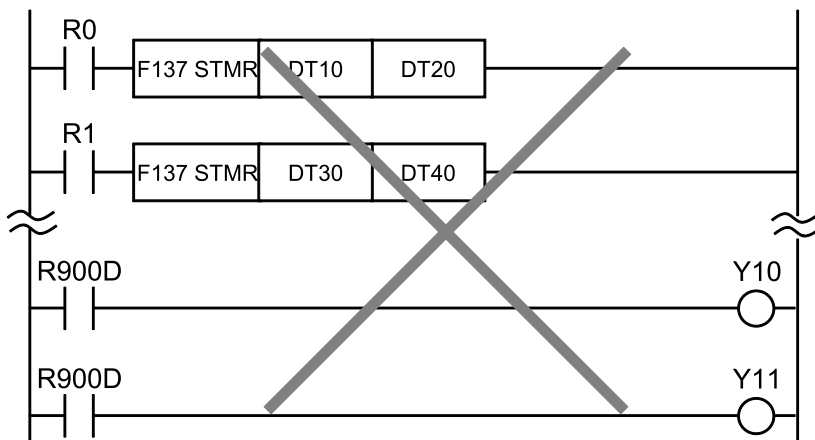

3.3 F183 DSTM (32-Bit, 0.01 s ON-Delay Timer)

3.3 F183 DSTM (32-Bit, 0.01 s ON-Delay Timer)

■ Instruction format

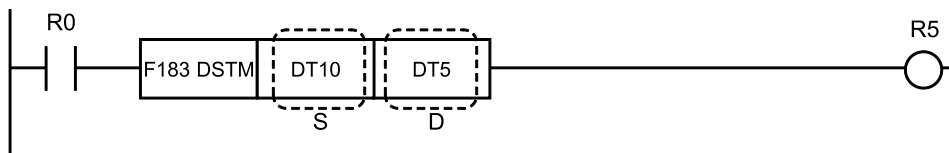

■ Instruction list

Instruction	Description
S	Area storing the setting value, or constant data
D	Process value area

■ Devices that can be specified (indicated by ●)

Operands	WX	WY	WR	WL	SV	EV	DT	LD	I	SWR	SDT	Constant				Index modifier	Integer Device
												K	H	M	f		
S	●	●	●	●	●	●	●	●	●	●	●	●					
D		●	●	●	●	●	●	●									

■ Outline of operation

- This instruction operates as a 32-bit addition expression ON-delay timer set in 0.01-second units.
- When the internal relay turns ON, addition of the elapsed time is performed. When the elapsed value $[D, D+1]$ (32 bits) equals or exceeds the set value, the relays used by the OT instruction described next in the program are turned ON.

■ Operation example

Operation of instruction format description program

The internal relay condition is established, the auxiliary timer becomes active, and when the value stored in data registers DT10 and $DT11 \times 0.01$ seconds has elapsed, R5 turns ON.

- When the internal relay is OFF, the process value area is cleared to 0. The relay in use for the OT instruction turns OFF.
- When the time of the special internal relay R900D is up, it turns ON. It is also possible to use R900D as a timer contact. (Turns OFF when the internal relay is OFF and during addition.)

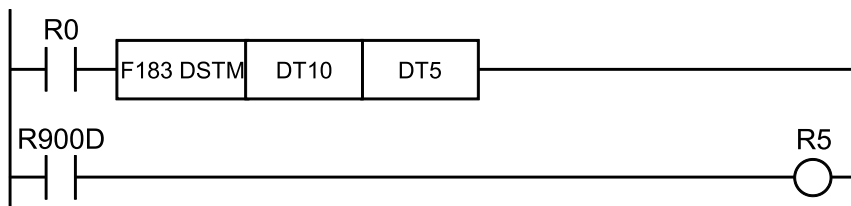

Operation is the same as the above example.

■ Setting the timer period

1. The timer period is $0.01 \times [\text{timer set value}]$.
2. The timer set value is set as a K constant in the range of K1 to K2147483647. 0.01 to 21474836.47 seconds in units of 0.01 second.

Example) If the set value is K500, the set time is $0.01 \times 500 = 5$ seconds.

■ Precautions for programming

- Ensure that the specifications of the area storing the set value and the process value area do not overlap with other timer/counter instructions or operation memory areas of high-level instructions.
- Addition is performed when the operation is executed, so the program should be created so the an operation is executed once per scan. (If an operation is performed more than once during one scan or cannot be performed even once due to an interrupt processing program or jump/loop instruction, correct results cannot be obtained.)

■ How the auxiliary timer works

1. When the internal relay changes from OFF to ON, 0s are transferred to the elapsed value area [D, D+1].

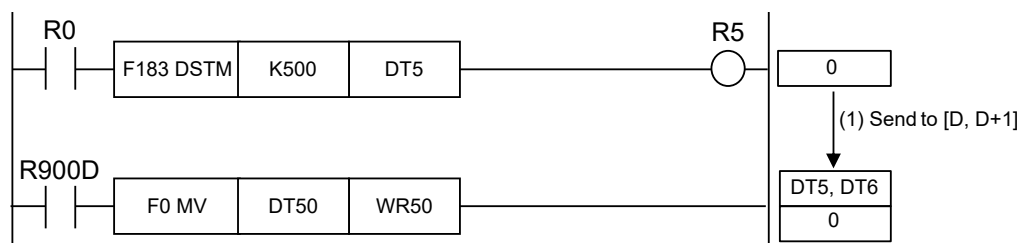

2. During each scan, if the internal relay is ON, the values in the elapsed value area of [D, D +1] are added.

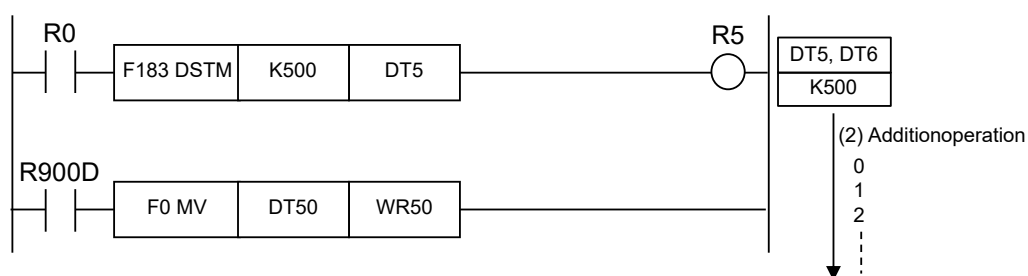

3. When the values in the elapsed value area [D, D+1] equal the values of [S, S+1], the relays used by the OT instruction described next in the program are turned ON. The special internal relay R900D also turns ON.

3.3 F183 DSTM (32-Bit, 0.01 s ON-Delay Timer)

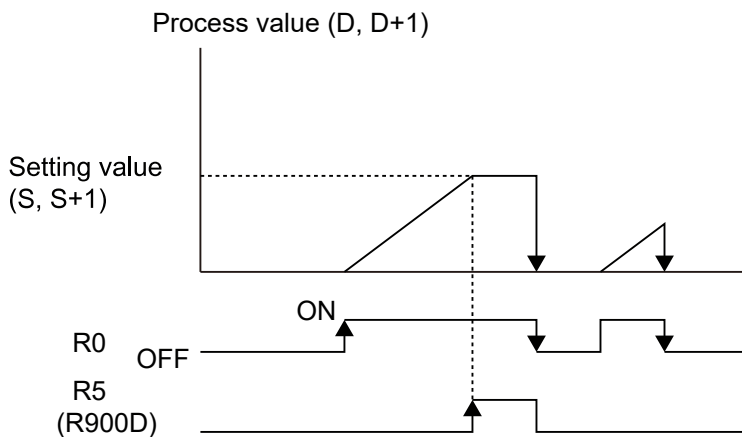
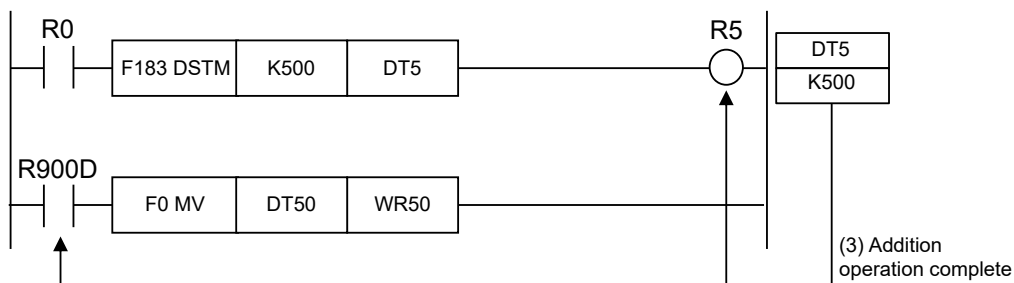

■ Precautions when using R900D

When using multiple auxiliary timers with R900D, ensure that R900D is used on the line after the auxiliary timer instruction.

<Example>

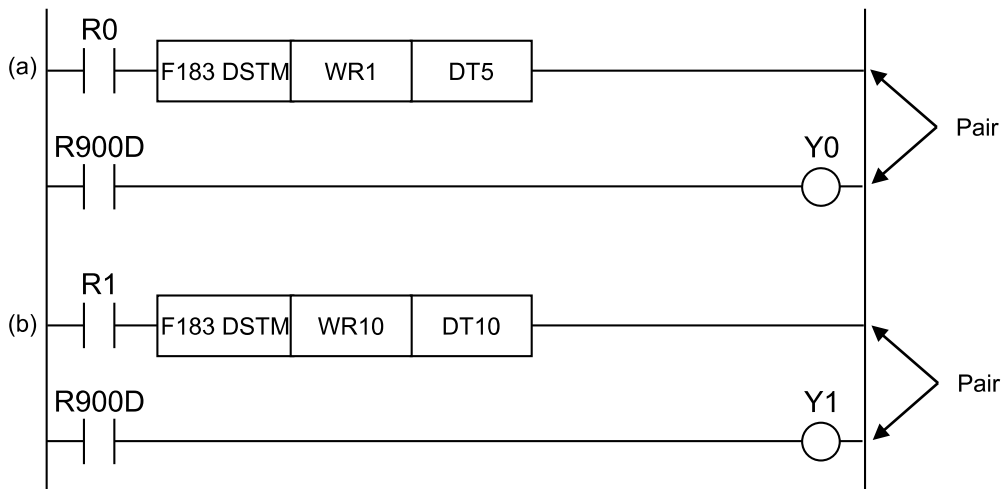

When the time is up for timer (a), activated by R0:ON, Y0 turns ON. When the time is up for timer (b), activated by R1:ON, Y1 turns ON.

- A correct operation cannot be obtained if specified as shown below.

3.3 F183 DSTM (32-Bit, 0.01 s ON-Delay Timer)

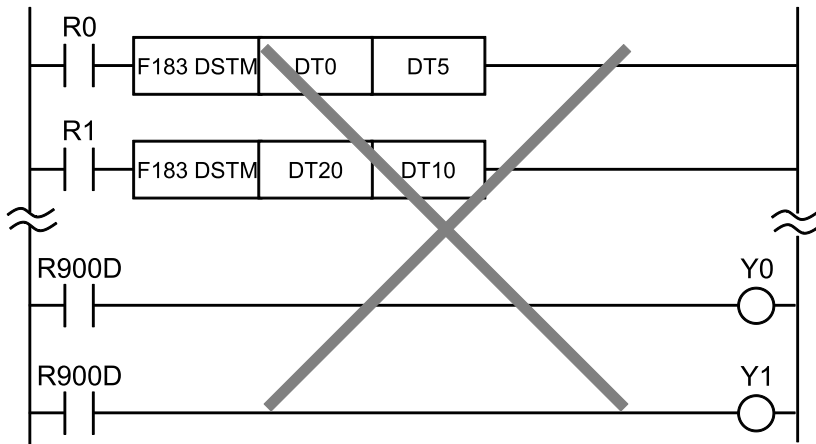

3.4 CT [Counter (Preset Subtraction Expression)]

3.4 CT [Counter (Preset Subtraction Expression)]

■ Instruction format

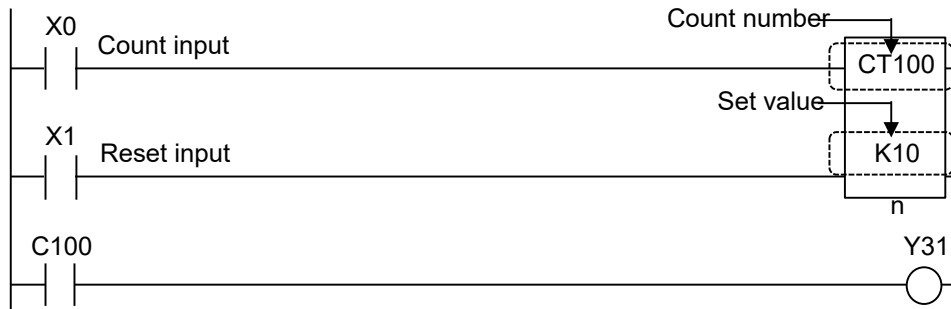

■ Instruction list

Instruction	Description
n	Counter set value

■ Devices that can be specified (indicated by ●)

Operands	WX	WY	WR	WL	SV	EV	DT	LD	I	SWR	SDT	Constant				Index modifier	Integer Device
												K	H	M	f		
n	●	●	●	●	●	●	●	●		●	●	●					

■ Outline of operation

- All counters are subtraction preset counters.
- When the reset input falls from ON to OFF, the value of the set value area SV is preset in the elapsed value area (EV).
- When the reset input is ON, the elapsed value is reset to 0.
- When the count input changes from OFF to ON, the set value is subtracted, and when the elapsed value reaches 0, it is output to the counter contact Cn (n is the counter number).
- If the count input and reset input both turn ON at the same time, the reset input is given priority.
- If the count input rises and the reset input falls at the same time, the count input is ignored and preset is executed.
- An OT instruction can be entered immediately after a counter instruction.

■ Operation example

Operation of instruction format description program

1. If X0 is turned ON 10 times, C100 turns ON, and Y31 turns ON.
2. The elapsed value is reset when X1 turns ON.

3.4 CT [Counter (Preset Subtraction Expression)]

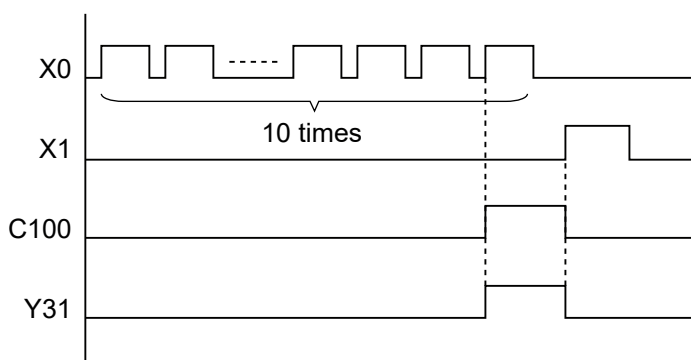

■ Setting the count value

The count value can be set to a decimal constant (K constant) in a setting range from K0 to K32767.

■ Counter operation

The following are examples of specifying a K constant as the set value. For an explanation of operations when a set value area number is specified, see "P.3-19". (This example shows a case in which "100" is specified for the counter.)

1. When switched to "RUN mode" or when the power is turned ON in "RUN mode", the counter set value is transferred to the set value area "SV" with the same number.
2. When the reset input falls, the value in the set value area SV is preset in the elapsed value area EV.

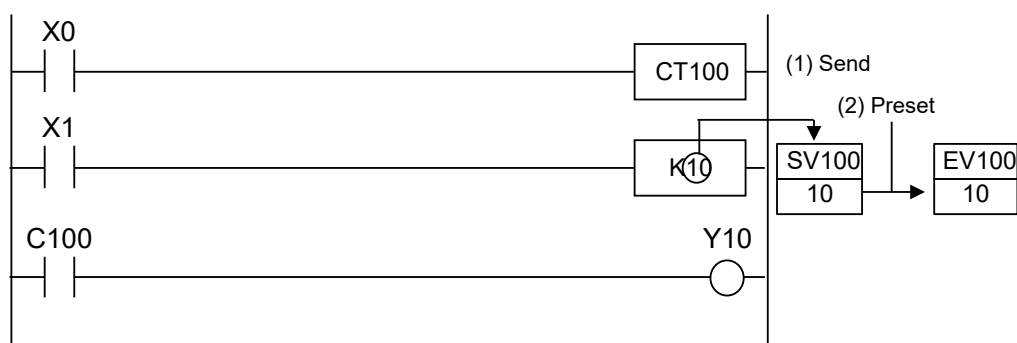

3. Each time the count input X0 turns ON, the value in the elapsed value area "EV" is subtracted.

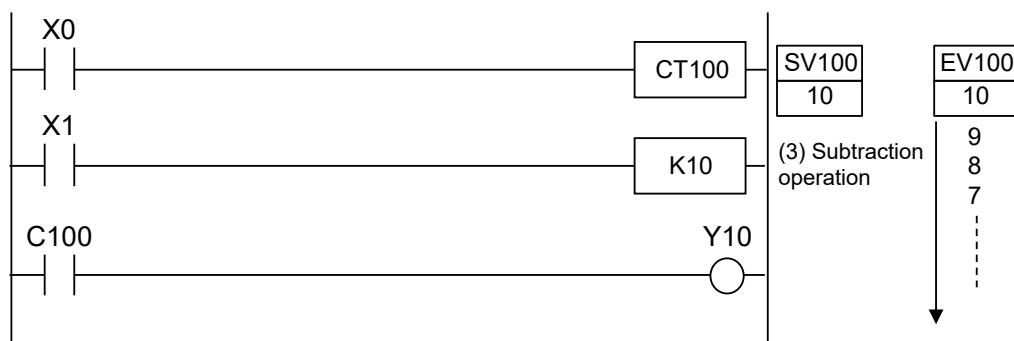

3.4 CT [Counter (Preset Subtraction Expression)]

4. When the value in the elapsed value area "EV" reaches zero, the counter contact "C" with the same number turns ON.

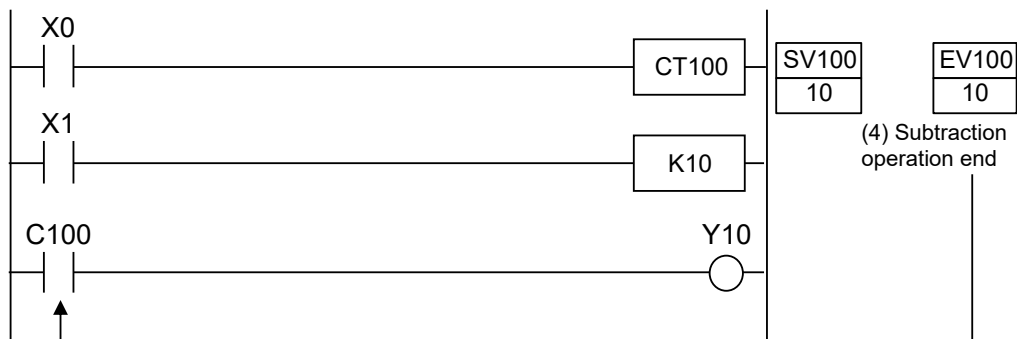

■ Precautions for programming

When combining a counter instruction with an AND stack instruction or POP stack instruction, be careful that the programming is correct.

■ Cautions on detecting the count input

In a counter instruction, the subtraction takes place when the rise of the count input from OFF to ON is detected.

- Counting is only performed at the rise, so even if the count input remains on, no further counting will occur.
- In cases where the count input is initially ON, such as when the mode is switched to RUN or when the power is turned on when in "RUN mode", subtraction will not take place at the first scan.

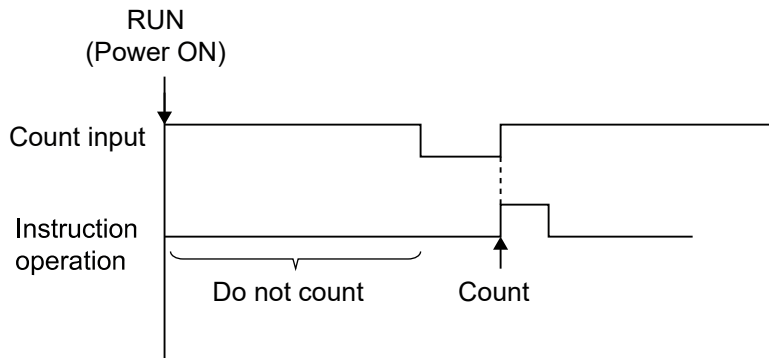

- Be aware that, if used with instructions that change the order of execution such as the MC to MCE instructions or the JP to LBL instructions (see 1 to 6 below), the operation of instructions may change depending on the timing of instruction execution and count input.
 1. MC to MCE instructions
 2. JP to LBL instructions
 3. LOOP to LBL instructions
 4. CNDE instruction
 5. Step ladder instructions
 6. Subroutine instructions

■ Related instructions

- Counter instructions also include an up/down counter instruction (F118 UDC).
- An increment instruction (F35+1) can be used to provide the same type of function.

■ Directly specifying a set value area number as a counter set value

The set value area number can be specified directly as the set value [n].

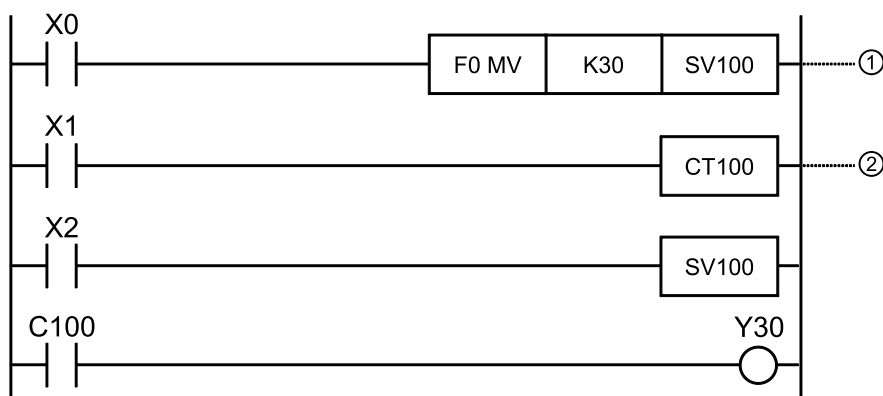

The program described above, which specifies SV100 for the set value, operates as follows.

1. When execution condition X0 is ON, the data transfer instruction (F0 MV) is executed and K30 is set in SV100.
 2. When the count input X1 turns ON, the subtraction operation begins from the set value of 30.
- Make the address of the set value area "SV" that specifies [n] the same as the counter number.

Display:

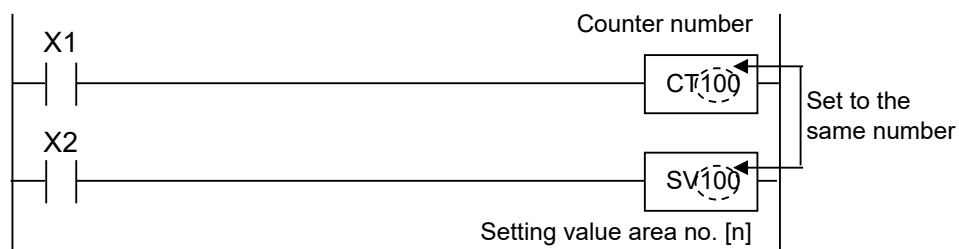

- Even if the value in the set value area "SV" is changed during the subtraction operation, the subtraction operation will continue from the value before the change. Counter operation from the new value will not begin until the counter is reset and the count input subsequently changes from OFF to ON.

■ Counter operation when a set value area number is directly specified

1. When the execution condition for a high-level instruction is ON, the value is set in the set value area "SV". The following diagram shows an example of using the F0 MV instruction.

3.4 CT [Counter (Preset Subtraction Expression)]

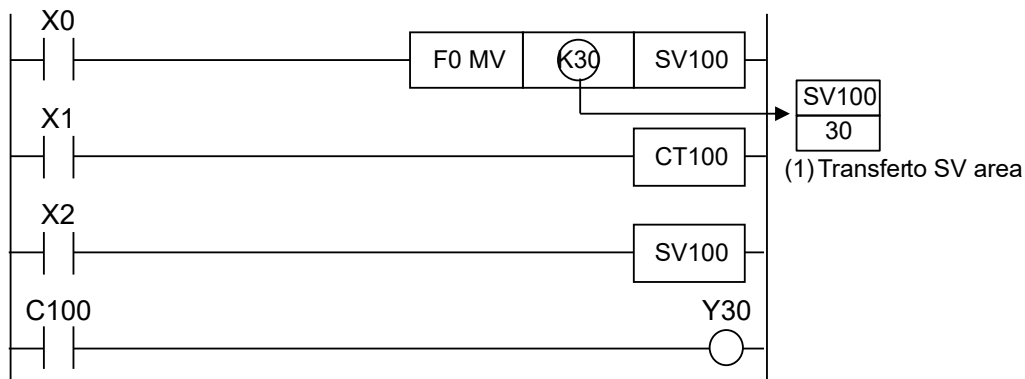

2. When the reset input falls, the value in the set value area "SV" is preset in the elapsed value area "EV".

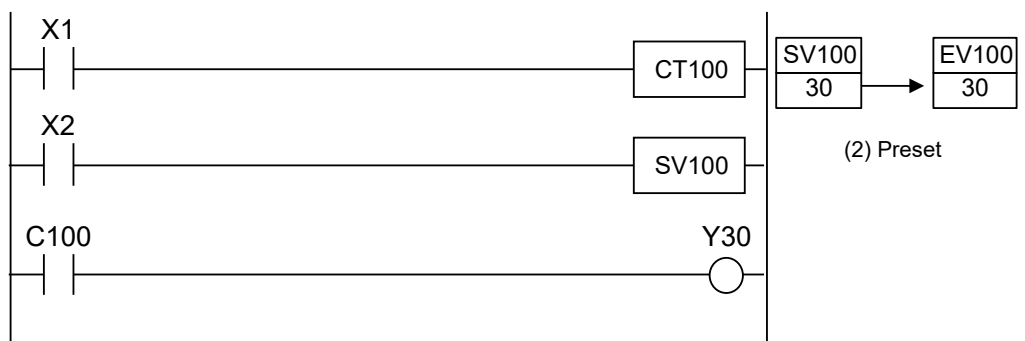

3. Each time the count input X1 turns ON, the value in the elapsed value area "EV" is subtracted.

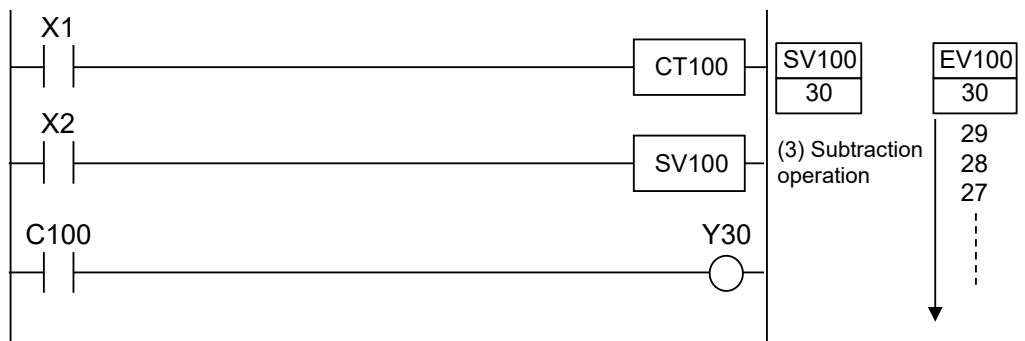

4. When the value in the elapsed value area "EV" reaches zero, the counter contact "C" with the same number turns ON.

3.4 CT [Counter (Preset Subtraction Expression)]

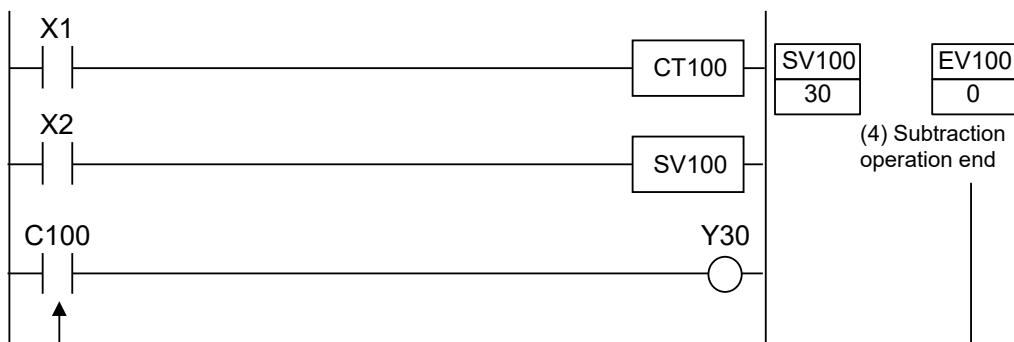

■ Examples of applying direct specification of set value area numbers

Example 1) Changing set values based on specified conditions

The set value is K50 when X0 is ON and K30 when X1 is ON.

● Ladder diagram

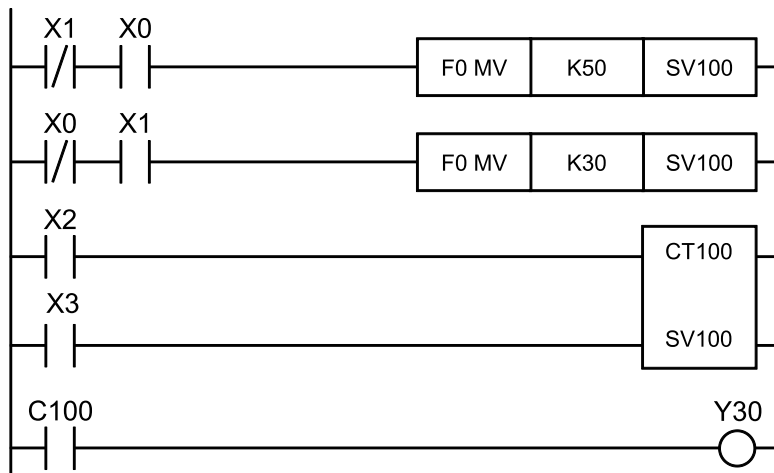

● Timing chart

Example when X0 turns ON.

3.4 CT [Counter (Preset Subtraction Expression)]

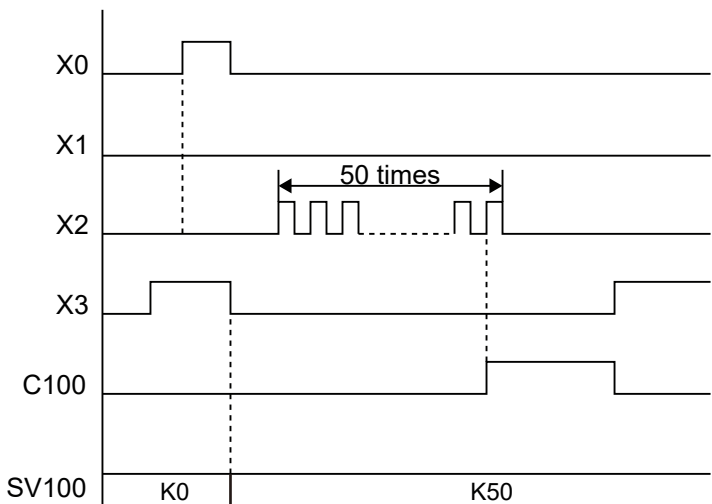

Example 2) Setting a set value from external digital switches

The BCD data of the digital switches connected to X0 through XF is converted and becomes the set value.

• **Connection example**

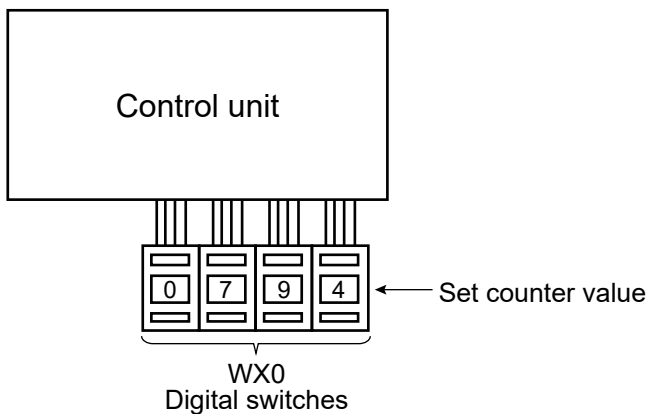

• **Ladder diagram**

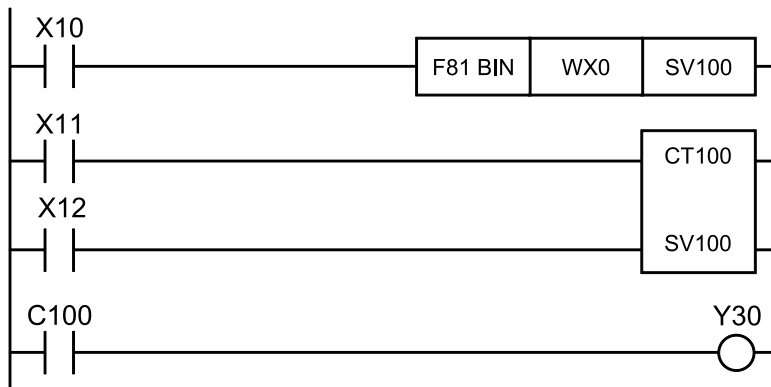

3.5 F118 UDC (Up/Down counter)

■ Instruction format

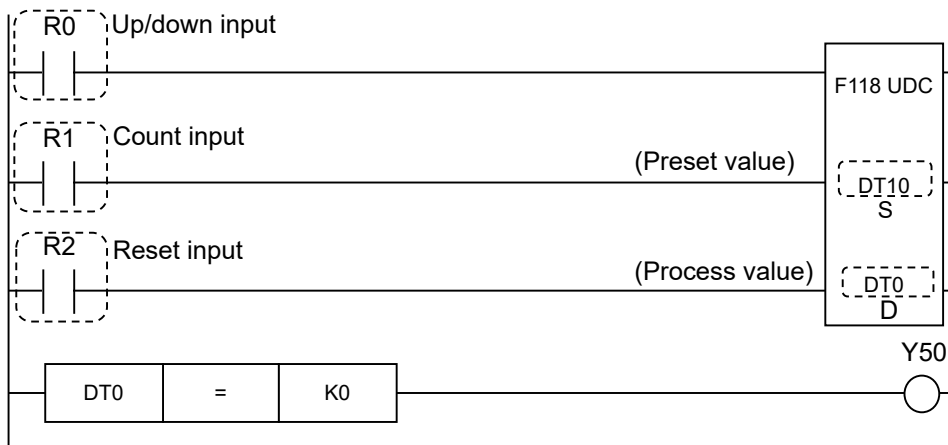

■ Instruction list

Instruction	Description
S	Area storing preset values, or constant data
D	Up/down counter elapsed value area

■ Devices that can be specified (indicated by ●)

Operands	WX	WY	WR	WL	SV	EV	DT	LD	I	SWR	SDT	Constant				Index modifier	Integer Device
												K	H	M	f		
S	●	●	●	●	●	●	●	●		●	●	●	●				
D		●	●	●	●	●	●	●									

■ Outline of operation

- This is a counter that switches between incremental counting (addition) and decremental counting (subtraction) depending on whether the relay specified by the up/down input is ON or OFF.
- The count operation is incremental counting (+1) when the up/down input is ON, and decremental counting (-1) when the up/down input is OFF. The elapsed value is stored in the area specified by [D].
- When the reset input is switched from ON to OFF, the preset value of [S] is transferred to [D]. The count range is K-32,768 (H8000) to K32,767 (H7FFF).
- When the count input is changed from OFF to ON (with reset input in an OFF state), the count operation is performed with the value set in [D] as the default value.
- When the reset input turns ON, the elapsed value area of [D] is cleared.
- The count result can be determined by comparing the elapsed value of [D] with the specified setting value by using the data comparison instruction.
- Execute the data comparison instruction immediately after the F118 UDC instruction.

3.5 F118 UDC (Up/Down counter)

■ Operation example

Operation of instruction format description program

The program on the previous page is an example in which the default value is set, and external output Y50 turns ON when target value is 0.

This can be used, for example, in programs such as those that cause an indicator lamp to light when the work being added or subtracted reaches a certain quantity.

1. When reset input R2 switches from ON to OFF, the DT10 value is written to DT0. This value is the target value.
2. If count input R1 is ON when R0 turns OFF, the DT0 value is decremented by 1 (decremental counting). If count input R1 is ON when R0 turns ON, the DT0 value is incremented by 1 (incremental counting).
3. As a result of work being added or subtracted, the counter elapsed value area DT0 value is compared with K0, and if DT0 is equal to K0, external output Y50 turns ON.

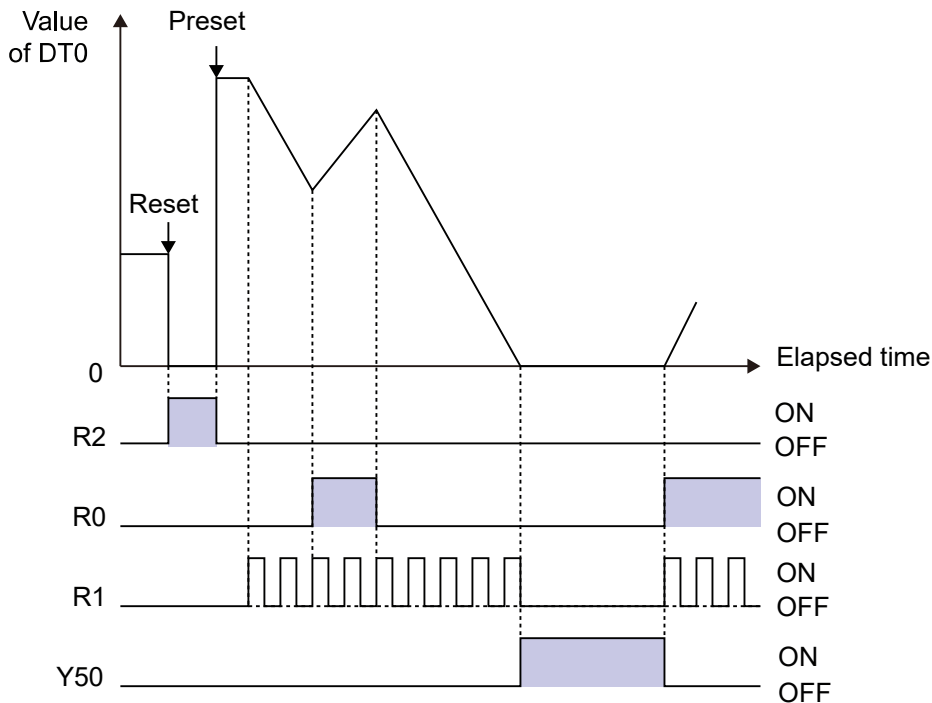

■ Precautions for programming

- If a hold type memory area is specified for the elapsed value area, the elapsed value acts in accordance with the content being held.
- Be aware that the default value when starting operation is not automatically preset to the elapsed value area. When performing preset, switch reset input from ON to OFF.
- When combining the F118 UDC instruction with an AND stack instruction or a POP stack instruction, be careful that the programming is correct.

■ Cautions on detecting the count input

With the F118 UDC instruction, the increment or decrement occurs when the rise of the count input from OFF to ON is detected.

- Counting is only performed at the rise, so even if the count input remains on, no further counting will occur.
- When switching to RUN or when powering on in "RUN mode", if the count input is ON from the beginning, increment/decrement is not carried out for the first scan.

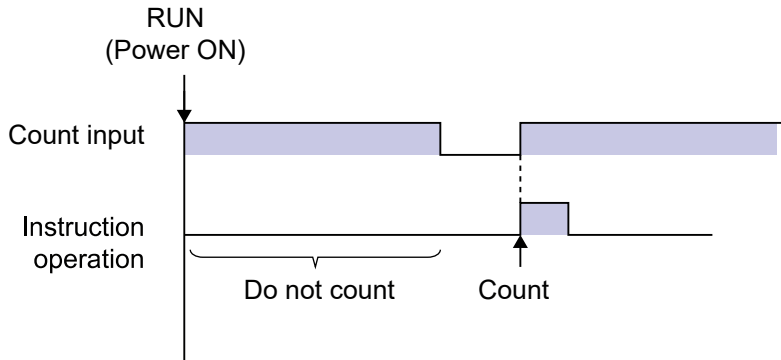

- Be aware that, if used with instructions that change the order of execution such as the MC to MCE instructions or the JP to LBL instructions (see 1 to 6 below), the operation of instructions may change depending on the timing of instruction execution and count input.
 1. MC to MCE instructions
 2. JP to LBL instructions
 3. LOOP to LBL instructions
 4. CNDE instruction
 5. Step ladder instructions
 6. Subroutine instructions

3.6 SR (Shift Register)

3.6 SR (Shift Register)

■ Instruction format

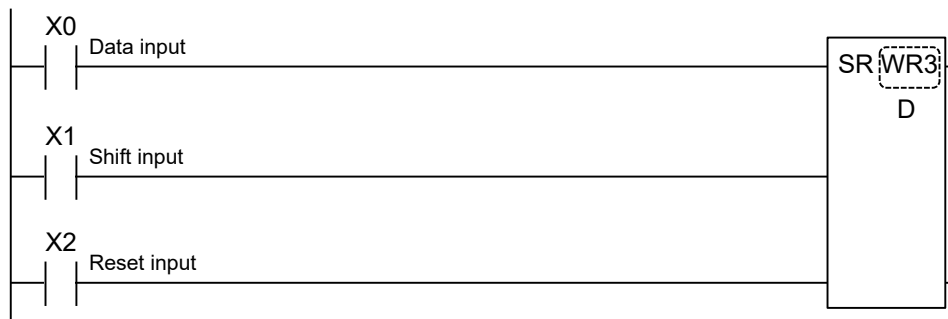

■ Instruction list

Instruction	Description
D	Specified register

■ Devices that can be specified (indicated by ●)

Operands	WX	WY	WR	WL	SV	EV	DT	LD	I	SWR	SDT	Constant				Index modifier	Integer Device
												K	H	M	f		
D			●														

■ Outline of operation

- An instruction that moves (shifts) the content of the specified register WR (16-bit unit) one bit to the left.
1. When shift input turns ON (rises), the contents of WR is shifted one bit to the left
 2. When shifting, the empty bit (least significant bit) is set to 1 if data input is ON or 0 if OFF.
- When shift input turns ON:



3. When reset input is ON, the content of the specified register is cleared.
When reset input turns ON:

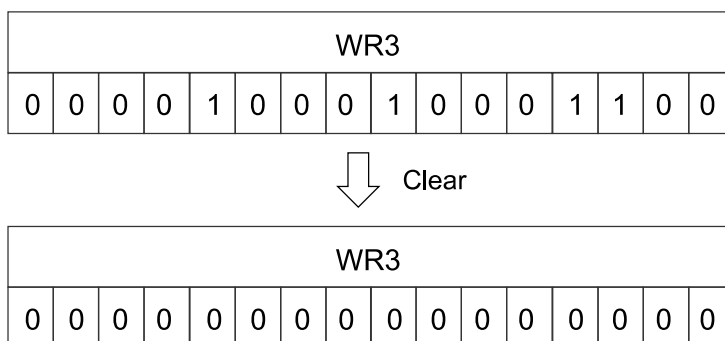

■ Operation example

Operation of instruction format description program

1. If X1 turns ON when X2 is in an OFF state, the content of WR3 (internal relays R30 to R3F) is shifted one bit to the left.
2. The bit left empty by the left shift (R30) is set to 1 when X0 is ON and 0 when OFF.
3. When X2 turns ON, the content of WR3 is reset to 0.

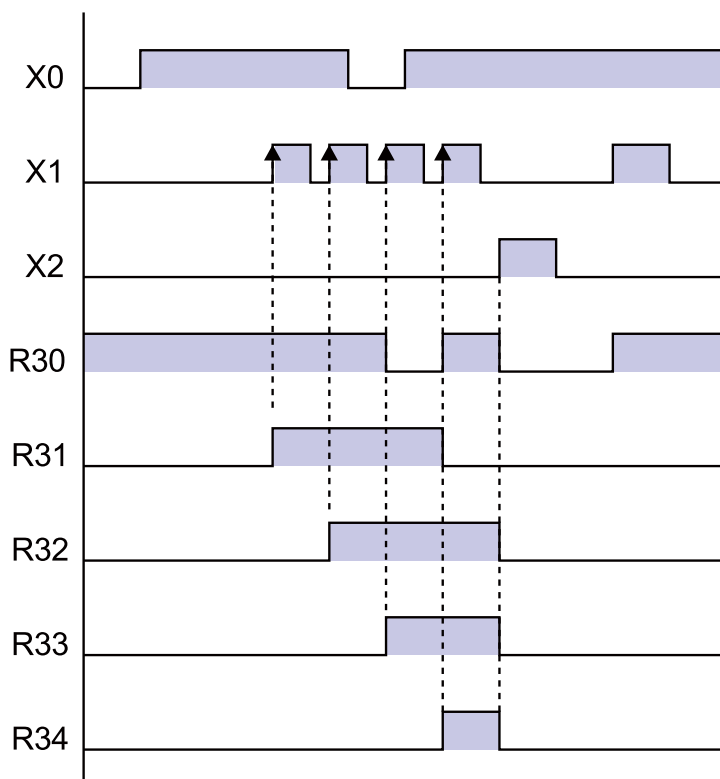

■ Precautions for programming

- The **SR** instruction requires data input, shift input, and reset input.

3.6 SR (Shift Register)

- When reset input and shift input rise simultaneously, reset input is prioritized.

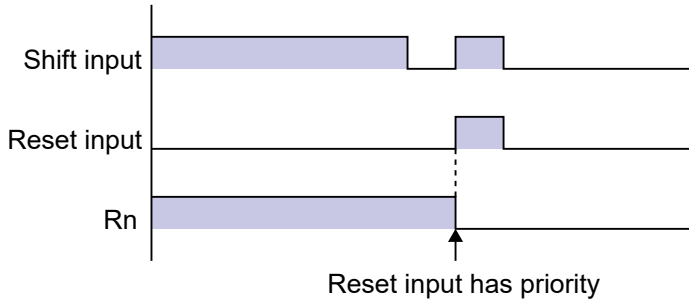

- Note that when a hold type memory area is specified for the shift register, an automatic reset is not performed when the power supply is turned ON.
- When combining a shift register instruction with an AND stack instruction or pop stack instruction, make sure that the syntax is correct.

■ Precautions for shift input detection

The SR instruction performs a shift when an OFF to ON rise is detected.

- If the shift input remains continuously ON, a shift will only take place at the rise. No further shifts will take place.
- In cases where the shift input is initially ON, such as when the mode is switched to RUN or when the power is turned on when in "RUN mode", a shift will not take place at the first scan.

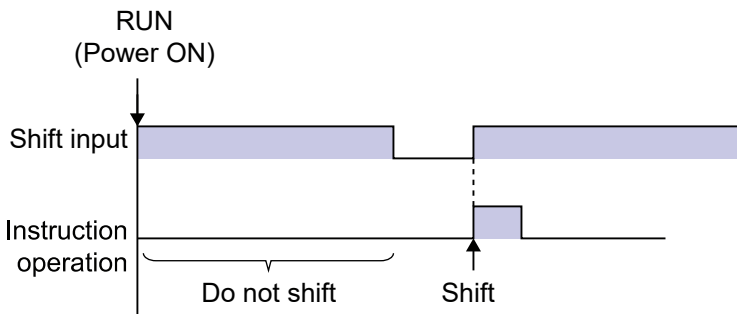

- Be aware that, if used in combination with instructions (see below, 1. to 6.) that change the order of execution of instructions such as the MC to MCE instructions or the JP to LBL instructions, depending on the execution of the instruction and the shift input timing the instruction operation changes.
 1. MC to MCE instructions
 2. JP to LBL instructions
 3. LOOP to LBL instructions
 4. CNDE instruction
 5. Step ladder instructions
 6. Subroutine instructions

■ Related instructions

In addition to this instruction, there is also a left/right shift register (F119 LRSR). The same type of operation can be implemented using data shift instructions (F100 SHR to F113 WBSL) or data rotate instructions (F120 ROR to F123 RCL).

3.7 F119 LRSR (Left/Right Shift Register)

■ Instruction format

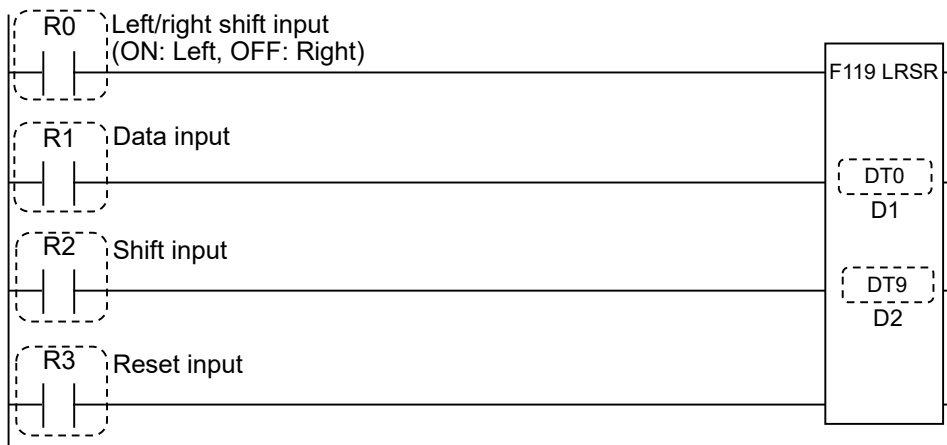

■ Instruction list

Instruction	Description
D1	Starting number of area to be shifted
D2	End number of area to be shifted

■ Devices that can be specified (indicated by ●)

Operands	WX	WY	WR	WL	SV	EV	DT	LD	I	SWR	SDT	Constant				Index modifier	Integer Device
												K	H	M	f		
D1		●	●	●	●	●	●	●									
D2		●	●	●	●	●	●	●									

■ Outline of operation

- This shift register changes direction, either left (direction of most significant bit) or right (direction of least significant bit), in which a shift of one bit is made based on the ON/OFF status of the relay specified by the left/right shift input.
- The shift operation is made to the left when the left/right shift input is ON, and to the right when OFF.
- Specify the same type of area for both [D1] and [D2]. Additionally, specify values so that [D1] is equal to or less than [D2].
- The following operation is performed.
 1. When the shift input changes from OFF to ON (the reset input is OFF), the contents of the area specified by [D1] and [D2] are shifted one bit to the left or right.
 2. When the data is shifted, 1 will be set in the empty bit left by the shift (the most significant bit or least significant bit) if the data input is ON, and 0 if the data input is OFF.

3.7 F119 LRSR (Left/Right Shift Register)

Also, the bit extracted by the shift (the most significant bit for a shift to the left, and the least significant bit for a shift to the right) will be set for the special internal relay R9009 (carry flag).

- If the reset input is ON, the contents of the specified area are cleared to 0.

■ Operation example

Operation of instruction format description program

Left shift

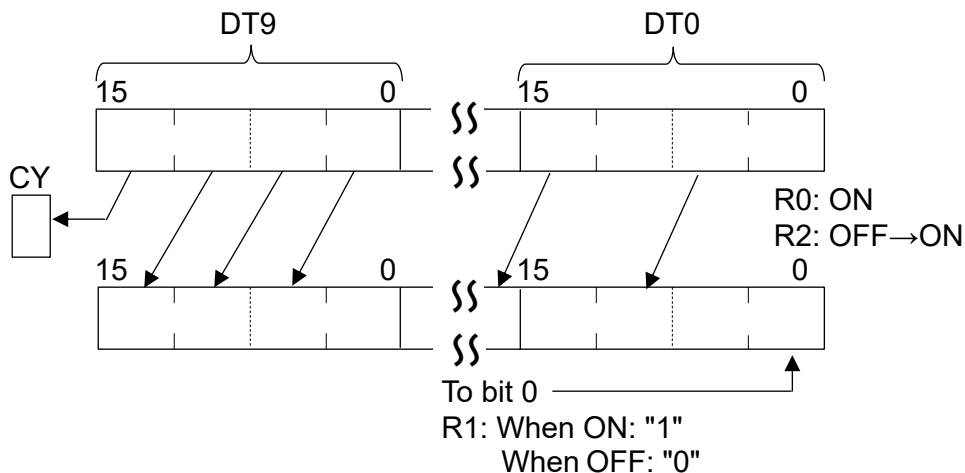

Right shift

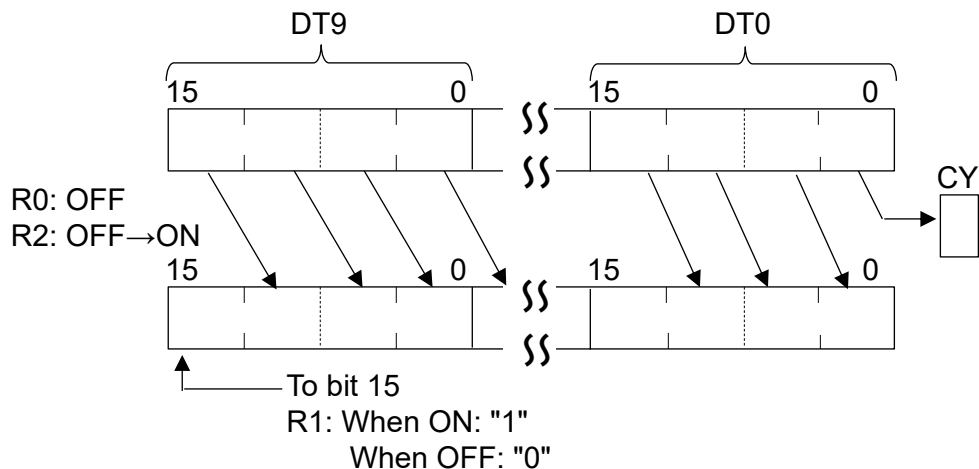

■ Precautions for shift input detection

In the F119 LRSR instruction, shift takes place when the OFF > ON rise of the shift input is detected.

- If the shift input remains continuously ON, a shift will only take place at the rise. No further shifts will take place.
- In cases where the shift input is initially ON, such as when the mode is switched to RUN or when the power is turned on when in "RUN mode", a shift will not take place at the first scan.

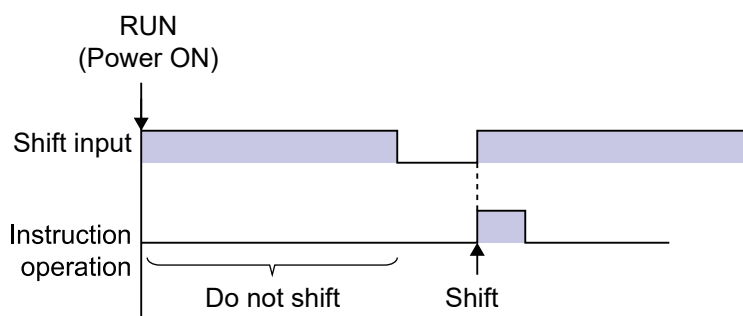

- Be aware that, if used in combination with instructions (see below, 1. to 6.) that change the order of execution of instructions such as the MC to MCE instructions or the JP to LBL instructions, depending on the execution of the instruction and the shift input timing the instruction operation changes.

1. MC to MCE instructions
2. JP to LBL instructions
3. LOOP to LBL instructions
4. CNDE instruction
5. Step ladder instructions
6. Subroutine instructions

■ Precautions for programming

When combining the F119 LRSR instruction with an AND stack instruction or POP stack instruction, be careful that the programming is correct.

■ Flag operations

Name	Description
R9007 R9008 (ER)	Turns ON when the [D1] address > [D2] address
R9009 (CY)	Turns ON when the bit extracted by the shift is "1"

3.8 F182 FILTR (Time Literal Process)

3.8 F182 FILTR (Time Literal Process)

■ Instruction format

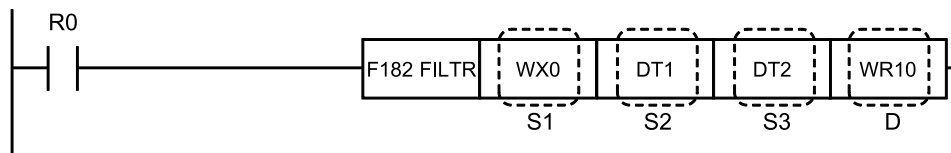

■ Instruction list

Instruction	Description
S1	Area storing the 16-bit data that is filter processing target
S2	Area storing the filter processing target bits, or constant data
S3	Area storing the filter processing time, or constant data
D	Area storing the filter processing result

■ Devices that can be specified (indicated by ●)

Operands	WX	WY	WR	WL	SV	EV	DT	LD	I	SWR	SDT	Constant				Index modifier	Integer Device
												K	H	M	f		
S1	●	●	●	●	●	●	●	●	●	●	●						
S2	●	●	●	●	●	●	●	●	●	●	●	●	●				
S3	●	●	●	●	●	●	●	●	●	●	●	●	●				
D		●	●	●	●	●	●	●	●								

■ Outline of operation

In the 16-bit data in the area specified by S1, for the bits specified by S2, 0 bits are directly output and 1 bits (filter processing targets) are output after filter processing for the amount of time (0 to 30000, ms units) specified by S3 and the result is output in bit units (the bit positions are the same as for S1) to the area specified by D.

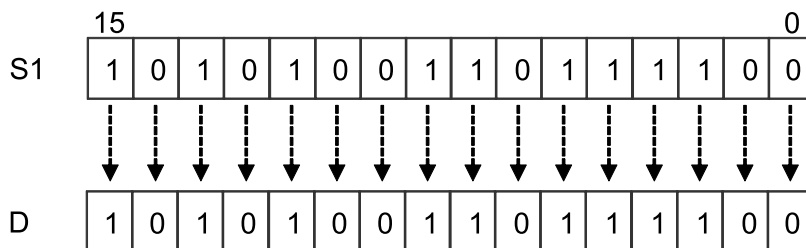

(Note 1) The bit positions of S1 and D correspond.

■ Precautions for programming

- When the execution condition rises, all input bits specified by S1 are directly output unconditionally.
- It is possible that an error of up to one scan may occur in the filter processing time.

■ Example of program execution

The changes in the execution condition R0 and the values of X0 to XF when the state before execution of this instruction (R0 = 0) is as follows are explained by using a time chart.

WX0 (Filter processing input data) = HA9BC

DT1 (Filter processing target bit) = H0001

DT2 (Filter processing time) = K500

WR10 (Filter processing result) = HFFFF

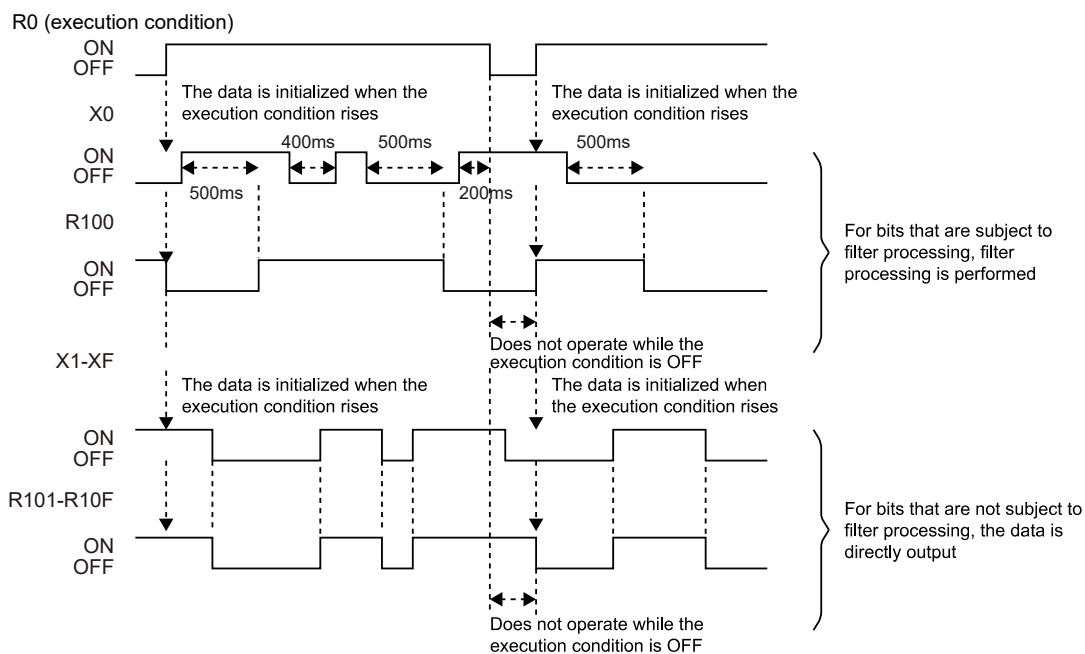

■ Flag operations

Name	Description
R9007	When the area is exceeded in index modification
R9008 (ER)	When the filter processing time specified by S3 is outside the range of K0 to K30000

(MEMO)

4 Control Instructions

4.1 MC/MCE (Master Control Relay / Master Control Relay End).....	4-2
4.2 JP/LBL (Jump/Label)	4-7
4.3 LOOP, LBL (Loop, Label).....	4-11
4.4 ED (End)	4-15
4.5 CNDE (Conditional end)	4-16
4.6 EJECT.....	4-18

4.1 MC/MCE (Master Control Relay / Master Control Relay End)

4.1 MC/MCE (Master Control Relay / Master Control Relay End)

■ Instruction format

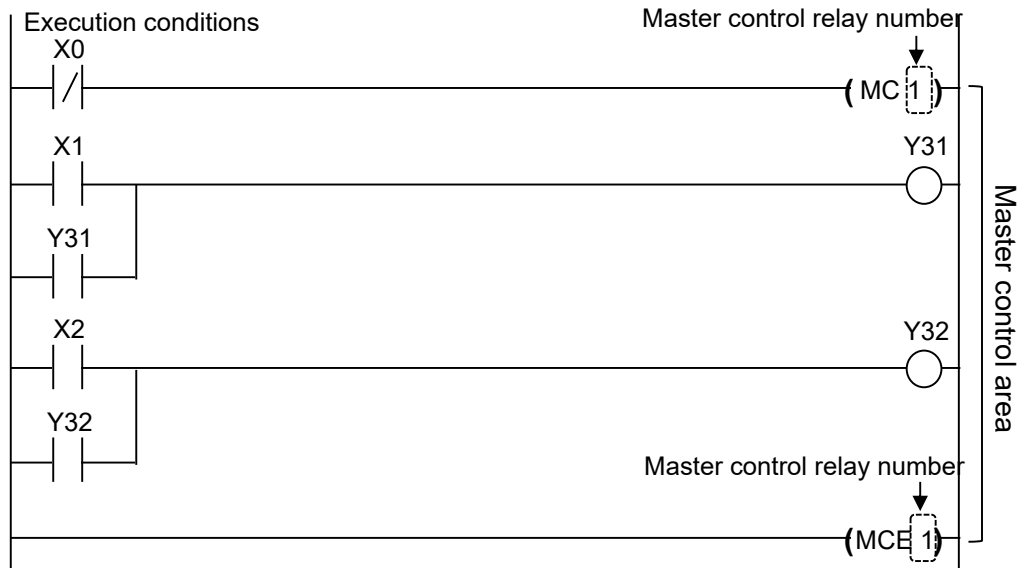

■ Outline of operation

- Executes the program between the **MC** and **MCE** instructions when the execution condition turns ON.
- When the execution condition is OFF, the state of each I/O relay is as follows.

OT instruction	All OFF
KP instruction	Holds the state
SET instruction	Holds the state
RST instruction	Holds the state
TM instruction	Reset
CT instruction	Holds the intermediate process
SR instruction	Holds the intermediate process
Differential instruction	Refer to the following
Other instructions	Not executed

- Caution is required when using an instruction that is executed by detecting the rise of an execution condition, such as a differential instruction (1 to 7 below).
 1. DF (rise differential)
 2. CT (counter) count input
 3. F118 UDC (up-down counter) count input
 4. SR (shift register) shift input
 5. F119 LRSR (left and right shift register) shift input
 6. NSTP (next step)
 7. Differential execution type high-level instruction (instruction specified by P and a number)

■ Operation example

Operation of instruction format description program

1. Executes the process between the **MC1** and **MCE1** instructions while the execution condition is ON.
2. If the execution condition is OFF, the process between the **MC1** and **MCE1** instructions is not executed and output is turned OFF.

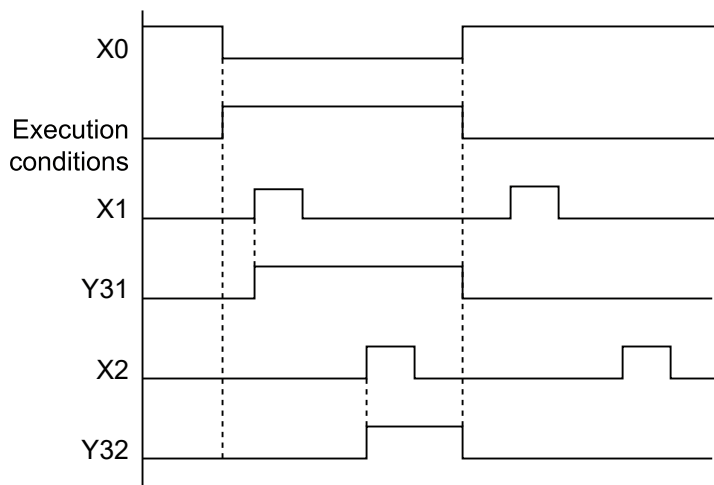

■ Operation of differential instructions between MC and MCE

- Note that if a differential instruction is used between MC and MCE, the output will vary as follows depending on the timing of the MC execution condition and the input of differential instruction.

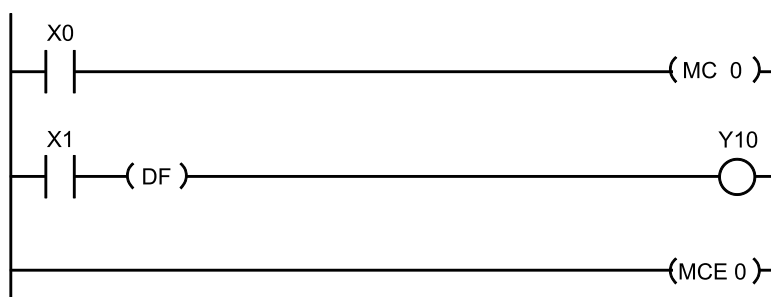

4.1 MC/MCE (Master Control Relay / Master Control Relay End)

Timing chart 1

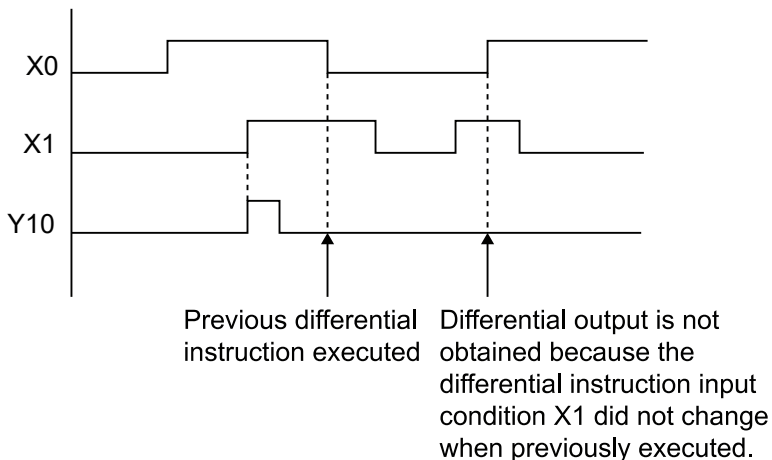

Timing chart 2

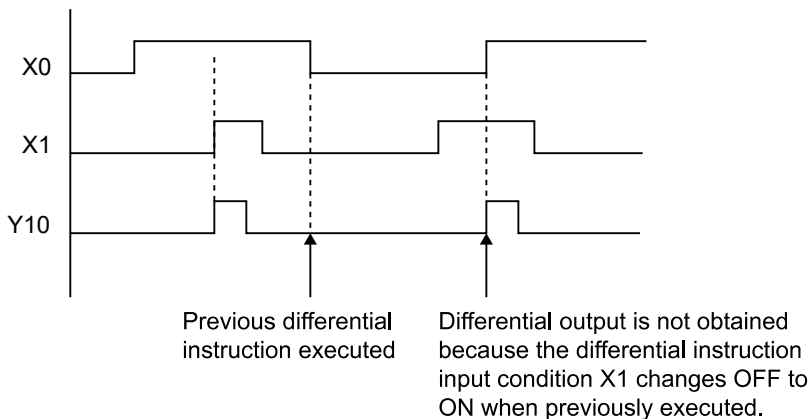

- Output will not be obtained if the same execution condition is specified for an MC instruction and a differential instruction. If output is needed, enter the differential instruction outside of the MC-MCE instruction sequence.

4.1 MC/MCE (Master Control Relay / Master Control Relay End)

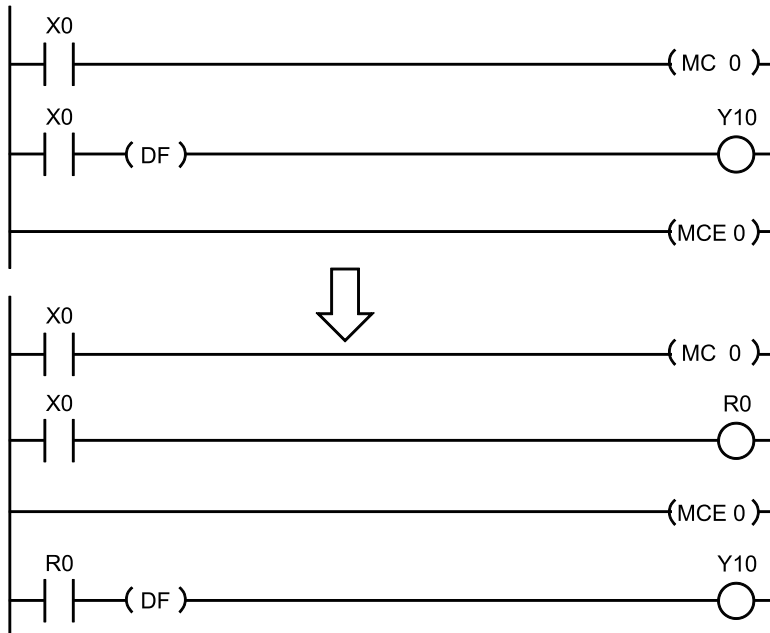

■ Precautions for programming

- A second **MC-MCE** instruction pair can be entered (nested) between an initial **MC-MCE** instruction pair. (There is no limit to the number of nestings.)

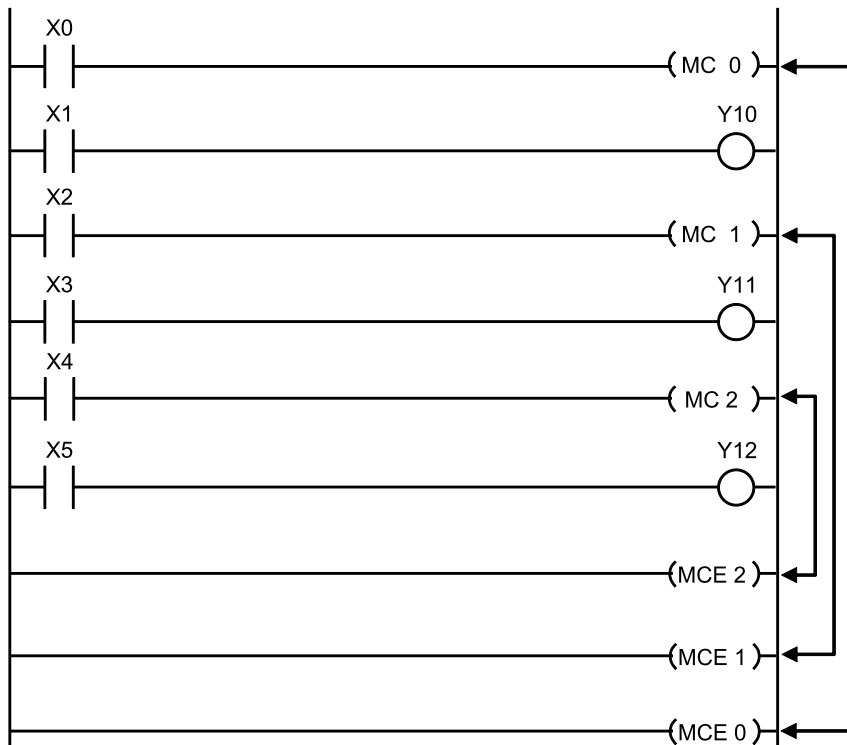

4.1 MC/MCE (Master Control Relay / Master Control Relay End)

- The program cannot be executed in the following cases.
 1. Either **MC** or **MCE** is missing.
 2. The order of **MC** and **MCE** is reversed.

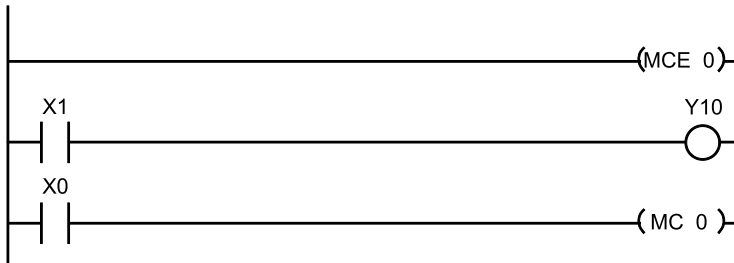

3. There is duplicated use of the specified number.

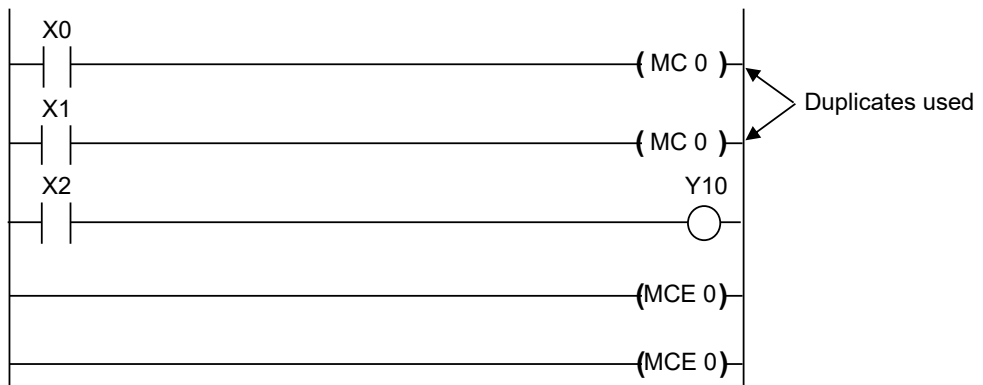

4.2 JP/LBL (Jump/Label)

■ Instruction format

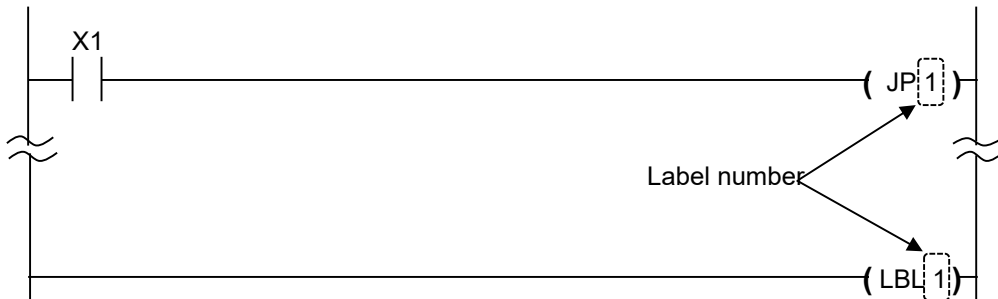

■ Outline of operation

- When the execution condition turns ON, the program jumps to the label (**LBL** instruction) with the same number as the specified number.
- Program execution continues from the next instruction after the jump destination label.

■ Operation example

Operation of instruction format description program

When execution condition X1 turns ON, the program jumps to label 1.

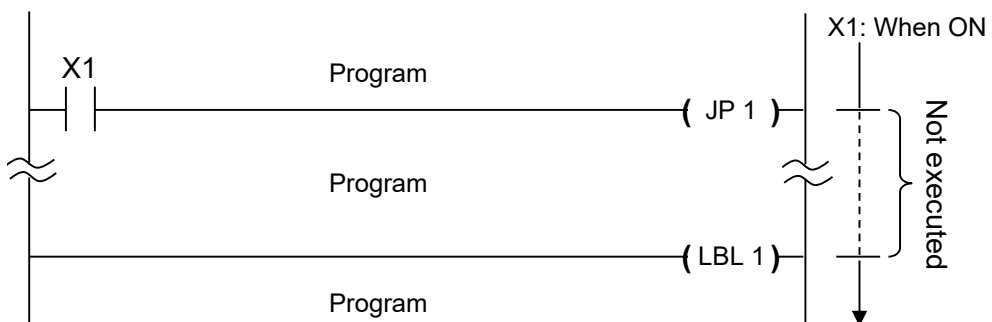

- The same label is used by the **JP** instruction and the **LOOP** instruction. Any instruction can be used as the starting point for the jump destination.
- It is possible to use **JP** instructions with the same label number multiple times.

4.2 JP/LBL (Jump/Label)

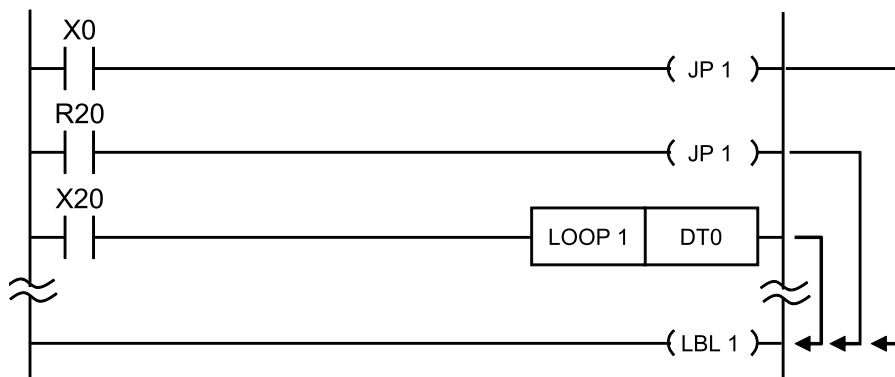

- 2 or more **LBL** instructions with the same number cannot be written in the same program.
- If the jump destination label is not programmed, a syntax error occurs.
- Caution is required when using an instruction that is executed by detecting the rise of an execution condition, such as a differential instruction (1 to 7 below).
 1. DF (rise differential)
 2. CT (counter) count input
 3. F118 UDC (up-down counter) count input
 4. SR (shift register) shift input
 5. F119 LRSR (left and right shift register) shift input
 6. NSTP (next step)
 7. Differential execution type high-level instruction (instruction specified by P and a number)

■ Precautions for programming

- If the label is written to an address before the **JP** instruction, be aware that there is a possibility that the scan cannot be completed, and an operation bottleneck error will occur.
- **JP** and **LBL** instructions cannot be used in a step ladder area (the range from **SSTP** to **STPE**).
- It is not possible to jump from a main program to a subprogram (a subroutine or interrupt program after the **ED** instruction), from a subprogram to a main program, or from a subprogram to another subprogram.

■ Operation of TM, CT, and SR instructions between JP and LBL instructions

- If the **LBL** instruction is at an address after the **JP** instruction, then processing of each instruction when executing the **JP** instruction will be as follows.

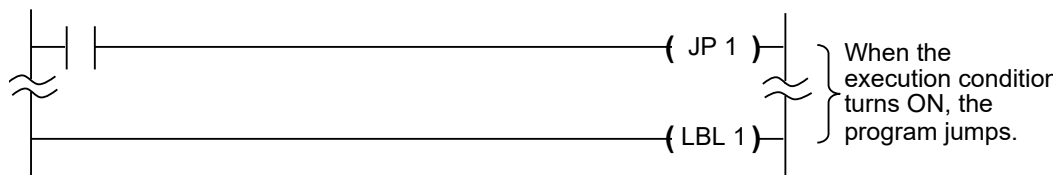

(1)	TM instruction	Clocking is not performed. If it is not executed once during a single scan, the correct time cannot be guaranteed.
(2)	CT instruction	Even if count input is ON, counting is not performed. The elapsed value is retained.

(3)	SR instruction	Even if shift input is ON, no shift is performed. The contents of the specified register are retained.
-----	----------------	--

- If the **LBL** instruction is at an address before the **JP** instruction, then processing of each instruction when executing the **JP** instruction will be as follows.

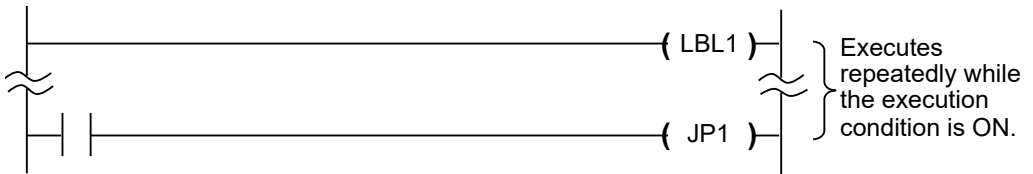

(1)	TM instruction	Multiple timings occur during a single scan, therefore the time cannot be guaranteed.
(2)	CT instruction	If the state of the count input does not change during the scan, it will operate in the usual way.
(3)	SR instruction	If the state of the shift input does not change during the scan, it will operate in the usual way.

■ **Operation of a differential instruction between JP and LBL**

- If a differential instruction is used between a JP and LBL instruction, be aware that the obtained output will differ as shown below depending on the execution condition of the JP and the input timing of the differential instruction.

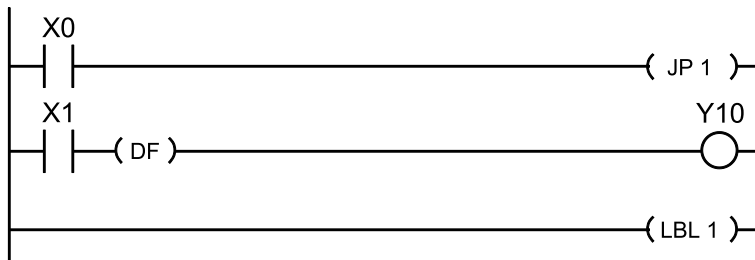

Timing chart 1

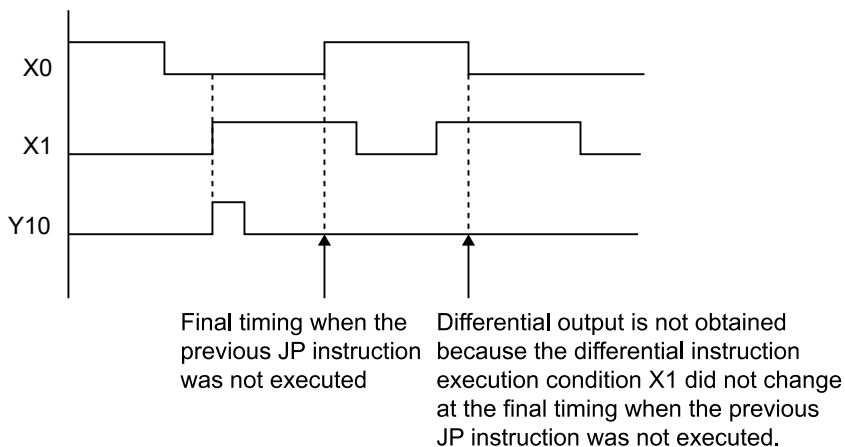

4.2 JP/LBL (Jump/Label)

Timing chart 2

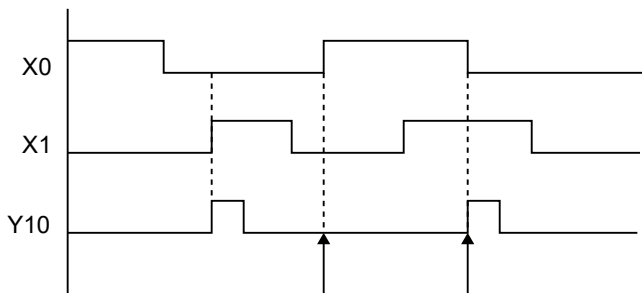

Final timing when the previous JP instruction was not executed

Differential output is not obtained because the differential instruction execution condition X1 changed OFF to ON at the final timing when the previous JP instruction was not executed.

- When the execution conditions for the **JP** instruction are the same as the execution conditions for the differential instruction, the leading edge (or trailing edge) of the execution condition for the differential instruction will not be detected. If differential output is required, write the differential instruction outside of the area between the **JP** and **LBL** instructions.

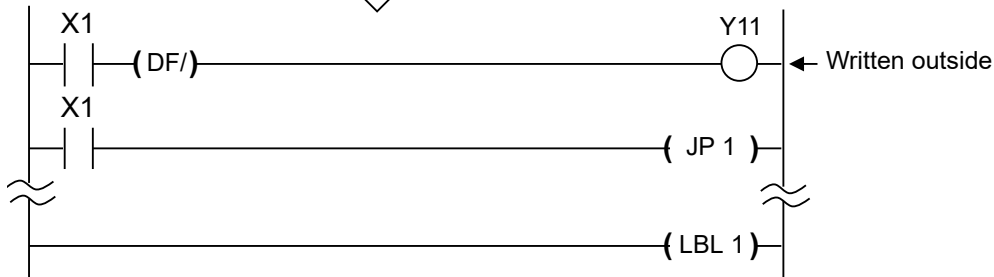
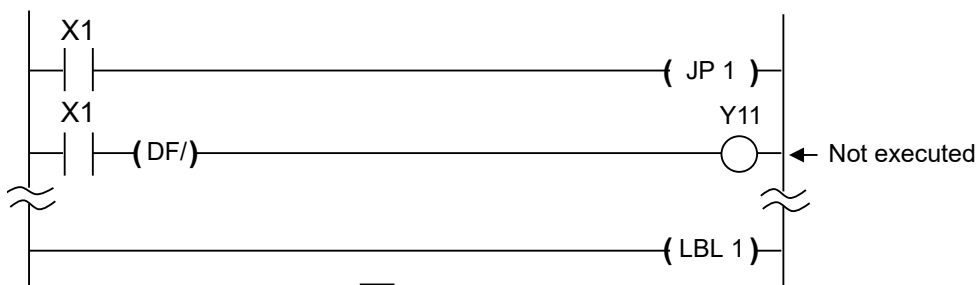

4.3 LOOP, LBL (Loop, Label)

■ Instruction format

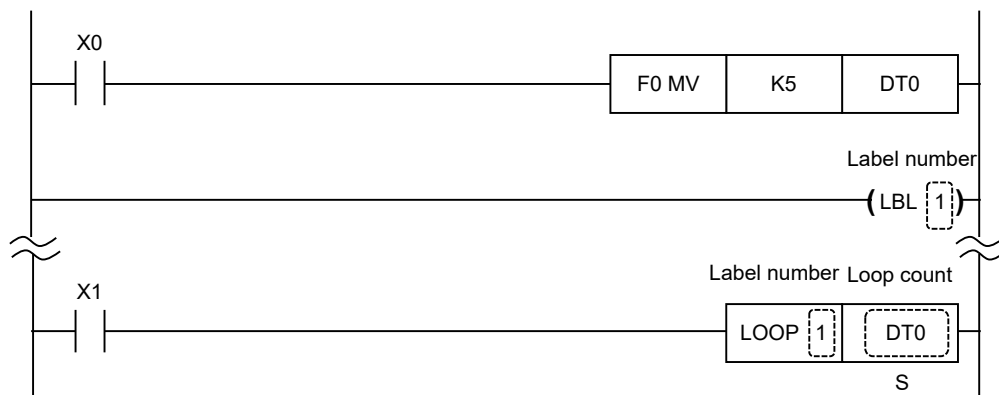

■ Instruction list

Instruction	Description
S	Area storing number of loop operations

■ Devices that can be specified (indicated by ●)

Operands	WX	WY	WR	WL	SV	EV	DT	LD	I	SWR	SDT	Constant				Index modifier	Integer Device
												K	H	M	f		
S		●	●	●	●	●	●	●	●								

■ Outline of operation

- When the execution condition turns ON, 1 is subtracted from the content of [S] and if the result does not equal 0, the operation jumps to the label (**LBL** instruction) with the same number as the specified number.
- Program execution continues starting from the instruction of the label at the jump destination.
- The **LOOP** instruction is used to set the number of times to execute the program. When the number of times (K constant) specified by [S] is reached, the operation does not jump even if the execution condition is established.

4.3 LOOP, LBL (Loop, Label)

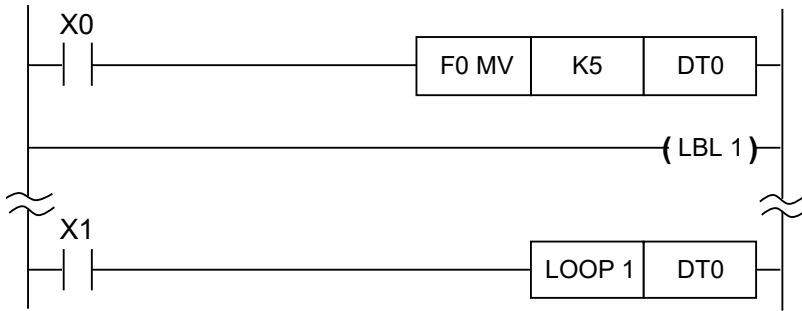

If DT0=K5, then after 5 jumps, there are no more jumps even if X1 is ON.

- If the memory area content specified by [S] is 0 from the start, the operation does not jump to a label number, and the next processing is performed.
- The same label is used by the **JP** instruction and the **LOOP** instruction. A label can be used as the jump destination for any instruction, as many times as required.

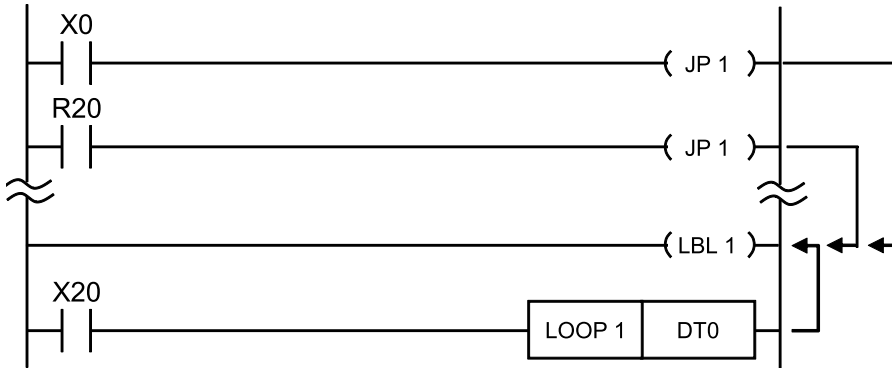

- Two or more **LBL** instructions with the same number cannot be written in the same program.
- If the jump destination label is not programmed, a syntax error occurs.

■ Operation of TM, CT, and SR instructions between LOOP and LBL instructions

- If the **LBL** instruction address is after that of the **LOOP** instruction, the TM, CT, and SR instructions are processed as follows when the **LOOP** instruction is executed.

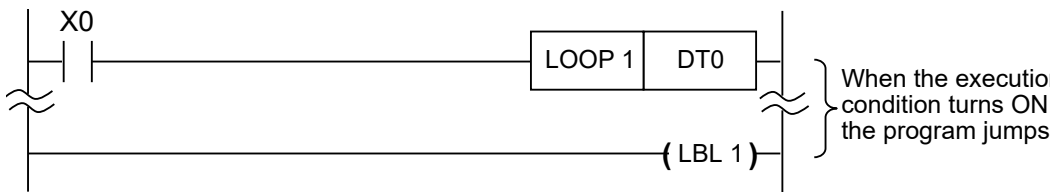

(1)	TM instruction	Clocking is not performed. If it is not executed once during a single scan, the correct time cannot be guaranteed.
(2)	CT instruction	Even if count input is ON, counting is not performed. The elapsed value is retained.
(3)	SR instruction	Even if shift input is ON, no shift is performed. The contents of the specified register are retained.

- If the **LBL** instruction address is before that of the **LOOP** instruction, the **TM**, **CT**, and **SR** instructions are processed as follows when the **LOOP** instruction is executed.

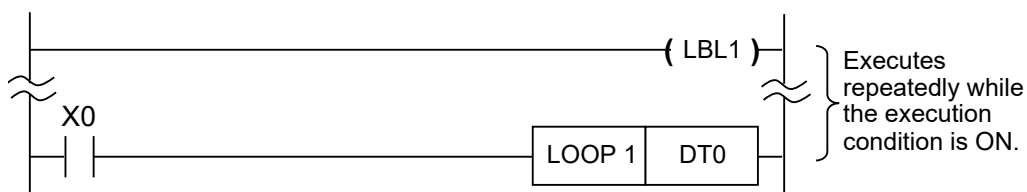

(1)	TM instruction	Multiple timings occur during a single scan, therefore the time cannot be guaranteed.
(2)	CT instruction	If the state of the count input does not change during the scan, it will operate in the usual way.
(3)	SR instruction	If the state of the shift input does not change during the scan, it will operate in the usual way.

■ Precautions for programming

- If the label is written to an address before the **LOOP** instruction, be aware of the following points.
 1. Ensure that the instruction for setting the loop count is written before **LBL** to **LOOP**. See the "P.4-12" program.
 2. Write each instruction repeatedly executed between **LBL** to **LOOP** so that they are executed under the same conditions as the **LOOP** instruction.
 3. During this repetition, it is possible that a single scan will exceed the operation bottleneck monitoring time and an operation bottleneck error may occur.

Example 1: When X5 turns ON, two F0 MV instructions are repeated five times.

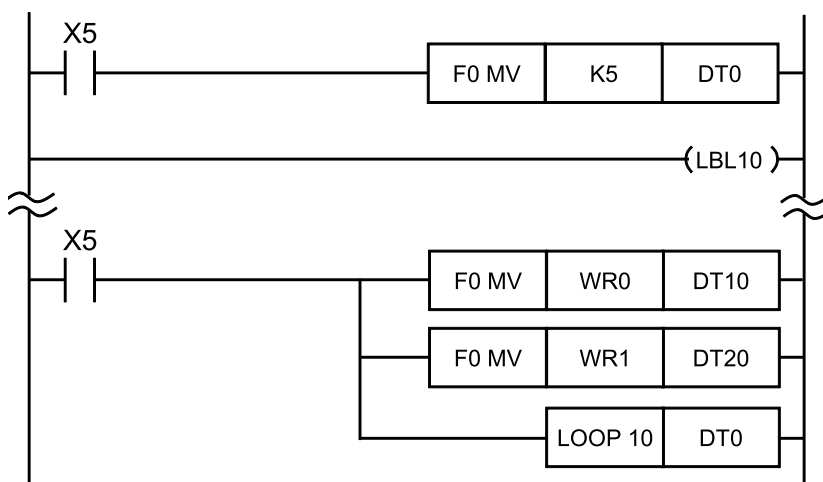

4.3 LOOP, LBL (Loop, Label)

Example 2: The DT100 value is transferred to DT200 to DT219.

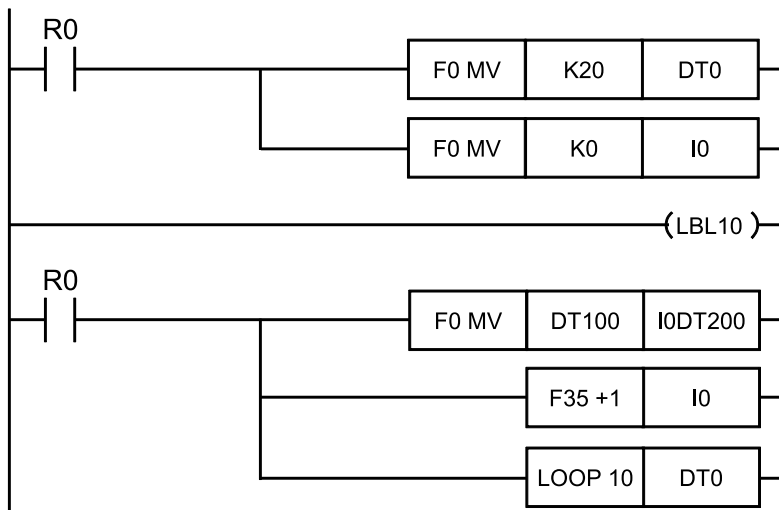

- The **LOOP** instruction and **LBL** instruction cannot be used in the step ladder area (**SSTP** to **STPE** range).
- It is not possible to jump from a main program to a subprogram (a subroutine or interrupt program after the **ED** instruction), from a subprogram to a main program, or from a subprogram to another subprogram.
- Caution is required when using an instruction that is executed by detecting the rise of an execution condition, such as a differential instruction (1 to 7 below).
 1. DF (rise differential)
 2. CT (counter) count input
 3. F118 UDC (up-down counter) count input
 4. SR (shift register) shift input
 5. F119 LRSR (left and right shift register) shift input
 6. NSTP (next step)
 7. Differential execution type high-level instruction (instruction specified by P and a number)

■ Flag operations

Name	Description
R9007 R9008 (ER)	Turns ON when the content of [S] is a negative value (the most significant bit is 1)

4.4 ED (End)

Indicates the end of a regular program area.

■ Instruction format

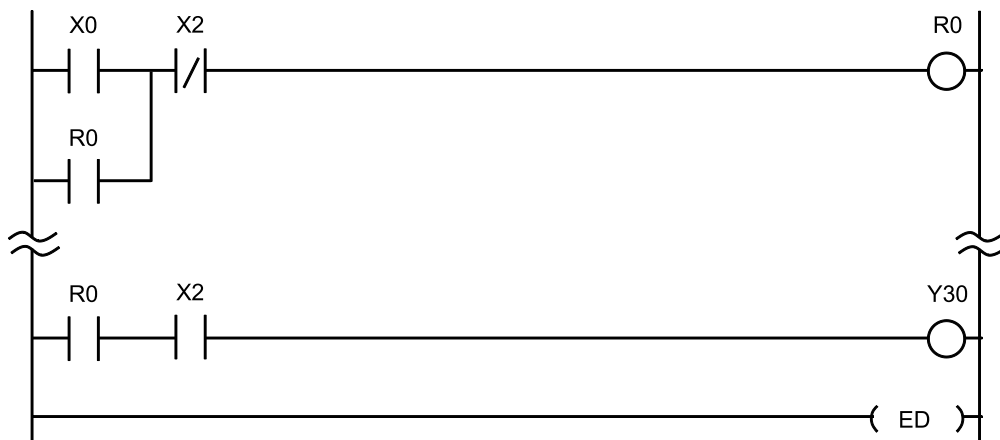

■ Outline of operation

- Write the **ED** instruction at the end of the regular program area.

Program area

Address

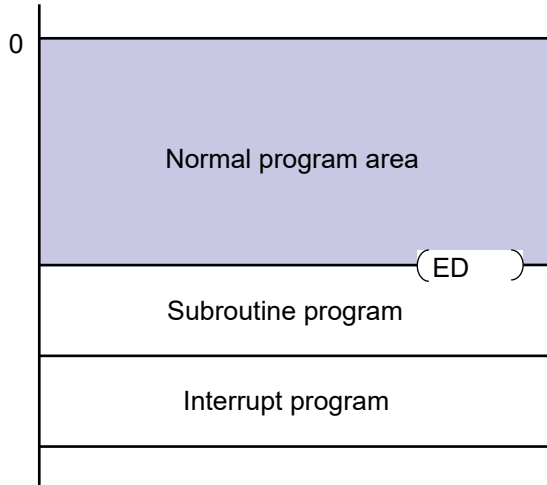

- Program areas are divided into the regular program area (main program) and "subroutine" and "interrupt program" areas (subprograms) using this instruction.
- Write subroutine programs and interrupt programs after the **ED** instruction.

4.5 CNDE (Conditional end)

4.5 CNDE (Conditional end)

■ Instruction format

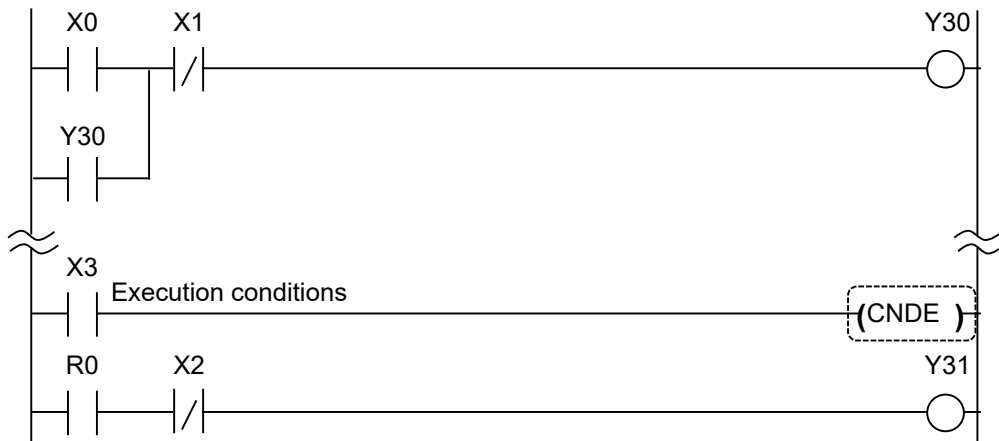

■ Outline of operation

- Ends arithmetic processing of the program at the specified address.
- When the execution condition turns ON, arithmetic processing of the program ends, and processing such as input and output is performed. When processing is complete, the operation returns to the starting address.
- The processing timing can be adjusted by performing the processing only after the required number of program scans are completed.
- The **CNDE** instruction is not available in a subprogram such as a subroutine or interrupt program. Use in the main program area.
- The **CNDE** instruction can be described any number of times in the main program.
- Caution is required when using an instruction that is executed by detecting the rise of an execution condition, such as a differential instruction (1 to 7 below).
 1. DF (rise differential)
 2. CT (counter) count input
 3. F118 UDC (up-down counter) count input
 4. SR (shift register) shift input
 5. F119 LRSR (left and right shift register) shift input
 6. NSTP (next step)
 7. Differential execution type high-level instruction (instruction specified by P and a number)

4.5 CNDE (Conditional end)

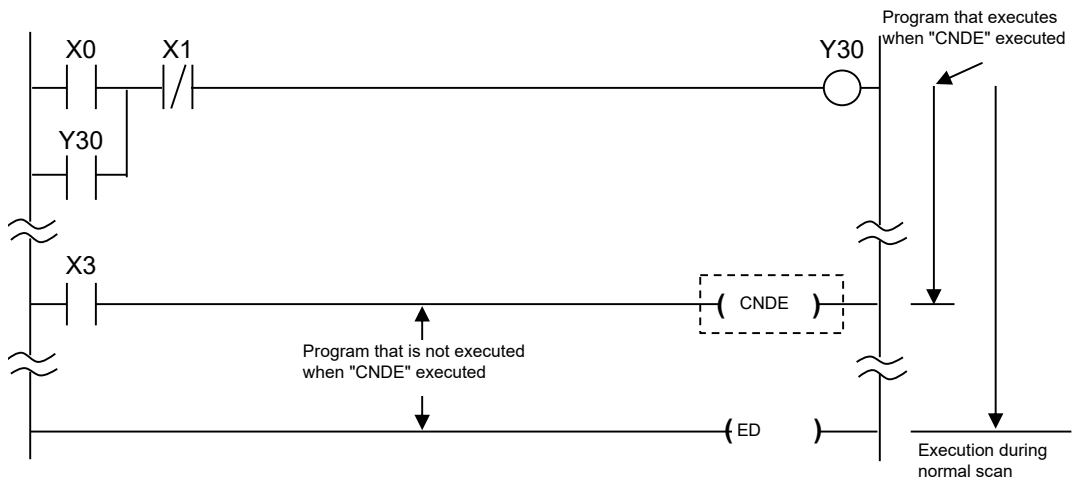

4.6 EJECT

■ **Instruction format**

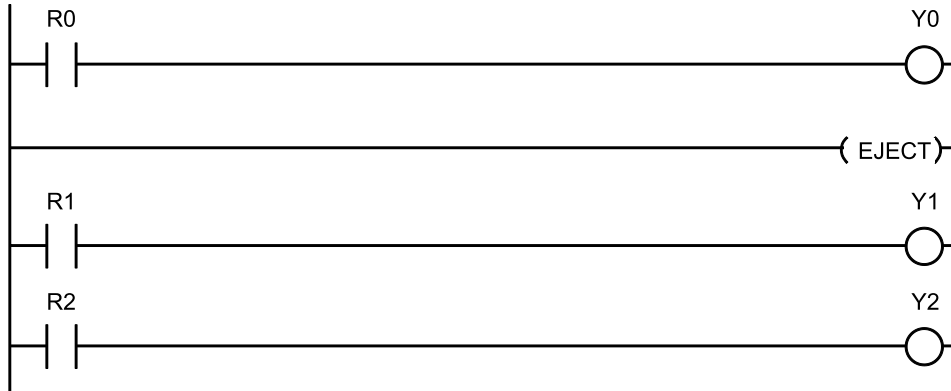

■ **Outline of operation**

- When printing out a program created using tool software, a page break occurs at the location at which this instruction is inserted.
- As with NOP instructions, no processing is performed in the program.

■ **Operation example**

Operation of instruction format description program

When printing out a created program, insert an EJECT instruction in the address where you would like a page break.

In the example above, a page break occurs at address 2.

5 Step ladder instructions

5.1 SSTP, NSTL (NSTP), CSTP, STPE (Start Step, Next Step, Clear Step, Step End).....	5-2
5.2 SCLR (Clear Multiple Processes)	5-17

5.1 SSTP, NSTL (NSTP), CSTP, STPE (Start Step, Next Step, Clear Step, Step End)

5.1 SSTP, NSTL (NSTP), CSTP, STPE (Start Step, Next Step, Clear Step, Step End)

■ Instruction format



■ Outline of operation

- When the **NSTL** or **NSTP** instruction is executed, the process of the specified number starting from the **SSTP** instruction is started and executed.
- The program from the **SSTP** instruction to the next **SSTP** or **STPE** instruction is considered one process.

<Example>

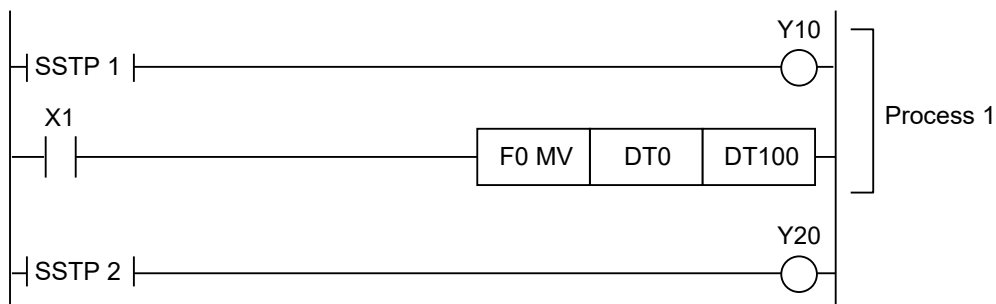

- These instructions make it easy to execute sequence control, selection branch control, parallel branch merge control, and similar operations.

1. Sequence control

Only the necessary processes are switched and executed in order.

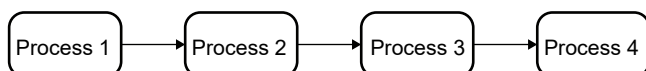

2. Selection branch control

5.1 SSTP, NSTL (NSTP), CSTP, STPE (Start Step, Next Step, Clear Step, Step End)

The processes are selected and executed according to conditions.

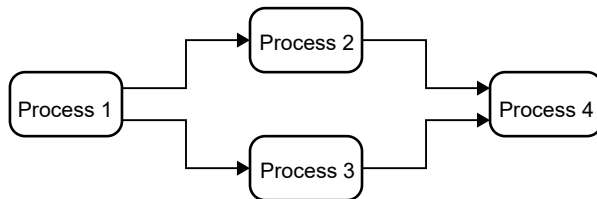

3. Parallel branch merge control

- Multiple processes are executed simultaneously.
- After each process is completed, the next process is executed.

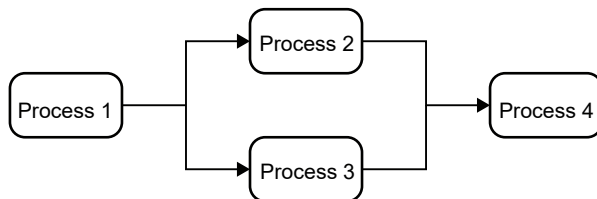

■ Syntax of step ladder instruction

SSTP start step

- This instruction indicates the "start of process n". Be sure to write "SSTP n" at the beginning of the process n program.



- Process n is defined as being from one "SSTP n" instruction to the next **SSTP** or **STPE** instruction.
- The same process number cannot be defined for more than one process.
- The **OUT** instruction can be connected directly from the bus bar immediately after the **SSTP** instruction.
- The **SSTP** instruction cannot be used in a subprogram (subroutine or interrupt program).
- The area starting from the first **SSTP** instruction to the **STPE** instruction is referred to as the "step ladder area". The programs in this area are all controlled as processes. Other areas are referred to as "normal ladder areas".

5.1 SSTP, NSTL (NSTP), CSTP, STPE (Start Step, Next Step, Clear Step, Step End)

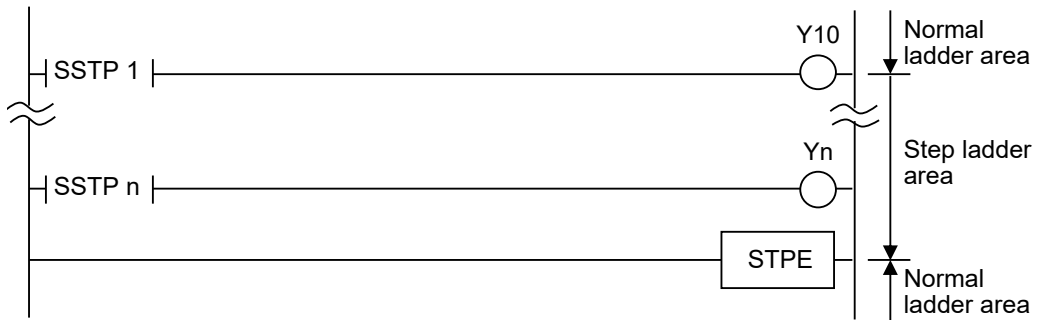

- There is a special internal relay that turns ON for one scan only when a process on the step ladder starts. (R9015: step ladder initial pulse relay.) This relay can be used to process only one scan when starting a process, such as resetting a counter.

NSTL next step (every scan execution type), NSTP next step (differential execution type)

- When an **NSTL n** or **NSTP n** instruction is executed, process n specified by n is invoked.
- The execution condition of the next step instruction becomes the start condition of the process.



- Write the process that starts first in the next step instruction in the normal ladder area.
- A process can be started from the normal ladder area or from a process that is executing.
- However, when you start a process with a next step instruction from within a process, the process that is executing and contains the next step instruction is automatically cleared and the specified process starts.

Be aware that the outputs and other processes are actually turned off by the clear operation during the next scan.

- The **NSTP** instruction is a differential execution type instruction, so it is executed for only one time when the execution condition rises. Also, since it only detects if the execution condition has changed between ON and OFF, the instruction is not executed when switching to "RUN mode" or when the power is turned ON while in "RUN mode" and the execution condition is already ON.

5.1 SSTP, NSTL (NSTP), CSTP, STPE (Start Step, Next Step, Clear Step, Step End)

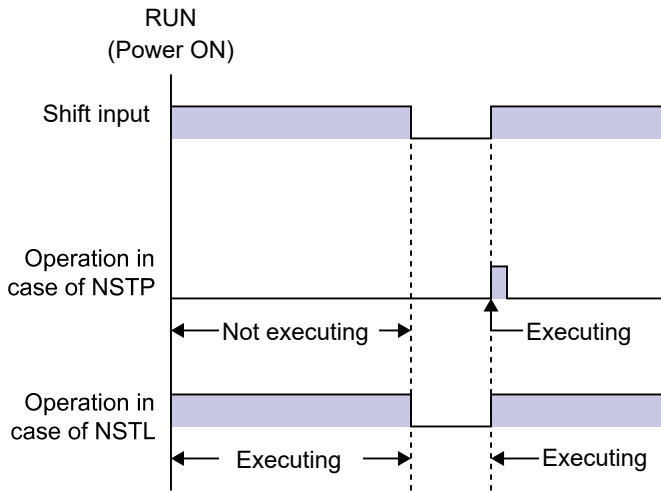

- Be aware that, if the **NSTP** instruction is used with instructions that change the order of execution such as the MC to MCE instructions or the JP to LBL instructions (see 1 to 6 below), the operation of instructions may change depending on the instruction execution and execution condition timing.
 1. MC to MCE instructions
 2. JP to LBL instructions
 3. LOOP to LBL instructions
 4. CNDE instruction
 5. Step ladder instructions
 6. Subroutine instructions
- When combining the NSTP instruction with an AND stack instruction or a POP stack instruction, be careful that the programming is correct.

CSTP clear step

When a **CSTPn** instruction is executed, process n specified by n is cleared. This instruction can be used to clear the final process or to clear the processes executing in parallel during parallel branch merge control.

<Example>



- A process can be cleared from the normal ladder area or from a process that is already started.
You can use the **SCLR** (block clear) instruction to clear multiple processes at once by specifying a range.

STPE step end

5.1 SSTP, NSTL (NSTP), CSTP, STPE (Start Step, Next Step, Clear Step, Step End)

Indicates the "end of the step ladder area". Be sure to write this instruction at the end of the final process. This makes the final process from **SSTP** to **STPE**.

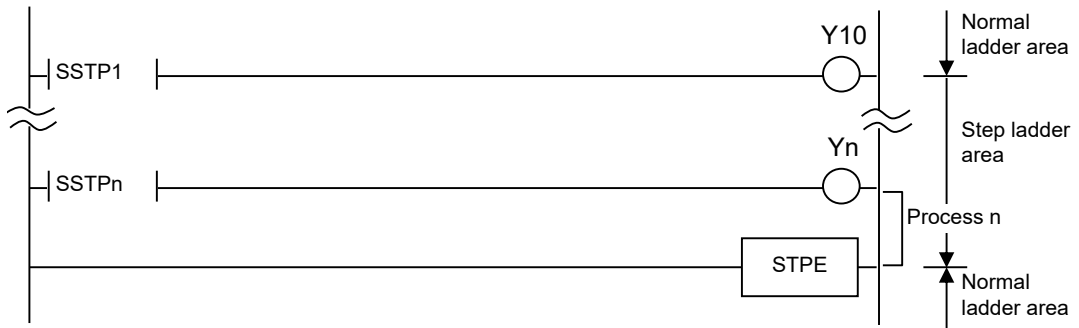

(Note 1) In this case, process n is the final process.

- The **STPE** instruction can only be written once, in the main program. (It cannot be written in subprograms such as subroutine programs and interrupt programs.)

■ Precautions for programming

- Processes do not need to be written in numerical order.
- In the step ladder area, you cannot use the following instructions:
 1. Jump instructions (**JP** and **LBL**)
 2. Loop instructions (**LOOP** and **LBL**)
 3. Master control instructions (**MC** and **MCE**)
 4. Subroutine instructions (**SUB** and **RET**) (*)
 5. Interrupt instructions (**INT** and **IRET**)
 6. **ED** instruction
 7. **CNDE** instruction

(Note): The **CALL** instruction can be used within the step ladder area.

- To clear all processes at once, use the master control relay in the program as follows.

e.g. All processes are cleared when X0 turns ON



5.1 SSTP, NSTL (NSTP), CSTP, STPE (Start Step, Next Step, Clear Step, Step End)

- Processes do not need to be started in numerical order. You can execute multiple processes simultaneously.
- When the output in a process that has not been started is forcibly turned ON or OFF, even if the forced ON/OFF operation is canceled, the output state will be held until the process starts.

■ Step ladder operations

- With step ladder operations, the program in the normal ladder area and the program in the processes invoked by the next step instruction (**NSTL** or **NSTP**) are executed. The program in processes that are not executing is ignored.

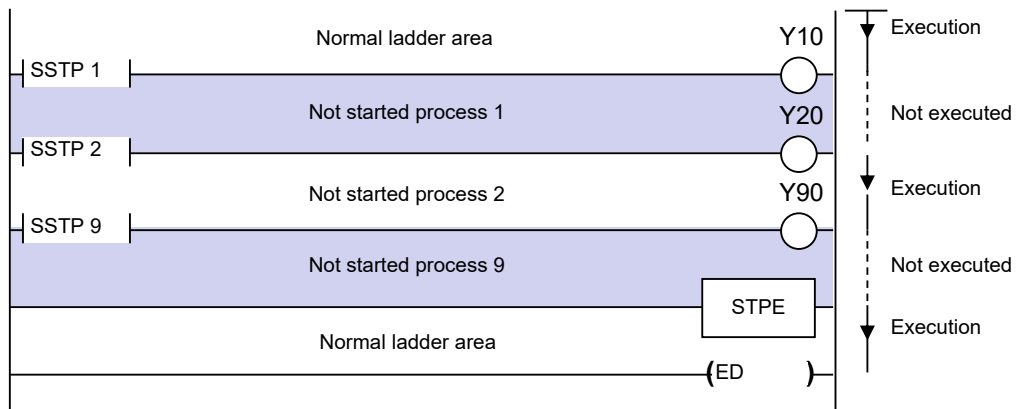

When only process 2 is executing as shown in the above figure, the program in the normal ladder area and in process 2 is executed.

- When a process is started and while the first scan is being performed, the step initial pulse relay (R9015) turns ON. It turns OFF for the second and subsequent scans. This relay can be used to reset counters and shift registers.

■ Precautions for clearing a process

- If the next step instruction is executed in an active process, that process is automatically cleared. However, the actual clear operation does not occur until the next scan. For this reason, when a process transitions, two processes may be executing at the same time for one scan. To prevent simultaneous execution of a set of outputs that should not be ON at the same time, write an interlock into the program. (If there is a possibility of processes being simultaneously ON because of hardware response delays, take measures in the hardware processing to allow the response delay to be taken into account, even if the program includes an interlock.)

5.1 SSTP, NSTL (NSTP), CSTP, STPE (Start Step, Next Step, Clear Step, Step End)

<Example>

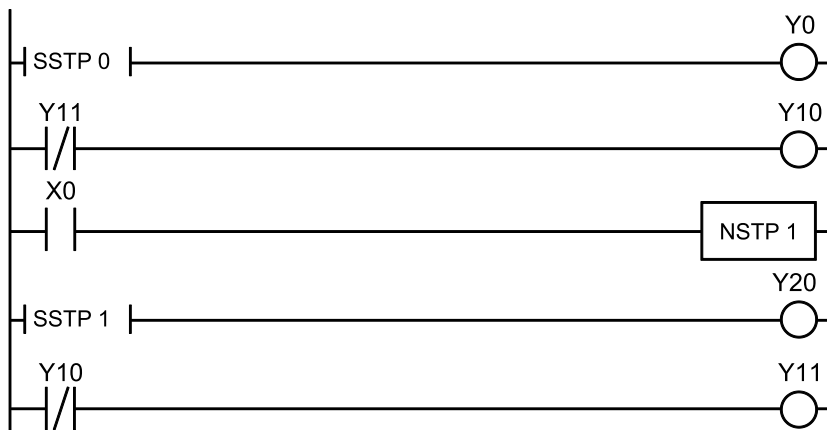

- When a process is cleared, the operation of each instruction used in that process is as follows.

OT instruction	All OFF
KP instruction	Holds the state
SET instruction	Holds the state
RST instruction	Holds the state
TM instruction	Resets the elapsed value and timer contact output
CT instruction	Holds the intermediate process
SR instruction	Holds the intermediate process
Differential instruction	Holds the state of the execution condition (Note 1)
Other instructions	Not executed

(Note 1) This is the same operation as when the execution condition of the **MC** instruction turns OFF. Refer to the explanation of the **MC** and **MCE** instructions.

- Caution is required when using an instruction that is executed by detecting the rise of an execution condition, such as a differential instruction (1 to 7 below).
 - DF (rise differential)
 - CT (counter) count input
 - F118 UDC (up-down counter) count input
 - SR (shift register) shift input
 - F119 LRSR (left and right shift register) shift input
 - NSTP (next step)
 - Differential execution type high-level instruction (instruction specified by P and a number)

■ Examples of step ladder instructions

(1) Sequence control

This is a program that repeats the work in a certain process until it is completed, and then moves to the next process.

- In the program, write the instruction to start the process to be executed next in each process. When the start instruction is executed, the next process is started, and the process that had been executing is cleared.

5.1 SSTP, NSTL (NSTP), CSTP, STPE (Start Step, Next Step, Clear Step, Step End)

- Processes do not need to be executed in numerical order. You can also program the start instruction to invoke a previous process according to conditions.

[Program example]

1. When X10 turns ON, process 10 is executed.
2. When X11 turns ON, process 10 is cleared and process 11 is executed.
3. When X12 turns ON, process 11 is cleared and process 12 is executed.
4. When X14 turns ON, process 12 is cleared and step ladder operation finishes.

• Process flowchart

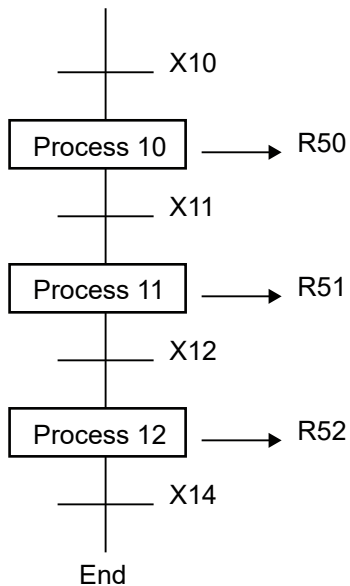

5.1 SSTP, NSTL (NSTP), CSTP, STPE (Start Step, Next Step, Clear Step, Step End)

• Program

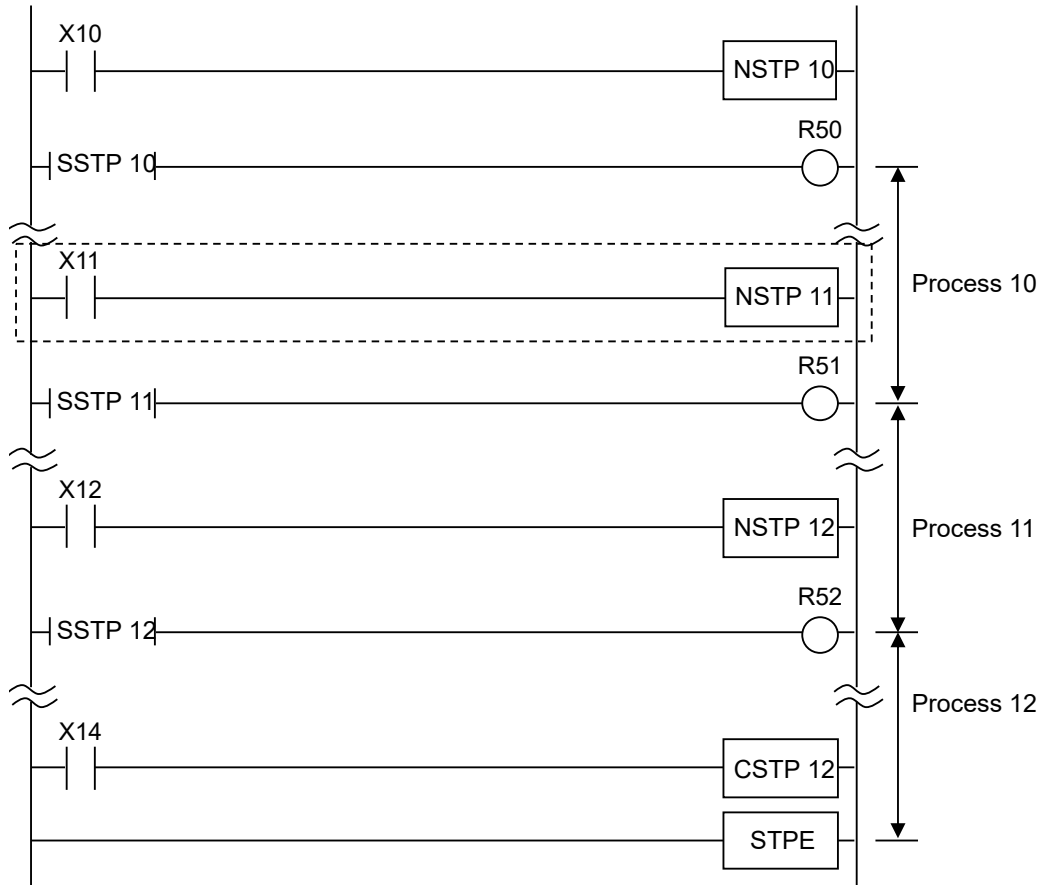

• Timing chart

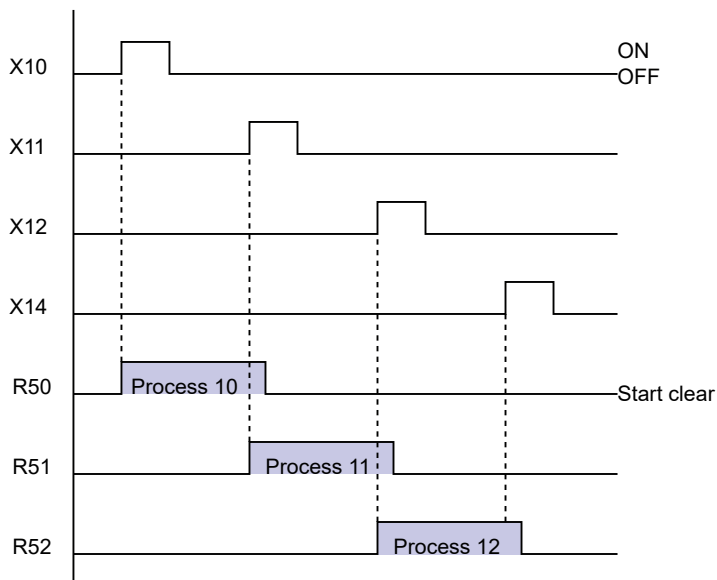

(2) Selection branch control of a process

This program selects and switches to the next process according to the actions and results of a particular process. Each process loops until its work is completed.

- In the program, write the instruction to start the process to be executed next in each process. The next process is selected and program execution is transferred according to the execution conditions.

[Program example]

1. When X100 turns ON, process 100 is executed.
2. While process 100 is executing,
 - when X101 turns ON, process 101 is executed.
 - Or when X102 turns ON, process 102 is executed.
3.
 - While process 101 is executing, when X103 turns ON, process 101 is cleared and process 200 is executed.
 - While process 102 is executing, when X104 turns ON, process 102 is cleared and process 200 is executed.
4. When X200 turns ON, process 200 is cleared and step ladder operation finishes.

• Process flowchart

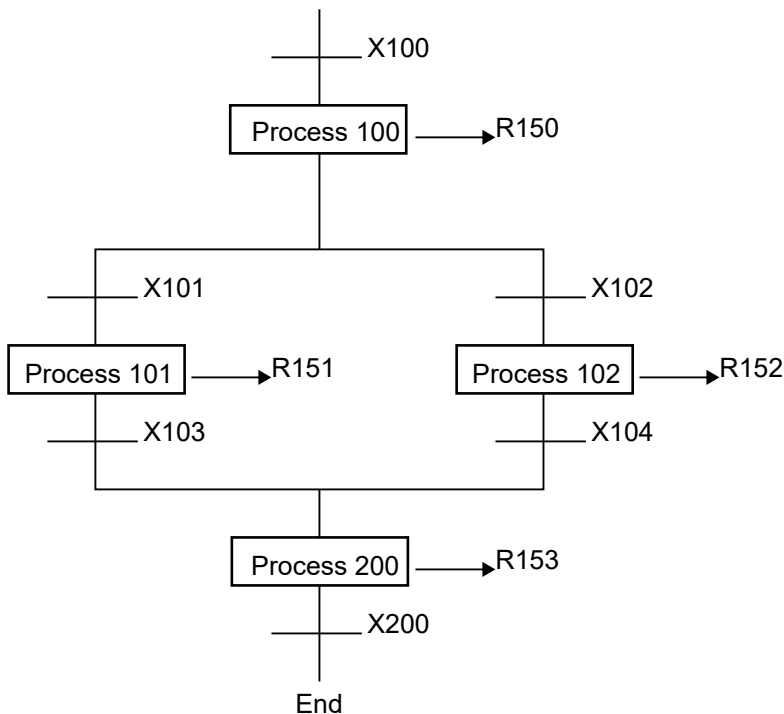

5.1 SSTP, NSTL (NSTP), CSTP, STPE (Start Step, Next Step, Clear Step, Step End)

• Program

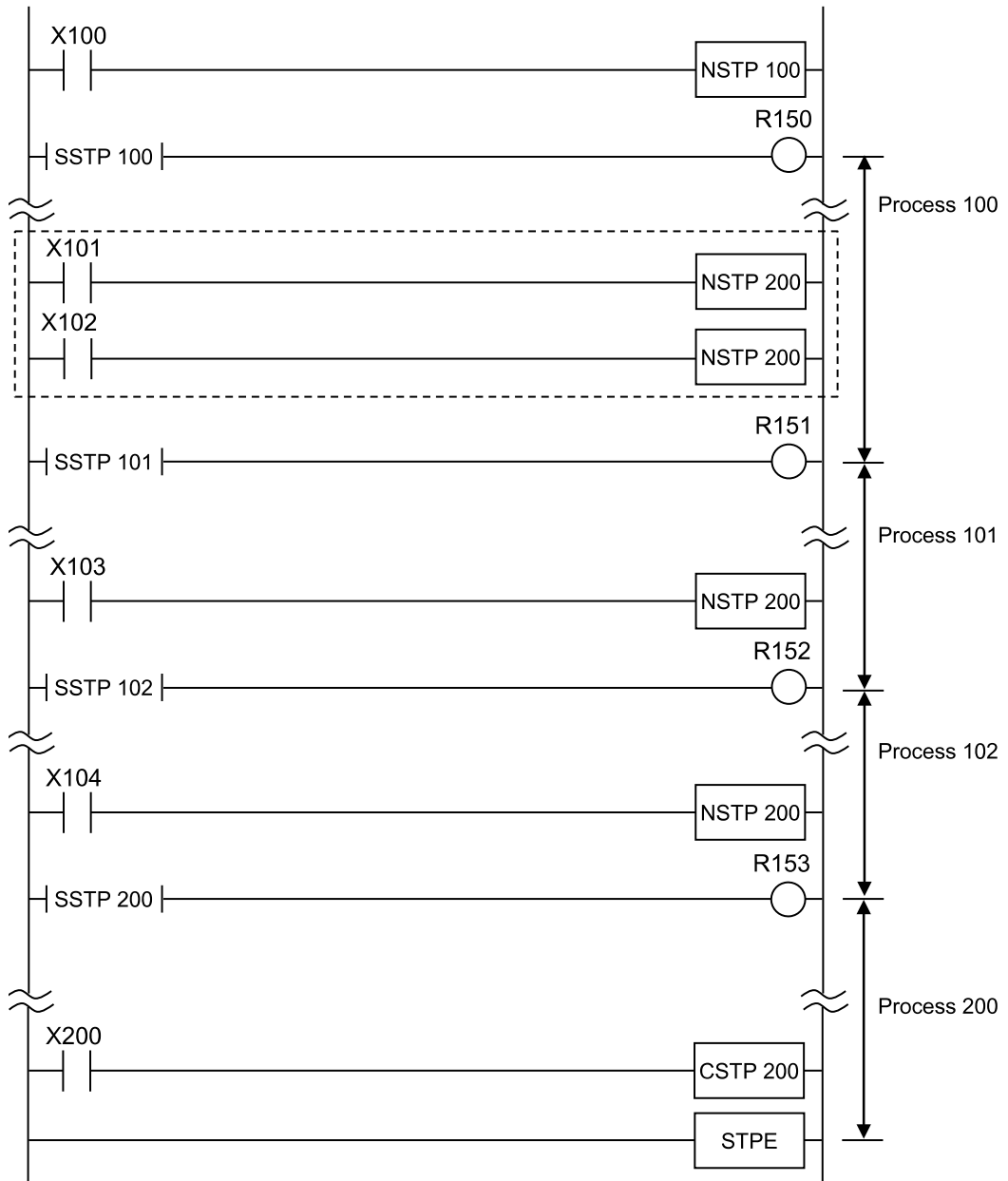

• Timing chart

This is an example of when X101 turns ON.

5.1 SSTP, NSTL (NSTP), CSTP, STPE (Start Step, Next Step, Clear Step, Step End)

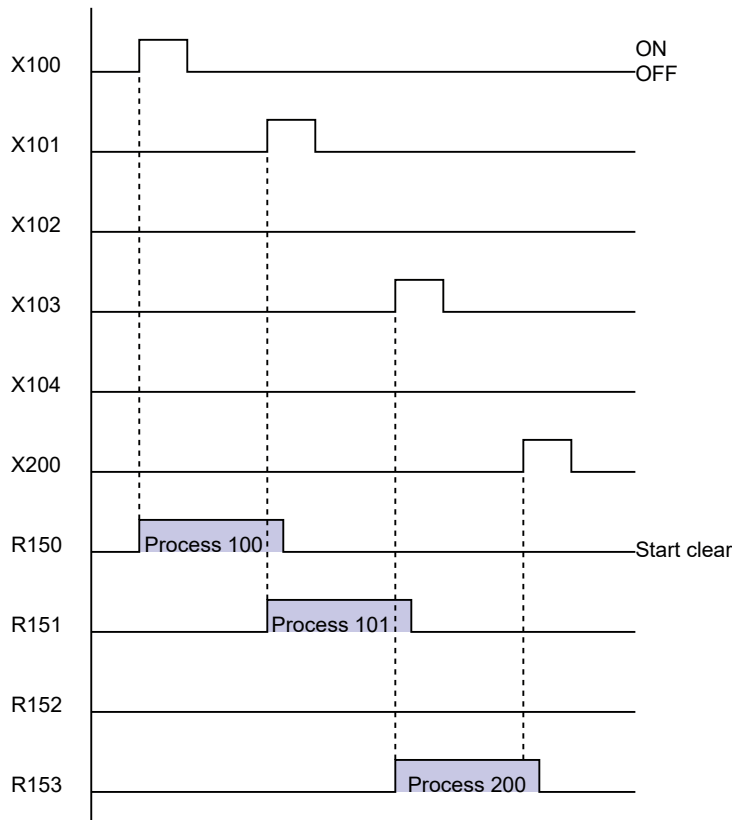

(3) Parallel branch merge control of a process

This program starts multiple processes at the same time. When the work is completed in each of the branched processes, they merge again before transferring execution to the next process.

- In the program, write multiple process transfer instructions for one execution condition in succession in a process.
- To merge processes, include a flag indicating the state of the other processes in the transfer condition for the next process. When they merge and execute the next process, clear all uncleared processes at the same time.

[Program example]

1. When X0 turns ON, process 0 is executed.
2. When X10 turns ON, process 0 is cleared and process 10 and process 20 are executed simultaneously (parallel branch).
3. When X11 turns ON, process 10 transitions to process 11.
4. With processes 11 and 20 executing, when X30 turns ON, execution transfers to process 30 (merge).
 - Process 20 is cleared with the clear instruction.
 - Process 11 is cleared and process 30 is executed.
5. When X31 turns ON, process 30 is cleared and process 0 is executed again.

5.1 SSTP, NSTL (NSTP), CSTP, STPE (Start Step, Next Step, Clear Step, Step End)

- Process flowchart

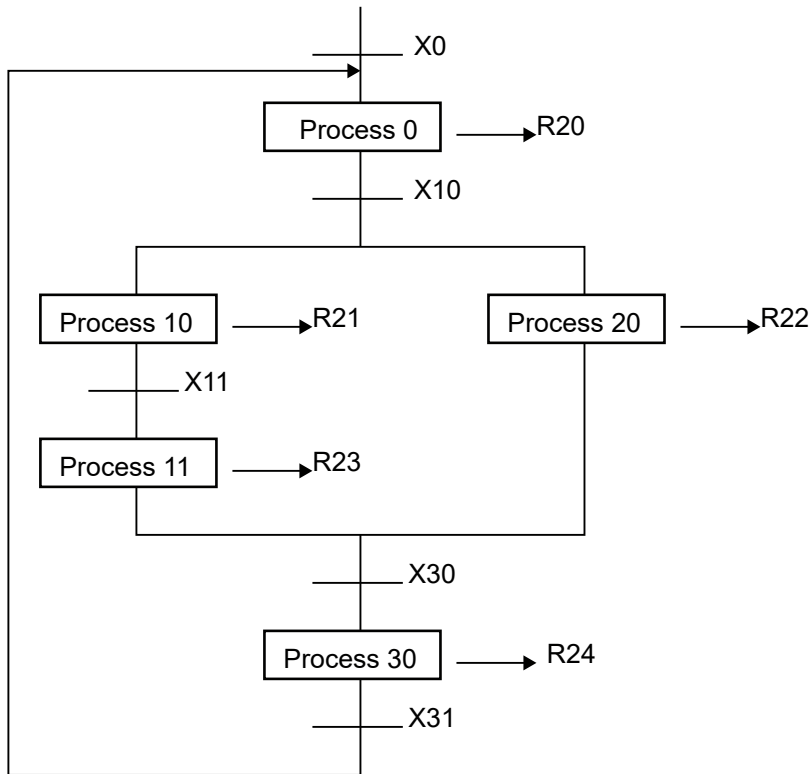

5.1 SSTP, NSTL (NSTP), CSTP, STPE (Start Step, Next Step, Clear Step, Step End)

• Program

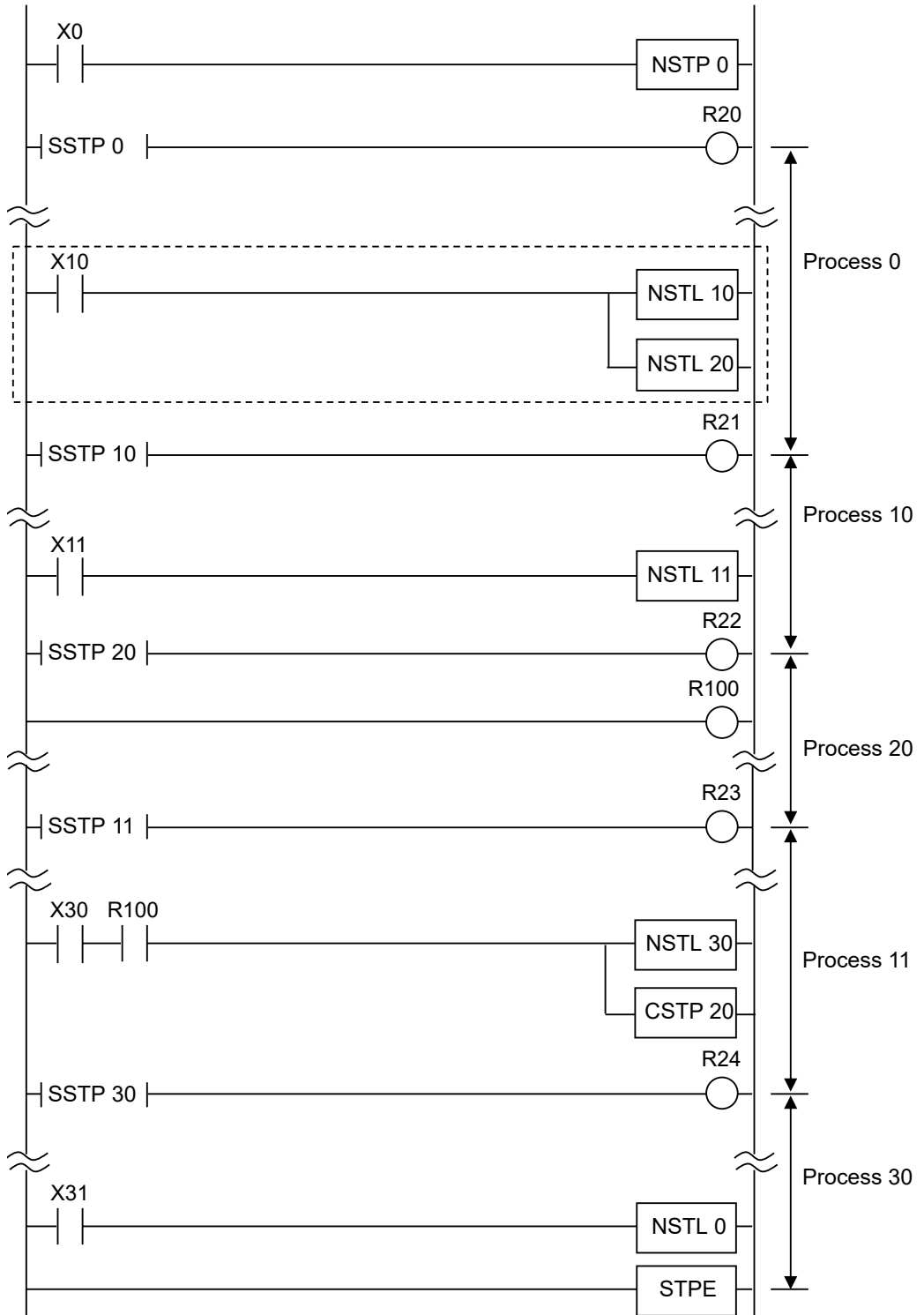

5.1 SSTP, NSTL (NSTP), CSTP, STPE (Start Step, Next Step, Clear Step, Step End)

• Timing chart

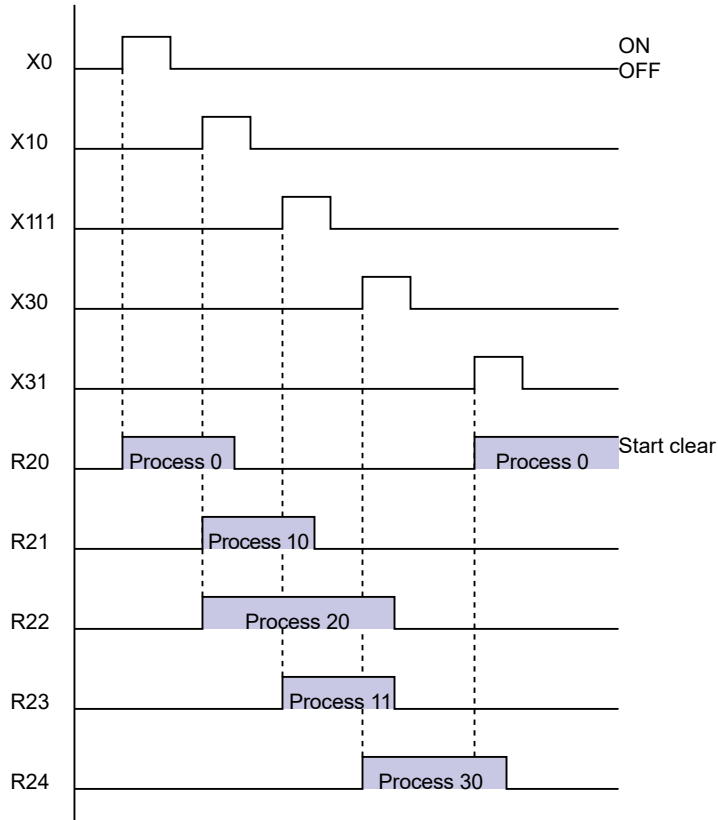

5.2 SCLR (Clear Multiple Processes)

■ Instruction format

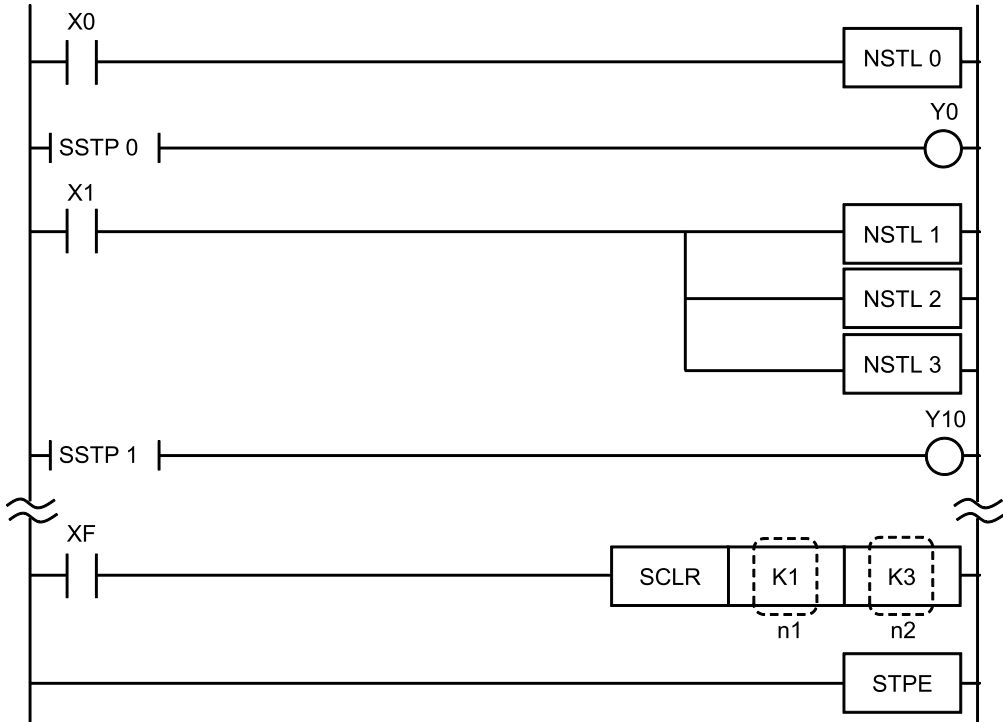

■ Outline of operation

When the **SCLR** instruction is executed, all active processes from process n1 through process n2 are cleared.

■ Operation example

Operation of instruction format description program

When input XF turns ON, active processes from 1 through 3 are cleared.

5.2 SCLR (Clear Multiple Processes)

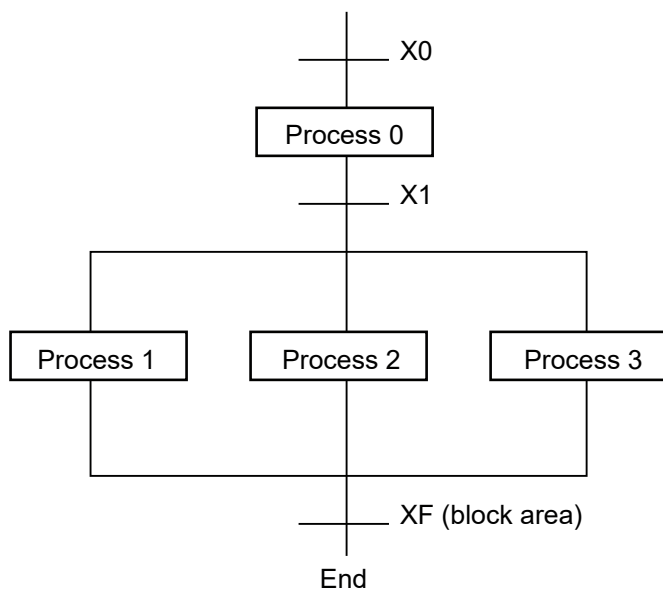

■ Precautions for programming

- Specify values so that n1 is equal to or smaller than n2.
- The **SCLR** instruction can be executed from both normal ladder areas and active processes.

6 Subroutine instructions

6.1 CALL/SUB/RET (Subroutine call, Subroutine entry, Subroutine return)6-2

6.1 CALL/SUB/RET (Subroutine call, Subroutine entry, Subroutine return)

6.1 CALL/SUB/RET (Subroutine call, Subroutine entry, Subroutine return)

■ Instruction format



■ Outline of operation

- When the execution condition turns ON, the **CALL** instruction is executed and the subroutine program of the specified number starting from the **SUB** instruction is executed.
- When the **RET** instruction is executed, the program returns to the address following the **CALL** instruction in the main program and execution of the main program continues.

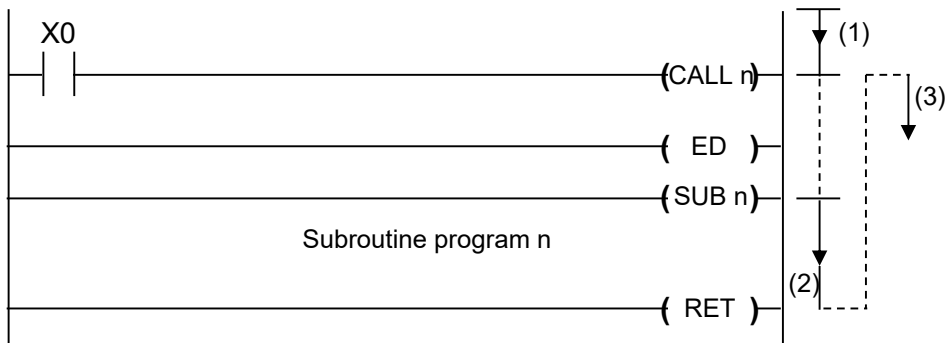

CALL n is executed in the order of (1) to (3).

■ Subroutine program syntax

- "Subroutine program n" is the program between the **SUB n** instruction and the **RET** instruction. Always write a subroutine to an address after the **ED** instruction.
- The **CALL n** instruction can be described in the main program and any other subroutine program, interrupt program, or step ladder. Additionally, a **CALL** instruction with the same number can be repeated.
- Subroutines can be nested up to 10 layers deep.

6.1 CALL/SUB/RET (Subroutine call, Subroutine entry, Subroutine return)

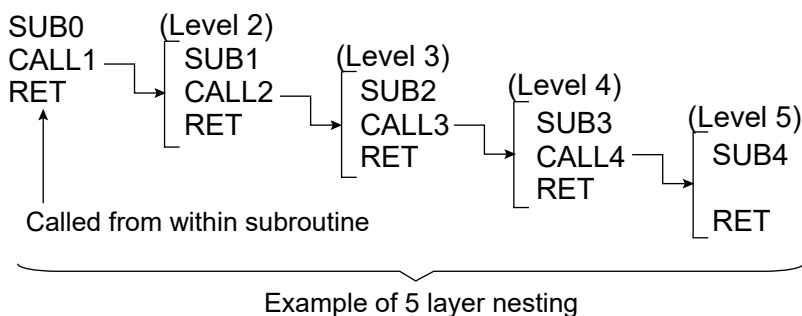

■ Precautions for programming

- A subroutine program cannot be described in an interrupt program.

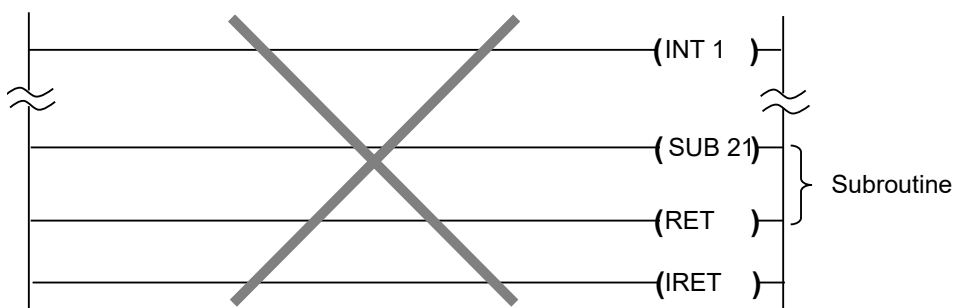

- An interrupt program cannot be described in a subroutine program.

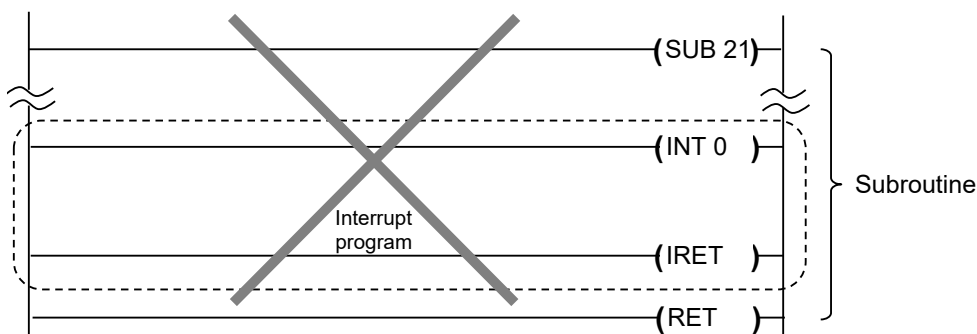

- Caution is required when using an instruction that is executed by detecting the rise of an execution condition, such as a differential instruction (1 to 7 below), in a subroutine.
 1. DF (rise differential)
 2. CT (counter) count input
 3. F118 UDC (up-down counter) count input
 4. SR (shift register) shift input
 5. F119 LRSR (left and right shift register) shift input
 6. NSTP (next step)
 7. Differential execution type high-level instruction (instruction specified by P and a number)

6.1 CALL/SUB/RET (Subroutine call, Subroutine entry, Subroutine return)

■ Operation when the execution condition of the **CALL** instruction turns OFF

When the execution condition of the **CALL** instruction turns OFF, the operation of that subroutine is not performed (the same applies to calls in master control and step ladders). In this case, the operation of each instruction used in the subroutine is as follows.

OT instruction	Holds the state.
KP instruction	Holds the state.
SET instruction	Holds the state.
RST instruction	Holds the state.
TM instruction	Clocking is not performed. Note that the time cannot be guaranteed if clocking is not performed once during a scan.
CT instruction	Holds the current progress.
SR instruction	Holds the current progress.
Differential instruction	The same as when a differential instruction is used between MC and MCE.
Other instructions	Not executed.

■ Flag operations

Name	Description
R9007 R9008 (ER)	Turns ON when the CALL instruction is executed in the 10th layer of a subroutine when 10-layer nesting is being performed

7 Interrupt Instructions

7.1 INT/IRET (Interrupt / Interrupt Return).....	7-2
7.2 ICTL (Interrupt Control).....	7-8
7.2.1 How to start the interrupt program when executing the high-speed counter match ON / match OFF instruction	7-15

7.1 INT/IRET (Interrupt / Interrupt Return)

7.1 INT/IRET (Interrupt / Interrupt Return)

■ Instruction format

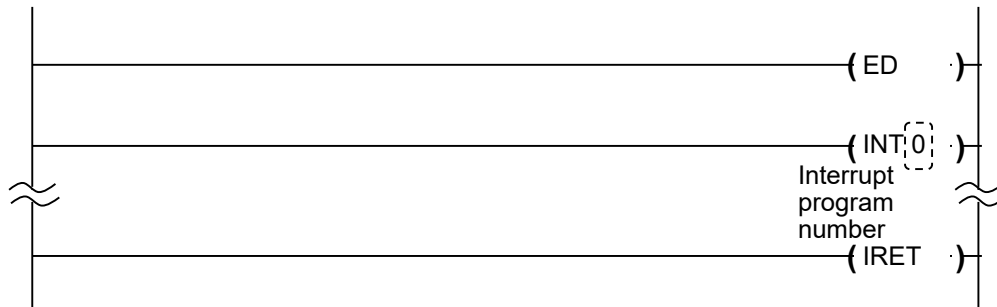

■ Outline of operation

- When an interrupt is input, the interrupt program of the number specified is executed starting from the **INT** instruction.
- When the interrupt program reaches the **IRET** instruction, the program returns to the address where the interrupt occurred and the main program resumes.

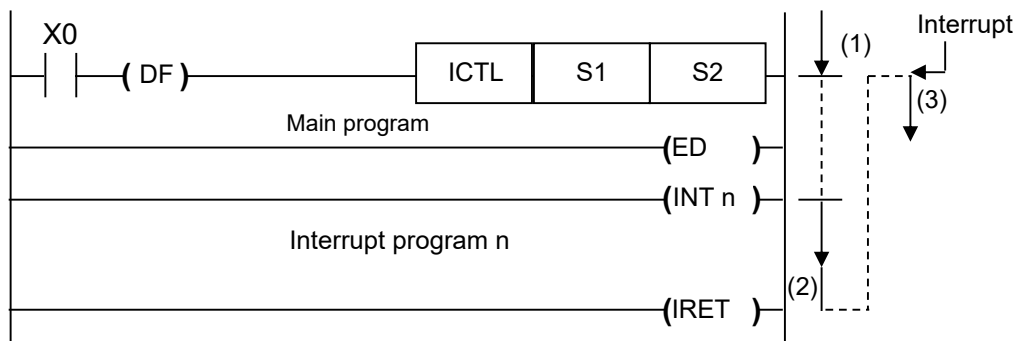

When an interrupt occurs, execution will occur in the order of (1) to (3).

■ Interrupt Program Syntax

- The interrupt program is the program between the **INT n** instruction and the **IRET** instruction. The interrupt program must always be placed in an address after the **ED** instruction.
- The number of the interrupt program is determined by the type of interrupt.

Interrupt program number	Interrupt input	High-speed counter target value match interrupt
INT0	X0	ch0
INT1	X1	ch1
INT2	X2	-
INT3	X3	ch2
INT4	X4	ch3
INT5	X5	-

Interrupt program number	Interrupt input	High-speed counter target value match interrupt
INT6	X6	-
INT7	X7	-
INT8	-	-
INT9	-	-
INT10	-	-
INT11	-	-
INT12	-	-
INT13	-	-
INT24	Periodic interrupt	-

(Note 1) When using a high-speed counter target value match interrupt program, the counting performance of the high-speed counter may decrease upon initiation of the interrupt program.

■ Before inputting an interrupt program

- Specify the contact to be used as the interrupt input.
Select the input contact to be used as the interrupt input and specify it in system register No. 403.

Note

- If the high-speed counter/pulse catch is set, that contact cannot be used as the interrupt input.
 - There is no need to specify the input contact for high-speed counter target value match interrupts and periodic interrupts.
- "Enable" execution of interrupt programs.
All interrupt programs are set to "execution disabled" as default. "Enable" interrupt programs to be executed using the **ICTL** instruction.

■ Precautions when rewriting during RUN

If the program is rewritten in "RUN mode", all interrupt programs will be set to "execution disabled", making it necessary to "enable" them after rewriting in RUN.

To automatically re-enable with a ladder program, use R9034 (rewrite during RUN completion flag). R9034 is a special relay that is ON for only 1 scan after completion of a rewrite during RUN.

■ Interrupt program execution

There are three types of interrupt.

- Interrupt from the input contact
An interrupt occurs from the input specified in system register No. 403.
- High-speed counter target value match interrupt
When executing a high-speed counter instruction, an interrupt occurs when the high-speed counter elapsed value equals the set target value.
- Periodic interrupt (INT24)
The interrupt occurs in fixed time intervals. The time interval is set with the **ICTL** instruction.

7.1 INT/IRET (Interrupt / Interrupt Return)

- If the interrupt occurs, the interrupt program with the corresponding number is executed.

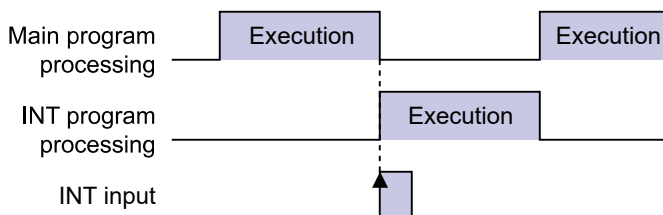

- If interrupts are disabled, they will be executed when execution is enabled with the **ICTL** instruction.

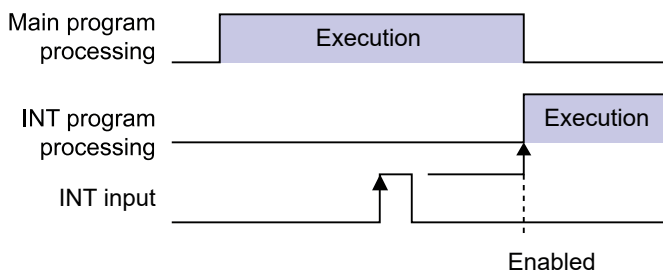

- If an interrupt occurs during execution of another interrupt program, it will be executed after the other program finishes.

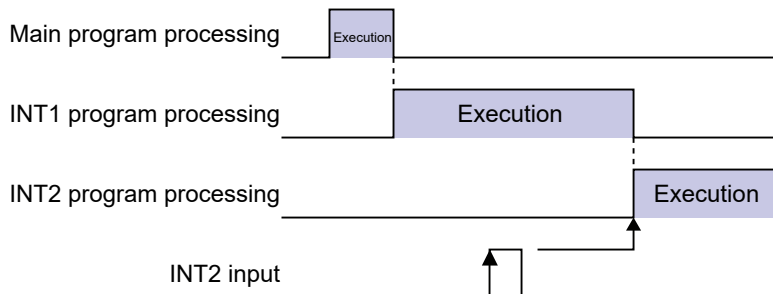

■ Precautions for programming

- A syntax error will occur if either the **INT** instruction or **IRET** instruction is missing.
- When an interrupt occurs, the operation memory corresponding to the interrupt input contact is not I/O refreshed. Therefore, contacts other than the interrupt input contact, such as the normally ON relay R9010, should be specified by the input conditions in the interrupt program.

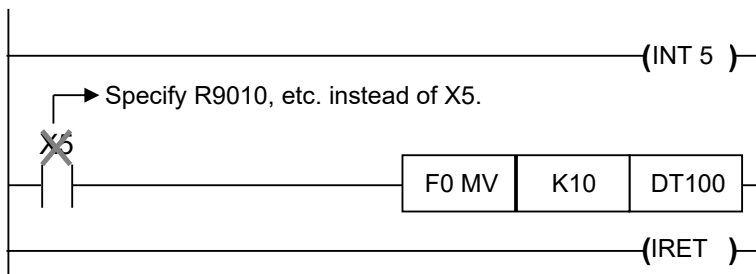

- A subroutine program cannot be used in an interrupt program.

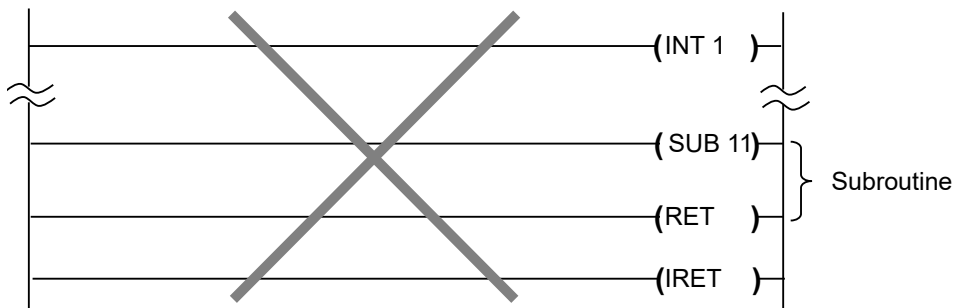

- An interrupt program cannot be used in a subroutine program.

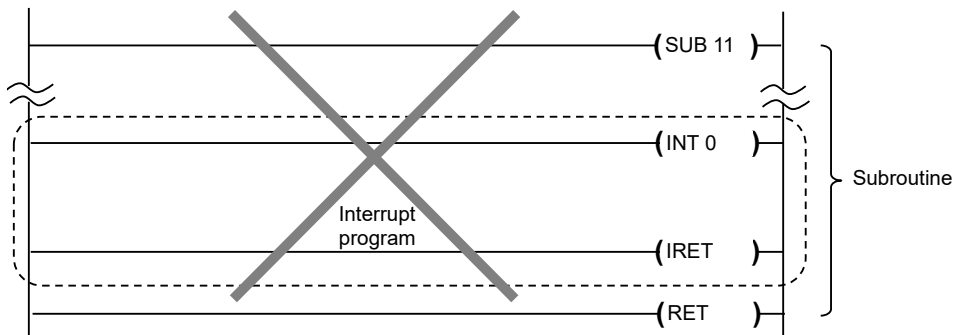

- Another interrupt program cannot be used in an interrupt program.

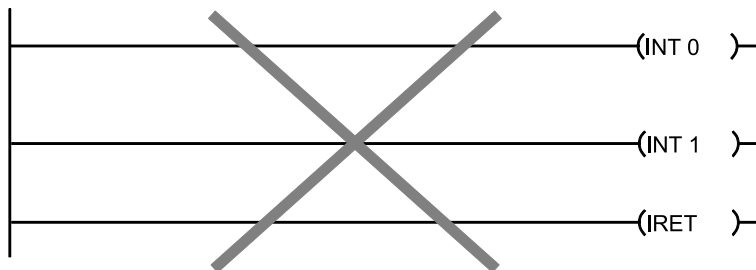

■ Control when multiple interrupts occur simultaneously

- When multiple interrupts occur simultaneously, the interrupt program with the smallest number is executed first. The other interrupt programs are then placed into an execution waiting state., After the first interrupt program is completed, the other programs will be executed in order from the smallest number.

7.1 INT/IRET (Interrupt / Interrupt Return)

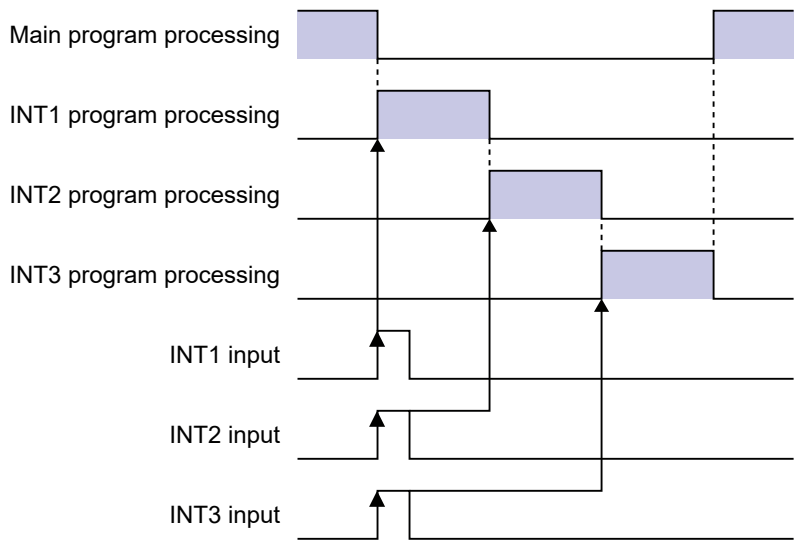

- When multiple interrupts occur during execution of an interrupt program, they will be executed in order from the smallest program number when the program has finished execution.

e.g.

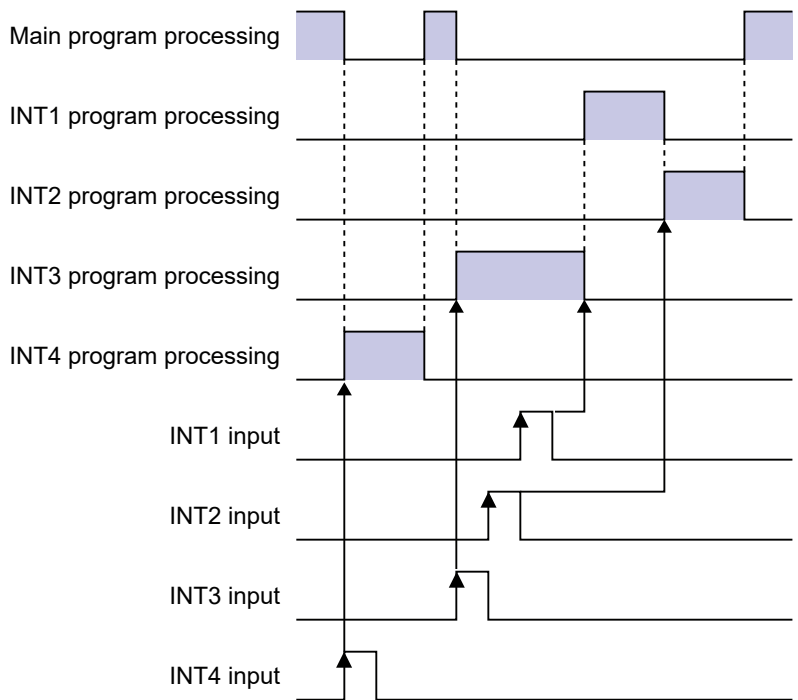

(Note 1) During execution of the INT3 program in the example above, INT1 will be executed before INT2, even if interrupt INT2 occurs before INT1.

■ Interrupt program execution waiting and clearing

- When multiple interrupts occur simultaneously or when a new interrupt occurs during execution of another interrupt program, the interrupts of lower priority will enter an "execution wait state". They will be executed in order when the other interrupt program finishes execution.

e.g.

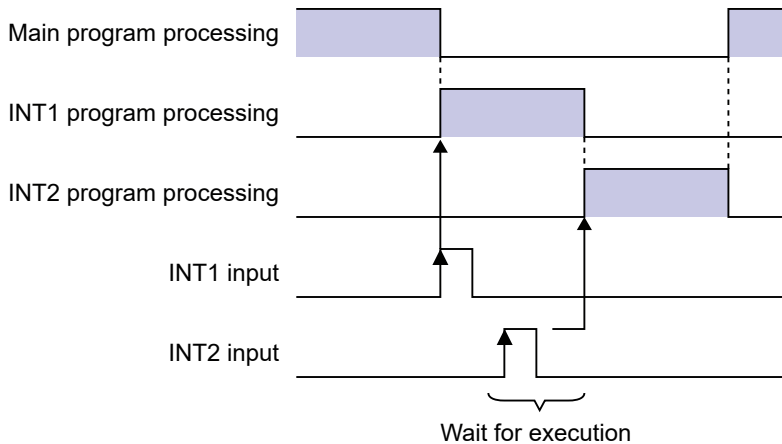

- If placed in execution wait state, there is a time difference between the occurrence of the interrupt and execution of the interrupt program. To avoid execution of these execution wait state programs, clear them using the **ICTL** instruction. Cleared interrupt programs will not be executed.

e.g.

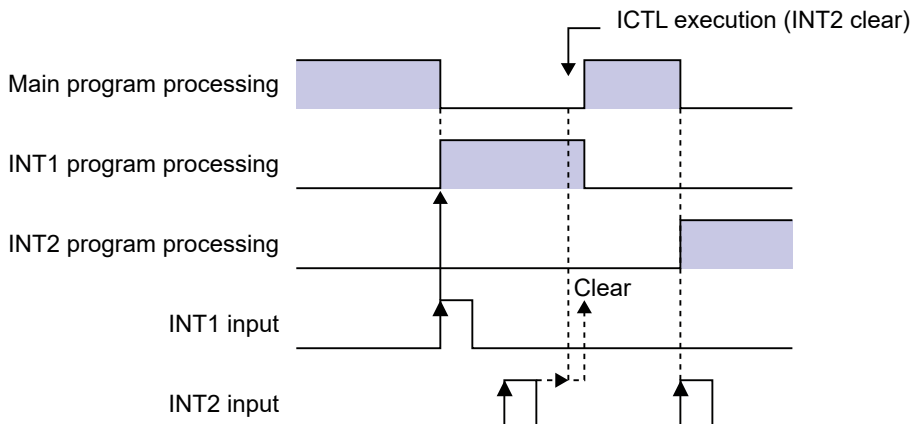

- Even when execution of interrupt programs is disabled with the **ICTL** instruction, if an interrupt occurs it will enter an "execution wait state". Waiting interrupt programs will be executed upon enabling execution with the **ICTL** instruction. As noted above, the interrupt programs in an execution wait state can be cleared by using the **ICTL** instruction.

7.2 ICTL (Interrupt Control)

7.2 ICTL (Interrupt Control)

■ Instruction format

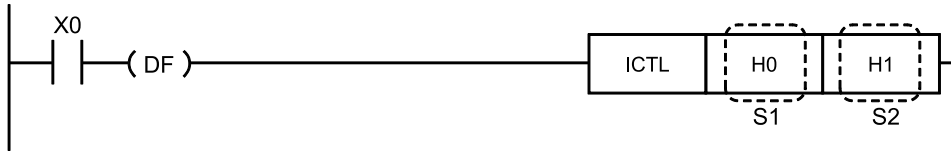

■ Operands

Items	Settings
S1	Area storing the control data, or constant data
S2	Area storing the control data, or constant data

■ Devices that can be specified (indicated by ●)

Operands	WX	WY	WR	WL	SV	EV	DT	LD	I	SWR	SDT	Constant				Index modifier	Integer Device
												K	H	M	f		
S1	●	●	●	●	●	●	●	●	●			●	●			●	
S2	●	●	●	●	●	●	●	●	●			●	●			●	

■ Outline of operation

- When the ICTL instruction is executed, based on the content of [S1] and [S2], either (1) enabling or disabling of the interrupt program is specified, or (2) clearing of the interrupt program is specified.
 - Perform differential execution using an instruction such as **DF** so that it is only executed once when setting.
 - Multiple ICTL instructions can be written consecutively for a single execution condition.
- Always execute this instruction before executing an interrupt program to enable interruption.

■ Precautions when rewriting during RUN

- If a rewrite during RUN is performed while using an interrupt function, the interrupt function will be disabled. It is necessary to re-enable execution of the interrupt program with an ICTL instruction.

e.g. A periodic interrupt every 10 ms is set at the start of operation (re-enables interrupt after rewriting during RUN.)

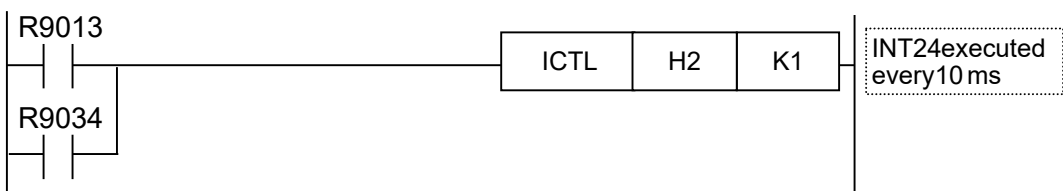

■ Description examples

Example 1) Setting a periodic interrupt every 10 ms at the start of operation

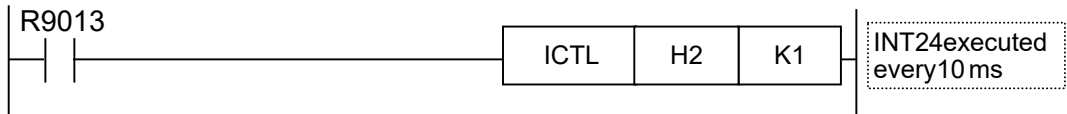

(Note 1) R9013 (initial pulse relay) is a relay that turns ON in only the first scan after execution begins.

Example 2) Enabling INT0 to 3 when X0 rises

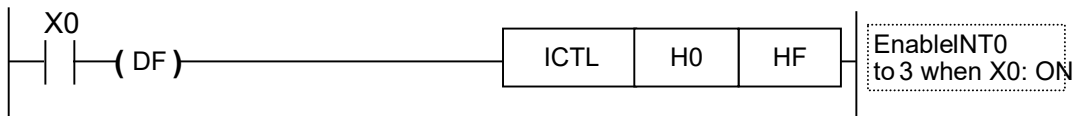

Example 3) Clearing interrupts other than INT0 when the INT0 program ends

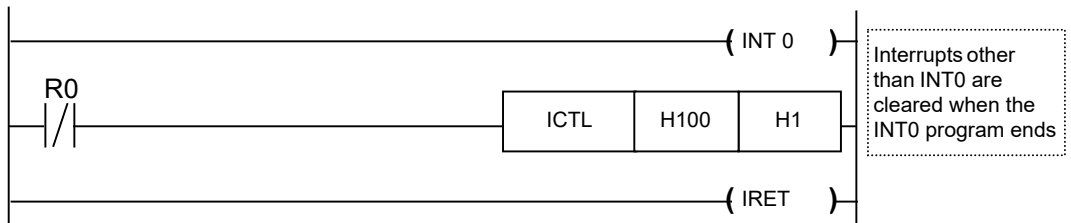

■ Specifying control data

[S1]: Specifies the type of interrupt and the function to be controlled

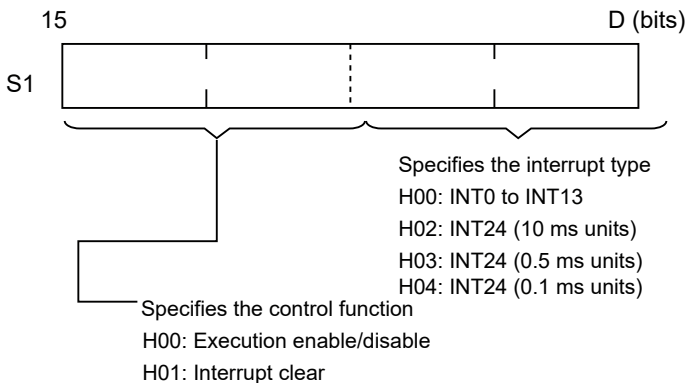

(1)	When specifying enable/disable execution of INT0 to 7	[S1] = H0
(2)	When specifying to clear interrupts for INT0 to 7	[S1] = H100
(3)	Time interval setting for INT24	[S1] = H2 (10 ms units) [S1] = H3 (0.5 ms units) [S1] = H4 (0.1 ms units)

7.2 ICTL (Interrupt Control)

■ Precautions for programming

Inputs that can actually be used as interrupt inputs. (Refer to the table below)

Interrupt program number	Interrupt input
INT0	X0
INT1	X1
INT2	X2
INT3	X3
INT4	X4
INT5	X5
INT6	X6
INT7	X7
INT8	-
INT9	-
INT10	-
INT11	-
INT12	-
INT13	-
INT24	Periodic interrupt

[S2]: Specifies the control content

- Specifying enable/disable execution of the interrupt program (when S1 = H0 or S1 = H1)
Set the control data to the bit corresponding to the interrupt program number you wish to control.
 - To enable execution, set the program number bit to "1"
 - To disable execution, set the program number bit to "0"

e.g. Enabling interrupt program INT1 and INT2, and disabling INT0 and INT3 to INT13

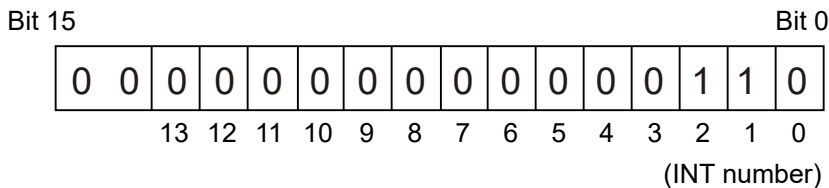

- Clear the interrupts (when S1 = H100)
Set the control data to the bit corresponding to the interrupt program number you wish to control.
 - Set the program number bits to be cleared to "0"
 - Set the program number bits not to be cleared to "1"

e.g. Clearing interrupt program INT0 to INT2, not clearing INT3 to IN13

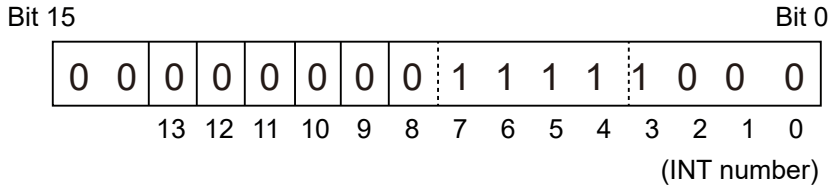

3. Specifying a periodic interrupt (when S1 = H2)

Specify the setting value with a decimal.

Time interval = value of [S2] × 10 (ms)

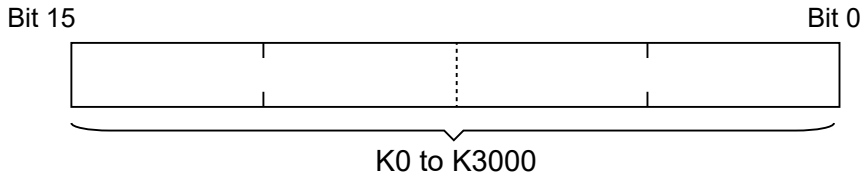

- Time interval setting is K1 to K3000 (10 ms to 30 s)
- Disable INT24 is K0

4. Specify a periodic interrupt (when S1 = H3)

Time interval = value of [S2] × 0.5 (ms)

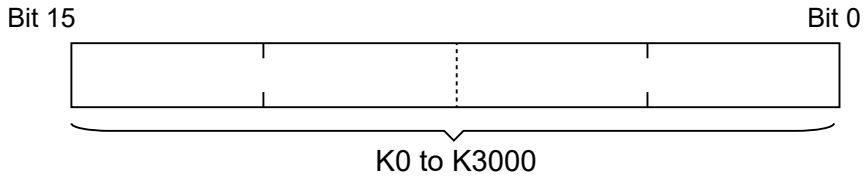

- Time interval setting is K1 to K3000 (0.5 ms to 1.5 s)
- Disable INT24 is K0

■ **Example setting to enable interrupt program execution**

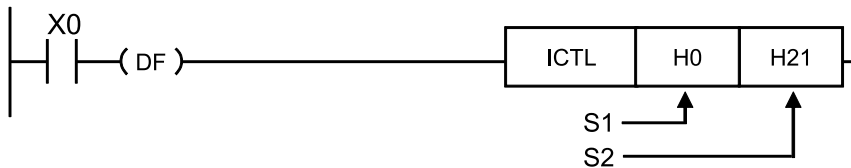

[S1]: H0000	Specifies enable/disable execution of interrupt programs corresponding to interrupts from a specified input contact or interrupts matching the target value
[S2]: H0021	Enable INT0 and INT5 (bits 0 and 5 are "1") and disable others

7.2 ICTL (Interrupt Control)

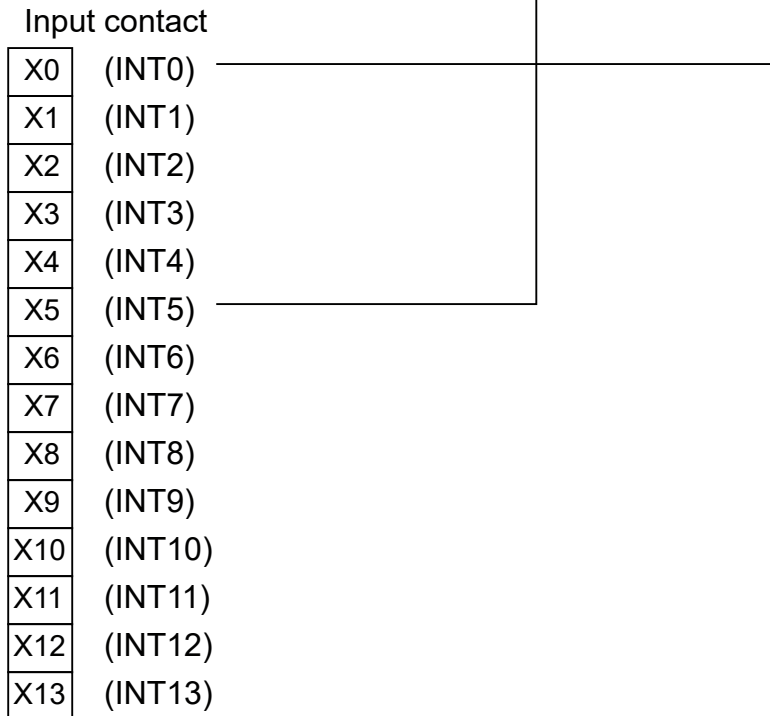
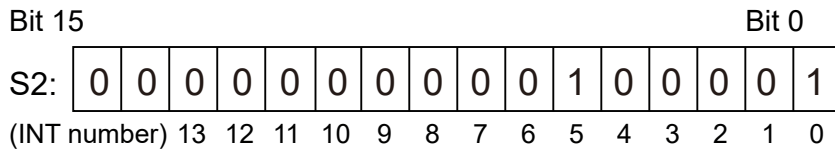

- Set the bits corresponding to the interrupts to be enabled to "1".

Description

If this ICTL instruction is executed, the No. 0 and No. 5 programs will be executed if the corresponding interrupt occurs.

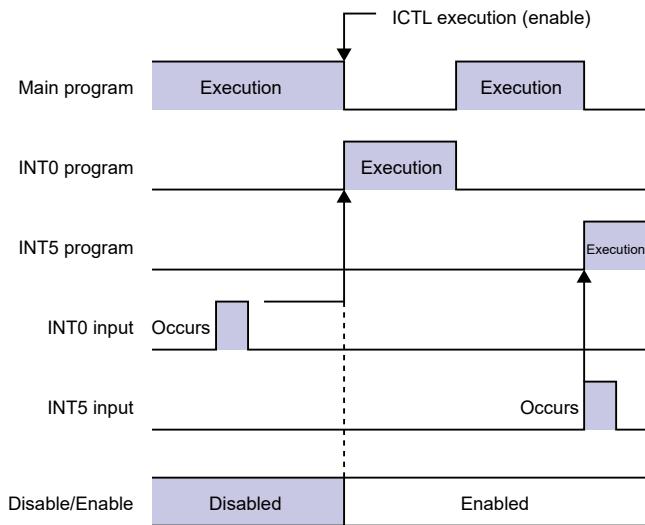

■ Example setting to clear interrupts

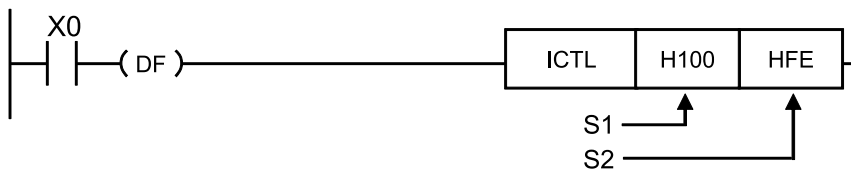

[S1]: H0100	Clears the interrupts from a specified input contact or interrupts matching the target value
[S2]: HFE	Clears INT0 interrupt (bit 0 is "0"), others are not cleared

(Note 1) Refer to the "Enable/Disable" example regarding the correspondence between setting values and interrupt input contacts.

Description

If in a state where an INT0 interrupt is occurring but the corresponding interrupt program is not being executed, executing this ICTL instruction will clear the interrupt.

7.2 ICTL (Interrupt Control)

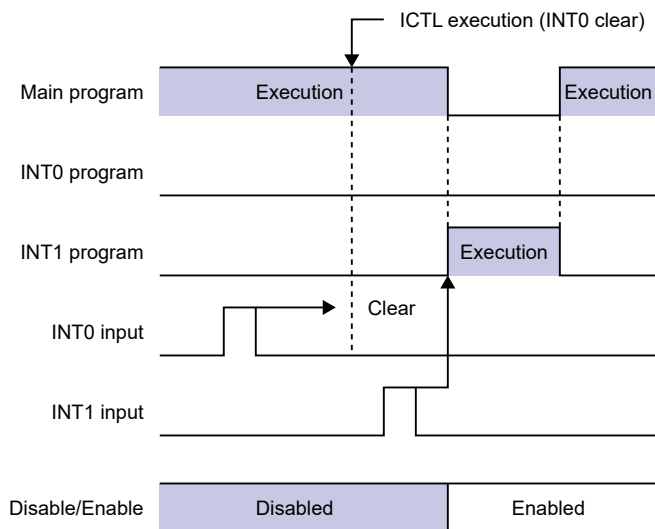

(Note 1) As INT0 has been cleared, it will not be executed even after being enabled. INT1 has not been cleared, so it will be executed after being enabled.

■ Example settings for periodic interrupt

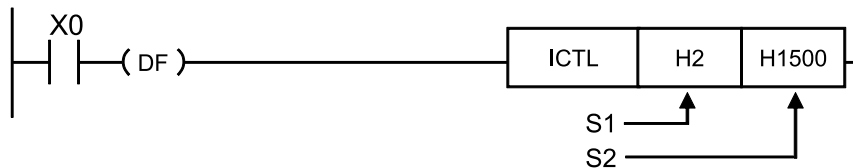

[S1]: H0002	Specifies a periodic interrupt
[S2]: K1500	Specifies the time interval of the periodic interrupt If K1500, the time interval is $K1500 \times 10 \text{ ms} = 15000 \text{ ms}$ (15 s)

Description

If this ICTL instruction is executed, a periodic interrupt will occur every 15 seconds and the INT24 interrupt program will be executed.

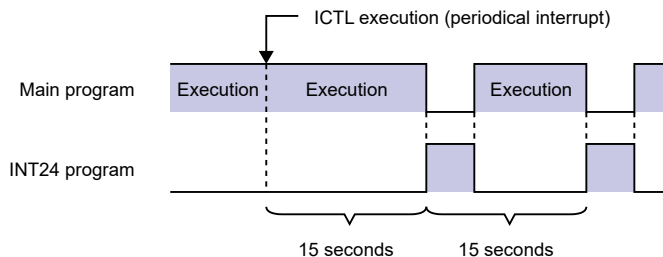

(Note 1) To stop the periodic interrupt, execute the following.

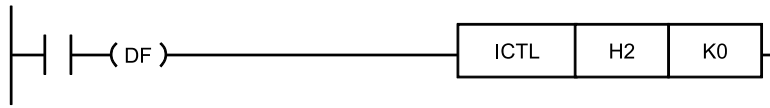

7.2.1 How to start the interrupt program when executing the high-speed counter match ON / match OFF instruction

1 2 Procedure

1. Set the counter via the system register. (It is not necessary to set the external interrupt.)
2. Specify the interrupt program in the program.

The high-speed counters correspond to the interrupt programs as indicated in the table below.

Interrupt program number	High-speed counter target value match interrupt
INT0	ch0
INT1	ch1
INT2	-
INT3	ch2
INT4	ch3
INT5	-
INT6	-
INT7	-
INT8	-
INT9	-
INT10	-
INT11	-
INT12	-
INT13	-

3. Enable the setting via the ICTL instruction. Enable ICTL H0, H9 - - INT0 and INT3.
4. Start the match ON / match OFF instruction.
5. The program is executed when the conditions for match ON / match OFF are met.

Note

- When using a high-speed counter target value match interrupt program, the counting performance of the high-speed counter may decrease upon initiation of the interrupt program.

(MEMO)

8 Special Setting Instructions

8.1 SYS1 (Communication Condition Setting).....	8-2
8.2 SYS1 (Password setting).....	8-8
8.3 SYS1 (Interrupt setting)	8-10
8.4 SYS1 [PC (PLC) Link Time Setting].....	8-12
8.5 SYS1 (MEWTOCOL-COM response control).....	8-14
8.6 SYS1 (Change high-speed counter operation mode).....	8-16
8.7 SYS2 [System Register (No.40 to No.48, No.50 to 57) Change]	8-18

8.1 SYS1 (Communication Condition Setting)

8.1 SYS1 (Communication Condition Setting)

■ Instruction format

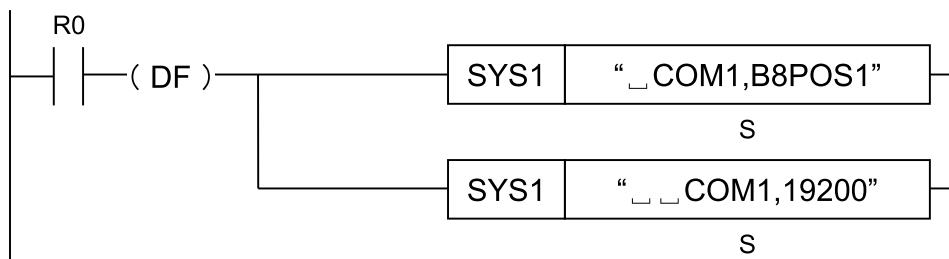

(Note 1) In the example shown in the figure above, the transmission format and baud rate of the COM1 port are set as below.

Character bit length: 8; Parity bit: Odd parity; Stop bit: 1

Baud rate: 19200 bps

■ Operands

Items	Settings
S	Character constant

■ Devices that can be specified (indicated by ●)

Operand s	WX	WY	WR	WL	SV	EV	DT	LD	I	SWR	SDT	Constant			Index modifier (Note 1)
												K	H	M	
S														●	

(Note 1) A character constant cannot be specified.

■ Outline of operation

- This instruction changes the communication conditions of the port specified as the first keyword to the contents specified as the second keyword.
- The following functions can be changed.
 - Transmission format
 - Baud rate
 - Unit number setting (direct / indirect)
 - COM response control
 - Header and terminator
 - End time
 - RS (Request to Send) control

■ Precautions on programming

- Enclose the first and second keywords in double quotation marks ("").
- Separate the first keyword and second keyword with a comma (,) without inserting a space.

8.1 SYS1 (Communication Condition Setting)

- Insert space characters in front of the first keyword so that the total number of characters of the first and second keywords is 12. (The number of space characters to be inserted in front of the first keyword is 12 minus the total number of characters to be entered for the keywords.)

For FPWIN-GR7 Ver.2.23 or later, if the character constant consists of less than 12 characters, space characters will be automatically input (to compensate for the shortage of characters) when the project is converted.

Example: When entering COM1 as the first keyword and 19200 as the second keyword

Specified contents	“	_	_	C	O	M	1	,	1	9	2	0	0	”
No. of characters		1	2	3	4	5	6	7	8	9	10	11	12	

- Even if this instruction is executed, the contents of the system ROM in the main unit will not be rewritten. Therefore, when the power is turned OFF and then ON, the contents of the system ROM is rewritten with the contents of the system register specified in FPWIN GR7.
- We recommend that this instruction be executed as a differentiated instruction.
- Because the system register settings are changed, a verification error may occur when verification is performed with FPWIN GR7.

■ Specifying the communication conditions (transmission format)

- Specify transmission format (data length, parity check, and stop bit).

First keyword	Second keyword		
Ports to be used	Data length	Parity check	Stop bit
COM0: COM0 port COM1: COM1 port COM2: COM2 port TOOL: COM0 port	B7: 7 bits B8: 8 bits	PN: No parity PO: Odd parity PE: Even parity	S1: 1 S2: 2

Setting examples

Example 1	S	“_COM0,B7PNS1”
Settings	Port: COM0 / Data length: 7 bits / Parity check: None / Stop bit: 1	
Example 2	S	“_COM1,B8PES2”
Settings	Port: COM1 / Data length: 8 bits / Parity check: Even parity / Stop bit: 2	
Example 3	S	“_COM2,B8POS1”
Settings	Port: COM2 / Data length: 8 bits / Parity check: Odd parity / Stop bit: 1	

■ Specifying the communication conditions (baud rate)

- Specify a baud rate.

First keyword	Second keyword		
Ports to be used	Baud rate		
COM0: COM0 port COM1: COM1 port	1200: 1200 bps 2400: 2400 bps	19200: 19200 bps 38400: 38400 bps	230400: 230400 bps

8.1 SYS1 (Communication Condition Setting)

First keyword	Second keyword
Ports to be used	Baud rate
COM2: COM2 port TOOL: COM0 port	4800: 4800 bps 57600: 57600 bps 9600: 9600 bps 115200: 115200 bps

(Note 1) If the baud rate is changed as below, communications passing through all COM ports will be reset.
Baud rates of all COM ports: 4800 bps or higher ↔ Baud rate of any of the COM ports: 2400 bps or lower

(Note 2) If the baud rate of any of the COM ports is 2400 bps or lower, F-ROM access will slow down.
Example) F12(ICRD) instruction, P13(ICWT) instruction, etc.

Setting example

Example 1	S	"_COM0,19200"
Settings	Port: COM0 / 19200 bps	
Example 2	S	"_COM1,1200"
Settings	Port: COM1 / 1200 bps	
Example 3	S	"_COM2,115200"
Settings	Port: COM2 / 115200 bps	

■ Specifying the communication conditions (unit number)

- Specify a unit number directly or indirectly.

First keyword	Second keyword	
Ports to be used	Unit number (for direct specification)	Unit number (for indirect specification)
COM0: COM0 port COM1: COM1 port COM2: COM2 port TOOL: COM0 port	No1 to No99: Unit numbers 1 to 99	For a DT number that contains a unit number, specify D followed by a four-digit number, as below. D0000 to D9999: DT0 to DT9999

(Note 1) For direct specification of unit numbers, you can specify unit numbers 1 to 99. For indirect specification of unit numbers, specify a DT number that contains a unit number.

Setting example

Example 1	S	"_COM0,No1"
Settings	(For direct specification of unit numbers) Port: COM0 / Unit number: No1	
Example 2	S	"_COM1,No99"
Settings	(For direct specification of unit numbers) Port: COM1 / Unit number: No99	
Example 3	S	"COM0No,D0000"
Settings	(For indirect specification of unit numbers) Port: COM0 / Unit number: Value set in DT0	

8.1 SYS1 (Communication Condition Setting)

Example 4	S	"COM2No,D0123"
Settings	(For indirect specification of unit numbers) Port: COM2 / Unit number: Value set in DT0123	

■ Specifying the communication conditions (response time of COM port)

- Specify the response time of a COM port.

First keyword	Second keyword
Ports to be used	Response time
COM0: COM0 port COM1: COM1 port COM2: COM2 port TOOL: COM0 port	WAIT0 to WAIT999 (n=0 to 999) [When the communication mode is computer link or MODBUS RTU] Set time = Scan time x n [When the communication mode is PLC link] Set time = n μs

Setting examples

Example 1	S	"_COM0,WAIT1"
Settings	Port: COM0 [When the communication mode computer link or MODBUS RTU] Scan time x 1 [When the communication mode is PLC link] 1 μs	
Example 2	S	"COM1,WAIT999"
Settings	Port: COM1 [When the communication mode is computer link or MODBUS RTU] Scan time x 999 [When the communication mode is PLC link] 999 μs	

■ Specifying the communication conditions (header / terminator)

- Specify a header or terminator.

First keyword	Second keyword	
Ports to be used	For header	For terminator
COM0: COM0 port COM1: COM1 port COM2: COM2 port TOOL: COM0 port	STX: With STX NOSTX: Without STX	ETX: ETX CR: CR CRLF: CR + LF NOTERM: No terminator TIME: Enables end time (Note 1)

(Note 1) The setting of TIME takes precedence over the settings of other terminators (EXT, CR, CRLF, and NOTERM).

Setting example

Example 1	S	"_COM0,STX"
Settings	Port: COM0 / Header: With STX	

8.1 SYS1 (Communication Condition Setting)

Example 2	S	"____COM1,ETX"
Settings	Port: COM1 / Terminator: ETX	
Example 3	S	"____COM1,CR"
Settings	Port: COM1 / Terminator: CR	
Example 4	S	"_COM2,NOTERM"
Settings	Port: COM2 / Terminator: No terminator	
Example 5	S	"____COM2,TIME"
Settings	Port: COM2 / Terminator: Enables end time	

■ Specifying the communication conditions (end time)

- Specify an end time.

First keyword	Second keyword
Ports to be used	End time
COM0: COM0 port COM1: COM1 port COM2: COM2 port TOOL: COM0 port	Specify an end time in 0.01 ms increments between 0.01 and 100 ms. T0 to T10000: 0.01ms to 100ms

Setting examples

Example 1	S	"____COM0,T0"
Settings	Port: COM0 / End time: Transfer time for approx. 4 bytes of data	
Example 2	S	"_COM1,T123"
Settings	Port: COM1 / End time: 1.23 ms	
Example 3	S	"_COM2,T10000"
Settings	Port: COM2 / End time: 100 ms	

■ Specifying the communication conditions (RS (Request to Send) control)

- RS control can be performed for 1-channel RS-232C type communication cassettes.
- RS control can only be set for the COM1 port.

First keyword	Second keyword
Ports to be used	RS (Request to Send) control
COM1: COM1 port	RTS1: Disables communication (turns ON the RS terminal) RTS0: Enables communication (turns OFF the RS terminal)

Setting example

Example 1	S	"_COM1,RTS1"
Settings	Port: COM1 / RS (Request to Send) control: Disables communication	
Example 2	S	"_COM1,RTS0"
Settings	Port: COM1 / RS (Request to Send) control: Enables communication	

■ Flag operations

Name	Description
R9007 R9008 (ER)	Set when non-keyword text or an out-of-range value is specified for the first and second keywords.
	Set when there is no comma between the first and second keywords.
	Set if no communication cassette is mounted when COM1 or COM2 is specified.
	Set if the baud rate or transmission format for COM1 is changed when COM1 is in PLC link mode.
	Set if the baud rate or transmission format is changed while the modem for the COM0, COM1, or COM2 port is being initialized.
	Set if the communication mode is set to any mode other than general-purpose communication mode when a header or terminator is set.
	Set if any communication cassette other than 1-channel RS-232C type communication cassettes is mounted when RS control is performed.
	Set if a unit number greater than the maximum unit number set in the system register is specified when COM1 is in PLC link mode.
Set if the communication speed is changed as below while F-ROM is being accessed. Baud rates of all COM ports: 4800 bps or higher ↔ Baud rate of any of the COM ports: 2400 bps or lower	

8.2 SYS1 (Password setting)

8.2 SYS1 (Password setting)

■ Instruction format

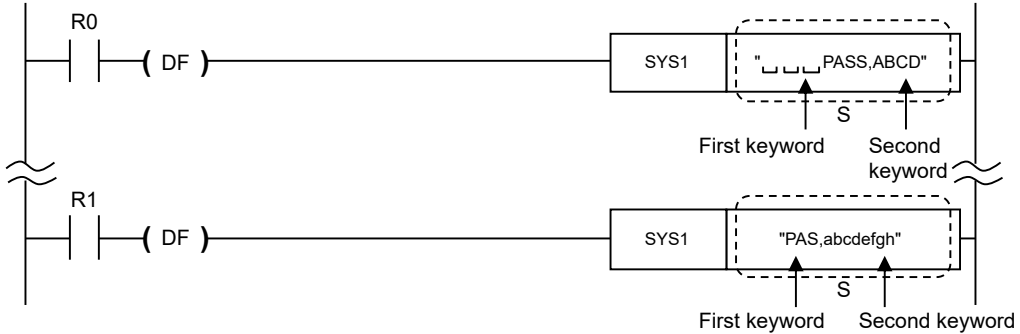

■ Operands

Items	Settings
S	Character constant

■ Devices that can be specified (indicated by ●)

Operands	WX	WY	WR	WL	SV	EV	DT	LD	I	SWR	SDT	Constant				Index modifier	Integer Device
											K	H	M	f			
S														●			

■ Outline of operation

The password specified for the controller is changed to the contents specified by the No. 2 keyword.

■ Operation example

Operation of instruction format description program

When R0 turns ON, the controller password is changed to "ABCD".

■ Specify keywords

- For a 4-digit password

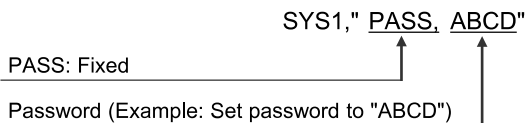

- For an 8-digit password

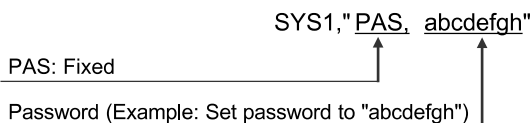

If there are fewer than eight characters, spaces are automatically added at the end to make eight characters.

■ Precautions for programming

- When this instruction is executed, it takes approximately 100 ms to write to the built-in F-ROM.
- If the specified password is the same as the password that has already been written, the password is not written to the F-ROM.
- It is recommended to use differential execution for this instruction.
- Put (12 characters – number of input characters) spaces in front of Keyword 1 so that Keyword 1 and Keyword 2 combined have 12 characters. In FPWIN GR7 Ver. 2.23 and later, if the character constant does not reach 12 characters, spaces are automatically input when the project is converted.

■ Flag operations

Name	Description
R9007	Turns ON when a character other than a keyword is specified
R9008	Turns ON when there is no comma between Keyword 1 and Keyword 2
(ER)	Turns ON when the keyword is specified in lower-case characters (for a 4-digit password)
	Turns ON when the data specified for the password specifies characters other than 0 to 9 and A to F, or the specified data consists of other than four digits (for a 4-digit password)

8.3 SYS1 (Interrupt setting)

8.3 SYS1 (Interrupt setting)

■ Instruction format

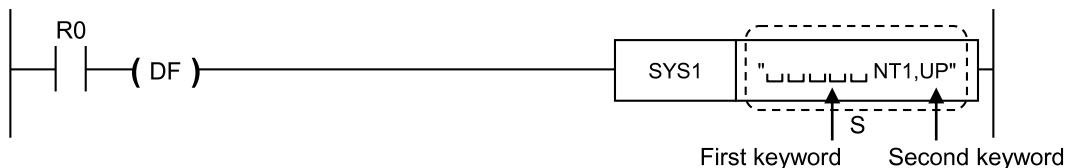

■ Operands

Items	Settings
S	Character constant

■ Devices that can be specified (indicated by ●)

Operands	WX	WY	WR	WL	SV	EV	DT	LD	I	SWR	SDT	Constant				Index modifier	Integer Device
												K	H	M	f		
S														●			

■ Outline of operation

The input specified by the No. 1 keyword is set as the interrupt input, and the input conditions are changed to the contents specified by the No. 2 keyword.

■ Operation example

Operation of instruction format description program

When R0 turns ON, input X1 is set to the interrupt input that becomes valid at the rising edge.

■ Specify keywords

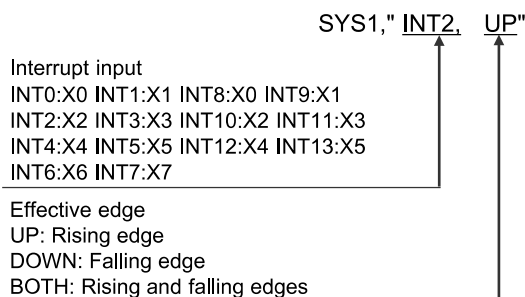

■ Precautions for programming

- Executing this instruction does not rewrite the contents of the system ROM of the main unit. As a result, turning the power supply OFF and then ON again rewrites the contents of the system registers specified by the programming tool software.
- It is recommended to use differential execution for this instruction.
- When UP or DOWN has been specified, the contents of the system registers change in accordance with the specification, meaning a verification error may occur in some cases

when the program is verified. When BOTH has been specified, the contents of the system registers do not change.

- Put (12 characters – number of input characters) spaces in front of Keyword 1 so that Keyword 1 and Keyword 2 combined have 12 characters. In FPWIN GR7 Ver. 2.23 and later, if the character constant does not reach 12 characters, spaces are automatically input when the project is converted.

■ Flag operations

Name	Description
R9007	Turns ON when a character other than a keyword is specified
R9008	Turns ON when there is no comma between Keyword 1 and Keyword 2
(ER)	Turns ON when the keyword is specified in lower-case alphabet characters

8.4 SYS1 [PC (PLC) Link Time Setting]

■ **Instruction format**

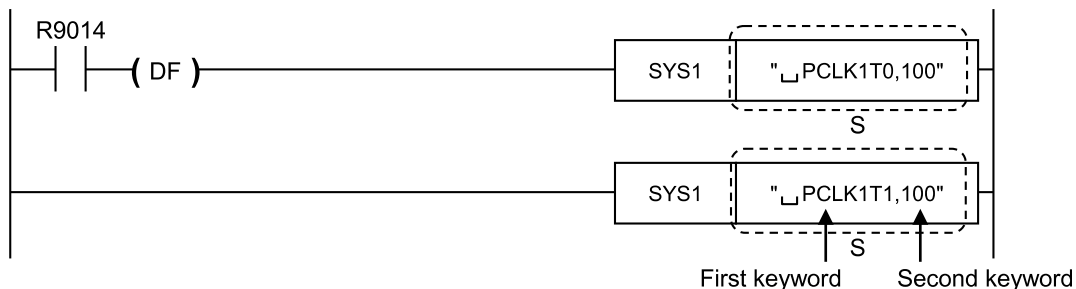

■ **Operands**

Items	Settings
S	Character constant

■ **Devices that can be specified (indicated by ●)**

Operands	WX	WY	WR	WL	SV	EV	DT	LD	I	SWR	SDT	Constant				Index modifier	Integer Device
												K	H	M	f		
S															●		

■ **Outline of operation**

- Set the condition specified by Keyword 1 as the time specified by Keyword 2.
- The setting for the link entry waiting time is set if the transmission cycle time is shortened when there are stations that have not joined the link (*).
*Stations that have not joined the link: stations that have not been connected between the No. 1 station and the station with the largest number, or stations for which the power supply has not been turned on
- The error detection time setting for the transmission assurance relay is set if the time between the power supply being turned OFF at one station and the transmission assurance relay from the powered-OFF station being turned OFF at a different station is to be shortened.

■ **Operation example**

Operation of instruction format description program

During PC (PLC) link, when R9014 turns ON (at leading edge), the link entry waiting time and error detection time for the transmission assurance relay are set as follows.

Link entry waiting time: 100 ms

Transmission assurance relay error detection time: 100 ms

■ **Specify Keywords**

1. Link entry waiting time

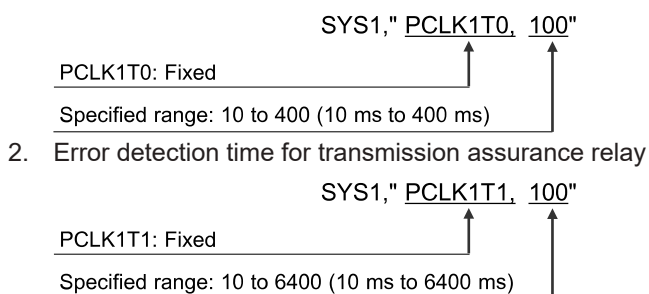

■ Precautions for programming

- The program should be placed at the beginning of all PLCs being linked, and the same values should be set.
- This instruction should be specified with special internal relay R9014 as the differential execution condition.
- Execution of this instruction does not affect the system register setting contents.
- Put a (12 characters – number of input characters) space in front of Keyword 1 so that Keyword 1 and Keyword 2 combined have 12 characters. In FPWIN GR7 Ver. 2.23 and later, if the character constant does not reach 12 characters, spaces are automatically input when the project is converted.

■ Precautions when setting the link entry waiting time

- This should be set to be at least twice that of the largest scan time of each PLC to be linked.
- If set to a shorter value, there may be some PLCs that are not be able to join the link, even if they are powered on.
- If there are any stations that have not joined the link, the settings should not be changed, especially if there are no problems, even if the link transmission cycle time is longer as a result. (The default value is 400 ms.)

■ Precautions when setting the error detection time for the transmission assurance relay

- This should be set to be at least twice that of the largest transmission cycle time when all PLCs are linked.
- If set to a shorter value, there is a possibility that the transmission assurance relay will malfunction.
- The settings should not be changed, especially if there are no problems, even if the transmission assurance relay detection time is longer as a result. (The default value is 6400 ms.)

■ Flag operations

Name	Description
R9007 R9008 (ER)	Turns ON when a character other than a keyword is specified
	Turns ON when there is no comma between Keyword 1 and Keyword 2
	Turns ON when the keyword is specified in lower-case alphabet characters
	Turns ON when a value outside the specified range is specified

8.5 SYS1 (MEWTOCOL-COM response control)

8.5 SYS1 (MEWTOCOL-COM response control)

■ Instruction format

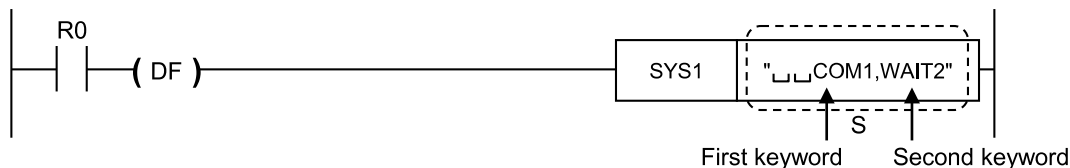

■ Operands

Items	Settings
S	Character constant

■ Devices that can be specified (indicated by ●)

Operands	WX	WY	WR	WL	SV	EV	DT	LD	I	SWR	SDT	Constant				Index modifier	Integer Device
												K	H	M	f		
S														●			

■ Outline of operation

- The MEWTOCOL-COM response time of the port specified by the No. 1 keyword is delayed based on the contents specified by the No. 2 keyword.
- This instruction is used to delay the response time on the PLC side until a state is reached in which commands can be sent by an external device and responses can be received from the PLC.

Usage example:

When a commercial RS232C/RS485 converter is being used to carry out communication between a computer and the PLC, this instruction is used to return the PLC response after switching of the enable signal has been completed on the converter side.

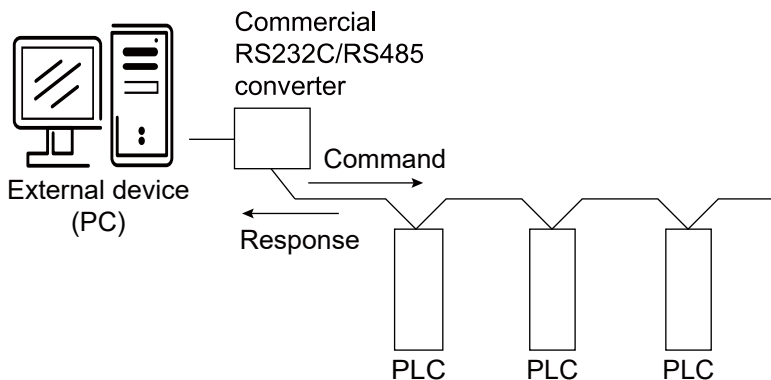

■ Specify keywords

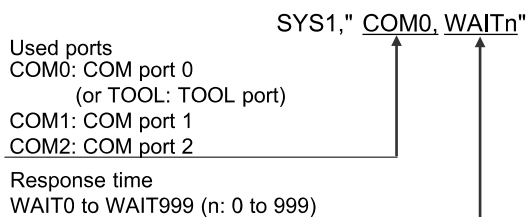

- If the communication mode has been set to computer link mode or MODBUS RTU mode
 Set time = scan time x n (n: 0 to 999)
- If the communication mode has been set to PC (PLC) link mode
 Set time = n μs (n: 0 to 999)
- If n = 0, the delay time set by this instruction will be set to "None".

■ Precautions for programming

Because PC (PLC) links may become unstable, do not change settings unless absolutely necessary.

- This instruction is valid only if the setting on the controller side has been set to computer link mode or PC (PLC) link mode.
- Set all the PLCs to be linked to the same value so that execution occurs at the rise of R9014 at the beginning of the program.
- Executing this instruction does not change the settings in the system registers.
- If the settings are changed, set to approximately double or more.
- It is recommended to use differential execution for this instruction.
- When the power supply to the PLC turns OFF, the settings set by this instruction are cleared. (The set value becomes 0.)

However, the settings will be retained if the mode is switched to "PROG. mode" after this instruction has been executed.

- If a commercial RS232C/RS485 converter is being used in PC (PLC) link mode, this instruction should be programmed in all of the connected stations (PLCs).
- Put (12 characters – number of input characters) spaces in front of Keyword 1 so that Keyword 1 and Keyword 2 combined have 12 characters. In FPWIN GR7 Ver. 2.23 and later, if the character constant does not reach 12 characters, spaces are automatically input when the project is converted.

■ Flag operations

Name	Description
R9007 R9008 (ER)	Turns ON when a character other than a keyword is specified
	Turns ON when there is no comma between Keyword 1 and Keyword 2
	Turns ON when the keyword is specified in lower-case alphabet characters
	Turns ON when no communication cassette has been installed when COM1 or COM2 has been set

8.6 SYS1 (Change high-speed counter operation mode)

8.6 SYS1 (Change high-speed counter operation mode)

■ Instruction format



■ Operands

Items	Settings
S	Character constant

■ Devices that can be specified (indicated by ●)

Operands	WX	WY	WR	WL	SV	EV	DT	LD	I	SWR	SDT	Constant				Index modifier	Integer Device
												K	H	M	f		
S														●			

■ Outline of operation

The high-speed counter operation mode specified by Keyword 1 is changed to the operation mode specified by Keyword 2. It is possible to switch between addition input and subtraction input.

■ Operation example

Operation of instruction format description program

When R0 turns ON, the operation mode of high-speed counter CH0 is set to addition mode.

■ Specify keywords

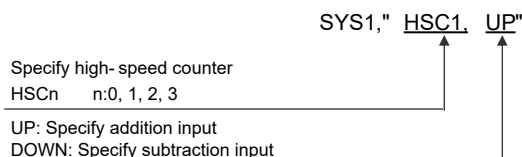

■ Precautions for programming

- With this instruction, if the high-speed counter system register setting is neither addition input nor subtraction input, an operation error is returned. Specify the system register setting to addition or subtraction in advance. Also, when addition input is specified, even if addition input is specified again, the setting remains addition input. This is the same when subtraction input is specified.
- Executing this instruction does not rewrite the contents of the system ROM of the main unit. As a result, turning the power supply OFF and then ON again rewrites the contents of the system registers specified by the programming tool software.
- It is recommended to use differential execution for this instruction.

8.6 SYS1 (Change high-speed counter operation mode)

- When UP or DOWN has been specified, the contents of the system registers change in accordance with the specification, meaning a verification error may occur in some cases when the program is verified. When BOTH has been specified, the contents of the system registers do not change.
- Put (12 characters – number of input characters) spaces in front of Keyword 1 so that Keyword 1 and Keyword 2 combined have 12 characters. In FPWIN GR7 Ver. 2.23 and later, if the character constant does not reach 12 characters, spaces are automatically input when the project is converted.

■ Flag operations

Name	Description
R9007 R9008 (ER)	Turns ON when a character other than a keyword is specified
	Turns ON when there is no comma between Keyword 1 and Keyword 2
	Turns ON when the keyword is specified in lower-case alphabet characters
	When the system register setting is something other than addition input or subtraction input

8.7 SYS2 [System Register (No.40 to No.48, No.50 to 57) Change]

8.7 SYS2 [System Register (No.40 to No.48, No.50 to 57) Change]

■ Instruction format

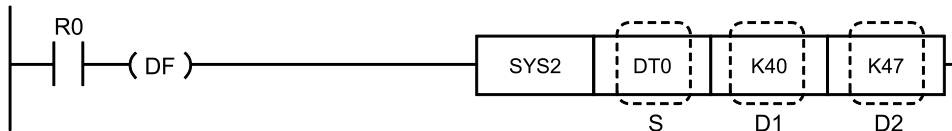

■ Operands

Items	Settings
S	Starting number of area storing 16-bit data
D1	Starting number of the system register to be specified (K40 to K47, K50 to K57)
D2	Ending number of the system register to be specified (K40 to K47, K50 to K57)

■ Devices that can be specified (indicated by ●)

Operands	WX	WY	WR	WL	SV	EV	DT	LD	I	SW R	SD T	Constant				Index modifier	Integer Device
												K	H	M	f		
S							●										
D1												●					
D2												●					

■ Outline of operation

The contents of system registers No. 40 to 48 and No. 50 to 57 are changed to the contents of the data register starting with [S].

■ System registers No. 40 to 48, No. 50 to 57

	No.	Name	Sett values/range
PC (PLC) W0-0 setting	40	Range used by link relay	0 to 64 words
	41	Range used by link register	0 to 128 words
	42	Link relay transmission starting No.	0 to 63
	43	Link relay transmission size	0 to 64 words
	44	Link register transmission starting No.	0 to 127
	45	Link register transmission size	0 to 127 words
	46	PC (PLC) link switch flag	0: Standard, 1: Reverse
	47	MEWNET-W0 PC (PLC) link maximum station number specification	1 to 16
	48	PLC link baud rate	0: 115200 bps 1: 230400 bps
PC (PLC)	50	Range used by link relay	0 to 64 words

8.7 SYS2 [System Register (No.40 to No.48, No.50 to 57) Change]

	No.	Name	Sett values/range
W0-1 setting	51	Range used by link register	0 to 128 words
	52	Link relay transmission starting No.	64 to 127
	53	Link relay transmission size	0 to 64 words
	54	Link register transmission starting No.	128 to 255
	55	Link register transmission size	0 to 127 words
	57	MEWNET-W0 PC (PLC) link maximum station number specification	1 to 16

■ Program example

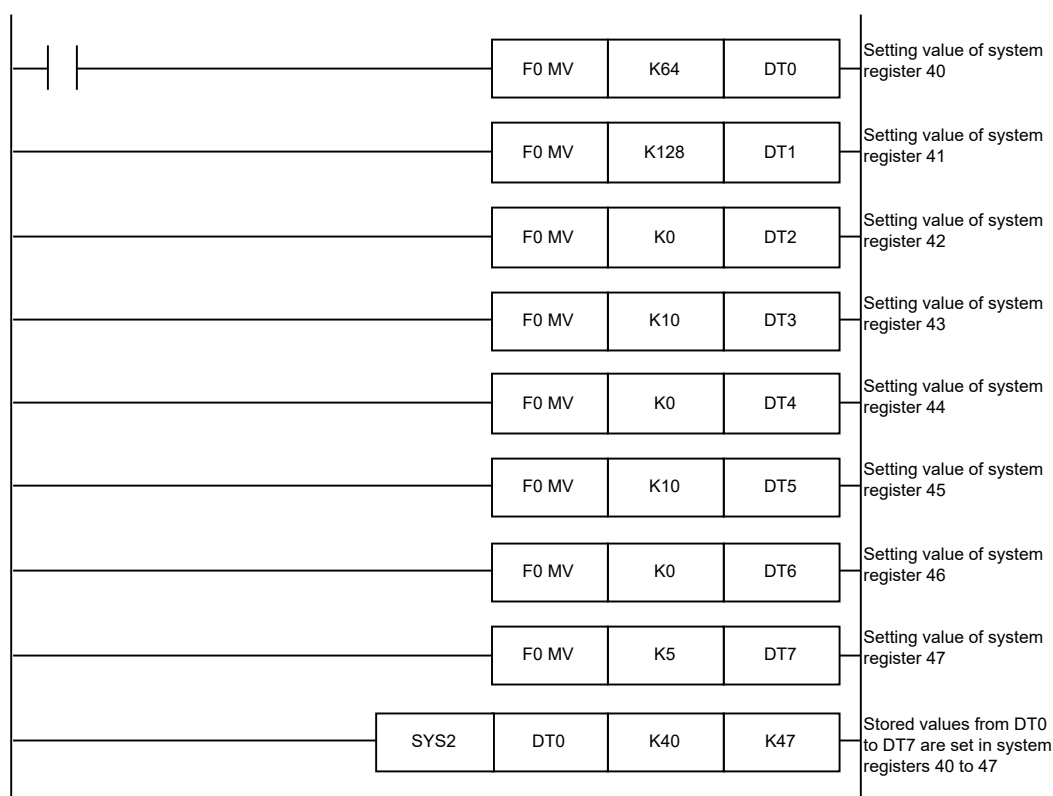

■ Precautions for programming

- Executing this instruction does not rewrite the contents of the system ROM of the main unit. As a result, when the power supply is turned OFF and ON again, the contents of the system registers set with the tool software are rewritten.
- Specify a value between K40 and K48 or between K50 and K57 for [D1] or [D2]. Ensure that D1 is less than or equal to D2.
- Since the value of the system register is changed, a verification error may occur during program verification.

8.7 SYS2 [System Register (No.40 to No.48, No.50 to 57) Change]

■ Flag operations

Name	Description
R9007	Turns ON when D1>D2
R9008 (ER)	Turns ON when a set value is outside the specified range of a system register setting value

9 Compare Contact Instructions

9.1 ST=, ST <>, ST>, ST>=, ST<, ST<= [16-Bit Data Comparison (Start)]	9-2
9.2 AN=, AN<>, AN>, AN>=, AN<, AN<= [16-bit data comparison (AND)]	9-4
9.3 OR= OR <> OR > OR >= OR < OR <= [16-bit data comparison (OR)]	9-6
9.4 STD=, STD<>, STD>, STD>=, STD<, STD<= [32-bit data comparison (start)]	9-8
9.5 AND=, AND<>, AND>, AND>=, AND<, AND<= [32-Bit Data Comparison (AND)].....	9-10
9.6 ORD=, ORD<>, ORD>, ORD>=, ORD<, ORD<= [32-Bit Data Comparison (OR)].....	9-12
9.7 STF=, STF<>, STF>, STF>=, STF< and STF<= [Floating point real number data comparison (start)].....	9-14
9.8 ANF=, ANF<>, ANF>, ANF>=, ANF<, ANF<= [Floating point real number data comparison (AND)]	9-16
9.9 ORF=, ORF<>, ORF>, ORF>=, ORF<, ORF<= [floating point real number data comparison (OR)]	9-18

9.1 ST=, ST <>, ST>, ST>=, ST<, ST<= [16-Bit Data Comparison (Start)]

9.1 ST=, ST <>, ST>, ST>=, ST<, ST<= [16-Bit Data Comparison (Start)]

■ Instruction format

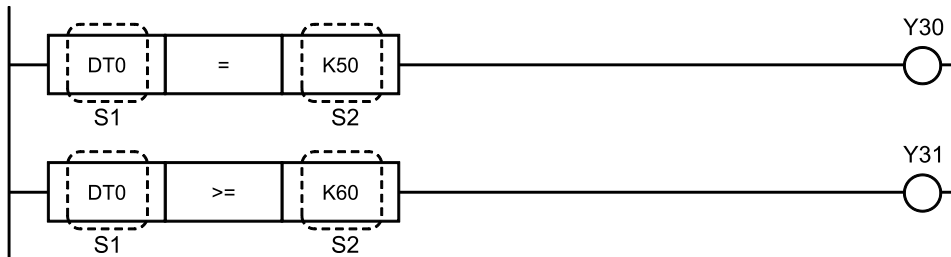

■ Operands

Items	Settings
S1	Comparison data 1: Number of area storing 16-bit data, or constant data
S2	Comparison data 2: Number of area storing 16-bit data, or constant data

■ Devices that can be specified (indicated by ●)

Operands	WX	WY	WR	WL	SV	EV	DT	LD	I	SWR	SDT	Constant				Index modifier	Integer Device
												K	H	M	f		
S1	●	●	●	●	●	●	●	●	●	●	●	●	●	●	●	●	
S2	●	●	●	●	●	●	●	●	●	●	●	●	●	●	●	●	

■ Outline of operation

- The signed 16-bit data specified by [S1] is compared with the signed 16-bit data specified by [S2].
- If the comparison results in one of the specified statuses (=, <, >, etc.), a logical operation is initiated with the contacts operating as liaison contacts.
- Comparison results and operations relate as follows.

Comparison instruction	Relationship between S1 and S2		
	S1 < S2	S1 = S2	S1 > S2
ST =	OFF	ON	OFF
ST <>	ON	OFF	ON
ST >	OFF	OFF	ON
ST >=	OFF	ON	ON
ST <	ON	OFF	OFF
ST <=	ON	ON	OFF

(Note 1) "<>" is displayed as "≠".
 ">=" is displayed as "≥".
 "<=" is displayed as "≤".

■ **Operation example**

Operation of instruction format description program

Compares the value of data register DT0 with K50. If DT0 = K50, external output Y30 turns ON.
Compares the value of DT0 with K60. If DT0 ≥ K60, Y31 turns ON.

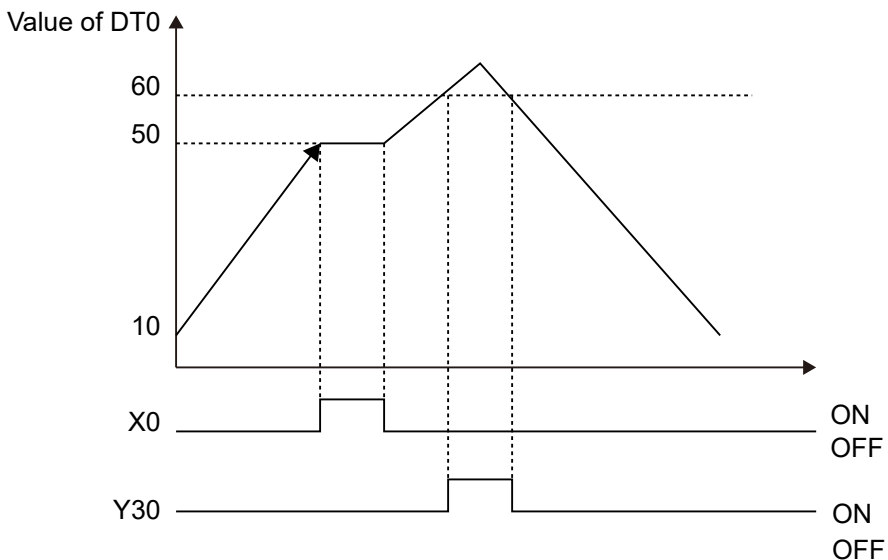

■ **Precautions for use**

- These instructions start from the bus bar.
- In the case of BCD data, etc., data is compared as a negative value if the most significant bit is 1, so the comparison results may not be accurate. In cases such as this, compare after converting the data to binary data by using an instruction such as F81 BIN.

■ **Flag operations**

Name	Description
R9007 R9008 (ER)	Turns ON when the area is exceeded in index modification.

9.2 AN=, AN<>, AN>, AN>=, AN<, AN<= [16-bit data comparison (AND)]

9.2 AN=, AN<>, AN>, AN>=, AN<, AN<= [16-bit data comparison (AND)]

■ Instruction format

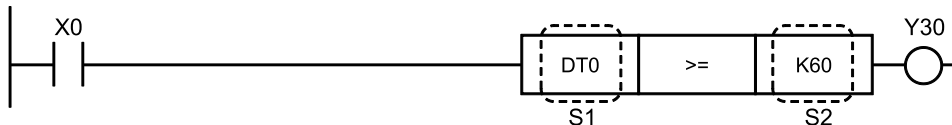

■ Operands

Items	Settings
S1	Comparison data 1: Number of area storing 16-bit data, or constant data
S2	Comparison data 2: Number of area storing 16-bit data, or constant data

■ Devices that can be specified (indicated by ●)

Operands	WX	WY	WR	WL	SV	EV	DT	LD	I	SWR	SDT	Constant				Index modifier	Integer Device
												K	H	M	f		
S1	●	●	●	●	●	●	●	●	●	●	●	●	●	●	●	●	
S2	●	●	●	●	●	●	●	●	●	●	●	●	●	●	●	●	

■ Outline of operation

- The signed 16-bit data specified by [S1] is compared with the signed 16-bit data specified by [S2].
- If the comparison results in one of the specified statuses (=, <, >, etc.), the contacts are connected in series as liaison contacts.
- Comparison results and operations relate as follows.

Comparison instruction	Relationship between S1 and S2		
	S1 < S2	S1 = S2	S1 > S2
AN=	OFF	ON	OFF
AN<>	ON	OFF	ON
AN>	OFF	OFF	ON
AN>=	OFF	ON	ON
AN<	ON	OFF	OFF
AN<=	ON	ON	OFF

(Note 1) "<>" is displayed as "≠".

">=" is displayed as "≥".

"<=" is displayed as "≤".

■ Operation example

Operation of instruction format description program

When internal relay X0 turns ON, the value of DT0 and K60 are compared, and if DT0 is equal to or greater than K60, the external output Y30 turns ON. If X0 is OFF or if DT0 is less than K60, Y30 turns OFF.

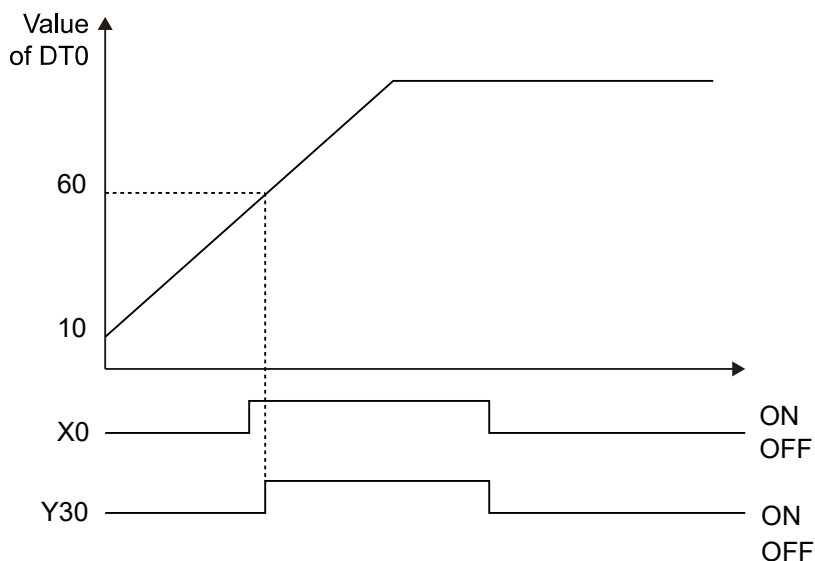

■ Precautions for use

- These instructions can be used consecutively.
- In the case of BCD data, etc., data is compared as a negative value if the most significant bit is 1, so the comparison results may not be accurate. In cases such as this, compare after converting the data to binary data by using an instruction such as F81 BIN.

■ Flag operations

Name	Description
R9007 R9008 (ER)	Turns ON when the area is exceeded in index modification.

9.3 OR= OR <> OR > OR >= OR < OR <= [16-bit data comparison (OR)]

9.3 OR= OR <> OR > OR >= OR < OR <= [16-bit data comparison (OR)]

■ Instruction format

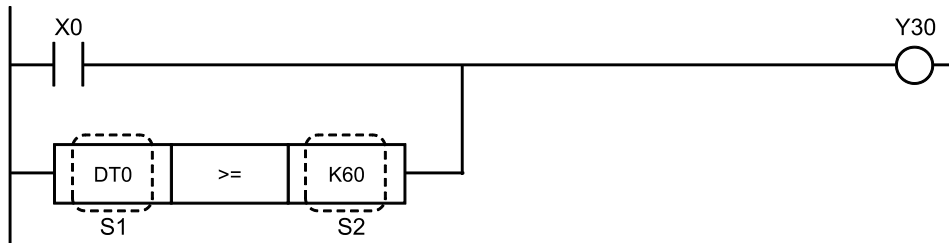

■ Operands

Items	Settings
S1	Comparison data 1: Number of area storing 16-bit data, or constant data
S2	Comparison data 2: Number of area storing 16-bit data, or constant data

■ Devices that can be specified (indicated by ●)

Operands	WX	WY	WR	WL	SV	EV	DT	LD	I	SWR	SDT	Constant				Index modifier	Integer Device
												K	H	M	f		
S1	●	●	●	●	●	●	●	●	●	●	●	●	●	●	●	●	
S2	●	●	●	●	●	●	●	●	●	●	●	●	●	●	●	●	

■ Outline of operation

- The signed 16-bit data specified by [S1] is compared with the signed 16-bit data specified by [S2].
- When comparison results are the specified status (=, <, >, etc.), a parallel connection occurs as the conductive contact.
- Comparison results and operations relate as follows.

Comparison instruction	Relationship between S1 and S2		
	S1 < S2	S1 = S2	S1 > S2
OR =	OFF	ON	OFF
OR <>	ON	OFF	ON
OR >	OFF	OFF	ON
OR >=	OFF	ON	ON
OR <	ON	OFF	OFF
OR <=	ON	ON	OFF

(Note 1) "<>" is displayed as "≠".

">=" is displayed as "≥".

"<=" is displayed as "≤".

■ **Operation example**

Operation of instruction format description program

When external input X0 turns ON, or the result of comparison between the value of DT0 and K60 is $DT0 \geq K60$, external output Y30 turns ON. If X0 is OFF and $DT0 < K60$, Y30 turns OFF.

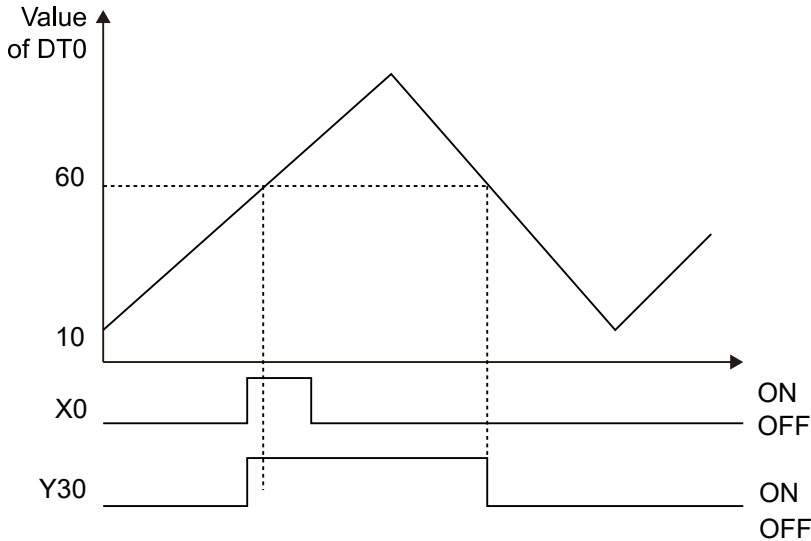

■ **Precautions for use**

- This instruction starts from the bus bar.
- These instructions can be used consecutively.
- In the case of BCD data, etc., data is compared as a negative value if the most significant bit is 1, so the comparison results may not be accurate. In cases such as this, compare after converting the data to binary data by using an instruction such as F81 BIN.

■ **Flag operations**

Name	Description
R9007 R9008 (ER)	Turns ON when the area is exceeded in index modification.

9.4 STD=, STD<>, STD>, STD>=, STD<, STD<= [32-bit data comparison (start)]

9.4 STD=, STD<>, STD>, STD>=, STD<, STD<= [32-bit data comparison (start)]

■ **Instruction format**

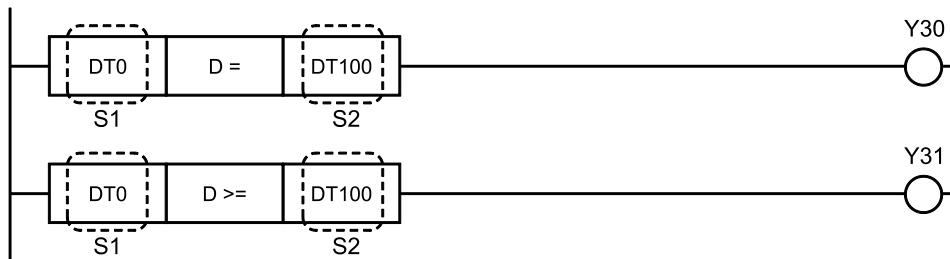

■ **Operands**

Items	Settings
S1	Comparison data 1: Area number storing the 32-bit data, or constant data
S2	Comparison data 2: Area number storing the 32-bit data, or constant data

■ **Devices that can be specified (indicated by ●)**

Operands	WX	WY	WR	WL	SV	EV	DT	LD	I	SWR	SDT	Constant				Index modifier	Integer Device
												K	H	M	f		
S1	●	●	●	●	●	●	●	●	●	●	●	●	●	●	●	●	
S2	●	●	●	●	●	●	●	●	●	●	●	●	●	●	●	●	

■ **Outline of operation**

- Compares the signed 32-bit data of the combined area of [S1] and [S1+1] with the signed 32-bit data of the combined area of [S2] and [S2+1].
- If the comparison results in one of the specified statuses (=, <, >, etc.), a logical operation is initiated with the contacts operating as liaison contacts.
- The relationship between comparison results and operation is the same as "9.1 ST=, ST <>, ST>, ST>=, ST<, ST<= [16-Bit Data Comparison (Start)]".
- Memory area is specified by the memory area number of the lower order hexadecimal part.

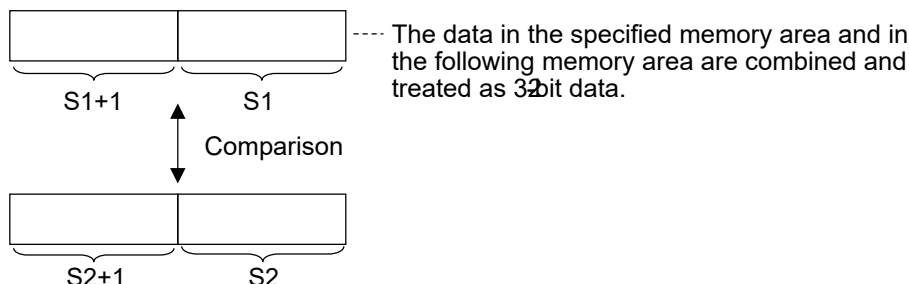

■ **Operation example**

Operation of instruction format description program

The 32-bit value that is a combination of data registers DT0 and DT1 is compared with the 32-bit value that is a combination of DT100 and DT101, and if (DT0, DT1) = (DT100, DT101), external output Y30 turns ON. If (DT0, DT1) is greater than (DT100, DT101), Y31 turns ON.

■ **Precautions for use**

- These instructions start from the bus bar.
- In the case of BCD data, etc., data is compared as a negative value if the most significant bit is 1, so the comparison results may not be accurate. In these instances, use the F83 DBIN instruction or similar to convert to binary data before comparison.

■ **Flag operations**

Name	Description
R9007 R9008 (ER)	Turns ON when the area is exceeded in index modification.

9.5 AND=, AND<>, AND>, AND>=, AND<, AND<= [32-Bit Data Comparison (AND)]

9.5 AND=, AND<>, AND>, AND>=, AND<, AND<= [32-Bit Data Comparison (AND)]

■ Instruction format

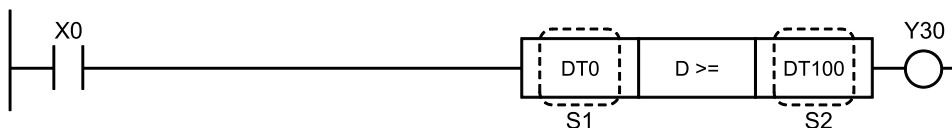

■ Operands

Items	Settings
S1	Comparison data 1: Area number storing the 32-bit data, or constant data
S2	Comparison data 2: Area number storing the 32-bit data, or constant data

■ Devices that can be specified (indicated by ●)

Operands	WX	WY	WR	WL	SV	EV	DT	LD	I	SWR	SDT	Constant				Index modifier	Integer Device
												K	H	M	f		
S1	●	●	●	●	●	●	●	●	●	●	●	●	●	●	●	●	
S2	●	●	●	●	●	●	●	●	●	●	●	●	●	●	●	●	

■ Outline of operation

- Compares the signed 32-bit data of the combined area of [S1] and [S1+1] with the signed 32-bit data of the combined area of [S2] and [S2+1].
- If the comparison results in one of the specified statuses (=, <, >, etc.), the contacts are connected in series as liaison contacts.
- The relationship between comparison results and operation is the same as "9.2 AN=, AN<>, AN>, AN>=, AN<, AN<= [16-bit data comparison (AND)]".
- Memory area is specified by the memory area number of the lower order hexadecimal part.

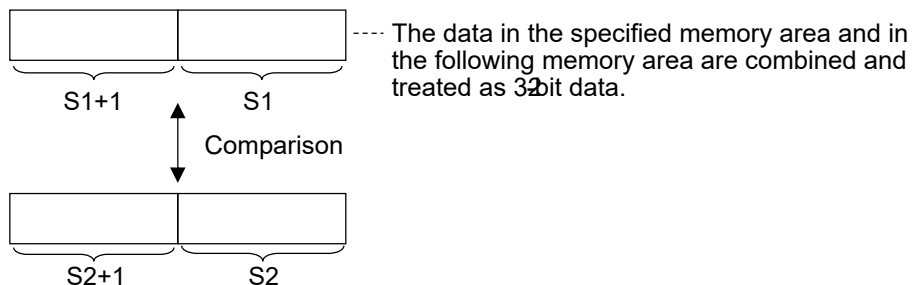

■ Operation example

Operation of instruction format description program

When the external input X0 is ON, and when the comparison result of the combined 32-bit values of data registers DT0 and DT1 and the combined 32-bit values of DT100 and DT101 is

9.5 AND=, AND<>, AND>, AND>=, AND<, AND<= [32-Bit Data Comparison (AND)]

(DT0, DT1) ≥ (DT100, DT101), the external output Y30 turns ON. If X0 is OFF or if (DT0, DT1) is less than (D100, D101), Y30 turns OFF.

■ Precautions for use

- These instructions can be used consecutively.
- In the case of BCD data, etc., data is compared as a negative value if the most significant bit is 1, so the comparison results may not be accurate. In these instances, use the F83 DBIN instruction or similar to convert to binary data before comparison.

■ Flag operations

Name	Description
R9007 R9008 (ER)	Turns ON when the area is exceeded in index modification.

9.6 ORD=, ORD<>, ORD>, ORD>=, ORD<, ORD<= [32-Bit Data Comparison (OR)]

9.6 ORD=, ORD<>, ORD>, ORD>=, ORD<, ORD<= [32-Bit Data Comparison (OR)]

■ Instruction format

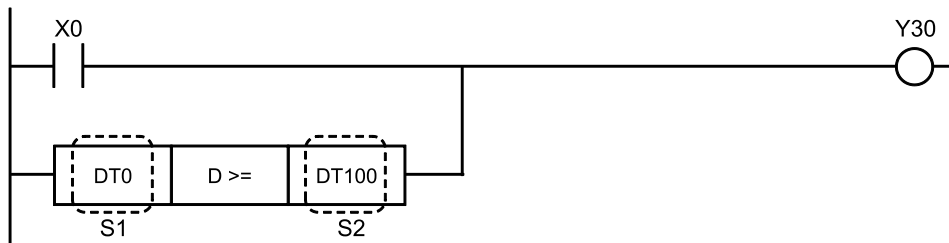

■ Operands

Items	Settings
S1	Comparison data 1: Area number storing the 32-bit data, or constant data
S2	Comparison data 2: Area number storing the 32-bit data, or constant data

■ Devices that can be specified (indicated by ●)

Operands	WX	WY	WR	WL	SV	EV	DT	LD	I	SWR	SDT	Constant				Index modifier	Integer Device
												K	H	M	f		
S1	●	●	●	●	●	●	●	●	●	●	●	●	●	●	●	●	
S2	●	●	●	●	●	●	●	●	●	●	●	●	●	●	●	●	

■ Outline of operation

- This compares signed 32-bit data for the combined [S1] and [S1+1] area with the signed 32-bit data for the combined [S2] and [S2+1] area.
- When comparison results are the specified status (=, <, >, etc.), a parallel connection occurs as the conductive contact.
- The relationship between comparison results and operation is the same as "9.3 OR= OR <> OR > OR >= OR < OR <= [16-bit data comparison (OR)]".
- Memory area is specified by the memory area number of the lower order hexadecimal part.

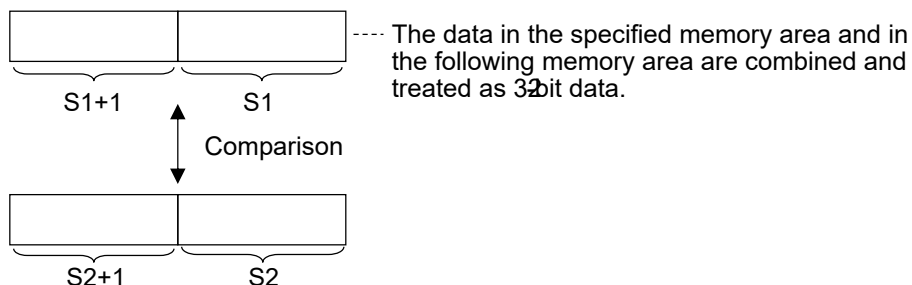

■ Operation example

Operation of instruction format description program

When external input X0 turns ON, or when $(DT0, DT1) \geq (DT100, DT101)$ after a comparison between the 32-bit value from combining data register DT0 and DT1 and the 32-bit value from combining data register DT100 and DT101, then the external output Y30 is ON. If X0 is OFF and $(DT0, DT1) < (DT100, DT101)$, then Y30 turns OFF.

■ Precautions for use

- This instruction starts from the bus bar.
- These instructions can be used consecutively.
- In the case of BCD data, etc., data is compared as a negative value if the most significant bit is 1, so the comparison results may not be accurate. In these instances, use the F83 DBIN instruction or similar to convert to binary data before comparison.

■ Flag operations

Name	Description
R9007 R9008 (ER)	Turns ON when the area is exceeded in index modification.

9.7 STF=, STF<>, STF>, STF>=, STF< and STF<= [Floating point real number data comparison (start)]

9.7 STF=, STF<>, STF>, STF>=, STF< and STF<= [Floating point real number data comparison (start)]

■ **Instruction format**

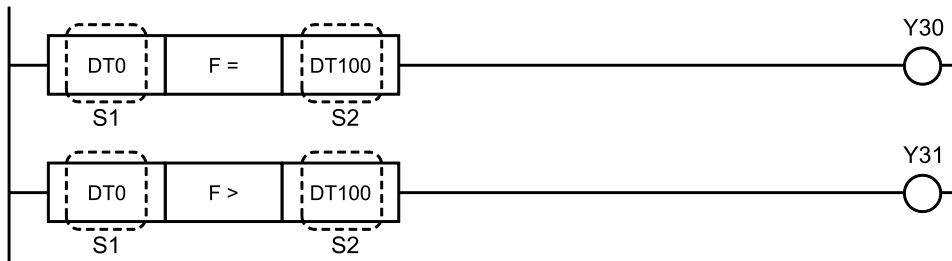

■ **Operands**

Items	Settings
S1	Area storing real number data, or real number data (comparison data 1) (two words)
S2	Area storing real number data, or real number data (comparison data 2) (two words)

■ **Devices that can be specified (indicated by ●)**

Operands	WX	WY	WR	WL	SV	EV	DT	LD	I	SWR	SDT	Constant				Index modifier	Integer Device
												K	H	M	f		
S1	●	●	●	●	●	●	●	●	●	●	●	●	●	●	●	●	●
S2	●	●	●	●	●	●	●	●	●	●	●	●	●	●	●	●	●

■ **Outline of operation**

- Compares the real number data in the area combining [S1] and [S1+1] with the real number data in the area combining [S2] and [S2+1].
- If the comparison results in one of the specified statuses (=, <, >, etc.), a logical operation is initiated with the contacts operating as liaison contacts.
- The relationship between comparison results and operation is the same as "9.1 ST=, ST<>, ST>, ST>=, ST<, ST<= [16-Bit Data Comparison (Start)]".
- Memory area is specified by the memory area number of the lower order hexadecimal part.

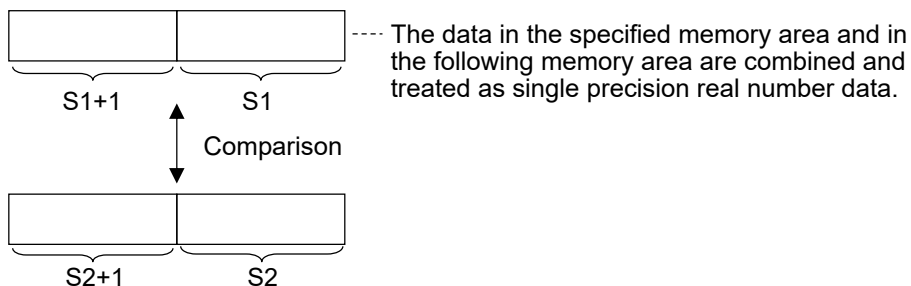

■ **Operation example**

Operation of instruction format description program

The real number that is a combination of data registers DT0 and DT1 is compared with the real number that is a combination of data registers DT100 and DT101, and if (DT0, DT1) is equal to (DT100, DT101), external output Y30 turns ON. If (DT0, DT1) is greater than (DT100, DT101), Y31 turns ON.

■ **Precautions for use**

- These instructions start from the bus bar.
- If [S1] and [S2] are specified with an integer device, the operation occurs after the integer data is internally converted to real numbers.
- If a K constant is specified for [S1] or [S2], the same processing is performed as when an integer device is specified.

■ **Flag operations**

Name	Description
R9007	Turns ON when the area is exceeded in index modification.
R9008 (ER)	Turns ON when non-real-number data is specified in [S1, S1+1] or [S2, S2+1]

9.8 ANF=, ANF<>, ANF>, ANF>=, ANF<, ANF<= [Floating point real number data comparison (AND)]

9.8 ANF=, ANF<>, ANF>, ANF>=, ANF<, ANF<= [Floating point real number data comparison (AND)]

■ Instruction format

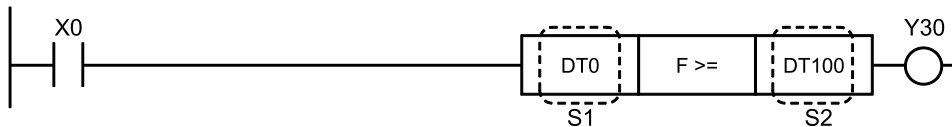

■ Operands

Items	Settings
S1	Area storing real number data, or real number data (comparison data 1) (two words)
S2	Area storing real number data, or real number data (comparison data 2) (two words)

■ Devices that can be specified (indicated by ●)

Operands	WX	WY	WR	WL	SV	EV	DT	LD	I	SW R	SD T	Constant				Index modifier	Integer Device
												K	H	M	f		
S1	●	●	●	●	●	●	●	●	●	●	●	●	●	●	●	●	●
S2	●	●	●	●	●	●	●	●	●	●	●	●	●	●	●	●	●

■ Outline of operation

- Compares the real number data in the area combining [S1] and [S1+1] with the real number data in the area combining [S2] and [S2+1].
- If the comparison result is one of the specified statuses (=, >, <, etc.), the contacts are connected in series as liaison contacts.
- The relationship between comparison results and operation is the same as "9.2 AN=, AN<>, AN>, AN>=, AN<, AN<= [16-bit data comparison (AND)]".
- Memory area is specified by the memory area number of the lower order hexadecimal part.

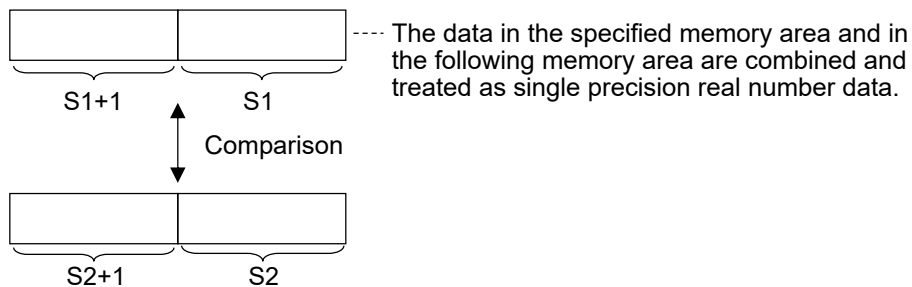

■ Operation example

Operation of instruction format description program

When external input X0 turns ON, the real number that is a combination of data registers DT0 and DT1 is compared with the real number that is a combination of data registers DT100 and

9.8 ANF=, ANF<>, ANF>, ANF>=, ANF<, ANF<= [Floating point real number data comparison (AND)]

DT101, and if (DT0, DT1) is equal to or greater than (DT100, DT101), external output Y30 turns ON. If X0 is OFF or if (DT0, DT1) is less than (D100, D101), Y30 turns OFF.

■ Precautions for use

- These instructions can be used consecutively.
- If [S1] and [S2] are specified with an integer device, the operation occurs after the integer data is internally converted to real numbers.
- If a K constant is specified for [S1] or [S2], the same processing is performed as when an integer device is specified.

■ Flag operations

Name	Description
R9007	Turns ON when the area is exceeded in index modification.
R9008 (ER)	Turns ON when non-real-number data is specified in [S1, S1+1] or [S2, S2+1]

9.9 ORF=, ORF<>, ORF>, ORF>=, ORF<, ORF<= [floating point real number data comparison (OR)]

9.9 ORF=, ORF<>, ORF>, ORF>=, ORF<, ORF<= [floating point real number data comparison (OR)]

■ **Instruction format**

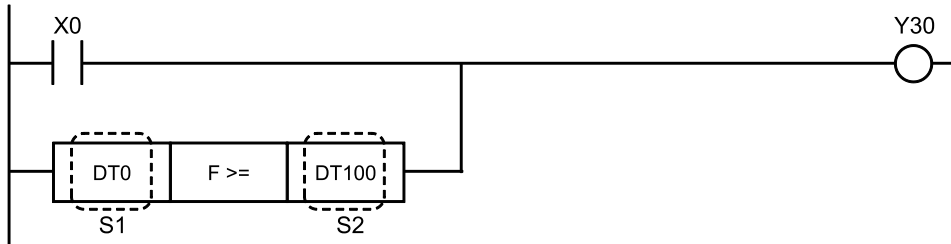

■ **Operands**

Items	Settings
S1	Area storing real number data, or real number data (comparison data 1) (two words)
S2	Area storing real number data, or real number data (comparison data 2) (two words)

■ **Devices that can be specified (indicated by ●)**

Operands	WX	WY	WR	WL	SV	EV	DT	LD	I	SWR	SDT	Constant				Index modifier	Integer Device
												K	H	M	f		
S1	●	●	●	●	●	●	●	●	●	●	●	●	●	●	●	●	●
S2	●	●	●	●	●	●	●	●	●	●	●	●	●	●	●	●	●

■ **Outline of operation**

- Compares the real number data in the area combining [S1] and [S1+1] with the real number data in the area combining [S2] and [S2+1].
- If the comparison result is in the specified status (=, >, <, ...), it is connected in parallel as a conducting contact.
- The relationship between comparison results and operation is the same as "9.3 OR= OR <> OR > OR >= OR < OR <= [16-bit data comparison (OR)]".
- Memory area is specified by the memory area number of the lower order hexadecimal part.

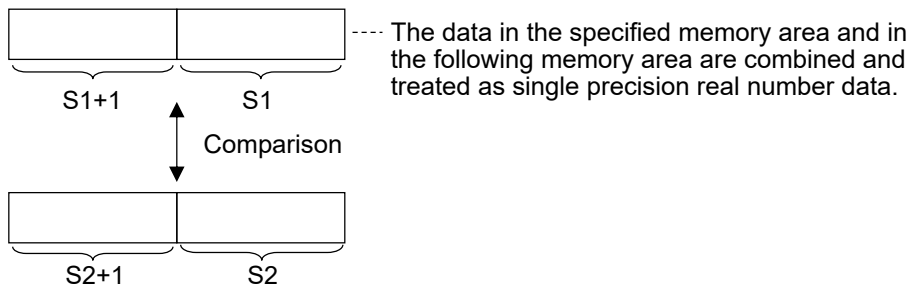

■ **Operation example**

Operation of instruction format description program

If external input X0 is ON, or if the real number values of combined data registers DT0 and DT1 and the real number values of combined data registers DT100 and DT101 are compared and $(DT0, DT1) \geq (DT100, DT101)$, then the external output Y30 turns ON. If X0 is OFF and $(DT0, DT1) < (DT100, DT101)$, then Y30 turns OFF.

■ **Precautions for use**

- This instruction starts from the bus bar.
- These instructions can be used consecutively.
- If [S1] and [S2] are specified with an integer device, the operation occurs after the integer data is internally converted to real numbers.
- If a K constant is specified for [S1] or [S2], the same processing is performed as when an integer device is specified.

■ **Flag operations**

Name	Description
R9007	Turns ON when the area is exceeded in index modification.
R9008 (ER)	Turns ON when non-real-number data is specified in [S1, S1+1] or [S2, S2+1]

(MEMO)

10 Transfer Instructions

10.1 F0 MV (16-bit data transfer).....	10-2
10.2 F0 MV (10 μ sec Ring Counter Read)	10-4
10.3 F1 DMV (32-Bit Data Transfer)	10-5
10.4 F2 MV/ (16-bit data inversion and transfer)	10-7
10.5 F3 DMV/ (32-bit data inversion and transfer).....	10-9
10.6 F5 BTM (Bit Data Transfer).....	10-11
10.7 F6 DGT (Digit data transfer)	10-16
10.8 F7 MV2 (16-bit 2 Data Transfer)	10-20
10.9 F8 DMV2 (32-bit 2 Data Transfer)	10-22
10.10 F10 BKMV (Block Move).....	10-24
10.11 F11 COPY (Block Copy)	10-27
10.12 F12 ICRD (F-ROM Read)	10-29
10.13 P13 ICWT (F-ROM Write).....	10-31
10.14 F15 XCH (16-bit data exchange)	10-33
10.15 F16 DXCH (32-bit data exchange).....	10-35
10.16 F17 SWAP (Higher/Lower Byte Exchange in 16-Bit Data)	10-37
10.17 F18 BXCH (Block Exchange).....	10-39
10.18 F190 MV3 (16-Bit 3-Data Batch Transfer)	10-41
10.19 F191 DMV3 (32-Bit 3-Data Batch Transfer).....	10-43

10.1 F0 MV (16-bit data transfer)

10.1 F0 MV (16-bit data transfer)

Transfers the 16-bit data in the specified area number.

■ Instruction format

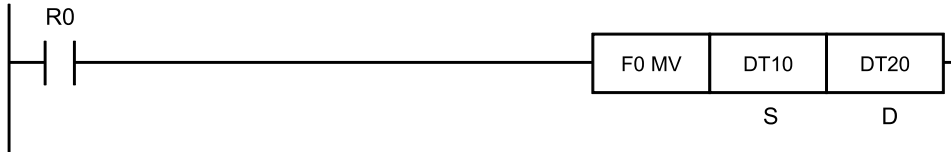

■ Operands

Items	Settings
S	Area storing the hexadecimal data or constant data
D	Area where data is transferred to

■ Devices that can be specified (indicated by ●)

Operands	WX	WY	WR	WL	SV	EV	DT	LD	I	SW R	SD T	Constant				Index modifier	Integer Device
												K	H	M	f		
S	●	●	●	●	●	●	●	●	●	●	●	●	●	●	●	●	
D		●	●	●	●	●	●	●	●	●	●					●	

■ Outline of operation

- The 16-bit data in the memory area specified by [S] is transferred to the memory area specified by [D].

■ Operation example

Example 1: Instruction format and described program operation

- When the internal relay R0 turns ON, the content of data register DT10 is transferred to data register DT20.

Example 2: Constant K30 is transferred to the timer 0 setting value area when internal relay R1 turns ON

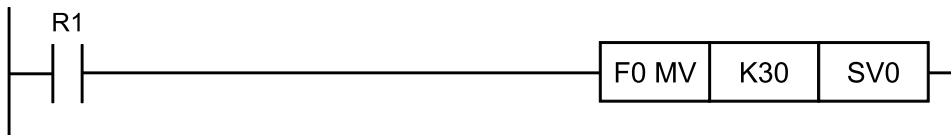

Example 3: The timer 0 elapsed value is transferred to data register DT0 when R2 turns ON

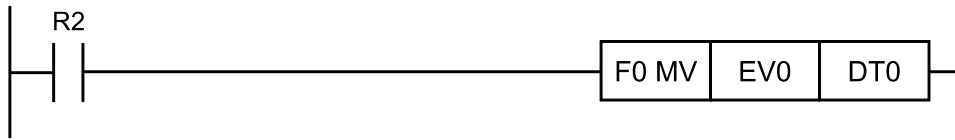

■ Flag operations

Name	Description
R9007 R9008 (ER)	Turns ON when the area is exceeded in index modification.

10.2 F0 MV (10 μsec Ring Counter Read)

10.2 F0 MV (10 μsec Ring Counter Read)

■ Instruction format

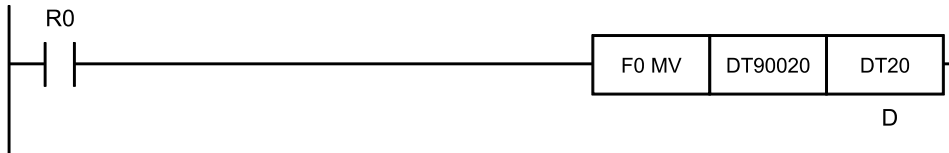

■ Operands

Items	Settings
D	Area where data is transferred to

■ Devices that can be specified (indicated by ●)

Operands	WX	WY	WR	WL	SV	EV	DT	LD	I	SWR	SDT	Constant			Index modifier	Integer Device
												K	H	M		
D		●	●	●	●	●	●	●	●						●	

■ Outline of operation

- When this instruction is executed, the 10 μsec ring counter (H0 to HFFFF) is read once, and the read value is transferred to the memory area specified by [D]. At the same time, the value stored in special data register DT90020 (10 μsec ring counter) is also updated.

■ Operation example

Operation of instruction format description program

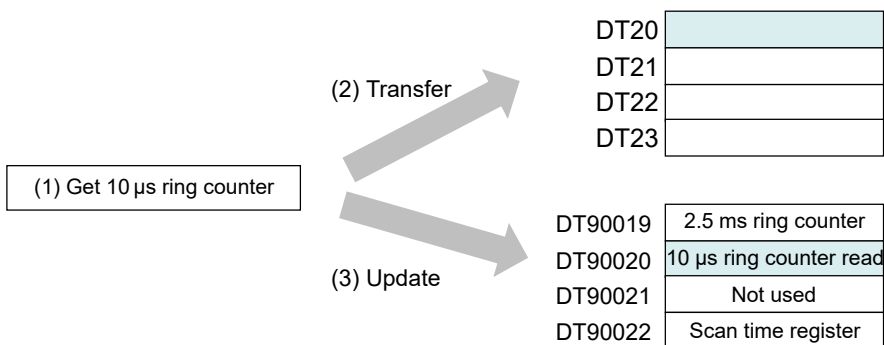

■ Flag operations

Name	Description
R9007 R9008 (ER)	Turns ON when the area is exceeded in index modification.

10.3 F1 DMV (32-Bit Data Transfer)

Transfers 32-bit data to the specified area number.

■ Instruction format

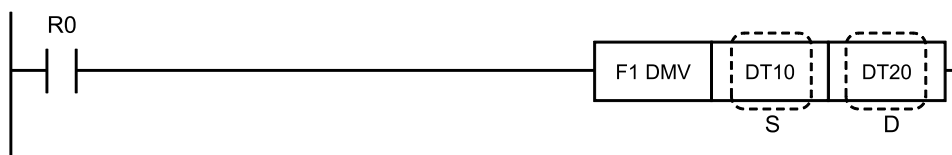

■ Operands

Items	Settings
S	Area storing 32-bit data, or constant data
D	Area where data is transferred to

■ Devices that can be specified (indicated by ●)

Operands	WX	WY	WR	WL	SV	EV	DT	LD	I	SWR	SDT	Constant				Index modifier	Integer Device
												K	H	M	f		
S	●	●	●	●	●	●	●	●	●	●	●	●	●	●	●	●	
D		●	●	●	●	●	●	●	●							●	

■ Outline of operation

The 32-bit data in the memory area specified by [S] is transferred to the memory area specified by [D].

■ Operation example

Operation of instruction format description program

When the internal relay R0 turns ON, the content of data register DT10 and DT11 is transferred to data register DT20 and DT21.

- Specify a lower 16-bit memory area for the memory area.

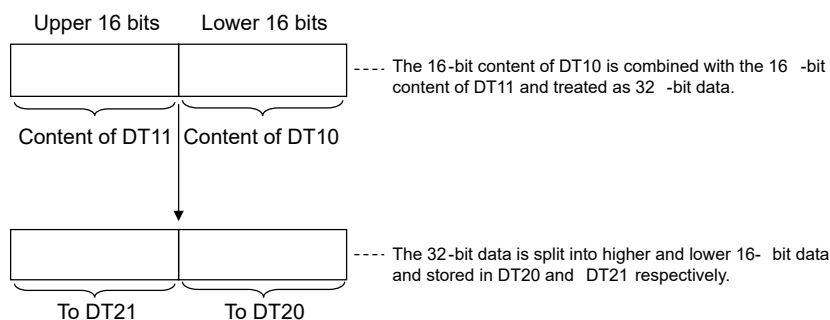

10.3 F1 DMV (32-Bit Data Transfer)

■ Flag operations

Name	Description
R9007 R9008 (ER)	Turns ON when the area is exceeded in index modification.

10.4 F2 MV/ (16-bit data inversion and transfer)

Inverts and transfers 16-bit data at the specified area number.

■ Instruction format

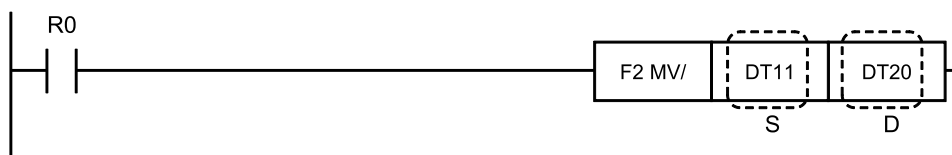

■ Operands

Items	Settings
S	Area storing the hexadecimal data or constant data
D	Area where data is transferred to

■ Devices that can be specified (indicated by ●)

Operand s	WX	WY	WR	WL	SV	EV	DT	LD	I	SW R	SD T	Constant				Index modifier	Integer Device
												K	H	M	f		
S	●	●	●	●	●	●	●	●	●	●	●	●	●	●	●	●	
D		●	●	●	●	●	●	●	●							●	

■ Outline of operation

The 16-bit data in the area specified by [S] is logically inverted ($0 \Leftrightarrow 1$ inversion) and transferred to the area specified by [D].

BIN

0	0	0	0	0	1	0	0	1	1	0	1	0	0	1	0
---	---	---	---	---	---	---	---	---	---	---	---	---	---	---	---

HEX 0 4 D 2



BIN

1	1	1	1	1	0	1	1	0	0	1	0	1	1	0	1
---	---	---	---	---	---	---	---	---	---	---	---	---	---	---	---

HEX F B 2 D

■ Operation example

Operation of instruction format description program

When internal relay R0 turns ON, the contents of data register DT11 are logically inverted and transferred to data register DT20.

10.4 F2 MV/ (16-bit data inversion and transfer)

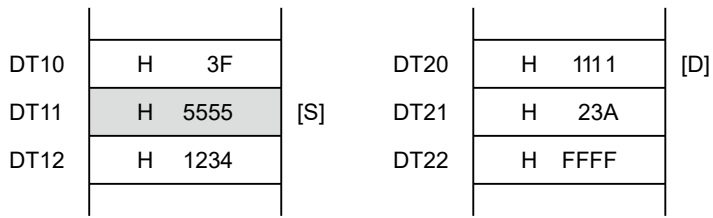

R0:ON

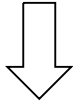

F2 execution

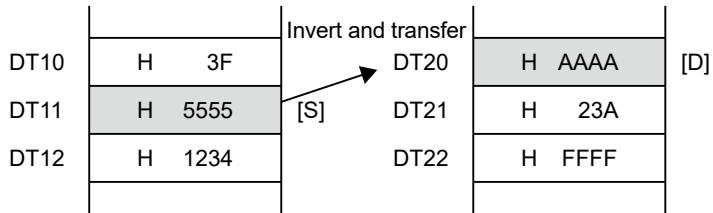

DT11 = "0101 0101 0101 0101" (H5555)

↓ Invert and transfer

DT20 = "1010 1010 1010 1010" (HAAAA)

■ Flag operations

Name	Description
R9007 R9008 (ER)	Turns ON when the area is exceeded in index modification.

10.5 F3 DMV/ (32-bit data inversion and transfer)

Inverts the 32-bit data in the specified area number and transfers it.

■ Instruction format

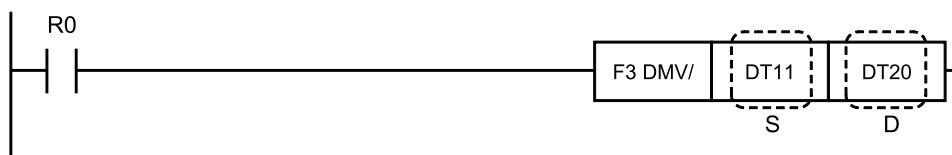

■ Operands

Items	Settings
S	Area storing 32-bit data, or constant data
D	Area where data is transferred to

■ Devices that can be specified (indicated by ●)

Operand s	WX	WY	WR	WL	SV	EV	DT	LD	I	SW R	SD T	Constant				Index modifier	Integer Device
												K	H	M	f		
S	●	●	●	●	●	●	●	●	●	●	●	●	●	●	●	●	
D		●	●	●	●	●	●	●	●							●	

■ Outline of operation

The 32-bit data in the area specified by [S] is logically inverted ($0 \Leftrightarrow 1$ inversion) and transferred to the area specified by [D].

S	1	1	0	0	1	1	0	1	0	0	0	1	0	1	0	1
S+1	0	0	0	0	0	1	1	1	0	1	0	1	1	0	1	1
↓																
D	0	0	1	1	0	0	1	0	1	1	1	0	1	0	1	0
D+1	1	1	1	1	1	0	0	0	1	0	1	0	0	1	0	0

■ Operation example

Operation of instruction format description program

When internal relay R0 turns ON, the contents of data registers DT11 and DT12 are logically inverted and transferred to data registers DT20 and DT21.

10.5 F3 DMV/ (32-bit data inversion and transfer)

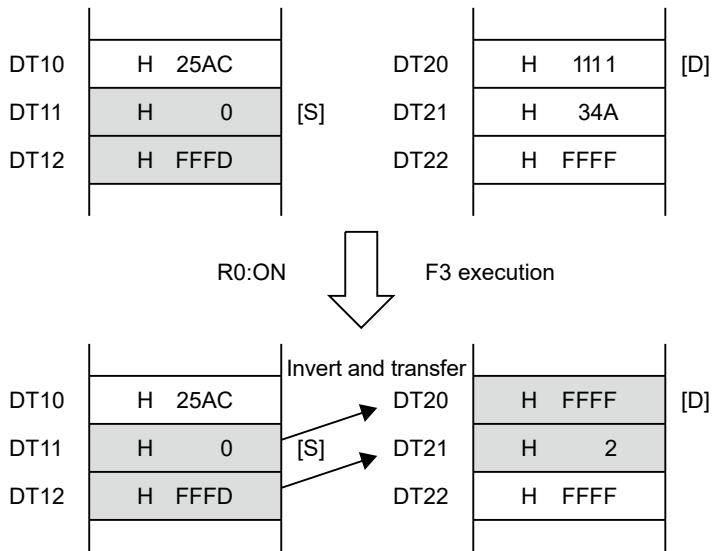

■ Flag operations

Name	Description
R9007 R9008 (ER)	Turns ON when the area is exceeded in index modification.

10.6 F5 BTM (Bit Data Transfer)

Transfers 1-bit data in the specified 16-bit data to the specified bit.

■ Instruction format

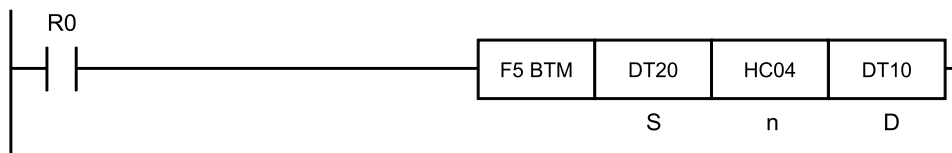

■ Operands

Items	Settings
S	Area storing the hexadecimal data or constant data
n	Area specifying the transfer method
D	Data destination storage area

■ Devices that can be specified (indicated by ●)

Operands	WX	WY	WR	WL	SV	EV	DT	LD	I	SWR	SDT	Constant				Index modifier	Integer Device
												K	H	M	f		
S	●	●	●	●	●	●	●	●	●	●	●	●	●	●	●	●	
n	●	●	●	●	●	●	●	●	●	●	●	●	●	●	●	●	
D		●	●	●	●	●	●	●	●							●	

■ Outline of operation

- Transfers the content of one bit ("1" or "0") at any position in the 16-bit data of the area specified by [S] to any bit of the memory area specified by [D]. The bit position is specified by the value of [n].

■ Operation example

Operation of instruction format description program

- When internal relay R0 turns ON, the content of bit 4 of data register DT20 is transferred to bit 12 of DT10.

10.6 F5 BTM (Bit Data Transfer)

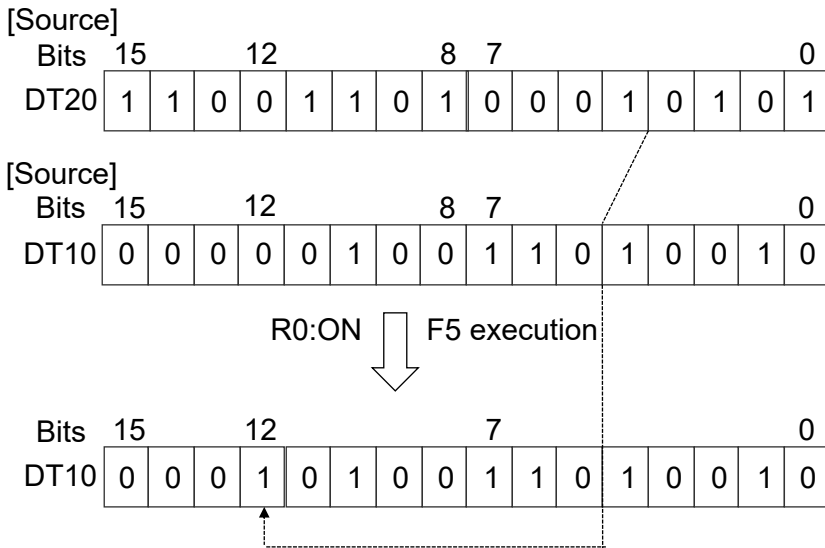

■ About transfer method specification [n]

- Specify [n] as an H constant in the following format:

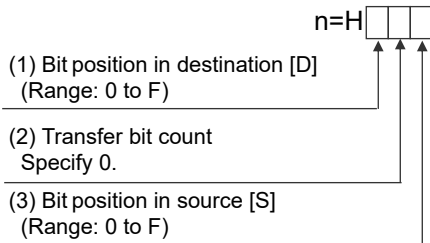

Bit position specification of [S] and [D]

Bits Position	15	14	13	12	11	10	9	8	7	6	5	4	3	2	1	0
Set value (H)	F	E	D	C	B	A	9	8	7	6	5	4	3	2	1	0

For example, specify A to specify bit 10. When transferring bit 4 of [S] to bit 12 of [D], $n = \text{HC04}$.

■ Transferring multiple bits

- When the number of transfer bits is specified in n , the specified bits from the position specified by [S] are transferred to the position whose start is specified by [D].
- Up to 16 bits can be transferred. Specify the number of transfer bits as a hexadecimal number. The range is 0 to F (1 bit to 16 bits).

Number of transfer bits	Setting (n)
1 bit	$\text{H}\square\square$
2-bit	$\text{H}\square\square$

Number of transfer bits	Setting (n)
3 bits	H□2□
4-bit	H□3□
5 bits	H□4□
6 bits	H□5□
7 bits	H□6□
8 bits	H□7□
9 bits	H□8□
10 bits	H□9□
11 bits	H□A□
12 bits	H□B□
13 bits	H□C□
14 bits	H□D□
15 bits	H□E□
16 bits	H□F□

Example 1: When transferring two bits (n = H□1□)

Transfer two bits from [S] bit 5 to [D] bit 10... n = HA15

Bits 15 12 11 8 7 4 3 0
 [S] 0 0 1 0 0 1 0 1 1 1 0 0 1 1 0 1

┌───┐
 │ │
 └───┘ 2 bits from bit 5

Bits 15 12 11 8 7 4 3 0
 [D] 1 1 1 0 1 1 0 1 0 0 0 1 1 0 0 1

↓ F5 execution

Bits 15 12 11 8 7 4 3 0
 [D] 1 1 1 0 1 0 0 1 0 0 0 1 1 0 0 1

┌───┐
 │ │
 └───┘ Transfer bits 5 to 6 of [S]
 to bits 10 to 11 of [D]

- When 0 is specified for the number of transfer bits, the single specified bit is transferred.
- If the specified range is outside the area of [S], the contents of the part extending beyond the area are set to 0 and transferred.

10.6 F5 BTM (Bit Data Transfer)

Example 2: Transfer four bits from bit 14 of [S] to bit 2 of [D]... n = H23E

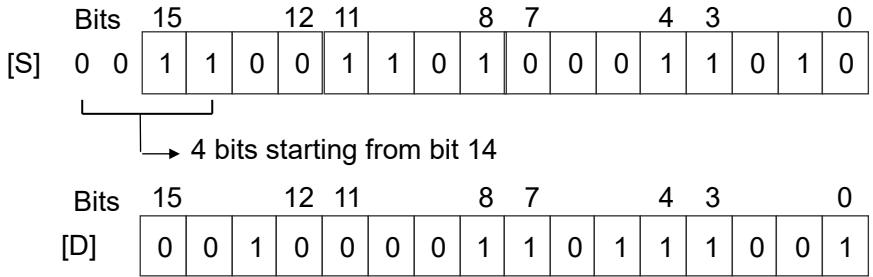

F5 execution

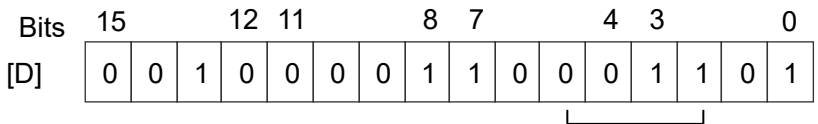

Bits 14 to 15 of [S] are sent to bits 2 to 3 of [D].
0 is stored in bits 4 to 5 of [D].

- If the specified range is outside the area of [D], the part extending beyond the area will not be transferred. Data is not written to the next address.

Example 3: Transfer six bits from bit 6 of [S] to bit 12 of [D]... n = HC56

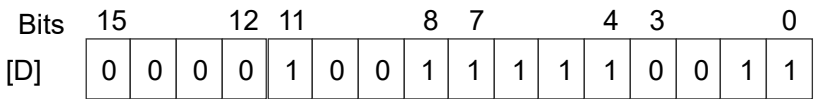
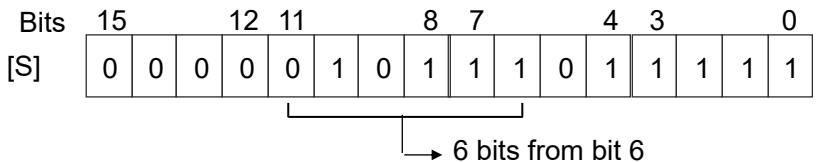

F5 execution

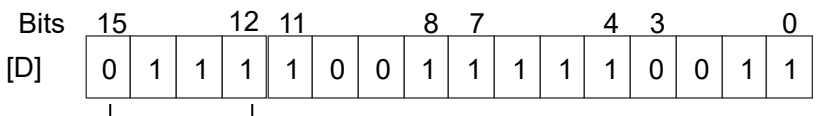

Among bits 6 to 11 of [S], bits 6 to 9 are sent to bits 12 to 15 in [D]
(The content of bits 10 to 11 of [S] have no effect)

■ **Flag operations**

Name	Description
R9007 R9008 (ER)	Turns ON when the area is exceeded in index modification.

10.7 F6 DGT (Digit data transfer)

10.7 F6 DGT (Digit data transfer)

Transfers the specified 16-bit data in 4-bit (digit) units.

■ Instruction format

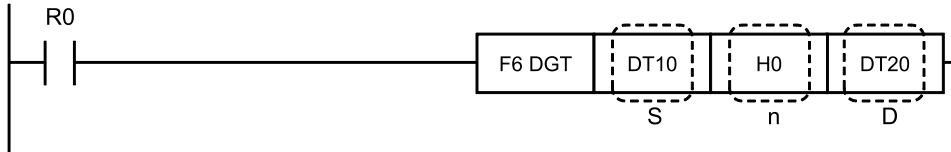

■ Operands

Items	Settings
S	Area storing the hexadecimal data or constant data
n	Area specifying the transfer method
D	Area where data is transferred to

■ Devices that can be specified (indicated by ●)

Operands	WX	WY	WR	WL	SV	EV	DT	LD	I	SWR	SDT	Constant				Index modifier	Integer Device
												K	H	M	f		
S	●	●	●	●	●	●	●	●	●	●	●	●	●	●	●	●	
n	●	●	●	●	●	●	●	●	●	●	●	●	●	●	●	●	
D		●	●	●	●	●	●	●	●							●	

■ Outline of operation

The 16-bit data in the memory area specified by [S] is transferred to the memory area specified by [D], according to the transfer method specified by [n].

■ Operation example

Operation of instruction format description program

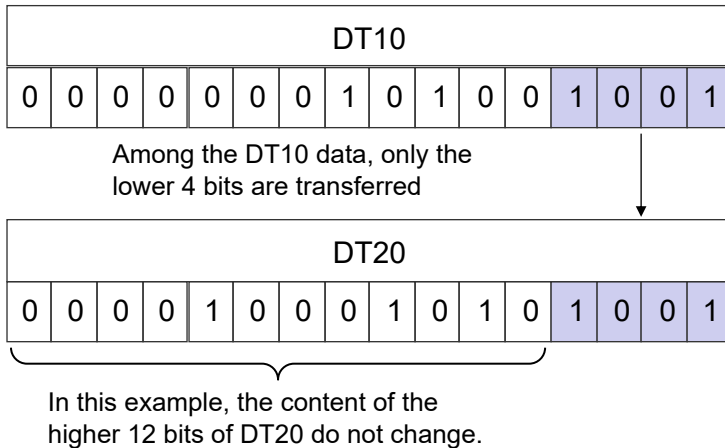

■ What is a digit?

- Digits are units of four bits used when handling data.
- With this instruction, 16-bit data is separated into four digits for convenience. Starting from the lowest four bits, these digits are named digit 0, digit 1, digit 2, and digit 3.

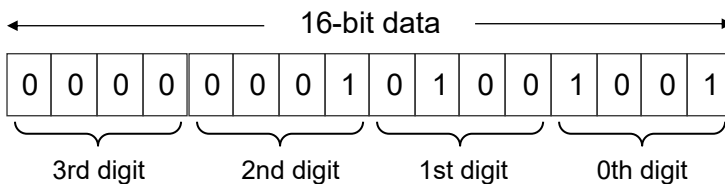

■ About transfer method specification [n]

- For designating
 - (1) which digit to transfer to at the transfer destination;
 - (2) how many digits to transfer; and
 - (3) which digit to transfer from at the transfer source with digit transfer.
- Specify [n] as an H constant in the following format:

10.7 F6 DGT (Digit data transfer)

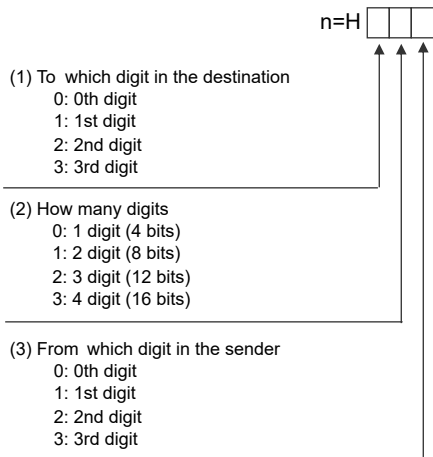

If (1) or (2) is 0, such as "H000" in the program example on the previous page, use the short form "H0".

■ Examples of transfer methods

The following digit transfer patterns are possible based on the specification of [n]:

1. One digit is transferred to a parallel destination

Transferring from digit 1 to digit 1

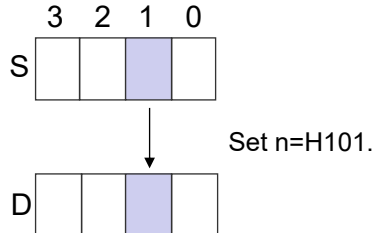

2. One digit is transferred to a non-parallel destination

Transferring from digit 3 to digit 0

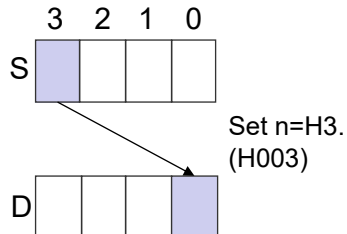

3. Multiple digits are transferred to a parallel destination

Transferring digits 2 and 3 to digits 2 and 3

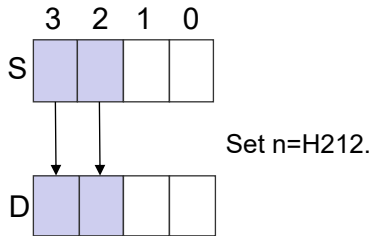

4. Multiple digits are transferred to a non-parallel destination

Transferring digits 0 and 1 to digits 2 and 3

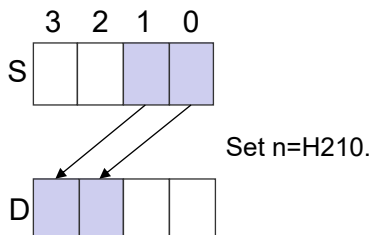

5. Four digits are transferred

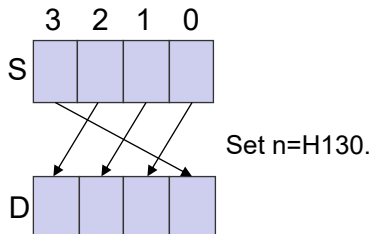

■ **Flag operations**

Name	Description
R9007 R9008 (ER)	Turns ON when the area is exceeded in index modification.

10.8 F7 MV2 (16-bit 2 Data Transfer)

10.8 F7 MV2 (16-bit 2 Data Transfer)

Two 16-bit data are transferred from the specified area number.

■ Instruction format

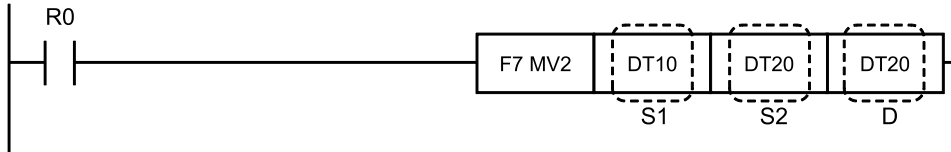

■ Operands

Items	Settings
S1	Area storing the hexadecimal data or constant data
S2	Area storing the hexadecimal data or constant data
D	Starting address of the data transfer destination (two words)

■ Devices that can be specified (indicated by ●)

Operands	WX	WY	WR	WL	SV	EV	DT	LD	I	SWR	SDT	Constant				Index modifier	Integer Device
												K	H	M	f		
S1	●	●	●	●	●	●	●	●	●	●	●	●			●		
S2	●	●	●	●	●	●	●	●	●	●	●	●			●		
D		●	●	●	●	●	●	●	●						●		

■ Outline of operation

The two 16-bit data (two words) specified by [S1] and [S2] are transferred to the memory area (two words) specified by [D].

■ Operation example

Operation of instruction format description program

When the execution condition R0 turns ON, the contents of data register DT10 is transferred to DT30, and the contents of DT20 is transferred to DT31.

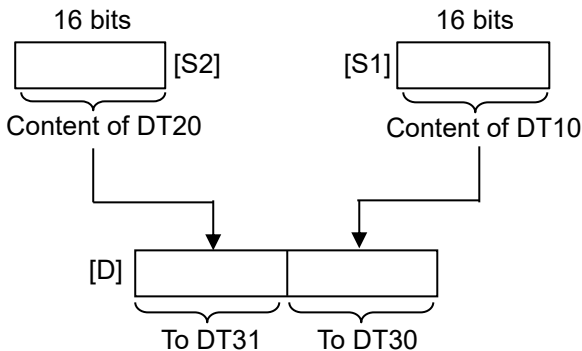

■ Related instructions

Use the F190 MV3 instruction to transfer three types of 16-bit data.

■ Flag operations

Name	Description
R9007 R9008 (ER)	Turns ON when the area is exceeded in index modification.

10.9 F8 DMV2 (32-bit 2 Data Transfer)

10.9 F8 DMV2 (32-bit 2 Data Transfer)

Two 32-bit data are transferred from the specified area number.

■ Instruction format

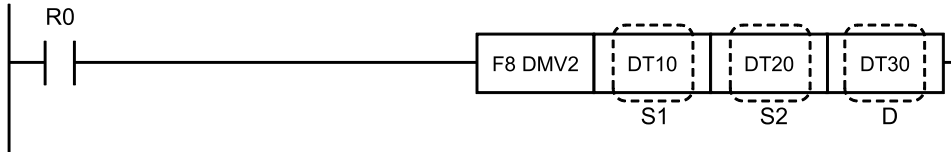

■ Operands

Items	Settings
S1	Area storing 32-bit data, or constant data
S2	Area storing 32-bit data, or constant data
D	Starting address of the data transfer destination area (four words)

■ Devices that can be specified (indicated by ●)

Operands	WX	WY	WR	WL	SV	EV	DT	LD	I	SWR	SDT	Constant				Index modifier	Integer Device
												K	H	M	f		
S1	●	●	●	●	●	●	●	●	●	●	●	●	●	●	●	●	
S2	●	●	●	●	●	●	●	●	●	●	●	●	●	●	●	●	
D		●	●	●	●	●	●	●	●							●	

■ Outline of operation

- The two 32-bit data (four words) specified in [S1] and [S2] are transferred to the memory area (four words) specified in [D].
- The specification of [S1] and [S2] specifies the lower 16-bit memory area.
- The specification of [D] specifies the start of the 4 word memory area.

■ Operation example

Operation of instruction format description program

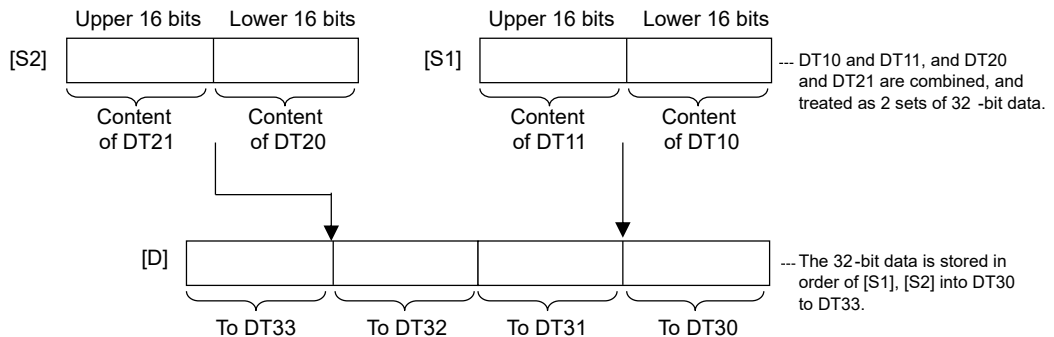

■ **Flag operations**

Name	Description
R9007 R9008 (ER)	Turns ON when the area is exceeded in index modification.

10.10 F10 BKMV (Block Move)

10.10 F10 BKMV (Block Move)

Transfers data at the block unit.

■ Instruction format

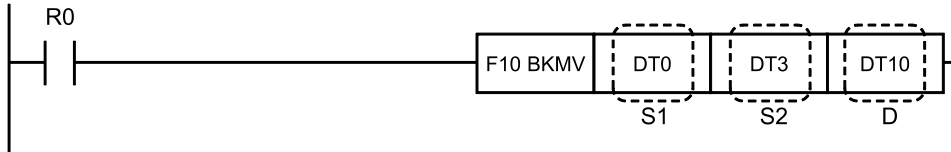

■ Operands

Items	Settings
S1	Starting address of the source data
S2	Final address of the source data
D	Data destination storage area

■ Devices that can be specified (indicated by ●)

Operands	WX	WY	WR	WL	SV	EV	DT	LD	I	SW R	SD T	Constant				Index modifier	Integer Device
												K	H	M	f		
S1	●	●	●	●	●	●	●	●		●	●					●	
S2	●	●	●	●	●	●	●	●		●	●					●	
D		●	●	●	●	●	●	●								●	

■ Outline of operation

This bulk transfers the data between the area specified by [S1] and the area specified by [S2] to the area specified by [D] and later.

■ Operation example

Operation of instruction format description program

When the internal relay R0 turns ON, the data of data registers DT0 to DT3 is transferred to the data registers DT10 to DT13.

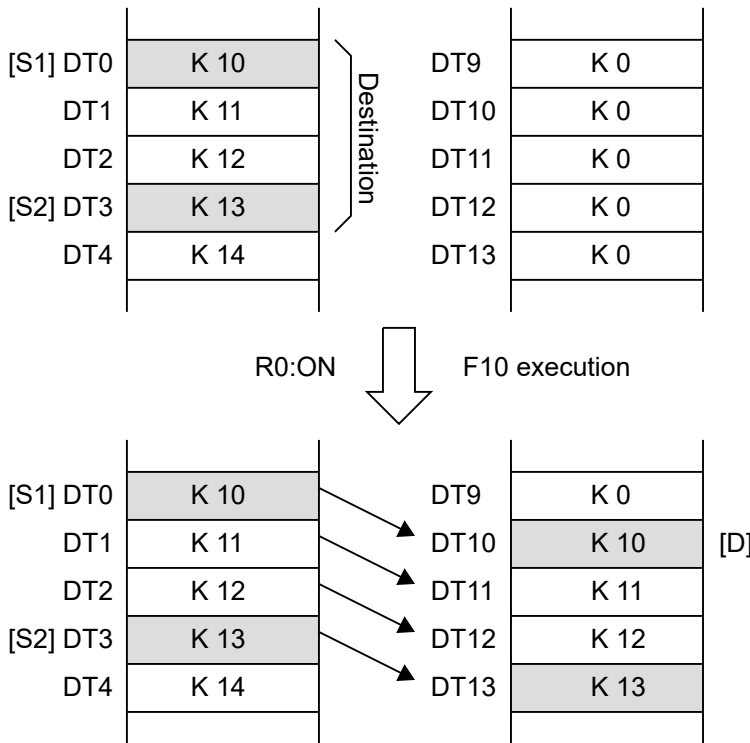

■ **Precautions for programming**

- Specify the same type of memory area for [S1] and [S2].
- Specify the number of the lower address with [S1], and the number of the higher address with [S2].

If [S1] > [S2] is specified and an instruction executed, an operation error will occur.

■ **Precautions if the same type of memory area is specified for S1, S2, and D**

- If [S1] and [D] have the same type and same number of memory area specified, the instruction is not executed.
- If the block being transferred overlaps the destination, transfer results will be overwritten.
- If [S1] < [D], data is transferred starting from the higher address.

In the following example, the data is stored in the order DT4 > DT3 > DT2 > DT1.

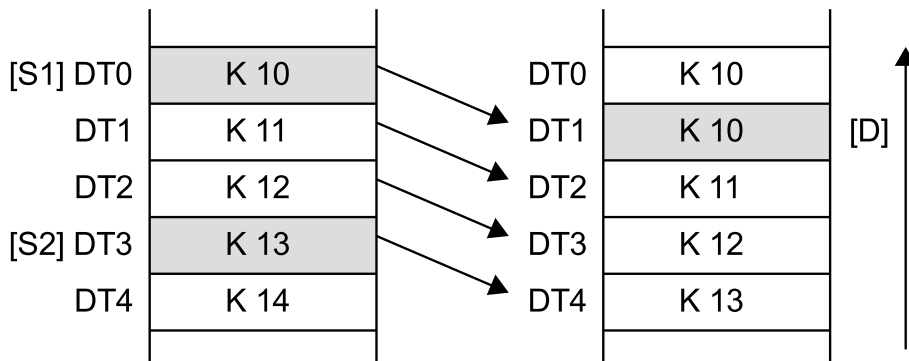

10.10 F10 BKMV (Block Move)

- If $[S1] > [D]$, data is transferred starting from the lower address.
In the following example, the data is stored in the order $DT0 > DT1 > DT2$.

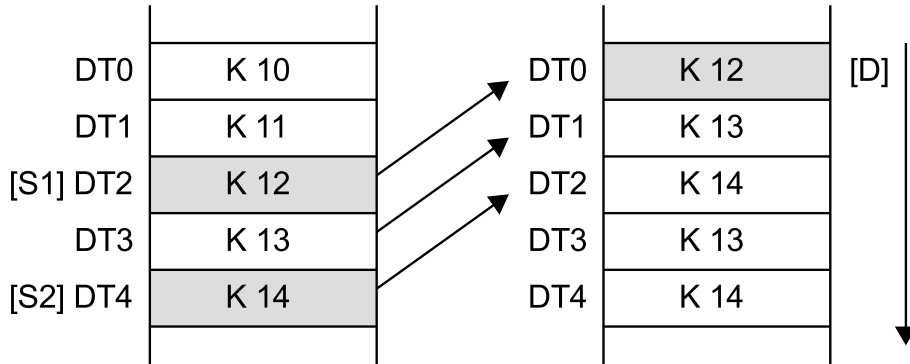

■ Flag operations

Name	Description
R9007 R9008 (ER)	Turns ON when the area is exceeded in index modification.

10.11 F11 COPY (Block Copy)

Copies the specified data to all areas in the range specified by the block.

■ Instruction format

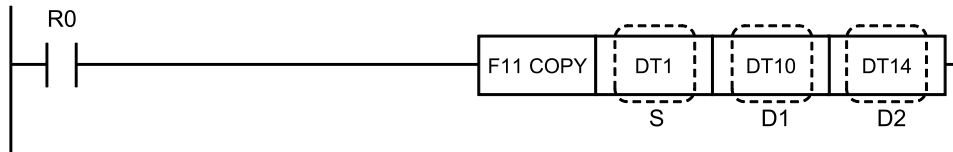

■ Operands

Items	Settings
S	Area storing the copy source data, or constant data
D1	Starting number of data copy destination area
D2	End number of data copy destination area

■ Devices that can be specified (indicated by ●)

Operands	WX	WY	WR	WL	SV	EV	DT	LD	I	SW R	SD T	Constant				Index modifier	Integer Device
												K	H	M	f		
S	●	●	●	●	●	●	●	●	●	●	●	●	●	●	●	●	
D1		●	●	●	●	●	●	●									●
D2		●	●	●	●	●	●	●									●

■ Outline of operation

16-bit data in the area specified by [S] is copied to all areas between [D1] and [D2].

■ Operation example

Operation of instruction format description program

The data from data register DT1 is copied to each data register from DT10 to DT14 when internal relay R0 turns ON.

10.11 F11 COPY (Block Copy)

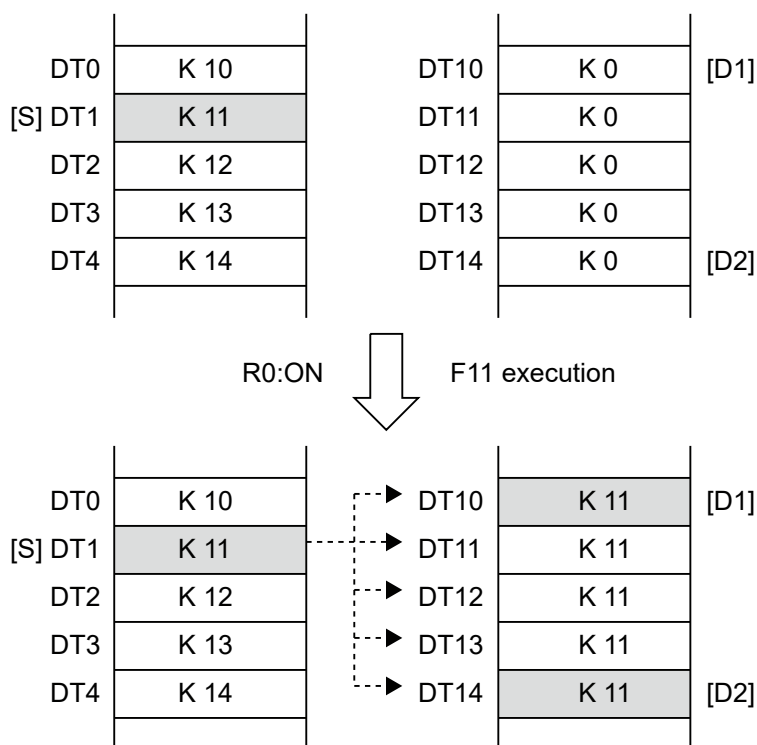

■ Precautions for programming

- Specify the same type of memory area for both [D1] and [D2].
- The area of the lower address for the block being copied should be specified by [D1], and the higher address should be specified by [D2]. If specified as [D1] > [D2], an operation error will occur when the instruction is executed.
- When the same number is specified for [D1] and [D2], the 16-bit data is transferred to that number's area.

■ Flag operations

Name	Description
R9007	Turns ON when the area is exceeded in index modification.
R9008	
(ER)	Turns ON when the D1 address > D2 address

10.12 F12 ICRD (F-ROM Read)

Reads the specified data from the F-ROM area.

■ Instruction format

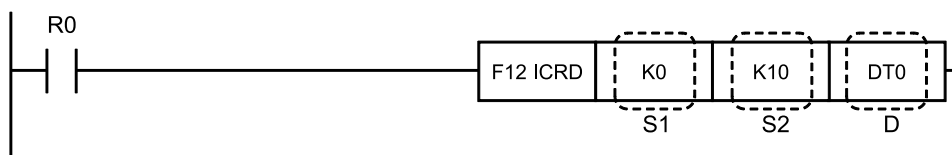

■ Operands

Items	Settings
S1	Starting block number (settable range: K0 to K31) of the data read from the F-ROM area
S2	Number of reading blocks (settable range: K1 to K32)
D	Starting number of the area storing the read data

■ Devices that can be specified (indicated by ●)

Operands	WX	WY	WR	WL	SV	EV	DT	LD	I	SWR	SDT	Constant				Index modifier	Integer Device
												K	H	M	f		
S1												●					
S2												●					
D							●										

■ Outline of operation

From

Transfers data starting with the block specified by **S1** in the F-ROM for the blocks specified by **S2**.

To

Transfers to the memory area starting with the address specified by **D** in the data register.

Transfer units

Data is transferred by the following units.

Data to be transferred per block: 2,048 words

■ Settable range of the operand D

The settable range of the operand **D** varies depending on the model and system register No. 0 (setting of the program area size).

Model	System register No. 0 Setting of program area size	Settable range
C14	16 (Fixed)	DT0 to DT10240
C30 / C60	24	DT0 to DT63488

10.12 F12 ICRD (F-ROM Read)

Model	System register No. 0 Setting of program area size	Settable range
	32	DT0 to DT30720
	40	DT0 to DT10240

■ Example of operation

Operation of instruction format description program

When the execution condition R0 is ON, 10 blocks of data starting from block 0 is transferred from the F-ROM to data registers DT0 to DT20479.

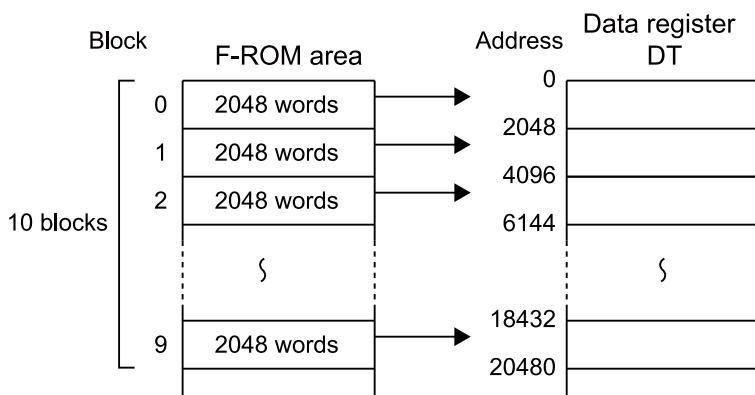

■ Precautions for programming

- Since the initial data of the F-ROM is indeterminate, be careful when reading data from the F-ROM when no data is written yet.

■ Flag operations

Name	Description
R9007	Turns ON when the address specified by [S1] is not in the F-ROM area.
R9008	Turns ON when the value specified by [S2] exceeds the range of the F-ROM area.
(ER)	Turns ON when the area is exceeded at the time when the blocks specified by [D] onwards are transferred.

10.13 P13 ICWT (F-ROM Write)

Transfer specified data to the F-ROM area.

■ Instruction format

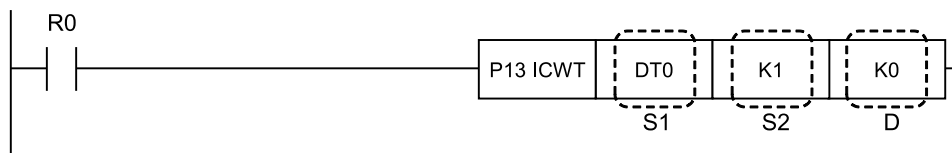

■ Operands

Items	Settings
S1	Starting number of the area storing written data
S2	Number of writing blocks (settable range: K1)
D	Starting number of the write destination (settable range: K0 to K31) of the F-ROM area

■ Devices that can be specified (indicated by ●)

Operand	WX	WY	WR	WL	SV	EV	DT	LD	I	SW R	SD T	Constant				Index modifier	Integer Device
												K	H	M	f		
S1							●										
S2												●					
D												●					

■ Outline of operation

From

Transfers data starting with the address specified by **S1** in the data register for the blocks specified by **S2**.

To

Transfers to the memory area starting with the block specified by **D** in the F-ROM.

Transfer units

Data is transferred by the following units.

Data to be transferred per block: 2048 words

■ Settable range of the operand S1

The settable range of the operand **S1** varies depending on the model and system register No. 0 (setting of the program area size).

Model	System register No. 0 Setting of program area size	Settable range
C14	16 (Fixed)	DT0 to DT10240
C30 / C60	24	DT0 to DT63488

10.13 P13 ICWT (F-ROM Write)

Model	System register No. 0 Setting of program area size	Settable range
	32	DT0 to DT30720
	40	DT0 to DT10240

■ Example of operation

Operation of instruction format description program

When the execution condition R0 is ON, data of one block (2,048 words) is transferred to block 0 in the F-ROM area.

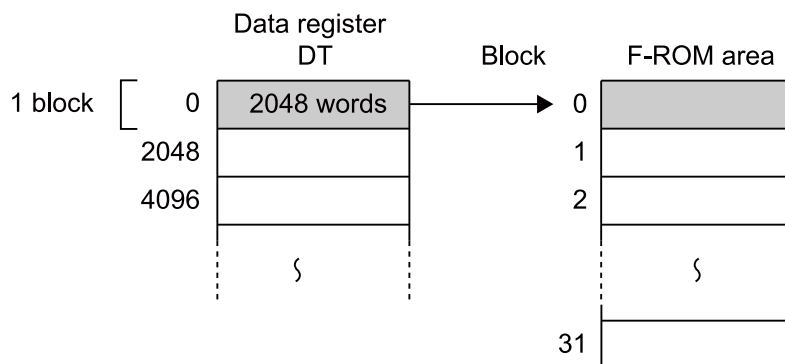

■ Precautions for programming

- The number of blocks that can be written is only one.
- The instruction operation time is approx. 100 ms max. When writing multiple blocks, divide them into multiple scans.
- Data can be written to F-ROM up to 10000 times.
- This instruction is differential execution type (P13) to prevent a large number of write operations to F-ROM due to program mistakes
- When creating a program, be careful that write operations to F-ROM are not repeatedly performed.
- Do not use it in interrupt programs.

■ Flag operations

Name	Description
R9007	Turns ON when the area is exceeded at the time when the blocks specified by [S1] onwards are transferred.
R9008	Turns ON when the number of blocks specified by [S2] is other than one.
(ER)	Turns ON when the address specified by [D] is not in the F-ROM area.

10.14 F15 XCH (16-bit data exchange)

Exchanges 16-bit data of two areas.

■ Instruction format

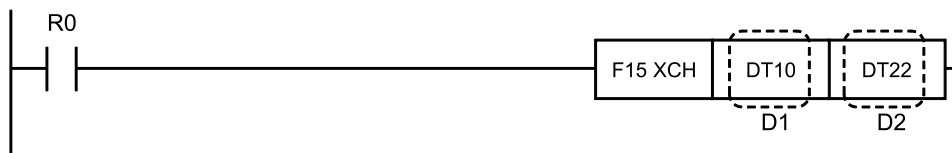

■ Operands

Items	Settings
D1	Area that stores the 16-bit data to exchange with D2
D2	Area that stores the 16-bit data to exchange with D1

■ Devices that can be specified (indicated by ●)

Operands	WX	WY	WR	WL	SV	EV	DT	LD	I	SWR	SDT	Constant				Index modifier	Integer Device
												K	H	M	f		
D1		●	●	●	●	●	●	●	●							●	
D2		●	●	●	●	●	●	●	●							●	

■ Outline of operation

Exchanges the data in the area specified by [D1] with that in the area specified by [D2].

■ Operation example

Operation of instruction format description program

The contents of data register DT10 and data register DT22 are exchanged when internal relay R0 turns ON.

10.14 F15 XCH (16-bit data exchange)

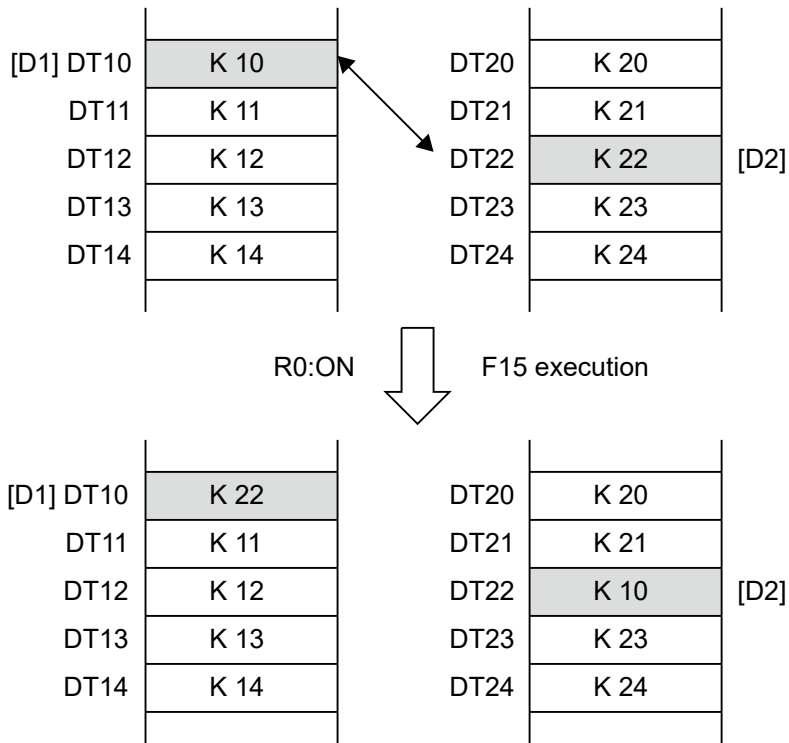

■ Flag operations

Name	Description
R9007 R9008 (ER)	Turns ON when the area is exceeded in index modification.

10.15 F16 DXCH (32-bit data exchange)

Exchanges the 32-bit data of two areas.

■ Instruction format

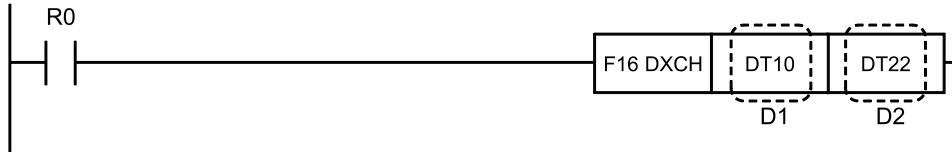

■ Operands

Items	Settings
D1	Area storing the 32-bit data to be exchanged with D2
D2	Area storing the 32-bit data to be exchanged with D1

■ Devices that can be specified (indicated by ●)

Operands	WX	WY	WR	WL	SV	EV	DT	LD	I	SWR	SDT	Constant				Index modifier	Integer Device
												K	H	M	f		
D1		●	●	●	●	●	●	●	●							●	
D2		●	●	●	●	●	●	●	●							●	

■ Outline of operation

The first two words of the content (32-bit) at the start of the area specified by [D1] are exchanged with the first two words of the content (32-bit) at the start of the area specified by [D2].

■ Operation example

Operation of instruction format description program

When internal relay R0 turns ON, the data in data registers DT10 and DT11 is exchanged with the data in data registers DT22 and DT23.

10.15 F16 DXCH (32-bit data exchange)

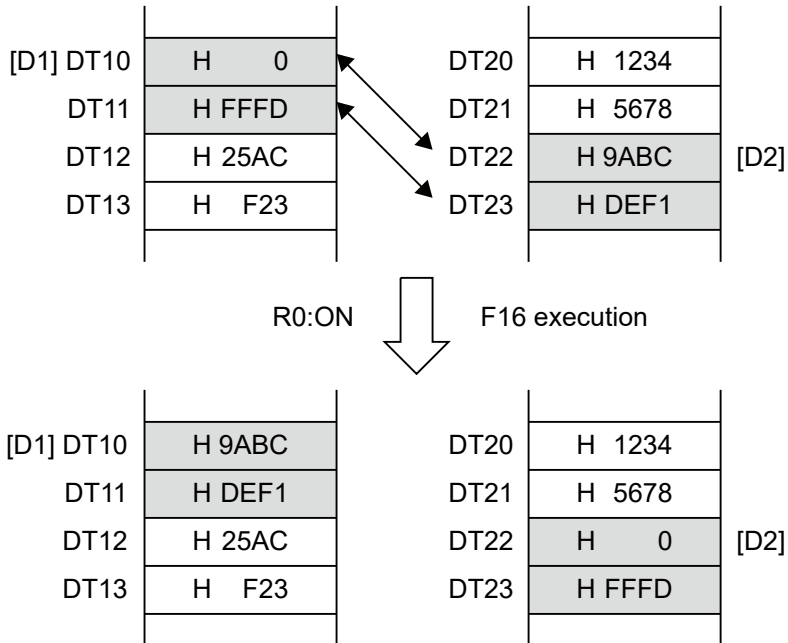

■ Flag operations

Name	Description
R9007 R9008 (ER)	Turns ON when the area is exceeded in index modification.

10.16 F17 SWAP (Higher/Lower Byte Exchange in 16-Bit Data)

Exchanges higher (8-bit) and lower (8-bit) order bytes in 16-bit data.

■ **Instruction format**

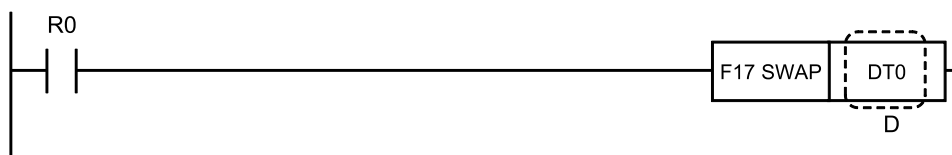

■ **Operands**

Items	Settings
D	Area storing 16-bit data for higher 8-bit and lower 8-bit exchange

■ **Devices that can be specified (indicated by ●)**

Operands	WX	WY	WR	WL	SV	EV	DT	LD	I	SWR	SDT	Constant				Index modifier	Integer Device
												K	H	M	f		
D		●	●	●	●	●	●	●	●							●	

■ **Outline of operation**

Exchanges the higher and lower order bytes of the 16-bit data stored in the area specified by [D].

■ **Operation example**

Operation of instruction format description program

The higher and lower bytes stored in data register DT0 are exchanged when internal relay R0 turns ON.

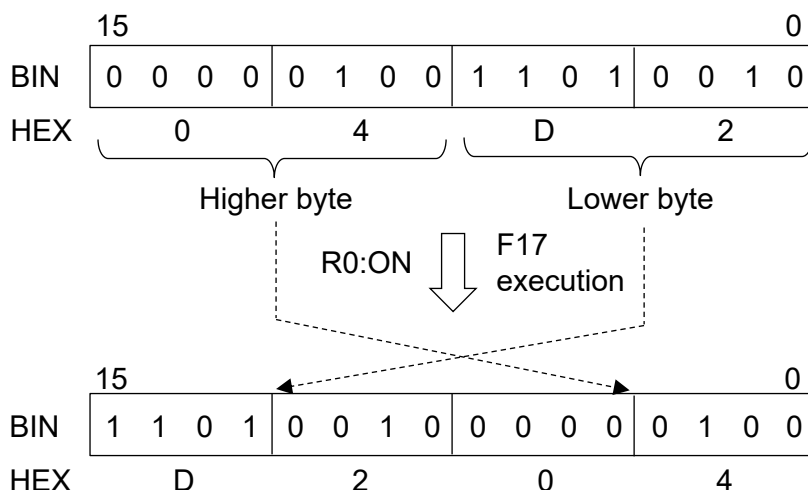

10.16 F17 SWAP (Higher/Lower Byte Exchange in 16-Bit Data)

■ Flag operations

Name	Description
R9007 R9008 (ER)	Turns ON when the area is exceeded in index modification.

10.17 F18 BXCH (Block Exchange)

Exchanges data in blocks.

■ Instruction format

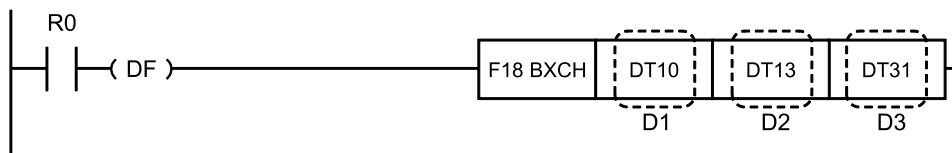

■ Operands

Items	Settings
D1	Starting address for exchange block 1
D2	Ending address for exchange block 1
D3	Starting address for exchange block 2

■ Devices that can be specified (indicated by ●)

Operands	WX	WY	WR	WL	SV	EV	DT	LD	I	SW R	SD T	Constant				Index modifier	Integer Device
												K	H	M	f		
D1		●	●	●	●	●	●	●	●							●	
D2		●	●	●	●	●	●	●	●							●	
D3		●	●	●	●	●	●	●	●							●	

■ Outline of operation

Exchanges the data from the area specified in [D1] to the area specified in [D2] with the data in the area starting at [D3].

■ Precautions for programming

- Specify the same type of memory address for [D1] and [D2].
- Specify the number of the lower address with [D1], and the number of the higher address with [D2].
If specified as [D1] > [D2], an operation error will occur when the instruction is executed.
- If the blocks to be exchanged overlap, they cannot be exchanged correctly. However, an error will not occur.

■ Operation example

Operation of instruction format description program

When the execution condition R0 is ON, data is exchanged between data registers DT10 to DT13 and DT31 to DT34.

10.17 F18 BXCH (Block Exchange)

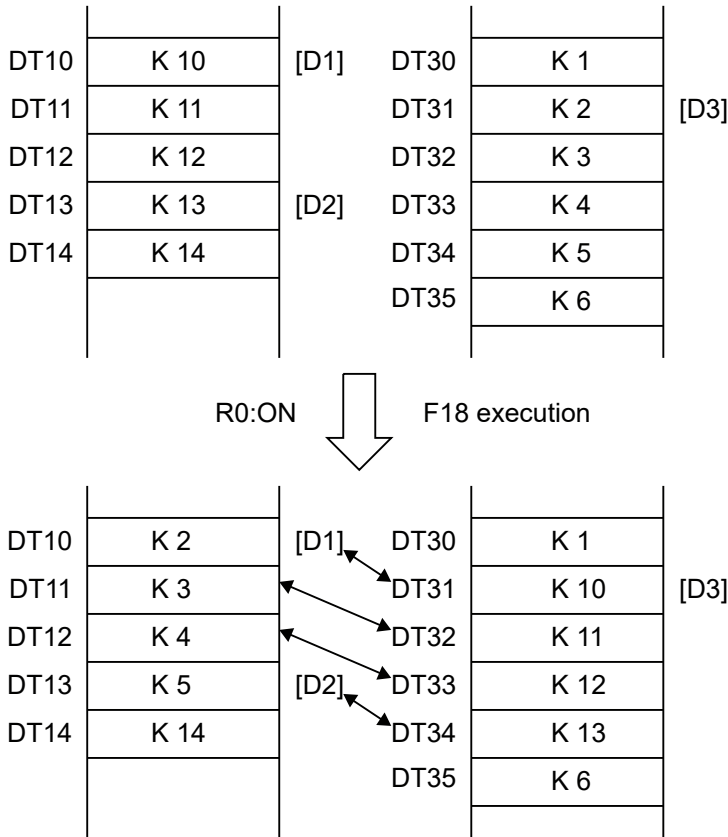

■ Flag operations

Name	Description
R9007	Turns ON when the area is exceeded in index modification.
R9008	Turns ON when [D1] > [D2]
(ER)	Turns ON when area is exceeded when exchanging blocks specified in [D3] or higher

10.18 F190 MV3 (16-Bit 3-Data Batch Transfer)

Three 16-bit data items are batch-transferred from the specified area number.

■ Instruction format

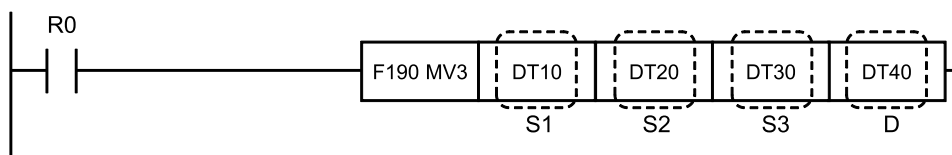

■ Operands

Items	Settings
S1	Area storing the hexadecimal data or constant data
S2	Area storing the hexadecimal data or constant data
S3	Area storing the hexadecimal data or constant data
D	Starting address of the data transfer destination area (three words)

■ Devices that can be specified (indicated by ●)

Operands	WX	WY	WR	WL	SV	EV	DT	LD	I	SWR	SDT	Constant				Index modifier	Integer Device
												K	H	M	f		
S1	●	●	●	●	●	●	●	●	●			●	●			●	
S2	●	●	●	●	●	●	●	●	●			●	●			●	
S3	●	●	●	●	●	●	●	●	●			●	●			●	
D		●	●	●	●	●	●	●	●							●	

■ Outline of operation

The three types of 16-bit data in the memory areas specified by [S1], [S2], and [S3] are batch-transferred to the memory area (three words) specified by [D].

■ Operation example

Operation of instruction format description program

When internal relay R0 turns ON, the content of data register DT10 is transferred to DT40, the content of DT20 is transferred to DT41, and the content of DT30 is transferred to DT42, in a batch.

10.18 F190 MV3 (16-Bit 3-Data Batch Transfer)

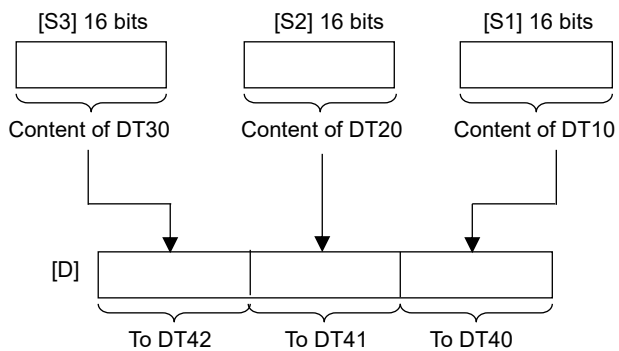

■ Related instructions

Use the F87 MV2 instruction when batch-transferring two types of 16-bit data.

■ Flag operations

Name	Description
R9007 R9008 (ER)	Turns ON when the area is exceeded in index modification.

10.19 F191 DMV3 (32-Bit 3-Data Batch Transfer)

Three 32-bit data items are batch-transferred from the specified area number.

■ Instruction format

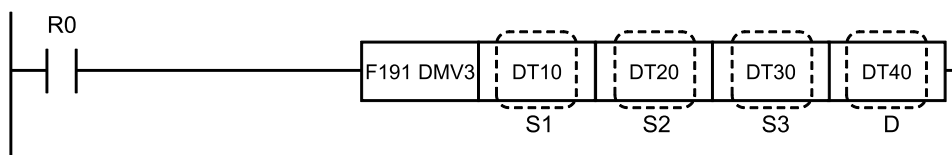

■ Operands

Items	Settings
S1	Area storing 32-bit data, or constant data
S2	Area storing 32-bit data, or constant data
S3	Area storing 32-bit data, or constant data
D	Starting address of the data transfer destination area (six words)

■ Devices that can be specified (indicated by ●)

Operands	WX	WY	WR	WL	SV	EV	DT	LD	I	SWR	SDT	Constant				Index modifier	Integer Device
												K	H	M	f		
S1	●	●	●	●	●	●	●	●	●			●	●			●	
S2	●	●	●	●	●	●	●	●	●			●	●			●	
S3	●	●	●	●	●	●	●	●	●			●	●			●	
D		●	●	●	●	●	●	●	●							●	

■ Outline of operation

The three types of 32-bit data in the memory areas specified by [S1], [S2], and [S3] are batch-transferred to the memory area (six words) specified by [D].

■ Operation example

Operation of instruction format description program

When internal relay R0 turns ON, the combined 32-bit content of data registers DT10 and DT11, data registers DT20 and DT21, and data registers DT30 and DT31 is batch-transferred to the 6-word area starting from data register DT40.

10.19 F191 DMV3 (32-Bit 3-Data Batch Transfer)

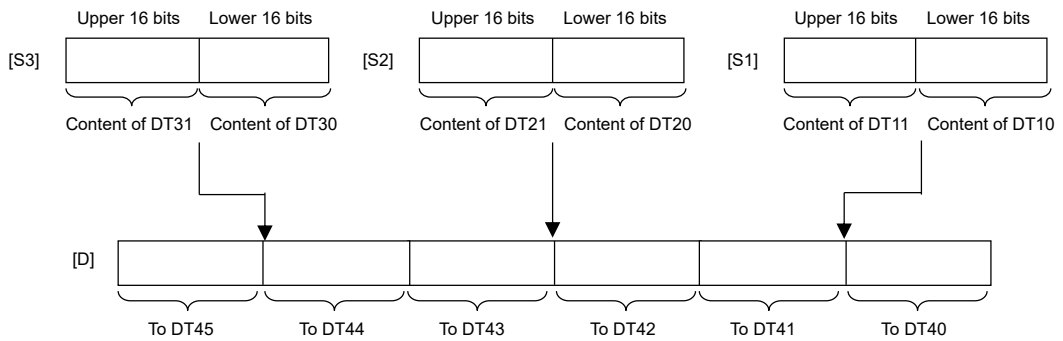

■ Related instructions

Use the F8 DMV2 instruction when batch-transferring two types of 32-bit data.

■ Flag operations

Name	Description
R9007 R9008 (ER)	Turns ON when the area is exceeded in index modification.

11 Binary Arithmetic Instructions

11.1 F20 + (16-Bit Addition)	11-2
11.2 F21 D+ (32-bit Addition).....	11-4
11.3 F22 + [16-bit addition (storage destination can be specified)]	11-6
11.4 F23 D+ [32-bit addition (storage destination can be specified)]	11-8
11.5 F25 - (16-bit Subtraction)	11-10
11.6 F26 D- (32-bit subtraction)	11-13
11.7 F27 - [16-bit Subtraction (Storage Destination Specifiable)]	11-15
11.8 F28 D- [32-Bit Subtraction (Can Specify Storage Destination)]	11-18
11.9 F30 * (Hexadecimal Multiplication).....	11-20
11.10 F31 D* (32-Bit Data Multiplication).....	11-22
11.11 F32 % (16-Bit Data Division)	11-24
11.12 F33 D% (32-Bit Data Division)	11-26
11.13 F34 *W [16-bit data multiplication (resulting in one word)].....	11-28
11.14 F35 +1 [16-bit increment (+1)].....	11-30
11.15 F36 D+1 [32-Bit Increment (+1)]	11-32
11.16 F37 -1 [16-Bit Decrement (-1)]	11-34
11.17 F38 D-1 [32-bit decrement (-1)].....	11-36
11.18 F39 D*D [32-Bit Data Multiplication (Result in Two Words)]	11-38

11.1 F20 + (16-Bit Addition)

11.1 F20 + (16-Bit Addition)

16-bit data is added.

■ Instruction format

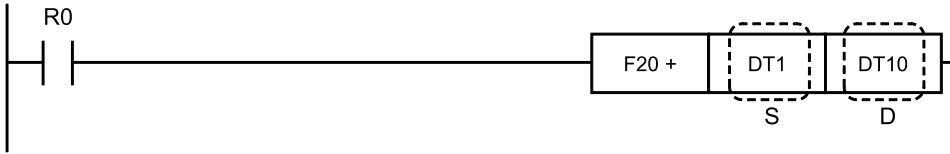

■ Operands

Items	Settings
S	Area storing the 16-bit data to be added, or constant data
D	Area storing the data (16-bit) to be added

■ Devices that can be specified (indicated by ●)

Operand s	WX	WY	WR	WL	SV	EV	DT	LD	I	SW R	SD T	Constant				Index modifier	Integer Device
												K	H	M	f		
S	●	●	●	●	●	●	●	●	●	●	●	●	●		●		
D		●	●	●	●	●	●	●	●						●		

■ Outline of operation

- The 16-bit data specified in [S] is added to the 16-bit data representing the decimal specified in [D].
 $(D) + (S) \rightarrow (D)$

■ Operation example

Operation of instruction format description program

When internal relay R0 turns ON, the content of data register DT10 is added to the content of data register DT1. When the decimal number 4 is in DT1, and 8 is in DT10, it will be as follows.

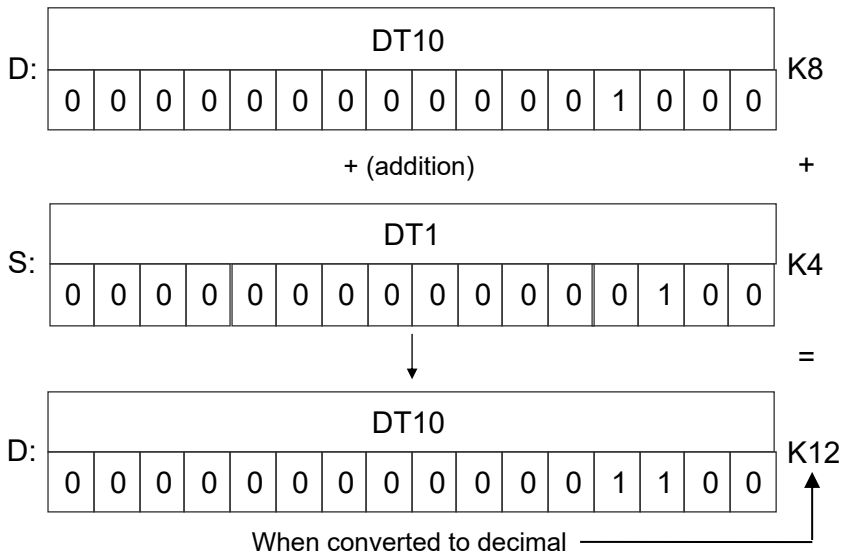

■ Precautions for programming

- With arithmetic operation instructions, in the event that the operation result falls beyond the range of values that can be handled, either an overflow or underflow occurs.
- Under normal circumstances, do not allow an overflow or underflow to occur.
- If an overflow or underflow occurs, use the 32-bit operation instruction.
- Use the F89 EXT sign extension instruction to convert the 16-bit data into 32-bit data.
- If an overflow or underflow occurs, the CY flag (special internal relay R9009) turns ON.

■ Flag operations

Name	Description
R9007 R9008 (ER)	Turns ON when the area is exceeded in index modification.
R900B (=)	Turns ON when the calculation result is "0"
R9009 (CY)	Turns ON when operation result overflows/underflows

11.2 F21 D+ (32-bit Addition)

11.2 F21 D+ (32-bit Addition)

32-bit data is added.

■ Instruction format

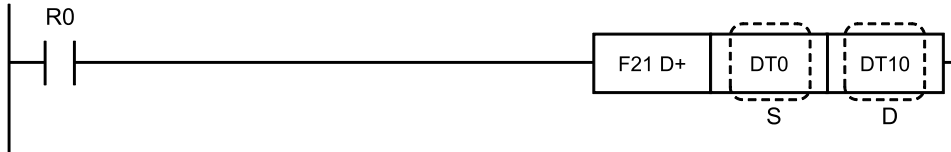

■ Operands

Items	Settings
S	Area storing the 32-bit data to be added, or constant data
D	Area storing the data (32-bit) to be added

■ Devices that can be specified (indicated by ●)

Operand s	WX	WY	WR	WL	SV	EV	DT	LD	I	SW R	SD T	Constant				Index modifier	Integer Device
												K	H	M	f		
S	●	●	●	●	●	●	●	●	●	●	●	●	●		●		
D		●	●	●	●	●	●	●	●						●		

■ Outline of operation

- The 32-bit data specified in [S] is added to the 32-bit data representing the decimal specified in [D].
 $(D+1, D) + (S+1, S) \rightarrow (D+1, D)$

■ Operation example

Operation of instruction format description program

When the internal relay R0 is ON, the content (32-bit) of data registers DT10 to DT11 is added to the content (32-bit) of data registers DT0 to DT1.

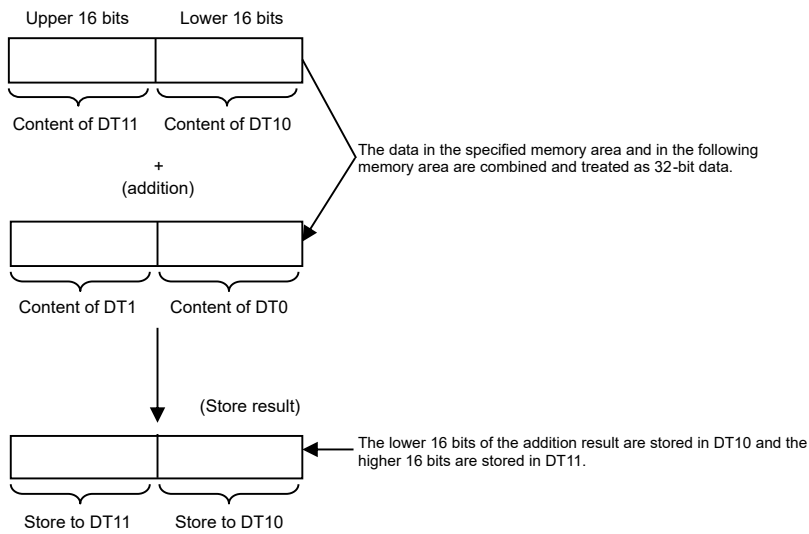

■ Precautions for programming

- With arithmetic operation instructions, in the event that the operation result falls beyond the range of values that can be handled, either an overflow or underflow occurs.
- Ensure that overflows and underflows do not occur in normal circumstances.
- If an overflow or underflow occurs, the CY flag (special internal relay R9009) turns ON.

■ Flag operations

Name	Description
R9007 R9008 (ER)	Turns ON when the area is exceeded in index modification.
R900B (=)	Turns ON when the calculation result is "0"
R9009 (CY)	Turns ON when operation result overflows/underflows

11.3 F22 + [16-bit addition (storage destination can be specified)]

11.3 F22 + [16-bit addition (storage destination can be specified)]

This is an instruction that adds 16-bit data.

■ Instruction format

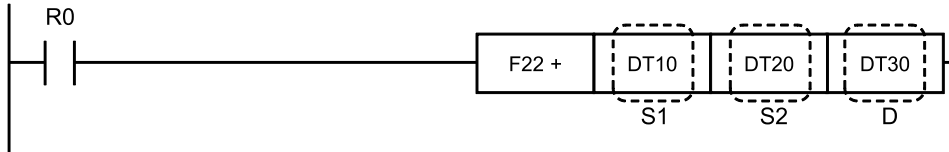

■ Operands

Items	Settings
S1	Area storing the 16-bit data to be added, or constant data
S2	Area storing the 16-bit data to be added, or constant data
D	Area storing the addition results

■ Devices that can be specified (indicated by ●)

Operands	WX	WY	WR	WL	SV	EV	DT	LD	I	SWR	SDT	Constant				Index modifier	Integer Device
												K	H	M	f		
S1	●	●	●	●	●	●	●	●	●	●	●	●	●	●	●	●	
S2	●	●	●	●	●	●	●	●	●	●	●	●	●	●	●	●	
D		●	●	●	●	●	●	●	●							●	

■ Outline of operation

- The 16-bit data expressing a decimal number specified by [S1] and [S2] is added, and the result is stored in [D].
(S1) + (S2) → (D)

■ Operation example

Operation of instruction format description program

When internal relay R0 turns ON, the contents of data register DT10 and data register DT20 are added together, and the result is stored in data register DT30. If DT10 contains decimal 8 and DT20 contains decimal 4, the result is as follows.

11.3 F22 + [16-bit addition (storage destination can be specified)]

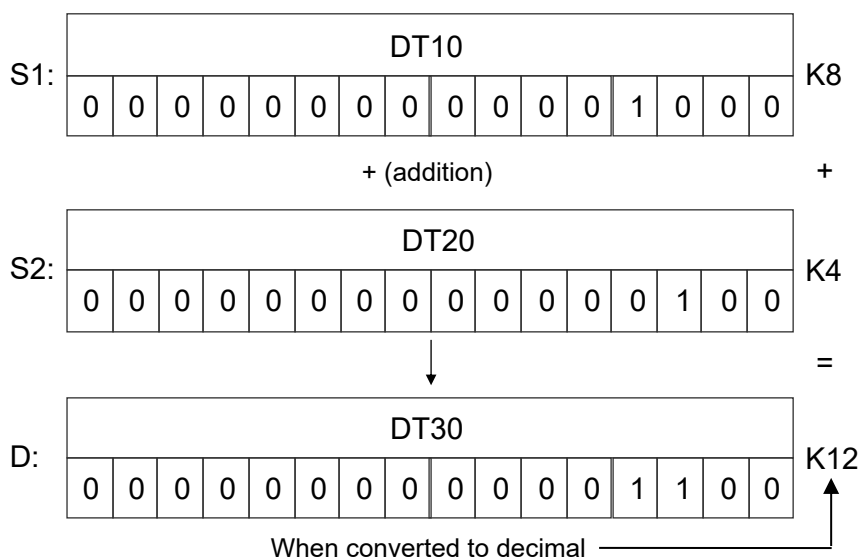

■ Precautions for programming

- With arithmetic operation instructions, in the event that the operation result falls beyond the range of values that can be handled, either an overflow or underflow occurs.
- Under normal circumstances, do not allow an overflow or underflow to occur.
- If an overflow or underflow occurs, use the 32-bit operation instruction.
- Use the F89 EXT sign extension instruction to convert the 16-bit data into 32-bit data.
- If an overflow or underflow occurs, the CY flag (special internal relay R9009) turns ON.

■ Flag operations

Name	Description
R9007 R9008 (ER)	Turns ON when the area is exceeded in index modification.
R900B (=)	Turns ON when the calculation result is "0"
R9009 (CY)	Turns ON when operation result overflows/underflows

11.4 F23 D+ [32-bit addition (storage destination can be specified)]

11.4 F23 D+ [32-bit addition (storage destination can be specified)]

This is an instruction that adds 32-bit data.

■ Instruction format

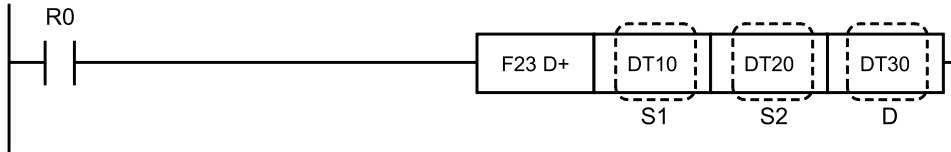

■ Operands

Items	Settings
S1	Area storing the 32-bit data to be added, or constant data
S2	Area storing the 32-bit data to be added, or constant data
D	Area storing the addition results

■ Devices that can be specified (indicated by ●)

Operands	WX	WY	WR	WL	SV	EV	DT	LD	I	SW R	SD T	Constant				Index modifier	Integer Device
												K	H	M	f		
S1	●	●	●	●	●	●	●	●	●	●	●	●	●	●	●		
S2	●	●	●	●	●	●	●	●	●	●	●	●	●	●	●		
D		●	●	●	●	●	●	●	●							●	

■ Outline of operation

- The 32-bit data expressing a decimal number specified by [S1] and [S2] is added, and the result is stored in [D].
 $(S1+1, S1) + (S2+1, S2) \rightarrow (D+1, D)$
- The memory area is specified by the memory area number of the lower 16-bit portion.

■ Operation example

Operation of instruction format description program

When internal relay R0 turns ON, the contents of data registers DT10 and DT11 are added to the contents of data registers DT20 and DT21, and the result is stored in data registers DT30 and DT31.

11.4 F23 D+ [32-bit addition (storage destination can be specified)]

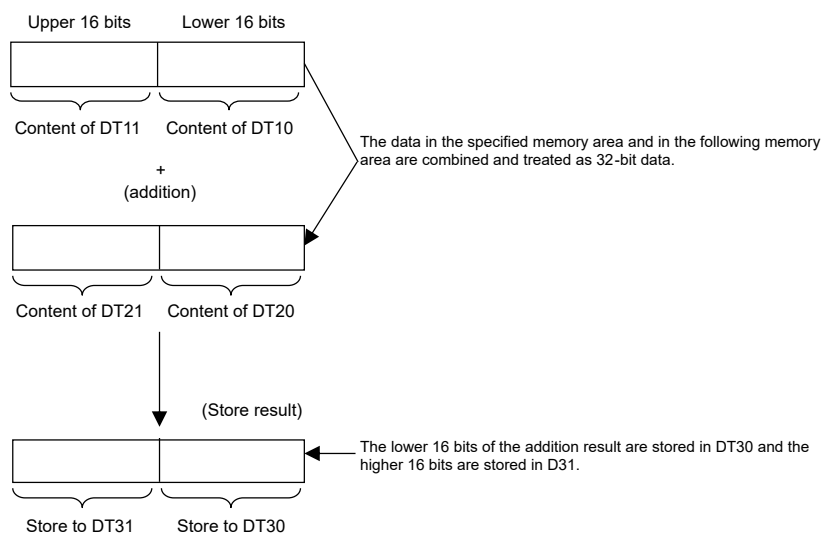

■ Precautions for programming

- With arithmetic operation instructions, in the event that the operation result falls beyond the range of values that can be handled, either an overflow or underflow occurs.
- Ensure that overflows and underflows do not occur in normal circumstances.
- If an overflow or underflow occurs, the CY flag (special internal relay R9009) turns ON.

■ Flag operations

Name	Description
R9007 R9008 (ER)	Turns ON when the area is exceeded in index modification.
R900B (=)	Turns ON when the calculation result is "0"
R9009 (CY)	Turns ON when operation result overflows/underflows

11.5 F25 - (16-bit Subtraction)

11.5 F25 - (16-bit Subtraction)

16-bit data is subtracted.

■ Instruction format

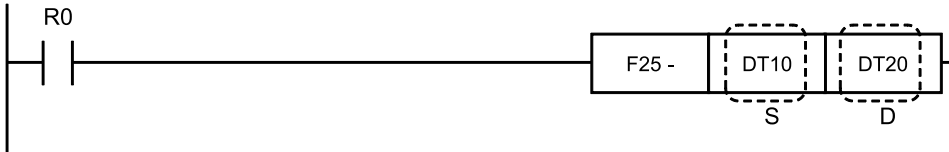

■ Operands

Items	Settings
S	Area storing the subtrahend (16-bit data), or constant data
D	Area storing the subtrahend from (16-bit data)

■ Devices that can be specified (indicated by ●)

Operand s	WX	WY	WR	WL	SV	EV	DT	LD	I	SW R	SD T	Constant				Index modifier	Integer Device
												K	H	M	f		
S	●	●	●	●	●	●	●	●	●	●	●	●	●	●	●	●	
D		●	●	●	●	●	●	●	●						●		

■ Outline of operation

- The 16-bit data specified by [S] is subtracted from the 16-bit decimal data specified by [D].
(D) - (S) -> (D)

■ Operation example

Operation of instruction format description program

Subtracts the contents of data register DT10 from the contents of data register DT20 when internal relay R0 turns ON.

Specific Example 1) When the decimal number 16 is in DT20 and the decimal number 4 is in DT10

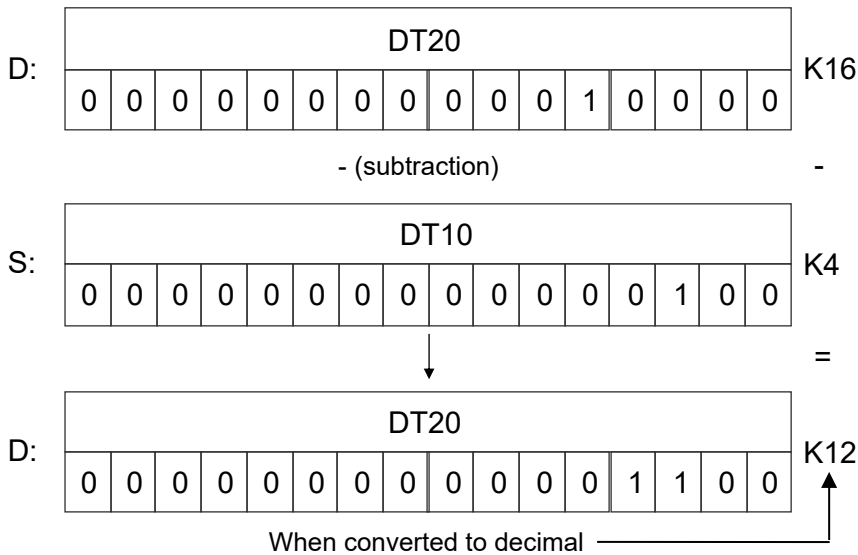

Specific Example 2) When the decimal number 3 is in DT20 and the decimal number 5 is in DT10

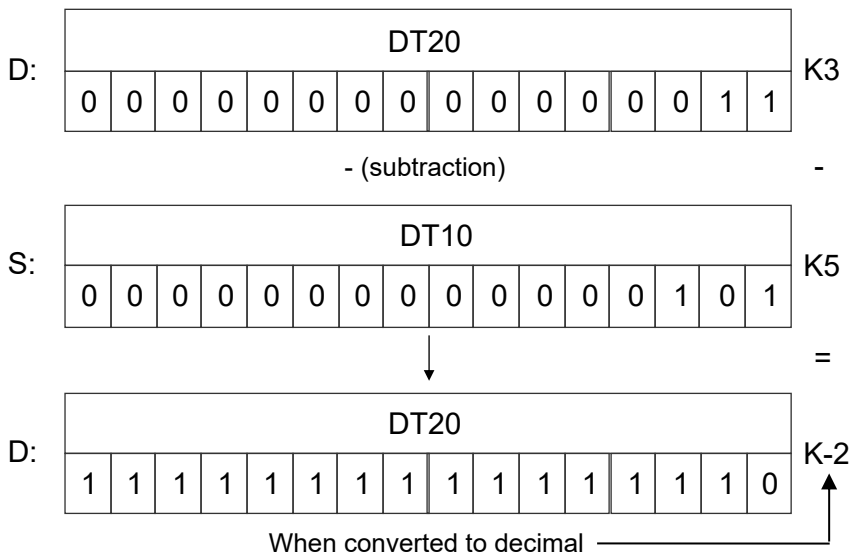

■ **Precautions for programming**

- With arithmetic operation instructions, in the event that the operation result falls beyond the range of values that can be handled, either an overflow or underflow occurs.
- Under normal circumstances, do not allow an overflow or underflow to occur.
- If an overflow or underflow occurs, use the 32-bit operation instruction.
- Use the F89 EXT sign extension instruction to convert the 16-bit data into 32-bit data.
- If an overflow or underflow occurs, the CY flag (special internal relay R9009) turns ON.

11.5 F25 - (16-bit Subtraction)

■ Flag operations

Name	Description
R9007 R9008 (ER)	Turns ON when the area is exceeded in index modification.
R900B (=)	Turns ON when the calculation result is "0"
R9009 (CY)	Turns ON when operation result overflows/underflows

11.6 F26 D- (32-bit subtraction)

Subtracts 32-bit data.

■ Instruction format

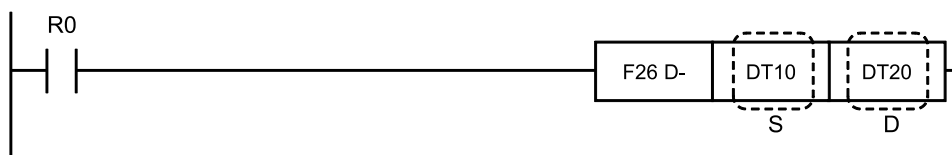

■ Operands

Items	Settings
S	Area that stores subtrahends (32-bit data), or constant data
D	Area storing the number to be subtracted (32-bit data)

■ Devices that can be specified (indicated by ●)

Operand s	WX	WY	WR	WL	SV	EV	DT	LD	I	SW R	SD T	Constant				Index modifier	Integer Device
												K	H	M	f		
S	●	●	●	●	●	●	●	●	●	●	●	●	●	●	●	●	
D		●	●	●	●	●	●	●	●							●	

■ Outline of operation

- The 32-bit data specified by [S] is subtracted from the 32-bit data expressing a decimal number specified by [D].
 $(D+1, D) - (S+1, S) \rightarrow (D+1, D)$

■ Operation example

Operation of instruction format description program

When internal relay R0 turns ON, the content of data registers DT10 and DT11 (32 bits) is subtracted from the content of data registers DT20 and DT21(32 bits).

11.6 F26 D- (32-bit subtraction)

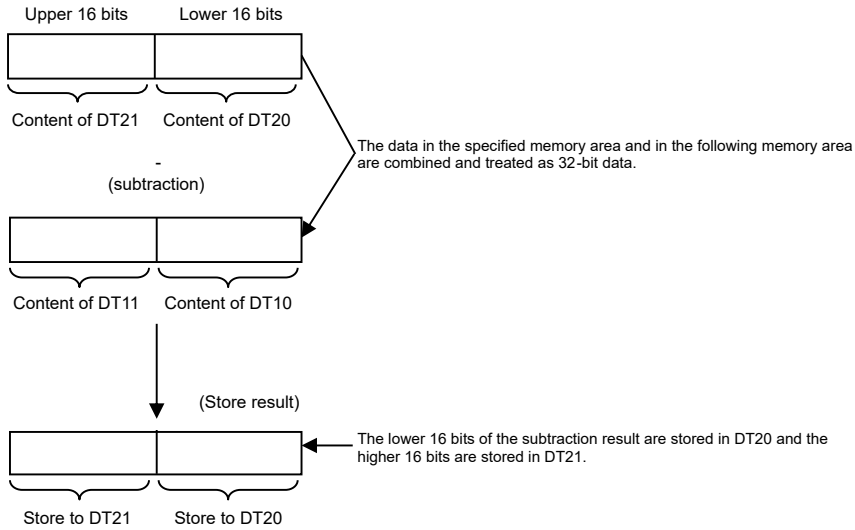

■ Precautions for programming

- With arithmetic operation instructions, in the event that the operation result falls beyond the range of values that can be handled, either an overflow or underflow occurs.
- Ensure that overflows and underflows do not occur in normal circumstances.
- If an overflow or underflow occurs, the CY flag (special internal relay R9009) turns ON.

■ Flag operations

Name	Description
R9007 R9008 (ER)	Turns ON when the area is exceeded in index modification.
R900B (=)	Turns ON when the calculation result is "0"
R9009 (CY)	Turns ON when operation result overflows/underflows

11.7 F27 - [16-bit Subtraction (Storage Destination Specifiable)]

16-bit data is subtracted.

■ **Instruction format**

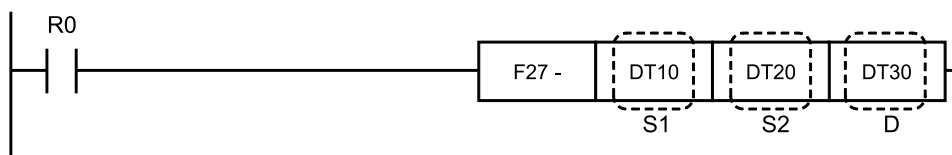

■ **Operands**

Items	Settings
S1	Area storing the number to be subtracted (16-bit data), or constant data
S2	Area storing the subtrahend (16-bit data), or constant data
D	Area that stores operation results

■ **Devices that can be specified (indicated by ●)**

Operands	WX	WY	WR	WL	SV	EV	DT	LD	I	SW R	SD T	Constant				Index modifier	Integer Device
												K	H	M	f		
S1	●	●	●	●	●	●	●	●	●	●	●	●				●	
S2	●	●	●	●	●	●	●	●	●	●	●	●				●	
D		●	●	●	●	●	●	●	●							●	

■ **Outline of operation**

- The 16-bit data specified in [S2] is subtracted from the 16-bit data representing the decimal of the memory area specified in [S1], and the result is stored in [D].
(S1) - (S2) → (D)

■ **Operation example**

Operation of instruction format description program

When the internal relay R0 is ON, the content of data register DT20 is subtracted from the content of data register D10, and the operation result is stored in data register DT30.

Example 1) If the decimal 16 is in DT10, and 4 is in DT20

11.7 F27 - [16-bit Subtraction (Storage Destination Specifiable)]

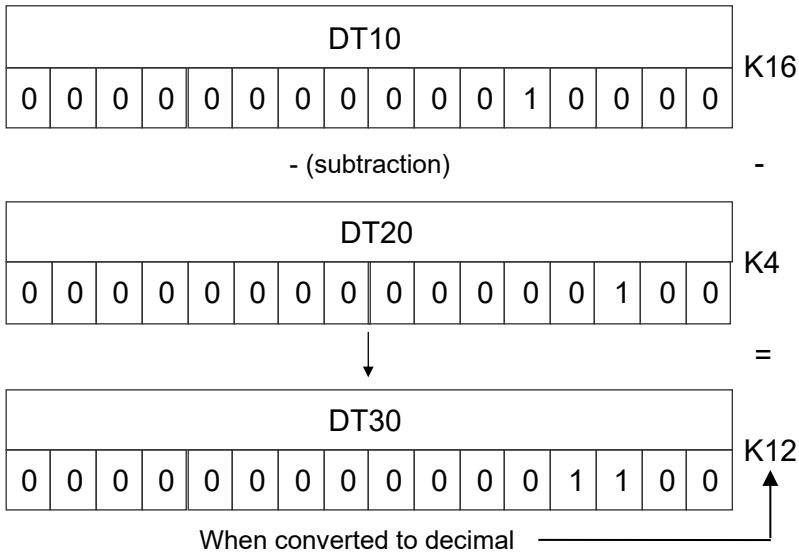

Example 2) If the decimal 3 is in DT10, and 5 is in DT20

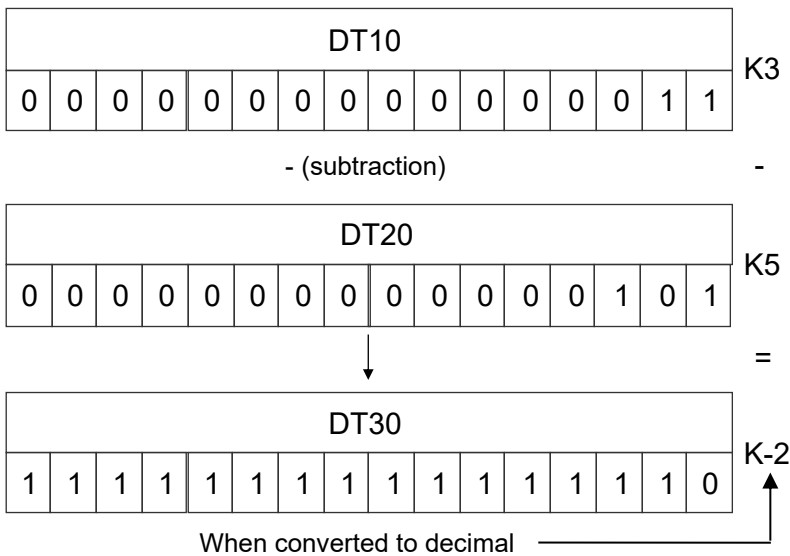

■ Precautions for programming

- With arithmetic operation instructions, in the event that the operation result falls beyond the range of values that can be handled, either an overflow or underflow occurs.
- Under normal circumstances, do not allow an overflow or underflow to occur.
- If an overflow or underflow occurs, use the 32-bit operation instruction.
- Use the F89 EXT sign extension instruction to convert the 16-bit data into 32-bit data.
- If an overflow or underflow occurs, the CY flag (special internal relay R9009) turns ON.

■ Flag operations

Name	Description
R9007 R9008 (ER)	Turns ON when the area is exceeded in index modification.
R900B (=)	Turns ON when the calculation result is "0"
R9009 (CY)	Turns ON when operation result overflows/underflows

11.8 F28 D- [32-Bit Subtraction (Can Specify Storage Destination)]

11.8 F28 D- [32-Bit Subtraction (Can Specify Storage Destination)]

Subtracts 32-bit data.

■ Instruction format

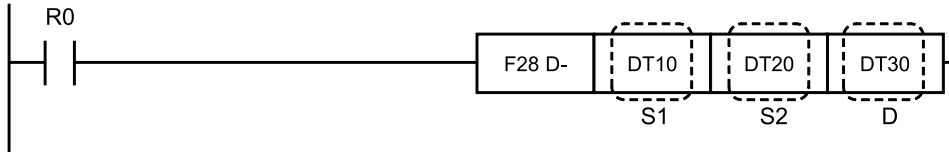

■ Operands

Items	Settings
S1	Area that stores minuends (32-bit data), or constant data
S2	Area that stores subtrahends (32-bit data), or constant data
D	Area that stores operation results

■ Devices that can be specified (indicated by ●)

Operands	WX	WY	WR	WL	SV	EV	DT	LD	I	SWR	SDT	Constant				Index modifier	Integer Device
												K	H	M	f		
S1	●	●	●	●	●	●	●	●	●	●	●	●	●	●	●		
S2	●	●	●	●	●	●	●	●	●	●	●	●	●	●	●		
D		●	●	●	●	●	●	●	●							●	

■ Outline of operation

- 32-bit data specified in [S2] is subtracted from the 32-bit data, representing a decimal, of the memory area specified in [S1], and the result is stored in [D].
 $(S1+1, S1) - (S2+1, S2) \rightarrow (D+1, D)$
- The memory area is specified by the memory area number of the lower 16-bit portion.

■ Operation example

Operation of instruction format description program

When the internal relay R0 is ON, the content of data registers DT20 to DT21 is subtracted from the content of DT10 to DT11, and the operation result is stored in DT30 to DT31.

11.8 F28 D- [32-Bit Subtraction (Can Specify Storage Destination)]

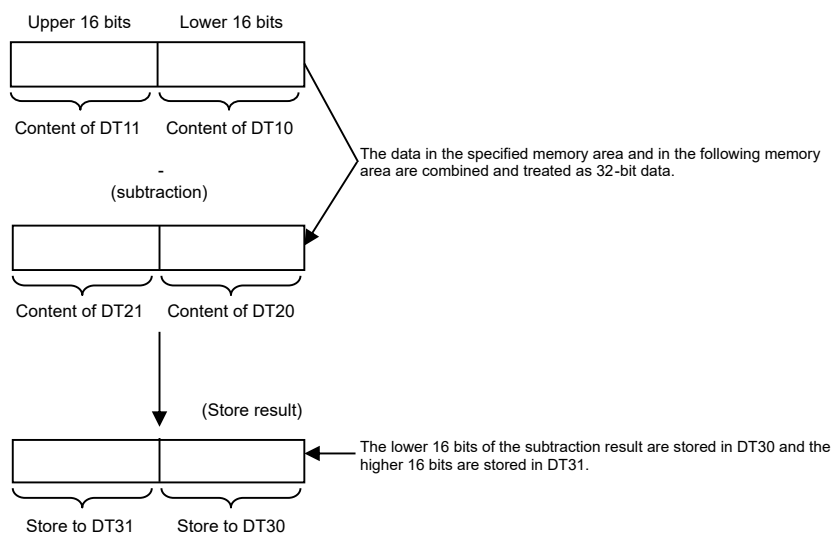

■ Precautions for programming

- With arithmetic operation instructions, in the event that the operation result falls beyond the range of values that can be handled, either an overflow or underflow occurs.
- Ensure that overflows and underflows do not occur in normal circumstances.
- If an overflow or underflow occurs, the CY flag (special internal relay R9009) turns ON.

■ Flag operations

Name	Description
R9007 R9008 (ER)	Turns ON when the area is exceeded in index modification.
R900B (=)	Turns ON when the calculation result is "0"
R9009 (CY)	Turns ON when operation result overflows/underflows

11.9 F30 * (Hexadecimal Multiplication)

11.9 F30 * (Hexadecimal Multiplication)

Multiplies hexadecimal data.

■ Instruction format

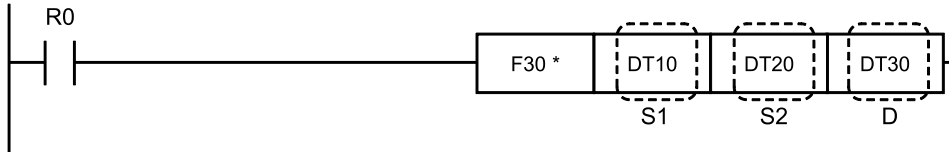

■ Operands

Items	Settings
S1	Area storing the hexadecimal data or constant data
S2	Area storing the hexadecimal data or constant data
D	Area storing the multiplication results (32-bit data)

■ Devices that can be specified (indicated by ●)

Operands	WX	WY	WR	WL	SV	EV	DT	LD	I	SW R	SD T	Constant				Index modifier	Integer Device
												K	H	M	f		
S1	●	●	●	●	●	●	●	●	●	●	●	●	●	●	●	●	
S2	●	●	●	●	●	●	●	●	●	●	●	●	●	●	●	●	
D		●	●	●	●	●	●	●	●							●	

■ Outline of operation

- Multiplies the hexadecimal data expressed in decimal form that is specified by [S1] with the hexadecimal data specified by [S2], and stores the result in the area specified by [D].
(S1) × (S2) → (D+1, D)
- The calculation result is stored using 32-bit data (K constant).
- Storage destination [D] is specified by the number of the memory area with the lower order 16 bits.

■ Operation example

Operation of instruction format description program

The contents of data registers DT10 and DT20 are multiplied and stored in data registers DT30 and DT31 when internal relay R0 turns ON. When 8 is in the decimal number in DT10 (K constant) and 2 is in the decimal number 4 in DT20.

11.9 F30 * (Hexadecimal Multiplication)

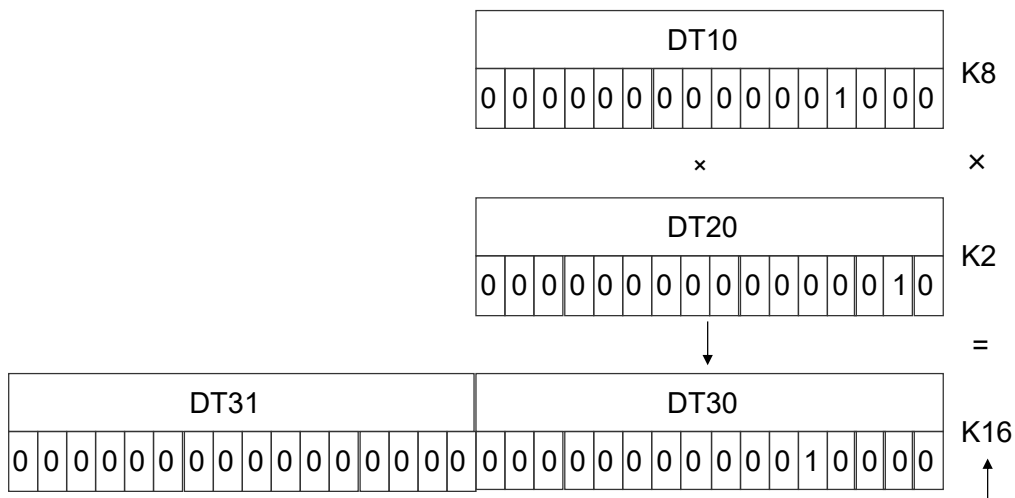

Of the 32-bit data multiplication results, the lower order 16 bits are stored in the specified memory area (DT30) and the higher order 16 bits is stored in the next area after the specified area (DT31).

■ Flag operations

Name	Description
R9007 R9008 (ER)	Turns ON when the area is exceeded in index modification.
R900B (=)	Turns ON when the calculation result is "0"

11.10 F31 D* (32-Bit Data Multiplication)

11.10 F31 D* (32-Bit Data Multiplication)

Multiplies 32-bit data items.

■ Instruction format

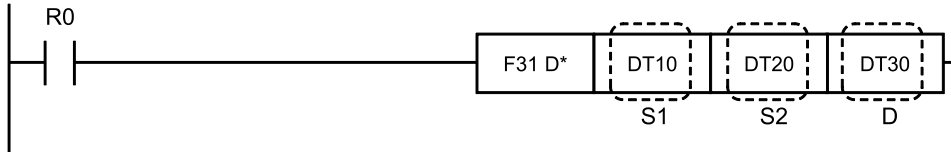

■ Operands

Items	Settings
S1	Multiplicand data: Area storing 32-bit data, or constant data
S2	Multiplier data: Area storing 32-bit data, or constant data
D	Storage destination: Area storing multiplication result (64-bit data)

■ Devices that can be specified (indicated by ●)

Operands	WX	WY	WR	WL	SV	EV	DT	LD	I	SWR	SDT	Constant				Index modifier	Integer Device
												K	H	M	f		
S1	●	●	●	●	●	●	●	●	●	●	●	●	●	●	●		
S2	●	●	●	●	●	●	●	●	●	●	●	●	●	●	●		
D		●	●	●	●	●	●	●								●	

■ Outline of operation

- Multiplies the 32-bit data representing decimal data specified by [S1] and the 32-bit data specified by [S2], and stores the result in the area specified by [D].
 $(S1+1, S1) \times (S2+1, S2) \rightarrow (D+3, D+2, D+1, D)$
- The calculation result is stored in the 64-bit area.
- The memory area is specified by the number of the lowest 16-bit memory area.

■ Operation example

Operation of instruction format description program

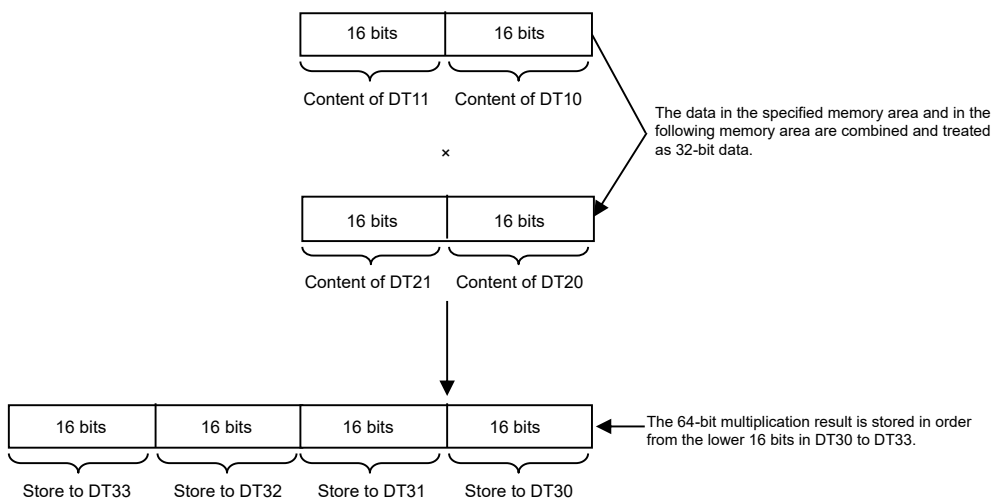

■ Flag operations

Name	Description
R9007 R9008 (ER)	Turns ON when the area is exceeded in index modification.
R900B (=)	Turns ON when the calculation result is "0"

11.11 F32 % (16-Bit Data Division)

11.11 F32 % (16-Bit Data Division)

Divides 16-bit data.

■ Instruction format

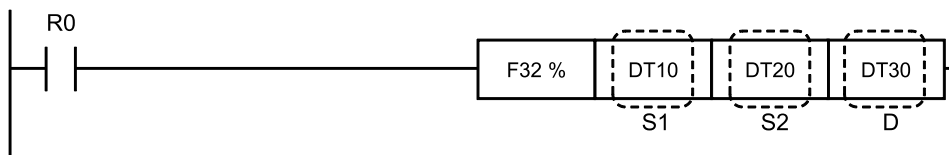

■ Operands

Items	Settings
S1	Dividend data: Area storing 16-bit data, or constant data
S2	Divisor data: Area storing 16-bit data, or constant data
D	Storage destination: Area storing the division result (quotient) (remainder stored as 16-bit data in DT90015)

■ Devices that can be specified (indicated by ●)

Operands	WX	WY	WR	WL	SV	EV	DT	LD	I	SW R	SD T	Constant				Index modifier	Integer Device
												K	H	M	f		
S1	●	●	●	●	●	●	●	●	●	●	●	●	●	●	●		
S2	●	●	●	●	●	●	●	●	●	●	●	●	●	●	●		
D		●	●	●	●	●	●	●	●						●		

■ Outline of operation

- The 16-bit data expressing a decimal specified by [S1] is divided by the 16-bit data specified by [S2]. The quotient is stored in [D], and the remainder is stored in special data register DT90015.

(S1) ÷ (S2) → Quotient (D) Remainder (DT90015)

■ Operation example

Operation of instruction format description program

When internal relay R0 turns ON, data register DT10 is divided by data register DT20, and the quotient is stored in DT30 and the remainder in DT90015. If the content in DT10 is decimal number (K constant) 15 and the content in DT20 is 4, the result is as follows.

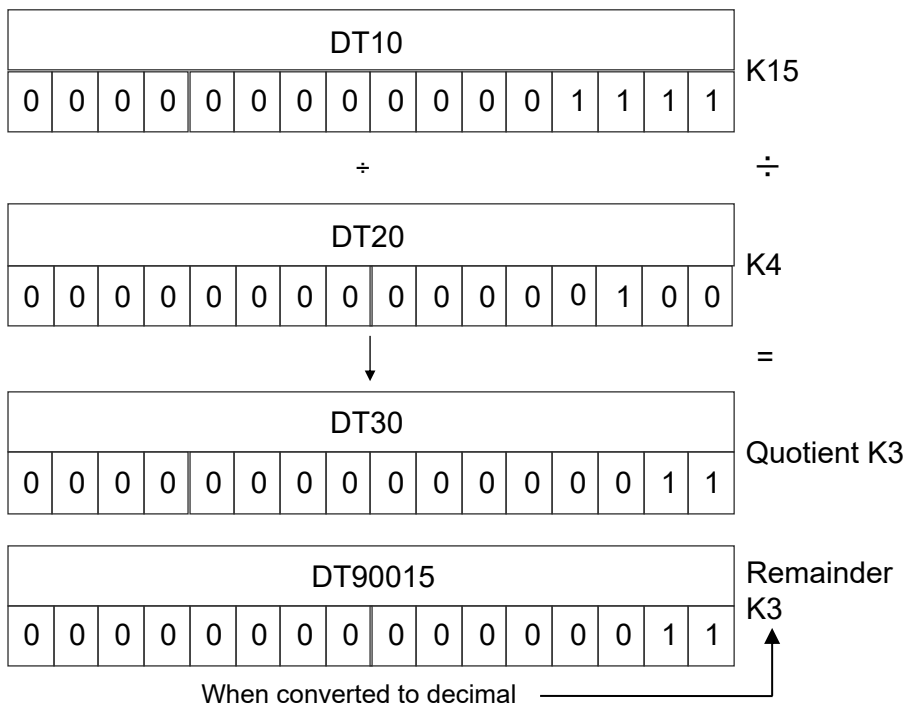

■ Flag operations

Name	Description
R9007	Turns ON when the area is exceeded in index modification.
R9008 (ER)	
R900B (=)	Turns ON when the calculation result is "0"
R9009 (CY)	Turns ON when the negative maximum value is divided by "-1"

11.12 F33 D% (32-Bit Data Division)

11.12 F33 D% (32-Bit Data Division)

Divides 32-bit data.

■ Instruction format

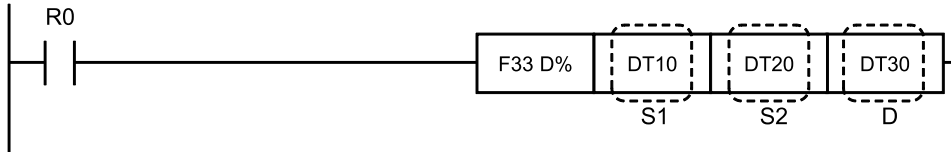

■ Operands

Items	Settings
S1	Dividend data: Area storing 32-bit data, or constant data
S2	Divisor data: Area storing 32-bit data, or constant data
D	Storage destination: Area storing the division result (quotient) (remainder stored as 32-bit data in DT90015 and DT90016)

■ Devices that can be specified (indicated by ●)

Operands	WX	WY	WR	WL	SV	EV	DT	LD	I	SWR	SDT	Constant				Index modifier	Integer Device
												K	H	M	f		
S1	●	●	●	●	●	●	●	●	●	●	●	●	●	●	●		
S2	●	●	●	●	●	●	●	●	●	●	●	●	●	●	●		
D		●	●	●	●	●	●	●	●						●		

■ Outline of operation

- The 32-bit data expressing a decimal specified by [S1] is divided by the 32-bit data specified by [S2]. The quotient is stored in [D], and the remainder is stored in special data registers DT90015 and DT90016.

$(S1 + 1, S1) \div (S2 + 1, S2) \rightarrow$ Quotient (D+1, D) Remainder (DT90016, DT90015)

- Memory area is specified by the memory area number of the lower order hexadecimal part.

■ Operation example

Operation of instruction format description program

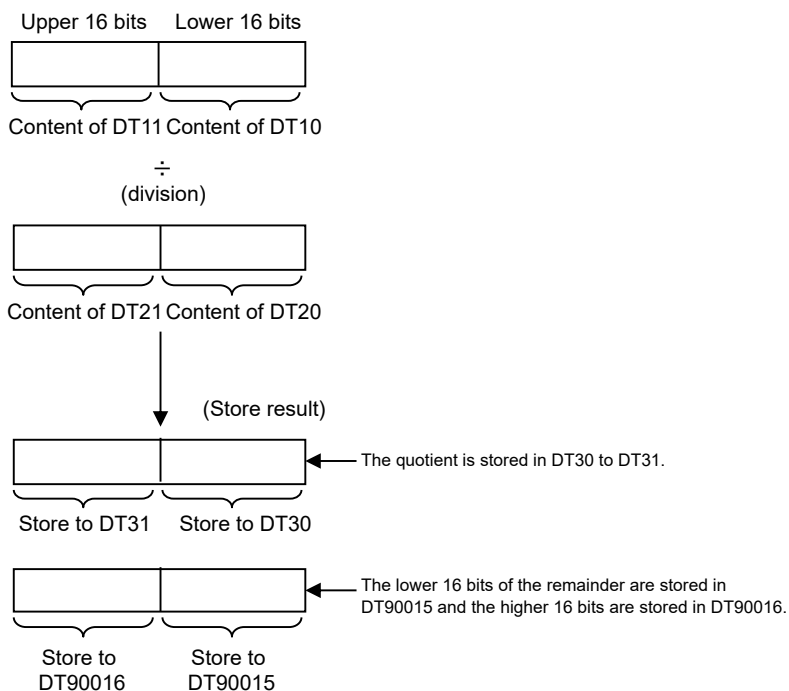

■ Flag operations

Name	Description
R9007	Turns ON when the area is exceeded in index modification.
R9008 (ER)	Turns ON when [S2] is "0"
R900B (=)	Turns ON when the calculation result is "0"
R9009 (CY)	Turns ON when the negative maximum value is divided by "-1"

11.13 F34 *W [16-bit data multiplication (resulting in one word)]

11.13 F34 *W [16-bit data multiplication (resulting in one word)]

Multiplies 16-bit data and stores the result in a 16-bit, one-word area.

■ Instruction format

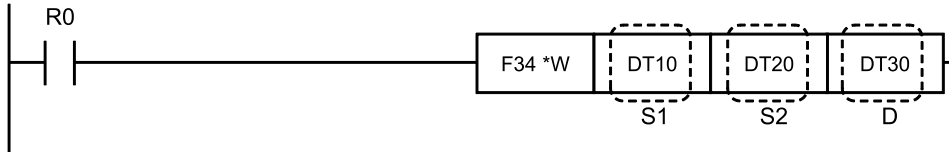

■ Operands

Items	Settings
S1	Area storing the hexadecimal data or constant data
S2	Area storing the hexadecimal data or constant data
D	Area storing multiplication result (16-bit data)

■ Devices that can be specified (indicated by ●)

Operands	WX	WY	WR	WL	SV	EV	DT	LD	I	SWR	SDT	Constant				Index modifier	Integer Device
												K	H	M	f		
S1	●	●	●	●	●	●	●	●	●	●	●	●	●		●		
S2	●	●	●	●	●	●	●	●	●	●	●	●	●		●		
D		●	●	●	●	●	●	●	●						●		

■ Outline of operation

- The 16-bit data specified by [S1] and the 16-bit data specified by [S2] are multiplied, and the result is stored in the area specified by [D].
(S1) x (S2) → (D)
- The operation result is stored as one word of 16-bit data.

■ Operation example

Operation of instruction format description program

When the DT10 content is decimal 8

11.13 F34 *W [16-bit data multiplication (resulting in one word)]



■ Precautions for programming

Keep the operation result [D] within the range of K-32768 to K32767.

■ Flag operations

Name	Description
R9007	Turns ON when the area is exceeded in index modification.
R9008 (ER)	Turns ON when the operation result exceeds 16 bits
R900B (=)	Turns ON when the calculation result is "0"

11.14 F35 +1 [16-bit increment (+1)]

11.14 F35 +1 [16-bit increment (+1)]

Adds 1 to 16-bit data.

■ Instruction format

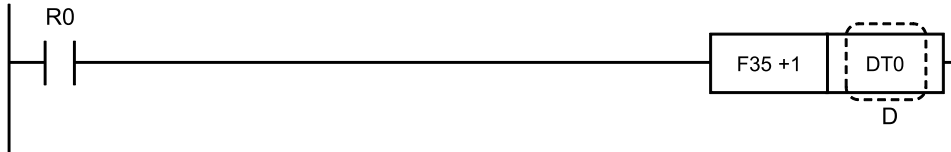

■ Operands

Items	Settings
D	Area to which 1 is to be added

■ Devices that can be specified (indicated by ●)

Operands	WX	WY	WR	WL	SV	EV	DT	LD	I	SWR	SDT	Constant				Index modifier	Integer Device
												K	H	M	f		
D		●	●	●	●	●	●	●	●							●	

■ Outline of operation

- 1 is added to the 16-bit data that expresses the decimal number specified by [D] and the result is stored in [D].
 $(D) + 1 \rightarrow (D)$

■ Operation example

Operation of instruction format description program

When internal relay R0 turns ON, 1 is added to the contents of data register DT0.

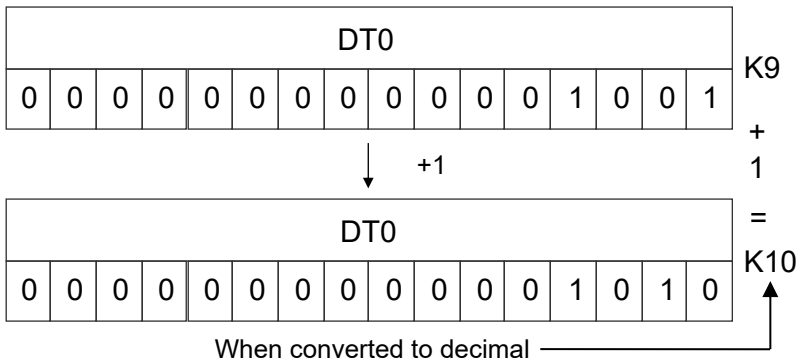

■ Precautions for programming

- With arithmetic operation instructions, in the event that the operation result falls beyond the range of values that can be handled, an overflow occurs.

- Ensure that overflows do not occur in normal circumstances.
- If an overflow occurs, use a 32-bit operation instruction.
- If an overflow occurs, the CY flag (special internal relay R9009) turns ON.

■ Flag operations

Name	Description
R9007 R9008 (ER)	Turns ON when the area is exceeded in index modification.
R900B (=)	Turns ON when the calculation result is "0"
R9009 (CY)	Turns ON when operation result overflows

11.15 F36 D+1 [32-Bit Increment (+1)]

11.15 F36 D+1 [32-Bit Increment (+1)]

Adds 1 to 32-bit data.

■ Instruction format

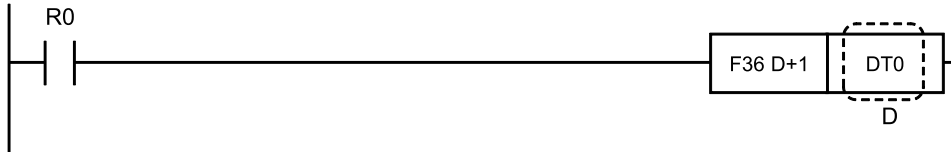

■ Operands

Items	Settings
D	The area (32-bit) that +1 is added to

■ Devices that can be specified (indicated by ●)

Operands	WX	WY	WR	WL	SV	EV	DT	LD	I	SWR	SDT	Constant				Index modifier	Integer Device
												K	H	M	f		
D		●	●	●	●	●	●	●	●							●	

■ Outline of operation

- Adds +1 to the 32-bit data, representing a decimal, specified in [D] and stores it in the 2-word memory area starting at [D].
 $(D+1, D) + 1 \rightarrow (D+1, D)$

■ Operation example

Operation of instruction format description program

When the internal relay R0 is ON, adds +1 to the content of the combined 32 bits of data registers DT0 and DT1.

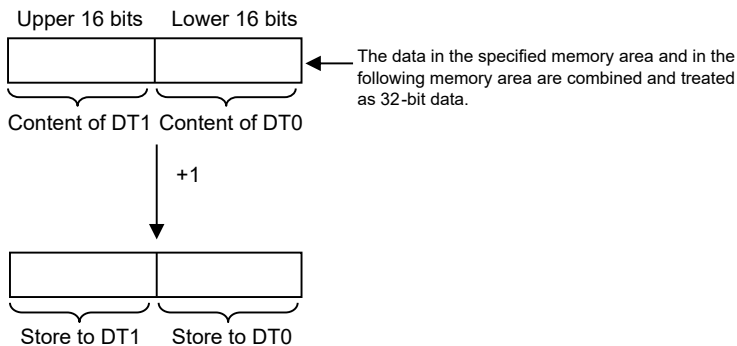

■ Precautions for programming

- With arithmetic operation instructions, in the event that the operation result falls beyond the range of values that can be handled, an overflow occurs.
- Ensure that overflows do not occur in normal circumstances.
- If an overflow occurs, the CY flag (special internal relay R9009) turns ON.

■ Flag operations

Name	Description
R9007 R9008 (ER)	Turns ON when the area is exceeded in index modification.
R900B (=)	Turns ON when the calculation result is "0"
R9009 (CY)	Turns ON when operation result overflows

11.16 F37 -1 [16-Bit Decrement (-1)]

11.16 F37 -1 [16-Bit Decrement (-1)]

Subtracts 1 from 16-bit data.

■ Instruction format

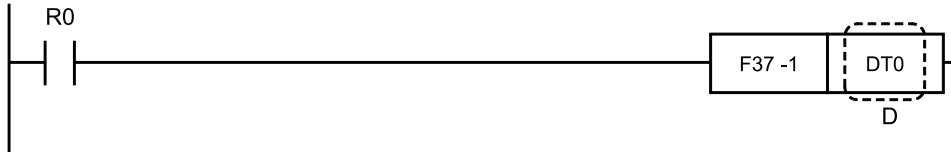

■ Operands

Items	Settings
D	Area to be decreased by 1

■ Devices that can be specified (indicated by ●)

Operands	WX	WY	WR	WL	SV	EV	DT	LD	I	SWR	SDT	Constant				Index modifier	Integer Device
												K	H	M	f		
D		●	●	●	●	●	●	●	●							●	

■ Outline of operation

- The 16-bit data specified by [D] and expressed in base 10 is decreased by 1 and stored in [D].
 $(D) - 1 \rightarrow (D)$

■ Operation example

Operation of instruction format description program

When internal relay R0 is ON, the content of data register DT0 is decreased by 1.

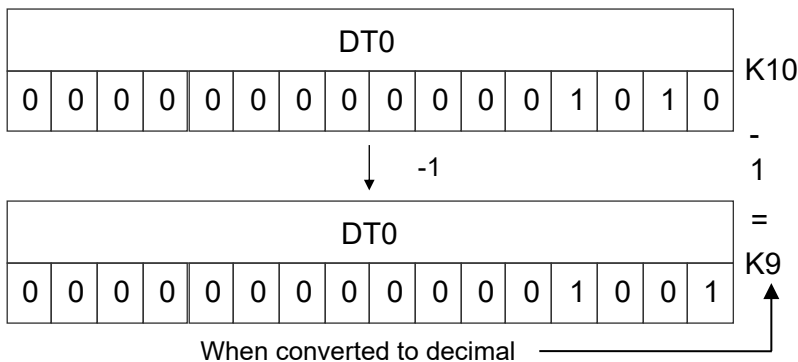

■ Precautions for programming

- If the result of an arithmetic operation instruction exceeds the numerical range that can be handled, an underflow will result.

- Under normal circumstances, do not allow an underflow to occur.
- If an underflow occurs, use the 32-bit operation instruction.
- If an underflow occurs, the CY flag (special internal relay R9009) will turn ON.

■ **Flag operations**

Name	Description
R9007 R9008 (ER)	Turns ON when the area is exceeded in index modification.
R900B (=)	Turns ON when the calculation result is "0"
R9009 (CY)	Turns ON when the calculation result underflows

11.17 F38 D-1 [32-bit decrement (-1)]

11.17 F38 D-1 [32-bit decrement (-1)]

Subtracts 1 from 32-bit data.

■ Instruction format

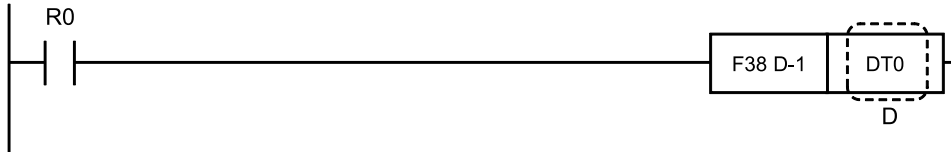

■ Operands

Items	Settings
D	Area (32-bit) from which 1 is subtracted

■ Devices that can be specified (indicated by ●)

Operands	WX	WY	WR	WL	SV	EV	DT	LD	I	SW R	SD T	Constant				Index modifier	Integer Device
												K	H	M	f		
D		●	●	●	●	●	●	●	●							●	

■ Outline of operation

- 1 is subtracted from the 32-bit data that expresses the decimal number specified by [D] and the result is stored in the 2-word memory area starting at [D].

$$(D+1, D) - 1 \rightarrow (D+1, D)$$

■ Operation example

Operation of instruction format description program

When internal relay R0 turns ON, 1 is subtracted from the contents of the 32-bit data that is a combination of data registers DT0 and DT1.

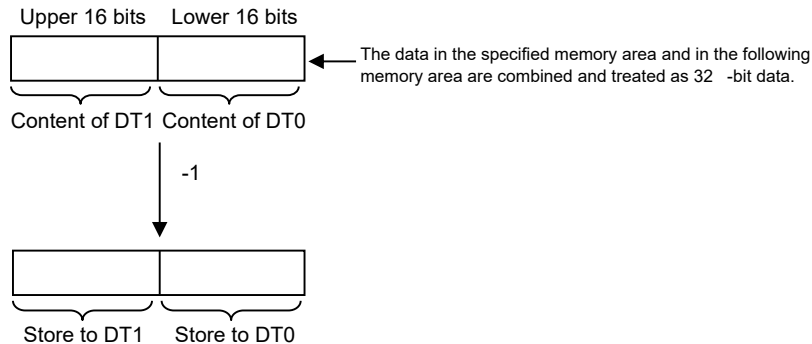

■ Precautions for programming

- If the result of an arithmetic operation instruction exceeds the numerical range that can be handled, an underflow will result.
- Under normal circumstances, do not allow an underflow to occur.
- If an underflow occurs, the CY flag (special internal relay R9009) will turn ON.

■ Flag operations

Name	Description
R9007 R9008 (ER)	Turns ON when the area is exceeded in index modification.
R900B (=)	Turns ON when the calculation result is "0"
R9009 (CY)	Turns ON when the calculation result underflows

11.18 F39 D*D [32-Bit Data Multiplication (Result in Two Words)]

11.18 F39 D*D [32-Bit Data Multiplication (Result in Two Words)]

Multiplies 32-bit data items and stores the result in the 32-bit two-word area.

■ Instruction format

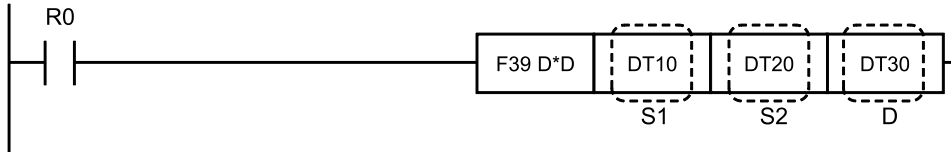

■ Operands

Items	Settings
S1	Multiplicand data: Area storing 32-bit data, or constant data
S2	Multiplier data: Area storing 32-bit data, or constant data
D	Storage destination: Area storing multiplication result (32-bit data)

■ Devices that can be specified (indicated by ●)

Operands	WX	WY	WR	WL	SV	EV	DT	LD	I	SWR	SDT	Constant				Index modifier	Integer Device
												K	H	M	f		
S1	●	●	●	●	●	●	●	●	●	●	●	●	●	●	●		
S2	●	●	●	●	●	●	●	●	●	●	●	●	●	●	●		
D		●	●	●	●	●	●	●	●							●	

■ Outline of operation

- The 32-bit data specified by [S1] and the 32-bit data specified by [S2] are multiplied, and the result is stored in the area specified by [D].
 $(S1+1, S1) \times (S2+1, S2) \rightarrow (D+1, D)$
- The operation result is stored as two words of 32-bit data.

■ **Operation example**

Operation of instruction format description program

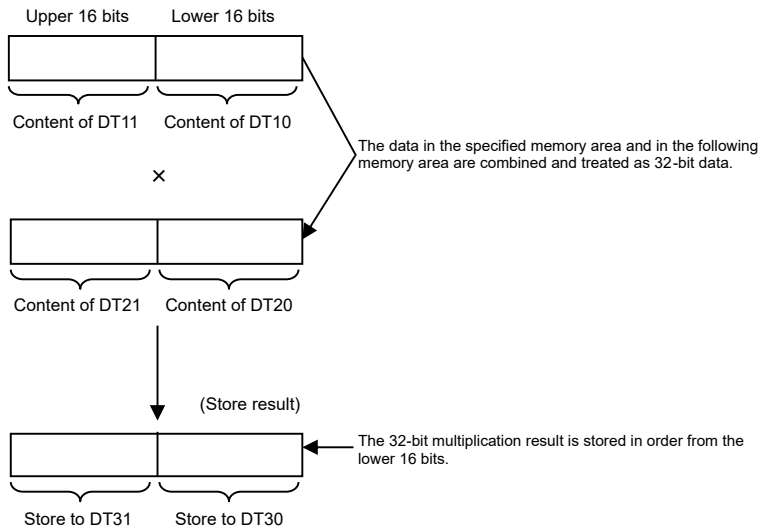

■ **Precautions for programming**

Keep the operation result [D] within the range of K-2147483648 to K2147483647.

■ **Flag operations**

Name	Description
R9007	Turns ON when the area is exceeded in index modification.
R9008 (ER)	Turns ON when the operation result exceeds 32 bits
R900B (=)	Turns ON when the calculation result is "0"

(MEMO)

12 BCD Data Arithmetic Instructions

12.1	F40 B+ (4-Digit Addition)	12-2
12.2	F41 DB+ (8-Digit Addition)	12-4
12.3	F42 B+ [4-digit addition (storage destination specifiable)]	12-6
12.4	F43 DB+ [8-digit addition (storage destination can be specified)]	12-8
12.5	F45 B- (4-Digit Subtraction)	12-10
12.6	F46 DB- (8-Digit Subtraction)	12-12
12.7	F47 B- [4-digit subtraction (storage destination specifiable)]	12-14
12.8	F48 DB- [8-digit subtraction (storage destination can be specified)]	12-16
12.9	F50 B* (4-Digit Multiplication)	12-18
12.10	F51 DB* (8-digit multiplication)	12-20
12.11	F52 B% (4-digit division)	12-22
12.12	F53 DB% (8-Digit Division)	12-24
12.13	F55 B+1 [4-digit BCD increment (+1)]	12-26
12.14	F56 DB+1 [8-digit BCD Increment (+1)]	12-28
12.15	F57 B-1 [4-digit BCD decrement (-1)]	12-30
12.16	F58 DB-1 [8-digit BCD Decrement (-1)]	12-32

12.1 F40 B+ (4-Digit Addition)

12.1 F40 B+ (4-Digit Addition)

Adds 4-digit BCD data.

■ Instruction format

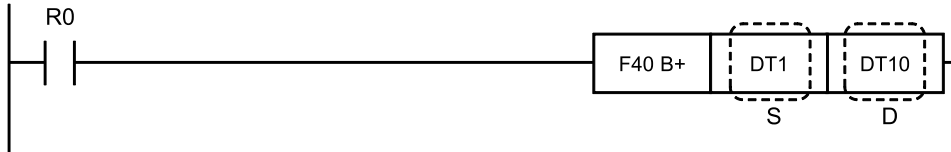

■ Operands

Items	Settings
S	Area storing the 4-digit BCD data to be added, or constant data
D	Area storing the 4-digit BCD data to be added to

■ Devices that can be specified (indicated by ●)

Operand s	WX	WY	WR	WL	SV	EV	DT	LD	I	SW R	SD T	Constant				Index modifier	Integer Device
												K	H	M	f		
S	●	●	●	●	●	●	●	●	●	●	●	●	●		●		
D		●	●	●	●	●	●	●	●						●		

■ Outline of operation

- The 4-digit BCD data specified by [S] is added to the 4-digit BCD data (H constant) specified by [D].
 $(D) + (S) \rightarrow (D)$

■ Operation example

Operation of instruction format description program

When internal relay R0 turns ON, the content of data register DT10 is added to the content of data register DT1. If DT1 contains BCD 4 and DT10 contains 8, the result is as follows.

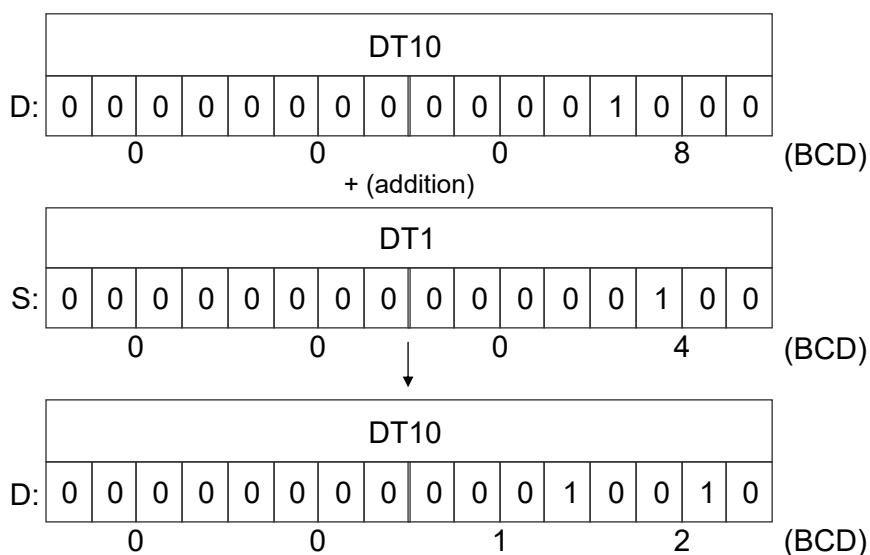

■ Precautions for programming

- If the result of an arithmetic operation instruction exceeds the maximum value that can be handled, this will result in an overflow.
- Ensure that overflows do not occur in normal circumstances.
- In the case of an overflow, use an 8-digit arithmetic operation instruction.
- If an overflow occurs, the CY flag (special internal relay R9009) turns ON.

■ Flag operations

Name	Description
R9007	Turns ON when the area is exceeded in index modification.
R9008 (ER)	Turns ON when the specified data is not BCD data
R900B (=)	Turns ON when the calculation result is "0"
R9009 (CY)	Turns ON when operation result overflows

12.2 F41 DB+ (8-Digit Addition)

12.2 F41 DB+ (8-Digit Addition)

Adds 8-digit BCD data.

■ Instruction format

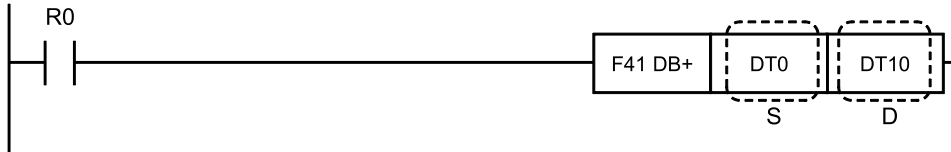

■ Operands

Items	Settings
S	Area storing the 8-digit BCD data to be added, or constant data
D	Area storing the 8-digit BCD data to be added to

■ Devices that can be specified (indicated by ●)

Operand s	WX	WY	WR	WL	SV	EV	DT	LD	I	SW R	SD T	Constant				Index modifier	Integer Device
												K	H	M	f		
S	●	●	●	●	●	●	●	●	●	●	●	●	●	●	●	●	
D		●	●	●	●	●	●	●	●						●		

■ Outline of operation

- The 8-digit BCD data specified by [S] is added to the 8-bit BCD data (H constant) specified by [D].
 $(D+1, D) + (S+1, S) \rightarrow (D+1, D)$

■ Operation example

Operation of instruction format description program

When internal relay R0 turns ON, the contents of data registers DT0 and DT1 are added to the contents of data registers DT10 and DT11.

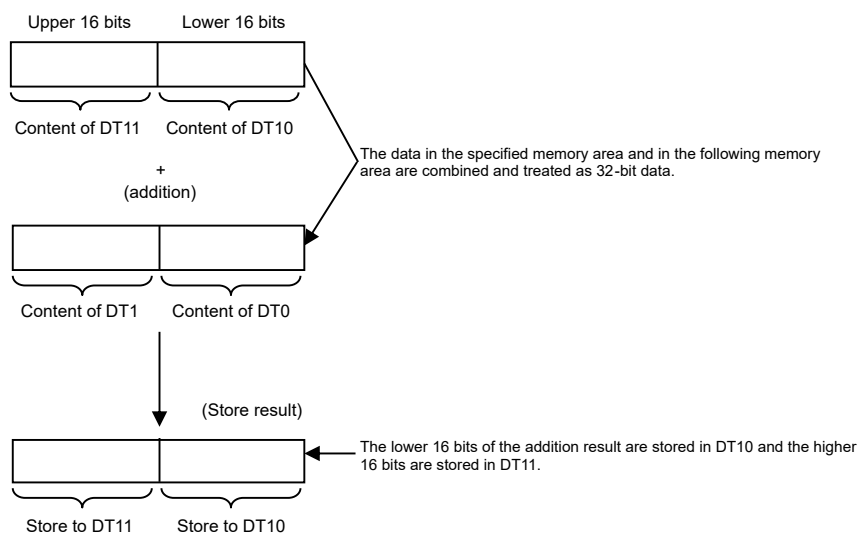

■ Precautions for programming

- If the result of an arithmetic operation instruction exceeds the maximum value that can be handled, this will result in an overflow.
- Ensure that overflows do not occur in normal circumstances.
- If an overflow occurs, the CY flag (special internal relay R9009) turns ON.

■ Flag operations

Name	Description
R9007	Turns ON when the area is exceeded in index modification.
R9008 (ER)	Turns ON when the specified data is not BCD data
R900B (=)	Turns ON when the calculation result is "0"
R9009 (CY)	Turns ON when operation result overflows

12.3 F42 B+ [4-digit addition (storage destination specifiable)]

12.3 F42 B+ [4-digit addition (storage destination specifiable)]

Adds 4-digit BCD data.

■ Instruction format

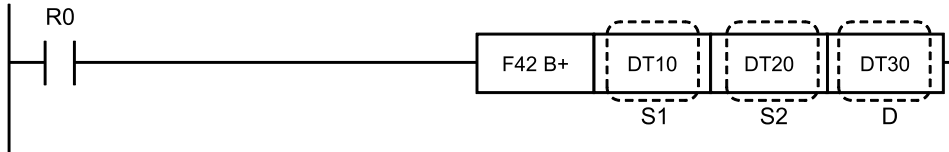

■ Operands

Items	Settings
S1	Area storing the 4-digit BCD data to be added, or constant data
S2	Area storing the 4-digit BCD data to be added, or constant data
D	Area storing the addition results

■ Devices that can be specified (indicated by ●)

Operands	WX	WY	WR	WL	SV	EV	DT	LD	I	SWR	SDT	Constant				Index modifier	Integer Device
												K	H	M	f		
S1	●	●	●	●	●	●	●	●	●	●	●	●	●	●	●	●	
S2	●	●	●	●	●	●	●	●	●	●	●	●	●	●	●	●	
D		●	●	●	●	●	●	●	●							●	

■ Outline of operation

- The 4-digit BCD data (H constant) specified by [S1] and [S2] are added together, and the result is stored in [D].
(S1) + (S2) → (D)

■ Operation example

Operation of instruction format description program

When internal relay R0 turns ON, the contents of data register DT10 and data register DT20 are added together, and the result is stored in data register DT30. If DT10 contains BCD 8 and DT20 contains BCD 4, the result is as follows.

12.3 F42 B+ [4-digit addition (storage destination specifiable)]



■ Precautions for programming

- If the result of an arithmetic operation instruction exceeds the maximum value that can be handled, this will result in an overflow.
- Ensure that overflows do not occur in normal circumstances.
- In the case of an overflow, use an 8-digit arithmetic operation instruction.
- If an overflow occurs, the CY flag (special internal relay R9009) turns ON.

■ Flag operations

Name	Description
R9007	Turns ON when the area is exceeded in index modification.
R9008 (ER)	Turns ON when the specified data is not BCD data
R900B (=)	Turns ON when the calculation result is "0"
R9009 (CY)	Turns ON when operation result overflows

12.4 F43 DB+ [8-digit addition (storage destination can be specified)]

12.4 F43 DB+ [8-digit addition (storage destination can be specified)]

Adds 8-digit BCD data.

■ Instruction format

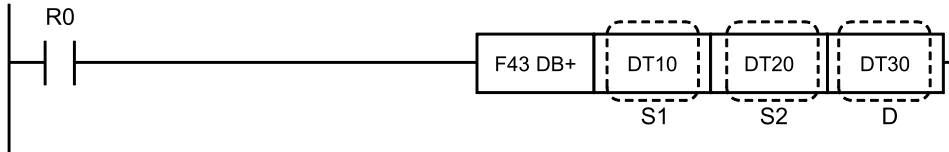

■ Operands

Items	Settings
S1	Area storing the 8-digit BCD data to be added, or constant data
S2	Area storing the 8-digit BCD data to be added, or constant data
D	Area storing the addition results

■ Devices that can be specified (indicated by ●)

Operands	WX	WY	WR	WL	SV	EV	DT	LD	I	SW R	SD T	Constant				Index modifier	Integer Device
												K	H	M	f		
S1	●	●	●	●	●	●	●	●	●	●	●	●	●	●	●	●	
S2	●	●	●	●	●	●	●	●	●	●	●	●	●	●	●	●	
D		●	●	●	●	●	●	●	●							●	

■ Outline of operation

- The 8-digit BCD data (H constant) specified by [S1] and [S2] are added together, and the result is stored in [D].
 $(S1+1, S1) + (S2+1, S2) \rightarrow (D+1, D)$
- The memory area is specified by the memory area number of the lower 16-bit portion.

■ Operation example

Operation of instruction format description program

When internal relay R0 turns ON, the contents of data registers DT10 and DT11 are added to the contents of data registers DT20 and DT21, and the result is stored in data registers DT30 and DT31.

12.4 F43 DB+ [8-digit addition (storage destination can be specified)]

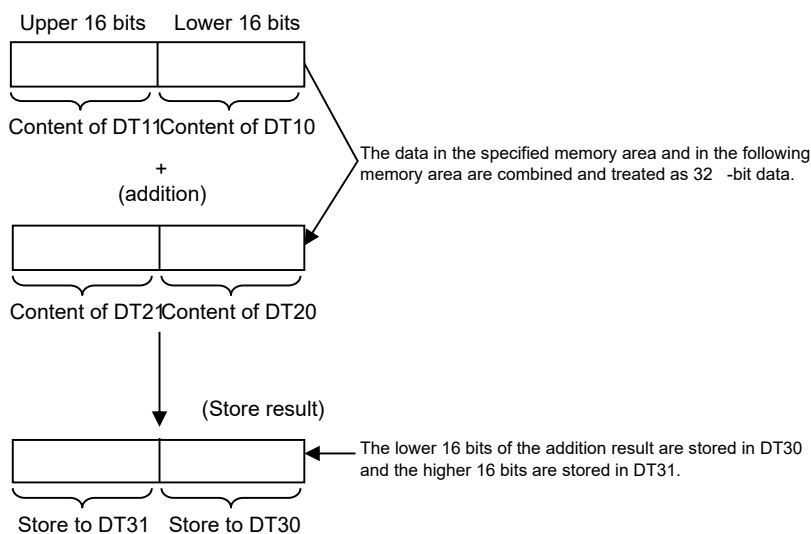

■ Precautions for programming

- If the result of an arithmetic operation instruction exceeds the maximum value that can be handled, this will result in an overflow.
- Ensure that overflows do not occur in normal circumstances.
- If an overflow occurs, the CY flag (special internal relay R9009) turns ON.

■ Flag operations

Name	Description
R9007	Turns ON when the area is exceeded in index modification.
R9008 (ER)	Turns ON when the specified data is not BCD data
R900B (=)	Turns ON when the calculation result is "0"
R9009 (CY)	Turns ON when operation result overflows

12.5 F45 B- (4-Digit Subtraction)

12.5 F45 B- (4-Digit Subtraction)

Subtracts 4-digit BCD data.

■ Instruction format

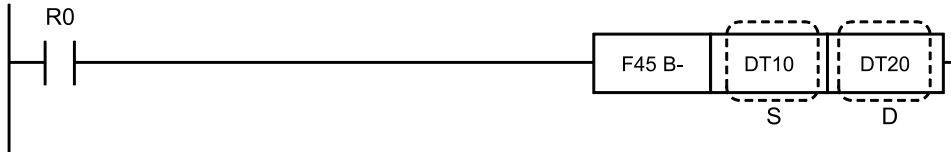

■ Operands

Items	Settings
S	Area storing the subtrahend (4-digit BCD data) or constant data
D	Area storing the subtrahend (4-digit BCD data)

■ Devices that can be specified (indicated by ●)

Operand s	WX	WY	WR	WL	SV	EV	DT	LD	I	SW R	SD T	Constant				Index modifier	Integer Device
												K	H	M	f		
S	●	●	●	●	●	●	●	●	●	●	●	●	●	●	●	●	
D		●	●	●	●	●	●	●	●							●	

■ Outline of operation

- The 4-digit BCD data specified by [S] is subtracted from the 4-digit BCD data (H constant) specified by [D].
 $(D) - (S) \rightarrow (D)$

■ Operation example

Operation of instruction format description program

Subtracts the contents of data register DT10 from the contents of data register DT20 when internal relay R0 turns ON. When BCD is 16 in DT20 and 4 in DT10, it is as shown below.

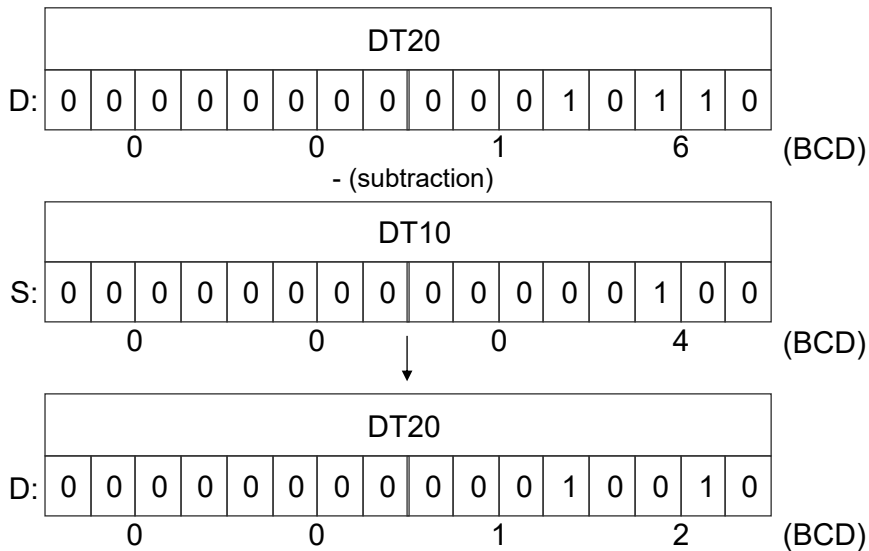

■ **Precautions for programming**

- If the result of an arithmetic operation instruction exceeds the maximum value that can be handled, this will result in an underflow.
- Under normal circumstances, do not allow an underflow to occur.
- If an underflow occurs, use an 8-digit arithmetic operation instruction.
- If an underflow occurs, the CY flag (special internal relay R9009) will turn ON.

■ **Flag operations**

Name	Description
R9007	Turns ON when the area is exceeded in index modification.
R9008 (ER)	Turns ON when the specified data is not BCD data
R900B (=)	Turns ON when the calculation result is "0"
R9009 (CY)	Turns ON when the calculation result underflows

12.6 F46 DB- (8-Digit Subtraction)

12.6 F46 DB- (8-Digit Subtraction)

Subtracts 8-digit BCD data.

■ Instruction format

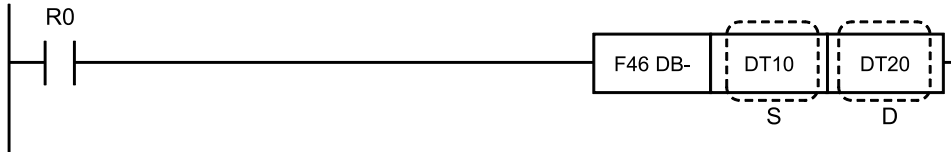

■ Operands

Items	Settings
S	Area that stores the subtrahend (8-digit BCD data), or constant data
D	Area storing the number to be subtracted (8-digit BCD data)

■ Devices that can be specified (indicated by ●)

Operand s	WX	WY	WR	WL	SV	EV	DT	LD	I	SW R	SD T	Constant				Index modifier	Integer Device
												K	H	M	f		
S	●	●	●	●	●	●	●	●	●	●	●	●	●	●	●	●	
D		●	●	●	●	●	●	●	●						●		

■ Outline of operation

- The 8-digit BCD data specified by [S] is subtracted from the 8-digit BCD data (H constant) specified by [D].
 $(D+1, D) - (S+1, S) \rightarrow (D+1, D)$

■ Operation example

Operation of instruction format description program

When internal relay R0 turns ON, the content of data registers DT10 and DT11 is subtracted from the content of data registers DT20 and DT21.

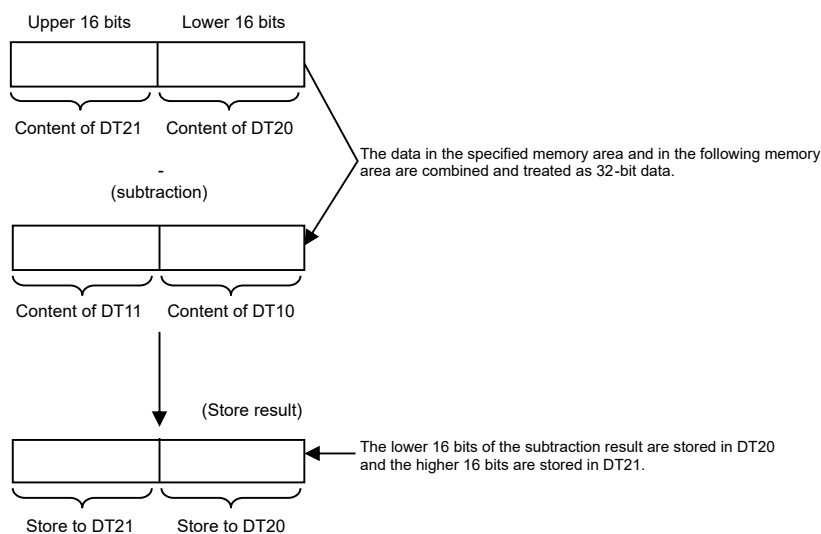

■ Precautions for programming

- If the result of an arithmetic operation instruction exceeds the maximum value that can be handled, this will result in an underflow.
- Under normal circumstances, do not allow an underflow to occur.
- If an underflow occurs, the CY flag (special internal relay R9009) will turn ON.

■ Flag operations

Name	Description
R9007	Turns ON when the area is exceeded in index modification.
R9008 (ER)	Turns ON when the specified data is not BCD data
R900B (=)	Turns ON when the calculation result is "0"
R9009 (CY)	Turns ON when the calculation result underflows

12.7 F47 B- [4-digit subtraction (storage destination specifiable)]

12.7 F47 B- [4-digit subtraction (storage destination specifiable)]

Subtracts 4-digit BCD data.

■ Instruction format

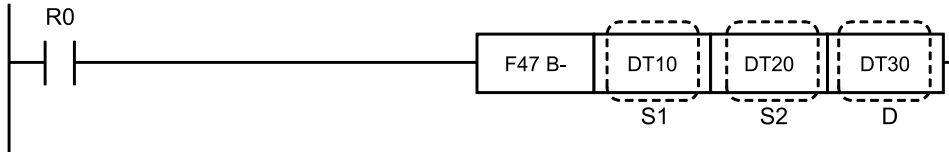

■ Operands

Items	Settings
S1	Area storing the minuend (4-digit BCD data), or constant data
S2	Area storing the subtrahend (4-digit BCD data) or constant data
D	Area that stores the calculation result

■ Devices that can be specified (indicated by ●)

Operands	WX	WY	WR	WL	SV	EV	DT	LD	I	SW R	SD T	Constant				Index modifier	Integer Device
												K	H	M	f		
S1	●	●	●	●	●	●	●	●	●	●	●	●	●	●	●		
S2	●	●	●	●	●	●	●	●	●	●	●	●	●	●	●		
D		●	●	●	●	●	●	●	●							●	

■ Outline of operation

- The 4-digit BCD data specified by [S2] is subtracted from the 4-digit BCD data (H constant) specified by [S1], and the result is stored in [D].
(S1) - (S2) → (D)

■ Operation example

Operation of instruction format description program

When internal relay R0 turns ON, the content of data register DT20 is subtracted from the content of data register DT10, and the result is stored in data register DT30. If DT10 contains BCD 16 and DT20 contains BCD 4, the result is as follows.



■ **Precautions for programming**

- If the result of an arithmetic operation instruction exceeds the maximum value that can be handled, this will result in an underflow.
- Under normal circumstances, do not allow an underflow to occur.
- If an underflow occurs, use an 8-digit arithmetic operation instruction.
- If an underflow occurs, the CY flag (special internal relay R9009) will turn ON.

■ **Flag operations**

Name	Description
R9007	Turns ON when the area is exceeded in index modification.
R9008 (ER)	Turns ON when the specified data is not BCD data
R900B (=)	Turns ON when the calculation result is "0"
R9009 (CY)	Turns ON when the calculation result underflows

12.8 F48 DB- [8-digit subtraction (storage destination can be specified)]

12.8 F48 DB- [8-digit subtraction (storage destination can be specified)]

Subtracts 8-digit BCD data.

■ Instruction format

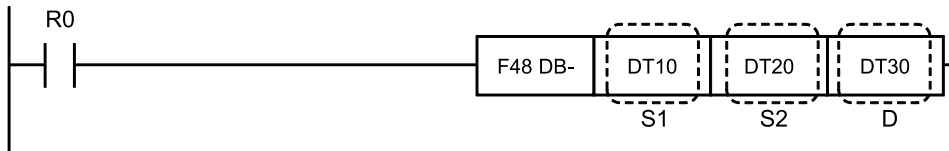

■ Operands

Items	Settings
S1	Area that stores the minuend (8-digit BCD data), or constant data
S2	Area that stores the subtrahend (8-digit BCD data), or constant data
D	Area that stores the calculation result

■ Devices that can be specified (indicated by ●)

Operands	WX	WY	WR	WL	SV	EV	DT	LD	I	SWR	SDT	Constant				Index modifier	Integer Device
												K	H	M	f		
S1	●	●	●	●	●	●	●	●	●	●	●	●	●	●	●	●	
S2	●	●	●	●	●	●	●	●	●	●	●	●	●	●	●	●	
D		●	●	●	●	●	●	●	●							●	

■ Outline of operation

- Subtracts the 8-digit BCD data specified by [S2] from the 8-digit BCD data (H constant) in the area specified by [S1], and stores the result in [D].
 $(S1+1, S1) - (S2+1, S2) \rightarrow (D+1, D)$
- Memory area is specified by the memory area number of the lower order hexadecimal part.

■ Operation example

Operation of instruction format description program

Subtracts the contents of data registers DT20 to DT21 from the contents of data registers DT10 to DT11 when internal relay X0 turns ON, and stores the calculation result in data registers DT30 to DT31.

12.8 F48 DB- [8-digit subtraction (storage destination can be specified)]

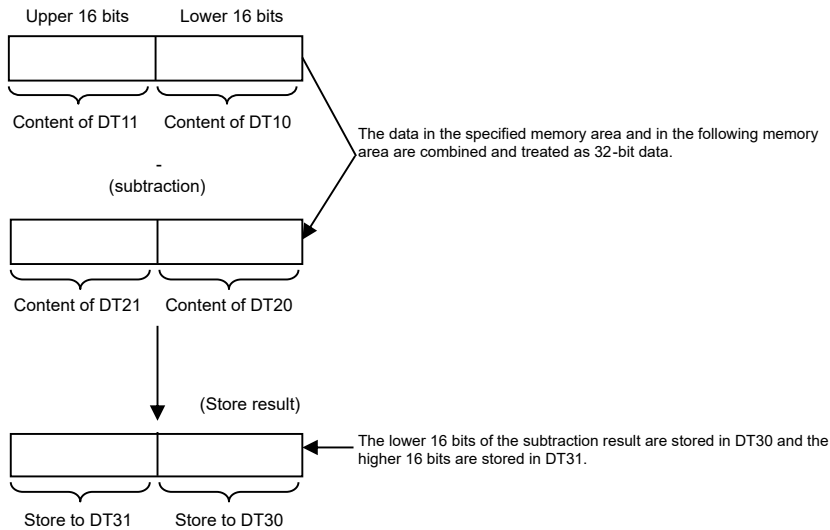

■ Precautions for programming

- If the result of an arithmetic operation instruction falls below the minimum value which can be handled, an underflow will result.
- Under normal circumstances, do not allow an underflow to occur.
- If an underflow occurs, the CY flag (special internal relay R9009) will turn ON.

■ Flag operations

Name	Description
R9007	Turns ON when the area is exceeded in index modification.
R9008 (ER)	Turns ON when the specified data is not BCD data
R900B (=)	Turns ON when the calculation result is "0"
R9009 (CY)	Turns ON when the calculation result underflows

12.9 F50 B* (4-Digit Multiplication)

12.9 F50 B* (4-Digit Multiplication)

Multiplies 4-digit BCD data.

■ Instruction format

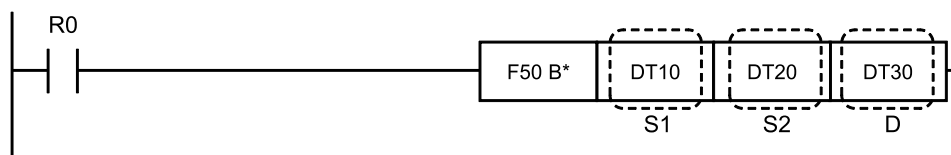

■ Operands

Items	Settings
S1	Area storing 4-digit BCD data, or constant data
S2	Area storing 4-digit BCD data, or constant data
D	Area storing multiplication result (8-digit BCD data)

■ Devices that can be specified (indicated by ●)

Operands	WX	WY	WR	WL	SV	EV	DT	LD	I	SWR	SDT	Constant				Index modifier	Integer Device
												K	H	M	f		
S1	●	●	●	●	●	●	●	●	●	●	●	●	●		●		
S2	●	●	●	●	●	●	●	●	●	●	●	●	●		●		
D		●	●	●	●	●	●	●	●						●		

■ Outline of operation

- Multiplies the 4-digit BCD data specified by [S1] (H constant) by the 4-digit BCD data specified by [S2], and the result is stored in the area specified by [D].
(S1) × (S2) → (D+1, D)
- The operation result is stored as 32-bit data (8-digit BCD).
- Storage destination [D] is specified by the number of the memory area with the lower order 16 bits.

■ Operation example

Operation of instruction format description program

e.g. If DT10 contains BCD 8 and DT20 contains BCD 2

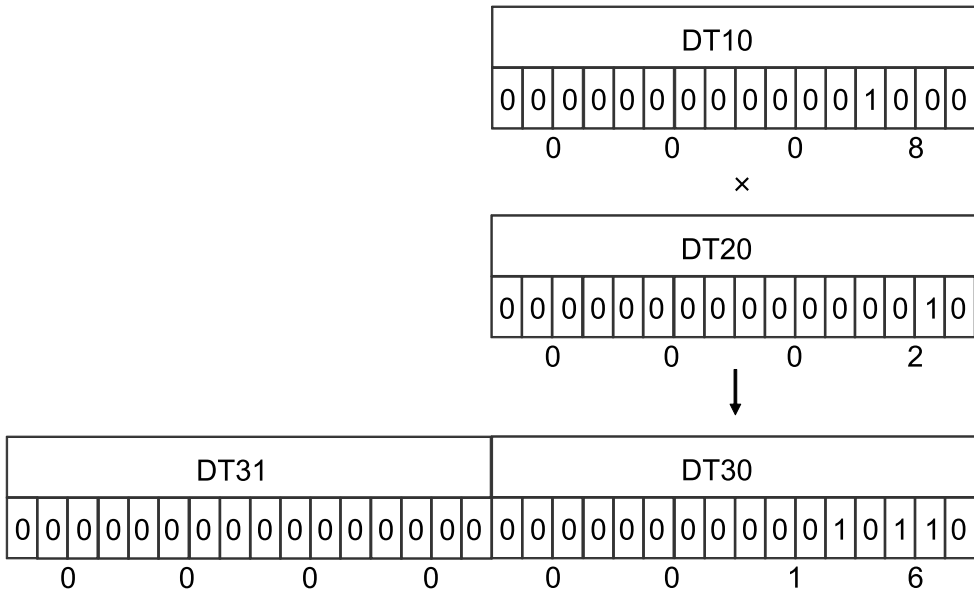

Of the 32-bit data multiplication results, the lower order 16 bits are stored in the specified memory area (DT30) and the higher order 16 bits is stored in the next area after the specified area (DT31).

■ **Flag operations**

Name	Description
R9007	Turns ON when the area is exceeded in index modification.
R9008 (ER)	Turns ON when the specified data is not BCD data
R900B (=)	Turns ON when the calculation result is "0"

12.10 F51 DB* (8-digit multiplication)

12.10 F51 DB* (8-digit multiplication)

Multiplies 8-digit BCD data.

■ Instruction format

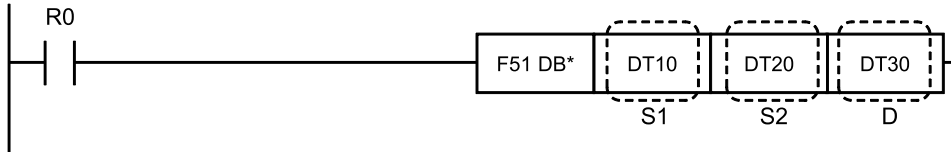

■ Operands

Items	Settings
S1	Multiplicand data: Area storing 8-digit BCD data, or constant data
S2	Multiplier data: Area storing 8-digit BCD data, or constant data
D	Storage destination: Area storing multiplication result (64-bit data)

■ Devices that can be specified (indicated by ●)

Operands	WX	WY	WR	WL	SV	EV	DT	LD	I	SW R	SD T	Constant				Index modifier	Integer Device
												K	H	M	f		
S1	●	●	●	●	●	●	●	●	●	●	●	●	●	●	●	●	
S2	●	●	●	●	●	●	●	●	●	●	●	●	●	●	●	●	
D		●	●	●	●	●	●	●								●	

■ Outline of operation

- The 8-digit BCD data (H constant) specified by [S1] is multiplied by the 8-digit BCD data specified by [S2], and the result is stored in the area specified by [D].
 $(S1+1, S1) \times (S2+1, S2) \rightarrow (D+3, D+2, D+1, D)$
- The operation result is stored as 64-bit data (16-digit BCD).
- The memory area is specified by the number of the lowest 16-bit memory area.

■ Operation example

Operation of instruction format description program

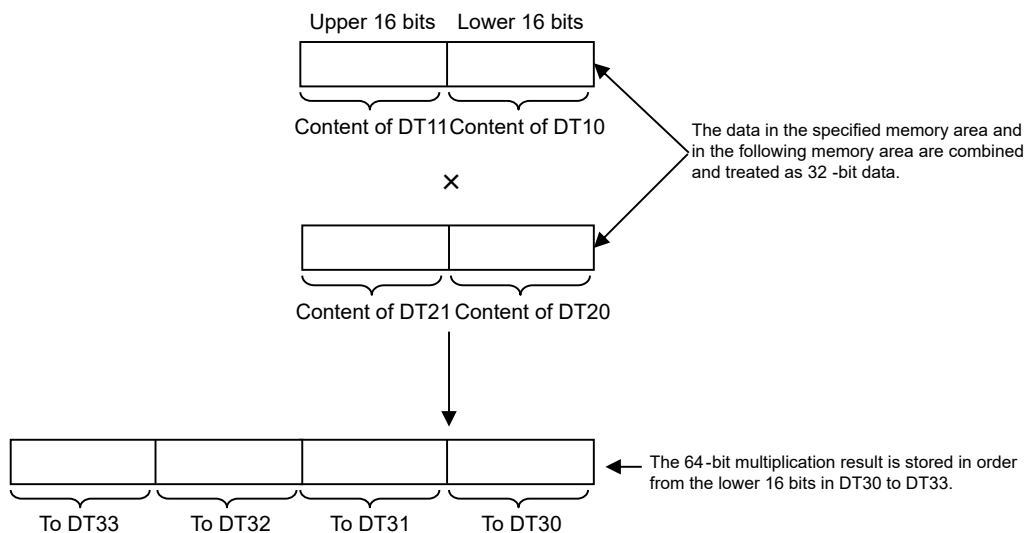

■ Flag operations

Name	Description
R9007	Turns ON when the area is exceeded in index modification.
R9008 (ER)	Turns ON when the specified data is not BCD data
R900B (=)	Turns ON when the calculation result is "0"

12.11 F52 B% (4-digit division)

12.11 F52 B% (4-digit division)

Divides 4-digit BCD data.

■ Instruction format

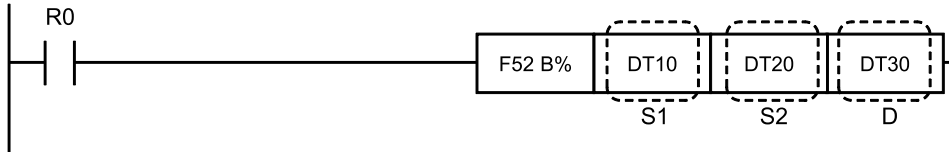

■ Operands

Items	Settings
S1	Dividend data: Area storing 4-digit BCD data, or constant data
S2	Divisor data: Area storing 4-digit BCD data, or constant data
D	Storage destination: Area storing the divisor result (quotient) (remainder stored as 16-bit data in DT90015)

■ Devices that can be specified (indicated by ●)

Operands	WX	WY	WR	WL	SV	EV	DT	LD	I	SWR	SDT	Constant				Index modifier	Integer Device
												K	H	M	f		
S1	●	●	●	●	●	●	●	●	●	●	●	●	●	●	●	●	
S2	●	●	●	●	●	●	●	●	●	●	●	●	●	●	●	●	
D		●	●	●	●	●	●	●	●						●		

■ Outline of operation

- The 4-digit BCD data (H constant) specified by [S1] is divided by the 4-digit BCD data specified by [S2], with the quotient stored in [D] and the remainder stored in a special data register.

$(S1) \div (S2) \rightarrow \text{Quotient (D)}$

Remainder (DT90015)

■ Operation example

Operation of instruction format description program

When the internal relay R0 turns ON, the contents of DT10 are divided by the contents of DT20, with the quotient stored in DT30 and the remainder stored as BCD in DT90015.

If DT10 contains BCD 15 and DT20 contains BCD 4, the result is as follows.

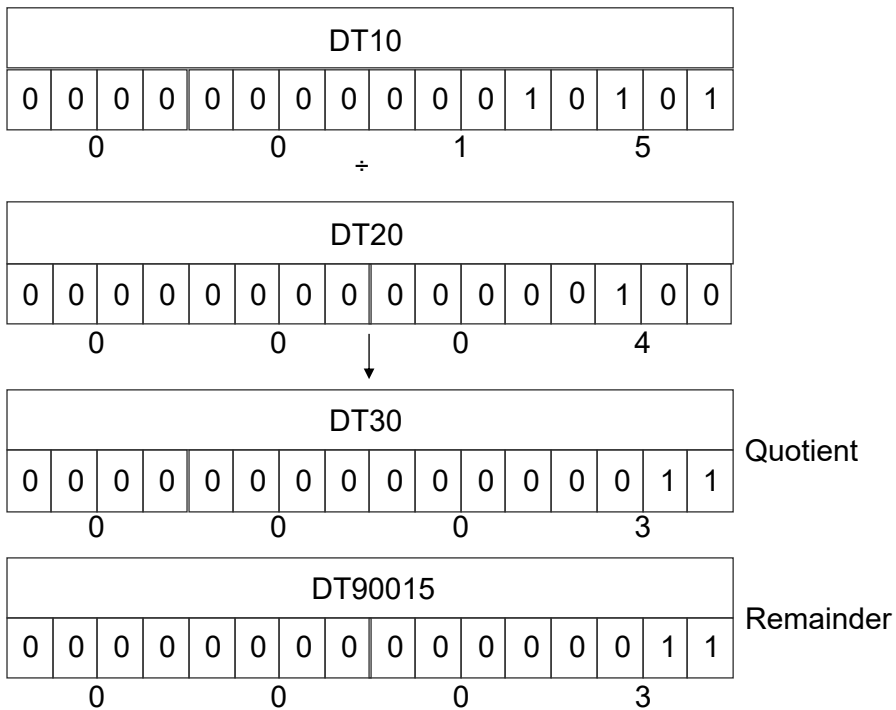

■ Flag operations

Name	Description
R9007	Turns ON when the area is exceeded in index modification.
R9008	Turns ON when the specified data is not BCD data
(ER)	Turns ON when S2 is "0" (when S1 is divided by "0")
R900B (=)	Turns ON when the operation result (quotient) is "0"

12.12 F53 DB% (8-Digit Division)

12.12 F53 DB% (8-Digit Division)

Divides 8-digit BCD data.

■ Instruction format

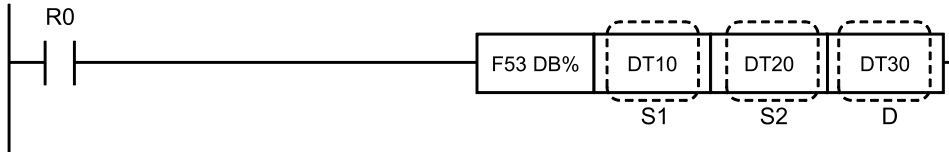

■ Operands

Items	Settings
S1	Dividend data: Area storing 8-digit BCD data, or constant data
S2	Divisor data: Area storing 8-digit BCD data, or constant data
D	Storage destination: Area storing the divisor result (quotient) (remainder stored as 32-bit data in DT90015 and DT90016)

■ Devices that can be specified (indicated by ●)

Operands	WX	WY	WR	WL	SV	EV	DT	LD	I	SWR	SDT	Constant				Index modifier	Integer Device
												K	H	M	f		
S1	●	●	●	●	●	●	●	●	●	●	●	●	●	●	●		
S2	●	●	●	●	●	●	●	●	●	●	●	●	●	●	●		
D		●	●	●	●	●	●	●	●						●		

■ Outline of operation

- The 8-digit BCD data (H constant) from the area specified by [S1] is divided by the 8-digit BCD data from the area specified by [S2]. The quotient is stored in the area specified by [D], and the remainder is stored as BCD in special data registers DT90015 and DT90016.

$(S1 + 1, S1) \div (S2 + 1, S2) \rightarrow$ Quotient (D + 1, D)

Remainder (DT90016, DT90015)

- Memory area is specified by the memory area number of the lower order hexadecimal part.

■ Operation example

Operation of instruction format description program

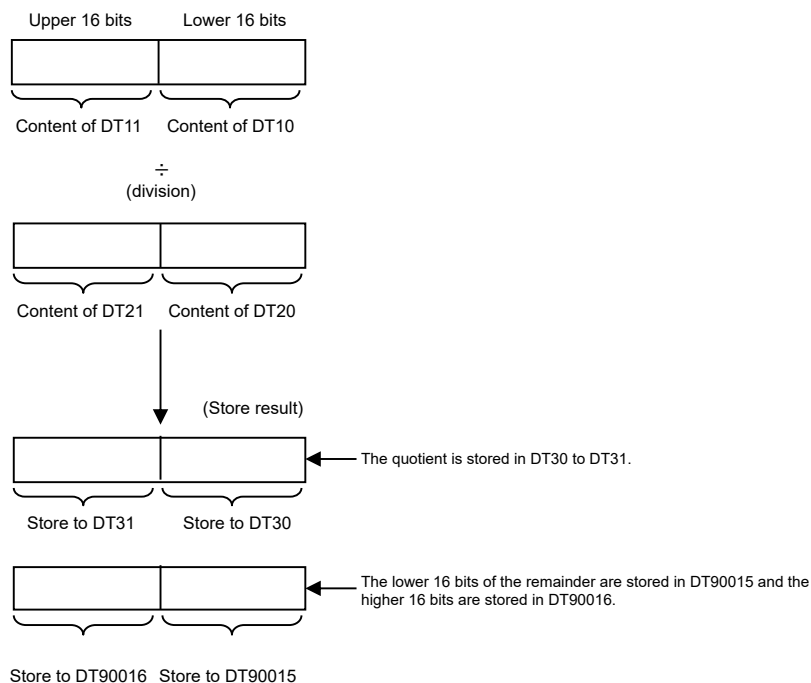

■ Flag operations

Name	Description
R9007	Turns ON when the area is exceeded in index modification.
R9008	Turns ON when the specified data is not BCD data
(ER)	Turns ON when S2 is "0" (when S1 is divided by "0")
R900B (=)	Turns ON when the operation result (quotient) is "0"

12.13 F55 B+1 [4-digit BCD increment (+1)]

12.13 F55 B+1 [4-digit BCD increment (+1)]

Adds 1 to 4-digit BCD data.

■ Instruction format

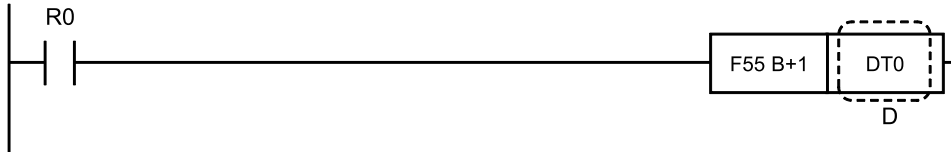

■ Operands

Items	Settings
D	Area to which 1 is to be added

■ Devices that can be specified (indicated by ●)

Operands	WX	WY	WR	WL	SV	EV	DT	LD	I	SWR	SDT	Constant				Index modifier	Integer Device
												K	H	M	f		
D		●	●	●	●	●	●	●	●							●	

■ Outline of operation

- 1 is added to the 4-digit BCD data (H constant) specified by [D] and the result is stored in [D].
 $(D) + 1 \rightarrow (D)$

■ Operation example

Operation of instruction format description program

When internal relay R0 turns ON, 1 is added to the contents of data register DT0.

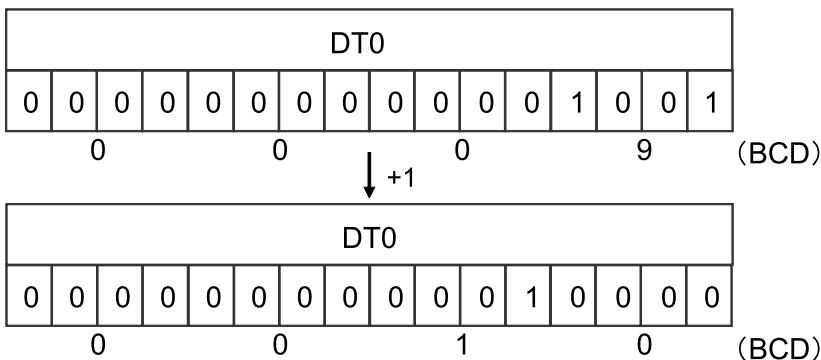

■ Precautions for programming

- If the result of an arithmetic operation instruction exceeds the maximum value that can be handled, this will result in an overflow.

- Ensure that overflows do not occur in normal circumstances.
- In the case of an overflow, use an 8-digit arithmetic operation instruction.
- If an overflow occurs, the CY flag (special internal relay R9009) turns ON.

■ Flag operations

Name	Description
R9007	Turns ON when the area is exceeded in index modification.
R9008 (ER)	Turns ON when the content of [D] is not BCD data (BCD error)
R900B (=)	Turns ON when the calculation result is "0"
R9009 (CY)	Turns ON when operation result overflows

12.14 F56 DB+1 [8-digit BCD Increment (+1)]

12.14 F56 DB+1 [8-digit BCD Increment (+1)]

Adds 1 to the 8-digit BCD data.

■ Instruction format

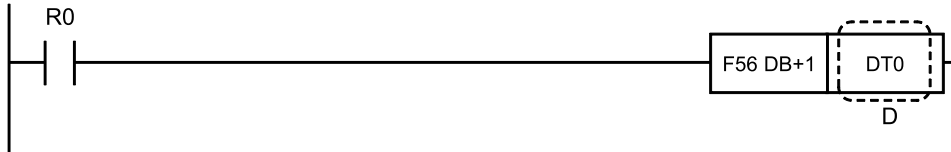

■ Operands

Items	Settings
D	The area (32-bit) that +1 is added to

■ Devices that can be specified (indicated by ●)

Operands	WX	WY	WR	WL	SV	EV	DT	LD	I	SWR	SDT	Constant				Index modifier	Integer Device
												K	H	M	f		
D		●	●	●	●	●	●	●	●							●	

■ Outline of operation

- Adds +1 to the 8-digit BCD data (H constant) specified by [D], then stores the result in the 2-word memory area starting with [D].
 $(D+1, D) + 1 \rightarrow (D+1, D)$

■ Operation example

Operation of instruction format description program

Adds 1 to the contents (8-digit BCD data) of data registers DT1 and DT0 when internal relay R0 turns ON.

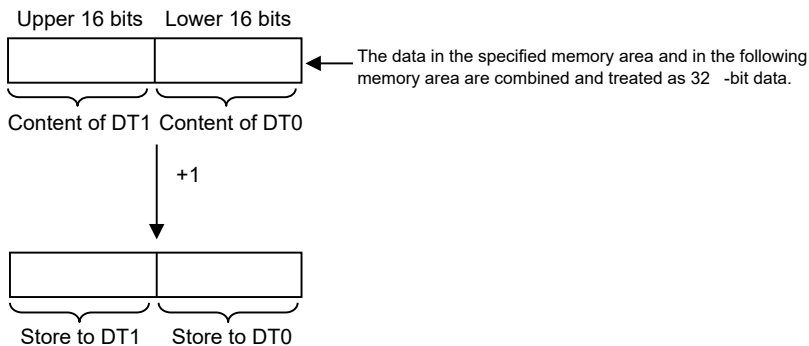

■ Precautions for programming

- If the result of an arithmetic operation instruction exceeds the maximum value that can be handled, this will result in an overflow.
- Ensure that overflows do not occur in normal circumstances.
- If an overflow occurs, the CY flag (special internal relay R9009) turns ON.

■ Flag operations

Name	Description
R9007	Turns ON when the area is exceeded in index modification.
R9008 (ER)	Turns ON when the content of the area specified by [D] is not BCD data (BCD error)
R900B (=)	Turns ON when the calculation result is "0"
R9009 (CY)	Turns ON when operation result overflows

12.15 F57 B-1 [4-digit BCD decrement (-1)]

12.15 F57 B-1 [4-digit BCD decrement (-1)]

Subtracts 1 from 4-digit BCD data.

■ Instruction format

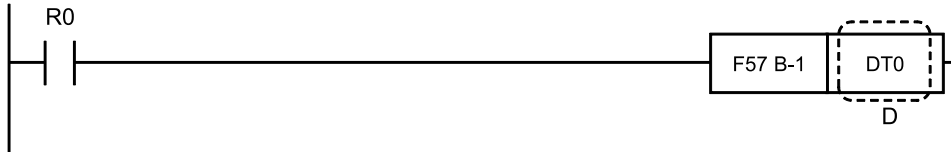

■ Operands

Items	Settings
D	Area to be decreased by 1

■ Devices that can be specified (indicated by ●)

Operands	WX	WY	WR	WL	SV	EV	DT	LD	I	SWR	SDT	Constant				Index modifier	Integer Device
												K	H	M	f		
D		●	●	●	●	●	●	●	●							●	

■ Outline of operation

- 1 is subtracted from the 4-digit BCD data (H constant) specified by [D] and the result is stored in [D].
 $(D) - 1 \rightarrow (D)$

■ Operation example

Operation of instruction format description program

When internal relay R0 turns ON, 1 is subtracted from the content of data register DT0.

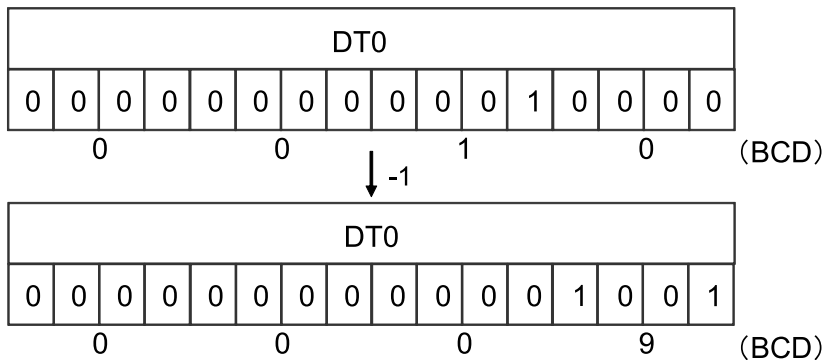

■ Precautions for programming

- If the result of an arithmetic operation instruction exceeds the maximum value that can be handled, this will result in an underflow.
- Under normal circumstances, do not allow an underflow to occur.
- If an underflow occurs, use an 8-digit arithmetic operation instruction.
- If an underflow occurs, the CY flag (special internal relay R9009) will turn ON.

■ Flag operations

Name	Description
R9007	Turns ON when the area is exceeded in index modification.
R9008 (ER)	Turns ON when the content of [D] is not BCD data (BCD error)
R900B (=)	Turns ON when the calculation result is "0"
R9009 (CY)	Turns ON when the calculation result underflows

12.16 F58 DB-1 [8-digit BCD Decrement (-1)]

12.16 F58 DB-1 [8-digit BCD Decrement (-1)]

Subtracts 1 from 8-digit BCD data.

■ Instruction format

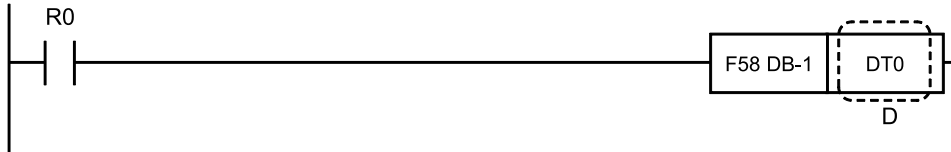

■ Operands

Items	Settings
D	Area (32-bit) from which 1 is subtracted

■ Devices that can be specified (indicated by ●)

Operands	WX	WY	WR	WL	SV	EV	DT	LD	I	SWR	SDT	Constant				Index modifier	Integer Device
												K	H	M	f		
D		●	●	●	●	●	●	●	●							●	

■ Outline of operation

- Subtracts 1 from 8-digit BCD data (H constant) specified by [D] and stores the result in the two-word memory area starting with [D].
 $(D+1, D) - 1 \rightarrow (D+1, D)$

■ Operation example

Operation of instruction format description program

Subtracts 1 from the 8-digit BCD data content of data registers DT0 and DT1 when internal relay R0 turns ON.

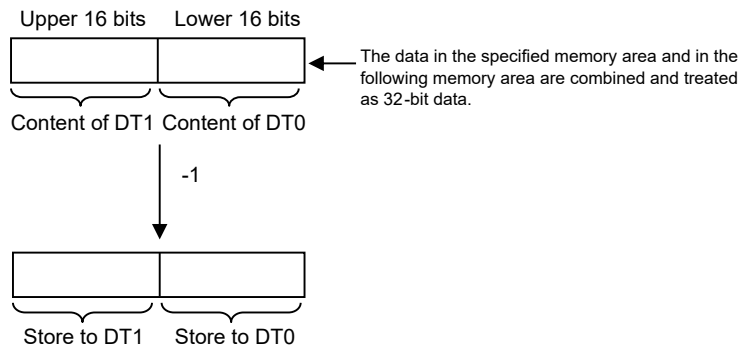

■ Precautions for programming

- If the result of an arithmetic operation instruction falls below the minimum value which can be handled, an underflow will result.
- Under normal circumstances, do not allow an underflow to occur.
- If an underflow occurs, the CY flag (special internal relay R9009) will turn ON.

■ Flag operations

Name	Description
R9007 R9008 (ER)	Turns ON when the area is exceeded in index modification. Turns ON when the content of [D] is not BCD data (BCD error)
R900B (=)	Turns ON when the calculation result is "0"
R9009 (CY)	Turns ON when the calculation result underflows

(MEMO)

13 Data Comparison Instructions

13.1 F60 CMP (16-bit data comparison).....	13-2
13.2 F61 DCMP (32-Bit Data Comparison)	13-8
13.3 F62 WIN (16-Bit Data Band Comparison).....	13-12
13.4 F63 DWIN (32-bit data band comparison)	13-14
13.5 F64 BCMP (Block match detection).....	13-16
13.6 F373 DTR (16-bit data change detection)	13-19
13.7 F374 DDTR (32-bit data change detection).....	13-21

13.1 F60 CMP (16-bit data comparison)

13.1 F60 CMP (16-bit data comparison)

Compares the two specified 16-bit data and outputs the judgment result to special internal relays.

■ Instruction format

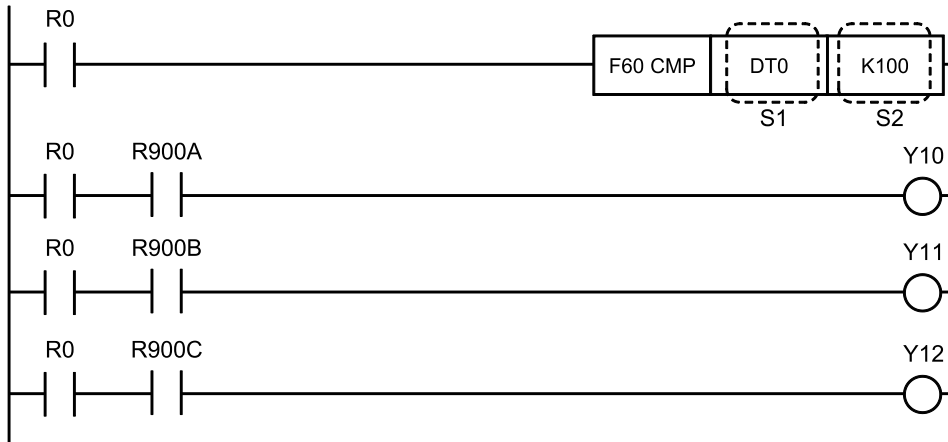

■ Operands

Items	Settings
S1	Comparison data 1: Area storing 16-bit data, or constant data
S2	Comparison data 2: Area storing 16-bit data, or constant data

■ Devices that can be specified (indicated by ●)

Operands	WX	WY	WR	WL	SV	EV	DT	LD	I	SW R	SD T	Constant				Index modifier	Integer Device
	K	H	M	f													
S1	●	●	●	●	●	●	●	●	●	●	●	●	●			●	
S2	●	●	●	●	●	●	●	●	●	●	●	●	●			●	

■ Outline of operation

- The 16-bit data specified by [S1] expressing a decimal number is compared with the 16-bit data specified by [S2], and the judgment result is output to special internal relays R9009 to R900C (comparison instruction judgement flags).
- R9009 to R900C are assigned based on whether [S1] or [S2] is larger or smaller, as shown in the table below.

Relationship between S1 and S2	Flag			
	R900A	R900B	R900C	R9009
	>	=	<	Carry
S1 < S2	OFF	OFF	ON	↓
S1 = S2	OFF	ON	OFF	OFF

Relationship between S1 and S2	Flag			
	R900A	R900B	R900C	R9009
	>	=	<	Carry
S1 > S2	ON	OFF	OFF	↕

(Note 1) ↕ changes.

■ Operation example

Operation of instruction format description program

When internal relay R0 turns ON and when the data register DT0 value is K100, output relay Y11 turns ON. When the value is smaller than K100, Y12 turns ON, and when the value is larger than K100, Y10 turns ON.

■ About internal relays

- In the program example on the previous page, comparison is only performed when R0 turns ON.
- If ongoing comparison is necessary, use relay R9010, which is always ON, as the internal relay.

e.g.

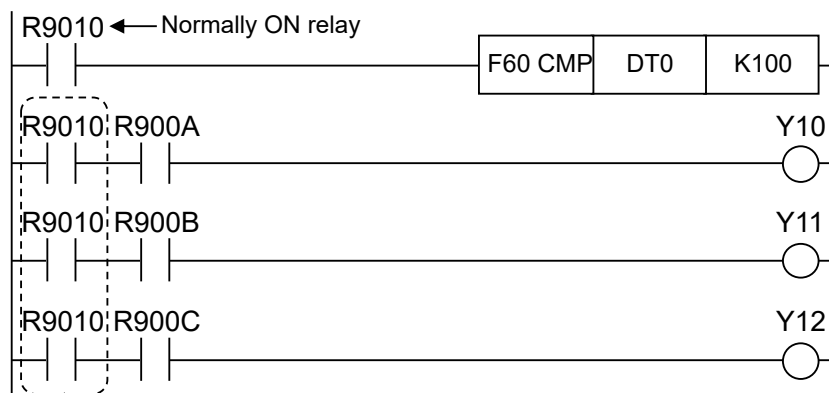

↑ This part can be omitted because it always executes.

- The following programming is possible using instructions PSHS, RDS, and POPS.

13.1 F60 CMP (16-bit data comparison)

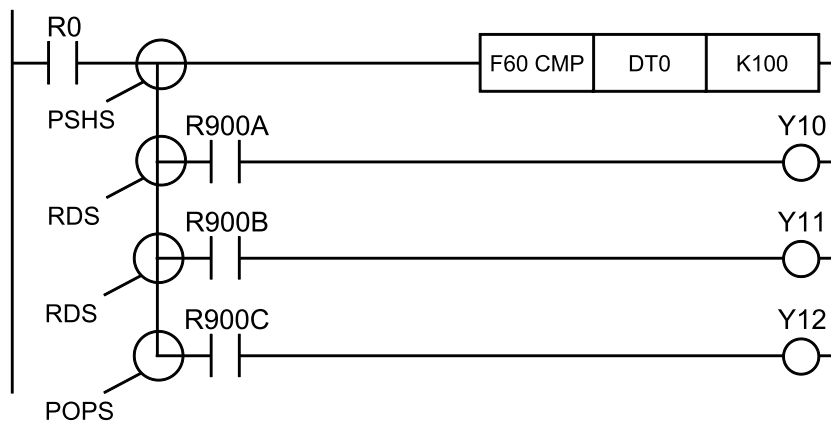

This program has the same operation as the program example.

■ Precautions when using two or more comparison instructions

- The comparison instruction judgment flags R900A to R900C are updated each time comparison instructions are executed.
- Therefore, when using two or more comparison instructions:
 1. Insert programs using judgment flags immediately after the comparison instruction.
 2. Output to the output relay or internal relay for each comparison instruction.

e.g. Example of comparison of DT0 and K100, and DT1 and K200

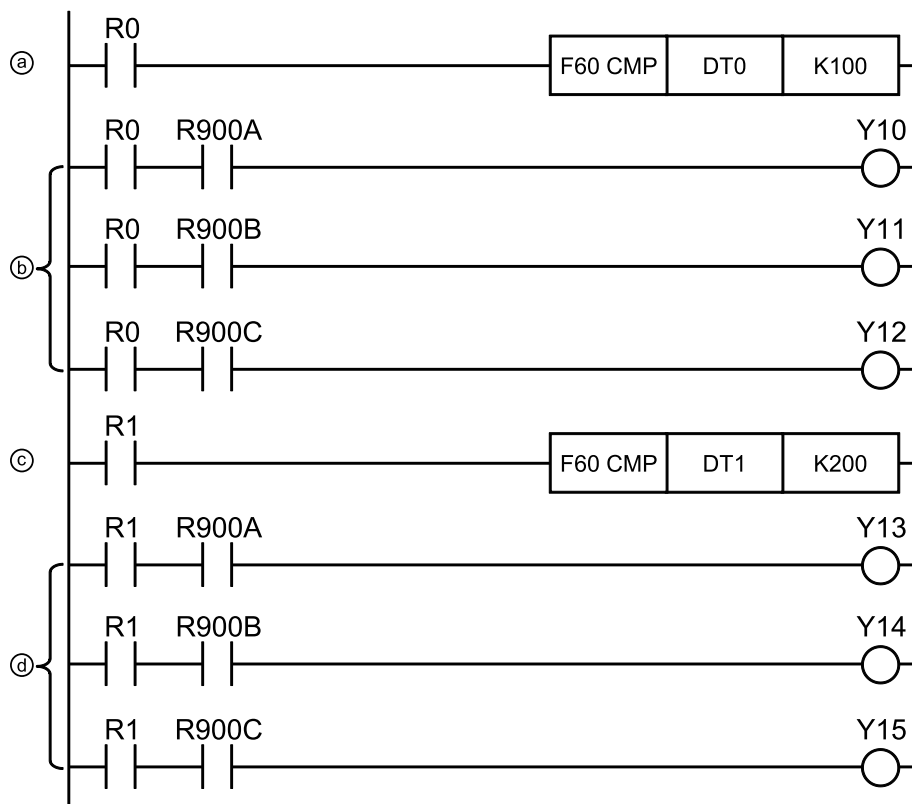

The comparison result for (a) is reflected in the contents of output relays Y10 to Y12 of program (b), and the comparison result for (c) is reflected in the contents of output relays Y13 to Y15 of program (d).

■ Precautions when comparing BCD data or external data

- When comparing BCD data or unsigned 16-bit data (0 to FFFF), construct a judgment program such as the one shown below using R900B and R9009 instead of R900A and R900C.

13.1 F60 CMP (16-bit data comparison)

e.g. Comparing the BCD data in DT0 and DT1

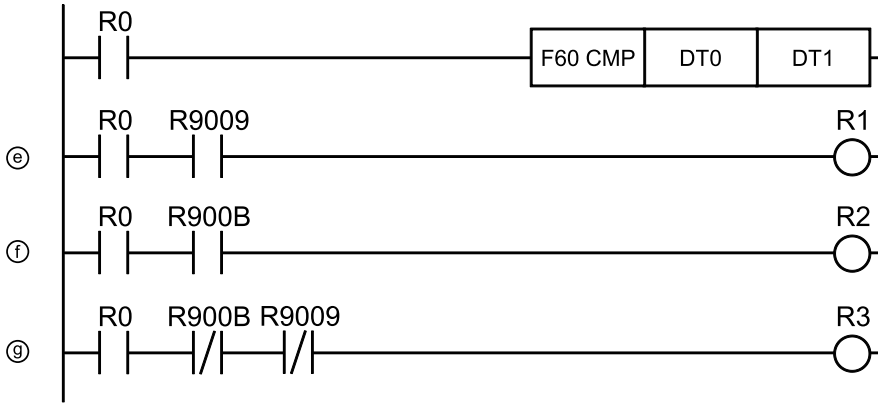

(e)	When DT0 is less than DT1, R1 turns ON
(f)	When DT0 is equal to DT1, R2 turns ON
(g)	When DT0 is greater than DT1, R3 turns ON

- Flag operation when comparing BCD data or unsigned 16-bit data (0 to FFFF)

Relationship between S1 and S2	Flag			
	R900A	R900B	R900C	R9009
	>	=	<	Carry
S1 < S2	↓	OFF	↓	ON
S1 = S2	OFF	ON	OFF	OFF
S1 > S2	↓	OFF	↓	OFF

(Note 1) ↓ changes.

<Remarks>

For example, because R900A turns OFF and R900C turns ON when S1 = H8000 and S2 = H1000, accurate comparison results cannot be obtained with a judgment program that uses R900A and R900C.

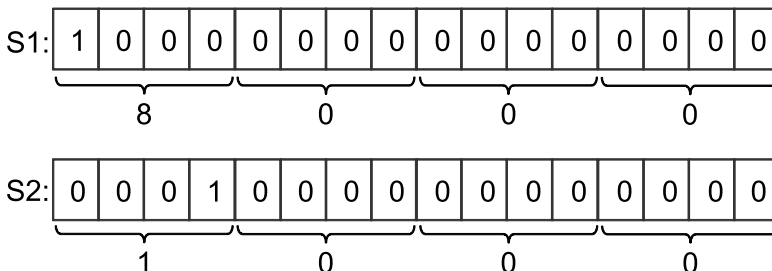

■ Flag operations

Name	Description
R9007 R9008	Turns ON when the area is exceeded in index modification.

13.1 F60 CMP (16-bit data comparison)

Name	Description
(ER)	

13.2 F61 DCMP (32-Bit Data Comparison)

13.2 F61 DCMP (32-Bit Data Comparison)

Compares two specified 32-bit data, and outputs the result to special internal relays.

■ Instruction format

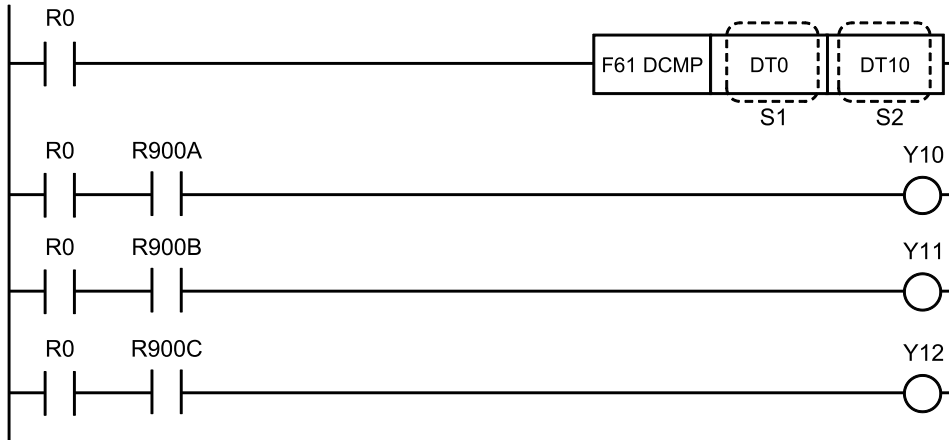

■ Operands

Items	Settings
S1	Comparison data 1: Area storing 32-bit data, or constant data
S2	Comparison data 2: Area storing 32-bit data, or constant data

■ Devices that can be specified (indicated by ●)

Operands	WX	WY	WR	WL	SV	EV	DT	LD	I	SW R	SD T	Constant				Index modifier	Integer Device
	K	H	M	f													
S1	●	●	●	●	●	●	●	●	●	●	●	●	●			●	
S2	●	●	●	●	●	●	●	●	●	●	●	●	●			●	

■ Outline of operation

- Compare the 32-bit data specified by [S1] and expressed as a decimal with 32-bit data in the area specified by [S2], and outputs the result to special internal relay flags (R9009 to R900C).
- R9009 to R900C are assigned based on whether [S1] or [S2] is larger or smaller, as shown in the table below.

Relationship between S1 and S2	Flag			
	R900A	R900B	R900C	R9009
	>	=	<	Carry
$(S1+1, S1) < (S2+1, S2)$	OFF	OFF	ON	↓
$(S1+1, S1) = (S2+1, S2)$	OFF	ON	OFF	OFF
$(S1+1, S1) > (S2+1, S2)$	ON	OFF	OFF	↓

(Note 1) ↑ changes.

- Memory area is specified by the memory area number of the lower order hexadecimal part.

■ Operation example

Operation of instruction format description program

When internal relay R0 is ON, the 32-bit data that is a combination of data registers DT0 and DT1 is compared with the 32-bit data that is a combination of data registers DT10 and DT11, and if the values of the two data are the same, the output relay Y11 turns ON. If the data in DT0 to DT1 is smaller than the data in DT10 to DT11, Y12 turns ON, and if it is larger Y10 turns ON.

■ About internal relays

- In the above program example, the comparison is performed only when R0 is ON.
- If ongoing comparison is necessary, use relay R9010, which is always ON, as the internal relay.

e.g.

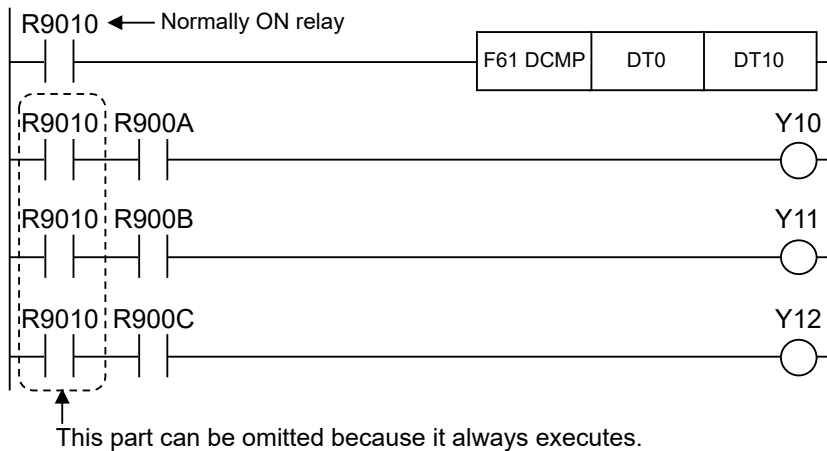

- The following programming is possible using instructions PSHS, RDS, and POPS.

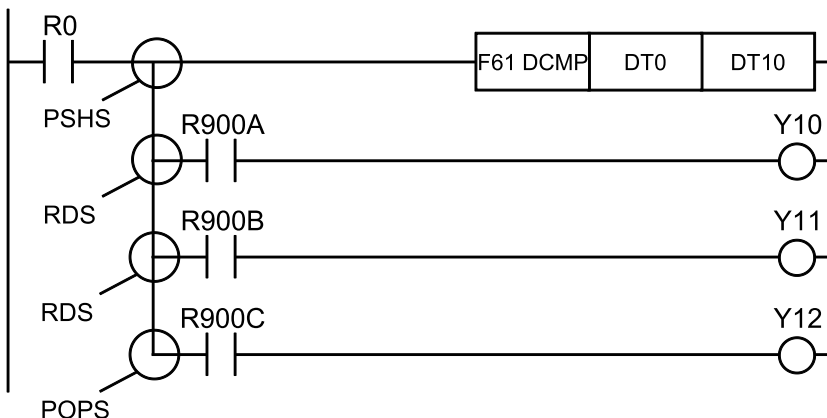

This program has the same operation as the program example.

13.2 F61 DCMP (32-Bit Data Comparison)

■ Precautions when using two or more comparison instructions

- The comparison instruction judgment flags R900A to R900C are updated each time comparison instructions are executed.
- Therefore, when using two or more comparison instructions:
 1. Insert programs using judgment flags immediately after the comparison instruction.
 2. Output to the output relay or internal relay for each comparison instruction.

e.g. Comparison of DT0 to DT1 with DT10 to DT11, and DT2 to DT3 with DT20 to DT21

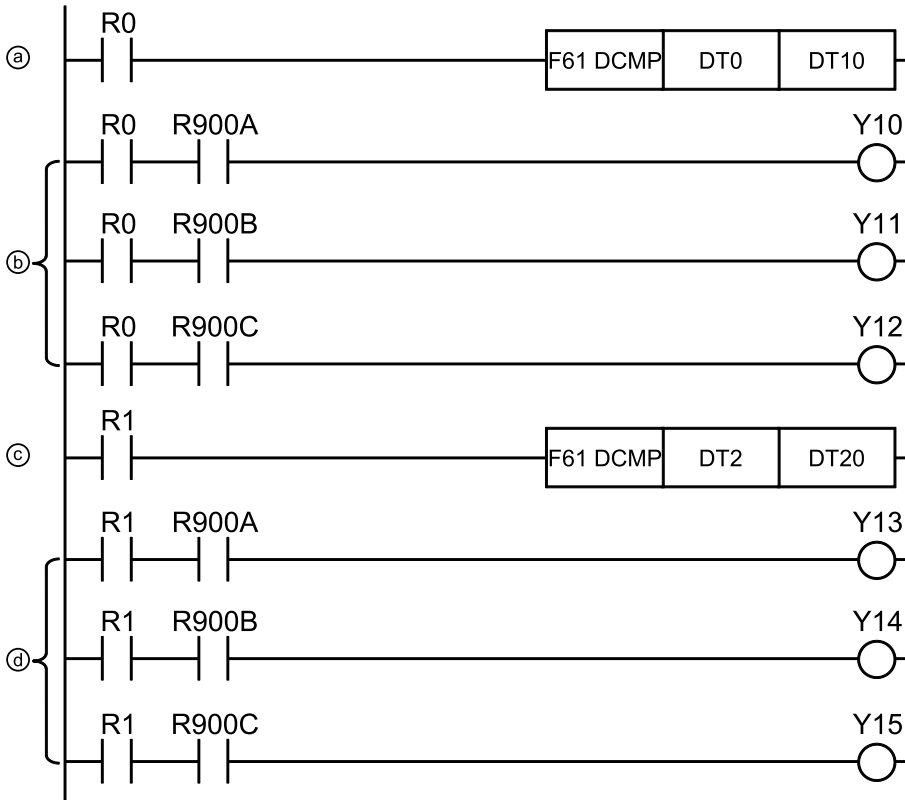

The comparison result for (a) is reflected in the contents of output relays Y10 to Y12 of program (b), and the comparison result for (c) is reflected in the contents of output relays Y13 to Y15 of program (d).

■ Precautions when comparing BCD data or external data

- When comparing BCD data or unsigned 16-bit data (0 to FFFFFFFF), do not use R900A and R900C. Use R900B and R9009, and create a judgment program such as the one shown below.

e.g. Comparing BCD data in DT0 to DT1 with BCD Data in DT10 to DT11

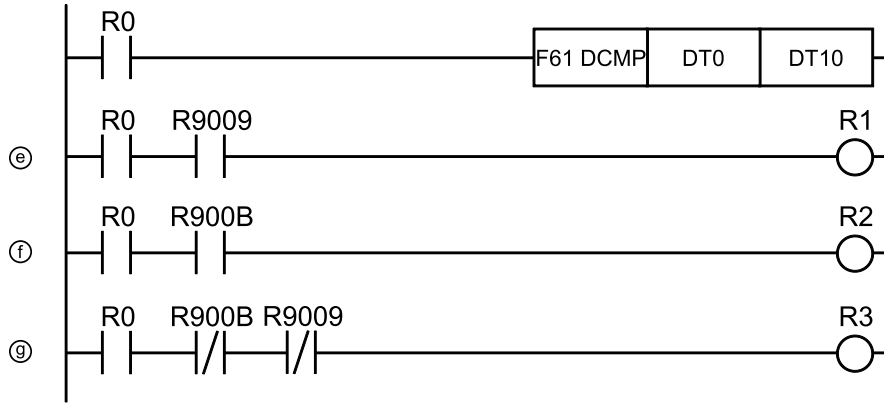

(e)	R1 turns ON when (DT1, DT0) < (DT11, DT10)
(f)	R2 turns ON when (DT1, DT0) = (DT11, DT10)
(g)	R3 turns ON when (DT1, DT0) > (DT11, DT10)

- Flag operations when comparing BCD data or unsigned 32-bit data (0 to FFFFFFFF)

Relationship between (S1+1, S1) and (S2+1, S2)	Flag			
	R900A	R900B	R900C	R9009
	>	=	<	Carry
(S1+1, S1) < (S2+1, S2)	↓	OFF	↓	ON
(S1+1, S1) = (S2+1, S2)	OFF	ON	OFF	OFF
(S1+1, S1) > (S2+1, S2)	↓	OFF	↓	OFF

(Note 1) ↓ changes.

<Remarks>

For example, when S1 = H80000000 (K - 2,147,483,648) and S2 = H10000001 (K + 268,435,457), and when the F61 DCMP instruction is executed, the judgment is S1 < S2, R900A turns OFF, and R900C turns ON. Correct comparison results cannot be obtained with judgment programs that use R900A and R900C.

■ Flag operations

Name	Description
R9007 R9008 (ER)	Turns ON when the area is exceeded in index modification.

13.3 F62 WIN (16-Bit Data Band Comparison)

13.3 F62 WIN (16-Bit Data Band Comparison)

Performs a band comparison of signed 16-bit data and outputs the comparison result to special internal relays.

■ Instruction format

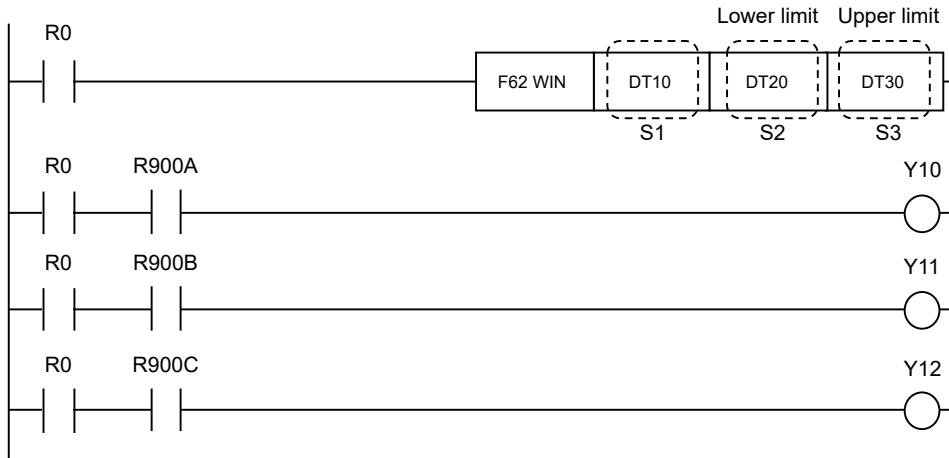

■ Operands

Items	Settings
S1	Comparison data: Area storing 16-bit data, or constant data
S2	Lower limit data: Area storing 16-bit data, or constant data
S3	Upper limit data: Area storing 16-bit data, or constant data

■ Devices that can be specified (indicated by ●)

Operands	WX	WY	WR	WL	SV	EV	DT	LD	I	SW R	SD T	Constant				Index modifier	Integer Device
												K	H	M	f		
S1	●	●	●	●	●	●	●	●	●	●	●	●	●	●	●	●	
S2	●	●	●	●	●	●	●	●	●	●	●	●	●	●	●	●	
S3	●	●	●	●	●	●	●	●	●	●	●	●	●	●	●	●	

■ Outline of operation

- A band comparison is performed on signed 16-bit data expressing a decimal number. The signed 16-bit data specified by [S1] is compared with the range specified by [S2] (lower limit value) and [S3] (upper limit value) to determine whether it falls in that range, and the comparison result is output to the special internal relays R9009 to R900C (comparison instruction judgment flag).
- The relationship between [S1], [S2], and [S3] affects R9009 to R900C as follows.

Relationship between S1, S2, and S3	Flag			
	R900A	R900B	R900C	R9009
	>	=	<	Carry
S1 < S2	OFF	OFF	ON	×
S2 ≤ S1 ≤ S3	OFF	ON	OFF	×
S3 < S1	ON	OFF	OFF	×

(Note 1) ×: Does not change.

■ Operation example

Operation of instruction format description program

When internal relay R0 turns ON, the value of DT10 is compared with the range bounded by the lower limit value of DT20 and the upper limit value of DT30 to determine if it falls within that range.

e.g. When DT20 contains K-500 and DT30 contains K500

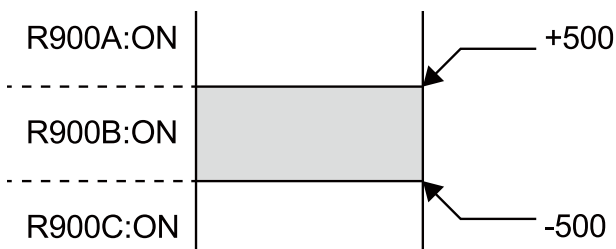

When DT10 = K-680	R900C: ON, Y12: ON
When DT10 = K-500	R900B: ON, Y11: ON
When DT10 = K256	R900B: ON, Y11: ON
When DT10 = K680	R900A: ON, Y10: ON

■ Precautions for programming

Set so that the lower limit value is equal to or less than the upper limit value (S2 ≤ S3).

■ Flag operations

Name	Description
R9007	Turns ON when the area is exceeded in index modification.
R9008	
(ER)	ON when S2 > S3

13.4 F63 DWIN (32-bit data band comparison)

13.4 F63 DWIN (32-bit data band comparison)

Performs a band comparison of signed 32-bit data and outputs the comparison result to special internal relays.

■ Instruction format

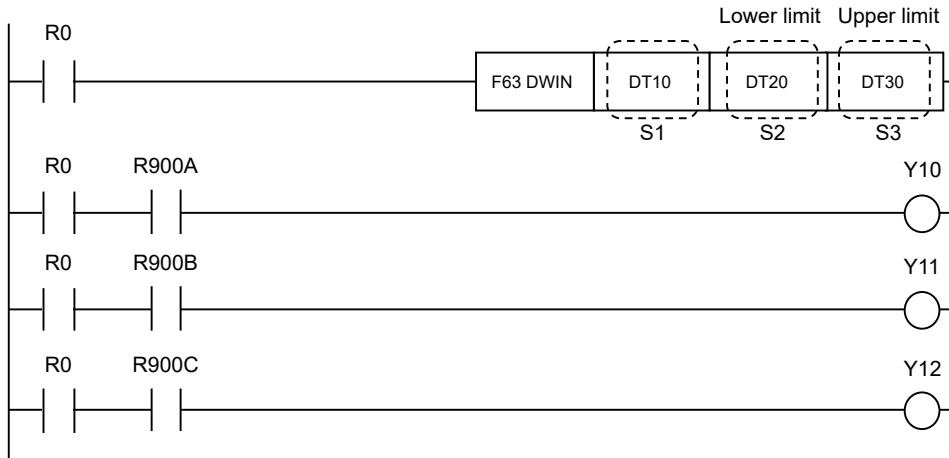

■ Operands

Items	Settings
S1	Comparison data: Area storing 32-bit data, or constant data
S2	Lower limit data: Area storing 32-bit data, or constant data
S3	Upper limit data: Area storing 32-bit data, or constant data

■ Devices that can be specified (indicated by ●)

Operands	WX	WY	WR	WL	SV	EV	DT	LD	I	SWR	SDT	Constant				Index modifier	Integer Device
												K	H	M	f		
S1	●	●	●	●	●	●	●	●	●	●	●	●	●	●	●	●	
S2	●	●	●	●	●	●	●	●	●	●	●	●	●	●	●	●	
S3	●	●	●	●	●	●	●	●	●	●	●	●	●	●	●	●	

■ Outline of operation

- A band comparison is performed on signed 32-bit data expressing a decimal number. The signed 32-bit data specified by [S1] is compared with the range specified by [S2] (lower limit value) and [S3] (upper limit value) to determine whether it falls in that range, and the comparison result is output to the special internal relays R9009 to R900C (comparison instruction judgement flag).
- The 32-bit data specified by each operand is read from the next area.
 - [S1] = (S1+1, S1)
 - [S2] = (S2+1, S2)
 - [S3] = (S3+1, S3)

- The relationship between [S1], [S2], and [S3] affects R9009 to R900C as follows.

Relationship between S1, S2, and S3	Flag			
	R900A	R900B	R900C	R9009
	>	=	<	Carry
S1 < S2	OFF	OFF	ON	×
S2 ≤ S1 ≤ S3	OFF	ON	OFF	×
S3 < S1	ON	OFF	OFF	×

(Note 1) ×: Does not change.

■ Operation example

Operation of instruction format description program

When internal relay R0 turns ON, the value of (DT11, DT10) is compared with the range bounded by the lower limit value of (DT21, DT20) and the upper limit value of (DT31, DT30) to determine if it falls within that range.

e.g. When DT20 and DT21 contain K-50000, and DT30 and DT31 contain K50000

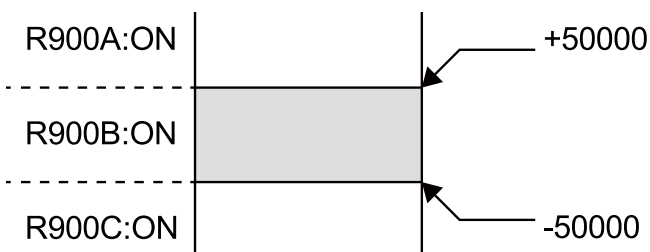

When (DT11, DT10) = K-68000	R900C: ON, Y12: ON
When (DT11, DT10) = K-50000	R900B: ON, Y11: ON
When (DT11, DT10) = K25600	R900B: ON, Y11: ON
When (DT11, DT10) = K68000	R900A: ON, Y10: ON

■ Precautions for programming

Set so that the lower limit value (S2+1, S2) is equal to or less than the upper limit value (S3+1, S3).

■ Flag operations

Name	Description
R9007	Turns ON when the area is exceeded in index modification.
R9008	
(ER)	Turns ON when (S2+1, S2) is greater than (S3+1, S3)

13.5 F64 BCMP (Block match detection)

13.5 F64 BCMP (Block match detection)

Detects matches in two block-specified areas in byte units.

■ Instruction format

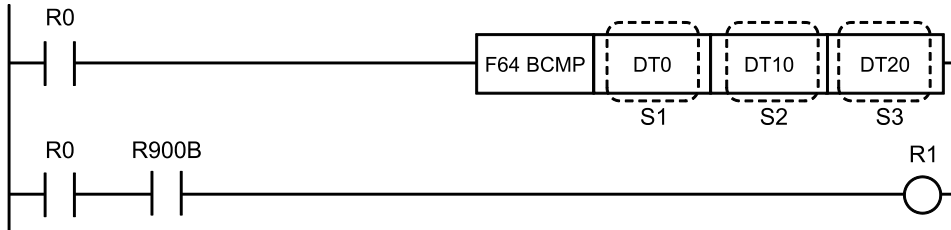

■ Operands

Items	Settings
S1	Area storing the control data (4-digit BCD data), or constant data
S2	Starting address of comparison block 1
S3	Starting address of comparison block 2

■ Devices that can be specified (indicated by ●)

Operands	WX	WY	WR	WL	SV	EV	DT	LD	I	SWR	SDT	Constant				Index modifier	Integer Device
												K	H	M	f		
S1	●	●	●	●	●	●	●	●	●	●	●	●	●			●	
S2	●	●	●	●	●	●	●	●		●	●					●	
S3	●	●	●	●	●	●	●	●		●	●					●	

■ Outline of operation

- The contents of the area specified by [S2] (comparison block 1) are compared with the contents of the area specified by [S3] (comparison block 2).
- When the comparison result shows that the contents of the blocks match, special internal relay R900B ("="flag) turns ON.
- [S1] is the control data that determines factors such as the size of the comparison.

■ How to specify control data [S1]

Specify a 4-digit BCD (H constant) according to the following format.

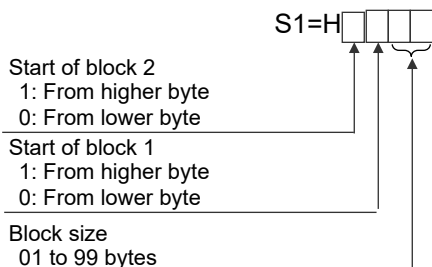

<Setting example>

When specifying the 4 bytes from the low byte of the area specified by [S2] as block 1 and the 4 bytes from the high byte of the area specified by [S3] as block 2, set [S1] to H1004.

■ Operation example**Operation of instruction format description program**

When internal relay R0 turns ON, the block starting at data register DT10 is compared with the block starting at data register DT20. When the values of the two blocks are the same, R1 turns ON. If H1004 is entered in DT0, the two blocks are as follows.

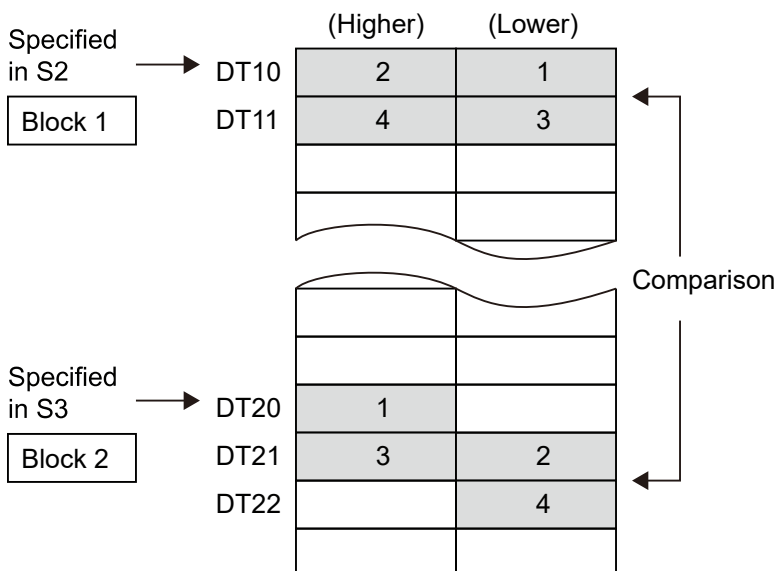
**■ Precautions for programming**

The flag R900B used for comparison instruction judgment is refreshed each time a comparison instruction, etc., is executed. Accordingly:

1. The program that uses R900B should be inserted immediately after the BCMP instruction.
2. Output the flag value to an output relay or internal relay and save the result.

13.5 F64 BCMP (Block match detection)

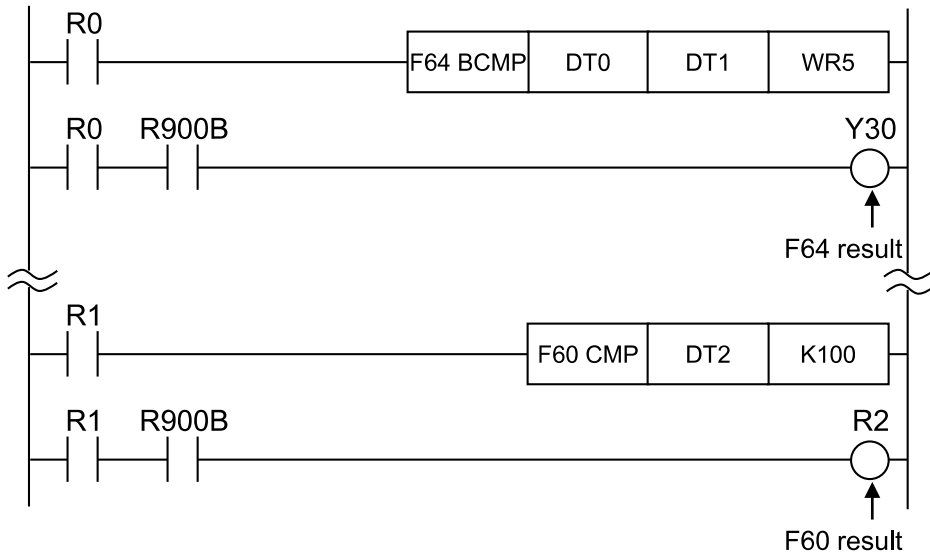

(Note 1) As shown in the program example above, make sure to place the comparison internal relay before the flag relay. This is not necessary for normal execution.

■ Flag operations

Name	Description
R9007	Turns ON when the area is exceeded in index modification.
R9008	Turns ON when the content specified by [S1] is not comprised of BCD data
(ER)	Turns ON when the specified block range exceeds the area

13.6 F373 DTR (16-bit data change detection)

Detects changes in word data numerical values.

■ Instruction format

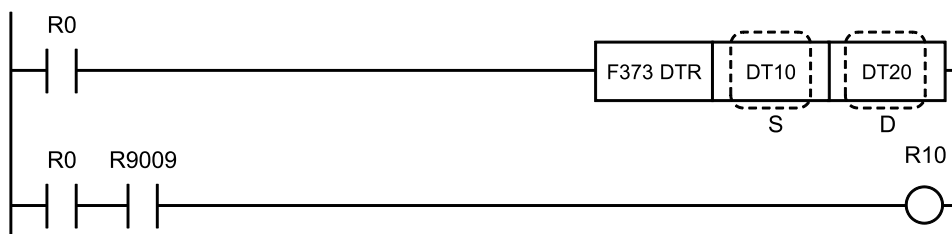

■ Operands

Items	Settings
S	Area that detects data changes
D	Area that stores data status during the previous execution

■ Devices that can be specified (indicated by ●)

Operand s	WX	WY	WR	WL	SV	EV	DT	LD	I	SW R	SD T	Constant				Index modifier	Integer Device
												K	H	M	f		
S	●	●	●	●	●	●	●	●	●	●	●					●	
D		●	●	●	●	●	●	●	●							●	

■ Outline of operation

- If the data in the area specified by [S] has changed since the previous time it was executed, the internal relay R9009 ("CY"flag) turns ON.
[D] is used as an area for memorizing the preceding values, and the current values are stored when the instruction is completed.

■ Operation example

Operation of instruction format description program

When execution condition R0 is ON, if there are changes compared to when data register DT10 was previously executed, R9009 turns ON, and R10 also turns ON following this.

■ Precautions for programming

Flag R9009, which is used for detecting data changes, is updated each time a calculation instruction, etc. is executed. Therefore,

- a program using R9009 should be inserted immediately after the F373 DTR instruction.
- Output to an output relay or internal relay to hold the results.

13.6 F373 DTR (16-bit data change detection)

Note

- Always insert execution conditions before the flag relay (R9009), as shown in the above program example. This is not necessary for normal execution.

■ Flag operations

Name	Description
R9007 R9008 (ER)	Turns ON when the area is exceeded in index modification.
R9009 (CY)	Turns ON if there are changes to the specified data area

13.7 F374 DDTR (32-bit data change detection)

Detects changes in double-word data (32-bit data) values.

■ Instruction format

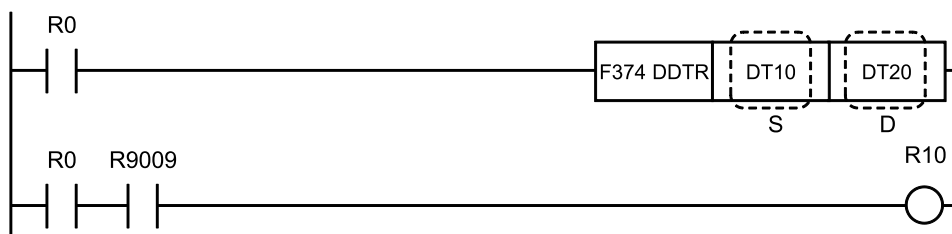

■ Operands

Items	Settings
S	Area that detects data changes
D	Area that stores data status during the previous execution

■ Devices that can be specified (indicated by ●)

Operand s	WX	WY	WR	WL	SV	EV	DT	LD	I	SW R	SD T	Constant				Index modifier	Integer Device
												K	H	M	f		
S	●	●	●	●	●	●	●	●	●	●	●					●	
D		●	●	●	●	●	●	●	●							●	

■ Outline of operation

- Internal relay R9009 (the "CY" flag) turns ON if the data in the area specified by [S, S+1] has changed from the data values of the previous execution.
[D, D+1] is used as an area for recording previous values, with the current values being stored when instruction execution is complete.

■ Operation example

Operation of instruction format description program

When execution condition R0 is ON, if there are changes compared to when data register DT10 was previously executed, R9009 turns ON, and R10 also turns ON following this.

■ Precautions for programming

Flag R9009, which is used for detecting data changes, is updated each time a calculation instruction, etc., is executed. Therefore:

- The program that uses R9009 should be inserted immediately after the F374 DDTR instruction.
- Output to an output relay or internal relay to hold the results.

13.7 F374 DDTR (32-bit data change detection)

Note

- Always insert execution conditions before the flag relay (R9009), as shown in the above program example. This is not necessary for normal execution.

■ Flag operations

Name	Description
R9007 R9008 (ER)	Turns ON when the area is exceeded in index modification.
R9009 (CY)	Turns ON if there are changes to the specified data area

14 Boolean Instructions

14.1 F65 WAN (Logical Conjunction of 16-Bit Data).....	14-2
14.2 F66 WOR (16-bit data OR)	14-4
14.3 F67 XOR (16-bit data exclusive OR)	14-6
14.4 F68 XNR (Exclusive NOR of 16-bit data).....	14-8
14.5 F69 WUNI (Word Coupling).....	14-10
14.6 F215 DAND (32-bit data logical conjunction).....	14-12
14.7 F216 DOR (OR Operation of 32-bit Data).....	14-14
14.8 F217 DXOR (32-Bit Data Exclusive OR)	14-16
14.9 F218 DXNR (32-bit Data Exclusive NOR)	14-18
14.10 F219 DUNI (Double word combination).....	14-20

14.1 F65 WAN (Logical Conjunction of 16-Bit Data)

14.1 F65 WAN (Logical Conjunction of 16-Bit Data)

Calculates the logical conjunction of 16-bit data.

■ Instruction format

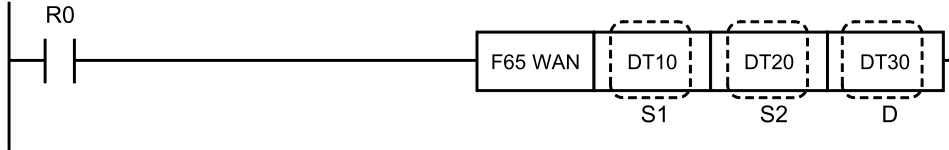

■ Operands

Items	Settings
S1	Data 1: Area storing data on which to perform the logical operation, or constant data
S2	Data 2: Area storing data on which to perform the logical operation, or constant data
D	Storage location: Area storing the operation result

■ Devices that can be specified (indicated by ●)

Operands	WX	WY	WR	WL	SV	EV	DT	LD	I	SW R	SD T	Constant				Index modifier	Integer Device
												K	H	M	f		
S1	●	●	●	●	●	●	●	●	●	●	●	●	●	●	●	●	
S2	●	●	●	●	●	●	●	●	●	●	●	●	●	●	●	●	
D		●	●	●	●	●	●	●	●							●	

■ Outline of operation

- A bitwise logical conjunction is performed on each bit of the contents of the area specified by [S1] and the contents of the area specified by [S2], and the results are stored in [D].
 $(S1) \wedge (S2) \rightarrow (D)$
- This instruction can be used for operations such as forcibly turning OFF (bit masking) specific parts of data.

■ Operation example

Operation of instruction format description program

When internal relay R0 turns ON, a bitwise logical conjunction is performed on each bit of the contents of data register DT10 and the contents of data register DT20, and the results are stored in data register DT30.

14.1 F65 WAN (Logical Conjunction of 16-Bit Data)

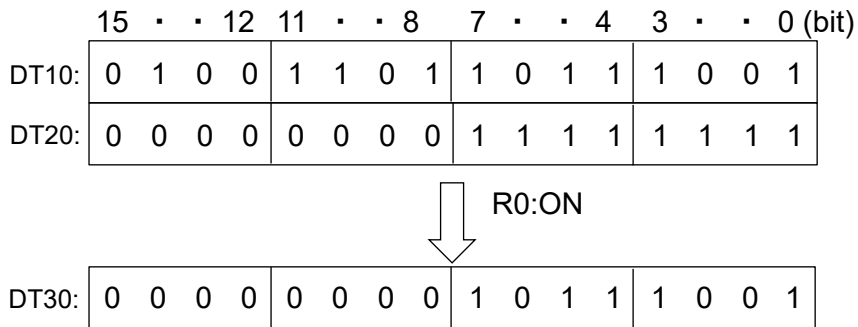

■ Logical conjunction (AND)

S1 bit	S2 bit	Logical conjunction
0	0	0
0	1	0
1	0	0
1	1	1

■ Flag operations

Name	Description
R9007 R9008 (ER)	Turns ON when the area is exceeded in index modification.
R900B (=)	Turns ON when the calculation result is "0"

14.2 F66 WOR (16-bit data OR)

14.2 F66 WOR (16-bit data OR)

Calculates the OR of 16-bit data.

■ Instruction format

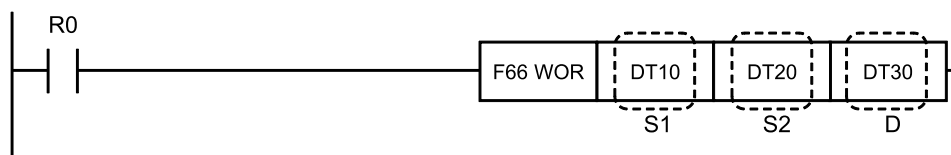

■ Operands

Items	Settings
S1	Data 1: Area storing data on which to perform the logical operation, or constant data
S2	Data 2: Area storing data on which to perform the logical operation, or constant data
D	Storage location: Area storing the operation result

■ Devices that can be specified (indicated by ●)

Operands	WX	WY	WR	WL	SV	EV	DT	LD	I	SWR	SDT	Constant				Index modifier	Integer Device
												K	H	M	f		
S1	●	●	●	●	●	●	●	●	●	●	●	●	●	●	●	●	
S2	●	●	●	●	●	●	●	●	●	●	●	●	●	●	●	●	
D		●	●	●	●	●	●	●	●							●	

■ Outline of operation

- A bitwise OR is performed on each bit of the contents of the area specified by [S1] and the contents of the area specified by [S2], and the results are stored in the area specified by [D].
(S1) v (S2) → (D)
- This instruction can be used to forcibly turn ON specific parts of data.

■ Operation example

Operation of instruction format description program

When internal relay R0 turns ON, a bitwise OR is performed on each bit of the contents of data register DT10 and the contents of data register DT20, and the result is stored in data register DT30.

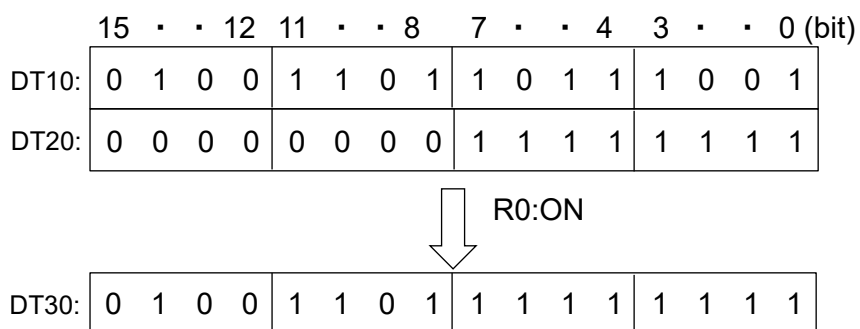

■ Logical disjunction (OR)

S1 bit	S2 bit	Logical disjunction
0	0	0
0	1	1
1	0	1
1	1	1

■ Flag operations

Name	Description
R9007 R9008 (ER)	Turns ON when the area is exceeded in index modification.
R900B (=)	Turns ON when the calculation result is "0"

14.3 F67 XOR (16-bit data exclusive OR)

14.3 F67 XOR (16-bit data exclusive OR)

Calculates the exclusive OR of 16-bit data.

■ Instruction format

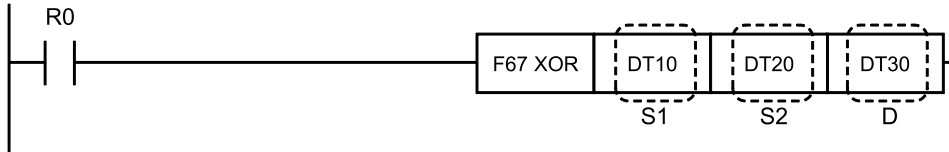

■ Operands

Items	Settings
S1	Data 1: Area storing data on which to perform the logical operation, or constant data
S2	Data 2: Area storing data on which to perform the logical operation, or constant data
D	Storage location: Area storing the operation result

■ Devices that can be specified (indicated by ●)

Operands	WX	WY	WR	WL	SV	EV	DT	LD	I	SWR	SDT	Constant				Index modifier	Integer Device
												K	H	M	f		
S1	●	●	●	●	●	●	●	●	●	●	●	●	●	●	●	●	
S2	●	●	●	●	●	●	●	●	●	●	●	●	●	●	●	●	
D		●	●	●	●	●	●	●	●							●	

■ Outline of operation

- An exclusive OR is performed on each bit of the contents of the area specified by [S1] and the contents of the area specified by [S2], and the results are stored in the area specified by [D].

$$\{(S1) \wedge (S2)\} \vee \{(S1) \wedge (S2)\} \rightarrow (D)$$

- This can be used to detect bits whose ON/OFF status does not match.
- When the values of [S1] and [S2] are the same, all the bits in the data specified by [D] become 0.

■ Operation example

Operation of instruction format description program

When internal relay R0 turns ON, an exclusive OR is performed on each bit of the contents of data register DT10 and the contents of data register DT20, and the result is stored in data register DT30.

14.3 F67 XOR (16-bit data exclusive OR)

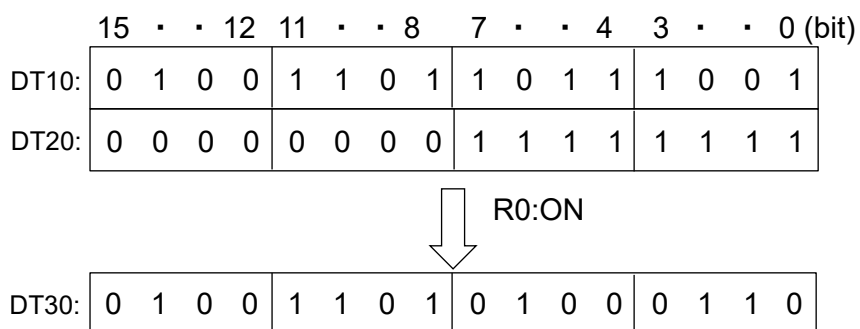

■ Exclusive OR (XOR)

S1 bit	S2 bit	Exclusive OR
0	0	0
0	1	1
1	0	1
1	1	0

■ Flag operations

Name	Description
R9007 R9008 (ER)	Turns ON when the area is exceeded in index modification.
R900B (=)	Turns ON when the calculation result is "0"

14.4 F68 XNR (Exclusive NOR of 16-bit data)

14.4 F68 XNR (Exclusive NOR of 16-bit data)

Calculates the exclusive NOR of 16-bit data.

■ Instruction format

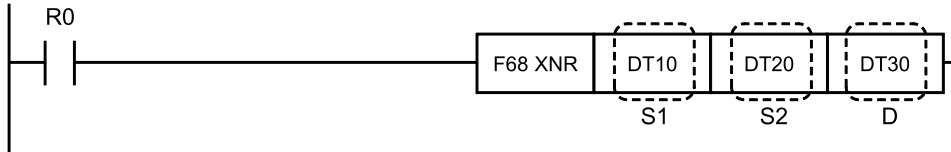

■ Operands

Items	Settings
S1	Data 1: Area storing data on which to perform the logical operation, or constant data
S2	Data 2: Area storing data on which to perform the logical operation, or constant data
D	Storage location: Area storing the operation result

■ Devices that can be specified (indicated by ●)

Operands	WX	WY	WR	WL	SV	EV	DT	LD	I	SWR	SDT	Constant				Index modifier	Integer Device
												K	H	M	f		
S1	●	●	●	●	●	●	●	●	●	●	●	●	●	●	●	●	
S2	●	●	●	●	●	●	●	●	●	●	●	●	●	●	●	●	
D		●	●	●	●	●	●	●	●							●	

■ Outline of operation

- An exclusive NOR is performed on each bit of the contents of the area specified by [S1] and the contents of the area specified by [S2], and the results are stored in the area specified by [D].

$$\{(S1) \wedge (S2)\} \vee \{(S1) \wedge (S2)\} \rightarrow (D)$$

- This can be used to detect bits with matching ON/OFF status.
- When the values of [S1] and [S2] are the same, all the bits in the data specified by [D] become 1.

■ Operation example

Operation of instruction format description program

When internal relay R0 turns ON, if the values of the bits in the same positions in data registers DT10 and DT20 are equal, the bits in the same positions in data register DT30 turn ON (1). If they are not equal, they turn OFF (0).

14.4 F68 XNR (Exclusive NOR of 16-bit data)

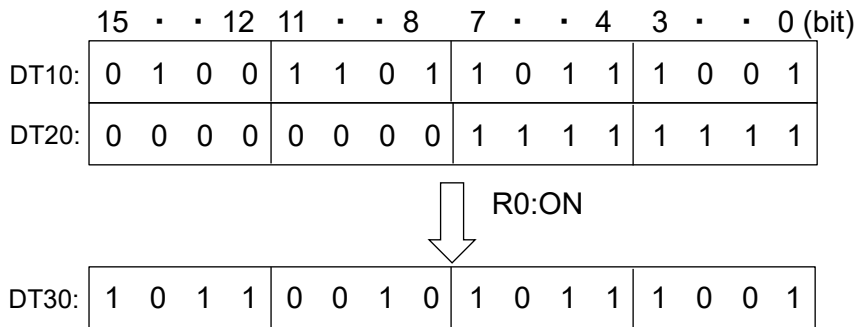

■ Exclusive NOR (XNR)

S1 bit	S2 bit	Exclusive NOR
0	0	1
0	1	0
1	0	0
1	1	1

■ Flag operations

Name	Description
R9007 R9008 (ER)	Turns ON when the area is exceeded in index modification.
R900B (=)	Turns ON when the calculation result is "0"

14.5 F69 WUNI (Word Coupling)

14.5 F69 WUNI (Word Coupling)

Combines two sets of word data.

■ Instruction format

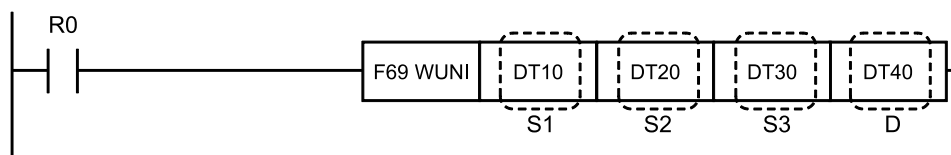

■ Operands

Items	Settings
S1	Area storing data to be combined, or constant data
S2	Area storing data to be combined, or constant data
S3	Area storing mask data for combining, or constant data
D	Area that stores operation results

■ Devices that can be specified (indicated by ●)

Operands	WX	WY	WR	WL	SV	EV	DT	LD	I	SWR	SDT	Constant				Index modifier	Integer Device
												K	H	M	f		
S1	●	●	●	●	●	●	●	●	●	●	●	●	●		●		
S2	●	●	●	●	●	●	●	●	●	●	●	●	●		●		
S3	●	●	●	●	●	●	●	●	●	●	●	●	●		●		
D		●	●	●	●	●	●	●	●						●		

■ Outline of operation

- Using the mask data specified by [S3], the two sets of word data specified by [S1] and [S2] are combined in bit units, and stored in the area specified by [D].

$([S1] \text{ AND } [S3]) \text{ OR } ([S2] \text{ AND } [S3]) \rightarrow [D]$

When [S3] is H0, [S2] is stored in [D]

When [S3] is HFFFF, [S1] is stored in [D].

■ Operation example

Operation of instruction format description program

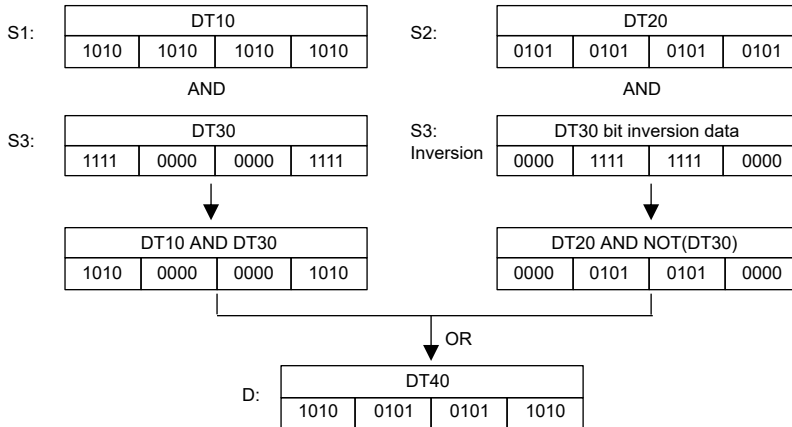

■ Flag operations

Name	Description
R9007 R9008 (ER)	Turns ON when the area is exceeded in index modification.
R900B (=)	Turns ON when the calculation result is "0"

14.6 F215 DAND (32-bit data logical conjunction)

14.6 F215 DAND (32-bit data logical conjunction)

Calculates logical conjunction of double word data.

■ Instruction format

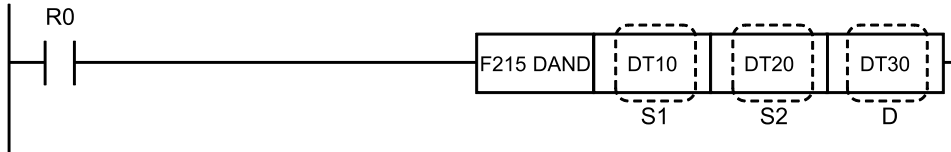

■ Operands

Items	Settings
S1	Area storing the data on which OR operations will be performed, or constant data (two words)
S2	Area storing the data on which OR operations will be performed, or constant data (two words)
D	Storage destination: Area that stores calculation results (two words)

■ Devices that can be specified (indicated by ●)

Operands	WX	WY	WR	WL	SV	EV	DT	LD	I	SWR	SDT	Constant				Index modifier	Integer Device
												K	H	M	f		
S1	●	●	●	●	●	●	●	●	●	●	●	●	●		●		
S2	●	●	●	●	●	●	●	●	●	●	●	●	●		●		
D		●	●	●	●	●	●	●	●						●		

■ Outline of operation

- Takes the logical conjunction for each bit of the double word data specified by [S1, S1+1] and the double word data specified by [S2, S2+2], and stores the results in [D, D+1].

■ Operation example

Operation of instruction format description program

	15		0													
DT10	1	0	0	1	0	1	1	0	0	0	1	0	0	0	1	
DT11	1	1	0	0	0	1	1	0	1	0	1	0	1	0	0	1

Logical conjunction

	15		0													
DT20	1	1	1	1	1	1	1	1	0	0	0	0	0	0	0	0
DT21	0	0	0	0	0	0	0	0	1	1	1	1	1	1	1	1



	15		0													
DT30	1	0	0	1	0	1	1	0	0	0	0	0	0	0	0	0
DT31	0	0	0	0	0	0	0	0	1	0	1	0	1	0	0	1

■ Flag operations

Name	Description
R9007 R9008 (ER)	Turns ON when the area is exceeded in index modification.
R900B (=)	Turns ON when the calculation result is "0"

14.7 F216 DOR (OR Operation of 32-bit Data)

14.7 F216 DOR (OR Operation of 32-bit Data)

Performs OR operations double word data.

■ Instruction format

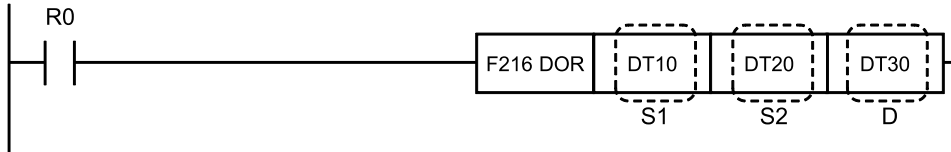

■ Operands

Items	Settings
S1	Area storing the data on which OR operations will be performed, or constant data (two words)
S2	Area storing the data on which OR operations will be performed, or constant data (two words)
D	Storage destination: Area that stores calculation results (two words)

■ Devices that can be specified (indicated by ●)

Operands	WX	WY	WR	WL	SV	EV	DT	LD	I	SWR	SDT	Constant				Index modifier	Integer Device
												K	H	M	f		
S1	●	●	●	●	●	●	●	●	●	●	●	●	●	●	●	●	
S2	●	●	●	●	●	●	●	●	●	●	●	●	●	●	●	●	
D		●	●	●	●	●	●	●	●							●	

■ Outline of operation

- Performs OR operation on each bit of the double word data specified by [S1, S1+1] and [S2, S2+1], and stores the results in [D, D+1].

■ Operation example

Operation of instruction format description program

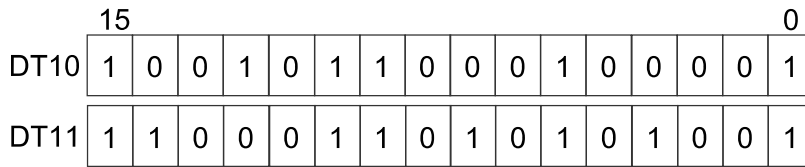

Logical disjunction

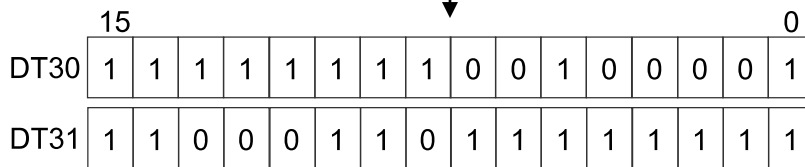
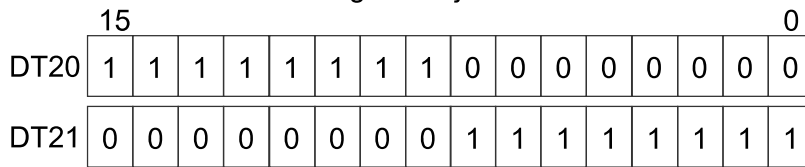

■ Flag operations

Name	Description
R9007 R9008 (ER)	Turns ON when the area is exceeded in index modification.
R900B (=)	Turns ON when the calculation result is "0"

14.8 F217 DXOR (32-Bit Data Exclusive OR)

14.8 F217 DXOR (32-Bit Data Exclusive OR)

Calculates the exclusive OR of double-word data.

■ Instruction format

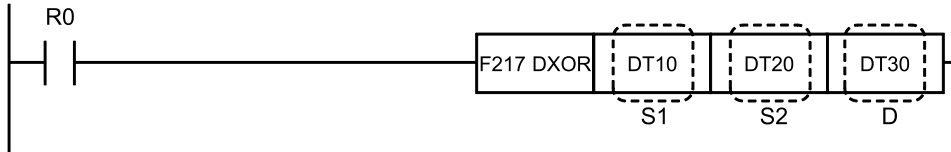

■ Operands

Items	Settings
S1	Area storing the data on which OR operations will be performed, or constant data (two words)
S2	Area storing the data on which OR operations will be performed, or constant data (two words)
D	Storage destination: Area that stores calculation results (two words)

■ Devices that can be specified (indicated by ●)

Operands	WX	WY	WR	WL	SV	EV	DT	LD	I	SWR	SDT	Constant				Index modifier	Integer Device
												K	H	M	f		
S1	●	●	●	●	●	●	●	●	●	●	●	●	●	●	●	●	
S2	●	●	●	●	●	●	●	●	●	●	●	●	●	●	●	●	
D		●	●	●	●	●	●	●	●							●	

■ Outline of operation

- An exclusive OR is performed on each bit of the double-word data specified by [S1, S1+1] and the double-word data specified by [S2, S2+1], and the results are stored in the area specified by [D, D+1].

- This can be used to detect which bits are not the same.

Matching bit = 0

Non-matching bit = 1

■ Operation example

Operation of instruction format description program

	15		0													
DT10	1	0	0	1	0	1	1	0	0	0	1	0	0	0	1	
DT11	1	1	0	0	0	1	1	0	1	0	1	0	1	0	0	1

Exclusive OR

	15		0													
DT20	1	1	1	1	1	1	1	1	0	0	0	0	0	0	0	0
DT21	0	0	0	0	0	0	0	0	1	1	1	1	1	1	1	1



	15		0													
DT30	0	1	1	0	1	0	0	1	0	0	1	0	0	0	0	1
DT31	1	1	0	0	0	1	1	0	0	1	0	1	0	1	1	0

■ Flag operations

Name	Description
R9007 R9008 (ER)	Turns ON when the area is exceeded in index modification.
R900B (=)	Turns ON when the calculation result is "0"

14.9 F218 DXNR (32-bit Data Exclusive NOR)

14.9 F218 DXNR (32-bit Data Exclusive NOR)

Calculates the exclusive NOR of double word data.

■ Instruction format

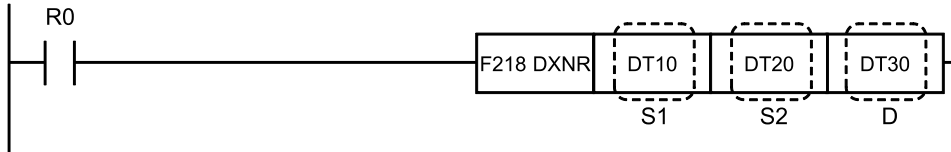

■ Operands

Items	Settings
S1	Area storing the data on which OR operations will be performed, or constant data (two words)
S2	Area storing the data on which OR operations will be performed, or constant data (two words)
D	Storage destination: Area that stores calculation results (two words)

■ Devices that can be specified (indicated by ●)

Operands	WX	WY	WR	WL	SV	EV	DT	LD	I	SWR	SDT	Constant				Index modifier	Integer Device
												K	H	M	f		
S1	●	●	●	●	●	●	●	●	●	●	●	●	●			●	
S2	●	●	●	●	●	●	●	●	●	●	●	●	●			●	
D		●	●	●	●	●	●	●	●							●	

■ Outline of operation

- Retrieves the exclusive NOR of each bit for the double word data specified by [S1, S1+1] and the double word data specified by [S2, S2+1] before storing the result in [D, D+1].
- This can be used to determine whether each bit matches.

Matching bit = 1

Non-matching bit = 0

■ Operation example

Operation of instruction format description program

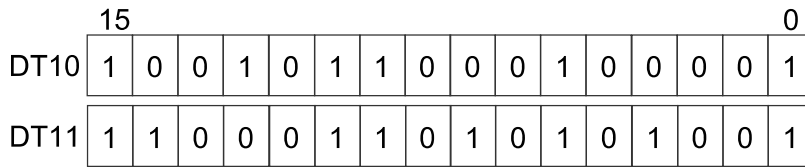

Exclusive NOR

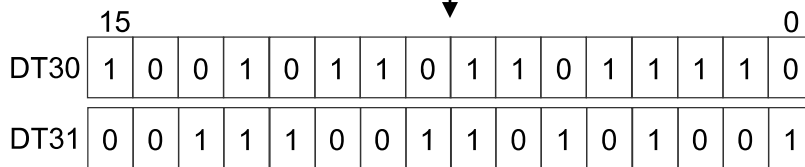
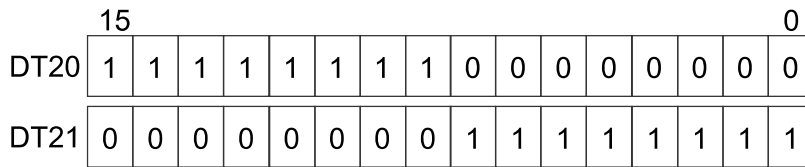

■ Flag operations

Name	Description
R9007 R9008 (ER)	Turns ON when the area is exceeded in index modification.
R900B (=)	Turns ON when the calculation result is "0"

14.10 F219 DUNI (Double word combination)

14.10 F219 DUNI (Double word combination)

Combines two double words.

■ Instruction format

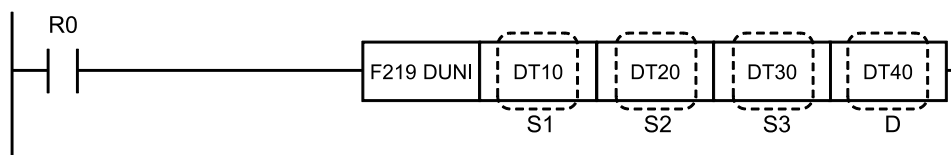

■ Operands

Items	Settings
S1	Area storing the data to be combined, or constant data (two words)
S2	Area storing the data to be combined, or constant data (two words)
S3	Area storing mask data for combination, or constant data (two words)
D	Area storing the operation results (two words)

■ Devices that can be specified (indicated by ●)

Operands	WX	WY	WR	WL	SV	EV	DT	LD	I	SWR	SDT	Constant				Index modifier	Integer Device
												K	H	M	f		
S1	●	●	●	●	●	●	●	●	●	●	●	●	●		●		
S2	●	●	●	●	●	●	●	●	●	●	●	●	●		●		
S3	●	●	●	●	●	●	●	●	●	●	●	●	●		●		
D		●	●	●	●	●	●	●	●						●		

■ Outline of operation

- Using the mask data specified by [S3, S3+1], the two double word data specified by [S1, S1+1] and [S2, S2+1] are combined in bit units and stored in the area specified by [D, D+1].
 $([S1, S1+1] \text{ AND } [S3, S3+1]) \text{ OR } ([S2, S2+1] \text{ AND } [S3, S3+1]) \rightarrow [D, D+1]$
- If [S3, S3+1] is H0, then [S2, S2+1] → [D, D+1]
- If [S3, S3+1] is HFFFFFFF, then [S1, S1+1] → [D, D+1]

■ Operation example

Operation of instruction format description program

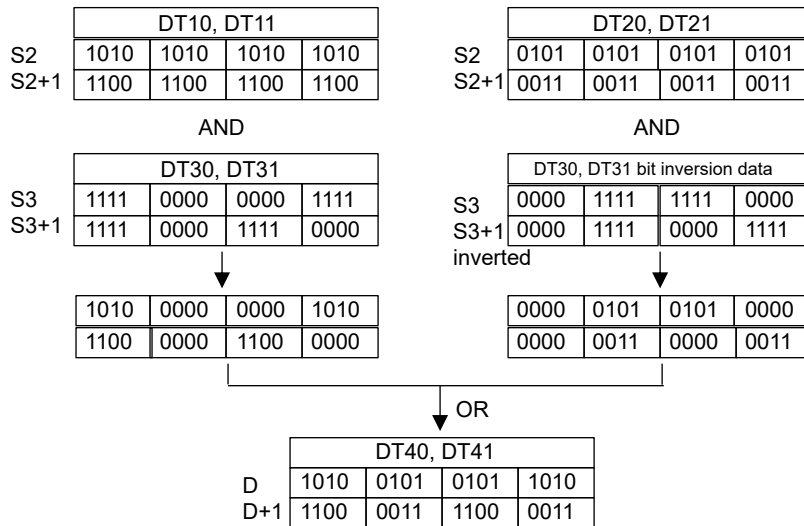

■ Flag operations

Name	Description
R9007 R9008 (ER)	Turns ON when the area is exceeded in index modification.
R900B (=)	Turns ON when the calculation result is "0"

(MEMO)

15 Data Conversion Instructions

15.1 F70 BCC (Block Check Code Calculation)	15-3
15.2 F71 HEXA (HEX to Hexadecimal ASCII Conversion).....	15-7
15.3 F72 AHEX (Hexadecimal ASCII to Hex conversion).....	15-10
15.4 F73 BCDA (BCD to Decimal ASCII conversion).....	15-14
15.5 F74 ABCD (Decimal ASCII Code to BCD Conversion).....	15-18
15.6 F75 BINA (BIN to Decimal ASCII conversion)	15-22
15.7 F76 ABIN (Decimal ASCII Code to BIN Conversion).....	15-25
15.8 F77 DBIA (BIN → Decimal ASCII Conversion).....	15-29
15.9 F78 DABI (Decimal ASCII → BIN conversion).....	15-32
15.10 F80 BCD (16-bit BIN to 4-digit BCD conversion).....	15-36
15.11 F81 BIN (4-digit BCD to 16-bit BIN conversion).....	15-38
15.12 F82 DBCD (32-bit BIN → 8-digit BCD conversion).....	15-40
15.13 F83 DBIN (8-Digit BCD to 32-Bit BIN Conversion)	15-41
15.14 F84 INV (16-bit data invert).....	15-42
15.15 F85 NEG (Hexadecimal Data Complement of 2).....	15-43
15.16 F86 DNEG (32-bit Data Complement of 2).....	15-44
15.17 F87 ABS (Absolute value of 16-bit data)	15-46
15.18 F88 DABS (Absolute value of 32-bit data).....	15-47
15.19 F89 EXT (Sign Extension)	15-48
15.20 F90 DECO (Decode).....	15-50
15.21 F91 SEGT (7-segment decode).....	15-53
15.22 F92 ENCO (Encode).....	15-55
15.23 F93 UNIT (16-bit data combine)	15-58
15.24 F94 DIST (16-Bit Data Distribution)	15-60
15.25 F96 SRC (16-Bit Data Search)	15-62
15.26 F97 DSRC (32-bit Data Search)	15-64
15.27 F230 TMSEC (Time data to second conversion).....	15-66
15.28 F231 SECTM (Second to Time Data Conversion).....	15-69
15.29 F235 GRY (16-Bit Binary to Gray Code Conversion)	15-72
15.30 F236 DGRY (32-Bit Data to Gray code)	15-73

15 Data Conversion Instructions

- 15.31 F237 GBIN (16-bit gray code to binary conversion) 15-74
- 15.32 F238 DGBIN (32-bit Gray Code to Binary Conversion) 15-75
- 15.33 F240 COLM (Bit Line to Bit Column Conversion) 15-77
- 15.34 F241 LINE (Bit Column to Bit Line Conversion) 15-79

15.1 F70 BCC (Block Check Code Calculation)

Calculates block check code (BCC).

■ Instruction format

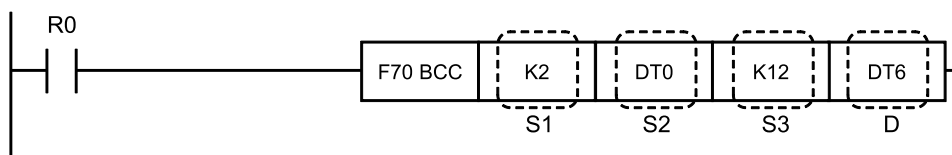

■ Operands

Items	Settings
S1	Area storing data specifying the calculation method, or constant data
S2	Starting address of the area storing target data
S3	Area storing the length (number of bytes) of the target data, or constant data
D	Area that stores operation results

■ Devices that can be specified (indicated by ●)

Operands	WX	WY	WR	WL	SV	EV	DT	LD	I	SW R	SD T	Constant				Index modifier	Integer Device
												K	H	M	f		
S1	●	●	●	●	●	●	●	●	●	●	●	●	●			●	
S2	●	●	●	●	●	●	●	●		●	●					●	
S3	●	●	●	●	●	●	●	●	●	●	●	●	●			●	
D		●	●	●	●	●	●	●								●	

■ Outline of operation

- Creates block check code (BCC) from the starting position for the calculation specified by S1 and S2 using the calculation method specified by S1, and stores the result at the storage position specified by D and S1 according to the conversion method specified by S1.

15.1 F70 BCC (Block Check Code Calculation)

Specification of control data [S1]

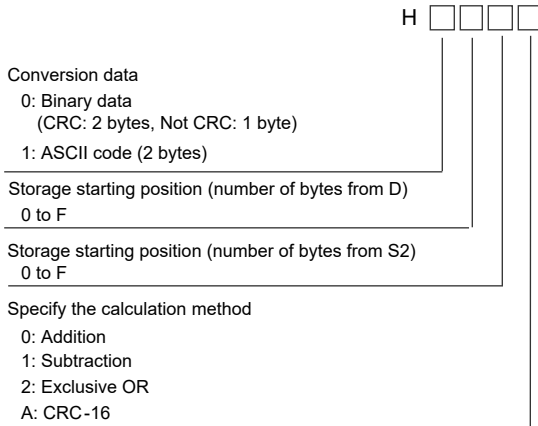

(Note 1) If CRC-16 is specified as the calculation method, ASCII code cannot be specified for the conversion data.

■ Calculation method

If the calculation method specified by [S1] is CRC, the calculation is carried out using the following generator polynomial. (Same calculation method as MODBUS-RTU.)

Generator polynomial: $X^{16}+X^{15}+X^2+1$

■ Operation example

Operation of instruction format description program

When the internal relay R0 turns ON, this calculates the BCC for the 12 bytes of data stored starting from data register DT0, via an exclusive OR operation. The result is stored in the lower byte of DT6.

■ Usage example 1

In this example, the block check code of the message being sent "%01#RCSX0000" is calculated and is added after the message.

- Transmission is performed using ASCII codes.
- BCC is calculated via an exclusive OR.

1. The message should be stored in the memory area as shown below.

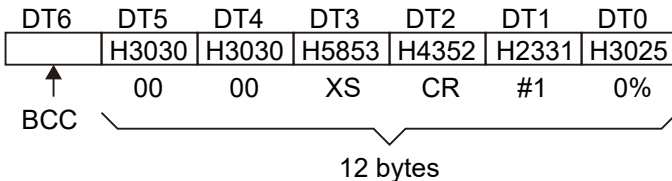

2. The BCC instruction is as shown below.

15.1 F70 BCC (Block Check Code Calculation)

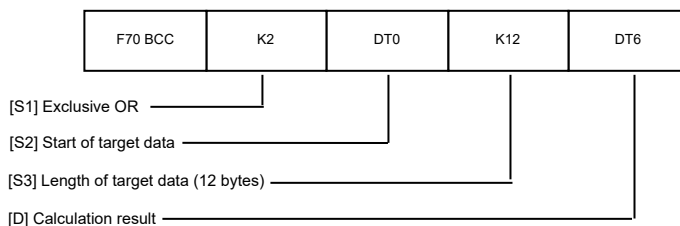

> When this is executed, BCC (H 1D) is stored in the lower byte of DT6 of [D].

- Calculation method

Calculation is performed as shown below. (Explained in Usage example 2.)

% → H25 → 00100101 (a)

0 → H30 → 00110000 (b)

1 → H31 → 00110001 (c)

→ H23 → 00100011 (d)

R → H52 → 01010010 (e)

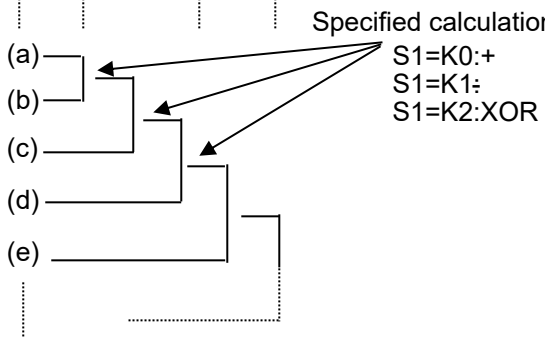

Calculation is performed in the order of carrying out the specified calculation in 8-bit units, and carrying out calculations on that result with the next 8 bits.

■ Usage example 2

In this example the block check code of the message being sent "%01#RCSX0000" is calculated and is added at the end of the message

- Calculation method: addition, conversion data: binary data

DT9	DT8	DT7	DT6	DT5	DT4	DT3	DT2	DT1	DT0
H0000	H0000	H0000	H0000	H3030	H3030	H5853	H4352	H2331	H3025
				00	00	XS	CR	#1	0%

Specification of control data [S1]

DT10 = H0C00

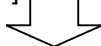

DT9	DT8	DT7	DT6	DT5	DT4	DT3	DT2	DT1	DT0
H0000	H0000	H0000	H00A9	H3030	H3030	H5853	H4352	H2331	H3025
				00	00	XS	CR	#1	0%

- Calculation method: addition, conversion data: ASCII code

15.1 F70 BCC (Block Check Code Calculation)

DT9	DT8	DT7	DT6	DT5	DT4	DT3	DT2	DT1	DT0
H0000	H0000	H0000	H0000	H3030	H3030	H5853	H4352	H2331	H3025

00 00 XS CR #1 0%

Specification of control data [S1]

DT10 = H1C00

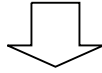

DT9	DT8	DT7	DT6	DT5	DT4	DT3	DT2	DT1	DT0
H0000	H0000	H0000	H3941	H3030	H3030	H5853	H4352	H2331	H3025

9A 00 00 XS CR #1 0%

- Calculation method: addition, conversion data: ASCII code

DT9	DT8	DT7	DT6	DT5	DT4	DT3	DT2	DT1	DT0
H0000	H0000	H0030	H3030	H3058	H5343	H5223	H3130	H2500	H0000

0 00 0X SC R# 10 %

Specification of control data [S1]

DT10 = H1F30

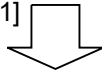

DT9	DT8	DT7	DT6	DT5	DT4	DT3	DT2	DT1	DT0
H0000	H0039	H4130	H3030	H3058	H5343	H5223	H3130	H2500	H0000

9 A0 00 0X SC R# 10 %

- Calculation method: CRC, conversion data: binary data

DT9	DT8	DT7	DT6	DT5	DT4	DT3	DT2	DT1	DT0
H0000	H0000	H0000	H0000	H3030	H3030	H5853	H4352	H2331	H3025

00 00 XS CR #1 0%

Specification of control data [S1]

DT10 = H0C0A

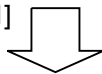

DT9	DT8	DT7	DT6	DT5	DT4	DT3	DT2	DT1	DT0
H0000	H0000	H0000	H2E0A	H3030	H3030	H5853	H4352	H2331	H3025

00 00 XS CR #1 0%

■ Flag operations

Name	Description
R9007	When the calculation method specified by S1 is outside the specified range
R9008 (ER)	When the conversion data specified by S1 is outside the specified range

15.2 F71 HEXA (HEX to Hexadecimal ASCII Conversion)

Converts hexadecimal numeric values to ASCII code.

■ Instruction format

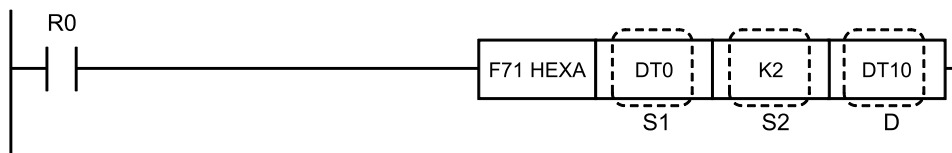

■ Operands

Items	Settings
S1	Starting number for the area storing the hexadecimal numeric values
S2	Area storing the length of the numeric value (number of bytes) to be converted, or constant data
D	Starting number of the area storing the ASCII code of conversion result

■ Devices that can be specified (indicated by ●)

Operands	WX	WY	WR	WL	SV	EV	DT	LD	I	SWR	SDT	Constant				Index modifier	Integer Device
												K	H	M	f		
S1	●	●	●	●	●	●	●	●		●	●					●	
S2	●	●	●	●	●	●	●	●	●	●	●	●	●			●	
D		●	●	●	●	●	●	●								●	

■ Outline of operation

- The hexadecimal numeric data stored in the area specified by [S1] is converted to ASCII codes and stored in the area specified by [D].
- [S2] specifies the number of data bytes to be converted.
- The amount of the result (ASCII code) is twice the converted data.

■ Operation example

Operation of instruction format description program

When internal relay R0 turns ON, the hexadecimal numeric data stored in data register DT0 (two bytes) is converted to ASCII codes and stored in DT10 and DT11.

Hexadecimal number (DT0)

H ABCD



ASCII code (DT11, DT10)

H 42414443

B A D C

DT11 DT10

15.2 F71 HEXA (HEX to Hexadecimal ASCII Conversion)

■ Precautions for programming

1. The two characters that make up one byte are interchanged when stored.
2. Converts two bytes as one section.

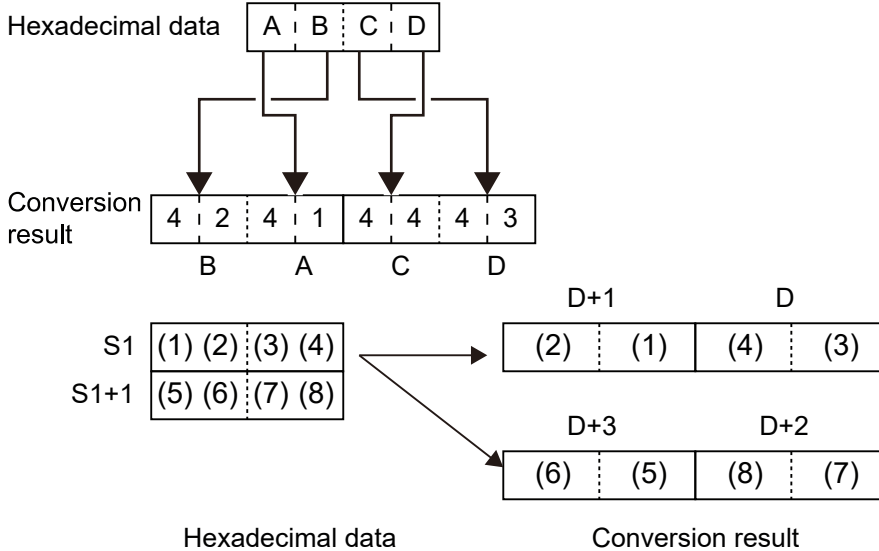

■ Conversion example

The following shows the conversion of hexadecimal number data to ASCII code.

Conversion of 4 bytes (S2 = K4)

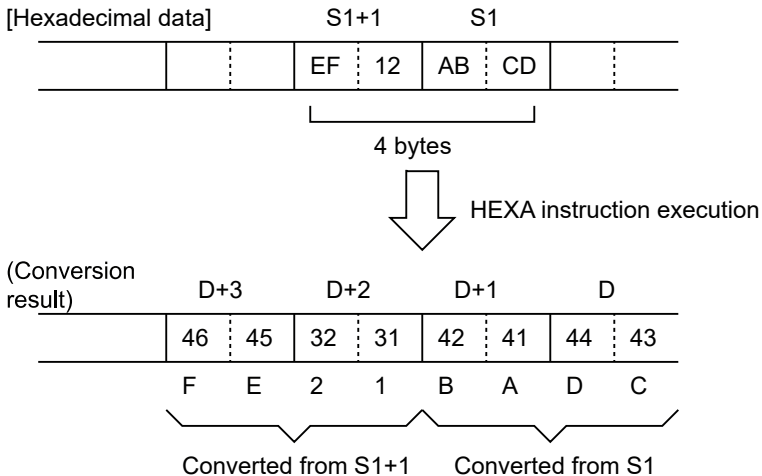

Conversion of 3 bytes (S2 = K3)

Since the data to be converted is specified in byte units, it is also possible to convert only the low byte of one-word data.

15.2 F71 HEXA (HEX to Hexadecimal ASCII Conversion)

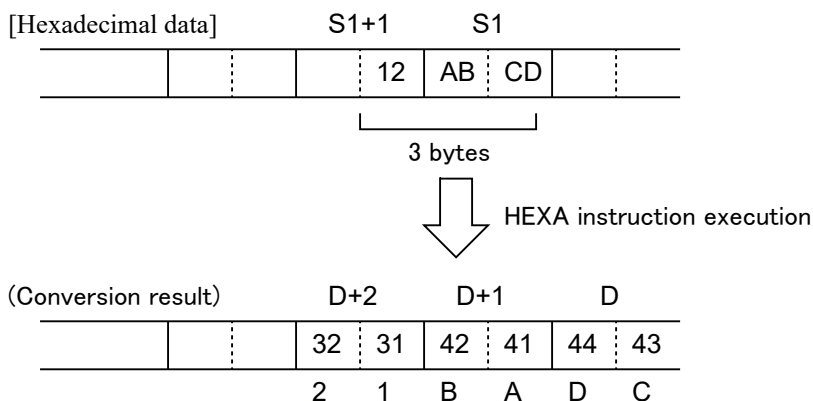

■ Reference: ASCII code

		Higher	
		3	4
Lower	0	0	@
	1	1	A
	2	2	B
	3	3	C
	4	4	D
	5	5	E
	6	6	F
	7	7	G
	8	8	H
	9	9	I

■ Flag operations

Name	Description
R9007 R9008 (ER)	Turns ON when the area is exceeded in index modification.
	Turns ON when the conversion range of the number of bytes specified by [S2] exceeds the area
	Turns ON when the conversion result exceeds the area
	Turns ON when the [S2] specification is "0"

15.3 F72 AHEX (Hexadecimal ASCII to Hex conversion)

15.3 F72 AHEX (Hexadecimal ASCII to Hex conversion)

Converts character strings in ASCII code to hexadecimal numbers.

■ Instruction format

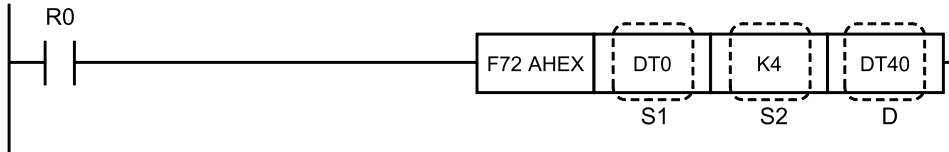

■ Operands

Items	Settings
S1	Starting number of the area storing the ASCII code
S2	Area storing the number of ASCII codes (number of characters) to be converted, or constant data
D	Number of the start of the area storing the hexadecimal number that is the result of conversion

■ Devices that can be specified (indicated by ●)

Operands	WX	WY	WR	WL	SV	EV	DT	LD	I	SW R	SD T	Constant				Index modifier	Integer Device
												K	H	M	f		
S1	●	●	●	●	●	●	●	●		●	●					●	
S2	●	●	●	●	●	●	●	●	●	●	●	●	●			●	
D		●	●	●	●	●	●	●								●	

■ Outline of operation

- The ASCII codes stored in the area specified by [S1] are converted into hexadecimal numeric data and stored in the area specified by [D].
- The number of ASCII codes (number of characters) to be converted is specified by [S2].
- The volume of the result (hexadecimal numeric data) is half that of the converted ASCII codes.

■ Operation example

Operation of instruction format description program

When the internal relay R0 turns ON, the ASCII codes stored in data registers DT0 and DT1 (four characters) are converted into hexadecimal numeric data and stored in DT40.

ASCII code (DT1, DT0)

H 44 43 42 41
 D C B A
 DT1 DT0



Value in hexadecimal (DT40)
 H CDAB

■ **Precautions for programming**

1. Two ASCII code characters are converted into two 1-byte numeric digits. At this time, the upper and lower characters are interchanged.
2. Four characters are converted as one segment of data.

ASCII code string

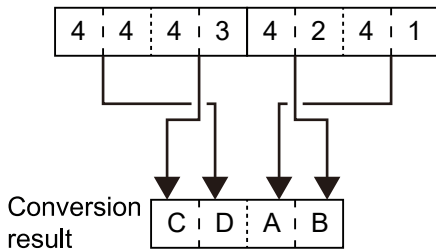

■ **Conversion example**

- ASCII codes are converted into hexadecimal data as shown below.

Conversion of eight characters (S2 = K8)

[ASCII code]

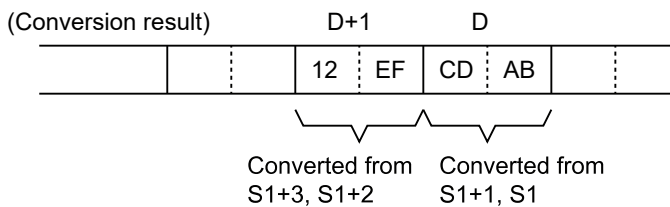
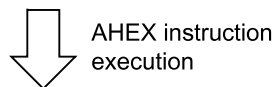
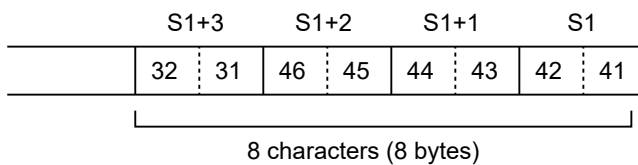

15.3 F72 AHX (Hexadecimal ASCII to Hex conversion)

Conversion of seven characters (S2 = K7)

[ASCII code]

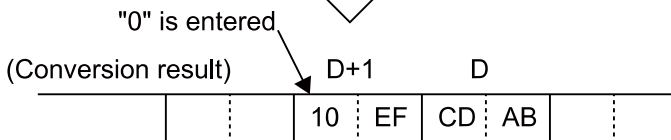
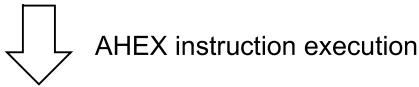
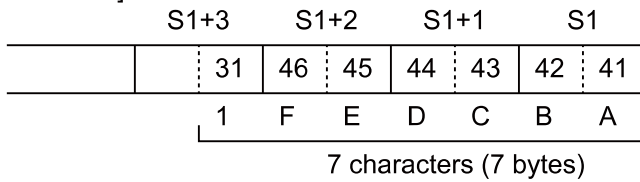

Conversion of six characters (S2 = K6)

[ASCII code]

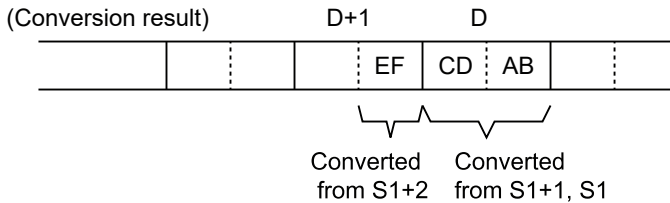
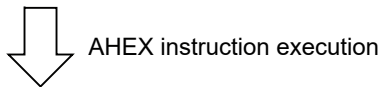
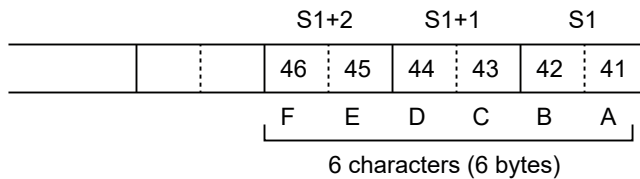

(Note 1) In the conversion results, only the data for the low byte is stored in the D+1 word. The data for the high byte is left as it is and does not change.

- The conversion results are stored in byte units. If an odd number of characters is being converted, bits 0 to 3 of the final data (byte) of the conversion results will be filled with "0".

15.3 F72 AHEX (Hexadecimal ASCII to Hex conversion)

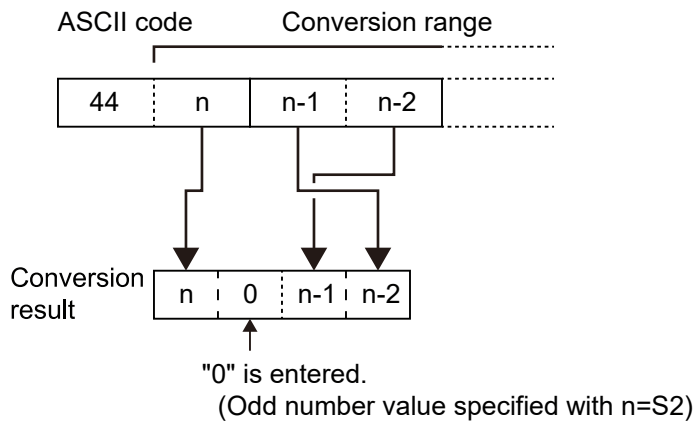

■ Reference: ASCII code

		Higher	
		3	4
Lower	0	0	@
	1	1	A
	2	2	B
	3	3	C
	4	4	D
	5	5	E
	6	6	F
	7	7	G
	8	8	H
	9	9	I

■ Flag operations

Name	Description
R9007 R9008 (ER)	Turns ON when the area is exceeded in index modification.
	Turns ON when the conversion range of the number of bytes specified by [S2] exceeds the area
	Turns ON when the conversion result exceeds the area
	Turns ON when the [S2] specification is "0"
	Turns ON when there is a character code other than 0 to F in the ASCII codes specified by [S1]

15.4 F73 BCDA (BCD to Decimal ASCII conversion)

15.4 F73 BCDA (BCD to Decimal ASCII conversion)

Converts up to eight digits of BCD data to ASCII code character strings.

■ Instruction format

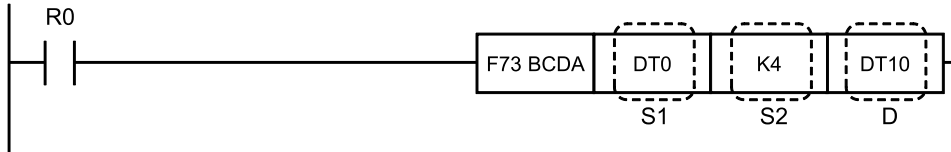

■ Operands

Items	Settings
S1	Starting number of the area storing the BCD numerical value
S2	Area storing data indicating the amount and direction of data to be converted, or constant data
D	Starting number of the area storing the ASCII code of conversion result

■ Devices that can be specified (indicated by ●)

Operands	WX	WY	WR	WL	SV	EV	DT	LD	I	SWR	SDT	Constant				Index modifier	Integer Device
												K	H	M	f		
S1	●	●	●	●	●	●	●	●		●	●					●	
S2	●	●	●	●	●	●	●	●	●	●	●	●	●			●	
D		●	●	●	●	●	●	●								●	

■ Outline of operation

- The BCD data stored in the area specified by [S1] is converted to ASCII code and stored in the area specified by [D]. Up to four bytes (8 digits) can be converted.
- The amount (number of bytes) of BCD data to be converted and the conversion direction is specified by [S2].
- The amount of the conversion result (ASCII code) is twice the converted data.

■ Setting the conversion data amount and conversion direction [S2]

Specify a 4-digit BCD (H constant) according to the following format.

S2=H 00

Conversion range
0: Forward direction
1: Reverse direction

Amount of data to convert
1 to 4 bytes

- Since the amount of data to be converted is specified in bytes, it is also possible to convert only the low byte of one word data.
- Refer to the example for a description of the conversion direction.

■ Precautions for programming

- The two characters that make up one byte are interchanged when stored.
- Converts two bytes as one section.

Forward direction

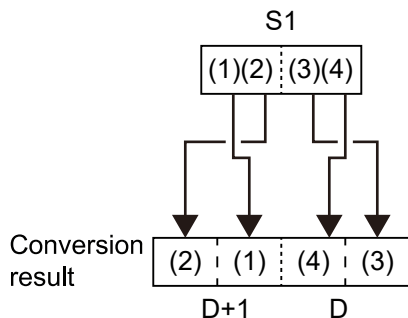

Reverse direction

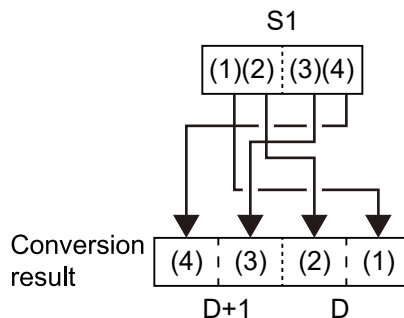

<Example>

When internal relay R0 turns ON, the BCD data stored in data register DT0 is converted to ASCII code and stored in DT10.

1. When S2 = H2 (forward direction, 2-byte conversion)

```

BCD data (DT0)
H 1234
  ↓
ASCII code (DT11, DT10)
H 32313433
  2 1 4 3
  └──┬──┘ └──┬──┘
    DT11 DT10
    
```

2. When S2 = H1002 (reverse direction, 2-byte conversion)

```

BCD data (DT0)
H 1234
  ↓
ASCII code (DT11, DT10)
H 34333231
  4 3 2 1
  └──┬──┘ └──┬──┘
    DT11 DT10
    
```

■ Conversion example

For the above program

The conversion from BCD data to ASCII code is performed as shown below.

15.4 F73 BCDA (BCD to Decimal ASCII conversion)

Forward conversion of four bytes (S2 = H0004)

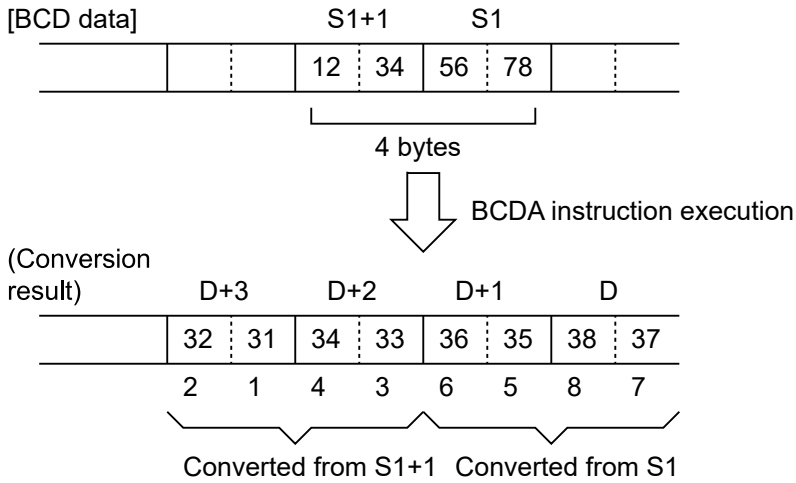

Reverse conversion of four bytes (S2 = H1004)

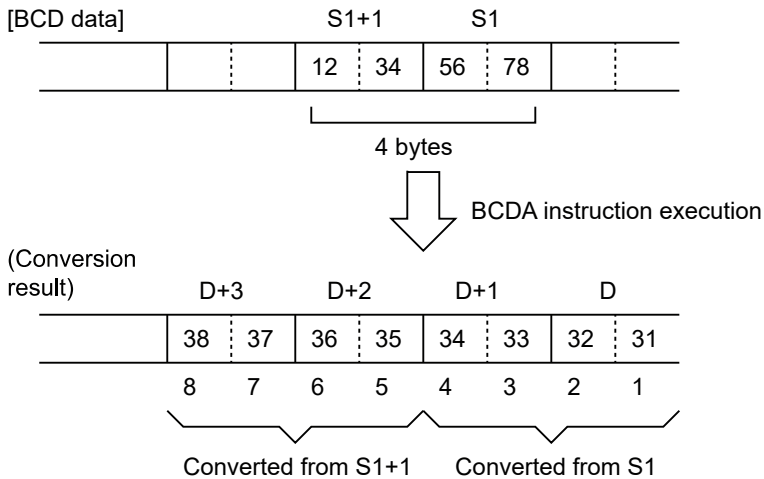

■ Reference: ASCII code

		Higher
		3
Lower	0	0
	1	1
	2	2
	3	3
	4	4
	5	5
	6	6
	7	7

15.4 F73 BCDA (BCD to Decimal ASCII conversion)

		Higher
		3
	8	8
	9	9

■ Flag operations

Name	Description
R9007 R9008 (ER)	Turns ON when the area is exceeded in index modification.
	Turns ON when there is data other than BCD in the data starting with [S1]
	Turns ON when the number of bytes specified by [S2] exceeds the area of [S1]
	Turns ON when the conversion result exceeds the area
	Turns ON when the number of bytes specified by [S2] is "0"
	Turns ON when the number of bytes specified by [S2] is greater than four

15.5 F74 ABCD (Decimal ASCII Code to BCD Conversion)

15.5 F74 ABCD (Decimal ASCII Code to BCD Conversion)

Converts an ASCII character string to 4-digit BCD data.

■ Instruction format

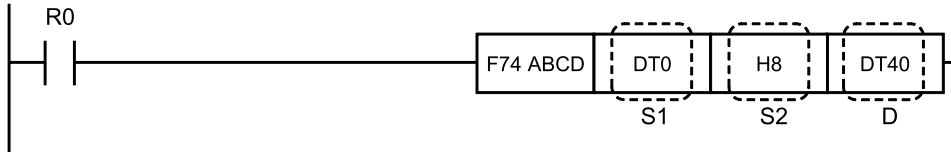

■ Operands

Items	Settings
S1	Starting number of the area storing the ASCII code
S2	Area storing data indicating the number of ASCII codes and direction of data to be converted, or constant data
D	Number of the start of the area storing the BCD value that is the result of conversion

■ Devices that can be specified (indicated by ●)

Operands	WX	WY	WR	WL	SV	EV	DT	LD	I	SWR	SDT	Constant				Index modifier	Integer Device
												K	H	M	f		
S1	●	●	●	●	●	●	●	●		●	●					●	
S2	●	●	●	●	●	●	●	●	●	●	●	●	●			●	
D		●	●	●	●	●	●	●								●	

■ Outline of operation

- The ASCII codes that are stored in the area starting from the number specified by [S1] are converted into BCD data and stored in the area starting from the number specified by [D]. A maximum of eight characters can be converted.
- The number of ASCII codes (number of characters) to be converted and the conversion direction are specified by [S2].
- The conversion result (BCD data) is half the volume of the converted ASCII code strings.

■ Specification of number of characters to be converted and conversion direction [S2]

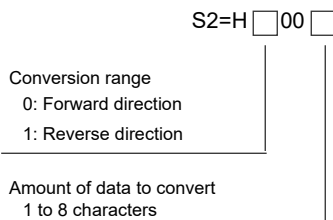

■ Precautions for programming

- Two ASCII code characters are converted into 1-byte numeric values (two digits). At this time, the upper and lower characters are interchanged.
- Four characters are stored as one segment of data.
- The conversion results are stored in byte units. If an odd number of characters is being converted, the conversion result is as follows.
 - i) Bits 0 to 3 of the final data are filled with "0". (In the forward direction)
 - ii) Bits 4 to 7 of the final data are filled with "0". (In the reverse direction)

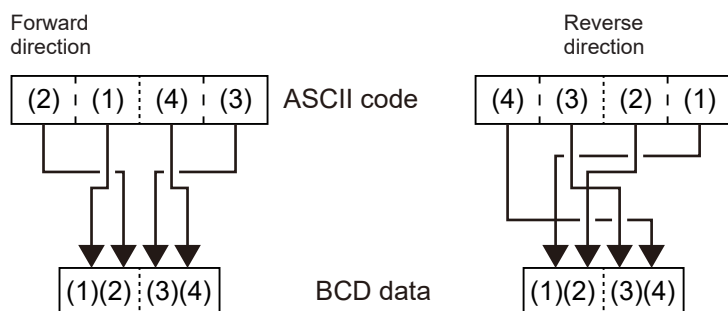

<Example>

When internal relay R0 turns ON, the ASCII codes stored in data registers starting from DT0 are converted to BCD numeric data and stored in DT40.

1. When S2 = H4 (forward direction, 4-byte conversion)

ASCII code (DT1, DT0)

H 34 33 32 31
 4 3 2 1
 DT1 DT0



BCD data (DT40)

H 3412

2. When S2 = H1004 (reverse direction, 4-byte conversion)

ASCII code (DT1, DT0)

H 34 33 32 31
 4 3 2 1
 DT1 DT0



BCD data (DT40)

H 1234

■ Conversion example

For the above program

ASCII codes are converted into BCD data as shown below.

15.5 F74 ABCD (Decimal ASCII Code to BCD Conversion)

Conversion of eight characters (S2 = H0008)

[ASCII code]

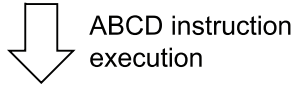
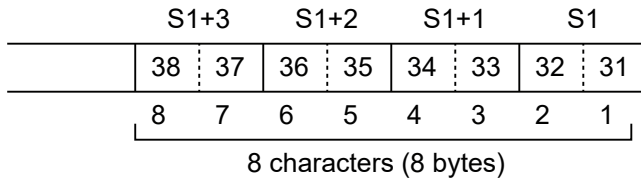

(Conversion result)

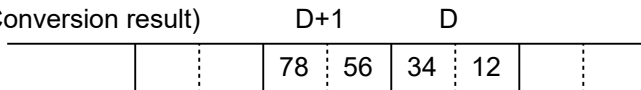

Conversion of seven characters (S2 = H1007)

[ASCII code]

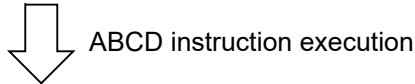
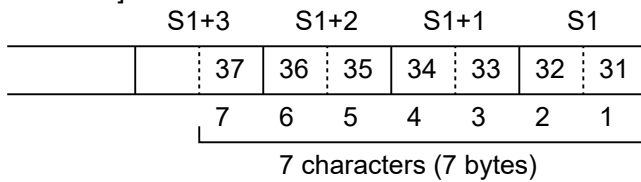

"0" is entered

(Conversion result)

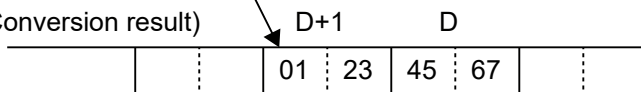

■ Reference: ASCII code

		Higher
		3
Lower	0	0
	1	1
	2	2
	3	3
	4	4
	5	5
	6	6
	7	7
	8	8
	9	9

■ Flag operations

Name	Description
	Turns ON when the area is exceeded in index modification.
R9007	Turns ON when there is a character code other than 0 to 9 in the ASCII codes specified by [S1]
R9008	Turns ON when the number of characters specified by [S2] exceeds the area of [S1]
(ER)	Turns ON when the conversion result exceeds the area
	Turns ON when the number of characters specified by [S2] is "0"
	Turns ON when the number of characters specified by [S2] is greater than 8

15.6 F75 BINA (BIN to Decimal ASCII conversion)

15.6 F75 BINA (BIN to Decimal ASCII conversion)

Converts 16-bit BIN data expressing a decimal number to an ASCII code character string.

■ Instruction format

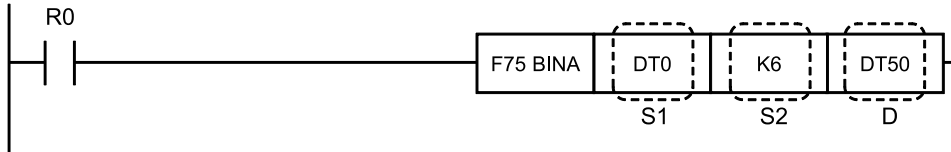

■ Operands

Items	Settings
S1	Area storing the hexadecimal data or constant data
S2	Area storing the number of bytes of the area storing the conversion results, or constant data
D	Starting number of the area storing the ASCII code of conversion result

■ Devices that can be specified (indicated by ●)

Operands	WX	WY	WR	WL	SV	EV	DT	LD	I	SW R	SD T	Constant				Index modifier	Integer Device
												K	H	M	f		
S1	●	●	●	●	●	●	●	●	●	●	●	●				●	
S2	●	●	●	●	●	●	●	●	●	●	●	●				●	
D		●	●	●	●	●	●	●								●	

■ Outline of operation

- The 16-bit data expressing a decimal number specified by [S1] is converted to ASCII code. The ASCII code is stored in the area specified by [D]. The start of the storage area is specified by [D] and its size is specified by [S2].
- Specify the number of bytes in [S2] as a decimal number. (This specification cannot be made with BCD data.)

■ Operation example

Operation of instruction format description program

When internal relay R0 is ON, the 16-bit data (expressing a decimal number) stored in data register DT0 is converted to ASCII code and stored in DT50 to DT52 (six bytes).

DT0: K-100 (H FF9C)



DT52~DT50: H 30 30 31 2D 20 20
 0 0 1 -
 DT52 DT51 DT50

■ **Precautions for programming**

- If the conversion target is a positive number, a sign code (+) is not added in front of the numeric data.
- If the conversion target is a negative number, a sign code (-: H2D) is added in front of the numeric data.
- Any remaining storage area is filled with spaces (H20).
- The position of the ASCII code may change depending on the size of the storage area as data is filled in the direction of the final address.

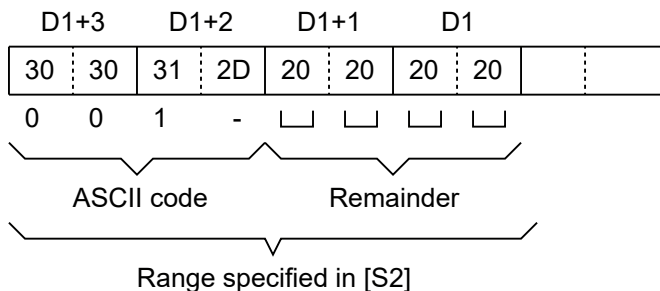

- An operation error occurs if the number of bytes of ASCII codes following conversion (including the minus sign) is larger than the number of bytes specified by S2. When specifying S2, make sure the number of digits to be converted including the sign is taken into consideration.

■ **Conversion example**

The conversion from a 16-bit decimal number to ASCII code is performed as follows.

When converting a negative number

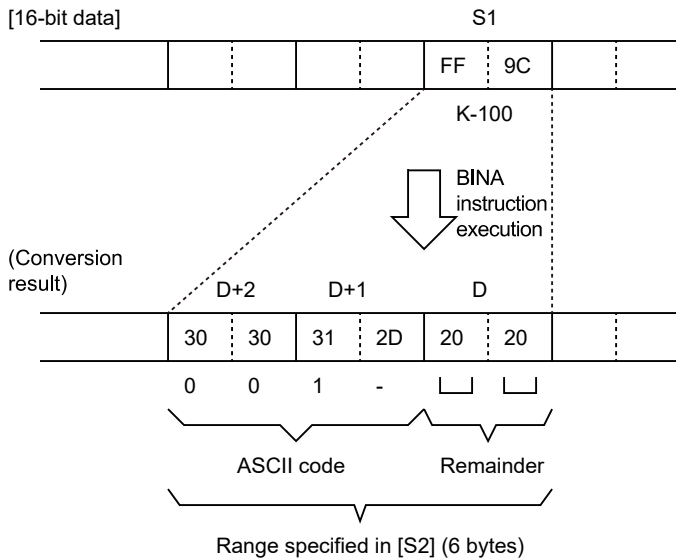

15.6 F75 BINA (BIN to Decimal ASCII conversion)

When converting a positive number

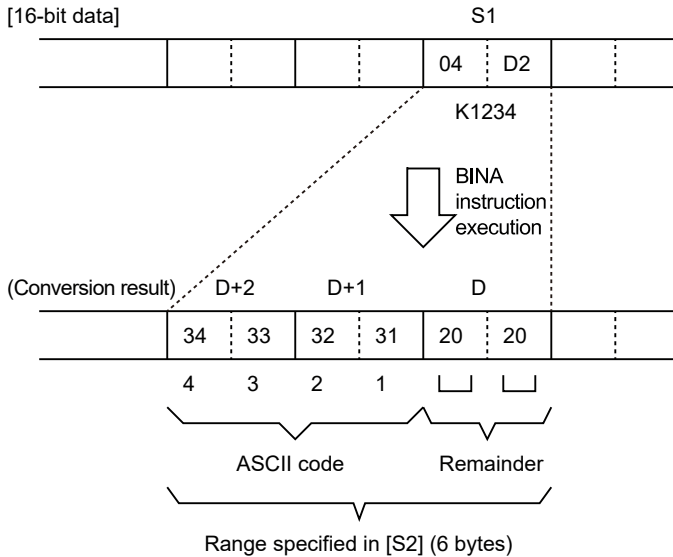

■ Reference: ASCII code

		Higher
		3
Lower	0	0
	1	1
	2	2
	3	3
	4	4
	5	5
	6	6
	7	7
	8	8
	9	9

■ Flag operations

Name	Description
R9007 R9008 (ER)	Turns ON when the area is exceeded in index modification.
	Turns ON when the number of bytes specified by [S2] exceeds the area specified by [D]
	Turns ON when the number of bytes specified by [S2] is "0"
	Turns ON when the conversion result exceeds the area
	Turns ON when the number of bytes of the conversion result exceeds the number of bytes specified by [S2]

15.7 F76 ABIN (Decimal ASCII Code to BIN Conversion)

Converts an ASCII code character string expressing a decimal number to 16-bit BIN data.

■ Instruction format

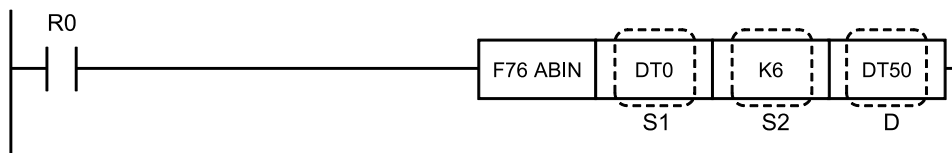

■ Operands

Items	Settings
S1	Starting number of the area storing the ASCII code to be converted
S2	Area storing the number of bytes of data to be converted, or constant data
D	Area to store the conversion result

■ Devices that can be specified (indicated by ●)

Operands	WX	WY	WR	WL	SV	EV	DT	LD	I	SWR	SDT	Constant				Index modifier	Integer Device
												K	H	M	f		
S1	●	●	●	●	●	●	●	●		●	●					●	
S2	●	●	●	●	●	●	●	●	●	●	●	●	●			●	
D		●	●	●	●	●	●	●								●	

■ Outline of operation

- The ASCII code expressing a decimal value of the number of bytes (number of characters) specified by [S2] starting from the area specified by [S1] is converted to a decimal value (16-bit K constant). The decimal value is stored in the area specified by [D].
- Specify the number of bytes in [S2] as a decimal number. (This specification cannot be made with BCD data.)

■ Operation example

Operation of instruction format description program

When internal relay R0 turns ON, the ASCII code stored in data registers DT0 to DT2 (6 bytes) is converted to a decimal number (16-bit data), and stored in DT50.

ASCII code (DT2 to DT0)

H 30 30 31 2D 30 30
 0 0 1 -
 DT2 DT1 DT0



16-bit data (DT50)
 K-100

15.7 F76 ABIN (Decimal ASCII Code to BIN Conversion)

■ Precautions for programming

- Store the ASCII code for conversion in the direction of the final address of the specified area.
- Fill the remaining bytes with "0" (H30) or spaces (H20).
- Signed ASCII codes (+: H2B, -: H2D) are also converted. The + sign can be omitted.

■ Conversion example

Conversion of ASCII code to a 16-bit decimal number is performed as shown below.

Example of conversion of an ASCII code expressing a negative number

[ASCII code]

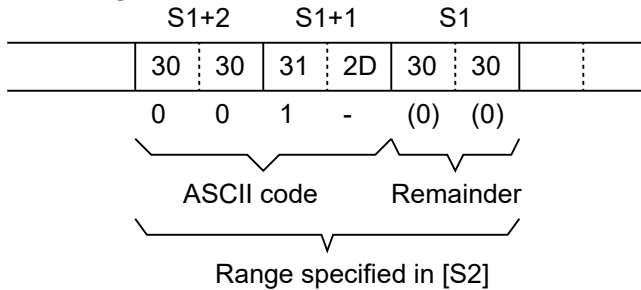

↓ ABIN instruction execution

(Conversion result)

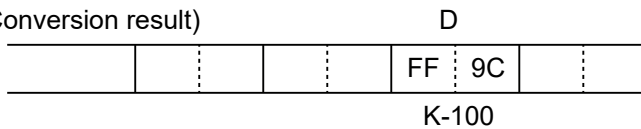

15.7 F76 ABIN (Decimal ASCII Code to BIN Conversion)

Example of conversion of an ASCII code expressing a positive number

Example (1)

[ASCII code]

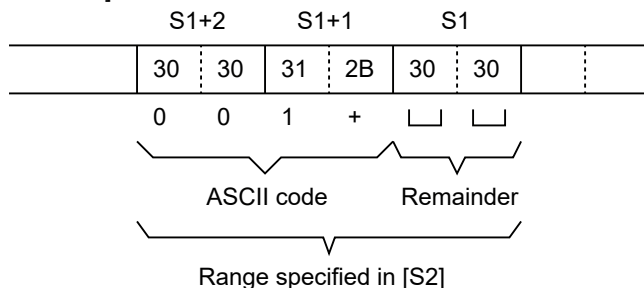

Example (2)

[ASCII code]

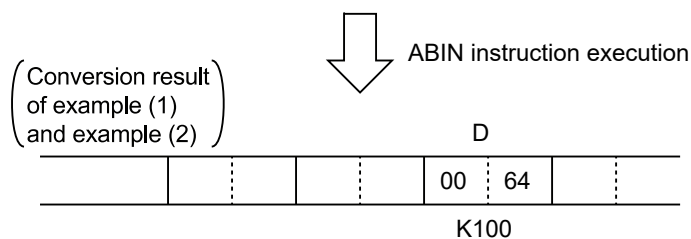
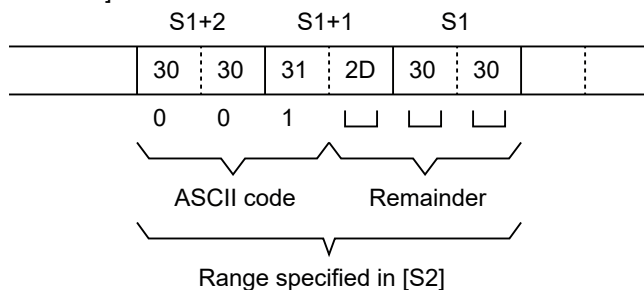

■ Reference: ASCII code

		Higher
		3
Lower	0	0
	1	1
	2	2
	3	3
	4	4
	5	5
	6	6
	7	7
	8	8

15.7 F76 ABIN (Decimal ASCII Code to BIN Conversion)

		Higher
		3
	9	9

■ Flag operations

Name	Description
R9007 R9008 (ER)	Turns ON when the area is exceeded in index modification.
	Turns ON when the number of bytes specified by [S2] exceeds the area of [S1]
	Turns ON when the number of bytes specified by [S2] is "0"
	Turns ON when the conversion result exceeds the area
	Turns ON when the conversion result exceeds 16 bits of data
	Turns ON when an ASCII code containing characters other than the numbers 0 to 9, signed code, or spaces is specified for [S1]

15.8 F77 DBIA (BIN → Decimal ASCII Conversion)

Converts 32-bit BIN data expressing a decimal number to an ASCII code character string.

■ Instruction format

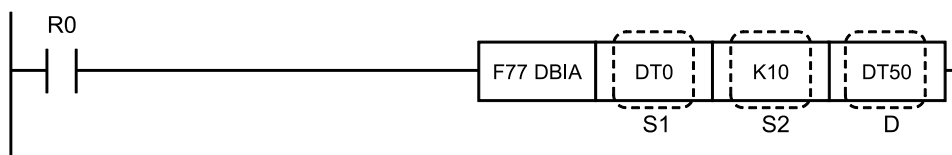

■ Operands

Items	Settings
S1	Starting number of the area storing 32-bit data, or constant data
S2	Area storing the number of bytes of the area storing the conversion results, or constant data
D	Starting number of the area storing the ASCII code of conversion result

■ Devices that can be specified (indicated by ●)

Operands	WX	WY	WR	WL	SV	EV	DT	LD	I	SWR	SDT	Constant				Index modifier	Integer Device
												K	H	M	f		
S1	●	●	●	●	●	●	●	●	●	●	●	●	●	●	●	●	
S2	●	●	●	●	●	●	●	●	●	●	●	●	●	●	●	●	
D		●	●	●	●	●	●	●								●	

■ Outline of operation

- The 32-bit data expressing a decimal number specified by [S1] is converted to ASCII code. The ASCII code is stored in the area starting with the area specified by [D]. The start of the storage area is specified by [D] and the number of bytes is specified by [S2].
- Specify the number of bytes in [S2] as a decimal number (K constant).

■ Operation example

Operation of instruction format description program

When internal relay R0 turns ON, the 32-bit data stored in data registers DT0 and DT1 is converted to ASCII code expressing a decimal number and stored in DT50 to DT54 (10 bytes).

32-bit data (DT0, DT1)

K12345678



ASCII codes DT50 to DT54:

H 38 37 36 35 34 33 32 31 20 20

8 7 6 5 4 3 2 1
 DT54 DT53 DT52 DT51 DT50

15.8 F77 DBIA (BIN → Decimal ASCII Conversion)

■ Precautions for programming

- If the conversion target is a positive number, a sign code (+) is not added in front of the numeric data.
- If the conversion target is a negative number, a sign code (–: H2D) is added in front of the numeric data.
- Any remaining storage area is filled with spaces (H20).
- The position of the ASCII code may change depending on the size of the storage area as data is filled in the direction of the final address.
- An operation error occurs if the number of bytes of ASCII codes following conversion (including the minus sign) is larger than the number of bytes specified by S2. When specifying S2, make sure the number of digits to be converted including the sign is taken into consideration.

■ Conversion example

The following shows conversion of a 32-bit decimal number to ASCII codes.

When converting a negative number

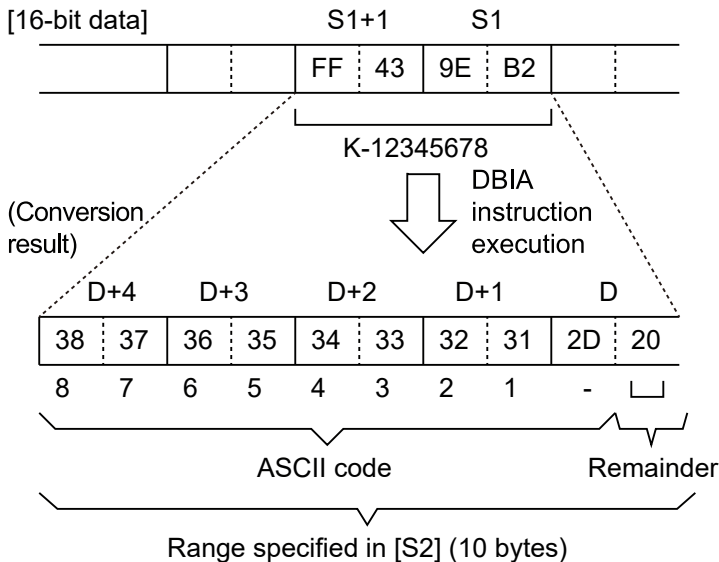

When converting a positive number

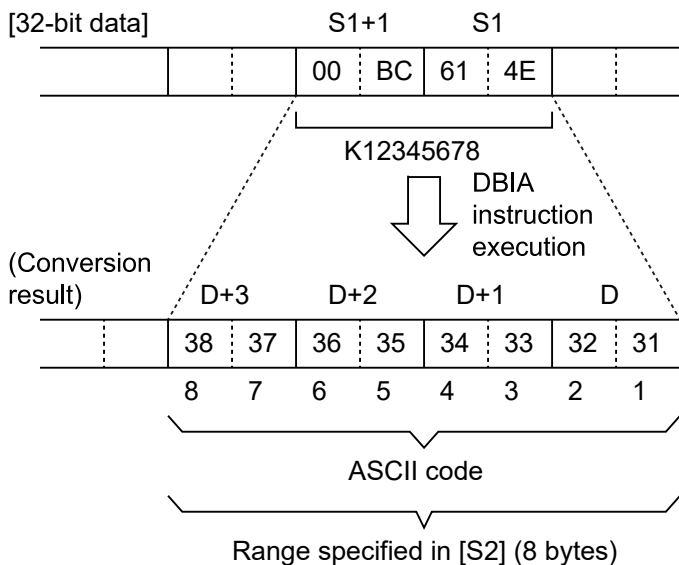

■ **Reference: ASCII code**

		Higher
		3
Lower	0	0
	1	1
	2	2
	3	3
	4	4
	5	5
	6	6
	7	7
	8	8
	9	9

■ **Flag operations**

Name	Description
R9007 R9008 (ER)	Turns ON when the area is exceeded in index modification.
	Turns ON when the number of bytes specified by [S2] exceeds the area specified by [D]
	Turns ON when the number of bytes specified by [S2] is "0"
	Turns ON when the conversion result exceeds the area
	Turns ON when the number of bytes of the conversion result exceeds the number of bytes specified by [S2]

15.9 F78 DABI (Decimal ASCII → BIN conversion)

15.9 F78 DABI (Decimal ASCII → BIN conversion)

Converts an ASCII code character string expressing a decimal number to 32-bit BIN data.

■ Instruction format

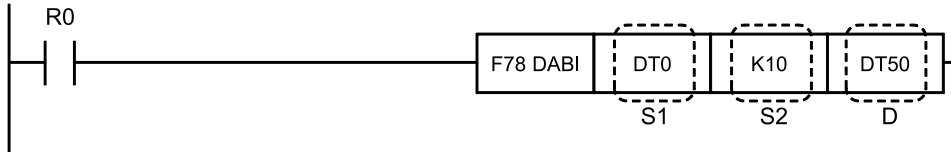

■ Operands

Items	Settings
S1	Starting number of the area storing the ASCII code to be converted
S2	Area storing the numerical values (number of bytes = number of characters) representing the range to be converted, or constant data
D	Number of the start of the area storing the conversion result

■ Devices that can be specified (indicated by ●)

Operands	WX	WY	WR	WL	SV	EV	DT	LD	I	SWR	SDT	Constant				Index modifier	Integer Device
												K	H	M	f		
S1	●	●	●	●	●	●	●	●		●	●				●		
S2	●	●	●	●	●	●	●	●	●	●	●	●	●		●		
D		●	●	●	●	●	●	●							●		

■ Outline of operation

- The ASCII code string expressing a decimal value of the number of bytes (number of characters) specified by [S2] starting from the area specified by [S1] is converted to a decimal value (32-bit K constant). The decimal value is stored in two words starting from the area specified by [D].
- Specify the number of bytes in [S2] as a decimal number.

■ Operation example

Operation of instruction format description program

When internal relay R0 turns ON, the ASCII codes stored in data registers DT0 to DT4 (10 bytes) are converted to decimal numbers, and stored in DT50 and DT51.

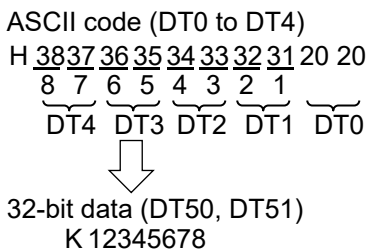

■ **Precautions for programming**

- Store the ASCII code for conversion in the direction of the final address of the specified area.
- Fill the remaining bytes with "0" (H30) or spaces (H20).
- Signed ASCII codes (+: H2B, -: H2D) are also converted. The + sign can be omitted.

■ **Conversion example**

Conversion of ASCII code to a 32-bit decimal number is performed as shown below.

Example of conversion of an ASCII code string expressing a negative number

[ASCII code]

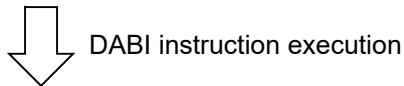

(Conversion result)

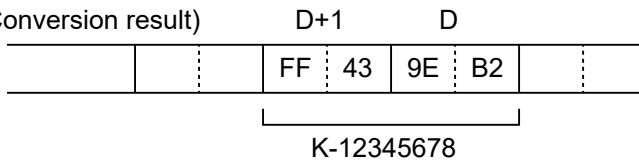

15.9 F78 DABI (Decimal ASCII → BIN conversion)

Example of conversion of an ASCII code expressing a positive number

Example (1)

[ASCII code]

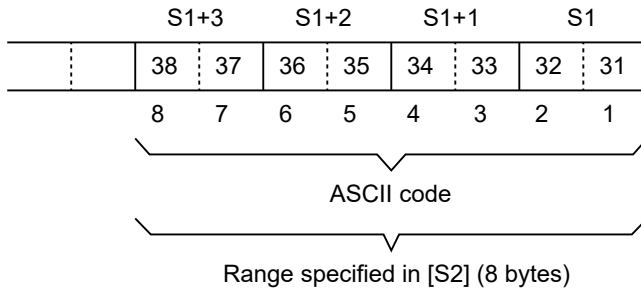

Example (2)

[ASCII code]

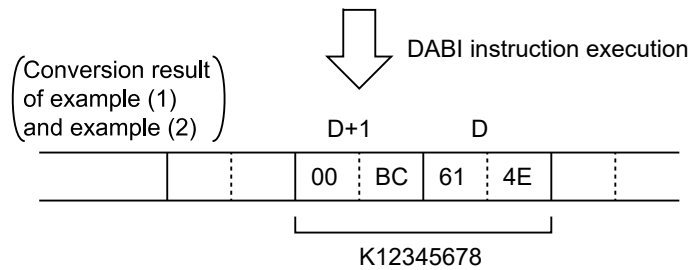
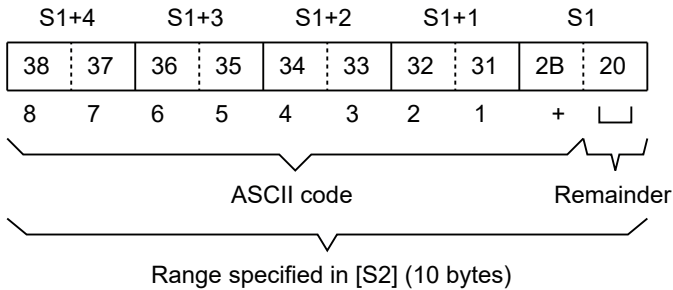

■ Reference: ASCII code

		Higher
		3
Lower	0	0
	1	1
	2	2
	3	3
	4	4
	5	5
	6	6
	7	7

15.9 F78 DABI (Decimal ASCII → BIN conversion)

		Higher
		3
	8	8
	9	9

■ Flag operations

Name	Description
R9007 R9008 (ER)	Turns ON when the area is exceeded in index modification.
	Turns ON when the number of bytes specified by [S2] exceeds the area of [S1]
	Turns ON when the number of bytes specified by [S2] is "0"
	Turns ON when the conversion result exceeds the area
	Turns ON when the conversion result exceeds 32 bits of data
	Turns ON when an ASCII code containing characters other than the numbers 0 to 9, signed code, or spaces is specified for [S1]

15.10 F80 BCD (16-bit BIN to 4-digit BCD conversion)

15.10 F80 BCD (16-bit BIN to 4-digit BCD conversion)

Converts 16-bit binary data to 4-digit BCD.

■ Instruction format

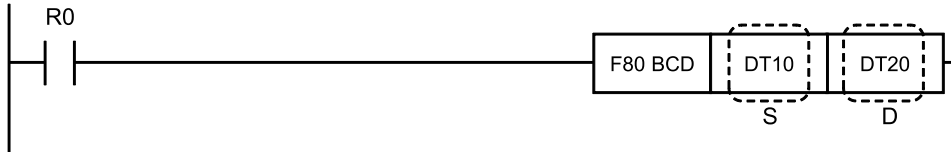

■ Operands

Items	Settings
S	Target data: Area storing 16-bit data, or constant data
D	Storage destination: Area storing 4-digit BCD data following conversion

■ Devices that can be specified (indicated by ●)

Operands	WX	WY	WR	WL	SV	EV	DT	LD	I	SWR	SDT	Constant				Index modifier	Integer Device
												K	H	M	f		
S	●	●	●	●	●	●	●	●	●	●	●	●	●	●	●	●	
D		●	●	●	●	●	●	●	●							●	

■ Outline of operation

- The 16-bit data expressing a decimal number specified by [S] is converted to 4-digit BCD data and stored in the area specified by [D].

■ Operation example

Operation of instruction format description program

When internal relay R0 turns ON, the contents of data register DT10 are converted to 4-digit BCD data and stored in data register DT20.

If DT10 is converted decimal number 16, the following will be stored in DT20.

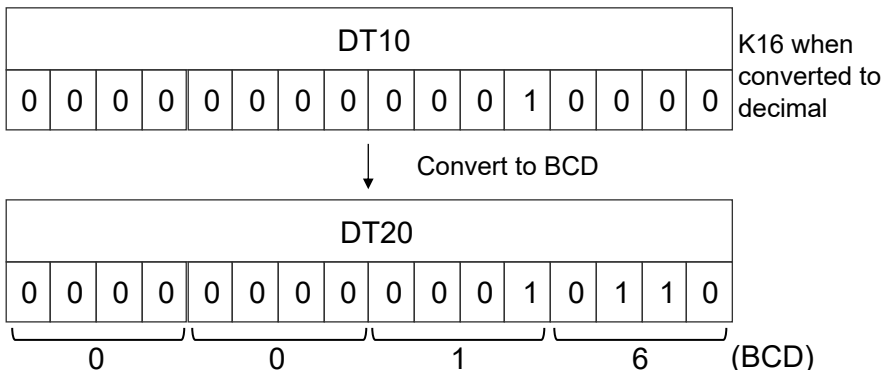

■ Precautions for programming

- The maximum value of 16-bit data that can be converted is K9999 (H270F).

■ Flag operations

Name	Description
R9007	Turns ON when the area is exceeded in index modification.
R9008 (ER)	Turns ON when the binary data exceeds the range that can be converted to BCD (when negative, or over K9999)

15.11 F81 BIN (4-digit BCD to 16-bit BIN conversion)

15.11 F81 BIN (4-digit BCD to 16-bit BIN conversion)

Converts 4-digit BCD data to 16-bit binary data.

■ Instruction format

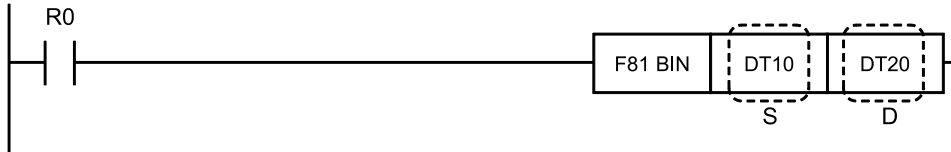

■ Operands

Items	Settings
S	Target data: Area storing 4-digit BCD data, or constant data
D	Storage destination: Area storing converted binary data

■ Devices that can be specified (indicated by ●)

Operand s	WX	WY	WR	WL	SV	EV	DT	LD	I	SW R	SD T	Constant				Index modifier	Integer Device
												K	H	M	f		
S	●	●	●	●	●	●	●	●	●	●	●	●	●	●	●	●	
D		●	●	●	●	●	●	●	●							●	

■ Outline of operation

The 4-digit BCD data specified by [S] is converted to 16-bit data expressing a decimal number and stored in the area specified by [D].

■ Operation example

Operation of instruction format description program

When internal relay R0 turns ON, the content of data register DT10 is converted to 16-bit data expressing a decimal number and stored in data register DT20. If DT10 is BCD data consisting of H15, the following will be stored in DT20.



■ Flag operations

Name	Description
R9007	Turns ON when the area is exceeded in index modification.
R9008 (ER)	Turns ON if [S] is not BCD data

15.12 F82 DBCD (32-bit BIN → 8-digit BCD conversion)

15.12 F82 DBCD (32-bit BIN → 8-digit BCD conversion)

Converts 32-bit binary data to 8-digit BCD data.

■ Instruction format

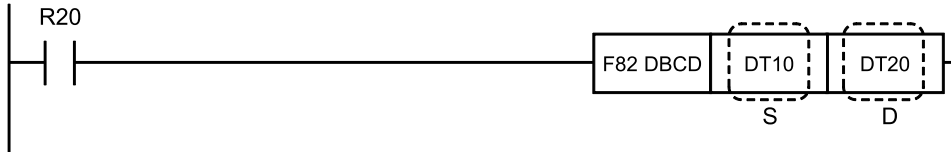

■ Operands

Items	Settings
S	Target data: Area storing 32-bit data, or constant data
D	Storage destination: Area storing 8-digit BCD data following conversion

■ Devices that can be specified (indicated by ●)

Operand s	WX	WY	WR	WL	SV	EV	DT	LD	I	SW R	SD T	Constant				Index modifier	Integer Device
												K	H	M	f		
S	●	●	●	●	●	●	●	●	●	●	●	●	●	●	●	●	
D		●	●	●	●	●	●	●	●						●		

■ Outline of operation

The 32-bit data specified by [S] expressing a decimal number is converted to 8-digit BCD data and stored in the area specified by [D].

■ Operation example

Operation of instruction format description program

When internal relay R20 turns ON, the content of data registers DT10 and DT11 is converted to 8-digit BCD data, and stored in DT21 and DT22.

■ Precautions for programming

The maximum value of binary data that can be converted is K99999999 (H5F5E0FF).

■ Flag operations

Name	Description
R9007	Turns ON when the area is exceeded in index modification.
R9008 (ER)	When the binary data exceeds the range that can be converted to BCD data (when the value is negative or exceeds K99999999)

15.13 F83 DBIN (8-Digit BCD to 32-Bit BIN Conversion)

Converts 8-digit BCD data to 32-bit binary data.

■ Instruction format

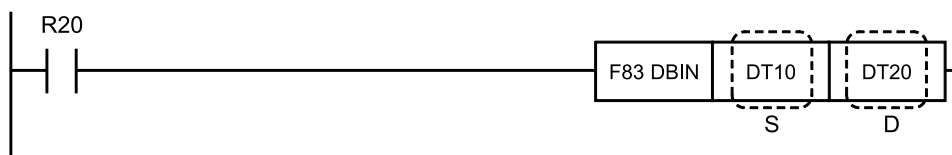

■ Operands

Items	Settings
S	Target data: Area storing 8-digit BCD data, or constant data
D	Storage destination: Area storing converted binary data

■ Devices that can be specified (indicated by ●)

Operand s	WX	WY	WR	WL	SV	EV	DT	LD	I	SW R	SD T	Constant				Index modifier	Integer Device
												K	H	M	f		
S	●	●	●	●	●	●	●	●	●	●	●	●	●	●	●	●	
D		●	●	●	●	●	●	●	●							●	

■ Outline of operation

The 8-digit BCD data specified by [S] is converted to 32-bit data expressing a decimal number and stored in the area specified by [D].

■ Operation example

Operation of instruction format description program

When internal relay R20 turns ON, the value expressing the 8-digit BCD data in data registers DT10 and DT11 is converted to 32-bit data (K constant) and stored in DT20 and DT21.

■ Flag operations

Name	Description
R9007	Turns ON when the area is exceeded in index modification.
R9008 (ER)	Turns ON if [S] is not BCD data

15.14 F84 INV (16-bit data invert)

15.14 F84 INV (16-bit data invert)

Inverts 16-bit data.

■ Instruction format

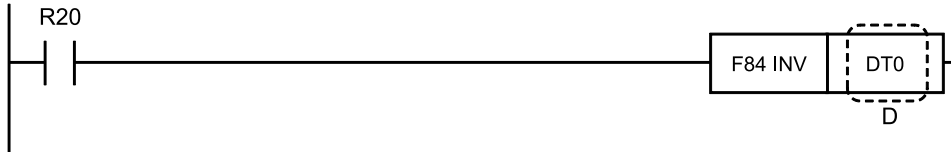

■ Operands

Items	Settings
D	Area that stores the data to invert

■ Devices that can be specified (indicated by ●)

Operands	WX	WY	WR	WL	SV	EV	DT	LD	I	SW R	SD T	Constant				Index modifier	Integer Device
												K	H	M	f		
D		●	●	●	●	●	●	●	●							●	

■ Outline of operation

- Inverts 1 (ON) and 0 (OFF) of each bit of the 16-bit data specified by [D].
- This instruction can be used to output to 7-segment display that uses negative logic operation.

■ Operation example

Operation of instruction format description program

Inverts the contents of data register DT0 when internal relay R20 turns ON.

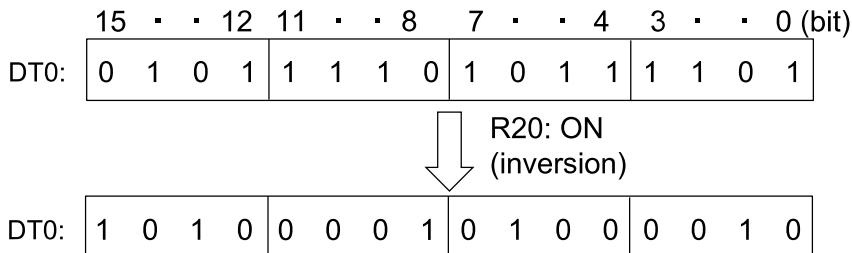

■ Flag operations

Name	Description
R9007 R9008 (ER)	Turns ON when the area is exceeded in index modification.

15.15 F85 NEG (Hexadecimal Data Complement of 2)

Takes complement of 2 in hexadecimal data.

■ Instruction format

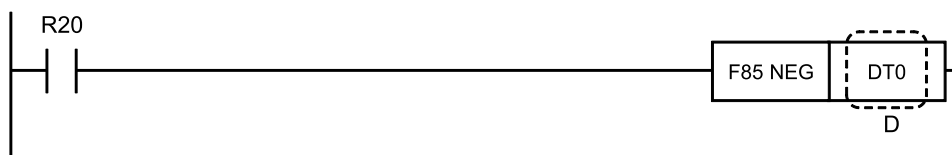

■ Operands

Items	Settings
D	Area for storing original data and its complement of 2

■ Devices that can be specified (indicated by ●)

Operands	WX	WY	WR	WL	SV	EV	DT	LD	I	SWR	SDT	Constant				Index modifier	Integer Device
												K	H	M	f		
D		●	●	●	●	●	●	●	●							●	

■ Outline of operation

- Inverts the content of hexadecimal data specified by [D] and adds +1 (takes complement of 2).
- Useful for inverting the signs of 16-bit data.

■ Operation example

Operation of instruction format description program

Inverts the content of data register DT0 and adds +1 when internal relay R20 turns ON.

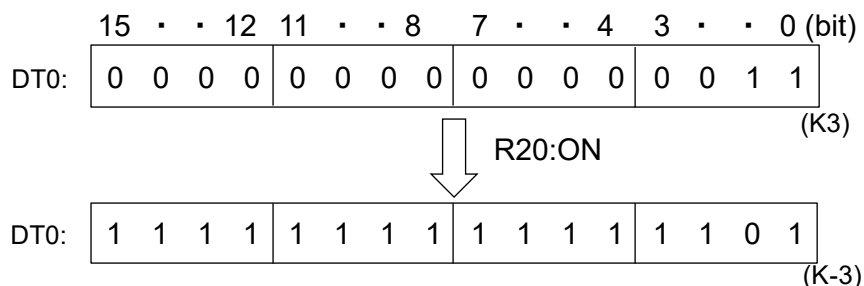

■ Flag operations

Name	Description
R9007 R9008 (ER)	Turns ON when the area is exceeded in index modification.

15.16 F86 DNEG (32-bit Data Complement of 2)

15.16 F86 DNEG (32-bit Data Complement of 2)

Takes complement of 2 in 32-bit data.

■ Instruction format

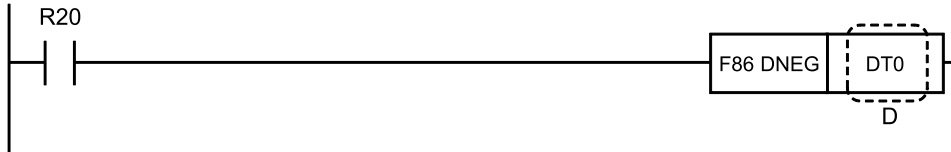

■ Operands

Items	Settings
D	Starting number of area for storing original data and its complement of 2

■ Devices that can be specified (indicated by ●)

Operands	WX	WY	WR	WL	SV	EV	DT	LD	I	SW R	SD T	Constant				Index modifier	Integer Device
												K	H	M	f		
D		●	●	●	●	●	●	●	●							●	

■ Outline of operation

- Inverts the content of 32-bit data specified by [D] and [D+1] and adds +1.
- Useful for inverting the signs of 32-bit data.

■ Operation example

Operation of instruction format description program

Inverts the 32-bit content of DT0 and DT1 and adds +1 when internal relay R20 turns ON.

	15	14	13	12	11	10	9	8	7	6	5	4	3	2	1	0 (bit)
DT0:	1	1	1	1	1	1	1	1	1	1	1	1	1	1	0	1
DT1:	1	1	1	1	1	1	1	1	1	1	1	1	1	1	1	1
(K-3)																
<div style="display: flex; align-items: center; justify-content: center;"> <div style="font-size: 2em; margin-right: 10px;">↓</div> <div style="text-align: left;">R20:ON</div> </div>																
DT0:	0	0	0	0	0	0	0	0	0	0	0	0	0	0	1	1
DT1:	0	0	0	0	0	0	0	0	0	0	0	0	0	0	0	0
(K3)																

■ **Flag operations**

Name	Description
R9007 R9008 (ER)	Turns ON when the area is exceeded in index modification.

15.17 F87 ABS (Absolute value of 16-bit data)

15.17 F87 ABS (Absolute value of 16-bit data)

Calculates the absolute value of signed 16-bit data.

■ Instruction format

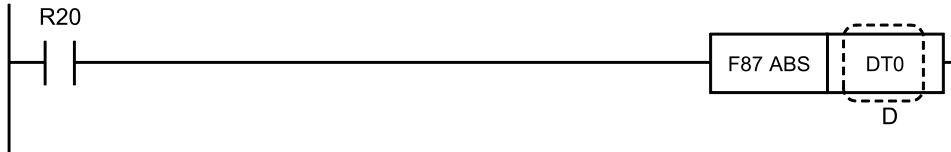

■ Operands

Items	Settings
D	Area storing the data for which the absolute value will be calculated

■ Devices that can be specified (indicated by ●)

Operands	WX	WY	WR	WL	SV	EV	DT	LD	I	SWR	SDT	Constant				Index modifier	Integer Device
												K	H	M	f		
D		●	●	●	●	●	●	●	●							●	

■ Outline of operation

- The absolute value of the signed 16-bit data specified by [D] is calculated and stores in [D].
- This is effective for processing data in which the polarity (+ or -) changes.

■ Operation example

Operation of instruction format description program

When internal relay R20 turns ON, the absolute value of the value of data register DT0 is calculated. For instance, regardless of whether the value of DT0 is K1 or K-1, it will be K1 when this instruction is executed.

■ Flag operations

Name	Description
R9007	Turns ON when the area is exceeded in index modification.
R9008 (ER)	
R9009 (CY)	Turns ON when the value is negative (other than the minimum)

15.18 F88 DABS (Absolute value of 32-bit data)

Calculates the absolute value of signed 32-bit data.

■ Instruction format

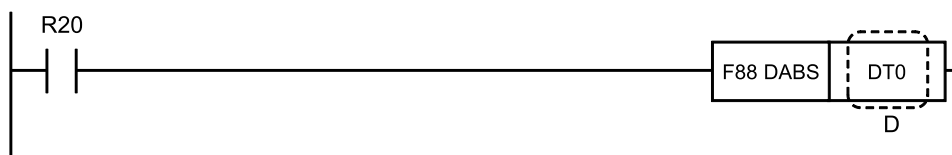

■ Operands

Items	Settings
D	Starting number of the area storing the data for which the absolute value will be calculated

■ Devices that can be specified (indicated by ●)

Operands	WX	WY	WR	WL	SV	EV	DT	LD	I	SWR	SDT	Constant				Index modifier	Integer Device
												K	H	M	f		
D		●	●	●	●	●	●	●	●							●	

■ Outline of operation

- The absolute value of the signed 32-bit data stored in [D] and [D+1] is calculated and stored in [D] and [D+1].
- This is effective for processing data in which the polarity (+ or -) changes.

■ Operation example

Operation of instruction format description program

When internal relay R20 turns ON, the absolute value of the signed 32-bit data in DT0 and DT1 is calculated and stored in DT0 and DT1.

■ Flag operations

Name	Description
R9007	Turns ON when the area is exceeded in index modification.
R9008 (ER)	Turns ON when the minimum value is negative (H80000000)
R9009 (CY)	Turns ON when the value is negative (other than the minimum)

15.19 F89 EXT (Sign Extension)

15.19 F89 EXT (Sign Extension)

Extends 16-bit data to 32-bit data without changing signs or values.

■ Instruction format

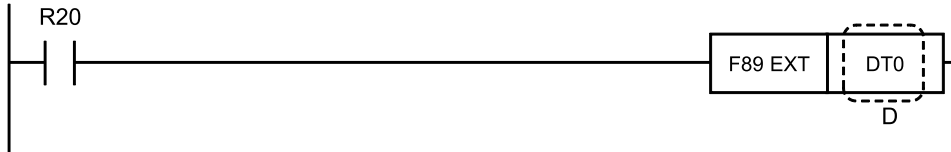

■ Operands

Items	Settings
D	Area where data for sign extension is stored

■ Devices that can be specified (indicated by ●)

Operands	WX	WY	WR	WL	SV	EV	DT	LD	I	SWR	SDT	Constant				Index modifier	Integer Device
												K	H	M	f		
D		●	●	●	●	●	●	●	●							●	

■ Outline of operation

- Converts 16-bit data to 32-bit data without changing its signs or values.
- If the sign bit (bit 15) of the 16-bit data specified in [D] is 0, all 16 bits in the area following [D] become 0. If the sign bit is 1, all 16 bits become 1. Thus, 16-bit data is converted to 32-bit data without its signs or values being changed.
- After execution of the F89 EXT instruction, double word data starting at [D] can be used as an operand for a 32-bit operation instruction.

■ Operation example

Operation of instruction format description program

When the internal relay R20 is ON, all 16 bits of DT1 are filled with the content of bit 15 of the data in DT0. If K-2 is stored in DT0, the data will be as follows.

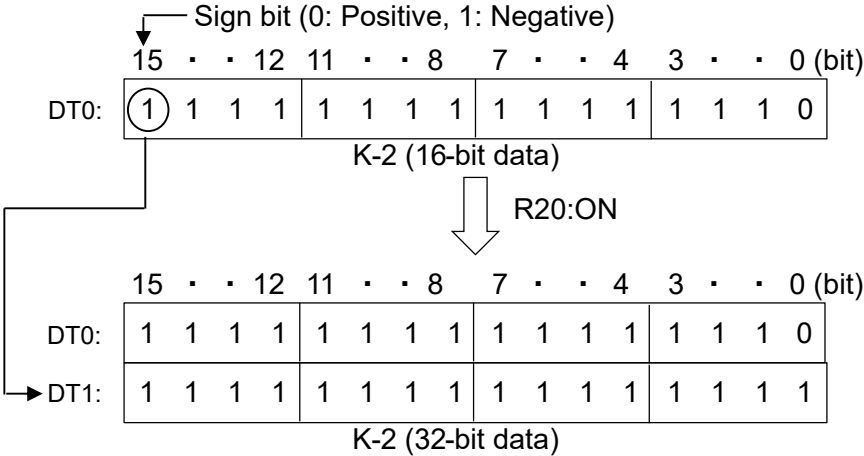

■ Flag operations

Name	Description
R9007 R9008 (ER)	Turns ON when the area is exceeded in index modification.

15.20 F90 DECO (Decode)

15.20 F90 DECO (Decode)

Decodes the specified data.

■ Instruction format

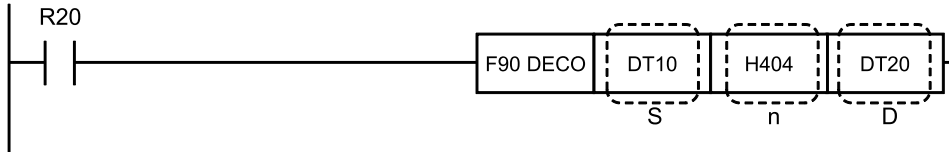

■ Operands

Items	Settings
S	Area storing conversion data, or constant data
n	Area storing the control data, or constant data
D	Starting address of the area storing the conversion result

■ Devices that can be specified (indicated by ●)

Operands	WX	WY	WR	WL	SV	EV	DT	LD	I	SWR	SDT	Constant				Index modifier	Integer Device		
												K	H	M	f				
S	●	●	●	●	●	●	●	●	●	●	●	●	●	●	●	●			
n	●	●	●	●	●	●	●	●	●	●	●	●	●	●	●	●	●		
D		●	●	●	●	●	●	●	●								●		

■ Outline of operation

- The part of the data specified by [S] is decoded and the decoded result is stored in the area specified by [D].
- The part to be decoded is specified by control data [n].
- The length of the area required to store the decoded result depends on the length of the data to be decoded.

■ Operation example

Operation of instruction format description program

When internal relay R20 turns ON, the part of data register DT10 specified by [n] = H404 (H constant) is decoded and the result is stored in data register DT20.

e.g. When the value (control data) of [n] is H404

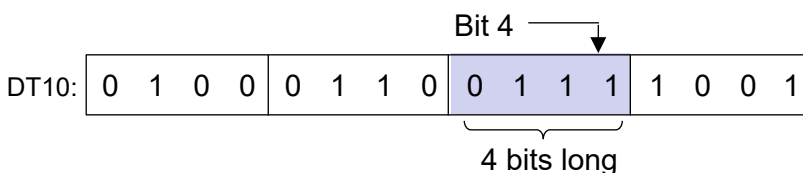

The decoded result for the specified part ("0111" = 7) is stored in the 2⁴ bit area starting from DT20.

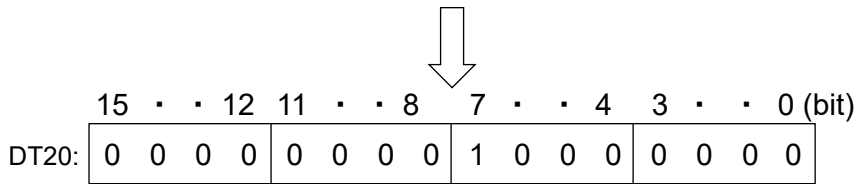

Bit 7 of the 2⁴ bit area starting from DT20 is turned ON, and the other bits are set to 0.

■ **Specifying the data to be decoded (control data [n])**

Specify the conversion start bit and conversion effective bit length.

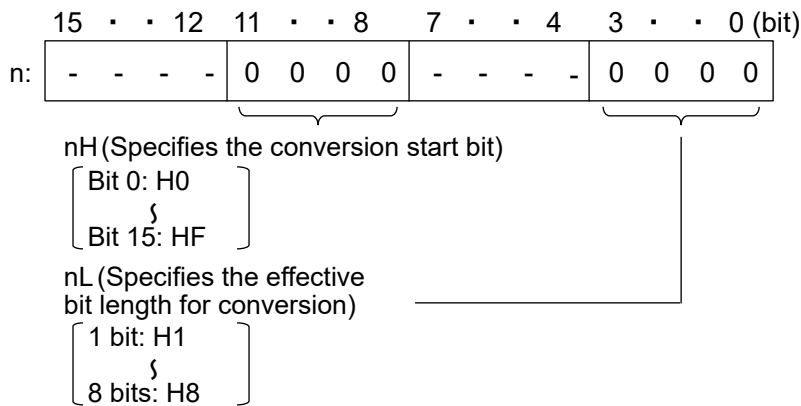

The effective bit length of the decoded result is 2^{nL} bits.

See the table below for the effective bit length and occupied length of the result.

e.g. When control data [n] is H0404 and the data to be decoded is the 4 bits from bit 4 in the area specified by [S].

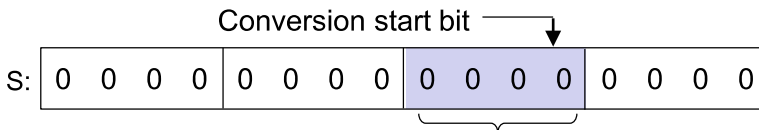

: Decode target Effective bit length for conversion

Specification of nL and length of result

Effective bit length for <nL value> conversion	Occupation length of decoded result	Effective bit length of decoded result	Value other than effective bit length in D
1	1 word	2-bit	0
2	1 word	4-bit	0
3	1 word	8 bits	0
4	1 word	16 bits	-

15.20 F90 DECO (Decode)

Effective bit length for <nL value> conversion	Occupation length of decoded result	Effective bit length of decoded result	Value other than effective bit length in D
5	2 words	32 bits	-
6	4 words	64 bits	-
7	8 words	128 bits	-
8	16 words	256 bits	-

Conversion example

When decoding 4-bit data (nL = 4), the contents of the conversion data and the decoded result are as follows.

Conversion data	Decoded result
0000	00000000000000000001
0001	00000000000000000010
0010	00000000000000000100
0011	00000000000000000100
0100	000000000000010000
0101	000000000000010000
0110	000000000001000000
0111	000000000100000000
1000	000000001000000000
1001	000000010000000000
1010	000000100000000000
1011	000001000000000000
1100	000100000000000000
1101	001000000000000000
1110	010000000000000000
1111	100000000000000000

■ Flag operations

Name	Description
R9007 R9008 (ER)	Turns ON when the area is exceeded in index modification.
	Turns ON when the effective bit length for conversion (nL) is not $1 \leq nL \leq 8$
	Turns ON (integrity) when the conversion start bit No. (nH) and conversion effective bit length (nL) are not $1 \leq (nH + nL) \leq 16$
	Turns ON when the decoded result exceeds the area specified by [D] when stored

15.21 F91 SEGT (7-segment decode)

Converts specified 16-bit data to 4-digit data for 7-segment display.

■ Instruction format

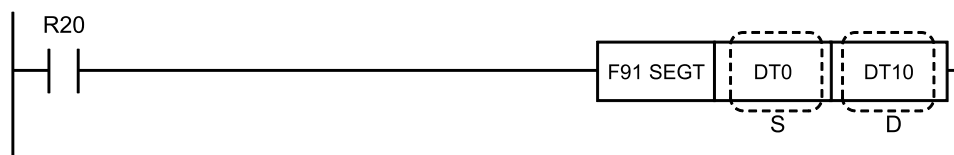

■ Operands

Items	Settings
S	Area storing conversion data, or constant data
D	Starting address of the area storing the conversion result

■ Devices that can be specified (indicated by ●)

Operands	WX	WY	WR	WL	SV	EV	DT	LD	I	SWR	SDT	Constant				Index modifier	Integer Device
												K	H	M	f		
S	●	●	●	●	●	●	●	●	●	●	●	●	●	●	●	●	
D		●	●	●	●	●	●	●	●							●	

■ Outline of operation

- Converts 16-bit data specified by [S] to four-digit data for 7-segment display, and stores this in the area starting from the two-word area specified by [D].
- Refer to the table below for the relationship between the displayed contents, the contents specified for [S], and the 7-segment display data.

■ Operation example

Operation of instruction format description program

Converts the contents of data register DT0 to 7-segment display data when internal relay R20 turns ON. The converted results are stored in data registers DT10 and DT11. For example, to display "ABCD", the following would be entered.

1. DT0 is set to H ABCD.

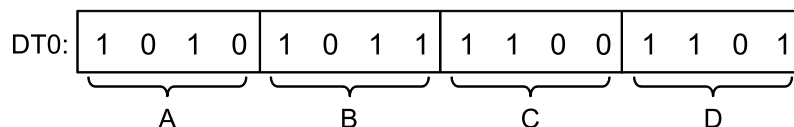

2. When the content of DT0 is converted to 7-segment display data, it is as follows.

15.21 F91 SEGT (7-segment decode)

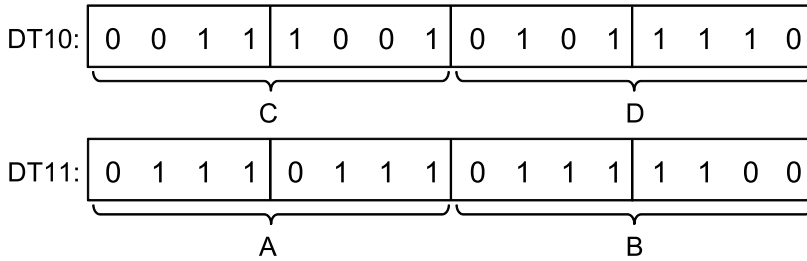

■ Relationship between display content and data

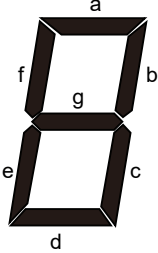
Value	Conversion data 1 digit [S]					Data for 7-segment display 1 digit [D]							7-segment display																		
						g	f	e	d	c	b	a																			
0	0	0	0	0	0	0	1	1	1	1	1	1	1	0	<div style="display: flex; align-items: center; justify-content: center;"> <div style="margin-right: 10px;"> <table border="1" style="border-collapse: collapse; text-align: center;"> <tr><td> </td><td>a</td></tr> <tr><td> </td><td>b</td></tr> <tr><td> </td><td>c</td></tr> <tr><td> </td><td>d</td></tr> <tr><td> </td><td>e</td></tr> <tr><td> </td><td>f</td></tr> <tr><td> </td><td>g</td></tr> <tr><td> </td><td> </td></tr> </table> </div>  </div>		a		b		c		d		e		f		g		
	a																														
	b																														
	c																														
	d																														
	e																														
	f																														
	g																														
1	0	0	0	1	0	0	0	0	0	1	1	0	1	1																	
2	0	0	1	0	0	1	0	1	1	0	1	1	1	2																	
3	0	0	1	1	0	1	0	0	1	1	1	1	1	3																	
4	0	1	0	0	0	1	1	0	0	1	1	0	1	4																	
5	0	1	0	1	0	1	1	0	1	1	0	1	1	5																	
6	0	1	1	0	0	1	1	1	1	1	0	1	1	6																	
7	0	1	1	1	0	0	1	0	0	1	1	1	1	7																	
8	1	0	0	0	0	1	1	1	1	1	1	1	1	8																	
9	1	0	0	1	0	1	1	0	1	1	1	1	1	9																	
A	1	0	1	0	0	1	1	1	0	1	1	1	1	A																	
B	1	0	1	1	0	1	1	1	1	1	0	0	1	B																	
C	1	1	0	0	0	0	1	1	1	0	0	1	1	C																	
D	1	1	0	1	0	1	0	1	1	1	1	0	1	D																	
E	1	1	1	0	0	1	1	1	1	0	0	1	1	E																	
F	1	1	1	1	0	1	1	1	0	0	0	1	1	F																	

■ Flag operations

Name	Description
R9007	Turns ON when the area is exceeded in index modification.
R9008 (ER)	Turns ON when the area is exceeded when conversion results are stored in the area specified by [D]

15.22 F92 ENCO (Encode)

Encodes the specified data.

■ Instruction format

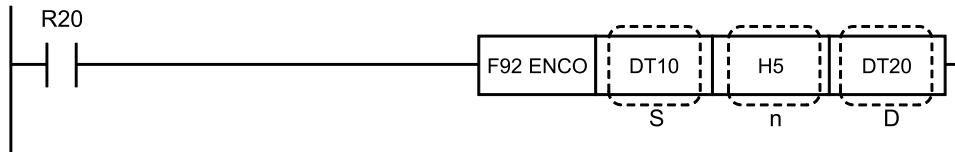

■ Operands

Items	Settings
S	Starting address of the area storing conversion data
n	Area storing the control data, or constant data
D	Area to store the conversion result

■ Devices that can be specified (indicated by ●)

Operands	WX	WY	WR	WL	SV	EV	DT	LD	I	SW R	SD T	Constant				Index modifier	Integer Device
												K	H	M	f		
S	●	●	●	●	●	●	●	●		●	●					●	
n	●	●	●	●	●	●	●	●	●	●	●	●	●			●	
D		●	●	●	●	●	●	●	●							●	

■ Outline of operation

- Encodes a section of the data specified in [S], and stores the encoded result in the area specified in [D].
- The target section to be encoded is specified by the control data [n].
- If multiple bits are ON in the target section for encoding, the higher bit is enabled.
- The content of the 2^{nL} bits starting from the area specified in [S] are encoded. The encoded result is stored as a decimal, within the 8 bits starting from the bit specified in nH.
- Sections of the area specified in [D] that are not storing the conversion result will be 0.

■ Operation example

Operation of instruction format description program

When the internal relay R20 is ON, the bit area (data register starting at DT10) specified in [n] = H5 (H constant) is encoded, and the result is stored in DT20.

When the value of [n] (control data) is H5

The effective bits for conversion are the 32-bit section from DT10 (DT10 to DT11). The bit numbers that are ON in this two-word area are stored as decimals from bit 0 of DT20.

15.22 F92 ENCO (Encode)

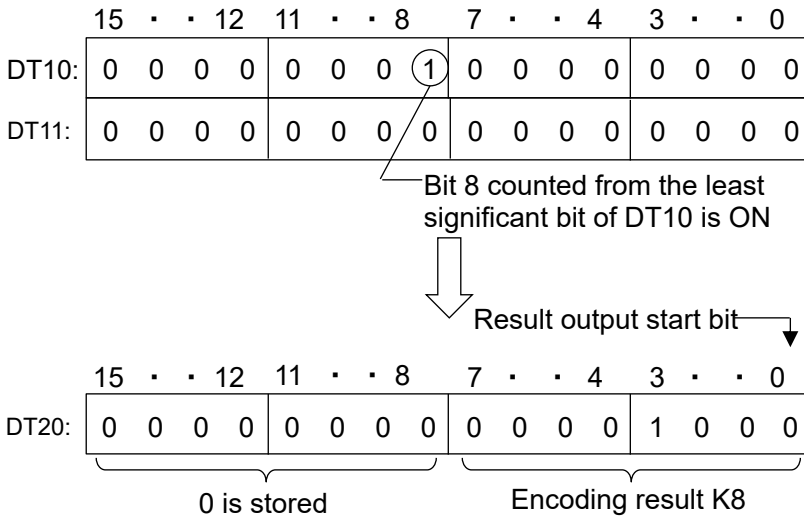

■ Specifying the target to be encoded (control data [n])

Specifies the effective bit length for conversion and the starting bit for output of the result.

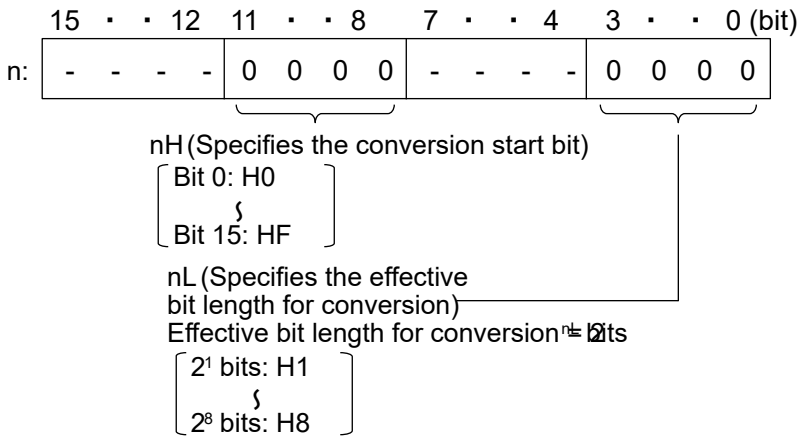

e.g. When the control data [n] is H0005

The target to be encoded is the 2⁵ bits (32-bit = two words) starting from the area specified by [S].

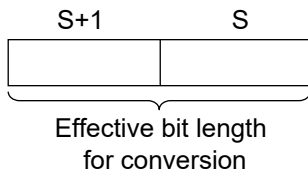

The result is stored from bit 0 in the area specified by [D].

Specification of nL and length of result

Value of nL	Effective bit length for conversion
1	2-bit
2	4-bit
3	8-bit (one byte)
4	16-bit (one word)
5	32-bit (two words)
6	64-bit (four words)
7	128-bit (eight words)
8	256-bit (16 words)

Conversion example

When encoding 16-bit data (nL = 4), the content of the conversion data and the encoding result will be as follows.

Conversion data (16-bit)				Encoding result
0000	0000	0000	0001	0000
0000	0000	0000	0010	0001
0000	0000	0000	0100	0010
0000	0000	0000	1000	0011
0000	0000	0001	0000	0100
0000	0000	0010	0000	0101
0000	0000	0100	0000	0110
0000	0000	1000	0000	0111
0000	0001	0000	0000	1000
0000	0010	0000	0000	1001
0000	0100	0000	0000	1010
0000	1000	0000	0000	1011
0001	0000	0000	0000	1100
0010	0000	0000	0000	1101
0100	0000	0000	0000	1110
1000	0000	0000	0000	1111

■ Flag operations

Name	Description
R9007 R9008 (ER)	Turns ON when the area is exceeded in index modification.
	Turns ON when the effective bit length for conversion (nL) is not $1 \leq nL \leq 8$
	Turns ON when the result output start bit no. (nH) and the effective bit length for conversion (nL) is not $1 \leq (nH + nL) \leq 16$ (consistency)
	Turns ON when all the data to be encoded is "0"

15.23 F93 UNIT (16-bit data combine)

15.23 F93 UNIT (16-bit data combine)

Combines the lower order 4 bits (bits 0 to 3) of 16-bit data.

■ Instruction format

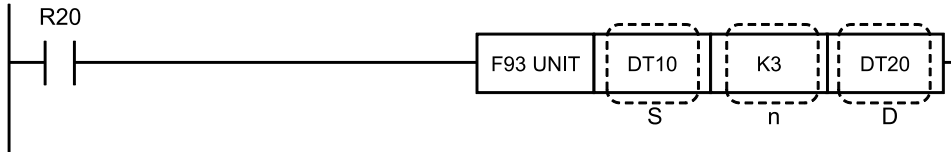

■ Operands

Items	Settings
S	The starting address of the area that stores the data to be combined
n	Area storing the number of data to be combined, or constant data
D	Area that stores the combined data

■ Devices that can be specified (indicated by ●)

Operands	WX	WY	WR	WL	SV	EV	DT	LD	I	SWR	SDT	Constant				Index modifier	Integer Device
												K	H	M	f		
S	●	●	●	●	●	●	●	●		●	●					●	
n	●	●	●	●	●	●	●	●	●	●	●	●	●			●	
D		●	●	●	●	●	●	●	●							●	

■ Outline of operation

- The lower 4 bits of n points of data from the area specified by [S] are stored in order 4 bits at a time from the lower order of the area specified by [D].
- The number of data areas to be combined [n] can be specified within the range 0 to 4.
- When n = 0, no operation takes place.
- If n < 4, the remainder of [D] is filled with "0".

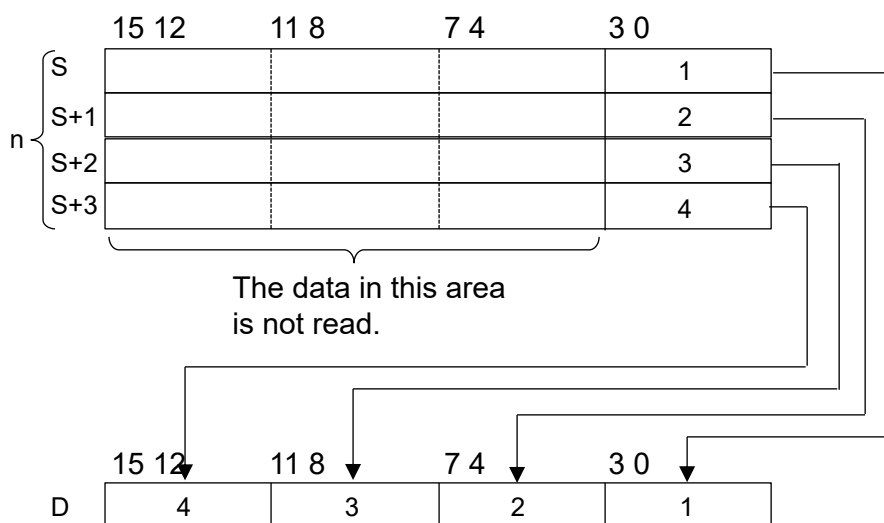

■ Operation example

Operation of instruction format description program

When internal relay R20 is ON, the lower 4 bits from data register 10, the lower 4 bits from DT11, and the lower 4 bits from DT12 are each stored from the lower order of DT20 4 bits at a time.

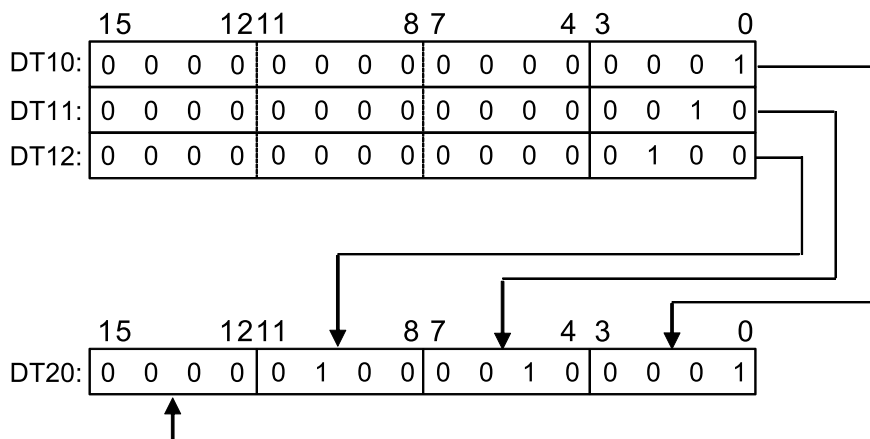

If $[n]$ is less than 4, the 4 bits corresponding to the output destination are filled with "0".

■ Flag operations

Name	Description
R9007	Turns ON when the area is exceeded in index modification.
R9008 (ER)	Turns ON if the number of data areas to be combined $[n]$ is $n \geq 5$

15.24 F94 DIST (16-Bit Data Distribution)

15.24 F94 DIST (16-Bit Data Distribution)

Divides 16-bit data into four 4-bit units and distributes it.

■ Instruction format

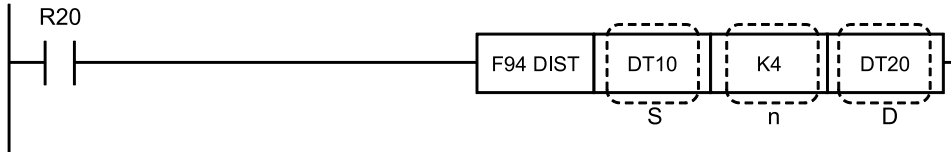

■ Operands

Items	Settings
S	Area storing the 16-bit data to be divided, or constant data
n	Area storing the number of data items to be divided, or constant data
D	Starting address of the area storing each divided digit

■ Devices that can be specified (indicated by ●)

Operands	WX	WY	WR	WL	SV	EV	DT	LD	I	SWR	SDT	Constant				Index modifier	Integer Device
												K	H	M	f		
S	●	●	●	●	●	●	●	●	●	●	●	●	●		●		
n	●	●	●	●	●	●	●	●	●	●	●	●	●		●		
D		●	●	●	●	●	●	●	●						●		

■ Outline of operation

- The 16-bit data specified by [S] is divided into 4-bit (1-digit) units, and the digits specified by [n] are each stored in the lower 4 bits (bit positions 0 to 3) of n areas in order starting from the area specified by [D].
- The range of the number of data divisions that can be specified [n] is 0 to 4.
- When n = 0, no operation takes place.

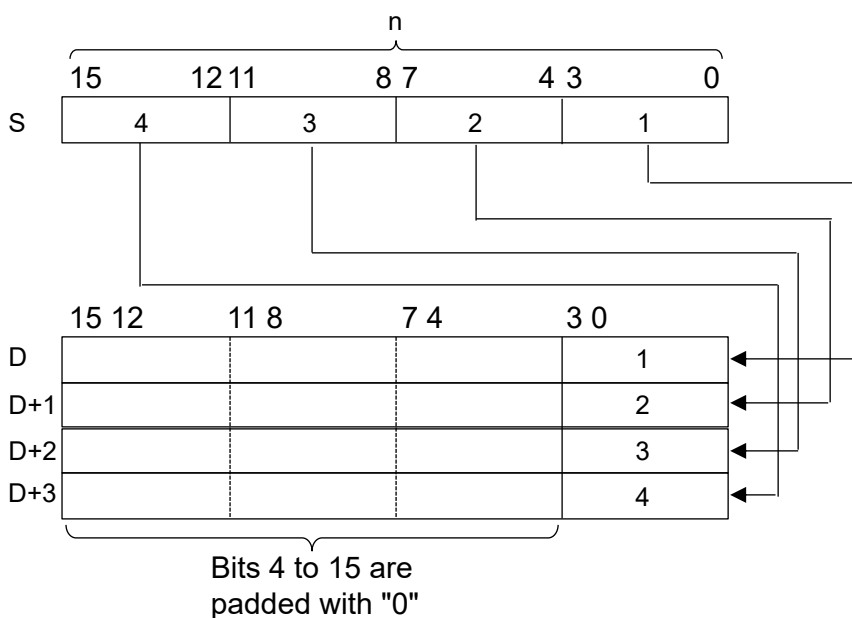

■ **Operation example**

Operation of instruction format description program

When internal relay R20 turns ON, the data of data register DT10 is divided into 4 bits from the low bit, and 1 digit each is stored in order in the lower 4 bits of data registers DT20 to DT23.

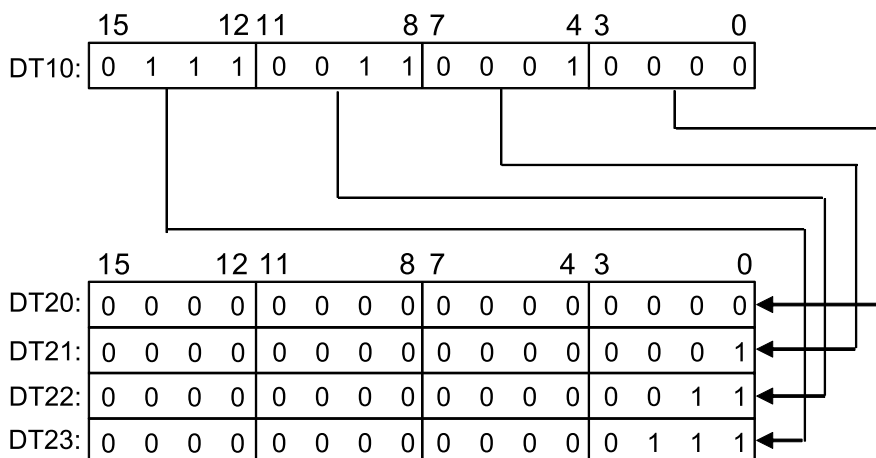

■ **Flag operations**

Name	Description
R9007	Turns ON when the area is exceeded in index modification.
R9008	Turns ON when the number of divided data items [n] is equal to or greater than 5
(ER)	Turns ON when the area is exceeded when distributing n data items to the address specified by [D]

15.25 F96 SRC (16-Bit Data Search)

15.25 F96 SRC (16-Bit Data Search)

Searches for the specified 16-bit data from the area in the specified range (table).

■ Instruction format

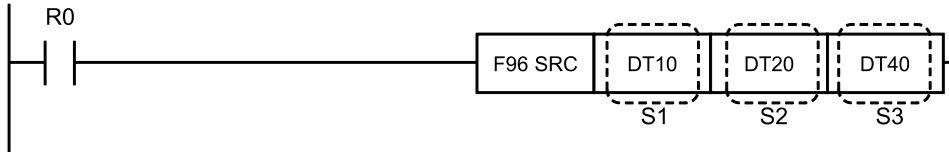

■ Operands

Items	Settings
S1	Area storing the data to be searched, or constant data
S2	Search table starting address
S3	Search table ending address

■ Devices that can be specified (indicated by ●)

Operands	WX	WY	WR	WL	SV	EV	DT	LD	I	SWR	SDT	Constant				Index modifier	Integer Device
												K	H	M	f		
S1	●	●	●	●	●	●	●	●	●	●	●	●			●		
S2		●	●	●	●	●	●	●							●		
S3		●	●	●	●	●	●	●							●		

■ Outline of operation

- The search data comprised of the 16-bit data specified by [S1] is searched for in the area (table) in the range specified by [S2] and [S3].
The search results are stored as follows.
 1. The number of registers that have the same value is stored as a decimal number in special data register DT90037.
 2. The position of the first matching register is stored in special data register DT90038 at a relative position to [S2].
- [S2] specifies the starting address, and [S3] the ending address for the table.
- Specify the same type of memory area for [S2] and [S3]. Additionally, specify values so that [S2] is equal to or less than [S3].
- Data is searched in the direction from [S2] to [S3].

■ Operation example

Operation of instruction format description program

When internal relay R0 turns ON, data that is the same content as the data in data register DT10 is searched in the range of data registers DT20 to DT40.

For example, to search the area of the value H1234, H1234 is written to DT10.

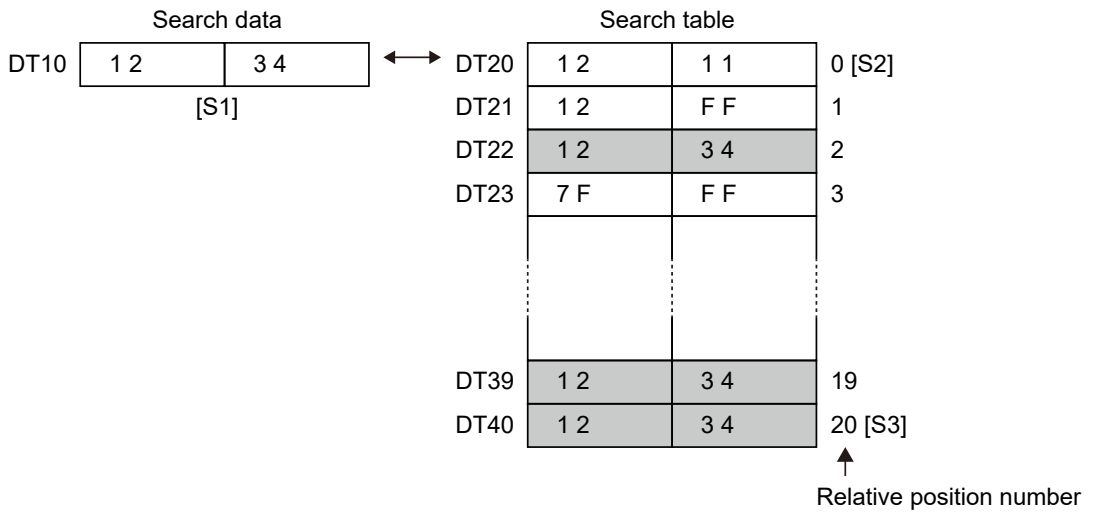

If DT22, DT39, and DT40 match the searched data, the following occurs.

1. If the number of registers matching the searched data equals 3
"K3" is stored in DT90037.
2. If the position of the first matching data (the relative position number) equals 2
"K2" is stored in DT90038.

■ **Flag operations**

Name	Description
R9007	Turns ON when the area is exceeded in index modification.
R9008 (ER)	ON when [S2] > [S3]

15.26 F97 DSRC (32-bit Data Search)

15.26 F97 DSRC (32-bit Data Search)

Searches for specified 32-bit data in any area range (table).

■ Instruction format

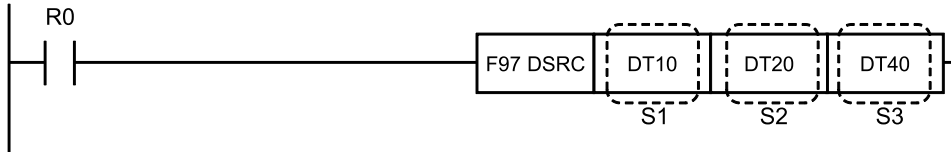

■ Operands

Items	Settings
S1	Area storing the data to search for, or constant data (32-bit)
S2	Address of the search table starting area (32-bit)
S3	Address of the search table ending area (32-bit)

■ Devices that can be specified (indicated by ●)

Operands	WX	WY	WR	WL	SV	EV	DT	LD	I	SWR	SDT	Constant				Index modifier	Integer Device
												K	H	M	f		
S1	●	●	●	●	●	●	●	●	●	●	●	●	●	●	●		
S2		●	●	●	●	●	●	●	●							●	
S3		●	●	●	●	●	●	●	●							●	

■ Outline of operation

- Searches the area range (table) specified by [S2] and [S3] for the 32-bit search data specified by [S1].
The search results are stored as follows.
 1. The number of registers with the same value is stored in special data register DT90037.
 2. The position of the first matching register is stored in special data register DT90038 at a relative position to [S2].
- [S2] specifies the starting address, and [S3] the ending address for the table.
- Specify the same type of memory area for [S2] and [S3]. Additionally, specify values so that [S2] is equal to or less than [S3].
- Data is searched in the direction from [S2] to [S3].

■ Operation example

Operation of instruction format description program

Searches data registers DT20 through DT40 for the same data as that in data registers DT10 and DT11 when execution condition R0 turns on.

For example, to search the area for the value "H01234567", write "H01234567" to DT10 and DT11.

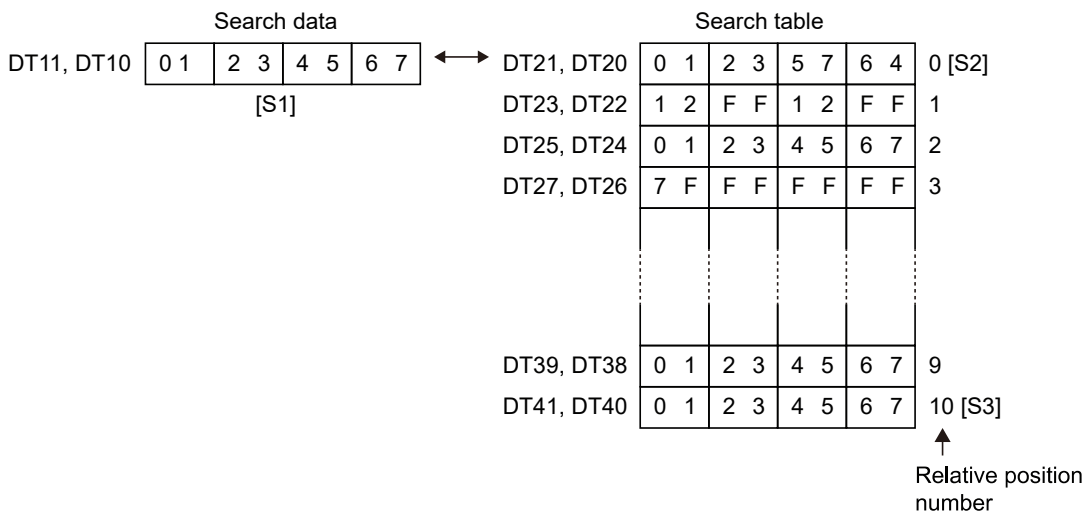

If "DT24, DT25", "DT38, DT39", and "DT40, DT41" match the searched data, the following occurs.

1. If the number of registers matching the searched data equals 3
"K3" is stored in DT90037.
2. If the position of the first matching data (the relative position number) equals 2
"K2" is stored in DT90038.

■ Flag operations

Name	Description
R9007	Turns ON when the area is exceeded in index modification.
R9008 (ER)	ON when [S2] > [S3]

15.27 F230 TMSEC (Time data to second conversion)

15.27 F230 TMSEC (Time data to second conversion)

Converts the specified time of day data (year, month, day, hour, minute, second) into number of seconds.

■ Instruction format

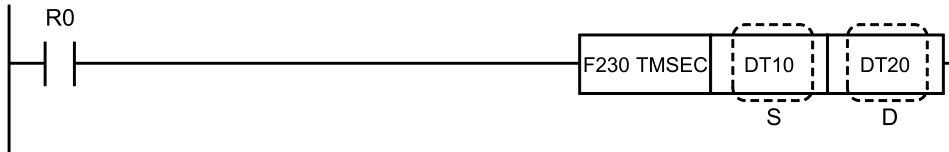

■ Operands

Items	Settings
S	Area storing the data to be converted, or constant data
D	Area to store the conversion result

■ Devices that can be specified (indicated by ●)

Operands	WX	WY	WR	WL	SV	EV	DT	LD	I	SWR	SDT	Constant				Index modifier	Integer Device
												K	H	M	f		
S	●	●	●	●	●	●	●	●	●	●	●					●	
D		●	●	●	●	●	●	●	●							●	

■ Outline of operation

- The input time data [S to S+2] is converted from standard time (*1) to number of seconds and the conversion result is stored in [D, D+1] as a 32-bit integer value.
(*1): Standard time is 00:00'00" on January 1, '01. The conversion result is output as a binary value.
- Time data conversion outputs time that takes into account leap years.

1 minute	60 seconds conversion
1 hour	60 minutes conversion
1 day	24 hours conversion
1 year (leap year)	366 days conversion
1 year (regular year)	365 days conversion
Leap year	2/29 (every 4 years)

- The time data (S) must be specified as BCD data and a value within the range must be registered.

15.27 F230 TMSEC (Time data to second conversion)

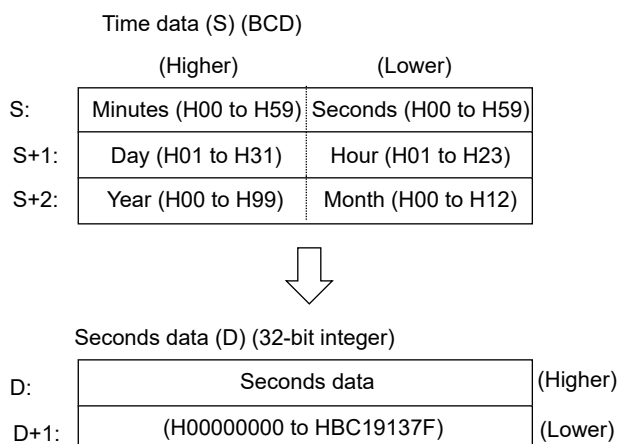

■ Operation example

Operation of instruction format description program

When internal relay R0 turns ON, the time data of data registers DT10 to DT12 is converted from standard time to number of seconds and the result is stored in DT20 and DT21.

Example 1)

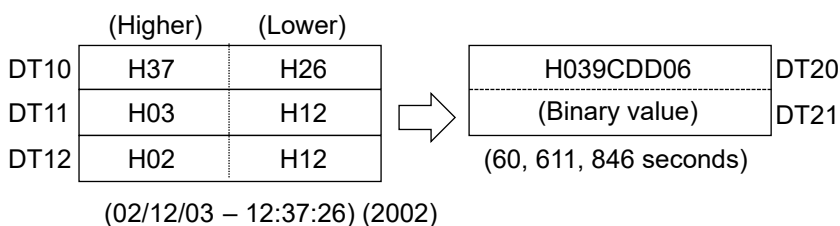

Example 2)

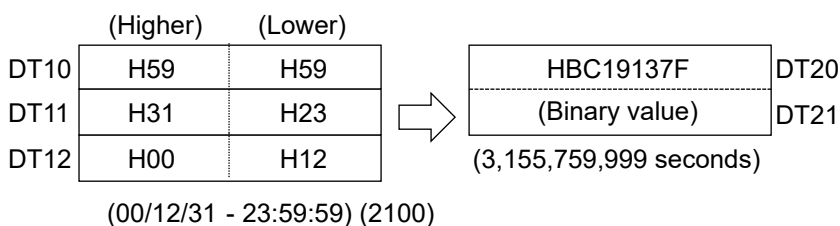

Correspondence between time of day data and second data

	Time data (S)	Second data (D)
2001	'01/01/01 00:00:00	H00000000
:	'01/01/01 00:00:01	H00000001
:	:	:
:	'01/01/01 00:01:00	H0000003C
:	:	:

15.27 F230 TMSEC (Time data to second conversion)

	Time data (S)	Second data (D)
:	'01/01/01 01:00:00	H00000E10
:	:	:
:	'01/01/01 00:00:00	H00015180
:	:	:
2099	'99/12/31 23:59:59	HBA368E7F
2100	'00/01/01 00:00:00	HBA368E80
:	:	:
2100	'00/12/31 23:59:59	HBC19137F

■ Flag operations

Name	Description
R9007 R9008 (ER)	Turns ON when the area is exceeded in index modification.
	Turns ON when a value other than BCD is specified for [S]
	Turns ON when a value that exceeds the range is specified for any one of month, day, hour, minute, or second in the time data of [S]
	Turns ON when the data of [S] exceeds the area

15.28 F231 SECTM (Second to Time Data Conversion)

The specified number of seconds is changed into time data (year/month/day/hour/minute/second).

■ **Instruction format**

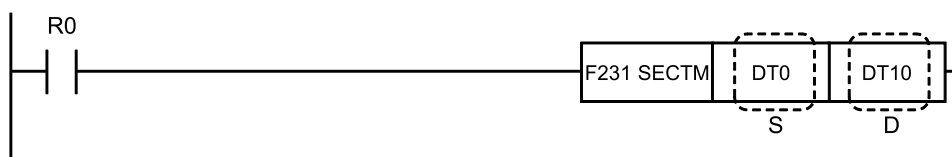

■ **Operands**

Items	Settings
S	Area storing the number of seconds (32 bits)
D	Starting area storing the time data

■ **Devices that can be specified (indicated by ●)**

Operands	WX	WY	WR	WL	SV	EV	DT	LD	I	SWR	SDT	Constant				Index modifier	Integer Device
												K	H	M	f		
S	●	●	●	●	●	●	●	●	●	●	●					●	
D		●	●	●	●	●	●	●	●							●	

■ **Outline of operation**

- The input number of seconds [S to S+2] is converted to the time data based on the standard time (*1), and stored in [D, D+1].
(*1): Standard time is 00:00'00" on January 1, '01.
- Time data conversion outputs time that takes into account leap years.

1 minute	60 seconds conversion
1 hour	60 minutes conversion
1 day	24 hours conversion
1 year (leap year)	366 days conversion
1 year (regular year)	365 days conversion
Leap year	2/29 (every 4 years)

- The number of seconds (S) must be within a range of values that can be expressed in time data, equaling up to 100 years.

H 0 to H BC19137F	Normal conversion
H BC191380 to H FFFFFFFF	Conversion error

15.28 F231 SECTM (Second to Time Data Conversion)

Seconds data (S) (32bit integer)

S:	Seconds data	(Lower)
S+1:	(H00000000 to HBC19137F)	(Higher)



Time of day data (D) (BCD)

	(Higher)	(Lower)
D:	Minutes (H00 to H59)	Seconds (H00 to H59)
D+1:	Day (H01 to H31)	Hour (H01 to H23)
D+2:	Year (H00 to H99)	Month (H00 to H12)

■ Operation example

Operation of instruction format description program

When the internal relay R0 is ON, the number of seconds for the data registers DT0 and DT1 is converted to the time data based on the standard time, and stored in DT10 to DT12.

Example 1)

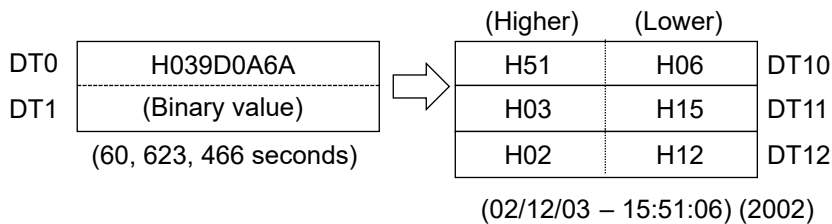

Example 2)

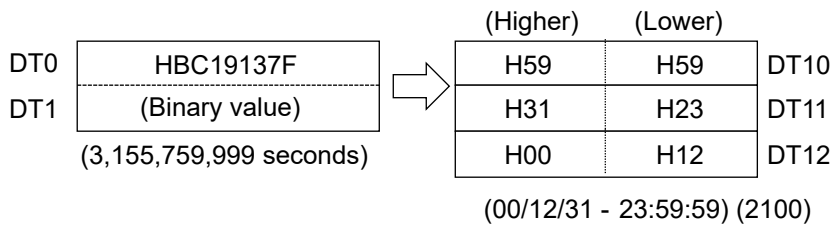

Second conversion

Second data (D)	Time data (S)	
H00000000	'01/01/01 00:00:00	2001
H00000001	'01/01/01 00:00:01	:
:	:	:
H0000003C	'01/01/01 00:01:00	:
:	:	:

15.28 F231 SECTM (Second to Time Data Conversion)

Second data (D)	Time data (S)	
H00000E10	'01/01/01 01:00:00	:
:	:	:
H00015180	'01/01/01 00:00:00	:
:	:	:
HBA368E7F	'99/12/31 23:59:59	2099
HBA368E80	'00/01/01 00:00:00	2100
:	:	:
HBC19137F	'00/12/31 23:59:59	2100

■ Flag operations

Name	Description
R9007 R9008 (ER)	Turns ON when the area is exceeded in index modification.
	Turns ON when the number of seconds [S] is $[S] \geq \text{HBC191380}$ (number of seconds in 100 years)
	Turns ON when the data memory of [D] exceeds the area

15.29 F235 GRY (16-Bit Binary to Gray Code Conversion)

15.29 F235 GRY (16-Bit Binary to Gray Code Conversion)

Converts the specified 16-bit data to gray code.

■ Instruction format

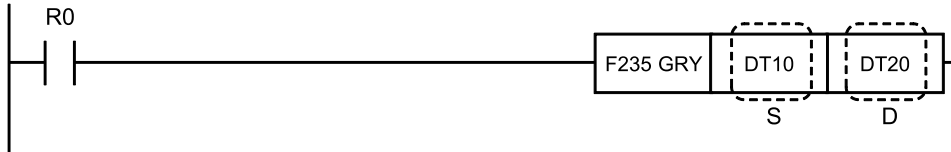

■ Operands

Items	Settings
S	Area storing the data to be converted, or constant data
D	Area to store the conversion result

■ Devices that can be specified (indicated by ●)

Operands	WX	WY	WR	WL	SV	EV	DT	LD	I	SWR	SDT	Constant				Index modifier	Integer Device
												K	H	M	f		
S	●	●	●	●	●	●	●	●	●	●	●	●	●	●	●	●	
D		●	●	●	●	●	●	●	●							●	

■ Outline of operation

- The 16-bit data in the area specified by [S] is converted to gray code and stored in the area specified by [D].

i Info.

- For the gray code, refer the correspondence table in "P.15-75".

■ Flag operations

Name	Description
R9007 R9008 (ER)	Turns ON when the area is exceeded in index modification.

15.30 F236 DGRY (32-Bit Data to Gray code)

Converts specified 32-bit data to gray code.

■ Instruction format

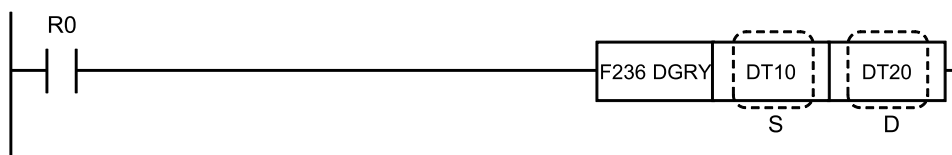

■ Operands

Items	Settings
S	Area (two word) storing the data to be converted, or constant data
D	Area (two word) to store the conversion result

■ Devices that can be specified (indicated by ●)

Operands	WX	WY	WR	WL	SV	EV	DT	LD	I	SW R	SD T	Constant				Index modifier	Integer Device
												K	H	M	f		
S	●	●	●	●	●	●	●	●	●	●	●	●	●	●	●	●	
D		●	●	●	●	●	●	●	●							●	

■ Outline of operation

- Converts the 32-bit data specified by [S] to gray code, and stores the converted data in the area specified by [D].

i Info.

- For the gray code, refer the correspondence table in "P.15-75".

■ Flag operations

Name	Description
R9007 R9008 (ER)	Turns ON when the area is exceeded in index modification.

15.31 F237 GBIN (16-bit gray code to binary conversion)

15.31 F237 GBIN (16-bit gray code to binary conversion)

Converts the gray code in the specified area to 16-bit binary data.

■ Instruction format

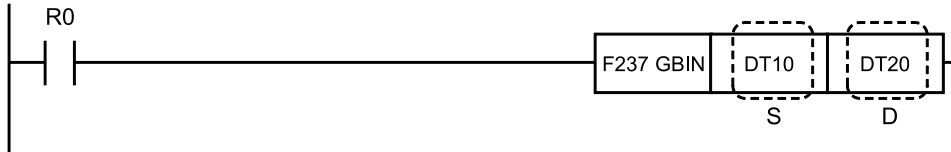

■ Operands

Items	Settings
S	Area storing the data to be converted, or constant data
D	Area to store the conversion result

■ Devices that can be specified (indicated by ●)

Operands	WX	WY	WR	WL	SV	EV	DT	LD	I	SWR	SDT	Constant				Index modifier	Integer Device
												K	H	M	f		
S	●	●	●	●	●	●	●	●	●	●	●	●	●		●		
D		●	●	●	●	●	●	●	●						●		

■ Outline of operation

- The gray code of the area specified by [S] is converted to 16-bit binary data and stored in the area specified by [D].

i Info.

- For the gray code, refer the correspondence table in "P.15-75".

■ Flag operations

Name	Description
R9007 R9008 (ER)	Turns ON when the area is exceeded in index modification.

15.32 F238 DGBIN (32-bit Gray Code to Binary Conversion)

The gray code in the specified area is converted to 32-bit binary data.

■ Instruction format

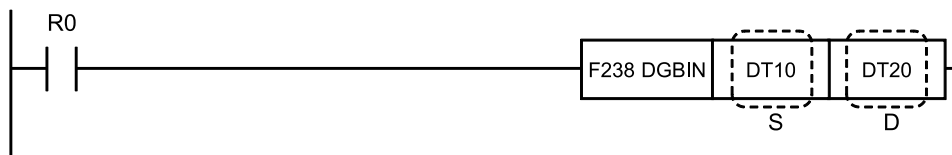

■ Operands

Items	Settings
S	Area (two word) storing the data to be converted, or constant data
D	Area (two words) to store the conversion result

■ Devices that can be specified (indicated by ●)

Operands	WX	WY	WR	WL	SV	EV	DT	LD	I	SWR	SDT	Constant				Index modifier	Integer Device
												K	H	M	f		
S	●	●	●	●	●	●	●	●	●	●	●	●	●	●	●	●	
D		●	●	●	●	●	●	●	●							●	

■ Outline of operation

- The gray code in the area specified in [S] is converted to 32-bit binary data and stored in the area specified in [D].

i Info.

- For the gray code, refer the correspondence table in "P.15-75".

■ Flag operations

Name	Description
R9007 R9008 (ER)	Turns ON when the area is exceeded in index modification.

BIN/Gray Code Correspondence Table

Decimal (Decimal)	Binary (Binary)	Gray code (Gray code)
0	0000 0000 0000 0000	0000 0000 0000 0000
1	0000 0000 0000 0001	0000 0000 0000 0001
2	0000 0000 0000 0010	0000 0000 0000 0011

15.32 F238 DGBIN (32-bit Gray Code to Binary Conversion)

Decimal (Decimal)	Binary (Binary)	Gray code (Gray code)
3	0000 0000 0000 0011	0000 0000 0000 0010
4	0000 0000 0000 0100	0000 0000 0000 0110
5	0000 0000 0000 0101	0000 0000 0000 0111
6	0000 0000 0000 0110	0000 0000 0000 0101
7	0000 0000 0000 0111	0000 0000 0000 0100
8	0000 0000 0000 1000	0000 0000 0000 1100
9	0000 0000 0000 1001	0000 0000 0000 1101
10	0000 0000 0000 1010	0000 0000 0000 1111
11	0000 0000 0000 1011	0000 0000 0000 1110
12	0000 0000 0000 1100	0000 0000 0000 1010
13	0000 0000 0000 1101	0000 0000 0000 1011
14	0000 0000 0000 1110	0000 0000 0000 1001
15	0000 0000 0000 1111	0000 0000 0000 1000
16	0000 0000 0001 0000	0000 0000 0001 1000
17	0000 0000 0001 0001	0000 0000 0001 1001
18	0000 0000 0001 0010	0000 0000 0001 1011
19	0000 0000 0001 0011	0000 0000 0001 1010
20	0000 0000 0001 0100	0000 0000 0001 1110
21	0000 0000 0001 0101	0000 0000 0001 1111
22	0000 0000 0001 0110	0000 0000 0001 1101
23	0000 0000 0001 0111	0000 0000 0001 1100
24	0000 0000 0001 1000	0000 0000 0001 0100
25	0000 0000 0001 1001	0000 0000 0001 1101
26	0000 0000 0001 1010	0000 0000 0001 0111
27	0000 0000 0001 1011	0000 0000 0001 0110
28	0000 0000 0001 1100	0000 0000 0001 0010
29	0000 0000 0001 1101	0000 0000 0001 0011
30	0000 0000 0001 1110	0000 0000 0001 0001
31	0000 0000 0001 1111	0000 0000 0001 0000
32	0000 0000 0010 0000	0000 0000 0011 0000
63	0000 0000 0011 1111	0000 0000 0010 0000
64	0000 0000 0100 0000	0000 0000 0110 0000
:	:	:
255	0000 0000 1111 1111	0000 0000 1000 0000

15.33 F240 COLM (Bit Line to Bit Column Conversion)

Converts a bit line to a bit column.

■ Instruction format

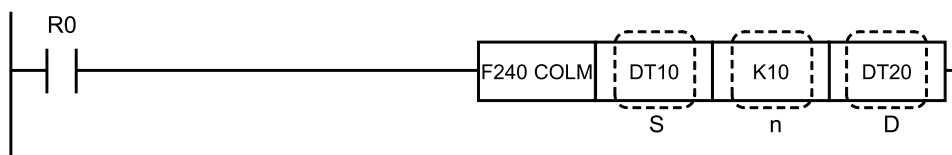

■ Operands

Items	Settings
S	Area storing the hexadecimal data or constant data
n	Area storing the bit position specification, or constant data
D	Starting address of the area that will be overwritten by the bit column

■ Devices that can be specified (indicated by ●)

Operand s	WX	WY	WR	WL	SV	EV	DT	LD	I	SW R	SD T	Constant				Index modifier	Integer Device
												K	H	M	f		
S	●	●	●	●	●	●	●	●	●	●	●	●	●			●	
n	●	●	●	●	●	●	●	●	●	●	●	●	●			●	
D		●	●	●	●	●	●	●	●							●	

■ Outline of operation

- The bit data at the position specified by [n] in the 16-word data area starting from [D] is rewritten by the 16-bit data of the area specified by [S].
- The contents of the bits of the 16-word data area starting from [D] that are not specified do not change.
- [n] can be specified in the range of 0 to 15.

15.33 F240 COLM (Bit Line to Bit Column Conversion)

e.g. When the specified bit position $n = 10$ (K10)

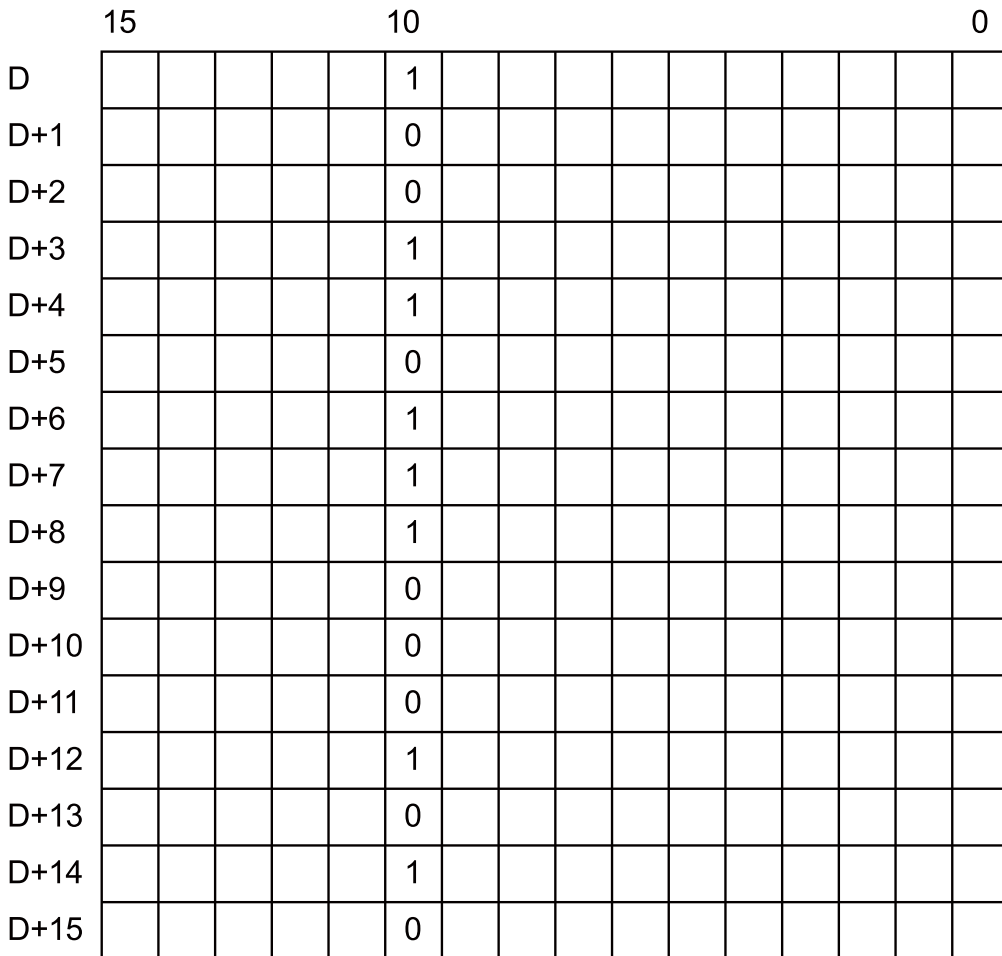
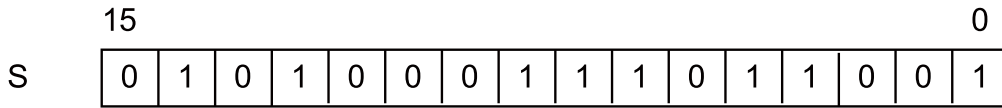

■ Flag operations

Name	Description
R9007	Turns ON when the area is exceeded in index modification.
R9008	Turns ON if $0 \leq [n] \leq 15$ is not true
(ER)	Turns ON when the conversion result exceeds the area specified by [D] when stored

15.34 F241 LINE (Bit Column to Bit Line Conversion)

Converts a bit column to a bit line.

■ **Instruction format**

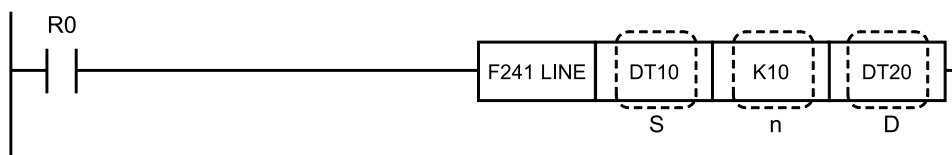

■ **Operands**

Items	Settings
S	Starting address of area where bit column will be read
n	Area storing the bit position specification, or constant data
D	Area to store the conversion result

■ **Devices that can be specified (indicated by ●)**

Operand s	WX	WY	WR	WL	SV	EV	DT	LD	I	SW R	SD T	Constant				Index modifier	Integer Device
												K	H	M	f		
S	●	●	●	●	●	●	●	●	●	●	●					●	
n	●	●	●	●	●	●	●	●	●	●	●	●	●			●	
D		●	●	●	●	●	●	●	●							●	

■ **Outline of operation**

- Reads the bit data at the position specified by [n] from the area specified by [S] and stores it in the area specified by [D].
- [n] can be specified in the range of 0 to 15.

15.34 F241 LINE (Bit Column to Bit Line Conversion)

e.g. When the specified bit position $n = 10$ (K10)

	15					10									0
S						1									
S+1						0									
S+2						0									
S+3						1									
S+4						1									
S+5						0									
S+6						1									
S+7						1									
S+8						1									
S+9						0									
S+10						0									
S+11						0									
S+12						1									
S+13						0									
S+14						1									
S+15						0									



	15														0	
D	0	1	0	1	0	0	0	1	1	1	0	1	1	0	0	1

■ **Flag operations**

Name	Description
R9007	Turns ON when the area is exceeded in index modification.
R9008	Turns ON if $0 \leq [n] \leq 15$ is not true
(ER)	Turns ON when the conversion range specified by [S] exceeds the area

16 Data Shift Instruction

16.1 F100 SHR (n bit Right Shift of 16-bit Data).....	16-2
16.2 F101 SHL (Left Shift of n Bits in 16-Bit Data)	16-4
16.3 F102 DSHR (Right Shift of n Bits in 32-Bit Data).....	16-6
16.4 F103 DSHL (Left Shift of n Bits in 32-Bit Data).....	16-8
16.5 F105 BSR (One digit shift to the right).....	16-10
16.6 F106 BSL (One digit shift to the left).....	16-12
16.7 F108 BITR (Right shift of multiple bits of an n-bit range).....	16-14
16.8 F109 BITL (Left Shift of Multiple Bits of an n-Bit Range)	16-16
16.9 F110 WSHR (One word shift to the right)	16-18
16.10 F111 WSHL (Bulk Left Shift of Word Unit)	16-20
16.11 F112 WBSR (Bulk right shift of digit unit).....	16-22
16.12 F113 WBSL (Digit Bulk Left Shift).....	16-24

16.1 F100 SHR (n bit Right Shift of 16-bit Data)

16.1 F100 SHR (n bit Right Shift of 16-bit Data)

Shifts 16-bit data to the right by a specified number of bits.

■ Instruction format

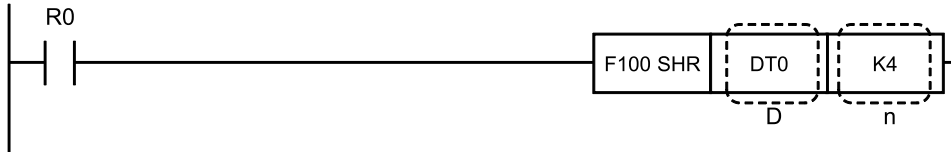

■ Operands

Items	Settings
D	Area storing the 16-bit data to be shifted
n	Area storing the number of bits to be shifted, or constant data

■ Devices that can be specified (indicated by ●)

Operands	WX	WY	WR	WL	SV	EV	DT	LD	I	SWR	SDT	Constant				Index modifier	Integer Device
												K	H	M	f		
D		●	●	●	●	●	●	●	●						●		
n	●	●	●	●	●	●	●	●	●	●	●	●			●		

■ Outline of operation

- Shifts the 16-bit data specified by [D] by the number of bits (specified in decimal form) specified by [n] to the right (the lower bit direction).

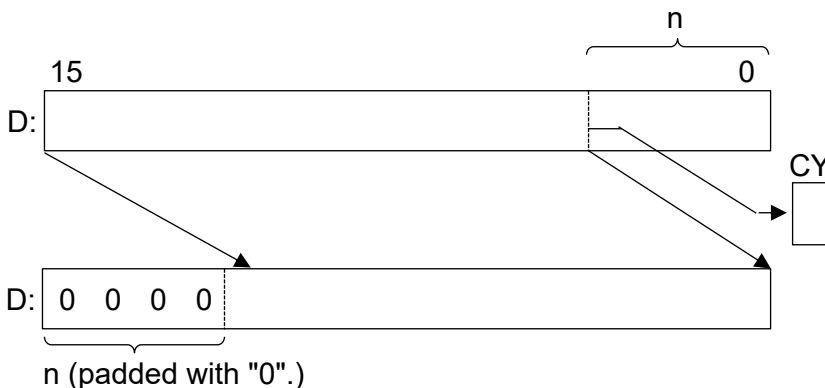

- If a right shift is performed,
 - the n number of bits are filled with 0 from the most significant bit.
 - The content from the least significant bit to the n bit is stored in the CY (carry) flag (R9009).
- For [n], only the lower 8 bits of the 16-bit data are valid. The shift amount can be selected from 1 bit to 255 bits.

16.1 F100 SHR (n bit Right Shift of 16-bit Data)

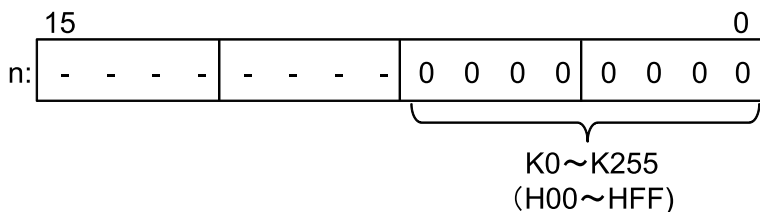

(Note 1) The bits marked - are invalid.

■ Operation example

Operation of instruction format description program

Shifts the content of DT0 four bits to the right when internal relay R0 turns ON. The content of bit 3 before the shift is stored in the CY (carry) flag.

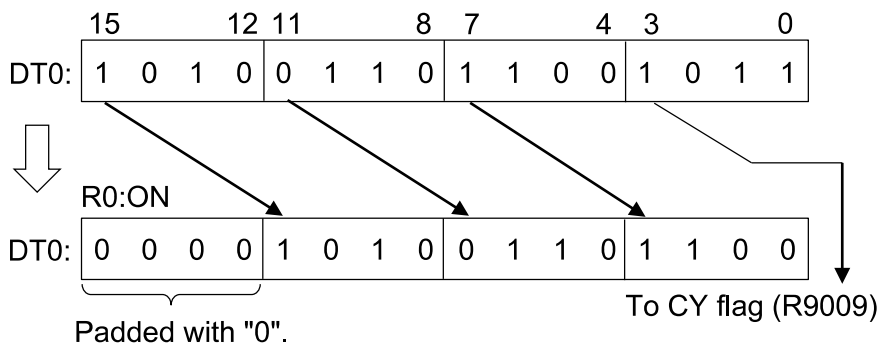

■ Flag operations

Name	Description
R9007 R9008 (ER)	Turns ON when the area is exceeded in index modification.
R9009 (CY)	Turns ON when the content of the least significant bit to the n bit is "1"

16.2 F101 SHL (Left Shift of n Bits in 16-Bit Data)

16.2 F101 SHL (Left Shift of n Bits in 16-Bit Data)

Shifts 16-bit data to the left by the specified number of bits.

■ Instruction format

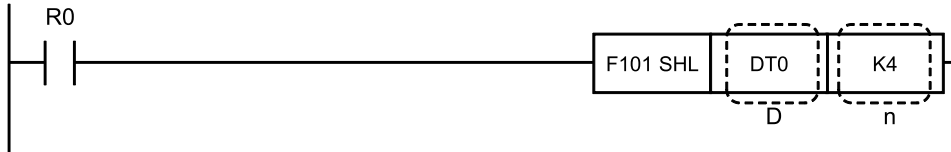

■ Operands

Items	Settings
D	Area storing the 16-bit data to be shifted
n	Area storing the number of bits to be shifted, or constant data

■ Devices that can be specified (indicated by ●)

Operands	WX	WY	WR	WL	SV	EV	DT	LD	I	SWR	SDT	Constant				Index modifier	Integer Device
												K	H	M	f		
D		●	●	●	●	●	●	●	●						●		
n	●	●	●	●	●	●	●	●	●	●	●	●			●		

■ Outline of operation

- The 16-bit data specified by [D] is shifted to the left (in the high bit direction) by the number of bits specified by [n] (specified as a decimal number).

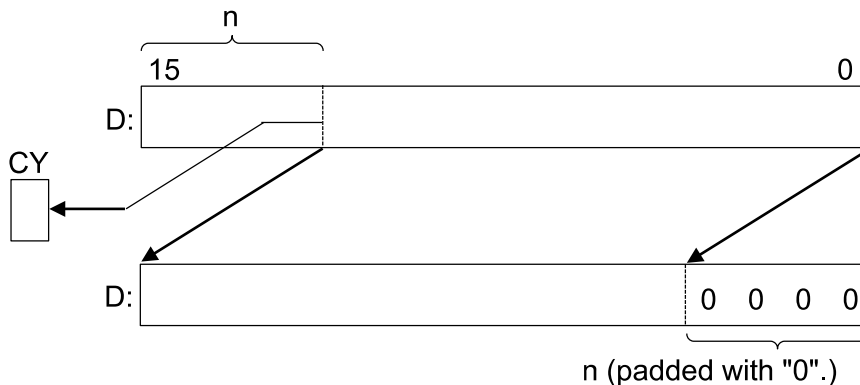

- When the data shifts to the left, the following occurs:
 - n bits starting from the least significant bit are filled with 0s.
 - The data in the nth bit from the most significant bit is stored in the CY (carry) flag (R9009).
- For [n], only the lower 8 bits of the 16-bit data are valid. The shift amount can be selected from 1 bit to 255 bits.

16.2 F101 SHL (Left Shift of n Bits in 16-Bit Data)

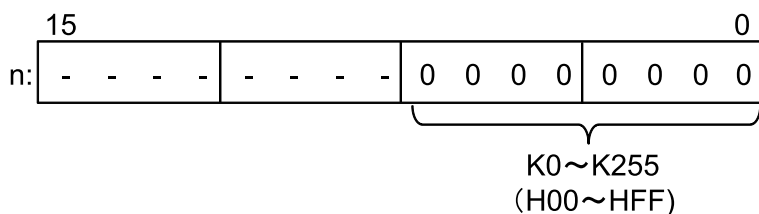

(Note 1) The bits marked - are invalid.

■ Operation example

Operation of instruction format description program

When internal relay R0 turns ON, the content of DT0 shifts four bits to the left. The content of bit 12 before the shift is stored in the CY (carry) flag.

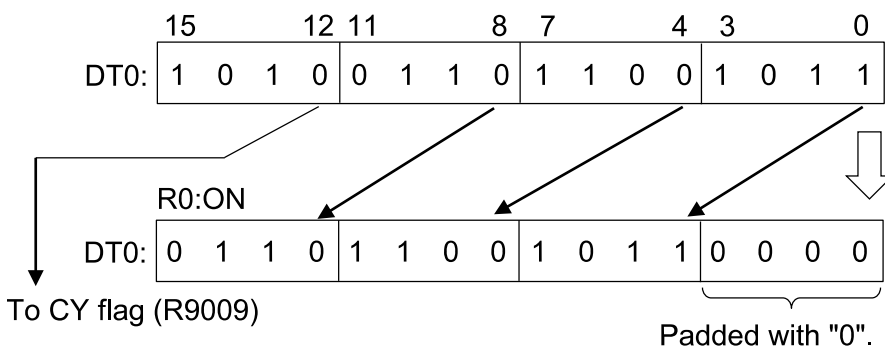

■ Flag operations

Name	Description
R9007 R9008 (ER)	Turns ON when the area is exceeded in index modification.
R9009 (CY)	Turns ON when the content of the nth bit from the most significant bit is "1"

16.3 F102 DSHR (Right Shift of n Bits in 32-Bit Data)

16.3 F102 DSHR (Right Shift of n Bits in 32-Bit Data)

Shifts 32-bit data (double-word data) n bits to the right.

■ Instruction format

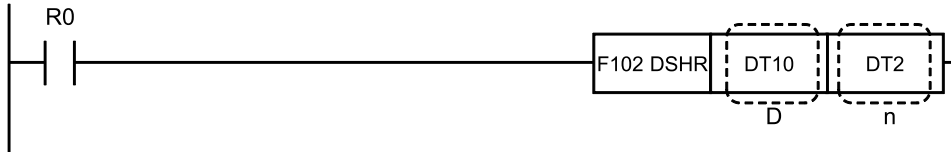

■ Operands

Items	Settings
D	Area storing the double-word data to be shifted (two words)
n	Area storing the number of bits to be shifted, or constant data

■ Devices that can be specified (indicated by ●)

Operands	WX	WY	WR	WL	SV	EV	DT	LD	I	SWR	SDT	Constant				Index modifier	Integer Device
												K	H	M	f		
D		●	●	●	●	●	●	●	●						●		
n	●	●	●	●	●	●	●	●	●	●	●	●	●		●		

■ Outline of operation

- The double-word data specified by [D, D+1] is shifted to the right (in the low bit direction) by the number of bits specified by [n] (16-bit K constant).

n bits shifted to the right

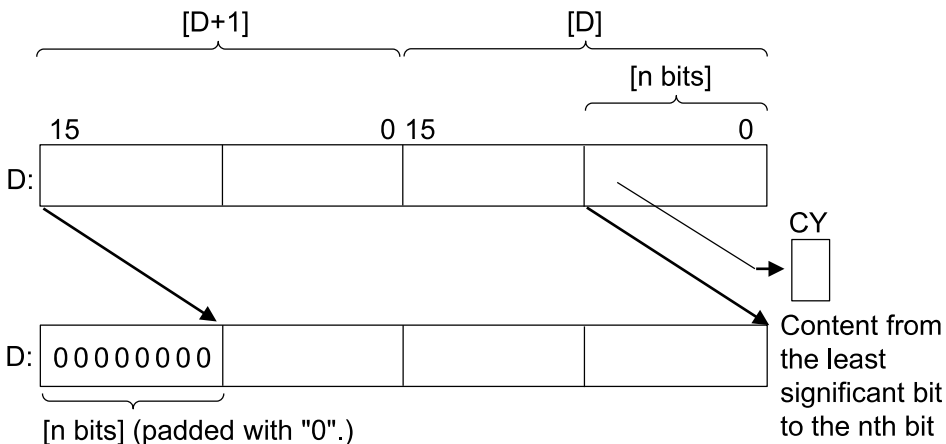

- If a right shift is performed,
 - the n number of bits are filled with 0 from the most significant bit.
 - The content from the least significant bit to the n bit is stored in the CY (carry) flag (R9009).

16.3 F102 DSHR (Right Shift of n Bits in 32-Bit Data)

- For [n], only the lower 8 bits of the 16-bit data are valid. The shift amount can be selected from 1 bit to 255 bits.

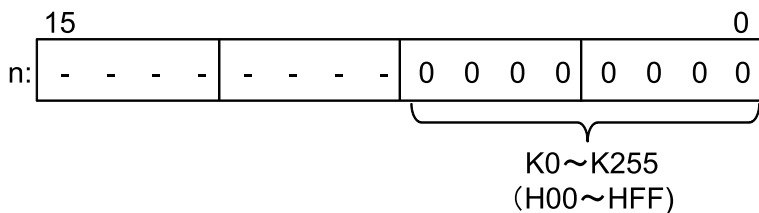

(Note 1) The bits marked - are invalid.

- When [n] = K0, the content of [D, D+1] and the CY flag do not change.
- When [n] is specified as K32 or higher, the content of [D, D+1] changes to 0.

■ Flag operations

Name	Description
R9007 R9008 (ER)	Turns ON when the area is exceeded in index modification.
R9009 (CY)	Reflects the content of the nth bit from the least significant bit immediately before the instruction is executed.

16.4 F103 DSHL (Left Shift of n Bits in 32-Bit Data)

16.4 F103 DSHL (Left Shift of n Bits in 32-Bit Data)

Shifts 32-bit data (double-word data) n bits to the left.

■ Instruction format

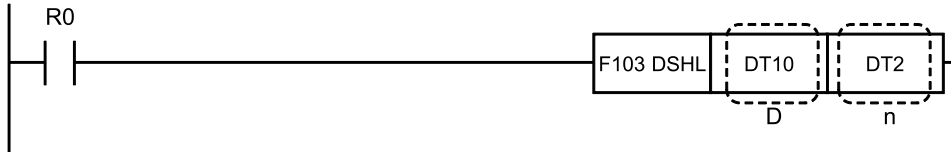

■ Operands

Items	Settings
D	Area storing the double-word data to be shifted (two words)
n	Area storing the number of bits to be shifted, or constant data

■ Devices that can be specified (indicated by ●)

Operands	WX	WY	WR	WL	SV	EV	DT	LD	I	SWR	SDT	Constant				Index modifier	Integer Device
												K	H	M	f		
D		●	●	●	●	●	●	●	●							●	
n	●	●	●	●	●	●	●	●	●	●	●	●	●			●	

■ Outline of operation

- The double-word data specified by [D, D+1] is shifted to the left (in the high bit direction) by the number of bits specified by [n] (16-bit K constant).

n bits shifted to the left

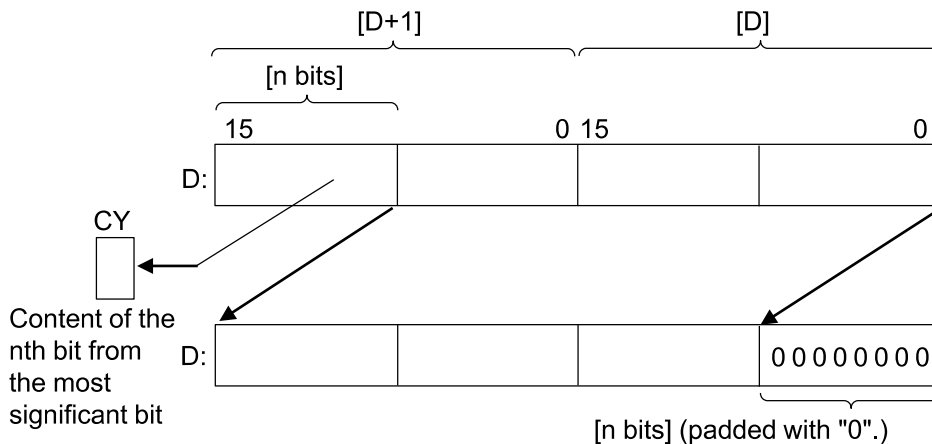

- When the data shifts to the left, the following occurs:
 - n bits starting from the least significant bit are filled with 0s.
 - The data in the nth bit from the most significant bit is stored in the CY (carry) flag (R9009).

16.4 F103 DSHL (Left Shift of n Bits in 32-Bit Data)

- For [n], only the lower 8 bits of the 16-bit data are valid. The shift amount can be selected from 1 bit to 255 bits.

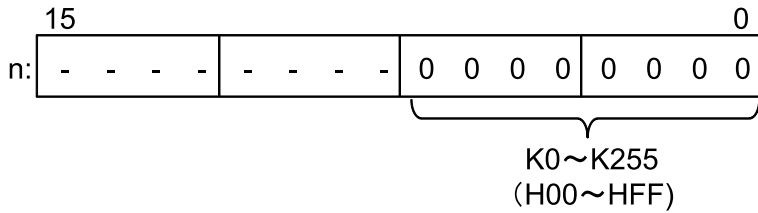

(Note 1) The bits marked - are invalid.

- When [n] = K0, the content of [D, D+1] and the CY flag do not change.
- When [n] is specified as K32 or higher, the content of [D, D+1] changes to 0.

■ Flag operations

Name	Description
R9007 R9008 (ER)	Turns ON when the area is exceeded in index modification.
R9009 (CY)	Reflects the content of the nth bit from the most significant bit immediately before the instruction is executed.

16.5 F105 BSR (One digit shift to the right)

16.5 F105 BSR (One digit shift to the right)

Shifts 16-bit data one digit (four bits) to the right.

■ Instruction format

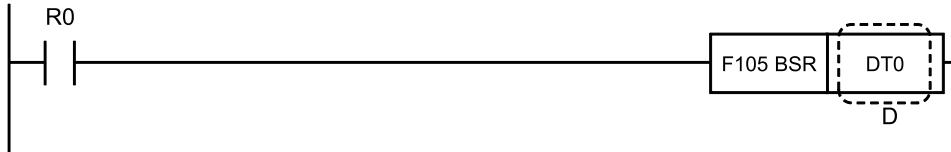

■ Operands

Items	Settings
D	Area storing the 16-bit data to be shifted

■ Devices that can be specified (indicated by ●)

Operands	WX	WY	WR	WL	SV	EV	DT	LD	I	SWR	SDT	Constant				Index modifier	Integer Device
												K	H	M	f		
D		●	●	●	●	●	●	●	●							●	

■ Outline of operation

- The 16-bit data (four digits) specified by [D] is shifted one digit (four bits) to the right (downward direction).

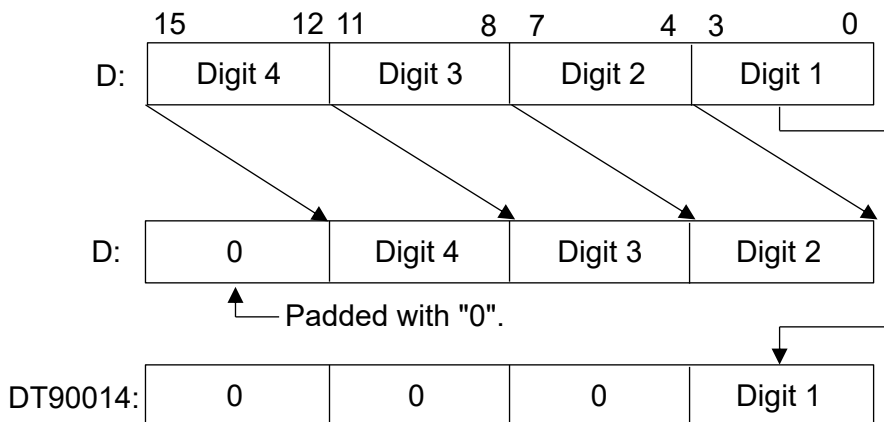

- If a right shift is performed,
 - Bits 0 to 3 (digit 1) from before the shift are stored in bits 0 to 3 of special data register DT90014.
 - After the shift, bits 12 to 15 are filled with 0.

■ Operation example

Operation of instruction format description program

When internal relay R0 turns ON, the content of DT0 shifts one digit to the right. The content of bits 0 to 3 before the shift are stored in bits 0 to 3 of DT90014.

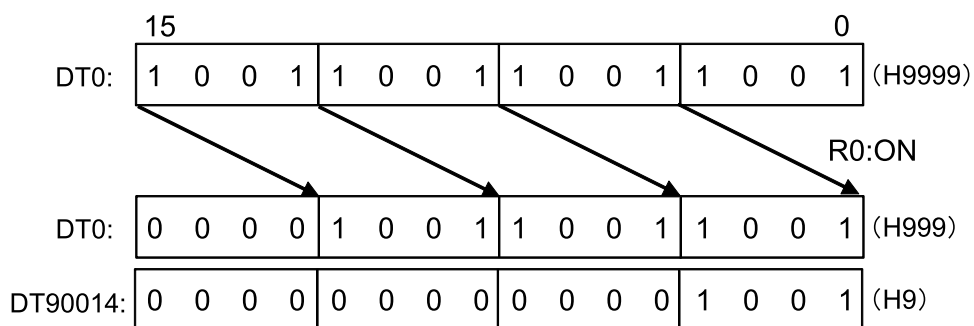

■ Flag operations

Name	Description
R9007 R9008 (ER)	Turns ON when the area is exceeded in index modification.

16.6 F106 BSL (One digit shift to the left)

16.6 F106 BSL (One digit shift to the left)

Shifts 16-bit data one digit (four bits) to the left.

■ Instruction format

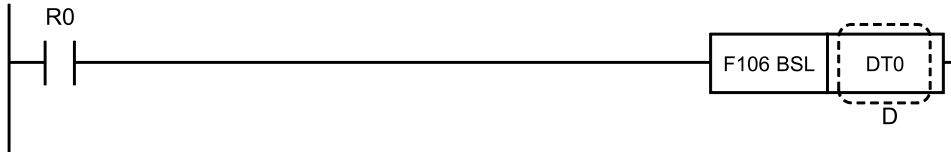

■ Operands

Items	Settings
D	Area storing the 16-bit data to be shifted

■ Devices that can be specified (indicated by ●)

Operands	WX	WY	WR	WL	SV	EV	DT	LD	I	SWR	SDT	Constant				Index modifier	Integer Device
												K	H	M	f		
D		●	●	●	●	●	●	●	●							●	

■ Outline of operation

- The 16-bit data (four digits) specified by [D] is shifted one digit (four bits) to the left (upward direction).

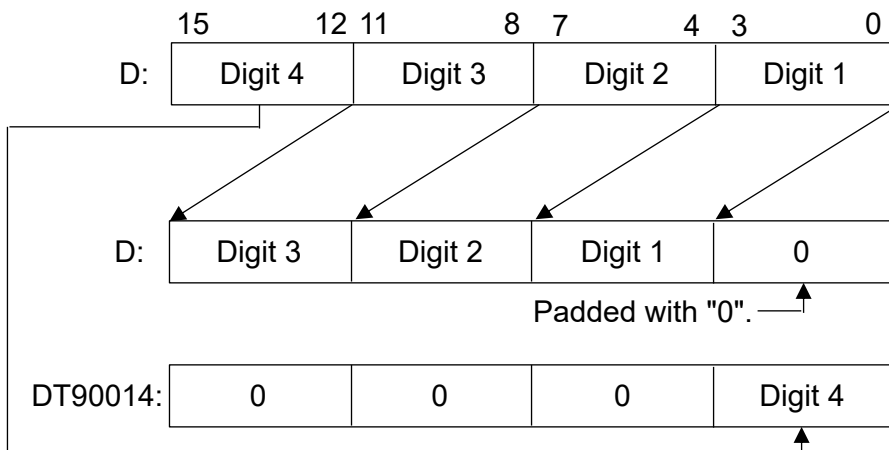

- When the data shifts to the left, the following occurs:
 1. Bits 12 to 15 from before the shift are stored in bits 0 to 3 of special data register DT90014.
 2. After the shift, bits 0 to 3 are filled with 0.

■ Operation example

Operation of instruction format description program

When internal relay R0 turns ON, the content of DT0 shifts one digit to the left. The contents of bits 12 to 15 before the shift are stored in bits 0 to 3 of DT90014.

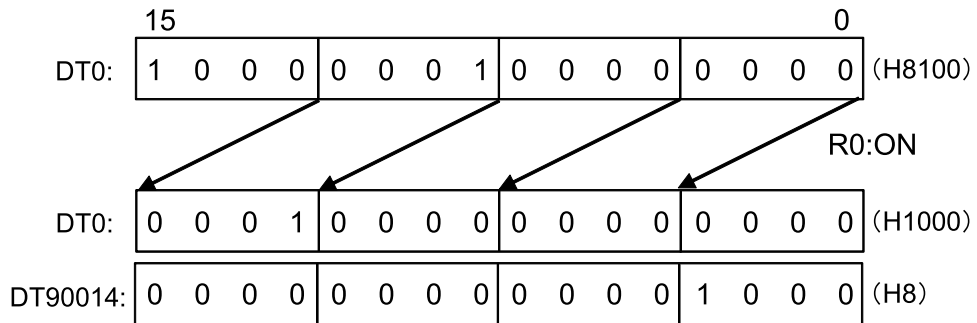

■ Flag operations

Name	Description
R9007 R9008 (ER)	Turns ON when the area is exceeded in index modification.

16.7 F108 BITR (Right shift of multiple bits of an n-bit range)

16.7 F108 BITR (Right shift of multiple bits of an n-bit range)

Shifts a block area to the right in bit units.

■ Instruction format

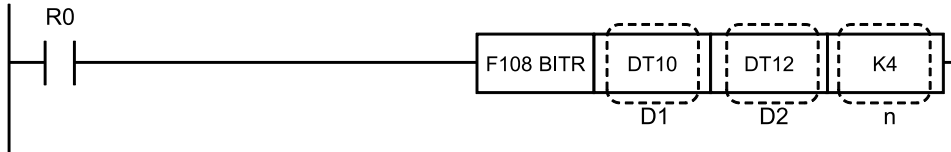

■ Operands

Items	Settings
D1	Starting address of the area to be shifted
D2	Ending address of the area to be shifted
n	Area storing the number of bits to be shifted, or constant data

■ Devices that can be specified (indicated by ●)

Operands	WX	WY	WR	WL	SV	EV	DT	LD	I	SWR	SDT	Constant				Index modifier	Integer Device
												K	H	M	f		
D1		●	●	●	●	●	●	●	●							●	
D2		●	●	●	●	●	●	●	●							●	
n	●	●	●	●	●	●	●	●	●	●	●	●	●			●	

■ Outline of operation

- The area in the range specified by [D1] and [D2] is shifted to the right by the number of bits specified by [n].

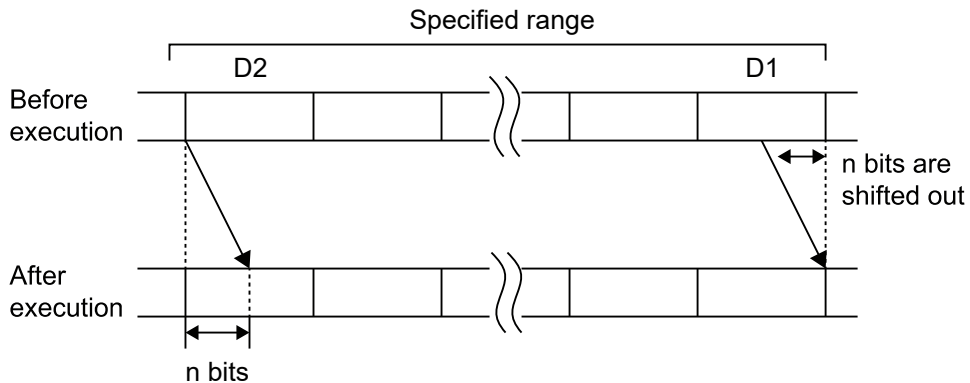

- The starting address of the area to be shifted is specified by [D1] and the ending address is specified by [D2].
- Specify the same type of area for both [D1] and [D2]. Also, specify values so that D1 is equal to or smaller than D2.

16.7 F108 BITR (Right shift of multiple bits of an n-bit range)

- When a right-shift is executed, the following occur:
 1. The lowest n bits of [D1] before the shift is executed are shifted out.
 2. The highest n bits of [D2] after the shift is executed are filled with 0.
- No operation takes place if [n] = 0.
- If [n] is set to a number of bits that exceeds the area in the range specified by [D1] and [D2], the value of the area from [D1] to [D2] is 0.

■ Operation example

Operation of instruction format description program

When internal relay R0 turns ON, the three-word data in DT10 to DT12 is shifted four bits to the right

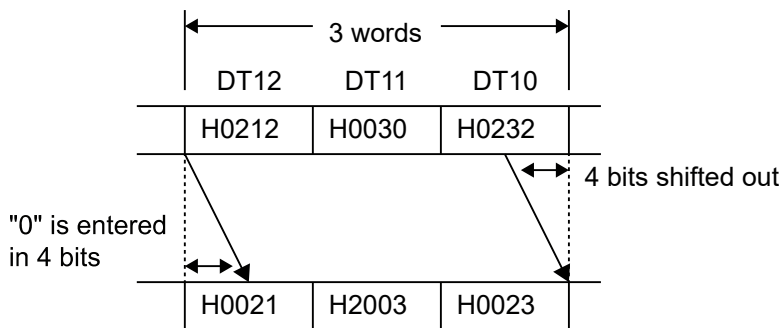

■ Flag operations

Name	Description
R9007	Turns ON when the area is exceeded in index modification.
R9008 (ER)	Turns ON when [D1] > [D2]

16.8 F109 BITL (Left Shift of Multiple Bits of an n-Bit Range)

16.8 F109 BITL (Left Shift of Multiple Bits of an n-Bit Range)

Shifts a block area left in bit units.

■ Instruction format

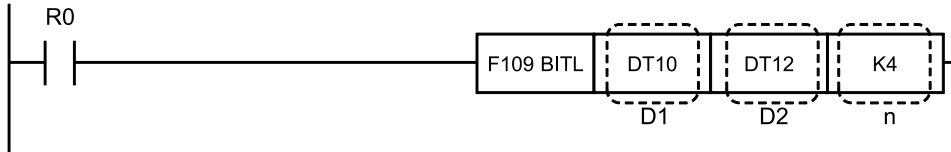

■ Operands

Items	Settings
D1	Starting address of the area to be shifted
D2	Ending address of the area to be shifted
n	Area storing the number of bits to be shifted, or constant data

■ Devices that can be specified (indicated by ●)

Operands	WX	WY	WR	WL	SV	EV	DT	LD	I	SWR	SDT	Constant				Index modifier	Integer Device
												K	H	M	f		
D1		●	●	●	●	●	●	●	●							●	
D2		●	●	●	●	●	●	●	●							●	
n	●	●	●	●	●	●	●	●	●	●	●	●	●			●	

■ Outline of operation

- The area in the range specified by [D1] and [D2] is shifted left by the number of bits specified by [n].

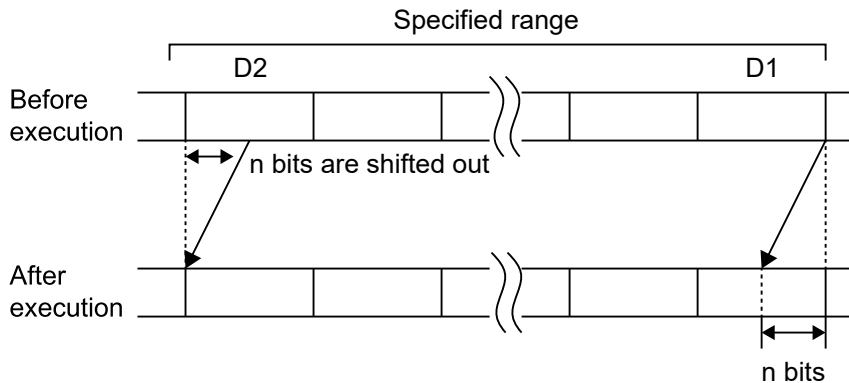

- The starting address of the area to be shifted is specified by [D1] and the ending address is specified by [D2].
- Specify the same type of area for both [D1] and [D2]. Also, specify values so that D1 is equal to or smaller than D2.

16.8 F109 BITL (Left Shift of Multiple Bits of an n-Bit Range)

- When the data shifts to the left, the following occurs:
 1. The highest n bits of [D2] before the shift is executed are shifted out.
 2. The lowest n bits of [D1] after the shift is executed are filled with 0.
- No operation takes place if [n] = 0.
- If [n] is set to a number of bits that exceeds the area in the range specified by [D1] and [D2], the value of the area from [D1] to [D2] is 0.

■ Operation example

Operation of instruction format description program

When internal relay R0 turns ON, the three-word data in DT10 to DT12 is shifted four bits to the left.

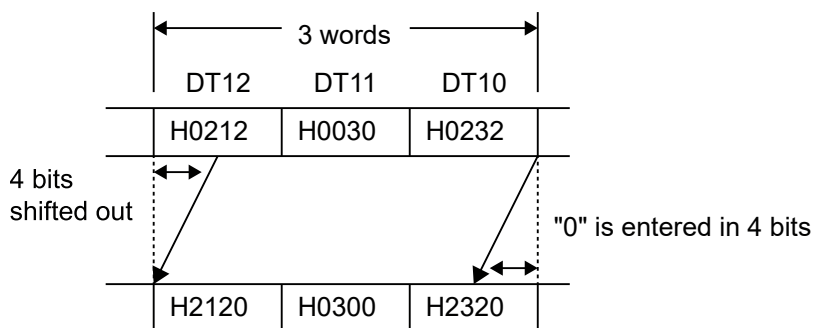

■ Flag operations

Name	Description
R9007	Turns ON when the area is exceeded in index modification.
R9008 (ER)	Turns ON when [D1] > [D2]

16.9 F110 WSHR (One word shift to the right)

16.9 F110 WSHR (One word shift to the right)

Shifts the specified data range one word to the right.

■ Instruction format

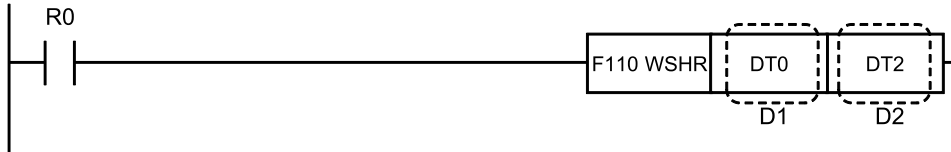

■ Operands

Items	Settings
D1	Starting address of the area to be shifted
D2	Ending address of the area to be shifted

■ Devices that can be specified (indicated by ●)

Operands	WX	WY	WR	WL	SV	EV	DT	LD	I	SWR	SDT	Constant				Index modifier	Integer Device
												K	H	M	f		
D1		●	●	●	●	●	●	●								●	
D2		●	●	●	●	●	●	●								●	

■ Outline of operation

- The area of the range specified by [D1] and [D2] is shifted one word to the right (downward direction).

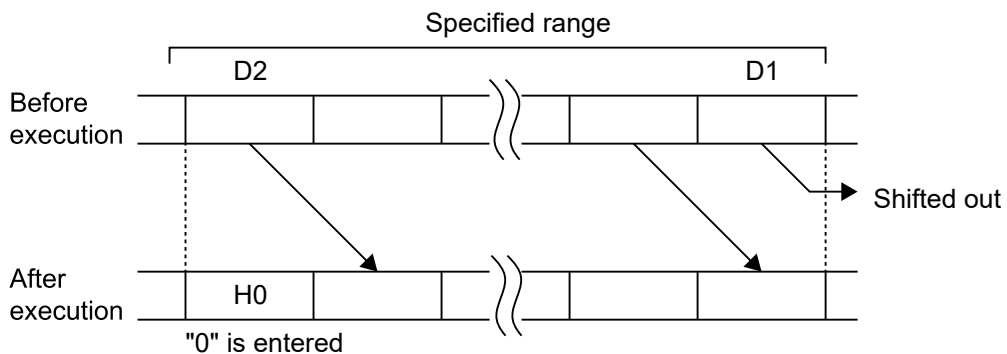

- The starting address of the area to be shifted is specified by [D1] and the ending address is specified by [D2].
- Specify the same type of area for both [D1] and [D2]. Also, make sure that [D1] address \leq [D2] address.
- When a right-shift is executed, the following occur:
 1. The content of [D1] before the execution is permanently deleted.
 2. [D2] is filled with H0 after the execution.

■ Operation example

Operation of instruction format description program

When internal relay R0 turns ON, the three-word data in DT0 to DT2 is shifted one word to the right.

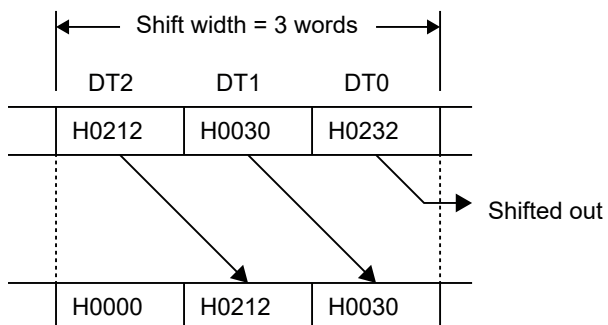

■ Flag operations

Name	Description
R9007	Turns ON when the area is exceeded in index modification.
R9008 (ER)	Turns ON when the [D1] address > [D2] address

16.10 F111 WSHL (Bulk Left Shift of Word Unit)

16.10 F111 WSHL (Bulk Left Shift of Word Unit)

Data in the specified range is shifted one word to the left.

■ Instruction format

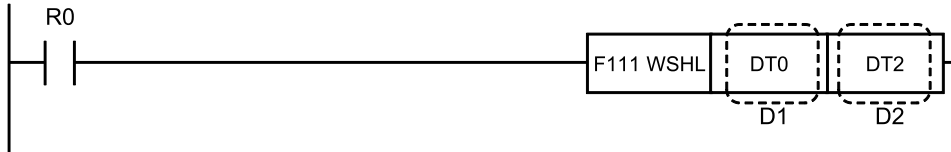

■ Operands

Items	Settings
D1	Starting address of the area to be shifted
D2	Ending address of the area to be shifted

■ Devices that can be specified (indicated by ●)

Operands	WX	WY	WR	WL	SV	EV	DT	LD	I	SWR	SDT	Constant				Index modifier	Integer Device
												K	H	M	f		
D1		●	●	●	●	●	●	●								●	
D2		●	●	●	●	●	●	●								●	

■ Outline of operation

- The range area specified by [D1] and [D2] is shifted to the left (upper direction) by one word.

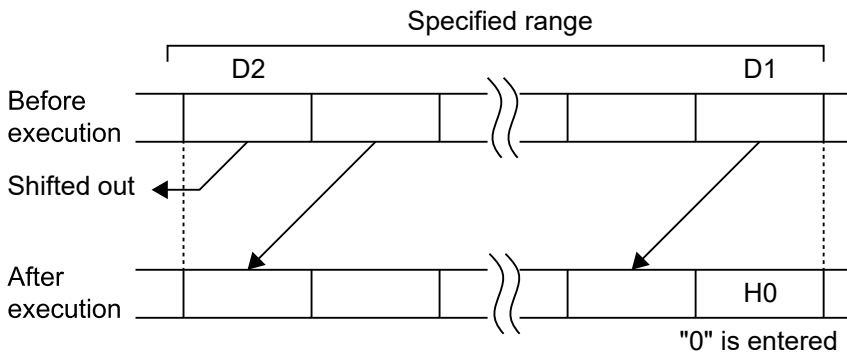

- The starting address of the area to be shifted is specified by [D1] and the ending address is specified by [D2].
- Specify the same type of area for both [D1] and [D2]. Also, make sure that [D1] address \leq [D2] address.
- When the data shifts to the left, the following occurs:
 1. The content of [D2] before the execution is permanently deleted.
 2. [D1] is filled with H0 after the execution.

■ Operation example

Operation of instruction format description program

Three-word data from DT0 to DT2 is shifted one word to the left when internal relay R0 turns ON.

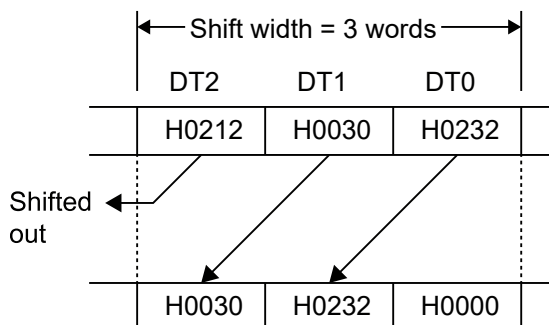

■ Flag operations

Name	Description
R9007	Turns ON when the area is exceeded in index modification.
R9008 (ER)	Turns ON when the [D1] address > [D2] address

16.11 F112 WBSR (Bulk right shift of digit unit)

16.11 F112 WBSR (Bulk right shift of digit unit)

Data in the specified range is shifted 1 digit to the right.

■ Instruction format

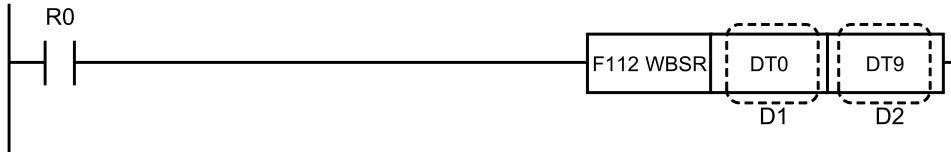

■ Operands

Items	Settings
D1	Starting address of the area to be shifted
D2	Ending address of the area to be shifted

■ Devices that can be specified (indicated by ●)

Operands	WX	WY	WR	WL	SV	EV	DT	LD	I	SW R	SD T	Constant				Index modifier	Integer Device
												K	H	M	f		
D1		●	●	●	●	●	●	●								●	
D2		●	●	●	●	●	●	●								●	

■ Outline of operation

- The area of the range specified in [D1] and [D2] is shifted to the right (lower direction) by 1 digit (4 bits).

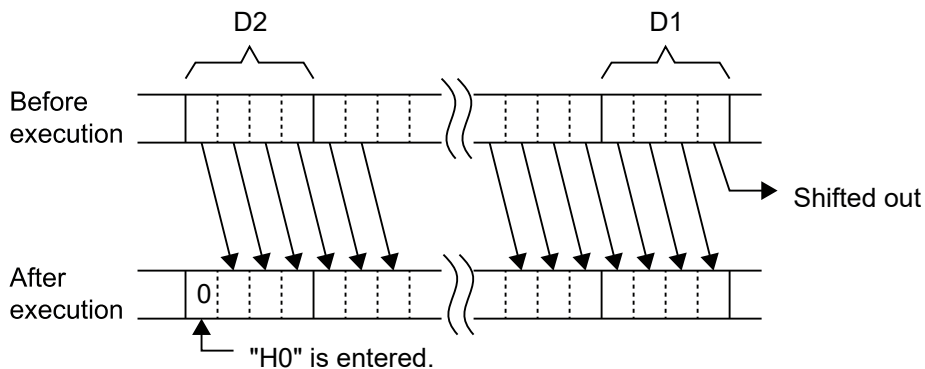

- The starting address of the area to be shifted is specified by [D1] and the ending address is specified by [D2].
- Specify the same type of area for both [D1] and [D2]. Also, make sure that [D1] address \leq [D2] address.
- When a right-shift is executed, the following occur:
 1. The content of bits 0 to 3 of [D1] (digit 1) prior to execution is deleted.
 2. Bits 12 to 15 of [D2] (digit 4) are filled with "0" after execution.

■ Operation example

Operation of instruction format description program

When internal relay R0 is ON, 10 word data of DT0 to DT9 is shifted 1 digit to the right.

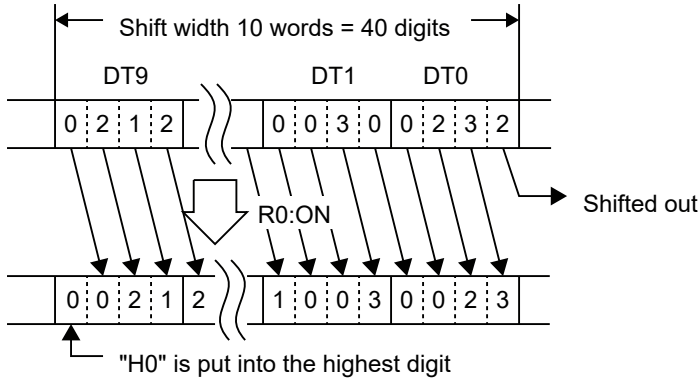

■ Flag operations

Name	Description
R9007	Turns ON when the area is exceeded in index modification.
R9008 (ER)	Turns ON when the [D1] address > [D2] address

16.12 F113 WBSL (Digit Bulk Left Shift)

Shifts data in a specified range one digit to the left.

■ **Instruction format**

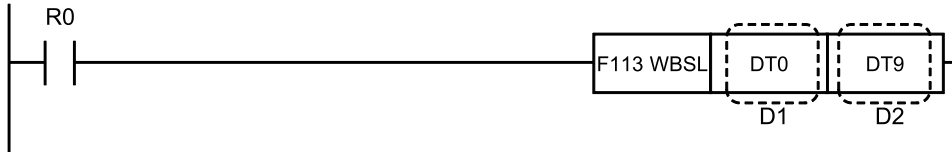

■ **Operands**

Items	Settings
D1	Starting address of the area to be shifted
D2	Ending address of the area to be shifted

■ **Devices that can be specified (indicated by ●)**

Operands	WX	WY	WR	WL	SV	EV	DT	LD	I	SWR	SDT	Constant				Index modifier	Integer Device
												K	H	M	f		
D1		●	●	●	●	●	●	●								●	
D2		●	●	●	●	●	●	●								●	

■ **Outline of operation**

- Shifts an area of a range specified in [D1] and [D2] one digit (4 bits) to the left (toward the higher digit).

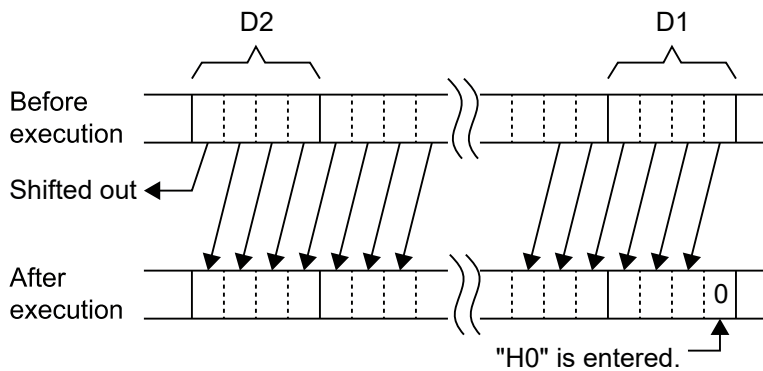

- The starting address of the area to be shifted is specified by [D1] and the ending address is specified by [D2].
- Specify the same type of area for both [D1] and [D2]. Also, make sure that [D1] address ≤ [D2] address.
- When the data shifts to the left, the following occurs:
 1. The content of bits 12 to 15 (digit 4) of [D2] prior to executing is shifted out.
 2. Bits 0 to 3 (digit 1) of [D1] after executing become "0".

■ Operation example

Operation of instruction format description program

When the internal relay R0 is ON, the data of 10 words from DT0 to DT9 is shifted to the left by one digit.

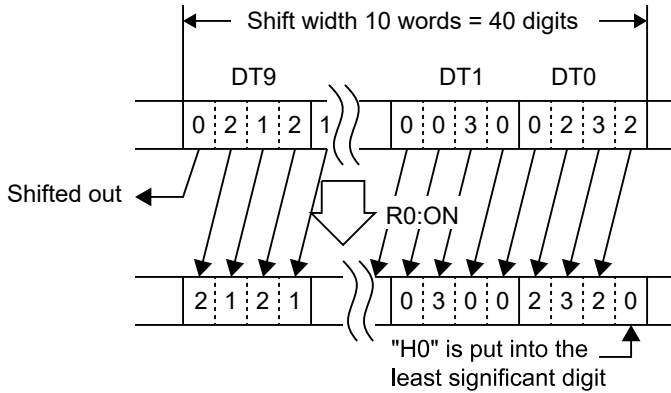

■ Flag operations

Name	Description
R9007	Turns ON when the area is exceeded in index modification.
R9008 (ER)	Turns ON when the [D1] address > [D2] address

(MEMO)

17 Data Rotation Instructions

17.1	F120 ROR (16-Bit Data Rotation to the Right).....	17-2
17.2	F121 ROL (16-Bit Data Rotation to the Left)	17-4
17.3	F122 RCR [16-bit data rotation to the right (with carry)]	17-6
17.4	F123 RCL [16-Bit Data Left Rotation (with Carry)].....	17-8
17.5	F125 DROR [32-Bit Data Right Rotation]	17-10
17.6	F126 DROL (32-bit data left rotation).....	17-12
17.7	F127 DRCR [32-bit data rotation to the right (with carry)].....	17-14
17.8	F128 DRCL [32-bit data rotation to the left (with carry)]	17-16

17.1 F120 ROR (16-Bit Data Rotation to the Right)

17.1 F120 ROR (16-Bit Data Rotation to the Right)

Rotates the specified 16-bit data to the right.

■ Instruction format

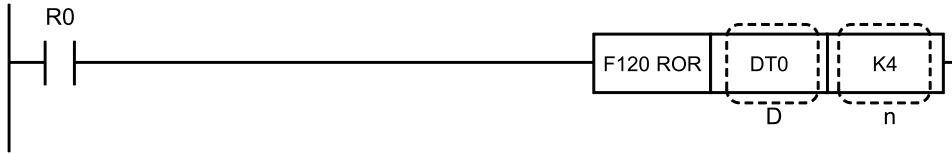

■ Operands

Items	Settings
D	Area targeted for rotation
n	Area storing the number of bits specified to be rotated, or constant data

■ Devices that can be specified (indicated by ●)

Operands	WX	WY	WR	WL	SV	EV	DT	LD	I	SWR	SDT	Constant				Index modifier	Integer Device
												K	H	M	f		
D		●	●	●	●	●	●	●	●						●		
n	●	●	●	●	●	●	●	●	●	●	●	●			●		

■ Outline of operation

- The 16-bit data specified by [D] is rotated to the right (in the low bit direction) by the number of bits specified by [n].

Example of rotation 1 bit to the right

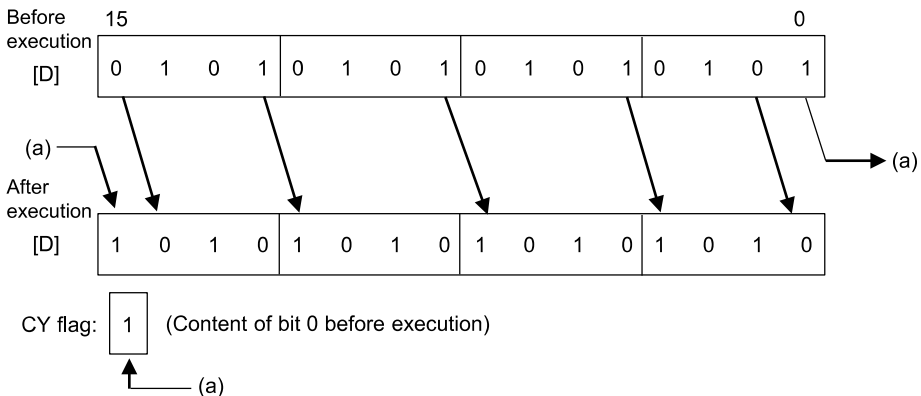

- When rotated to the right, the content of the bit that is 1 bit below the bit that moves to the least significant bit when rotated is stored in the CY flag (R9009). This bit is moved to the most significant bit as a result of rotation.
- For [n], only the lower 8 bits of the 16-bit data are valid.

17.1 F120 ROR (16-Bit Data Rotation to the Right)

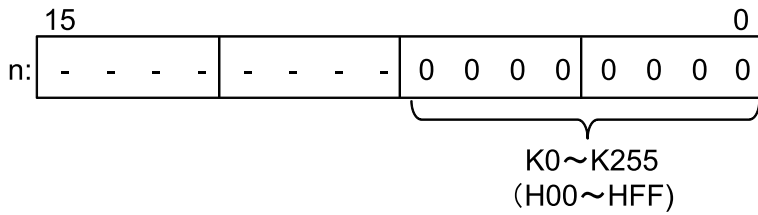

(Note 1) The bits marked - are invalid.

■ Operation example

Operation of instruction format description program

When internal relay R0 turns ON, the content of data register DT0 is rotated 4 bits to the right.

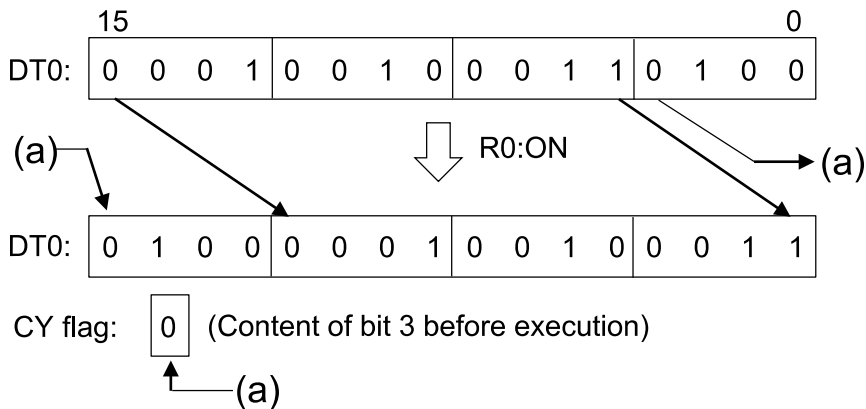

■ Precautions for programming

For the value of n, the operation is the same for every multiple of 16.

e.g.

When n = 16, the operation is the same as when n = 0 (the CY flag does not change either)

When n = 17, the operation is the same as when n = 1

When n = 32, the operation is the same as when n = 0 (the CY flag does not change either)

When n = 33, the operation is the same as when n = 1

■ Flag operations

Name	Description
R9007 R9008 (ER)	Turns ON when the area is exceeded in index modification.
R9009 (CY)	Turns ON when the instruction is executed when the [n]th bit from the least significant bit is "1" before execution

17.2 F121 ROL (16-Bit Data Rotation to the Left)

17.2 F121 ROL (16-Bit Data Rotation to the Left)

Rotates the specified 16-bit data to the left.

■ Instruction format

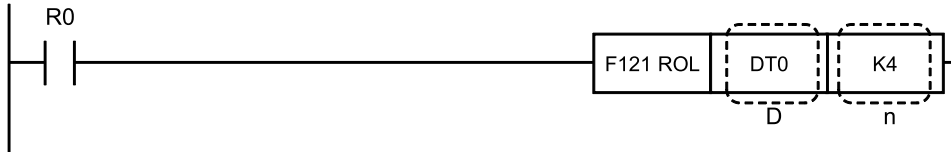

■ Operands

Items	Settings
D	Area targeted for rotation
n	Area storing the number of bits specified to be rotated, or constant data

■ Devices that can be specified (indicated by ●)

Operands	WX	WY	WR	WL	SV	EV	DT	LD	I	SWR	SDT	Constant				Index modifier	Integer Device
												K	H	M	f		
D		●	●	●	●	●	●	●	●						●		
n	●	●	●	●	●	●	●	●	●	●	●	●			●		

■ Outline of operation

- The 16-bit data specified by [D] is rotated to the left (in the high bit direction) by the number of bits specified by [n].

Example of rotation 1 bit to the left

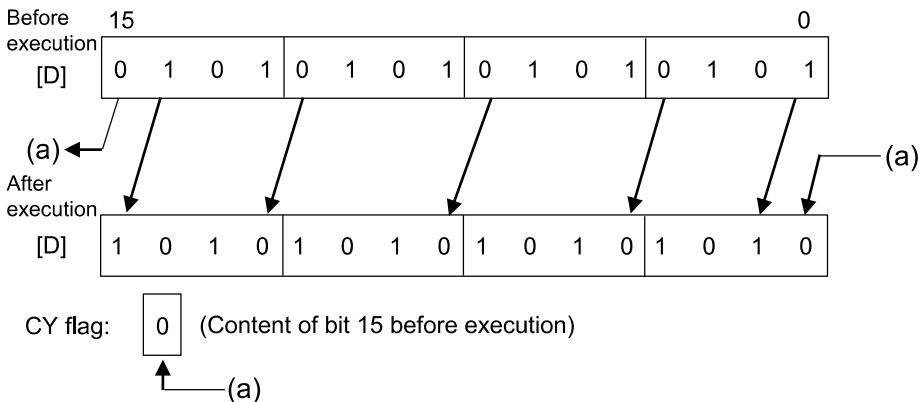

- When rotated to the left, the content of the bit that is 1 bit above the bit that moves to the most significant bit when rotated is stored in the CY flag (R9009). This bit is moved to the least significant bit as a result of rotation.
- For [n], only the lower 8 bits of the 16-bit data are valid.

17.2 F121 ROL (16-Bit Data Rotation to the Left)

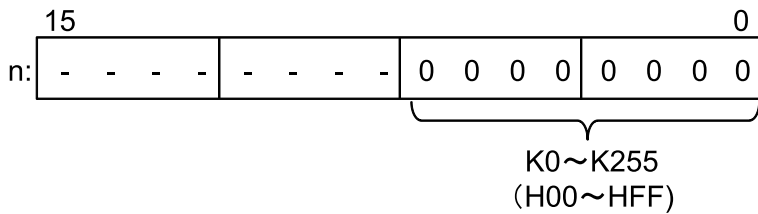

(Note 1) The bits marked - are invalid.

■ Operation example

Operation of instruction format description program

When internal relay R0 turns ON, the content of data register DT0 is rotated 4 bits to the left.

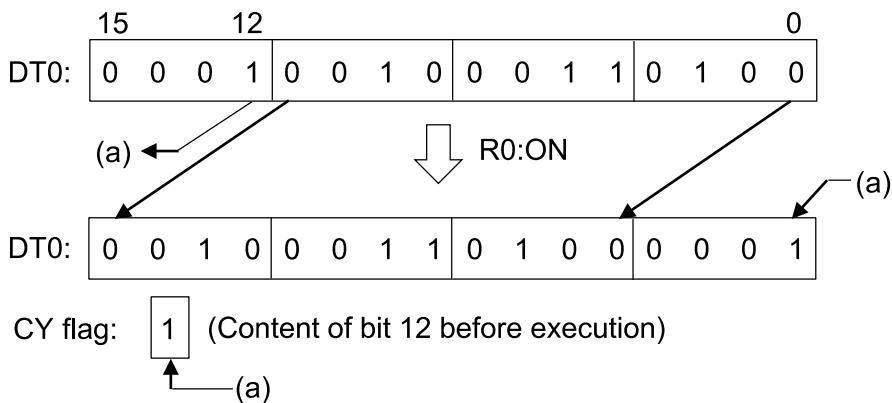

■ Precautions for programming

For the value of n, the operation is the same for every multiple of 16.

e.g.

When n = 16, the operation is the same as when n = 0 (the CY flag does not change either)

When n = 17, the operation is the same as when n = 1

When n = 32, the operation is the same as when n = 0 (the CY flag does not change either)

When n = 33, the operation is the same as when n = 1

■ Flag operations

Name	Description
R9007 R9008 (ER)	Turns ON when the area is exceeded in index modification.
R9009 (CY)	Turns ON when the instruction is executed when the [n]th bit from the most significant bit is "1" before execution

17.3 F122 RCR [16-bit data rotation to the right (with carry)]

17.3 F122 RCR [16-bit data rotation to the right (with carry)]

Rotate 17 bits of data made up of the specified 16-bit data and the carry flag to the right.

■ Instruction format

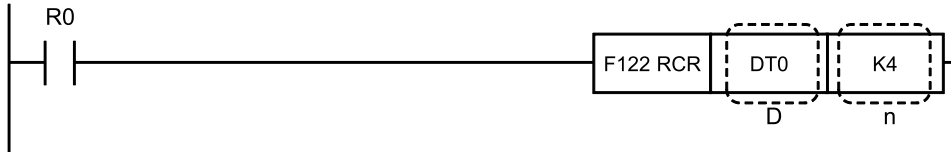

■ Operands

Items	Settings
D	Area targeted for rotation
n	Area storing the number of bits specified to be rotated, or constant data

■ Devices that can be specified (indicated by ●)

Operands	WX	WY	WR	WL	SV	EV	DT	LD	I	SWR	SDT	Constant				Index modifier	Integer Device
												K	H	M	f		
D		●	●	●	●	●	●	●	●						●		
n	●	●	●	●	●	●	●	●	●	●	●	●			●		

■ Outline of operation

- The 16-bit data specified by [D] is rotated to the right (in the low bit direction) by the number of bits specified by [n], including the CY (carry) flag (R9009).

Example of rotation 1 bit to the right

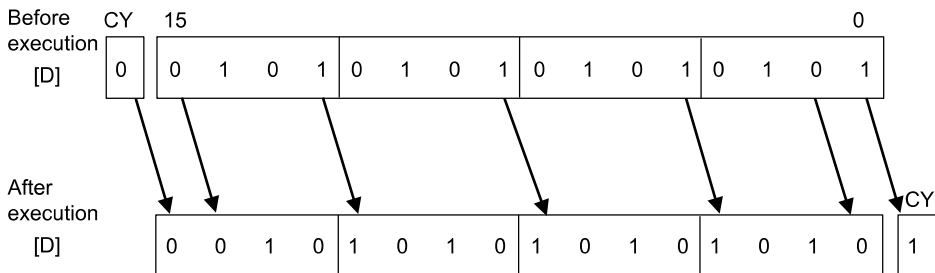

- When data is rotated to the right, the following operation occurs:
 1. The content of the bit that is 1 bit below the bit that moves to the least significant bit when rotated is stored in the CY flag (R9009).
 2. The content of the CY flag (R9009) before execution is stored in the [n]th bit from the most significant bit.
- For [n], only the lower 8 bits of the 16-bit data are valid.

17.3 F122 RCR [16-bit data rotation to the right (with carry)]

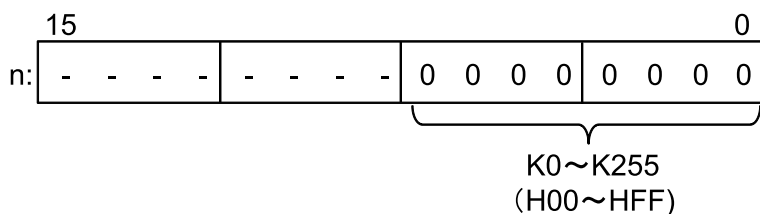

(Note 1) The bits marked - are invalid.

■ Operation example

Operation of instruction format description program

When internal relay R0 turns ON, the content of data register DT0 is rotated 4 bits to the right. (The CY value immediately before execution is assumed to be 1.)

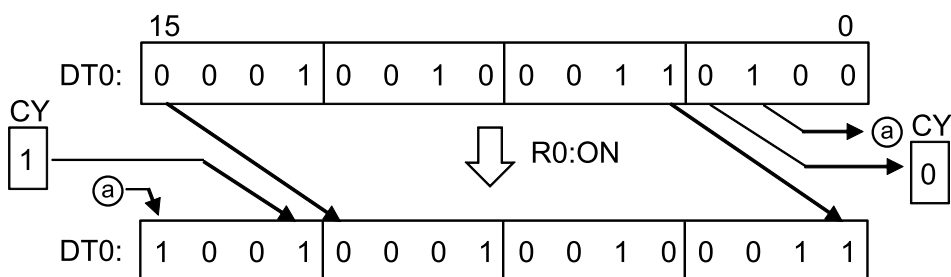

■ Precautions for programming

For the value of n, the operation is the same for every multiple of 17.

e.g.

When n = 17, the operation is the same as when n = 0

When n = 18, the operation is the same as when n = 1

When n = 34, the operation is the same as when n = 0

When n = 35, the operation is the same as when n = 1

■ Flag operations

Name	Description
R9007 R9008 (ER)	Turns ON when the area is exceeded in index modification.
R9009 (CY)	Turns ON when the instruction is executed when the [n]th bit from the least significant bit is "1" before execution

17.4 F123 RCL [16-Bit Data Left Rotation (with Carry)]

17.4 F123 RCL [16-Bit Data Left Rotation (with Carry)]

Rotates 17-bit data, consisting of specified 16-bit data with carry flag data added, to the left.

■ Instruction format

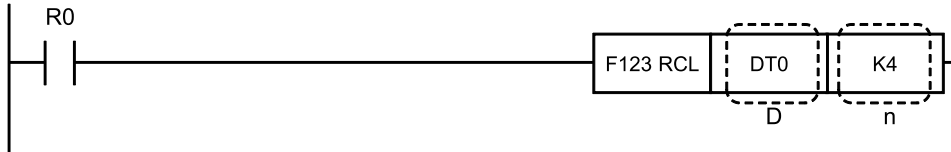

■ Operands

Items	Settings
D	Area targeted for rotation
n	Area storing the number of bits specified to be rotated, or constant data

■ Devices that can be specified (indicated by ●)

Operands	WX	WY	WR	WL	SV	EV	DT	LD	I	SWR	SDT	Constant				Index modifier	Integer Device
												K	H	M	f		
D		●	●	●	●	●	●	●	●						●		
n	●	●	●	●	●	●	●	●	●	●	●	●			●		

■ Outline of operation

- Rotates 16-bit data specified by [D], including CY (carry) flag (R9009) data, to the left (toward higher bits) by the number of bits specified by [n].

Example of rotation 1 bit to the left

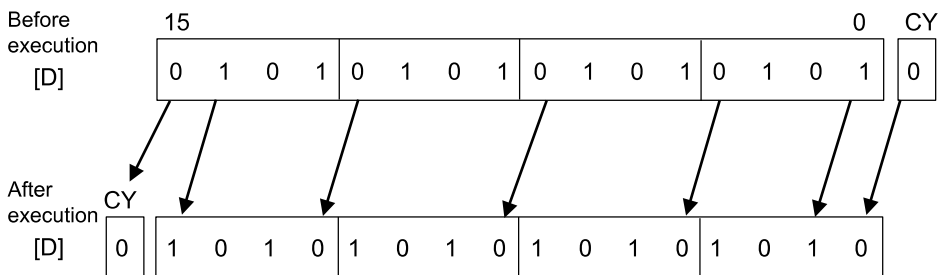

- When data is rotated to the left, the following operation occurs:
 - The content of the bit that is 1 bit higher than the bit that moves to the most significant bit when rotated is stored in the CY flag (R9009).
 - The content of the CY flag (R9009) before execution is stored in the [n]th bit from the least significant bit.
- For [n], only the lower 8 bits of the 16-bit data are valid.

17.4 F123 RCL [16-Bit Data Left Rotation (with Carry)]

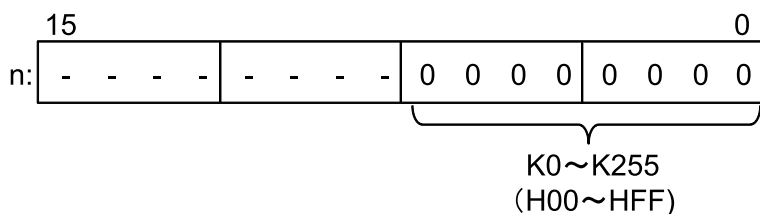

(Note 1) The bits marked - are invalid.

■ Operation example

Operation of instruction format description program

When internal relay R0 turns ON, the content of data register DT0 is rotated 4 bits to the left. (The CY value immediately before execution is assumed to be 1.)

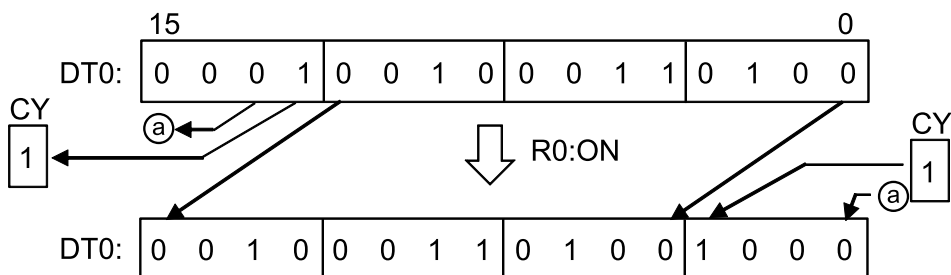

■ Precautions for programming

For the value of n, the operation is the same for every multiple of 17.

e.g.

When n = 17, the operation is the same as when n = 0

When n = 18, the operation is the same as when n = 1

When n = 34, the operation is the same as when n = 0

When n = 35, the operation is the same as when n = 1

■ Flag operations

Name	Description
R9007 R9008 (ER)	Turns ON when the area is exceeded in index modification.
R9009 (CY)	Turns ON when the instruction is executed when the [n]th bit from the most significant bit is "1" before execution

17.5 F125 DROR [32-Bit Data Right Rotation]

17.5 F125 DROR [32-Bit Data Right Rotation]

Rotates "n" bits of 32-bit data (double word data) to the right.

■ Instruction format

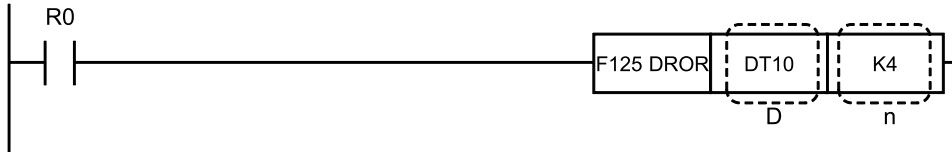

■ Operands

Items	Settings
D	Area to be rotated (two words)
n	Area storing the number of bits specified to be rotated, or constant data

■ Devices that can be specified (indicated by ●)

Operands	WX	WY	WR	WL	SV	EV	DT	LD	I	SWR	SDT	Constant				Index modifier	Integer Device
												K	H	M	f		
D		●	●	●	●	●	●	●	●						●		
n	●	●	●	●	●	●	●	●	●	●	●	●			●		

■ Outline of operation

- Rotates a number of bits specified by [n] of double word data specified by [D, D+1], to the right (toward lower bits).

Example of rotation 1 bit to the right

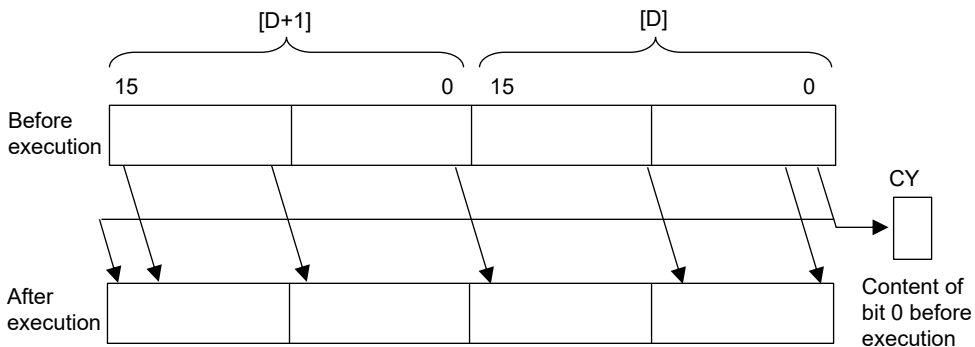

- When data is rotated to the right, the data which moves to 1 bit above the least significant bit position when rotation occurs is stored in the CY flag (R9009). This bit is moved to the most significant bit position as a result of the rotation.
- For [n], only the lower 8 bits of the 16-bit data are valid.

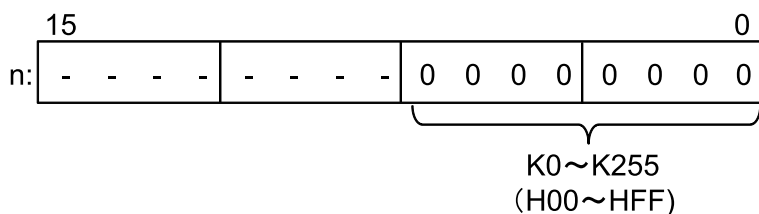

(Note 1) The bits marked - are invalid.

- When $[n] = K0$, the contents of $[D, D+1]$ and the CY flag do not change.

■ Operation example

Operation of instruction format description program

When the internal relay R0 turns ON, the contents of DT11 and DT10 are rotated 4 bits to the right. The content of bit 3 before execution is stored in the CY flag.

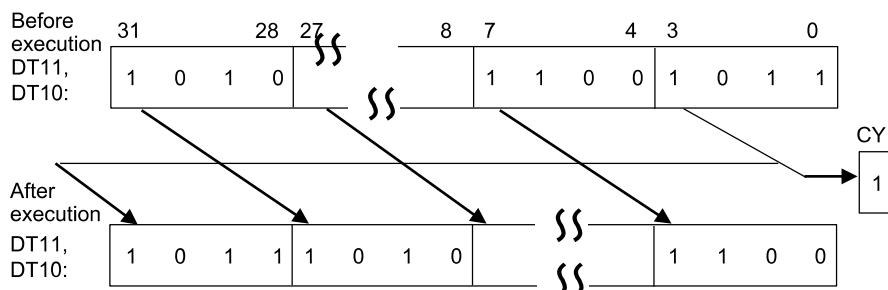

■ Precautions for programming

If n is a multiple of 32, this will result in the same operation as $n = 0$.

■ Flag operations

Name	Description
R9007 R9008 (ER)	Turns ON when the area is exceeded in index modification.
R9009 (CY)	Reflects the content of the n th bit from the least significant bit immediately before the instruction is executed.

17.6 F126 DROL (32-bit data left rotation)

17.6 F126 DROL (32-bit data left rotation)

Rotates 32-bit data (double word data) n bits to the left.

■ Instruction format

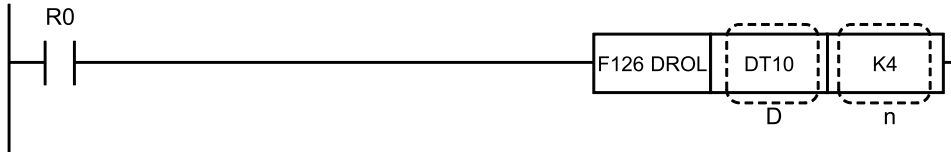

■ Operands

Items	Settings
D	Area to be rotated (two words)
n	Area storing the number of bits specified to be rotated, or constant data

■ Devices that can be specified (indicated by ●)

Operands	WX	WY	WR	WL	SV	EV	DT	LD	I	SWR	SDT	Constant				Index modifier	Integer Device
												K	H	M	f		
D		●	●	●	●	●	●	●	●						●		
n	●	●	●	●	●	●	●	●	●	●	●	●	●		●		

■ Outline of operation

- Rotates double word data specified by [D, D+1] a number of bits specified by [n] to the left (toward higher bits).

Example of rotation 1 bit to the left

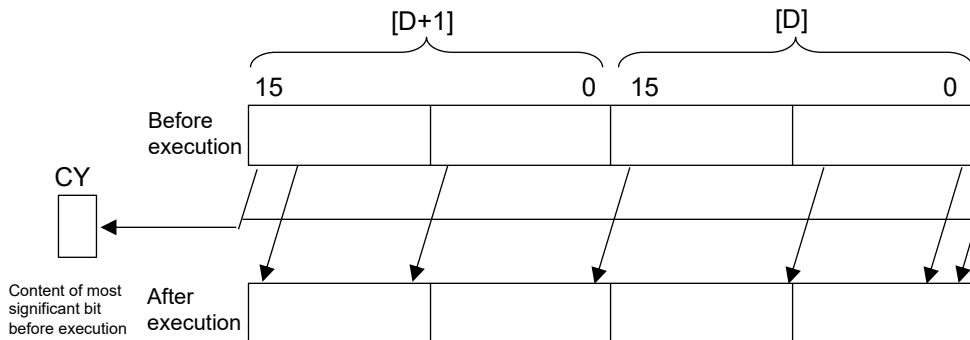

- When rotated to the left, the content of the bit that is 1 bit above the bit that moves to the most significant bit when rotated is stored in the CY flag (R9009). After rotation, this bit moves to the least significant bit.
- For [n], only the lower 8 bits of the 16-bit data are valid.

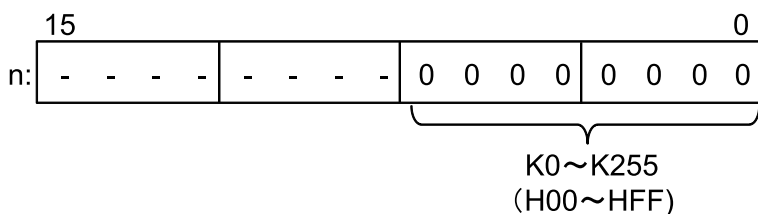

(Note 1) The bits marked - are invalid.

- When $[n]=K0$, the contents of $[D, D+1]$ and the CY flag do not change.

■ **Operation example**

Operation of instruction format description program

When the internal relay R0 turns ON, the contents of DT11 and DT10 are rotated 4 bits to the left. The CY flag stores the contents of bit 28 from before execution.

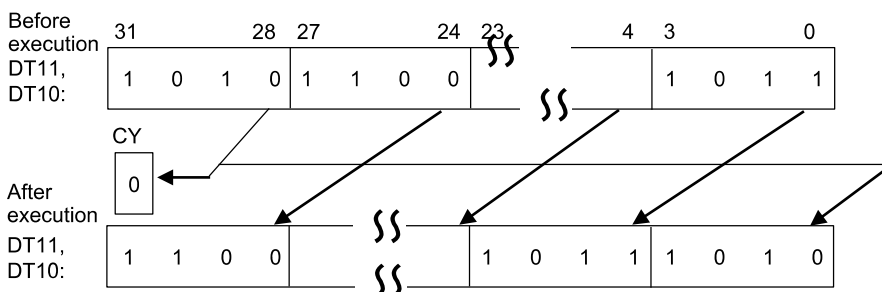

■ **Precautions for programming**

If n is a multiple of 32, this will result in the same operation as $n=0$.

■ **Flag operations**

Name	Description
R9007 R9008 (ER)	Turns ON when the area is exceeded in index modification.
R9009 (CY)	Reflects the content of the n th bit from the most significant bit immediately before the instruction is executed.

17.7 F127 DRCR [32-bit data rotation to the right (with carry)]

17.7 F127 DRCR [32-bit data rotation to the right (with carry)]

Rotates 32-bit data (double-word data) n bits to the right together with carry data.

■ Instruction format

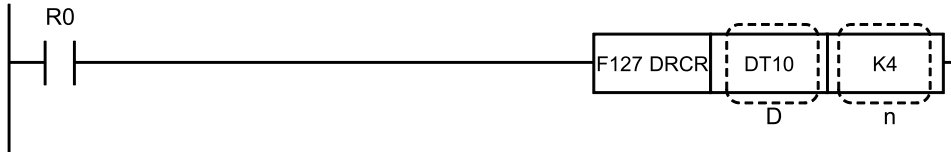

■ Operands

Items	Settings
D	Area to be rotated (two words)
n	Area storing the number of bits specified to be rotated, or constant data

■ Devices that can be specified (indicated by ●)

Operands	WX	WY	WR	WL	SV	EV	DT	LD	I	SWR	SDT	Constant				Index modifier	Integer Device
												K	H	M	f		
D		●	●	●	●	●	●	●	●						●		
n	●	●	●	●	●	●	●	●	●	●	●	●	●		●		

■ Outline of operation

- The double-word data specified by [D, D+1] is rotated to the right (in the low bit direction) by the number of bits specified by [n], including the CY (carry) flag (R9009).

Example of 1-bit right rotation (with carry)

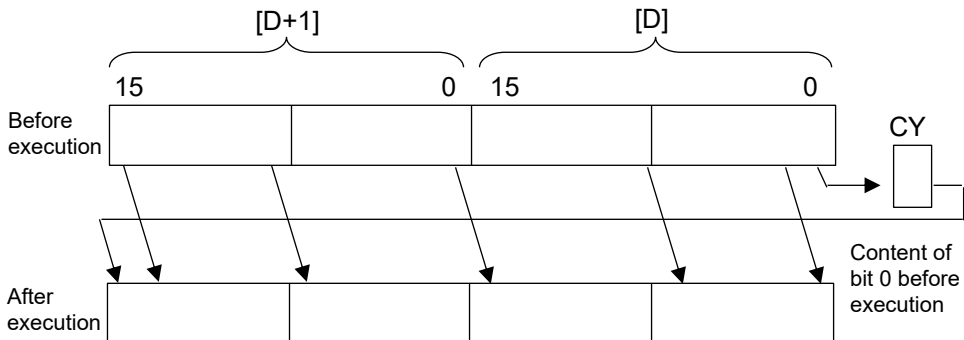

- When data is rotated to the right, the following operation occurs:
 - The content of the bit that is 1 bit below the bit that moves to the least significant bit when rotated is stored in the CY flag (R9009).
 - The content of the CY flag (R9009) before execution is stored in the [n]th bit from the most significant bit.
- For [n], only the lower 8 bits of the 16-bit data are valid.

17.7 F127 DRCR [32-bit data rotation to the right (with carry)]

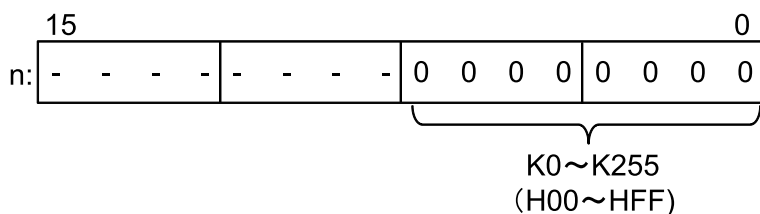

(Note 1) The bits marked - are invalid.

- When $[n] = K0$, the contents of $[D, D+1]$ and the CY flag do not change.

■ Operation example

Operation of instruction format description program

When internal relay R10 turns ON, the contents of DT11 and DT10 are rotated 4 bits to the right.

The content of bit 3 before execution is stored in the CY flag. The content of the CY flag before execution is stored in bit 28.

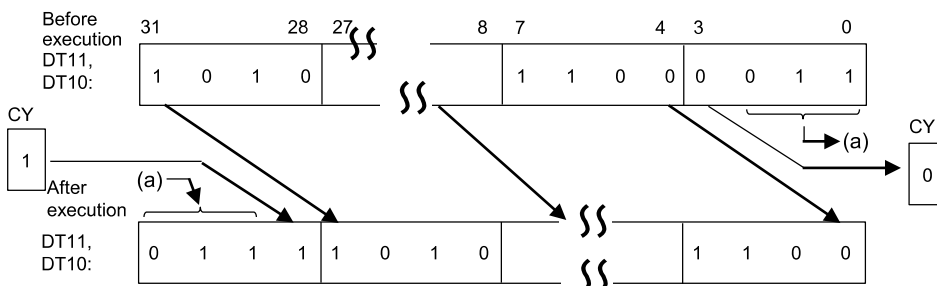

■ Precautions for programming

When $n = (a \text{ multiple of } 33)$, the operation is the same as when $n = 0$.

■ Flag operations

Name	Description
R9007 R9008 (ER)	Turns ON when the area is exceeded in index modification.
R9009 (CY)	Reflects the content of the nth bit from the least significant bit immediately before the instruction is executed.

17.8 F128 DRCL [32-bit data rotation to the left (with carry)]

17.8 F128 DRCL [32-bit data rotation to the left (with carry)]

Rotates 32-bit data (double-word data) n bits to the left with carry data.

■ Instruction format

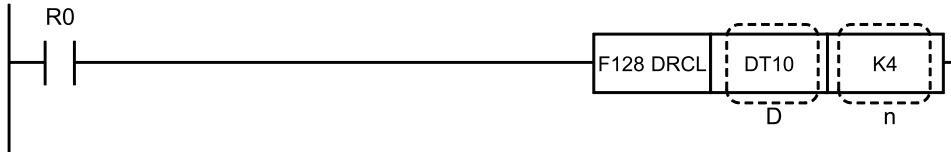

■ Operands

Items	Settings
D	Area to be rotated (two words)
n	Area storing the number of bits specified to be rotated, or constant data

■ Devices that can be specified (indicated by ●)

Operands	WX	WY	WR	WL	SV	EV	DT	LD	I	SWR	SDT	Constant				Index modifier	Integer Device
												K	H	M	f		
D		●	●	●	●	●	●	●	●						●		
n	●	●	●	●	●	●	●	●	●	●	●	●	●		●		

■ Outline of operation

- The double-word data specified by [D, D+1] is rotated to the left (in the high bit direction) by the number of bits specified by [n], including the CY (carry) flag (R9009).

Example of rotation 1 bit to the left (with carry data)

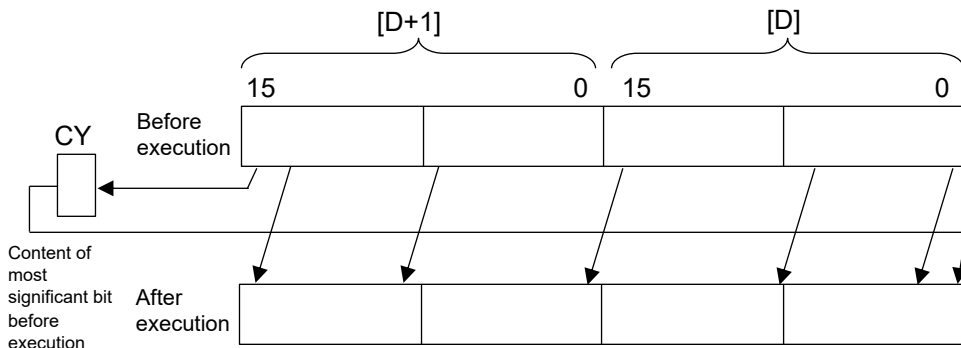

- When data is rotated to the left, the following operation occurs:
 - The content of the bit that is 1 bit higher than the bit that moves to the most significant bit when rotated is stored in the CY flag (R9009).
 - The content of the CY flag (R9009) before execution is stored in the [n]th bit from the least significant bit.
- For [n], only the lower 8 bits of the 16-bit data are valid.

17.8 F128 DRCL [32-bit data rotation to the left (with carry)]

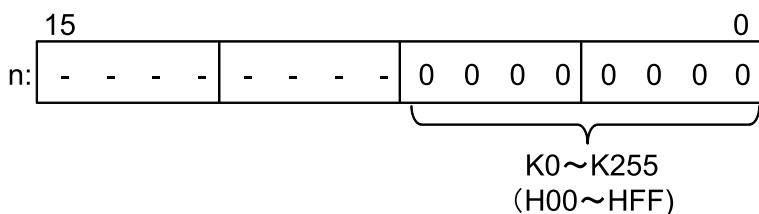

(Note 1) The bits marked - are invalid.

- When $[n] = K0$, the contents of $[D, D+1]$ and the CY flag do not change.

■ Operation example

Operation of instruction format description program

When the internal relay R0 turns ON, the contents of DT11 and DT10 are rotated 4 bits to the left.

The CY flag stores the contents of bit 28 from before execution. The content of the CY flag before execution is stored in bit 3.

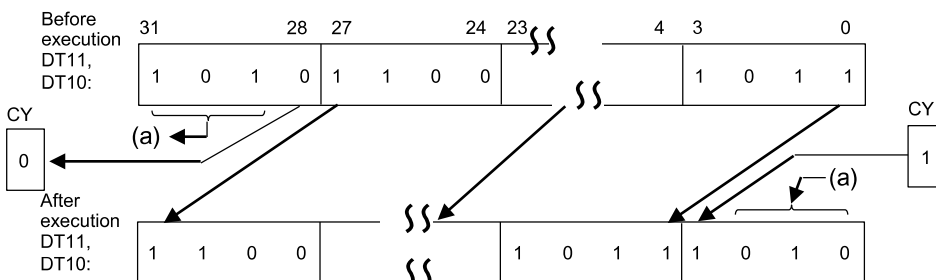

■ Precautions for programming

When $n = (a \text{ multiple of } 33)$, the same operation is the same as when $n = 0$.

■ Flag operations

Name	Description
R9007 R9008 (ER)	Turns ON when the area is exceeded in index modification.
R9009 (CY)	Reflects the content of the nth bit from the most significant bit immediately before the instruction is executed.

(MEMO)

18 Data Buffer Instruction

18.1 F98 CMPR (Compress shift read).....	18-2
18.2 F99 CMPW (Compress Shift Write)	18-6
18.3 How to Use the FIFO (First-in First-out) Buffer	18-10
18.4 F115 FIFT (FIFO Buffer Definition)	18-11
18.5 F116 FIFR (Reading from FIFO buffer).....	18-14
18.6 F117 FIFW (Data write to FIFO buffer)	18-18

18.1 F98 CMPR (Compress shift read)

18.1 F98 CMPR (Compress shift read)

Reads the data at the highest address in the specified range and compresses the data upward.

■ Instruction format

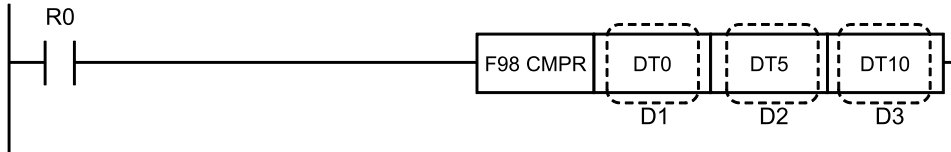

■ Operands

Items	Settings
D1	Starting address of specified range
D2	Final address of specified range
D3	Area storing read data

■ Devices that can be specified (indicated by ●)

Operands	WX	WY	WR	WL	SV	EV	DT	LD	I	SW R	SD T	Constant				Index modifier	Integer Device
												K	H	M	f		
D1		●	●	●	●	●	●	●								●	
D2		●	●	●	●	●	●	●								●	
D3		●	●	●	●	●	●	●								●	

■ Outline of operation

- In the area of the range specified by [D1] and [D2], the content of [D2] (highest address in the specified range) is transferred to the area specified by [D3].
Non-zero data is shifted (compressed) in sequential order in the direction of the higher addresses in the specified range.

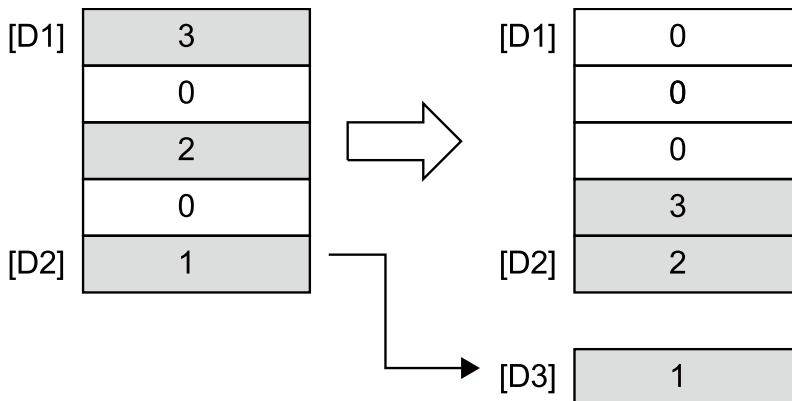

- The starting address of the area is specified by [D1] and the final address is specified by [D2].

- Specify the same type of area for both [D1] and [D2]. Additionally, specify values so that [D1] is equal to or less than [D2].
- If all of the content in the range specified by [D1] and [D2] is 0, 0 is stored in [D3].

■ Operation example

Operation of instruction format description program

When internal relay R0 turns ON, the content of data register DT5 is transferred to data register DT10.

Additionally, the non-zero content in the range of DT0 to DT5 is stored in order from DT5. Any remaining content becomes "0".

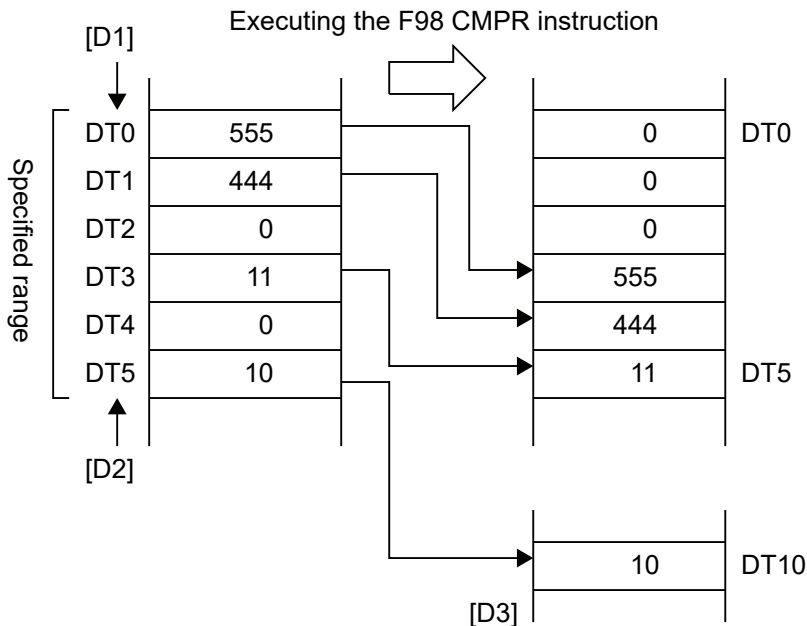

■ Application example

- This instruction can be combined with the "Compress shift Write" (F99 CMPW) instruction to use a memory area of the specified range as a buffer.
 1. Executing the F99 CMPW instruction

When data is written to the starting address of the buffer (the area of the specified range), it accumulates in the buffer in sequential order. The oldest data will be at the final address of the buffer.

18.1 F98 CMPR (Compress shift read)

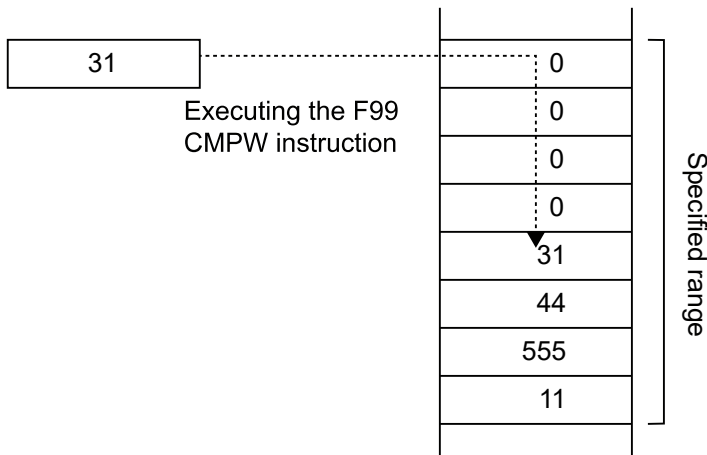

2. Executing the F98 CMPR instruction

When data at the final address of the buffer (the area of the specified range) is read, data can be extracted in sequential order, starting from the oldest data. Any remaining data in the buffer is shifted in the direction of the higher addresses, so the oldest data at any point will always be stored at the final address.

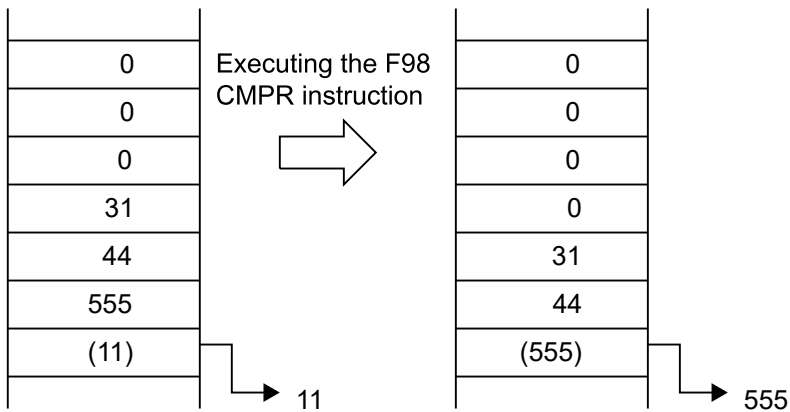

- This can be used to extract valid non-zero data from data written in random order.

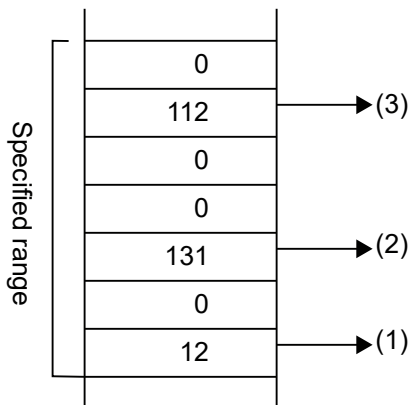

Each time the F98 CMPR instruction is executed, data is extracted in sequential order from (1) to (3).

■ Flag operations

Name	Description
R9007	Turns ON when the area is exceeded in index modification.
R9008	Turns ON when [D1] > [D2]
(ER)	Turns ON when [D1] and [D2] are not the same type of area

18.2 F99 CMPW (Compress Shift Write)

18.2 F99 CMPW (Compress Shift Write)

Writes data to the starting address in the specified range, and compresses the data upward.

■ Instruction format

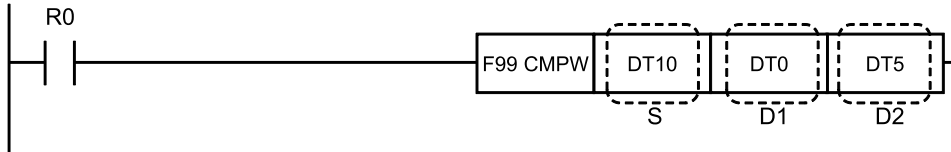

■ Operands

Items	Settings
S	Area storing the hexadecimal data or constant data
D1	Starting address of specified range
D2	Final address of specified range

■ Devices that can be specified (indicated by ●)

Operands	WX	WY	WR	WL	SV	EV	DT	LD	I	SWR	SDT	Constant				Index modifier	Integer Device
												K	H	M	f		
S	●	●	●	●	●	●	●	●	●	●	●	●	●	●	●	●	
D1		●	●	●	●	●	●	●								●	
D2		●	●	●	●	●	●	●								●	

■ Outline of operation

- In the area of the range specified by [D1] and [D2], the content of the area specified by [S] is transferred to [D1] (starting address in the specified range). Non-zero data is shifted (compressed) in sequential order in the direction of the higher addresses in the specified range.

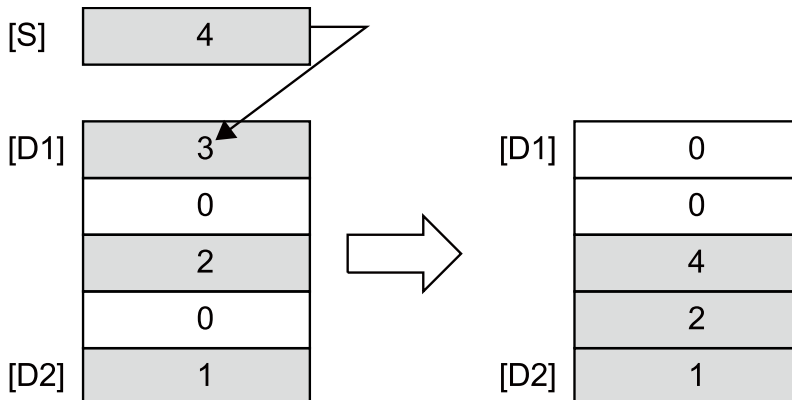

- The starting address of the area is specified by [D1] and the final address is specified by [D2].

- Specify the same type of area for both [D1] and [D2]. Additionally, specify values so that [D1] is equal to or less than [D2].
- If the content of [S] is 0, only a compressed shift is carried out.

■ Operation example

Operation of instruction format description program

When internal relay R0 turns ON, the content of data register DT10 is transferred to data register DT0. Additionally, the non-zero content in the range of DT0 to DT5 is stored in order from DT5. Any remaining content becomes "0".

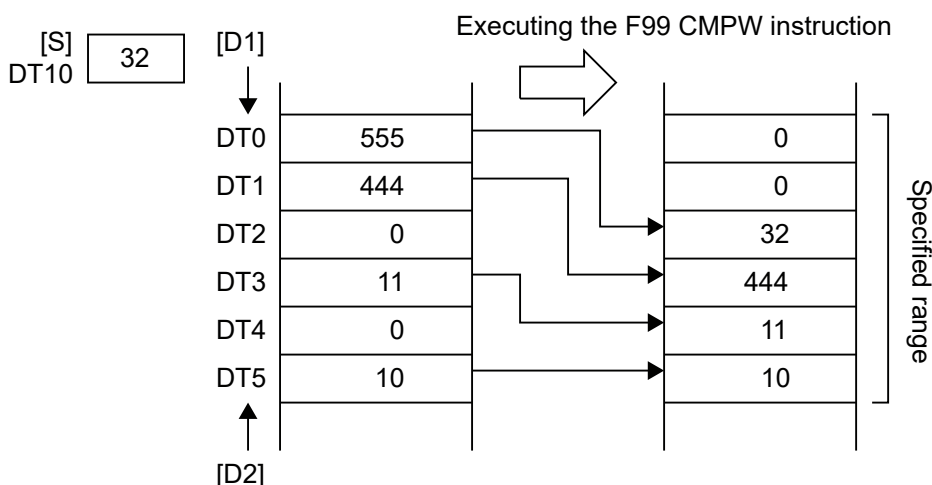

(Note 1) Because the content of [S] is written to DT0 first, the original content of DT0 (555 for example) is overwritten.

■ Application example

- This instruction can be combined with the "Compress shift read" (F98 CMPR) instruction to use a memory area of the specified range as a buffer.
 1. Executing the F99 CMPW instruction

When data is written to the starting address of the buffer (the area of the specified range), it accumulates in the buffer in sequential order. The oldest data will be at the final address of the buffer.

18.2 F99 CMPW (Compress Shift Write)

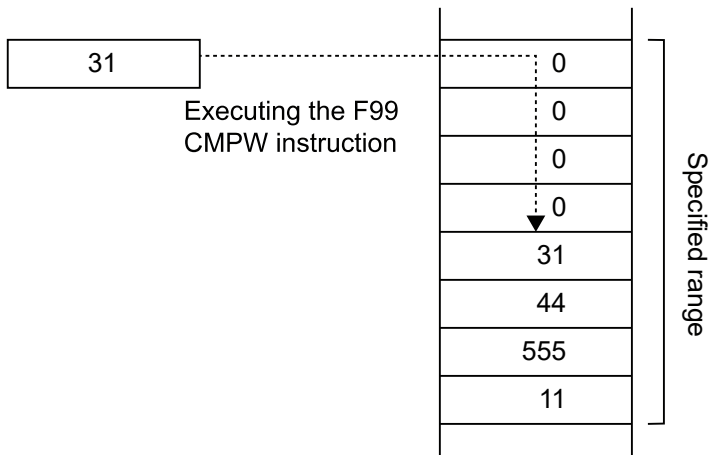

2. Executing the F98 CMPR instruction

When data at the final address of the buffer (the area of the specified range) is read, data can be extracted in sequential order, starting from the oldest data. Any remaining data in the buffer is shifted in the direction of the higher addresses, so the oldest data at any point will always be stored at the final address.

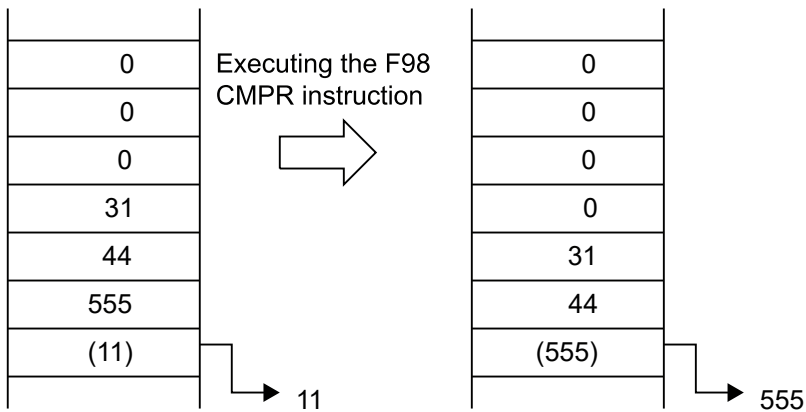

- This can be used to extract valid non-zero data from data written in random order.

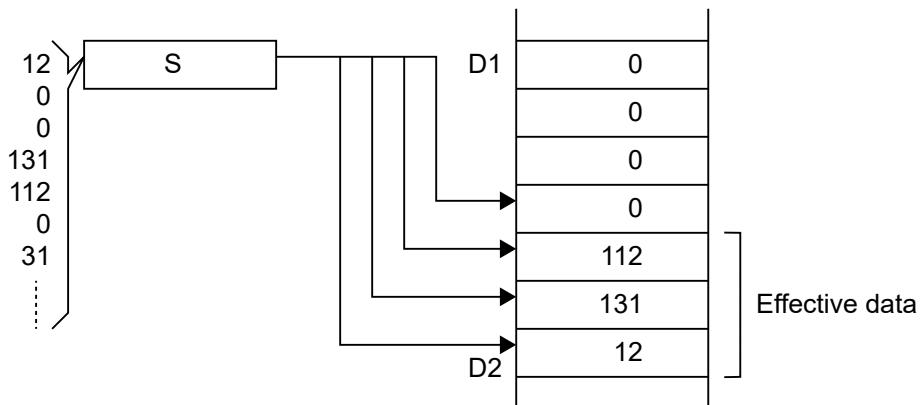

Executing the F99 CMPW instruction causes only the valid data to be stored.

■ Flag operations

Name	Description
R9007	Turns ON when the area is exceeded in index modification.
R9008	Turns ON when [D1] > [D2]
(ER)	Turns ON when [D1] and [D2] are not the same type of area

18.3 How to Use the FIFO (First-in First-out) Buffer

18.3 How to Use the FIFO (First-in First-out) Buffer

The FIFO buffer is a buffer area that stores data in the order it is written, and starts reading in order from the first data stored. It is convenient to use the FIFO buffer as a record of the order of objects on a conveyor line or buffer line.

1 2 Procedure

1. The F115 FIFT instruction defines the area to be used as the FIFO buffer. (Use it just once before read/write.)
2. Use the F117 FIFW instruction for data write, and the F116 FIFR instruction for read.

Data write

- After data is written, it is stored in the data storage area in order starting from the first written data. The write pointer indicates the next write area.
- When the data storage area becomes full, it is no longer possible to write.

Data read

- When read is executed, data is transferred in order from the first data that was stored. The read pointer indicates the area that will be read.
- If read is executed when there is no data written to the data storage area, an error is returned.

<Example of data storage area>

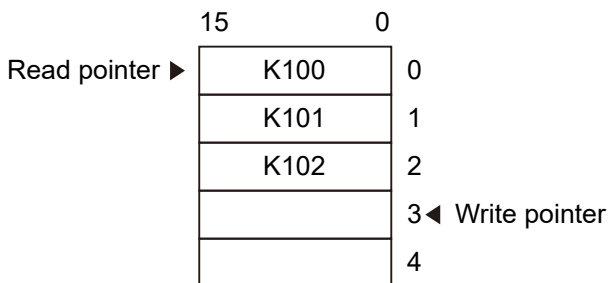

As shown in the figure above, when data is written, it is stored in area "3". The write pointer moves to "4". (Data will next be written to "4".) When a read is executed, data is read from the "0" area. The read pointer moves to "1". (Data will next be read from "1").

18.4 F115 FIFT (FIFO Buffer Definition)

Defines the start and size of the FIFO buffer area.

■ Instruction format

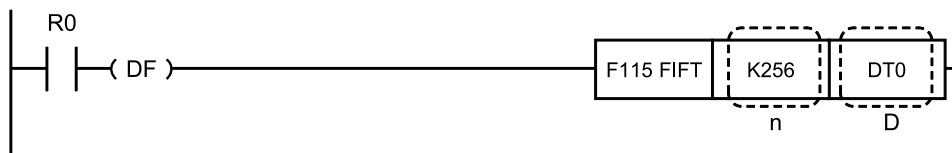

■ Operands

Items	Settings
n	Area storing the size (number of words) of the FIFO buffer, or constant data
D	Starting address for the FIFO buffer area

■ Devices that can be specified (indicated by ●)

Operand s	WX	WY	WR	WL	SV	EV	DT	LD	I	SW R	SD T	Constant				Index modifier	Integer Device
												K	H	M	f		
n	●	●	●	●	●	●	●	●	●	●	●	●	●			●	
D		●	●	●	●	●	●	●								●	

■ Outline of operation

- The area used as the FIFO buffer is defined. A data storage area of n words (n = K1 to K256) is defined for the area specified by [D].

Definition of the area using the F115 FIFT instruction should be executed only once, before writing to or reading from the FIFO buffer. Normally, reading and writing are disabled while this instruction is being executed.

- When the F115 FIFT instruction is executed, the FIFO buffer area is defined as follows.

18.4 F115 FIFT (FIFO Buffer Definition)

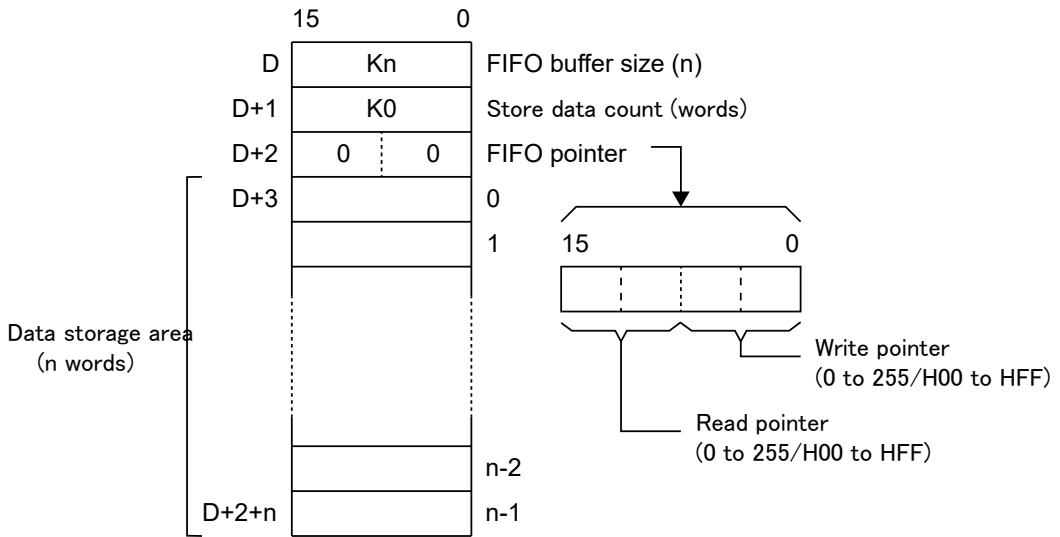

- When the F115 FIFT instruction is executed, the following are stored as default values: [D] = n (the value specified by the F115 FIFT instruction), [D+1] = K0 and [D+2] = H0000.

■ Operation example

Operation of instruction format description program

When internal relay R0 turns ON, the area starting from DT0 is defined as the FIFO buffer area. "FIFO buffer size" (K256) is stored in DT0, "number of data items" is stored in DT1 (with a default value of K0), and "FIFO pointer" (with a default value of H0000) is stored in DT2. When $n = K256$, the 256 words from DT3 to DT258 are defined as the data storage area.

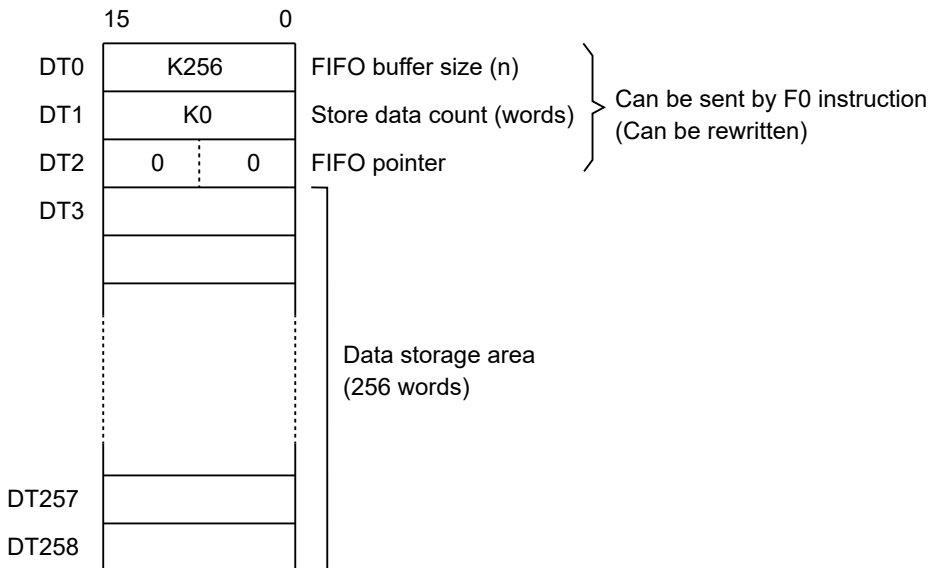

■ Flag operations

Name	Description
R9007	Turns ON when the area is exceeded in index modification.

18.4 F115 FIFT (FIFO Buffer Definition)

Name	Description
R9008 (ER)	Turns ON when $n = 0$
	Turns ON when $n > 256$
	Turns ON when the final address of the FIFO set according to the FIFO size exceeds the area

18.5 F116 FIFR (Reading from FIFO buffer)

18.5 F116 FIFR (Reading from FIFO buffer)

Reads the data from the specified FIFO buffer.

■ Instruction format

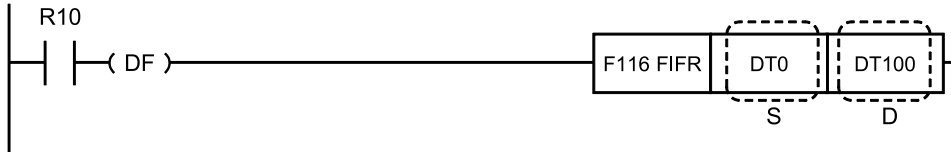

■ Operands

Items	Settings
S	Starting address for the FIFO buffer area
D	Area storing the data read from the FIFO buffer

■ Devices that can be specified (indicated by ●)

Operands	WX	WY	WR	WL	SV	EV	DT	LD	I	SWR	SDT	Constant				Index modifier	Integer Device
												K	H	M	f		
S		●	●	●	●	●	●	●								●	
D		●	●	●	●	●	●	●	●							●	

■ Outline of operation

- The data is read from the FIFO buffer at the start of the area specified by [S], and is stored in the area specified by [D]. For [S], specify the start of the FIFO buffer defined by the FIFT instruction.
- Data is read from the address specified by the read pointer when the instruction is executed.

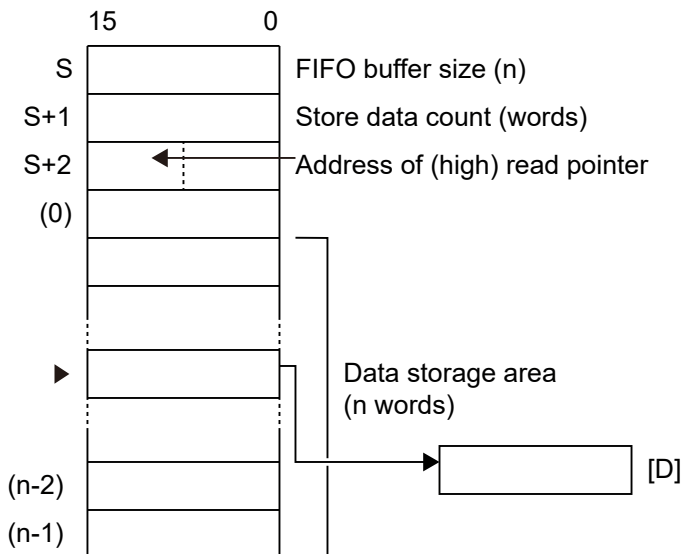

(Note 1) (0) to (n-1) are addresses assigned to the data storage areas.

(Note 2) n is the value specified by the F115 FIFT instruction.

(Note 3) ▶ is the read pointer.

- The read pointer is stored in the upper eight bits of the third word of the FIFO buffer area. It is indicated by an address in the data storage area. The actual address is the starting address of the FIFO buffer area specified by [S], plus 3, plus the read pointer value (in which only the upper byte is a decimal value).
- When a read is executed, 1 is subtracted from the number of stored data and the read pointer is incremented by 1.

Note

- An error occurs if the instruction is executed when the number of stored data is 0. No data set for [D].
- A read is only performed when the read pointer is not equal to the write pointer.
- If this instruction is executed while the read pointer is pointing to the ending address of the FIFO buffer (n defined by the F115 FIFT instruction minus 1), the read pointer becomes 0.

■ Operation example

Operation of instruction format description program

When internal relay R10 turns ON, data is read from the FIFO buffer area at the start of DT0 and stored in DT100.

18.5 F116 FIFR (Reading from FIFO buffer)

[When the read pointer is 2]

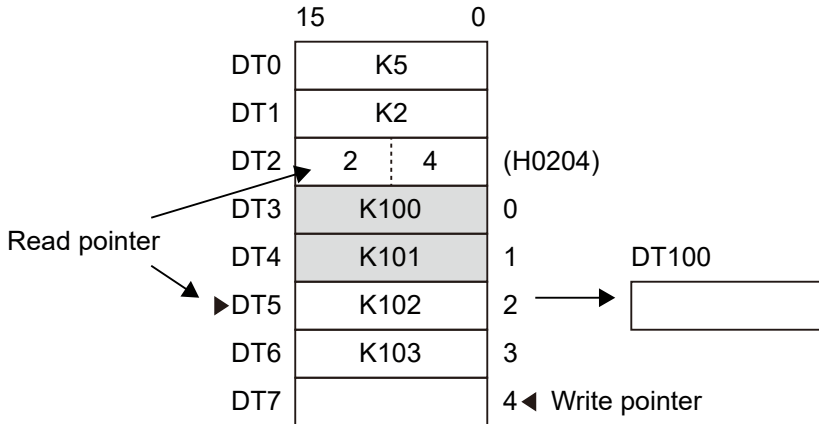

↓ FIFR execution

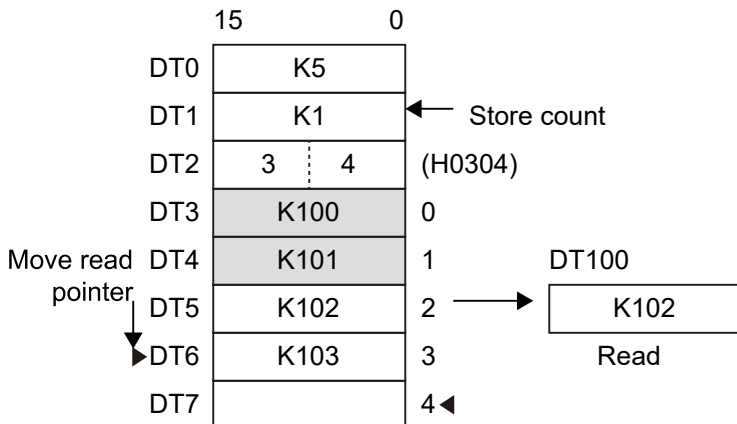

1. The content of DT5 indicated by read pointer 2 is transferred to DT100.
2. After reading, 1 is subtracted from the content of DT1 (number of stored data), and the read pointer moves to 3. (The next time a read is executed, the content of DT6 indicated by 3 is transferred to DT100.)

■ Precautions for programming

An error occurs if the F116 FIFR instruction is executed when the number of stored data ($[S+1]$) is 0.

[Reference]

In the program below, the F116 FIFR instruction is not executed when the data storage number is 0.

18.5 F116 FIFR (Reading from FIFO buffer)

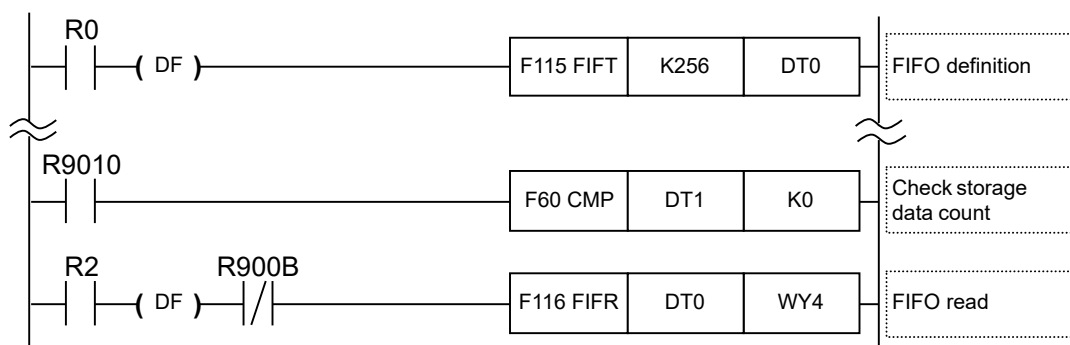

■ Flag operations

Name	Description
R9007 R9008 (ER)	Turns ON when the area is exceeded in index modification.
	Turns ON when the size of the FIFO specified by [S] (n) is n = 0 or n > 256
	Turns ON when the number of data stored in the FIFO is 0
	Turns ON when the number of stored data items of the FIFO is larger than the FIFO size (n)
	Turns ON when the final address of the FIFO based on the FIFO size (n) exceeds the area
	Turns ON when the FIFO read pointer is larger than the size of the FIFO (n)
	Turns ON when, after reading data, the FIFO read pointer is K256 (H100) or higher

18.6 F117 FIFW (Data write to FIFO buffer)

18.6 F117 FIFW (Data write to FIFO buffer)

Writes data to the specified FIFO buffer.

■ Instruction format

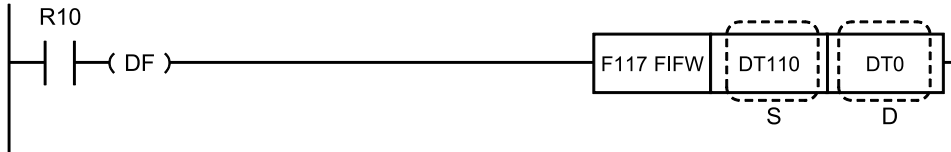

■ Operands

Items	Settings
S	Area storing the 16-bit data to write to the FIFO buffer, or constant data
D	Starting address for the FIFO buffer area

■ Devices that can be specified (indicated by ●)

Operand s	WX	WY	WR	WL	SV	EV	DT	LD	I	SW R	SD T	Constant				Index modifier	Integer Device
												K	H	M	f		
S	●	●	●	●	●	●	●	●	●	●	●	●	●	●	●		
D		●	●	●	●	●	●	●							●		

■ Outline of operation

- The 16-bit data specified by [S] is stored in the FIFO buffer starting at the area specified by [D]. Specify the start of the FIFO buffer defined by the FIFT instruction for [D].
- The specified data is written to the address indicated by the write pointer when the instruction is executed.

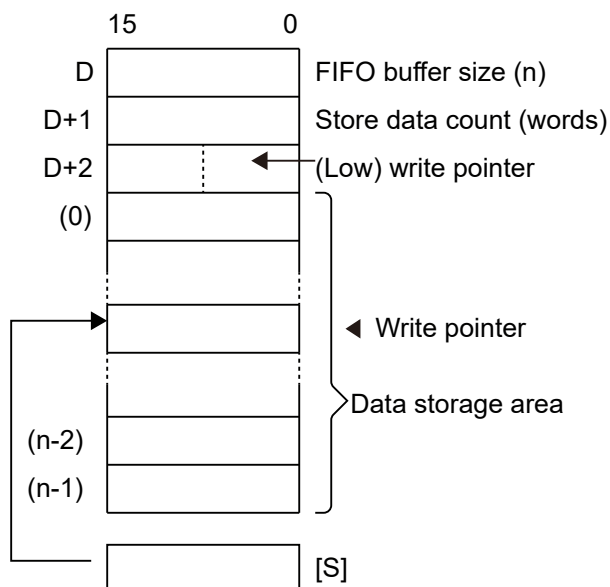

(Note 1) (0) to (n-1) are addresses assigned to the data storage areas.

(Note 2) n is the value specified by the F115 FIFT instruction.

- The write pointer is stored in the lower eight bits of the third word of the FIFO buffer area. It is indicated by a relative position in the data storage area. The actual address is the starting address of the FIFO buffer area specified by [D], plus 3, plus the write pointer value (in which only the lower byte is a decimal value).
- When a write is executed, 1 is added to the number of stored data items, and the write pointer is incremented 1.

Note

- An error occurs if this instruction is executed when the FIFO buffer is full (the number of stored data items = size n of the FIFO defined by the F115 FIFT instruction). In this case, the write is not performed.
- If this instruction is executed when the write pointer is indicating the final address in the FIFO buffer (the n value defined by the F115 FIFT instruction), the write pointer will be set to 0.

■ Operation example

Operation of instruction format description program

When internal relay R10 turns ON, the contents of DT110 are written to the FIFO buffer area that starts from by DT0.

18.6 F117 FIFW (Data write to FIFO buffer)

When the write pointer is 3

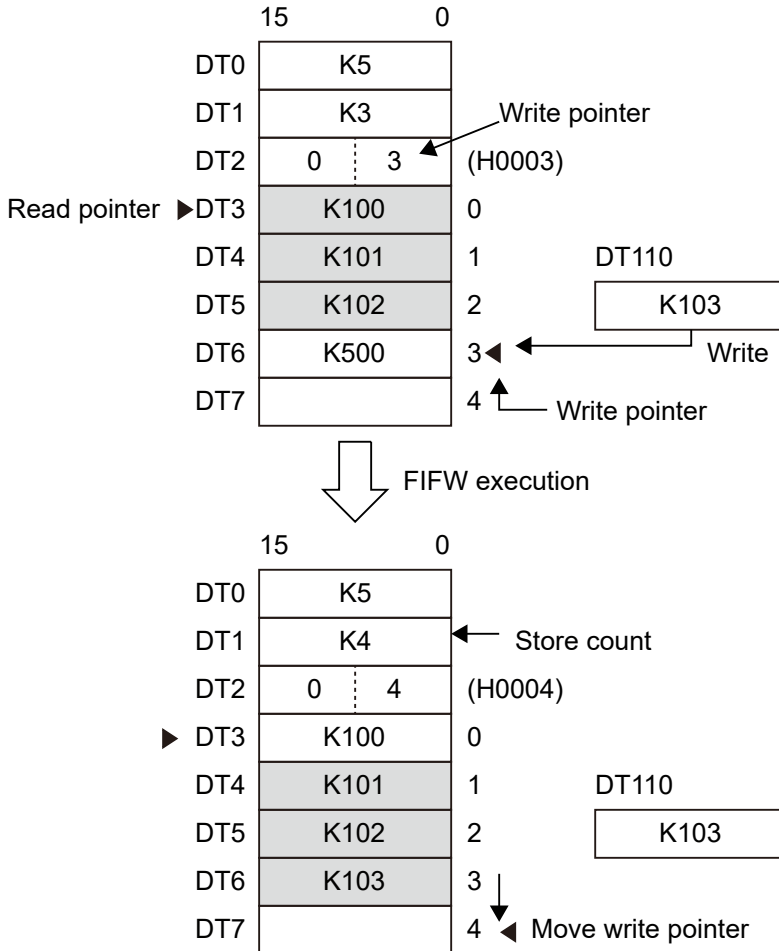

1. The contents "103" of DT110 are sent to DT6, which is indicated by pointer 3.
2. After the data has been written, 1 is added to the contents of DT1 (the number of stored data items), and the write pointer moves to 4. (The next time that writing is executed, the contents of DT110 are written to DT7, which is indicated by 4.)

■ Precautions when using this instruction

If data is received that exceeds the capacity of the buffer, an operation error occurs.

Example: If the write pointer is at the end of the FIFO buffer

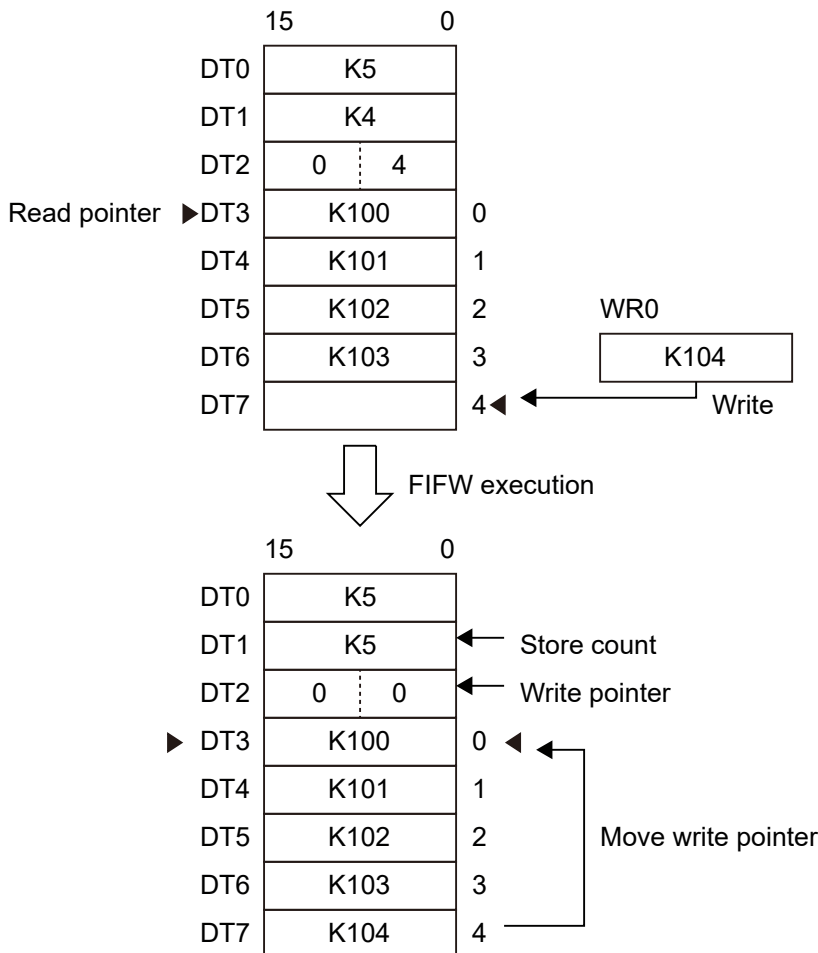

When the F117 FIFW instruction is executed, after data is written to the final address (4) in the buffer, the write pointer becomes the starting address (0).

18.6 F117 FIFW (Data write to FIFO buffer)

Example: When the write pointer has made one complete cycle

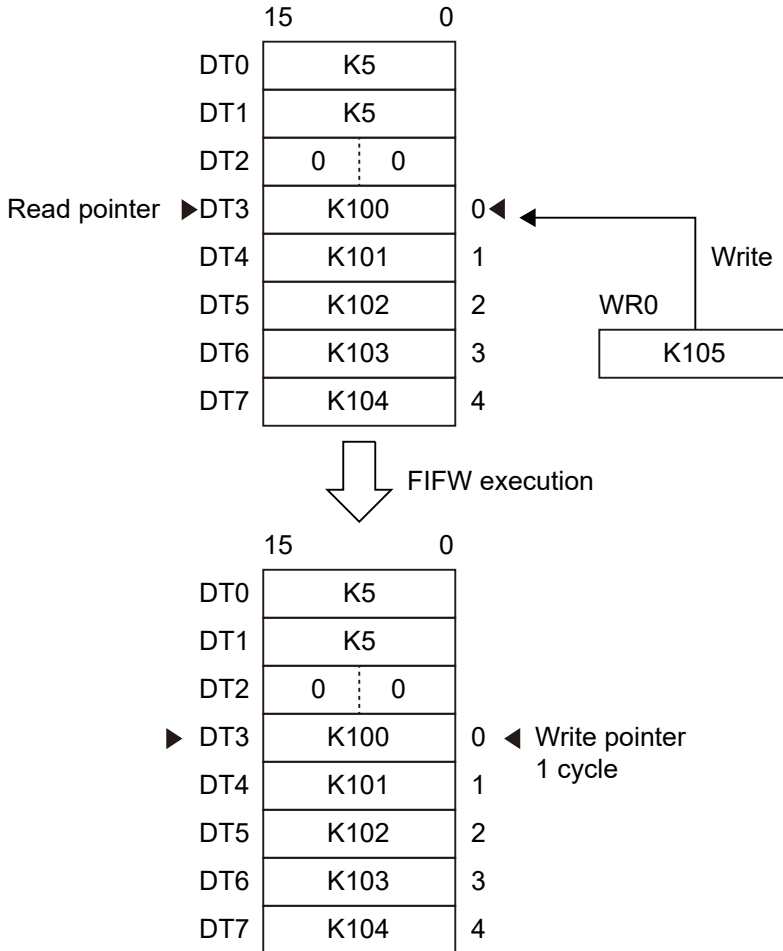

An error occurs and processing is not carried out.

Because the number of data items stored in the FIFO buffer (DT1 = 5) exceeds the size of the FIFO buffer (DT0 = 5), the operation is not executed, and an operation error occurs.

■ Measures to avoid operation errors

1. Do not execute the F117 FIFW instruction using the comparison instruction. Avoid executing the F117 FIFW instruction when the size of the FIFO buffer (DT0) is equal to the number of data items stored in the buffer (DT1).

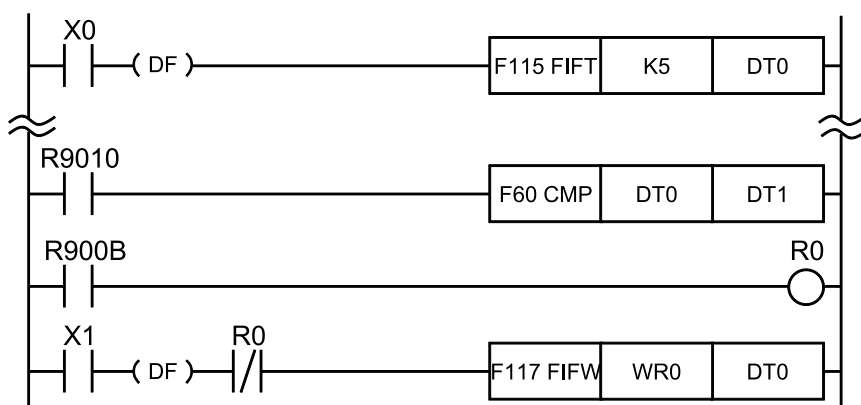

2. Execute the F117 FIFW instruction after executing the F116 FIFR instruction.

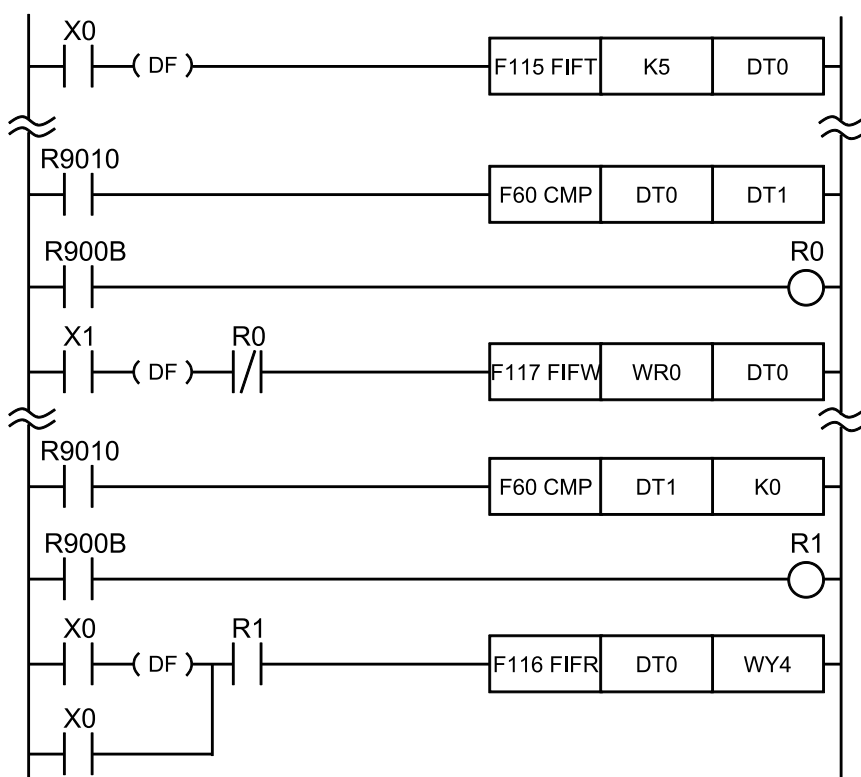

■ Flag operations

Name	Description
R9007 R9008 (ER)	Turns ON when the area is exceeded in index modification.
	Turns ON when the size (n) of the FIFO specified by [D] is n = 0, or when n > 256
	Turns ON when the number of stored data items of the FIFO is larger than the FIFO size (n)
	Turns ON when the final address of the FIFO based on the FIFO size (n) exceeds the area

18.6 F117 FIFW (Data write to FIFO buffer)

Name	Description
	Turns ON when the write pointer of the FIFO is larger than the FIFO size (n)
	Turns ON when the FIFO write pointer is K256 (H100) or higher after the data is written

19 Bit Manipulation Instructions

19.1 F130 BTS (16-bit data bit set).....	19-2
19.2 F131 BTR (16-Bit Data Reset).....	19-4
19.3 F132 BTI (16-bit Data Bit Invert).....	19-6
19.4 F133 BTT (16-bit data bit test).....	19-8
19.5 F135 BCU [Count of total number of 1 bits in 16-bit data]	19-10
19.6 F136 DBCU [Count of total number of ON bits (1) in 32-bit data].....	19-12

19.1 F130 BTS (16-bit data bit set)

19.1 F130 BTS (16-bit data bit set)

Turns a bit of the specified 16-bit data ON.

■ Instruction format

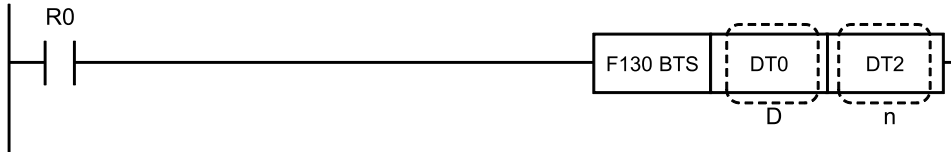

■ Operands

Items	Settings
D	Area in which bit is to be set
n	Area storing position of bit to be set, or constant data

■ Devices that can be specified (indicated by ●)

Operands	WX	WY	WR	WL	SV	EV	DT	LD	I	SWR	SDT	Constant				Index modifier	Integer Device
												K	H	M	f		
D		●	●	●	●	●	●	●	●						●		
n	●	●	●	●	●	●	●	●	●	●	●	●			●		

■ Outline of operation

- The bit with the number specified by [n] in the 16-bit data specified by [D] is turned ON. Bits other than the specified bit do not change.
- Set [n] in the range from K0 to K15. Only the lower 4 bits of the 16-bit data are valid.

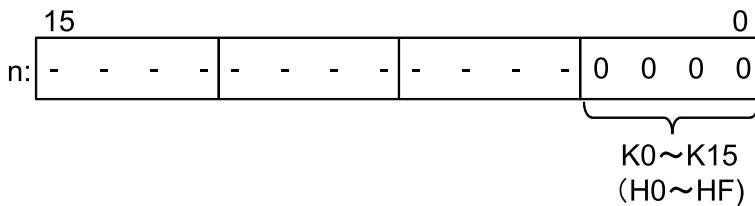

(Note 1) The bits marked - are invalid.

■ Operation example

Operation of instruction format description program

When internal relay R0 turns ON, the bit specified by DT2 in the data stored in DT0 is turned ON. When DT2 = K7, the operation is as shown below.

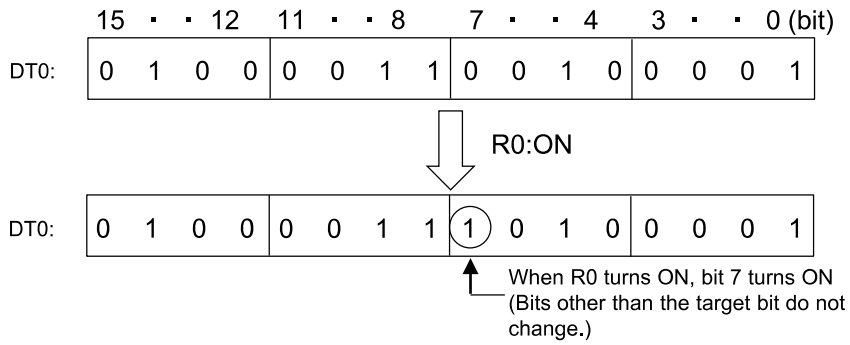

■ Flag operations

Name	Description
R9007 R9008 (ER)	Turns ON when the area is exceeded in index modification.

19.2 F131 BTR (16-Bit Data Reset)

19.2 F131 BTR (16-Bit Data Reset)

Turns OFF a specified bit of 16-bit data.

■ Instruction format

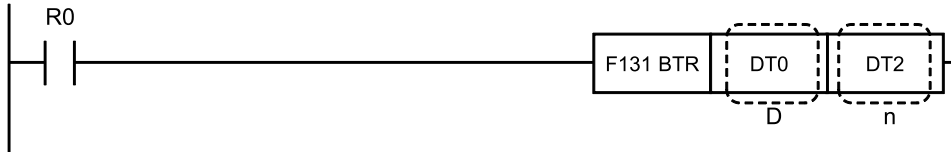

■ Operands

Items	Settings
D	Area where the bit will be reset
n	Area storing the specification of the bit position to be reset, or constant data

■ Devices that can be specified (indicated by ●)

Operands	WX	WY	WR	WL	SV	EV	DT	LD	I	SWR	SDT	Constant				Index modifier	Integer Device
												K	H	M	f		
D		●	●	●	●	●	●	●	●							●	
n	●	●	●	●	●	●	●	●	●	●	●	●	●			●	

■ Outline of operation

- Turns OFF a bit specified by the number [n] in the 16-bit data specified by [D]. Bits other than the specified bit do not change.
- Set [n] in the range from K0 to K15. Only the lower 4 bits of the 16-bit data are valid.

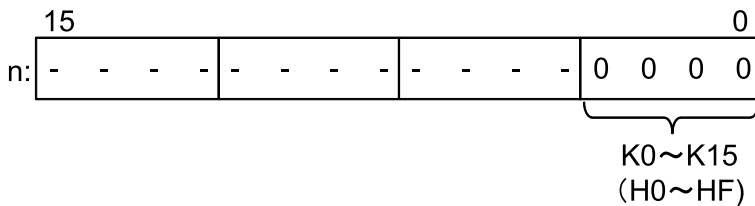

(Note 1) The bits marked - are invalid.

■ Operation example

Operation of instruction format description program

Turns OFF the bit specified by DT2 in the data stored in DT0 when internal relay R0 turns ON. When DT2 = K7, the operation is as shown below.

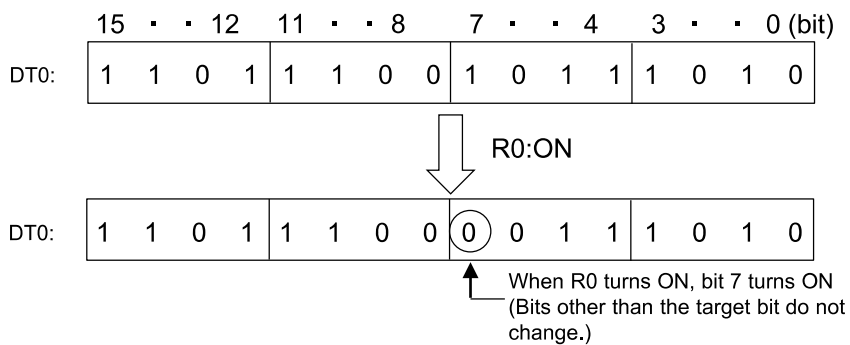

■ Flag operations

Name	Description
R9007 R9008 (ER)	Turns ON when the area is exceeded in index modification.

19.3 F132 BTI (16-bit Data Bit Invert)

19.3 F132 BTI (16-bit Data Bit Invert)

Inverts a specific bit in 16-bit data.

■ Instruction format

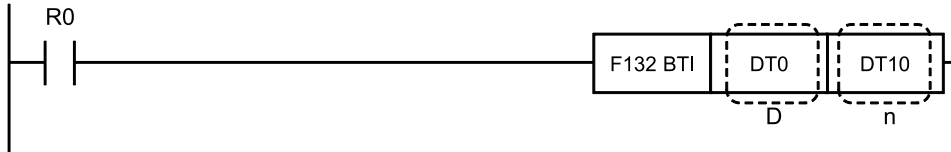

■ Operands

Items	Settings
D	Target area for bit inversion
n	Area storing the number of the bit to be inverted, or constant data

■ Devices that can be specified (indicated by ●)

Operands	WX	WY	WR	WL	SV	EV	DT	LD	I	SWR	SDT	Constant				Index modifier	Integer Device
												K	H	M	f		
D		●	●	●	●	●	●	●	●						●		
n	●	●	●	●	●	●	●	●	●	●	●	●	●		●		

■ Outline of operation

- Inverts (OFF -> ON or ON -> OFF) the bit number specified by [n] in the 16-bit data specified by [D]. Bits other than the specified bit do not change.
- [n] is in the range of K0 to K15. Only the lower 4 bits of the 16-bit data are valid.

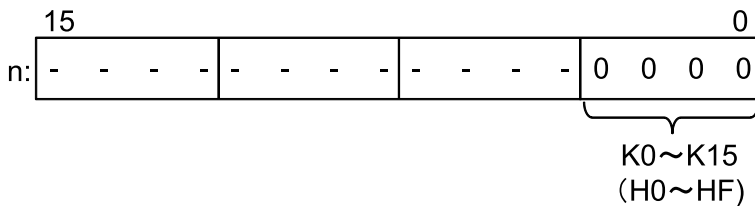

(Note 1) The bits marked - are invalid.

■ Operation example

Operation of instruction format description program

Inverts the bit specified by DT10 in data stored in DT0 when internal relay R0 turns ON. When DT10 = K7, the operation is as shown below.

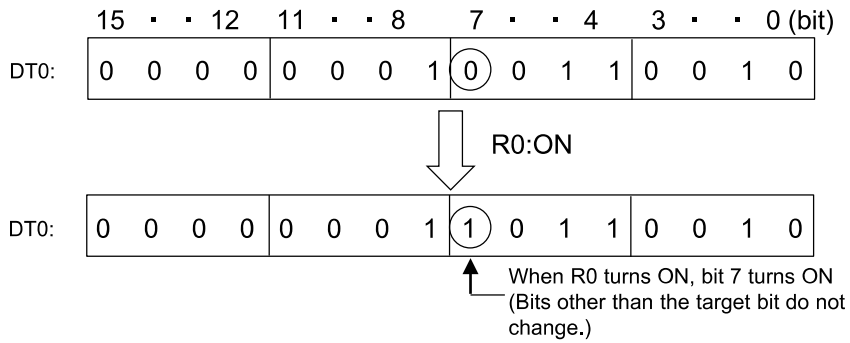

■ Flag operations

Name	Description
R9007 R9008 (ER)	Turns ON when the area is exceeded in index modification.

19.4 F133 BTT (16-bit data bit test)

19.4 F133 BTT (16-bit data bit test)

Tests the specified bit in the specified 16-bit data (to determine whether it is ON or OFF).

■ Instruction format

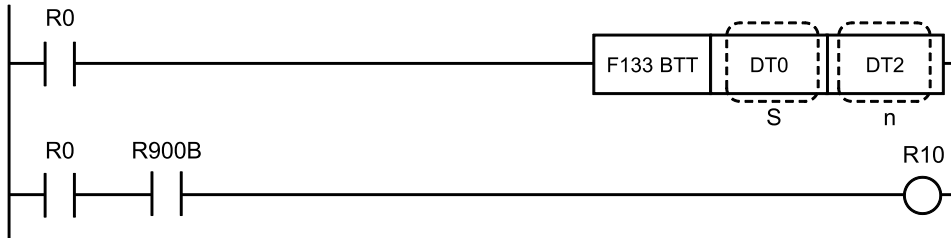

■ Operands

Items	Settings
S	Target area for bit test
n	Area storing the numbers of the bits to be tested, or constant data

■ Devices that can be specified (indicated by ●)

Operands	WX	WY	WR	WL	SV	EV	DT	LD	I	SWR	SDT	Constant				Index modifier	Integer Device
												K	H	M	f		
S		●	●	●	●	●	●	●	●							●	
n	●	●	●	●	●	●	●	●	●	●	●	●	●			●	

■ Outline of operation

- The bit with the number specified by [n] in the 16-bit data specified by [S] is judged to either be ON or OFF, and the judgment result is output to special internal relay R900B ["=(ZERO)" flag].
- The judgment result is as follows.

State of specified bit	"=(ZERO)" flag (R900B)
ON (1)	OFF (0)
OFF (0)	ON (1)

- [n] can be specified in the range of K0 to K15. Only the lower 4 bits of the 16-bit data are valid.

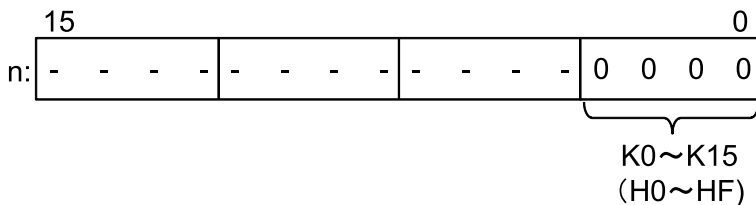

(Note 1) The bits marked - are invalid.

■ Operation example

Operation of instruction format description program

When internal relay R0 turns ON, the bit specified by DT2 in the data stored in data register DT0 is determined to either be ON or OFF. If the specified bit is OFF, internal relay R10 turns ON. If DT2 = K7, then the following happens.

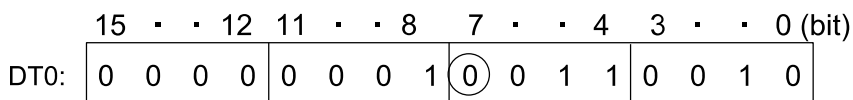

↑
Test bit 7.

As bit 7 is OFF (0), R900B: ON (test result), so R10: ON

■ Precautions when using the judgment flag (R900B) twice or more

- The judgment flag R900B is updated each time an operation instruction or comparison instruction is executed.
- Accordingly, when using the judgment flag twice or more,
 1. the program using the judgment flag should be inserted immediately after the instruction that executes the judgment; and
 2. the flag should be output to an output relay or internal relay for each instruction.

■ Flag operations

Name	Description
R9007 R9008 (ER)	Turns ON when the area is exceeded in index modification.
R900B (=)	Turns ON when the test bit (bit n) is "0"

19.5 F135 BCU [Count of total number of 1 bits in 16-bit data]

19.5 F135 BCU [Count of total number of 1 bits in 16-bit data]

Counts the number of ON bits in the specified 16-bit data.

■ Instruction format

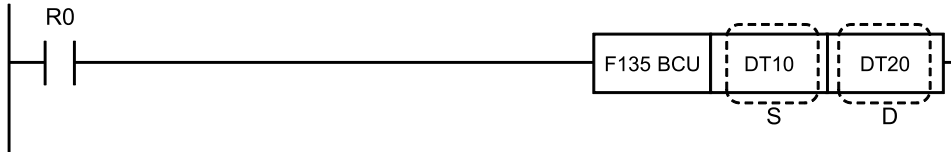

■ Operands

Items	Settings
S	Area storing the 16-bit data subject to the bit count, or constant data
D	Area storing the number of ON bits

■ Devices that can be specified (indicated by ●)

Operands	WX	WY	WR	WL	SV	EV	DT	LD	I	SWR	SDT	Constant				Index modifier	Integer Device
												K	H	M	f		
S	●	●	●	●	●	●	●	●	●	●	●	●	●	●	●	●	
D		●	●	●	●	●	●	●	●						●		

■ Outline of operation

- The number of ON bits (bits with a value of 1) in the 16-bit data specified by [S] is counted, and the result is stored in the area specified by [D].
- The result is stored as a decimal number.

■ Operation example

Operation of instruction format description program

When internal relay R0 turns ON, the number of ON bits in the data stored in DT10 is stored in DT20.

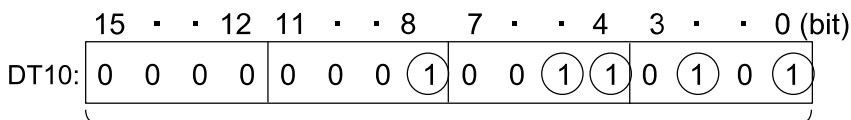

Count of "1" (ON) bits is 5

When R0 turns ON, K5 is stored in DT20.

■ Flag operations

Name	Description
R9007 R9008	Turns ON when the area is exceeded in index modification.

19.5 F135 BCU [Count of total number of 1 bits in 16-bit data]

Name	Description
(ER)	

19.6 F136 DBCU [Count of total number of ON bits (1) in 32-bit data]

19.6 F136 DBCU [Count of total number of ON bits (1) in 32-bit data]

Counts the number of ON bits in the specified 32-bit data.

■ Instruction format

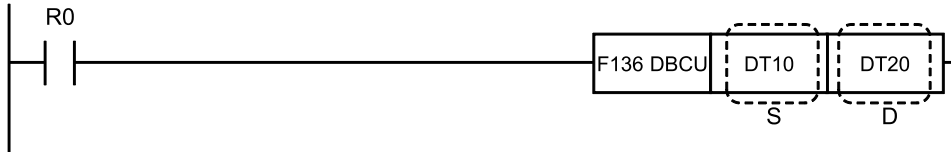

■ Operands

Items	Settings
S	Area storing the 32-bit data subject to the bit count, or constant data
D	Area storing the number of ON bits

■ Devices that can be specified (indicated by ●)

Operands	WX	WY	WR	WL	SV	EV	DT	LD	I	SWR	SDT	Constant				Index modifier	Integer Device
												K	H	M	f		
S	●	●	●	●	●	●	●	●	●	●	●	●	●	●	●	●	
D		●	●	●	●	●	●	●	●							●	

■ Outline of operation

- The number of ON bits (bits with a value of 1) in the 32-bit data specified by [S] and [S+1] is counted, and the result is stored in the area specified by [D].
- The result is stored as a decimal number.

■ Operation example

Operation of instruction format description program

When internal relay R0 turns ON, the number of ON bits in the data stored in DT10 and DT11 is stored in DT20.

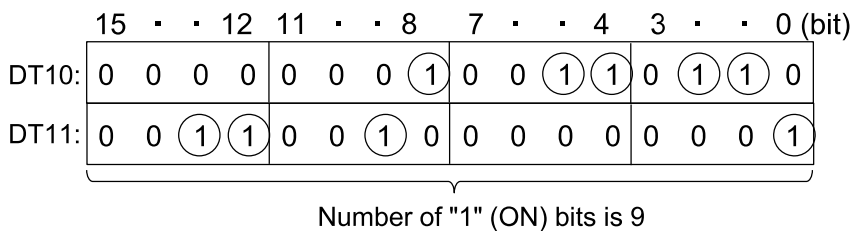

When R0 turns ON, K9 is stored in DT20.

■ Flag operations

Name	Description
R9007	Turns ON when the area is exceeded in index modification.

19.6 F136 DBCU [Count of total number of ON bits (1) in 32-bit data]

Name	Description
R9008 (ER)	

(MEMO)

20 Special Instructions

20.1 F138 HMSS (Hours, Minutes, and Seconds Data to Seconds Conversion).....	20-2
20.2 F139 SHMS (Converts Data to Hours, Minutes, and Seconds Data)	20-4
20.3 F140 STC (carry flag set).....	20-6
20.4 F141 CLC (Carry flag reset).....	20-7
20.5 F143 IORF (Partial I/O refresh).....	20-8
20.6 F147 PR (Printout).....	20-10
20.7 F148 ERR (Self-diagnostic Error Set).....	20-15
20.8 F149 MSG (Message Display).....	20-17
20.9 F150 READ (Data read from intelligent unit)	20-18
20.10 F151 WRT (Data Write into Intelligent Unit).....	20-21
20.11 F157 CADD (Date and Time Addition).....	20-24
20.12 F158 CSUB (Date and Time Subtraction).....	20-27
20.13 F160 DSQR (32-bit Data Square Root)	20-32

20.1 F138 HMSS (Hours, Minutes, and Seconds Data to Seconds Conversion)

20.1 F138 HMSS (Hours, Minutes, and Seconds Data to Seconds Conversion)

Converts data representing hours, minutes, and seconds into data representing seconds.

■ Instruction format

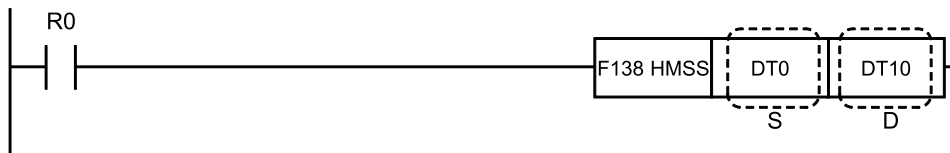

■ Operands

Items	Settings
S	Starting address of the area storing the two-word data representing hours/minutes/seconds
D	Starting address of the area storing the conversion result (second data)

■ Devices that can be specified (indicated by ●)

Operands	WX	WY	WR	WL	SV	EV	DT	LD	I	SWR	SDT	Constant				Index modifier	Integer Device
												K	H	M	f		
S	●	●	●	●	●	●	●	●	●	●	●					●	
D		●	●	●	●	●	●	●	●							●	

■ Outline of operation

- Converts the 2-word time data (hours/minutes/seconds) starting at the address specified by [S], converts it to seconds, and then stores the result in the 2-word area starting from the address specified by [D].

■ Data Structure

- Time data [S] representing hours, minutes, and seconds
 - is composed of 2-word BCD (H constant) data.
 - Specify as shown below: hours (4-digit), minutes (2-digit), and seconds (2-digit). (Can be specified with a maximum of 9999 hours, 59 minutes, and 59 seconds.)

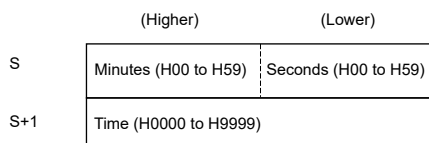

e.g. 3 hours, 45 minutes, and 19 seconds

S = H4519

S+1 = H0003

- Time data [D] representing seconds

20.1 F138 HMSS (Hours, Minutes, and Seconds Data to Seconds Conversion)

- is composed of 2-word BCD (H constant, maximum 8-digit) data.
- It is stored as shown below.

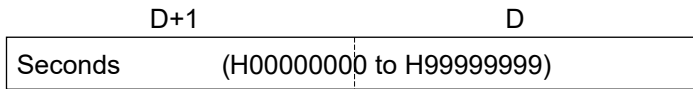

e.g. 35,999,999 seconds

D = H9999

D+1 = H3599

Note: As the maximum time data that can be specified is 9999 hours, 59 minutes, and 59 seconds, the actual maximum value for the seconds that will be stored in [D] is 35,999,999 seconds.

■ Operation example

Operation of instruction format description program

The time data representing hours, minutes, and seconds that is stored in data registers DT0 and DT1 is converted to seconds and then stored in DT10 and DT11 when internal relay R0 turns ON.

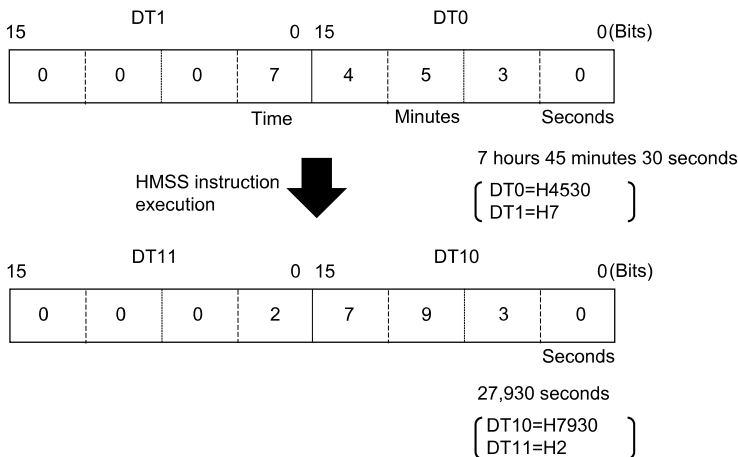

■ Flag operations

Name	Description
R9007 R9008 (ER)	Turns ON when the area is exceeded in index modification.
	Turns ON when the data specified by [S] is not BCD data
	Turns ON when the portion of [S] representing minutes and seconds is exceeds the range of 00 to 59

20.2 F139 SHMS (Converts Data to Hours, Minutes, and Seconds Data)

20.2 F139 SHMS (Converts Data to Hours, Minutes, and Seconds Data)

Converts data representing seconds (up to 8 digits) to data representing hours, minutes, and seconds.

■ Instruction format

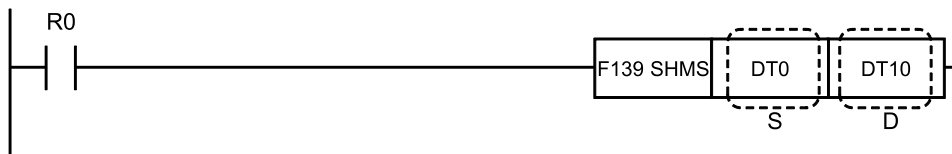

■ Operands

Items	Settings
S	Starting address of the area storing the 2-word data representing seconds
D	Starting address of the area that stores the conversion result (hours, minutes, and seconds data)

■ Devices that can be specified (indicated by ●)

Operands	WX	WY	WR	WL	SV	EV	DT	LD	I	SWR	SDT	Constant				Index modifier	Integer Device
												K	H	M	f		
S	●	●	●	●	●	●	●	●	●	●	●					●	
D		●	●	●	●	●	●	●	●							●	

■ Outline of operation

- Converts the 2-word time data (in seconds) starting from the address specified by [S] to time data expressed in hours, minutes, and seconds (H constant), and stores the result in the 2-word area whose starting address is specified by [D].

■ Data structure

- Time data representing seconds [S]
 - is composed of two-word BCD (H constant, maximum 8-digit) data.
 - Specify in seconds as shown below.

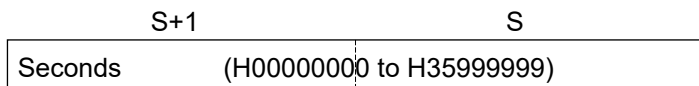

e.g. 35,999,999 seconds

S = H9999

S+1 = H3599

Note: The maximum value that can be stored in [D] is 9,999 hours, 59 minutes and 59 seconds, so the maximum value that can be specified for the time data for the seconds unit is 35,999,999 seconds.

20.2 F139 SHMS (Converts Data to Hours, Minutes, and Seconds Data)

- Time data representing hours, minutes, and seconds [D]
 - is composed of two-word BCD (H constant) data.
 - The time data represents hours (4 digits), minutes (2 digits), and seconds (2 digits) as shown below.

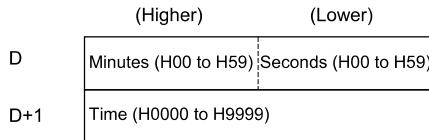

e.g. 3 hours, 45 minutes, and 19 seconds

D = H4519

D+1 = H0003

■ Operation example

Operation of instruction format description program

Converts the seconds data stored in data registers DT0 to DT1 to hour, minute, and second data when internal relay R0 turns ON. The converted hour, minute, and second data is stored in data registers DT10 to DT11.

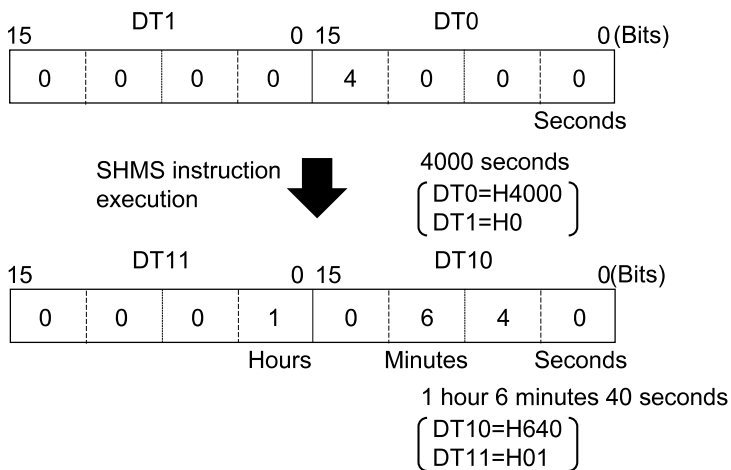

■ Flag operations

Name	Description
R9007	Turns ON when the area is exceeded in index modification.
R9008	Turns ON when the data specified by [S] is not BCD data
(ER)	Turns ON when the content of [S] exceeds 35,999,999

20.3 F140 STC (carry flag set)

20.3 F140 STC (carry flag set)

Turns the CY flag ON.

■ Instruction format

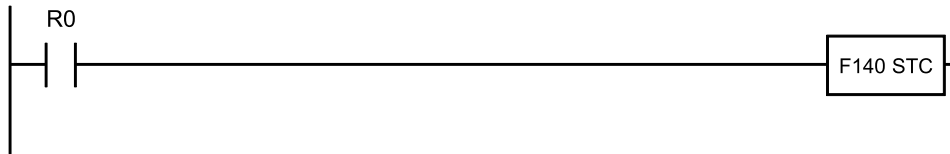

■ Outline of operation

The CY (carry) flag (R9009) is turned ON.

■ Flag operations

Name	Description
R9009 (CY)	Turns ON after this instruction is executed

20.4 F141 CLC (Carry flag reset)

Turns the CY flag OFF.

■ Instruction format

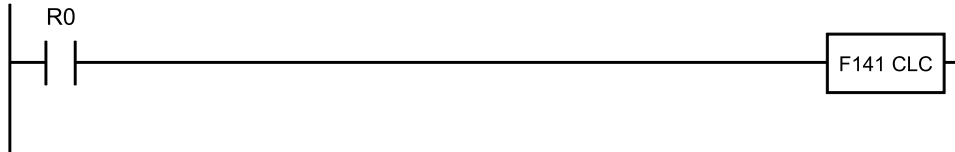

■ Outline of operation

The CY (carry) flag (R9009) is turned OFF.

■ Flag operations

Name	Description
R9009 (CY)	Turns OFF after this instruction is executed

20.5 F143 IORF (Partial I/O refresh)

The input or output of a specified range is refreshed.

■ **Instruction format**

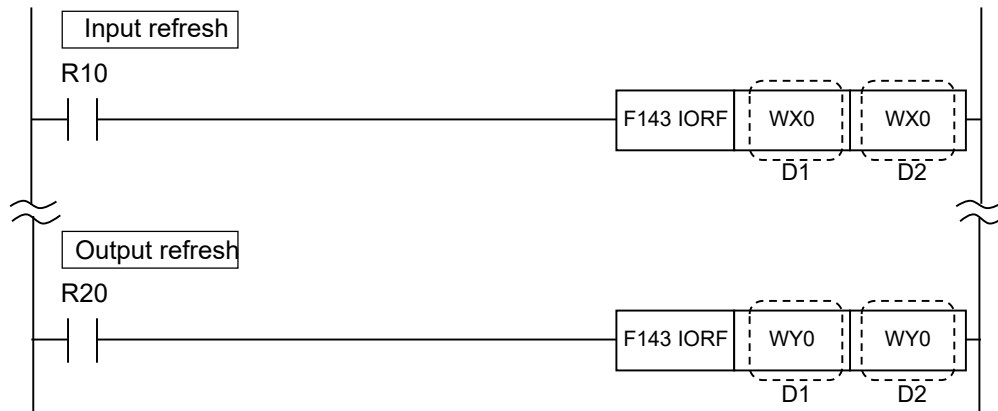

■ **Operands**

Items	Settings
D1	The starting word no. of the I/O to be refreshed
D2	The ending word no. of the I/O to be refreshed

■ **Devices that can be specified (indicated by ●)**

Operands	WX	WY	WR	WL	SV	EV	DT	LD	I	SW R	SD T	Constant				Index modifier	Integer Device
	K	H	M	f													
D1	●	●														●	
D2	●	●														●	

■ **Outline of operation**

- An I/O refresh (input / output processing) of the external input X or external output Y is executed for a range from the number specified in [D1] to the number specified in [D2].
- When refreshing input, specify WX** to [D1] and [D2].
- When refreshing output, specify WY** to [D1] and [D2].
- The input or output range that can be partially refreshed is as shown below.

Objects covered by partial refresh (indicated by ●)

Control unit	Extension cassette	FP-X / FP-X0 expansion	FP0 expansion adapter
●	●		

■ **Example of operation**

Operation of instruction format description program

When internal relay R10 is ON, an I/O refresh of input relay WX0 (X0 to XF) is executed.

20.5 F143 IORF (Partial I/O refresh)

When internal relay R20 is ON, an I/O refresh of output relay WY0 (Y0 to YF) is executed.

20.6 F147 PR (Printout)

Outputs text data (ASCII codes) to the printer.

■ **Instruction format**

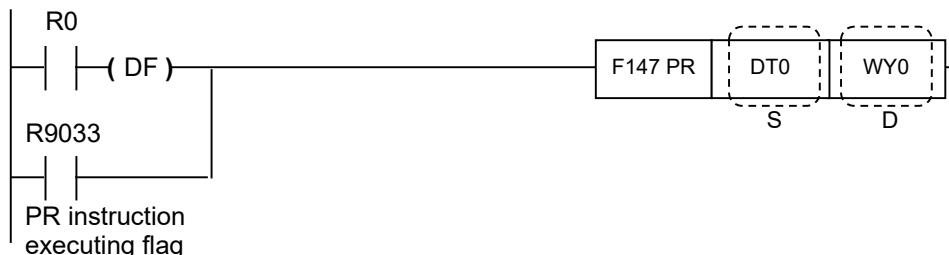

■ **Operands**

Items	Settings
S	Starting address of the area storing printout data (ASCII codes)
D	Area for output of printout data

■ **Devices that can be specified (indicated by ●)**

Operands	WX	WY	WR	WL	SV	EV	DT	LD	I	SWR	SDT	Constant				Index modifier	Integer Device
												K	H	M	f		
S	●	●	●	●	●	●	●	●	●	●	●						
D		●															

■ **Outline of operation**

- Outputs the ASCII codes (for 12 characters) stored in the six-word area starting with the address specified by [S] to the area WY specified by [D].

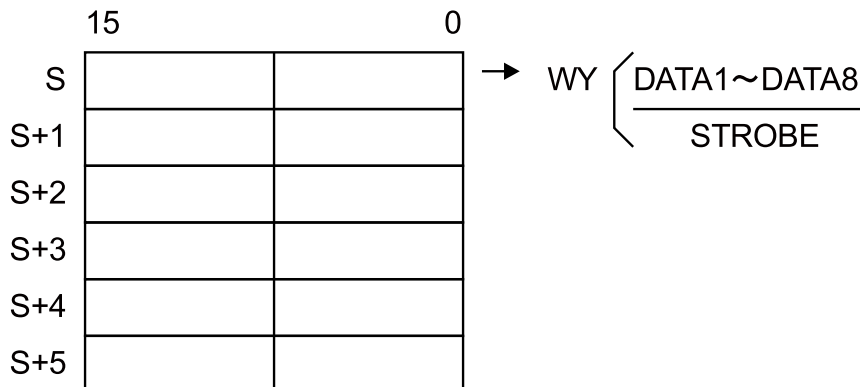

- In the WY area, Y₀ to Y₇ are data signals DATA1 to DATA8, and Y₈ is the strobe signal. Y₉ to Y_F are not used. When the printout instruction is executed, the printout data is output from Y₀ to Y₇ (ASCII code), and the strobe signal is output from Y₈.
- ASCII code is output in order from the starting address.

- Be sure to set the printer control code (LF, CR) as data within the 6-word (12 characters) area above.
- After the start of execution of a printout instruction, 37 scans are required until 12 characters complete output. (See the "P.20-13" Time Chart for more details.)

■ Precautions for programming

- Multiple F147 PR instructions cannot be executed at the same time. The program should be set up so that the printout flag (R9033) is used during execution of a F147 PR instruction to inhibit simultaneous execution.
- The ASCII code conversion instruction (F95 ASC) can be used to convert character constants (M) to ASCII codes.
- Character constants can be input only with programming tool software.
- A transistor-type output unit (output board) is necessary.
- When this instruction is executed, zero <OFF> is set for Y□9 to Y□F in the WY area specified by [D].

■ Operation example

Operation of instruction format description program

The ASCII codes stored in data registers DT0 to DT5 are output to WY0 when internal relay R10 turns ON.

■ Connection method

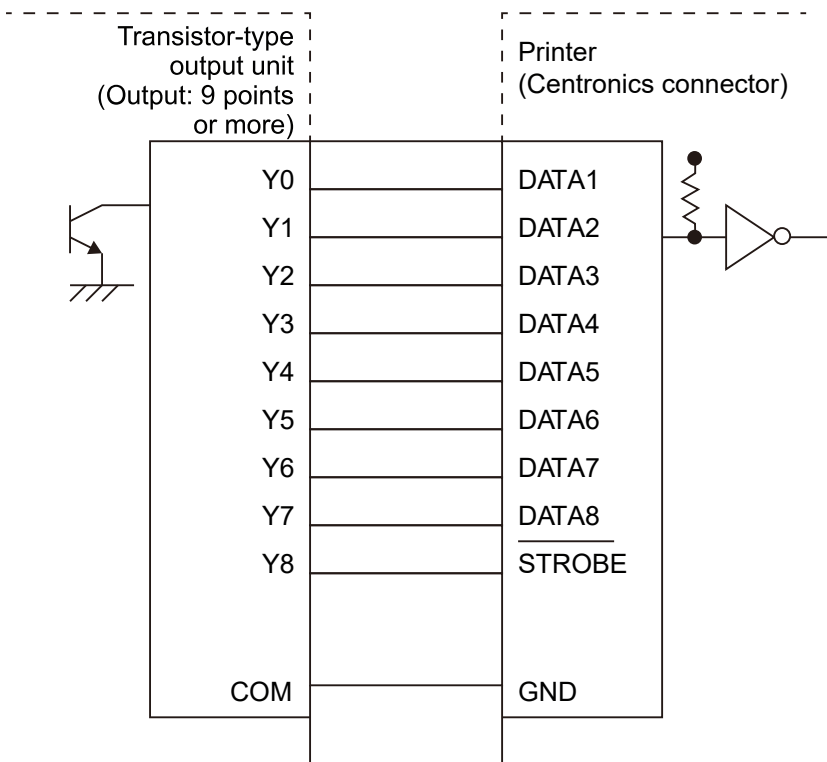

■ **Data setting**

Set the data to be printed out in order from the lower byte of the first word.

<Example> **Outputting 10 characters "ABCDEFGHIJ" to a printer**

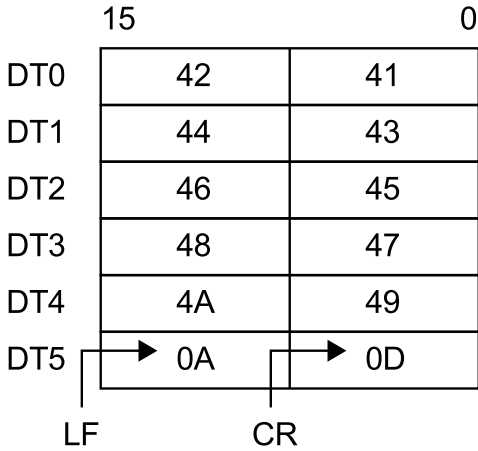

■ **Printer output using eight-point output**

- When only eight output points are being used, connections should be made as shown below, and the program should be set up so that the strobe signal is output from Y7. However, in this case, only alphanumeric characters can be output.

Connection example

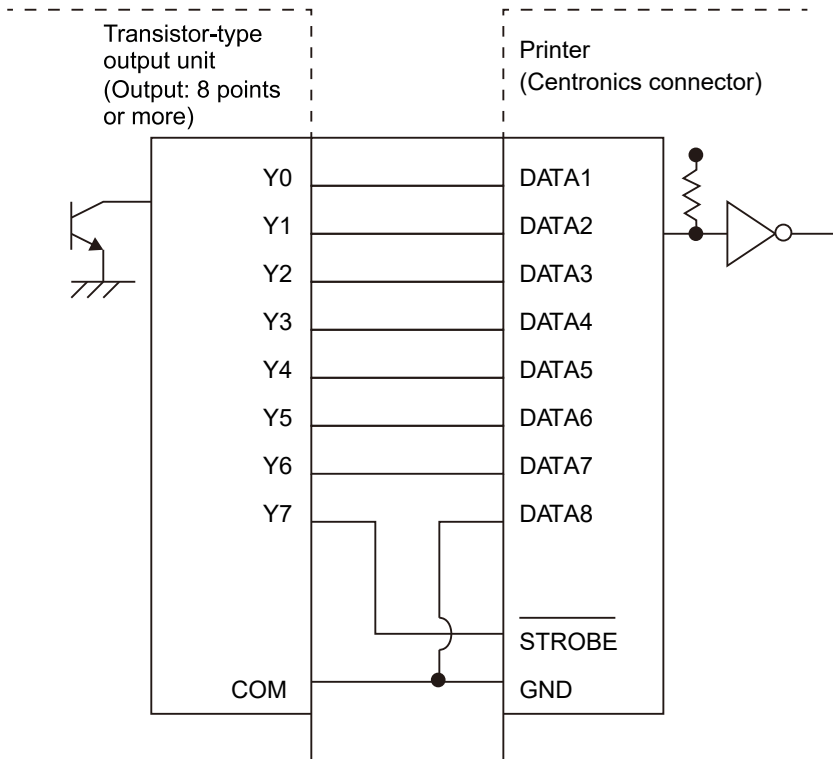

Program example

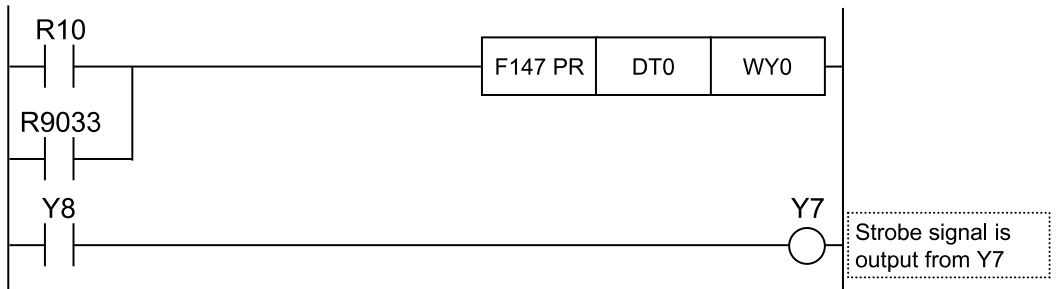

■ Timing chart

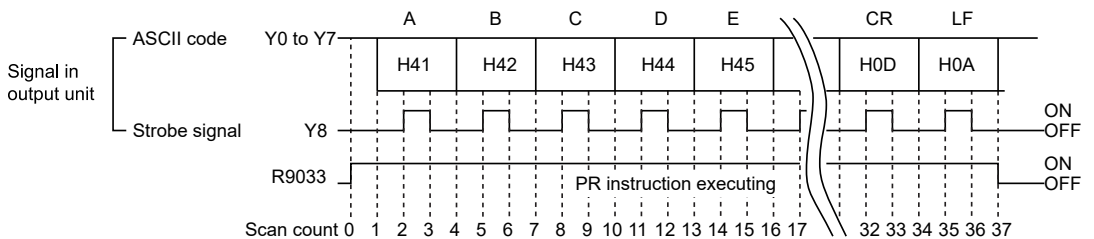

20.6 F147 PR (Printout)

■ Flag operations

Name	Description
R9007	Turns ON when the six words starting with [S] exceed the range of the area
R9008 (ER)	Turns ON when another F147 (PR) instruction attempts execution while one F147 (PR) instruction is being executed

20.7 F148 ERR (Self-diagnostic Error Set)

Detects a self-diagnostic error according to detection conditions that are arbitrarily set.

■ Instruction format

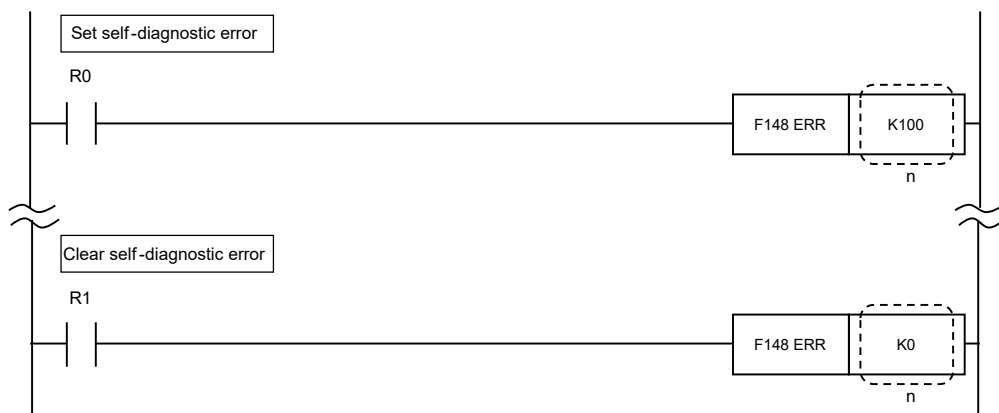

■ Operand

Items	Settings
n	Self-diagnostic error code (0, 100 to 299)

■ Devices that can be specified (indicated by ●)

Operand	WX	WY	WR	WL	SV	EV	DT	LD	I	SW R	SD T	Constant				Index modifier	Integer Device
												K	H	M	f		
n												●	●				

■ Outline of operation

- Stores the self-diagnostic error code specified by [n] in the special data register (DT90000) and turns ON the self-diagnostic error flag (R9000). Also, the ERR. LED flashes.
- [n] (self-diagnostic error code) can be set in a range from K100 to K299. Depending on the setting value, it is determined whether to stop or continue operation when the instruction is executed.

Setting of [n]	Operations when an error occurs
K100 to K199	Operation stops
K200 to K299	Operation continues

- When K200 to K299 is set to [n] and if multiple F148 ERR instructions are processed at the same time, the lower code is accepted with higher priority.
- When 0 is set to [n] and if F148 ERR is executed, the self-diagnostic error with error code 43 or higher is cleared.

Items	Operations when the self-diagnostic error is cleared
ERR. LED	OFF

20.7 F148 ERR (Self-diagnostic Error Set)

Items		Operations when the self-diagnostic error is cleared
R9000	Self-diagnostic error flag	OFF
R9005	Backup battery error flag (current type)	
R9006	Backup battery error flag (hold type)	
R9007	Operation error flag (hold type) (ER flag)	
R9008	Operation error flag (latest type) (ER flag)	
R9109	Memory configuration mismatch detection flag	
R9166	SNTP time updating failure	
DT90000	self-diagnostic error code	Cleared to zero.
DT90017	Address with operation error (hold type)	
DT90018	Address with operation error (latest type)	
DT90007	Address in case of system register error	
DT90299	Memory configuration mismatch detail	
DT90590	Details of network errors	

- It is possible to repeatedly write the same F148 ERR instructions with the same error code.

■ Example of operation

Operation of instruction format description program

- When the internal relay R0 is ON, the self-diagnostic error 100 is set. Also, the ERR flashes and operation stops. (Design the program so that the internal relay R0 turns ON when a situation occurs where the self-diagnostic error 100 needs to be set.)
- When the internal relay R1 is ON, the self-diagnostic error with error code 43 or higher is cleared.

■ Checking the self-diagnostic error

- The checking procedure is the same as that for ordinary self-diagnostic errors.
Special data registers No.: DT90000, DT90017, DT90018

■ Flag operation

Name	Description
R9007 R9008 (ER)	Turns ON when the [n] is outside the set range.

20.8 F149 MSG (Message Display)

Displays a message on the programming tool.

■ Instruction format

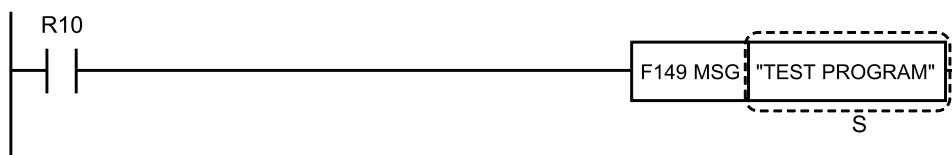

■ Operands

Items	Settings
S	Message (character constant)

■ Devices that can be specified (indicated by ●)

Operands	WX	WY	WR	WL	SV	EV	DT	LD	I	SW R	SD T	Constant				Index modifier	Integer Device
												K	H	M	f		
S														●			

■ Outline of operation

- The characters specified by [S] are displayed on the programming tool connected to the controller.
- The message can also be read from "Message display" on the tool software menu.
- The character constant M can only be input by programming tool software.
- The message flag (R9026) turns ON, and the content of [S] is set to special data registers DT90030 to DT90035.
- If a message is already being displayed, the displayed content does not change even if this instruction is executed. To clear the message displayed, click the "Cancel" button on the "Display PLC Message" screen using the programming tool software.

■ Operation example

Operation of instruction format description program

When internal relay R10 turns ON, the message "TEST PROGRAM" is displayed on the programming tool.

20.9 F150 READ (Data read from intelligent unit)

20.9 F150 READ (Data read from intelligent unit)

Reads data from the memory of the intelligent unit.

■ Instruction format

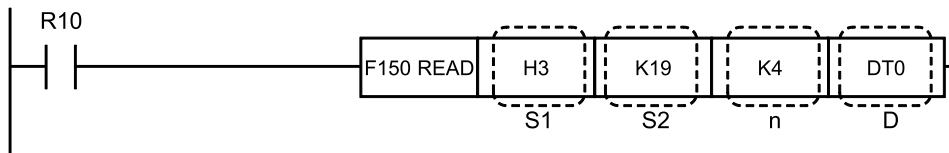

■ Operands

Items	Settings
S1	Slot number and bank number specification
S2	Read start address of the intelligent unit memory
n	Read word count
D	Starting number of area storing read data

■ Devices that can be specified (indicated by ●)

Operands	WX	WY	WR	WL	SV	EV	DT	LD	I	SWR	SDT	Constant				Index modifier	Integer Device
												K	H	M	f		
S1												●	●			●	
S2												●	●			●	
n												●	●			●	
D		●	●	●	●	●	●	●	●							●	

■ Outline of operation

- The number of words [n] of the data stored in the shared memory of the intelligent unit specified by [S1] is read from the address specified by [S2] and is stored from the area specified by [D] in the control unit.

■ Operation example

Operation of instruction format description program

When internal relay R10 turns ON, the four-word data at addresses 19 to 22 is read from the shared memory of the intelligent unit installed in slot number 3 and stored in data registers DT0 to DT3 of the control unit.

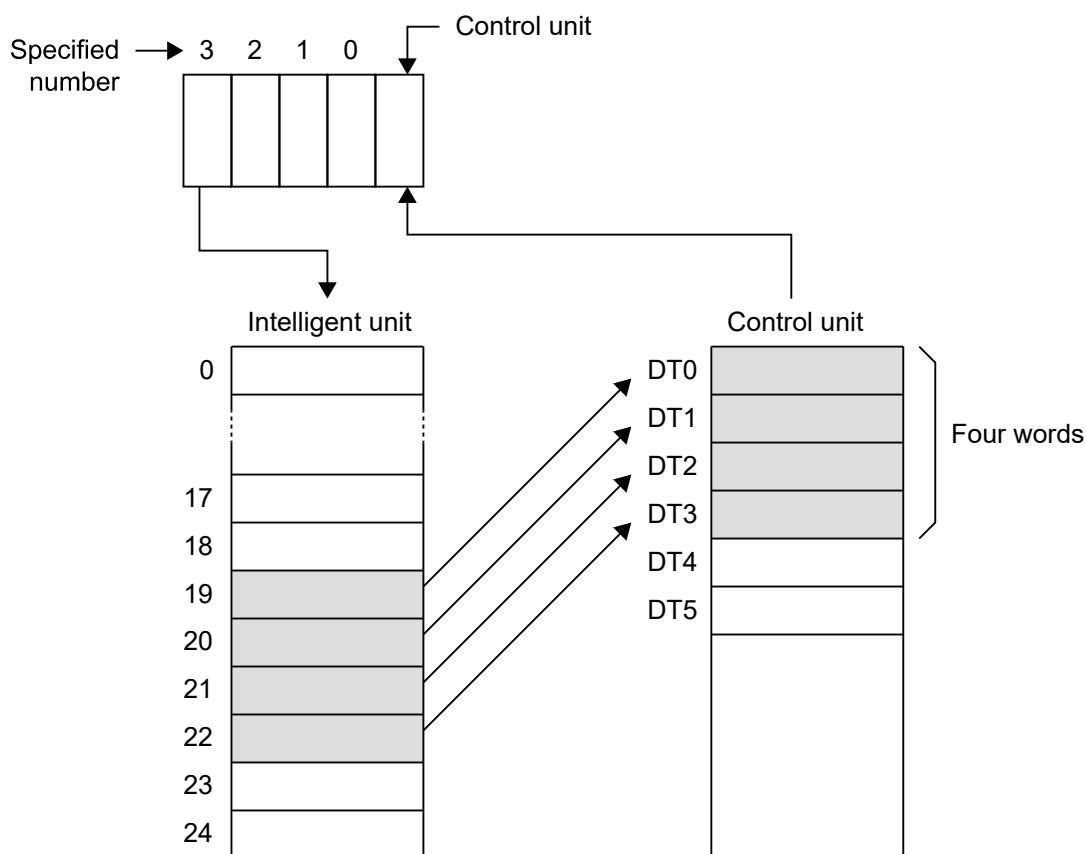

■ Specifying each item

- Specification of slot number and bank number [S1]
Specify the slot where the intelligent unit is installed. If the memory has a bank, specify the bank number as well.
- Read start address of the intelligent unit shared memory [S2]
Specify by referring to the shared memory list for each intelligent unit.
e.g. For address 2, specify K2.
- Read word count [n]
Specify with a K constant.
e.g. To read 10 words of data, specify K10.

■ How to specify S1

(1) For intelligent units without banks

Specify the slot number where the target intelligent unit is installed.

20.9 F150 READ (Data read from intelligent unit)

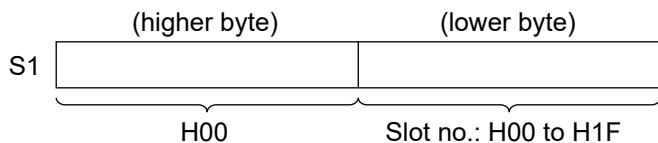

(2) For intelligent units with banks

Specify the slot number (H constant) where the target intelligent unit is installed and the bank number (H constant).



■ How to specify slot numbers

The slot number of the target intelligent unit is automatically allocated according to the installation position.

Slots are numbered from left to right from the control unit side.

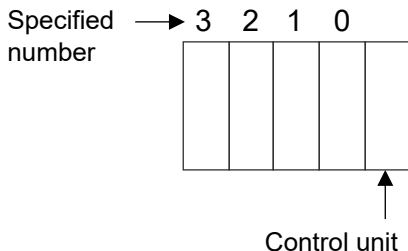

■ Flag operations

Name	Description
R9007	Turns ON when the value of [S1] is out of the specified range
R9008	Turns ON when the area is exceeded in index modification.
(ER)	Turns ON when the read data exceeds the area [D]

20.10 F151 WRT (Data Write into Intelligent Unit)

Writes data into the memory in an intelligent unit.

■ Instruction format

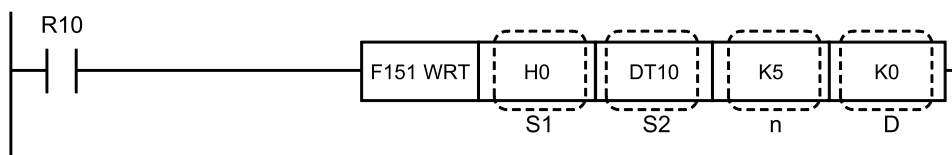

■ Operands

Items	Settings
S1	Slot number and bank number specification
S2	Starting number of area storing the write data
n	Number of words to be written
D	Starting address for writing in the memory of the intelligent unit

■ Devices that can be specified (indicated by ●)

Operands	WX	WY	WR	WL	SV	EV	DT	LD	I	SWR	SDT	Constant				Index modifier	Integer Device
												K	H	M	f		
S1												●	●			●	
S2	●	●	●	●	●	●	●	●	●	●	●	(N ot e 1)	(N ot e 1)			●	
n												●	●			●	
D												●	●			●	

(Note 1) If K/H constants are specified in [S2], the [S2] stored value (one word) is written to the address specified by [D]. The number of words to be written is fixed at 1, so any specification of [n] is ignored.

■ Outline of operation

- With the area in the control unit specified by [S2] as the start, [n] words of data are written to the shared memory of the intelligent unit specified by [S1], starting from the address specified by [D].

■ Operation example

Operation of instruction format description program

Five words of data from data registers DT10 to DT14 of the control unit are written into the addresses 0 to 4 of the intelligent unit shared memory (located in slot 0) when internal relay R10 turns ON.

20.10 F151 WRT (Data Write into Intelligent Unit)

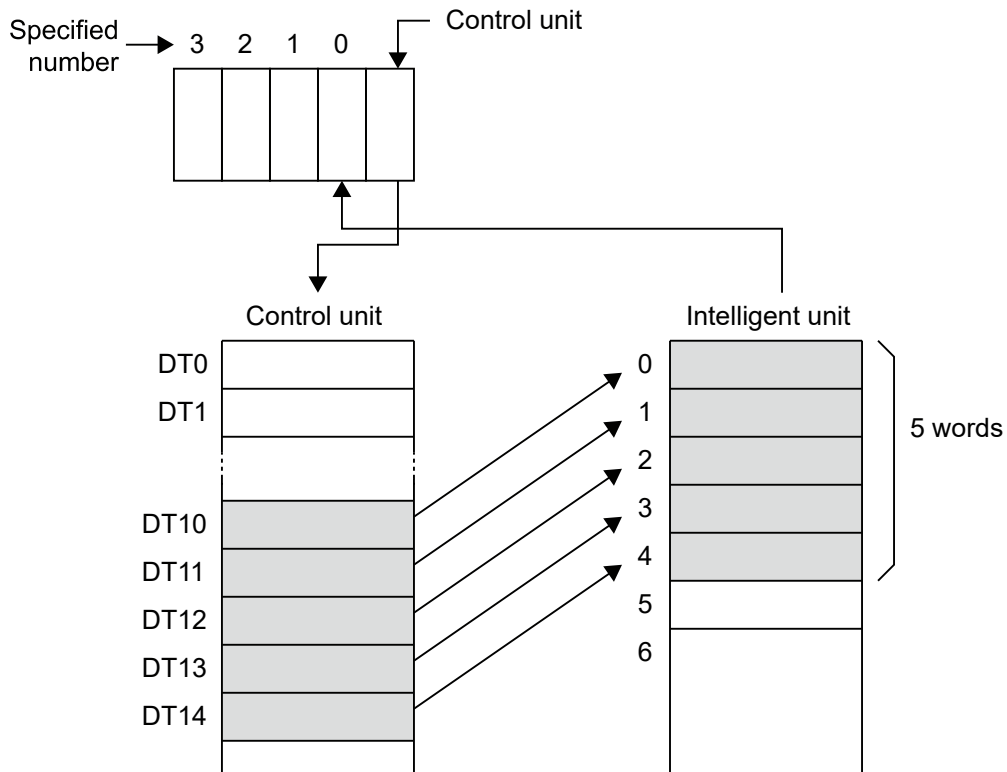

■ Specifying each item

- Specification of slot number and bank number [S1]
Specify the slot where the intelligent unit is installed. If the memory has a bank, specify the bank number as well.
- Number of words to be written [n]
Specify with a K constant.
e.g. To write 10 words of data, specify "K10".
- Starting address [D] for writing in the shared memory of the intelligent unit
Specify by referring to the shared memory list for each intelligent unit.
e.g. To specify address 2, specify "K2".

■ How to specify S1

(1) For intelligent units without banks

Specify the slot number where the target intelligent unit is installed.

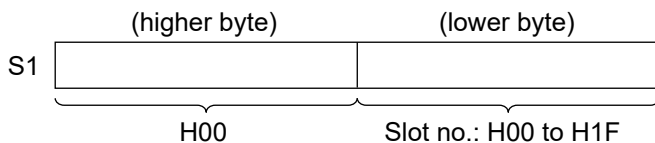

(2) For intelligent units with banks

Specify the slot number (H constant) where the target intelligent unit is installed and the bank number (H constant).

**■ How to specify slot numbers**

The slot number of the target intelligent unit is automatically allocated according to the installation position.

Slots are number from left to right from the control unit side.

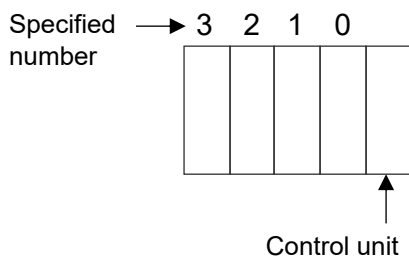
**■ Flag operations**

Name	Description
R9007	Turns ON when the value of [S1] is out of the specified range
R9008	Turns ON when the area is exceeded in index modification.
(ER)	Turns ON when the range of writing data exceeds the area specified by [S2]

20.11 F157 CADD (Date and Time Addition)

Calculates the date and time after a specified amount of time (hours, minutes, and seconds) has elapsed since a certain date and time (year, month, day, hour, minute, second).

■ **Instruction format**

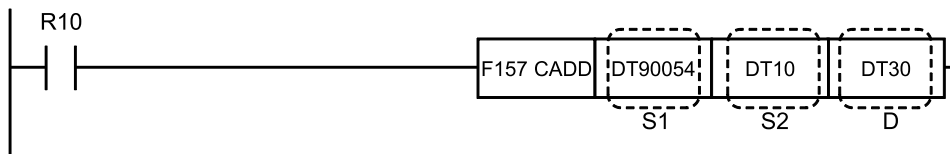

■ **Operands**

Items	Settings
S1	Starting address of area storing date and time data (three words)
S2	Starting address of area storing date and time data (two words), or constant data
D	Starting address of area storing addition result date and time data (three words)

■ **Devices that can be specified (indicated by ●)**

Operand s	WX	WY	WR	WL	SV	EV	DT	LD	I	SW R	SD T	Constant				Index modifier	Integer Device
												K	H	M	f		
S1	●	●	●	●	●	●	●	●		●	●					●	
S2	●	●	●	●	●	●	●	●	●	●	●	●	●			●	
D		●	●	●	●	●	●	●								●	

■ **Outline of operation**

- The three-word date and time data (year, month, day, hour, minute, second) that starts at the address specified by [S1] and the time data (hours, minutes, and seconds) specified by [S2] are added together. The result (time of elapsed value) is stored in the three-word area that starts at the address specified by [D].

<Time data>	(Higher)	(Lower)
[S1]	Minutes (H00 to H59)	Seconds (H00 to H59)
[S1+1]	Day (H01 to H31)	Hour (H01 to H23)
[S1]+2	Year (H00 to H99)	Month (H00 to H12)

+ (addition)

<Time data>	(Higher)	(Lower)
[S1]	Minutes (H00 to H59)	Seconds (H00 to H59)
[S1+1]	Time (H0000 to H9999)	



<Time data>	(Higher)	(Lower)
[D]	Minutes (H00 to H59)	Seconds (H00 to H59)
[D1+1]	Day (H01 to H31)	Hour (H01 to H23)
[D1]+2	Year (H00 to H99)	Month (H00 to H12)

- Specify the values for date and time data [S1] and time data [S2] using BCD data (H constant).

[Example of date and time data]

14 hours, 23 minutes, and 31 seconds on August 1, 1992

S1 = H2331 (23 hours, 31 minutes)

S1+1 = H0114 (1st of the month, 14th hour)

S1+2 = H9208 (1992, August)

[Example of time data]

32 hours, 50 minutes, and 45 seconds

S2 = H5045 (50 minutes, 45 seconds)

S2+1 = H0032 (32 hours)

■ Operation example

Operation of instruction format description program

When internal relay R0 turns ON, the built-in calendar timer reads date and time data and adds the time data stored in data registers DT10 and DT11. The date and time resulting from the addition is stored in DT30 to DT32.

20.11 F157 CADD (Date and Time Addition)

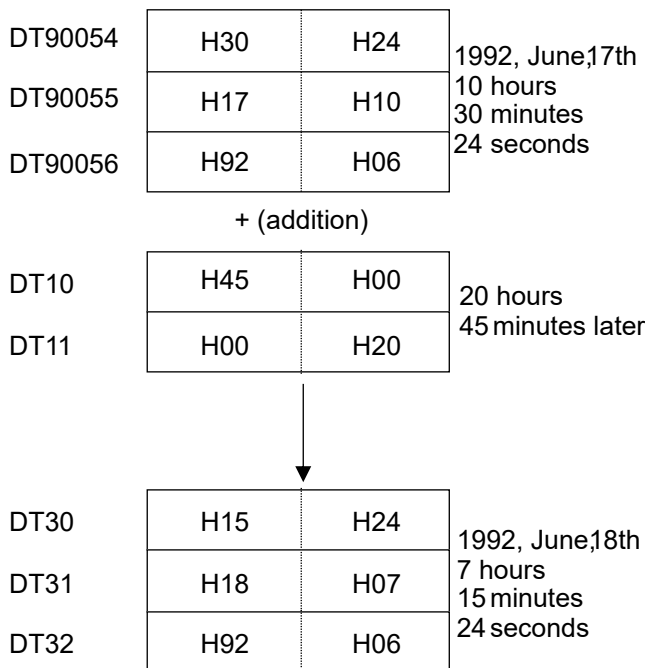

■ Data configuration of built-in calendar timer

	(Higher)	(Lower)
DT90054	Minutes	Seconds
DT90055	Day	Hours
DT90056	Year	Month

■ Precautions for programming

Special data registers DT90054 to DT90056, in which the values of the built-in calendar timer are stored, cannot be specified directly for [D]. To change the values of the built-in calendar timer, store the addition results in a separate memory area, and then use the F0 MV instruction to transfer the values to DT90054 to DT90056.

■ Flag operations

Name	Description
R9007 R9008 (ER)	Turns ON when the area is exceeded in index modification.
	Turns ON when the data specified by [S1] and [S2] is not BCD data
	Turns ON when the data specified by [S1] is not date and time data
	Turns ON when the data specified by [S2] is not time data
	Turns ON when the specified data exceeds the area

20.12 F158 CSUB (Date and Time Subtraction)

Calculates the date and time a specified amount of time (hours, minutes, and seconds) before a certain date and time (year, month, day, hour, minute, second).

■ Instruction format

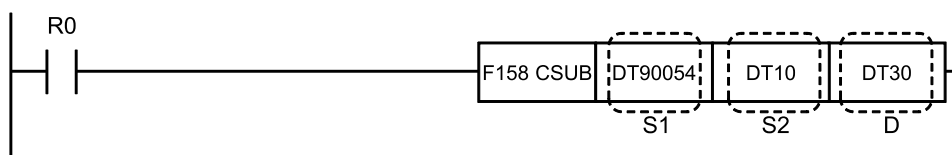

■ Operands

Items	Settings
S1	Starting address of area storing date and time data (three words)
S2	Starting address of area storing date and time data (two words), or constant data
D	Starting address of area storing subtraction result date and time data (three words)

■ Devices that can be specified (indicated by ●)

Operands	WX	WY	WR	WL	SV	EV	DT	LD	I	SW R	SD T	Constant				Index modifier	Integer Device
												K	H	M	f		
S1	●	●	●	●	●	●	●	●		●	●					●	
S2	●	●	●	●	●	●	●	●	●	●	●	●	●			●	
D		●	●	●	●	●	●	●								●	

■ Outline of operation

- The time data (hours, minutes, and seconds) specified by [S2] is subtracted from the three-word date and time data (year, month, day, hour, minute, second) that starts at the address specified by [S1]. The result is stored in the three-word area that starts at the address specified by [D].

20.12 F158 CSUB (Date and Time Subtraction)

<Time data>	(Higher)	(Lower)
[S1]	Minutes (H00 to H59)	Seconds (H00 to H59)
[S1+1]	Day (H01 to H31)	Hour (H01 to H23)
[S1+2]	Year (H00 to H99)	Month (H00 to H12)

- (subtraction)

<Time data>	(Higher)	(Lower)
[S1]	Minutes (H00 to H59)	Seconds (H00 to H59)
[S2+1]	Time (H0000 to H9999)	



<Time data>	(Higher)	(Lower)
[D]	Minutes (H00 to H59)	Seconds (H00 to H59)
[D1+1]	Day (H01 to H31)	Hour (H01 to H23)
[D1+2]	Year (H00 to H99)	Month (H00 to H12)

- Specify the values for date and time data [S1] and time data [S2] using BCD data (H constant).

[Example of date and time data]

14 hours, 23 minutes, and 31 seconds on December 1, 1994

S1 = H2331 (23 hours, 31 minutes)

S1+1 = H0114 (1st of the month, 14th hour)

S1+2 = H9412 (1994, December)

[Example of time data]

32 hours, 50 minutes, and 45 seconds

S2 = H5045 (50 minutes, 45 seconds)

S2+1 = H0032 (32 hours)

■ Operation example

Operation of instruction format description program

When internal relay R0 turns ON, the built-in calendar timer reads date and time data and subtracts the time data stored in data registers DT10 and DT11. The date and time resulting from the subtraction is stored in DT30 to DT32.

DT90054	H30	H24	1992, June,17th 10 hours 30 minutes 24 seconds
DT90055	H17	H10	
DT90056	H92	H06	
- (subtraction)			
DT10	H30	H30	3 hours 30 minutes 30 second earlier
DT11	H00	H03	
↓			
DT30	H59	H54	1992, June,17th 6 hours 59 minutes 54 seconds
DT31	H17	H06	
DT32	H92	H06	

■ Precautions for programming

Special data registers DT90054 to DT90056, in which the values of the built-in calendar timer are stored, cannot be specified directly for [D]. To change the values of the built-in calendar timer, store the addition results in a separate memory area, and then use the F0 MV instruction to transfer the values to DT90054 to DT90056.

■ Usage example: Calculating elapsed time

The F158 CSUB instruction can be used to calculate elapsed time. Using the calendar timer, the starting date and time and the ending date and time are stored in the data memory and the time that has elapsed between them is calculated.

This is explained using the example of calculating the stopped time for an operation that stopped at 08 hours, 02 minutes, and 15 seconds and restarted at 10 hours, 30 minutes, and 25 seconds.

This can be thought of as "subtracting 8 hours, 2 minutes, and 15 seconds from 10 hours, 30 minutes, and 25 seconds".

20.12 F158 CSUB (Date and Time Subtraction)

Start time [S2]	02	15	2 minutes, 15 seconds
	23	08	23rd day, 8 hours
	94	12	1994, December

Start time [S2]	30	25	30 minutes, 25 seconds
	23	10	23rd day, 10 hours
	94	12	1994, December

The data to be subtracted is taken from the starting date and time data as is shown below.

02	15	2 minutes, 15 seconds
00	08	8 hours

→ The part representing "day" is set to 0

↓ CSUB instruction executio

The result will be as follows.

[D]	02	10	2 minutes, 10 seconds
	23	02	23rd day, 2 hours
	94	12	1994, December

■ Data configuration of built-in calendar timer

	(Higher)	(Lower)
DT90054	Minutes	Seconds
DT90055	Day	Hours
DT90056	Year	Month

■ Flag operations

Name	Description
R9007 R9008 (ER)	Turns ON when the area is exceeded in index modification.
	Turns ON when the data specified by [S1] and [S2] is not BCD data
	Turns ON when the data specified by [S1] is not date and time data
	Turns ON when the data specified by [S2] is not time data

20.12 F158 CSUB (Date and Time Subtraction)

Name	Description
	Turns ON when the specified data exceeds the area

20.13 F160 DSQR (32-bit Data Square Root)

Calculates the square root of the specified 32-bit data.

■ **Instruction format**

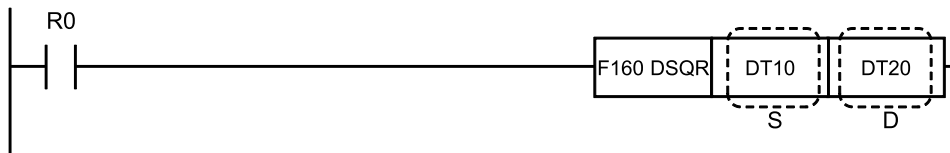

■ **Operands**

Items	Settings
S	Area storing the data for square root calculation, or constant data
D	Area storing the calculated square root

■ **Devices that can be specified (indicated by ●)**

Operands	WX	WY	WR	WL	SV	EV	DT	LD	I	SW R	SD T	Constant				Index modifier	Integer Device
												K	H	M	f		
S	●	●	●	●	●	●	●	●	●			●	●			●	
D		●	●	●	●	●	●	●	●							●	

■ **Outline of operation**

- Calculates the square root of the 32-bit data (K constant) stored in [S] and [S+1], then stores the result (K constant) in [D] and [D+1]. Fractions are rounded down.
 $\sqrt{[S]} \rightarrow [D]$

■ **Operation example**

Operation of instruction format description program

The square root ($\sqrt{\quad}$) of the 32-bit data stored in DT10 and DT11 is calculated and the result stored in DT20 and DT21 when internal relay R0 turns ON. When K64 is stored in DT10 to DT11, it will be as follows.

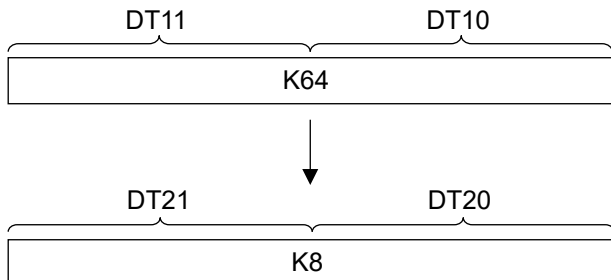

Finds the square root of 64, which is 8.

■ **Flag operations**

Name	Description
R9007	Turns ON when the area is exceeded in index modification.
R9008 (ER)	ON when the data specified by [S] is a negative value

(MEMO)

21 Communication Instruction

21.1 [F145 SEND] [F146 RECV] Instructions: Common Items.....	21-2
21.2 [F145 SEND] Data Transmission (MEWTOCOL-COM Master).....	21-4
21.3 [F146 RECV] Data Reception (MEWTOCOL-COM Master).....	21-7
21.4 [F145 SEND] Data Transmission (MODBUS Master: Function Code Specification).....	21-10
21.5 [F146 RECV] Data Reception (MODBUS Master: Function Code Specification)	21-12
21.6 [F145 SEND] Data Transmission (MODBUS Master).....	21-14
21.7 [F146 RECV] Data Reception (MODBUS Master).....	21-17
21.8 [F159 MTRN] Serial Data Send / Receive Instruction.....	21-20

21.1 [F145 SEND] [F146 RECV] Instructions: Common Items

Common items for SEND / RECV instructions are indicated.

■ System register settings

Using tool software, specify a communication mode for the COM port to be used.

Mode	System register No. 412
MEWTOCOL master	Computer link
MODBUS master	MODBUS RTU

■ Execution conditions for instructions

- Multiple SEND / RECV instructions cannot be executed at the same time to a single communication port. Create a program so that an instruction is executed when the SEND / RECV instruction execution flag is ON (1).

■ Confirmation of execution results of instructions

- While processing SEND / RECV instruction, only a Request to Send is issued. The actual transmission is performed when ED instruction is executed. Check the SEND / RECV instruction execution end flag to confirm the completion of transmission.
- When the instruction terminates abnormally, the SEND / RECV done flag turns ON. The error code is stored in the corresponding special data register. For details of error codes, refer to the error codes of each protocol.

■ Special relays / special data registers

	Operation	COM0	COM1	COM2	COM3	COM4
SEND/RECV instruction execution flag	0: Not executable 1: Executable	R9134	R913C (R9044)	R9144 (R904A)	R914C	R9154
SEND/RECV instruction execution end flag	0: Successful 1: Unsuccessful	R9135	R913D (R9045)	R9145 (R904B)	R914D	R9155
SEND/RECV instruction end code	When unsuccessful, an error code is stored.	DT90123	DT90124	DT90125	DT90127	DT90128

(Note 1) The Nos. in brackets indicate devices that are compatible with existing FP-X / FPsigma.

■ Timeout time setting

- Error code H73 indicates timeout waiting for a response.
- Timeout time can be changed in the area from 10.0 ms to 81.9 s (by 2.5 ms), using the system register No. 32. By default, the value is set to 10 s.
- In your program, be sure to wait for approx. the maximum scan time after transmission complete and before the next transmission, in the case of global transfer (transmission with H00 specified for unit No.).

- **Other restrictions**

This is not executable for special internal relays (R9000 onward) or for special data register (DT90000).

21.2 [F145 SEND] Data Transmission (MEWTOCOL-COM Master)

21.2 [F145 SEND] Data Transmission (MEWTOCOL-COM Master)

■ Instruction format

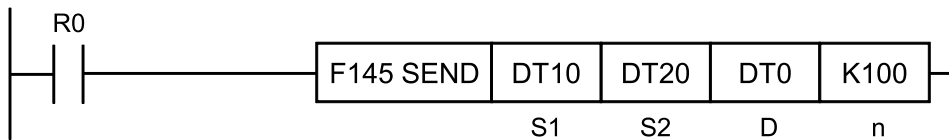

■ Devices that can be specified (indicated by ●)

Operands	WX	WY	WR	WL	SV	EV	DT	LD	In	SW R	SDT	Constant		Index modifier (Note 1)
												K	H	
S1	●	●	●	●	●	●	●	●		●	●			●
S2	●	●	●	●	●	●	●	●		●	●			●
D		●	●	●	●	●	●	●						
n		●	●	●	●	●	●	●				●	●	●

(Note 1) A character constant cannot be specified.

■ Operands

Operand	Settings		Setting range
S1	Specify the starting number of the area (2 words) that stores control data.		
	S1	Specify the transfer method. Word transfer: Specify the number of send words. Bit transfer: Specify the bit number of a master unit and that of a destination unit.	(Note 1)
	S1+1	Specify the COM port No. of a master unit and the unit number of a destination unit.	(Note 2)
S2	Specification of a master unit	Specify the area of a master unit that stores send data.	
D	Specification of a destination unit	Specify the area type of a destination unit that stores send data. The number is specified at 0.	
n	Specification of a destination unit	Specify the starting address of a destination unit that stores send data.	H0 to HFFFF

(Note 1) To [S1], the following specification should be applied. The specification method differs depending on word transfer and bit transfer.

21.2 [F145 SEND] Data Transmission (MEWTOCOL-COM Master)

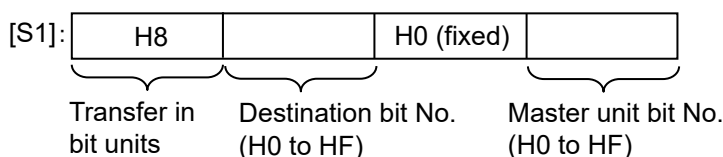
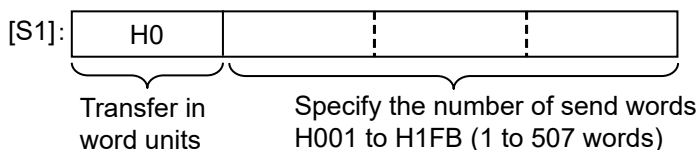

(Note 2) To [S1+1], the following specification should be applied.

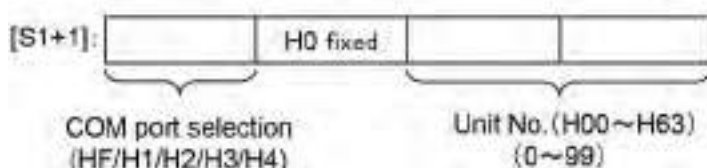

COM port selection (upper four bits)	HF	H1	H2	H3	H4
Port no.	COM0	COM1	COM2	COM3	COM4

■ Specifying the storage area of a destination unit by using [D] and [n]

Specify "0" for [D] as the device No.

Specify the memory area of a destination unit that stores sent data, by combining [D] (type) and [n] (address).

Example 1: [D]: DT0, [n]: K100

↓

DT100

Example 2: [D]: DT0, [n]: HFFF0

↓

DT65520

■ Flag operations

Name	Description
R9007 R9008 (ER)	Turns ON when the [S1] / [S1+1] control data value is outside the specified range.
	Turns ON when the [S2] or [D] area is exceeded, if the number of words specified in [S1] is taken during transfer in word units.
	Turns ON when [D]+[n] exceeds the [D] area
	Turns ON when the operation mode of the target COM port is other than computer link.
	Word unit <ul style="list-style-type: none"> • If [D] is DT / LD, turns ON when [n] is not from 0 to 99999. • If [D] is WY / WR / WL / SV / EV, turns ON when [n] is not from 0 to 9999.

21.2 [F145 SEND] Data Transmission (MEWTOCOL-COM Master)

Name	Description
	<p data-bbox="348 266 417 289">Bit unit</p> <ul data-bbox="348 297 768 355" style="list-style-type: none"><li data-bbox="348 297 768 320">• Turns ON when [D] is not WY / WR / WL.<li data-bbox="348 326 768 349">• Turns ON when [n] is not from 0 to 999. <hr/> <p data-bbox="348 369 754 392">Turns ON when the [D] device No. is not 0.</p> <hr/> <p data-bbox="348 411 1130 434">Turns ON when a Communication Cassette is not attached to the target COM port.</p>

21.3 [F146 RECV] Data Reception (MEWTOCOL-COM Master)

■ Instruction format

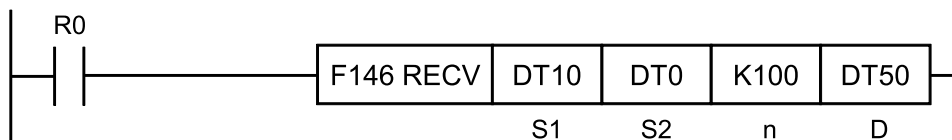

■ Devices that can be specified (indicated by ●)

Operands	WX	WY	WR	WL	SV	EV	DT	LD	In	SW R	SDT	Constant		Index modifier (Note 1)
												K	H	
S1	●	●	●	●	●	●	●	●		●	●			●
S2	●	●	●	●	●	●	●	●						
n		●	●	●	●	●	●	●				●	●	●
D		●	●	●	●	●	●	●						●

(Note 1) A character constant cannot be specified.

■ Operands

Operand	Settings		Setting range
S1	Specify the starting number of the area (2 words) that stores control data.		
	S1	Specify the transfer method. Word transfer: Specify the number of send words. Bit transfer: Specify the bit number of a master unit and that of a destination unit.	(Note 1)
	S1+1	Specify the COM port No. of a master unit and the unit number of a destination unit.	(Note 2)
S2	Specification of a destination unit	Specify the source data area of a destination unit. (Device No. is fixed to "0")	
n	Specification of a destination unit	Specify the starting address of the device in the source data area of a destination unit.	H0 to HFFFF
D	Specification of a master unit	Specify the device starting address of the receive data storage area in the master unit.	

(Note 1) To [S1], the following specification should be applied. The specification method differs depending on word transfer and bit transfer.

21.3 [F146 RECV] Data Reception (MEWTOCOL-COM Master)

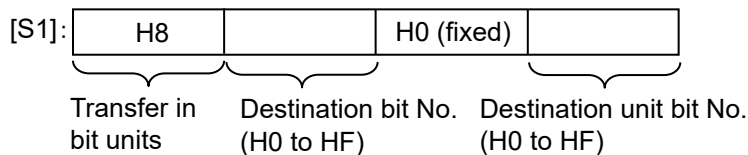
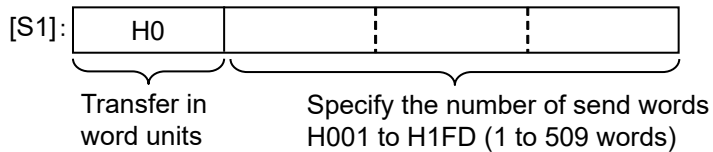

(Note 2) To [S1+1], the following specification should be applied.

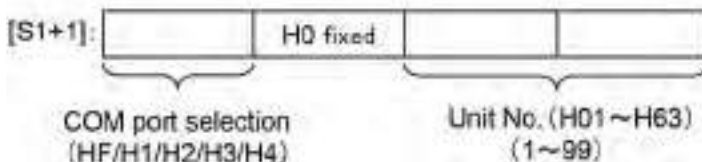

COM port selection (upper four bits)	HF	H1	H2	H3	H4
Port no.	COM0	COM1	COM2	COM3	COM4

■ Specifying [S2] as the starting address of the source data area

Specify "0" for [S2] as the device No. Specify the memory area of a destination unit that stores sent data, by combining [S2] (type) and [n] (address).

Example 1: [S2]: DT0, [n]: K100

↓
DT100

Example 2: [S2]: DT0, [n]: HFFF0

↓
DT65520

■ Flag operations

Name	Description
R9007 R9008 (ER)	Turns ON when the [S1] / [S1+1] control data value is outside the specified range.
	Turns ON when the [S2] or [D] area is exceeded, if the number of words specified in [S1] is taken during transfer in word units.
	Turns ON when [S2]+[n] exceeds the [S2] area.
	Turns ON when the operation mode of the target COM port is other than computer link.
	Word unit <ul style="list-style-type: none"> • If [S2] is DT / LD, turns ON when [n] is not from 0 to 99999. • If [S2] is WX / WY / WR / WL / SV / EV, turns ON when [n] is not from 0 to 9999. Bit unit

21.3 [F146 RECV] Data Reception (MEWTOCOL-COM Master)

Name	Description
	<ul style="list-style-type: none">• Turns ON when [S2] is not WX / WY / WR / WL.• Turns ON when [n] is not from 0 to 999.
	Turns ON when the [S2] device No. is not 0.
	Turns ON when a Communication Cassette is not attached to the target COM port.

21.4 [F145 SEND] Data Transmission (MODBUS Master: Function Code Specification)

21.4 [F145 SEND] Data Transmission (MODBUS Master: Function Code Specification)

■ Instruction format

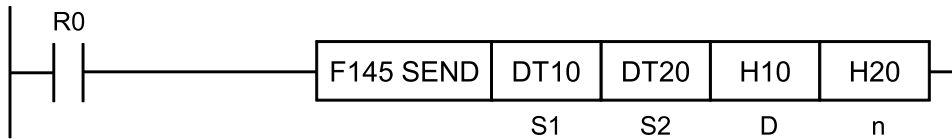

■ Devices that can be specified (indicated by ●)

Operands	WX	WY	WR	WL	SV	EV	DT	LD	In	SW R	SDT	Constant		Index modifier (Note 1)
												K	H	
S1	●	●	●	●	●	●	●	●		●	●	●	●	●
S2	●	●	●	●	●	●	●	●		●	●			●
D		●	●	●	●	●	●	●				●	●	
n		●	●	●	●	●	●	●				●	●	●

(Note 1) A character constant cannot be specified.

■ Operands

Item	Settings	Setting range
S1	Specify the COM port No. of a master unit, MODBUS command to be sent, and the unit number of a destination unit.	(Note 1)
S2	Specification of a master unit Operation memory area that stores data to be sent.	(Note 2)
D	Specification of a destination unit Specify a MODBUS address ^(Note 3)	H0 to HFFFF
n	Specification of a destination unit Specify the number of sent data. ^{(Note 2)(Note 4)}	1 to 127 words 1 to 2040 bits

(Note 1) In [S1], specify the combination of the COM port No. of a master unit, MODBUS function code and the unit number of a destination unit. When the COM port No. is 0, specify HF for the highest digit.

Example: In the case of COM port 1, MODBUS function code 6, and destination unit No. 10, specify H160A.

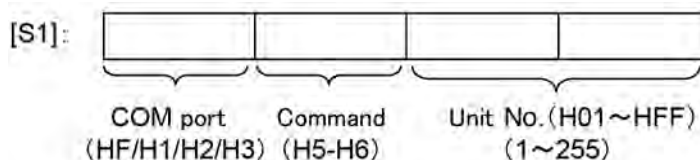

21.4 [F145 SEND] Data Transmission (MODBUS Master: Function Code Specification)

COM port selection (upper four bits)	HF	H1	H2	H3
Port no.	COM0	COM1	COM2	COM3

(Note 2) Depending on the operation memory type specified in operand [S1] and the number of send data specified in operand [n], the transfer method and the function code of MODBUS command to be sent vary.

Device type specified in [S2]	Transfer method	Send No. of data [n]	MODBUS command to be sent
16-Bit device: WX, WY, WR, WL, DT, LD	Register transmission	1	Preset single register (06)
		2 to 127	HF: Force multiple coils (15) H10: Preset multiple registers (16)
1-bit device X, Y, R, L	Bit transmission	1	H5: Force single coil (05)
		2 to 2040	HF: Force multiple coils (15):

(Note 3) When "0" is specified for the destination unit number, global transfer is applied. In this process, there is no response message from a destination unit.

(Note 4) For the number of send data [n], specify the number of words in the case of register transfer, and specify the number of bits in the case of bit transfer.

■ Flag operations

Name	Description
R9007 R9008 (ER)	Turns ON when the [S1] control data value is outside the specified range.
	Turns ON when the COM port specification of control data specified in [S1] is not MODBUS mode.
	Turns ON when the number of send data [n] is 0.
	Turns ON when the number of send data is negative.
	Turns ON when the number of send data [n] exceeds the operation memory area specified in [S2].
	Turns ON when the number of send data [n] exceeds limitation in MODBUS specification.

21.5 [F146 RECV] Data Reception (MODBUS Master: Function Code Specification)

21.5 [F146 RECV] Data Reception (MODBUS Master: Function Code Specification)

■ Instruction format

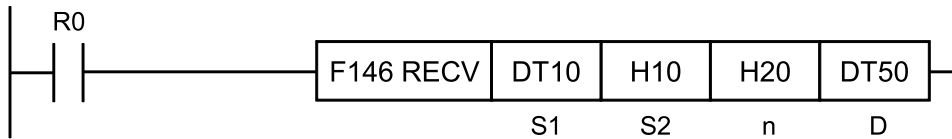

■ Devices that can be specified (indicated by ●)

Operands	WX	WY	WR	WL	SV	EV	DT	LD	In	SW R	SDT	Constant		Index modifier (Note 1)
												K	H	
S1	●	●	●	●	●	●	●	●		●	●	●	●	●
S2	●	●	●	●			●	●				●	●	
n		●	●	●	●	●	●	●				●	●	●
D		●	●	●	●	●	●	●						●

(Note 1) A character constant cannot be specified.

■ Operands

Item	Settings	Setting range
S1	Specify the COM port No. of a master unit, MODBUS command to be sent, and the unit number of a destination unit.	(Note 1)
S2	Specification of a destination unit Specify a MODBUS address	H0 to HFFFF
n	Specification of a destination unit Specify the number of received data. (Note 2)	1 to 127 words 1 to 2040 bits
D	Specification of a master unit Operation memory area that stores receive data. (Note 3)	

(Note 1) In [S1], specify the combination of the COM port No. of a master unit, MODBUS function code and the unit number of a destination unit. When the COM port No. is 0, specify HF for the highest digit.

Example: In the case of COM port No. 1, MODBUS function code 3, and destination unit No. 10, specify H130A.

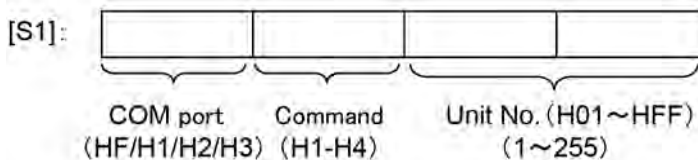

21.5 [F146 RECV] Data Reception (MODBUS Master: Function Code Specification)

COM port selection (upper four bits)	HF	H1	H2	H3
Port no.	COM0	COM1	COM2	COM3

(Note 2) For the number of receive data [n], specify the number of words in the case of register transfer, and specify the number of bits in the case of bit transfer.

(Note 3) Depending on the operation memory type specified in operand [D], and the number of receive data specified in operand [n], the transfer method and the function code of MODBUS command vary.

Device specified in [D]	Transfer method	MODBUS command to be sent
16-Bit device: WX, WY, WR, WL, DT, LD	Register transmission	H1: Read coil state (01) H2: Read input state (02) H3: Read hold register (03) H4: Read input register (04)
1-bit device X, Y, R, L	Bit transmission	H1: Read coil state (01) H2: Read input state (02)

■ Flag operations

Name	Description
R9007 R9008 (ER)	Turns ON when the [S1] control data value is outside the specified range.
	Turns ON when the COM port specification of control data specified in [S1] is not MODBUS mode.
	Turns ON when the number of receive data [n] is 0
	Turns ON when the number of receive data is negative
	Turns ON when the number of receive data [n] exceeds MODBUS specification
	Turns ON when the operation memory area specified in [D] is exceeded if the number of receive data [n] is received.

21.6 [F145 SEND] Data Transmission (MODBUS Master)

21.6 [F145 SEND] Data Transmission (MODBUS Master)

■ Instruction format

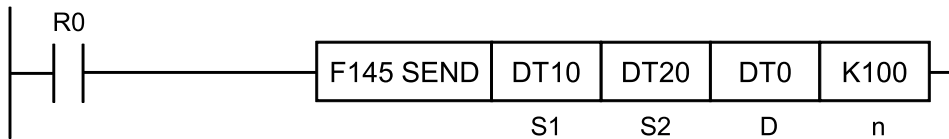

■ Devices that can be specified (indicated by ●)

Operands	WX	WY	WR	WL	SV	EV	DT	LD	In	SW R	SDT	Constant		Index modifier (Note 1)
												K	H	
S1	●	●	●	●	●	●	●	●		●	●			●
S2	●	●	●	●	●	●	●	●		●	●			●
D		●	●				●							
N		●	●	●	●	●	●	●				●	●	●

(Note 1) A character constant cannot be specified.

■ Operands

Operand	Settings	Remarks	
S1	Specify the starting number of the area (2 words) that stores control data.		
	S1	Specify the transfer method. Word transfer: Specify the number of send words. Bit transfer: Specify the bit number of a master unit and that of a destination unit.	(Note 1)(Note 4)
	S1+1	Specify the COM port No. of a master unit and the unit number of a destination unit.	(Note 2)(Note 3)
S2	Specification of a master unit	Specify the area of a master unit that stores send data. (Note 4)	
D	Specification of a destination unit	Specify the area type of a destination unit that stores send data. The number is specified at 0. (Note 5)	
n	Specification of a destination unit	Specify the starting address of a destination unit that stores send data. (Note 5)	

(Note 1) To [S1], the following specification should be applied. The specification method differs depending on word transfer and bit transfer.

21.6 [F145 SEND] Data Transmission (MODBUS Master)

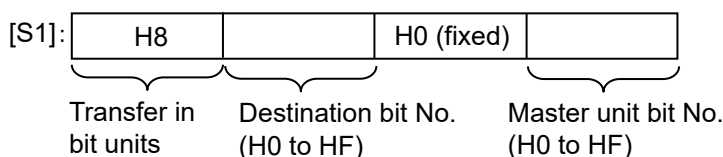
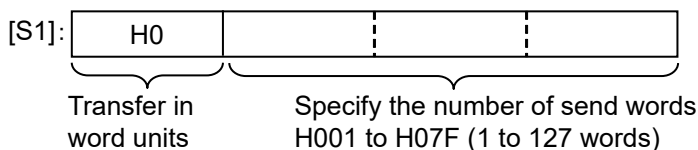

(Note 2) To [S1+1], the following specification should be applied.

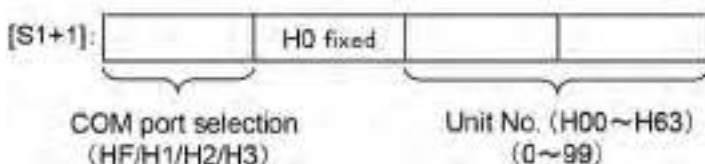

COM port selection (upper four bits)	HF	H1	H2	H3
Port no.	COM0	COM1	COM2	COM3

(Note 3) When "0" is specified for the destination unit number, global transfer is applied. In this process, there is no response message from a destination unit.

(Note 4) Depending on the transfer method specified for operand [S1] and the device type specified for operand [S2], the function code of MODBUS command to be sent varies.

Device type specified in [S2]	Transfer method specified in [S1]	MODBUS function code to be sent
16-Bit device: WX, WY, WR, WL, DT, LD	Register transmission	Force multiple coils (15) Preset multiple registers (16)
1-bit device X, Y, R, L	Bit transmission	Force multiple coils (15)

(Note 5) The area of the destination unit is specified by the combination of operands [D] and [n].
When [D] = DT0 and [n] = K100, the memory area of the destination unit starts with DT100.

■ Flag operations

Name	Description
R9007 R9008 (ER)	Turns ON when the [S1] / [S1+1] control data value is outside the specified range.
	Turns ON when the [S2] or [D] area is exceeded, if the number of words specified in [S1] is taken during transfer in word units.
	Turns ON when [D]+[n] exceeds the [D] area
	Turns ON when the COM port specification of control data specified in [S1+1] is not MODBUS mode.
	Turns ON when the [D] area is DT during transfer in bit units.

21.6 [F145 SEND] Data Transmission (MODBUS Master)

Name	Description
	Turns ON when the [D] device No. is not 0.

Info.

- This is convenient to write data into Panasonic's PLC via MODBUS RTU.
- For MODBUS reference Nos. and device Nos., refer to "[Device No. Correspondence Table](#)".

21.7 [F146 RECV] Data Reception (MODBUS Master)

■ Instruction format

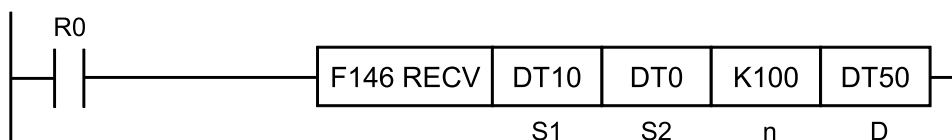

■ Devices that can be specified (indicated by ●)

Operands	WX	WY	WR	WL	SV	EV	DT	LD	In	SW R	SDT	Constant		Index modifier (Note 1)
												K	H	
S1	●	●	●	●	●	●	●	●		●	●			●
S2	●	●	●	●			●	●						
n		●	●	●	●	●	●	●				●	●	●
D		●	●	●	●	●	●	●						●

(Note 1) A character constant cannot be specified.

■ Operands

Operand	Settings		Remarks
S1	Specify the starting number of the area (2 words) that stores control data.		
	S1	Specify the transfer method. Word transfer: Specify the number of send words. Bit transfer: Specify the bit number of a master unit and that of a destination unit.	(Note 1)(Note 3)
	S1+1	Specify the COM port No. of a master unit and the unit number of a destination unit.	(Note 2)
S2	Specification of a destination unit	Specify the source data area of a destination unit. (Device No. is fixed to "0")	(Note 4)
n	Specification of a destination unit	Specify the starting address of the device in the source data area of a destination unit.	(Note 4)
D	Specification of a master unit	Specify the device starting address of the receive data storage area in the master unit.	(Note 3)

(Note 1) To [S1], the following specification should be applied. The specification method differs depending on word transfer and bit transfer.

21.7 [F146 RECV] Data Reception (MODBUS Master)

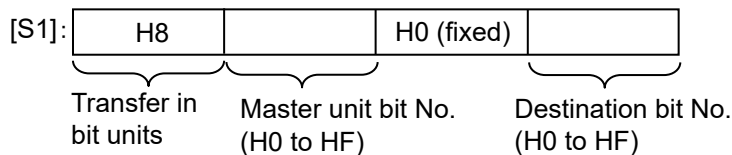
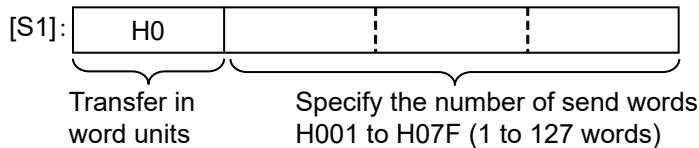

(Note 2) To [S1+1], the following specification should be applied.

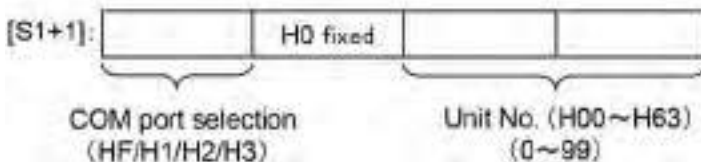

COM port selection (upper four bits)	HF	H1	H2	H3
Port no.	COM0	COM1	COM2	COM3

(Note 3) Depending on the transfer method specified for operand [S1] and the device type specified for operand [D], the function code of MODBUS command to be sent varies.

Device type specified in [D]	Transfer method specified in [S1]	MODBUS function code to be sent
16-bit device: WX, WY, WR, WL, DT, LD	Register transmission	H1: Read coil state (01) H2: Read input state (02) H3: Read hold register (03) H4: Read input register (04)
1-bit device X, Y, R, L	Bit transmission	H1: Read coil state (01) H2: Read input state (02)

(Note 4) The area of the destination unit is specified by the combination of operands [S2] and [n].
When [S2] = DT0 and [n] = K100, the memory area of the destination unit starts with DT100.

■ Flag operations

Name	Description
R9007 R9008 (ER)	Turns ON when the [S1] / [S1+1] control data value is outside the specified range.
	Turns ON when the [S2] or [D] area is exceeded, if the number of words specified in [S1] is taken during transfer in word units.
	Turns ON when [S2]+[n] exceeds the [S2] area.
	Turns ON when the COM port specification of control data specified in [S1+1] is not MODBUS mode.
	Turns ON when the [S2] area is DT / WL / LD, during transfer in bit units.

21.7 [F146 RECV] Data Reception (MODBUS Master)

Name	Description
	Turns ON when the [S2] device No. is not 0.

Info.

- This is convenient to read data from Panasonic PLC via MODBUS-RTU.
- For MODBUS reference Nos. and device Nos., refer to "[Device No. Correspondence Table](#)".

21.8 [F159 MTRN] Serial Data Send / Receive Instruction

■ **Instruction format**

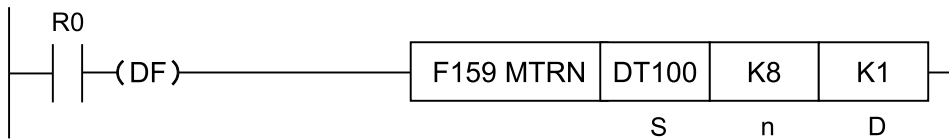

■ **Devices that can be specified (indicated by ●)**

Operands	WX	WY	WR	WL	SV	EV	DT	LD	I	Constant		Index modifier (Note 1)
										K	H	
S							●					●
n	●	●	●	●	●	●	●	●	●	●	●	●
D										●		●

(Note 1) A character constant cannot be specified.

■ **Operands**

Item	Settings
S	Starting area (data register) of the data table
n	Area storing the number of bytes of data to be sent, or constant data <ul style="list-style-type: none"> ● Add the terminator (end code) during transmission when the value is positive. ● Do not add the terminator (end code) during transmission when the value is negative. ● In the case of H8000, the purpose of COM port is switched.
D	COM port number for sending data (K0: COM0; K1: COM1; K2: COM2; K3: COM3)

■ **Outline of operation**

Data is sent or received with an external device connected to the COM port. F159 (MTRN) instruction has the following three functions.

Item	Description
Send	In the data register starting with [S], data to be sent to an external device is set as a table in advance. By executing the [F159 MTRN] instruction, data of [n] bytes is sent from the COM port to an external device.
Receive	Data sent to COM port is stored in the receive buffer (data register DT) specified by the system register. Once the reception is done, the “reception done flag” turns on, and disables further reception. When the [F159 MTRN] instruction is executed, the “reception done flag” turns OFF, and enables reception. The F159 (MTRN) instruction is used to turn OFF the reception done flag for general-purpose communication (i.e. to enable reception).
Operation mode switching	Operation mode of COM port can be switched between “general-purpose communication mode” and “computer link mode”.

■ System register settings

- Using the system register, it is required to set to “general-purpose communication mode” in COM port.
- Using the system register, it is required to align the baud rate and transmission format with an external device.
- To secure an area for storing receive data in the data register (DT), it is required to specify “Receive buffer starting number in general-purpose communication” and “Receive buffer capacity in general-purpose communication” using the system register.

■ Related flag / system register No.

	Operation	COM0	COM1	COM2	COM3
Communication error flag	0: Normal 1: Error	R9130	R9138	R9140	R9148
Operation mode flag	0: Other than general-purpose communication 1: General-purpose communication	R9131	R9139	R9141	R9149
Reception done flag	0: Reception enabled 1: Reception disabled (reception done)	R9132	R913A	R9142	R914A
Transmission done flag	0: Transmission in progress 1: Transmission done (transmission enabled)	R9133	R913B	R9143	R914B
Receive buffer starting number	Specify the DT range to be used as a receive buffer, using the system register.	No.420	No.416	No.418	No.422
Receive buffer capacity		No.421	No.417	No.419	No.423

■ Creation of send data table [S]

- Send data is stored as follows in a given memory area (e.g. data register DT). The number of send data bytes [n] is automatically added to the starting word. Send data should be stored in [S+1] and later.
- Do not include the terminator in the send data. The terminator is added automatically. When no terminator is to be added during transmission, specify a negative value for [n]. Alternatively, select “None” from the terminator setting in the system register.
- When the header (start code) is set to “STX” in system register, do not add the header to send data. The header is added automatically.

Example: When 8-byte data “ABCDEFGH” is sent with [S] as DT100

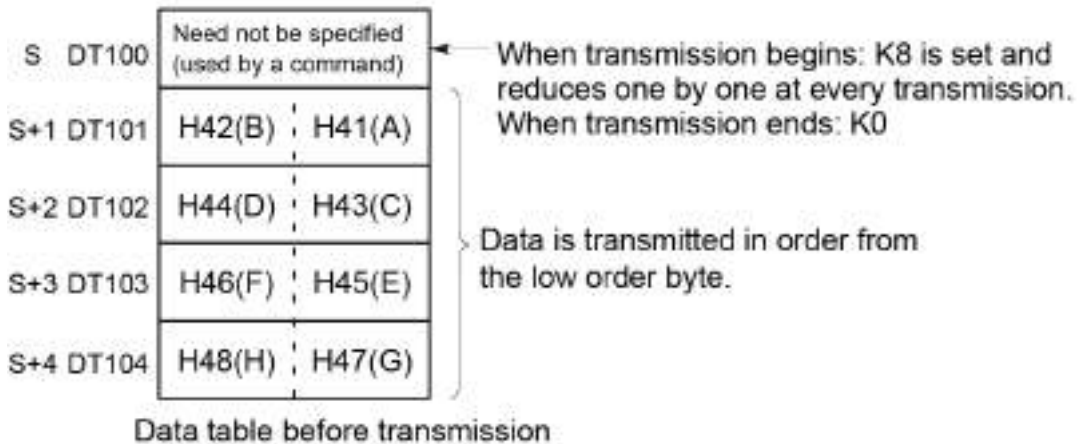

■ **Precautions during programming**

- F159 (MTRN) instruction should be executed after confirming that the transmission done flag for the target COM port has turned ON.
- The maximum data that can be sent in a single session is 2,048 bytes.

■ **Structure of receive data**

Receive data is stored in the receive buffer (data register DT) specified in the system register. The number of receive data bytes is stored in the starting word.

Example: When 8-byte data “ABCDEFGH” is received

Specify 200 for the “receive buffer starting number”, and 5 for the “receive buffer capacity”, in the system register.

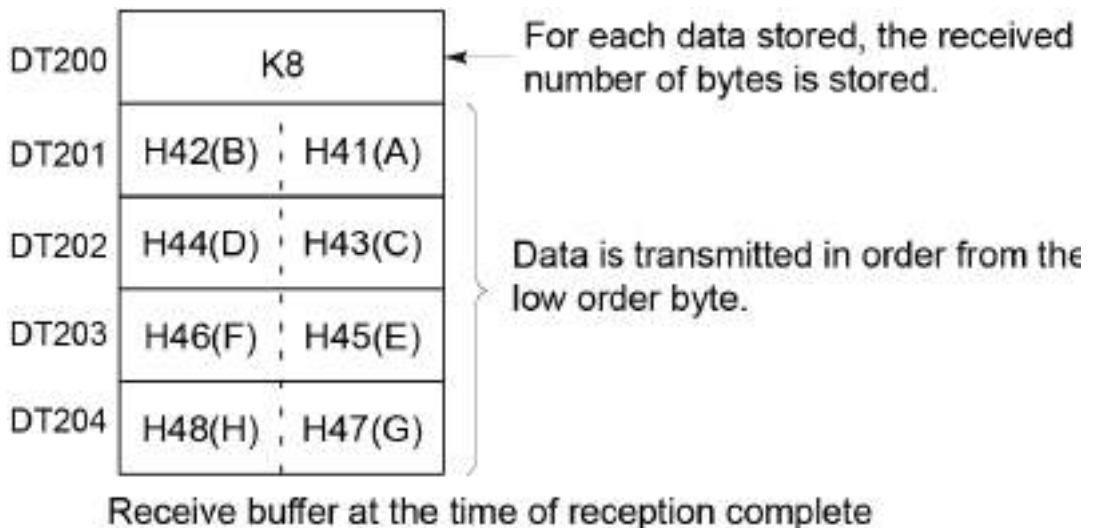

■ Operations when data is received

When the reception done flag is OFF, operation takes place as follows when data is sent from an external device.

	Item	Description
(1)	Storage of receive data	Incoming data is stored in ascending order from the lower-order byte of the 2nd-word area of the receive buffer. Header and terminator (start and end codes) are not stored.
(2)	Reception done flag ON	When the terminator (end code) is received, the reception done flag turns ON. Reception of any further data is prohibited.
(3)	Execute F159 (MTRN) instruction	When an F159 (MTRN) instruction is executed, the reception done flag turns OFF. The number of received bytes in the receive buffer starting number is cleared. Data in the receive buffer is not cleared.
(4)	Storage of the following receive data	Reception is enabled when the reception done flag turns OFF, and the storage of receive data is restarted.

■ Flag operations

Name	Description
R9007	Turns ON when the area is exceeded in index modification
R9008 (ER)	Turns ON when the data table exceeds the area in the specification of bytes in [n].

(MEMO)

22 Sampling Trace Instructions

22.1 Sampling Trace	22-2
22.2 F155 SMPL (Sampling).....	22-3
22.3 F156 STRG (Sampling trigger)	22-4

22.1 Sampling Trace

This is a function used to sample the ON/OFF status of registered contacts and the data stored in the registers, either periodically or when the appropriate conditions have been established, and store the results in memory. This function can be used to confirm changes in the data.

- 16 contacts and up to three words for registers can be registered.

1 2 Procedure

- 1.** Specify registration of the data to be sampled and the sampling method (such as the number of times or the time interval).
- 2.** Instruct the sampling trace to begin.
- 3.** Execute sampling.
Sampling can be executed as periodic sampling or according to the F155 (SMPL) instruction.
- 4.** Stop the sampling trace.
Apply a stop command trigger by using a programming tool software online operation or by executing the F156 (STRG) instruction. When the trigger is applied, the sampling trace is stopped after sampling of the specified delay count is performed. The programming tool software can also be used to initiate a forced stop.)
- 5.** The programming tool software can be used to read the sampling results from the control unit, and to monitor and confirm them.

22.2 F155 SMPL (Sampling)

Performs sampling when a sampling trace is executed.

■ Instruction format

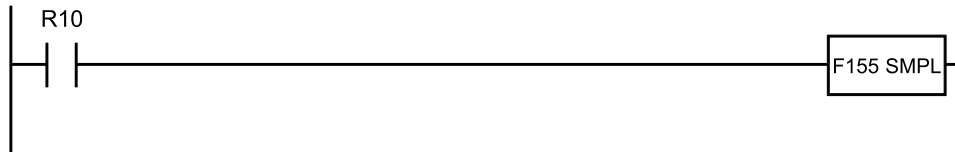

■ Outline of operation

- During a sampling trace, sampling is performed on the specified data (contacts and registers), and the executed data content is stored in the sampling trace memory.
- If the sampling trace settings and startup have not been specified by using the programming tool software, processing is not performed even if the internal relay condition is established.

■ Operation example

Operation of instruction format description program

When the internal relay R10 is ON, sampling is performed on previously registered contacts or registers.

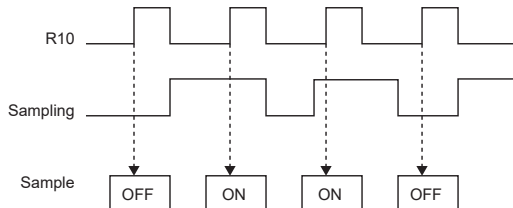

Registration of the data to be sampled, specification of the sampling method (such as the cable and the time interval), and specification of the command to start a sampling trace can only be performed by using the programming tool software.

22.3 F156 STRG (Sampling trigger)

22.3 F156 STRG (Sampling trigger)

Applies a stop command trigger during sampling trace execution.

■ Instruction format

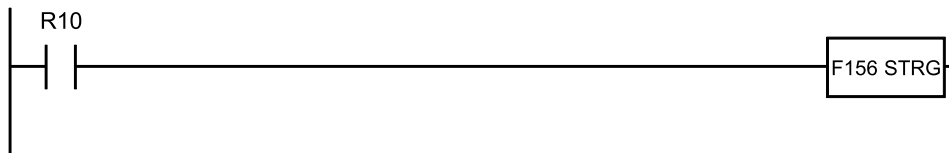

■ Outline of operation

- This instruction applies a sampling trace stop command trigger. When the trigger is applied, the sampling trace is stopped after sampling of the specified delay count is performed.
- If the sampling trace settings and startup have not been specified by using the programming tool software, processing is not performed even if the internal relay condition is established.

■ Operation example

Operation of instruction format description program

When internal relay R10 turns ON, a sampling trace stop command trigger is applied.

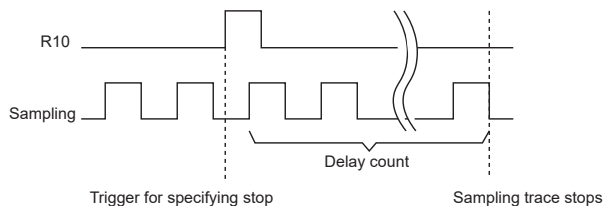

Registration of the data to be sampled, specification of the sampling method (such as the cable and the time interval), and specification of the command to start a sampling trace can only be performed by using the programming tool software.

23 High-speed Counter Instruction

23.1 [F0 MV] High-speed Counter Control Instruction	23-2
23.2 [F1 DMV] Elapsed Value Write / Read Instruction	23-4
23.3 [F166 HC1S] High-speed Counter Target Value Match ON Instruction and [F167 HC1R] High-speed Counter Target Value Match OFF Instruction	23-5
23.4 Sample Program (Positioning Operation With Inverter: Single- Speed)	23-7
23.5 Sample Program (Positioning Operation With Inverter: Double- Speed)	23-9

23.1 [F0 MV] High-speed Counter Control Instruction

23.1 [F0 MV] High-speed Counter Control Instruction

Performs the controls such as the software reset, disabling the count and clearing the high-speed counter instruction.

■ Instruction format

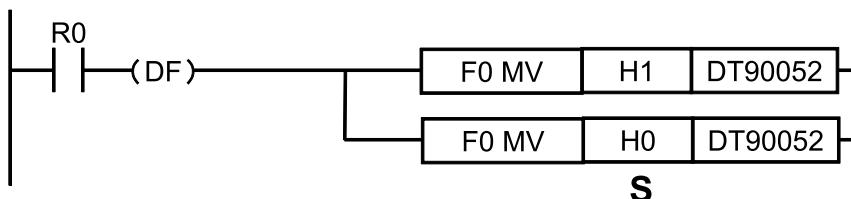

■ Operand

Operand	Settings
S	Area storing the control code of the high-speed counter or constant data

■ Memory area type that can be specified

Operand	WX	WY	WR	WL	SV	EV	DT	LD	I	Constant		Index modifier
										K	H	
S	•	•	•	•	•	•	•	•	•	•	•	•

■ Outline of operation

- Performs the high-speed counter control according to the control code specified by [S].
- This instruction is used when performing the following operations with the high-speed counter.
 1. When performing the software reset
 2. When disabling the count
 3. When disabling the reset input by an external input temporarily
 4. When canceling the control executed by the high-speed counter instruction F165 (CAM0) / F166 (HC1S) / F167 (HC1R) or when clearing the target value match interrupt
- The control codes once written are held until the next writing.
- The control code written by the F0 (MV) instruction is written to the special data register DT90052. At the same time, it is written to the control code monitor area. The written data is the data for lower 8 bits only.

■ Precautions during programming

- The setting of disabling the reset input is valid only when allocating the reset input in the system register.
- In the external reset input setting for the transistor output type, the reset input (X6 or X7) allocated to the Control Unit input is switched between enable and disable. In the reset input setting for the relay output type, the pulse I/O cassette reset input (X102 or X202) allocated in the high-speed counter setting of the system register is switched between enable and disable.

■ Allocation of control codes

- The following bits are allocated according to the specified channel and functions

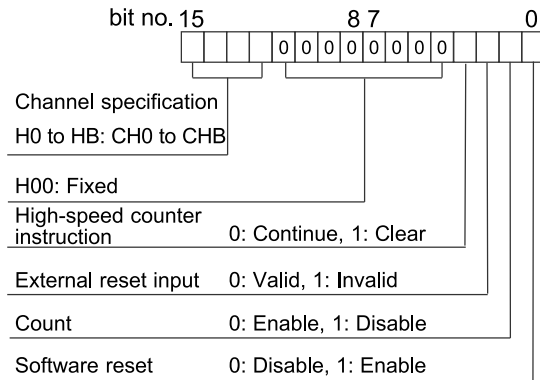

- When controlling the above functions using external inputs, arbitrary inputs can be allocated.

■ Example of program

The following example shows the program for performing the software reset of the high-speed counter CH0 using the input X7.

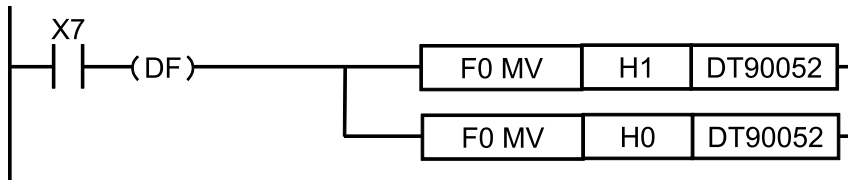

i Info.

- For details of the allocations of I/O and flags, refer to "Allocation of Memory Areas".

23.2 [F1 DMV] Elapsed Value Write / Read Instruction

23.2 [F1 DMV] Elapsed Value Write / Read Instruction

Writes and reads the elapsed value of the high-speed counter / pulse output.

■ Instruction format

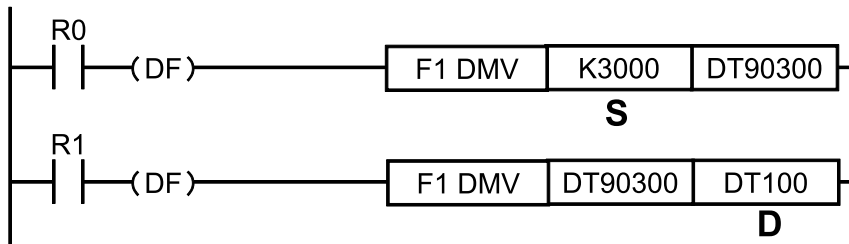

■ Operand

Operand	Settings
S	When setting: Area storing the elapsed value (32-bit) set in the high-speed counter / pulse output or constant data K-2,147,483,648 to K2,147,483,647
D	When reading: Area reading the elapsed value of the high-speed counter / pulse output

■ Memory area type that can be specified

Operand	WX	WY	WR	WL	SV	EV	DT	LD	I	Constant		Index modifier
										K	H	
S	•	•	•	•	•	•	•	•	•	•	•	•
D	-	•	•	•	•	•	•	•	•	-	-	•

■ Outline of operation (Reading elapsed value)

- Reads the content of the special data register storing the elapsed value of the high-speed counter / pulse output and writes to the area specified by [D].

■ Outline of operation (Setting elapsed value)

- At the same time as writing the value to the elapsed value area of the high-speed counter / pulse output which uses 32-bit data specified by [S], sets it in the elapsed value area of the high-speed counter used within the system.

■ Precautions during programming

- Only F1 (DMV) instruction can perform the writing. The writing cannot be performed by other high-level instructions such as transfer instruction F0 (MV) and arithmetic instructions.
- Specify the memory area of [S] or [D] with the memory area number for the lower 16 bits.

i Info.

- For details of the allocations of I/O and flags, refer to “Allocation of Memory Areas”.

23.3 [F166 HC1S] High-speed Counter Target Value Match ON Instruction and [F167 HC1R] High-speed Counter Target Value Match OFF Instruction

23.3 [F166 HC1S] High-speed Counter Target Value Match ON Instruction and [F167 HC1R] High-speed Counter Target Value Match OFF Instruction

Turns ON or OFF the specified output when the elapsed value of the high-speed counter matches the target value set by the operand.

■ Instruction format

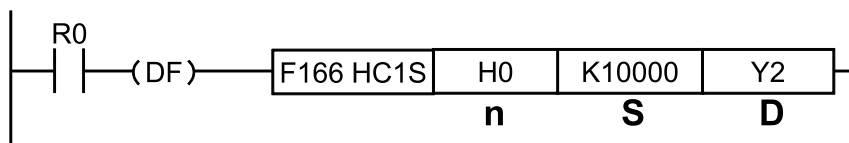

■ Operand

Operand	Settings
n	Target channel number of the high-speed counter for the match output
S	Target value data of the high-speed counter or the starting number of the area storing data
D	Output coil which turns ON or OFF when the values match (Y0 to Y29F)

■ Memory area type that can be specified

Operand	WX	WY	WR	WL	SV	EV	DT	LD	I	Constant		Index modifier
										K	H	
n	-	-	-	-	-	-	-	-	-	•	•	-
S	•	•	•	•	•	•	•	•	•	•	•	•
D	-	-	-	-	-	-	-	-	-	-	-	-

■ Outline of operation

- Sets the value specified by [S] as the target value of the high-speed counter, and controls the specified output [Yn] when the elapsed value matches the target value. This operation is executed as an interrupt processing.
- In the case of [F166 HC1S] instruction, the output turns ON from OFF. In the case of [F167 HC1R] instruction, the output turns OFF from ON.
- Stores the value of [S] in the target value area when the instruction is executed.
- Clears the setting of the target value and the control of the target value match output when the value matches the target value.
- For resetting the output turned ON/OFF when the values match, use the RST instruction or F0 (MV) instruction, or use the F166 (HC1R) instruction and F167 (HC1R) instruction in a pair.

■ Example of program

The following example shows the program for setting the output Y0 when the elapsed value of the high-speed counter CH0 matches K10000.

23.3 [F166 HC1S] High-speed Counter Target Value Match ON Instruction and [F167 HC1R] High-speed Counter Target Value Match OFF Instruction

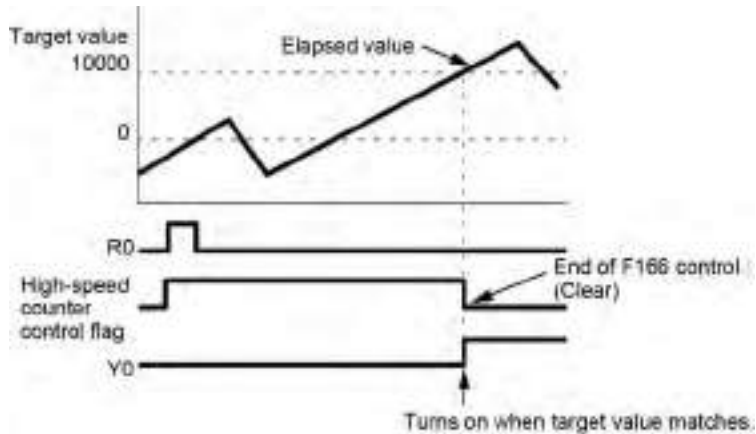
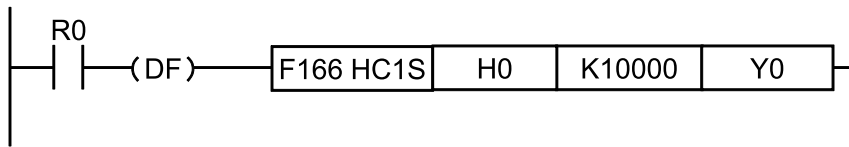

■ Precautions during programming

- The high-speed counter control active flag turns ON until the value matches the target value after the execution condition of the instruction has turned ON. During this processing, the high-speed counter instruction F165 (CAM0) / F166 (HC1S) / F167 (HC1R) cannot be executed for the high-speed counter of the same channel.
- When the hardware reset is performed before the elapsed value matches the target value, the elapsed value will be reset. However, the settings of the target value and the target value match output will not be cleared.
- For the output Y specified for the target value match output, it is not checked whether the output is overlapped with the OT, KP and other high-level instructions.
- When describing the same channel in both the normal program and the interrupt program, be sure to program not to execute them simultaneously.

i Info.

- For details of the allocations of I/O and flags, refer to "Allocation of Memory Areas".

23.4 Sample Program (Positioning Operation With Inverter: Single-Speed)

Counts the feedback signals from the encoder with the high-speed counter. The operation of the inverter stops when the count value reaches 5000.

■ Wiring example

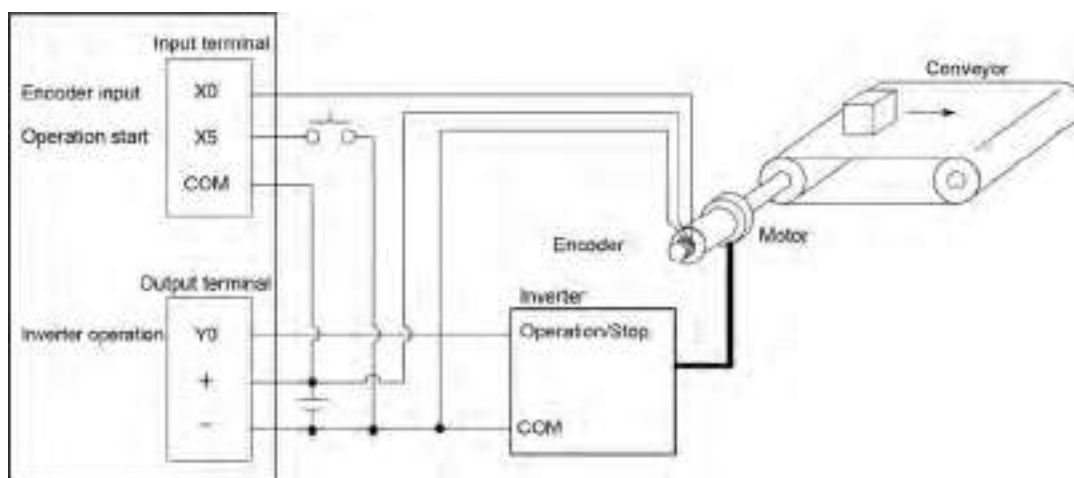

■ Operation chart



■ I/O allocation table

I/O No.	Description	I/O No.	Description
X0	Encoder input	R100	Positioning operation is running
X5	Operation start signal	R101	Positioning operation starts
Y0	Inverter operation signal	R102	Positioning done pulse
-		R9110	High-speed counter CH0 control active flag

23.4 Sample Program (Positioning Operation With Inverter: Single-Speed)

■ Sample program

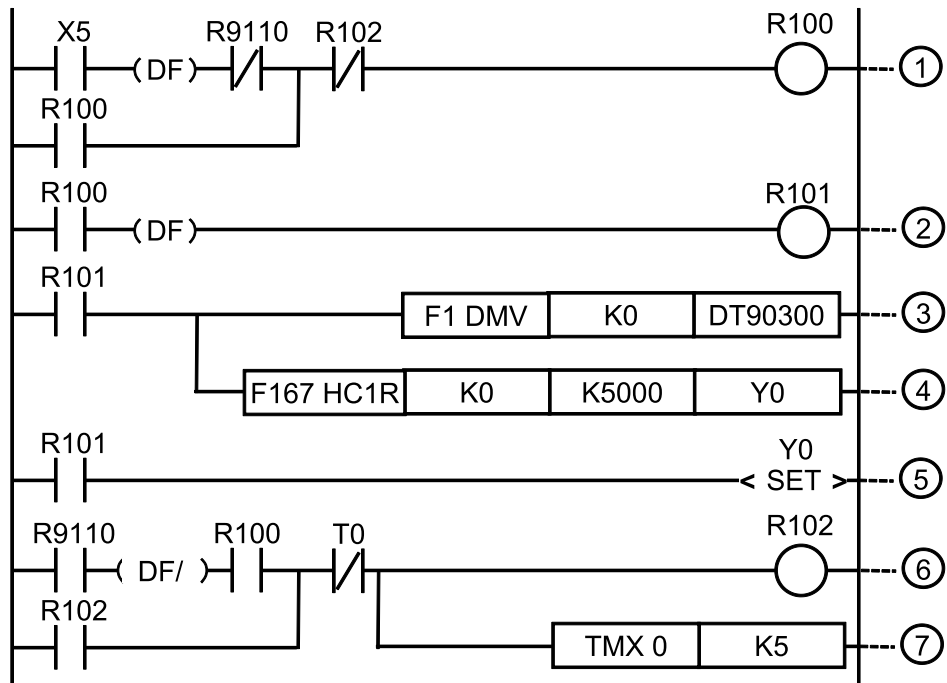

(1)	Positioning operation is running
(2)	Positioning operation starts
(3)	Resets the elapsed value of the high-speed counter CH0.
(4)	Target value match OFF instruction: Y0 turns OFF when the elapsed value of the high-speed counter reaches 5000 pulses.
(5)	Sets the inverter operation signal Y0.
(6)	Positioning done pulse (0.5 sec)
(7)	Sets 0.5 sec with 0.1-second timer.

23.5 Sample Program (Positioning Operation With Inverter: Double-Speed)

Counts the feedback signals from the encoder with the high-speed counter. Switches the inverter operation to low speed operation when the count value reaches 4500. The operation of the inverter stops when the count value reaches 5000.

■ Wiring example

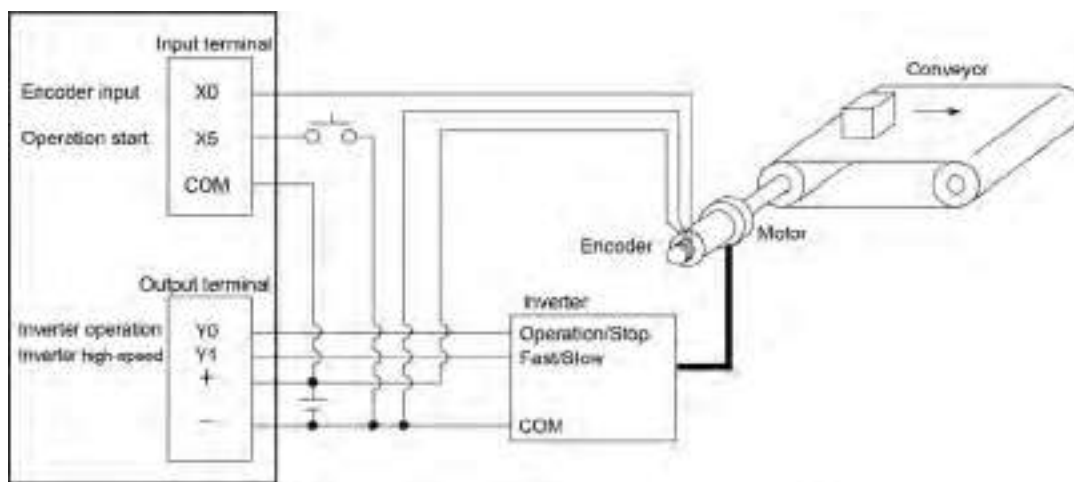

■ Operation chart

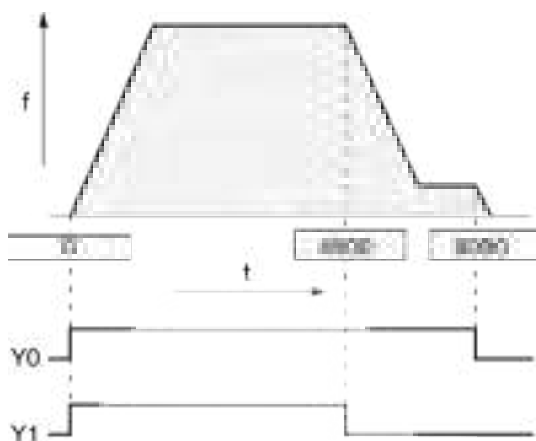

■ I/O allocation table

I/O No.	Description	I/O No.	Description
X0	Encoder input	R100	Positioning operation is running
X5	Operation start signal	R101	Arrival at deceleration point
Y0	Inverter operation signal	R102	Positioning operation starts
Y1	Inverter high-speed signal	R103	Positioning done pulse

23.5 Sample Program (Positioning Operation With Inverter: Double-Speed)

I/O No.	Description	I/O No.	Description
-		R900C	Comparison instruction < Flag
		R9110	High-speed counter CH0 control active flag

■ Sample program

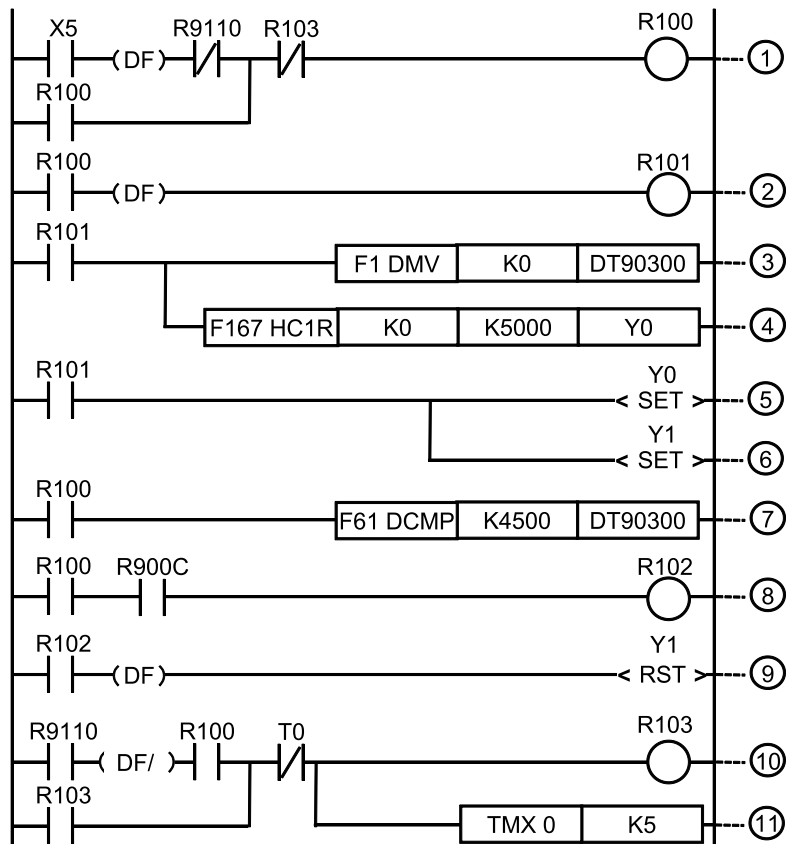

(1)	Positioning operation is running
(2)	Positioning operation starts
(3)	Resets the elapsed value of the high-speed counter CH0.
(4)	Target value match OFF instruction: Y0 turns OFF when the elapsed value of the high-speed counter reaches 5000 pulses.
(5)	Sets Y0 (inverter operation signal).
(6)	Sets Y1 (inverter high-speed signal).
(7)	32-bit data comparison instruction: R900C turns ON when the elapsed value of the high-speed counter CH0 is larger than 4500 pulses.
(8)	Arrival at deceleration point
(9)	Resets Y1 (inverter high-speed signal).
(10)	Positioning done pulse (0.5 sec)
(11)	0.1-second timer: Sets K5. It is used as 0.5-second timer.

24 High-speed Counter Cam Control Instruction

24.1 [F165 CAM0] High-speed Counter Cam Control Instruction.....	24-2
24.2 Sample Program (Upper Limit Control, Reset, Addition)	24-7
24.3 Sample Program (Upper Limit Control, Instruction Clear, Addition) .	24-9
24.4 Sample Program (Upper Limit Control, Subtraction)	24-11

24.1 [F165 CAM0] High-speed Counter Cam Control Instruction

Performs the cam output up to a maximum of 32 points (ON / OFF) according to the elapsed value of the high-speed counter.

■ **Instruction format**



■ **Operand**

Operand	Settings
S	Starting number of data table

■ **Memory area type that can be specified**

Operand	WX	WY	WR	WL	SV	EV	DT	LD	I	Constant		Index modifier
										K	H	
S	-	-	-	-	-	-	•	-	-	-	-	•

■ **Outline of operation**

- Performs the cam output up to a maximum of 32 points (ON/OFF) according to the elapsed value of the high-speed counter in the pattern specified for the data table starting with [S]. The output device can be selected from internal relay, output relay and link relay.
- The ON set value and OFF set value can be arbitrarily specified as a paired target values for a single cam output regardless of the magnitude of target values or the order for one cam output. The pattern of ON/OFF varies according to the setting.

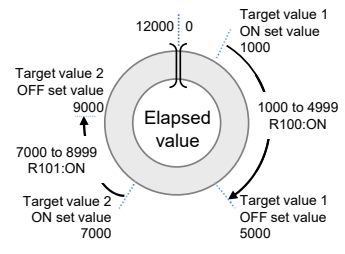
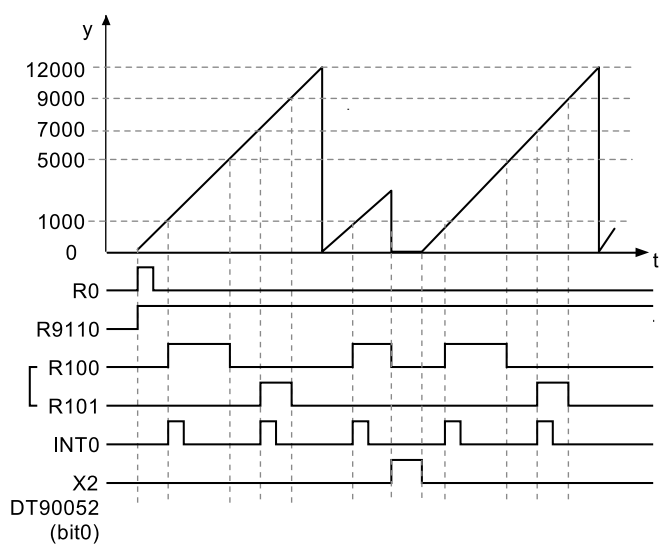

24.1 [F165 CAM0] High-speed Counter Cam Control Instruction

■ Upper limit control

With the F165 (CAM0) instruction, the control with a specified upper limit can be performed. The settings for enabling / disabling the upper limit control and the upper limit are specified in the data table.

		Upper limit control: Enable	Upper limit control: Disable
Counting range		0 to Upper limit	Negative min. value to Positive max. value
Operation when exceeding the counting range	When added	When the elapsed value exceeds the upper limit, it returns to 0.	When the elapsed value exceeds the positive maximum value, it returns to the negative minimum value.
	When subtracted	When the elapsed value falls below 0, it returns to the upper limit.	When the elapsed value falls below the negative minimum value, it returns to the positive maximum value.

■ Data table settings

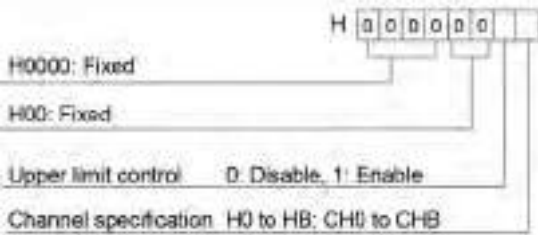
Operand	Settings	Description
S, S+1	High-speed counter channel Upper and lower limit control	Specify the high-speed counter channel where the cam control is performed and whether or not to execute the upper and lower limit control as a hexadecimal constant. 
S+2, S+3	Output device type (Note 1)	Specify the device type set for the cam output. H0: Link relay (L), H1: Internal relay (R), H2: Output relay (Y)
S+4, S+5	Starting word no. of output device	Specify the starting word number of the device set for the cam output. (Note 2)
S+6, S+7	No. of target values	Settable range: K1 to K32 (Note 2)
S+8, S+9	Target value 1: ON set value	Set the ON set value and OFF set value according to the number of target values. (Note 3) Settable range: K-2147483647 to K2147483646 (H80000001 to H7FFFFFFE) The cam output described in the next page is acquired according to the magnitude of the ON set values and elapsed value.
S+10, S+11	Target value 1: ON set value	
S+12, S+13	Target value 2: ON set value	
S+14, S+15	Target value 2: ON set value	
-----	-----	
S+(m-1)x4+8 S+(m-1)x4+9	Target value m: ON set value	
S+(m-1)x4+10 S+(m-1)x4+11	Target value m: OFF set value	
S+(m-1)x4+12	Upper limit (Note 4)	Settable range:

24.1 [F165 CAM0] High-speed Counter Cam Control Instruction

Operand	Settings	Description
S+(m-1)x4+13		K1 to K2147483646 (H1 to H7FFFFFFE)

- (Note 1) When specifying the output relay (Y), values are also output to the Control Unit output as well as operation memories.
- (Note 2) When the number of target values [S+6, S+7] is set to 1-16, the cam output is allocated to one word of output device. When set to 17-32, it is allocated to two words of output device. Refer to the next page for details.
- (Note 3) The number of target values specified after [S+8, S+9] varies according to the number of target values specified in [S+6, S+7].
- (Note 4) The upper limit of the data table end is valid only when the upper limit control is set to "Yes" in [S, S+1]. This setting can be omitted when the upper limit control is set to "No".
- (Note 5) The data table varies in the range of 12 to 138 words according to the number of target values and the specified upper limit setting

■ Specification of output device: [S+2] to [S+5]

- When the number of target values is set to 1-16, one word is used. When the number of target values is set to 17-32, two words are used.
- One device is allocated to a paired target values (ON set value and OFF set value).
(Example): When the output device type is set to "Internal relay", the starting word number of output device is set to "0", and the number of target values is set to "32", R0 to R1F are allocated as the device for the cam output.

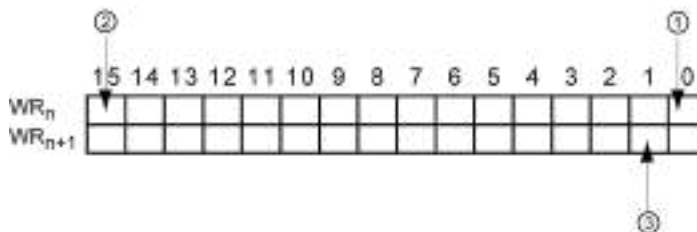

(1)	When the elapsed value reaches the target value 1, R0 turns ON or OFF.
(2)	When the elapsed value reaches the target value 16, RF turns ON or OFF.
(3)	When the elapsed value reaches the target value 18, R11 turns ON or OFF.

■ Specification of target values: From [S+8]

The acquired output varies according to the ON set value and OFF set value.

	ON set value < OFF set value	ON set value > OFF set value	ON set value = OFF set value
When added			

24.1 [F165 CAM0] High-speed Counter Cam Control Instruction

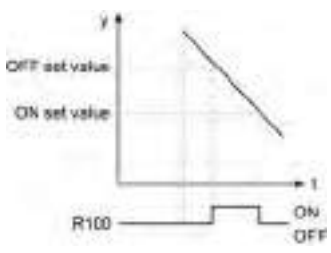
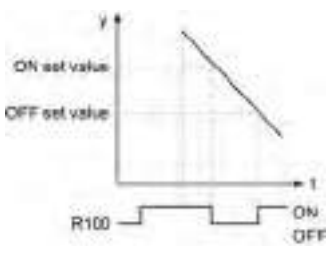
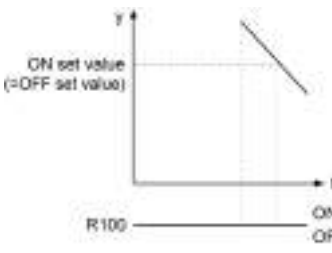
	ON set value < OFF set value	ON set value > OFF set value	ON set value = OFF set value
When subtracted			
Description	When the elapsed value is larger than or equal to the ON set value and smaller than the OFF set value, the corresponding output bit turns ON. When the elapsed value is out of the range, the corresponding bit turns off.	When the elapsed value is smaller than the ON set value and larger than or equal to the OFF set value, the corresponding output bit turns off. When the elapsed value is out of the range, the corresponding bit turns ON.	The corresponding bit always turns off.

■ Notes on programming

- This instruction cannot be used when the high-speed counter function is not used. Allocate arbitrary channels and contacts in the system register "high-speed counter setting"
- The high-speed counter control active flag corresponding to the specified channel turns ON until the execution of the high-speed counter control instruction F0 (MV) is cleared after the execution condition of the F165 (CAM0) instruction has turned ON. When the high-speed counter control active flag is on, the high-speed counter control instruction F165 (CAM0) / F166 (HC1S) / F167 (HC1R) for which the same channel is specified cannot be executed.
- This instruction can be activated for up to two channels simultaneously.
- To stop the control of this instruction, execute "Clear high-speed counter instruction" by the high-speed counter control instruction F0 (MV). Even when executing "Clear high-speed counter instruction", the output allocated to the cam output is held. Also, the counting of the high-speed counter continues and the upper limit control becomes disabled.
- Reset or preset the high-speed counter elapsed value before executing the instruction.
- Do not rewrite the elapsed value for the control using the F1 (DMV) instruction after the execution of the instruction. After the execution of the instruction, the setting of the active target values do not change even if the operation memory of the specified target values (ON set value/OFF set value) is changed.
- When controlling the output device using the main program, set each target value so that "minimum moving time between each target value" is larger than "1 scan time".
- When controlling the output device using an interrupt program, set each target value so that "minimum moving time between each target value" is larger than "maximum execution time of interrupt program".
- When the maximum value control and the hardware / software reset is used at the same time, do not operate them intensively in a short time.
- When hardware / software reset is used, set the minimum target value to an integer value that is 1 or more.
- When the hardware reset or software reset is executed during the high-speed counter control, the high-speed counter elapsed value is reset to 0. The output allocated to the cam output will be the output according to the elapsed value 0.
- It is also possible to start the interrupt program INTn every time the elapsed value reaches each target value. For this operation, the activation of the interrupt program should be permitted by the interrupt control instruction ICTL.

24.1 [F165 CAM0] High-speed Counter Cam Control Instruction

Info.

- For details of the allocations of I/O and flags, refer to “Allocation of Memory Areas”.

24.2 Sample Program (Upper Limit Control, Reset, Addition)

The following shows the program for performing two cam outputs (R100, R101) according to the elapsed value of the high-speed counter CH0. When the elapsed value reaches the target value (ON set value), the cam output turns ON, and when it reaches the target value (OFF set value), it turns OFF. When it reaches the target value (ON set value), the interrupt program is started. When the elapsed value exceeds the upper limit, it returns to 0.

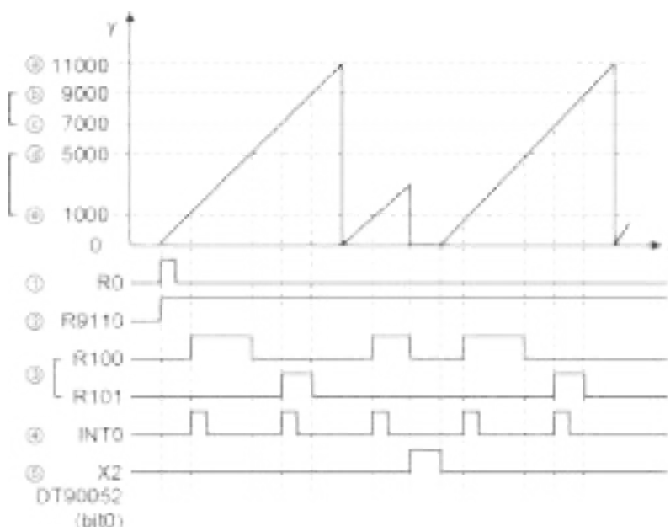

Code	Value	Description
(a)	Upper limit	When the elapsed value exceeds the upper limit, it returns to 0.
(b)	Target value 2: OFF set value	The cam output is performed according to the target values.
(c)	Target value 2: ON set value	In this example, the ON set value is smaller than the OFF set value for each target value.
(d)	Target value 1: OFF set value	Therefore, When added: When the elapsed value reaches the ON set value, the cam output turns ON, and when it reaches the OFF set value, it turns OFF.
(e)	Target value 1: ON set value	When subtracted: When the elapsed value falls below the OFF set value, the cam output turns ON, and when it falls below the ON set value, it turns OFF.
(1)	Execution condition	When the execution condition turns ON from OFF, the instruction is executed and the cam control starts.
(2)	High-speed counter instruction active flag	The high-speed counter instruction active flag turns ON during the execution of the instruction. Even when the reset signal exists, the execution of the instruction continues.
(3)	Cam output	The output turns ON/OFF according the set values.
(4)	Interrupt	When the elapsed value reaches the ON set value, the interrupt program starts.
(5)	Reset signal	When the hardware reset (X2) or software reset DT90052 (bit 0) turns ON, the elapsed value of the high-speed counter is reset to 0. The outputs corresponding to the elapsed value 0 (both R100 and R101 in the above example) become OFF.

(Note 1) It shows the hardware reset input (X2) for the high-speed counter CH0.

24.2 Sample Program (Upper Limit Control, Reset, Addition)

■ Sample program

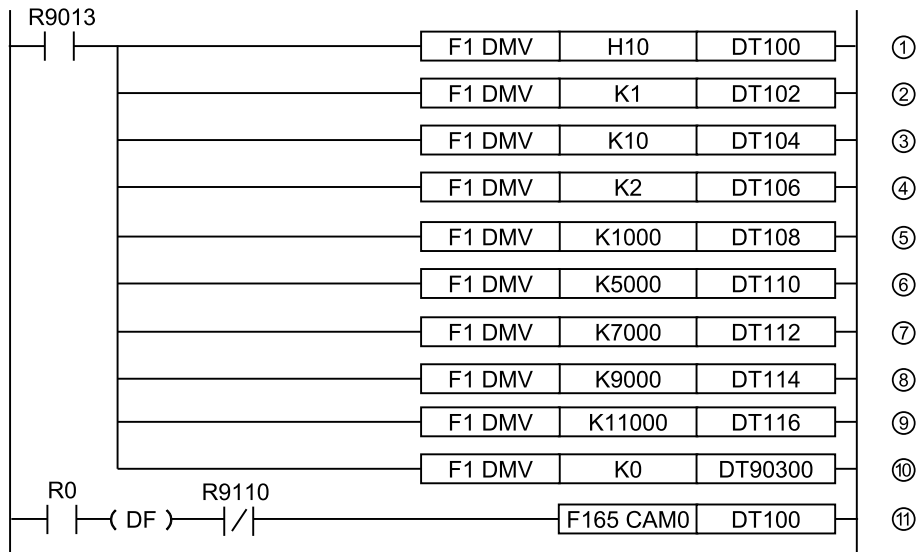

Code	Description
(1)	High-speed counter channel H10: Performs the upper limit control, CH0
(2)	Cam output device type K1: Internal relay (R)
(3)	Word number of cam output device K10
(4)	Specification of the number of target values K2
(5)	Target value 1: ON set value K1000
(6)	Target value 1: OFF set value K5000
(7)	Target value 2: ON set value K7000
(8)	Target value 2: ON set value K9000
(9)	Upper limit + K11000
(10)	Presets 0 as the elapsed value.
(11)	Executes the F165 (CAM0) instruction and starts the cam control.

24.3 Sample Program (Upper Limit Control, Instruction Clear, Addition)

The following shows the program for performing two cam outputs (R100, R101) according to the elapsed value of the high-speed counter CH0. In the case of addition, when the elapsed value reaches the target value (ON set value), the cam output turns ON, and when it reaches the target value (OFF set value), it turns OFF. When it reaches the target value (ON set value), the interrupt program is started. When the elapsed value exceeds the upper limit, it returns to 0. The instruction is cleared by the high-speed counter control instruction F0 (MV).

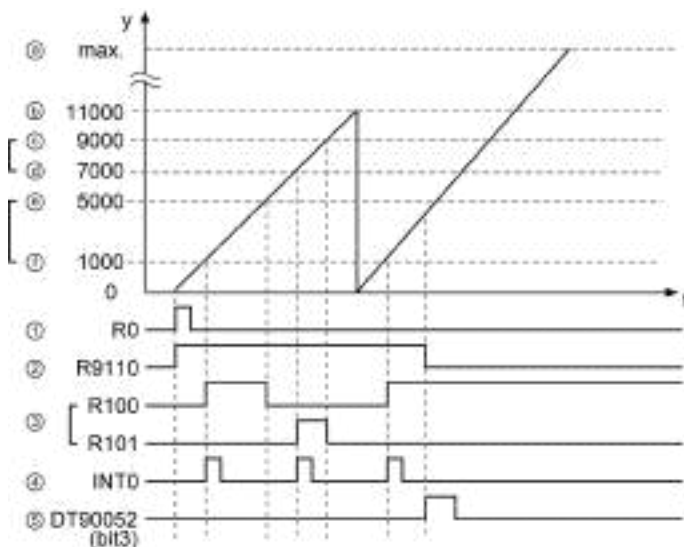

Code	Value	Description
(a)	Positive maximum value	When the instruction clear is executed, the upper limit control is canceled and the counting continues up to the positive maximum value.
(b)	Upper limit	When the elapsed value exceeds the upper limit, it returns to 0.
(c)	Target value 2: OFF set value	The cam output is performed according to the target values.
(d)	Target value 2: ON set value	In this example, the ON set value is smaller than the OFF set value for each target value.
(e)	Target value 1: OFF set value	Therefore, When added: When the elapsed value reaches the ON set value, the cam output turns ON, and when it reaches the OFF set value, it turns OFF.
(f)	Target value 1: ON set value	When subtracted: When the elapsed value falls below the OFF set value, the cam output turns ON, and when it falls below the ON set value, it turns OFF.
(1)	Execution condition	When the execution condition turns ON from OFF, the instruction is executed and the cam control starts.
(2)	High-speed counter instruction active flag	The high-speed counter instruction active flag turns ON during the execution of the instruction. When the high-speed counter control instruction F0 (MV) is executed, it turns OFF.
(3)	Cam output	The output turns ON/OFF according the set values.
(4)	Interrupt	In the case of addition, when the elapsed value reaches the ON set value, the interrupt program is started.

24.3 Sample Program (Upper Limit Control, Instruction Clear, Addition)

Code	Value	Description
(5)	Clear high-speed counter instruction	By the high-speed counter control instruction F0 (MV), when the bit 3 of the special data register DT90052 turns ON from OFF, the executed F165 (CAM0) instruction is cleared.

■ Sample program

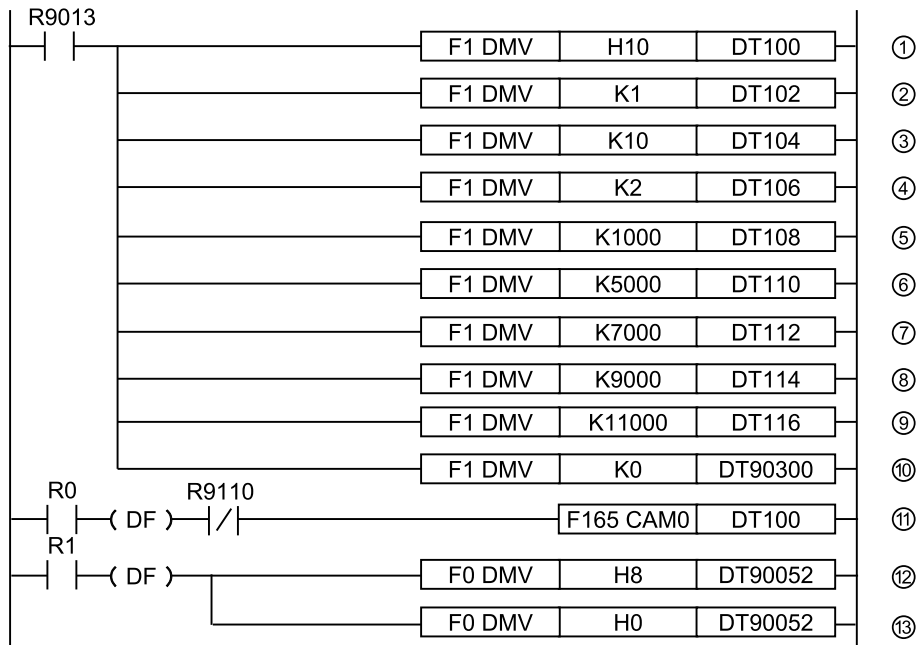

Code	Description
(1)	High-speed counter channel H10: Performs the upper limit control, CH0
(2)	Cam output device type K1: Internal relay (R)
(3)	Word number of cam output device K10
(4)	Specification of the number of target values K2
(5)	Target value 1: ON set value K1000
(6)	Target value 1: OFF set value K5000
(7)	Target value 2: ON set value K7000
(8)	Target value 2: ON set value K9000
(9)	Upper limit + K11000
(10)	Presets 0 as the elapsed value.
(11)	Executes the F165 (CAM0) instruction and starts the cam control.
(12)	Clears the executed F165 (CAM0) instruction by turning the DT90052 (bit 3) OFF → ON → OFF.

24.4 Sample Program (Upper Limit Control, Subtraction)

The following shows the program for performing three cam outputs (R100-R102) according to the elapsed value of the high-speed counter CH0. In the case of subtraction, when the elapsed value falls below the target value (OFF set value), the cam output turns ON, and when it falls below the target value (ON set value) the cam output turns OFF. When it falls below the target value (OFF set value), the interrupt program is started. When the elapsed value falls below 0, it returns to the upper limit.

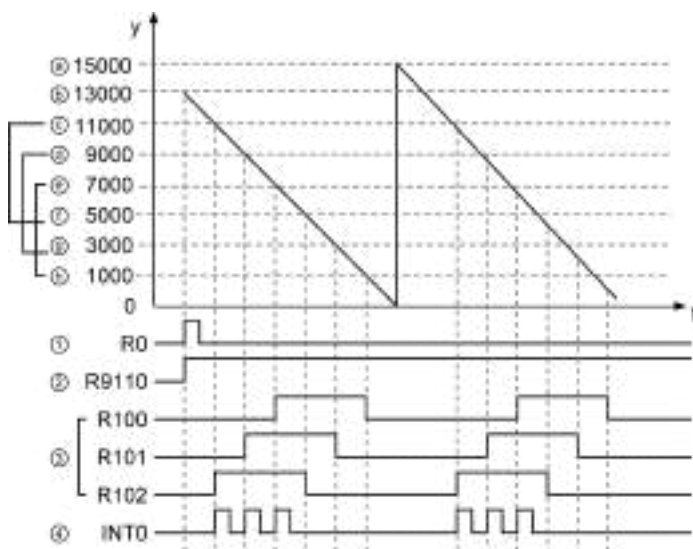

Code	Value	Description
(a)	Upper limit	When the high-speed counter elapsed value falls below 0, it returns to the upper limit.
(b)	Elapsed value	The control is started from the elapsed value when executed. In this example, the elapsed value 13000 is preset.
(c)	Target value 3: OFF set value	The cam output is performed according to the target values. In this example, the ON set value is smaller than the OFF set value for each target value. When subtracted: When the elapsed value falls below the OFF set value, the cam output turns ON, and when it falls below the ON set value, it turns OFF. When added: When the elapsed value reaches the ON set value, the cam output turns ON, and when it reaches the OFF set value, it turns OFF.
(d)	Target value 2: OFF set value	
(e)	Target value 1: OFF set value	
(f)	Target value 3: ON set value	
(g)	Target value 2: ON set value	
(h)	Target value 1: ON set value	
(1)	Execution condition	When the execution condition turns ON from OFF, the instruction is executed and the cam control starts.
(2)	High-speed counter instruction active flag	The high-speed counter instruction active flag turns ON during the execution of the instruction.

24.4 Sample Program (Upper Limit Control, Subtraction)

Code	Value	Description
(3)	Cam output	The output turns ON/OFF according the set values.
(4)	Interrupt program activation	In the case of subtraction, when the elapsed value falls below the OFF set value, the interrupt program is started.

■ Sample program

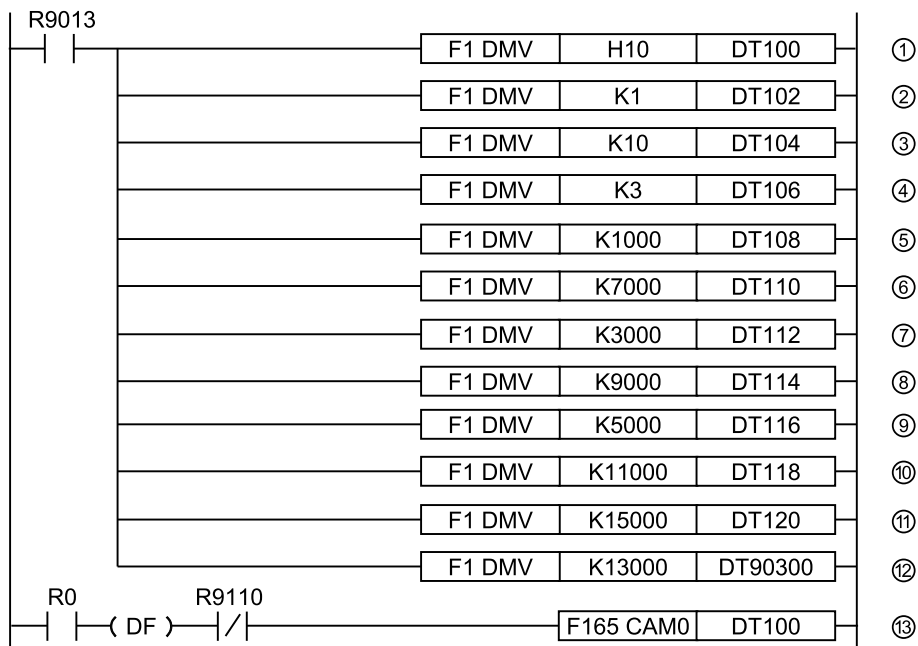

Code	Description
(1)	High-speed counter channel H10: Performs the upper limit control, CH0
(2)	Cam output device type K1: Internal relay (R)
(3)	Word number of cam output device K10
(4)	Specification of the number of target values K3
(5)	Target value 1: ON set value K1000
(6)	Target value 1: OFF set value K7000
(7)	Target value 2: ON set value K3000
(8)	Target value 2: OFF set value K9000
(9)	Target value 3: ON set value K5000
(10)	Target value 3: OFF set value K11000
(11)	Upper limit value K15000
(12)	Presets 13000 as the elapsed value.
(13)	Executes the F165 (CAM0) instruction and starts the cam control.

25 PWM Output Instructions

25.1 [F173 PWMH] PWM Output Instruction (Frequency Specification) ..	25-2
25.2 [F173 PWMH] PWM Output Instruction (Control Code Specification)	25-4

25.1 [F173 PWMH] PWM Output Instruction (Frequency Specification)

25.1 [F173 PWMH] PWM Output Instruction (Frequency Specification)

The PWM output is performed according to the set parameters.

■ Instruction format

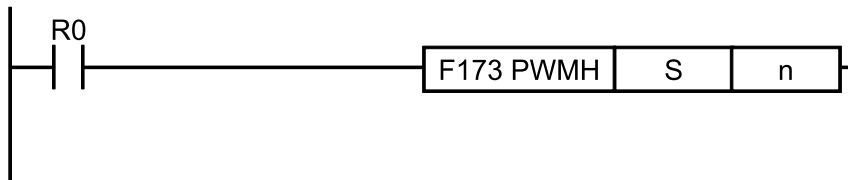

■ Operand

Operand	Settings	
	Starting address of the memory area storing the parameters of the PWM output.	
S	S	Specify the control code HFF.
	S+1	Specify the output frequency in 2-word 32-bit data.
	S+2	Setting range: K1 to K100000 (1 Hz to 100 kHz: in 1 Hz increments)
	S+3	Duty ratio (Resolution of 1000 or 100) For the output frequencies K1 to K70000, Setting range: K0 to K1000 (0.0% to 100.0%) For the output frequencies K70001 to K100000, Setting range: K0 to K1000 (0% to 100%)
n	Channel nos. used for PWM output: K0 (CH0: Y0), K1 (CH1: Y2), K2 (CH3: Y4), K3 (CH4: Y6)	

■ Memory area type that can be specified

Operand	WX	WY	WR	WL	SV	EV	DT	LD	I	Constant		Index modifier
										K	H	
S	-	-	-	-	-	-	•	-	-	-	-	•
n	-	-	-	-	-	-	-	-	-	•	•	-

■ Outline of operation

- The PWM output is performed from a specified output. The output is performed when the execution condition is ON.
- The output frequency and duty ratio are specified in the operands [S1+1] to [S1+3].

■ Precautions during programming

- This instruction cannot be executed when a control active flag corresponding to each channel is ON.
- The duty may be different from the set ratio according to the load voltage and load current especially in the vicinity of minimum and maximum values. The duty can be changed for each scan. However, the control code cannot be changed during the execution of an instruction.

25.1 [F173 PWMH] PWM Output Instruction (Frequency Specification)

- When rewriting during RUN is performed during the operation, the PWM output stops while a program is being rewritten.

■ Example of program

The following sample shows the program for performing the PWM output with 10 kHz and the duty ratio of 50% from CH0 (Y0).

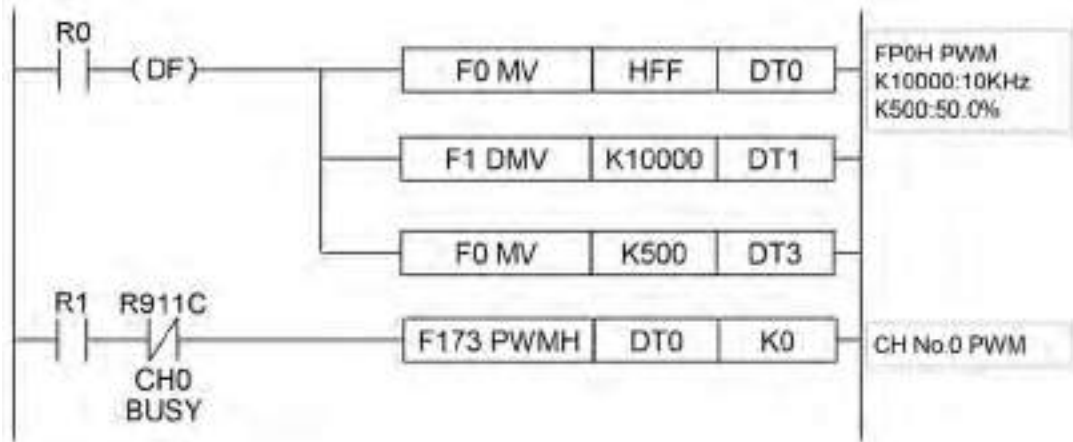

i Info.

- For details of the allocations of I/O and flags, refer to "Allocation of Memory Areas".

25.2 [F173 PWMH] PWM Output Instruction (Control Code Specification)

25.2 [F173 PWMH] PWM Output Instruction (Control Code Specification)

The PWM output is performed according to the set parameters.

■ Instruction format

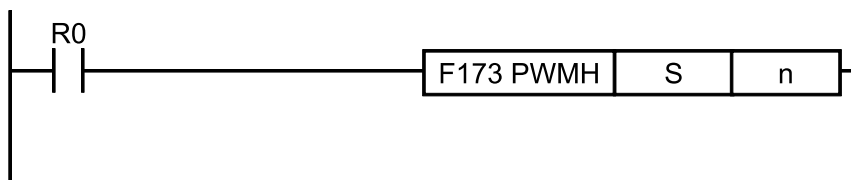

■ Operand

Operand	Settings
S	Starting address of the memory area storing the parameters of the PWM output.
	S Specify the control code. K0 to K30
	S+1 Duty ratio (Resolution of 1000 or 100) For the control codes K0 to K27, Setting range: K0 to K1000 (0.0% to 100.0%) For the control codes K28 to K30, Setting range: K0 to K1000 (0% to 100%)
n	Channel nos. used for PWM output: K0 (CH0: Y0), K1 (CH1: Y2), K2 (CH3: Y4), K3 (CH4: Y6)

■ Memory area type that can be specified

Operand	WX	WY	WR	WL	SV	EV	DT	LD	I	Constant		Index modifier
										K	H	
S	-	-	-	-	-	-	•	-	-	-	-	•
n	-	-	-	-	-	-	-	-	-	•	•	-

■ Outline of operation

- The PWM output is performed from a specified output. The output is performed when the execution condition is ON.
- The output frequency and cycle are determined by a specified control code. The duty ratio is specified in the operand [S1+1].

■ Precautions during programming

- This instruction cannot be executed when a control active flag corresponding to each channel is ON.
- The duty may be different from the set ratio according to the load voltage and load current especially in the vicinity of minimum and maximum values. The duty can be changed for each scan. However, the control code cannot be changed during the execution of an instruction.
- When rewriting during RUN is performed during the operation, the PWM output stops while a program is being rewritten.

25.2 [F173 PWMH] PWM Output Instruction (Control Code Specification)

■ Control code

S	Frequency (Hz)	Cycle (ms)	Resolution	S	Frequency (Hz)	Cycle (ms)	Resolution	
K0	1.5	666.67	1000	K16	2000.0	0.50	1000	
K1	2.0	500.00		K17	3000.0	0.33		
K2	4.0	250.00		K18	6000.0	0.17		
K3	6.0	166.67		K19	12500.0	0.08		
K4	8.0	125.00		K20	15000.0	0.067		
K5	10.0	100.00		K21	20000.0	0.050		
K6	20.0	50.00		K22	25000.0	0.040		
K7	50.0	20.00		K23	30000.0	0.033		
K8	100.0	10.00		K24	40000.0	0.025		
K9	200.0	5.00		K25	50000.0	0.020		
K10	400.0	2.50		K26	60000.0	0.017		
K11	500.0	2.00		K27	70000.0	0.0143		
K12	700.0	1.48		K28	80000.0	0.0125		100
K13	1000.0	1.00		K29	90000.0	0.0111		
K14	1300.0	0.77	K30	100000.0	0.010			
K15	1600.0	0.625		-				

■ Example of program

The following sample shows the program for performing the PWM output with 1 kHz and the duty ratio of 50% from CH0 (Y0).

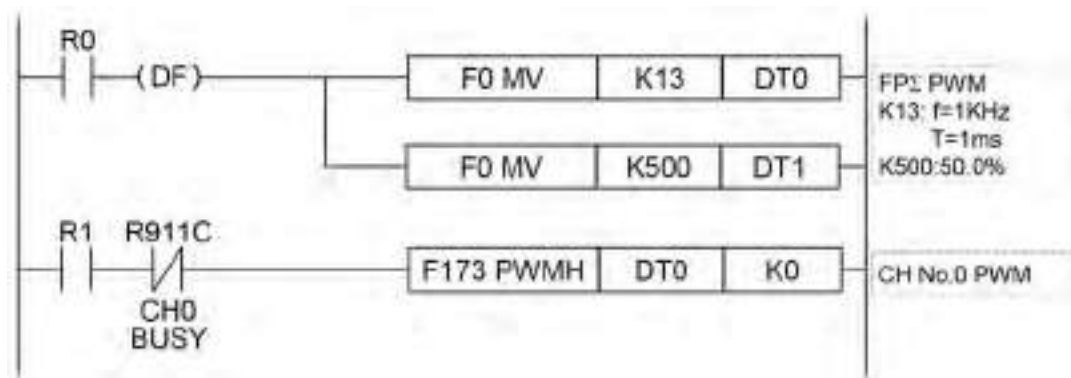

i Info.

- For details of the allocations of I/O and flags, refer to “Allocation of Memory Areas”.

(MEMO)

26 Character String Instructions

26.1	F95 ASC (ASCII code conversion)	26-2
26.2	F250 BTOA (Binary to ASCII Conversion)	26-5
26.3	F251 ATOB (ASCII to Binary Conversion)	26-11
26.4	F252 ACHK (ASCII Data Check)	26-19
26.5	F253 SSET (Character Constant → ASCII Code Conversion: with Storage Area Size)	26-21
26.6	Overview of String Instructions F257 SCMP to F265 SREP	26-25
26.7	F257 SCMP (Comparing Character Strings)	26-26
26.8	F258 SADD (Character String Concatenation)	26-28
26.9	F259 LEN (Number of Characters in a Character String)	26-30
26.10	F260 SSRC (Search for character string)	26-32
26.11	F261 RIGHT [Retrieve from Character String (Right)]	26-34
26.12	F262 LEFT [Retrieving data from character strings (left side)]	26-36
26.13	F263 MIDR (Character String From Character String Retrieval)	26-38
26.14	F264 MIDW (Writing a Character String to a Character String)	26-40
26.15	F265 SREP (Replace Character Strings)	26-42

26.1 F95 ASC (ASCII code conversion)

26.1 F95 ASC (ASCII code conversion)

Converts the specified character constants into ASCII codes.

■ Instruction format

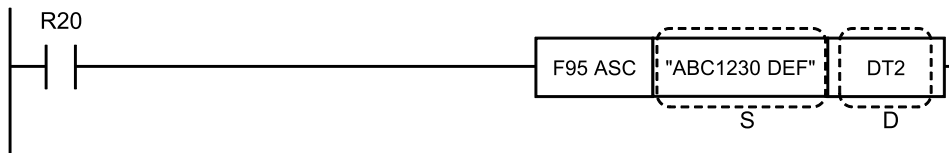

■ Operands

Items	Settings
S	Character constants (12 characters)
D	Number at the start of the area storing the ACSII codes

■ Devices that can be specified (indicated by ●)

Operands	WX	WY	WR	WL	SV	EV	DT	LD	I	SWR	SDT	Constant				Index modifier	Integer Device	
												K	H	M	f			
S																		
D		●	●	●	●	●	●	●	●									

■ Outline of operation

The character constants specified by [S] (12 characters) are converted into ASCII codes and stored in the 6-word area starting from [D].

■ Operation example

Operation of instruction format description program

When internal relay R20 turns ON, the specified character constants (ABC1230 DEF) are converted into ASCII codes and stored in DT2 to DT7.

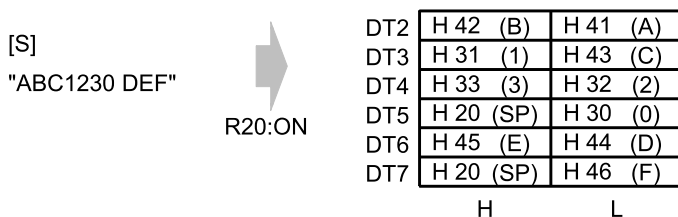

If the number of character constants specified by [S] is less than 12, the blanks in the destination storage area are filled with spaces (H20).

■ Precautions for programming

The character constant M can only be input by programming tool software.

Conversion example

When converting one letter (A), there are three possible input methods.

1. At the start of the specified character constants (1st character)
2. At the end of the specified character constants (12th character)
3. In the middle of the specified character constants (2nd to 11th character)

(1) At the start (1st character)

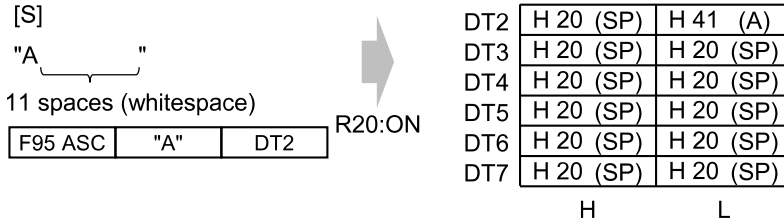

The letter is input as above. A is only input to the low byte of DT2. The blanks are all filled with spaces (H20) in the destination storage area.

(2) At the end (12th character)

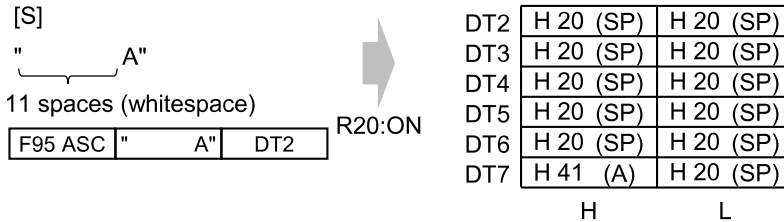

The letter is input as above. A is only input to the high byte of DT7. DT2 to DT6 and the low byte of D27 are all filled with spaces (H20) in the destination storage area.

(3) In the middle (7th character)

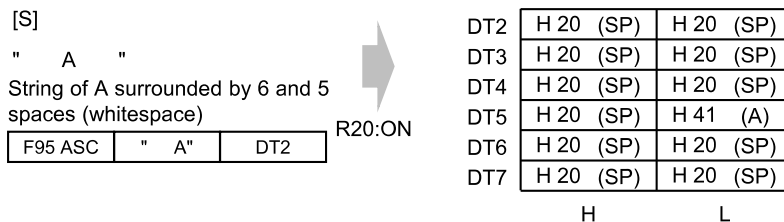

The letter is input as above. A is only input to the low byte of DT5. The rest of the destination storage area is filled with spaces (H20).

26.1 F95 ASC (ASCII code conversion)

■ Reference: JIS8 code table

								0	0	0	0	0	0	0	0	1	1	1	1	1	1	1	1	1			
								0	0	0	0	1	1	1	1	0	0	0	0	1	1	1	1	1	1		
								0	0	1	1	0	0	1	1	0	0	1	1	0	0	1	1	0	1	1	
								0	1	0	1	0	1	0	1	0	1	0	1	0	1	0	1	0	1	0	1
b ₇	b ₆	b ₅	b ₄	b ₃	b ₂	b ₁	b ₀	Column	0	1	2	3	4	5	6	7	8	9	A	B	C	D	E	F			
0	0	0	0	0	0	0	0	Row	NUL	TC ₇ (DEL)	(SP)	0	@	P	~	p	↑	↑	Undefined	-	タ	ミ	↑	↑			
0	0	0	1	1					TC ₁ (SOH)	DC ₁	!	1	A	Q	a	q			。	ア	チ	ム					
0	0	1	0	2					TC ₂ (STX)	DC ₂	"	2	B	R	b	r			「	イ	ツ	メ					
0	0	1	1	3					TC ₃ (ETX)	DC ₃	#	3	C	S	c	s			」	ウ	テ	モ					
0	1	0	0	4					TC ₄ (EOT)	DC ₄	\$	4	D	T	d	t			、	エ	ト	ヤ					
0	1	0	1	5					TC ₅ (ENQ)	TC ₅ (NAK)	%	5	E	U	e	u			・	オ	ナ	ユ					
0	1	1	0	6					TC ₆ (ACK)	TC ₆ (SYN)	&	6	F	V	f	v			ヲ	カ	ニ	ヨ					
0	1	1	1	7					BEL	TC ₁₀ (ETB)	'	7	G	W	g	w			ア	キ	ヌ	ラ					
1	0	0	0	8					EE ₉ (BS)	CAN	(8	H	X	h	x			イ	ク	ネ	リ					
1	0	0	1	9					EE ₁ (HT)	EM)	9	I	Y	i	y			ウ	ケ	ノ	ル					
1	0	1	0	A					EE ₂ (LF)	SUB	*	:	J	Z	j	z			エ	コ	ハ	レ					
1	0	1	1	B					EE ₃ (VT)	ESC	+	;	K	[k				オ	サ	ヒ	ロ					
1	1	0	0	C					EE ₄ (FF)	IS ₂ (FS)	,	<	L	¥	l				ヤ	シ	フ	ワ					
1	1	0	1	D					EE ₅ (CR)	IS ₃ (GS)	-	=	M]	m				ユ	ス	ヘ	ン					
1	1	1	0	E					SO	IS ₂ (RS)	.	>	N	^	n	—			ヨ	セ	ホ	。					
1	1	1	1	F					SI	IS ₁ (US)	/	?	O	_	o	DEL	↓	↓	ツ	ソ	マ	。	↓	↓			

(Note 1)

Only the character constants in the range indicated by in the table above can be input by programming tool software.

■ Flag operations

Name	Description
R9007 R9008 (ER)	Turns ON when the area exceeds the 6-word area starting from [D]

26.2 F250 BTOA (Binary to ASCII Conversion)

Converts 16-bit/32-bit binary data to an ASCII code character string.

■ Instruction format

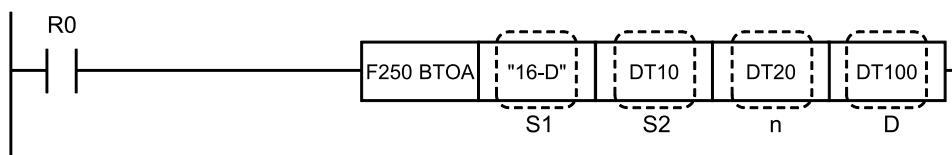

■ Operands

Items	Settings
S1	Control character string
S2	Starting number of area storing binary data
n	Conversion method
D	Starting number of the area storing the ASCII code of conversion result

■ Devices that can be specified (indicated by ●)

Operand s	WX	WY	WR	WL	SV	EV	DT	LD	I	SW R	SD T	Constant				Index modifier (Note 1)	Integer Device
												K	H	M	f		
S1	●	●	●	●	●	●	●	●	●	●	●				●		
S2	●	●	●	●	●	●	●	●	●	●	●				●		
n	●	●	●	●	●	●	●	●	●	●	●	●	●		●		
D		●	●	●	●	●	●	●	●						●		

(Note 1) A character constant cannot be specified.

■ Outline of operation

Converts the binary data stored in the area specified by S2 to ASCII data using the conversion method of n according to the 4 control characters specified by S1. The converted result is stored in the area specified by D.

■ Specifying each item

Specifying control character strings and their meanings [S1]

"16-D"	Converts 16-bit data to decimal ASCII data
"32-D"	Converts 32-bit data to decimal ASCII data
"16+H"	Converts 16-bit data to hexadecimal ASCII data (normal direction)
"32+H"	Converts 32-bit data to hexadecimal ASCII data (normal direction)
"16-H"	Converts 16-bit data to hexadecimal ASCII data (reverse direction)
"32-H"	Converts 32-bit data to hexadecimal ASCII data (reverse direction)

26.2 F250 BTOA (Binary to ASCII Conversion)

(Note 1) Details of normal and reverse directions are described later

Specifying the conversion method [n]

Example of converting 16-bit data (K1234 and K56) to decimal ASCII codes

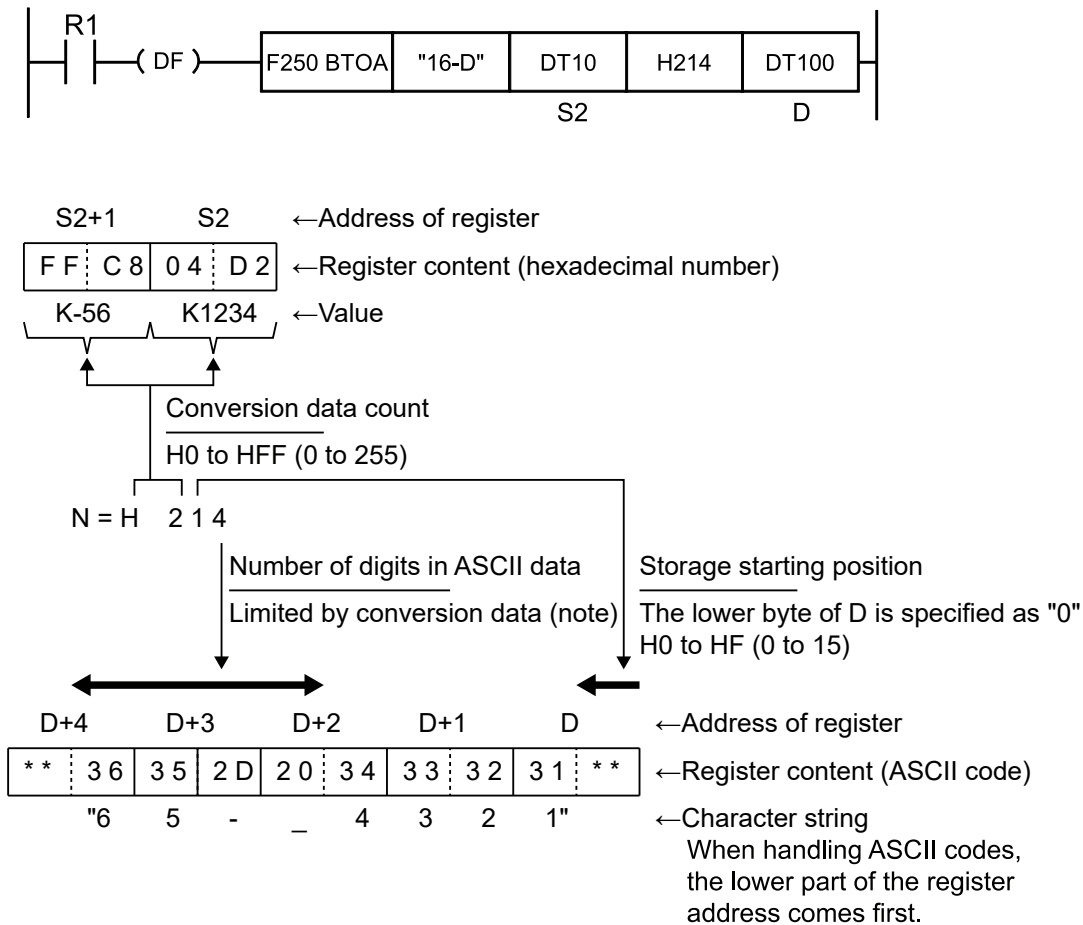

Note

- Number of digits in ASCII data
 When the number of digits of the ASCII data is larger than the converted result, a "_" (space) is stored before the data.
 - When converting 16-bit data to hexadecimal ASCII data
 Specified range: H1 to H4
 When less than H4, the specified number of digits is stored from the lower bytes. If the digit number of the original data is larger with a specification less than H4, this is an error
 - When converting 32-bit data to hexadecimal ASCII data
 Specified range: H1 to H8
 When less than H8, the specified number of digits is stored from the lower bytes. If the digit number of the original data is larger with a specification less than H8, this is an error
 - When converting to decimal ASCII data
 Specified range: H1 to HF
 Source data is treated as signed binary data. When it is a negative number, the minus sign "-" is added.
 About normal direction and reverse direction (only when converting to hexadecimal ASCII data)

■ **Conversion example**

- Converting 16-bit data (K1234 and K56) to decimal ASCII data

DT10 = K 1234 → "1234__56"
 DT11 = K 56

Number of converted data is "2", starting position for storage is "0", and size of the storage area is "4"

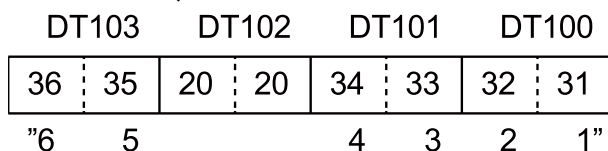
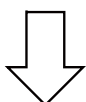
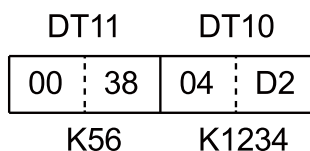
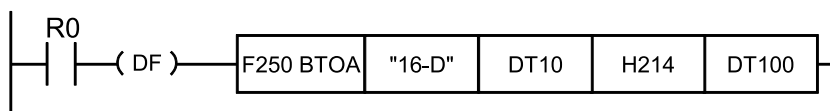

- Converting 32-bit data (K1234 and K56789) to decimal ASCII data

DT10,11 = K 1234 → "_ 1234__56789"

26.2 F250 BTOA (Binary to ASCII Conversion)

DT12,13 = K 56789

Number of converted data is "2", starting position for storage is "1", and size of the storage area is "7"

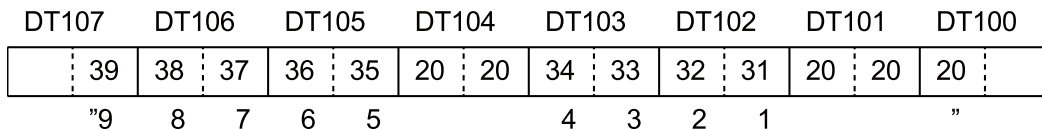
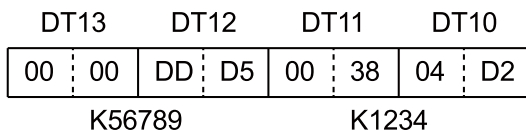
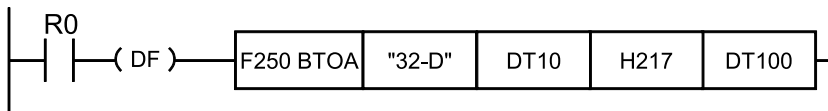

- Converting 16-bit data (H0123 and H89AB) to hexadecimal ASCII data

DT10 = H 123 → "2301AB89"

DT11 = H 89AB

Number of converted data is "2", starting position for storage is "1", and size of the storage area is "4" (normal direction)

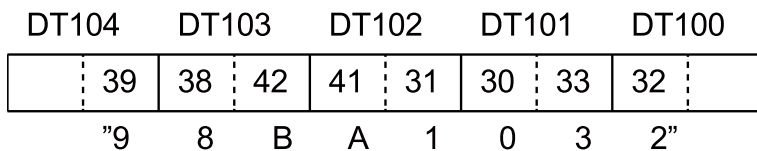
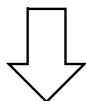
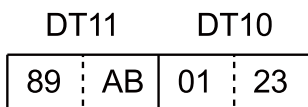
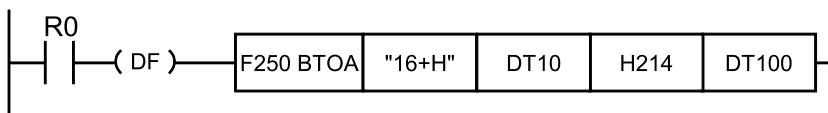

For the reverse direction (when "16+H" is "16-H")

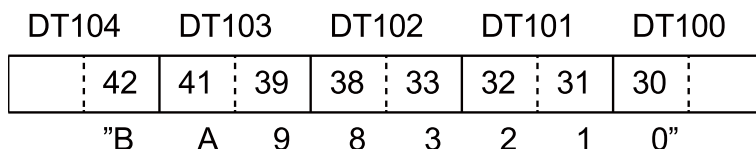

- Converting 32-bit data (H00000123 and H0089ABCD) to hexadecimal ASCII data (normal direction)

DT10,11 = H 123 → "230100CDAB89"
 DT12,13 = H 89ABCD

Number of converted data is "2", starting position for storage is "0", and size of the storage area is "6"

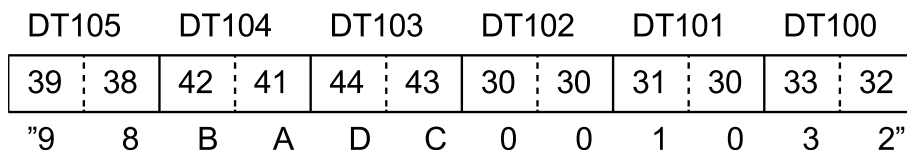
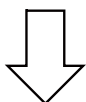
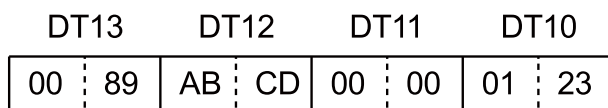
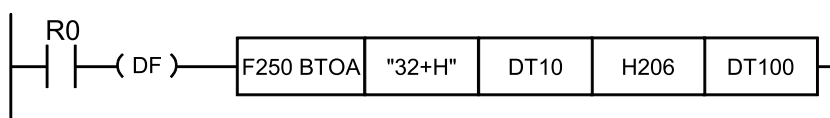

For the reverse direction (when "32+H" is "32-H")

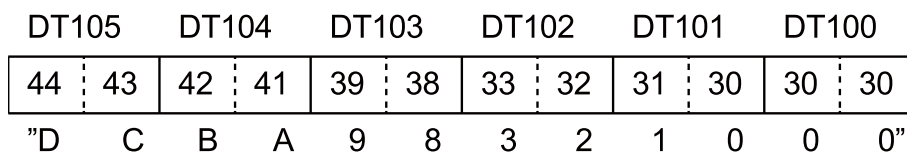

■ **Flag operations**

Name	Description
R9007 R9008 (ER)	When there is an error in the control string specified by S1
	When the conversion format specified by S1 is in decimal, and the direction of converted data is changed to the normal direction
	When the conversion format specified by S1 is in hexadecimal, and the size of the area for storing ASCII codes specified by N exceeds the rated value (Rated value for 16-bit data: 4) (Rated value for 32-bit data: 8)

26.2 F250 BTOA (Binary to ASCII Conversion)

Name	Description
	When the number of the conversion data specified by N is 0
	When the converted result exceeds the size of the area for storing ASCII codes specified by N
	When the converted result exceeds the area
	When the area is exceeded in index modification

26.3 F251 ATOB (ASCII to Binary Conversion)

Converts ASCII code character strings to 16-bit/32-bit binary data.

■ Instruction format

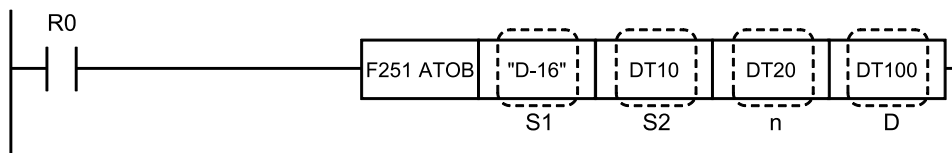

■ Operands

Items	Settings
S1	Control character string
S2	Starting number of the area storing the ASCII code
n	Conversion method
D	Starting number of the area for storing the binary data of the converted result

■ Devices that can be specified (indicated by ●)

Operand s	WX	WY	WR	WL	SV	EV	DT	LD	I	SW R	SD T	Constant				Index modifier (Note 1)	Integer Device
												K	H	M	f		
S1	●	●	●	●	●	●	●	●	●	●	●				●		
S2	●	●	●	●	●	●	●	●	●	●	●				●		
n	●	●	●	●	●	●	●	●	●	●	●	●	●		●		
D		●	●	●	●	●	●	●	●						●		

(Note 1) A character constant cannot be specified.

■ Outline of operation

Converts the ASCII data stored in the area specified by S2 to binary data using the conversion method in n, according to the four control characters specified in S1. The converted result is stored in the area specified by D.

■ Specifying each item

Specifying control character strings and their meanings [S1]

		Range of data that can be handled
"D-16"	Convert decimal ASCII data to 16-bit data	-32,768 to +32767
"D-32"	Convert decimal ASCII data to 32-bit data	-2,147,483,648 to +2,147,483,647
"H+16"	Convert hexadecimal ASCII data to 16-bit data (forward direction)	0 to FFFF
"H+32"	Convert hexadecimal ASCII data to 32-bit data (forward direction)	0 to FFFFFFFF

26.3 F251 ATOB (ASCII to Binary Conversion)

		Range of data that can be handled
"H-16"	Convert hexadecimal ASCII data to 16-bit data (reverse direction)	0 to FFFF
"H-32"	Convert hexadecimal ASCII data to 32-bit data (reverse direction)	0 to FFFFFFFF

(Note 1) Details of normal and reverse directions are described later

Specifying the conversion method [n]

Example of converting the ASCII data string "123456789012" to four sets of three decimal digits

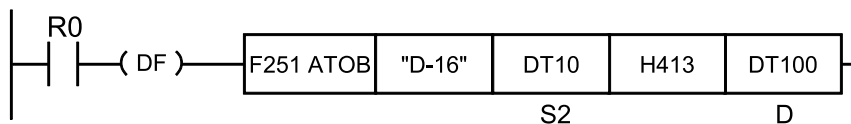
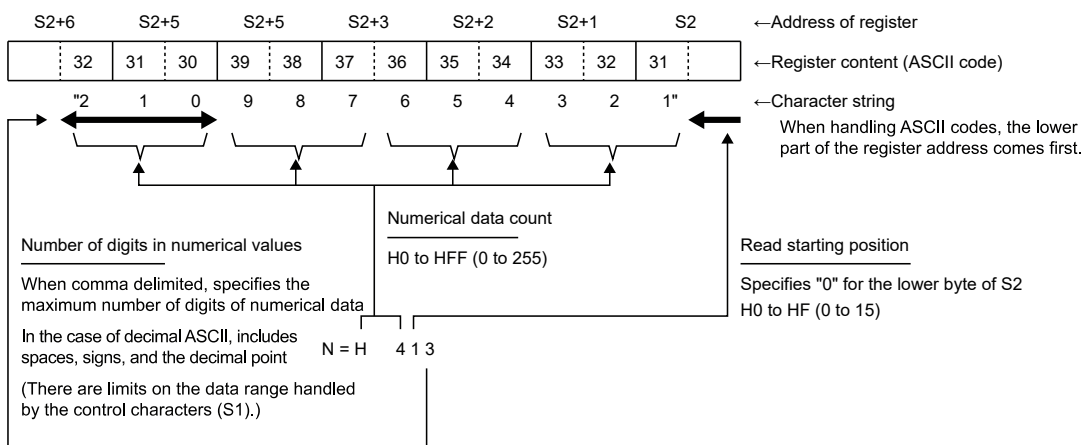

When converting via the above program

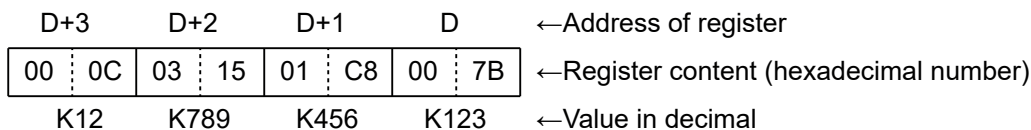

About normal direction and reverse direction (only when converting to hexadecimal ASCII data)

For hexadecimal ASCII data, conversions in the forward and reverse directions are possible. Example of converting "0123456789ABCDEF"

26.3 F251 ATOB (ASCII to Binary Conversion)

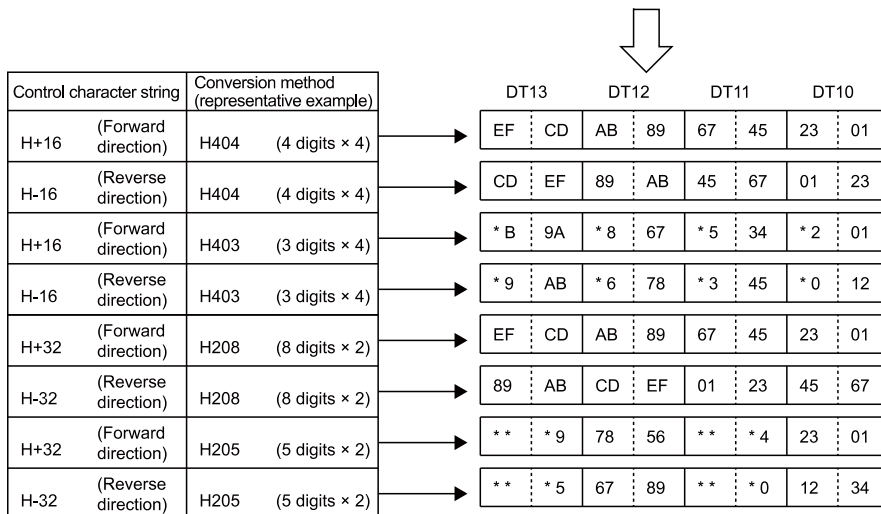
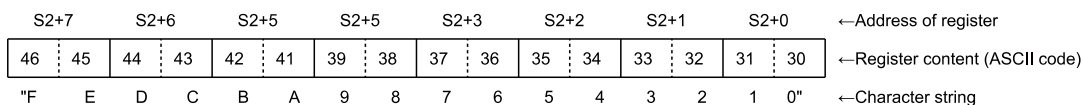

*"0" is entered to unused digits.

■ Conversion example

- Example of converting to four sets of three decimal digits (when there is no comma ",")

"123456789012" →	Converts to 16-bit data
	DT100 = K 123
	DT101 = K 456
	DT102 = K 789
	DT103 = K 12

When the number of numeric data items is "4", starting position for reading is "1", number of digits is "3"

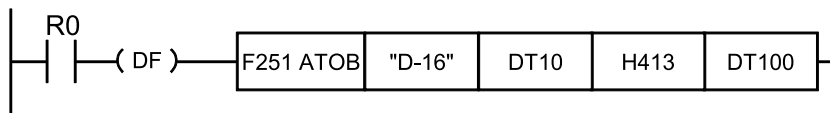

26.3 F251 ATOB (ASCII to Binary Conversion)

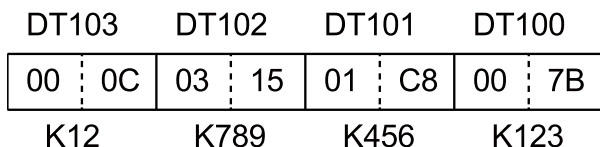
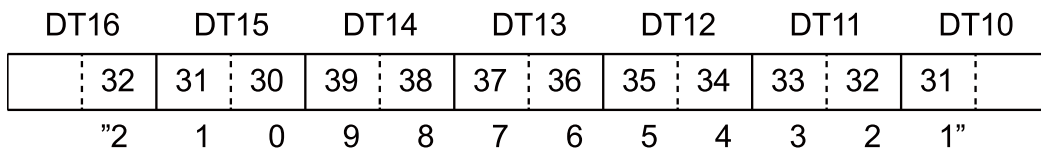

When converting to 32-bit data (when "D-16" is "D-32")

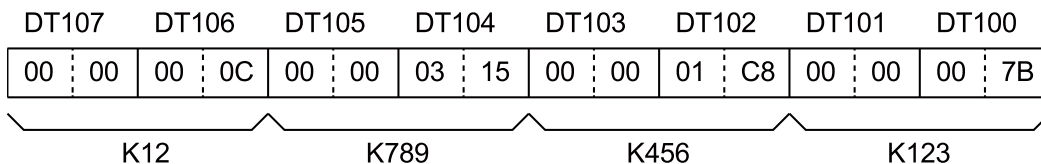

- Example of converting to three sets of four hexadecimal digits

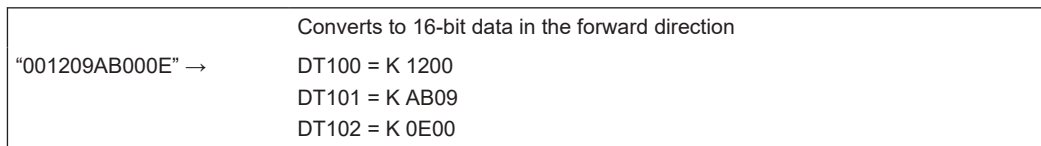

When the number of numeric data items is "3", starting position for reading is "1", number of digits to be converted is "4"

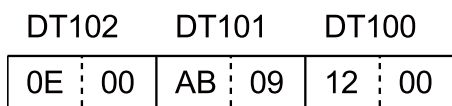
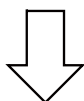
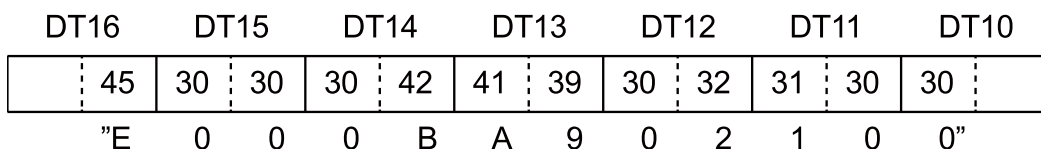
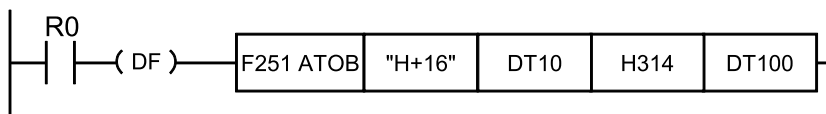

When converting to 16-bit data in the reverse direction (when "H+16" is "H-16")

DT102	DT101	DT100
00 0E	09 AB	00 12

When converting to 32-bit data in the forward direction (when "H+16" is "H+32")

DT105	DT104	DT103	DT102	DT101	DT100
00 00	0E 00	00 00	AB 09	00 00	12 00

When converting to 32-bit data in the reverse direction (when "H+16" is "H-32")

DT105	DT104	DT103	DT102	DT101	DT100
00 00	00 0E	00 00	09 AB	00 00	00 12

- Example of converting to four sets of decimal numbers (when there is a comma "," separator)

"12,345,6789,0," →	DT100 = K 12
The character string ends in a comma	DT101 = K 345
	DT102 = K 6789
	DT103 = K 0

When the number of numeric data items is "4", starting position for reading is "1", number of digits is "4" (Converts to 16-bit data)

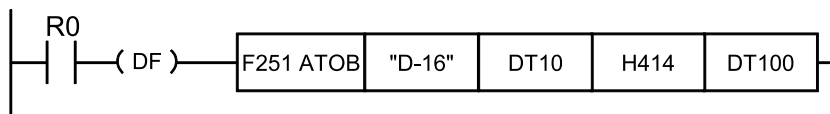

(Note 1) Specify the maximum number of digits.

DT17	DT16	DT15	DT14	DT13	DT12	DT11	DT10
2C	30 2C	31 30	39 38	2C 35	34 33	2C 32	31
,	0 ,	9 8	7 6	,	5 4 3	,	2 1"



DT103	DT102	DT101	DT100
00 00	1A 85	01 59	00 0C
K0	K6789	K345	K12

- Example of converting to two sets of five decimal digits with decimal points (when there is no comma ",")

"12345.50006.7" →	DT100 = K 12345
	DT101 = K 67

26.3 F251 ATOB (ASCII to Binary Conversion)

When the number of numeric data items is "2", starting position for reading is "0", number of digits is "6", when converting to 16-bit data

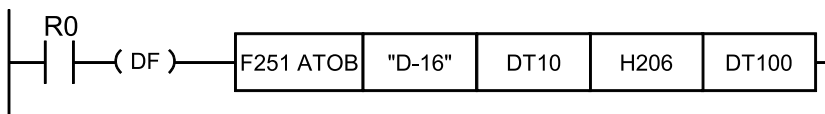

(Note 1) A decimal point is also counted as a digit

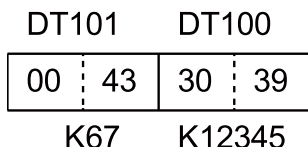
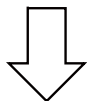
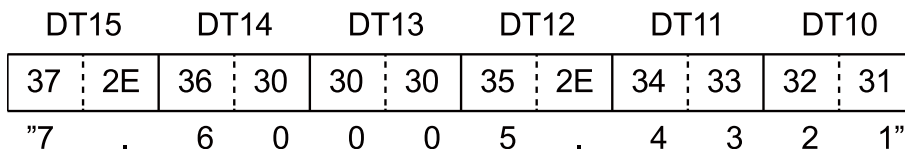

- Example of converting to two sets of decimal digits with decimal points (when there is a comma "," separator)

"1234.5,6.7" →	DT100 = K 12345
The character string ends in a comma	DT101 = K 67

When the number of numeric data items is "2", starting position for reading is "0", number of digits is "6", when converting to 16-bit data

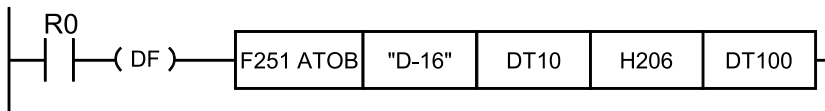

(Note 1) A decimal point is also counted as a digit

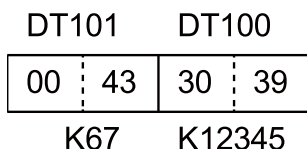
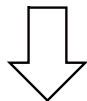
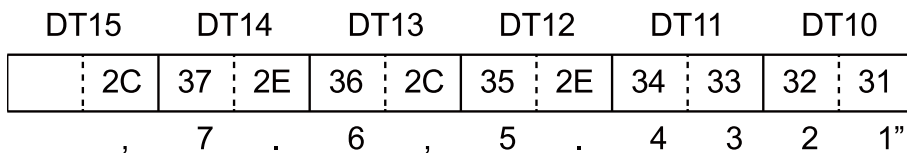

■ Particular examples

- If there is numeric data larger than the specified number of digits between commas (example: four sets of decimal numbers, and number of digits is four)

"1234, 567890, 12, 345" →	K 1234 K 5678 K90: The overflowed numbers become one numeric data K12 K345: Ignored
---------------------------	---

- If there is no value between commas (example: four sets of decimal numbers)

"123, 456,, 78" →	Operation error
-------------------	-----------------

- If there is only a decimal point between commas (example: three sets of decimal numbers with decimal points)

"1234. 5,,.6.7" →	Operation error *If there is any number, for example "2." or ".2", it is converted
-------------------	---

■ Flag operations

Name	Description
R9007 R9008 (ER)	When there is an error in the control string specified by S1
	When the conversion format specified by S1 is in decimal, and the direction of converted data is changed to the normal direction
	When the conversion format specified by S1 is hexadecimal, and the size of the area for storing ASCII codes specified by n exceeds the rated value (Rated value for 16-bit data: 4) (Rated value for 32-bit data: 8)
	The ASCII code specified by S2 contains any code other than 0 to F, a sign, a space, a dot, or a comma
	The number of converted blocks specified by n is 0
	The size of the area for storing ASCII codes specified by n is 0
	The ASCII code to be converted exceeds the area

26.3 F251 ATOB (ASCII to Binary Conversion)

Name	Description
	When the converted result exceeds the area
	The converted result exceeds the converted data scale specified by n
	When the area is exceeded in index modification

26.4 F252 ACHK (ASCII Data Check)

Checks whether the specified ASCII data is correct.

■ Instruction format

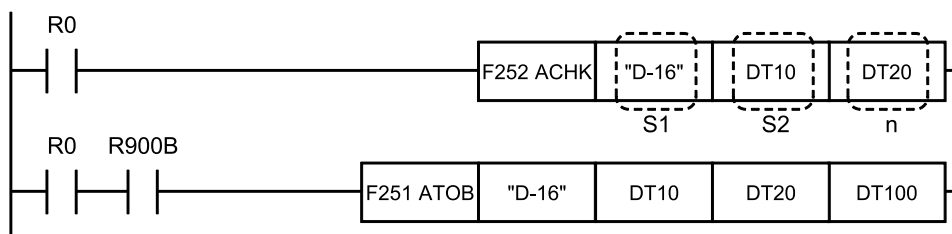

■ Operands

Items	Settings
S1	Area storing the control character string, or character string data
S2	Starting number of the area storing the ASCII code
n	Area storing the conversion method, or constant data

■ Devices that can be specified (indicated by ●)

Operand s	WX	WY	WR	WL	SV	EV	DT	LD	I	SW R	SD T	Constant				Index modifier (Note 1)	Integer Device
												K	H	M	f		
S1	●	●	●	●	●	●	●	●	●	●	●				●		
S2	●	●	●	●	●	●	●	●	●	●	●				●		
n	●	●	●	●	●	●	●	●	●	●	●	●	●		●		

(Note 1) A character constant cannot be specified.

■ Outline of operation

- This instruction checks whether the ASCII code stored in the area specified by S2 can be correctly converted using the conversion method specified by n in accordance with the 4-character control characters specified by S1.
- It checks whether the character string to be converted by the F251 ATOB instruction can be converted.

This instruction can be executed before the character string is converted by the F251 ATOB instruction and if an error is found in the data, can control to not execute the F251 ATOB instruction. Specify S1, S2, and n to be the same values as in the F251 ATOB instruction. As a result of the check, the special relay R900B turns ON if the data is correct and OFF if there is an error.

■ Specifying each item

The method to specify S1, S2, and n is the same as for the F251 ATOB instruction, so refer to the description of F251 ATOB ASCII to Binary Conversion.

26.4 F252 ACHK (ASCII Data Check)

■ Flag operations

Name	Description
R9007 R9008 (ER)	When there is an error in the control string specified by S1
	When the conversion format specified by S1 is in decimal, and the direction of converted data is changed to the normal direction
	When the conversion format specified by S1 is hexadecimal, and the size of the area for storing ASCII codes specified by n exceeds the rated value (Rated value for 16-bit data: 4) (Rated value for 32-bit data: 8)
	The number of converted blocks specified by n is 0
	The size of the area for storing ASCII codes specified by n is 0
	The ASCII code to be converted exceeds the area
	When the area is exceeded in index modification

26.5 F253 SSET (Character Constant → ASCII Code Conversion: with Storage Area Size)

■ Instruction format

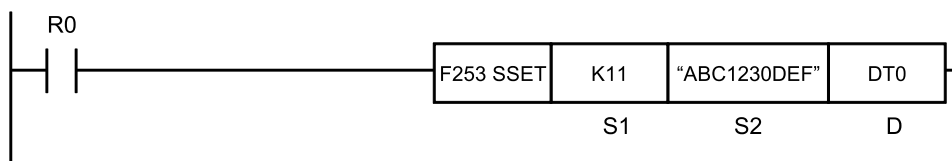

■ Operands

Items	Settings
S1	Storage area size (permissible range: K1 to K32767, H8000)
S2	Character constant to be converted (permissible range: 0 to 256 characters)
D	Starting device address of the destination

■ Devices that can be specified (indicated by ●)

Operands	WX	WY	WR	WL	SV	EV	DT	LD	I	SW R	SDT	Constant			Index modifier (Note 1)
												K	H	M	
S1	●	●	●	●	●	●	●	●	●			●	●		●
S2														●	
D		●	●	●	●	●	●	●	●						●

(Note 1) A character constant cannot be specified.

■ Outline of operation

- When **S1** (storage area size) is K1 to K32767:
The storage area size specified in **S1** is stored in **D**.
The character constant specified by **S2** is converted into ASCII code. The number of characters (1 word) is stored in **D+1**, and ASCII converted character data is stored in **D+2** and the subsequent area, in ascending order from lower bytes.
- When **S1** (storage area size) is H8000:
The character constant specified by **S2** is converted into ASCII code. The number of characters (1 word) is stored in **D**, and ASCII converted character data is stored in **D+2** and the subsequent area, in ascending order from lower bytes.
- A character constant is bracketed in "" (double quotation marks).
- Character constants can be set from 0 to 256 characters.
- A string that consists of "" (double quotation marks) only is regarded as NULL characters.
- NULL(00) is not added to the end of characters during setting.

26.5 F253 SSET (Character Constant → ASCII Code Conversion: with Storage Area Size)

■ Processing

Example 1) When a string "ABC1230 DEF" (11 characters including a space) is to be converted

S1...K12 S2... "ABC1230 DEF" D...DT0

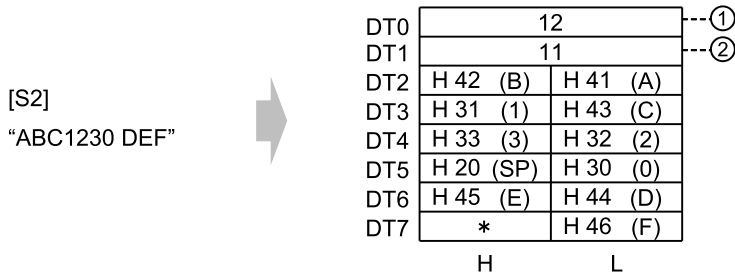

(Note 1) Data outside the range in the destination (*) (bytes higher than DT7) does not change.

(1)	Storage area size	(2)	Number of characters
-----	-------------------	-----	----------------------

Example 2) With the 16 characters from A to P as one set, when 16 sets (256 characters in total) are to be repeatedly converted

S1...K256 S2... "ABCDEF...KLMNOP" D...DT0

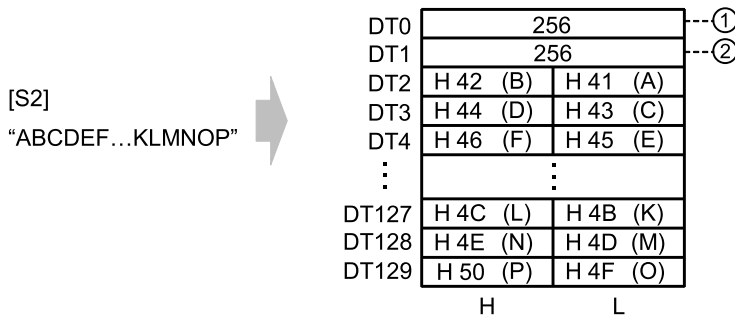

(1)	Storage area size	(2)	Number of characters
-----	-------------------	-----	----------------------

Example 3) A string of zero character bracketed by "" (i.e. double quotation marks in sequel) is converted

S1...K1 S2... "" D...DT0

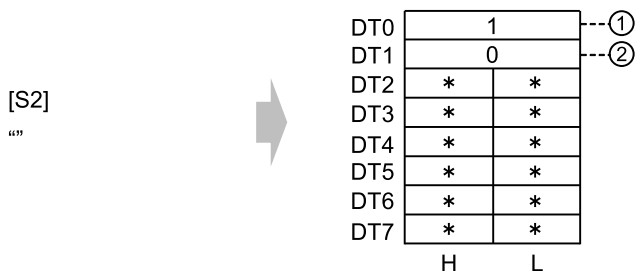

(Note 1) Data outside the range in the destination (*) (DT2 to DT7) does not change.

26.5 F253 SSET (Character Constant → ASCII Code Conversion: with Storage Area Size)

(1) Storage area size	(2) Number of characters
-----------------------	--------------------------

Example 4) When a string “ABC1230 DEF” (11 characters including a space) is to be converted

S1...H8000 S2... “ABC1230 DEF” D...DT0

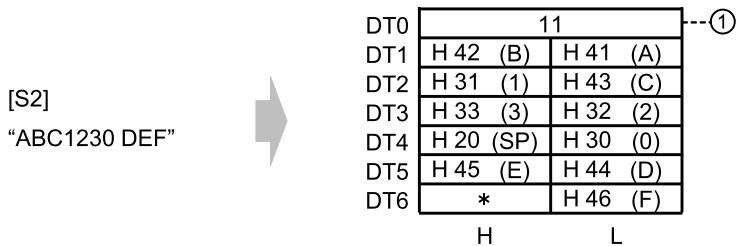

(Note 1) Data outside the range in the destination (*) (bytes higher than DT6) does not change.

(1) No. of characters

Example 5) With the 16 characters from A to P as one set, when 16 sets (256 characters in total) are to be repeatedly converted

S1...H8000 S2... “ABCDEF...KLMNOP” D...DT0

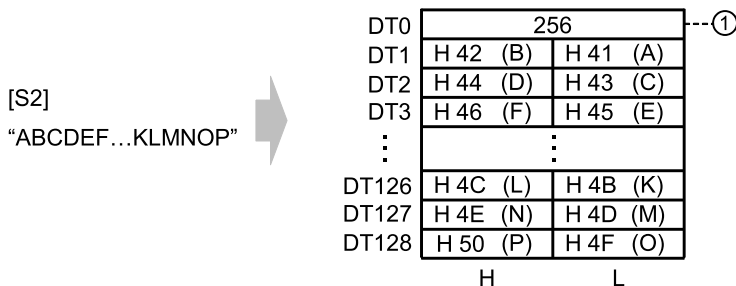

(1) No. of characters

Example 6) A string of zero character bracketed by “” (i.e. double quotation marks in sequel) is to be converted

S1...H8000 S2... “” D...DT0

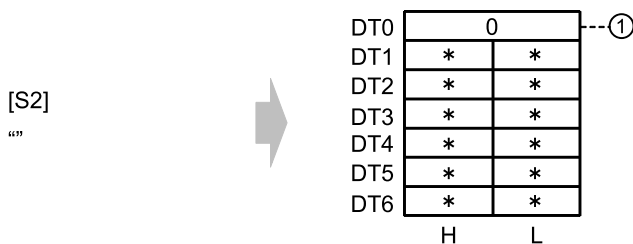

(Note 1) Data outside the range in the destination (*) (DT1 to DT6) does not change.

(1) No. of characters

26.5 F253 SSET (Character Constant → ASCII Code Conversion: with Storage Area Size)

■ Flag operations

Name	Description
R9007 R9008 (ER)	Turns ON when the area is exceeded in index modification.
	Turns ON when the accessible range is exceeded if the storage area size starting with D is secured.
	Turns ON when a value outside the permissible range is specified for S1 .
	Turns ON when the number of characters is larger than the storage area size.

26.6 Overview of String Instructions F257 SCMP to F265 SREP

■ **Data table structure**

The character string data table sets the character string size, number of characters, and character data.

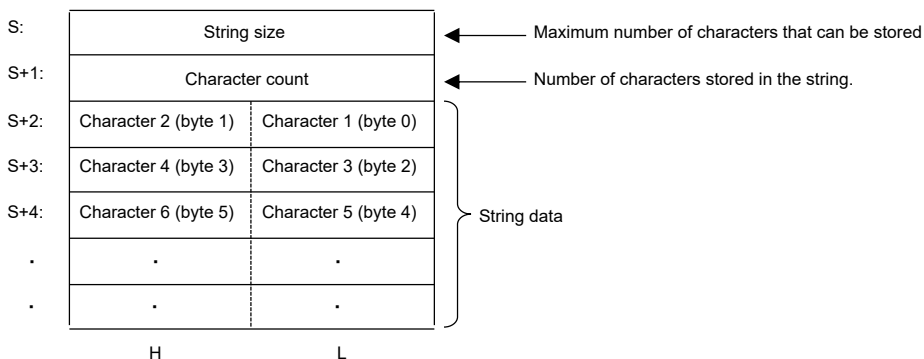

e.g. When a [character string size (20 characters), number of characters (12 characters), character data "ABCDEFGHJKLM"] data table is specified for DT0

The F253 SSET instruction is used to set the character string data table.

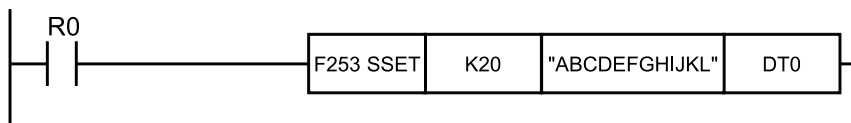

DT0	20	
DT1	12	
DT2	"B"	"A"
DT3	"D"	"C"
DT4	"F"	"E"
DT5	"H"	"G"
DT6	"J"	"I"
DT7	"L"	"K"
	H	L

26.7 F257 SCMP (Comparing Character Strings)

26.7 F257 SCMP (Comparing Character Strings)

Compares two specified character strings, and outputs the judgment result to a special internal relay.

■ Instruction format

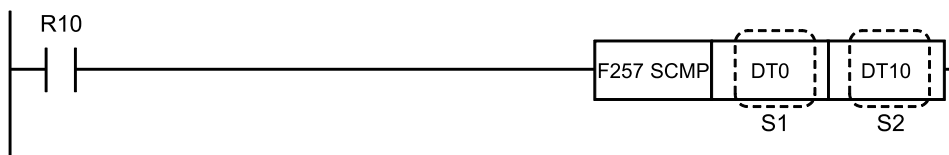

■ Operands

Items	Settings
S1	Character string 1 for comparison
S2	Character string 2 for comparison

■ Devices that can be specified (indicated by ●)

Operands	WX	WY	WR	WL	SV	EV	DT	LD	I	SWR	SDT	Constant				Index modifier	Integer Device
												K	H	M	f		
S1	●	●	●	●	●	●	●	●	●	●	●					●	
S2	●	●	●	●	●	●	●	●	●	●	●					●	

■ Outline of operation

- The character string specified for [S1] is compared to the character string specified for [S2], and the judgment result is output to special internal relays R9009 to R900C (judgment flags for comparison instructions).
- R9009 to R900C are assigned based on whether [S1] or [S2] is larger or smaller, as shown in the table below.

Relationship of S1 and S2	Flag			
	R900A	R900B	R900C	R9009
	>	=	<	Carry
S1<S2	OFF	OFF	ON	Fluctuates
S1=S2	OFF	ON	OFF	OFF
S1>S2	ON	OFF	OFF	Fluctuates

■ Operation example

Operation of instruction format description program

When internal relay R10 is ON, data registers DT1 and DT11 are compared. In this case, it is determined that [S1] < [S2], and R900C turns ON.

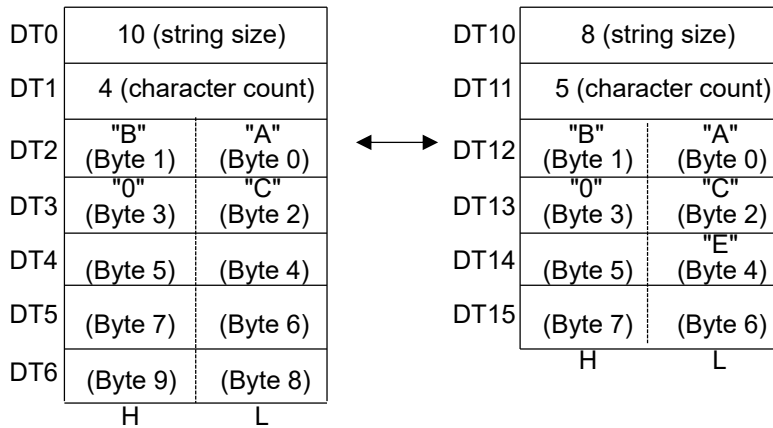

■ Precautions for programming

- If the number of characters is different, the greater/lesser relationship is as shown below.

S1	Greater/lesser	S2
"ABCDE"	=	"ABCDE"
"ABCD"	<	"ABCDE"
"B"	>	"ABCDE"

- Comparison of character strings is performed in sequence from byte 0, one character at a time.
- If one character string has fewer characters than the other, it may still be handled as larger if a large character code is used when the comparison is made.
e.g. "B">"ABCDE"
- To specify a character string, indicate the number of the area in which the character string size and number of characters have been specified. For detailed information about the table configuration of the data area, refer to "P.26-25".

■ Flag operations

Name	Description
R9007	Turns ON when the area is exceeded in index modification.
R9008 (ER)	Turns ON when number of characters is greater than the character string size

26.8 F258 SADD (Character String Concatenation)

26.8 F258 SADD (Character String Concatenation)

Concatenates one character string with another.

■ Instruction format

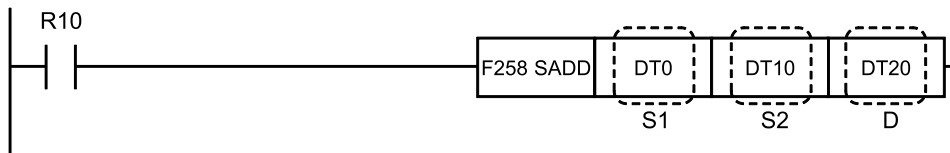

■ Operands

Items	Settings
S1	Character string to be concatenated
S2	Character string to be concatenated
D	Area in which the concatenated character strings are stored

■ Devices that can be specified (indicated by ●)

Operands	WX	WY	WR	WL	SV	EV	DT	LD	I	SWR	SDT	Constant				Index modifier	Integer Device
												K	H	M	f		
S1	●	●	●	●	●	●	●	●	●	●	●					●	
S2	●	●	●	●	●	●	●	●	●	●	●					●	
D		●	●	●	●	●	●	●	●							●	

■ Outline of operation

- The character string specified by [S1] is concatenated with the character string specified by [S2], and the result is stored in the character string specified by [D].
- At the start of the area for storing results [D], specify the character string size via the user program.

■ Operation example

Operation of instruction format description program

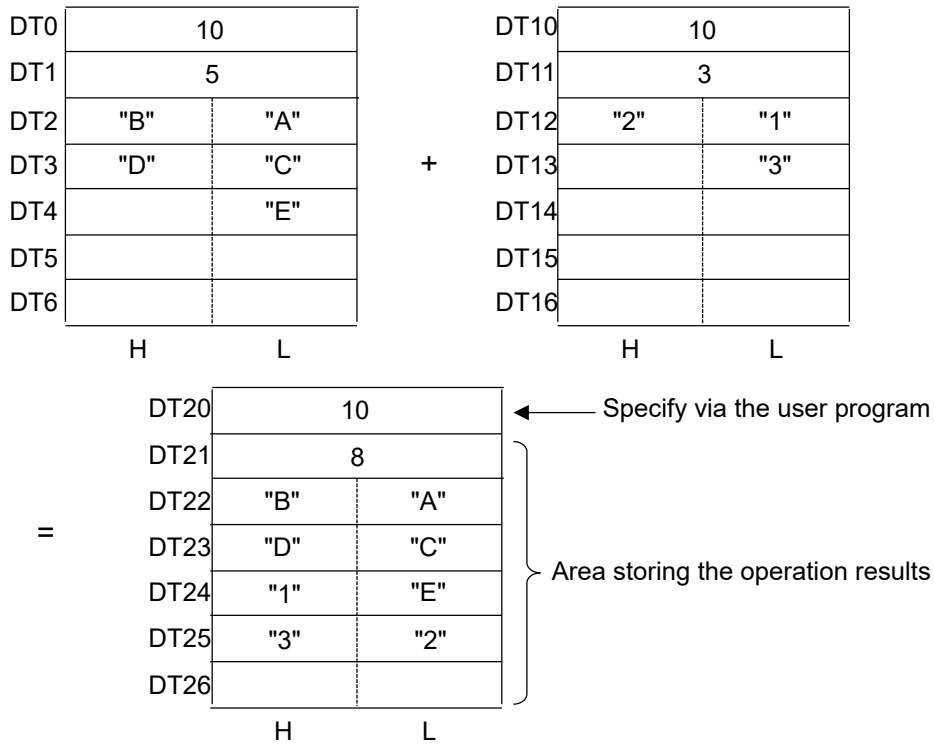

■ Precautions for programming

If the result of the concatenation operation is larger than the character string size of [D], only as many characters as will fit in [D] are stored.

■ Flag operations

Name	Description
R9007	Turns ON when the area is exceeded in index modification.
R9008 (ER)	Turns ON when number of characters is greater than the character string size
R9009 (CY)	Turns ON when the operation result is greater than the size of the character string specified by [D]

26.9 F259 LEN (Number of Characters in a Character String)

26.9 F259 LEN (Number of Characters in a Character String)

Determines the number of characters stored in a character string.

■ Instruction format

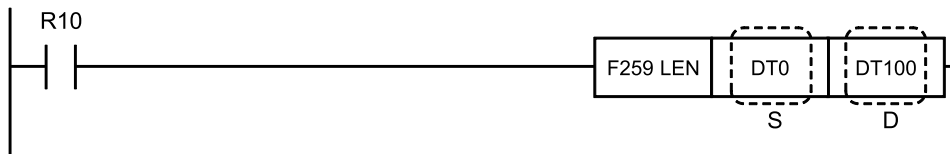

■ Operands

Items	Settings
S	Character string
D	Area that stores the number of characters in the calculation result

■ Devices that can be specified (indicated by ●)

Operands	WX	WY	WR	WL	SV	EV	DT	LD	I	SWR	SDT	Constant				Index modifier	Integer Device
												K	H	M	f		
S	●	●	●	●	●	●	●	●	●	●	●					●	
D	●	●	●	●	●	●	●	●	●							●	

■ Outline of operation

The number of characters in the character string specified by [S] is determined, and the result is stored in [D].

■ Operation example

Operation of instruction format description program

DT0	10	
DT1	8	
DT2	"B"	"A"
DT3	"D"	"C"
DT4	"1"	"E"
DT5	"3"	"2"
DT6		

H L

$$= \text{DT100} \boxed{8}$$

■ Precautions for programming

If the number of characters is greater than the character string size, an operation error occurs.

■ Flag operations

Name	Description
R9007	Turns ON when the area is exceeded in index modification.
R9008 (ER)	Turns ON when number of characters is greater than the character string size

26.10 F260 SSRC (Search for character string)

26.10 F260 SSRC (Search for character string)

Searches for the specified character string.

■ Instruction format

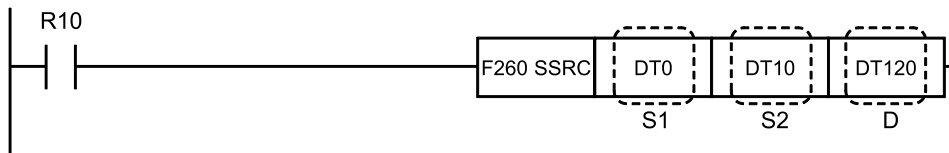

■ Operands

Items	Settings
S1	Area storing the character data to be searched (character string or character constant)
S2	Character string to be searched
D	Area storing the search result

■ Devices that can be specified (indicated by ●)

Operands	WX	WY	WR	WL	SV	EV	DT	LD	I	SWR	SDT	Constant				Index modifier	Integer Device
												K	H	M	f		
S1	●	●	●	●	●	●	●	●	●	●	●					●	
S2	●	●	●	●	●	●	●	●	●	●	●					●	
D		●	●	●	●	●	●	●	●							●	

■ Outline of operation

- The character data specified by [S1] is searched for the character string specified by [S2].
- The number of characters that are the same based on the search result is stored in [D] and the first matching relative position (in byte units) is stored in [D+1].

■ Operation example

Operation of instruction format description program

The characters in DT0 are searched from the character string in DT10 and the result is stored in DT120.

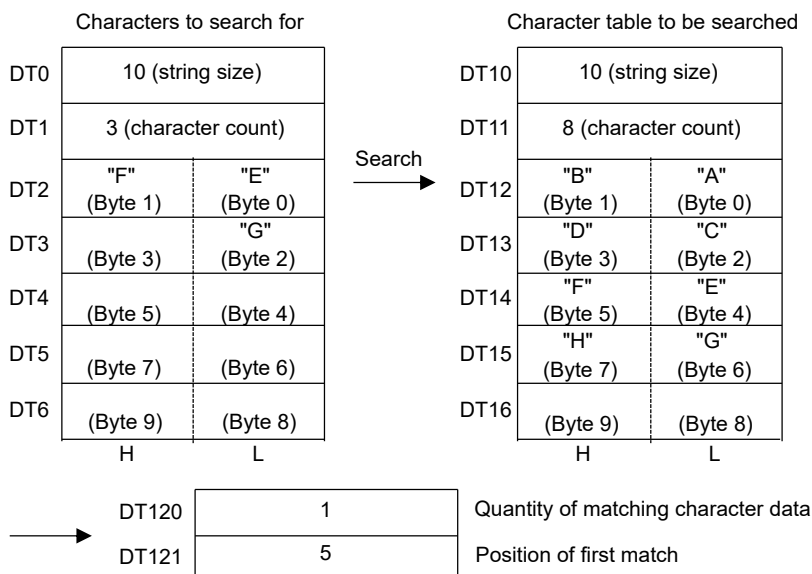

■ Precautions for programming

- Specify a number of characters so that [S1] is less than or equal to [S2].
- For [S1+1], the number of characters in the character string on the search side, specify a value for the number of characters to be searched.

e.g.

4 (string size)	
1 (character count)	
"B"	"A"
"D"	"C"

← When the character count is 1, searches for the character ".
When the character count is 2, searches for the characters "AB" as a single block

■ Flag operations

Name	Description
R9007	Turns ON when the area is exceeded in index modification.
R9008 (ER)	Turns ON when number of characters is greater than the character string size

26.11 F261 RIGHT [Retrieve from Character String (Right)]

Retrieves a character string with the specified number of characters from the right side of a character string.

■ **Instruction format**

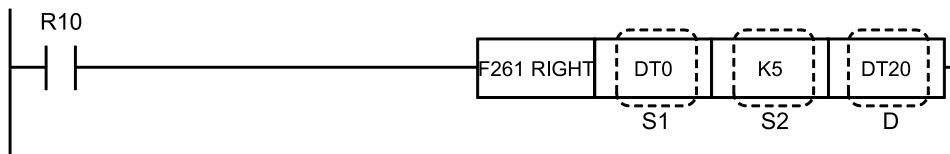

■ **Operands**

Items	Settings
S1	Character string
S2	Area storing the number of characters, or constant data
D	Area storing the character string

■ **Devices that can be specified (indicated by ●)**

Operands	WX	WY	WR	WL	SV	EV	DT	LD	I	SW R	SD T	Constant				Index modifier	Integer Device
												K	H	M	f		
S1	●	●	●	●	●	●	●	●	●	●	●					●	
S2	●	●	●	●	●	●	●	●	●	●	●	●	●			●	
D		●	●	●	●	●	●	●	●							●	

■ **Outline of operation**

- The number of characters specified by [S2] are retrieved from the right side of the character string (the end of character data) specified by [S1], and are transferred to the character string specified by [D].
- At the start of the area for storing results [D], specify the character string size via the user program.

■ **Operation example**

Operation of instruction format description program

Five characters are retrieved from the end of character string DT0 and transferred to DT20.

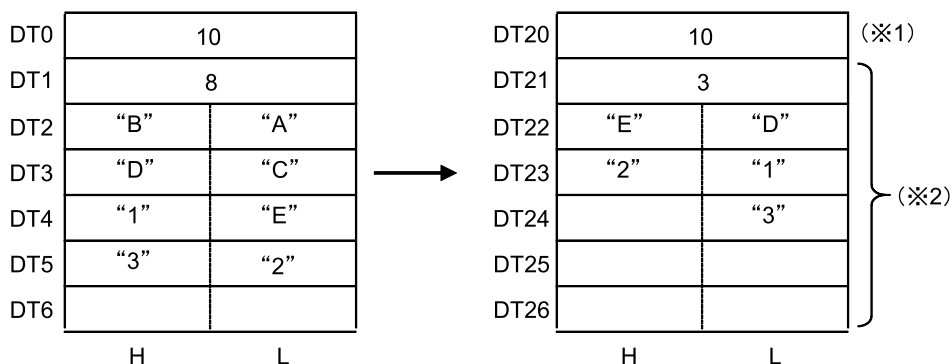

(*1): Specify via the user program

(*2): Area storing the operation results

■ Precautions for programming

- The character data of [D] prior to the operation is cleared.
- If the number of characters in [S2] is greater than the number of characters in the [S1] character string, the number of characters of the [S1] character string is sent.
- If the number of characters specified by [S2] is greater than the size of the character string specified by [D], then the number of characters equal to the size of the character string specified by [D] are transferred.

■ Flag operations

Name	Description
R9007	Turns ON when the area is exceeded in index modification.
R9008 (ER)	Turns ON when number of characters is greater than the character string size
R9009 (CY)	Turns ON when the operation result is greater than the size of the character string specified by [D]

26.12 F262 LEFT [Retrieving data from character strings (left side)]

26.12 F262 LEFT [Retrieving data from character strings (left side)]

Retrieves the specified number of characters from the left side of a character string.

■ Instruction format

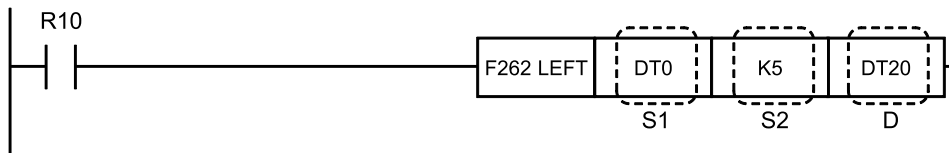

■ Operands

Items	Settings
S1	Character string
S2	Area storing the number of characters, or constant data
D	Area storing the character string

■ Devices that can be specified (indicated by ●)

Operands	WX	WY	WR	WL	SV	EV	DT	LD	I	SWR	SDT	Constant				Index modifier	Integer Device
												K	H	M	f		
S1	●	●	●	●	●	●	●	●	●	●	●					●	
S2	●	●	●	●	●	●	●	●	●	●	●	●	●			●	
D		●	●	●	●	●	●	●	●							●	

■ Outline of operation

- The number of characters specified by [S2] are retrieved from the left side of the character string (the start of character data) specified by [S1], and are transferred to the character string specified by [D].
- At the start of the area for storing results [D], specify the character string size via the user program.

■ Operation example

Operation of instruction format description program

Five characters are retrieved from the start of the character string in DT0 and transferred to DT20.

26.12 F262 LEFT [Retrieving data from character strings (left side)]

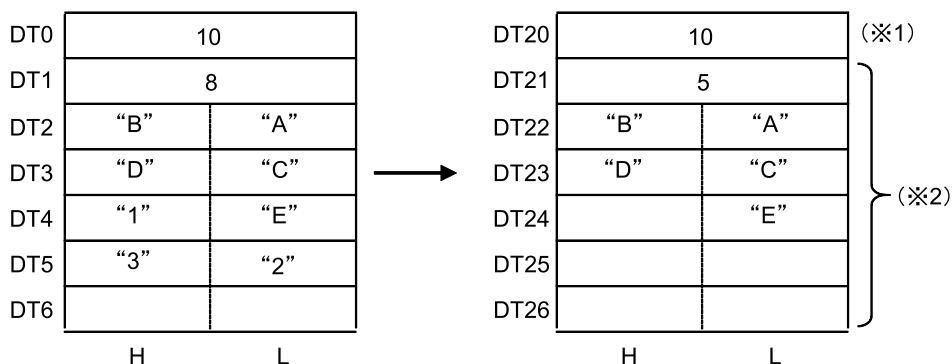

(*1): Specify via the user program

(*2): Area storing the operation results

■ Precautions for programming

- The character data of [D] prior to the operation is cleared.
- If the number of characters specified by [S2] is greater than the number of characters in the character string specified by [S1], then the number of characters in the character string specified by [S1] are transferred.
- If the number of characters specified by [S2] is greater than the size of the character string specified by [D], then the number of characters equal to the size of the character string specified by [D] are transferred.

■ Flag operations

Name	Description
R9007	Turns ON when the area is exceeded in index modification.
R9008 (ER)	
R9009 (CY)	Turns ON when the operation result is greater than the size of the character string specified by [D]

26.13 F263 MIDR (Character String From Character String Retrieval)

Retrieves a character string of the specified number of characters from the specified position in a character string.

■ **Instruction format**

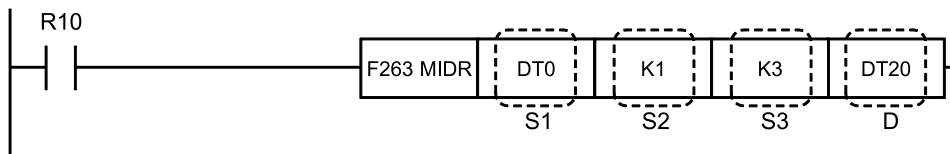

■ **Operands**

Items	Settings
S1	Character string
S2	Area storing the character string position, or constant data
S3	Area storing the number of characters, or constant data
D	Area storing the character string

■ **Devices that can be specified (indicated by ●)**

Operands	WX	WY	WR	WL	SV	EV	DT	LD	I	SWR	SDT	Constant				Index modifier	Integer Device
												K	H	M	f		
S1	●	●	●	●	●	●	●	●	●	●	●					●	
S2	●	●	●	●	●	●	●	●	●	●	●	●	●			●	
S3	●	●	●	●	●	●	●	●	●	●	●	●	●			●	
D		●	●	●	●	●	●	●	●							●	

■ **Outline of operation**

- The number of characters specified by [S3] is retrieved from the position specified by [S2] in the character string specified by [S1], and is transferred to the character string specified by [D].
- At the start of the area for storing results [D], specify the character string size via the user program.

■ **Operation example**

Operation of instruction format description program

Three characters are retrieved from position byte 1 (2nd character) of the DT0 character string, and are transferred to DT20.

26.13 F263 MIDR (Character String From Character String Retrieval)

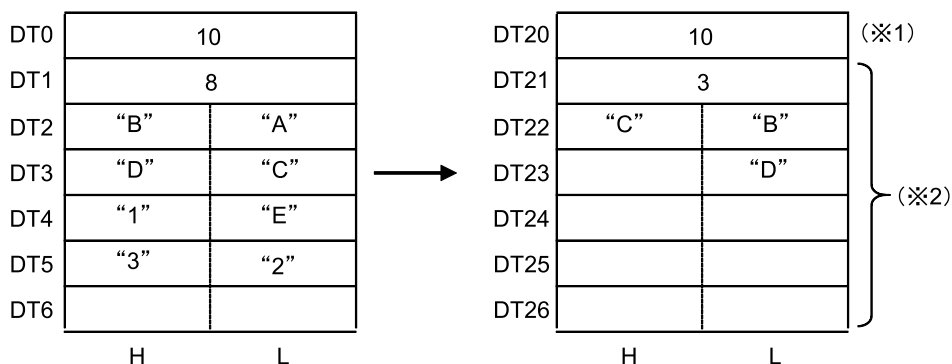

(*1): Specify via the user program

(*2): Area storing the operation results

■ Precautions for programming

- The character data of [D] prior to the operation is cleared.
- If the number of characters specified by [S3] is greater than the number of characters in the character string specified by [S1] from the position specified by [S2], then the number of characters in the character string specified by [S1] are transferred.
- If the number of characters of the operation result is greater than the size of the character string specified by [D], then the number of characters equal to the size of the character string specified by [D] are transferred.
- The position specified by [S2] has K0 specified for the least significant byte (byte 0), and the positions are counted in the order of 0, 1, 2, etc., starting from the least significant byte.

■ Flag operations

Name	Description
R9007	Turns ON when the area is exceeded in index modification.
R9008	Turns ON when number of characters is greater than the character string size
(ER)	Turns ON when the number of characters specified by [S1] is less than [S2]
R9009	Turns ON when the operation result is greater than the size of the character string specified by [D]
(CY)	

26.14 F264 MIDW (Writing a Character String to a Character String)

These instructions write a specified number of characters from a character string to a specified position in the character string.

■ **Instruction format**

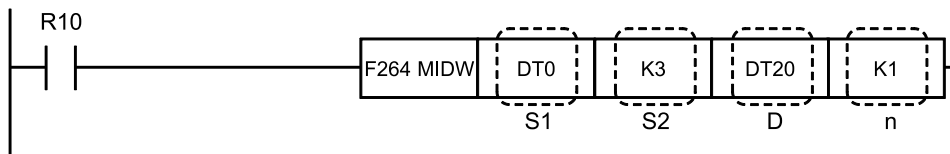

■ **Operands**

Items	Settings
S1	Character string
S2	Area storing the number of characters, or constant data
D	Starting address of the area storing a character string
n	Area storing the character string position, or constant data

■ **Devices that can be specified (indicated by ●)**

Operands	WX	WY	WR	WL	SV	EV	DT	LD	I	SW R	SD T	Constant				Index modifier (Note 1)	Integer Device
												K	H	M	f		
S1	●	●	●	●	●	●	●	●	●	●	●			●			
S2	●	●	●	●	●	●	●	●	●	●	●	●			●		
D		●	●	●	●	●	●	●	●						●		
n	●	●	●	●	●	●	●	●	●	●	●	●			●		

(Note 1) A character constant cannot be specified.

■ **Outline of operation**

The number of characters specified by [S2] is retrieved from the character string specified by [S1], and is transferred to the [n] position of the character string specified by [D].

■ **Operation example**

Operation of instruction format description program

Retrieves 3 characters from the DT0 character string, and transfers these to the byte 1 position (second character) of the DT20 character string block.

26.14 F264 MIDW (Writing a Character String to a Character String)

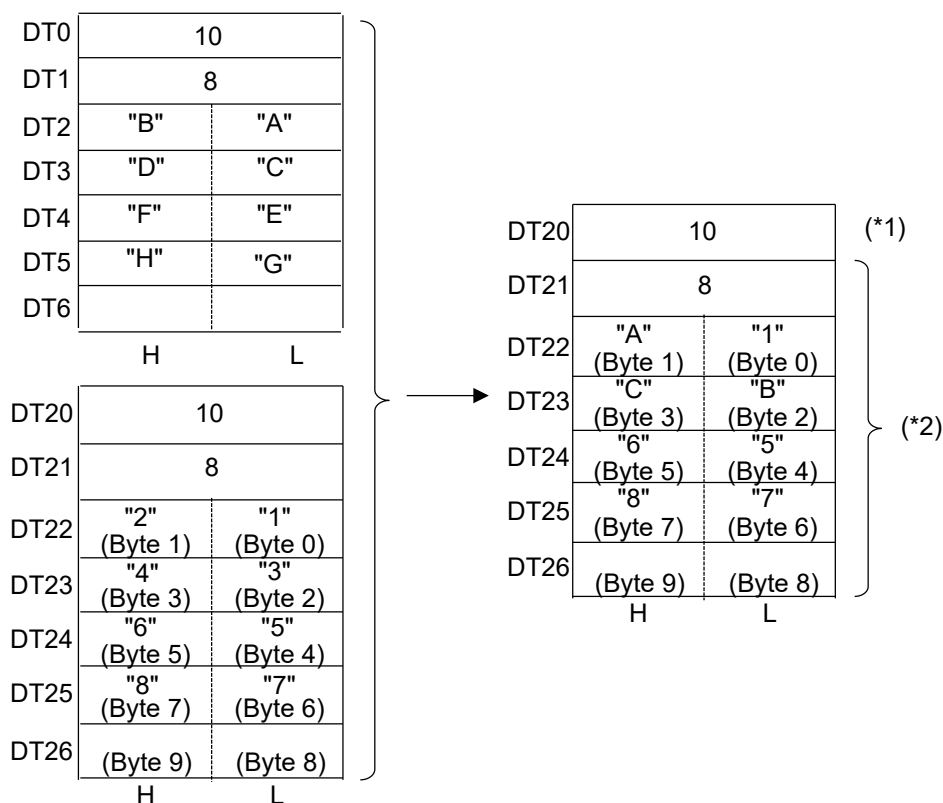

(*1): Specify via the user program

(*2): Area storing the operation results

■ Precautions for programming

- The [D] character data before calculation is not cleared. (This is overwritten.)
- If the number of characters in [S2] is greater than the number of characters in the [S1] character string, the number of characters of the [S1] character string is sent.
- If the position of [n] is greater than number of characters in the [D] character string, an operation error occurs.
- If the number of characters in the operation result is greater than the size of the [D] character string, then replacement is done only within a range the size of the [D] character string.
- The [n] position sets the least significant byte as K0 (byte 0), counting up in the order of 0, 1, 2, etc. starting from the least significant byte.

■ Flag operations

Name	Description
R9007	Turns ON when the area is exceeded in index modification.
R9008 (ER)	Turns ON when number of characters is greater than the character string size
	Turns ON when the number of characters of [D] < [n]
R9009 (CY)	Turns ON when the operation result is greater than the size of the character string specified by [D]

26.15 F265 SREP (Replace Character Strings)

Replaces the specified number of characters in a character string with the same number of different characters, starting from the specified position.

■ **Instruction format**

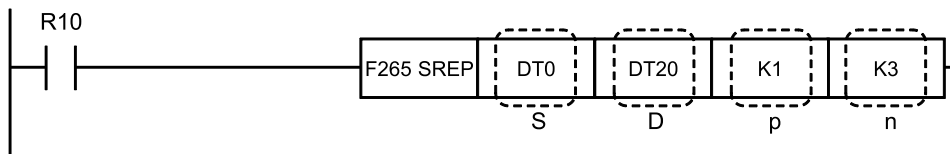

■ **Operands**

Items	Settings
S	Replacement character string
D	Starting address of the area storing a character string
p	Area storing the first byte position of the characters to be replaced, or constant data
n	Area storing the number of characters to be replaced from the source data, or constant data

■ **Devices that can be specified (indicated by ●)**

Operands	WX	WY	WR	WL	SV	EV	DT	LD	I	SW R	SD T	Constant				Index modifier (Note 1)	Integer Device
												K	H	M	f		
S	●	●	●	●	●	●	●	●	●	●	●			●			
D		●	●	●	●	●	●	●	●						●		
p	●	●	●	●	●	●	●	●	●	●	●	●	●		●		
n	●	●	●	●	●	●	●	●	●	●	●	●	●		●		

(Note 1) A character constant cannot be specified.

■ **Outline of operation**

The number of characters specified by [n] are replaced with the character string specified by [S], starting from position [p] in the character string specified by [D].

■ **Operation example**

Operation of instruction format description program

The DT0 character string is replaced with the number of characters in DT1 (five characters) from byte p = 1 in DT20. In this case, n = 3 characters of the data stored in the source are deleted and replaced.

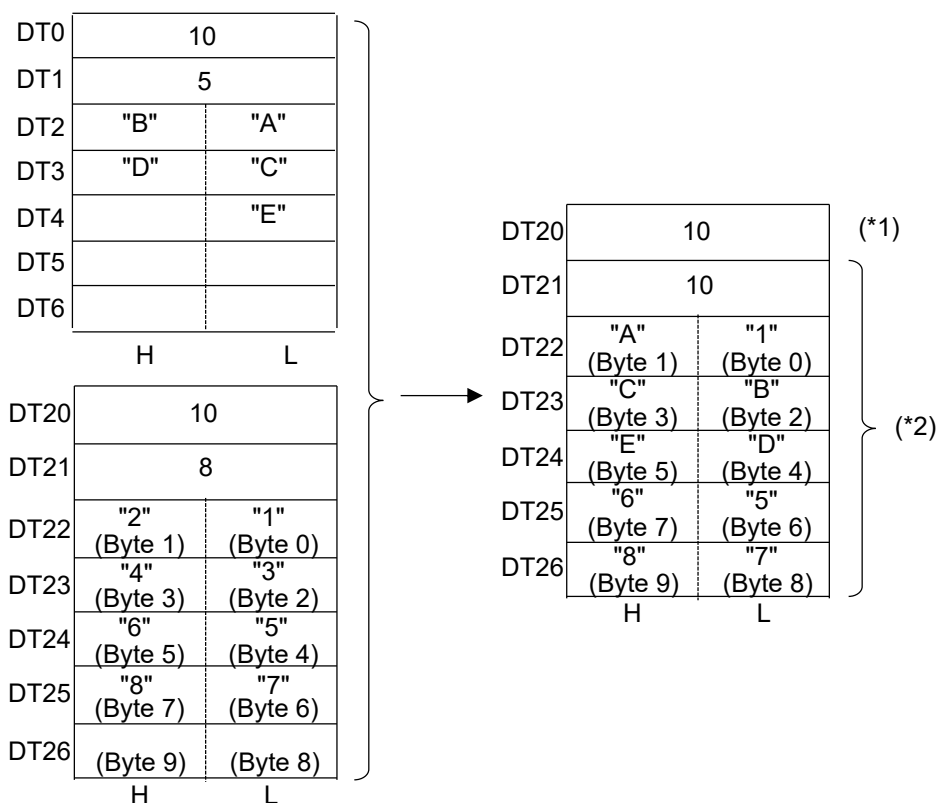

(*1): Specify via the user program

(*2): Area storing the operation results

■ Precautions for programming

- The character data from [D] prior to the operation is not cleared. (This is overwritten.)
- If the number of characters in [n] is larger than the number of characters in the character string [S] subsequent to the point specified by [p], the number of characters in character string [S] subsequent to the point specified by [p] are replaced.
- If the position specified by [p] exceeds the number of characters in the character string specified by [D], an operation error occurs.
- The position specified by [p] sets the low byte as K0 (byte 0), and the positions are counted in the order 0, 1, 2, ... starting from the low byte.

■ Flag operations

Name	Description
R9007	Turns ON when the area is exceeded in index modification.
R9008	Turns ON when number of characters is greater than the character string size
(ER)	Turns ON when the number of characters of [D] is less than [n]
R9009	Turns ON when the operation result is greater than the size of the character string specified by [D]
(CY)	

(MEMO)

27 Data Manipulation Instructions

27.1	F270 MAX [maximum value (16-bit)]	27-2
27.2	F271 DMAX [Maximum value (32-bit)].....	27-4
27.3	F272 MIN [Minimum Value (16-bit)]	27-6
27.4	F273 DMIN [Minimum value (32-bit)].....	27-8
27.5	F275 MEAN [Total and Mean Value (16-Bit)].....	27-10
27.6	F276 DMEAN [Total and Mean Value (32Bit)].....	27-12
27.7	F277 SORT [Sort (16-bit data)].....	27-14
27.8	F278 DSORT [Sort (32-bit)]	27-16
27.9	F282 SCAL [Scaling (linearization) of 16-bit data].....	27-18
27.10	F283 DSCAL [32-Bit Data Scaling (Linearization)]	27-21
27.11	F284 RAMP (16-bit Data Ramp Output)	27-24
27.12	F285 LIMIT [Upper and lower limit control (word data)].....	27-26
27.13	F286 DLIMIT [Upper and Lower Limit Control (Double Word)].....	27-28
27.14	F287 BAND [Deadband Control (Word)].....	27-30
27.15	F288 DBAND [Deadband Control (Double Word)].....	27-32
27.16	F289 ZONE [zone control (word)]	27-34
27.17	F290 DZONE [Zone control (double word)]	27-36

27.1 F270 MAX [maximum value (16-bit)]

27.1 F270 MAX [maximum value (16-bit)]

Finds the maximum value in the specified memory area range (word data table).

■ Instruction format

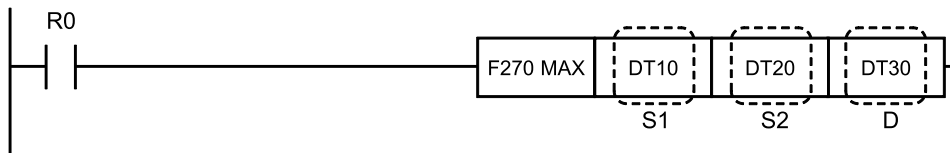

■ Operands

Items	Settings
S1	Starting area that stores word data
S2	Ending area that stores word data
D	Area storing the operation results (two words)

■ Devices that can be specified (indicated by ●)

Operands	WX	WY	WR	WL	SV	EV	DT	LD	I	SWR	SDT	Constant				Index modifier	Integer Device
												K	H	M	f		
S1	●	●	●	●	●	●	●	●	●	●	●					●	
S2	●	●	●	●	●	●	●	●	●	●	●					●	
D		●	●	●	●	●	●	●	●							●	

■ Outline of operation

- Searches for the maximum value in the word data tables from the area specified by [S1] to the area specified by [S2], stores the result in the area specified by [D], and stores the relative address value from [S1] in [D+1].

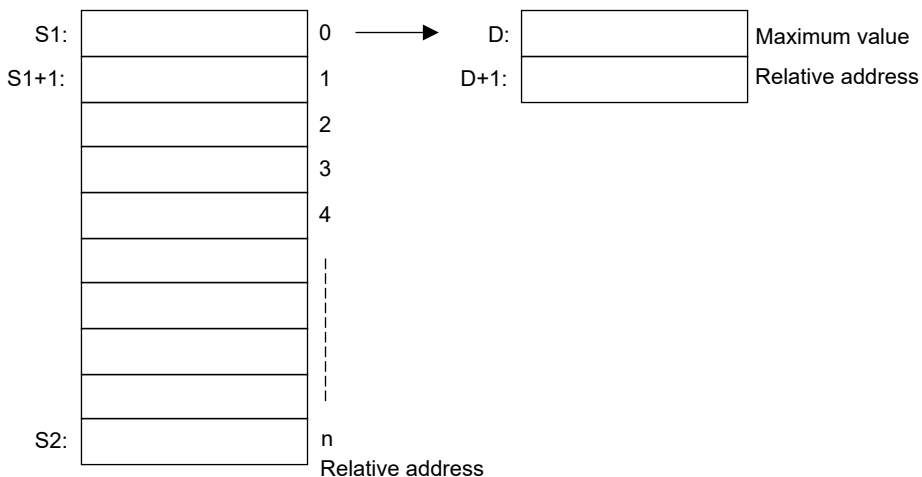

- If there is multiple data with the same value as the maximum value, the relative address of the first value found searching from [S1] is stored in [D+1].

■ Precautions for programming

[D+1] will stored even if it overflows the specified device area, so it may corrupt the start of other device areas. (Area overflow checks are not performed.)

■ Flag operations

Name	Description
R9007	Turns ON when the area is exceeded in index modification.
R9008	ON when [S1] is greater than [S2]
(ER)	Turns ON when S1 and S2 are different devices

27.2 F271 DMAX [Maximum value (32-bit)]

27.2 F271 DMAX [Maximum value (32-bit)]

Calculates the maximum value of the specified memory area range (double word data table).

■ Instruction format

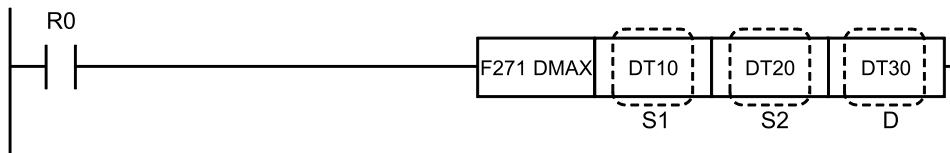

■ Operands

Items	Settings
S1	Starting area storing double word data
S2	Ending area storing double word data
D	Area storing the result of the operation (three words)

■ Devices that can be specified (indicated by ●)

Operands	WX	WY	WR	WL	SV	EV	DT	LD	I	SWR	SDT	Constant				Index modifier	Integer Device
												K	H	M	f		
S1	●	●	●	●	●	●	●	●	●	●	●					●	
S2	●	●	●	●	●	●	●	●	●	●	●					●	
D		●	●	●	●	●	●	●	●							●	

■ Outline of operation

- The maximum value is searched for in the double word data table between the area specified by [S1] and the area specified by [S2] and the result is stored in the area specified by [D]. The address relative to [S1] is stored in [D+2].

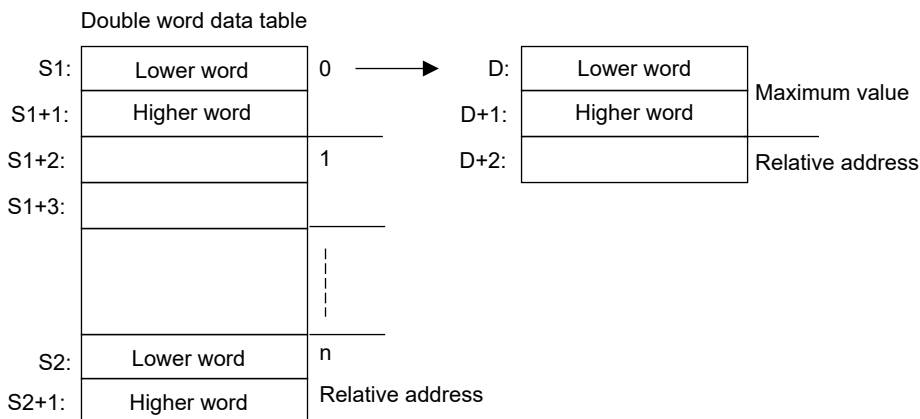

- If [S2] specifies a high word of double word data, processing will take place over the same area as if a low word had been specified.

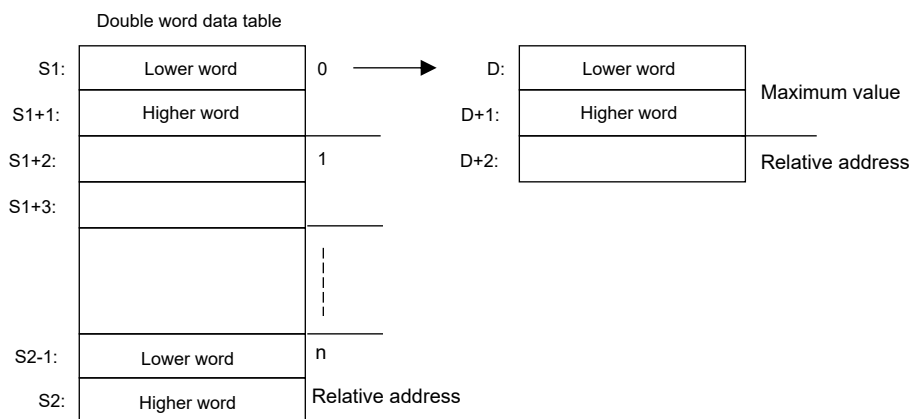

- If there is multiple data with the same value as the maximum value, the relative address of the first value found searching from [S1] is stored in [D+2].

■ **Precautions for programming**

- [D+2] will be stored even if it overflows the specified device area, so it may corrupt the start of other device areas. (Area overflow checks are not performed.)
- The stored relative address value is counted in 32-bit units.

■ **Flag operations**

Name	Description
R9007	Turns ON when the area is exceeded in index modification.
R9008	ON when [S1] is greater than [S2]
(ER)	Turns ON when S1 and S2 are different devices

27.3 F272 MIN [Minimum Value (16-bit)]

27.3 F272 MIN [Minimum Value (16-bit)]

Finds the minimum value in the specified memory area range (word data table).

■ Instruction format

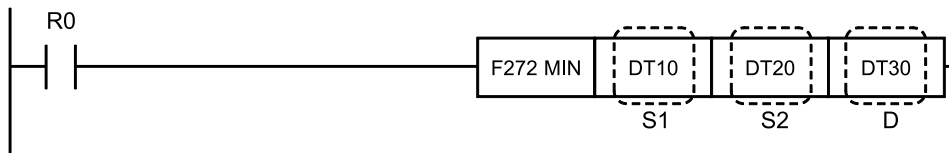

■ Operands

Items	Settings
S1	Starting area that stores word data
S2	Ending area that stores word data
D	Area storing the operation results (two words)

■ Devices that can be specified (indicated by ●)

Operands	WX	WY	WR	WL	SV	EV	DT	LD	I	SWR	SDT	Constant				Index modifier	Integer Device
												K	H	M	f		
S1	●	●	●	●	●	●	●	●	●	●	●					●	
S2	●	●	●	●	●	●	●	●	●	●	●					●	
D		●	●	●	●	●	●	●	●							●	

■ Outline of operation

- Searches for a minimum value in the word data table from the area specified in [S1] to the area specified in [S2], stores the result in the area specified in [D], and stores the relative address value from [S1] in [D+1].

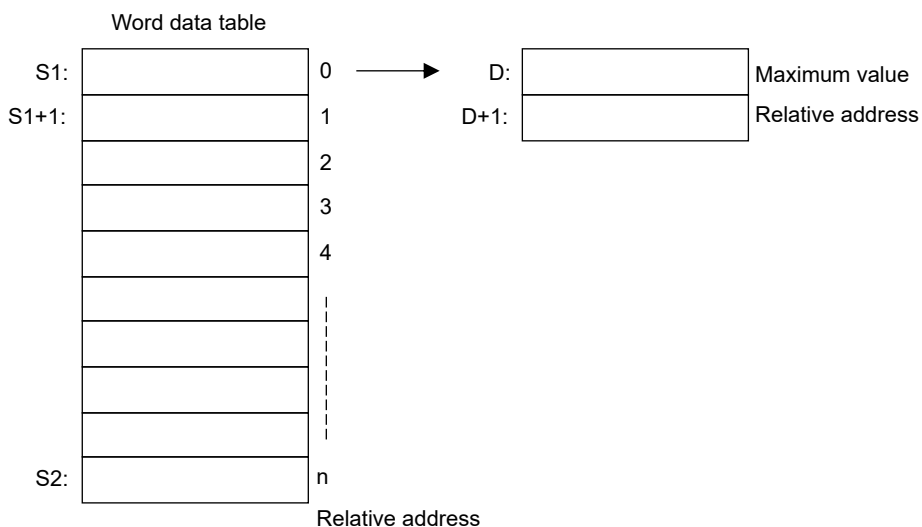

- When there is multiple data sharing the same minimum value, the relative address of the first result found searching from [S1] is stored in [D+1].

■ Precautions for programming

[D+1] will stored even if it overflows the specified device area, so it may corrupt the start of other device areas. (Area overflow checks are not performed.)

■ Flag operations

Name	Description
R9007	Turns ON when the area is exceeded in index modification.
R9008	ON when [S1] is greater than [S2]
(ER)	Turns ON when S1 and S2 are different devices

27.4 F273 DMIN [Minimum value (32-bit)]

27.4 F273 DMIN [Minimum value (32-bit)]

Finds the minimum value of the specified memory area range (double word data table).

■ Instruction format

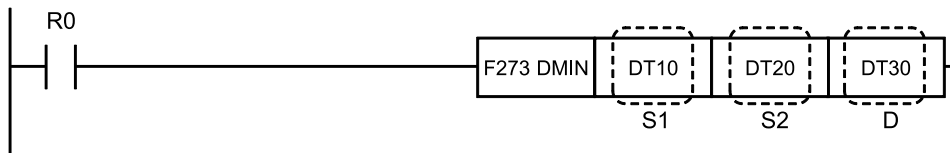

■ Operands

Items	Settings
S1	Starting area storing double word data
S2	Ending area storing double word data
D	Area storing the result of the operation (three words)

■ Devices that can be specified (indicated by ●)

Operands	WX	WY	WR	WL	SV	EV	DT	LD	I	SWR	SDT	Constant				Index modifier	Integer Device
												K	H	M	f		
S1	●	●	●	●	●	●	●	●	●	●	●					●	
S2	●	●	●	●	●	●	●	●	●	●	●					●	
D		●	●	●	●	●	●	●	●							●	

■ Outline of operation

- Searches for the minimum value in the double word data table between the area specified by [S1] and the area specified by [S2] and stores the result in the area specified by [D]. The relative address value relative to [S1] is stored in [D+2].

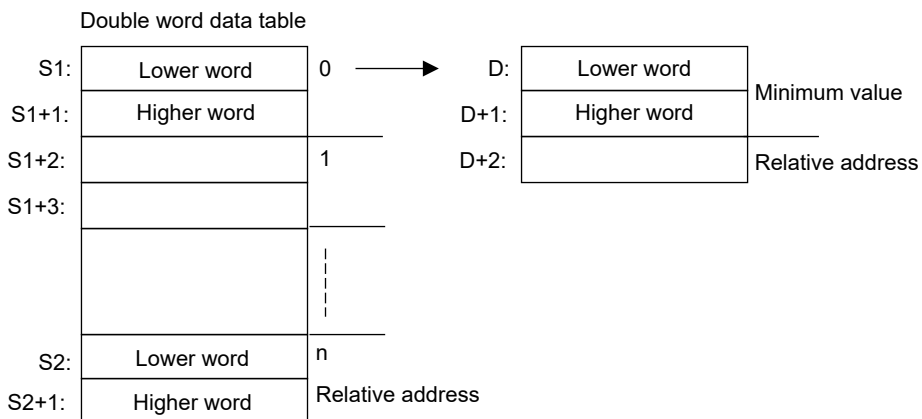

- If [S2] specifies a high word of double word data, processing will take place over the same area as if a low word had been specified.

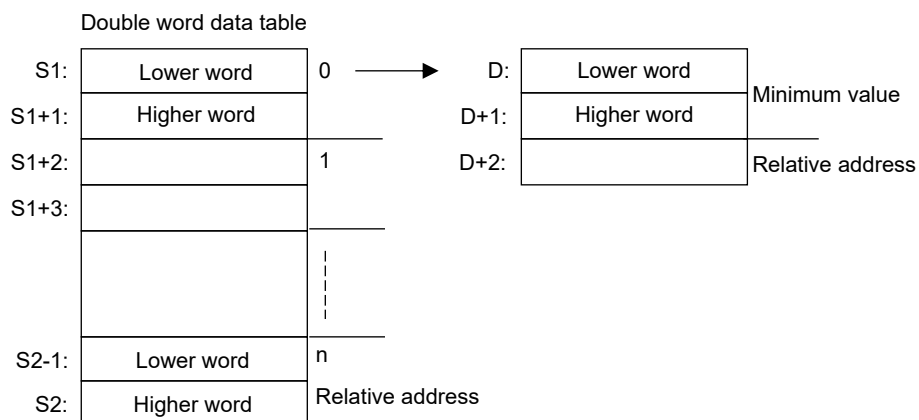

- When there is multiple data sharing the same minimum value, the relative address of the first result found searching from [S1] is stored in [D+2].

■ Precautions for programming

- [D+2] will stored even if it overflows the specified device area, so it may corrupt the start of other device areas. (Area overflow checks are not performed.)
- The stored relative address value is counted in 32-bit units.

■ Flag operations

Name	Description
R9007	Turns ON when the area is exceeded in index modification.
R9008	ON when [S1] is greater than [S2]
(ER)	Turns ON when S1 and S2 are different devices

27.5 F275 MEAN [Total and Mean Value (16-Bit)]

27.5 F275 MEAN [Total and Mean Value (16-Bit)]

Calculates the total value and mean value of the specified memory area range (word data).

■ Instruction format

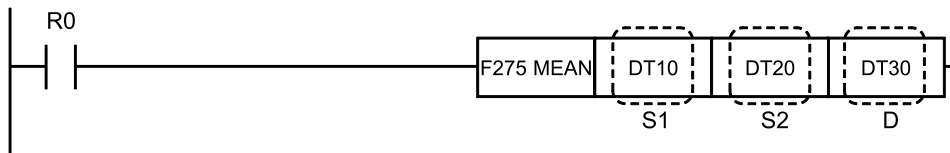

■ Operands

Items	Settings
S1	Starting area that stores word data
S2	Ending area that stores word data
D	Area storing the result of the operation (three words)

■ Devices that can be specified (indicated by ●)

Operands	WX	WY	WR	WL	SV	EV	DT	LD	I	SWR	SDT	Constant				Index modifier	Integer Device
												K	H	M	f		
S1	●	●	●	●	●	●	●	●	●	●	●					●	
S2	●	●	●	●	●	●	●	●	●	●	●					●	
D		●	●	●	●	●	●	●	●							●	

■ Outline of operation

- The total value and mean value of the word data (signed) from the area specified by [S1] to the area specified by [S2] are obtained and stored in the area specified by [D].

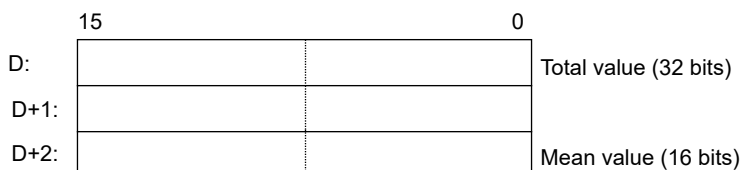

- For the mean value, the decimal is rounded down to make an integer.

■ Precautions for programming

[D+2 will stored even if it overflows the specified device area, so it may corrupt the start of other device areas. (Area overflow checks are not performed.)

■ Flag operations

Name	Description
R9007	Turns ON when the area is exceeded in index modification.

27.5 F275 MEAN [Total and Mean Value (16-Bit)]

Name	Description
R9008 (ER)	ON when [S1] is greater than [S2] Turns ON when S1 and S2 are different devices
R9009 (CY)	Turns ON when overflow/underflow occurs during calculation

27.6 F276 DMEAN [Total and Mean Value (32Bit)]

27.6 F276 DMEAN [Total and Mean Value (32Bit)]

Calculates the total and mean values of the specified memory area range (double word data).

■ Instruction format

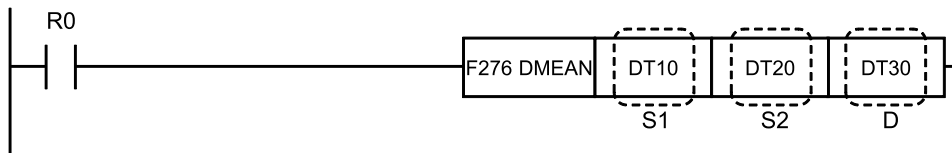

■ Operands

Items	Settings
S1	Starting area storing double word data
S2	Ending area storing double word data
D	Area storing the operation results (6 words)

■ Devices that can be specified (indicated by ●)

Operands	WX	WY	WR	WL	SV	EV	DT	LD	I	SWR	SDT	Constant				Index modifier	Integer Device
												K	H	M	f		
S1	●	●	●	●	●	●	●	●	●	●	●					●	
S2	●	●	●	●	●	●	●	●	●	●	●					●	
D		●	●	●	●	●	●	●	●							●	

■ Outline of operation

- The total and mean values of the double word data (signed) from the area specified by [S1] to the area specified by [S2] are stored in the area specified by [D].

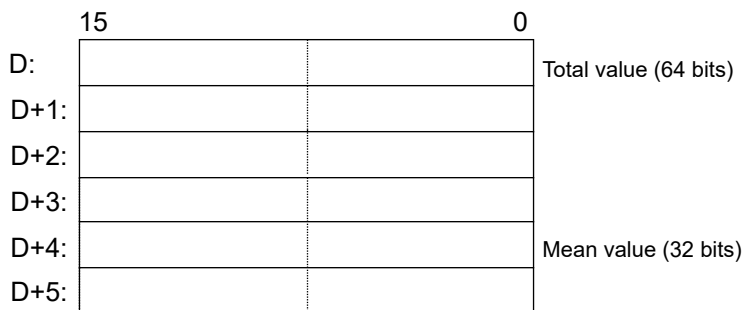

- If [S2] specifies a high word of double word data, processing will take place over the same area as if a low word had been specified.

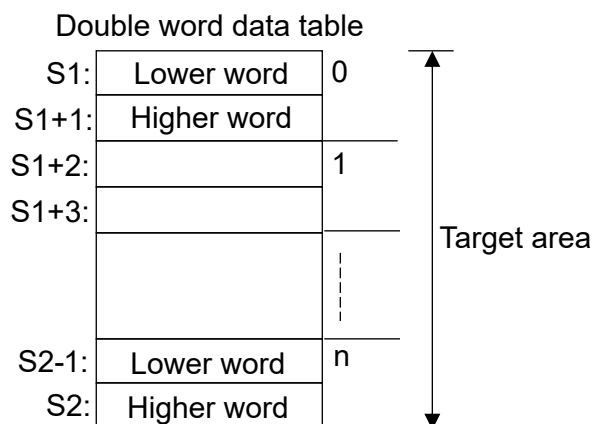

- For the mean value, the decimal is rounded down to make an integer.

■ Precautions for programming

[D+5] will be stored even if it overflows the specified device area, so it may corrupt the start of other device areas. (Area overflow checks are not performed.)

■ Flag operations

Name	Description
R9007	Turns ON when the area is exceeded in index modification.
R9008 (ER)	ON when [S1] is greater than [S2] Turns ON when S1 and S2 are different devices
R9009 (CY)	Turns ON when overflow/underflow occurs during calculation

27.7 F277 SORT [Sort (16-bit data)]

27.7 F277 SORT [Sort (16-bit data)]

Sorts the strings (word data) in the specified memory area range into ascending or descending order.

■ Instruction format

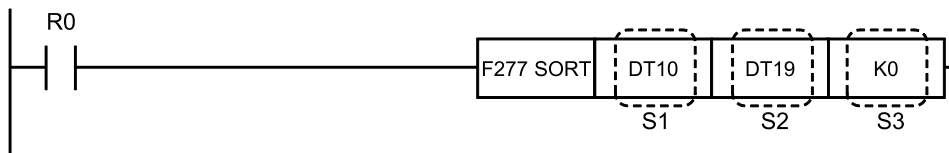

■ Operands

Items	Settings
S1	Starting area storing sort data
S2	Ending area storing sort data
S3	Area storing sort conditions, or constant data

■ Devices that can be specified (indicated by ●)

Operand s	WX	WY	WR	WL	SV	EV	DT	LD	I	SW R	SD T	Constant				Index modifier	Integer Device
												K	H	M	f		
S1		●	●	●	●	●	●	●	●							●	
S2		●	●	●	●	●	●	●	●							●	
S3	●	●	●	●	●	●	●	●	●	●	●	●	●			●	

■ Outline of operation

- The word data (signed) from the area specified by [S1] to the area specified by [S2] is sorted into ascending or descending order.
- When S1 = S2, no operation takes place.
- The sort conditions are specified in [S3].
K0: Ascending order
K1: Descending order
- During sorting, the data from [S1] to [S2] is sorted in sequential order in accordance with the sort procedure. Note that the number of times data is compared increases proportionally to the square of the number of data words, and therefore the operation time will increase if there is a large number of data words to be sorted.

■ Operation example

Operation of instruction format description program

- Ascending order
If data is stored in DT10 to DT19 as shown below and [S3] = K0, the following operation is performed.

DT10:	K300	➔	DT10:	K-30
11:	K10		11:	K-3
12:	K3		12:	K-1
13:	K-1		13:	K1
14:	K1000		14:	K3
15:	K-30		15:	K10
16:	K100		16:	K30
17:	K30		17:	K1000
18:	K1		18:	K300
19:	K-3		19:	K1000

- Descending order

If data is stored in DT10 to DT19 as shown below and [S3] = K1, the following operation is performed.

DT10:	K300	➔	DT10:	K1000
11:	K10		11:	K300
12:	K3		12:	K100
13:	K-1		13:	K30
14:	K1000		14:	K10
15:	K-30		15:	K3
16:	K100		16:	K1
17:	K30		17:	K-1
18:	K1		18:	K-3
19:	K-3		19:	K-30

- Flag operations

Name	Description
R9007	Turns ON when the area is exceeded in index modification.
R9008	ON when [S1] is greater than [S2]
(ER)	Turns ON when S1 and S2 are different devices

27.8 F278 DSORT [Sort (32-bit)]

27.8 F278 DSORT [Sort (32-bit)]

Sorts strings (double word data) in the specified memory area in ascending or descending order.

■ Instruction format

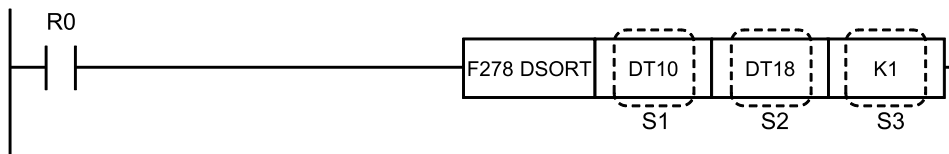

■ Operands

Items	Settings
S1	Starting area storing sort data
S2	Ending area storing sort data
S3	Area storing sort conditions, or constant data

■ Devices that can be specified (indicated by ●)

Operands	WX	WY	WR	WL	SV	EV	DT	LD	I	SW R	SD T	Constant				Index modifier	Integer Device
												K	H	M	f		
S1		●	●	●	●	●	●	●	●							●	
S2		●	●	●	●	●	●	●	●							●	
S3	●	●	●	●	●	●	●	●	●	●	●	●	●			●	

■ Outline of operation

- Sorts the double word data (signed) in the areas specified by [S1] and [S2] into ascending or descending order.
- When S1 = S2, no operation takes place.
- The sort conditions are specified in [S3].
K0: Ascending order
K1: Descending order
- During sorting, the data from [S1] to [S2] is sorted in sequential order in accordance with the sort procedure. Note that the number of times data is compared increases proportionally to the square of the number of data words, and therefore the operation time will increase if there is a large number of data words to be sorted.
- If [S2] specifies a high word of double word data, processing will take place over the same area as if a low word had been specified.

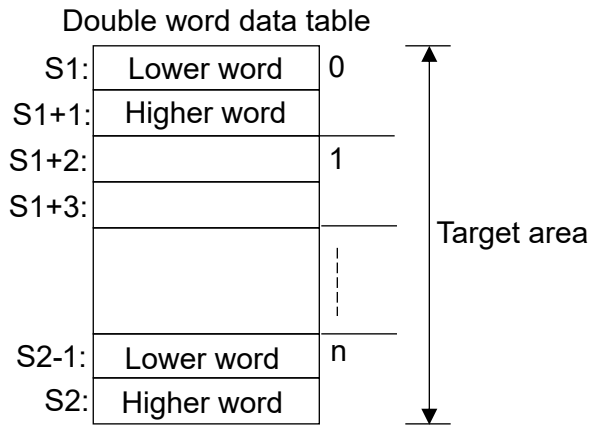

■ Operation example

Operation of instruction format description program

- Ascending order

If data is stored in DT10 to DT19 as below and [S3] = K0, the following operation will be performed.

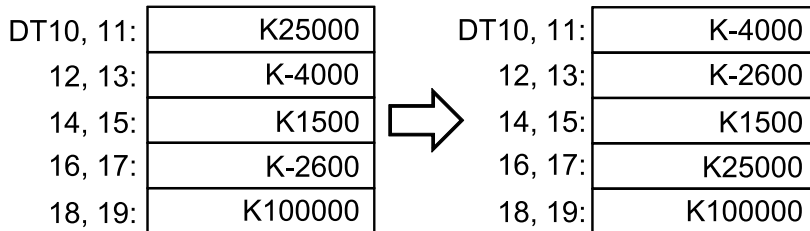

- Descending order

If data is stored in DT10 to DT19 as shown below and [S3] = K1, the following operation is performed.

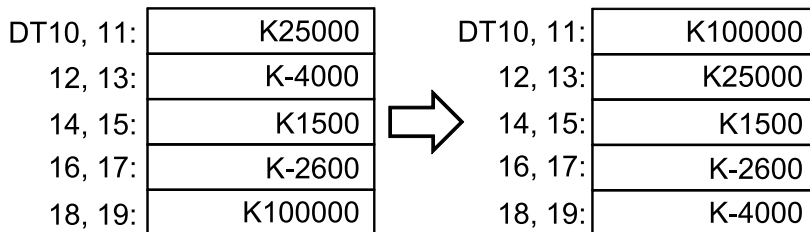

■ Flag operations

Name	Description
R9007	Turns ON when the area is exceeded in index modification.
R9008	ON when [S1] is greater than [S2]
(ER)	Turns ON when S1 and S2 are different devices

27.9 F282 SCAL [Scaling (linearization) of 16-bit data]

27.9 F282 SCAL [Scaling (linearization) of 16-bit data]

Performs scaling of the given data table and finds output value Y with regards to input value X.

■ Instruction format

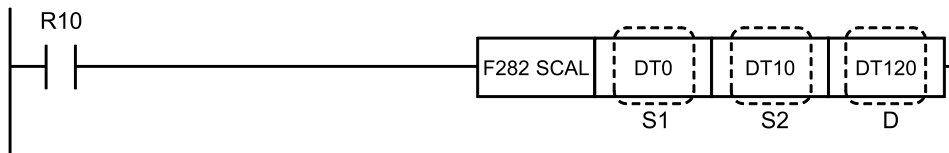

■ Operands

Items	Settings
S1	Source 16-bit data equivalent to input value X, or the area where it is stored
S2	Starting address of the data table used for scaling (linearization)
D	Area where output result Y is stored

■ Devices that can be specified (indicated by ●)

Operands	WX	WY	WR	WL	SV	EV	DT	LD	I	SWR	SDT	Constant				Index modifier	Integer Device
												K	H	M	f		
S1	●	●	●	●	●	●	●	●	●	●	●	●	●		●		
S2	●	●	●	●	●	●	●	●	●	●	●				●		
D		●	●	●	●	●	●	●	●						●		

■ Outline of operation

- The 16-bit data specified by [S1] is scaled in accordance with the data table specified by [S2], and the output value for input value X is calculated.
- The number of items in the data table n is determined by the value [n] specified in [S2] at the top of the data table.

Structure of the data table used in scaling (linearization) (if S2 = DT10 and n = K10)

S2:	n	DT10
S2+1:	x1	DT11
S2+2:	x2	DT12
S2+3:	x3	DT13
~~~~~		
S2+n-1:	xn-1	DT19
S2+n:	xn	DT20
S2+n+1:	y1	DT21
S2+n+2:	y2	DT22
S2+n+3:	y3	DT23
~~~~~		
S2+2n-1:	yn-1	DT29
S2+2n:	yn	DT30

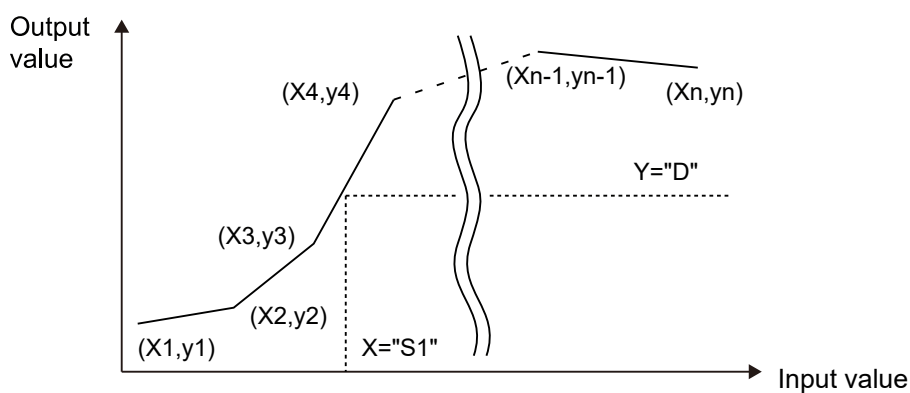
**■ Operation example****Operation of instruction format description program**

The data table is referenced starting from DT10, output value Y for the input value stored in DT0 is calculated, and the result is stored in DT120.

■ Precautions for programming

- Make $X_{t-1} < X_t$.
- Create x_t and y_t as signed 16-bit data.
- If $X(S1) < x_1$, then $Y(D) = y_1$.
- If $X(S1) > x_n$, then $Y(D) = y_n$. n has a maximum of 99.

■ Flag operations

Name	Description
R9007	Turns ON when the area is exceeded in index modification.

27.9 F282 SCAL [Scaling (linearization) of 16-bit data]

Name	Description
R9008 (ER)	Turns ON when $n < 2$ or $n > 99$ in [S2]
	Turns ON when data table in [S2] exceeds area
	Turns ON when X_n is not in ascending order

27.10 F283 DSCAL [32-Bit Data Scaling (Linearization)]

Performs scaling of the given data table and finds output value Y with regards to input value X.

■ Instruction format

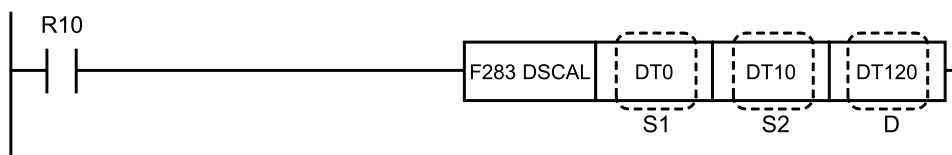

■ Operands

Items	Settings
S1	Original 32-bit data corresponding to input value X, or storage area
S2	Starting address of the data table used for scaling (linearization)
D	Area where output result Y is stored

■ Devices that can be specified (indicated by ●)

Operands	WX	WY	WR	WL	SV	EV	DT	LD	I	SWR	SDT	Constant				Index modifier	Integer Device
												K	H	M	f		
S1	●	●	●	●	●	●	●	●	●	●	●	●				●	
S2	●	●	●	●	●	●	●	●	●	●	●					●	
D		●	●	●	●	●	●	●	●							●	

■ Outline of operation

- Performs scaling of the 32-bit data specified in [S1] according to the data table specified in [S2], and finds output value Y with regards to input value X.
- The number of items in the data table n is determined by the value [n] specified in [S2] at the top of the data table.

Structure of the data table used in scaling (linearization) (if S2 = DT10 and n = K10)

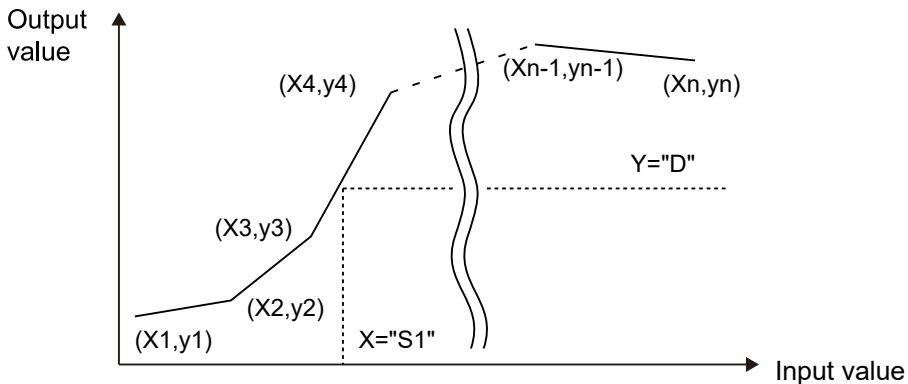
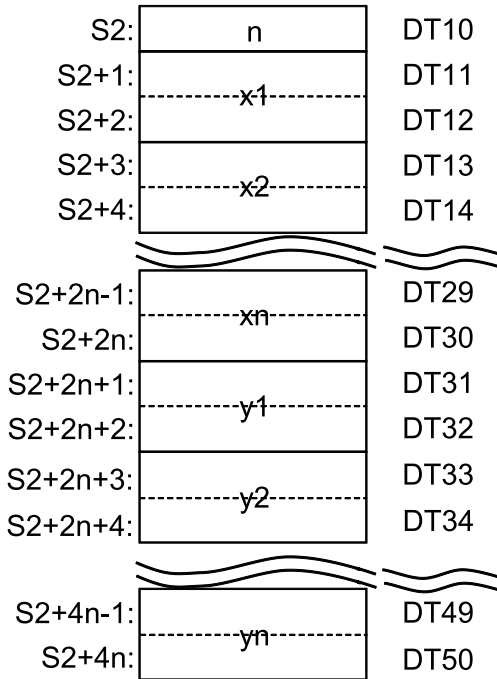

■ **Operation example**

Operation of instruction format description program

Finds output value Y with regards to input value X stored in DT0, with reference to the data table starting from DT10, and stores the result in DT120 to DT121.

■ **Precautions for programming**

- Make $X_{t-1} < X_t$.
- Create xt and yt as signed 32-bit data.
- If $X(S1) < x1$, then $Y(D) = y1$.
- If $X(S1) > xn$, then $Y(D) = yn$. n has a maximum of 99.

■ Flag operations

Name	Description
R9007 R9008 (ER)	Turns ON when the area is exceeded in index modification.
	Turns ON when $n < 2$ or $n > 99$ in [S2]
	Turns ON when data table in [S2] exceeds area
	Turns ON when X_n is not in ascending order

27.11 F284 RAMP (16-bit Data Ramp Output)

27.11 F284 RAMP (16-bit Data Ramp Output)

Linear output is executed based on the elapsed time from the start of execution, by performing scaling from the output default value, target value, and time width.

■ Instruction format

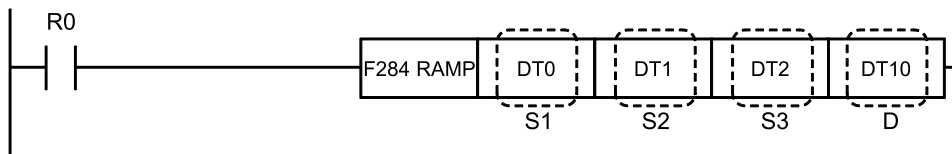

■ Operands

Items	Settings
S1	Area storing the default value, or constant data
S2	Area storing the target value, or constant data
S3	Area storing the time width, or constant data
D	Data output area

■ Devices that can be specified (indicated by ●)

Operands	WX	WY	WR	WL	SV	EV	DT	LD	I	SWR	SDT	Constant				Index modifier	Integer Device
												K	H	M	f		
S1	●	●	●	●	●	●	●	●	●	●	●	●	●			●	
S2	●	●	●	●	●	●	●	●	●	●	●	●	●			●	
S3	●	●	●	●	●	●	●	●	●	●	●	●	●			●	
D		●	●	●	●	●	●	●	●							●	

■ Outline of operation

Scaling is performed from the 16-bit output default value of the area specified by [S1], the 16-bit output target value of the area specified by [S2], and the 16-bit output time width (in ms units) of the area specified by [S3], and linear output is performed according to the elapsed time from the start of execution.

■ Precautions for programming

It is possible that a maximum error of 1 scan may occur in the output time width.

<Example> If the following values are set in a program

DT0 (default value) = K1000

DT1 (target value) = K5000

DT2 (time width) = K400

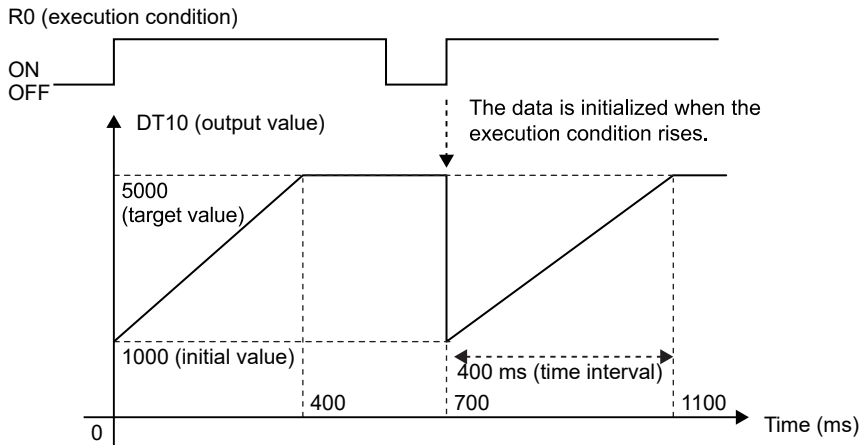

DT0 (default value) = K5000

DT1 (target value) = K1000

DT2 (time width) = K400

R0 (execution condition)

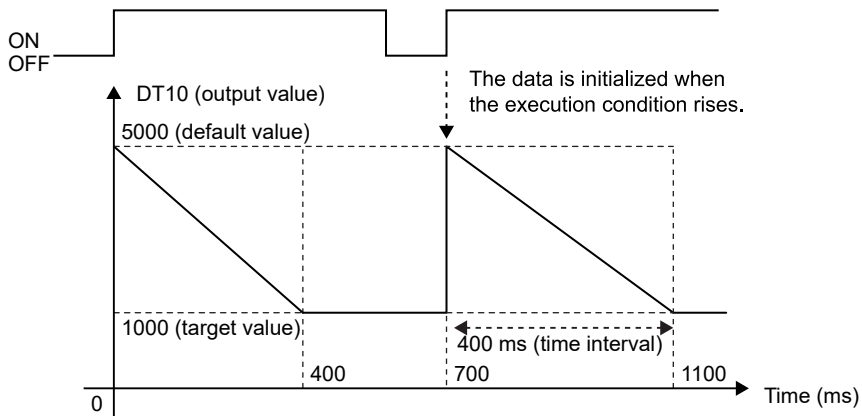

■ Flag operations

Name	Description
R9007	Turns ON when the area is exceeded in index modification.
R9008 (ER)	If the output time width specified in S3 is out of range of K1 to K30000

27.12 F285 LIMT [Upper and lower limit control (word data)]

27.12 F285 LIMT [Upper and lower limit control (word data)]

Performs upper and lower limit control (word data).

■ Instruction format

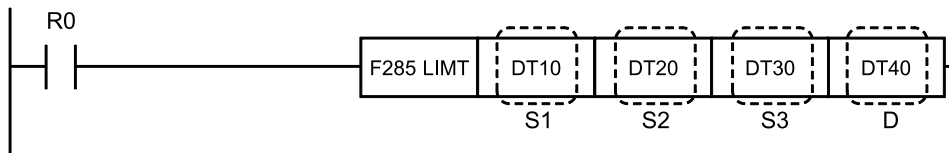

■ Operands

Items	Settings
S1	Area storing the lower limit or lower limit data
S2	Area storing the upper limit or upper limit data
S3	Area storing the input value or input value data
D	Area storing the output value

■ Devices that can be specified (indicated by ●)

Operands	WX	WY	WR	WL	SV	EV	DT	LD	I	SWR	SDT	Constant				Index modifier	Integer Device
												K	H	M	f		
S1	●	●	●	●	●	●	●	●	●	●	●	●	●	●	●		
S2	●	●	●	●	●	●	●	●	●	●	●	●	●	●	●		
S3	●	●	●	●	●	●	●	●	●	●	●	●	●	●	●		
D		●	●	●	●	●	●	●	●						●		

■ Outline of operation

- The output value (word data) stored in the area specified by [D] is controlled according to whether or not the input value (word data) specified by [S3] falls within the range bounded by the upper and lower limits specified by [S1] and [S2].
- The output value is determined based on the following conditions.
 - If lower limit value [S1] is greater than input value [S3], then lower limit value [S1] becomes output value [D]
 - If upper limit value [S2] is less than input value [S3], then upper limit value [S2] becomes output value [D]
 - If lower limit value [S1] is equal to or less than input value [S3], which is equal to or less than upper limit value [S2], then input value [S3] becomes output value [D]

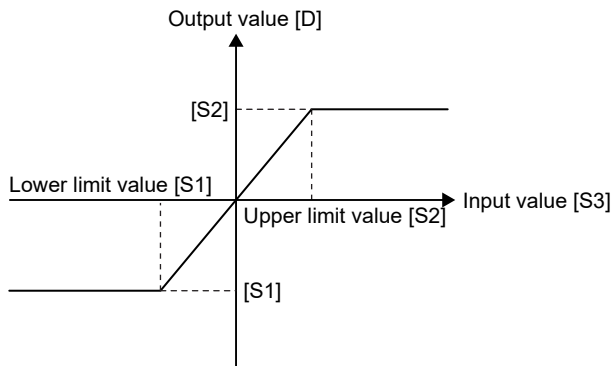

- For control using only the upper limit value
Specify K-32768 (or H8000) for the lower limit value [S1].
- For control using only the lower limit value
Specify K32767 (or H7FFF) for the upper limit value [S2].

■ Flag operations

Name	Description
R9007	Turns ON when the area is exceeded in index modification.
R9008 (ER)	ON when [S1] is greater than [S2]
R900B (=)	Turns ON when the operation result falls within the upper/lower limit range

27.13 F286 DLIMIT [Upper and Lower Limit Control (Double Word)]

27.13 F286 DLIMIT [Upper and Lower Limit Control (Double Word)]

Performs upper and lower limit control (double word).

■ Instruction format

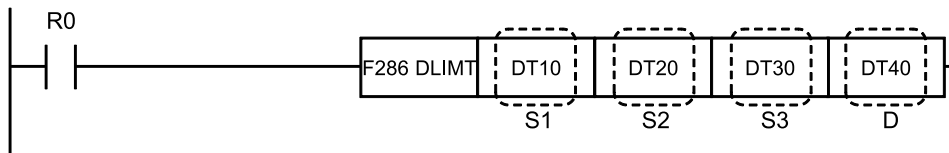

■ Operands

Items	Settings
S1	Area storing the lower limit, or lower limit data (two words)
S2	Area storing the upper limit, or upper limit data (two words)
S3	Area storing the input value, or input value data (two words)
D	Area storing the output value (two words)

■ Devices that can be specified (indicated by ●)

Operands	WX	WY	WR	WL	SV	EV	DT	LD	I	SWR	SDT	Constant				Index modifier	Integer Device
												K	H	M	f		
S1	●	●	●	●	●	●	●	●	●	●	●	●	●	●	●		
S2	●	●	●	●	●	●	●	●	●	●	●	●	●	●	●		
S3	●	●	●	●	●	●	●	●	●	●	●	●	●	●	●		
D		●	●	●	●	●	●	●	●							●	

■ Outline of operation

- The output value (double-word data) stored in the area specified by [D] is controlled according to whether or not the input value (double-word data) specified by [S3] falls within the range bounded by the upper and lower limits specified by [S1] and [S2].
- The output value is determined based on the following conditions.
 - If lower limit value [S1, S1+1] is greater than input value [S3, S3+1], then lower limit value [S1, S1+1] becomes output value [D, D+1]
 - If upper limit value [S2, S2+1] is less than input value [S3, S3+1], then upper limit value [S2, S2+1] becomes output value [D, D+1]
 - If lower limit value [S1, S1+1] is equal to or less than input value [S3, S3+1], which is equal to or less than upper limit value [S2, S2+1], then input value [S3, S3+1] becomes output value [D, D+1]

27.13 F286 DLIMIT [Upper and Lower Limit Control (Double Word)]

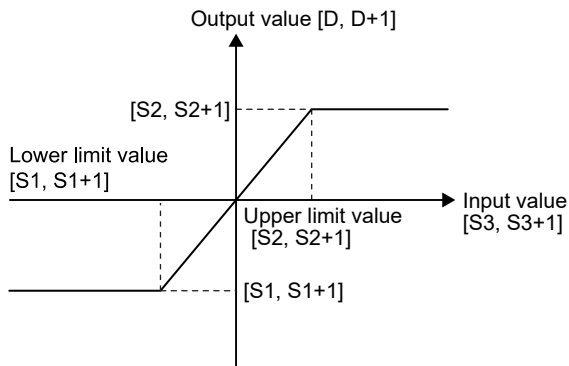

- For control using only the upper limit value
Set K-2147483648 (or H80000000) for lower limit [S1, S1+1].
- For control using only the lower limit value
Set K2147483647 (or H7FFFFFFF) for upper limit [S2, S2+1].

■ Flag operations

Name	Description
R9007	Turns ON when the area is exceeded in index modification.
R9008 (ER)	ON when [S1] is greater than [S2]
R900B (=)	Turns ON when the operation result falls within the upper/lower limit range

27.14 F287 BAND [Deadband Control (Word)]

Performs deadband control (word).

■ **Instruction format**

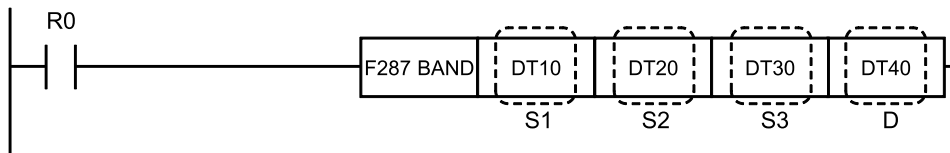

■ **Operands**

Items	Settings
S1	Area storing the lower limit or lower limit data
S2	Area storing the upper limit or upper limit data
S3	Area storing the input value or input value data
D	Area storing the output value

■ **Devices that can be specified (indicated by ●)**

Operands	WX	WY	WR	WL	SV	EV	DT	LD	I	SWR	SDT	Constant				Index modifier	Integer Device
												K	H	M	f		
S1	●	●	●	●	●	●	●	●	●	●	●	●	●	●	●		
S2	●	●	●	●	●	●	●	●	●	●	●	●	●	●	●		
S3	●	●	●	●	●	●	●	●	●	●	●	●	●	●	●		
D		●	●	●	●	●	●	●	●							●	

■ **Outline of operation**

- The output value (word data) stored in the area specified by [D] is controlled based in whether or not the input value (word data) specified by [S3] is inside or outside of the deadband bounded by the upper and lower limits specified by [S1] and [S2].
- The output value is determined based on the following conditions.
 - When the lower limit [S1] is greater than the input value [S3], input value [S3] minus lower limit [S1] equals output value [D]
 - When the upper limit [S2] is less than the input value [S3], input value [S3] minus upper limit [S2] equals output value [D]
 - When the lower limit [S1] is equal to or less than the input value [S3] that is equal to or less than the upper limit [S2], 0 equals output value [D]

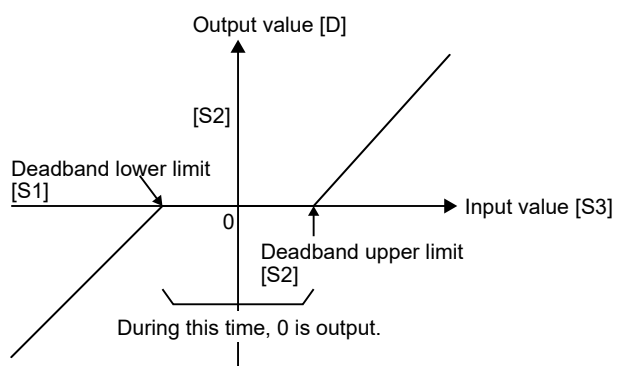

■ Operation example

Operation of instruction format description program

When K-100 is stored in DT10 and K100 in DT20, the following operation will be performed.

Value of DT30	Value stored in DT40
K-300	K-200
K-200	K-100
K-100 to K100	K0
K200	K100
K300	K200

■ Flag operations

Name	Description
R9007	Turns ON when the area is exceeded in index modification.
R9008 (ER)	ON when [S1] is greater than [S2]
R9009 (CY)	ON when the calculation result overflows or underflows
R900B (=)	Turns ON when the calculation result is "0"

27.15 F288 DBAND [Deadband Control (Double Word)]

Carries out deadband control (double word).

■ **Instruction format**

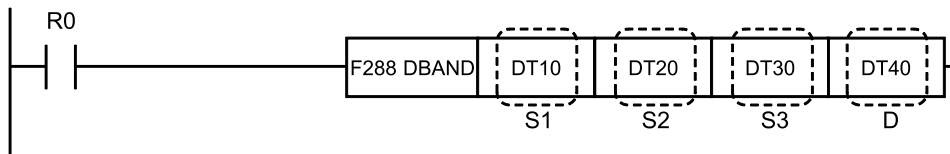

■ **Operands**

Items	Settings
S1	Area storing the lower limit, or lower limit data (two words)
S2	Area storing the upper limit, or upper limit data (two words)
S3	Area storing the input value, or input value data (two words)
D	Area storing the output value (two words)

■ **Devices that can be specified (indicated by ●)**

Operands	WX	WY	WR	WL	SV	EV	DT	LD	I	SWR	SDT	Constant				Index modifier	Integer Device
												K	H	M	f		
S1	●	●	●	●	●	●	●	●	●	●	●	●	●	●	●		
S2	●	●	●	●	●	●	●	●	●	●	●	●	●	●	●		
S3	●	●	●	●	●	●	●	●	●	●	●	●	●	●	●		
D		●	●	●	●	●	●	●	●							●	

■ **Outline of operation**

- The output value (double word data) stored in the area specified by [D] is controlled according to whether or not the input value (double word data) specified by [S3] is inside the range of the upper and lower limits of the deadband specified by [S1] and [S2].
- The output value is determined based on the following conditions.
 - When the lower limit [S1, S1+1] > input value [S3, S3+1], the input value [S3, S3+1] - the lower limit [S1, S1+1] becomes the output value [D, D+1]
 - When the upper limit [S2, S2+1] < input value [S3, S3+1], the input value [S3, S3+1] - the upper limit [S2, S2+1] becomes the output value [D, D+1]
 - When the lower limit [S1, S1+1] ≤ input value [S3, S3+1] ≤ the upper limit [S2, S2+1], 0 becomes the output value [D, D+1]

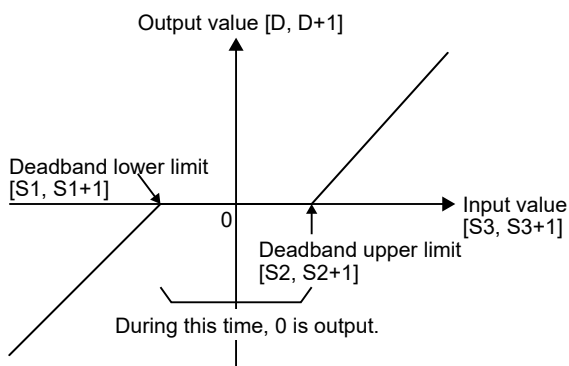

■ **Operation example**

Operation of instruction format description program

If K-10000 is stored in DT10 and DT11, and K10000 is stored in DT20 and DT21, the following operation is performed.

Values of DT30, and DT31	Values stored in DT40 and DT41
K-30000	K-20000
K-20000	K-10000
K-10000 to K10000	K0
K20000	K10000
K30000	K20000

■ **Flag operations**

Name	Description
R9007	Turns ON when the area is exceeded in index modification.
R9008 (ER)	ON when [S1] is greater than [S2]
R9009 (CY)	ON when the calculation result overflows or underflows
R900B (=)	Turns ON when the calculation result is "0"

27.16 F289 ZONE [zone control (word)]

Performs zone control (word).

■ **Instruction format**

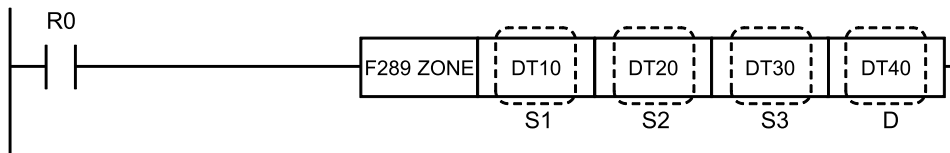

■ **Operands**

Items	Settings
S1	Area where negative bias value is stored, or negative bias value data
S2	Area where positive bias value is stored, or positive bias value data
S3	Area storing the input value or input value data
D	Area storing the output value

■ **Devices that can be specified (indicated by ●)**

Operands	WX	WY	WR	WL	SV	EV	DT	LD	I	SWR	SDT	Constant				Index modifier	Integer Device
												K	H	M	f		
S1	●	●	●	●	●	●	●	●	●	●	●	●	●	●	●		
S2	●	●	●	●	●	●	●	●	●	●	●	●	●	●	●		
S3	●	●	●	●	●	●	●	●	●	●	●	●	●	●	●		
D		●	●	●	●	●	●	●	●						●		

■ **Outline of operation**

- The bias value specified by [S1] or [S2] is added to the input value (word data) specified by [S3], and the output value is stored in the area specified by [D].
- The output value is determined based on the following conditions.
 - When input value [S3] < 0, input value [S3] + negative bias value [S1] → output value [D]
 - When input value [S3] = 0, 0 → output value [D]
 - When input value [S3] > 0, input value [S3] + positive bias value [S2] → output value [D]

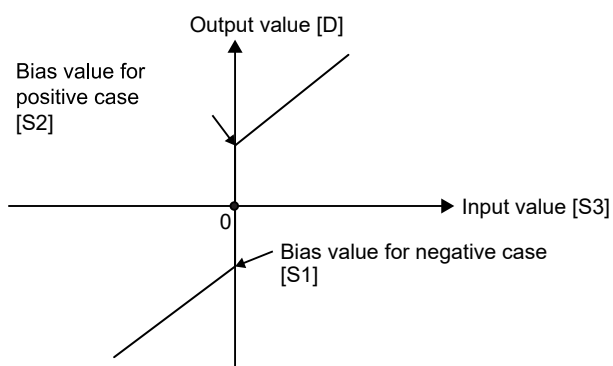

■ Operation example

Operation of instruction format description program

When K-100 is stored in DT10, and K100 is stored in DT20

Value of DT30	Value stored in DT40
K-300	K-400
K-200	K-300
K-100	K-200
K0	K0
K100	K200
K200	K300
K300	K400

■ Flag operations

Name	Description
R9007 R9008 (ER)	Turns ON when the area is exceeded in index modification.
R9009 (CY)	ON when the calculation result overflows or underflows
R900B (=)	Turns ON when the input value is "0"

27.17 F290 DZONE [Zone control (double word)]

27.17 F290 DZONE [Zone control (double word)]

Carries out zone control (double word).

■ Instruction format

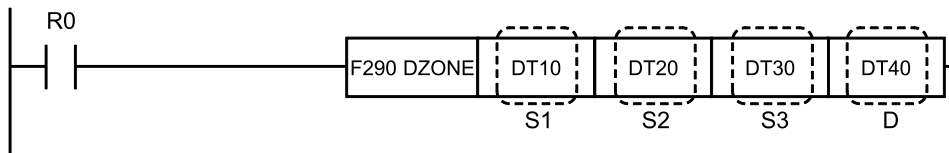

■ Operands

Items	Settings
S1	Area storing negative bias values, or negative bias value data (two words)
S2	Area storing positive bias values, or positive bias value data (two words)
S3	Area storing the input value, or input value data (two words)
D	Area storing the output value (two words)

■ Devices that can be specified (indicated by ●)

Operands	WX	WY	WR	WL	SV	EV	DT	LD	I	SWR	SDT	Constant				Index modifier	Integer Device
												K	H	M	f		
S1	●	●	●	●	●	●	●	●	●	●	●	●	●	●	●		
S2	●	●	●	●	●	●	●	●	●	●	●	●	●	●	●		
S3	●	●	●	●	●	●	●	●	●	●	●	●	●	●	●		
D		●	●	●	●	●	●	●	●						●		

■ Outline of operation

- The bias value specified by [S1] or [S2] is added to the input value (double-word data) specified by [S3], and stored in the area specified by [D].
- The output value is determined based on the following conditions.
 - When the input values [S3, S3+1] are less than zero, the input values [S3, S3+1] plus the negative bias values [S1, S1+1] are stored in [D, D+1] as the output values
 - When the input values [S3, S3+1] equal zero, zero is stored in [D, D+1] as the output values
 - When the input values [S3, S3+1] are greater than zero, the input values [S3, S3+1] plus the positive bias values [S2, S2+1] are stored in [D, D+1] as the output values

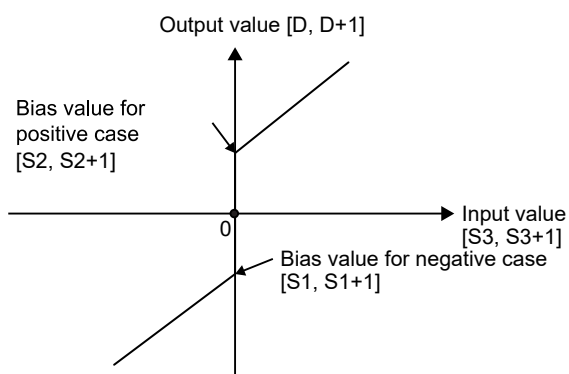

■ Operation example

Operation of instruction format description program

If K-10000 is stored in DT10 and DT11, and K10000 is stored in DT20 and DT21, the following operation is performed.

Values of DT30, and DT31	Values stored in DT40 and DT41
K-30000	K-40000
K-20000	K-30000
K-10000	K-20000
K0	K0
K10000	K20000
K20000	K30000
K30000	K40000

■ Flag operations

Name	Description
R9007 R9008 (ER)	Turns ON when the area is exceeded in index modification.
R9009 (CY)	ON when the calculation result overflows or underflows
R900B (=)	Turns ON when the input value is "0"

(MEMO)

28 Floating-point Instruction

28.1	F309 FMV (Transfer Floating Point Real Number Data)	28-3
28.2	F310 F+ (Floating point real number data addition)	28-5
28.3	F311 F- (Floating point real number data subtraction)	28-7
28.4	F312 F* (Floating Point Real Number Data Multiplication)	28-9
28.5	F313 F% (Floating point real number data division)	28-11
28.6	F314 SIN (Sine of floating point real number data)	28-13
28.7	F315 COS (Floating Point Real Number Data Cosine)	28-15
28.8	F316 TAN (Floating Point Real Number Data Tangent)	28-17
28.9	F317 ASIN (Arcsine of Floating Point Real Number Data)	28-19
28.10	F318 ACOS (Arccosine of Floating Point Real Number Data)	28-21
28.11	F319 ATAN (Arctangent of floating point real number data)	28-23
28.12	F320 LN (Floating Point Real Number Natural Logarithm)	28-25
28.13	F321 EXP (Floating Point Real Number Data Exponent)	28-27
28.14	F322 LOG (Floating Point Real Number Data Common Logarithm)	28-29
28.15	F323 PWR (Floating point real number data power)	28-31
28.16	F324 FSQR (Floating Point Real Number Square Root)	28-33
28.17	F325 FLT (16-Bit Integer Data to Floating Point Real Number Data Conversion)	28-35
28.18	F326 DFLT (32-Bit Integer to Floating Point Real Number Data Conversion)	28-37
28.19	F327 INT [Floating Point Real Number Data to 16-Bit Data Conversion (Largest Integer not Exceeding Floating Point Real Number Data)]	28-39
28.20	F328 DINT [Floating point real number data to 32-bit integer conversion (largest integer not exceeding floating point real number)]	28-41
28.21	F329 FIX [Floating Point Real Number Data to 16-Bit Integer (Round Down to Nearest Integer) Conversion]	28-43
28.22	F330 DFIX [Convert Floating Point Real Number Data to 32-Bit Integers, (Rounding Down the Decimal Point)]	28-45
28.23	F331 ROFF [Convert Floating Point Real Number Data to a 16-Bit Integer (Rounded Off to the Nearest Integer)]	28-47

28 Floating-point Instruction

28.24 F332 DROFF [Floating point real number Data → 32-bit integer conversion (rounding off at the decimal point)]	28-49
28.25 F333 FINT (Round down floating point real number data at the decimal point).....	28-51
28.26 F334 FRINT (Round off floating point real number data to the first decimal place).....	28-53
28.27 F335 F+/- (Floating Point Real Number Data Sign Conversion).....	28-55
28.28 F336 FABS (Floating Point Real Number Data Absolute Value)	28-57
28.29 F337 RAD (Floating Point Real Number Data Degree to Radian)..	28-59
28.30 F338 DEG (Radian to Degree Floating Point Real Number Data Conversion).....	28-61

28.1 F309 FMV (Transfer Floating Point Real Number Data)

Transfers the specified real number data to the specified area.

■ Instruction format

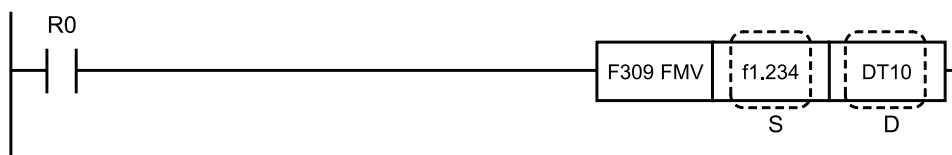

■ Operands

Items	Settings
S	Transfer data: Area storing real number data (32-bit), or constant data
D	Destination: Data transfer destination area

■ Devices that can be specified (indicated by ●)

Operands	WX	WY	WR	WL	SV	EV	DT	LD	I	SWR	SDT	Constant				Index modifier	Integer Device
												K	H	M	f		
S																●	
D		●	●	●	●	●	●	●	●							●	

■ Outline of operation

- The floating-point type real number data (32-bit) specified by [S] is transferred to the memory area specified by [D].
Specify a lower 16-bit memory area for the memory area.

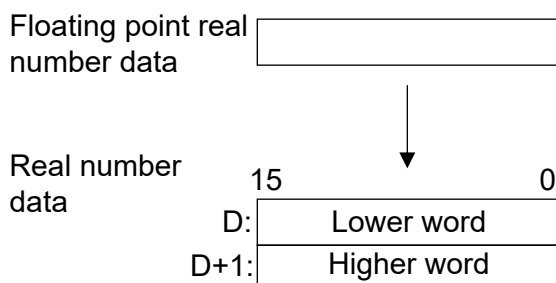

- The range of constants that can be specified in [S] is as follows.
Positive numbers f 0.0000001 to f 9999999
Negative numbers f -9999999 to f -0.000001

■ Operation example

Operation of instruction format description program

When the execution condition R0 is ON, the floating-point type constant value f 1.234 is transferred to data registers DT10 to DT11.

28.1 F309 FMV (Transfer Floating Point Real Number Data)

DT10:

(f1.234)

DT11:

■ Flag operations

Name	Description
R9007 R9008 (ER)	Turns ON when the area is exceeded in index modification.

28.2 F310 F+ (Floating point real number data addition)

Adds real number data.

■ Instruction format

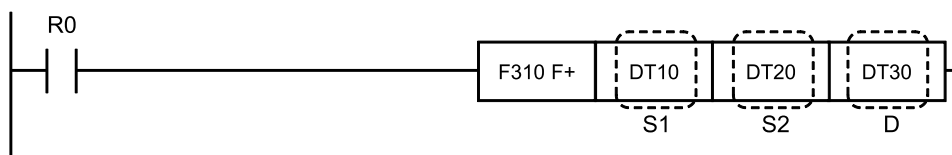

■ Operands

Items	Settings
S1	Area storing augend data, or augend data (two words)
S2	Area storing addend data, or addend data (two words)
D	Area storing the addition result (two words)

■ Devices that can be specified (indicated by ●)

Operands	WX	WY	WR	WL	SV	EV	DT	LD	I	SWR	SDT	Constant				Index modifier	Integer Device
												K	H	M	f		
S1	●	●	●	●	●	●	●	●	●	●	●	●	●	●	●	●	●
S2	●	●	●	●	●	●	●	●	●	●	●	●	●	●	●	●	●
D		●	●	●	●	●	●	●	●							●	●

■ Outline of operation

- The real number data specified by [S1, S1+1] and [S2, S2+1] is added, and the result is stored in [D, D+1].

$$[S1, S1+1] + [S2, S2+1] \rightarrow [D, D+1]$$

- If [S1] and [S2] are specified with an integer device, the operation occurs after the integer data is internally converted to real numbers.

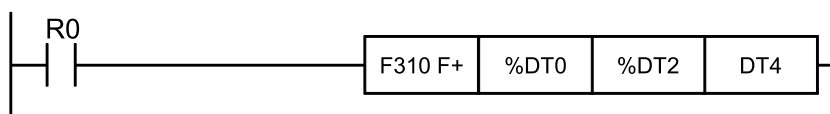

- If [D] is specified with an integer device, the real number is converted to integer data and stored.

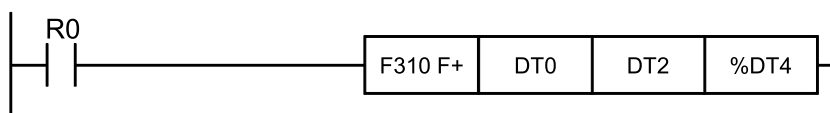

28.2 F310 F+ (Floating point real number data addition)

- If a K constant is specified for [S1] or [S2], the same process is performed as if an integer device was specified.

■ Program example

- When R0 is turned ON, f 4.554 is stored in DT30 and DT31.

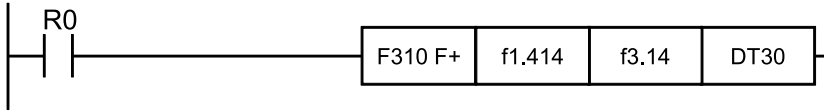

- When R0 is turned ON, f 135.795 is stored in DT30 and DT31.

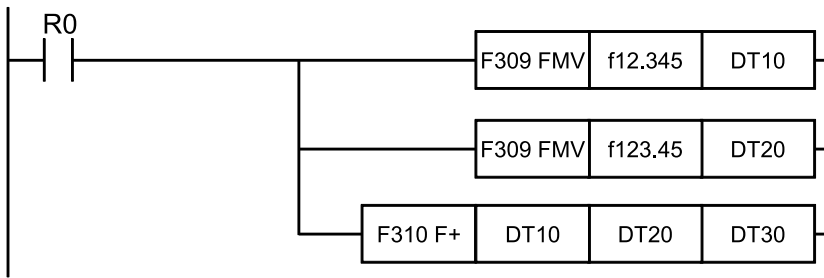

■ Flag operations

Name	Description
R9007	Turns ON when the area is exceeded in index modification.
R9008 (ER)	Turns ON when non-real-number data is specified in [S1, S1+1] or [S2, S2+1] Turns ON when the operation result exceeds the integer range when an integer device is specified in [D, D+1]
R9009 (CY)	Turns ON when operation result overflows

28.3 F311 F- (Floating point real number data subtraction)

Subtracts real number data.

■ Instruction format

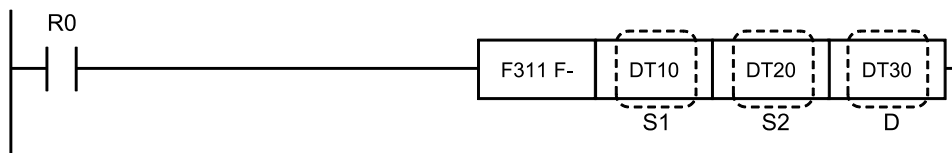

■ Operands

Items	Settings
S1	Area storing the minuend data, or the minuend data (two words)
S2	Area storing the subtrahend data, or the subtrahend data (two words)
D	Area storing the operation results (two words)

■ Devices that can be specified (indicated by ●)

Operands	WX	WY	WR	WL	SV	EV	DT	LD	I	SW R	SD T	Constant				Index modifier	Integer Device
												K	H	M	f		
S1	●	●	●	●	●	●	●	●	●	●	●	●	●	●	●	●	●
S2	●	●	●	●	●	●	●	●	●	●	●	●	●	●	●	●	●
D		●	●	●	●	●	●	●	●							●	●

■ Outline of operation

- The subtrahend data specified by [S2, S2+1] is subtracted from the minuend data specified by [S1, S1+1], and the result is stored in [D, D+1].
 $[S1, S1+1] - [S2, S2+1] \rightarrow [D, D+1]$
- If [S1] and [S2] are specified with an integer device, the operation occurs after the integer data is internally converted to real numbers.

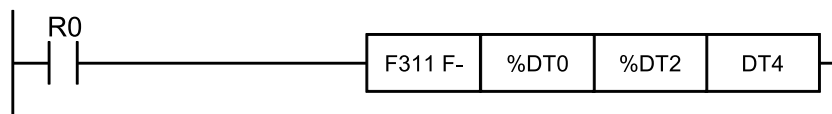

- If [D] is specified with an integer device, the real number is converted to integer data and stored.

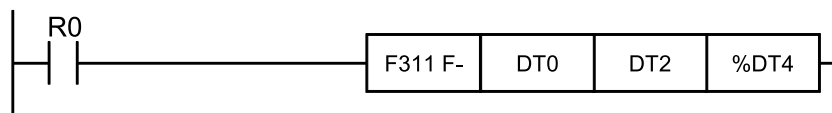

28.3 F311 F- (Floating point real number data subtraction)

- If a K constant is specified for [S1] or [S2], the same process is performed as if an integer device was specified.

■ Program example

- When R0 turns ON, f 0.445 is stored in DT30 and DT31.

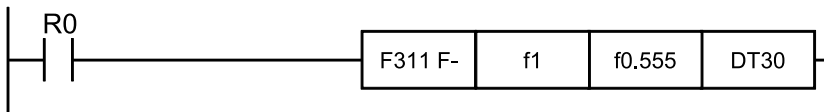

- When R0 turns ON, f 100.05 is stored in DT30 and DT31.

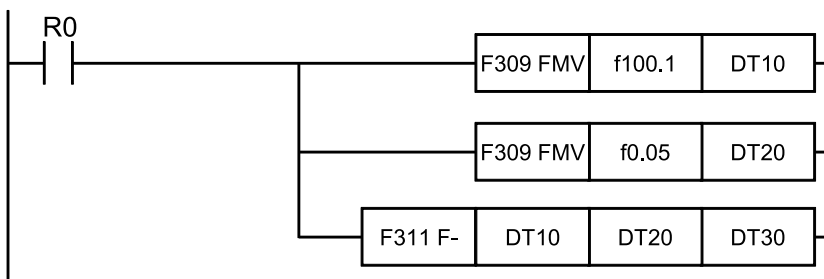

■ Flag operations

Name	Description
R9007	Turns ON when the area is exceeded in index modification.
R9008 (ER)	Turns ON when non-real-number data is specified in [S1, S1+1] or [S2, S2+1] Turns ON when the operation result exceeds the integer range when an integer device is specified in [D, D+1]
R9009 (CY)	Turns ON when operation result overflows

28.4 F312 F* (Floating Point Real Number Data Multiplication)

Multiplies real number data items.

■ Instruction format

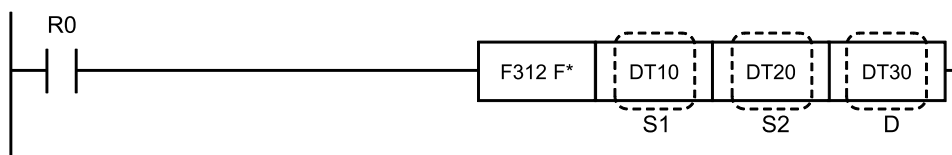

■ Operands

Items	Settings
S1	Area storing the multiplicand data, or the multiplicand data (two words)
S2	Area storing the multiplier data, or the multiplier data (two words)
D	Area storing the operation results (two words)

■ Devices that can be specified (indicated by ●)

Operands	WX	WY	WR	WL	SV	EV	DT	LD	I	SW R	SD T	Constant				Index modifier	Integer Device
												K	H	M	f		
S1	●	●	●	●	●	●	●	●	●	●	●	●	●	●	●	●	●
S2	●	●	●	●	●	●	●	●	●	●	●	●	●	●	●	●	●
D		●	●	●	●	●	●	●	●							●	●

■ Outline of operation

- Multiplies the multiplicand data specified by [S1, S1+1] and the multiplier data specified by [S2, S2+1], and stores the result in [D, D+1].
 $[S1, S1+1] \times [S2, S2+1] \rightarrow [D, D+1]$
- If [S1] and [S2] are specified with an integer device, the operation occurs after the integer data is internally converted to real numbers.

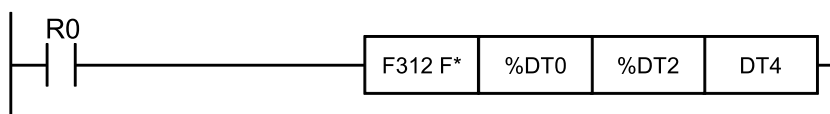

- If [D] is specified with an integer device, the real number is converted to integer data and stored.

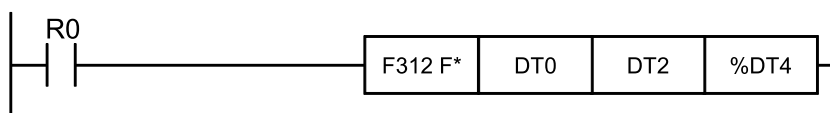

28.4 F312 F* (Floating Point Real Number Data Multiplication)

- If a K constant is specified for [S1] or [S2], the same process is performed as if an integer device was specified.

■ Program example

The f123.4000 is stored to DT30 and DT31 when the R0 turns ON.

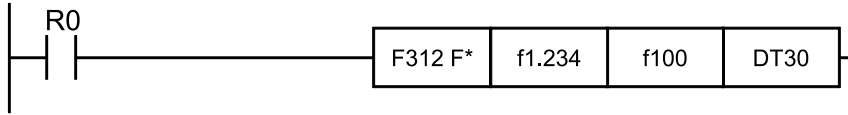

■ Flag operations

Name	Description
R9007	Turns ON when the area is exceeded in index modification.
R9008	Turns ON when non-real-number data is specified in [S1, S1+1] or [S2, S2+1]
(ER)	Turns ON when the operation result exceeds the integer range when an integer device is specified in [D, D+1]
R9009	Turns ON when operation result overflows
(CY)	

28.5 F313 F% (Floating point real number data division)

Divides real number data.

■ Instruction format

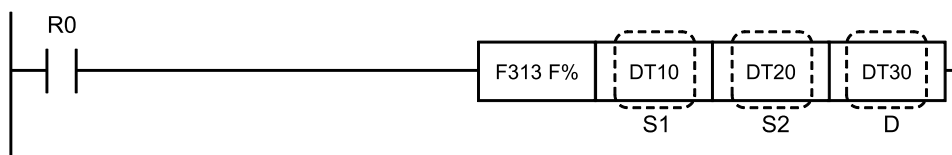

■ Operands

Items	Settings
S1	Area storing the dividend data, or dividend data (two words)
S2	Area storing the divisor data, or divisor data (two words)
D	Area storing the operation results (two words)

■ Devices that can be specified (indicated by ●)

Operands	WX	WY	WR	WL	SV	EV	DT	LD	I	SWR	SDT	Constant				Index modifier	Integer Device
												K	H	M	f		
S1	●	●	●	●	●	●	●	●	●	●	●	●	●	●	●	●	●
S2	●	●	●	●	●	●	●	●	●	●	●	●	●	●	●	●	●
D		●	●	●	●	●	●	●	●							●	●

■ Outline of operation

- Divides the dividend data specified by [S1, S1+1] by the divisor data specified by [S2, S2+1], and stores the result in [D, D+1].
 $[S1, S1+1] \div [S2, S2+1] \rightarrow [D, D+1]$
- If [S1] and [S2] are specified with an integer device, the operation occurs after the integer data is internally converted to real numbers.

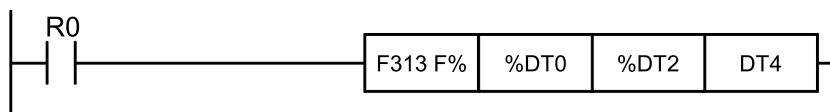

- If [D] is specified with an integer device, the real number is converted to integer data and stored.

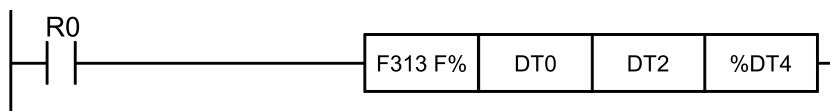

28.5 F313 F% (Floating point real number data division)

- If a K constant is specified for [S1] or [S2], the same process is performed as if an integer device was specified.

■ Program example

When R0 turns ON, f5.432100 is stored to DT30 to DT31.

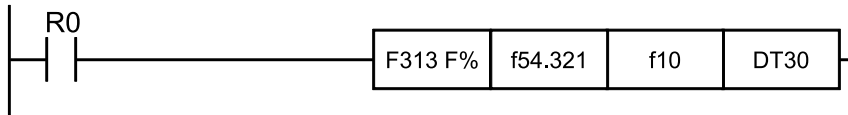

■ Flag operations

Name	Description
R9007 R9008 (ER)	Turns ON when the area is exceeded in index modification.
	Turns ON when non-real-number data is specified in [S1, S1+1] or [S2, S2+1]
	Turns ON when the operation result exceeds the integer range when an integer device is specified in [D, D+1]
	Turns ON when divided by 0.0
R9009 (CY)	Turns ON when operation result overflows

28.6 F314 SIN (Sine of floating point real number data)

Calculates the trigonometric function $\sin()$.

■ Instruction format

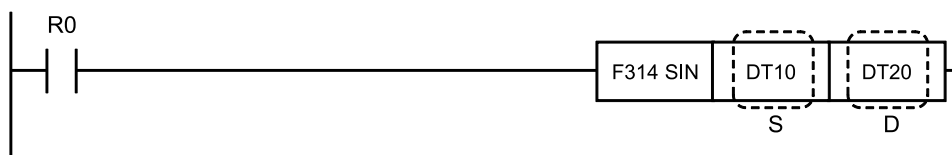

■ Operands

Items	Settings
S	Area storing angle data, or angle data (two words)
D	Area storing the operation results (two words)

■ Devices that can be specified (indicated by ●)

Operands	WX	WY	WR	WL	SV	EV	DT	LD	I	SWR	SDT	Constant				Index modifier	Integer Device
												K	H	M	f		
S	●	●	●	●	●	●	●	●	●	●	●	●	●	●	●	●	●
D		●	●	●	●	●	●	●	●						●		●

■ Outline of operation

- $\sin([S, S+1])$ of the angle data specified by $[S, S+1]$ (unit: radian) is calculated, and the result is stored in $[D, D+1]$.
 $\sin([S, S+1]) \rightarrow [D, D+1]$
- If $[S]$ is specified with an integer device, the operation occurs after the integer data is internally converted to real numbers.

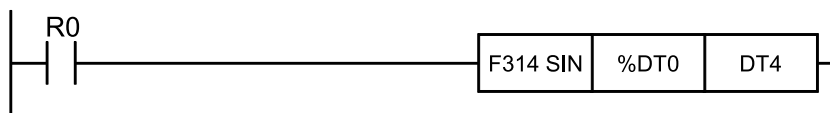

- If $[D]$ is specified with an integer device, the real number is converted to integer data and stored.

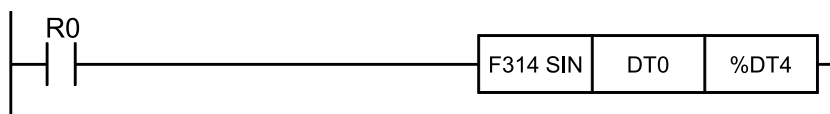

- If a K constant is specified for $[S]$, the same process is performed as if an integer device was specified.

28.6 F314 SIN (Sine of floating point real number data)

■ Precautions for programming

The accuracy decreases as the absolute value of the input value increases. Where possible, use angle data within the range -2π radians \leq input $\leq 2\pi$ radians.

■ Program example

When R0 turns ON, f0.4999999 is stored in DT20 and DT21.

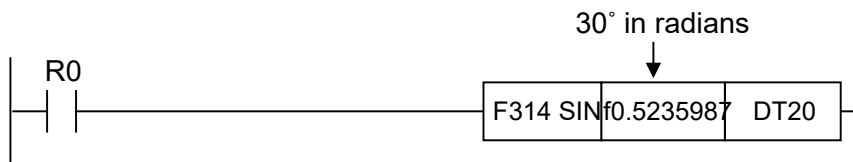

■ Flag operations

Name	Description
R9007 R9008 (ER)	Turns ON when the area is exceeded in index modification.
	Turns ON when non-real number data is specified in [S, S+1]
	Turns ON when the operation result exceeds the integer range when an integer device is specified in [D, D+1]
	Turns ON when the absolute value of the input value is 52707176 or higher
R9009 (CY)	Turns ON when operation result overflows
R900B (=)	Turns ON when the calculation result is "0"

28.7 F315 COS (Floating Point Real Number Data Cosine)

Operates the trigonometric function cos().

■ **Instruction format**

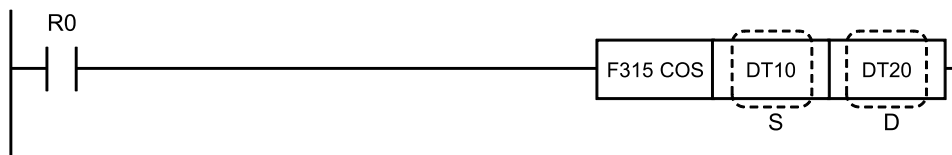

■ **Operands**

Items	Settings
S	Area storing angle data, or angle data (two words)
D	Area storing the operation results (two words)

■ **Devices that can be specified (indicated by ●)**

Operands	WX	WY	WR	WL	SV	EV	DT	LD	I	SWR	SDT	Constant				Index modifier	Integer Device
												K	H	M	f		
S	●	●	●	●	●	●	●	●	●	●	●	●	●	●	●	●	●
D		●	●	●	●	●	●	●	●							●	●

■ **Outline of operation**

- Calculates cos ([S, S+1]) of angle data (unit: radians) specified in [S, S+1], and stores the result in [D, D+1].
 $\cos([S, S+1]) \rightarrow [D, D+1]$
- If [S] is specified with an integer device, the operation occurs after the integer data is internally converted to real numbers.

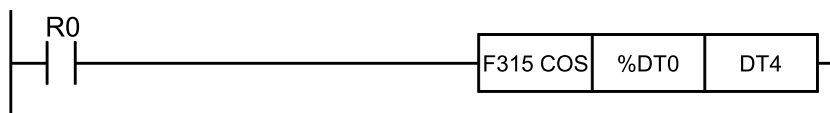

- If [D] is specified with an integer device, the real number is converted to integer data and stored.

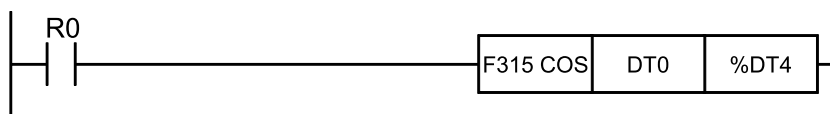

- If a K constant is specified for [S], the same process is performed as if an integer device was specified.

28.7 F315 COS (Floating Point Real Number Data Cosine)

■ Precautions for programming

The accuracy decreases as the absolute value of the input value increases. Where possible, use angle data within the range -2π radians \leq input $\leq 2\pi$ radians.

■ Program example

When R0 is ON, f 0.7071068 is stored in DT20 to DT21.

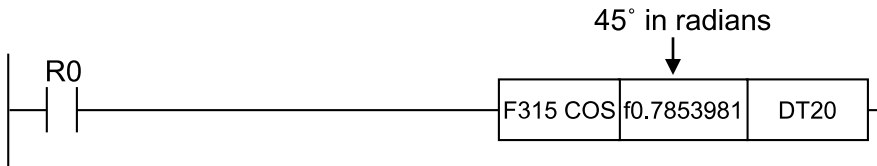

■ Flag operations

Name	Description
R9007 R9008 (ER)	Turns ON when the area is exceeded in index modification.
	Turns ON when non-real number data is specified in [S, S+1]
	Turns ON when the operation result exceeds the integer range when an integer device is specified in [D, D+1]
	Turns ON when the absolute value of the input value is 52707176 or higher
R9009 (CY)	Turns ON when operation result overflows
R900B (=)	Turns ON when the calculation result is "0"

28.8 F316 TAN (Floating Point Real Number Data Tangent)

Calculates the trigonometrical function tan().

■ **Instruction format**

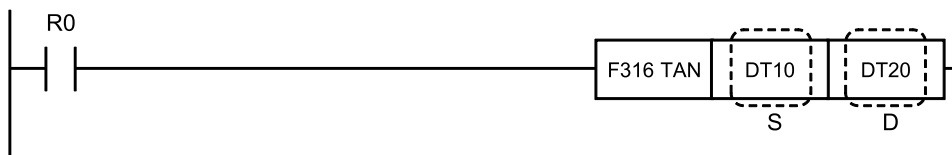

■ **Operands**

Items	Settings
S	Area storing angle data, or angle data (two words)
D	Area storing the operation results (two words)

■ **Devices that can be specified (indicated by ●)**

Operands	WX	WY	WR	WL	SV	EV	DT	LD	I	SWR	SDT	Constant				Index modifier	Integer Device
												K	H	M	f		
S	●	●	●	●	●	●	●	●	●	●	●	●	●	●	●	●	●
D		●	●	●	●	●	●	●	●						●		●

■ **Outline of operation**

- The tan([S and S+1]) of angle data (unit: radians) specified by S and S+1 is calculated and the result stored in D and D+1.
tan([S, S+1]) -> [D, D+1]
- If [S] is specified with an integer device, the operation occurs after the integer data is internally converted to real numbers.

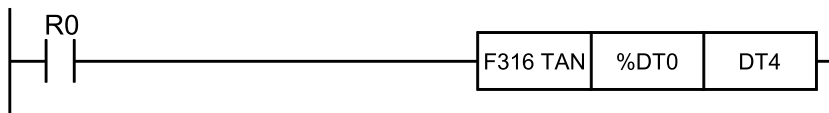

- If [D] is specified with an integer device, the real number is converted to integer data and stored.

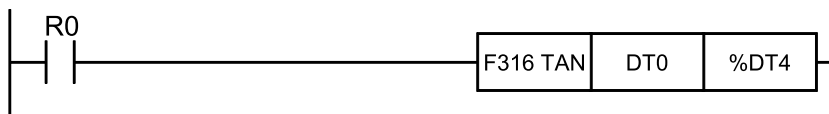

- If a K constant is specified for [S], the same process is performed as if an integer device was specified.

28.8 F316 TAN (Floating Point Real Number Data Tangent)

■ Precautions for programming

The accuracy decreases as the absolute value of the input value increases. Where possible, use angle data within the range -2π radians \leq input $\leq 2\pi$ radians.

■ Program example

f 1.732048 is stored in DT20 and DT21 when R0 turns ON.

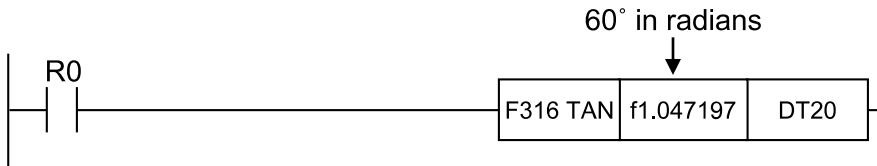

■ Flag operations

Name	Description
R9007 R9008 (ER)	Turns ON when the area is exceeded in index modification.
	Turns ON when non-real number data is specified in [S, S+1]
	Turns ON when the operation result exceeds the integer range when an integer device is specified in [D, D+1]
	Turns ON when the absolute value of the input value is 52707176 or higher
R9009 (CY)	Turns ON when operation result overflows
R900B (=)	Turns ON when the calculation result is "0"

28.9 F317 ASIN (Arcsine of Floating Point Real Number Data)

Calculates the trigonometric function $\text{SIN}^{-1}()$.

■ Instruction format

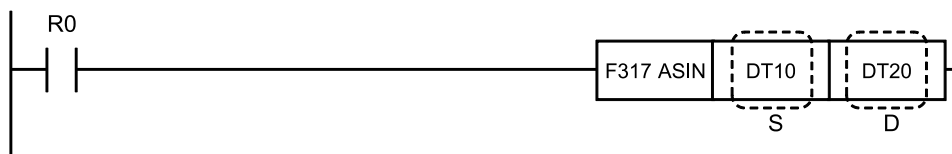

■ Operands

Items	Settings
S	Area storing angle data, or angle data (two words)
D	Area storing the operation results (two words)

■ Devices that can be specified (indicated by ●)

Operands	WX	WY	WR	WL	SV	EV	DT	LD	I	SW R	SD T	Constant				Index modifier	Integer Device
												K	H	M	f		
S	●	●	●	●	●	●	●	●	●	●	●	●	●	●	●	●	●
D		●	●	●	●	●	●	●	●						●		●

■ Outline of operation

- Calculates an angle from the SIN value specified in [S, S+1] and stores the result in [D, D+1] (in radians).

$$\text{SIN}^{-1}([S, S+1]) \rightarrow [D, D+1]$$

- If [S] is specified with an integer device, the operation occurs after the integer data is internally converted to real numbers.

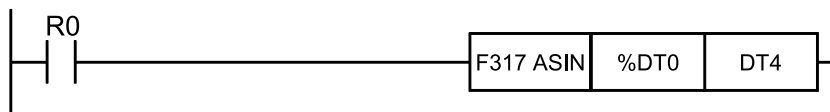

- If [D] is specified with an integer device, the real number is converted to integer data and stored.

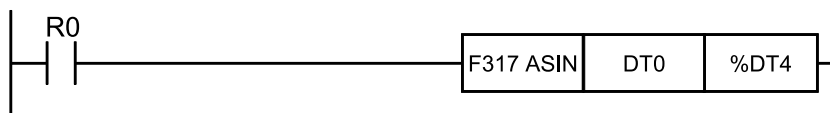

- If a K constant is specified for [S], the same process is performed as if an integer device was specified.

28.9 F317 ASIN (Arcsine of Floating Point Real Number Data)

■ Precautions for programming

[D, D+1] is stored in the following range:

$$-\pi/2 \leq [D, D+1] \leq \pi/2$$

[radians]

[radians]

■ Program example

f0.5235986 (30° radians) is stored in DT20 to DT21 when R0 turns ON.

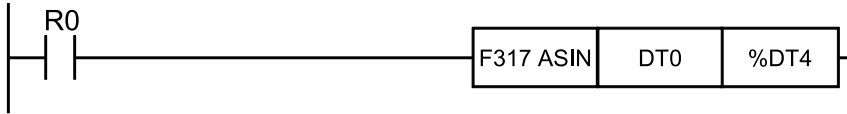

■ Flag operations

Name	Description
R9007 R9008 (ER)	Turns ON when the area is exceeded in index modification.
	Turns ON when non-real number data is specified in [S, S+1]
	Turns ON when [S, S+1] is not within the range $-1.0 \leq [S, S+1] \leq 1.0$
R9009 (CY)	Turns ON when the operation result exceeds the integer range when an integer device is specified in [D, D+1]
R900B (=)	Turns ON when the calculation result is "0"

28.10 F318 ACOS (Arccosine of Floating Point Real Number Data)

Calculates the trigonometric function $\text{COS}^{-1}()$.

■ **Instruction format**

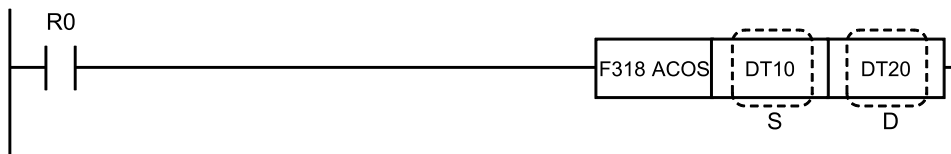

■ **Operands**

Items	Settings
S	Area storing angle data, or angle data (two words)
D	Area storing the operation results (two words)

■ **Devices that can be specified (indicated by ●)**

Operand s	WX	WY	WR	WL	SV	EV	DT	LD	I	SW R	SD T	Constant				Index modifier	Integer Device
												K	H	M	f		
S	●	●	●	●	●	●	●	●	●	●	●	●	●	●	●	●	●
D		●	●	●	●	●	●	●	●						●		●

■ **Outline of operation**

- The angle from the COS value specified by [S, S+1] is calculated and the result (unit: radian) is stored in [D, D+1].

$$\text{COS}^{-1}([S, S+1]) \rightarrow [D, D+1]$$

- If [S] is specified with an integer device, the operation occurs after the integer data is internally converted to real numbers.

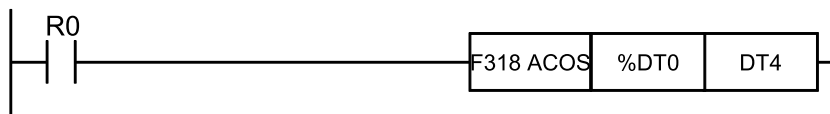

- If [D] is specified with an integer device, the real number is converted to integer data and stored.

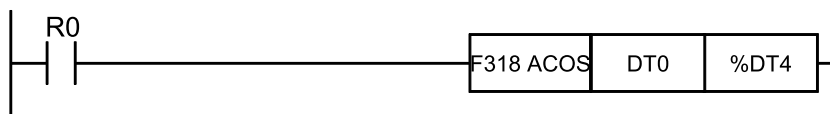

- If a K constant is specified for [S], the same process is performed as if an integer device was specified.

28.10 F318 ACOS (Arccosine of Floating Point Real Number Data)

■ Precautions for programming

[D, D+1] is stored in the following range:

$$0.0 \leq [D, D+1] \leq \pi$$

[radians] [radians]

■ Program example

When R0 turns ON, f0.7853980 (45° in radians) is stored in DT20 and DT21.

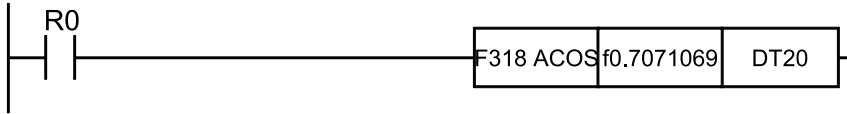

■ Flag operations

Name	Description
R9007 R9008 (ER)	Turns ON when the area is exceeded in index modification.
	Turns ON when non-real number data is specified in [S, S+1]
	Turns ON when [S, S+1] is not $-1.0 \leq [S, S+1] \leq 1.0$
R9009 (CY)	Turns ON when the operation result exceeds the integer range when an integer device is specified in [D, D+1]
R900B (=)	Turns ON when the calculation result is "0"

28.11 F319 ATAN (Arc tangent of floating point real number data)

Calculates the trigonometrical function $\text{TAN}^{-1}()$.

■ Instruction format

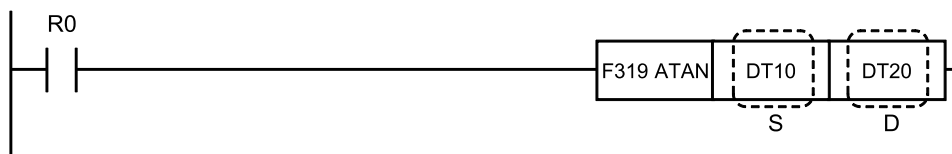

■ Operands

Items	Settings
S	Area storing angle data, or angle data (two words)
D	Area storing the operation results (two words)

■ Devices that can be specified (indicated by ●)

Operands	WX	WY	WR	WL	SV	EV	DT	LD	I	SW R	SD T	Constant				Index modifier	Integer Device
												K	H	M	f		
S	●	●	●	●	●	●	●	●	●	●	●	●	●	●	●	●	●
D		●	●	●	●	●	●	●	●							●	●

■ Outline of operation

- The angle from the TAN value specified by [S, S+1] is calculated and the result (unit: radian) is stored in [D, D+1].

$$\text{TAN}^{-1}([S, S+1]) \rightarrow [D, D+1]$$

- If [S] is specified with an integer device, the operation occurs after the integer data is internally converted to real numbers.

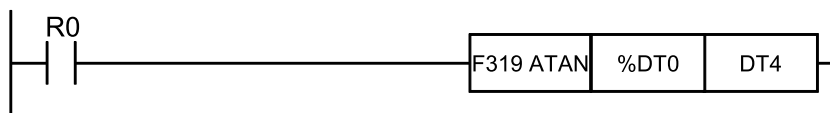

- If [D] is specified with an integer device, the real number is converted to integer data and stored.

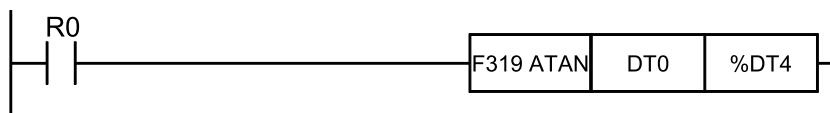

- If a K constant is specified for [S], the same process is performed as if an integer device was specified.

28.11 F319 ATAN (Arctangent of floating point real number data)

■ Precautions for programming

[D, D+1] is stored in the following range:

$$-\pi/2 < [D, D+1] < \pi/2$$

[radians]

[radians]

■ Program example

f1.047197 (60° in radians) is stored in DT20 to DT21 when R0 turns ON.

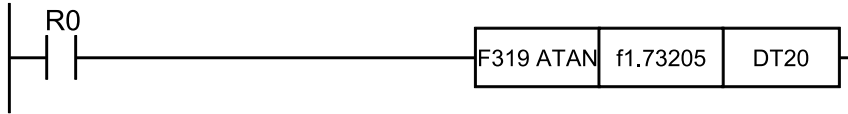

■ Flag operations

Name	Description
R9007	Turns ON when the area is exceeded in index modification.
R9008	Turns ON when non-real number data is specified in [S, S+1]
(ER)	Turns ON when the operation result exceeds the integer range when an integer device is specified in [D, D+1]
R9009	Turns ON when operation result overflows
(CY)	
R900B	Turns ON when the calculation result is "0"
(=)	

28.12 F320 LN (Floating Point Real Number Natural Logarithm)

Calculates the natural logarithm LN().

■ **Instruction format**

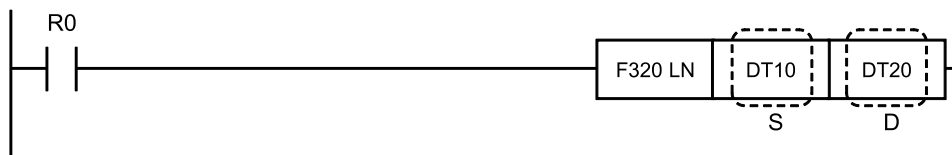

■ **Operands**

Items	Settings
S	Area storing angle data, or angle data (two words)
D	Area storing the operation results (two words)

■ **Devices that can be specified (indicated by ●)**

Operands	WX	WY	WR	WL	SV	EV	DT	LD	I	SWR	SDT	Constant				Index modifier	Integer Device
												K	H	M	f		
S	●	●	●	●	●	●	●	●	●	●	●	●	●	●	●	●	●
D		●	●	●	●	●	●	●	●							●	●

■ **Outline of operation**

- The natural logarithm LN ([S, S+1]) is calculated from the operation data specified by [S, S+1], and the result is stored in [D, D+1].
LN([S, S+1]) → [D, D+1]
- If [S] is specified with an integer device, the operation occurs after the integer data is internally converted to real numbers.

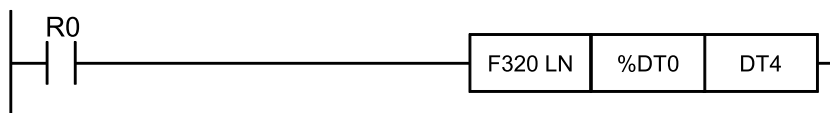

- If [D] is specified with an integer device, the real number is converted to integer data and stored.

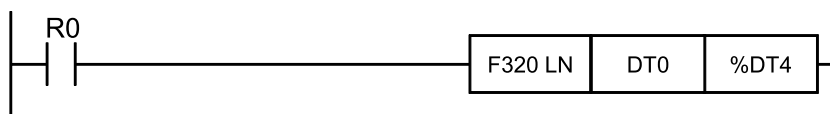

28.12 F320 LN (Floating Point Real Number Natural Logarithm)

■ Program example

- When R0 turns ON, f1.6094379 is stored in DT20 and DT21.

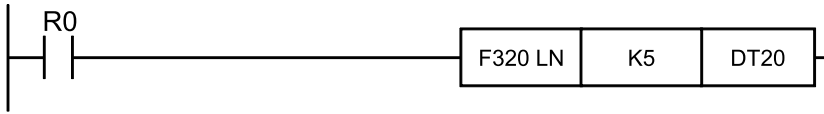

- When R0 turns ON, f-0.3160815 is stored in DT30 and DT31.

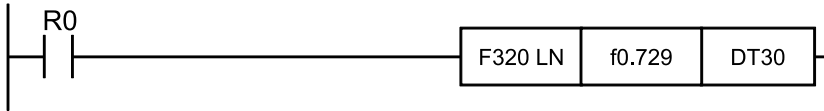

■ Flag operations

Name	Description
R9007 R9008 (ER)	Turns ON when the area is exceeded in index modification.
	Turns ON when non-real number data is specified in [S, S+1]
	Turns ON when [S, S+1] is not 0 < [S, S+1]
R9009 (CY)	Turns ON when the operation result exceeds the integer range when an integer device is specified in [D, D+1]
R900B (=)	Turns ON when the calculation result is "0"

28.13 F321 EXP (Floating Point Real Number Data Exponent)

Calculates the exponent EXP().

■ **Instruction format**

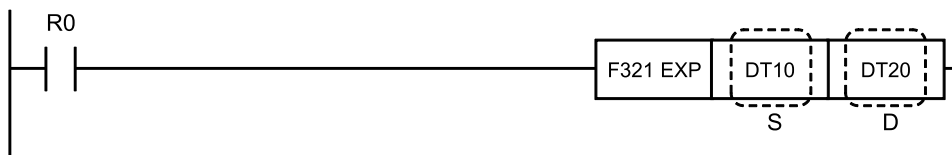

■ **Operands**

Items	Settings
S	Area storing angle data, or angle data (two words)
D	Area storing the operation results (two words)

■ **Devices that can be specified (indicated by ●)**

Operand s	WX	WY	WR	WL	SV	EV	DT	LD	I	SW R	SD T	Constant				Index modifier	Integer Device
												K	H	M	f		
S	●	●	●	●	●	●	●	●	●	●	●	●	●	●	●	●	●
D		●	●	●	●	●	●	●	●							●	●

■ **Outline of operation**

- The exponent EXP ([S, S+1]) is calculated from the operation data specified by [S, S+1], and the result is stored in [D, D+1].
EXP([S, S+1]) → [D, D+1]
The calculation is performed with exponent base (e) equal to "2.718282".
- If [S] is specified with an integer device, the operation occurs after the integer data is internally converted to real numbers.

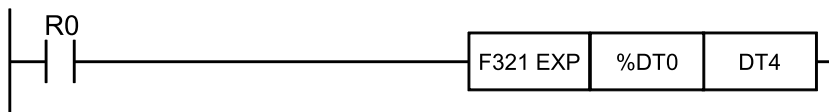

- If [D] is specified with an integer device, the real number is converted to integer data and stored.

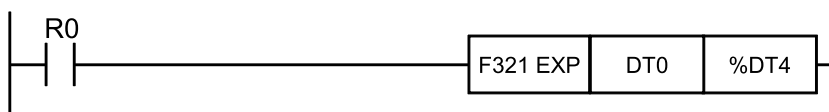

28.13 F321 EXP (Floating Point Real Number Data Exponent)

■ Program example

- When R0 turns ON, f7.389056 is stored in DT20 and DT21.

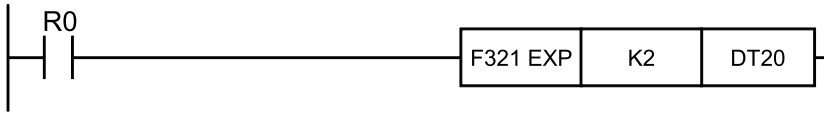

- When R0 turns ON, f221.406402 is stored in DT30 and DT31.

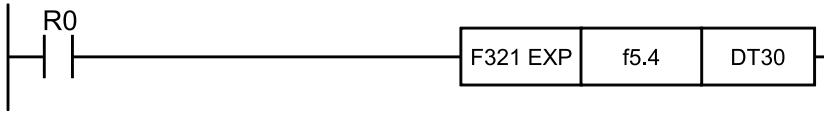

■ Flag operations

Name	Description
R9007	Turns ON when the area is exceeded in index modification.
R9008	Turns ON when non-real number data is specified in [S, S+1]
(ER)	Turns ON when the operation result exceeds the integer range when an integer device is specified in [D, D+1]
R9009 (CY)	Turns ON when operation result overflows
R900B (=)	Turns ON when the calculation result is "0"

28.14 F322 LOG (Floating Point Real Number Data Common Logarithm)

Calculates the logarithm LOG().

■ **Instruction format**

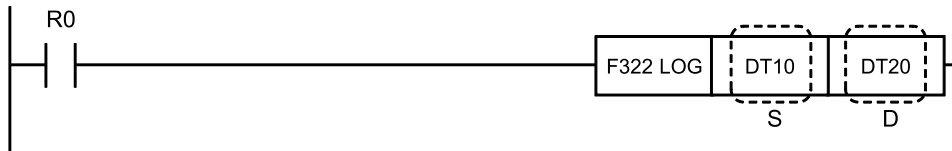

■ **Operands**

Items	Settings
S	Area storing angle data, or angle data (two words)
D	Area storing the operation results (two words)

■ **Devices that can be specified (indicated by ●)**

Operands	WX	WY	WR	WL	SV	EV	DT	LD	I	SWR	SDT	Constant				Index modifier	Integer Device
												K	H	M	f		
S	●	●	●	●	●	●	●	●	●	●	●	●	●	●	●	●	●
D		●	●	●	●	●	●	●	●							●	●

■ **Outline of operation**

- The logarithm LOG (S and S+1) is calculated using the data specified by S and S+1 and the result stored in D and D+1.
LOG([S, S+1]) -> [D, D+1]
- If [S] is specified with an integer device, the operation occurs after the integer data is internally converted to real numbers.

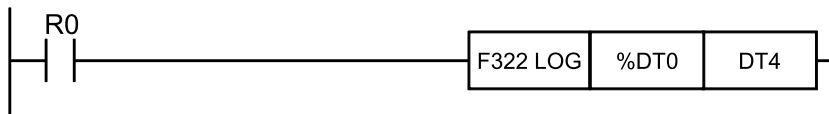

- If [D] is specified with an integer device, the real number is converted to integer data and stored.

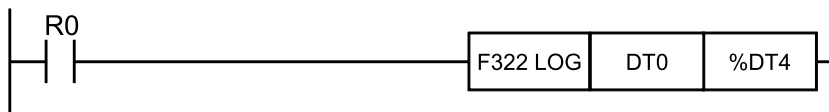

28.14 F322 LOG (Floating Point Real Number Data Common Logarithm)

- If a K constant is specified for [S], the same process is performed as if an integer device was specified.

■ Program example

- f 1.30103 is stored in DT20 and DT21 when R0 turns ON.

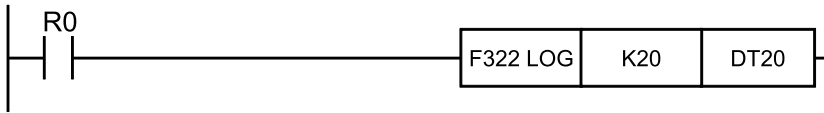

- f 0.0108932 is stored in DT30 and DT31 when R0 turns ON.

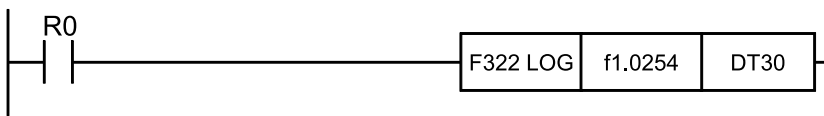

■ Flag operations

Name	Description
R9007 R9008 (ER)	Turns ON when the area is exceeded in index modification.
	Turns ON when non-real number data is specified in [S, S+1]
	Turns ON when [S, S+1] is not $0 < [S, S+1]$
R9009 (CY)	Turns ON when the operation result exceeds the integer range when an integer device is specified in [D, D+1]
R900B (=)	Turns ON when the calculation result is "0"

28.15 F323 PWR (Floating point real number data power)

Calculates powers for real number data.

■ Instruction format

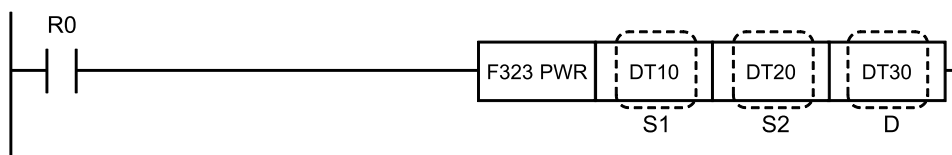

■ Operands

Items	Settings
S1	Area storing the base data, or base data (two words)
S2	Area storing the power data, or power data (two words)
D	Area storing the operation results (two words)

■ Devices that can be specified (indicated by ●)

Operands	WX	WY	WR	WL	SV	EV	DT	LD	I	SWR	SDT	Constant				Index modifier	Integer Device
												K	H	M	f		
S1	●	●	●	●	●	●	●	●	●	●	●	●	●	●	●	●	●
S2	●	●	●	●	●	●	●	●	●	●	●	●	●	●	●	●	●
D		●	●	●	●	●	●	●	●							●	●

■ Outline of operation

- Raises the base data specified by [S1, S1+1] to the power data specified by [S2, S2+1], and stores the result in [D, D+1].

$$[S1, S1+1]^{[S2, S2+1]} \rightarrow [D, D+1]$$

- If [S1] and [S2] are specified with an integer device, the operation occurs after the integer data is internally converted to real numbers.

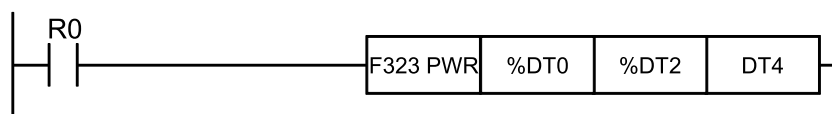

- If [D] is specified with an integer device, the real number is converted to integer data and stored.

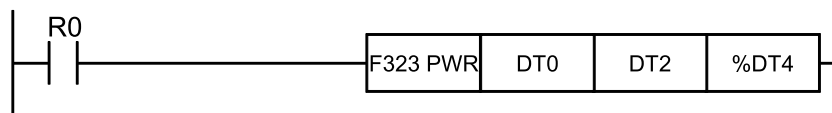

28.15 F323 PWR (Floating point real number data power)

- If a K constant is specified for [S1] or [S2], the same process is performed as if an integer device was specified.

■ Program example

- When R0 turns ON, f 625.0 is stored to DT20 to DT21.



- When R0 turns ON, f 30.51758 is stored to DT30 to DT31.



■ Flag operations

Name	Description
R9007 R9008 (ER)	Turns ON when the area is exceeded in index modification.
	Turns ON when non-real-number data is specified in [S1, S1+1] or [S2, S2+1]
	Turns ON when the power of negative number data is not an integer
	Turns ON when the operation result exceeds the integer range when an integer device is specified in [D, D+1]
R9009 (CY)	Turns ON when operation result overflows
R900B (=)	Turns ON when the calculation result is "0"

28.16 F324 FSQR (Floating Point Real Number Square Root)

Calculates the square root of real number data.

■ **Instruction format**

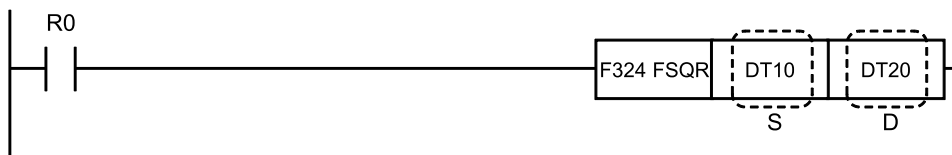

■ **Operands**

Items	Settings
S	Area storing operation data, or operation data (two words)
D	Area storing the operation results (two words)

■ **Devices that can be specified (indicated by ●)**

Operands	WX	WY	WR	WL	SV	EV	DT	LD	I	SWR	SDT	Constant				Index modifier	Integer Device
												K	H	M	f		
S	●	●	●	●	●	●	●	●	●	●	●	●	●	●	●	●	●
D		●	●	●	●	●	●	●	●							●	●

■ **Outline of operation**

- The square root of the operation data specified by [S, S+1] is calculated and the result is stored in [D, D+1].
 $\sqrt{[S, S+1]} \rightarrow [D, D+1]$
- If [S] is specified with an integer device, the operation occurs after the integer data is internally converted to real numbers.

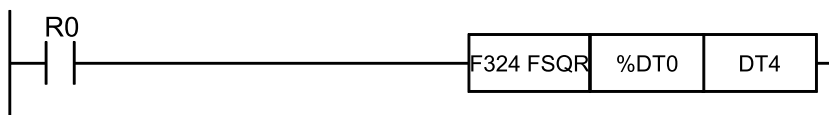

- If [D] is specified with an integer device, the real number is converted to integer data and stored.

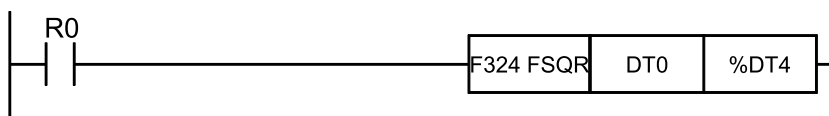

- If a K constant is specified for [S], the same process is performed as if an integer device was specified.

28.16 F324 FSQR (Floating Point Real Number Square Root)

■ Program example

When R0 turns ON, f1.41421 is stored in DT20 and DT21.

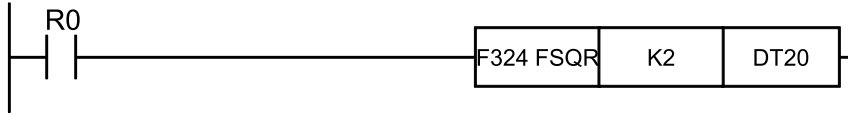

■ Flag operations

Name	Description
R9007 R9008 (ER)	Turns ON when the area is exceeded in index modification.
	Turns ON when non-real number data is specified in [S, S+1]
	Turns ON when [S, S+1] is not $0 \leq [S, S+1]$
R9009 (CY)	Turns ON when the operation result exceeds the integer range when an integer device is specified in [D, D+1]
R900B (=)	Turns ON when the calculation result is "0"

28.17 F325 FLT (16-Bit Integer Data to Floating Point Real Number Data Conversion)

Converts 16-bit integer data to real number data.

■ Instruction format

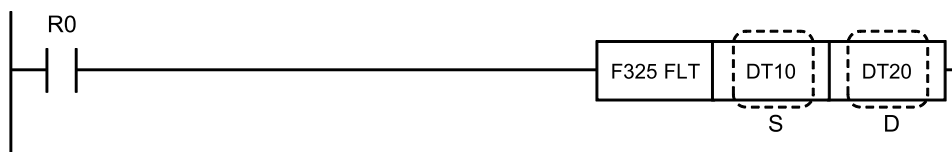

■ Operands

Items	Settings
S	Area storing operation data, or operation data (two words)
D	Area storing the operation results (two words)

■ Devices that can be specified (indicated by ●)

Operands	WX	WY	WR	WL	SV	EV	DT	LD	I	SWR	SDT	Constant				Index modifier	Integer Device
												K	H	M	f		
S	●	●	●	●	●	●	●	●	●	●	●	●	●	●	●	●	
D		●	●	●	●	●	●	●	●							●	

■ Outline of operation

Converts the operation data (signed 16-bit integer data) specified by [S] to real number data, and stores this in [D].

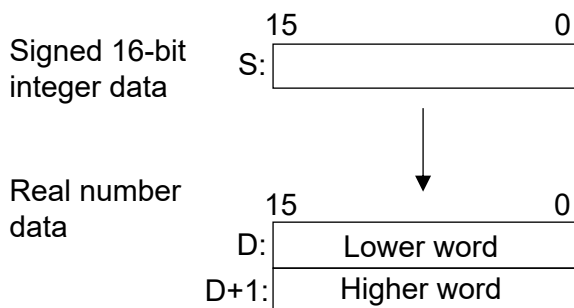

■ Flag operations

Name	Description
R9007 R9008 (ER)	Turns ON when the area is exceeded in index modification.
R900B	Turns ON when the calculation result is "0"

28.17 F325 FLT (16-Bit Integer Data to Floating Point Real Number Data Conversion)

Name	Description
(=)	

28.18 F326 DFLT (32-Bit Integer to Floating Point Real Number Data Conversion)

Converts 32-bit integers to real number data.

■ Instruction format

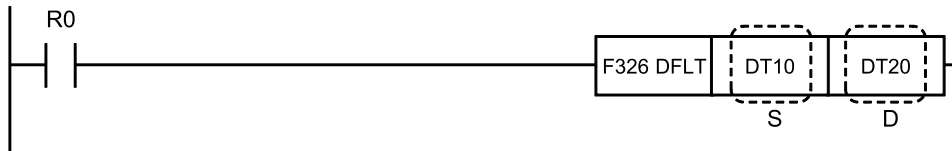

■ Operands

Items	Settings
S	Area storing operation data, or operation data (two words)
D	Area storing the operation results (two words)

■ Devices that can be specified (indicated by ●)

Operands	WX	WY	WR	WL	SV	EV	DT	LD	I	SWR	SDT	Constant				Index modifier	Integer Device
												K	H	M	f		
S	●	●	●	●	●	●	●	●	●	●	●	●	●	●	●	●	
D		●	●	●	●	●	●	●	●							●	

■ Outline of operation

The operation data (signed 32-bit integer data) specified by [S, S+1] is converted to real number data and stored in [D, D+1].

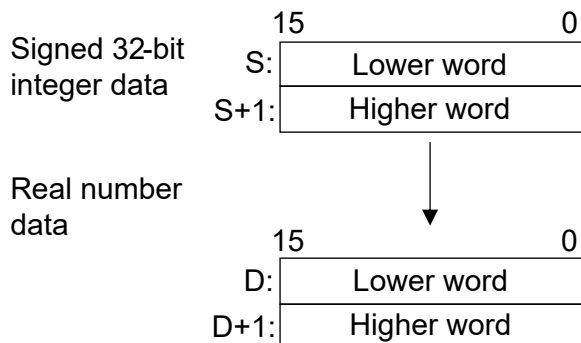

■ Flag operations

Name	Description
R9007 R9008 (ER)	Turns ON when the area is exceeded in index modification.

28.18 F326 DFLT (32-Bit Integer to Floating Point Real Number Data Conversion)

Name	Description
R9009 (CY)	Turns ON when the significant digits of the mantissa for the operation result real number data cannot be obtained
R900B (=)	Turns ON when the calculation result is "0"

28.19 F327 INT [Floating Point Real Number Data to 16-Bit Data Conversion (Largest Integer not Exceeding Floating Point Real Number Data)]

28.19 F327 INT [Floating Point Real Number Data to 16-Bit Data Conversion (Largest Integer not Exceeding Floating Point Real Number Data)]

Converts real number data to 16-bit integers (largest integer not exceeding floating point real number).

■ Instruction format

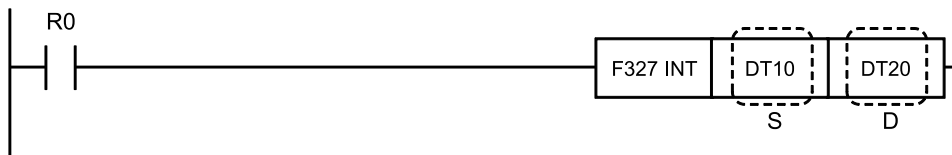

■ Operands

Items	Settings
S	Area storing operation data, or operation data (two words)
D	Area storing the operation results (two words)

■ Devices that can be specified (indicated by ●)

Operands	WX	WY	WR	WL	SV	EV	DT	LD	I	SWR	SDT	Constant				Index modifier	Integer Device
												K	H	M	f		
S	●	●	●	●	●	●	●	●	●	●	●	●	●	●	●	●	
D		●	●	●	●	●	●	●	●							●	

■ Outline of operation

The real number data (-32767.99 to +32767.99) specified by [S, S+1] is converted to signed 16-bit integers (largest integer not exceeding floating point real number) and stored in [D].

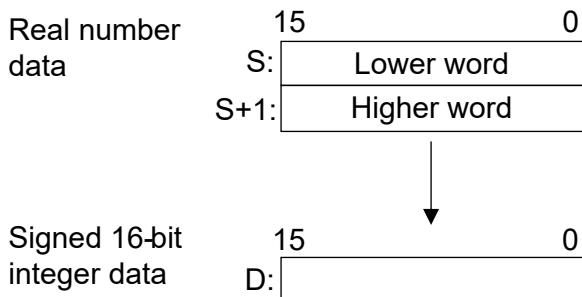

■ Operation example

Operation of instruction format description program

- If the real number 1.234 is stored in DT10 and DT11, the following operation is performed.

28.19 F327 INT [Floating Point Real Number Data to 16-Bit Data Conversion (Largest Integer not Exceeding Floating Point Real Number Data)]

DT10: (f1.234)
 DT11:



DT20: (K1)

- If the real number -1.234 is stored in DT10 and DT11, the following operation is performed.

DT10: (f-1.234)
 DT11:



DT20: (K-2)

■ Flag operations

Name	Description
R9007	Turns ON when the area is exceeded in index modification.
R9008	Turns ON when non-real number data is specified in [S, S+1]
(ER)	Turns ON when [D] exceeds the 16-bit integer range
R900B (=)	Turns ON when the calculation result is "0"

28.20 F328 DINT [Floating point real number data to 32-bit integer conversion (largest integer not exceeding floating point real number)]

28.20 F328 DINT [Floating point real number data to 32-bit integer conversion (largest integer not exceeding floating point real number)]

Converts real number data to 32-bit integers (largest integer not exceeding floating point real number).

■ Instruction format

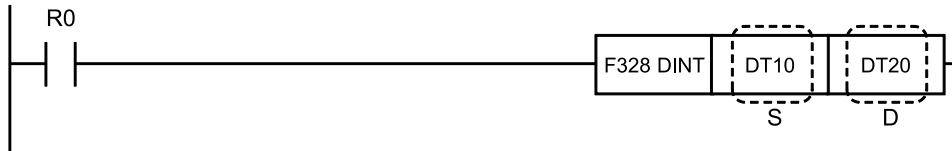

■ Operands

Items	Settings
S	Area storing operation data, or operation data (two words)
D	Area storing the operation results (two words)

■ Devices that can be specified (indicated by ●)

Operands	WX	WY	WR	WL	SV	EV	DT	LD	I	SWR	SDT	Constant				Index modifier	Integer Device
												K	H	M	f		
S	●	●	●	●	●	●	●	●	●	●	●	●	●	●	●	●	
D		●	●	●	●	●	●	●	●							●	

■ Outline of operation

The real number data (-2,147,483,000 to +2,147,483,000) specified by [S, S+1] is converted to signed 32-bit integers (largest integer not exceeding floating point real number) and stored in [D, D+1].

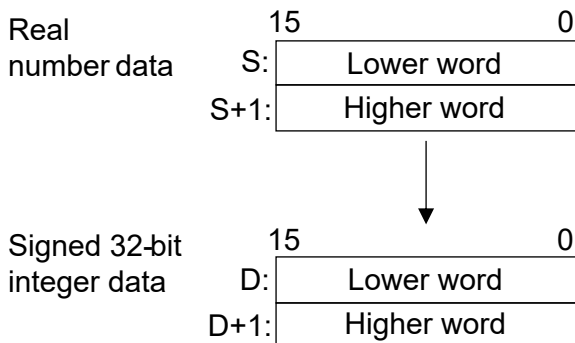

■ Operation example

Operation of instruction format description program

- If the real number 12345.67 is stored in DT10 and DT11, the following operation is performed.

28.20 F328 DINT [Floating point real number data to 32-bit integer conversion (largest integer not exceeding floating point real number)]

DT10: (f12345.67)
DT11:



DT20: (K12345)
DT21:

- If the real number -12345.67 is stored in DT10 and DT11, the following operation is performed.

DT10: (f-12345.67)
DT11:



DT20: (K-12346)
DT21:

■ Flag operations

Name	Description
R9007	Turns ON when the area is exceeded in index modification.
R9008	Turns ON when non-real number data is specified in [S, S+1]
(ER)	Turns ON when [D, D+1] exceeds the 32-bit integer range
R900B (=)	Turns ON when the calculation result is "0"

28.21 F329 FIX [Floating Point Real Number Data to 16-Bit Integer (Round Down to Nearest Integer) Conversion]

Converts real number data to a 16-bit integer (rounded down to the nearest integer).

■ **Instruction format**

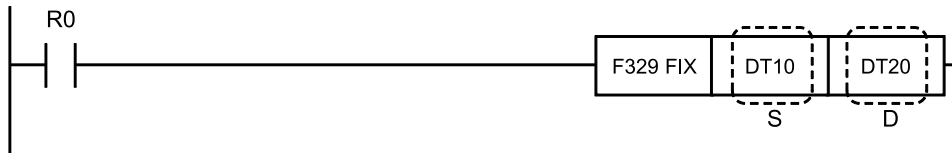

■ **Operands**

Items	Settings
S	Area storing operation data, or operation data (two words)
D	Area storing the operation results (two words)

■ **Devices that can be specified (indicated by ●)**

Operands	WX	WY	WR	WL	SV	EV	DT	LD	I	SWR	SDT	Constant				Index modifier	Integer Device
												K	H	M	f		
S	●	●	●	●	●	●	●	●	●	●	●		●		●		
D		●	●	●	●	●	●	●	●						●		

■ **Outline of operation**

Converts real number data specified in [S, S+1] (-32767.99 to +32767.99) to a signed 16-bit integer (rounded down to the nearest integer), and stores it in [D].

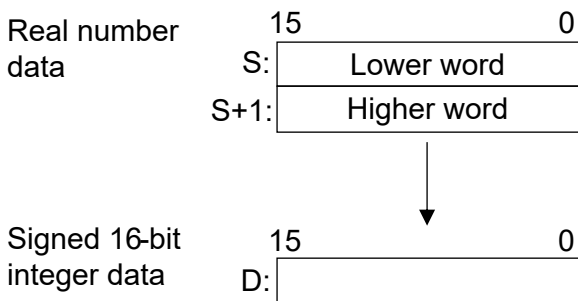

■ **Operation example**

Operation of instruction format description program

- When the real number 1.234567 is stored in DT10 and DT11, the following operation is performed.

28.21 F329 FIX [Floating Point Real Number Data to 16-Bit Integer (Round Down to Nearest Integer) Conversion]

DT10: (f1.234567)
 DT11:



DT20: (K1)

- When the real number -1.234567 is stored in DT10 and DT11, the following operation is performed.

DT10: (f-1.234567)
 DT11:



DT20: (K-1)

■ Flag operations

Name	Description
R9007	Turns ON when the area is exceeded in index modification.
R9008	Turns ON when non-real number data is specified in [S, S+1]
(ER)	Turns ON when [D] exceeds the 16-bit integer range
R900B	Turns ON when the calculation result is "0"
(=)	

28.22 F330 DFIX [Convert Floating Point Real Number Data to 32-Bit Integers, (Rounding Down the Decimal Point)]

Converts real number data to 32-bit integers (rounding down the decimal point).

■ Instruction format

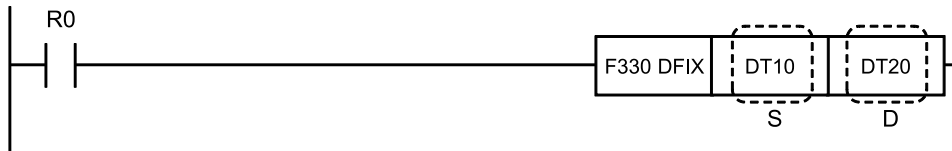

■ Operands

Items	Settings
S	Area storing operation data, or operation data (two words)
D	Area storing the operation results (two words)

■ Devices that can be specified (indicated by ●)

Operands	WX	WY	WR	WL	SV	EV	DT	LD	I	SW R	SD T	Constant				Index modifier	Integer Device
												K	H	M	f		
S	●	●	●	●	●	●	●	●	●	●	●	●	●	●	●	●	
D		●	●	●	●	●	●	●	●							●	

■ Outline of operation

The real number data (-2,147,483,000 to +2,147,483,000) specified by [S, S+1] is converted to signed 32-bit integers (rounding down the decimal point), and stored in [D, D+1].

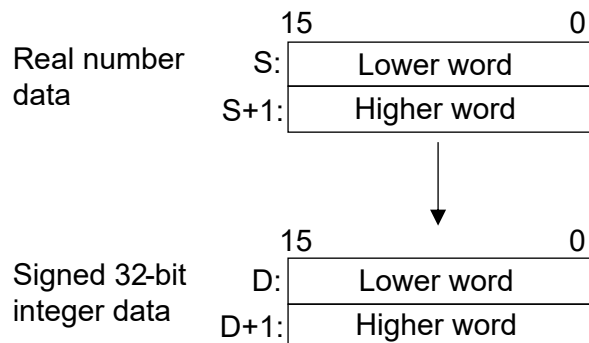

■ Operation example

Operation of instruction format description program

- If the real number 123456.7 is stored in DT10 to DT11, the following operation is performed.

28.22 F330 DFIX [Convert Floating Point Real Number Data to 32-Bit Integers, (Rounding Down the Decimal Point)]

DT10: (f123456.7)
DT11:



DT20: (K123456)
DT21:

- If the real number -123456.7 is stored in DT10 to DT11, the following operation is performed.

DT10: (f-123456.7)
DT11:



DT20: (K-123456)
DT21:

■ Flag operations

Name	Description
R9007	Turns ON when the area is exceeded in index modification.
R9008	Turns ON when non-real number data is specified in [S, S+1]
(ER)	Turns ON when [D, D+1] exceeds the 32-bit integer range
R900B (=)	Turns ON when the calculation result is "0"

28.23 F331 ROFF [Convert Floating Point Real Number Data to a 16-Bit Integer (Rounded Off to the Nearest Integer)]

Converts real number data to a 16-bit integer (rounded off to the nearest integer).

■ Instruction format

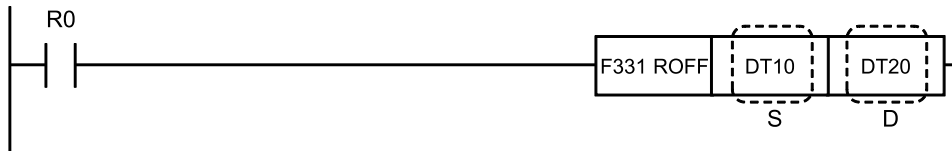

■ Operands

Items	Settings
S	Area storing operation data, or operation data (two words)
D	Area storing the operation results (two words)

■ Devices that can be specified (indicated by ●)

Operands	WX	WY	WR	WL	SV	EV	DT	LD	I	SW R	SD T	Constant				Index modifier	Integer Device
												K	H	M	f		
S	●	●	●	●	●	●	●	●	●	●	●	●	●	●	●	●	
D		●	●	●	●	●	●	●	●							●	

■ Outline of operation

Converts the real number data (-32767.99 to +32767.99) specified in [S, S+1] to a signed 16-bit integer (rounded off to the nearest integer) and stores it in [D].

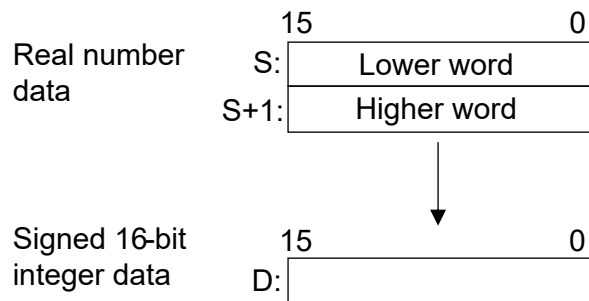

■ Operation example

Operation of instruction format description program

- When the real number 1234.567 is stored in DT10 and DT11, the following operation will be performed.

28.23 F331 ROFF [Convert Floating Point Real Number Data to a 16-Bit Integer (Rounded Off to the Nearest Integer)]

DT10: (f1234.567)
 DT11:



DT20: (K1235)

- When the real number -1234.567 is stored in DT10 and DT11, the following operation will be performed.

DT10: (f-1234.567)
 DT11:



DT20: (K-1235)

■ Flag operations

Name	Description
R9007	Turns ON when the area is exceeded in index modification.
R9008	Turns ON when non-real number data is specified in [S, S+1]
(ER)	Turns ON when [D] exceeds the 16-bit integer range
R900B	Turns ON when the calculation result is "0"
(=)	

28.24 F332 DROFF [Floating point real number Data → 32-bit integer conversion (rounding off at the decimal point)]

Converts real number data to 32-bit integers (rounding off at the decimal point).

■ **Instruction format**

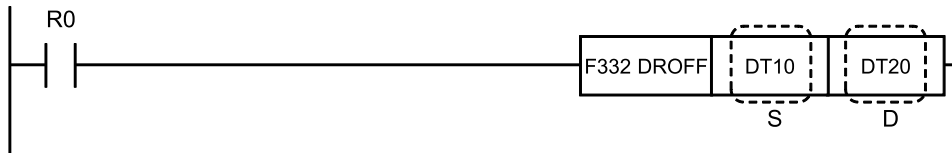

■ **Operands**

Items	Settings
S	Area storing operation data, or operation data (two words)
D	Area storing the operation results (two words)

■ **Devices that can be specified (indicated by ●)**

Operands	WX	WY	WR	WL	SV	EV	DT	LD	I	SWR	SDT	Constant				Index modifier	Integer Device
												K	H	M	f		
S	●	●	●	●	●	●	●	●	●	●	●	●	●	●	●	●	
D		●	●	●	●	●	●	●	●							●	

■ **Outline of operation**

The real number data specified by [S, S+1] (-2,147,483,000 to +2,147,483,000) is converted to signed 32-bit integers (rounding off at the decimal point) and stored in [D, D+1].

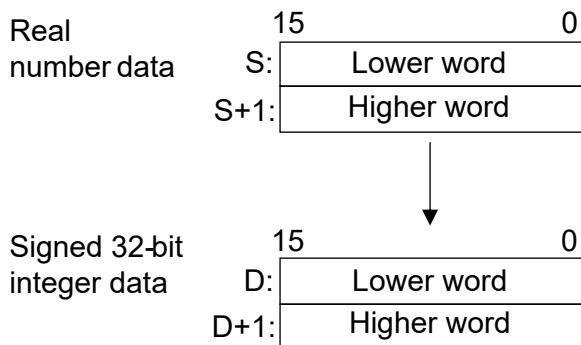

■ **Operation example**

Operation of instruction format description program

- If the real number 45678.51 is stored in DT10 and DT11, the following operation is performed.

28.24 F332 DROFF [Floating point real number Data → 32-bit integer conversion (rounding off at the decimal point)]

DT10: (f45678.51)
DT11:



DT20: (K45679)
DT21:

- If the real number -45678.51 is stored in DT10 and DT11, the following operation is performed.

DT10: (f-45678.51)
DT11:



DT20: (K-45679)
DT21:

■ Flag operations

Name	Description
R9007	Turns ON when the area is exceeded in index modification.
R9008	Turns ON when non-real number data is specified in [S, S+1]
(ER)	Turns ON when [D, D+1] exceeds the 32-bit integer range
R900B (=)	Turns ON when the calculation result is "0"

28.25 F333 FINT (Round down floating point real number data at the decimal point)

Rounds down real number data at the decimal point. (The largest integer not exceeding the floating point type data)

■ Instruction format

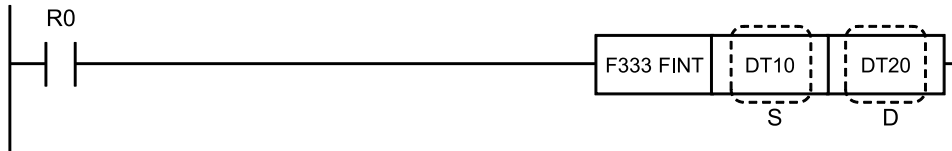

■ Operands

Items	Settings
S	Area storing operation data, or operation data (two words)
D	Area storing the operation results (two words)

■ Devices that can be specified (indicated by ●)

Operands	WX	WY	WR	WL	SV	EV	DT	LD	I	SWR	SDT	Constant				Index modifier	Integer Device
												K	H	M	f		
S	●	●	●	●	●	●	●	●	●	●	●	●	●	●	●	●	
D		●	●	●	●	●	●	●	●							●	

■ Outline of operation

The real number data specified by [S, S+1] is rounded down at the decimal point and the result is stored in [D, D+1].

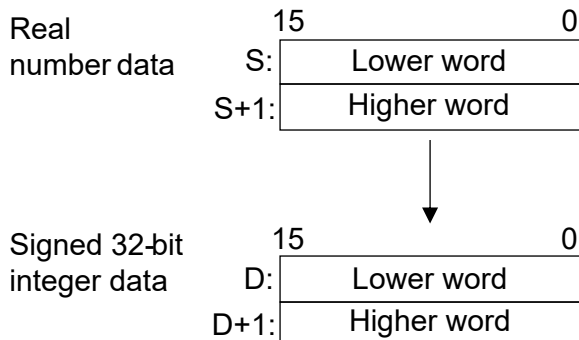

■ Operation example

Operation of instruction format description program

- When the real number 1234.567 is stored in DT10 and DT11, the following operation will be performed.

28.25 F333 FINT (Round down floating point real number data at the decimal point)

DT10: (f1234.567)
DT11:



DT20: (f1234.000)
DT21:

- When the real number -1234.567 is stored in DT10 and DT11, the following operation will be performed.

DT10: (f-1234.567)
DT11:



DT20: (f-1235.000)
DT21:

■ Flag operations

Name	Description
R9007	Turns ON when the area is exceeded in index modification.
R9008 (ER)	Turns ON when non-real number data is specified in [S, S+1]
R9009 (CY)	Turns ON when operation result overflows
R900B (=)	Turns ON when the calculation result is "0"

28.26 F334 FRINT (Round off floating point real number data to the first decimal place)

Rounds off real number data to the first decimal place.

■ Instruction format

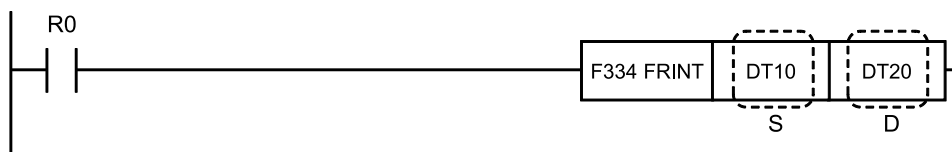

■ Operands

Items	Settings
S	Area storing operation data, or operation data (two words)
D	Area storing the operation results (two words)

■ Devices that can be specified (indicated by ●)

Operands	WX	WY	WR	WL	SV	EV	DT	LD	I	SW R	SD T	Constant				Index modifier	Integer Device
												K	H	M	f		
S	●	●	●	●	●	●	●	●	●	●	●	●	●	●	●	●	
D		●	●	●	●	●	●	●	●							●	

■ Outline of operation

The decimal part of the real number data specified by [S, S+1] is rounded off to the first decimal place, and the result is stored in [D, D+1].

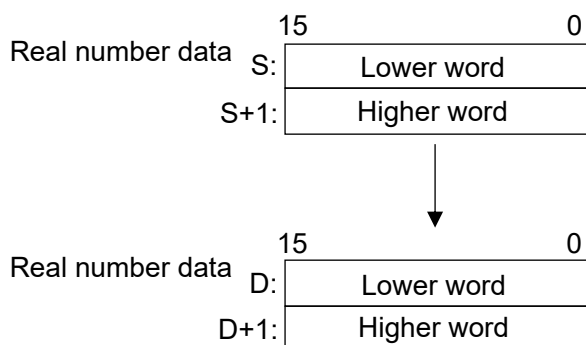

■ Operation example

Operation of instruction format description program

- When the real number 1234.567 is stored in DT10 and DT11, the following operation will be performed.

28.26 F334 FRINT (Round off floating point real number data to the first decimal place)

DT10: (f1234.567)
DT11:



DT20: (f1235.000)
DT21:

- When the real number -1234.567 is stored in DT10 and DT11, the following operation will be performed.

DT10: (f-1234.567)
DT11:



DT20: (f-1235.000)
DT21:

■ Flag operations

Name	Description
R9007	Turns ON when the area is exceeded in index modification.
R9008 (ER)	Turns ON when non-real number data is specified in [S, S+1]
R9009 (CY)	Turns ON when operation result overflows
R900B (=)	Turns ON when the calculation result is "0"

28.27 F335 F+/- (Floating Point Real Number Data Sign Conversion)

Changes the sign of real number data.

■ **Instruction format**

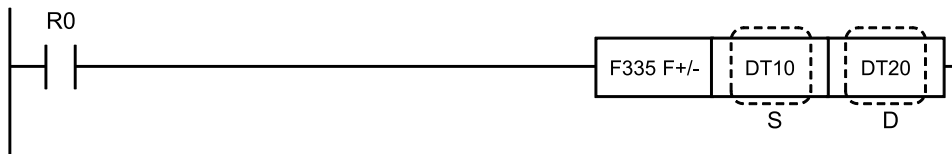

■ **Operands**

Items	Settings
S	Area storing operation data, or operation data (two words)
D	Area storing the operation results (two words)

■ **Devices that can be specified (indicated by ●)**

Operands	WX	WY	WR	WL	SV	EV	DT	LD	I	SWR	SDT	Constant				Index modifier	Integer Device
												K	H	M	f		
S	●	●	●	●	●	●	●	●	●	●	●	●	●	●	●	●	●
D		●	●	●	●	●	●	●	●						●		

■ **Outline of operation**

The sign for the real number data specified by [S, S+1] is changed and the result stored in [D, D+1].

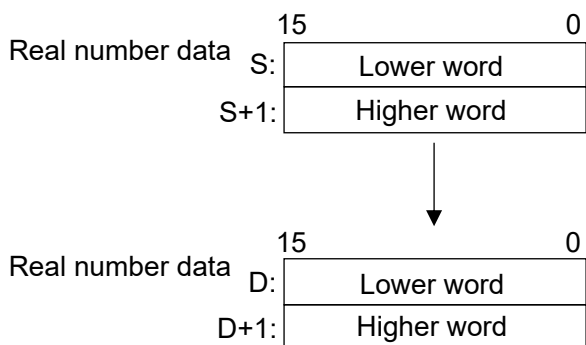

■ **Operation example**

Operation of instruction format description program

- If the real number "-60000.00" is stored in DT10 to DT11, the following operation will be performed.

28.27 F335 F+/- (Floating Point Real Number Data Sign Conversion)

DT10: (f-60000.00)
DT11:



DT20: (f60000.00)
DT21:

- If the real number "-30000.00" is stored in DT10 to DT11, the following operation will be performed.

DT10: (f-30000.00)
DT11:



DT20: (f30000.00)
DT21:

■ Flag operations

Name	Description
R9007	Turns ON when the area is exceeded in index modification.
R9008 (ER)	Turns ON when non-real number data is specified in [S, S+1]
R9009 (CY)	Turns ON when operation result overflows

28.28 F336 FABS (Floating Point Real Number Data Absolute Value)

Calculates the absolute value of real number data.

■ **Instruction format**

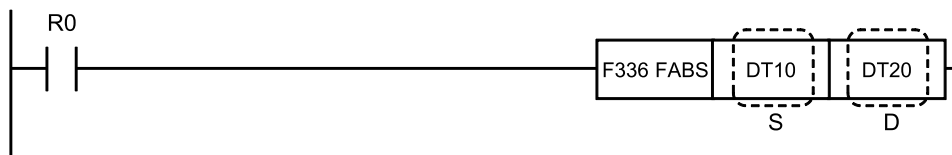

■ **Operands**

Items	Settings
S	Area storing operation data, or operation data (two words)
D	Area storing the operation results (two words)

■ **Devices that can be specified (indicated by ●)**

Operands	WX	WY	WR	WL	SV	EV	DT	LD	I	SWR	SDT	Constant				Index modifier	Integer Device
												K	H	M	f		
S	●	●	●	●	●	●	●	●	●	●	●	●	●	●	●	●	●
D		●	●	●	●	●	●	●	●						●		

■ **Outline of operation**

- Calculates the absolute value of the real number data specified in [S, S+1], then stores the result in [D, D+1].

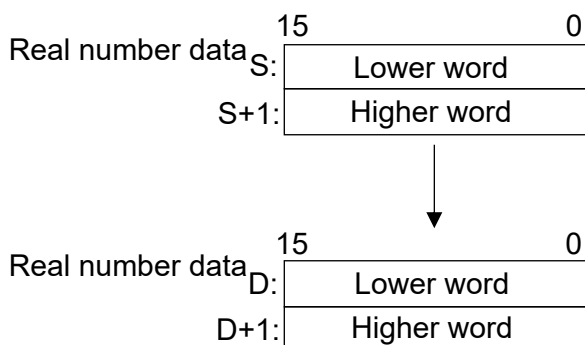

- If [S] is specified with an integer device, the operation occurs after the integer data is internally converted to real numbers.
- If a K constant is specified for [S], the same process is performed as if an integer device was specified.

■ **Operation example**

Operation of instruction format description program

28.28 F336 FABS (Floating Point Real Number Data Absolute Value)

- When the real number 1234.567 is stored in DT10 and DT11, the following operation will be performed.

DT10: (f1234.567)
DT11:



DT20: (f1234.567)
DT21:

- When the real number -1234.567 is stored in DT10 and DT11, the following operation will be performed.

DT10: (f-1234.567)
DT11:



DT20: (f1234.567)
DT21:

■ Flag operations

Name	Description
R9007	Turns ON when the area is exceeded in index modification.
R9008 (ER)	Turns ON when non-real number data is specified in [S, S+1]
R9009 (CY)	Turns ON when operation result overflows
R900B (=)	Turns ON when the calculation result is "0"

28.29 F337 RAD (Floating Point Real Number Data Degree to Radian)

Converts the unit of an angle from [degrees] to [radians].

■ **Instruction format**

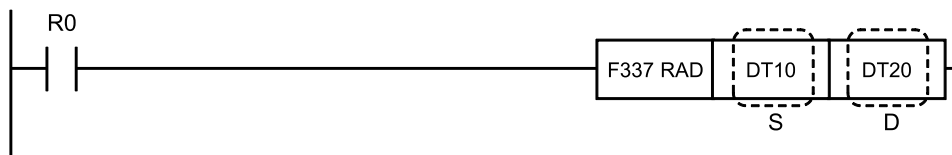

■ **Operands**

Items	Settings
S	Area storing angle [degrees] data, or angle [degrees] (two words)
D	Area (two word) to store the conversion result

■ **Devices that can be specified (indicated by ●)**

Operands	WX	WY	WR	WL	SV	EV	DT	LD	I	SWR	SDT	Constant				Index modifier	Integer Device
												K	H	M	f		
S	●	●	●	●	●	●	●	●	●	●	●	●	●	●	●	●	●
D		●	●	●	●	●	●	●	●						●		

■ **Outline of operation**

- The angle [degrees] specified by [S, S+1] is converted into an angle [radians] (real number data), and the result is stored in [D, D+1].

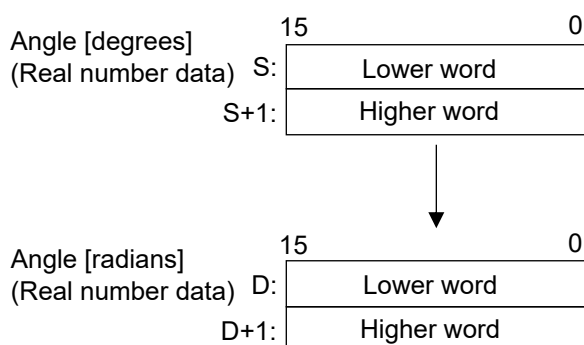

- If [S] is specified with an integer device, the operation occurs after the integer data is internally converted to real numbers.
- If a K constant is specified for [S], the same process is performed as if an integer device was specified.

■ **Program example**

When R0 turns ON, f0.7853981 is stored in DT20 and DT21.

28.29 F337 RAD (Floating Point Real Number Data Degree to Radian)

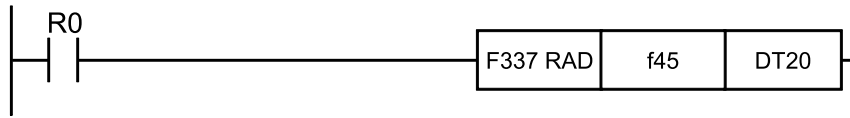

■ Flag operations

Name	Description
R9007	Turns ON when the area is exceeded in index modification.
R9008 (ER)	Turns ON when non-real number data is specified in [S, S+1]
R9009 (CY)	Turns ON when operation result overflows
R900B (=)	Turns ON when the calculation result is "0"

28.30 F338 DEG (Radian to Degree Floating Point Real Number Data Conversion)

Converts the unit of an angle from radians to degrees.

■ Instruction format

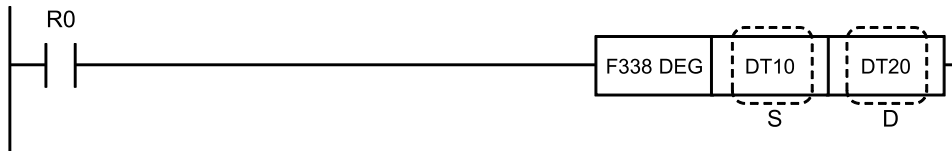

■ Operands

Items	Settings
S	Area storing angle data (radians), or angle data (radians) (two words)
D	Area (two words) to store the conversion result

■ Devices that can be specified (indicated by ●)

Operands	WX	WY	WR	WL	SV	EV	DT	LD	I	SWR	SDT	Constant				Index modifier	Integer Device
												K	H	M	f		
S	●	●	●	●	●	●	●	●	●	●	●	●	●	●	●	●	
D		●	●	●	●	●	●	●	●							●	●

■ Outline of operation

- The angle data in radians (real number data) specified by [S, S+1] is converted to angle data in degrees, and the result is stored in [D, D+1].

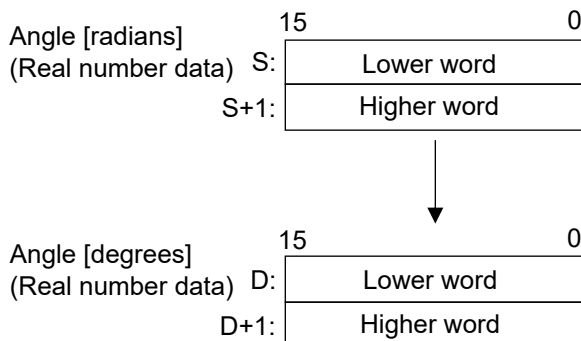

- If [D] is specified with an integer device, the real number is converted to integer data and stored.

28.30 F338 DEG (Radian to Degree Floating Point Real Number Data Conversion)

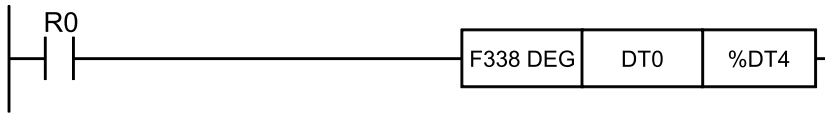

- If a K constant is specified for [S], the same process is performed as if an integer device was specified.

■ Program example

When R0 turns to ON, f30.00000 is stored in DT20 and DT21.

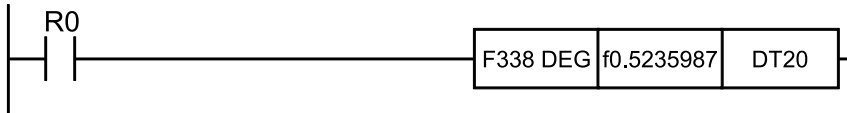

■ Precautions for programming

When a constant is specified for [S], an integer device cannot be specified for [D].

■ Flag operations

Name	Description
R9007	Turns ON when the area is exceeded in index modification.
R9008 (ER)	Turns ON when non-real number data is specified in [S, S+1] Turns ON when the operation result exceeds the integer range when an integer device is specified in [D, D+1]
R9009 (CY)	Turns ON when operation result overflows
R900B (=)	Turns ON when the calculation result is "0"

29 Real number data processing instructions

29.1 F345 FCMP (Floating Point Real Number Data Real Number Comparison)	29-2
29.2 F346 FWIN (Floating point real number data band comparison).....	29-4
29.3 F347 FLIMIT (Floating point real number data upper/lower limit control)	29-6
29.4 F348 FBAND (Floating point real number data dead-band control) .	29-8
29.5 F349 FZONE (Floating Point Real Number Data Zone Control)	29-10
29.6 F354 FSCAL (Scaling of real number data).....	29-12

29.1 F345 FCMP (Floating Point Real Number Data Real Number Comparison)

29.1 F345 FCMP (Floating Point Real Number Data Real Number Comparison)

Compares real number data and outputs the judgment result to special internal relays.

■ Instruction format

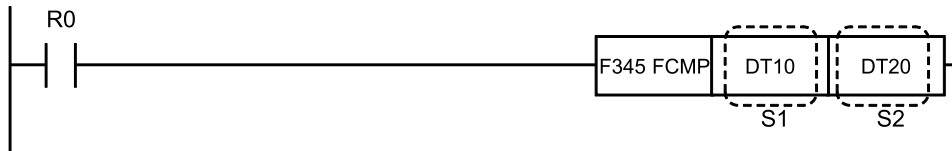

■ Operands

Items	Settings
S1	Area storing the real number data, or real number data (comparison data 1) (two words)
S2	Area storing the real number data, or real number data (comparison data 2) (two words)

■ Devices that can be specified (indicated by ●)

Operands	WX	WY	WR	WL	SV	EV	DT	LD	I	SWR	SDT	Constant				Index modifier	Integer Device
												K	H	M	f		
S1	●	●	●	●	●	●	●	●	●	●	●	●	●	●	●	●	●
S2	●	●	●	●	●	●	●	●	●	●	●	●	●	●	●	●	●

■ Outline of operation

- The real number data specified by [S1, S1+1] is compared with the real number data specified by [S2, S2+1], and the judgment result is output to the special internal relay flags (R9009 to R900C).
- The size relationship between [S1, S1+1] and [S2, S2+1] affects R9009 to R900C as follows.

Relationship between [S1, S1+1] and [S2, S2+1]	Flag			
	R900A	R900B	R900C	R9009
	>	=	<	Carry
[S1, S1+1] < [S2, S2+1]	OFF	OFF	ON	↑
[S1, S1+1] = [S2, S2+1]	OFF	ON	OFF	OFF
[S1, S1+1] > [S2, S2+1]	ON	OFF	OFF	↑

- If [S1] and [S2] are specified with an integer device, the operation occurs after the integer data is internally converted to real numbers.
- If a K constant is specified for [S1] or [S2], the same processing is performed as when an integer device is specified.

■ **Flag operations**

Name	Description
R9007	Turns ON when the area is exceeded in index modification.
R9008 (ER)	Turns ON when non-real-number data is specified in [S1, S1+1] or [S2, S2+1]

29.2 F346 FWIN (Floating point real number data band comparison)

29.2 F346 FWIN (Floating point real number data band comparison)

Compares real number data with a band and outputs the judgment result to special internal relays.

■ Instruction format

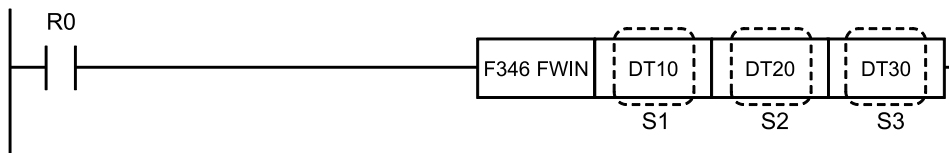

■ Operands

Items	Settings
S1	Comparison data: Area storing real number data, or real number data (two words)
S2	Lower limit data: Area storing real number data, or real number data (two words)
S3	Upper limit data: Area storing real number data, or real number data (two words)

■ Devices that can be specified (indicated by ●)

Operands	WX	WY	WR	WL	SV	EV	DT	LD	I	SW R	SD T	Constant				Index modifier	Integer Device
												K	H	M	f		
S1	●	●	●	●	●	●	●	●	●	●	●	●	●	●	●	●	●
S2	●	●	●	●	●	●	●	●	●	●	●	●	●	●	●	●	●
S3	●	●	●	●	●	●	●	●	●	●	●	●	●	●	●	●	●

■ Outline of operation

- A band comparison is performed on real number data.
The real number data specified by [S1, S1+1] is compared with the range specified by [S2, S2+1] (lower limit value) and [S3, S3+1] (upper limit value) to determine whether it falls in that range, and the comparison result is output to the special internal relays R9009 to R900C (comparison instruction judgment flags).
- The relationship between [S1, S1+1], [S2, S2+1], and [S3, S3+1] affects R9009 to R900C as follows.
x: Does not change.

Relationship between [S1, S1+1], [S2, S2+1], [S3, S3+1]	Flag			
	R900A	R900B	R900C	R9009
	>	=	<	Carry
[S1, S1+1] < [S2, S2+1]	OFF	OFF	ON	x
[S2, S2+1] ≤ [S1, S1+1] ≤ [S3, S3+1]	OFF	ON	OFF	x
[S3, S3+1] < [S1, S1+1]	ON	OFF	OFF	x

29.2 F346 FWIN (Floating point real number data band comparison)

- If [S1] to [S3] are specified with an integer device, the operation occurs after the integer data is internally converted to real numbers.
- If a K constant is specified for [S1], [S2], or [S3], the same process is performed as if an integer device was specified.

■ Flag operations

Name	Description
R9007	Turns ON when the area is exceeded in index modification.
R9008	Turns ON when non-real-number data is specified in [S1, S1+1], [S2, S2+1] or [S3, S3+1]
(ER)	Turns ON when [S2, S2+1] is greater than [S3, S3+1]

29.3 F347 FLIMIT (Floating point real number data upper/lower limit control)

29.3 F347 FLIMIT (Floating point real number data upper/lower limit control)

Performs upper and lower limit control (real number data).

■ Instruction format

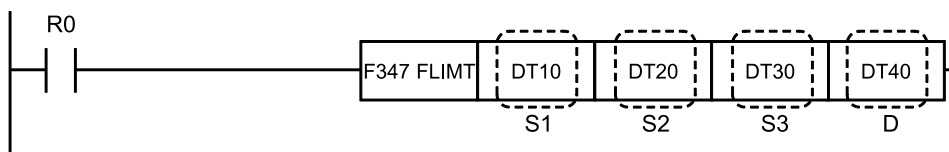

■ Operands

Items	Settings
S1	Area storing the lower limit, or lower limit data (two words)
S2	Area storing the upper limit, or upper limit data (two words)
S3	Area storing the input value, or input value data (two words)
D	Area storing the output value (two words)

■ Devices that can be specified (indicated by ●)

Operands	WX	WY	WR	WL	SV	EV	DT	LD	I	SWR	SDT	Constant				Index modifier	Integer Device
												K	H	M	f		
S1	●	●	●	●	●	●	●	●	●	●	●	●	●	●	●	●	●
S2	●	●	●	●	●	●	●	●	●	●	●	●	●	●	●	●	●
S3	●	●	●	●	●	●	●	●	●	●	●	●	●	●	●	●	●
D		●	●	●	●	●	●	●	●						●	●	●

■ Outline of operation

- The output value (real number data) stored in the area specified by [D] is controlled according to whether or not the input value (real number data) specified by [S3] falls within the range bounded by the upper and lower limits (real number data) specified by [S1] and [S2].
- The output value is determined based on the following conditions.
 - If lower limit value [S1, S1+1] is greater than input value [S3, S3+1], then lower limit value [S1, S1+1] becomes output value [D, D+1]
 - If upper limit value [S2, S2+1] is less than input value [S3, S3+1], then upper limit value [S2, S2+1] becomes output value [D, D+1]
 - If lower limit value [S1, S1+1] is equal to or less than input value [S3, S3+1], which is equal to or less than upper limit value [S2, S2+1], then input value [S3, S3+1] becomes output value [D, D+1]

29.3 F347 FLIMIT (Floating point real number data upper/lower limit control)

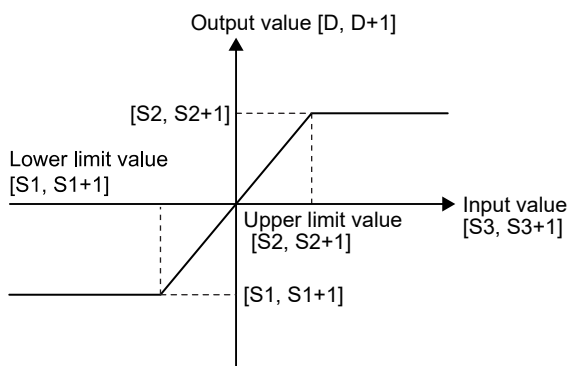

- If [S1] to [S3] are specified with an integer device, the operation occurs after the integer data is internally converted to real numbers.

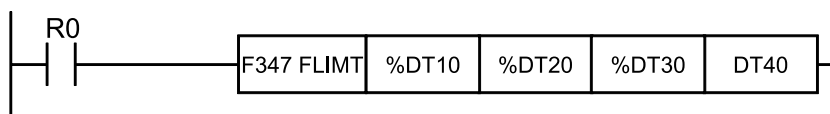

- If [D] is specified with an integer device, the real number is converted to integer data and stored.

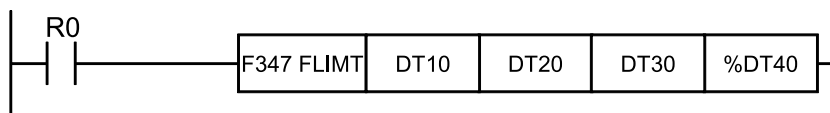

- If a K constant is specified for [S1], [S2], or [S3], the same process is performed as if an integer device was specified.

■ Flag operations

Name	Description
R9007 R9008 (ER)	Turns ON when the area is exceeded in index modification.
	Turns ON when non-real-number data is specified in [S1, S1+1], [S2, S2+1] or [S3, S3+1]
	Turns ON when [S1, S1+1] is greater than [S2, S2+1]
R900B (=)	Turns ON when the operation result exceeds the integer range when an integer device is specified in [D, D+1]
R900B (=)	Turns ON when the operation result falls within the upper/lower limit range

29.4 F348 FBAND (Floating point real number data dead-band control)

29.4 F348 FBAND (Floating point real number data dead-band control)

Performs dead-band control (real number data).

■ Instruction format

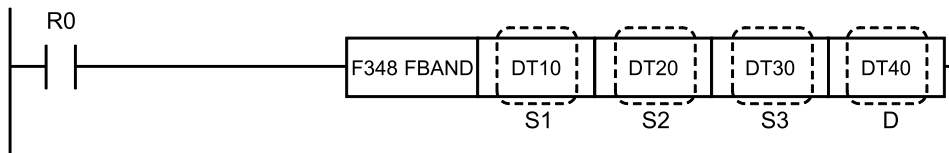

■ Operands

Items	Settings
S1	Area storing the lower limit, or lower limit data (two words)
S2	Area storing the upper limit, or upper limit data (two words)
S3	Area storing the input value, or input value data (two words)
D	Area storing the output value (two words)

■ Devices that can be specified (indicated by ●)

Operands	WX	WY	WR	WL	SV	EV	DT	LD	I	SWR	SDT	Constant				Index modifier	Integer Device
												K	H	M	f		
S1	●	●	●	●	●	●	●	●	●	●	●	●	●	●	●	●	●
S2	●	●	●	●	●	●	●	●	●	●	●	●	●	●	●	●	●
S3	●	●	●	●	●	●	●	●	●	●	●	●	●	●	●	●	●
D		●	●	●	●	●	●	●	●							●	●

■ Outline of operation

- The output value (real number data) stored in the area specified by [D] is controlled according to whether the input value (real number data) specified by [S3] is within the range of the upper and lower limits (real number data) of the dead-band specified by [S1] and [S2].
- The output value is determined based on the following conditions.
 - When the lower limit [S1, S1+1] > input value [S3, S3+1], the input value [S3, S3+1] - the lower limit [S1, S1+1] becomes the output value [D, D+1]
 - When the upper limit [S2, S2+1] < input value [S3, S3+1], the input value [S3, S3+1] - the upper limit [S2, S2+1] becomes the output value [D, D+1]
 - When the lower limit [S1, S1+1] ≤ input value [S3, S3+1] ≤ the upper limit [S2, S2+1], 0.0 becomes the output value [D, D+1]

29.4 F348 FBAND (Floating point real number data dead-band control)

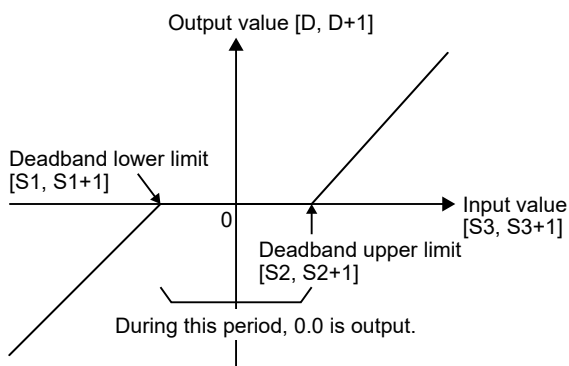

- If [S1] to [S3] are specified with an integer device, the operation occurs after the integer data is internally converted to real numbers.

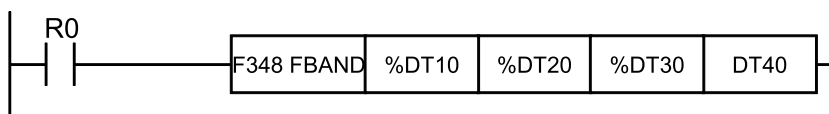

- If [D] is specified with an integer device, the real number is converted to integer data and stored.

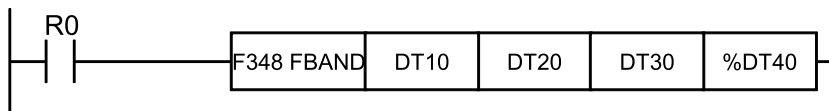

- If a K constant is specified for [S1], [S2], or [S3], the same process is performed as if an integer device was specified.

■ Flag operations

Name	Description
R9007 R9008 (ER)	Turns ON when the area is exceeded in index modification.
	Turns ON when non-real-number data is specified in [S1, S1+1], [S2, S2+1] or [S3, S3+1]
	Turns ON when [S1, S1+1] is greater than [S2, S2+1]
R9009 (CY)	Turns ON when the operation result exceeds the integer range when an integer device is specified in [D, D+1]
R900B (=)	Turns ON when the operation result falls within the upper/lower limit range

29.5 F349 FZONE (Floating Point Real Number Data Zone Control)

29.5 F349 FZONE (Floating Point Real Number Data Zone Control)

Performs zone control (real number data).

■ Instruction format

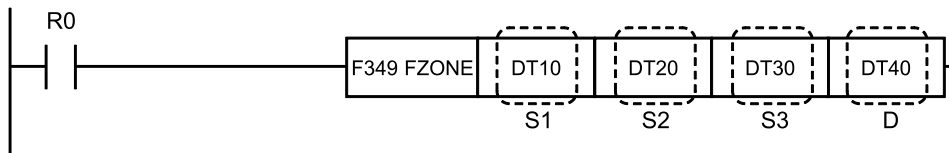

■ Operands

Items	Settings
S1	Area storing negative bias values, or negative bias value data (two words)
S2	Area storing positive bias values, or positive bias value data (two words)
S3	Area storing the input value, or input value data (two words)
D	Area storing the output value (two words)

■ Devices that can be specified (indicated by ●)

Operands	WX	WY	WR	WL	SV	EV	DT	LD	I	SWR	SDT	Constant				Index modifier	Integer Device
												K	H	M	f		
S1	●	●	●	●	●	●	●	●	●	●	●	●	●	●	●	●	●
S2	●	●	●	●	●	●	●	●	●	●	●	●	●	●	●	●	●
S3	●	●	●	●	●	●	●	●	●	●	●	●	●	●	●	●	●
D		●	●	●	●	●	●	●	●						●	●	●

■ Outline of operation

- The bias value specified in [S1] or [S2] is added to the input value (real number data) specified in [S3], and the result is stored in the area specified in [D].
- The output value is determined based on the following conditions.
 - When the input value [S3, S3+1] is less than 0.0, the input value [S3, S3+1] + the negative bias value [S1, S1+1] is the output value [D, D+1]
 - When the input value [S3, S3+1] is equal to 0.0, 0.0 is the output value [D, D+1]
 - When the input value [S3, S3+1] is more than 0.0, the input value [S3, S3+1] + the positive bias value [S2, S2+1] is the output value [D, D+1]

29.5 F349 FZONE (Floating Point Real Number Data Zone Control)

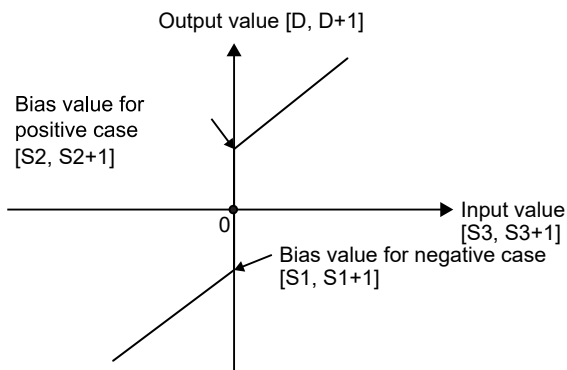

- If [S1] to [S3] are specified with an integer device, the operation occurs after the integer data is internally converted to real numbers.

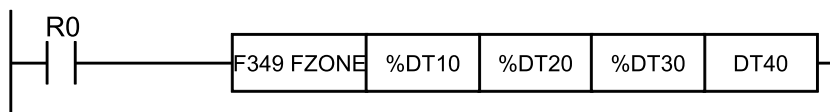

- If [D] is specified with an integer device, the real number is converted to integer data and stored.

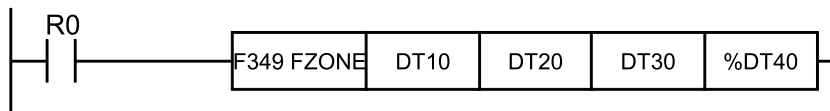

- If a K constant is specified for [S1], [S2], or [S3], the same process is performed as if an integer device was specified.

■ Flag operations

Name	Description
R9007	Turns ON when the area is exceeded in index modification.
R9008	Turns ON when non-real-number data is specified in [S1, S1+1], [S2, S2+1] or [S3, S3+1]
(ER)	Turns ON when the operation result exceeds the integer range when an integer device is specified in [D, D+1]
R9009	Turns ON when operation result overflows
(CY)	
R900B	Turns ON when the input value is "0"
(=)	

29.6 F354 FSCAL (Scaling of real number data)

Performs scaling (linearization) using a real number data table and calculates the output (Y) for the input value (X).

■ **Instruction format**

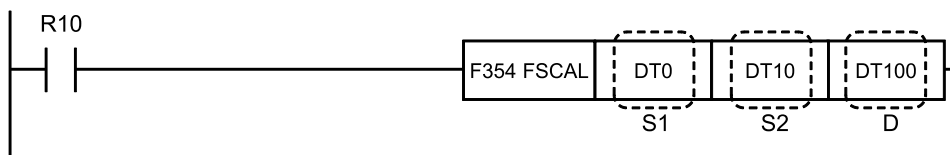

■ **Operands**

Items	Settings
S1	Real value or area representing the input value (X)
S2	Starting area of data table used for scaling
D	Area storing output value (Y)

■ **Devices that can be specified (indicated by ●)**

Operands	WX	WY	WR	WL	SV	EV	DT	LD	I	SWR	SDT	Constant				Index modifier	Integer Device
												K	H	M	f		
S1	●	●	●	●	●	●	●	●	●	●	●	●	●	●	●	●	
S2	●	●	●	●	●	●	●	●	●	●	●					●	
D		●	●	●	●	●	●	●	●							●	●

■ **Outline of operation**

- The input real value [S1] is scaled (linearized) according to the real number data table specified by [S2], and the output value is stored in [D].
- The section corresponding to the input value [S1] is searched from the table specified by [S2], the linear interpolation between these two points is calculated, and the output value is obtained.

When the specified input value is outside the registration range in the table, the start point (x0) or end point (xn) is stored for the output value (Y0 or Yn).

$$[S1] \leq x0 [D] \leftarrow y0$$

$$[S1] \geq xn [D] \leftarrow yn$$

■ **Operation example**

Operation of instruction format description program

The output value Y for the input value stored in DT0 is obtained by referring to the data table starting from DT10, and the result is stored in DT100.

29.6 F354 FSCAL (Scaling of real number data)

S2:	Registration point count ($m \leftarrow n+1$)	DT10
S2+1:	x0	DT11
S2+2:	(Real number value)	DT12
S2+3:	x1	DT13
S2+4:	(Real number value)	DT14
~~~~~		
S2+2n+1:	xn	DT29
S2+2n+2:	(Real number value)	DT30
S2+2n+3:	y0	DT31
S2+2n+4:	(Real number value)	DT32
S2+2n+5:	y1	DT33
S2+2n+6:	(Real number value)	DT34
~~~~~		
S2+4n+3:	yn	DT49
S2+4n+4:	(Real number value)	DT50

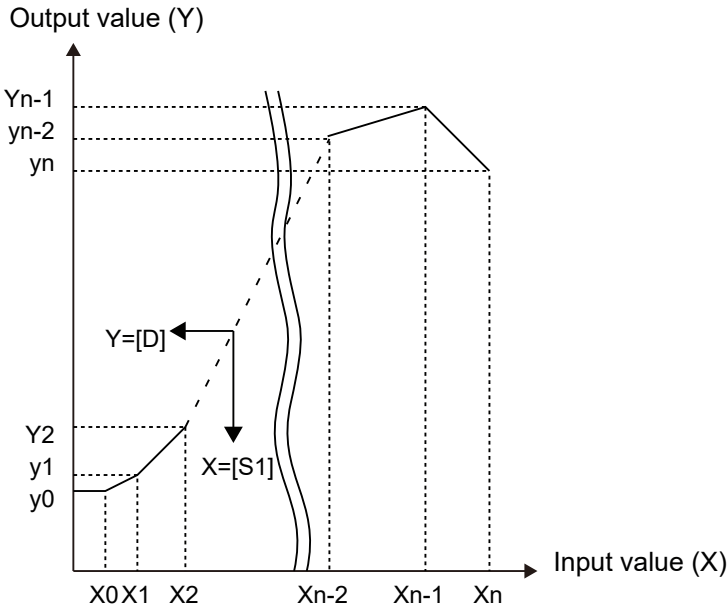

- The data table [S2] used for scaling must have two or more sections registered. In addition, the points must be registered in order from the smallest number on the X axis to the largest number.
 $2 \leq \text{Number of registered points (m)} \leq 99$ [Number of registered points (m) = $n + 1$]
 $x_{t-1} < x_t$ ($1 \leq t \leq n$)
- When the distance between two points on the data table is very large, an operation error will occur.

29.6 F354 FSCAL (Scaling of real number data)

(This occurs when the distance between two points cannot be represented by a real number.)

e.g.

First point: $(x_0, y_0) = (\text{HFF000000}, \text{HFF000000}) = (-1.7 \times 10^{34}, -1.7 \times 10^{34})$

Second point: $(x_1, y_1) = (\text{H7F000000}, \text{H7F000000}) = (+1.7 \times 10^{34}, +1.7 \times 10^{34})$

- The measurement error of the output result is proportional to the distance between two points of the data table.
- When an integer device is specified for the input value [S1], scaling is performed after converting it to a real value.
- When an integer device is specified for the output value [S2], the output result is converted to an integer value and stored.

■ Flag operations

Name	Description
R9007 R9008 (ER)	Turns ON when the area is exceeded in index modification.
	Turns ON when a non-real value is entered in [S1]
	Turns ON when $m < 2$ or $m > 99$ in the registered points of [S2]
	Turns ON when a non-real value is specified for the real value (xt, yt) specified in [S2]
	Turns ON when the data table of [S2] is not registered in ascending order of the X axis
	Turns ON when data table in [S2] exceeds area
	Turns ON when an overflow (calculation not possible) occurs in the scaling calculation
	Turns ON when the output result exceeds the integer range when an integer device is specified in [D]

30 Process Control Instructions

30.1 F355 PID (PID Operation).....	30-2
30.2 F356 EZPID (Easy PID).....	30-9

30.1 F355 PID (PID Operation)

30.1 F355 PID (PID Operation)

PID operation is performed.

■ Instruction format

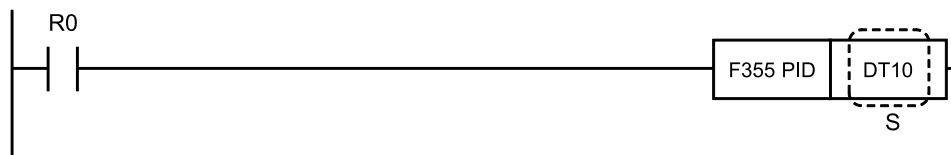

■ Operands

Items	Settings
S	Starting number of parameter area (30 word) for PID operation

■ Devices that can be specified (indicated by ●)

Operands	WX	WY	WR	WL	SV	EV	DT	LD	I	SWR	SDT	Constant				Index modifier	Integer Device
												K	H	M	f		
S							●										

■ Outline of operation

- PID operation is performed to match and hold the measurement value [S+2] at the setting value [S+1], and the result is output to [S+3].
- Derivative priority type or proportional-derivative priority type can be selected for PID operation.
- Set the coefficients (proportional gain, integral time, derivative time) used for PID operation and the operation type/interval in the parameter table. PID operation will be performed according to the specified content.

■ Types of PID operation

(1) Reverse operation / Forward operation

The vertical direction of output when there is a change to the process can be selected.

- Specify "Reverse operation" if increasing the output when the measured value falls. (Heating, etc.)
- Specify "Forward operation" if decreasing the output when the measured value rises. (Cooling, etc.)

(2) Derivative priority type PID / Proportional-derivative priority type PID

- In general, with "Derivative priority type PID control", there is increased fluctuation in the output when the set value changes, but convergence is faster.
- In general, with "Proportional-derivative priority type PID control", there is less output fluctuation when the set value changes, but convergence is slower.

Parameter table settings

[S]		Control mode
[S+1]		Set point value (SP)
[S+2]		Measured process value (PV)
[S+3]		Output value (MV)
[S+4]		Output lower limit
[S+5]		Output upper limit
[S+6]		Proportional gain (Kp)
[S+7]		Integral time (Ti)
[S+8]		Derivative time (Td)
[S+9]		Control interval (Ts)
[S+10]		Auto-tuning progress status
[S+11]		} Work area for PID operation
⋮		
⋮		
⋮		
⋮		
⋮		
⋮		
⋮		
⋮		
[S+29]		

Description of each parameter

(1) Control mode [S]

Specify the PID operation type and auto-tuning with H constants.

Control mode		[S] value	
		When not executing auto-tuning	When executing auto-tuning
Derivative type	Reverse	H0	H8000
	Forward	H1	H8001
Proportional-derivative type	Reverse	H2	H8002
	Forward	H3	H8003

- Auto-tuning

The optimal values for the PID parameters Kp, Ti, and Td are measured by measuring the process response.

When auto-tuning is executed, the estimated results are reflected in the parameter area after auto-tuning is complete. (Depending on the process, execution of auto-tuning may not be possible. In such cases, the process will return to the original parameter operation.)

For precautions regarding the execution of auto-tuning, please refer to "P.30-5".

- Reverse operation, forward operation

The vertical direction of output when there is a change to the process is determined.

Reverse	The output is increased if the measured value of the process falls. (e.g. heating)
Forward	The output is increased if the measured value of the process rises. (e.g. cooling)

30.1 F355 PID (PID Operation)

- Derivative priority type, proportional-derivative priority type PID

There is a change in output when the setting value is changed.

Derivative type	Generally, there is significant fluctuation when the setting value is changed, but convergence is fast.
Proportional-derivative type	Generally, there is less fluctuation when the setting value is changed, but convergence is slow.

(2) Set value (SP) [S+1]

Set the target value for the process control within the following range.

K0 to K10000

(3) Measured value (PV) [S+2]

Use an A/D conversion unit, etc., to input the current value of process control. Make sure it is within the following range.

K0 to K10000

(4) Output value (MV) [S+3]

The value from PID processing is stored. Use a D/A conversion unit, etc., to output to the process.

K0 to K10000

(5) Output lower limit [S+4]

K0 to K9999 (< upper limit)

(6) Output upper limit [S+5]

K1 to K10000 (> lower limit)

Specify the output value (MV) range. Values for the specified range are output.

Make sure that $0 \leq \text{output lower limit} < \text{output upper limit} \leq 10000$.

(7) Proportional gain (Kp) [S+6]

Specify the coefficient used for PID operation.

The setting value $\times 0.1$ is the actual proportional gain.

The setting value range is K1 to K9999 (0.1 to 999.9, specified in units of 0.1).

If auto-tuning is specified in the operation mode specifications, the setting value is automatically adjusted and rewritten.

(8) Integral time (Ti) [S+7]

Specify the coefficient used for PID operation.

Actual integral time is set point value $\times 0.1$.

The setting value range is K1 to K30000 (0.1 to 3000 seconds, specified in units of 0.1 second).

If 0 is specified, integration will not be executed.

If auto-tuning is specified in the operation mode specifications, the setting value is automatically adjusted and rewritten.

(9) Derivative time (Td) [S+8]

Specify the coefficient used for PID operation.

Actual derivative time is set point value $\times 0.1$.

The setting value range is K0 to K10000 (0 to 1000 seconds, specified in units of 0.1 second).

If auto-tuning is specified in the operation mode specifications, the setting value is automatically adjusted and rewritten.

(10) Control interval (Ts) [S+9]

Specify the interval for executing the PID operation. The setting value $\times 0.01$ is the actual control interval.

The setting value range is K1 to K6000 (0.01 to 60.0 seconds, specified in units of 0.01 second).

(11) Auto-tuning progress status [S+10]

When auto-tuning is specified in the operation mode, the degree of progress of auto-tuning is displayed. The values of K1 to K5 are stored according to the progress status from the default value [0], and are returned to the default value after auto-tuning is completed.

(12) Work area for PID operation [S+11] to [S+29]

The work area used by the system that is required for operations.

■ Precautions when executing auto-tuning

Note the following points if "Auto-tuning Execution" is set in the parameter table (control mode [S]).

- After auto-tuning is complete, the area of control mode [S] is automatically rewritten from H8000 to H8003, to H0 to H3. Make sure that it is not rewritten again by the program, etc.
- After auto-tuning is complete, the optimal values for proportional gain [Kp], integral time [Ti], and derivative time [Td] are stored, but it is necessary to specify appropriate values within the setting range (for example, the lower limit) before execution.
- After auto-tuning is complete, the optimal values for proportional gain [Kp], integral time [Ti], and derivative time [Td] are stored. Be careful that the stored values are not rewritten.
- The optimal values for Kp, Ti, and Td are calculated by auto-tuning determining the set point value (SP) by measuring the change of the measured value (PV) when the output value (MV) is set to the upper limit, causing the measured value (PV) to fluctuate, and then measuring the change of the measured value (PV) when the output value (MV) is set to the lower limit.
- The change of the output value (MV) for auto-tuning is completed after a minimum of 3 changes: upper limit output -> lower limit output -> upper limit output. If the auto-tuning progress status is still at 0 after several changes, shorten the control synchronization Ts and execute auto-tuning again.

■ Precautions for programming

- Including the work area for operation, a 30 word area is required for the parameter table. Take care that the values in this area are not rewritten by other instructions.
- Even if the parameter table exceeds the area, an error will not be detected. When specifying [S], specify a number that is within a minimum of 30 words from the last number.
- Take care that the area is not exceeded by index modification. Even if the area is exceeded, an error will not be detected.
- Use an A/D conversion unit, etc., to input the current value of the measured value [S+2].
- Use a D/A conversion unit, etc., to output the result of PID processing [S+3] to the process.
- If two or more PID instructions specifying the same table are included in the program, it may not operate correctly.

<Example>

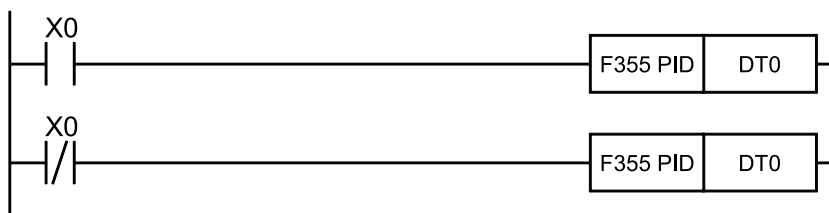

30.1 F355 PID (PID Operation)

(Reason) This is because the F355 PID instruction operates internally using the specified table, even when the execution condition is not met.

In such cases, set the tables to separate addresses.

i Info.

- See the following operational expressions regarding PID operation.

■ Outline of operation of PID control

PID control is a feedback control method widely used in the instrumentation field to control process quantities such as temperature, pressure, flow rate, and fluid levels.

(1) Proportional operation

Control operation that produces an output proportional to the size of the input

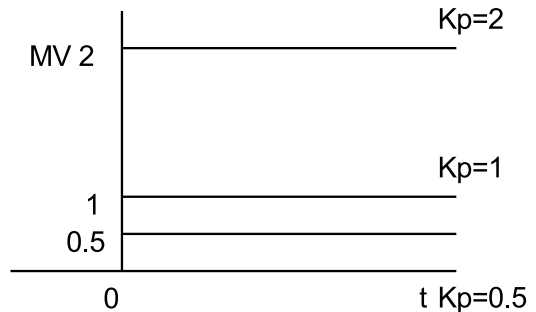
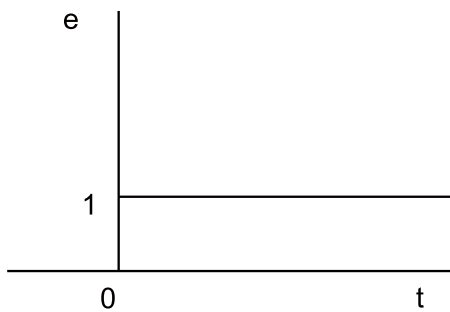
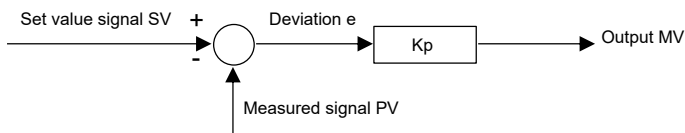

A constant control quantity is maintained.

An offset (regular deviation) remains.

The larger the K_p value, the stronger the action of the proportional operation.

(2) Integral operation

Control operation that produces an output proportional to the integral time of the input.

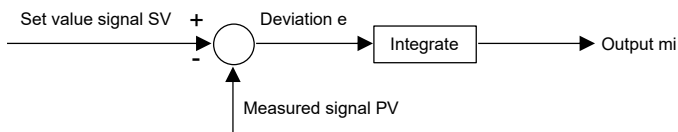

$$m_i = 1/T_i \int e dt$$

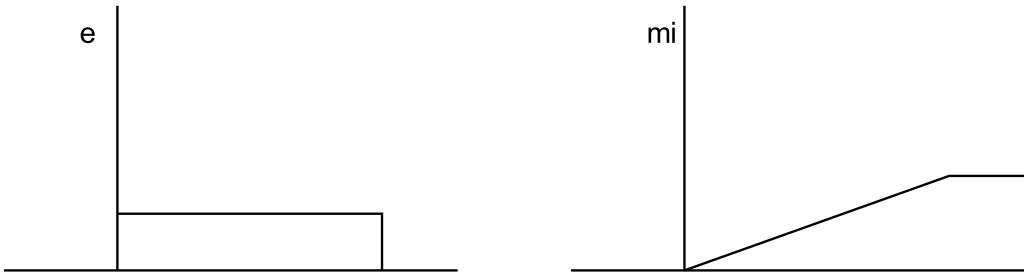

The resulting offset is removed by combining with proportional operation or proportional-derivative operation.

The smaller the T_i value, the stronger the action of the integral operation.

(3) Derivative operation

Control operation that produces an output proportional to the time derivative value of the input.

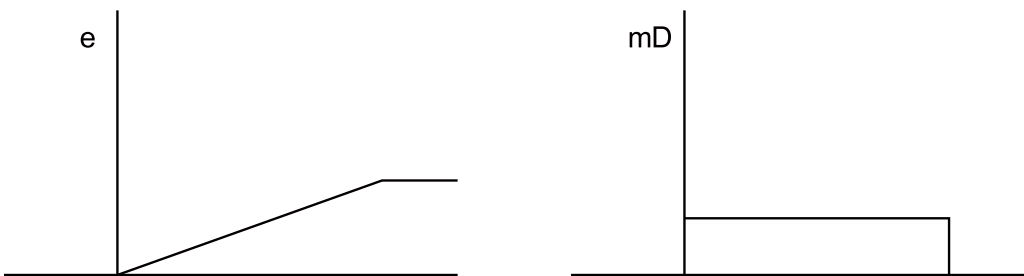
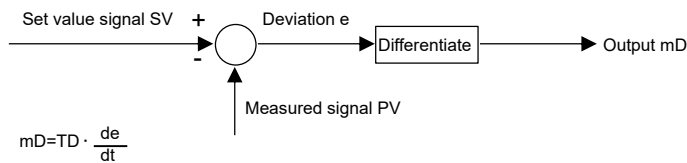

The advancing property of derivative operation reduces the negative effects that the delaying property of the process has on control.

The larger the T_d value, the stronger the action of the derivative operation.

Pure derivative operation becomes temporarily inoperative if noise, etc., is input. This has a negative effect on the controlled process, so incomplete derivative operation is executed.

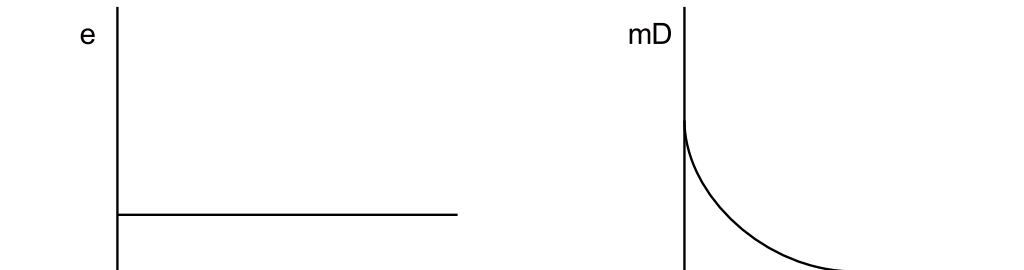

(4) PID operation

A combination of proportional, integral, and derivative operation is called PID operation.

30.1 F355 PID (PID Operation)

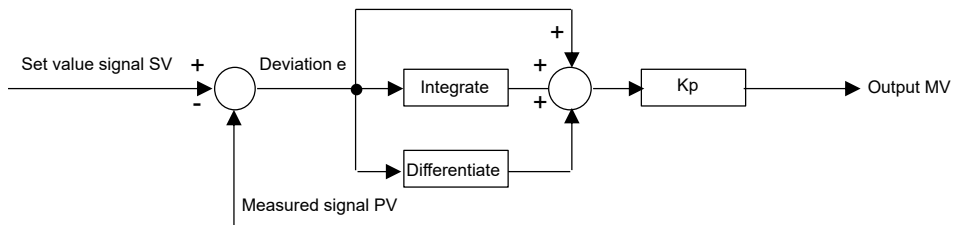

If the parameters in PID control are set to their optimal values, the control quantity can be quickly matched to the target value and maintained.

■ Flag operations

Name	Description
R9007	Turns ON when the parameter setting value is out of range
R9008 (ER)	Turns ON when the area is exceeded in index modification.

30.2 F356 EZPID (Easy PID)

Temperature control (PID) can be easily performed using the image of a temperature controller.

■ Instruction format

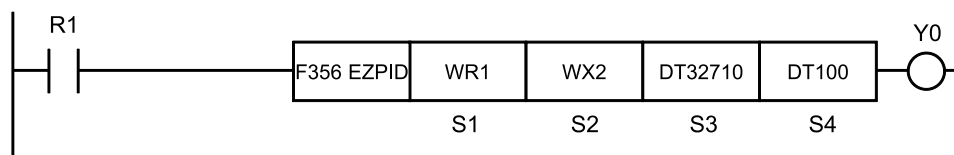

■ Operands

Items	Settings
S1	Control data
S2	Measured process value (PV)
S3	Starting No. of area storing PID control parameters
S4	Starting No. of calculation work area

■ Devices that can be specified (indicated by ●)

Operands	WX	WY	WR	WL	SV	EV	DT	LD	I	SWR	SDT	Constant				Index modifier	Integer Device
												K	H	M	f		
S1		●	●	●	●	●	●	●	●								
S2	●	●	●	●	●	●	●	●	●	●	●						
S3		●	●	●	●	●	●	●									
S4		●	●	●	●	●	●	●									

■ Outline of operation

- PID processing is performed to hold the measured process value (PV) at the set point value (SP).

Writing the OUT instruction immediately after this instruction enables the PWM output (ON-OFF output) similar to a temperature controller.

An auto-tuning function is also available to calculate the PID control parameters automatically.

It can also be used with analog output as it outputs numerical values as well as PWM output.

■ General explanation of the memory areas used

S1	Starts auto-tuning of the control data (one word) and reports its completion. Specifying a non-hold type area (e.g. WR) is recommended to allow operation on a per-bit basis.	
	When bit 0 is 1	Auto-tuning request. This instruction resets the bit if auto-tuning is completed. Reset this bit to cancel auto-tuning.
	When bit 0 is 0	PID control
	Bit 1	When auto-tuning has completed successfully, 1 is set.

30.2 F356 EZPID (Easy PID)

	Bit 2	Turn this bit ON to hold the output MV (S4) when the execution condition of this instruction changes from OFF to ON. When this bit is OFF, MV is cleared.
	When bit 3 is 0	Specifies PWM output
	When bit 3 is 1	Specifies analog output
	When bit 4 is 0	The maximum value and minimum value of the internal output are +20% and -20% of the output range (output upper limit value - output lower limit value) respectively.
	When bit 4 is 1	The maximum value and minimum value of the internal output are the output upper limit value and output lower limit value respectively. *The output lower limit value is specified by S4+1, and the output upper limit value is specified by S4+2.
	Bits 5 to F	Reserved bits. Normally use 0.
S2	Area storing the measured process value (PV) (one word) The input WXn of a temperature input unit can be directly specified. Effective range: K-30000 to K+30000	
S3	Area to specify the target value (SP) and control parameters. (Four words) It is recommended that this area is allocated to hold-type operation memory.	
	S3	Stores the set point value (SP). Must be set from the instruction or a display. Setting range: K-30000 to K+30000
	S3+1	Stores the proportional gain (KP). Actual gain is set point value \times 0.1. Automatically set after auto-tuning is completed. Setting range: K1 to K9999 (0.1 to 999.9)
	S3+2	Stores the integral time (TI) Actual integral time is set point value \times 0.1. Automatically set after auto-tuning is completed. Setting range: K0 to K30000 (0 to 3000 s)
	S3+3	Stores the derivative time (TD). Actual derivative time is set point value \times 0.1. Automatically set after auto-tuning is completed. Setting range: K0 to K10000 (0 to 1000 s)
S4	Divided into output (MV), specified area of control mode, auto-tuning related area, and operation work area. The area in the range of S4 to S4+29 is necessary for the instruction. (See below for details.) It is recommended to allocate it in the non-hold area. Also, do not use the data in this area for other purposes.	

■ Easy usage

<PWM output in reverse operation (heating)>

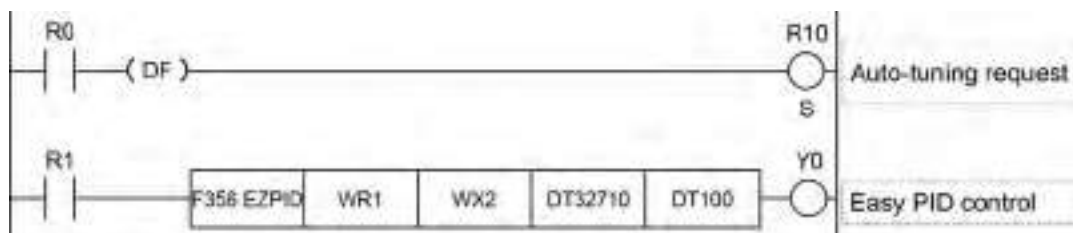

- Specify the set point value (SP) with the instruction or a display before the operation.
- If auto-tuning is requested with a device such as a display, the above auto-tuning request program is not necessary.
- Work areas DT100 to DT129 return to the default value when R1 turns on. (However, only DT100 (MV) can be held.)
- The control conditions are as follows: operation cycle 1 s, derivative-type reverse operation (heating), PWM resolution = 1000.
- PID control starts from the next scan, and PWM output is executed for Y0.
- Program as described above to start auto-tuning with the instruction, and turn ON R1 after turning ON R0.
- When auto-tuning has completed successfully, R11 turns ON and KP, TI, and TD are set.
- After that, if R1 is ON continuously, it will change to PID control automatically, and PWM output will be executed for Y0.

Note

- If execution condition R1 has turned OFF during PID control, PWM output Y0 also turns OFF. However, the output manipulated value MV is held.

■ When changing control conditions

- The area S4+1 to S4+9 must be changed to change control conditions. Change it before the second execution of the F356 EZPID instruction.

<Details of S4>

S4: Divided into output (MV), specified area of control mode, auto-tuning related area, and operation work area. It is recommended to allocate it in the non-hold area. Also, do not use the data in this area for other purposes.

Output (MV) and control mode area (Used with the normal default values.)

Memory	Function	Default	Range:																		
S4	The output manipulated value (MV) of the calculation result is stored	K0	K-10000 to K10000																		
S4+1	Specify the lower limit of the output manipulated value (MV)	K0	Minimum K-10000																		
S4+2	Specify the upper limit of the manipulated value (MV)	K10000	Maximum K+10000																		
S4+3	Specify the 100% output band (range where PID control is not performed)	K0	K0 to K80 (%)																		
S4+4	Specify the control cycle (TS). Setting unit = 10 ms, default value = 1 s	K100	K1 to K3000 (0.01 to 30 s)																		
S4+5	Specify the control mode (see table below)	K0	K0 to K3																		
<table border="1"> <thead> <tr> <th colspan="2">Control mode</th> <th>Value</th> <th>Example</th> </tr> </thead> <tbody> <tr> <td rowspan="2">Derivative type</td> <td>Reverse</td> <td>K0</td> <td>Heating</td> </tr> <tr> <td>Forward</td> <td>K1</td> <td>Cooling</td> </tr> <tr> <td rowspan="2">Proportional-derivative type</td> <td>Reverse</td> <td>K2</td> <td>Heating</td> </tr> <tr> <td>Forward</td> <td>K3</td> <td>Cooling</td> </tr> </tbody> </table>		Control mode		Value	Example	Derivative type	Reverse	K0	Heating	Forward	K1	Cooling	Proportional-derivative type	Reverse	K2	Heating	Forward	K3	Cooling		
Control mode		Value	Example																		
Derivative type	Reverse	K0	Heating																		
	Forward	K1	Cooling																		
Proportional-derivative type	Reverse	K2	Heating																		
	Forward	K3	Cooling																		
Reverse operation and forward operation Reverse operation: If the measured process value drops, the output is increased (example: heating)																					

30.2 F356 EZPID (Easy PID)

Memory	Function	Default	Range:
	Forward operation: If the measured process value increases, the output is increased (example: cooling) Derivative-type and proportional-derivative type Derivative type: Approaches the set point value faster, but is more likely to overshoot. Proportional-derivative type: Approaches the set point value slower, but is less likely to overshoot.		

Auto-tuning related area (Used with the normal default values.)

Memory	Function	Default	Range:
S4+6	Specify the bias value for performing auto-tuning.	K0	From K0
S4+7	Specify the correction data (a1) of the auto-tuning result (KP).	K125	K50 to K500%
S4+8	Specify the correction data (a2) of the auto-tuning result (TI).	K200	K50 to K500%
S4+9	Specify the correction data (a3) of the auto-tuning result (TD).	K100	K50 to K500%
S4+10	Stores the status while auto-tuning is being performed.	K0	K0 to K5

Operation work area

Memory	Function	Default	Range:
S4+11 to S4+29	The area up to S4+29 is the work area for the PID and auto-tuning operations.	0	

(Note 1) The default value is written when the execution condition turns on.

The output manipulated value (MV) is output only within the range of the upper limit value and lower limit value.

Configure the settings so that $-10000 \leq \text{lower limit value} < \text{upper limit value} \leq 10000$.

■ How to output PWM

- The PWM output cycle is determined by the value set for S4+4. The default value is a cycle of 1 s. The PWM duty cycle is determined by what percentage of K0 to K10000 is comprised of the output MV (S4).
- When either the lower or upper limit value of output MV, specified by S4+1 and S4+2, is a negative value, the PMW output is always OFF.
- The PWM output is always OFF when the output MV is K0, and it is always ON when the output MV is K10000.

■ Explanation of specific usage

1. Only changing control mode with PWM output

- Change the content of the control mode (S4+5) to K1 to K3, using an instruction such as F0 MV.

Example: Change the control mode from the default = derivative type to the proportional-derivative type.

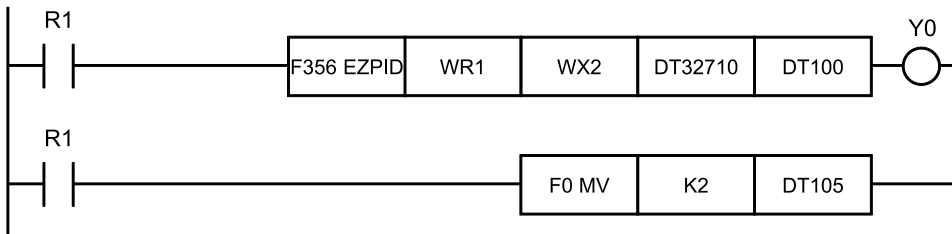

2. Using an analog output unit for output

1. Set the analog output flag (bit 3 of S1) to 1.
2. Set the output lower limit value (S4+1) and the output upper limit value (S4+2) according to the output range of the analog output unit.

e.g. <Lower limit value=K0, upper limit value=K2000>, <lower limit value=K0, upper limit value=K4000>

3. Control cycle (TS): Change the value of (S4+4) according to the input update cycle of the temperature input unit (normally 0.1 s or more)

e.g. TS=K10 (100 ms)

4. Change the control mode if necessary.
5. Transmit the output manipulated value (MV) to WY on the analog output unit.

Note

- When analog output is used for the output, it is not necessary to write an OUT instruction immediately after this instruction.

Also, when using analog output, PWM output is fixed to OFF.

Example: Control with the output upper limit value (S4+2) set to K4000 and the control cycle (S4+4) set to 10 s

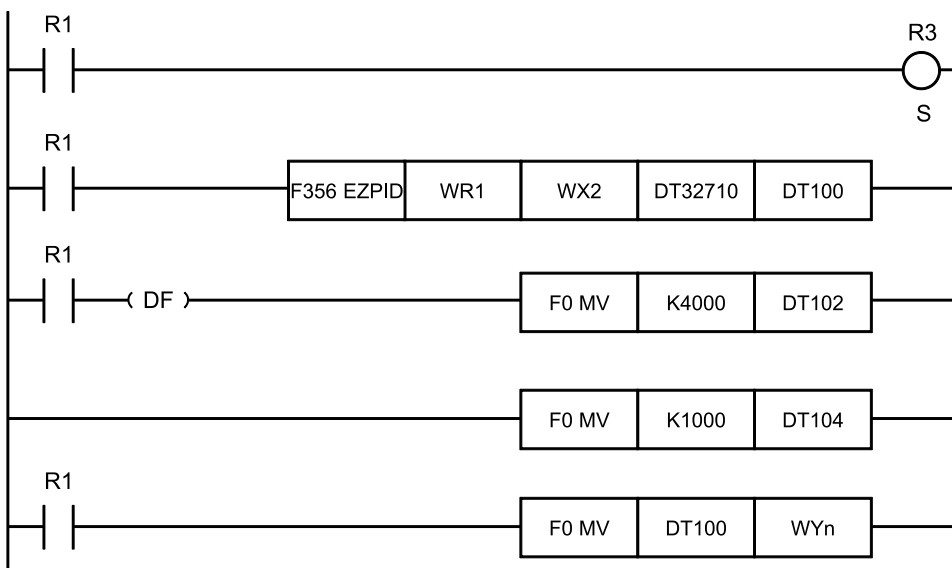

■ More details on setting methods

1. Setting the 100% output band (S4+3)

The 100% output band specifies the percentage of the set value for the measured process value (PV) to be above when PID control is started.

100% output is performed in the area up to the specified process value.

If the measured process value (PV) is less than the set point value (SP) × this setting, it has the effect of shortening the time to reach the set point value (SP), during which 100% output is performed.

For example, if this setting is set to K80, 100% output is performed up to 80% of the set point value (SP), and PID control starts from there.

If this setting has K0=the default value, PID control is performed from the beginning.

2. Fine adjustment of auto-tuning

1. Correction of auto-tuning results (S4+7, S4+8, and S4+9)

When auto-tuning has completed, the parameters KP, TI, and TD are stored in (S3+1, S3+2, and S3+3). The result can be corrected with these parameters at this time.

e.g. To correct KP to 2 times its value, set S4+7 to K200 (meaning 200%) and perform auto-tuning.

To correct TI to 1.25 times its value, set S4+8 to K125 (meaning 125%) and perform auto-tuning.

To correct TD to 0.75 times its value, set S4+9 to K75 (meaning 75%) and perform auto-tuning.

2. Auto-tuning bias value (S4+6)

Auto-tuning is executed with the set point value (SP') as [set point value (SP) - auto-tuning bias value].

This is used to control excessive temperature rise while auto-tuning is performed.

For the forward operation, auto-tuning is executed with the value set to [set point value (SP) + this set value].

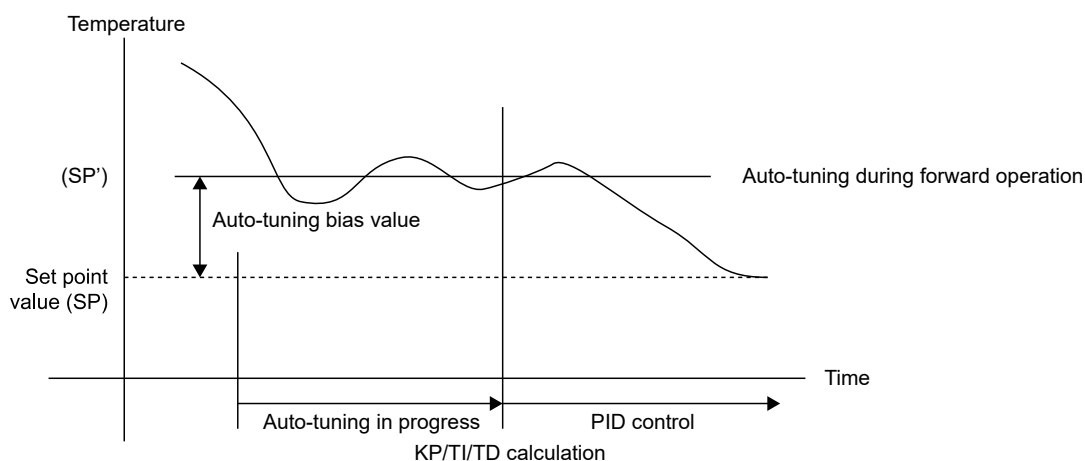
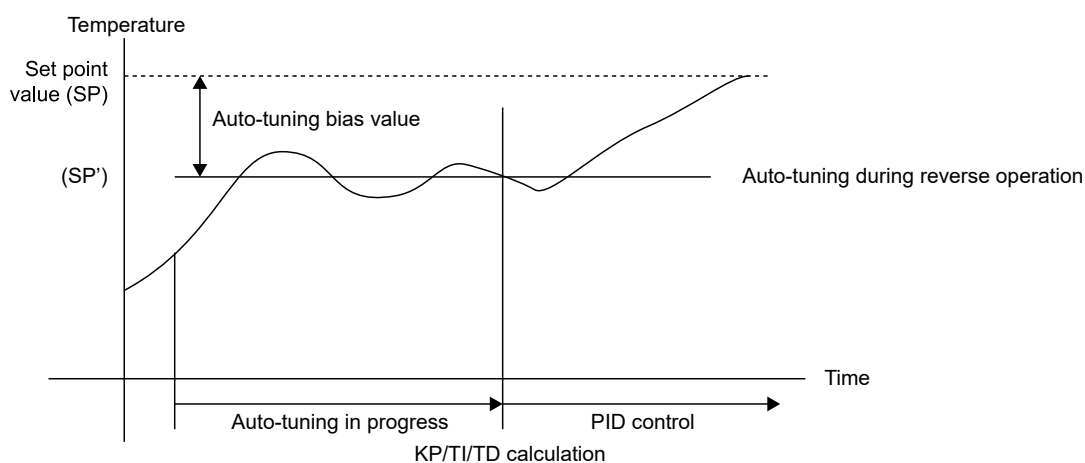

(Note 1) Even if auto-tuning is started when the measured process value (PV) is close to the set point value (SP), auto-tuning is performed with the above SP'.

■ Precautions for programming

- When the execution condition turns on, the area S4 to S4+29 is initialized.
If the values are set to non-default values, write using the always-ON relay R9010 as the execution condition, with an instruction such as the F0 MV instruction.
- The PID operation instruction always calculates the operation cycle and PWM output timing internally, so be sure to perform only one operation during a single scan. Additionally, do not attempt to execute it during a subroutine or interrupt program. This instruction cannot be written more than once with the same operand specified.
- Do not turn OFF the execution condition during PID processing. Otherwise, PID processing will be disabled.
- If you do not want to synchronize the PWM output cycle for controlling multiple objects, you can delay the startup timing, for example by adjusting the startup condition rise time.
- After executing this instruction, the execution conditions will change. This means that subsequent instructions will not work correctly in the program shown below.

30.2 F356 EZPID (Easy PID)

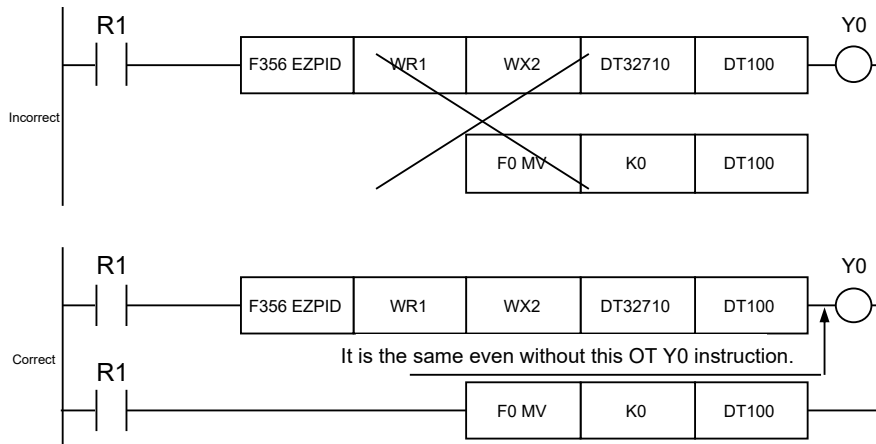

■ Conditions when operation errors occur

- When the following parameters are out of the setting range: S2: measured process value (PV), S3: set point value (SP), S3+1: KP, S3+2: TI, S3+3: TD, S4+1 to S4+9
- When the area specified by S3 or S4 exceeds the upper limit of the specified operation device

■ Internal operation specifications

- When the execution condition turns on, the operation work is initialized.
- If the parameters KP, TI, and TD are all 0 when PID operation starts, they are initialized at 1, 0, and 0 respectively, and the operation is continued.
- At the rising edge of the AT signal, the AT successful completion flag and AT completion code are cleared.
- The AT set value operates with <set point value (SP) - bias value> as the target value. The default bias value is 0.
- When AT successfully completes, it stores the result obtained by multiplying the calculation results KP, TI, and TD by correction data a1, a2, and a3. The default value is 100%.
- When AT successfully completes, the AT successful completion flag is set, and the AT completion code is stored in AT step.
- If AT terminates abnormally, the parameters KP, TI, and TD are unchanged.
- PWM output is output at the duty cycle when the MV output range is 0 to 10000.
- For analog output (when bit 3 of S1 is 1), the internal calculated value is output in the range 0 to 10000 and converted to the specified range.
- Conversion formula: $(\text{upper limit value} - \text{lower limit value}) \times \text{internal calculated value} / 10000 + \text{lower limit value}$
e.g. When upper limit value = 40000, lower limit value = 0, and internal calculated value = 5000: output manipulated value MV = 2000

■ Precautions when using MV holding function

- When using the MV holding function, use the default upper and lower limit values.

31 Positioning Control Instructions (Table Setting Mode)

31.1 [F380 POSST] Positioning Table Start Instruction	31-2
31.2 [F381 JOGST] JOG Operation Start Instruction	31-4
31.3 [F382 ORGST] Home Return Start Instruction	31-6
31.4 [F383 MPOST] Positioning Table Simultaneous Start Instruction.....	31-8
31.5 [F384 PTBLR] Positioning Parameter Read Instruction	31-10
31.6 [F385 PTBLW] Positioning Parameter Write Instruction	31-12

31.1 [F380 POSST] Positioning Table Start Instruction

31.1 [F380 POSST] Positioning Table Start Instruction

Starts the positioning operation according to the data specified in the positioning memory (positioning table area). This instruction is used to start the E-point control, P-point control, C-point control, J-point control or linear interpolation control.

■ Instruction format

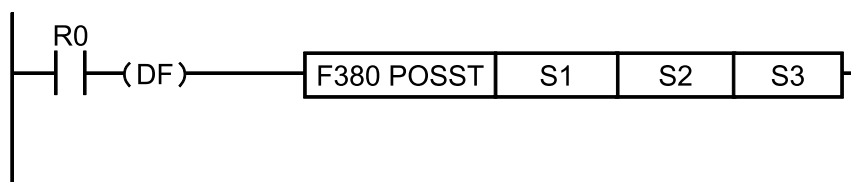

■ Operand

Operand	Settings	Setting range
S1	Channel number to start the positioning operation (Unsigned 16-bit integer)	0 to 5
S2	Table number to start (Unsigned 16-bit integer)	1 to 20
S3	Output assignment	0 (Pulse output), 1 (Calculation only)

■ Memory area type that can be specified

Operand	WX	WY	WR	WL	SV	EV	DT	LD	I	Constant		Index modifier
										K	H	
S1	•	•	•	•	•	•	•	•	•	•	•	•
S2	•	•	•	•	•	•	•	•	•	•	•	•
S3	•	•	•	•	•	•	•	•	•	•	•	•

■ Outline of operation

- Starts the positioning operation according to the data specified in the positioning memory (positioning table area).
- When Calculation only is specified for [S3], only the table calculation is executed. When starting the positioning operation for the same channel and the same table from the next scan after executing the calculation, the startup time of the positioning control is reduced.

■ Precautions during programming

- If an operand is an out-of-range value, an operation error occurs.
- The stop operation has priority when the conditions of system stop, emergency stop, limit stop and deceleration stop are satisfied.
- An operation error occurs when the system register of a specified channel is other than "Pulse output [Table setting mode]".
- A self-diagnostic error (positioning operation error) occurs when the set value or the value of the positioning memory (axis setting area) is abnormal.

31.1 [F380 POSST] Positioning Table Start Instruction

- When the channel to be started has been already operating, the positioning control does not start and it terminates.

■ Flag operations

Name	Description
R9007 R9008 (ER)	When the area is exceeded at the time of index modification
	When the [S1] value is outside the set range
	When the [S2] value is outside the set range
	When the [S3] value is outside the set range
	When the pulse output (table operation) has not been set in the system register

31.2 [F381 JOGST] JOG Operation Start Instruction

31.2 [F381 JOGST] JOG Operation Start Instruction

Starts the JOG operation according to the parameters specified in the positioning memory (axis setting area).

■ Instruction format

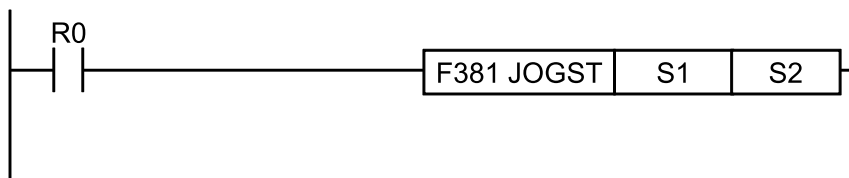

■ Operand

Operand	Settings	Setting range
S1	Channel number to start the JOG operation (Unsigned 16-bit integer)	0 to 5
S2	Operating direction (Unsigned 16-bit integer)	0 (Forward), 1 (Reverse)

■ Memory area type that can be specified

Operand	WX	WY	WR	WL	SV	EV	DT	LD	I	Constant		Index modifier
										K	H	
S1	•	•	•	•	•	•	•	•	•	•	•	•
S2	•	•	•	•	•	•	•	•	•	•	•	•

■ Outline of operation

- Executes the JOG operation according to the JOG operation parameters specified in the positioning memory (axis setting area). While the execution condition is valid, the JOG operation continues.
- The target speed can be changed by rewriting the positioning parameter area with a user program. The change is executed after it becomes a constant speed.

■ Precautions during programming

- If an operand is an out-of-range value, an operation error occurs.
- The stop operation has priority when the conditions of system stop, emergency stop, limit stop and deceleration stop are satisfied.
- An operation error occurs when the system register of a specified channel is other than "Pulse output [Table setting mode]".
- A self-diagnostic error (positioning operation error) occurs when the set value or the value of the positioning memory (axis setting area) is abnormal.
- The JOG operation needs to be stopped for switching between the forward rotation and reverse rotation.
- In case of changing a speed, when the target speed after the change is an out-of-range value, the speed change is not executed and the operation continues.

■ Flag operations

Name	Description
R9007 R9008 (ER)	When the area is exceeded at the time of index modification
	When the [S1] value is outside the set range
	When the [S2] value is outside the set range
	When the pulse output (table operation) has not been set in the system register

31.3 [F382 ORGST] Home Return Start Instruction

Starts the home return operation according to the parameters specified in the positioning memory (axis setting area).

■ Instruction format

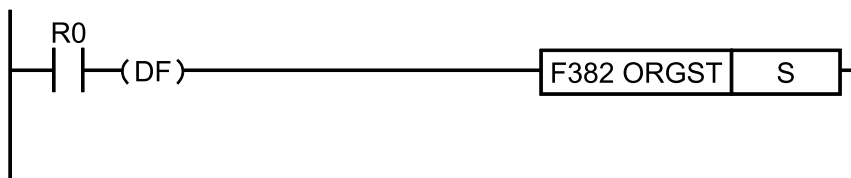

■ Operand

Operand	Settings	Setting range
S	Channel number to start the home return (Unsigned 16-bit integer)	0 to 5

■ Memory area type that can be specified

Operand	WX	WY	WR	WL	SV	EV	DT	LD	I	Constant		Index modifier
										K	H	
S	•	•	•	•	•	•	•	•	•	•	•	•

■ Outline of operation

- Starts the home return operation according to the home return parameters specified in the positioning memory (axis setting area).

■ Precautions during programming

- If an operand is an out-of-range value, an operation error occurs.
- The stop operation has priority when the conditions of system stop, emergency stop, limit stop and deceleration stop are satisfied.
- An operation error occurs when the system register of a specified channel is other than "Pulse output [Table setting mode]".
- An operation error occurs when the home return pattern is set to either "DOG method 1", "DOG method 3", or "Home position method" unless the home input is set in the system register.
- The home return operation is started when the home return pattern is set to either "DOG method 2" or "Data set method" even if the home input is not set.
- A self-diagnostic error (positioning operation error) occurs when the set value or the value of the positioning memory (axis setting area) is abnormal.

■ Flag operations

Name	Description
R9007	When the area is exceeded at the time of index modification
R9008 (ER)	When the [S] value is outside the set range

31.3 [F382 ORGST] Home Return Start Instruction

Name	Description
	When the pulse output (table operation) has not been set in the system register

31.4 [F383 MPOST] Positioning Table Simultaneous Start Instruction

31.4 [F383 MPOST] Positioning Table Simultaneous Start Instruction

Starts the positioning tables for multiple axes specified on Configurator PMX. The tables of the E-point control, P-point control and C-point control can be started.

■ Instruction format

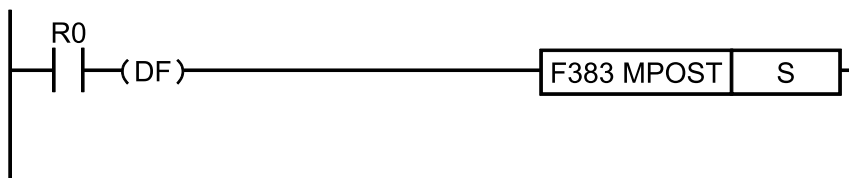

■ Operand

Operand	Settings
S	The starting area of the data register storing the data table numbers (unsigned 16-bit integer) to be started simultaneously

■ Memory area type that can be specified

Operand	WX	WY	WR	WL	SV	EV	DT	LD	I	Constant		Index modifier
										K	H	
S	-	-	-	-	-	-	•	-	-	-	-	•

■ Outline of operation

- Starts the positioning table numbers of the channels specified in the area starting with [S] simultaneously.
- Positioning tables that can be specified are those for the single-axis control only.
- Table numbers are specified in the range of 0 to 20. In the case of 0, the table is not executed simultaneously with other tables.

S	Output specification (0: Pulse output, 1: Calculation only)
S+1	CH0 Positioning table number (0 to 20)
S+2	CH1 Positioning table number (0 to 20)
S+3	CH2 Positioning table number (0 to 20)
S+4	CH3 Positioning table number (0 to 20)
S+5	CH4 Positioning table number (0 to 20)
S+6	CH5 Positioning table number (0 to 20)

■ Precautions during programming

- If an operand is an out-of-range value, an operation error occurs.
- The stop operation has priority when the conditions of system stop, emergency stop, limit stop and deceleration stop are satisfied.
- An operation error occurs when the system register of a specified channel is other than "Pulse output [Table setting mode]".

31.4 [F383 MPOST] Positioning Table Simultaneous Start Instruction

- Only when all the specified channels can be started, they are executed simultaneously. When the BUSY flag of any channel is on, tables are not started simultaneously and the process is terminated.
- Use F380 POSST instruction to start linear interpolation. When the table of the interpolation axis control has been specified with F383 MPOST instruction, a self-diagnostic error (positioning operation error) occurs.

■ Flag operations

Name	Description
R9007 R9008 (ER)	When the area is exceeded at the time of index modification
	When the [S] data table exceeds the area
	When the [S] value is outside the set range
	When the pulse output (table operation) has not been set in the system register

31.5 [F384 PTBLR] Positioning Parameter Read Instruction

31.5 [F384 PTBLR] Positioning Parameter Read Instruction

Reads the positioning parameter data stored in the positioning memory of the unit to the operation memory area.

■ Instruction format



■ Operand

Operand	Settings			
S1	Specification of channel numbers and positioning memory area			
	<table border="1"> <tr> <td>(Higher 8 bits) channel no.:</td> <td>H0 to H5</td> </tr> <tr> <td>(Lower 8 bits) Area no.:</td> <td>H00 (Common area), H01 (Axis information area), H02 (Axis setting area), H03 (Positioning table area)</td> </tr> </table>	(Higher 8 bits) channel no.:	H0 to H5	(Lower 8 bits) Area no.:
(Higher 8 bits) channel no.:	H0 to H5			
(Lower 8 bits) Area no.:	H00 (Common area), H01 (Axis information area), H02 (Axis setting area), H03 (Positioning table area)			
S2	Starting address of the positioning memory storing read data (offset address) or operation memory area storing the starting address			
n	No. of read words			
D	Operation memory storing read data			

(Note 1) When reading the common area, the setting of channel numbers is invalid.

(Note 2) The operand S1 is specified using a combination of hexadecimal numbers. For the axis information area of channel number 3, specify H301.

■ Memory area type that can be specified

Operand	WX	WY	WR	WL	SV	EV	DT	LD	I	Constant		Index modifier
										K	H	
S1	•	•	•	•	•	•	•	•	•	•	•	•
S2	•	•	•	•	•	•	•	•	•	•	•	•
n	•	•	•	•	•	•	•	•	•	•	•	•
D	-	•	•	•	•	•	•	•	•	-	-	•

■ Outline of operation

- Reads [n] words of the data stored in the positioning memory starting with [S2], and stores it in the operation memory area starting with [D].
- Channel numbers and the type of positioning memory are specified by [S1].

■ Precautions during programming

- If an operand is an out-of-range value, an operation error occurs.

■ Flag operations

Name	Description
R9007 R9008 (ER)	When the [S1] value is outside the set range
	When the [S2] value exceeds the positioning area specified by [S1]
	When the no. of read words is "0"
	When the read data exceeds the area of [D]

31.6 [F385 PTBLW] Positioning Parameter Write Instruction

31.6 [F385 PTBLW] Positioning Parameter Write Instruction

This instruction is used to write positioning parameters and positioning table data with user programs.

■ Instruction format

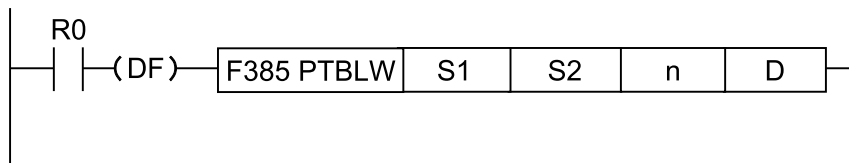

■ Operand

Operand	Settings			
S1	Specification of channel numbers and positioning memory area			
	<table border="1"> <tr> <td>(Higher 8 bits) channel no.:</td> <td>H0 to H5</td> </tr> <tr> <td>(Lower 8 bits) Area no.:</td> <td>H00 (Common area), H01 (Axis information area), H02 (Axis setting area), H03 (Positioning table area)</td> </tr> </table>	(Higher 8 bits) channel no.:	H0 to H5	(Lower 8 bits) Area no.:
(Higher 8 bits) channel no.:	H0 to H5			
(Lower 8 bits) Area no.:	H00 (Common area), H01 (Axis information area), H02 (Axis setting area), H03 (Positioning table area)			
S2	Operation memory area storing written data			
n	No. of written data			
D	Starting address of the positioning memory storing data (offset address) or operation memory area storing the starting address			

(Note 1) When writing data to the common area, the setting of channel numbers is invalid.

(Note 2) The operand S1 is specified using a combination of hexadecimal numbers. For the axis setting area of channel number 3, specify H302.

■ Memory area type that can be specified

Operand	WX	WY	WR	WL	SV	EV	DT	LD	I	Constant		Index modifier
										K	H	
S1	•	•	•	•	•	•	•	•	•	•	•	•
S2	•	•	•	•	•	•	•	•	•	-	-	•
n	•	•	•	•	•	•	•	•	•	•	•	•
D	•	•	•	•	•	•	•	•	•	•	•	•

■ Outline of operation

- Reads [n] words of the data stored in the area starting with [S2], and stores it in the positioning memory area starting with [D].
- Channel numbers and the type of positioning memory are specified by [S1].

■ Precautions during programming

- If an operand is an out-of-range value, an operation error occurs.

i Info.

- For details of positioning memory, refer to "[Positioning Memory](#)".

■ **Flag operations**

Name	Description
R9007 R9008 (ER)	When the [S1] value is outside the set range
	When the [D] value exceeds the positioning area specified by [S1]
	When the range of the data written from [D] exceeds the positioning area specified by [S1]
	When the no. of written data is "0"
	When the written data exceeds the area of [S2]

(MEMO)

32 Positioning Control Instructions (FP-X Compatible Mode)

32.1 [F1 DMV] Elapsed Value Write / Read Instruction	32-2
32.2 [F171 (SPDH)] Pulse Output (Trapezoidal Control).....	32-3
32.3 [F171 (SPDH)] Pulse Output (Home Return).....	32-8
32.4 [F172 (PLSH)] Pulse Output (JOG operation)	32-13
32.5 [F174 (SP0H)] Pulse Output (Selectable Data Table Control Operation)	32-16
32.6 [F175 (SPSH)] Pulse Output (Linear Interpolation)	32-21

32.1 [F1 DMV] Elapsed Value Write / Read Instruction

32.1 [F1 DMV] Elapsed Value Write / Read Instruction

Writes and reads the elapsed value of the high-speed counter / pulse output.

■ Instruction format

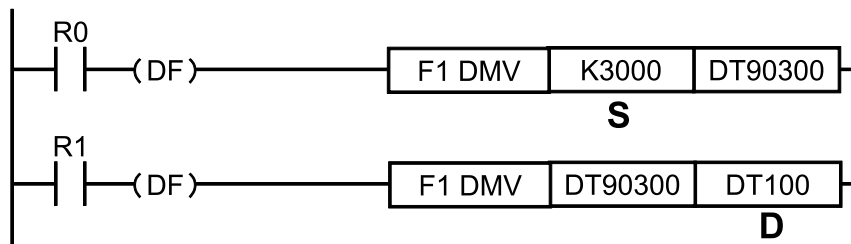

■ Operand

Operand	Settings
S	When setting: Area storing the elapsed value (32-bit) set in the high-speed counter / pulse output or constant data K-2,147,483,648 to K2,147,483,647
D	When reading: Area reading the elapsed value of the high-speed counter / pulse output

■ Memory area type that can be specified

Operand	WX	WY	WR	WL	SV	EV	DT	LD	I	Constant		Index modifier
										K	H	
S	•	•	•	•	•	•	•	•	•	•	•	•
D	-	•	•	•	•	•	•	•	•	-	-	•

■ Outline of operation (Reading elapsed value)

- Reads the content of the special data register storing the elapsed value of the high-speed counter / pulse output and writes to the area specified by [D].

■ Outline of operation (Setting elapsed value)

- At the same time as writing the value to the elapsed value area of the high-speed counter / pulse output which uses 32-bit data specified by [S], sets it in the elapsed value area of the high-speed counter used within the system.

■ Precautions during programming

- Only F1 (DMV) instruction can perform the writing. The writing cannot be performed by other high-level instructions such as transfer instruction F0 (MV) and arithmetic instructions.
- Specify the memory area of [S] or [D] with the memory area number for the lower 16 bits.

i Info.

- For details of the allocations of I/O and flags, refer to “Allocation of Memory Areas”.

32.2 [F171 (SPDH)] Pulse Output (Trapezoidal Control)

This instruction outputs pulses from a specified pulse output channel according to specified parameters.

■ Instruction format

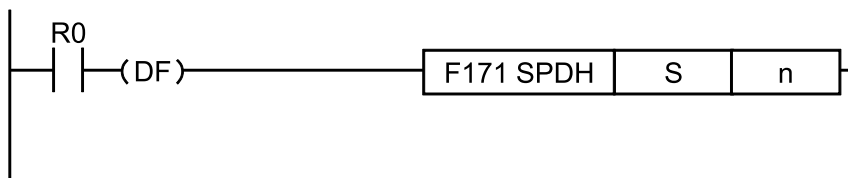

■ Operand

Operand	Settings
S	Starting number of the area in which data tables are registered
n	Target channel for pulse output

■ Memory area type that can be specified

Operand	WX	WY	WR	WL	SV	EV	DT	LD	I	Constant		Index modifier
										K	H	
S	-	-	-	-	-	-	•	-	-	-	-	•
n	-	-	-	-	-	-	-	-	-	•	•	-

■ Outline of operation

- Outputs pulses from a specified channel when a corresponding control active flag is OFF and the execution condition is ON.
- The control code, initial speed, maximum speed, acceleration / deceleration time, and target value are specified by creating data tables [S] to [S+11] described on the next page using a user program.
- Switches the frequency from the initial speed to the maximum speed in the specified acceleration / deceleration time. At the time of deceleration, switches the frequency with the same inclination as that for acceleration.
- For setting the frequency to 50 kHz or more, specify the duty of 1/4 (25%).

■ Operation mode

Incremental <Relative value control>

Outputs the pulses set with the target value.

32.2 [F171 (SPDH)] Pulse Output (Trapezoidal Control)

	Selection			
Target value	CW / CCW	PLS+SIGN Forward OFF Reverse ON	PLS+SIGN Forward ON Reverse OFF	Elapsed value
Positive value	Pulse output from CW	Pulse output when direction output is OFF	Pulse output when direction output is ON	Addition
Negative value	Pulse output from CCW	Pulse output when direction output is ON	Pulse output when direction output is OFF	Subtraction

Absolute <Absolute value control>

Outputs the pulses of the difference between the set target value and current value.

	Selection			
Target value	CW / CCW	PLS+SIGN Forward OFF Reverse ON	PLS+SIGN Forward ON Reverse OFF	Elapsed value
When target value is larger than current value	Pulse output from CW	Pulse output when direction output is OFF	Pulse output when direction output is ON	Addition
When target value is smaller than current value	Pulse output from CCW	Pulse output when direction output is ON	Pulse output when direction output is OFF	Subtraction

■ Data table settings

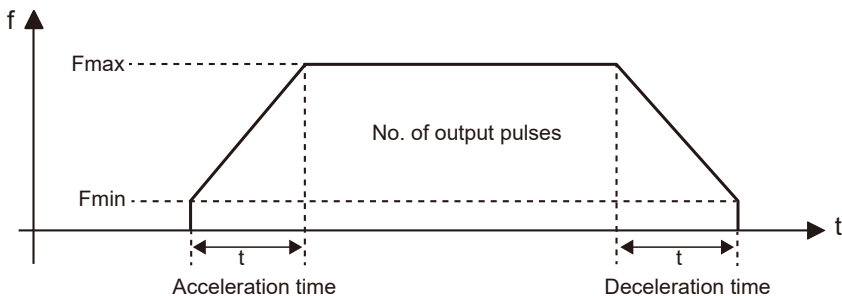

32.2 [F171 (SPDH)] Pulse Output (Trapezoidal Control)

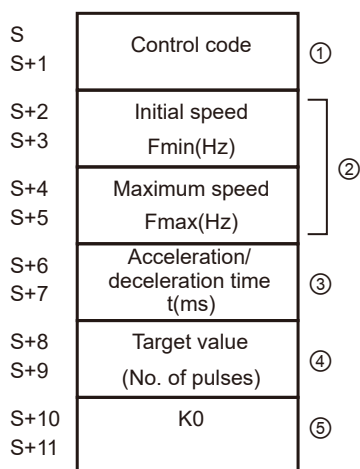

	Operand	Settings	Description									
(1)	S, S+1	Control code	<p>Specify the control code by setting the H constant.</p> <div style="text-align: right; margin-bottom: 5px;"> H <input type="checkbox"/><input type="checkbox"/><input type="checkbox"/><input type="checkbox"/><input type="checkbox"/><input type="checkbox"/><input type="checkbox"/><input type="checkbox"/> </div> <p>0: Fixed</p> <p>Acceleration/deceleration time setting 0: Normal 1: Acceleration/deceleration time priority</p> <p>Output setting 0: Pulse output 1: Calculate only</p> <p>Acceleration/deceleration steps 0: 30 steps 1: 60 steps</p> <p>Duty (on width) 0: Duty 1/2 (50%) 1: Duty 1/4 (25%)</p> <p>Frequency range Not used</p> <p>Operation mode and output method 0: Incremental CW/CCW 2: Incremental PLS+SIGN (forward off/reverse on) 3: Incremental PLS+SIGN (forward on/reverse off) 10: Absolute CW/CCW 12: Absolute PLS+SIGN (forward off/reverse on) 13: Absolute PLS+SIGN (forward on/reverse off)</p>									
(2)	S+2, S+3	Initial speed Fmin (Hz)	<p>The setting range of the settable maximum speed varies according to the setting of the initial speed as shown in the table below.</p> <table border="1" style="width: 100%; border-collapse: collapse;"> <thead> <tr style="background-color: #d9e1f2;"> <th style="width: 15%;">Range</th> <th style="width: 35%;">Initial speed</th> <th style="width: 50%;">Maximum speed</th> </tr> </thead> <tbody> <tr> <td style="text-align: center;">Low speed</td> <td>K1 to K49 (1 to 49 Hz)</td> <td>Initial speed to K22000 (to 22 kHz)</td> </tr> <tr> <td style="text-align: center;">High-speed</td> <td>K50 to K100000 (50 Hz to 100 kHz)</td> <td>Initial speed to K100000 (to 100 kHz)</td> </tr> </tbody> </table>	Range	Initial speed	Maximum speed	Low speed	K1 to K49 (1 to 49 Hz)	Initial speed to K22000 (to 22 kHz)	High-speed	K50 to K100000 (50 Hz to 100 kHz)	Initial speed to K100000 (to 100 kHz)
Range	Initial speed	Maximum speed										
Low speed	K1 to K49 (1 to 49 Hz)	Initial speed to K22000 (to 22 kHz)										
High-speed	K50 to K100000 (50 Hz to 100 kHz)	Initial speed to K100000 (to 100 kHz)										
	S+4, S+5	Maximum speed Fmax (Hz)										

32.2 [F171 (SPDH)] Pulse Output (Trapezoidal Control)

	Operand	Settings	Description
			When the initial speed is set to low speed, an operation error occurs if a value exceeding K22000 is specified for the maximum speed.
(3)	S+6, S+7	Acceleration / deceleration time t (ms)	Acceleration / deceleration time (ms) With 30 steps: K30 to K32760 (Specify in 30 ms increments.) With 60 steps: K60 to K32760 (Specify in 60 ms increments.) (Note 1) When the time is not specified in 30 ms nor 60 ms increments, it will be automatically corrected to the multiple value (larger value) of 30 ms or 60 ms.
(4)	S+8, S+9	Target value	Target value K-2147483648 to K2147483647 pulse
(5)	S+10, S+11	K0	Set K0 to the last two words of the data table.

■ Example of program

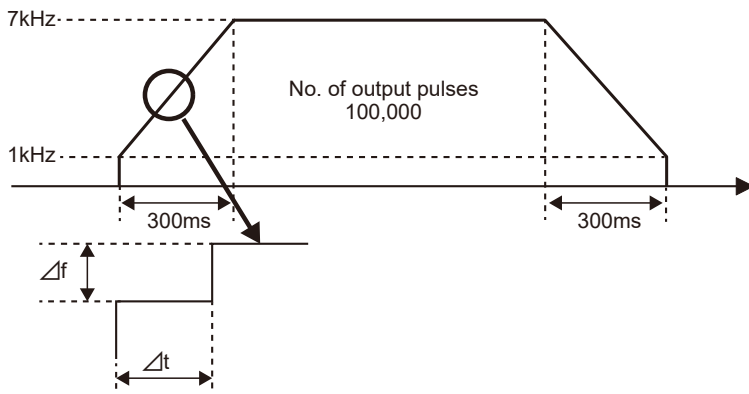
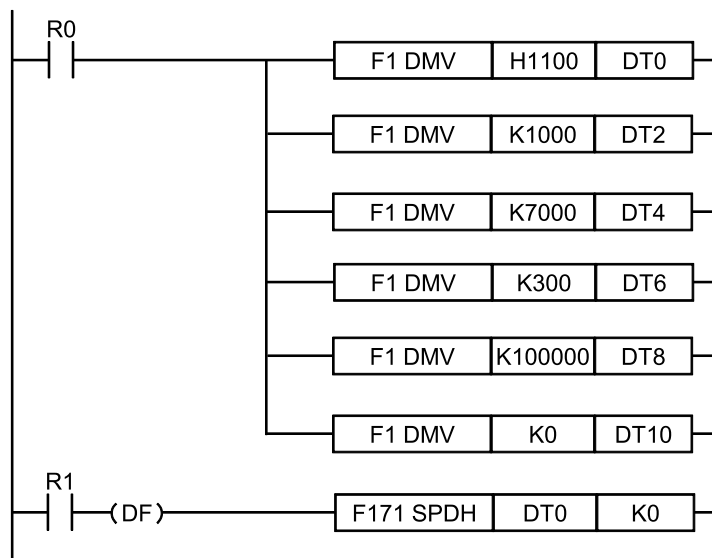

- With 30 steps:
 $\Delta f = (7000 - 1000) / 30 \text{ steps} = 200 \text{ (Hz)}$
 $\Delta t = 300 \text{ ms} / 30 \text{ steps} = 10 \text{ ms}$
- With 60 steps:
 $\Delta f = (7000 - 1000) / 60 \text{ steps} = 100 \text{ (Hz)}$
 $\Delta t = 300 \text{ ms} / 60 \text{ steps} = 5 \text{ ms}$

■ Regarding the specification of acceleration / deceleration time

For specifying acceleration / deceleration time, No. of steps and initial speed, set the value to be calculated by the formula below. Specify acceleration / deceleration time in 30 ms increments with 30 steps, and in 60 ms increments with 60 steps. When the time is not specified in 30 ms nor 60 ms increments, it will be automatically corrected to the multiple value (larger value) of 30 ms or 60 ms.

Acceleration / deceleration time t [ms] \geq (No. of steps \times 1000) / Initial speed f_0 [Hz]

- When "Acceleration / deceleration time priority" is specified for the control code, the initial speed is corrected according to the time.
The corrected speed is stored in the correction speed area of initial speed of special data registers (from DT90400).
(Example): When the initial speed is 10 Hz, and acceleration / deceleration time is 1 msec, the initial speed is corrected to 1000 Hz.
- When the corrected initial speed exceeds the maximum speed, the initial speed is corrected to the maximum speed.
(Example): When the initial speed is 10 Hz, the maximum speed is 500 Hz, acceleration / deceleration time is 1 msec, and acceleration / deceleration time priority is specified, it takes 100 msec for outputting one pulse at the initial speed and it exceeds 1 msec of acceleration / deceleration time.
Although the initial speed is corrected to 1000 Hz as "Acceleration / deceleration time priority" is specified, it is corrected to 500 Hz because it exceeds the maximum speed.

■ Supplement to pulse output operation

When outputting pulses with the PLS+SIGN (direction output) method, pulses will be output approx. 300 μ s later after the output of direction signal (SIGN). (The characteristics of a motor driver are considered.)

■ Precautions during programming

- When describing the same channel in both the normal program and the interrupt program, be sure to program not to execute them simultaneously.
- This instruction cannot be executed when a control active flag corresponding to each channel is ON.
- Select "Pulse output" for the channel setting corresponding to the system register no. 402.
- By performing the rewriting during RUN while outputting pulses, more pulses than the setting may be output.

Info.

- For details of the allocations of I/O and flags, refer to "Allocation of Memory Areas".

32.3 [F171 (SPDH)] Pulse Output (Home Return)

32.3 [F171 (SPDH)] Pulse Output (Home Return)

This instruction outputs pulses from a specified pulse output channel according to specified parameters.

■ Instruction format

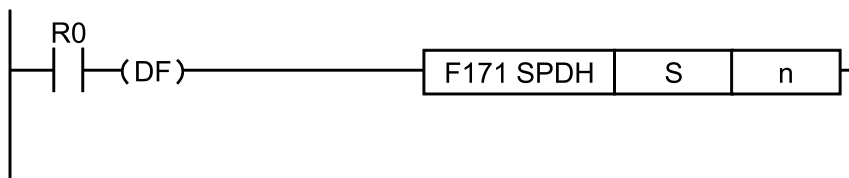

■ Operand

Operand	Settings
S	Starting number of the area in which data tables are registered
n	Target channel for pulse output

■ Memory area type that can be specified

Operand	WX	WY	WR	WL	SV	EV	DT	LD	I	Constant		Index modifier
										K	H	
S	-	-	-	-	-	-	•	-	-	-	-	•
n	-	-	-	-	-	-	-	-	-	•	•	-

■ Outline of operation

- Outputs pulses from a specified channel when a corresponding control active flag is OFF and the execution condition is ON.
- The control code, initial speed, maximum speed, acceleration / deceleration time, and deviation counter clear signal are specified by creating data table described on the next page using a user program.
- Switches the frequency from the initial speed to the maximum speed in the specified acceleration / deceleration time. At the time of deceleration, switches the frequency with the same inclination as that for acceleration.
- For setting the frequency to 50 kHz or more, specify the duty of 1/4 (25%).

■ Explanation of operation mode

Home return

The pulses are continuously output until the home input (X2 or X5) is enabled. To shift to deceleration operation when detecting the near home, turn the corresponding bit of special data register DT90052 to OFF→ON→OFF by the near home input. The value in the elapsed value area during the home return operation differs from the current value.

Home return mode I (Home return by near home input and home input)

When the near home input is enabled, deceleration will be performed, and the pulse output will stop after the home input. The operation varies according to the setting of the control code (low byte) described on the next page.

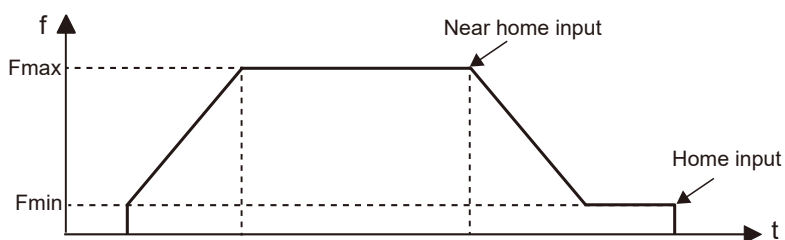

Home return mode II (Home return by home input only)

When the home input is enabled, the pulse output will stop. Set the control code (low byte) on the next page to H20 to H27.

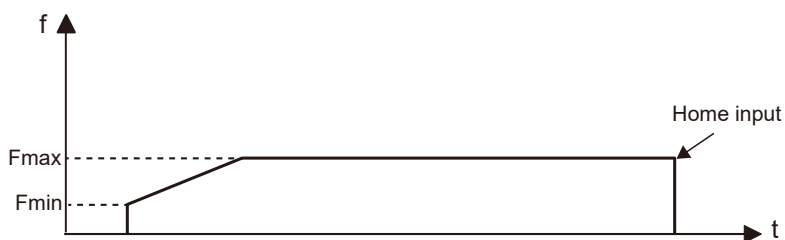

■ Data table settings

S	Control code	①
S+1		
S+2	Initial speed Fmin(Hz)	②
S+3		
S+4	Maximum speed Fmax(Hz)	②
S+5		
S+6	Acceleration/ deceleration time t(ms)	③
S+7		
S+8	Deviation counter clear signal output time t_r (ms)	④
S+9		

	Operand	Settings	Description
(1)	S, S+1	Control code	Specify the control code by setting the H constant.

32.3 [F171 (SPDH)] Pulse Output (Home Return)

	Operand	Settings	Description									
			<div style="text-align: right; margin-bottom: 10px;"> H <input type="checkbox"/> <input type="checkbox"/> <input type="checkbox"/> <input type="checkbox"/> <input type="checkbox"/> <input type="checkbox"/> <input type="checkbox"/> <input type="checkbox"/> </div> 0: Fixed Acceleration/deceleration time setting 0: Normal 1: Acceleration/deceleration time priority Output setting 0: Pulse output 1: Calculate only Acceleration/deceleration steps 0: 30 steps 1: 60 steps Duty (on width) 0: Duty 1/2 (50%) 1: Duty 1/4 (25%) Frequency range Not used Operation mode and output method 20: Homing mode 1 CW 21: Homing mode 1 CCW 22: Homing mode 1 Directional output off 23: Homing mode 1 Directional output on 24: Homing mode 1 CW + deviation counter reset 25: Homing mode 1 CCW + deviation counter reset 26: Homing mode 1 Direction output off + deviation counter reset 27: Homing mode 1 Direction output on + deviation counter reset 30: Homing mode 2 CW 31: Homing mode 2 CCW 32: Homing mode 2 Directional output off 33: Homing mode 2 Direction output on 34: Homing mode 2 CW + deviation counter reset 35: Homing mode 2 CCW + deviation counter reset 36: Homing mode 2 Direction output off + deviation counter reset 37: Homing mode 2 Direction output on + deviation counter reset									
(2)	S+2, S+3	Initial speed Fmin (Hz)	The setting range of the settable maximum speed varies according to the setting of the initial speed as shown in the table below. <table border="1" style="width: 100%; border-collapse: collapse; margin-top: 10px;"> <thead> <tr> <th>Range</th> <th>Initial speed</th> <th>Maximum speed</th> </tr> </thead> <tbody> <tr> <td>Low speed</td> <td>K1 to K49 (1 to 49 Hz)</td> <td>Initial speed to K22000 (to 22 kHz)</td> </tr> <tr> <td>High-speed</td> <td>K50 to K100000 (50 Hz to 100 kHz)</td> <td>Initial speed to K100000 (to 100 kHz)</td> </tr> </tbody> </table> When the initial speed is set to low speed, an operation error occurs if a value exceeding K22000 is specified for the maximum speed.	Range	Initial speed	Maximum speed	Low speed	K1 to K49 (1 to 49 Hz)	Initial speed to K22000 (to 22 kHz)	High-speed	K50 to K100000 (50 Hz to 100 kHz)	Initial speed to K100000 (to 100 kHz)
	Range	Initial speed		Maximum speed								
Low speed	K1 to K49 (1 to 49 Hz)	Initial speed to K22000 (to 22 kHz)										
High-speed	K50 to K100000 (50 Hz to 100 kHz)	Initial speed to K100000 (to 100 kHz)										
	S+4, S+5	Maximum speed Fmax (Hz)										
(3)	S+6, S+7	Acceleration / deceleration time t (ms)	Acceleration / deceleration time (ms) With 30 steps: K30 to K32760 With 60 steps: K60 to K32760									
(4)	S+8, S+9	Deviation counter clear signal output time tr (ms)	Set the output time of the deviation counter clear signal. 0.5 ms to 100 ms [K0 to K100] Setting value + error (0.5 ms or less) When this signal is not used or the time is set to less than 0.5 ms, specify K0.									

■ Example of program

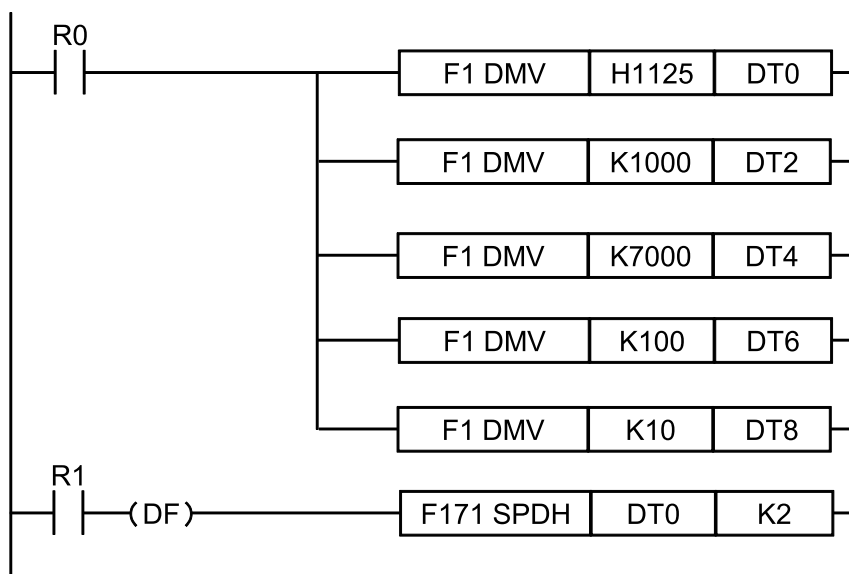

■ Regarding the specification of acceleration / deceleration time

For specifying acceleration / deceleration time, No. of steps and initial speed, set the value to be calculated by the formula below. Specify acceleration / deceleration time in 30 ms increments with 30 steps, and in 60 ms increments with 60 steps. When the time is not specified in 30 ms nor 60 ms increments, it will be automatically corrected to the multiple value (larger value) of 30 ms or 60 ms.

Acceleration / deceleration time t [ms] \geq (No. of steps \times 1000) / Initial speed f_0 [Hz]

- When "Acceleration / deceleration time priority" is specified for the control code, the initial speed is corrected according to the time.
The corrected speed is stored in the correction speed area of initial speed of special data registers (from DT90400).
(Example): When the initial speed is 10 Hz, and acceleration / deceleration time is 1 msec, the initial speed is corrected to 1000 Hz.
- When the corrected initial speed exceeds the maximum speed, the initial speed is corrected to the maximum speed.
(Example): When the initial speed is 10 Hz, the maximum speed is 500 Hz, acceleration / deceleration time is 1 msec, and acceleration / deceleration time priority is specified, it takes 100 msec for outputting one pulse at the initial speed and it exceeds 1 msec of acceleration / deceleration time.
Although the initial speed is corrected to 1000 Hz as "Acceleration / deceleration time priority" is specified, it is corrected to 500 Hz because it exceeds the maximum speed.

■ Supplement to pulse output operation

When outputting pulses with the PLS+SIGN (direction output) method, pulses will be output approx. 300 μ s later after the output of direction signal (SIGN). (The characteristics of a motor driver are considered.)

32.3 [F171 (SPDH)] Pulse Output (Home Return)

■ Precautions during programming

- When the control code (low byte) is H20 to H27 (home return mode I), the home input is enabled even after the near home input, the completion of deceleration, or in the middle of deceleration.
- When the control code (low byte) is H30 to H37 (home return mode II), the home input is enabled only after the near home input and the completion of deceleration up to the value of initial speed.
- Even when the home input is enabled, the pulse output starts by the execution of this instruction.
- When the near home input is enabled during acceleration, the deceleration operation will start.
- When describing the same channel in both the normal program and the interrupt program, be sure to program not to execute them simultaneously.
- This instruction cannot be executed when a control active flag corresponding to each channel is ON.
- Select "Pulse output" for the channel setting corresponding to the system register no. 402.
- By performing the rewriting during RUN while outputting pulses, more pulses than the setting may be output.
- For performing the software reset, disabling the counting, stopping the pulse output or near home processing, refer to the F0 (MV) instruction, pulse output control.

Info.

- For details of the allocations of I/O and flags, refer to "Allocation of Memory Areas".

32.4 [F172 (PLSH)] Pulse Output (JOG operation)

This instruction outputs pulses from a specified pulse output channel according to specified parameters.

■ Instruction format

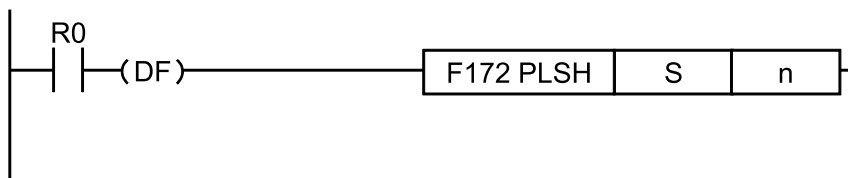

■ Operand

Operand	Settings
S	Starting number of the area in which data tables are registered
n	Target channel for pulse output

■ Memory area type that can be specified

Operand	WX	WY	WR	WL	SV	EV	DT	LD	I	Constant		Index modifier
										K	H	
S	-	-	-	-	-	-	•	-	-	-	-	•
n	-	-	-	-	-	-	-	-	-	•	•	-

■ Outline of operation

- Outputs pulses from a specified channel when a corresponding control active flag is OFF and the execution condition is ON. The output is performed when the execution condition is ON.
- By specifying the addition counting or subtraction counting mode for the control code, it can be used for the instruction for activating JOG operation.
- The frequency can be changed in each scan, or the target value can be changed asynchronously. However, the control code cannot be changed during the execution of an instruction.
- For setting the frequency to 50 kHz or more, specify the duty of 1/4 (25%).

■ Data table settings

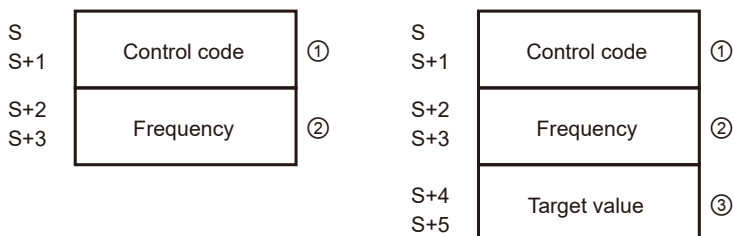

32.4 [F172 (PLSH)] Pulse Output (JOG operation)

Operand	Settings	Description									
(1) S, S+1	Control code	<p>Specify the control code by setting the H constant.</p> <p style="text-align: center;">H <input type="checkbox"/><input type="checkbox"/><input type="checkbox"/><input type="checkbox"/><input type="checkbox"/><input type="checkbox"/><input type="checkbox"/><input type="checkbox"/><input type="checkbox"/></p> <p>0: Fixed</p> <p>Acceleration/deceleration steps 0: Mode with no target value 1: Target value match stop mode</p> <p>Duty (on width) 0: Duty 1/2 (50%) 1: Duty 1/4 (25%)</p> <p>Frequency range Not used</p> <p>Output method 00: No counting CW 01: No counting CCW 10: Addition counting CW 12: Addition counting Directional output off 13: Addition counting Directional output on 21: Subtraction counting CW 22: Subtraction counting Directional output off 23: Subtraction counting Directional output on</p>									
(2) S+2, S+3	Frequency	<p>The setting range of the settable change speed varies according to the setting of the initial speed as shown in the table below.</p> <table border="1"> <thead> <tr> <th>Range</th> <th>Initial speed</th> <th>Change speed</th> </tr> </thead> <tbody> <tr> <td>Low speed</td> <td>K1 to K49 (1 to 49 Hz)</td> <td>K1 to K22000 (1 Hz to 22 kHz)</td> </tr> <tr> <td>High-speed</td> <td>K50 to K100000 (50 Hz to 100 kHz)</td> <td>K1 to K100000 (1 Hz to 100 kHz)</td> </tr> </tbody> </table> <p>When the initial speed is set to low speed, it is corrected to 22 kHz even when specifying a value exceeding K22000 for the change speed.</p>	Range	Initial speed	Change speed	Low speed	K1 to K49 (1 to 49 Hz)	K1 to K22000 (1 Hz to 22 kHz)	High-speed	K50 to K100000 (50 Hz to 100 kHz)	K1 to K100000 (1 Hz to 100 kHz)
Range	Initial speed	Change speed									
Low speed	K1 to K49 (1 to 49 Hz)	K1 to K22000 (1 Hz to 22 kHz)									
High-speed	K50 to K100000 (50 Hz to 100 kHz)	K1 to K100000 (1 Hz to 100 kHz)									
(3) S+4, S+5	Target value	<p>Target value (absolute value) It is used when setting the target value match stop mode. (Absolute only)</p> <p>Specify the target value in the following range. If a value outside of the range is specified, the number of pulses different from the specified value is output. When specifying the no counting mode, the target value setting is ignored.</p> <table border="1"> <thead> <tr> <th>Output method</th> <th>Settable range of target value</th> </tr> </thead> <tbody> <tr> <td>Addition counting</td> <td>Values larger than the current value</td> </tr> <tr> <td>Subtraction counting</td> <td>Values smaller than the current value</td> </tr> </tbody> </table>	Output method	Settable range of target value	Addition counting	Values larger than the current value	Subtraction counting	Values smaller than the current value			
Output method	Settable range of target value										
Addition counting	Values larger than the current value										
Subtraction counting	Values smaller than the current value										

■ Supplement to pulse output operation

When outputting pulses with the PLS+SIGN (direction output) method, pulses will be output approx. 300 μ s later after the output of direction signal (SIGN). (The characteristics of a motor driver are considered.)

■ Precautions during programming

- This instruction cannot be executed when a control active flag corresponding to each channel is ON.
- When describing the same channel in both the normal program and the interrupt program, be sure to program not to execute them simultaneously.
- Select "Pulse output" for the channel setting corresponding to the system register no. 402.
- When rewriting during RUN is performed during the operation, the pulse output stops while a program is being rewritten.
- Even if the control code is changed after starting the instruction, the change is invalid. It does not affect on the operation.
- When the frequency is changed to a value outside of the settable range after executing the instruction, the operation is performed with the minimum or maximum value in the specification range without causing an operation error.

Info.

- For details of the allocations of I/O and flags, refer to "Allocation of Memory Areas".

32.5 [F174 (SP0H)] Pulse Output (Selectable Data Table Control Operation)

32.5 [F174 (SP0H)] Pulse Output (Selectable Data Table Control Operation)

This instruction outputs pulses from a specified pulse output channel according to a specified data table.

■ Instruction format

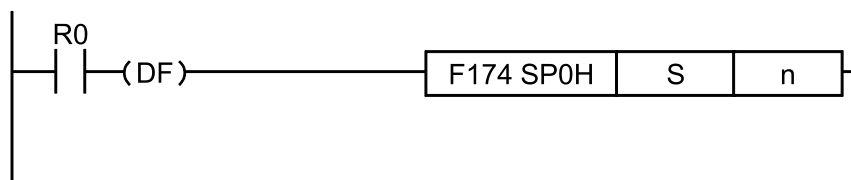

■ Operand

Operand	Settings
S	Starting number of the area in which data tables are registered
n	Target channel for pulse output

■ Memory area type that can be specified

Operand	WX	WY	WR	WL	SV	EV	DT	LD	I	Constant		Index modifier
										K	H	
S	-	-	-	-	-	-	•	-	-	-	-	•
n	-	-	-	-	-	-	-	-	-	•	•	-

■ Outline of operation

- Outputs pulses from a specified channel according to the settings specified in the data table starting with the address specified by [S] when a corresponding control active flag is OFF and the execution condition is ON.
- Switches the pulse frequency when the elapsed value of the high-speed counter reaches the target value set in the data table. (It is performed by the interrupt processing.)
- Stops the pulse output when the elapsed value reaches the final target value.
- For setting the frequency to 50 kHz or more, specify the duty of 1/4 (25%).

32.5 [F174 (SP0H)] Pulse Output (Selectable Data Table Control Operation)

■ Data table settings

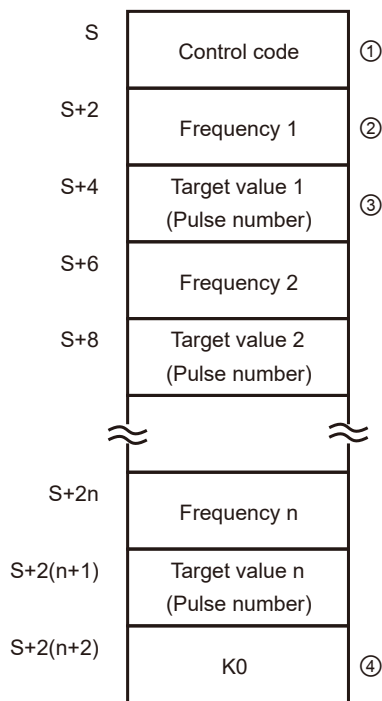

	Operand	Settings	Description						
(1)	S	Control code	<p>Specify the control code by setting the H constant.</p> <p style="text-align: center;">H <input type="checkbox"/><input type="checkbox"/><input type="checkbox"/><input type="checkbox"/><input type="checkbox"/><input type="checkbox"/><input type="checkbox"/><input type="checkbox"/><input type="checkbox"/></p> <p>0: Fixed</p> <p>Duty (on width)</p> <p>0: Duty 1/2 (50%)</p> <p>1: Duty 1/4 (25%)</p> <p>Frequency range</p> <p>Not used</p> <p>Operation mode</p> <p>0: Specify Incremental movement amount (pulse no.).</p> <p>1: Specify Absolute target value (absolute value).</p> <p>Output method</p> <p>0: Addition counting CW</p> <p>1: Subtraction counting CCW</p> <p>2: Addition counting PLS+SIGN (forward off)</p> <p>3: Subtraction counting PLS+SIGN (reverse on)</p> <p>4: Addition counting PLS+SIGN (forward on)</p> <p>5: Subtraction counting PLS+SIGN (reverse off)</p>						
(2)	S+2, S+2n	Frequency n	<p>The setting range of the settable maximum speed varies according to the setting of the initial speed as shown in the table below.</p> <table border="1"> <thead> <tr> <th>Range</th> <th>Initial speed</th> <th>Maximum speed</th> </tr> </thead> <tbody> <tr> <td>Low speed</td> <td>K1 to K49 (1 to 49 Hz)</td> <td>Initial speed to K22000 (to 22 kHz)</td> </tr> </tbody> </table>	Range	Initial speed	Maximum speed	Low speed	K1 to K49 (1 to 49 Hz)	Initial speed to K22000 (to 22 kHz)
Range	Initial speed	Maximum speed							
Low speed	K1 to K49 (1 to 49 Hz)	Initial speed to K22000 (to 22 kHz)							

32.5 [F174 (SP0H)] Pulse Output (Selectable Data Table Control Operation)

	Operand	Settings	Description																	
			Range	Initial speed	Maximum speed															
			High-speed	K50 to K100000 (50 Hz to 100 kHz)	Initial speed to K100000 (to 100 kHz)															
			<p>When the frequency 1 (initial speed) is the low speed range and the frequency n is not in the range between 1 Hz to 22 kHz, the pulse output stops.</p> <p>When the frequency 1 (initial speed) is the high speed range and the frequency n is not in the range between 50 Hz to 100 kHz, the pulse output stops.</p>																	
(3)	S+4, S+2(n+1)	Target value n	<p>Target value (K-2147483648 to K2147483647)</p> <p>The values of 32-bit data specified as target values should be within the range as shown in the table below.</p> <table border="1"> <thead> <tr> <th colspan="2">Control code setting</th> <th rowspan="2">Settable range of target value</th> </tr> <tr> <th>Operation mode</th> <th>Output method</th> </tr> </thead> <tbody> <tr> <td rowspan="2">Incremental</td> <td>Addition counting</td> <td>Positive values</td> </tr> <tr> <td>Subtraction counting</td> <td>Negative values</td> </tr> <tr> <td rowspan="2">Absolute</td> <td>Addition counting</td> <td>Values larger than the current value</td> </tr> <tr> <td>Subtraction counting</td> <td>Values smaller than the current value</td> </tr> </tbody> </table>			Control code setting		Settable range of target value	Operation mode	Output method	Incremental	Addition counting	Positive values	Subtraction counting	Negative values	Absolute	Addition counting	Values larger than the current value	Subtraction counting	Values smaller than the current value
Control code setting		Settable range of target value																		
Operation mode	Output method																			
Incremental	Addition counting	Positive values																		
	Subtraction counting	Negative values																		
Absolute	Addition counting	Values larger than the current value																		
	Subtraction counting	Values smaller than the current value																		
(4)	S+2(n+2)	K0	End of table (Pulse output stop setting)																	

■ Example of program

[Operation]

- (1) Starts the pulse output at 1000 Hz from the specified channel ch0 when the execution condition R10 of F174 (SP0H) instruction turns ON.
- (2) Switches the frequency to 2500 Hz when 1000 pulses are counted at 1000 Hz.
- (3) Switches the frequency to 5000 Hz when 3000 pulses are counted at 2500 Hz.
- (4) Switches the frequency to 1000 Hz when 8000 pulses are counted at 5000 Hz.
- (5) Stops the pulse output when 10000 pulses are counted.

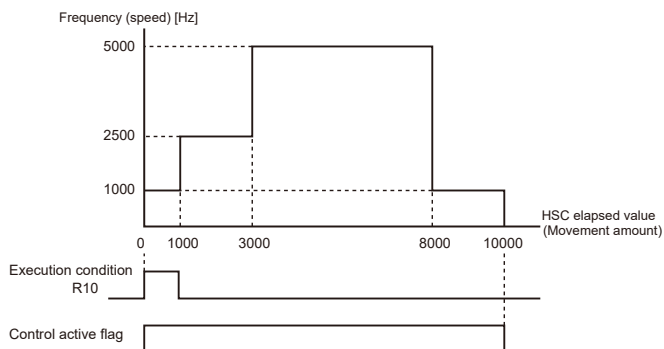

32.5 [F174 (SP0H)] Pulse Output (Selectable Data Table Control Operation)

(Note 1) When the execution condition R10 of F174 (SP0H) instruction turns ON, the control active flag will turn ON. When the elapsed value reaches 10000 and the pulse output stops, the control active flag will turn OFF.

[Settings and program]

Set the frequency range to 191 Hz to 100 kHz and duty 1/4 (25%), and the operation mode to Incremental and the output method to CW.

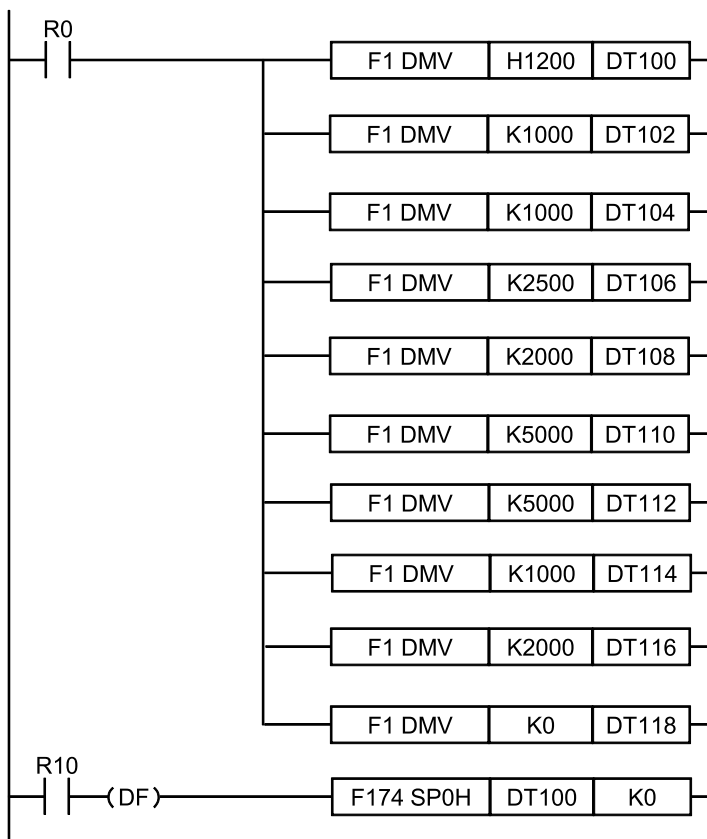

■ Supplement to pulse output operation

When outputting pulses with the PLS+SIGN (direction output) method, pulses will be output approx. 300 μ s later after the output of direction signal (SIGN). (The characteristics of a motor driver are considered.)

■ Precautions during programming

- The control active flag turns ON until the pulse output stops after the execution condition of F174 (SP0H) instruction has turned ON.
- This instruction cannot be executed when a control active flag corresponding to each channel is ON.
- Select "Pulse output" for the channel setting corresponding to the system register no. 402.
- When the control code or frequency 1 is any value outside of the settable range, an operation error occurs. (When the data of the frequency 1 is 0, nothing is executed and the operation ends.)

32.5 [F174 (SP0H)] Pulse Output (Selectable Data Table Control Operation)

- When the frequency after the second step is 0 or outside of the settable range, the pulse output stops.
- When the table pointer exceeds the area of data registers DT during the pulse output, the pulse output control will be canceled and the control active flag will turn OFF.
- The target values should be set in the range shown on the next page. If a value outside of the range is specified, the number of pulses different from the specified value is output.

Info.

- For details of the allocations of I/O and flags, refer to “Allocation of Memory Areas”.

32.6 [F175 (SPSH)] Pulse Output (Linear Interpolation)

Pulses are output from channel for 2 pulse output, in accordance with the parameters in the designated data table, so that the path to the target position forms a straight line.

■ Instruction format

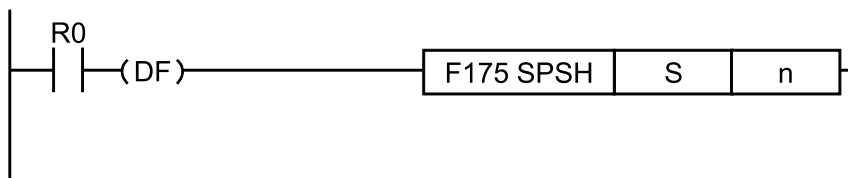

■ Operand

Operand	Settings
S	Starting number of the area in which data tables are registered
n	0 or 2

■ Memory area type that can be specified

Operand	WX	WY	WR	WL	SV	EV	DT	LD	I	Constant		Index modifier
										K	H	
S	-	-	-	-	-	-	•	-	-	-	-	•
n	-	-	-	-	-	-	-	-	-	•	•	-

■ Outline of operation

- Outputs pulses from a specified channel when a corresponding control active flag is OFF and the execution condition is ON.
- The control code, initial speed, maximum speed, acceleration / deceleration time, and target value are specified by creating data tables [S] to [S+11] described on the next page using a user program.
- For setting the frequency to 40 kHz or more, specify the duty of 1/4 (25%).

32.6 [F175 (SPSH)] Pulse Output (Linear Interpolation)

■ Data table settings

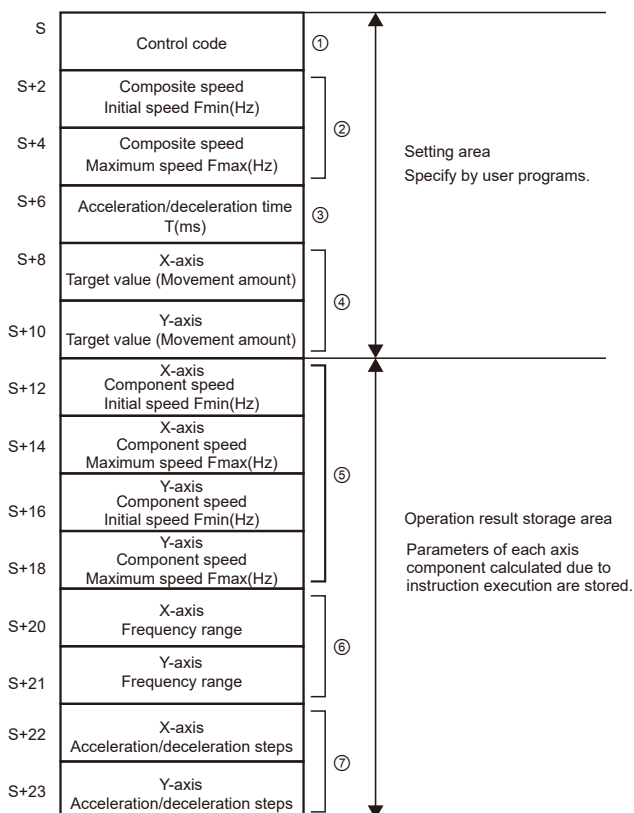

Setting area

	Operand	Settings	Description
(1)	S	Control code	<p>Specify the control code by setting the H constant.</p> <p>0: Fixed</p> <p>Duty (on width)</p> <p>0: Duty 1/2 (50%)</p> <p>1: Duty 1/4 (25%)</p> <p>0: Fixed</p> <p>Operation mode and output method</p> <p>00: Incremental CW/CCW</p> <p>02: Incremental PLS+SIGN (forward off/reverse on)</p> <p>03: Incremental PLS+SIGN (forward on/reverse off)</p> <p>10: Absolute CW/CCW</p> <p>12: Absolute PLS+SIGN (forward off/reverse on)</p> <p>13: Absolute PLS+SIGN (forward on/reverse off)</p>
(2)	S+2	Composite speed	Composite speed (Initial speed, maximum speed) (Hz) <K constant>

32.6 [F175 (SPSH)] Pulse Output (Linear Interpolation)

	Operand	Settings	Description
	S+4	Initial speed Fmin (Hz) Composite speed Maximum speed Fmax (Hz)	<p>1.5 Hz to 100 kHz [K1 to K100000] (However, for 1.5 Hz, the angle is 0 degree or 90 degrees only. Also, for specifying 1.5 Hz, specify K1.)</p> <ul style="list-style-type: none"> When the component speed becomes lower than the minimum speed in each frequency range, it will be a corrected component speed. Do not set 60 kHz or more when using any two of the high-speed counter, periodical interrupt and PLC link are used simultaneously. When the initial speed is set to the maximum speed, the pulse output is performed without acceleration and deceleration. Specify the composite speed to make the component speed of each axis be 1.5 Hz or more. Composite speed (Initial speed): 30 kHz or less <p>Notes on the specification of composite speed (initial speed) When each initial component speed of CH0 and CH2 is not 1.5 Hz or more by the following arithmetic expression, the path may not be linear. (When the following formula is not satisfied)</p> $f \geq \frac{1.5 \sqrt{(\Delta X^2 + \Delta Y^2)}}{\Delta X}$ <p>Δx: Channel whose distance of (target value - current value) is short Δy: Channel whose distance of (target value - current value) is long</p>
(3)	S+6	Acceleration / deceleration time T (ms)	<p>Acceleration / deceleration time (ms) <K constant> K0 to K32767</p> <p>In the case of 0, the pulse output is performed at the initial speed (composite speed) without acceleration and deceleration.</p>
(4)	S+8	X-axis Target value (Movement amount)	<p>K-8388608 to K8388607</p> <p>When only one axis is activated;</p> <ol style="list-style-type: none"> For the incremental mode, set the target value of the axis that is not activated to 0. For the absolute mode, set the target value of the axis that is not activated to the same as the current value. <p>(Note): In the case of linear interpolation, infinite rotation cannot be performed.</p>
	S+10	Y-axis Target value (Movement amount)	

Operation result storage area

	Operand	Settings	Description
(5)	S+12	X-axis component speed Initial speed Fxmin	<p>The component speed (initial speed and maximum speed of each axis) is stored as 2 words in real type.</p> $\text{X-axis component speed} = \frac{(\text{Composite speed}) \times (\text{X-axis movement amount})}{\sqrt{((\text{X-axis movement amount})^2 + (\text{Y-axis movement amount})^2)}}$ $\text{Y-axis component speed} = \frac{(\text{Composite speed}) \times (\text{Y-axis movement amount})}{\sqrt{((\text{X-axis movement amount})^2 + (\text{Y-axis movement amount})^2)}}$ <p>Example) Even when the initial speed is corrected, the calculated value is stored as is in the operation result storage area.</p>
	S+14	X-axis component speed Maximum	

32.6 [F175 (SPSH)] Pulse Output (Linear Interpolation)

	Operand	Settings	Description
		speed Fmax	
	S+16	Y-axis component speed Initial speed Fymin	
	S+18	Y-axis component speed Maximum speed Fmax (Hz)	
(6)	S+20	X-axis Frequency range	The frequency ranges are automatically selected by the system for the components of each axis 0: Low speed range (1 Hz to 22 kHz) 1: High speed range (50 Hz to 100 kHz)
	S+21	Y-axis Frequency range	When the initial speed (X / Y axis) is the low speed range and the maximum speed (X / Y axis) exceeds 22 kHz, the initial speed (X / Y axis) is corrected to 50 Hz. When the initial speed (X / Y axis) is less than 1 and the maximum speed (X / Y axis) exceeds 22 kHz or less, the initial speed (X / Y axis) is corrected to 1 Hz.
(7)	S+22	X-axis Acceleration / Deceleration steps	The acceleration / deceleration steps are automatically calculated by the system in the range of 0 to 60 steps. <ul style="list-style-type: none"> When the operation result is 0, the pulse output is performed at the initial speed (composite speed) without acceleration and deceleration. The acceleration / deceleration steps are calculated by the following formula; Acceleration / deceleration time (ms) x Initial component speed (Hz).
	S+23	Y-axis Acceleration / Deceleration steps	Example) When the settings are as follows; Incremental, Initial speed = 300 Hz, maximum speed = 5 kHz, Acceleration / deceleration time=0.5 s, CH0 target value = 1000, and CH2 target value = 50. $\text{CH0 Initial component speed} = \frac{300 \times 1000}{\sqrt{(1000^2 + 50^2)}} = 299.626 \text{ Hz}$ $\text{CH2 Initial component speed} = \frac{300 \times 50}{\sqrt{(1000^2 + 50^2)}} = 14.981 \text{ Hz}$ CH0 Acceleration/deceleration steps = $500 \times 10^{-3} \times 299.626 \approx 147.8 \rightarrow 60$ steps CH2 Acceleration/deceleration steps = $500 \times 10^{-3} \times 14.981 \approx 7.4 \rightarrow 7$ steps

■ Supplement to pulse output operation

When outputting pulses with the PLS+SIGN (direction output) method, pulses will be output approx. 300 μs later after the output of direction signal (SIGN). (The characteristics of a motor driver are considered.)

■ Precautions during programming

- Set the target value and movement amount to be within the following range.
-8,388,608 to +8,388,607
When using this instruction in combination with other positioning instructions such as F171, also set the target values for those instructions to be within the above range.
- When using this instruction for a purpose for which high accuracy is required, confirm the operation using a real machine.
- When describing the same channel in both the normal program and the interrupt program, be sure to program not to execute them simultaneously.
- Select "Pulse output" for the channel setting corresponding to the system register no. 402.
- By performing the rewriting during RUN while outputting pulses, more pulses than the setting may be output.

i Info.

- For details of the allocations of I/O and flags, refer to "Allocation of Memory Areas".

(MEMO)

33 Precautions for programming

33.1	Changing the Set Value of Timer/Counter During RUN	33-2
33.1.1	How to Rewrite Constants in the Program	33-2
33.1.2	Methods Used to Rewrite a Value in the Set Value Area	33-2
33.2	Use of Duplicate Output.....	33-5
33.2.1	Duplicate Output	33-5
33.2.2	Processing When Output Is Duplicated with OT, KP, SET, and RST Instructions	33-5
33.3	Rise Detection Method.....	33-7
33.3.1	Rise Detection Instructions	33-7
33.3.2	Operation and Precautions at Run Start Time	33-8
33.3.3	Precautions When Using Control Instructions	33-9
33.4	Operation Errors	33-12
33.4.1	Outline of Operation Errors	33-12
33.4.2	Operation Mode when an Operation Error Occurs	33-12
33.4.3	Handling the Occurrence of Operation Errors.....	33-13
33.4.4	Points to Review in Program.....	33-13
33.5	How to Use the Index Register	33-15
33.5.1	Index Registers	33-15
33.5.2	Index Modification Applicable Areas	33-15
33.5.3	Example of Using an Index Register.....	33-16
33.6	Handling BCD Data.....	33-18
33.7	Precautions for Programming	33-20
33.8	Rewrite Function During RUN.....	33-22
33.8.1	Operation of Rewrite During RUN.....	33-22
33.8.2	When Rewriting During RUN is not Possible	33-22
33.8.3	Method and Operation of Rewriting during RUN	33-24
33.9	Processing During Forced Input/Output	33-25

33.1 Changing the Set Value of Timer/Counter During RUN

33.1 Changing the Set Value of Timer/Counter During RUN

33.1.1 How to Rewrite Constants in the Program

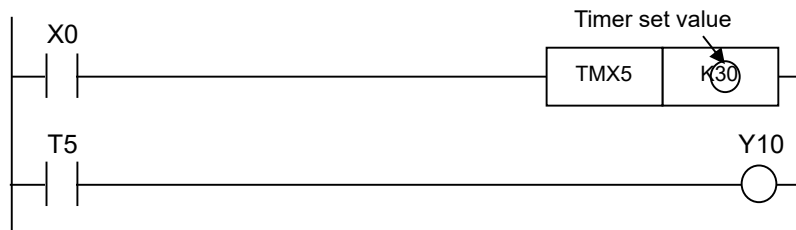

Method using programming tool software

Here is an example of changing the set value of timer 5 from K30 to K50.

1 2 Procedure

1. Place the cursor on the timer 5 set value K30.
2. Enter the new constant K50, and press the Enter key.
3. Finalize the program by using [PB conversion] or [project conversion], and write it to the main unit.

Operation and cautions after the change

- When the program is changed using programming tool software, the timers and counters in operation will continue to operate unchanged. The program will start operating with the changed settings after the next execution condition changes from OFF to ON.
- When the constants in the program are rewritten, the program itself is rewritten, so when the mode is switched and RUN again, or when the power is turned off and on, the program is preset with the changed settings.

33.1.2 Methods Used to Rewrite a Value in the Set Value Area

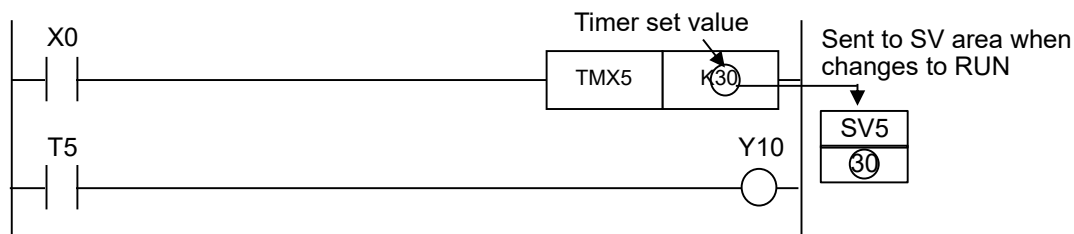

Changing a value in set value area SV

A value in set value area SV can be rewritten under the following conditions.

- Rewriting methods:
 1. Method using programming tool software
 2. Method using a program (high-level instruction)

Operation and cautions after the change

33.1 Changing the Set Value of Timer/Counter During RUN

- After the change, the active timer/counter will continue to run. The program will start operating with the changed settings after the next execution condition changes from OFF to ON.
- With these methods, the value in set value area SV will change; however, the program itself is not rewritten. Therefore, when the mode is changed and then set back to RUN, or when the power is turned back on, the operation will be as follows.
 1. When the set value is specified by a K constant
The K constant is preset in set value area SV. After the change, the value will no longer be valid.
 2. When the set value is specified by a set value area number
In the case of a non-hold-type timer/counter, 0 is preset in set value area SV. In the case of a hold-type timer/counter, the value changed by the method on the previous page is preset in set value area SV.

Method 1: Using programming tool software

From the menu bar, select: **Online>Device Monitor.**

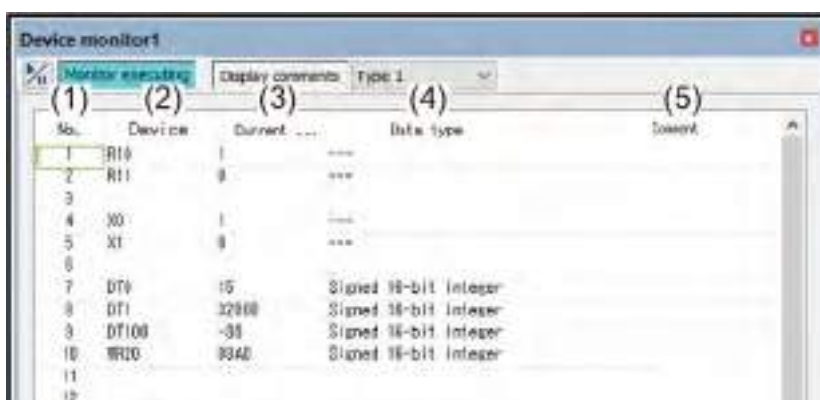

		Description
(1)	No.	Displays the line number.
(2)	Device	Pressing the <Enter> key or double-clicking in this field displays the device code and device number.
(3)	Current value	Displays the monitored data value. During online monitoring, data can be changed by pressing the <Enter> key or double-clicking in this field.
(4)	Data type	Pressing the <Enter> key or double-clicking in this field displays the number base (decimal, hexadecimal, binary, ASCII) and number of words to be monitored.
(5)	Comments	Displays the I/O comments for each register. I/O comments can be added for each register by pressing the <Enter> key or double-clicking in this field.

(Note 1) For details, see the FPCWIN GR7 help menu.

Method 2: Using a program (high-level instruction)

To change the set value of a timer/counter based on an input condition, etc., use a high-level instruction as shown below to rewrite the value in set value area SV of the relevant timer or counter.

33.1 Changing the Set Value of Timer/Counter During RUN

Example: Changing the set value to K20 when input X0 turns ON

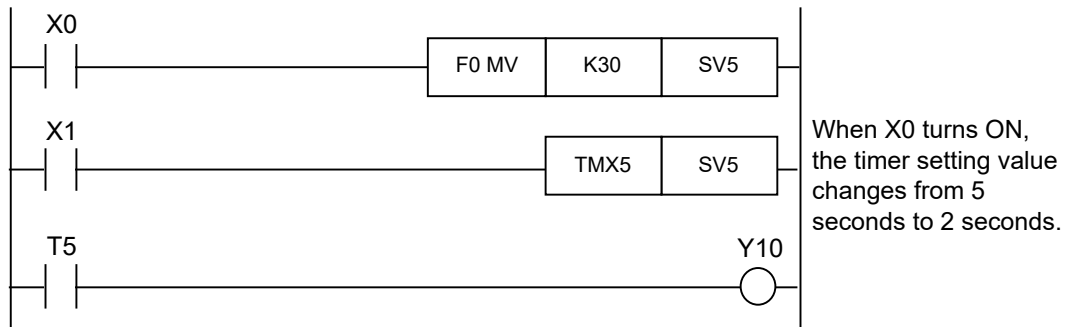

When X0 turns ON, the timer setting value changes from 5 seconds to 2 seconds.

The SV area can also be specified directly in the set value area. The set value can be changed by changing the value to be transmitted, using the F0 instruction, etc.

33.2 Use of Duplicate Output

33.2.1 Duplicate Output

- The term “duplicate output” refers to a case where the same output is specified in duplicate within one sequence program.
- If the same output is specified for the **OT** instruction and **KP** instruction, it is considered to be a duplicate output.
- Even if the same output is used for the **SET** instruction, **RST** instruction and a high-level instruction (such as data transfer), it is not regarded as a duplicate output.
- If the mode is switched to the "RUN mode" while the duplicate output state exists, an error occurs under normal conditions. (The ERR. LED flashes and the self-diagnostic error flag R9000 turns ON.)

■ How to check for a duplicate output

You can check for duplicate outputs in the program using the programming tool, by the following method.

Perform a total check on a project from the menu.

If a duplicate output is detected, an error message [Duplicate use (definition) error] and its address.

■ Enabling a duplicate output

- If you need to use output repeatedly due to the content of the program, a duplicate output can be enabled.
- In this case, change the setting of system register No. 20 to “Enable”.
- Once this is done, an error will not occur when the program is executed.

33.2.2 Processing When Output Is Duplicated with OT, KP, SET, and RST Instructions

■ Status of internal and output relays during operation

If instructions that output to internal and output relays, such as the OT instruction, KP instruction, SET instruction, RST instruction, and transfer instructions, are executed in duplicate, the contents are rewritten at each step during operation.

33.2 Use of Duplicate Output

<Example> Processing when the SET instruction, RST instruction, and OT instruction are used (X0 to X2 are all ON)

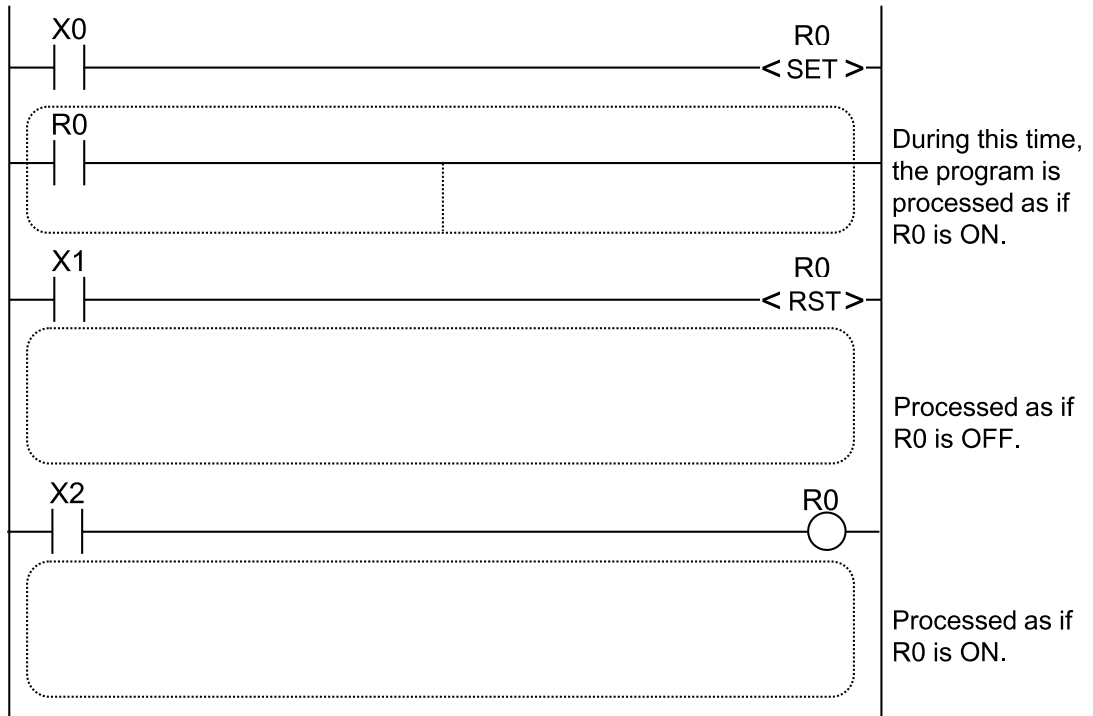

■ Determination of operation result

If the same output is used in duplicate by several instructions such as the OT instruction, KP instruction, SET instruction, RST instruction, or a transfer instruction, the output obtained when I/O refresh is performed is determined by the final operation results.

<Example> Output to the same output relay Y10 by the OT instruction, SET instruction, and RST instruction

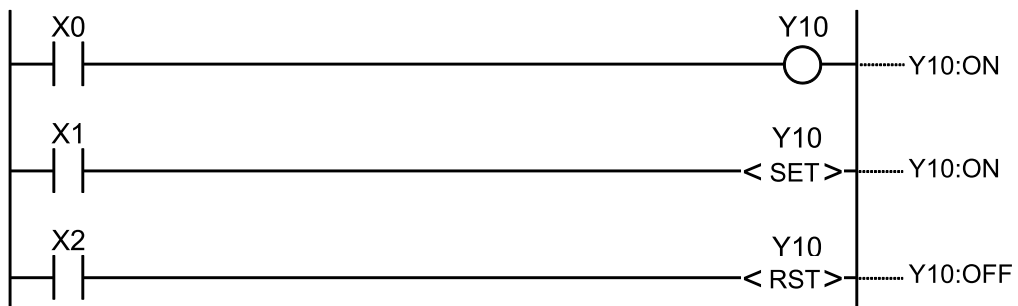

When X0 to X2 are all ON, output occurs with Y10 OFF when I/O refresh is performed.

33.3 Rise Detection Method

33.3.1 Rise Detection Instructions

■ Instructions for which rise detection is performed

1. DF (rise differential)
2. CT (counter) count input
3. F118 UDC (up-down counter) count input
4. SR (shift register) shift input
5. F119 LRSR (left and right shift register) shift input
6. NSTP (next step)
7. Differential execution type high-level instruction (instruction specified by P and a number)

■ What is rise detection?

Instructions for which rise detection is performed are only executed in the scan when the execution condition changes from OFF to ON.

1. Normal input detection

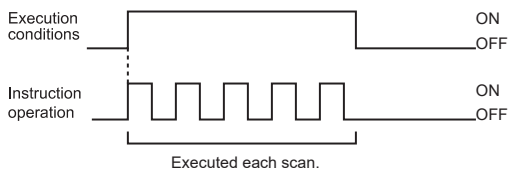

2. Rise detection

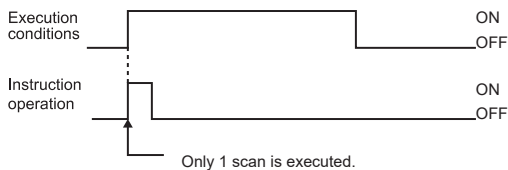

■ Rise detection method

The previous execution condition is compared with the current execution condition, and the instruction is executed only when the previous condition was OFF and the current condition is ON.

The instruction will not be executed otherwise.

■ Precautions for instructions for which rise detection is performed

- When RUN is started, such as when the power is turned on, instructions are not executed because the change of the execution condition from OFF to ON is not detected. See below.
- Be aware that, if used with instructions that change the order of execution, such as the instructions in 1 to 6 below, the operation of instructions may change depending on the input timing.

<Instructions that require caution when using instructions for which rise detection is performed>

1. MC to MCE instructions
2. JP to LBL instructions

33.3 Rise Detection Method

3. LOOP to LBL instructions
4. CNDE instruction
5. Step ladder instructions
6. Subroutine instructions

33.3.2 Operation and Precautions at Run Start Time

■ **Operation of first scan after RUN begins**

- The leading edge detection instruction is not executed when the mode has been switched to the "RUN mode", or when the power supply is booted in the "RUN mode", if the execution condition is already ON.

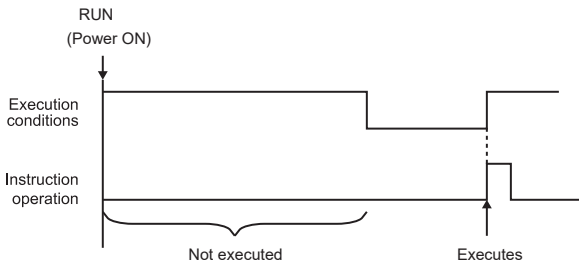

- If you need to execute an instruction when the execution condition is ON prior to switching to "RUN mode", use the special internal relay R9014 in your program as follows. (R9014 is a special internal relay which is OFF during the first scan and turns ON from the second scan onwards.)

Example 1: DF (leading edge differential) instruction

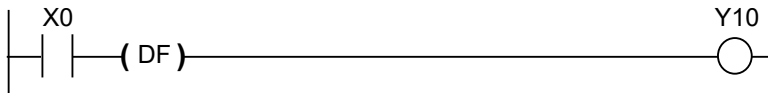

↓ Add R9014

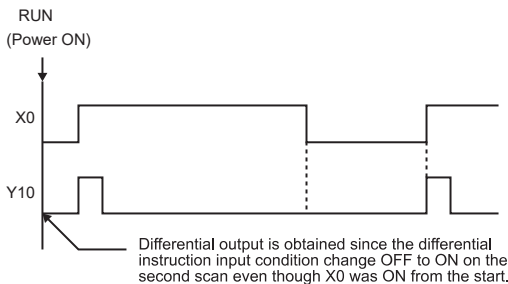
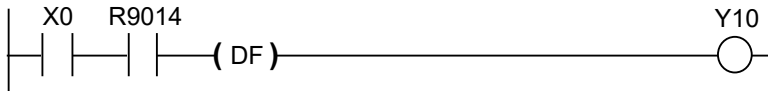

Example 2: CT (counter) instruction

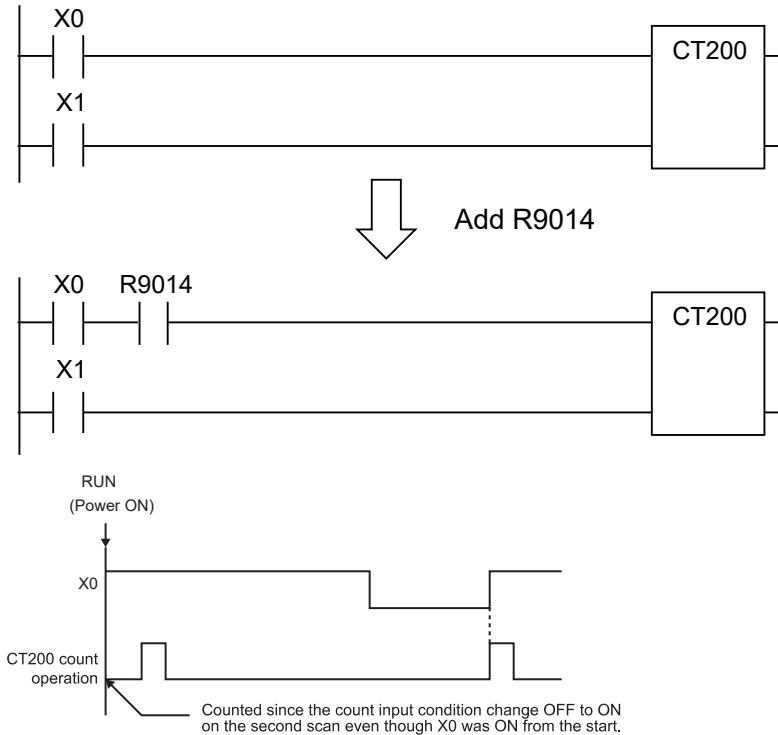

33.3.3 Precautions When Using Control Instructions

- Instructions that perform rise detection compare the execution condition from the last time that instruction was performed with current execution condition, and are only executed when the condition changes from OFF to ON. They are not executed in any other circumstance.
- When a rise detection instruction is used with an instruction that changes the order in which instructions are executed, such as MC and MCE, or JP and LBL, the operation of the instruction may change as follows depending on input timing.

Example 1: When using the differential instruction DF between MC and MCE

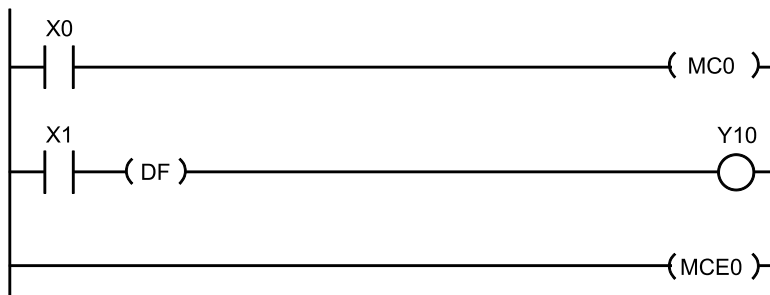

33.3 Rise Detection Method

[Timing chart 1]

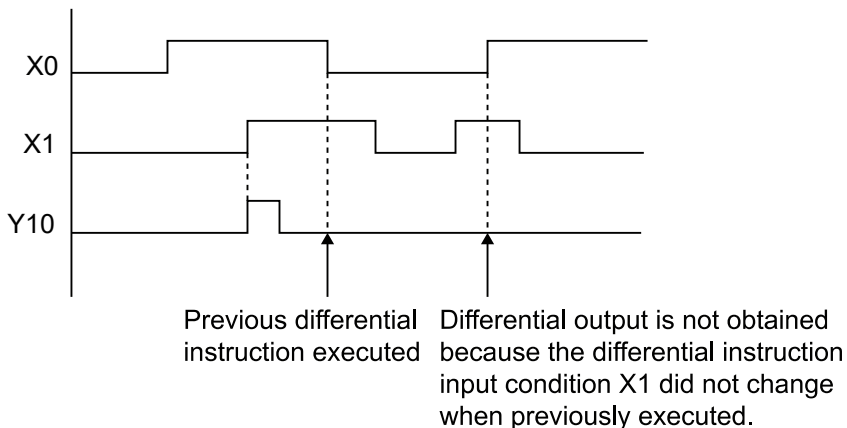

[Timing chart 2]

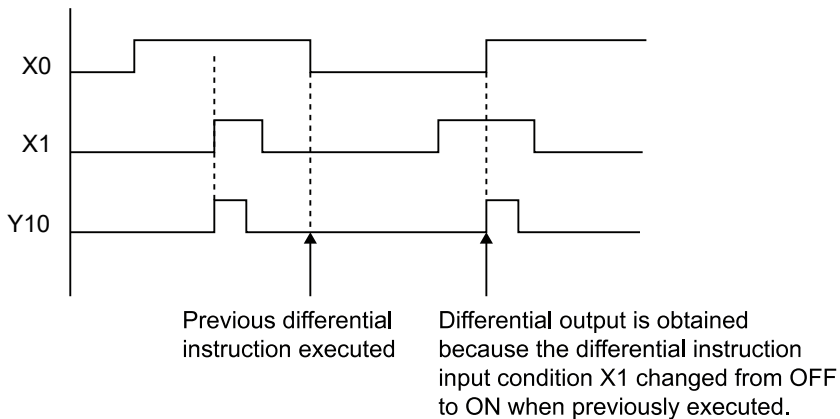

Example 2: When using the counter instruction between JP and LBL



[Timing chart 1]

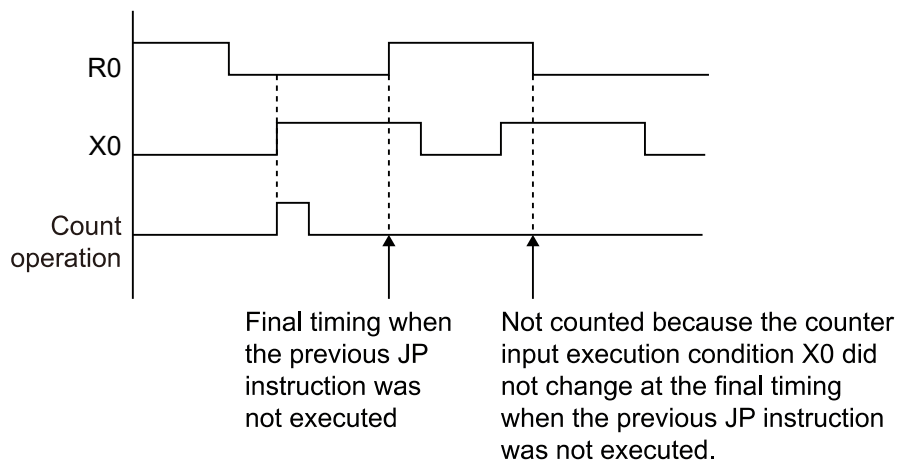

[Timing chart 2]

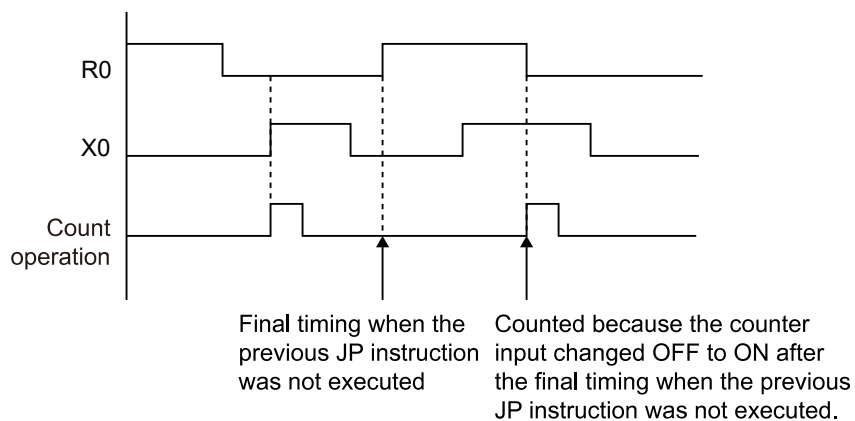

33.4 Operation Errors

33.4 Operation Errors

33.4.1 Outline of Operation Errors

■ Outline of operation errors

- An operation error is a condition in which operation is impossible when a high-level instruction is executed.
- When an operation error occurs, the ERR. LED on the control unit will flash and the operation error flags (R9007 and R9008) will turn ON.
- The operation error code K45 is set at special data register DT90000.
- The error address is stored in special data registers DT90017 and DT90018.

■ Types of operation error

(1)	Address error	The memory address (number) specified by index modification is outside the area which can be used.
(2)	BCD error	Operation is attempted on non-BCD data when an instruction handling BCD is executed. BCD conversion is attempted on data which is not within the possible conversion range.
(3)	Parameter error	In an instruction requiring the specification of control data, the specified data is outside the possible range.
(4)	Over area error	The data manipulated by a block instruction exceeds the memory range.

33.4.2 Operation Mode when an Operation Error Occurs

Normally, the operation stops when an operation error occurs.

To have the operation continue even if an operation error occurs, change system register No.26 to "Continuation".

Implement this change as follows.

1 Procedure

1. Set the control unit to "PROG. mode".
2. Select "System register settings".
3. From the "System register settings" menu, select the "Action on error" screen.
4. Clear the system register No.26 check box and change to "RUN".
5. Press [OK] to write the setting to the PLC.

33.4.3 Handling the Occurrence of Operation Errors

■ Procedure

1. Check the location where the error occurred

Refer to the error address stored in DT90017 and DT90018, then check the high-level instruction for that address.

2. Clear the error status

Clear the error by using the programming tool. (If the mode selection switch is set to RUN, the system will enter a RUN state when the error is cleared.)

Execute "Clear error" on the "Status display" menu of the programming tool software.

- The error can also be cleared by turning the power on and off in "PROG. mode". Note, however, that the content of the operation memory other than hold type data will be cleared.
- The error can also be cleared by using the self-diagnostic error set instruction (F148).

33.4.4 Points to Review in Program

Be sure to review your program by following the points below.

1. Check if an extraordinarily large value or negative value is stored in the index registers.

Example: When a data register is modified using an index register

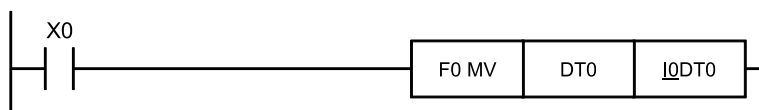

In this case, the index register modifies the address of data register DT0. If the value of I0 is too large, it will exceed the specifiable range of the data register. If the data in I0 is larger than the final address of the data register, an operation error will occur. The same is true when the data in I0 is a negative value.

2. Check if there is any data that cannot be converted by BCD-BIN data conversion.

Example: When BCD-to-BIN conversion is attempted

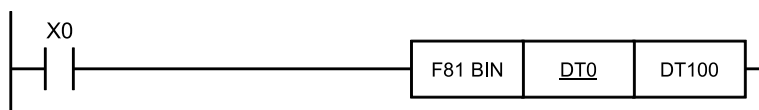

In this case, if DT0 contains a hexadecimal number that includes one of the digits A through F such as "12A4", the data conversion will be impossible and an operation error will result.

33.4 Operation Errors

Example: When BIN-to-BCD conversion is attempted

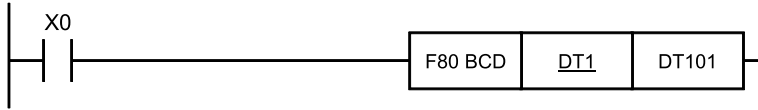

In this case, if DT1 contains a negative value or a value greater than K9999, an operation error will occur.

3. Check if the divisor of a division instruction is "0".

<Example>

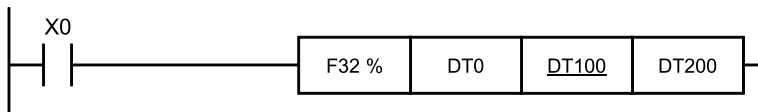

In this case, if the content of DT100 is "0", an operation error will occur.

33.5 How to Use the Index Register

33.5.1 Index Registers

- Index registers are used for indirect specification of values to numbers and operands in relays and memory areas. (This is called "index modification".)
- The range that can be specified is 14 points, and the numbers that can be specified are I0 to ID.
- Add the index register to the relay, memory area, or constant you want to modify, and then write the modifying value (16-bit data) to the index register.

<Example> Transferring the contents of data register DT100 to the number specified by the contents of an index register

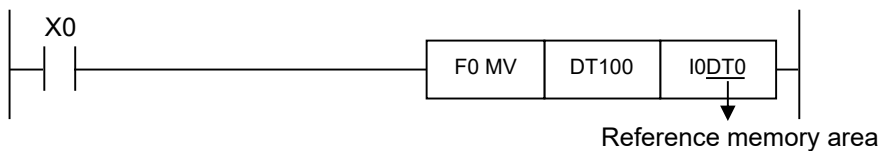

In this example, the number of the destination data register varies depending on the contents of I0 with DT0 acting as a base. For example, when I0 is K10, the destination will be DT10, and when the I0 is K20, the destination will be DT20.

- In this way, index registers allow the specification of multiple memory areas with a single instruction, and thus index registers are very convenient when handling large amounts of data.

33.5.2 Index Modification Applicable Areas

- Index registers can be used to modify other types of memory areas in addition to data register DT.
 - <Example> I0WX10, I2WY1, I3WR0, IASV0, IBEV2
- Constants can also be modified.
 - <Example> I0K10, I0H1001
- When a 32-bit constant is modified, the index registers of the specified number and the following number are used in combination to handle the data as 32-bit data. The result of the modification is 32-bit data.

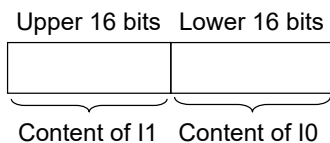

(Note 1) When modifying a 32-bit constant, do not specify the ID. Be aware that a syntax error will not occur even if this is specified.

33.5 How to Use the Index Register

33.5.3 Example of Using an Index Register

■ When external data is read successively

<Example> Writing the contents of input WX3 sequentially from data register DT0

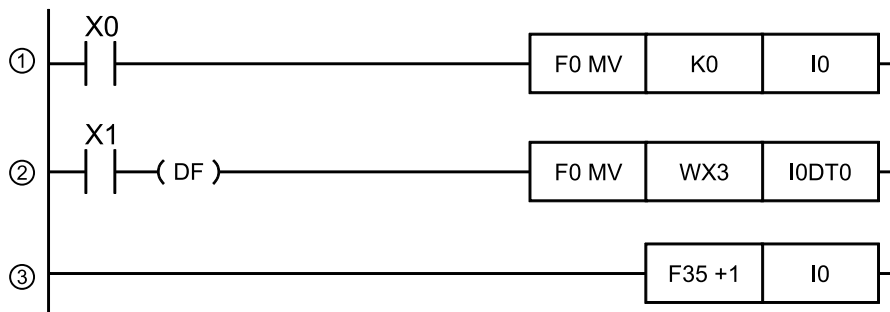

(1) When X0 is ON, index register I0 is set to 0.

(2) When X1 turns ON, the content of input WX3 is transferred to the data register specified by I0DT0.

(3) Adds 1 to I0.
In this case, the content of I0 changes in sequential order, so the write destination of the data register becomes as shown below.

Input of X1	Content of I0	Data writing destination
1st time	0	DT0
2nd time	1	DT1
3rd time	2	DT2

■ Inputting and outputting data according to the number specified by input

<Example 1> Setting a timer with a number specified by a digital switch

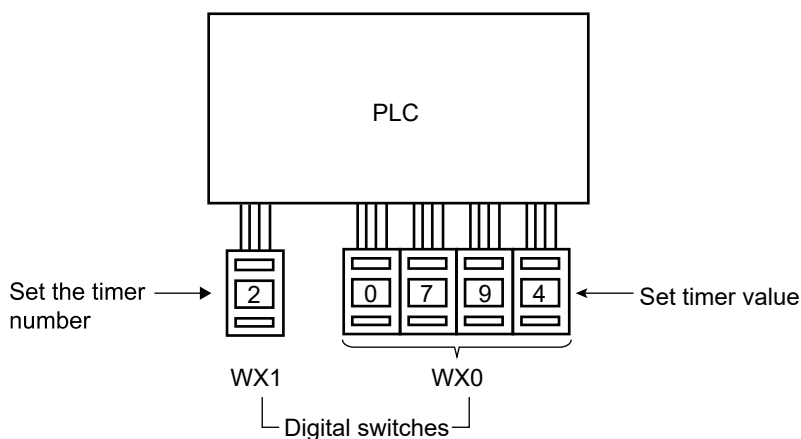

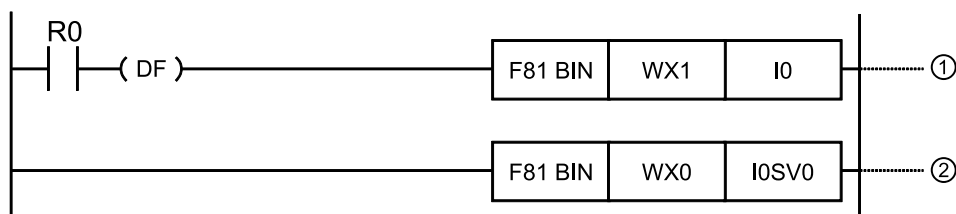

(1)	Timer number data WX1 is converted from BCD data to BIN data, and is set to index register I0.
(2)	Timer setting value data WX0 is converted from BCD data to BIN data, and is stored in the timer setting value area SV specified by the content of I0.

<Example 2> External output of the timer process value with the number specified by the digital switch

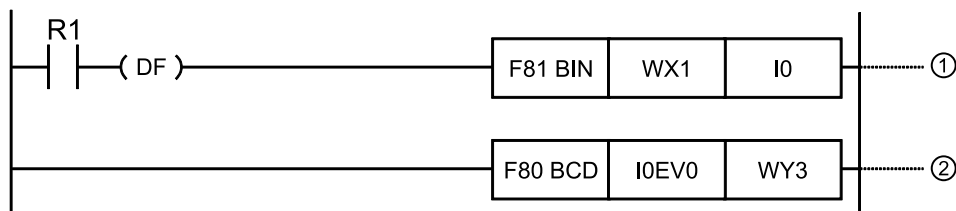
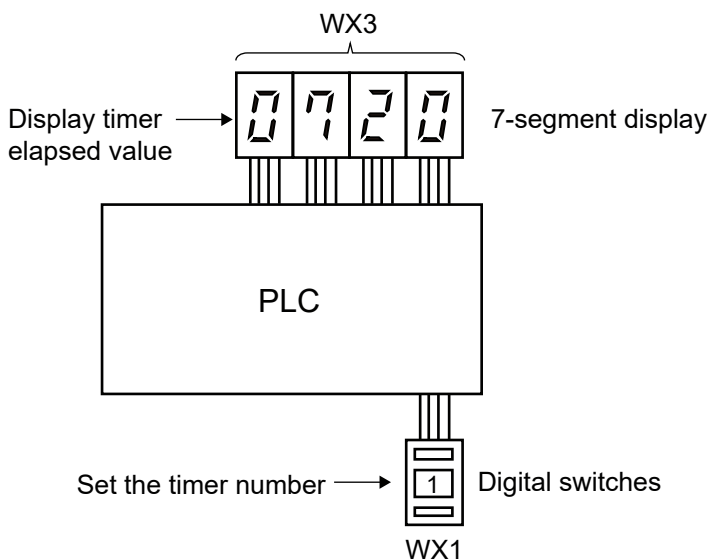

(1)	Timer number data WX1 is converted from BCD data to BIN data, and is set to index register I0.
(2)	The content of timer process value data EV specified by the content of I0 is converted to BCD data, and output to output WY3.

33.6 Handling BCD Data

(1) What is BCD?

BCD or binary coded decimal refers to a decimal number that is divided into single digits and expressed by binary numbers.

<Example> Decimal number expressed in BCD

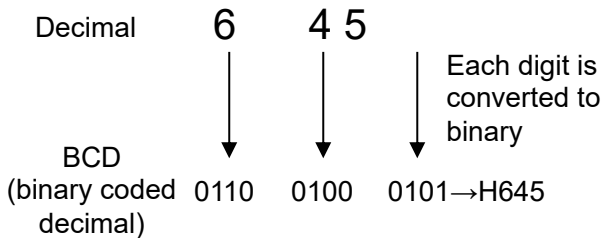

(2) Handling of BCD data in the PLC

- When inputting data from a digital switch to the PLC or outputting data to a 7-segment display (with decoder), the input or output must be BCD data. In this case, use a data conversion instruction as shown in the examples below.
- BCD arithmetic instructions (F40 through F58) also exist that can operate directly on BCD data. However, since operations in the PLC are usually processed in BIN, it is more convenient to use BIN operation instructions (F20 through F38).

■ Inputting from a digital switch

Use the F81 BIN instruction as the BCD to BIN conversion instruction.

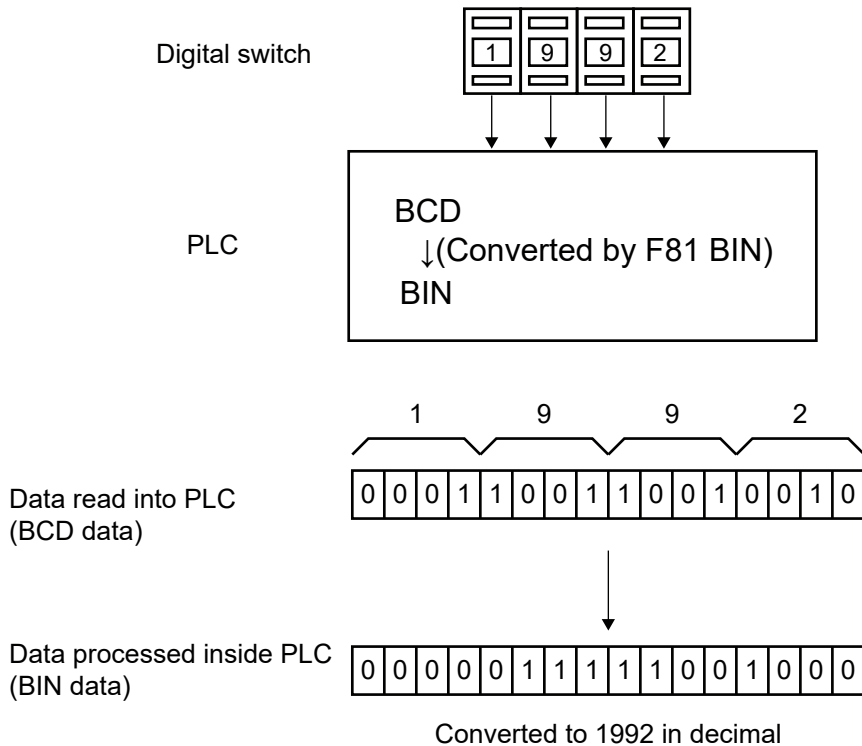

■ Outputting to a 7-segment display (with decoder)

Use the F80 BCD instruction as the BIN to BCD conversion instruction.

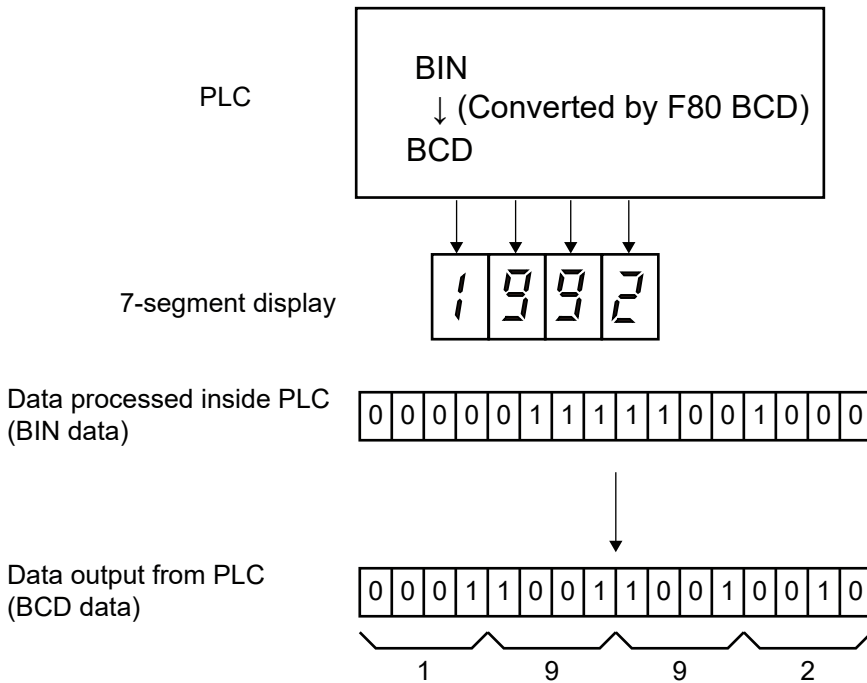

33.7 Precautions for Programming

33.7 Precautions for Programming

<Example 1>

Programs that do not execute correctly

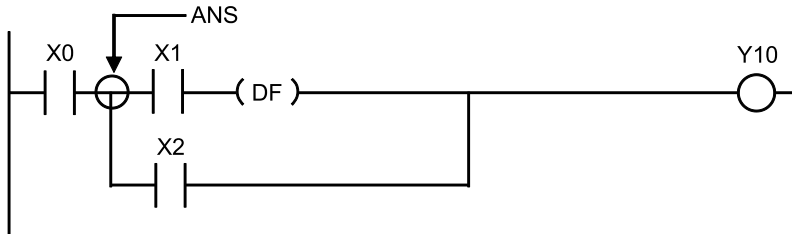

- If X1 turns ON first, Y10 does not turn ON even if X0 is ON.

Rewritten Program

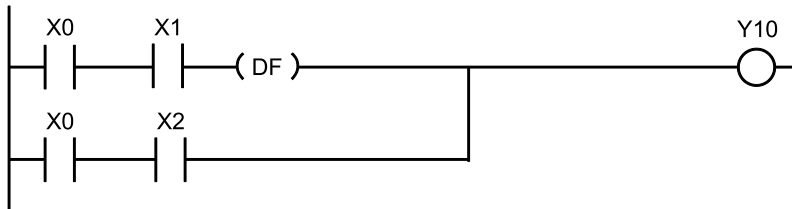

<Example 2>

Programs that do not execute correctly

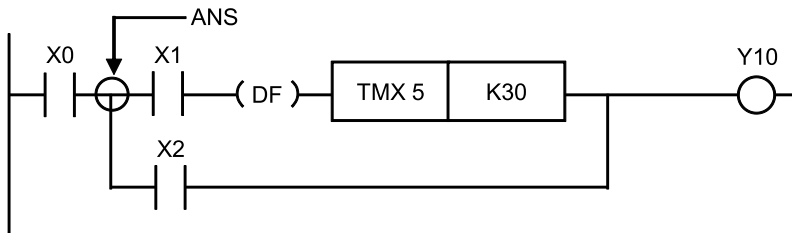

- Regardless of whether X0 is ON or OFF, if X1 is ON, TMX5 becomes active.

Rewritten program

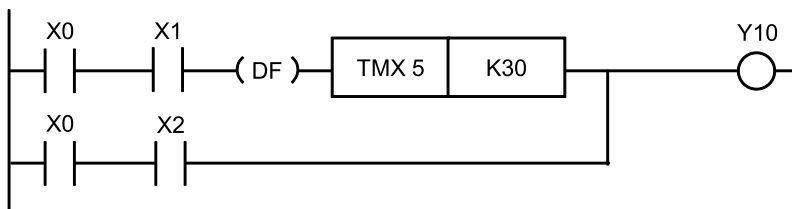

<Example 3>

Programs that do not execute correctly

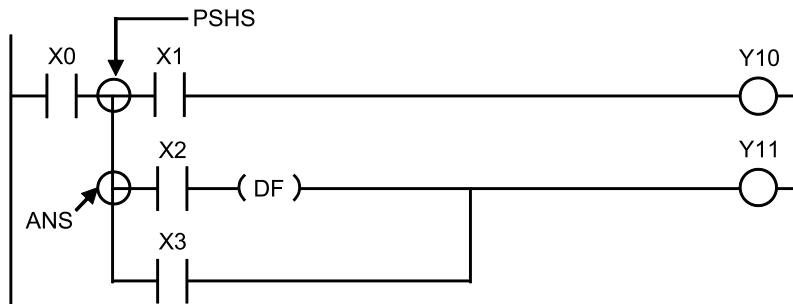

- If X2 is ON first, even if X0 is ON, Y11 does not turn ON.

Rewritten program

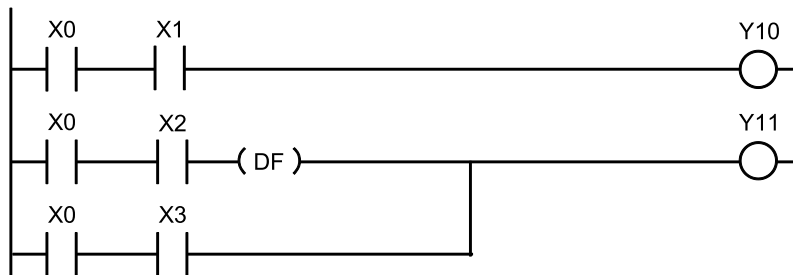

- When a combination of contacts are set as the execution condition of a differential instruction (DF) or timer instruction, do not use an AND stack, push stack, read stack, or pop stack instruction.

33.8 Rewrite Function During RUN

33.8 Rewrite Function During RUN

33.8.1 Operation of Rewrite During RUN

■ How Rewrite During RUN Works

A program can be rewritten even during "RUN mode".

When attempting to rewrite a program during RUN, the tool service time is temporarily extended, the program rewritten, and operation is resumed without changing the mode.

For this reason, the scan time of one scan when rewriting during RUN is extended by several ms to several hundred ms.

■ Controller Operation During Rewrite

(1)	External output (Y) is held.
(2)	External input (X) is ignored.
(3)	Timer (T) stops the clock.
(4)	Rise and fall changes in the inputs of the differential instructions (DF), counter instructions (C), and right/left shift registers are ignored.
(5)	Interrupt functions are stopped.
(6)	Internal clock relays (special internal relays) are also stopped.
(7)	Pulse output is stopped for the duration.

■ Setting Values for Timer/Counter Instructions

All set values specified with K constants for timer and counter instructions are preset to the set value SV area with corresponding numbers. (Values in elapsed value area EV do not change.)

■ Operation of the Rewrite During RUN Completion Flag

The rewrite during RUN completion flag (R9034) is a special internal relay that turns ON only for the first scan after rewrite during RUN is complete. It can be used instead of the initial pass relay following a change in a program.

33.8.2 When Rewriting During RUN is not Possible

■ When the timeout message is displayed

Even if the timeout message is displayed, it is likely that the PLC has been rewritten.

The ladder edit remains, so take the system offline, complete the program changes in the tool software, then change to online mode to check.

■ When timeout occurs using the GT series display unit through mode

Use GTWIN to extend the timeout period of the display unit. (The default value is 5 seconds.)

Select "Transfer" from **File** in the menu bar to open the data transfer screen. Select "Communication Conditions" from the data transfer screen to open the communication settings screen. The "Timeout" item displays the number of seconds, so change this value. Click the [OK] button to complete the setting change.

- When rewriting during run is not possible
 1. When the result of rewriting is a syntax error, rewriting is not possible.

[Specific example]

When the rewriting would not form a pair of the following instructions

- a) Step ladder instructions (SSTP/STPE)
- b) Subroutine instructions (SUB/RET)
- c) Interrupt instructions (INT/IRET)
- d) JP/LBL
- e) LOOP/LBL
- f) MC/MCE

Rewriting is not possible in the case of other syntax errors.

2. Rewriting during RUN is not possible during forced input/output operation.

- Interrupt processing restrictions

Do not perform a rewrite during RUN when using interrupt, high-speed counter, pulse output, or PWM output functions.

Note that when executing a rewrite during RUN, the following operations will occur.

1. Interrupt programs will be disabled. Re-enable with an ICTL instruction.

e.g. When using R9034 (Completion flag for rewrite during RUN)

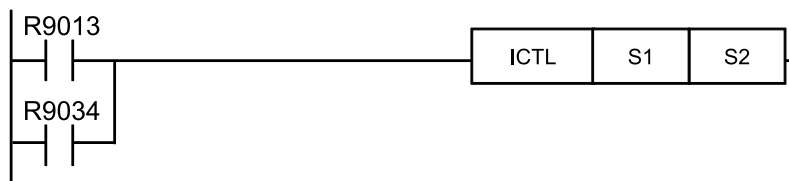

2. The high-speed counter will continue counting.
Target value match ON/OFF instructions (F166 HC1S / F167 HC1R) will continue.
Matching interrupt programs will be disabled during execution of the F166 HC1S / F167 HC1R instruction.
3. The pulse output and PWM output will be stopped.

Status	Instruction number	Name
Continue	F171 SPDH	Pulse output (with channel specification) (Home return)
Stop	F172 PLSH	Pulse output (with channel specification) (JOG operation)
Stop	F173 PLSH	PWM Output (with channel specification)
Continue	F174 SP0H	Pulse output (with channel specification) (Optional data table control operation)
Continue	F175 SPSH	Pulse output (linear interpolation)
Stop	F380 POSST	Positioning table start instruction
Stop	F381 JOGST	JOG operation start instruction
Stop	F383 MPOST	Positioning table simultaneous start instruction

4. Fixed time sampling trace will not be stopped.

33.8 Rewrite Function During RUN

33.8.3 Method and Operation of Rewriting during RUN

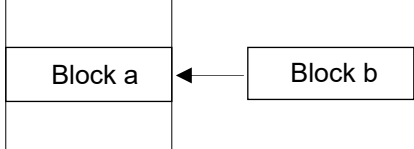
Items		FPWIN GR7 input
Rewrite method		<p>Up to 512 steps. Changes are made in block units. The program is rewritten online, when PB conversion is executed.</p> 
Unique operation of each instruction	OT/KP	If instructions that were written in block a are deleted in block b, the status prior to the rewriting is held.
	TM/CT	<ul style="list-style-type: none"> If instructions that were written in block a are deleted in block b, the status prior to the rewriting is held. The set values specified by K constants in TM/CT instructions are preset to the SVs of all the corresponding numbers in the program. (Elapsed value EV does not change)
	Fun high-level instructions	If instructions that were written in block a are deleted in block b, the status prior to the rewriting is held.
	MC/MCE	Always write MC/MCE instructions as a pair.
	CALL/ SUB/ RET	A subroutine is a program that appears between SUBn and RET instructions. Always write a subroutine to an address that comes after the ED instruction.
	INT/IRET	An interrupt program is a program that appears between INTn and IRET instructions. Always write a subroutine to an address that comes after the ED instruction.
	SSTP/ STPE	Processes that have the same number cannot be defined in duplicate. SSTP instructions cannot be written inside subprograms.
	JP/ LOOP/ LBL	Always write the instruction for setting the number of loops before the LBL-LOOP instructions.

33.9 Processing During Forced Input/Output

■ Processing when forced input/output is initiated during RUN

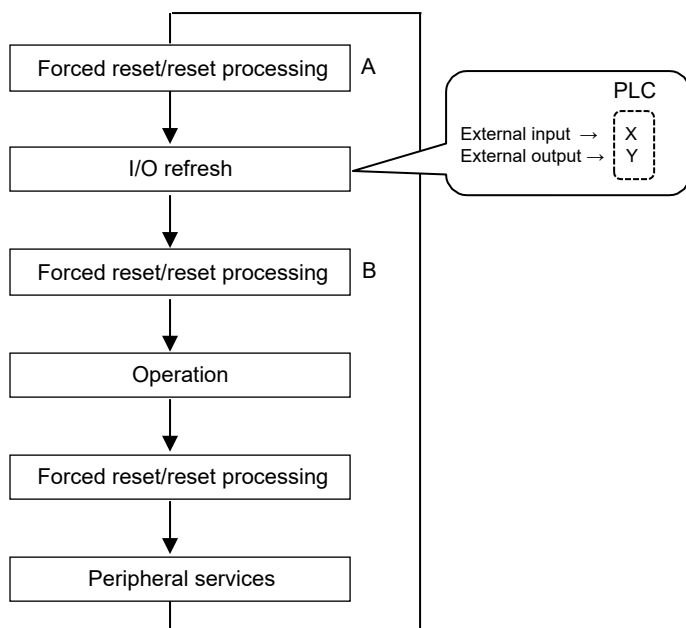

1. Processing of external input (X)
 - For a contact for which forced input/output is specified, the forced ON/OFF operation takes precedence regardless of the state of the input from the input device in procedure B in the above flowchart. The input LED will not blink at this time; however, the area of input X in the operation memory will be overwritten.
 - For contacts for which forced input/output is not specified, the ON/OFF state is read according to the input state from the input device.
2. Processing of external output (Y)
 - For a contact for which forced input/output is specified, the forced ON/OFF operation takes precedence regardless of the operation result in procedure A in the above flowchart. The area of output Y in the operation memory will be forcibly overwritten at this time. External output will occur at the input/output refresh timing in the above figure.
 - For contacts for which forced input/output is not specified, the ON/OFF state is determined by the operation result.
3. Processing of timer (T)/counter (C)
 - For a contact for which forced input/output is specified, the forced ON/OFF operation takes precedence regardless of the input condition of the timer/counter. The contact of the timer (T)/counter (C) in the operation memory is overwritten at this time. Timing and counting will not be performed during control.
 - For contacts for which forced input/output is not specified, the ON/OFF state is determined by the contents of the operation result.

Operation during operation

Forcibly controlled internal relay R and output Y are overwritten according to the operation result.

(MEMO)

Appendix Reference Material

Operation Memory Area.....	App-2
List of System Registers	App-4
List of System Registers	App-4
List of Special Relays.....	App-16
List of Special Data Registers.....	App-30
Communication Commands.....	App-47
List of MEWTOCOL Supported Commands	App-47
List of MODBUS Supported Commands.....	App-48
Positioning Memory	App-49
Configuration of Memory Map.....	App-49
Common Area (Memory Area No. 0)	App-50
Axis Information Area (Memory Area No. 1)	App-51
Axis Setting Area (Memory Area No. 2).....	App-52
Positioning Table Area (Memory Area No. 3).....	App-54
List of Error Codes	App-56
List of Syntax Check Errors	App-56
Self-diagnostic Errors.....	App-57
List of MEWTOCOL-COM Communication Error Codes	App-58
List of MODBUS Communication Error Codes	App-59
BIN/HEX/BCD Code Correspondence Table	App-60
ASCII Code Table, JIS8 Code Table	App-61

Operation Memory Area

■ List of operation memory areas

Items		Specifications	
		C14	C30 / C60
Relay	External input (X) ^(Note 1)	1760 points (X0 to X109F)	
	External output (Y) ^(Note 1)	1760 points (Y0 to Y109F)	
	Internal relay (R) ^(Note 2)	4096 points (R0 to R255F) or 8192 points (R0 to R511F)	
	Link relay (L)	2048 points (L0 to L127F)	
	Timer / Counter (T/C) ^(Note 3)	1024 points (1008 points for Timer: T0 to T1007, 16 points for Counter: C1008 to C1023) Timer: Can be measured up to (in 1 msec / 10 msec / 100 msec / 1 sec unit) x 32767. Counter: Can be measured up to 1 to 32767.	
	Special internal relay (R)	256 points (R9000 to R915F)	
Memory area	External input (WX)	110 words (WX0 to WX109)	
	External output (WY)	110 words (WY0 to WY109)	
	Internal relay (WR)	256 words (WR0 to WR255) or 512 words (WR0 to WR511) ^(Note 2)	
	Link relay (WL)	128 words (WL0 to WL127)	
	Data register (DT) ^(Note 4)	12285 words (DT0 to DT12284)	12285 words (DT0 to DT12284) 32765 words (DT0 to DT32764) 65533 words (DT0 to DT65532)
	Special data register (DT)	500 words (DT90000 to DT90499)	
	Link data register (LD)	256 words (LD0 to LD255)	
	Timer / counter set value area (SV)	1024 words (SV0 to SV1023)	
	Timer / counter elapsed value area (EV)	1024 words (EV0 to EV1023)	
	Index register (I)	14 words (I0 to ID)	
Constant	Decimal constants (K)	K-32,768 to K32,767 (for 16-bit operation) K-2,147,483,648 to K2,147,483,647 (for 32-bit operation)	
	Hexadecimal constants (H)	H0 to HFFFF (for 16-bit operation) H0 to HFFFFFFFF (for 32-bit operation)	
	Floating point type real numbers (f)	F-1.175494 x 10 ⁻³⁸ to F-3.402823 x 10 ³⁸ F 1.175494 x 10 ⁻³⁸ to F 3.402823 x 10 ³⁸	
Positioning memory		1800 words Out of these words, positioning table area: 20 tables for each channel, 250 words	

- (Note 1) The number of points in the above table is the number of points of operation memory. The number of points actually available to be used as I/O points is determined by the hardware combination.
- (Note 2) Can be selected by the setting of the system register no. 1 (internal relay capacity). To provide compatibility with the conventional FP-X Series Control Unit, select 4,096 points.
- (Note 3) The number of timer / counter points can be changed by the setting of the system register no.5.
- (Note 4) When the system register no.0 (sequence program capacity setting) is changed, the data register (DT) capacity also changes.

Program capacity		24K	32K	40K
Data register capacity	C30 / C60	65533 words	32765 words	12285 words

- (Note 5) For details on retention and non-retention areas, refer to *FP-XH User's Manual (Basic)*.
- (Note 6) For details on the configuration of positioning memory, refer to the *FP-XH User's Manual (Positioning / PWM Output / High-speed Counter)*.

List of System Registers

List of System Registers

List of System Registers

	No.	Name	Default	Setting range and description	
Memory Allocation	0	Setting of sequence program area size	16	C14: 16K words (fixed)	
			32	C30 / C60: 24, 32, 40K words ^(Note 1) ^(Note 2)	
	1	Internal relay area size	8192	4096, 8192 ^(Note 3)	
Hold / Non-hold 1	5	Counter starting address	1008	0 to 1024	
	6	Hold type area starting address for timer / counter	1008	0 to 1024	
	7	Hold type area starting address for internal relay	504	0 to 512	
	8	Hold type area starting address for data registers	C14:12230 C30/C60: 32450	0 to 65533	
	14	Holding the step ladder	Non-hold	Hold / Non-hold	
	4	Leading edge detection of the differential instruction during MC holds the previous value	Hold	Hold / Non-hold	
Hold / Non-hold 2	10	Hold type area starting word address setting for link relays for PC (PLC) link W0-0	64	0 to 64	
	11	Hold type area starting word address setting for link relays for PC (PLC) link W0-1	128	64 to 128	
	12	Hold type area starting word address setting for link data registers for PC (PLC) link W0-0	128	0 to 128	
	13	Hold type area starting word address setting for link data registers for PC (PLC) link W0-1	256	128 to 256	
Action on Error	20	Disable settings for duplicated output	Disable	Disable / Enable	
	23	Stop operation when an I/O verification error occurs	Stop	Stop / Run	
	25	Stop operation when positioning operation error occurs	Run	Run / Stop	
	26	Stop operation when calculating error occurs	Stop	Stop / Run	
	4	Alarm the battery abnormality	No	No:	The self-diagnostic error is not notified in case of battery error, and the "ERR.LED" does not flash.

No.	Name	Default	Setting range and description
			Yes: The self-diagnostic error is notified in case of battery error, and the "ERR.LED" flashes.

(Note 1) The system register no. 0 (Setting of sequence program area size) can be set only in off-line editing. To make the setting effective, you need to download it to the Control Unit.

(Note 2) If you change the system register no. 0 (Setting of sequence program area size), the size of the data register DT will be changed.

(Note 3) Select "4096" points for the system register no. 1 (Internal relay area size) to remain compatibility between the conventional FP-X Control Unit and the hold area when power supply is turned OFF.

(Note 4) The data in the range set by the system register is retained only when a backup battery is installed. Use the default values as they are when the battery is not installed.

	No.	Name	Default	Setting range and description
Time setting	31	Waiting time for managing multiple frame	6500.0 ms	10 to 81900 ms (in 2.5 ms unit)
	32	SEND / RECV / RMRD / RMWT instruction waiting time	10000.0 ms	10 to 81900 ms (in 2.5 ms unit)
	34	Constant scan time	Normal scan	0: Normal scan (in 0.5 ms unit) 0 to 350 ms: Scan at a specified time interval
	36	Expansion unit recognition time	0	0 to 10 seconds (in 0.1 second unit) 0: No waiting time
	37	Task time priority setting ^(Note 1)	Standard	Normal / Operation
PC link W0-0 setting	40	Size of link relays	0	0 to 64 words
	41	Size of link data registers	0	0 to 128 words
	42	Send area starting word address of link relay	0	0 to 63
	43	Size of link relays used for send area	0	0 to 64 words
	44	Send area starting address of link data register	0	0 to 127
	45	Size of link data registers used for send area	0	0 to 127 words
	46	PC (PLC) link switch flag	Normal	Normal / Reverse
	47	MEWNET-W0 PC (PLC) link max. station no.	16	1 to 16
	48	PC (PLC) link baud rate ^(Note 2)	115200 bps	115200 bps / 230400 bps
PC link W0-1 setting	50	Size of link relays	0	0 to 64 words
	51	Size of link data registers	0	0 to 128 words
	52	Send area starting word address of link relay	64	64 to 127
	53	Size of link relays used for send area	0	0 to 64 words
	54	Send area starting address of link data register	128	128 to 255

List of System Registers

No.	Name	Default	Setting range and description
55	Size of link data registers used for send area	0	0 to 127 words
57	MEWNET-W0 PC (PLC) link max. station no.	16	1 to 16

(Note 1) By selecting "Operation", the time taken for the communication processing is reduced for one port per scan. The operation processing takes priority.

(Note 2) The system register no. 48 (PLC link baud rate) is set in the same dialog box for the COM0 port and COM1 port settings.

■ FP-XH transistor type

No.	Name	Default	Setting range and description
400	High-speed counter setting (X0 to X3)	CH0: Not Set X0 as High Speed Counter	Not Set X0 as High Speed Counter Addition input (X0) Subtraction input (X0) 2 phase input (X0, X1) One input (X0, X1) Direction distinction (X0, X1)
		X0: Normal input ^(Note 4)	Normal input J-point positioning start input of pulse output CH0
		CH1: Not Set X1 as High Speed Counter	Not Set X1 as High Speed Counter Addition input (X1) Subtraction input (X1)
		X1: Normal input ^(Note 4)	Normal input J-point positioning start input of pulse output CH1
		CH2: Not Set X2 as High Speed Counter	Not Set X2 as High Speed Counter Addition input (X2) Subtraction input (X2) 2 phase input (X2, X3) One input (X2, X3) Direction distinction (X2, X3)
		X2: Normal input	Normal input Home input of pulse output CH4 (C60 only)
		CH3: Not Set X3 as High Speed Counter	Not Set X3 as High Speed Counter Addition input (X3) Subtraction input (X3)
		X3: Normal input	Normal input Home input of pulse output CH5 (C60 only)

(Note 1) When the high-speed counter CH0, CH2, CH4 and CH6 are set to one of 2-phase, individual and direction distinction, the setting of CH1, CH3, CH5 and CH7 are invalid.

(Note 2) The hard reset input of the high-speed counter is available only for CH0 and CH2. X6 can be allocated to CH0 and X7 can be allocated to CH2.

(Note 3) If the same input is set to the high-speed counter, pulse catch, and interrupt input, the priority order is as follows; 1. High-speed counter, 2. Pulse catch, 3. Interrupt input.

<Example> When the high-speed counter is used in the addition input mode, specifying X0 as interrupt input or pulse catch input will be invalid, and X0 will be activated as the counter input of the high-speed counter.

(Note 4) When the positioning control mode setting is set to FP-X compatibility instruction mode, the J-point positioning start input cannot be selected.

	No.	Name	Default	Setting range and description
Control Unit input settings (HSC / PLS)	401	High-speed counter / pulse output setting (X4 to X7)	CH4: Not Set X4 as High Speed Counter	Not Set X4 as High Speed Counter Addition input (X4) Subtraction input (X4) 2 phase input (X4, X5) One input (X4, X5) Direction distinction (X4, X5)
			X4: Normal input	Normal input Home input of pulse output CH0
			CH5: Not Set X5 as High Speed Counter	Not Set X5 as High Speed Counter Addition input (X5) Subtraction input (X5)
			X5: Normal input	Normal input Home input of pulse output CH1
			CH6: Not Set X6 as High Speed Counter	Not Set X6 as High Speed Counter Addition input (X6) Subtraction input (X6) 2 phase input (X6, X7) One input (X6, X7) Direction distinction (X6, X7)
			X6: Normal input	Normal input Home input of pulse output CH2 Reset input of high-speed counter CH0
			CH7: Not Set X7 as High Speed Counter	Not Set X7 as High Speed Counter Addition input (X7) Subtraction input (X7)
X7: Normal input	Normal input Home input of pulse output CH3 Reset input of high-speed counter CH2			

(Note 1) When the high-speed counter CH0, CH2, CH4 and CH6 are set to one of 2-phase, individual and direction distinction, the setting of CH1, CH3, CH5 and CH7 are invalid.

(Note 2) The hard reset input of the high-speed counter is available only for CH0 and CH2. X6 can be allocated to CH0 and X7 can be allocated to CH2.

(Note 3) If the same input is set to the high-speed counter, pulse catch, and interrupt input, the priority order is as follows; 1. High-speed counter, 2. Pulse catch, 3. Interrupt input.

<Example> When the high-speed counter is used in the addition input mode, specifying X0 as interrupt input or pulse catch input will be invalid, and X0 will be activated as the counter input of the high-speed counter.

List of System Registers

(Note 4) X4 to X7 can be also used as the home input of the pulse output CH0 to CH3. Select this input when using home input for the home return function of pulse output. In that case, X4 to X7 cannot be set as the high-speed counter.

■ FP-XH transistor type

	No.	Name	Default	Setting range and description																																
Control Unit output settings 2 (PLS / PWM)	407	Positioning control start setting	Table setting mode	Table setting mode FP-X compatible instruction mode																																
	402	Pulse / PWM output setting (Y0 to YB)	CH0:	Normal output (Y0, Y1) PWM output (Y0), Normal output (Y1) Pulse output [Table setting mode] (Y0, Y1) Pulse output (Y0, Y1)																																
			CH1:	Normal output (Y2, Y3) PWM output (Y2), Normal output (Y3) Pulse output [Table setting mode] (Y2, Y3) Pulse output (Y2, Y3)																																
			CH2:	Normal output (Y4, Y5) PWM output (Y4), Normal output (Y5) Pulse output [Table setting mode] (Y4, Y5) Pulse output (Y4, Y5)																																
			CH3:	Normal output (Y6, Y7) PWM output (Y6), Normal output (Y7) Pulse output [Table setting mode] (Y6, Y7) Pulse output (Y6, Y7)																																
			CH4:	Normal output (Y8, Y9) Pulse output [Table setting mode] (Y8, Y9) Pulse output (Y8, Y9)																																
			CH5:	Normal output (YA, YB) Pulse output (YA, YB) PWM output (YA), Normal output (YB)																																
Interrupt / pulse catch settings	403	Pulse catch input setting	Not set	Controller input <table border="1" style="display: inline-table; vertical-align: middle;"><tr><td>X0</td><td>X1</td><td>X2</td><td>X3</td><td>X4</td><td>X5</td><td>X6</td><td>X7</td></tr><tr><td><input type="checkbox"/></td><td><input type="checkbox"/></td><td><input type="checkbox"/></td><td><input type="checkbox"/></td><td><input type="checkbox"/></td><td><input type="checkbox"/></td><td><input type="checkbox"/></td><td><input type="checkbox"/></td></tr></table> The pressed contact is set as pulse catch input.	X0	X1	X2	X3	X4	X5	X6	X7	<input type="checkbox"/>	<input type="checkbox"/>	<input type="checkbox"/>	<input type="checkbox"/>	<input type="checkbox"/>	<input type="checkbox"/>	<input type="checkbox"/>	<input type="checkbox"/>																
	X0	X1	X2	X3	X4	X5	X6	X7																												
<input type="checkbox"/>	<input type="checkbox"/>	<input type="checkbox"/>	<input type="checkbox"/>	<input type="checkbox"/>	<input type="checkbox"/>	<input type="checkbox"/>	<input type="checkbox"/>																													
404	Interrupt input settings	Not set	Controller input <table border="1" style="display: inline-table; vertical-align: middle;"><tr><td>X0</td><td>X1</td><td>X2</td><td>X3</td><td>X4</td><td>X5</td><td>X6</td><td>X7</td></tr><tr><td><input type="checkbox"/></td><td><input type="checkbox"/></td><td><input type="checkbox"/></td><td><input type="checkbox"/></td><td><input type="checkbox"/></td><td><input type="checkbox"/></td><td><input type="checkbox"/></td><td><input type="checkbox"/></td></tr></table> The pressed contact is set as pulse catch input.	X0	X1	X2	X3	X4	X5	X6	X7	<input type="checkbox"/>	<input type="checkbox"/>	<input type="checkbox"/>	<input type="checkbox"/>	<input type="checkbox"/>	<input type="checkbox"/>	<input type="checkbox"/>	<input type="checkbox"/>																	
X0	X1	X2	X3	X4	X5	X6	X7																													
<input type="checkbox"/>	<input type="checkbox"/>	<input type="checkbox"/>	<input type="checkbox"/>	<input type="checkbox"/>	<input type="checkbox"/>	<input type="checkbox"/>	<input type="checkbox"/>																													
Interrupt edge setting	405	Control Unit input interrupt Edge settings	Leading edge	Leading edge <table border="1" style="display: inline-table; vertical-align: middle;"><tr><td>X0</td><td>X1</td><td>X2</td><td>X3</td><td>X4</td><td>X5</td><td>X6</td><td>X7</td></tr><tr><td><input type="checkbox"/></td><td><input type="checkbox"/></td><td><input type="checkbox"/></td><td><input type="checkbox"/></td><td><input type="checkbox"/></td><td><input type="checkbox"/></td><td><input type="checkbox"/></td><td><input type="checkbox"/></td></tr></table> Trailing edge <table border="1" style="display: inline-table; vertical-align: middle;"><tr><td>X0</td><td>X1</td><td>X2</td><td>X3</td><td>X4</td><td>X5</td><td>X6</td><td>X7</td></tr><tr><td><input type="checkbox"/></td><td><input type="checkbox"/></td><td><input type="checkbox"/></td><td><input type="checkbox"/></td><td><input type="checkbox"/></td><td><input type="checkbox"/></td><td><input type="checkbox"/></td><td><input type="checkbox"/></td></tr></table> The pressed contacts are set as leading and trailing edges.	X0	X1	X2	X3	X4	X5	X6	X7	<input type="checkbox"/>	<input type="checkbox"/>	<input type="checkbox"/>	<input type="checkbox"/>	<input type="checkbox"/>	<input type="checkbox"/>	<input type="checkbox"/>	<input type="checkbox"/>	X0	X1	X2	X3	X4	X5	X6	X7	<input type="checkbox"/>	<input type="checkbox"/>	<input type="checkbox"/>	<input type="checkbox"/>	<input type="checkbox"/>	<input type="checkbox"/>	<input type="checkbox"/>	<input type="checkbox"/>
X0	X1	X2	X3	X4	X5	X6	X7																													
<input type="checkbox"/>	<input type="checkbox"/>	<input type="checkbox"/>	<input type="checkbox"/>	<input type="checkbox"/>	<input type="checkbox"/>	<input type="checkbox"/>	<input type="checkbox"/>																													
X0	X1	X2	X3	X4	X5	X6	X7																													
<input type="checkbox"/>	<input type="checkbox"/>	<input type="checkbox"/>	<input type="checkbox"/>	<input type="checkbox"/>	<input type="checkbox"/>	<input type="checkbox"/>	<input type="checkbox"/>																													

- (Note 1) If the no. 407 (Positioning control start setting) is changed, the selection of the no. 402 (Pulse / PWM output setting) will be switched.
- (Note 2) For using the pulse output [Table setting mode] function, pulse output function and PWM output function, the Control Unit output setting must be set. The output specified for the pulse output and PWM output cannot be used as normal output.
- (Note 3) If the same input is set to the high-speed counter, pulse catch, and interrupt input, the priority order is as follows; 1. High-speed counter, 2. Pulse catch, 3. Interrupt input.
 <Example> When the high-speed counter is used in the addition input mode, specifying X0 as interrupt input or pulse catch input will be invalid, and X0 will be activated as the counter input of the high-speed counter.
- (Note 4) The settings of Nos. 403 to 406 are specified for each contact on the screen.

■ FP-XH relay type

	No.	Name	Default	Setting range and description
Pulse I/O cassette setting (HSC / PLS)	407	Positioning control start setting	Table setting mode	Table setting mode FP-X compatible instruction mode
	400	High-speed counter setting (X100 to X102)	CH8: Not Set X100 as High Speed Counter	Not Set X100 as High Speed Counter
				2 phase input (X100, X101)
				2 phase input (X100, X101) Reset input (X102)
				Addition input (X100)
	Addition input (X100) Reset input (X102)			
Subtraction input (X100)				
Subtraction input (X100) Reset input (X102)				
One input (X100, X101)				
One input (X100, X101) Reset input (X102)				
Direction distinction (X100, X101)				
Direction distinction (X100, X101) Reset input (X102)				
X100: Normal output (Note 7)	Normal input	J-point positioning start input of pulse output CH0		
400	High-speed counter setting (X101 to X102)	CH9: Not Set X101 as High Speed Counter	Not Set X101 as High Speed Counter	
			Addition input (X101)	
			Addition input (X101) Reset input (X102)	
Subtraction input (X101)				
Subtraction input (X101) Reset input (X102)				
Pulse output settings	CH0: Normal output	Normal output (Y100, Y101)		

List of System Registers

No.	Name	Default	Setting range and description
	(Y100 to Y101)		Pulse output [Table setting mode] (Y100, Y101) Pulse output (Y100, Y101) PWM output (Y100), Normal output (Y101)

- (Note 1) If the no. 407 (Positioning control start setting) is changed, the selection of the no. 400 (Pulse/ PWM output setting) will be switched.
- (Note 2) When the operation mode is set to 2-phase, individual, or direction distinction, the settings of CH9 in system register no. 400 are invalid.
- (Note 3) When the reset input settings are overlapped, priority is given to the setting of CH9 in system register no.400 and the setting of CHB in no.401.
- (Note 4) The CH8, CH9, and CH0 input signals in no. 400 are the signals when the Pulse I/O Cassette (AFPX-PLS) is installed on the cassette mounting part 1.
- (Note 5) The output cannot be used as a normal output if the operation mode is set for the pulse output CH0. If the operation mode is set to 1 for the pulse output CH0, reset input settings for the high-speed counters CH8 and CH9 are invalid.
- (Note 6) For using the pulse output [Table setting mode] function, pulse output function and PWM output function, the Control Unit output setting must be set. The output specified for the pulse output and PWM output cannot be used as normal output.
- (Note 7) When the positioning control mode setting is set to FP-X compatibility instruction mode, the J-point positioning start input cannot be selected.

No.	Name	Default	Setting range and description
Pulse I/O cassette setting (HSC / PLS)	401	High-speed counter setting (X200 to X202)	Not Set X200 as High Speed Counter
			2 phase input (X200, X201)
			2 phase input (X200, X201) Reset input (X202)
			Addition input (X200)
		CHA: Not Set X200 as High Speed Counter	Addition input (X200) Reset input (X202)
			Subtraction input (X200)
			Subtraction input (X200) Reset input (X202)
			One input (X200, X201)
			One input (X200, X201) Reset input (X202)
			Direction distinction (X200, X201)
			Direction distinction (X200, X201) Reset input (X202)
		X200: Normal input	Normal input J-point positioning start input of pulse output CH1
		CHB: Not Set X201 as High Speed Counter	Not Set X201 as High Speed Counter Addition input (X201)

No.	Name	Default	Setting range and description
			Addition input (X201) Reset input (X202) Subtraction input (X201) Subtraction input (X201) Reset input (X202)
	Pulse output settings (Y200 to Y201)	CH1: Normal output	Normal output (Y200, Y201) Pulse output [Table setting mode] (Y200, Y201) Pulse output (Y200, Y201) PWM output (Y200), Normal output (Y201)

- (Note 1) If the no. 407 (Positioning control start setting) is changed, the selection of the no. 401 (Pulse / PWM output setting) will be switched.
- (Note 2) When the operation mode is set to 2-phase, individual, or direction distinction, the settings of CHB in system register no. 401 are invalid.
- (Note 3) When the reset input settings are overlapped, priority is given to the setting of CH9 in system register no.400 and the setting of CHB in no.401.
- (Note 4) The CHA, CHB, and CH1 input signals in no. 401 are the signals when the Pulse I/O Cassette (AFPX-PLS) is installed on the cassette mounting part 2.
- (Note 5) The output cannot be used as a normal output if the operation mode is set for the pulse output CH1. If the operation mode is set to 1 for the pulse output CH1, reset input settings for the high-speed counters CHA and CHB are invalid.
- (Note 6) For using the pulse output [Table setting mode] function, pulse output function and PWM output function, the Control Unit output setting must be set. The output specified for the pulse output and PWM output cannot be used as normal output.

■ FP-XH relay type

No.	Name	Default	Setting range and description
Control Unit input settings (HSC)	402	High-speed counter setting (X0 to X7)	CH0: Not Set X0 as High Speed Counter Addition input (X0) Subtraction input (X0) 2 phase input (X0, X1)
			CH1: Not Set X1 as High Speed Counter Addition input (X1) Subtraction input (X1) 2 phase input (X0, X1)
			CH2: Not Set X2 as High Speed Counter Addition input (X2) Subtraction input (X2) 2 phase input (X2, X3)
			CH3: Not Set X3 as High Speed Counter Addition input (X3) Subtraction input (X3) 2 phase input (X2, X3)
			CH4: Not Set X4 as High Speed Counter Addition input (X4) Subtraction input (X4)

List of System Registers

No.	Name	Default	Setting range and description
		Not Set X4 as High Speed Counter	2 phase input (X4, X5)
		CH5: Not Set X5 as High Speed Counter	Not Set X5 as High Speed Counter Addition input (X5) Subtraction input (X5) 2 phase input (X4, X5)
		CH6: Not Set X6 as High Speed Counter	Not Set X6 as High Speed Counter Addition input (X6) Subtraction input (X6) 2 phase input (X6, X7)
		CH7: Not Set X7 as High Speed Counter	Not Set X7 as High Speed Counter Addition input (X7) Subtraction input (X7) 2 phase input (X6, X7)

(Note 1) For counting 2-phase inputs, only CH0, CH2, CH4 and CH6 can be used. When specifying 2-phase input to CH0, CH2, CH4, or CH6, provide the same setting although the setting for CH1, CH3, CH5, or CH7 that corresponds to each CH number is disregarded.

(Note 2) When system registers Nos. 400 to 404 are set for the same input contact simultaneously, the priority order is as follows; 1. High-speed counter 2. Pulse catch 3. Interrupt input

<Example> When the high-speed counter is used in the addition input mode, specifying X0 as interrupt input or pulse catch input will be invalid, and X0 will be activated as the counter input of the high-speed counter.

No.	Name	Default	Setting range and description														
Interrupt / pulse catch settings	403	Pulse catch input setting	Not set Control Unit input <table border="1" style="display: inline-table; vertical-align: middle;"><tr><td>X0</td><td>X1</td><td>X2</td><td>X3</td><td>X4</td><td>X5</td><td>X6</td><td>X7</td></tr></table> Pulse I/O cassette <table border="1" style="display: inline-table; vertical-align: middle;"><tr><td>X100</td><td>X101</td><td>X102</td><td>X200</td><td>X201</td><td>X202</td></tr></table> The pressed contact is set as pulse catch input.	X0	X1	X2	X3	X4	X5	X6	X7	X100	X101	X102	X200	X201	X202
	X0	X1	X2	X3	X4	X5	X6	X7									
X100	X101	X102	X200	X201	X202												
404	Interrupt input settings	Not set	Control Unit input <table border="1" style="display: inline-table; vertical-align: middle;"><tr><td>X0</td><td>X1</td><td>X2</td><td>X3</td><td>X4</td><td>X5</td><td>X6</td><td>X7</td></tr></table> Pulse I/O cassette <table border="1" style="display: inline-table; vertical-align: middle;"><tr><td>X100</td><td>X101</td><td>X102</td><td>X200</td><td>X201</td><td>X202</td></tr></table> The pressed contact is set as interrupt input.	X0	X1	X2	X3	X4	X5	X6	X7	X100	X101	X102	X200	X201	X202
X0	X1	X2	X3	X4	X5	X6	X7										
X100	X101	X102	X200	X201	X202												
Interrupt edge settings	405	Effective interrupt edge setting for Control Unit \bar{x} input	Leading edge Leading edge <table border="1" style="display: inline-table; vertical-align: middle;"><tr><td>X100</td><td>X101</td><td>X102</td><td>X200</td><td>X201</td><td>X202</td></tr></table> Trailing edge <table border="1" style="display: inline-table; vertical-align: middle;"><tr><td>X100</td><td>X101</td><td>X102</td><td>X200</td><td>X201</td><td>X202</td></tr></table> The pressed contacts are set as leading and trailing edges.	X100	X101	X102	X200	X201	X202	X100	X101	X102	X200	X201	X202		
	X100	X101	X102	X200	X201	X202											
X100	X101	X102	X200	X201	X202												
406	Pulse I/O cassette interrupt edge setting	Leading edge	Leading edge <table border="1" style="display: inline-table; vertical-align: middle;"><tr><td>X100</td><td>X101</td><td>X102</td><td>X200</td><td>X201</td><td>X202</td></tr></table> Trailing edge <table border="1" style="display: inline-table; vertical-align: middle;"><tr><td>X100</td><td>X101</td><td>X102</td><td>X200</td><td>X201</td><td>X202</td></tr></table> The pressed contacts are set as leading and trailing edges.	X100	X101	X102	X200	X201	X202	X100	X101	X102	X200	X201	X202		
X100	X101	X102	X200	X201	X202												
X100	X101	X102	X200	X201	X202												

List of System Registers

(Note 1) For counting 2-phase inputs, only CH0, CH2, CH4 and CH6 can be used. When specifying 2-phase input to CH0, CH2, CH4, or CH6, provide the same setting although the setting for CH1, CH3, CH5, or CH7 that corresponds to each CH number is disregarded.

(Note 2) The settings of Nos. 403 to 406 are specified for each contact on the screen.

(Note 3) When system registers Nos. 400 to 404 are set for the same input contact simultaneously, the priority order is as follows; 1. High-speed counter 2. Pulse catch 3. Interrupt input

<Example> When the high-speed counter is used in the addition input mode, specifying X0 as interrupt input or pulse catch input will be invalid, and X0 will be activated as the counter input of the high-speed counter.

No.	Name	Default	Setting range and description
410 411	Unit No.	1	1 to 99
412	Communication mode	Computer Link	Computer Link General-purpose communication PC(PLC) Link MODBUS RTU
	Modem connection	No	Yes / No
413 414	Transmission format	Data length: 8 bits Parity check: Odd Stop bit: 1 bit	Data length: 7bits / 8bits Parity check: None / Odd / Even Stop bit: 1 / 2 Terminator selection: Code / Time Terminator: CR / CR+LF / None Header: STX not exist. / STX exists
415	Baud rate	9600 bps	2400 bps, 4800 bps, 9600 bps, 19200 bps, 38400 bps, 57600 bps, 115200 bps, 230400 bps
416	(COM1) Receive buffer starting address during general-purpose communication	0	0 to 65532
417	(COM1) Receive buffer size during general-purpose communication	2048	0 to 2048
418	(COM2) Receive buffer starting address during general-purpose communication	2048	0 to 65532
419	(COM2) Receive buffer size during general-purpose communication	2048	0 to 2048
420	(COM0) Receive buffer starting address during general-purpose communication	4096	0 to 65532
421	(COM0)	2048	0 to 2048

List of System Registers

No.	Name	Default	Setting range and description
	Receive buffer size during general-purpose communication		
422	(COM3) Receive buffer starting address during general-purpose communication	6144	0 to 65532
423	(COM3) Receive buffer size during general-purpose communication	2048	0 to 2048
424	(COM0) Terminator judgement time (x 0.01 ms)	0	0 or 1 to 10000 (0.01 ms to 100 ms) When terminator judgement time is 0, transmission time is that for approx. 4 bytes.
425	(COM1) Terminator judgement time (x 0.01 ms)	0	
426	(COM2) Terminator judgement time (x 0.01 ms)	0	
427	(COM3) Terminator judgement time (x 0.01 ms)	0	

(Note 1) When computer link or MODBUS RTU is selected by No. 412 (Transmission mode), no. 413 (Transmission format) and no. 415 (Baud rate) can be set.

(Note 2) When selecting only the general-purpose communication in No. 412 (communication mode), you can set no. 413: transmission format terminal selection, end and start codes. In addition, when selecting the terminal as time only through no. 413, you can select no. 424 to no. 427.

(Note 3) The PC(PLC) link function is only available for COM0 or COM1 port. The transmission format is as follows: data length: 8 bits, parity: odd, stop bit: 1 bit (fixed). In addition, select the baud rate in PC link W0-0 system register no. 48 item.

No.	Name	Default	Setting range and description	
Time constant setting of Control Unit input	430	None	None 1 ms 2 ms 4 ms 8 ms 16 ms 32 ms 64 ms 128 ms 256 ms	
	431			Time constant setting of Control Unit input 1 X0 to X3
	432			Time constant setting of Control Unit input 2 X4 to X7
	433			Time constant setting of Control Unit input 2 X8 to XB
	434			Time constant setting of Control Unit input 3 XC to XF
	Time constant setting of Control Unit input 3 X10 to X13			

	No.	Name	Default	Setting range and description
	435	Time constant setting of Control Unit input 3 X14 to X17		
	436	Time constant setting of Control Unit input 4 X18 to X1B		
	437	Time constant setting of Control Unit input 4 X1C to X1F		

List of Special Relays

List of Special Relays

WR900 (Specified in units of words)

Relay no.	Name	Description
R9000	Self-diagnostic error flag	Turns ON when a self-diagnostic error occurs. → The self-diagnostic result is stored in DT90000.
R9001	Not used	
R9002	Function cassette I/O error flag	Turns ON when an abnormality is detected in the I/O type Function Cassette.
R9003	Function cassette error flag	Turns ON when an abnormality is detected in the Function Cassette.
R9004	I/O verification error flag	Turns ON when an I/O verification error is detected.
R9005	Backup battery error flag (current type)	Turns ON when a battery error occurs. Even if you choose not to notify battery error in the system register, this is also ON when the battery runs out.
R9006	Backup battery error flag (hold)	Turns ON when a battery error occurs. Even if you choose not to notify battery error in the system register, this is also ON when the battery runs out. Once a battery error has been detected, this is held even after recovery has been made. → It goes OFF if the power supply is turned OFF.
R9007	Operation error flag (hold) (ER flag)	Turns ON when an operation error occurs after the unit has started operating, and remains ON while the unit operation continues. → The address where the error occurred is stored in DT90017. (It indicates the first operation error that has occurred.)
R9008	Operation error flag (latest) (ER flag)	Turns ON every time an operation error occurs. → The address where the operation error occurred is stored in DT90018. Every time a new error occurs, the data will be updated.
R9009	Carry flag (CY flag)	This flag is set when the operation result overflow or under flow occurs, or when performing a shift system instruction.
R900A	> flag	Executes a comparison instruction, and turns ON if the result is larger.
R900B	= flag	Executes a comparison instruction, and turns ON if the result is equal. Executes operation instruction, and turns ON if the result is '0'.
R900C	< flag	Executes a comparison instruction, and turns ON if the result is smaller.
R900D	Auxiliary timer contact	Executes the auxiliary timer instruction (F137 / F138), and turns ON after the lapsed of a set time. Turns OFF when the execution condition turns to OFF.
R900E (R9130)	COM0 port communication error	Turns ON if a communication error is detected when using the COM0 port.
R900F	Constant scan error flag	Turns ON if the scan time exceeds the set time (system register no. 34) when performing the constant scan. It also turns ON when 0 is set in the system register no. 34.

(Note 1) The same function is allocated to the special internal relay in parentheses.

WR901 (Specified in units of words)

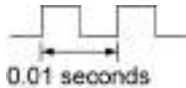
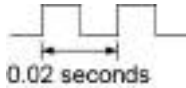
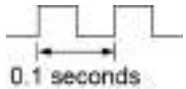
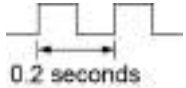
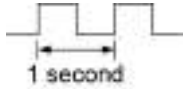
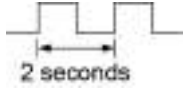
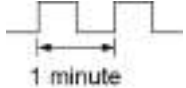
Relay no.	Name	Description
R9010	Always ON relay	Always on.
R9011	Always OFF relay	Always off.
R9012	Scan pulse relay	Turns ON and OFF alternately at each scan.
R9013	Initial pulse relay (ON)	Turns ON for only the first scan after operation (RUN) has been started, and turns OFF for the second and subsequent scans.
R9014	Initial pulse relay (OFF)	Turns OFF for only the first scan after operation (RUN) has been started, and turns ON for the second and subsequent scans.
R9015	Step ladder Initial pulse relay (ON)	Turns ON in the first scan only, following startup of any single process, during stepladder control.
R9016	Not used	
R9017	Not used	
R9018	0.01-sec clock pulse relay	Clock pulse with a 0.01-second cycle. 
R9019	0.02-sec clock pulse relay	Clock pulse with a 0.02-second cycle. 
R901A	0.1-sec clock pulse relay	Clock pulse with a 0.1-second cycle. 
R901B	0.2-sec clock pulse relay	Clock pulse with a 0.2-second cycle. 
R901C	1-sec clock pulse relay	Clock pulse with a 1-second cycle. 
R901D	2-sec clock pulse relay	Clock pulse with a 2-second cycle. 
R901E	1-min clock pulse relay	Clock pulse with a 1-minute cycle. 
R901F	Not used	

WR902 (Specified in units of words)

Relay no.	Name	Description
R9020	RUN mode flag	Turns OFF while the mode selector is set to PROG. Turns ON while the mode selector is set to RUN.
R9021	Not used	
R9022	Not used	

List of Special Relays

Relay no.	Name	Description
R9023	Not used	
R9024	Not used	
R9025	Not used	
R9026	Message flag	Turns ON when the message display instruction (F149) is executed.
R9027	Not used	
R9028	Not used	
R9029	Force flag	Turns ON during forced ON / OFF operation for input/output relays or timer / counter contacts.
R902A	Interrupt enable flag	Turns ON while the external interrupt trigger is enabled.
R902B	Not used	
R902C	Sample point flag	Sampling by instruction = 0 Sampling at constant time intervals = 1
R902D	Sampling trace end flag	When the sampling operation stops = 1 When the sampling operation starts = 0
R902E	Sampling stop trigger flag	When the sampling stop trigger occurs = 1 When the sampling stop trigger stops = 0
R902F	Sampling enable flag	When sampling starts = 1 When sampling stops = 0

WR903 (Specified in units of words)

Relay no.	Name	Description
R9030	Not used	
R9031	Not used	
R9032 (R9139)	COM1 port communication mode flag	Turns ON when using the general-purpose communication function. Turns OFF when using a function other than the general-purpose communication.
R9033	Print instruction execution flag	Off: Not executed On: Being executed
R9034	Program edit flag in RUN mode	This is a special internal relay which turns ON for only the first scan following the completion of rewriting in RUN mode.
R9035	Not used	
R9036	Not used	
R9037 (R9138)	COM1 port communication error flag	Turns ON if a transmission error occurs when performing data communication. Turns OFF when a transmission request is made by the F159 (MTRN) instruction.
R9038 (R913A)	COM1 port reception done flag during general-purpose communication	Turns ON when the end code is received in the general-purpose communication.
R9039 (R913B)	COM1 port transmission done flag during general-purpose communication	Turns ON when the transmission ends in the general-purpose communication. Turns OFF when the transmission is requested in the general-purpose communication.

Relay no.	Name	Description
R903A	Not used	
R903B	Not used	
R903C	Not used	
R903D	Not used	
R903E (R9132)	COM0 port reception done flag during general-purpose communication	Turns ON when the end code is received in the general-purpose communication.
R903F (R9133)	COM0 port transmission done flag during general-purpose communication	Turns ON when the transmission ends in the general-purpose communication. Turns OFF when the transmission is requested in the general-purpose communication.

(Note 1) R9030 to R903F will change even during one scanning cycle. In addition, the same functions are allocated to the special internal relays in parentheses.

WR904 (Specified in units of words)

Relay no.	Name	Description
R9040 (R9131)	COM0 port communication mode flag	Turns ON when using the general-purpose communication function. Turns OFF when using a function other than the general-purpose communication function.
R9041 (R913E)	COM1 port PC (PLC) link flag	Turns ON when using the PC (PLC) link function.
R9042 (R9141)	COM2 port communication mode flag	Turns ON when using the general-purpose communication function. Turns OFF when using a function other than the general-purpose communication function.
R9043	Not used	
R9044 (R913C)	COM1 port SEND / RECV instruction execution flag	Indicates whether the F145 (SEND) or F146 (RECV) instruction can be executed or not for the COM1 port. OFF: Not executable (Instruction is being executed) ON: Executable
R9045 (R913D)	COM1 port SEND / RECV instruction execution end flag	Indicates the execution state of the F145 (SEND) or F146 (RECV) instruction for the COM1 port. OFF: Normal end ON: Abnormal end (Communication error occurs) The error code is stored in DT90124.
R9046	Not used	
R9047 (R9140)	COM2 port communication error flag	Turns ON if a transmission error occurs when performing data communication. Turns OFF when a transmission request is made by the F159 (MTRN) instruction.
R9048 (R9142)	COM2 port reception done flag during general-purpose communication	Turns ON when the end code is received in the general-purpose communication.
R9049 (R9143)	COM2 port transmission done flag during general-purpose communication	Turns ON when the transmission ends in the general-purpose communication.

List of Special Relays

Relay no.	Name	Description
		Turns OFF when the transmission is requested in the general-purpose communication.
R904A (R9144)	COM2 port SEND / RECV instruction execution flag	Indicates whether the F145 (SEND) or F146 (RECV) instruction can be executed or not for the COM2 port. OFF: Not executable (Instruction is being executed) ON: Executable
R904B (R9145)	COM2 port SEND / RECV instruction execution end flag	Indicates the execution state of the F145 (SEND) or F146 (RECV) instruction for the COM2 port. OFF: Normal end ON: Abnormal end (Communication error occurs) The error code is stored in DT90125.
R904C to R904F	Not used	

(Note 1) R9040 to R904F will change even during one scanning cycle. In addition, the same functions are allocated to the special internal relays in parentheses.

WR905 (Specified in units of words)

Relay no.	Name	Description
R9050	MEWNET-W0 PC (PLC) link transmission error flag	When using MEWNET-W0 Turns ON when a transmission error occurs in the PC (PLC) link. Turns ON when there is an error in the setting for the PC (PLC) area link.
R9051 to R905F	Not used	

WR906 (Specified in units of words)

Relay no.	Name	Description
R9060	MEWNET-W0 Transmission assurance relay for PC (PLC) link 0	Unit no. 1 When normally communicating in the PC (PLC) link mode: ON When stopping, an error occurs or the PC (PLC) link is not performed: OFF
R9061		Unit no. 2 When normally communicating in the PC (PLC) link mode: ON When stopping, an error occurs or the PC (PLC) link is not performed: OFF
R9062		Unit no. 3 When normally communicating in the PC (PLC) link mode: ON When stopping, an error occurs or the PC (PLC) link is not performed: OFF
R9063		Unit no. 4 When normally communicating in the PC (PLC) link mode: ON When stopping, an error occurs or the PC (PLC) link is not performed: OFF

List of Special Relays

Relay no.	Name	Description
R9064	Unit no. 5	Unit no. 5 When normally communicating in the PC (PLC) link mode: ON When stopping, an error occurs or the PC (PLC) link is not performed: OFF
R9065	Unit no. 6	Unit no. 6 When normally communicating in the PC (PLC) link mode: ON When stopping, an error occurs or the PC (PLC) link is not performed: OFF
R9066	Unit no. 7	Unit no. 7 When normally communicating in the PC (PLC) link mode: ON When stopping, an error occurs or the PC (PLC) link is not performed: OFF
R9067	Unit no. 8	Unit no. 8 When normally communicating in the PC (PLC) link mode: ON When stopping, an error occurs or the PC (PLC) link is not performed: OFF
R9068	Unit no. 9	Unit no. 9 When normally communicating in the PC (PLC) link mode: ON When stopping, an error occurs or the PC (PLC) link is not performed: OFF
R9069	Unit no. 10	Unit no. 10 When normally communicating in the PC (PLC) link mode: ON When stopping, an error occurs or the PC (PLC) link is not performed: OFF
R906A	Unit no. 11	Unit no. 11 When normally communicating in the PC (PLC) link mode: ON When stopping, an error occurs or the PC (PLC) link is not performed: OFF
R906B	Unit no. 12	Unit no. 12 When normally communicating in the PC (PLC) link mode: ON When stopping, an error occurs or the PC (PLC) link is not performed: OFF
R906C	Unit no. 13	Unit no. 13 When normally communicating in the PC (PLC) link mode: ON When stopping, an error occurs or the PC (PLC) link is not performed: OFF
R906D	Unit no. 14	Unit no. 14 When normally communicating in the PC (PLC) link mode: ON When stopping, an error occurs or the PC (PLC) link is not performed: OFF

List of Special Relays

Relay no.	Name	Description
R906E		Unit no. 15 When normally communicating in the PC (PLC) link mode: ON When stopping, an error occurs or the PC (PLC) link is not performed: OFF
R906F		Unit no. 16 When normally communicating in the PC (PLC) link mode: ON When stopping, an error occurs or the PC (PLC) link is not performed: OFF

WR907 (Specified in units of words)

Relay no.	Name	Description
R9070	MEWNET-W0 Operation mode relay for PC (PLC) link 0	Unit no. 1 Turns ON when the unit no. 1 is in RUN mode. Turns OFF when the unit is in PROG. mode.
R9071		Unit no. 2 Turns ON when the unit no. 2 is in RUN mode. Turns OFF when the unit is in PROG. mode.
R9072		Unit no. 3 Turns ON when the unit no. 3 is in RUN mode. Turns OFF when the unit is in PROG. mode.
R9073		Unit no. 4 Turns ON when the unit no. 4 is in RUN mode. Turns OFF when the unit is in PROG. mode.
R9074		Unit no. 5 Turns ON when the unit no. 5 is in RUN mode. Turns OFF when the unit is in PROG. mode.
R9075		Unit no. 6 Turns ON when the unit no. 6 is in RUN mode. Turns OFF when the unit is in PROG. mode.
R9076		Unit no. 7 Turns ON when the unit no. 7 is in RUN mode. Turns OFF when the unit is in PROG. mode.
R9077		Unit no. 8 Turns ON when the unit no. 8 is in RUN mode. Turns OFF when the unit is in PROG. mode.
R9078		Unit no. 9 Turns ON when the unit no. 9 is in RUN mode. Turns OFF when the unit is in PROG. mode.
R9079		Unit no. 10 Turns ON when the unit no. 10 is in RUN mode. Turns OFF when the unit is in PROG. mode.
R907A		Unit no. 11 Turns ON when the unit no. 11 is in RUN mode. Turns OFF when the unit is in PROG. mode.
R907B		Unit no. 12 Turns ON when the unit no. 12 is in RUN mode. Turns OFF when the unit is in PROG. mode.
R907C		Unit no. 13 Turns ON when the unit no. 13 is in RUN mode. Turns OFF when the unit is in PROG. mode.
R907D		Unit no. 14 Turns ON when the unit no. 14 is in RUN mode. Turns OFF when the unit is in PROG. mode.
R907E		Unit no. 15 Turns ON when the unit no. 15 is in RUN mode. Turns OFF when the unit is in PROG. mode.

Relay no.	Name	Description
R907F	Unit no. 16	Turns ON when the unit no. 16 is in RUN mode. Turns OFF when the unit is in PROG. mode.

WR908 (Specified in units of words)

Relay no.	Name	Description
R9080	MEWNET-W0 Transmission assurance relay for PC (PLC) link 1	Unit no. 1 When normally communicating in the PC (PLC) link mode: ON When stopping, an error occurs or the PC (PLC) link is not performed: OFF
R9081		Unit no. 2 When normally communicating in the PC (PLC) link mode: ON When stopping, an error occurs or the PC (PLC) link is not performed: OFF
R9082		Unit no. 3 When normally communicating in the PC (PLC) link mode: ON When stopping, an error occurs or the PC (PLC) link is not performed: OFF
R9083		Unit no. 4 When normally communicating in the PC (PLC) link mode: ON When stopping, an error occurs or the PC (PLC) link is not performed: OFF
R9084		Unit no. 5 When normally communicating in the PC (PLC) link mode: ON When stopping, an error occurs or the PC (PLC) link is not performed: OFF
R9085		Unit no. 6 When normally communicating in the PC (PLC) link mode: ON When stopping, an error occurs or the PC (PLC) link is not performed: OFF
R9086		Unit no. 7 When normally communicating in the PC (PLC) link mode: ON When stopping, an error occurs or the PC (PLC) link is not performed: OFF
R9087		Unit no. 8 When normally communicating in the PC (PLC) link mode: ON When stopping, an error occurs or the PC (PLC) link is not performed: OFF
R9088		Unit no. 9 When normally communicating in the PC (PLC) link mode: ON

List of Special Relays

Relay no.	Name	Description
		When stopping, an error occurs or the PC (PLC) link is not performed: OFF
R9089		Unit no. 10 When normally communicating in the PC (PLC) link mode: ON When stopping, an error occurs or the PC (PLC) link is not performed: OFF
R908A		Unit no. 11 When normally communicating in the PC (PLC) link mode: ON When stopping, an error occurs or the PC (PLC) link is not performed: OFF
R908B		Unit no. 12 When normally communicating in the PC (PLC) link mode: ON When stopping, an error occurs or the PC (PLC) link is not performed: OFF
R908C		Unit no. 13 When normally communicating in the PC (PLC) link mode: ON When stopping, an error occurs or the PC (PLC) link is not performed: OFF
R908D		Unit no. 14 When normally communicating in the PC (PLC) link mode: ON When stopping, an error occurs or the PC (PLC) link is not performed: OFF
R908E		Unit no. 15 When normally communicating in the PC (PLC) link mode: ON When stopping, an error occurs or the PC (PLC) link is not performed: OFF
R908F		Unit no. 16 When normally communicating in the PC (PLC) link mode: ON When stopping, an error occurs or the PC (PLC) link is not performed: OFF

WR909 (Specified in units of words)

Relay no.	Name	Description
R9090	MEWNET-W0 Operation mode relay for PC (PLC) link 1	Unit no. 1 Turns ON when the unit no. 1 is in RUN mode. Turns OFF when the unit is in PROG. mode.
R9091		Unit no. 2 Turns ON when the unit no. 2 is in RUN mode. Turns OFF when the unit is in PROG. mode.
R9092		Unit no. 3 Turns ON when the unit no. 3 is in RUN mode. Turns OFF when the unit is in PROG. mode.
R9093		Unit no. 4 Turns ON when the unit no. 4 is in RUN mode. Turns OFF when the unit is in PROG. mode.

Relay no.	Name	Description
R9094		Unit no. 5 Turns ON when the unit no. 5 is in RUN mode. Turns OFF when the unit is in PROG. mode.
R9095		Unit no. 6 Turns ON when the unit no. 6 is in RUN mode. Turns OFF when the unit is in PROG. mode.
R9096		Unit no. 7 Turns ON when the unit no. 7 is in RUN mode. Turns OFF when the unit is in PROG. mode.
R9097		Unit no. 8 Turns ON when the unit no. 8 is in RUN mode. Turns OFF when the unit is in PROG. mode.
R9098		Unit no. 9 Turns ON when the unit no. 9 is in RUN mode. Turns OFF when the unit is in PROG. mode.
R9099		Unit no. 10 Turns ON when the unit no. 10 is in RUN mode. Turns OFF when the unit is in PROG. mode.
R909A		Unit no. 11 Turns ON when the unit no. 11 is in RUN mode. Turns OFF when the unit is in PROG. mode.
R909B		Unit no. 12 Turns ON when the unit no. 12 is in RUN mode. Turns OFF when the unit is in PROG. mode.
R909C		Unit no. 13 Turns ON when the unit no. 13 is in RUN mode. Turns OFF when the unit is in PROG. mode.
R909D		Unit no. 14 Turns ON when the unit no. 14 is in RUN mode. Turns OFF when the unit is in PROG. mode.
R909E		Unit no. 15 Turns ON when the unit no. 15 is in RUN mode. Turns OFF when the unit is in PROG. mode.
R909F		Unit no. 16 Turns ON when the unit no. 16 is in RUN mode. Turns OFF when the unit is in PROG. mode.

WR910 to WR912 (Specified in units of words)

Relay no.	Name	Description	
R9100 to R910F	Not used		
R9110	High-speed counter control flag	Turns ON while the F166 (HC1S) or F167 (HC1R) instruction is executed when using the high-speed counter function. Turns OFF when the operation is completed. (Note 1)	
R9111			HSC-CH0
R9112			HSC-CH1
R9113			HSC-CH2
R9114			HSC-CH3
R9115			HSC-CH4
R9116			HSC-CH5
R9117			HSC-CH6
R9118			HSC-CH7
R9119			HSC-CH8
R911A			HSC-CH9
R911B			HSC-CHA
	HSC-CHB		

List of Special Relays

Relay no.	Name	Description	
R911C	Pulse output control flag	When using the pulse output function or PWM output function with the F17x instruction, turns ON when the F171 (SPDH), F172 (PLSH), F173 (PVMH), F174 (SP0H) or F175 (SPSH) instruction is executed and the pulse output is performed. Turns OFF when the operation completed. (Note 2)	
R911D			PLS-CH0
R911E			PLS-CH1
R911F			PLS-CH2
R9120			PLS-CH3
R9121			PLS-CH4
R9122 to R912F	Not used		

(Note 1) R9118 to R911B are valid only when the pulse output cassette is installed on the relay type Control Unit.

(Note 2) R9120 to R9121 are valid only for the transistor type Control Unit.

WR913 (Specified in units of words)

Relay no.	Name	Description
R9130 (R900E)	COM0 port communication error flag	Turns ON if a transmission error occurs when performing data communication. Turns OFF when a transmission request is made by the F159 (MTRN) instruction.
R9131 (R9040)	COM0 port communication mode flag	Turns ON when using the general-purpose communication function. Turns OFF when using a function other than the general-purpose communication function.
R9132 (R903E)	COM0 port reception done flag during general-purpose communication	Turns ON when the end code is received in the general-purpose communication.
R9133 (R903F)	COM0 port transmission done flag during general-purpose communication	Turns ON when the transmission ends in the general-purpose communication. Turns OFF when the transmission is requested in the general-purpose communication.
R9134	COM0 port SEND / RECV instruction execution flag	Indicates whether the F145 (SEND) or F146 (RECV) instruction can be executed or not for the COM0 port. OFF: Not executable (Instruction is being executed) ON: Executable
R9135	COM0 port SEND / RECV instruction execution end flag	Indicates the execution state of the F145 (SEND) or F146 (RECV) instruction for the COM0 port. OFF: Normal end ON: Abnormal end (Communication error occurs) The error code is stored in DT90123.
R9136	COM0 port PC (PLC) link flag	Turns ON when using the PC (PLC) link function.
R9137	Not used	
R9138 (R9037)	COM1 port communication error flag	Turns ON if a transmission error occurs when performing data communication. Turns OFF when a transmission request is made by the F159 (MTRN) instruction.

Relay no.	Name	Description
R9139 (R9032)	COM1 port communication mode flag	Turns ON when using the general-purpose communication function. Turns OFF when using a function other than the general-purpose communication function.
R913A (R9038)	COM1 port reception done flag during general-purpose communication	Turns ON when the end code is received in the general-purpose communication.
R913B (R9039)	COM1 port transmission done flag during general-purpose communication	Turns ON when the transmission ends in the general-purpose communication. Turns OFF when the transmission is requested in the general-purpose communication.
R913C (R9044)	COM1 port SEND / RECV instruction execution flag	Indicates whether the F145 (SEND) or F146 (RECV) instruction can be executed or not for the COM1 port. OFF: Not executable (Instruction is being executed) ON: Executable
R913D (R9045)	COM1 port SEND / RECV instruction execution end flag	Indicates the execution state of the F145 (SEND) or F146 (RECV) instruction for the COM1 port. OFF: Normal end ON: Abnormal end (Communication error occurs) The error code is stored in DT90124.
R913E (R9041)	COM1 port PC (PLC) link flag	Turns ON when using the PC (PLC) link function.
R913F	Not used	

(Note 1) R9130 to R913F will change even during one scanning cycle. In addition, the same functions are allocated to the special internal relays in parentheses to retain compatibility with the conventional model FP-X Control Unit.

WR914 (Specified in units of words)

Relay no.	Name	Description
R9140 (R9047)	COM2 port communication error flag	Turns ON if a transmission error occurs when performing data communication. Turns OFF when a transmission request is made by the F159 (MTRN) instruction.
R9141 (R9042)	COM2 port communication mode flag	Turns ON when using the general-purpose communication function. Turns OFF when using a function other than the general-purpose communication function.
R9142 (R9048)	COM2 port reception done flag during general-purpose communication	Turns ON when the end code is received in the general-purpose communication.
R9143 (R9049)	COM2 port transmission done flag during general-purpose communication	Turns ON when the transmission ends in the general-purpose communication. Turns OFF when the transmission is requested in the general-purpose communication.
R9144 (R904A)	COM2 port SEND / RECV instruction execution flag	Indicates whether the F145 (SEND) or F146 (RECV) instruction can be executed or not for the COM2 port. OFF: Not executable (Instruction is being executed) ON: Executable

List of Special Relays

Relay no.	Name	Description
R9145 (R904B)	COM2 port SEND / RECV instruction execution end flag	Indicates the execution state of the F145 (SEND) or F146 (RECV) instruction for the COM2 port. OFF: Normal end ON: Abnormal end (Communication error occurs) The error code is stored in DT90125.
R9146	Not used	
R9147	Not used	
R9148	COM3 port communication error flag	Turns ON if a transmission error occurs when performing data communication. Turns OFF when a transmission request is made by the F159 (MTRN) instruction.
R9149	COM3 port communication mode flag	Turns ON when using the general-purpose communication function. Turns OFF when using a function other than the general-purpose communication function.
R914A	COM3 port reception done flag during general-purpose communication	Turns ON when the end code is received in the general-purpose communication.
R914B	COM3 port transmission done flag during general-purpose communication	Turns ON when the transmission ends in the general-purpose communication. Turns OFF when the transmission is requested in the general-purpose communication.
R914C	COM3 port SEND / RECV instruction execution flag	Indicates whether the F145 (SEND) or F146 (RECV) instruction can be executed or not for the COM3 port. OFF: Not executable (Instruction is being executed) ON: Executable
R914D	COM3 port SEND / RECV instruction execution end flag	Indicates the execution state of the F145 (SEND) or F146 (RECV) instruction for the COM3 port. OFF: Normal end ON: Abnormal end (Communication error occurs) The error code is stored in DT90127.
R914E	Not used	
R914F	Not used	

(Note 1) R9140 to R914F will change even during one scanning cycle. In addition, the same functions are allocated to the special internal relays in parentheses to retain compatibility with the conventional model FP-X Control Unit.

WR915 (Specified in units of words)

Relay no.	Name	Description
R9150	COM4 port communication error flag	Turns ON if a transmission error occurs when performing data communication. Turns OFF when a transmission request is made by the F159 (MTRN) instruction.
R9151 to R9153	Not used	
R9154	COM4 port	Indicates whether the F145 (SEND) or F146 (RECV) instruction can be executed or not for the COM4 port.

List of Special Relays

Relay no.	Name	Description
	SEND / RECV instruction execution flag	OFF: Not executable (Instruction is being executed) ON: Executable
R9155	COM4 port SEND / RECV instruction execution end flag	Indicates the execution state of the F145 (SEND) or F146 (RECV) instruction for the COM4 port. OFF: Normal end ON: Abnormal end (Communication error occurs) The error code is stored in DT90128.
R9156 to R915F	Not used	

List of Special Data Registers

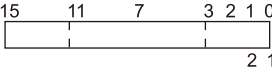
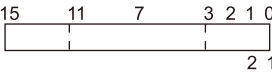
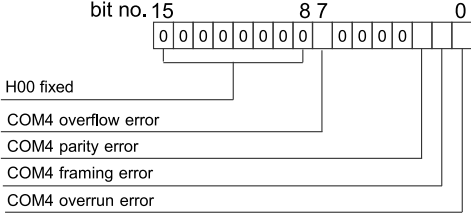
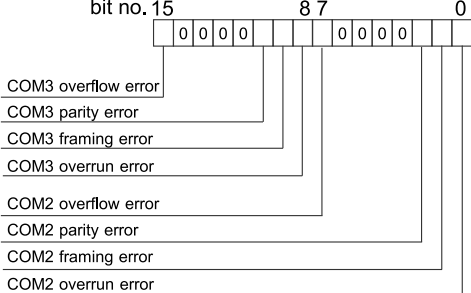
Register no.	Name	Description	R	W
DT90000	Self-diagnosis error code	When a self-diagnostic error occurs, the error code is stored.	○	×
DT90001	Not used		×	×
DT90002	Position where the Function Cassette I/O error occurred	When an error occurs in the Function Cassette, the corresponding bit turns ON. 15 11 7 3 2 1 0 (Bit No.)  ON(1): Error OFF(0): Normal	○	×
DT90003 to DT90005	Not used		×	×
DT90006	Position where the Function Cassette error occurred	When an error occurs in the Function Cassette, the corresponding bit turns ON. 15 11 7 3 2 1 0 (Bit No.)  ON(1): Error OFF(0): Normal	○	×
DT90007	System register error no.	When there is an inconsistency in the setting of a system register, the corresponding system register no. is stored.	○	×
DT90008	Communication error flag COM4 port	The error content when using the COM4 port is stored. ON (1): Error, OFF (0): Normal bit no. 15 8 7 0 	○	×
DT90009	Communication error flag COM2 port / COM3 port	The error content when using the COM2 / COM3 port is stored. ON (1): Error, OFF (0): Normal bit no. 15 8 7 0 	○	×
DT90010	FPX Expansion position of I/O verification mismatched unit	When the installation state of FP-X Expansion I/O Unit changes from the state that it was in when the power was turned ON, the bit corresponding to	○	×

List of Special Data Registers

Register no.	Name	Description	R	W
		<p>the unit number turns ON (1). Monitor with BIN display.</p> <p>15 11 7 3 2 1 0 (Bit no.)</p> <p>4 3 2 1 (Unit no.)</p> <p>ON(1): Abnormal OFF(0): Normal</p>		
DT90011	Expansion Cassette position of verification mismatched unit	<p>When the installation state of FP-X Expansion Cassette changes from the state that it was in when the power was turned ON, the bit corresponding to the Expansion Cassette installation position number turns ON (1). Monitor with BIN display.</p> <p>15 11 7 3 2 1 0 (Bit No.)</p> <p>2 1 (Extension number)</p> <p>ON(1): Error OFF(0): Normal</p>	○	×
DT90012 to DT90013	Not used		×	×
DT90014	Operation auxiliary register for data shift instruction	<p>As a result of the execution of data shift instruction F105 (BSR) or F106 (BSL), the overflowed 1-digit data is stored in bit 0 to bit 3.</p> <p>Reading and writing the value is available by the F0 (MV) instruction.</p>	○	○
DT90015	Operation auxiliary register for division instruction	<p>When executing the 16-bit division instruction F32(%) or F52(B%), the remainder of 16 bits is stored in DT90015.</p>	○	○
DT90016		<p>When executing the 32-bit division instruction F33(D%) or F53(DB%), the remainder of 32 bits is stored in DT90015 to DT90016. Reading and writing the value is available by the F1 (DMV) instruction.</p>		
DT90017	Address with operation error (Hold)	The address where the first operation error occurred after starting the operation is stored. Monitor using decimal display.	○	×
DT90018	Address with operation error (Latest)	The address where the operation error occurred is stored. It will be updated every time an error occurs. Monitor using decimal display.	○	×
DT90019	RING counter (2.5 ms) ^(Note 2)	<p>The stored value is incremented by one every 2.5 ms. (H0 to HFFFF)</p> <p>Difference between the values of 2 points (absolute value) x 2.5 ms = Elapsed time between the 2 points</p>	○	×
DT90020	RING counter (10 μs) ^(Note 2) ^(Note 3)	<p>The stored value is incremented by one every 10.67 μs. (H0 to HFFFF)</p> <p>Difference between the values of 2 points (absolute value) x 10.00 μs = Elapsed time between the 2 points</p> <p>Note) The accurate figure is 10.00 μs.</p>	○	×
DT90021	Not used		×	×
DT90022	Scan time (Current value) ^(Note 1)	<p>The current value of scan time is stored.</p> <p>[Stored value (decimal)] x 0.1 ms</p>	○	×

List of Special Data Registers

Register no.	Name	Description	R	W
		Example) For K50, it is within 5 ms.		
DT90023	Scan time (Minimum value) (Note 1)	The minimum value of scan time is stored. [Stored value (decimal)] x 0.1 ms Example) For K50, it is within 5 ms.	○	×
DT90024	Scan time (Maximum value) (Note 1)	The maximum value of scan time is stored. [Stored value (decimal)] x 0.1 ms Example) For K125, it is within 12.5 ms.	○	×

(Note 1) The scan time display shows the operation cycle time only in RUN mode. In PROG. mode, the scan time of operation is not displayed. The maximum and minimum values are cleared when switching the mode between RUN and PROG.

(Note 2) It is updated once at the beginning of every scan.

(Note 3) DT90020 is also updated when executing the F0 (MV), DT90020 and D instructions, therefore, it can be used for measuring a block time.

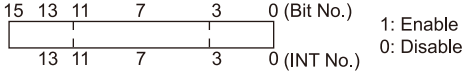
Register no.	Name	Description	R	W
DT90025	Interrupt enable (mask) status (INT0 to 13)	The content set by the ICTL instruction is stored. Monitor with BIN display.  INT0 to INT7: Interrupt input X0 to X7 INT8 to INT10: Interrupt input X100 to X102 INT11 to INT13: Interrupt input X200 to X202 INT0 to INT9: High-speed counter match interrupt CH0 to CH9 INT11 to INT12: High-speed counter match interrupt CHA, CHB	○	×
DT90026	Not used		×	×
DT90027	Periodical interrupt interval (INT24)	The content set by the ICTL instruction is stored. K0: Periodical interrupt is not used K1 to K3000: 0.1 ms to 0.35 s or 0.5 ms to 1.5 s or 10 ms to 30 s	○	×
DT90028	Interval of sampling trace	K0: Sampling by the SMPL instruction K1 to K3000 (×10 ms): 10 ms to 30 s	○	×
DT90029	Not used		×	×
DT90030	Character storage by F149 MSG instruction	The content (characters) set by the message display instruction (F149) is stored.	○	×
DT90031				
DT90032				
DT90033				
DT90034				
DT90035				
DT90036	Not used		×	×

List of Special Data Registers

Register no.	Name	Description	R	W
DT90037	Work 1 for search instruction	When executing the F96 (SRC) instruction, the number that matches the search data is stored.	○	×
DT90038	Work 2 for search instruction	When executing the F96 (SRC) instruction, the relative position that matches is stored.	○	×
DT90039	Not used		×	×
DT90040	Potentiometer input	The value of potentiometer input (K0 to K4000) is stored. It can be applied to the analog timer by reading it to the data register using a user program.	○	×
DT90041 to DT90043	Not used		×	×
DT90044	System work	Used by the system.	○	×
DT90045 to DT90051	Not used		×	×
Register no.	Name	Description	R	W
DT90052	High-speed counter control flag	<p>When using the high-speed counter function, various controls such as resetting the high-speed counter, disabling the count and clearing the execution of an instruction can be performed by writing values with the MV instruction (F0).</p> <div style="text-align: center;"> <p>bit no. 15 8 7 0</p> </div> <p>Channel specification H0 to HB: CH0 to CHB</p> <p>H00: Fixed</p> <p>High-speed counter instruction 0: Continue 1: Clear</p> <p>External reset input 0: Enable 1: Disable</p> <p>Count 0: Enable 1: Disable</p> <p>Software reset 0: Disable 1: Enable</p>	○	○
DT90052	Pulse output control flag	When using the pulse output function with the F17x instruction, various controls such as near home input, stopping the pulse output and canceling an instruction can be performed by writing values using the MV instruction (F0).	○	○

List of Special Data Registers

Register no.	Name	Description	R	W
		<div style="text-align: center;"> bit no. 15 8 7 4 3 1 0 </div> <p>Channel specification H0 to H5: CH0 to CH5</p> <p>H1: Fixed</p> <p>Near home 0: Invalid 1: Valid</p> <p>Pulse output 0: Continue 1: Stop</p> <p>Count 0: Enable 1: Disable</p> <p>Software reset 0: Disable 1: Enable</p>		

(Note 1) When selecting the positioning function in the table setting mode, the control using the pulse output control flag by DT90052 cannot be performed.

Register no.	Name	Description	R	W																
DT90053	Real-time clock monitoring (hour and minute)	The hour and minute data of the real-time clock is stored. You can only read, cannot write. <div style="text-align: center;"> </div> Hour dataH00 to H23 Minute dataH00 to H59	○	×																
DT90054	Real-time clock (minute and second)	The year, month, day, hour, minute, second and day-of-the-week data of the real-time clock is stored. The built-in real-time clock is applicable until 2099 and supports leap years. The real-time clock can be set (time synch) by writing desired values using the programming tool or a program based on the transfer instruction (F0). <div style="text-align: center;"> </div> <table border="1" style="width: 100%; border-collapse: collapse;"> <tr> <td style="width: 25%;">DT90054</td> <td style="width: 25%;">Minute data (H00 to H59)</td> <td style="width: 25%;">Second data (H00 to H59)</td> <td style="width: 25%;"></td> </tr> <tr> <td>DT90055</td> <td>Day data (H01 to H31)</td> <td>Hour data (H00 to H23)</td> <td></td> </tr> <tr> <td>DT90056</td> <td>Year data (H00 to H99)</td> <td>Month data (H01 to H12)</td> <td></td> </tr> <tr> <td>DT90057</td> <td>—</td> <td>Day of week data (H00 to H06)</td> <td></td> </tr> </table> The day of the week is not set automatically. Allocate an arbitrary value in the range of H0 to H6.	DT90054	Minute data (H00 to H59)	Second data (H00 to H59)		DT90055	Day data (H01 to H31)	Hour data (H00 to H23)		DT90056	Year data (H00 to H99)	Month data (H01 to H12)		DT90057	—	Day of week data (H00 to H06)		○	○
DT90054	Minute data (H00 to H59)		Second data (H00 to H59)																	
DT90055	Day data (H01 to H31)		Hour data (H00 to H23)																	
DT90056	Year data (H00 to H99)		Month data (H01 to H12)																	
DT90057	—	Day of week data (H00 to H06)																		
DT90055	Real-time clock (day and hour)																			
DT90056	Real-time clock (year and month)																			
DT90057	Real-time clock (day of week)																			
DT90058	Real-time clock time setting and 30-second compensation register	It is used to adjust the time of the built-in real-time clock. <ul style="list-style-type: none"> Adjust the time by a program By setting the MSB of DT90058 to 1, the time is adjusted to that written to DT90054 to DT90057 by the F0 instruction. After the execution of the	○	○																

List of Special Data Registers

Register no.	Name	Description	R	W
		<p>time adjustment, DT90058 will be cleared to zero. (It cannot be executed using any other instructions than F0 instruction.)</p> <p><Example> Turn X0 ON to set the time to 12:00:00 on the 5th day.</p> <pre> X0 ├──┬──<DF>──┬──[F0 MV, H 0, DT90054] Set 0 minute 0 second. ├──┬──[F0 MV, H 512, DT90055] Set 12th hour 5th day. ├──┬──[F0 MV, H8000, DT90058] Set the time. </pre> <ul style="list-style-type: none"> Correct a difference within 30 seconds. <p>By setting the LSB of DT90058 to 1, the time is moved up or down to be just 0 second.</p> <p>After the execution of the correction, DT90058 will be cleared to zero.</p> <p><Example> Turn X0 ON to correct the time to be 0 second.</p> <pre> X0 ├──┬──<DF>──┬──[F0 MV, H 1, DT90058] Correct to 0 second. </pre> <p>When the time is 0 to 29 seconds when the correction is executed, it is moved down. When it is 30 to 59 seconds, it is moved up. In the above example, when the time is 5 minutes 29 seconds, it will be 5 minutes 0 seconds. When the time is 5 minutes 35 seconds, it will be 6 minutes 0 seconds.</p>		

(Note 1) When rewriting the values of DT90054 to DT90057 using the programming tool, it is not necessary to write the data to DT90058 because the time adjustment is performed when rewritten.

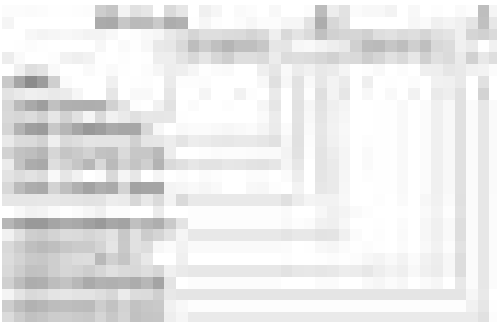
Register no.	Name	Description	R	W
DT90059	Communication error code COM0 port / COM1 port	<p>When a communication error occurs, the error code is stored.</p> <p>ON (1): Error, OFF (0): Normal</p> 	○	×
DT90060	Step ladder process (0 to 15)	<p>Indicates the starting status of the step ladder process. When the process starts, the bit corresponding to its process number turns ON.</p> <p>Monitor with BIN display.</p>	○	○
DT90061	Step ladder process (16 to 31)			
DT90062	Step ladder process (32 to 47)			

List of Special Data Registers

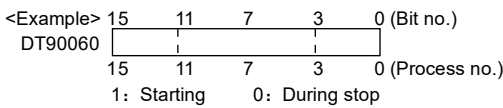
Register no.	Name	Description	R	W
DT90063	Step ladder process (48 to 63)			
DT90064	Step ladder process (64 to 79)			
DT90065	Step ladder process (80 to 95)			
DT90066	Step ladder process (96 to 111)			
DT90067	Step ladder process (112 to 127)			
DT90068	Step ladder process (128 to 143)			
DT90069	Step ladder process (144 to 159)			
DT90070	Step ladder process (160 to 175)			
DT90071	Step ladder process (176 to 191)			
DT90072	Step ladder process (192 to 207)			
DT90073	Step ladder process (208 to 223)	<Example> 		
DT90074	Step ladder process (224 to 239)			
DT90075	Step ladder process (240 to 255)	The data can be written using the programming tool.		
DT90076	Step ladder process (256 to 271)			
DT90077	Step ladder process (272 to 287)			
DT90078	Step ladder process (288 to 303)			
DT90079	Step ladder process (304 to 319)			
DT90080	Step ladder process (320 to 335)			
DT90081	Step ladder process (336 to 351)			
DT90082	Step ladder process (352 to 367)			
DT90083	Step ladder process (368 to 383)			
DT90084	Step ladder process (384 to 399)			
DT90085	Step ladder process (400 to 415)			

List of Special Data Registers

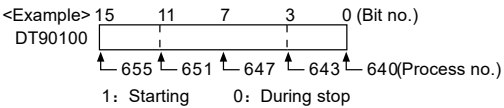
Register no.	Name	Description	R	W
DT90086	Step ladder process (416 to 431)	<p>Indicates the starting status of the step ladder process. When the process starts, the bit corresponding to its process number turns ON. Monitor with BIN display.</p> <p><Example> </p> <p>The data can be written using the programming tool.</p>	○	○
DT90087	Step ladder process (432 to 447)			
DT90088	Step ladder process (448 to 463)			
DT90089	Step ladder process (464 to 479)			
DT90090	Step ladder process (480 to 495)			
DT90091	Step ladder process (496 to 511)			
DT90092	Step ladder process (512 to 527)			
DT90093	Step ladder process (528 to 543)			
DT90094	Step ladder process (544 to 559)			
DT90095	Step ladder process (560 to 575)			
DT90096	Step ladder process (576 to 591)			
DT90097	Step ladder process (592 to 607)			
DT90098	Step ladder process (608 to 623)			
DT90099	Step ladder process (624 to 639)			
DT90100	Step ladder process (640 to 655)			
DT90101	Step ladder process (656 to 671)			
DT90102	Step ladder process (672 to 687)			
DT90103	Step ladder process (688 to 703)			
DT90104	Step ladder process (704 to 719)			
DT90105	Step ladder process (720 to 735)			
DT90106	Step ladder process (736 to 751)			
DT90107	Step ladder process (752 to 767)			
DT90108	Step ladder process (768 to 783)			

List of Special Data Registers

Register no.	Name	Description	R	W
DT90109	Step ladder process (784 to 799)			
DT90110	Step ladder process (800 to 815)			
DT90111	Step ladder process (816 to 831)			
DT90112	Step ladder process (832 to 847)			
DT90113	Step ladder process (848 to 863)			
DT90114	Step ladder process (864 to 879)			
DT90115	Step ladder process (880 to 895)			
DT90116	Step ladder process (896 to 911)			
DT90117	Step ladder process (912 to 927)			
DT90118	Step ladder process (928 to 943)			
DT90119	Step ladder process (944 to 959)			
DT90120	Step ladder process (960 to 975)			
DT90121	Step ladder process (976 to 991)			
DT90122	Step ladder process (992 to 999) (High byte is not used.)			
DT90123	COM0 SEND / RECV instruction end code	When an error occurs when executing the SEND / RECV instruction, the error code is stored.	○	×
DT90124	COM1 SEND / RECV instruction end code		○	×
DT90125	COM2 SEND / RECV instruction end code		○	×
DT90126	Forced ON/OFF operating station display	Used by the system.	○	×
DT90127	COM3 SEND / RECV instruction end code	When an error occurs when executing the SEND / RECV instruction, the error code is stored.	○	×
DT90127	COM4 SEND / RECV instruction end code		○	×

List of Special Data Registers

Register no.	Name	Description	R	W
DT90128 to DT90139	Not used		×	×
DT90140	MEWNET-W0 PC (PLC) link 0 status	PLC link 0 No. of times of reception	○	×
DT90141		PC (PLC) link 0 Reception interval (current value) (x2.5 ms)		
DT90142		PC (PLC) link 0 Reception interval (minimum value) (x2.5 ms)		
DT90143		PC (PLC) link 0 Reception interval (maximum value) (x2.5 ms)		
DT90144		PC (PLC) link 0 No. of times of transmission		
DT90145		PC (PLC) link 0 Transmission interval (current value) (x2.5 ms)		
DT90146		PC (PLC) link 0 Transmission interval (minimum value) (x2.5 ms)		
DT90147		PC (PLC) link 0 Transmission interval (maximum value) (x2.5 ms)		
DT90148	MEWNET-W0 PC (PLC) link 1 status	PC (PLC) link 1 No. of times of reception	○	×
DT90149		PC (PLC) link 1 reception interval (current value) (x2.5 ms)		
DT90150		PC (PLC) link 1 reception interval (minimum value) (x2.5 ms)		
DT90151		PC (PLC) link 1 reception interval (maximum value) (x2.5 ms)		
DT90152		PC (PLC) link 1 No. of times of transmission		
DT90153		PC(PLC) link 1 transmission interval (current value) (x2.5 ms)		
DT90154		PC(PLC) link 1 transmission interval (minimum value) (x2.5 ms)		
DT90155		PC(PLC) link 1 transmission interval (maximum value) (x2.5 ms)		
DT90156	MEWNET-W0 PC (PLC) link 0 status	PC (PLC) link 0 Work for measuring reception interval	○	×
DT90157		PC (PLC) link 0 Work for measuring transmission interval		
DT90158	MEWNET-W0 PC (PLC) link 1 status	PC (PLC) link 1 Work for measuring reception interval	○	×
DT90159		PC (PLC) link1 work for measuring transmission interval		
DT90160	MEWNET-W0 PC (PLC) link 0 unit no.	The unit number of PC (PLC) link 0 is stored.	○	×
DT90161	MEWNET-W0 PC (PLC) link 0 Error flag	The error content of PC (PLC) link 0 is stored.	○	×
DT90162 to DT90169	Not used		×	×
DT90170	MEWNET-W0	PC (PLC) link address duplicate destination	○	×

List of Special Data Registers

Register no.	Name	Description	R	W
DT90171	PC (PLC) link 0 status	No. of missing tokens		
DT90172		No. of duplicate tokens		
DT90173		No. of no signal states		
DT90174		No. of times of receptions of undefined commands		
DT90175		No. of sum check errors for reception		
DT90176		No. of received data format errors		
DT90177		Number of transmission errors		
DT90178		No. of procedure errors		
DT90179		No. of duplicate master units		
DT90180 to DT90218	Not used		×	×
DT90219	Unit number switch of DT90220 to DT90251	0: Unit nos. 1 to 8, 1: Unit nos. 9 to 16	○	×
DT90220	PC (PLC) link Unit no. 1 or 9	System registers 40 and 41	○	×
DT90221		System registers 42 and 43		
DT90222		System registers 44 and 45		
DT90223		System registers 46 and 47		
DT90224	PC (PLC) link Unit no. 2 or 10	System registers 40 and 41		
DT90225		System registers 42 and 43		
DT90226		System registers 44 and 45		
DT90227		System registers 46 and 47		
DT90228	PC (PLC) link Unit no. 3 or 11	System registers 40 and 41		
DT90229		System registers 42 and 43		
DT90230		System registers 44 and 45		

The settings of the system register related to the PC (PLC) function of each unit number is stored as follows.
 <Example>
 When DT90219 is 0;

DT90220 to DT90223 (Unit no. 1)

Settings of system registers 40, 42, 44, 46

Settings of system registers 41, 43, 45, 47

When the system register no. 46 of the home unit is the standard setting, the values in the home unit will be copied for nos. 46 and 47.
 When the system register no. 46 of the home unit is the reverse setting, the nos. 40 to 45 and 47 corresponding to those of the home unit will be 50 to 55 and 57, and 46 will be set as it is.
 Also, nos. 40 to 45 corresponding to other units will be the values after correcting the received values, and nos. 46 and 57 of the home unit will be set for nos. 46 and 47.

List of Special Data Registers

Register no.	Name	Description	R	W
DT90231		System registers 46 and 47		
DT90232		System registers 40 and 41		
DT90233	PC (PLC) link	System registers 42 and 43		
DT90234	Unit no. 4 or 12	System registers 44 and 45		
DT90235		System registers 46 and 47		
DT90236		System registers 40 and 41		
DT90237	PC (PLC) link	System registers 42 and 43		
DT90238	Unit no. 5 or 13	System registers 44 and 45		
DT90239		System registers 46 and 47		
DT90240		System registers 40 and 41		
DT90241	PC (PLC) link	System registers 42 and 43		
DT90242	Unit no. 6 or 14	System registers 44 and 45		
DT90243		System registers 46 and 47		
DT90244		System registers 40 and 41		
DT90245	PC (PLC) link	System registers 42 and 43		
DT90246	Unit no. 7 or 15	System registers 44 and 45		
DT90247		System registers 46 and 47		

List of Special Data Registers

Register no.	Name		Description	R	W
DT90248	PC (PLC) link Unit no. 8 or 16	System registers 40 and 41			
DT90249		System registers 42 and 43			
DT90250		System registers 44 and 45			
DT90251		System registers 46 and 47			
DT90252 to DT90299	Not used			×	×

Common to FP-XH relay type / transistor type

Register no.	Name		Description	R	W	
DT90300	Elapsed value area	Low word	HSC-CH0	The counting area of the high-speed counter Control Unit input CH0 (X0) or (X0, X1)	○	○
DT90301		High word				
DT90302	Target value area	Low word	HSC-CH0	When executing the F166 (HC1S) and F167 (HC1R) instructions, the target value is set.	○	○
DT90303		High word				
DT90304	Elapsed value area	Low word	HSC-CH1	The counting area of the high-speed counter Control Unit input (X1).	○	○
DT90305		High word				
DT90306	Target value area	Low word	HSC-CH1	When executing the F166 (HC1S) and F167 (HC1R) instructions, the target value is set.	○	○
DT90307		High word				
DT90308	Elapsed value area	Low word	HSC-CH2	The counting area of the high-speed counter Control Unit input (X2) or (X2, X3).	○	○
DT90309		High word				
DT90310	Target value area	Low word	HSC-CH2	When executing the F166 (HC1S) and F167 (HC1R) instructions, the target value is set.	○	○
DT90311		High word				
DT90312	Elapsed value area	Low word	HSC-CH3	The counting area of the high-speed counter Control Unit input (X3).	○	○
DT90313		High word				

List of Special Data Registers

Register no.	Name			Description	R	W
DT90314	Target value area	Low word		When executing the F166 (HC1S) and F167 (HC1R) instructions, the target value is set.	○	○
DT90315		High word			○	○
DT90316	Elapsed value area	Low word	HSC-CH4	The counting area of the high-speed counter Control Unit input (X4) or (X4, X5).	○	○
DT90317		High word			○	○
DT90318	Target value area	Low word		When executing the F166 (HC1S) and F167 (HC1R) instructions, the target value is set.	○	○
DT90319		High word			○	○
DT90320	Elapsed value area	Low word	HSC-CH5	The counting area of the high-speed counter Control Unit input (X5).	○	○
DT90321		High word			○	○
DT90322	Target value area	Low word		When executing the F166 (HC1S) and F167 (HC1R) instructions, the target value is set.	○	○
DT90323		High word			○	○
DT90324	Elapsed value area	Low word	HSC-CH6	The counting area of the high-speed counter Control Unit input (X6) or (X6, X7).	○	○
DT90325		High word			○	○
DT90326	Target value area	Low word		When executing the F166 (HC1S) and F167 (HC1R) instructions, the target value is set.	○	○
DT90327		High word			○	○
DT90328	Elapsed value area	Low word	HSC-CH7	The counting area of the high-speed counter Control Unit input (X7).	○	○
DT90329		High word			○	○
DT90330	Target value area	Low word		When executing the F166 (HC1S) and F167 (HC1R) instructions, the target value is set.	○	○
DT90331		High word			○	○

(Note 1) Only the F1 (DMV) instruction can perform the reading and writing of elapsed value area.

(Note 2) The target value area is set when the high-speed counter target value match instruction F166 (HC1S) or F167 (HC1R) is executed. It cannot be written by a user program.

FP-XH relay type

Register no.	Name			Description	R	W
DT90332	Elapsed value area	Low word	HSC-CH8	The counting area of the high-speed counter input (X100) or (X100, X101) of the pulse I/O cassette .	○	○

List of Special Data Registers

Register no.	Name		Description	R	W
DT90333	Target value area	High word	When executing the F166 (HC1S) and F167 (HC1R) instructions, the target value is set.	○	○
DT90334		Low word		○	○
DT90335		High word		○	○
DT90336	Elapsed value area	Low word	The counting area of the high-speed counter input (X101) of the pulse I/O cassette .	○	○
DT90337		High word		○	○
DT90338	Target value area	Low word	When executing the F166 (HC1S) and F167 (HC1R) instructions, the target value is set.	○	○
DT90339		High word		○	○
DT90340	Elapsed value area	Low word	The counting area of the high-speed counter input (X200) or (X200, X201) of the pulse I/O cassette .	○	○
DT90341		High word		○	○
DT90342	Target value area	Low word	When executing the F166 (HC1S) and F167 (HC1R) instructions, the target value is set.	○	○
DT90343		High word		○	○
DT90344	Elapsed value area	Low word	The counting area of the high-speed counter input (X201) of the pulse I/O cassette .	○	○
DT90345		High word		○	○
DT90346	Target value area	Low word	When executing the F166 (HC1S) and F167 (HC1R) instructions, the target value is set.	○	○
DT90347		High word		○	○

(Note 1) Only the F1 (DMV) instruction can perform the reading and writing of elapsed value area.

(Note 2) The target value area is set when the high-speed counter target value match instruction F166 (HC1S) or F167 (HC1R) is executed. It cannot be written by a user program.

(Note 3) DT90332 to DT90347 are valid only when the pulse I/O cassette is installed on the relay type Control Unit.

FP-XH relay type (FP-X compatible instruction mode)

Register no.	Name		Description	R	W
DT90348	Elapsed value area	Low word	The counting area of the pulse output (Y100, Y101) of the pulse I/O cassette.	○	○
DT90349		High word		○	○
DT90350	Target value area	Low word	When executing the pulse output instruction (F17x), the target value is set.	○	○

Register no.	Name			Description	R	W
DT90351		High word			○	○
DT90352	Elapsed value area	Low word	PLS-CH1	The counting area of the pulse output (Y200, Y201) of the pulse I/O cassette.	○	○
DT90353		High word			○	○
DT90354	Target value area	Low word		When executing the pulse output instruction (F17x), the target value is set.	○	○
DT90355		High word			○	○
DT90356 to DT90371	Not used				×	×

(Note 1) Only the F1 (DMV) instruction can perform the reading and writing of elapsed value area.

(Note 2) Only the F1 (DMV) instruction can perform the reading of target value area.

(Note 3) The target value area is set when the pulse output instruction F171(SPDH), F172(PLSH), F174(SPOH), or F175(PSH) is executed. It cannot be written by a user program.

FP-XH transistor type (FP-X compatible instruction mode)

Register no.	Name			Description	R	W
DT90348	Elapsed value area	Low word	PLS-CH0	The counting area of the pulse output CH0 (Y0, Y1).	○	○
DT90349		High word			○	○
DT90350	Target value area	Low word		When executing the pulse output instruction (F17x), the target value is set.	○	○
DT90351		High word			○	○
DT90352	Elapsed value area	Low word	PLS-CH1	The counting area of the pulse output CH1 (Y2, Y3)	○	○
DT90353		High word			○	○
DT90354	Target value area	Low word		When executing the pulse output instruction (F17x), the target value is set.	○	○
DT90355		High word			○	○
DT90356	Elapsed value area	Low word	PLS-CH2	The counting area of the pulse output CH2 (Y4, Y5)	○	○
DT90357		High word			○	○
DT90358	Target value area	Low word		When executing the pulse output instruction (F17x), the target value is set.	○	○
DT90359		High word			○	○
DT90360	Elapsed value area	Low word	PLS-CH3	The counting area of the pulse output CH3 (Y6, Y7)	○	○
DT90361		High word			○	○
DT90362	Target value area	Low word		When executing the pulse output instruction (F17x), the target value is set.	○	○
DT90363		High word			○	○
DT90364	Elapsed value area	Low word	PLS-CH4	The counting area of the pulse output CH4 (Y8, Y9)	○	○
DT90365		High word			○	○
DT90366	Target value area	Low word		When executing the pulse output instruction (F17x), the target value is set.	○	○
DT90367		High word			○	○

Communication Commands

List of MEWTOCOL Supported Commands

The MEWTOCOL commands that are supported by this product are as follows.

MEWTOCOL-COM

Type of instruction	Code	Description
Read contact area	RC (RCS) (RCP) (RCC)	Reads the ON / OFF status of contacts. <ul style="list-style-type: none"> • Specifies only one point. • Specifies multiple contacts. • Specifies a range in word units.
Write contact area	WC (WCS) (WCP) (WCC)	Turns ON or OFF a contact. <ul style="list-style-type: none"> • Specifies only one point. • Specifies multiple contacts. • Specifies a range in word units.
Read data area	RD	Reads the contents of a data area.
Write data area	WD	Writes data to a data area.
Register or reset contacts monitored	MC	Registers the contact to be monitored.
Register or reset data monitored	MD	Registers the data to be monitored.
Monitoring start	MG	Monitors a registered contact or data using MD and MC.
Preset contact area (fill command)	SC	Fills the area of a specified range with a 16-point ON / OFF pattern.
Preset data area (fill command)	SD	Writes the same contents to the data area of a specified range.
Read the status of PLC	RT	Reads PLC specification, an error code when an error occurs, etc.
Abort	AB	Aborts communication.

(Note 1) Some devices cannot be accessed due to format limitations of MEWTOCOL-COM communication commands.

Communication Commands

List of MODBUS Supported Commands

List of MODBUS Function Codes

■ Supported commands (●: Available, Blank: Not available)

Code	Name (MODBUS)	Name	Remarks (Reference No.)	Corresponding functions	
				Slave	Master
01	Read Coil Status	Read Y / R coils	0X	●	●
02	Read Input Status	Read X contact	1X	●	●
03	Read Hold Register	Read DT	4X	●	●
04	Read Input Registers	Read WL / LD	3X	●	●
05	Force Single Coil	Write single Y / R	0X	●	●
06	Preset Single Register	Write DT1 word	4X	●	●
08	Diagnostics	Loopback test	-	●	
15	Force Multiple Coils	Write multiple Y / R	0X	●	●
16	Preset Multiple Registers	Write DT multiple words	4X	●	●
22	Mask Write 4X Register	Write DT mask	4X	●	
23	Read / Write 4X Registers	Read / write DT	4X	●	

(Note 1) During master communication, MODBUS function codes 01, 02, 03 and 04 use F146 (RECV) instruction, while MODBUS function codes 05, 06, 15 and 16 use F145 (SEND) instruction.

Device No. Correspondence Table

■ Correspondence table between MODBUS command reference Nos. and device Nos.

MODBUS reference Nos.		Data on BUS (hexadecimal)	PLC device No.
Coil	000001-001760	0000-06DF	Y0-Y109F
	002049-010240	0800-27FF	R0-R511F
Input	100001-101760	0000-06DF	X0-X109F
Holding register	400001-465533	0000-FFFC	DT0-DT65532
Input register	300001-301028	0000-007F	WL0-WL127
	302001-302256	07D0-08CF	LD0-LD255

(Note 1) The table above indicates correspondence between MODBUS reference Nos. for accessing PLC through MODBUS protocol from a higher device and operation device Nos. of PLC.

Positioning Memory

Configuration of Memory Map

The positioning memory consists of four areas.

■ Whole memory map

Area		Absolute address (Decimal)	No. of words and configuration		
No.	Name				
0	Common area	0000 to 0029	30 words		
1	Axis information area	0030 to 0039	For CH0	10 words for each channel	
		0040 to 0049	For CH1		
		0050 to 0059	For CH2		
		0060 to 0069	For CH3		
		0070 to 0079	For CH4		
		0080 to 0089	For CH5		
		0090 to 0099	Reserved for system		
2	Axis setting area	0100 to 0129	For CH0	30 words for each channel	
		0130 to 0159	For CH1		
		0160 to 0189	For CH2		
		0190 to 0219	For CH3		
		0220 to 0249	For CH4		
		0250 to 0279	For CH5		
		0280 to 0299	Reserved for system		
3	Positioning table area	0300 to 0549	For CH0	250 words for each channel	
			0300 to 0309	Table 1	10 words for each table
			0490 to 0499	Table 20	
			0500 to 0549	Reserved for system	
		0550 to 0799	For CH1	250 words for each channel	
		0800 to 1049	For CH2		
		1050 to 1299	For CH3		
1300 to 1549	For CH4				
1550 to 1799	For CH5				

(Note 1) The addresses in the table are the addresses which indicate the configurations in the positioning memory. For reading / writing data using user programs, use an area number and offset address in combination for specification.

Positioning Memory

■ Reading from positioning memory

- It is possible to read the areas which are shown with "Available" in the "R" column in the following table using the F384 (PTBLR) instruction in user programs during RUN. The operand of the instruction is specified using the combination of the channel number, area number and offset address.

■ Writing to positioning memory

- When the mode changes from PROG. to RUN, the contents set by the tool software Configurator PMX will be stored.
- It is possible to rewrite the areas which are shown with "Available" in the "W" column in the following table using the F385 (PTBLW) instruction in user programs during RUN. The operand of the instruction is specified using the combination of the channel number, area number and offset address.
- Be sure not to execute writing in the reserved areas for the system.

Common Area (Memory Area No. 0)

●: Available, -: Not available

Address	Name	Default	Description	R	W																						
0000	Axis setting	H0	Stores used channels (axes) and usage methods. Monitor using binary display.	●	●																						
			<table border="1"> <thead> <tr> <th>bit no.</th> <th>Settings</th> </tr> </thead> <tbody> <tr> <td>0</td> <td>Not use CH0 (0) / Use CH0 (1)</td> </tr> <tr> <td>1</td> <td>Not use CH1 (0) / Use CH1 (1)</td> </tr> <tr> <td>2</td> <td>Not use CH2 (0) / Use CH2 (1)</td> </tr> <tr> <td>3</td> <td>Not use CH3 (0) / Use CH0 (1)</td> </tr> <tr> <td>4</td> <td>Not use CH4 (0) / Use CH3 (1)</td> </tr> <tr> <td>5</td> <td>Not use CH5 (0) / Use CH3 (1)</td> </tr> <tr> <td>6 to 7</td> <td>Disable the setting</td> </tr> <tr> <td>8</td> <td>Use CH0 and CH1 as an interpolation axis Not use (0) / Use (1)</td> </tr> <tr> <td>9</td> <td>Use CH2 and CH3 as an interpolation axis Not use (0) / Use (1)</td> </tr> <tr> <td>10 to 15</td> <td>Disable the setting</td> </tr> </tbody> </table>			bit no.	Settings	0	Not use CH0 (0) / Use CH0 (1)	1	Not use CH1 (0) / Use CH1 (1)	2	Not use CH2 (0) / Use CH2 (1)	3	Not use CH3 (0) / Use CH0 (1)	4	Not use CH4 (0) / Use CH3 (1)	5	Not use CH5 (0) / Use CH3 (1)	6 to 7	Disable the setting	8	Use CH0 and CH1 as an interpolation axis Not use (0) / Use (1)	9	Use CH2 and CH3 as an interpolation axis Not use (0) / Use (1)	10 to 15	Disable the setting
			bit no.			Settings																					
			0			Not use CH0 (0) / Use CH0 (1)																					
			1			Not use CH1 (0) / Use CH1 (1)																					
			2			Not use CH2 (0) / Use CH2 (1)																					
			3			Not use CH3 (0) / Use CH0 (1)																					
			4			Not use CH4 (0) / Use CH3 (1)																					
			5			Not use CH5 (0) / Use CH3 (1)																					
			6 to 7			Disable the setting																					
8	Use CH0 and CH1 as an interpolation axis Not use (0) / Use (1)																										
9	Use CH2 and CH3 as an interpolation axis Not use (0) / Use (1)																										
10 to 15	Disable the setting																										
0001	Positioning repeat count (CH0)	K0	Stores the repeat count in decimal when using the repeat control in the position control.	●	●																						
0002	Positioning repeat count (CH1)	K0	<table border="1"> <thead> <tr> <th>Set value</th> <th>Operation</th> </tr> </thead> <tbody> <tr> <td>0 or 1</td> <td>Not repeat an operation.</td> </tr> <tr> <td>2 to 254</td> <td>Repeat an operation for a specified number of times.</td> </tr> </tbody> </table>	Set value	Operation	0 or 1	Not repeat an operation.	2 to 254	Repeat an operation for a specified number of times.	●	●																
			Set value	Operation																							
0 or 1	Not repeat an operation.																										
2 to 254	Repeat an operation for a specified number of times.																										

Address	Name	Default	Description	R	W	
0003	Positioning repeat count (CH2)	K0		•	•	
			Set value			Operation
0004	Positioning repeat count (CH3)	K0	255 or more	Repeat an operation infinitely.	•	•
0005	Positioning repeat count (CH4)	-	-	•	•	
0006	Positioning repeat count (CH5)			•	•	
0007	Error code	H0	Stores a generated positioning error code in Hex format (hexadecimal) when using the pulse output function (table setting mode). The higher 8 bits indicate channel number. The lower 8 bits indicate error code.	•	-	
0008 to 0029	Reserved for system	-	-	-	-	

Axis Information Area (Memory Area No. 1)

•: Available, -: Not available

Offset address	Name	Default	Description	R	W
0000	Active or execution done table	K0	Stores the monitor values of the positioning table numbers during the execution or on the completion of each channel. Stored value: 0-20	•	-
0001	Repeat count current value	K0	Stores the repeat count during the operation of each channel. The execution start time is counted as "1". When the repeat count exceeds the upper limit, it returns to "0". When the repeat operation is not enabled, "0" is stored at the positioning control start time. Stored value: 0-65535	•	-
0002 -0003	Elapsed value (Current value coordinate)	K0	Stores the elapsed values (current value coordinate) of each channel. Range: -1,073,741,824 to 1,073,741,823 For the interpolation control, the setting range is as follows. -8,388,608 to +8,388,607	•	•
0004 -0009	Reserved for system	-	-	-	-

Positioning Memory

Axis Setting Area (Memory Area No. 2)

●: Available, -: Not available

Offset address	Name	Default	Description	R	W																					
0000	Pulse output control code	H0	Stores the settings of pulse output, home position, near home position, and limit signal of each channel. Monitor in binary format.	●	●																					
			<table border="1"> <thead> <tr> <th>bitno.</th> <th>Item</th> <th>Settings</th> </tr> </thead> <tbody> <tr> <td>0</td> <td>Pulse output method</td> <td>0 : Pulse/Sign 1 : CW/CCW</td> </tr> <tr> <td>1</td> <td>Pulse output rotation direction</td> <td>0: Elapsed value + Direction is CW (Forward OFF/Reverse ON) 1: Elapsed value + Direction is CCW (Forward ON/Reverse OFF)</td> </tr> <tr> <td>2</td> <td>Home position logic</td> <td rowspan="4">0: Normal Open (A contact) 1: Normal Close (B contact)</td> </tr> <tr> <td>3</td> <td>Home position proximity logic</td> </tr> <tr> <td>4</td> <td>Limit (+) switch logic</td> </tr> <tr> <td>5</td> <td>Limit (-) switch logic</td> </tr> <tr> <td>6-15</td> <td>Disable the setting</td> <td></td> </tr> </tbody> </table>			bitno.	Item	Settings	0	Pulse output method	0 : Pulse/Sign 1 : CW/CCW	1	Pulse output rotation direction	0: Elapsed value + Direction is CW (Forward OFF/Reverse ON) 1: Elapsed value + Direction is CCW (Forward ON/Reverse OFF)	2	Home position logic	0: Normal Open (A contact) 1: Normal Close (B contact)	3	Home position proximity logic	4	Limit (+) switch logic	5	Limit (-) switch logic	6-15	Disable the setting	
			bitno.			Item	Settings																			
			0			Pulse output method	0 : Pulse/Sign 1 : CW/CCW																			
			1			Pulse output rotation direction	0: Elapsed value + Direction is CW (Forward OFF/Reverse ON) 1: Elapsed value + Direction is CCW (Forward ON/Reverse OFF)																			
			2			Home position logic	0: Normal Open (A contact) 1: Normal Close (B contact)																			
			3			Home position proximity logic																				
			4			Limit (+) switch logic																				
5	Limit (-) switch logic																									
6-15	Disable the setting																									
0001-0002	Startup speed	K100	Stores the settings of the startup speed for each operation of each channel in decimal. Setting range: 1 to 100,000	●	●																					
0003	Home return method	HFF	Stores the settings of home return patterns of each channel. H0: DOG method 1 H1: DOG method 2 H2: DOG method 3 H3: Setting error H4: Setting error H5: Home position method (Z phase method) H6: Data set method HFF: Not use	●	●																					
0004	Home return direction	K0	Stores the settings of home return operation direction in decimal. 0: Elapsed value decreasing direction (Limit - direction) 1: Elapsed value increasing direction (Limit + direction)	●	●																					
0005	Home return acceleration time	K100	Stores the settings of the acceleration time for the home return of each channel in decimal. It indicates the time from the startup speed to the home return target speed. Setting range: 1-10,000 (ms)	●	●																					

Offset address	Name	Default	Description	R	W
0006	Home return deceleration time	K100	Stores the settings of the deceleration time for the home return of each channel in decimal. It indicates the time from the home return target speed to the startup speed. Setting range: 1-10,000 (ms)	•	•
0007 -0008	Home return target speed	K1000	Stores the settings of the target speed for the home return of each channel in decimal. Setting range: 1 to 100,000	•	•
0009 -0010	Home return creep speed	K100	Stores the settings of the creep speed for the home return of each channel in decimal. Setting range: 1 to 100,000	•	•
0011	Deviation counter clear time	K1	Stores the settings of the deviation counter clear signal ON time after the completion of home return of each channel in decimal. Setting range: 1 to 100 (ms) In the case of 0, no deviation counter clear signal is output. In the case of 100 or more, the ON time is set to 100 ms.	•	•
0012 -0013	Coordinate origin	K0	Stores the elapsed values (current value) after the home return. Range: -1,073,741,824 to 1,073,741,823 For the interpolation control, the setting range is as follows. -8,388,608 to +8,388,607	•	•
0014	JOG acceleration time	K0	Stores the settings of the acceleration time for the JOG operation of each channel in decimal. It indicates the acceleration time from startup speed to JOG operation target speed. Setting range: 0 to 10,000 (ms)	•	•
0015	JOG deceleration time	K0	Stores the settings of the deceleration time for the JOG operation of each channel in decimal. It indicates the deceleration time from JOG operation target speed to startup speed. Setting range: 0 to 10,000 (ms)	•	•
0016 -0017	JOG target speed	K1000	Stores the settings of the target speed for the JOG operation of each channel in decimal. Setting range: 1 to 100,000	•	•
0018 -0019	J point change target speed	K1000	Stores the settings of the target speed for changing the J-point control speed for each channel in decimal. Setting range: 1 to 100,000	•	•
0020	Emergency stop deceleration time	K100	Stores the settings of the deceleration time for the emergency stop operation of each channel in decimal. It indicates the deceleration time from 100 kHz to 0 Hz. Setting range: 0 to 10,000 (ms)	•	•
0021	Limit stop deceleration time	K100	Stores the settings of the deceleration time for the limit stop operation of each channel in decimal. It indicates the deceleration time from 100 kHz to 0 Hz. Setting range: 0 to 10,000 (ms)	•	•
0022 -0029	Reserved for system	-	-	-	-

Offset address	Name	Default	Description	R	W
			-8,388,608 to +8,388,607		
0008	Dwell time	K0	Stores the setting of dwell time. Setting range: 0 to 32,767ms	•	•
0009	Reserved for system	-	-	-	-

(Note 1) The offset addresses in the above table are for the table no. 0. They vary according to the table numbers as described on the next page.

■ Offset addresses

Table no.	Control code	Control pattern	Positioning acceleration time	Positioning deceleration time	Positioning target speed	Positioning movement amount	Dwell time
1	0	1	2	3	4-5	6-7	8
2	10	11	12	13	14-15	16-17	18
3	20	21	22	23	24-25	26-27	28
4	30	31	32	33	34-35	36-37	38
5	40	41	42	43	44-45	46-47	48
6	50	51	52	53	54-55	56-57	58
7	60	61	62	63	64-65	66-67	68
8	70	71	72	73	74-75	76-77	78
9	80	81	82	83	84-85	86-87	88
10	90	91	92	93	94-95	96-97	98
11	100	101	102	103	104-105	106-107	108
12	110	111	112	113	114-115	116-117	118
13	120	121	122	123	124-125	126-127	128
14	130	131	132	133	134-135	136-137	138
15	140	141	142	143	144-145	146-147	148
16	150	151	152	153	154-155	156-157	158
17	160	161	162	163	164-165	166-167	168
18	170	171	172	173	174-175	176-177	178
19	180	181	182	183	184-185	186-187	188
20	190	191	192	193	194-195	196-197	198

(Note 1) For the positioning target speed and positioning movement amount, specify the lower address number of 2-word area.

List of Error Codes

List of Syntax Check Errors

Error codes 1 to 8

Code	Name	Operation	Error contents and steps to take
E1	Syntax error	Stop	<ul style="list-style-type: none"> • A sequence program with a syntax error has been written. • Change to PROG. mode and correct the error.
E2	Duplicate use (definition) error ^(Note 1)	Stop	<ul style="list-style-type: none"> • The relay is used in the 'Out' instruction or 'Keep' instruction more than once. It also occurs when using the same timer / counter number. • Change to PROG. mode and correct the program so that one relay is not used for two or more instructions. Or, set the duplicated output to "enable" in the system register no. 20. A timer / counter instruction double definition error will be detected even if double output permission has been selected.
E3	Not paired error	Stop	<ul style="list-style-type: none"> • For instructions which must be used in a pair (such as JP and LBL), one instruction is either missing or in an incorrect position. • Change to PROG. mode and enter the two instructions which must be used in a pair in the correct positions.
E4	Parameter mismatch error	Stop	<ul style="list-style-type: none"> • An instruction has been written which does not agree with system register settings. The number setting in a program does not agree with the timer / counter range setting. • Change to PROG. mode, check the system register settings, and change so that the settings and the instruction agree.
E5	Program area error ^(Note 1)	Stop	<ul style="list-style-type: none"> • An instruction which must be written in a specific area (main program area or subprogram area) has been written to a different area (for example, a subroutine SUB to RET is placed before an ED instruction). • Change to PROG. mode and enter the instruction into the correct area.
E6	Compile memory full	Stop	<ul style="list-style-type: none"> • The program is too large to compile in the program memory. • Change to PROG. mode and reduce the total number of steps for the program.
E7	High-level instruction type error	Stop	<ul style="list-style-type: none"> • In the program, high-level instructions, which execute in every scan and at the leading edge of the trigger, are programmed to be triggered by one contact. • Correct the program so that the high-level instructions executed in every scan and only at the leading edge are triggered separately.
E8	High-level instruction operand combination error	Stop	<ul style="list-style-type: none"> • There is an incorrect operand in an instruction which requires a specific combination of operands (for example, the operands must all be of a certain type). • Enter the correct combination of operands.

(Note 1) The error codes E2 and E5 are detected even when rewriting data with syntax errors in RUN mode. In this case, nothing will be written into the Control Unit. The operation continues.

Self-diagnostic Errors			
------------------------	--	--	--

Code	Name	Operation	Error contents and steps to take
E20	Watchdog timeout	Stop	<ul style="list-style-type: none"> The watchdog timer is activated and the operation stops. A hardware error or operation congestion occurs. Check if an endless loop occurs by a control instruction which changes the flow of the process of a program (such as JP and LOOP). If there is no problem in the program, there may be an error in the hardware.
E22	Hardware error	Stop	<ul style="list-style-type: none"> There may be an error in the hardware. Please contact your dealer.
E25	Master memory model mismatch error	Stop	<ul style="list-style-type: none"> The models of master memories are different. Use the master memories created with the same model.
E26	User ROM error	Stop	<ul style="list-style-type: none"> When the master memory cassette is mounted, the master memory cassette may be damaged. Remove the master memory cassette and check whether the error occurs. If the error does not occur, the master memory is damaged. Rewrite the master memory and use it again. When the error does not turn off, please contact your dealer.
E27	Restrictions on the number of units installed	Stop	<ul style="list-style-type: none"> The number of the installed units exceeds the limitation. Turn off the power and re-configure units referring to the hardware manual.
E34	I/O status error	Stop	<ul style="list-style-type: none"> An abnormal unit is installed. Check the slot number with DT90036, and replace the abnormal unit with a normal unit.
E40	I/O error	Select	<ul style="list-style-type: none"> There may be an error in the Function Cassette. Check the position where the error occurs with the special data register DT90002 and fix the error. In the tool software, it can also be checked with the [I/O Error] button in the status display dialog box.
E41	Special unit out of control	Select	<ul style="list-style-type: none"> There may be an error in an intelligent unit. Check the position where the error occurs with the special data register DT90006 and fix the error. In the tool software, it can also be checked with the [Special Error] button in the "Status Display" dialog box.
E42	I/O verification error	Select	<ul style="list-style-type: none"> The I/O unit (Expansion Unit) wiring condition has changed compared to that at time of power-up. Check the I/O unit whose wiring condition has changed with the special data registers DT90010 and DT90011. Or check the fitting state of the expansion connector. In the tool software, it can also be checked with the [Verification Error] button in the "Status Display" dialog box.
E44	Positioning operation error occurred	Select	<ul style="list-style-type: none"> The error when using the table operation function occurs. The set parameter may be incorrect or the limit error may occur. Check if the parameter is in the settable range. The channel and content where the positioning operation error occurs can be confirmed by pressing the [Positioning errors] button in the "Status Display" dialog box.
E45	Operation error occurred	Select	<ul style="list-style-type: none"> Inexecutable operation error occurs.

List of Error Codes

Code	Name	Operation	Error contents and steps to take
			<ul style="list-style-type: none"> The address of the operation error can be confirmed by either special data registers DT90017 or DT90018. In the tool software, it can also be checked with the [Operation errors] button in the "Status Display" dialog box.
E48	System register setting error	Operation stops	<ul style="list-style-type: none"> The setting value of a system register is abnormal. Check the setting again. Example) The error occurs when the range of the data registers or internal relays set in the system register no. 0 or no. 1 are inconsistent with the settings of hold / non-hold area in the system register no. 7 or no. 8, or the buffer area setting for the general-purpose communication in the system register nos. 416 to 423. The system register number can be confirmed by the special register DT90007.
E49	Expansion unit power supply sequence error	Operation stops	<ul style="list-style-type: none"> The power supply to the Expansion Unit was turned ON later than that to the Control Unit. Turn on the power supply to the Expansion Unit earlier or at the same time as the Control Unit power supply.
E50	Battery error (A battery comes off or the voltage drops.)	Operation continues	<ul style="list-style-type: none"> The voltage of the backup battery lowered or the backup battery is not installed in the Control Unit. Check the backup battery, and replace or connect it if necessary. This self-diagnostic error can be set to be notified or not by the system register no. 4.
E100 to E199	Self-diagnostic error set by F148	Stop	<ul style="list-style-type: none"> An error that has been arbitrarily set by the high-level instruction F148 occurs. Take countermeasures according to the specified detection condition.
E200 to E299		Operation continues	

List of MEWTOCOL-COM Communication Error Codes

Code	Name	Description of error
I26	Unit number setting error	A command that cannot be used for global (unit no. FF) was received.
I40	BCC error	Transmission error occurred in received data.
I41	Format error	Command that does not match the format was received.
I42	NOT support error	An unsupported command was received.
I43	Multiframe process error	Another command was received during the multiframe processing.
I60	Parameter error	Specified parameter does not exist, or cannot be used.
I61	Data error	There is an error in the contact, data area, data number, size, range or format specification.
I62	Registration over error	The number of registration exceeded the restriction, or operation is performed without registration.
I63	PC mode error	Invalid command was executed in RUN mode.
I64	External memory error	There is an abnormality in hardware. There may be an abnormality in the internal ROM (F-ROM) / master memory.

Code	Name	Description of error
		At the time of ROM transfer, a specified content exceeds the capacity. A reading / writing error occurred.
!65	Protection error	Write operation was performed to a program or system register when the unit is protected (password setting) or when the Master Memory Cassette is installed.
!66	Address error	The code format of address data is incorrect, or the range specification is incorrect.
!67	Missing program error / Missing data error	Program cannot be read as there is no program in program area or an error in memory contents. Or unregistered program was read.
!68	Rewriting is disabled while in RUN mode	Editing an instruction that cannot be rewritten in RUN mode (ED, SUB, RET, INT, IRET, SSTP or STPE) is attempted. Nothing is written to the Control Unit.
!71	Exclusive control error	A command that cannot be processed simultaneously with the command in process was executed.

List of MODBUS Communication Error Codes

■ Error code details

1. Function code error
2. Device number error (out of range)
3. Device quantity error (out of range)

BIN/HEX/BCD Code Correspondence Table

BIN/HEX/BCD Code Correspondence Table

Decimal (Decimal)	Hexadecimal (Hexadecimal)	BIN Binary (Binary)		BCD Binary Coded Decimal (4-Digit) (Binary Coded Decimal)			
0	0000	00000000	00000000	0000	0000	0000	0000
1	0001	00000000	00000001	0000	0000	0000	0001
2	0002	00000000	00000010	0000	0000	0000	0010
3	0003	00000000	00000011	0000	0000	0000	0011
4	0004	00000000	00000100	0000	0000	0000	0100
5	0005	00000000	00000101	0000	0000	0000	0101
6	0006	00000000	00000110	0000	0000	0000	0110
7	0007	00000000	00000111	0000	0000	0000	0111
8	0008	00000000	00001000	0000	0000	0000	1000
9	0009	00000000	00001001	0000	0000	0000	1001
10	000A	00000000	00001010	0000	0000	0001	0000
11	000B	00000000	00001011	0000	0000	0001	0001
12	000C	00000000	00001100	0000	0000	0001	0010
13	000D	00000000	00001101	0000	0000	0001	0011
14	000E	00000000	00001110	0000	0000	0001	0100
15	000F	00000000	00001111	0000	0000	0001	0101
16	0010	00000000	00010000	0000	0000	0001	0110
17	0011	00000000	00010001	0000	0000	0001	0111
18	0012	00000000	00010010	0000	0000	0001	1000
19	0013	00000000	00010011	0000	0000	0001	1001
20	0014	00000000	00010100	0000	0000	0010	0000
21	0015	00000000	00010101	0000	0000	0010	0001
22	0016	00000000	00010110	0000	0000	0010	0010
23	0017	00000000	00010111	0000	0000	0010	0011
24	0018	00000000	00011000	0000	0000	0010	0100
25	0019	00000000	00011001	0000	0000	0010	0101
26	001A	00000000	00011010	0000	0000	0010	0110
27	001B	00000000	00011011	0000	0000	0010	0111
28	001C	00000000	00011100	0000	0000	0010	1000
29	001D	00000000	00011101	0000	0000	0010	1001
30	001E	00000000	00011110	0000	0000	0011	0000
31	001F	00000000	00011111	0000	0000	0011	0001
63	003F	00000000	00111111	0000	0000	0110	0011
255	00FF	00000000	11111111	0000	0010	0101	0101
9999	270F	00100111	00001111	1001	1001	1001	1001

ASCII Code Table, JIS8 Code Table

■ Reference ASCII code table

b7	b6	b5	b4	b3	b2	b1	b0	R	C									
								b7										
								b6	0	0	0	0	1	1	1	1		
								b5	0	0	1	1	0	0	1	1		
								b4	0	1	0	1	0	1	0	1		
									0	1	2	3	4	5	6	7		
				0	0	0	0	0	NUL	DEL	SPACE	0	@	P	`	p		
				0	0	0	1	1	SOH	DC1	!	1	A	Q	a	q		
				0	0	1	0	2	STX	DC2	"	2	B	R	b	r		
				0	0	1	1	3	ETX	DC3	#	3	C	S	c	s		
				0	1	0	0	4	EOT	DC4	\$	4	D	T	d	t		
				0	1	0	1	5	ENQ	NAK	%	5	E	U	e	u		
				0	1	1	0	6	ACK	SYN	&	6	F	V	f	v		
				0	1	1	1	7	BEL	ETB	'	7	G	W	g	w		
				1	0	0	0	8	BS	CAN	(8	H	X	h	x		
				1	0	0	1	9	HT	EM)	9	I	Y	i	y		
				1	0	1	0	A	LF	SUB	*	:	J	Z	j	z		
				1	0	1	1	B	VT	ESC	+	;	K	[k	{		
				1	1	0	0	C	FF	FS	,	<	L	¥	l			
				1	1	0	1	D	CR	GS	-	=	M]	m	}		
				1	1	1	0	E	SO	RS	.	>	N	^	n	~		
				1	1	1	1	F	SI	US	/	?	O	_	o	DEL		

ASCII Code Table, JIS8 Code Table

■ Reference JIS8 code table

								0	1	2	3	4	5	6	7	8	9	A	B	C	D	E	F		
b7	b6	b5	b4	b3	b2	b1	b0	0	1	2	3	4	5	6	7	8	9	A	B	C	D	E	F		
0	0	0	0	0	0	0	0	NUL	TC7 (DEL)	(SP)	0	@	P	.	p	↑	↑	Undefined	ー	タ	ミ	↑	↑		
0	0	0	1	1				TC1 (SOH)	DC1	!	1	A	Q	a	q			。	ア	チ	ム				
0	0	1	0	2				TC2 (STX)	DC2	"	2	B	R	b	r				「	イ	ツ	メ			
0	0	1	1	3				TC3 (ETX)	DC3	#	3	C	S	c	s				」	ウ	テ	モ			
0	1	0	0	4				TC4 (EOT)	DC4	\$	4	D	T	d	t				、	エ	ト	ヤ			
0	1	0	1	5				TC5 (ENQ)	TC8 (NAK)	%	5	E	U	e	u				・	オ	ナ	ユ			
0	1	1	0	6				TC6 (ACK)	TC9 (SYN)	&	6	F	V	f	v		Undefined			ヲ	カ	ニ	ヨ		
0	1	1	1	7				BEL	ETB	'	7	G	W	g	w		Undefined			ア	キ	ヌ	ラ		
1	0	0	0	8				EE0 (BS)	CAN	(8	H	X	h	x		Undefined			イ	ク	ネ	リ		
1	0	0	1	9				EE1 (HT)	EM)	9	I	Y	i	y		Undefined			ウ	ケ	ノ	ル		
1	0	1	0	A				EE2 (LF)	SUB	*	:	J	Z	j	z		Undefined			エ	コ	ハ	レ		
1	0	1	1	B				EE3 (VT)	ESC	+	;	K	[k			Undefined			オ	サ	ヒ	ロ		
1	1	0	0	C				EE4 (FF)	IS4 (FS)	.	<	L	¥	l			Undefined			ヤ	シ	フ	ワ		
1	1	0	1	D				EE5 (CR)	IS3 (GS)	-	=	M]	m			Undefined			ユ	ス	ヘ	ン		
1	1	1	0	E				SO	IS2 (RS)	.	>	N	^	n	-		Undefined			ヨ	セ	ホ	"		
1	1	1	1	F				SI	IS1 (US)	/	?	O	_	o	DEL	↓	↓		ッ	ソ	マ	'	↓	↓	

Do not use the undefined parts of the JIS8 code table.

Record of changes

The manual number is shown at the bottom of the cover page.

Date	Manual No.	Description of changes
Jul. 2021	WUME-FPXHPGRG-01	1st edition

(MEMO)

(MEMO)

Please contact

Panasonic Corporation

Panasonic Industrial Devices SUNX Co., Ltd.
<https://panasonic.net/id/pidsx/global>

Please visit our website for inquiries and about our sales network.

Panasonic Industrial Devices SUNX Co., Ltd. 2021

Unauthorized reproduction of this manual is strictly prohibited.
July 2021.

WUME-FPXHPGRG-01