

Programmable controller

FP-XH Series

User's Manual

Positioning Function / PWM Output / High-speed Counter Function

Western version

(MEMO)

Introduction

Thank you for purchasing a Panasonic product. Before you use the product, please carefully read through the user's manual, and understand it in detail to use the product properly.

Type of Manual

- This manual describes the "positioning function (table setting mode) / PWM output and high-speed counter function" implemented in the FP-XH Control Unit.
- The following user's manuals are available for the FP-XH series. Please refer to a relevant manual for the unit and purpose of your use.
- The manuals can be downloaded from our Download Center:https://industrial.panasonic.com/ac/e/dl_center/.

Unit name or purpose of use	Manual name	Manual code
FP-XH Control Unit	FP-XH User's Manual (Basic)	WUME-FPXHBASG
	FP Series Programming Manual	ARCT1F313E
Positioning Function / PWM Output / High-speed Counter Function	FP-XH User's Manual (Positioning / PWM Output / High-speed Counter)	WUME-FPXHPOSG
Communication Functions		
FP-X Extension (Communication) Cassette	FP-XH User's Manual (COM Communication)	WUME-FPXHCOMG
FP-X Expansion Unit	FP-X Series User's Manual	WUME-FPX
FP-X Function Cassettes		

SAFETY PRECAUTIONS

- To prevent accidents or personal injuries, please be sure to comply with the following items.
- Prior to installation, operation, maintenance and inspection, please read this manual carefully for proper use.
- Before using the product, please fully understand the knowledge related to the equipment, safety precautions and all other precautions.
- Safety precautions are divided into two levels in this manual: Warning and Caution.

WARNING

Incorrect operation may lead to death or serious injury.

- Take appropriate safety measures for the external circuit of the product to ensure the security of the whole system in case of abnormalities caused by product failure or external factors.
- Do not use this product in areas with inflammable gases.
Otherwise it may lead to an explosion.
- Do not put this product into a fire.
Otherwise it may cause damage to the battery or other electronic parts.
- Do not impact, charge or heat the lithium battery, and do not put it into a fire.
Otherwise it may lead to fire or damage.

CAUTION

Incorrect operation may lead to injury or material loss.

- To prevent the excessive exothermic heat or smoke generation of the product, a certain margin is required for guaranteed characteristics and performance ratings of relative products.
- Do not disassemble or modify the product.
Otherwise it may lead to the excessive exothermic heat or smoke generation of the product.
- Do not touch terminal blocks during power-on.

Otherwise it may result in an electric shock.

- Create an emergency stop and interlock circuit in the external devices.
- Connect wires and connectors reliably.

Otherwise it may lead to the excessive exothermic heat or smoke generation of the product.

- Do not carry out construction (wiring, removal, etc.) during power-on.

Otherwise it may result in an electric shock.

- If the equipment is used in a manner not specified by the Panasonic, the protection provided by the equipment may be impaired.
- This product has been developed/produced for industrial use only.

Description on Copyright and Trademarks

- The copyright of this manual is owned by **Panasonic Industrial Devices SUNX Co., Ltd**
- Unauthorized reproduction of this manual is strictly prohibited.
- Windows is a registered trademark of Microsoft Corporation in the U.S. and other countries.
- Ethernet is a registered trademark of Fuji Xerox Co., Ltd. and Xerox Corporation.
- Other company and product names are trademarks or registered trademarks of their respective companies.

Table of Contents

1 Functions of Unit and Restrictions on Combination	1-1
1.1 Functions of Unit.....	1-2
1.1.1 Overview of FP-XH Positioning Function.....	1-2
1.1.2 Unit type and available functions.....	1-3
1.2 Restrictions on Combinations and Functions.....	1-5
1.2.1 Applicable Versions of Unit and Software.....	1-5
1.2.2 Restrictions on the Combination of Pulse I/O Cassettes.....	1-5
1.2.3 Restrictions on I/O Allocation.....	1-5
1.2.4 Restrictions on Using Together with Communication Function.....	1-7
1.3 Comparison of Pulse Output Function.....	1-8
1.3.1 Types of Positioning Control Modes.....	1-8
1.3.2 Selection of Positioning Control Mode.....	1-8
1.3.3 Comparison of Two Control Modes.....	1-8
2 Wiring	2-1
2.1 Connections with Servo Motor Amplifier.....	2-2
2.1.1 Connection Example.....	2-2
2.1.2 Precautions on Connection.....	2-3
2.2 Connection with Stepping Motor Driver.....	2-4
2.2.1 Precautions on Connection.....	2-4
3 Power ON and OFF, and Items to Check	3-1
3.1 Safety Circuit Design.....	3-2
3.2 Before Turning On the Power.....	3-3
3.3 Procedure for Turning On the Power.....	3-4
3.3.1 Procedure for Turning On the Power.....	3-4
3.3.2 Procedure for Turning Off the Power.....	3-4
3.4 Confirming while the Power is ON.....	3-5
3.4.1 Items to check after turning on the power.....	3-5
3.4.2 Checking the Installation of the External Safety Circuit.....	3-6
3.4.3 Checking the Safety Circuit Based on the Unit.....	3-6
3.4.4 Checking the Operation of the Near Home Switch and Home Switch.....	3-6
3.4.5 Checking Rotating and Moving Directions and Moving Distance.....	3-7
4 Settings of Control Unit	4-1
4.1 Confirming I/O Allocation.....	4-2
4.1.1 When Using Pulse Output Table Setting Mode.....	4-2
4.1.2 When Using Pulse Output Function (FP-X Compatible Instruction Mode).....	4-3
4.1.3 When Using PWM Output Function.....	4-5
4.1.4 When Using High-speed Counter Function.....	4-6
4.2 Settings in Configurator PMX.....	4-8
4.2.1 Allocating Channels to be Used.....	4-8
4.2.2 Setting Parameters.....	4-9

4.2.3	Creating Positioning Data Table.....	4-11
4.2.4	Saving Positioning Parameters.....	4-13
4.2.5	Export and Import	4-14
4.2.6	Check on Parameter Data	4-14
4.2.7	Writing Parameters to Unit (1).....	4-15
4.2.8	Writing Parameters to Unit (2).....	4-15
4.3	System Register Settings.....	4-17
4.3.1	Confirming and Selecting Functions to be Used.....	4-17
4.4	Reading Elapsed Values.....	4-20
4.4.1	Elapsed Value (Current Value) Area	4-20
4.4.2	Elapsed Value (Current Value) Area	4-20
5	Operation Patterns.....	5-1
5.1	Stop Operation.....	5-2
5.1.1	Type of Stop Operations	5-2
5.1.2	Characteristics of Stop Operations	5-3
5.2	JOG Operation.....	5-4
5.2.1	Settings and Operation of JOG Operation	5-4
5.2.2	Settings and Operation of JOG Operation (Speed Changes).....	5-6
5.2.3	Speed Changes in JOG Operation	5-8
5.3	Home Return.....	5-9
5.3.1	Types of Home Return	5-9
5.3.2	Operation Patterns of Home Return	5-10
5.3.3	Settings and Operations of Home Return	5-12
5.4	Positioning Control.....	5-16
5.4.1	Types of Positioning Control	5-16
5.4.2	E-point Control (Single-Speed Positioning)	5-17
5.4.3	P-point Control (Double-Speed Positioning)	5-18
5.4.4	C-point Control.....	5-20
5.4.5	J-point Control (JOG Positioning)	5-22
5.4.6	J-point Control (JOG Positioning: Speed Changes)	5-23
5.4.7	Programming Cautions	5-26
5.5	Repeat Operation.....	5-28
5.5.1	Overview of Repeat Operation.....	5-28
5.5.2	Settings and Operations of Repeat Operation	5-29
5.5.3	Stop Operation During Repeat Operation	5-31
5.6	Linear Interpolation Control.....	5-33
5.6.1	Overview	5-33
5.6.2	Settings and Operations of Linear Interpolation.....	5-34
6	Operating Characteristics	6-1
6.1	Operational Difference Between Parameters	6-2
6.1.1	Startup speed.....	6-2
6.1.2	When Target Speed/Startup Speed is Less Than 50Hz	6-2
6.1.3	Operation Patterns and Start Speed Settings.....	6-3
6.2	Other Characteristics	6-5
6.2.1	Backup of Positioning Memory	6-5
6.2.2	Activation of Each Operation	6-5
6.2.3	Operation When PLC Mode Changes From RUN To PROG.....	6-5

7	Instruction References	7-1
7.1	Table Setting Mode Control Instruction	7-2
7.1.1	[F380 POSST] Positioning Table Start Instruction	7-2
7.1.2	[F381 JOGST] JOG Operation Start Instruction	7-3
7.1.3	[F382 ORGST] Home Return Start Instruction	7-4
7.1.4	[F383 MPOST] Positioning Table Simultaneous Start Instruction	7-5
7.1.5	[F384 PTBLR] Positioning Parameter Read Instruction.....	7-7
7.1.6	[F385 PTBLW] Positioning Parameter Write Instruction	7-8
7.2	FP-X Compatible Instruction Mode Control Instruction.....	7-10
7.2.1	[F171 (SPDH)] Pulse Output (Trapezoidal Control).....	7-10
7.2.2	[F171 (SPDH)] Pulse Output (Home Return).....	7-15
7.2.3	[F172 (PLSH)] Pulse Output (JOG operation)	7-19
7.2.4	[F174 (SP0H)] Pulse Output (Selectable Data Table Control Operation).....	7-22
7.2.5	[F175 (SPSH)] Pulse Output (Linear Interpolation).....	7-26
8	Troubleshooting	8-1
8.1	Self-diagnosis Function.....	8-2
8.1.1	Operation Monitor LEDs of Control Unit	8-2
8.1.2	Operation Mode When an Error Occurs	8-2
8.2	What to Do If an Error Occurs.....	8-4
8.2.1	ERR / ALM LED Flashes	8-4
8.2.2	What to Do When Positioning Error Occurs.....	8-5
8.2.3	Motor Does Not Rotate/Move (Output LED Flashes or is ON)	8-7
8.2.4	Motor Does Not Rotate/Move (Output LED is OFF)	8-7
8.2.5	Rotation/Movement Direction is Reversed.....	8-8
9	PWM output function.....	9-1
9.1	PWM output function.....	9-2
9.1.1	Overview of PWM Output Function.....	9-2
9.1.2	System Register Settings.....	9-2
9.1.3	[F173 PWMH] PWM Output Instruction (Frequency Specification) .	9-4
9.1.4	[F173 PWMH] PWM Output Instruction (Control Code Specification)	9-5
10	High-speed Counter Function	10-1
10.1	Overview of High-speed Counter Function	10-2
10.1.1	Overview of High-speed Counter Function	10-2
10.1.2	Counting Range and Elapsed Value (Current Value) Area	10-2
10.1.3	Areas Used For High-speed Counter Function	10-3
10.1.4	Input Mode Type	10-4
10.1.5	Minimum Input Pulse Width	10-5
10.2	System Register Settings.....	10-7
10.2.1	System Register Settings (Transistor Output Type).....	10-7
10.2.2	System Register Settings (Relay Output Type)	10-8
10.3	High-speed Counter Instruction	10-11
10.3.1	[F0 MV] High-speed Counter Control Instruction	10-11
10.3.2	[F1 DMV] Elapsed Value Write / Read Instruction	10-12

10.3.3 [F166 HC1S] High-speed Counter Target Value Match ON Instruction and [F167 HC1R] High-speed Counter Target Value Match OFF Instruction	10-14
10.3.4 Sample Program (Positioning Operation With Inverter: Single-Speed)	10-15
10.3.5 Sample Program (Positioning Operation With Inverter: Double-Speed)	10-17
10.4 High-speed Counter Cam Control Instruction	10-20
10.4.1 [F165 CAM0] High-speed Counter Cam Control Instruction	10-20
10.4.2 Sample Program (Upper Limit Control, Reset, Addition)	10-24
10.4.3 Sample Program (Upper Limit Control, Instruction Clear, Addition).....	10-26
10.4.4 Sample Program (Upper Limit Control, Subtraction)	10-28
10.5 Interrupt Program Activation	10-31
10.5.1 Overview of Function	10-31
10.5.2 Interrupt Activation When F165 (CAM0) is Executed	10-32
11 Specifications	11-1
11.1 Specifications	11-2
11.1.1 General Specifications	11-2
11.1.2 Performance Specifications.....	11-2
11.2 Allocation of Memory Areas	11-5
11.2.1 When Using Pulse Output Table Setting Mode	11-5
11.2.2 When Using Pulse Output Function (FP-X Compatible Instruction Mode).....	11-7
11.2.3 When Using PWM Output Function	11-8
11.2.4 When Using High-speed Counter Function.....	11-9
11.3 Positioning Memory.....	11-12
11.3.1 Configuration of Memory Map.....	11-12
11.3.2 Common Area (Memory Area No. 0).....	11-13
11.3.3 Axis Information Area (Memory Area No. 1)	11-14
11.3.4 Axis Setting Area (Memory Area No. 2).....	11-15
11.3.5 Positioning Table Area (Memory Area No. 3).....	11-17

1 Functions of Unit and Restrictions on Combination

1.1 Functions of Unit.....	1-2
1.1.1 Overview of FP-XH Positioning Function.....	1-2
1.1.2 Unit type and available functions.....	1-3
1.2 Restrictions on Combinations and Functions.....	1-5
1.2.1 Applicable Versions of Unit and Software.....	1-5
1.2.2 Restrictions on the Combination of Pulse I/O Cassettes.....	1-5
1.2.3 Restrictions on I/O Allocation.....	1-5
1.2.4 Restrictions on Using Together with Communication Function.....	1-7
1.3 Comparison of Pulse Output Function.....	1-8
1.3.1 Types of Positioning Control Modes.....	1-8
1.3.2 Selection of Positioning Control Mode.....	1-8
1.3.3 Comparison of Two Control Modes.....	1-8

1.1 Functions of Unit

1.1 Functions of Unit

1.1.1 Overview of FP-XH Positioning Function

■ **Up to 6-axis position control is available by combining with a driver of pulse string input type.**

- The pulse output can be performed up to 100 kHz, and servo motors can be controller.
- It is also available for a stepping motor connected by open collector output.

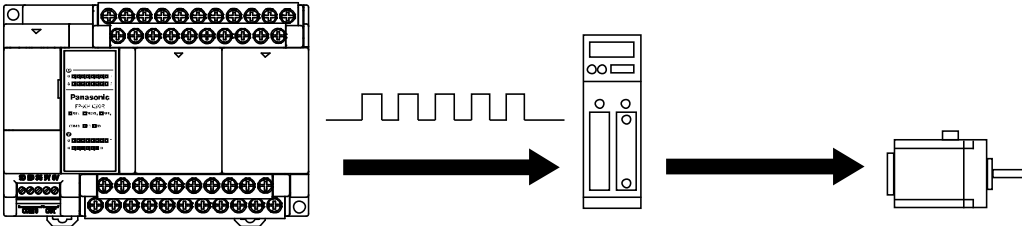

■ **Programs can be simplified by adopting the table setting mode.**

- The dedicated software "Configurator PMX" is available, which allows ease of setting a variety of parameters and positioning tables required for positioning control. "Configurator PMX" is started from the "Options" menu of tool software "FPWIN GR7".
- In user programs, positioning control is executed only by specifying axis numbers (channel numbers) and table numbers, and executing instructions.

The screenshot shows the "Configurator PMX" software window. The main area displays a table with the following columns: Table number, Operation p..., Control method, X axis (CH0)..., Accelerati..., Acceleration ..., Deceleration ..., Target ..., and Dwell time (ms). The table contains four rows of data, all with "E: End point" as the control method and "L: Linear" as the acceleration/deceleration type.

Table number	Operation p...	Control method	X axis (CH0)...	Accelerati...	Acceleration ...	Deceleration ...	Target ...	Dwell time (ms)
1	E: End point	I Increment	0	L: Linear	100	100	1000	0
2	E: End point	I Increment	0	L: Linear	100	100	1000	0
3	E: End point	I Increment	0	L: Linear	100	100	1000	0
4	E: End point	I Increment	0	L: Linear	100	100	1000	0

■ **Four kinds of position control patterns (Table setting mode)**

- Four patterns, which are E-point control (single-speed automatic trapezoidal acceleration / deceleration), P-point control (double-speed automatic trapezoidal acceleration / deceleration), C-point control (continuance point control) and J-point control (from speed control to position control), can be selected. They are created as tables on "Configurator PMX".

■ **Five kinds of home return operations are supported. (Table setting mode)**

- Five kinds of home return methods including home search are available. The most appropriate home return method can be selected in accordance with the system such as home input, near home input and the type of driver.

■ **FP-X compatible mode also available**

- There is a mode where the same instructions (F171 to F175, F0, and F1) as those for the conventional FP-X series.

Note

If the compatible mode setting is set to "FP-X mode", "Table setting mode" cannot be selected.

1.1.2 Unit type and available functions

Available conditions vary by functions.

■ **Comparison of functions and performances**

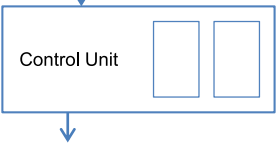
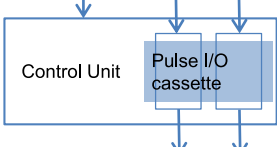
Item	Transistor output type			Relay output type			
	C14T	C30T	C60T	C14R	C30R	C60R	
Configuration	Using the input section of the Control Unit High-speed counter input  Pulse output / PWM output Using the output section of the Control Unit			Using the input section of the Control Unit or the input section of the pulse I/O cassette High-speed counter input  Pulse output / PWM output Using the output section of the pulse I/O cassette			
High-speed counter	Single-phase	Max. 8 channels (CH0 to CH7) Max. 100 kHz × 4 + Max. 10 kHz × 4			Using the input of the Control Unit Max. 8 channels (CH0 to CH7), Max. 10 kHz × 8 Per one pulse I/O cassette Max. 2 channels (CH8 and CH9 or CHA and CHB) Max. 100 kHz × 2		
	2-phase	Max. 4 channels (CH0, CH2, CH4, and CH6) Max. 50 kHz × 2 + Max. 10 kHz × 2			Using the input of the Control Unit Max. 4 channels (CH0, CH2, CH4, and CH6), Max. 5 kHz × 4 Per one pulse I/O cassette Max. 1 channel (CH8 or CHA) Max. 50 kHz × 2		
Pulse Output	Independent	Max. 3 axes (CH0 to CH2)	Max. 4 axes (CH0 to CH3)	Max. 6 axes (CH0 to CH5)	Per one pulse I/O cassette: Max. 1 axis Max. 1 axis (CH0) Max. 2 axes (CH0 and CH1) ^(Note 3)		
	Interpolation	Max. 2 axes (CH0)	Max. 4 axes (CH0 and CH2)	Max. 6 axes (CH0, CH2, and CH4)	Not available Max. 2 axes (CH0) ^(Note 3)		
PWM output	Max. 4 points (CH0 to CH3)			Per one pulse I/O cassette: Max. 1 point			
				Max. 1 point	Max. 2 points (CH0 and CH1) ^(Note 3)		

1.1 Functions of Unit

Item	Transistor output type			Relay output type		
	C14T	C30T	C60T	C14R	C30R	C60R
				(CH0)		

(Note 1) Functions, channel numbers and I/O numbers used are set in the tool software.

(Note 2) I/O numbers used for each function should be allocated so that they do not overlap.

(Note 3) The pulse I/O cassette can be attached to the relay output type Control Unit only. (C14R: 1 piece, C30R / C60R: Max. 2 pieces) When using two axes for the pulse output or two points for the PWM output, use two pulse I/O cassettes.

1.2 Restrictions on Combinations and Functions

1.2.1 Applicable Versions of Unit and Software

For using the FP-XH, the software of the following versions is necessary.

Item	Applicable version	
Programming tool software Control FPWIN GR / GR7 / Pro7	C14/C30/C60	FPWIN GR Ver.2.93 or later FPWIN GR7 Ver.2.5 or later FPWIN Pro7 Ver.7.03 or later
Configurator PMX	It is used for using the pulse output function in the table setting mode. It is implemented in FPWIN GR / GR7 / Pro7 and activated from the option menu.	

(Note 1) The latest version is provided free of charge at our download center (https://industrial.panasonic.com/ac/e/dl_center/software/). Use the latest version.

(Note 2) To use the FP-XH in FPWIN Pro7, it is also necessary to install a setup file. For details, see the above website.

1.2.2 Restrictions on the Combination of Pulse I/O Cassettes

There are following restrictions depending on units and cassettes to be used.

Unit Types		Installable number of cassettes	Pulse I/O cassette AFPX-PLS
Relay output type	C14R	Max. 1 unit	Installable
	C30R/C60R	Max. 2 units	
Transistor output type	C14T	Max. 1 unit	Uninstallable
	C30T/C60T	Max. 2 units	

1.2.3 Restrictions on I/O Allocation

- I/O signals used for each function are set in the tool software. They are allocated automatically when set by Configurator PMX.
- Allocate the I/O numbers used for the pulse output function, high-speed counter function and PWM output function so that they do not overlap.

■ Examples of unusable combinations

Example 1	When allocating input X4 to the home input of CH0 for the pulse output function, they cannot be used as the count input of high-speed counter CH4.
Example 2	When using the output Y0 as CH0 for the pulse output function, the PWM output CH0 cannot be used.

1.2 Restrictions on Combinations and Functions

■ Input signals of Control Unit

I/O No.	Pulse output function	High-speed counter function		
		Count input		Reset input
		Single-phase	2-phase	
X0	CH0 J-point control positioning control start input	CH0 Count input	CH0 Count input	-
X1	CH1 J-point control positioning control start input	CH1 Count input		-
X2	CH4 Home input	CH2 Count input	CH2 Count input	-
X3	CH5 Home input	CH3 Count input		-
X4	CH0 Home input	CH4 Count input	CH4 Count input	-
X5	CH1 Home input	CH5 Count input		-
X6	CH2 Home input	CH6 Count input	CH6 Count input	CH0 Reset input
X7	CH3 Home input	CH7 Count input		CH2 Reset input

■ Output signals of Control Unit

I/O No.	Pulse output function		PWM output function
	Pulse output	Deviation counter clear output	
Y0	CH0 CW or pulse output	-	CH0 PWM output
Y1	CH0 CCW or sign output	-	(Note 2)
Y2	CH1 CW or pulse output	-	CH1 PWM output
Y3	CH1 CCW or sign output	-	(Note 2)
Y4	CH2 CW or pulse output	CH0 (C14 type)	CH2 PWM output
Y5	CH2 CCW or sign output	CH1 (C14 type)	(Note 2)
Y6	CH3 CW or pulse output	-	CH3 PWM output
Y7	CH3 CCW or sign output	-	(Note 2)
Y8	CH4 CW or pulse output	CH0 (C30 type)	-
Y9	CH4 CCW or sign output	CH1 (C30 type)	-
YA	CH5 CW or pulse output	CH2 (C30 type)	-
YB	CH5 CCW or sign output	CH3 (C30 type)	-
YC	-	CH0 (C60 type)	-
YD	-	CH1 (C60 type)	-
YE	-	-	-
YF	-	-	-
Y10	-	CH2 (C60 type)	-
Y11	-	CH3 (C60 type)	-
Y12	-	CH4 (C60 type)	-
Y13	-	CH5 (C60 type)	-

1.2 Restrictions on Combinations and Functions

(Note 1) When using the target value match ON instruction (F166) or target value match OFF instruction (F167) in the high-speed counter function, arbitrary output is specified in the range of Y0 to Y29F in a user program so that it does not overlap the above functions.

(Note 2) When using the PWM output, the output numbers to be paired are normal output.

■ Pulse I/O cassette input signal

I/O No.	Pulse output function	High-speed counter function		
		Count input		Reset input
		Single-phase	2-phase	
X100	CH0 J-point control positioning control start input	CH8 Count input	CH8 Count input	-
X101	-	CH9 Count input		-
X102	CH0 Home input	-	-	CH8 Reset input or CH9 Reset input
X200	CH1 J-point control positioning control start input	CHA Count input	CHA Count input	
X201	-	CHB Count input		
X202	CH1 Home input	-	-	CHA Reset input or CHB Reset input

■ Pulse I/O cassette output signal

I/O No.	Pulse output function		PWM output function
	Pulse output	Deviation counter clear output	
Y100	CH0 CW or pulse output	-	CH0 PWM output
Y101	CH0 CCW or sign output	-	-
Y102	-	CH0 Deviation counter clear output	-
Y200	CH1 CW or pulse output	-	CH1 PWM output
Y201	CH1 CCW or sign output	-	-
Y202	-	CH1 Deviation counter clear output	-

1.2.4 Restrictions on Using Together with Communication Function

- The FP-XH series can communicate with external devices through the maximum of five communication interfaces including the COM0 port supported as standard and COM1 to COM4 ports used by communication cassettes.
- When using all the five ports from COM0 to COM4, the communication speed is 115.2 kbps max. and the pulse output function supports two axes max. When using four or less number of ports, the communication speed is 230.4 kbps max. and the pulse output function supports six axes max.

1.3 Comparison of Pulse Output Function

1.3 Comparison of Pulse Output Function

1.3.1 Types of Positioning Control Modes

For using the FP-XH pulse output function, the following two control modes are available.

■ Table setting mode

- Positioning parameters such as position command and speed command are created as data tables by tool software Configurator PMX in advance.
- As parameters are set in advance, programs can be simplified.
- Four patterns of position control modes and five patterns of home return modes are available.
- Dedicated instructions F380 to F385 are used for the control.
- Set positioning parameters and information on positioning tables can be exported as a setup file of Configurator PMX and reused between multiple units and projects.

■ FP-X compatible instruction mode

- Positioning parameters such as position command and speed command are set as operands of instructions.
- Dedicated instructions F171 to F175 and instructions F0 and F1 are used for the control.
- The system is similar to the pulse output function of the conventional FP-X.

1.3.2 Selection of Positioning Control Mode

- The positioning control mode is selected in the system register no. 407 by the tool software.

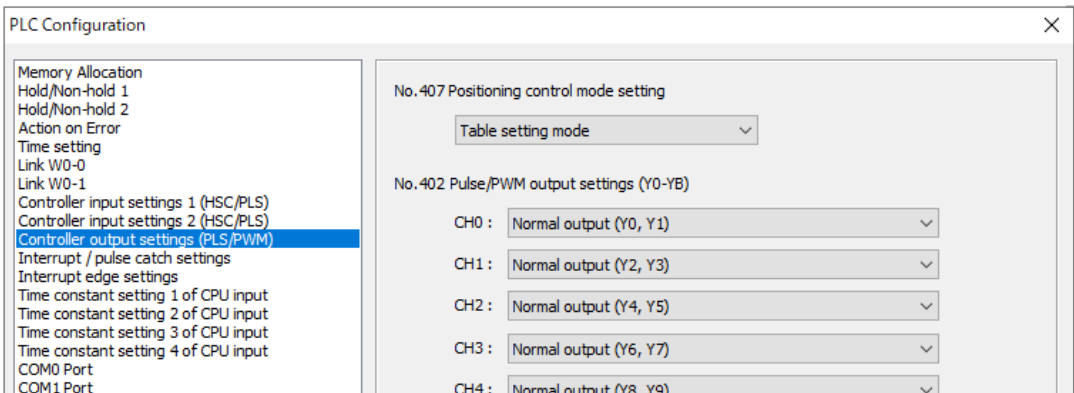

(Note 1) If the compatible mode setting is set to "FP-X mode", "Table setting mode" cannot be selected.

1.3.3 Comparison of Two Control Modes

There are following differences between the table setting mode and FP-X compatible instruction mode.

■ Comparison of Two Control modes

Item		Table setting mode	FP-X compatible instruction mode
Stop control	Type	Four patterns (System stop, Emergency stop, Limit stop, and Deceleration stop)	Emergency stop only
	Start	Turns ON the output contact allocated to each axis for each stop method.	Turns ON the bit 3 of the special data register DT90052 using F0 instruction in a user program.
JOG operation	Set	Set in the positioning parameters of Configurator PMX.	Set using the operands of instructions.
	Start	F381 instruction	F172 instruction
Home return	Type	Five patterns (DOG methods x 3, Home position method x 1, Data set method x 1)	Two patterns (DOG method x 1, Home position method x 1)
	Set	Set in the positioning parameters of Configurator PMX.	Set using the operands of instructions.
	Start	F382 instruction	F171 instruction
Positioning operation	Type	Four patterns (E-point control, P-point control, C-point control and J-point control)	E-point control (single-speed acceleration / deceleration), Multistep acceleration / deceleration control
	Set	Set in the positioning data table of Configurator PMX.	Set using the operands of instructions.
	Start	F380 instruction	F171 instruction
Positioning operation interpolation	Type	Three patterns (E-point control, P-point control, C-point control)	E-point control (single-speed acceleration / deceleration)
	Set	Set in the positioning data table of Configurator PMX.	Set using the operands of instructions.
	Start	F380 instruction	F175 instruction
Others		Dwell time setting, Repeat control (Positioning parameter setting) Multiple table simultaneous start (F383 instruction)	Data table control (F174 instruction)

■ Comparison in programming

Item		Table setting mode	FP-X compatible instruction mode
Read / Write of elapsed value	Area	Positioning memory	Special data registers DT90392 to DT90407
	Execute	F384 instruction (Read), F385 instruction (Write)	F1 instruction (Both Read and Write)
Confirmation of BUSY state		Input contacts X28 to X2D	Special relays R911C to R9121
Confirmation of positioning completion		Input contacts X30 to X35	Instead detects the fall of the above BUSY signal by a user program.
Confirmation of home return completion		Input contacts X48 to X4D	
Near home input		Allocate arbitrary input contacts and turn ON the outputs Y70 to Y75 by user programs.	Allocate arbitrary input contacts and turn ON the bit4 of the special data register DT90052 by user programs.

(MEMO)

2 Wiring

2.1 Connections with Servo Motor Amplifier	2-2
2.1.1 Connection Example	2-2
2.1.2 Precautions on Connection	2-3
2.2 Connection with Stepping Motor Driver	2-4
2.2.1 Precautions on Connection	2-4

2.1 Connections with Servo Motor Amplifier

2.1 Connections with Servo Motor Amplifier

2.1.1 Connection Example

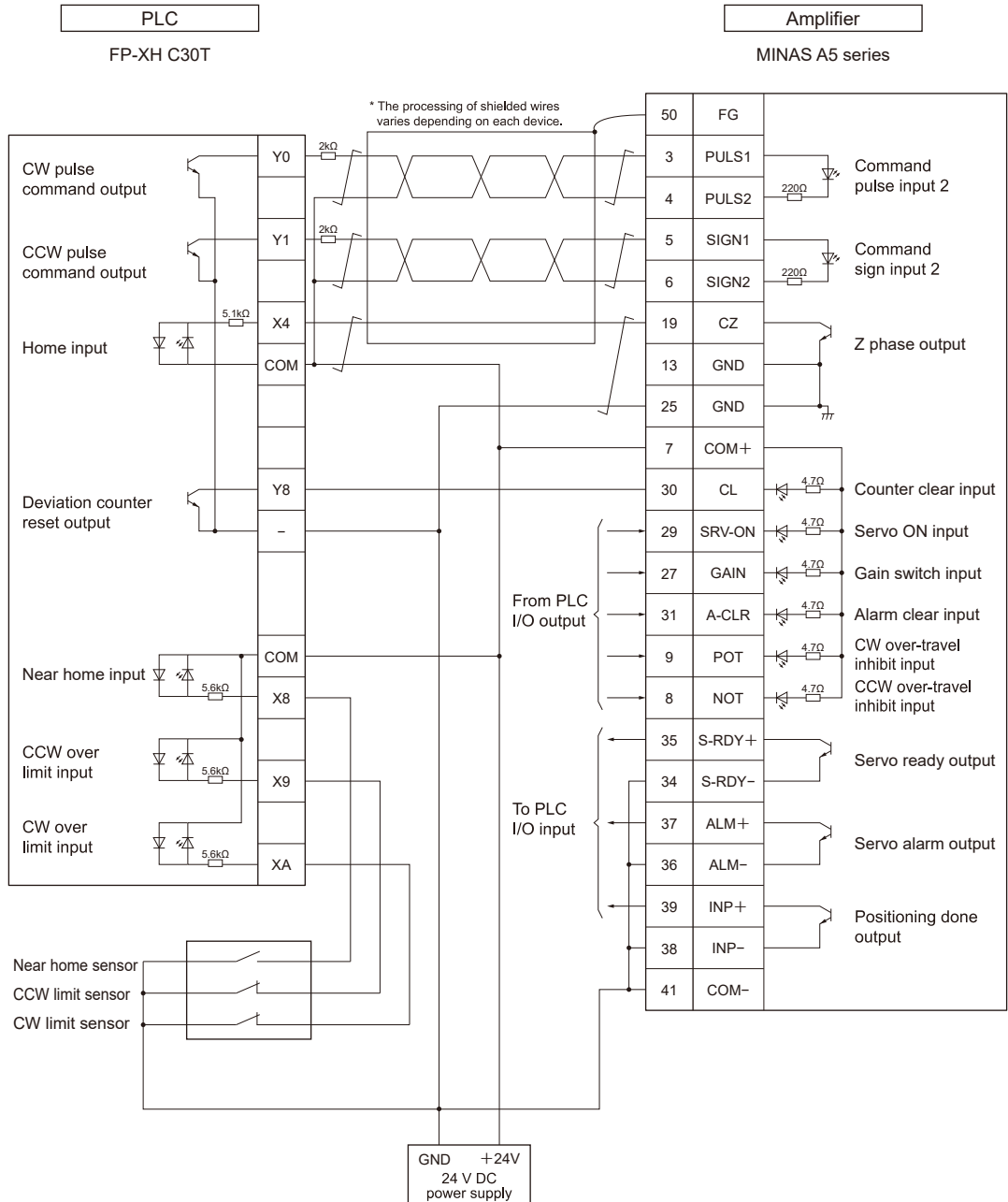

(Note 1) The allocation of I/O numbers on the controller side depends on unit types.

2.1.2 Precautions on Connection

■ Connections of various signals

Signal type	Point
Pulse command output	<ul style="list-style-type: none"> • Connect the output allocated to each channel and the command pulse input of servo amplifier. • Connect a resistor (2 kΩ) for limiting currents. • Use twisted-pair cables for the connection.
Home input	<ul style="list-style-type: none"> • Connect the input allocated to each channel and the Z phase input of servo amplifier. • Use twisted-pair cables for the connection.
Near home input	<ul style="list-style-type: none"> • Connect the near home sensor to an arbitrary input. • It will be valid when the outputs (Y70 to Y75) allocated to each channel in user programs turn ON.
CCW over limit input	<ul style="list-style-type: none"> • Connect the over limit switches to arbitrary inputs. • It will be valid when the outputs (Y80 to Y8B) allocated to each channel in user programs turn ON.
CW over limit input	
Deviation counter clear output	<ul style="list-style-type: none"> • Connect the output allocated to each channel and the counter clear input of servo amplifier. • The length of a deviation counter clear signal is specified in the range of 1 to 100 ms in the "Parameter setting" dialog box of Configurator PMX.
Servo ON output	<ul style="list-style-type: none"> • Connect an arbitrary output of PLC to the servo ON input of servo amplifier.

i Info.

- Use twisted-pair cables for the connection between the output of the unit and servo amplifiers.

2.2 Connection with Stepping Motor Driver

2.2 Connection with Stepping Motor Driver

2.2.1 Precautions on Connection

■ Connections of various signals

Signal type	Point
Pulse command output	<ul style="list-style-type: none">• Connect the output allocated to each channel and the command pulse input of motor driver.• Use twisted-pair cables for the connection.• Use a 24 V DC input for the input on the driver side. When the input interface of the driver is 5 V DC input, insert a resistor for limiting currents externally.
Home input	<ul style="list-style-type: none">• Connect the input allocated to each channel and the home sensor.• Use twisted-pair cables for the connection.
Near home input	<ul style="list-style-type: none">• Connect the near home sensor to an arbitrary input.• It will be valid when the outputs (Y70 to Y75) allocated to each channel in user programs turn ON.
CCW over limit input	<ul style="list-style-type: none">• Connect the over limit switches to arbitrary inputs.• It will be valid when the outputs (Y80 to Y8B) allocated to each channel in user programs turn ON.
CW over limit input	

Info.

- Use twisted-pair cables for the connection between the output of the unit and motor driver.

3 Power ON and OFF, and Items to Check

3.1 Safety Circuit Design	3-2
3.2 Before Turning On the Power	3-3
3.3 Procedure for Turning On the Power	3-4
3.3.1 Procedure for Turning On the Power	3-4
3.3.2 Procedure for Turning Off the Power	3-4
3.4 Confirming while the Power is ON	3-5
3.4.1 Items to check after turning on the power	3-5
3.4.2 Checking the Installation of the External Safety Circuit	3-6
3.4.3 Checking the Safety Circuit Based on the Unit	3-6
3.4.4 Checking the Operation of the Near Home Switch and Home Switch	3-6
3.4.5 Checking Rotating and Moving Directions and Moving Distance	3-7

3.1 Safety Circuit Design

3.1 Safety Circuit Design

■ System configuration example

Installation of the over limit switch

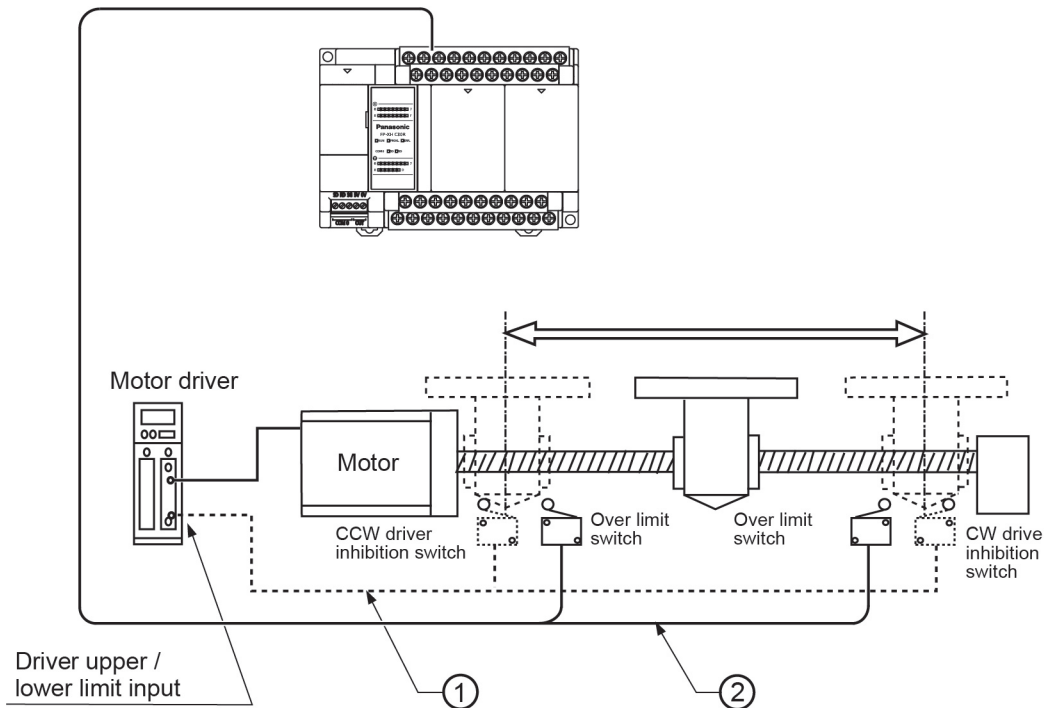

■ Confirmation of safety circuit

No.	Item	Description
(1)	Safety circuit based on external circuit	Install the safety circuit recommended by the manufacturer of the motor being used.
(2)	Safety circuit based on the unit	Install over limit switches as shown above. Connect the over limit switch inputs on the (+) and (-) sides to the input circuit of PLC.

3.2 Before Turning On the Power

■ System configuration example

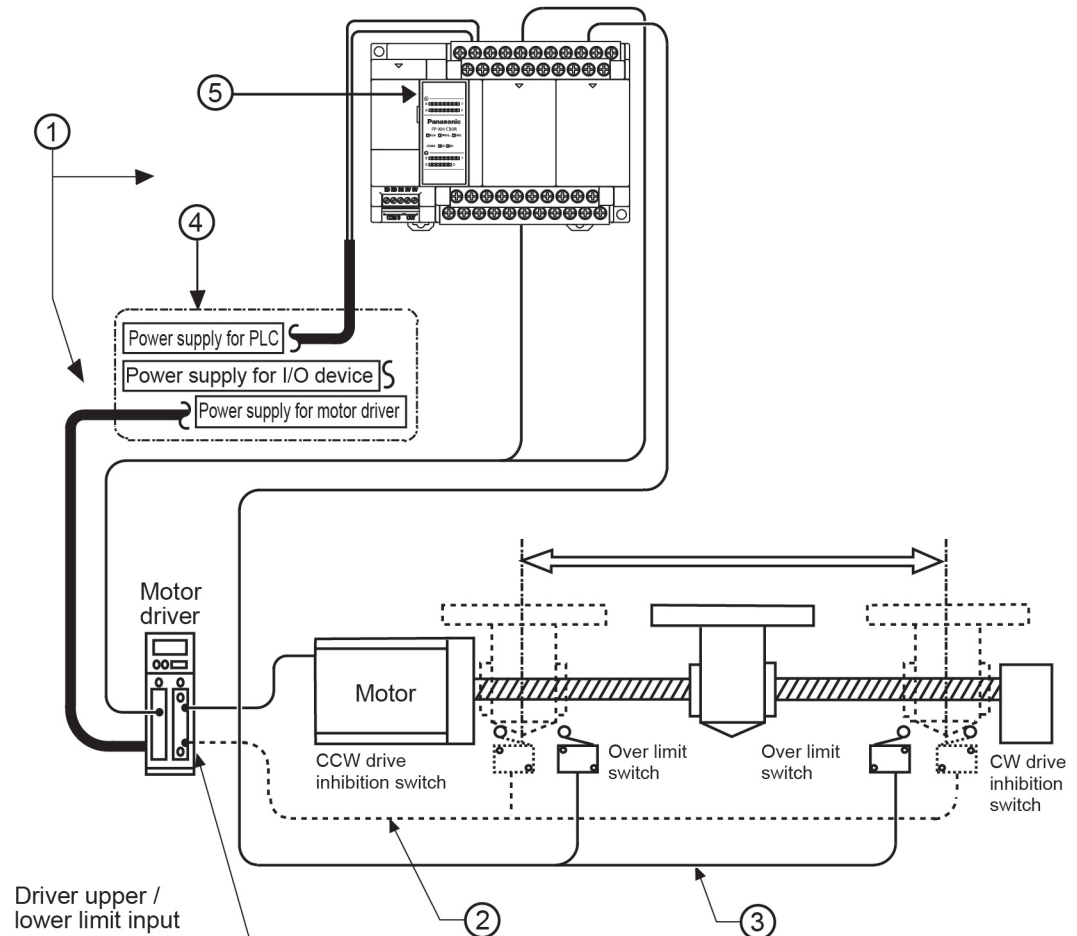

■ Items to check before turning ON the power

No.	Item	Description
(1)	Checking connections to the various devices	Check to make sure the various devices have been connected as indicated by the design.
(2)	Checking the installation of the external safety circuit	Check to make sure the safety circuit (wiring and installation of over limit switch) based on an external circuit has been installed securely.
(3)	Checking the installation of the safety circuit based on the unit	Check the connection between the unit and over limit switches. Check the installation condition of the over limit switches.
(4)	Checking the procedure settings for turning ON the power supplies	Make sure settings have been entered so that power supplies will be turned on according to the procedure outlined in section "Procedure for Turning ON the Power".
(5)	Checking the Control Unit mode selection switch	Set the Control Unit to PROG. mode. Setting it in the RUN mode can cause inadvertent operation.

3.3 Procedure for Turning On the Power

3.3 Procedure for Turning On the Power

3.3.1 Procedure for Turning On the Power

When turning on the power to the system incorporating the unit, consider the nature and states of any external devices connected to the system, and take sufficient care so that turning on the power will not initiate unexpected movements.

1 2 Procedure

1. Turn on the power supplies for the input and output devices connected to the PLC.
2. Turn ON the power supply for the PLC.
3. Turn ON the power supply for the motor driver.

3.3.2 Procedure for Turning Off the Power

1 2 Procedure

1. Check to make sure the rotation of the motor has stopped, and then turn OFF the power supply for the motor driver.
2. Turn off the power supply for the PLC.
3. Turn off the power supplies for the input and output devices connected to the PLC.

3.4 Confirming while the Power is ON

3.4.1 Items to check after turning on the power

■ System configuration example

Check each item in the following four major steps.

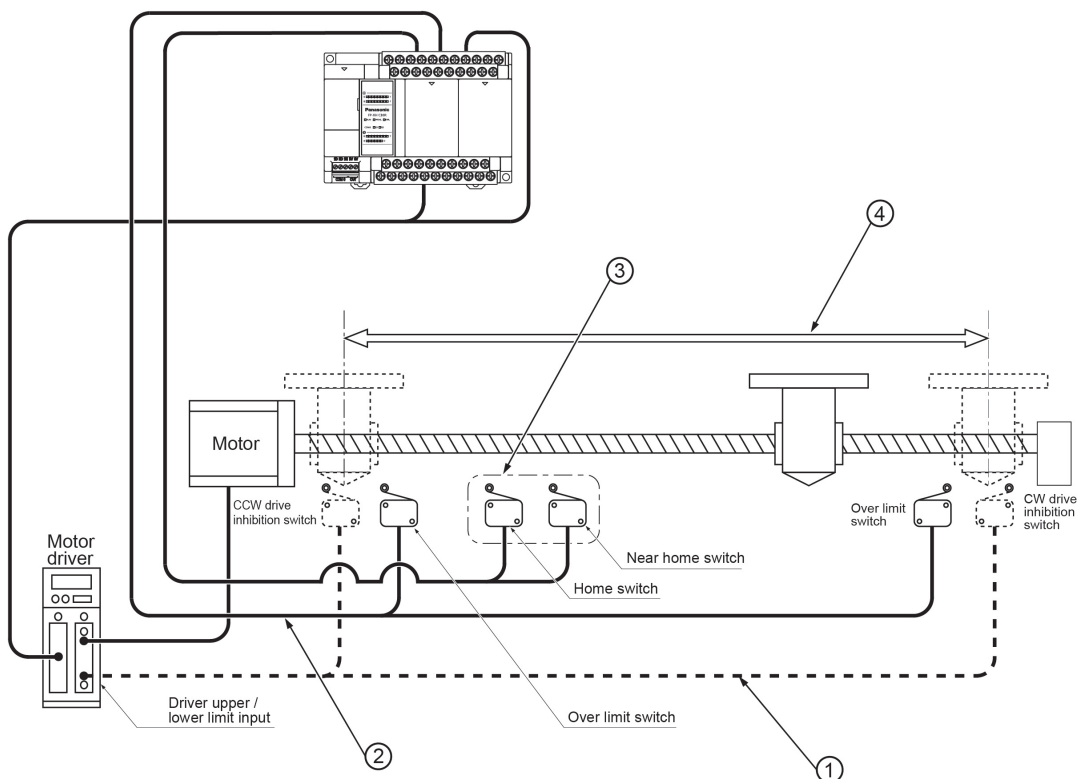

■ Items to check before turning ON the power

No.	Item	Description
(1)	Checking the installation of the external safety circuit	Check to make sure the safety circuit (wiring and installation of over limit switch) based on an external circuit has been installed securely.
(2)	Checking the safety circuit by the PLC unit	Check the connection between the unit and over limit switches. Check the installation condition of the over limit switches.
(3)	Checking the near home input and home input	Check if the near home input and home input are loaded as the inputs of the PLC and activated properly by performing JOG operation or home return operation.
(4)	Checking the rotation, moving direction, and moving distance.	Check the rotation, moving direction and moving distance by performing JOG operation or positioning operation.

3.4 Confirming while the Power is ON

3.4.2 Checking the Installation of the External Safety Circuit

Make a check on the safety circuit recommended by the motor manufacturer, which includes a check on the disconnection of the power supply to the motor driver with CW and CCW drive inhibition switch input from an external circuit.

3.4.3 Checking the Safety Circuit Based on the Unit

1 2 Procedure

1. Using forced operation of the over limit switch, check to see if the over limit input is being properly taken into the PLC side.
2. If necessary, input a program to start the JOG operation. Then operate the over limit input to check whether the motor will stop. The limit stop will be effective when output signals (Y80 to Y8B) allocated to each axis turn ON in user programs. In addition, the valid logic of over limit input can be changed in the parameter setting menu of "Configurator PMX".
3. Using the JOG operation, check to see if the over limit switch is functioning properly.

Operation at over limit input

Conditions	Direction	Limit status	Operation
When JOG operation is started	Forward	Over limit input (+): ON	Not executable, Error occurs.
		Over limit input (-): ON	Executable
	Reverse	Over limit input (+): ON	Executable
		Over limit input (-): ON	Not executable, Error occurs.
During JOG operation	Forward	Over limit input (+): ON	Limit stops, Error occurs.
		Over limit input (-): ON	Limit stops, Error occurs.
	Reverse	Over limit input (+): ON	Limit stops, Error occurs.
		Over limit input (-): ON	Limit stops, Error occurs.

3.4.4 Checking the Operation of the Near Home Switch and Home Switch

1 2 Procedure

1. Check if the near home input is loaded as input signals on the PLC properly by operating the home input and near home input forcibly.
2. Start the home return by inputting the home return program, and check if the operation transits to the deceleration operation by the near home input.

Points to check

Set the valid logic which enables the home input and near home input in the parameter setting menu of "Configurator PMX".

3. Check if the home stop position shifts by repeating the JOG and home return operations.

Points to check

A shift may result depending on the position of near home input or home input and the return speed.

4. If the home stopping position is shifted, change the position of near home input or reduce the home return speed.

3.4.5 Checking Rotating and Moving Directions and Moving Distance

1 2 Procedure

1. Execute the JOG operation to confirm the rotating direction and moving direction of the motor.

Points to check

The rotating direction is determined according to the installation of the ball screw or the "CW/CCW direction setting" of the parameter.

2. Check if the moving distance is that as designed by performing the JOG operation or positioning operation.

Points to check

The moving distance is determined according to the pitch of the ball screw, deceleration gear ratio or setting movement amount of the positioning data.

(MEMO)

4 Settings of Control Unit

4.1	Confirming I/O Allocation	4-2
4.1.1	When Using Pulse Output Table Setting Mode	4-2
4.1.2	When Using Pulse Output Function (FP-X Compatible Instruction Mode).....	4-3
4.1.3	When Using PWM Output Function	4-5
4.1.4	When Using High-speed Counter Function	4-6
4.2	Settings in Configurator PMX.....	4-8
4.2.1	Allocating Channels to be Used	4-8
4.2.2	Setting Parameters	4-9
4.2.3	Creating Positioning Data Table.....	4-11
4.2.4	Saving Positioning Parameters	4-13
4.2.5	Export and Import	4-14
4.2.6	Check on Parameter Data	4-14
4.2.7	Writing Parameters to Unit (1).....	4-15
4.2.8	Writing Parameters to Unit (2).....	4-15
4.3	System Register Settings.....	4-17
4.3.1	Confirming and Selecting Functions to be Used	4-17
4.4	Reading Elapsed Values.....	4-20
4.4.1	Elapsed Value (Current Value) Area	4-20
4.4.2	Elapsed Value (Current Value) Area	4-20

4.1 Confirming I/O Allocation

4.1 Confirming I/O Allocation

4.1.1 When Using Pulse Output Table Setting Mode

- The home input signal and positioning completion signal is allocated to I/O signals.

■ Allocation of I/O signals (Input)

Signal name		I/O No.					
		Axis 1	Axis 2	Axis 3	Axis 4	Axis 5	Axis 6
		CH0	CH1	CH2	CH3	CH4	CH5
When using the transistor output Control Unit	J-point control positioning start input	X0	X1	-	-	-	-
	Home input ^(Note 1)	X4	X5	X6	X7	X2	X3
Near home input ^{(Note 1)(Note 2)}		(Y70)	(Y71)	(Y72)	(Y73)	(Y74)	(Y75)
Over limit input (+) ^(Note 2)		(Y80)	(Y82)	(Y84)	(Y86)	(Y88)	(Y8A)
Over limit input (-) ^(Note 2)		(Y81)	(Y83)	(Y85)	(Y87)	(Y89)	(Y8B)
BUSY		X28	X29	X2A	X2B	X2C	X2D
Operation done		X30	X31	X32	X33	X34	X35
Home return done		X48	X49	X4A	X4B	X4C	X4D
When using the relay output type pulse I/O cassette	J-point control positioning start input	X100	X200	-	-	-	-
	Home input ^(Note 1)	X102	X202	-	-	-	-

(Note 1) Even when setting the linear interpolation, the interpolation operation is not performed for the home return. Execute the operation for X axes and Y axes separately.

(Note 2) The near home input, over limit input (+) and over limit input (-) will be valid when an arbitrary input is allocated and the output relay indicated in the above table turns ON.

■ Sample program

The following sample shows the program when the near home input, over limit input (+) and over limit input (-) are allocated to X10 to X12.

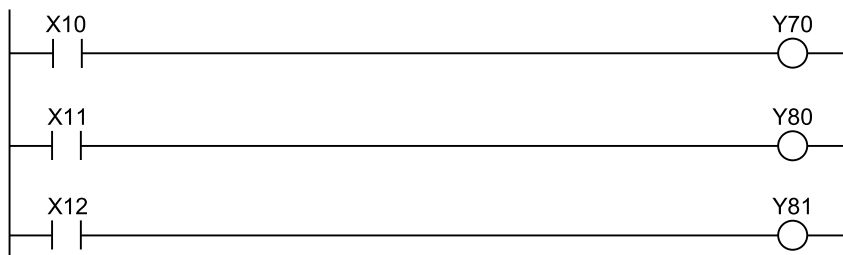



- When selecting the table setting mode, the control active flags (R911C to R911F) are not activated. Confirm that other instructions for the table setting mode (F380 to F383) are not activated using the above BUSY flags (X28 to X2D), and execute each instruction.

Allocation of I/O signals (Output)

Signal name		I/O No.						
		Axis 1	Axis 2	Axis 3	Axis 4	Axis 5	Axis 6	
		CH0	CH1	CH2	CH3	CH4	CH5	
When using the transistor output type Control Unit	CW output or Pulse output	Y0	Y2	Y4	Y6	Y8	YA	
	CCW output or Sign output	Y1	Y3	Y5	Y7	Y9	YB	
	Deviation counter clear output	C14	Y4	Y5	-	-	-	-
		C30	Y8	Y9	YA	YB	-	-
C60		YC	YD	Y10	Y11	Y12	Y13	
System stop		Y20						
Error clear request		Y21						
Emergency stop		Y50	Y51	Y52	Y53	Y54	Y55	
Deceleration stop		Y58	Y59	Y5A	Y5B	Y5C	Y5D	
J point control speed change		Y60	Y61	-	-	-	-	
Near home input ^(Note 1)		(Y70)	(Y71)	(Y72)	(Y73)	(Y74)	(Y75)	
Over limit input (+) ^(Note 1)		(Y80)	(Y82)	(Y84)	(Y86)	(Y88)	(Y8A)	
Over limit input (-) ^(Note 1)		(Y81)	(Y83)	(Y85)	(Y87)	(Y89)	(Y8B)	
When using the relay output type pulse I/O cassette	CW output or Pulse output	Y100	Y200	-	-	-	-	
	CCW output or Sign output	Y101	Y201	-	-	-	-	
	Deviation counter clear output ^(Note 1)	Y102	Y202	-	-	-	-	

(Note 1) The near home input, over limit input (+) and over limit input (-) will be valid when an arbitrary input is allocated and the output relay indicated in the above table turns ON.

4.1.2 When Using Pulse Output Function (FP-X Compatible Instruction Mode)

- The following reserved areas are allocated to the home input or control active flag.
- Allocate an arbitrary input to the near home input or pulse output stop signal (emergency stop).

4.1 Confirming I/O Allocation

■ Allocation of I/O signals (Input)

Signal name	I/O No.					
	Axis 1	Axis 2	Axis 3	Axis 4	Axis 5	Axis 6
	CH0	CH1	CH2	CH3	CH4	CH5
Home input ^(Note 1) When using the transistor output Control Unit	X4	X5	X6	X7	X2	X3
Near home input	(Note 2)	(Note 2)	(Note 2)	(Note 2)	(Note 2)	(Note 2)
Control active flag (BUSY)	R911C	R911D	R911E	R911F	R9120	R9121
Operation done	(Note 3)	(Note 3)	(Note 3)	(Note 3)	(Note 3)	(Note 3)
Home return done	(Note 3)	(Note 3)	(Note 3)	(Note 3)	(Note 3)	(Note 3)
Home input ^(Note 1) When using the pulse I/O cassette for relay output type Control Unit	X102	X202	-	-	-	-

(Note 1) Even when setting the linear interpolation, the interpolation operation is not performed for the home return. Execute the operation for X axes and Y axes separately.

(Note 2) The near home input will be enabled when an arbitrary input is allocated and the bit 4 of the special data register DT90052 is turned ON by the pulse output control instruction (F0).

(Note 3) The operation done flag or home return done flag are substituted by confirming that the control active flag turns from ON to OFF after the execution of the pulse output instruction (F171).

■ Allocation of I/O signals (Output)

Signal name		I/O No.						
		Axis 1	Axis 2	Axis 3	Axis 4	Axis 5	Axis 6	
		CH0	CH1	CH2	CH3	CH4	CH5	
When using the transistor output type Control Unit	CW output or Pulse output	Y0	Y2	Y4	Y6	Y8	YA	
	CCW output or Sign output	Y1	Y3	Y5	Y7	Y9	YB	
	Deviation counter clear output ^(Note 1)	C14	Y4	Y5	-	-	-	-
		C30	Y8	Y9	YA	YB		
	C60	YC	YD	Y10	Y11	Y12	Y13	
Emergency stop (Pulse output stop)		(Note 2)						
When using the relay output type pulse I/O cassette	CW output or Pulse output	Y100	Y200					
	CCW output or Sign output	Y101	Y201	-	-	-	-	
	Deviation counter clear output ^(Note 1)	Y102	Y202	-	-	-	-	

(Note 1) Even when setting the linear interpolation, the interpolation operation is not performed for the home return. Execute the operation for X axes and Y axes separately.

(Note 2) The emergency stop will be enabled by specifying channel numbers and turning ON the bit 3 of the special data register DT90052 by the pulse output control instruction (F0). In case of the emergency stop in the FP-X compatible instruction mode, pulses stop immediately.

■ **Allocation of I/O relating to pulse output control (Only in FP-X compatible instruction mode)**

- By using the special data register DT90052 by the pulse output control instruction (F0), operations such as loading the near home input and stopping the pulse output forcibly can be performed.

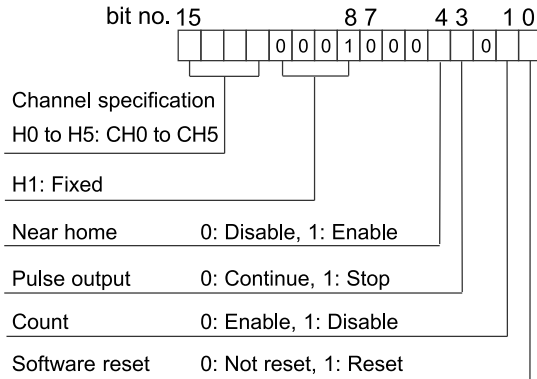

- When controlling the above functions using external inputs, arbitrary inputs can be allocated. The following program is for loading the near home input of CH1 using the input X10.

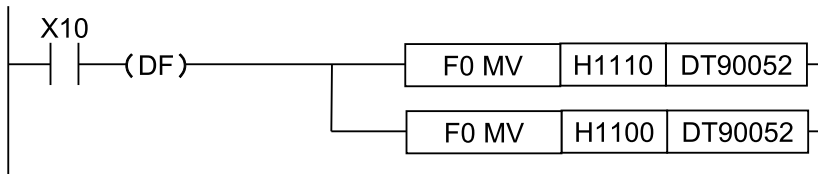

i Info.

- In the FP-X compatible instruction mode, the allocations of J-point control and over limit inputs are not available.
- In the FP-X compatible instruction mode, the allocations of system stop, error clear request, deceleration stop and J-point speed change are not available.

4.1.3 When Using PWM Output Function

- The following reserved areas are allocated to the PWM output or control active flag.
- Allocate them so that they do not overlap the I/O used for the pulse output function.

4.1 Confirming I/O Allocation

■ Allocation of I/O signals

Signal name		I/O No.			
		CH0	CH1	CH2	CH3
When using the transistor output Control Unit	PWM output	Y0	Y2	Y4	Y6
	Control active flag (BUSY)	R911C	R911D	R911E	R911F
When using the relay output type pulse I/O cassette	PWM output	Y100	Y200	-	-
	Control active flag (BUSY)	R911C	R911D	-	-

4.1.4 When Using High-speed Counter Function

- The following reserved areas are allocated to the hardware reset input or control active flag.

■ Allocation of I/O signals (When using internal input)

Signal name		I/O No.							
		CH0	CH1	CH2	CH3	CH4	CH5	CH6	CH7
Count input	Single-phase input	X0	X1	X2	X3	X4	X5	X6	X7
	2-phase input	X0 / X1	-	X2 / X3	-	X4 / X5	-	X6 / X7	-
Hardware reset input	Single-phase input	X6	-	X7	-	-	-	-	-
	2-phase input	X6	-	X7	-	-	-	-	-
Control active flag (BUSY)	Single-phase input	R9110	R9111	R9112	R9113	R9114	R9115	R9116	R9117
	2-phase input	R9110	-	R9112	-	R9114	-	R9116	-

■ Allocation of I/O signals (When using the input section of the pulse I/O cassette)

Signal name		I/O No.			
		CH8	CH9	CHA	CHB
Count input	Single-phase input	X100	X101	X200	X201
	2-phase input	X100 / X101	-	X200 / X201	-
Hardware reset input	Single-phase input	X102	X102	X202	X202
	2-phase input	X102	X102	X202	X202
Control active flag (BUSY)	Single-phase input	R9118	R9119	R911A	R911B
	2-phase input	R9118	-	R911A	-

(Note 1) The input X102 can be set to either CH8 or CH9 and the input X202 can be set to either CHA or CHB as a hardware reset input.

■ Allocation of I/O relating to high-speed counter control

- By using the special data register DT90052 by the high-speed counter control instruction (F0), operations such as the software reset of the high-speed counter and disabling / enabling the count can be performed.

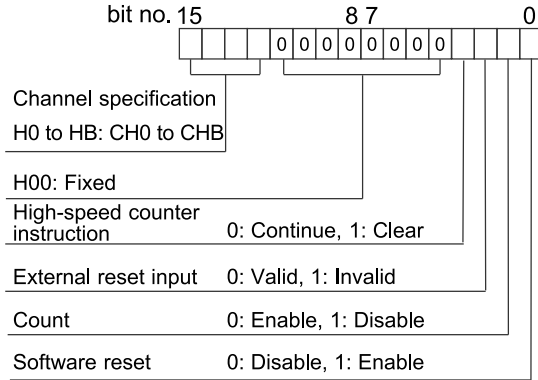

- When controlling the above functions using external inputs, arbitrary inputs can be allocated. The following program is for performing the software reset of CH0 using the input X7.

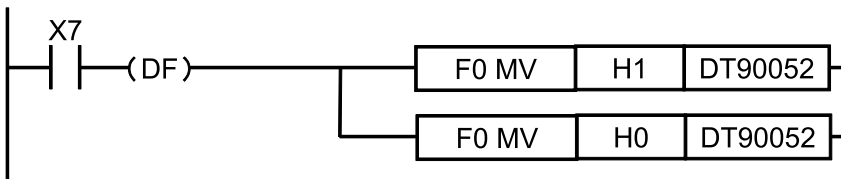

4.2 Settings in Configurator PMX

4.2 Settings in Configurator PMX

4.2.1 Allocating Channels to be Used

Use the Configurator PMX to allocate used channels and applications. The following procedure is explained on the condition that the FPWIN GR7 has already started.

1 2 Procedure

1. Select **Options>Positioning Table Settings** from the menu bar.
"Configurator PMX" will be activated.

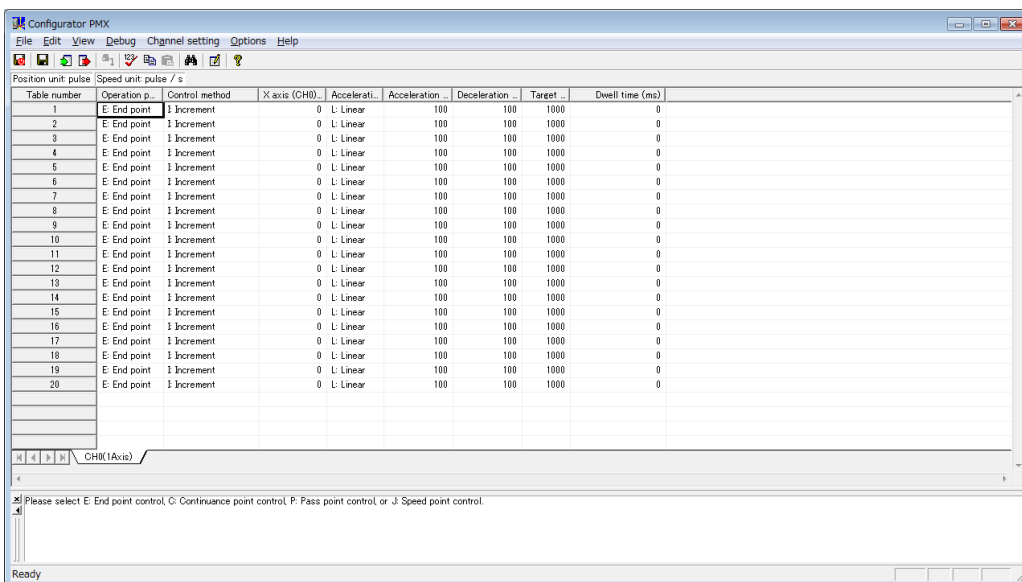

2. Select **Channel setting>Used channel setting** from the menu bar.
The "Used channel setting" dialog box will be displayed.

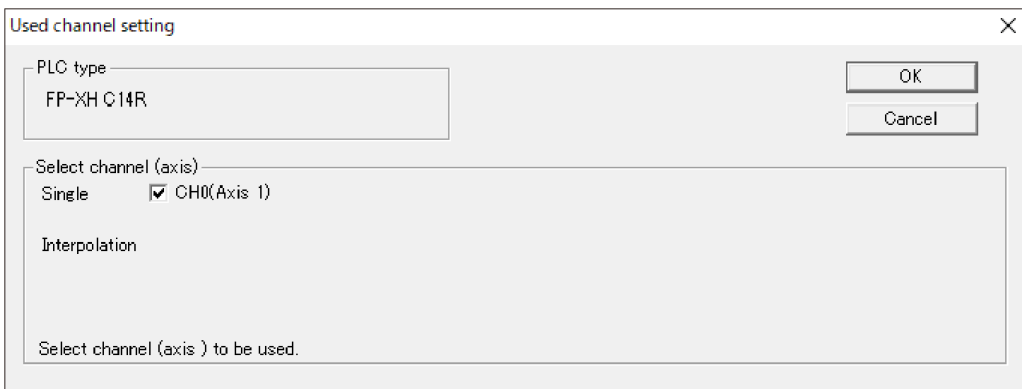

3. Select the axes to be used and the usage, and press the [OK] button.

When the setting is changed, a confirmation message box will be displayed. When the setting is changed, a confirmation message box appears.

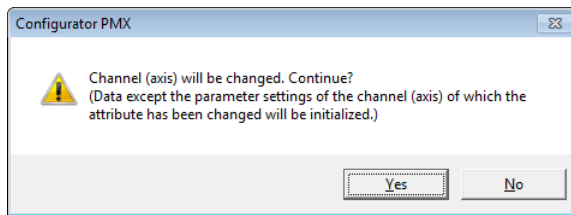

4. Confirm the change and press the [Yes] button.
A data table tab each is created for the groups set.

17	E: End point	I: Increment	0	L: Linear
18	E: End point	I: Increment	0	L: Linear

Navigation: CH0(1Axis) / CH1(2Axis) / CH2(3Axis)

i Info.

- When interpolation control is selected, the data table of the channel numbers of X and Y axes will be added, and [Interpolation] will be displayed on the tab.

17	E: End point	0: Linear (composit...	I: Increment
18	E: End point	0: Linear (composit...	I: Increment

Navigation: [Interpolation]CH0,CH1(1,2Axis) / CH2(3Axis)

- When changing "Used channel setting" in Configurator PMX, the system registers no. 400 to 402 and 407 corresponding to the I/O used for the positioning control will be automatically updated.

REFERENCE

4.3 System Register Settings

4.2.2 Setting Parameters

Use the Configurator PMX to allocate the most fundamental parameters for positioning control, such as the motor rotation direction, pulse output method (CW/CCW and Pulse/Sign), home input, limit input logic, and positioning control. The following procedure is explained on the condition that the Configurator PMX has already started.

1 2 Procedure

1. Select **Channel setting>Parameter settings** from the menu bar.
The "Parameter settings" dialog box appears.

4.2 Settings in Configurator PMX

Parameter settings		Channel0 (1 axis)	Channel1 (2 axis)	Channel2 (3 axis)	Channel3 (4 axis)
Basic	Pulse output method	Pulse/Sign	Pulse/Sign	Pulse/Sign	Pulse/Sign
	Pulse output rotation direction	CW direction +	CW direction +	CW direction +	CW direction +
	Startup speed	100	100	100	100
	Positioning repeat count	0	0	0	0
Input	Home position logic	Normal Open	Normal Open	Normal Open	Normal Open
	Home position proximity logic	Normal Open	Normal Open	Normal Open	Normal Open
	Limit + switch logic	Normal Open	Normal Open	Normal Open	Normal Open
	Limit - switch logic	Normal Open	Normal Open	Normal Open	Normal Open
Home return	Home return method	Not use	Not use	Not use	Not use
	Home return direction	Limit (-) direction	Limit (-) direction	Limit (-) direction	Limit (-) direction
	Home return acceleration time (ms)	100	100	100	100
	Home return deceleration time (ms)	100	100	100	100
	Home return target speed	1000	1000	1000	1000
	Home return creep speed	100	100	100	100
	Deviation counter clear time (ms)	1	1	1	1
	Coordinate origin	0	0	0	0
JOG operation	JOG acceleration time (ms)	0	0	0	0
	JOG deceleration time (ms)	0	0	0	0
	JOG target speed	1000	1000	1000	1000
	J point change target speed	1000	1000	1000	1000
Stop	Emergency stop deceleration time (ms)	100	100	100	100
	Limit stop deceleration time (ms)	100	100	100	100

Set the output method for pulse output.
Select from the followings.
Pulse/Sign method, CW/CCW method

OK Cancel Channel copy Initialize

2. Make necessary parameter settings according to the application and press the [OK] button. The settings will be stored as part of positioning parameter data.

Parameters

Parameter name	Default (unit)	Settings
Basic	Pulse output method	Pulse/Sign
	Pulse output rotation direction	CW direction +
	Startup speed	100 (pps)
	Positioning repeat count	0
		Pulse/Sign, CW/CCW When selecting Pulse/Sign mode: CW direction +: Select this setting for the case that the elapsed value is increased when Sign output turns off. CCW direction +: Select this setting for the case that the elapsed value is increased when Sign output turns on. When selecting CW/CCW mode: CW direction +: Select this setting for the case that the elapsed value is increased at the time of CW output. CCW direction +: Select this setting for the case that the elapsed value is increased at the time of CCW output. Set the startup speed common to each operation. This setting is common to JOG operation, home return, E-point control, P-point control, C-point control and J-point control. Setting range: 1 to 100,000 Specify this setting for performing repetitive controls when using E-point/P-point/C-point control.

Parameter name		Default (unit)	Settings
			0, 1: Not repeat 2 to 254: Repeat for the specified number of times. 255: Repeat infinitely until the execution of stop control.
Input	Home position logic	Normal Open	Select the input logic for each switch. Normal Open, Normal Close
	Home position proximity logic	Normal Open	
	Limit + switch logic	Normal Open	
	Limit - switch logic	Normal Open	
Home return	Home return method	Not use	DOG method 1, DOG method 2, DOG method 3, Home position method, Data set method, Not use
	Home return direction	Limit (-) direction	Limit (-) direction, Limit (+) direction
	Home return acceleration time	100 (ms)	Setting range: 1 to 10,000
	Home return deceleration time	100 (ms)	Setting range: 1 to 10,000
	Home return target speed	1000 (pps)	Setting range: 1 to 100,000
	Home return creep speed	100 (pps)	Setting range: 1 to 100,000
	Deviation counter clear time	1 (ms)	Setting range: 1 to 100
	Coordinate origin	0 (pulse)	When the home return method is Data set method, specify a coordinate origin. Setting range: -1,073,741,824 to 1,073,741,823 For the interpolation control, the range is as follows. Setting range: -8,388,608 to 8,388,607
JOG operation	JOG acceleration time	0 (ms)	Setting range: 0 to 10,000
	JOG deceleration time	0 (ms)	Setting range: 0 to 10,000
	JOG target speed	1000 (pps)	Setting range: 1 to 100,000
	J point change target speed	1000 (pps)	Set this setting for changing the speed during J-point control. Setting range: 1 to 100,000
Stop	Emergency stop deceleration time	100 (ms)	Setting range: 1 to 10,000
	Limit stop deceleration time	100 (ms)	Setting range: 1 to 10,000

4.2.3 Creating Positioning Data Table

- The positioning data tables are divided into sheets for each axis, and 20 tables ranging no. 1 to no. 20 can be set.

4.2 Settings in Configurator PMX

■ For independent axis control

Parameter name	Default (unit)	Description
Operation pattern	E: End point	Select one from the following operation patterns. E: End point, P: Pass point, C: Continuance point, J: Speed point
Control method	I: Increment	Select either. I: Increment or A: Absolute.
X-axis movement amount	0 (pulse)	Input a movement amount. Setting range: -1,073,741,824 to +1,073,741,823
Acceleration/ deceleration method	L: Linear	For FP0H, only L: Linear can be selected.
Acceleration time	100 (ms)	Set an acceleration time. Setting range: 1 to 10,000
Deceleration time	100 (ms)	Set a deceleration time. Setting range: 1 to 10,000
Target speed	1000 (pps)	Set a target speed. Setting range: 1 to 100,000
Dwell time	0 (ms)	Set the time from the completion of the positioning instruction in the E-point control until the positioning done flag turns ON. For the C-point control, it is the wait time between each table. Also, the dwell time setting is invalid for the P-point control.

■ For interpolation control

Parameter name	Default (unit)	Description
Operation pattern	E: End point	Select one from the following operation patterns. E: End point, P: Pass point, C: Continuance point
Interpolation operation	Linear (composite speed)	Select a specification method of speed. Linear (composite speed): Specify the speed combining the speed of X and Y axes. Linear (major axis speed): Specify the speed on the long axis side whose movement amount is large.
Control method	I: Increment	Select either. I: Increment or A: Absolute.
X-axis movement amount	0 (pulse)	Input a movement amount. Setting range: -8,388,608 to +8,388,607
Y-axis movement amount	0 (pulse)	Input a movement amount. Setting range: -8,388,608 to +8,388,607
Acceleration/ deceleration method	L: Linear	For FP0H, only L: Linear can be selected.
Acceleration time	100 (ms)	Set an acceleration time. Setting range: 1 to 10,000
Deceleration time	100 (ms)	Set a deceleration time. Setting range: 1 to 10,000

Parameter name	Default (unit)	Description
Interpolation speed	1000 (pps)	Set either composite speed or major axis speed in accordance with the selection of interpolation operation. Setting range: 1 to 100,000
Dwell time	0 (ms)	Set the time from the completion of the positioning instruction in the E-point control until the positioning done flag turns ON. For the C-point control, it is the wait time between each table. Also, the dwell time setting is invalid for the P-point control.

■ Selection of positioning operation patterns

- For the E-point control, enter settings in one row.
- For P-point control (speed change control), C-point control (continuance point control) and J-point control (JOG positioning control), they should be combined with E-point control of the next step as a pair and the settings should be input in two rows.

Table number	Operation p...	Control method	X axis (CH0)	Accelerati...	Acceleration ..	Deceleration ..	Target ..	Dwell time (ms)
1	E: End point	I: Increment	0	L: Linear	100	100	1000	0
2	E: End point	I: Increment	0	L: Linear	100	100	1000	0
3	E: End point	I: Increment	0	L: Linear	100	100	1000	0
4	E: End point	I: Increment	0	L: Linear	100	100	1000	0
5	E: End point	I: Increment	0	L: Linear	100	100	1000	0
6	E: End point	I: Increment	0	L: Linear	100	100	1000	0
7	E: End point	I: Increment	0	L: Linear	100	100	1000	0
8	E: End point	I: Increment	0	L: Linear	100	100	1000	0
9	E: End point	I: Increment	0	L: Linear	100	100	1000	0

■ Table numbers and activation of positioning

- Execute the positioning start instruction (F380) in the user program to specify table numbers in the Configurator PMX.
- The unit executes the control under the conditions set in the table by turning on the positioning start contact corresponding to a desired channel number (axis number) and table number. Specify the first data table number for each control in the program.

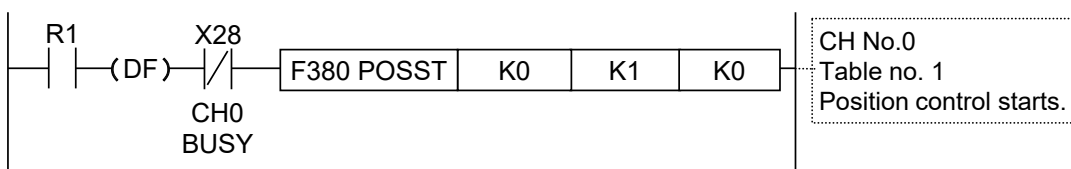

i Info.

- For details, refer to "5 Operation Patterns". For details of instructions, refer to "7 Instruction References".

4.2.4 Saving Positioning Parameters

Information on positioning parameters and positioning data tables set on Configurator PMX is saved as part of program files.

4.2 Settings in Configurator PMX

1 2 Procedure

1. Select **File>Save changes and exit** from the menu bar.
A confirmation message box appears.

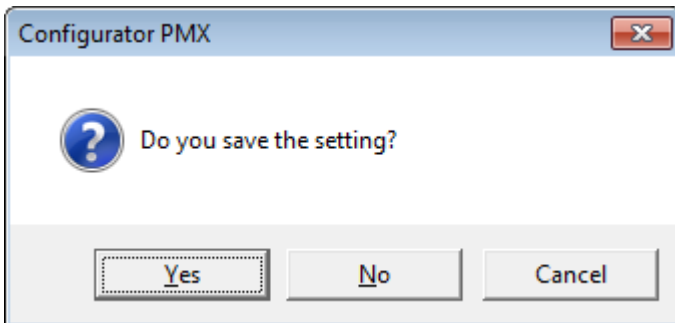

2. Press [Yes].
The set information will be saved as part of project files.

4.2.5 Export and Import

- Basic parameters and positioning parameters set can be exported to and imported from the Configurator PMX.
- Information on positioning parameters and positioning tables saved by using the export function can be reused between projects.

1 2 Procedure

1. Select **File>Export** from the menu bar.
The saving destination and file names appear.
2. Enter a saving destination and file name, and press [Save] button.
Information on the parameters and positioning data tables will be saved in a file with a “.pmx” extension.

i Info.

- When export is executed, information on the positioning data tables will be saved along with parameters set in the parameter setting menu.

4.2.6 Check on Parameter Data

- The following procedure is explained on the condition that the Configurator PMX has already started.

1 2 Procedure

1. Select **Debug>Check Parameter and Data Values** from the menu bar.

A message box appears to show the check result. If there is an error in the settings for the positioning data tables, an error message will appear and the cursor will move to the corresponding error position.

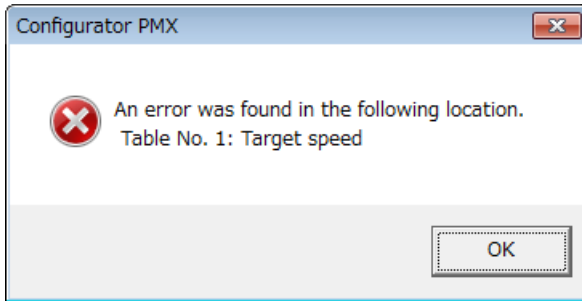

4.2.7 Writing Parameters to Unit (1)

- Information on parameters that have been set is transferred to the unit along with information on programs, comments and system registers.
- The following procedure is explained on the condition that the Configurator PMX has already started.

1 2 Procedure

1. Select **File>Save changes and exit** from the menu bar of the Configurator PMX.
2. When "Do you save the setting?" appears, press [Yes (Y)].
3. Select **Online>Download To PLC (Entire project)** from the FPCWIN GR7 menu bar. Positioning data will also be downloaded to the control unit along with information on programs, comments and system registers.

4.2.8 Writing Parameters to Unit (2)

- Information on parameters that have been set can also be downloaded to the unit in the Configurator PMX.
- The following procedure is explained on the condition that the Configurator PMX has already started.

1 2 Procedure

1. Select **File>Download positioning data** from the menu bar of the Configurator PMX. A message box for confirming the saving appears.

4.2 Settings in Configurator PMX

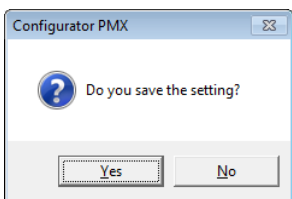

2. Press the [Yes] button.

A message confirming the download to the PLC appears. In the RUN mode, a message confirming that the mode is switched to the PROG. mode also appears.

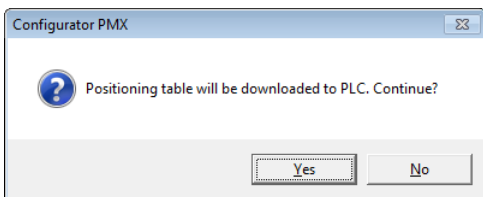

3. Press the [Yes] button.

A message confirming the switching of the operation mode appears.

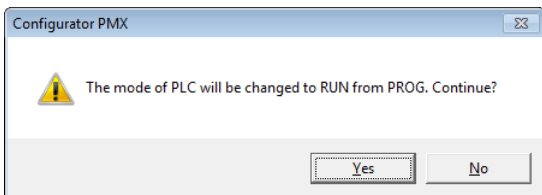

4. Press the [Yes] button to switch the operation mode.

4.3 System Register Settings

4.3.1 Confirming and Selecting Functions to be Used

The set condition can be confirmed by the following procedure. The following procedure is explained on the condition that the FPWIN GR7 has already started.

1 2 Procedure

1. Select **Options>System register settings** from the menu bar.
The "PLC Configuration" dialog box appears.
2. Select "Controller output setting (PLS / PWM)" from the left pane.

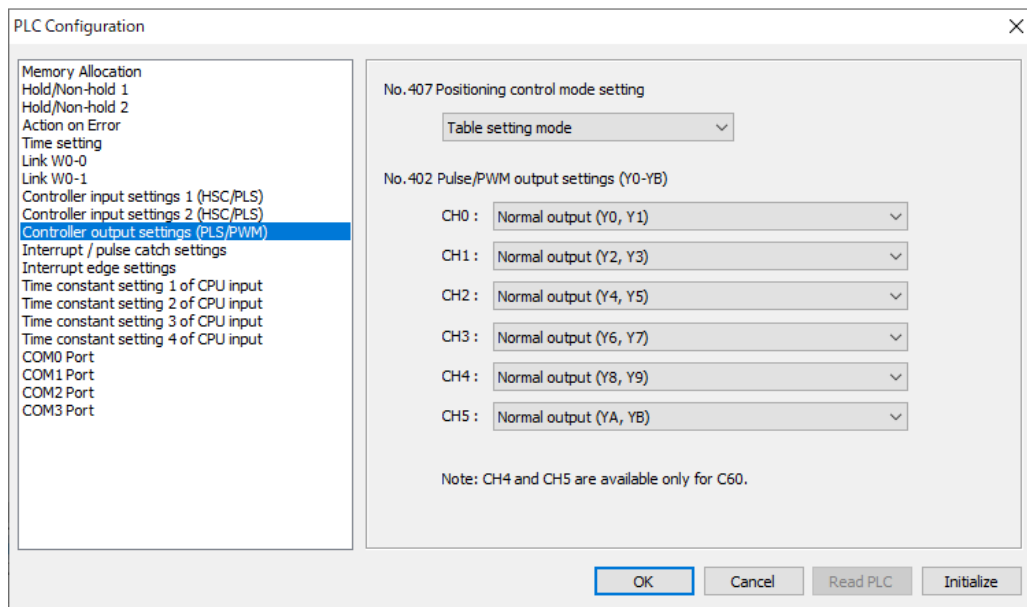

3. Confirm the functions to be used and change the settings as necessary.
4. Press the [OK] button.
The screen returns to the ladder edit screen. The settings will be downloaded to the PLC together with programs.

i Info.

- When the settings are saved in the Configurator PMX, the system registers corresponding to the I/O used for the positioning function will be automatically set.
- Change the settings of the corresponding system registers when the home input is not used or the PWM output is allocated to other channels.

4.3 System Register Settings

Settings when using table setting mode (Transistor output type)

Parameter name	No. and setting item		Settings
Control Unit input settings (HSC / PLS)	400 High-speed counter setting (X0 to X3)	X0	To use the J-point control, select J-point positioning start input of CH0.
		X1	To use the J-point control, select J-point positioning start input of CH1.
		X2	Select CH4 Home input or Normal input.
		X3	Select CH5 Home input or Normal input.
Control Unit input settings 2 (HSC / PLS)	401 High-speed counter pulse output setting (X4 to X7)	X4	Select CH0 Home input or Normal input.
		X5	Select CH1 Home input or Normal input.
		X6	Select CH2 Home input or Normal input.
		X7	Select CH3 Home input or Normal input.
Control Unit output settings (PLS / PWM)	407 Positioning control mode setting		Select the table setting mode or FP-X compatible instruction mode.
	402 Pulse / PWM output setting (Y0 to YB)	CH0	Select the output allocated to each channel. Normal output, PWM output, Pulse output [Table setting mode], Pulse output [FP-X compatible instruction mode]
		CH1	
		CH2	
		CH3	
		CH4	
CH5			

(Note 1) Displayed items vary according to models.

(Note 2) Select "Normal input" and "Normal output" for the input and output that is not used for the pulse output function or high-speed counter function.

(Note 3) "J-point positioning start input" for each channel can be selected only when "Table setting mode" is set in the system register no. 407.

Settings when using table setting mode (Relay output type)

Parameter name	No. and setting item		Settings
Pulse I/O cassette setting (HSC / PLS)	407 Positioning control mode setting		Select the table setting mode or FP-X compatible instruction mode.
	400 High-speed counter setting (X100 to X102)	X100	To use the J-point control, select J-point positioning start input of CH0.
	400 Pulse output setting (Y100 and Y101)	CH0	Select the output allocated to each channel. Normal output, PWM output, Pulse output [Table setting mode], Pulse output [FP-X compatible instruction mode]
	400 High-speed counter setting (X200 to X202)	X200	To use the J-point control, select J-point positioning start input of CH1.
	400 Pulse output setting	CH1	Select the output allocated to each channel. Normal output, PWM output, Pulse output [Table setting mode],

4.3 System Register Settings

Parameter name	No. and setting item	Settings
	(Y200 and Y201)	Pulse output [FP-X compatible instruction mode]

(Note 1) Displayed items vary according to models.

(Note 2) Select "Normal input" and "Normal output" for the input and output that is not used for the pulse output function or high-speed counter function.

(Note 3) "J-point positioning start input" for each channel can be selected only when Table setting mode is set in the system register no. 407.

4.4 Reading Elapsed Values

4.4 Reading Elapsed Values

4.4.1 Elapsed Value (Current Value) Area

- They are stored as 2-word 32-bit data in the axis information area of positioning memory.
- The elapsed value area will be reset when the power supply turns off. It will be held when switching the mode from RUN to PROG.

■ Counting range of elapsed value (current value) area

Section	Range
For single axis control	-1,073,741,824 to 1,073,741,823
For interpolation axis control	-8,388,608 to +8,388,607

4.4.2 Elapsed Value (Current Value) Area

Use [F384 PTBLR] positioning parameter read instruction for reading elapsed values.

■ Instruction format



Operand	Settings	Specification for reading the elapsed value area	
S1	Specification of channel numbers and positioning memory area	H1	Specify the axis information area of CH0.
		H101	Specify the axis information area of CH1.
		H201	Specify the axis information area of CH2.
		H301	Specify the axis information area of CH3.
		H401	Specify the axis information area of CH5.
S2	Starting address of positioning memory (Offset address)	H501	Specify the axis information area of CH5.
		K2	Specify the offset address.
n	No. of read words	K2	Specify two words.
D	Operation memory storing read data		Specify an arbitrary memory.

■ Sample program

The following sample shows the program when reading the elapsed value (current value) of CH3 to the data registers DT300 to DT301. For details of instructions, refer to "[7 Instruction References](#)".



(MEMO)

5 Operation Patterns

5.1 Stop Operation.....	5-2
5.1.1 Type of Stop Operations	5-2
5.1.2 Characteristics of Stop Operations	5-3
5.2 JOG Operation.....	5-4
5.2.1 Settings and Operation of JOG Operation	5-4
5.2.2 Settings and Operation of JOG Operation (Speed Changes).....	5-6
5.2.3 Speed Changes in JOG Operation	5-8
5.3 Home Return.....	5-9
5.3.1 Types of Home Return	5-9
5.3.2 Operation Patterns of Home Return	5-10
5.3.3 Settings and Operations of Home Return	5-12
5.4 Positioning Control.....	5-16
5.4.1 Types of Positioning Control	5-16
5.4.2 E-point Control (Single-Speed Positioning)	5-17
5.4.3 P-point Control (Double-Speed Positioning).....	5-18
5.4.4 C-point Control	5-20
5.4.5 J-point Control (JOG Positioning)	5-22
5.4.6 J-point Control (JOG Positioning: Speed Changes)	5-23
5.4.7 Programming Cautions	5-26
5.5 Repeat Operation.....	5-28
5.5.1 Overview of Repeat Operation.....	5-28
5.5.2 Settings and Operations of Repeat Operation	5-29
5.5.3 Stop Operation During Repeat Operation.....	5-31
5.6 Linear Interpolation Control.....	5-33
5.6.1 Overview	5-33
5.6.2 Settings and Operations of Linear Interpolation.....	5-34

5.1 Stop Operation

5.1 Stop Operation

5.1.1 Type of Stop Operations

■ Type of stop operations

Name	Timing chart	Occurrence condition and operation
System stop		<ul style="list-style-type: none"> Once the system stop contact (Y20) turns on, an active operation will stop and the pulse outputs of all channels will immediately stop. The similar operation is performed when the operation mode of the Control Unit is switched from RUN to PROG.
Emergency stop		<ul style="list-style-type: none"> Once an emergency stop contact (Y50 to Y55) turns on, an active operation will stop and the pulse outputs of corresponding channels will stop. Performs a deceleration stop in the deceleration time specified in the positioning parameter setting menu of Configurator PMX.
Limit stop		<ul style="list-style-type: none"> Once an over limit input (+) and over limit input (-) (Y80 to Y8B) turns on, an active operation will stop and the pulse outputs of corresponding channels will stop. Performs a deceleration stop in the "limit stop deceleration time" specified in the positioning parameter settings.
Deceleration stop		<ul style="list-style-type: none"> Once a deceleration stop contact (Y58 to Y5D) turns on, an active operation will stop and the pulse outputs of corresponding channels will stop. Performs a deceleration stop in the deceleration time specified for the active positioning operation.

■ Execution of stop operations

Stop controls are executed when the following I/O signals turn ON.

■ Allocation of I/O signals (Output)

Signal name	I/O No.					
	Axis 1	Axis 2	Axis 3	Axis 4	Axis 5	Axis 6
	CH0	CH1	CH2	CH3	CH4	CH5
System stop	Y20					

Signal name	I/O No.					
	Axis 1	Axis 2	Axis 3	Axis 4	Axis 5	Axis 6
	CH0	CH1	CH2	CH3	CH4	CH5
Emergency stop	Y50	Y51	Y52	Y53	Y54	Y55
Over limit input (+) ^(Note 1)	(Y80)	(Y82)	(Y84)	(Y86)	(Y88)	(Y8A)
Over limit input (-) ^(Note 1)	(Y81)	(Y83)	(Y85)	(Y87)	(Y89)	(Y8B)
Deceleration stop	Y58	Y59	Y5A	Y5B	Y5C	Y5D

(Note 1) The over limit input (+) and over limit input (-) will be valid when arbitrary inputs are allocated and the output relays indicated in the above table turn ON.

5.1.2 Characteristics of Stop Operations

■ Priority of stop operations

When stop control requests are made simultaneously, the stop operations are executed according to the following priority.

1. System stop > 2. Emergency stop > 3. Limit stop > 4. Deceleration stop

■ Dwell time setting

The dwell time setting is invalid in the stop operations regardless of patterns.

■ Flag processing

- In the case of system stop, the busy signal turns off and the operation done signal turns on.
- In the cases of emergency stop, limit stop and deceleration stop, the busy signal turns off and the operation done signal turns on after the completion of the pulse output during deceleration.

■ Elapsed value area (Current value coordinate)

- Even in a stop operation, the elapsed value area is always updated.
- After the emergency stop, limit stop or deceleration stop, deceleration is performed with each specified deceleration time, and the value when the pulse output stops is stored.
- In the case of system stop, the value when the pulse output stops is stored.

i Info.

- For details of the deceleration stop operations when repetitive control is executed, refer to ["5.5.3 Stop Operation During Repeat Operation"](#).

5.2 JOG Operation

5.2 JOG Operation

5.2.1 Settings and Operation of JOG Operation

The parameters for JOG operations are specified in the positioning parameter setting menus of Configuration PMX.

Pulses are output while the JOG operation start instruction (F381 JOGST) is executed.

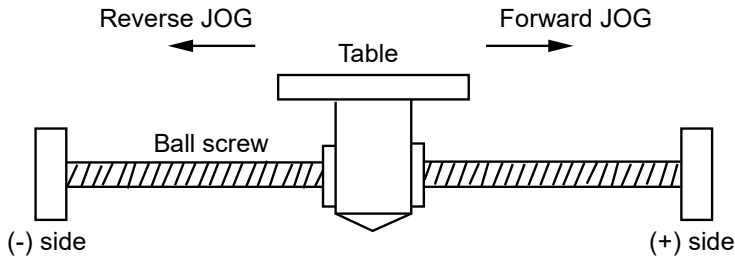

■ Operation diagram

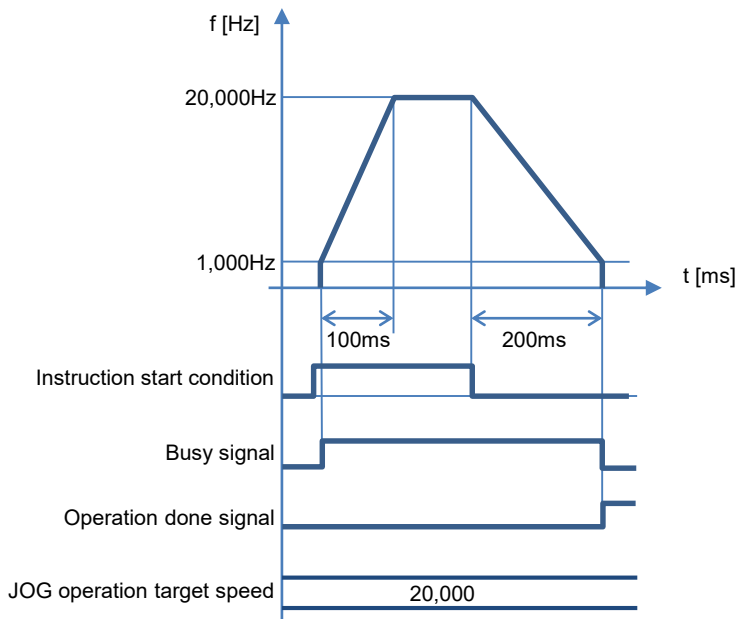

■ Operations of each contact

- The BUSY flags (X28 to X2D), which indicate that the motor is running, will turn ON when the JOG operation starts, and they will turn OFF when the operation completes.
- The operation done flags (X30 to X35), which indicate the completion of operation, will turn ON when the current operation is completed, and they will be held until the next positioning control, JOG operation or home return operation starts.

■ Notes on programming

- The startup contact and flag numbers vary depending on channel numbers (axis numbers).

■ Settings

Item	Setting example	
Axis setting area	Startup speed	1,000 Hz
	JOG operation acceleration time	100 ms
	JOG operation deceleration time	200 ms
	JOG operation target speed	20,000 Hz

■ Configurator PMX settings

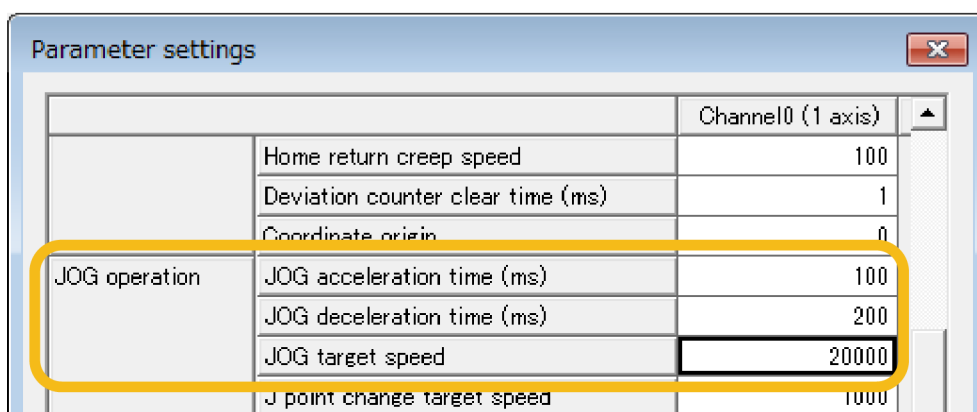

■ Sample program

The execution condition is set to be always executed. For details of instructions, refer to "7 Instruction References".

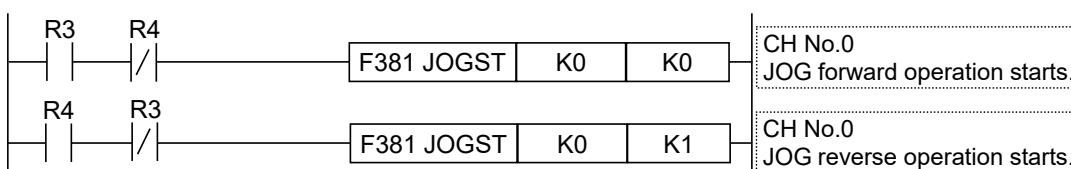

■ Operation at over limit input

Conditions	Direction	Limit status	Operation
At startup	Forward	Over limit input (+): ON	Not executable, Error occurs.
		Over limit input (-): ON	Executable
	Reverse	Over limit input (+): ON	Executable
		Over limit input (-): ON	Not executable, Error occurs.
During operation	Forward	Over limit input (+): ON	Limit stops, Error occurs. ^(Note 1)
		Over limit input (-): ON	Limit stops, Error occurs. ^(Note 1)
	Reverse	Over limit input (+): ON	Limit stops, Error occurs. ^(Note 1)

5.2 JOG Operation

Conditions	Direction	Limit status	Operation
		Over limit input (-): ON	Limit stops, Error occurs. <small>(Note 1)</small>

(Note 1) Create a program as below if you do not want to restart the instruction when the limit error occurs during an operation when the execution condition has been set to be always executed.

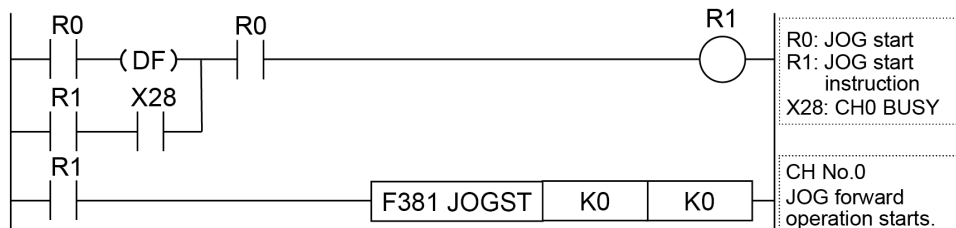

5.2.2 Settings and Operation of JOG Operation (Speed Changes)

It is possible to change a target speed during the JOG operation. The target speed is changed by rewriting the positioning memory using a user program.

■ Operation diagram

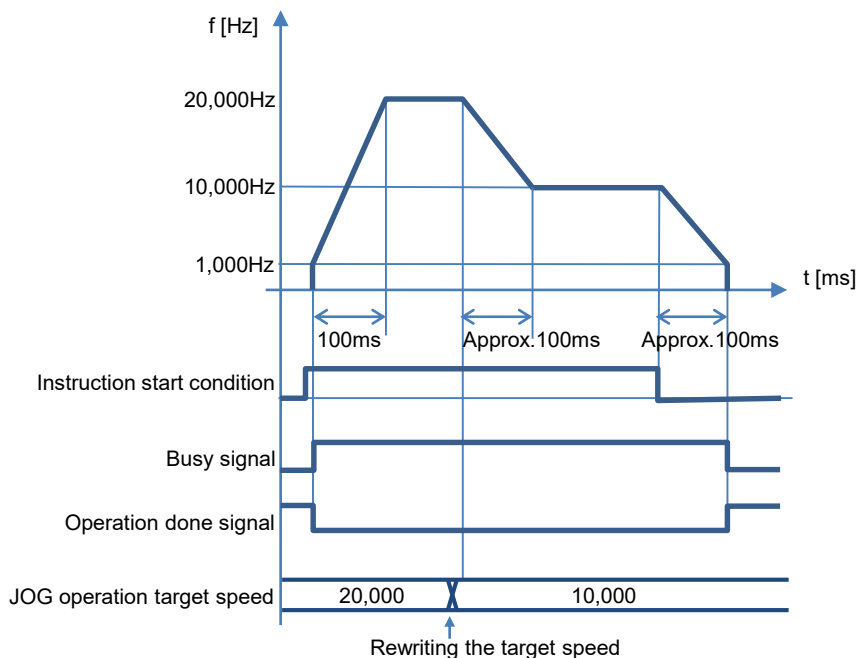

■ Operations of each contact

- The BUSY flags (X28 to X2D), which indicate that the motor is running, will turn ON when the JOG operation starts, and they will turn OFF when the operation completes.

- The operation done flags (X30 to X35), which indicate the completion of operation, will turn ON when the current operation is completed, and they will be held until the next positioning control, JOG operation or home return operation starts.

■ Characteristics of acceleration / deceleration zone when changing speeds

- In the case of the speed change in the JOG operation, the speed of acceleration zone and deceleration zone changes whenever the instruction is executed. The speed variation is obtained by the following formula.

Speed variation = (JOG operation target speed - Startup speed) / (JOG acceleration time or JOG deceleration time)

■ Settings

Item	Setting example	
Axis setting area	Startup speed	1,000 Hz
	JOG operation acceleration time	100 ms
	JOG operation deceleration time	200 ms
	JOG operation target speed	20,000 Hz → 10,000 Hz

■ Configurator PMX settings

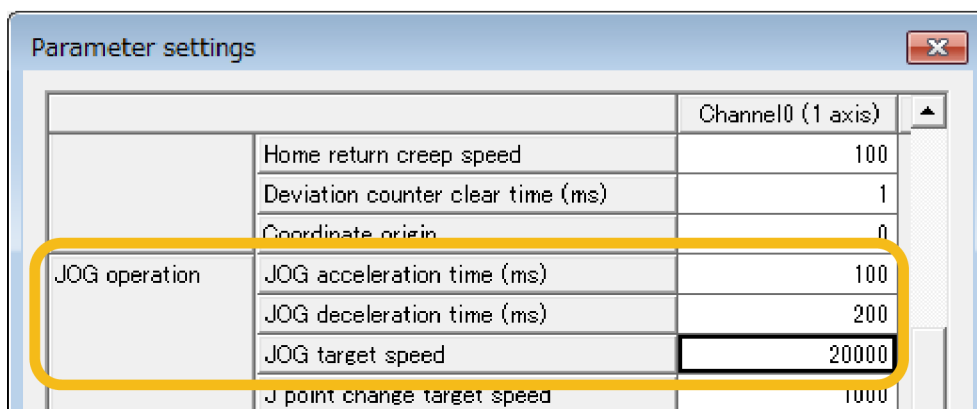

■ Sample program

The execution condition is set to be always executed. For details of instructions, refer to "7 Instruction References".

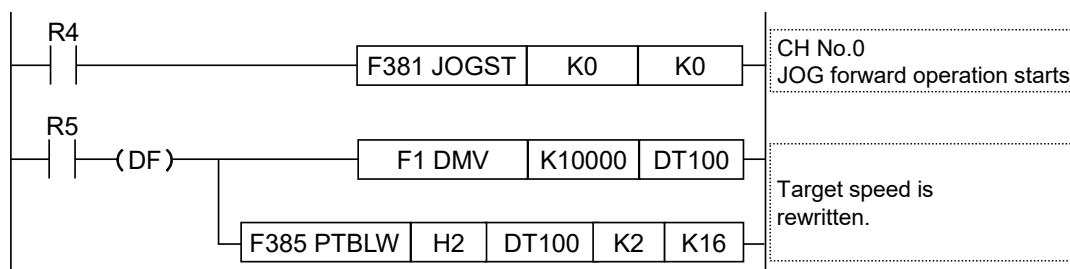

5.2 JOG Operation

■ Notes on programming

- To change a speed during the JOG operation, rewrite the value of the positioning memory (axis setting area) using a user program.
- The startup contact and flag numbers vary depending on channel numbers (axis numbers).

5.2.3 Speed Changes in JOG Operation

- The value of “JOG operation target speed” in the axis setting area is constantly monitored while the operation is being executed. When the target speed is changed, it will be changed with the same acceleration.
- The speed change is executed after the completion of acceleration/deceleration.
- The speed range in which the JOG operation can be set is 50Hz to 100kHz. When setting a value smaller than 50 Hz, it is corrected to 50 Hz.

5.3 Home Return

5.3.1 Types of Home Return

The home return is specified in the positioning parameter setting dialog box for each axis.

Name	Operation diagram	Operation and application
DOG method 1		<ul style="list-style-type: none"> • The leading edge of the first home input is set as a home position after the detection of the leading edge of the near home input. • Even when the limit input turns on, the motor rotation will be automatically reversed and the home return operation will continue. • This method is used when the home switch exists in the range that the near home switch is enabled, such as a system using a servo motor. This method can also be used when no home switch exists in the range that the near home switch is enabled.
DOG method 2		<ul style="list-style-type: none"> • The leading edge of a near home input is detected and it is set as a home position. • Even when the limit input turns on, the motor rotation will be automatically reversed and the home return operation will continue. • This method is used for performing the home return with the near home switch only.
DOG method 3		<ul style="list-style-type: none"> • The leading edge of the first home input in the home return direction set as a home position after the detection of a trailing edge (back end) of the near home input. • Even when the limit input turns on, the motor rotation will be automatically reversed and the home return operation will continue. • This method is used when no home switch exists in the range that the near home switch is enabled.
Home position method		<ul style="list-style-type: none"> • Moves the current position to the home return direction, and stops at the position where the leading edge of the home input is detected. This coordinate is set as the starting point. • When no home input exists in the home return direction, the limit input turns on and the operation stops. • This method is used for performing the home return with the home switch only. This method is compatible with the F171 instruction of the existing model FPsigma.

5.3 Home Return

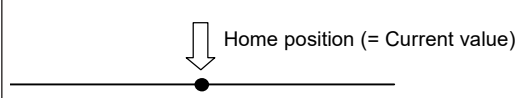
Name	Operation diagram	Operation and application
Data set method		<ul style="list-style-type: none"> • Performs the home return based on the home coordinate values in the axis setting area of positioning memory. • Performs the home return toward the home coordinate on the software. • When the starting point is within the limit switch, it cannot be started.

5.3.2 Operation Patterns of Home Return

The operations vary according to selected home return methods and the difference in current positions.

■ DOG method 1 (Edge detection of near home switch + Home switch, based on front end)

The leading edge of the first home switch is set as a home position after the detection of the leading edge of the near home switch.

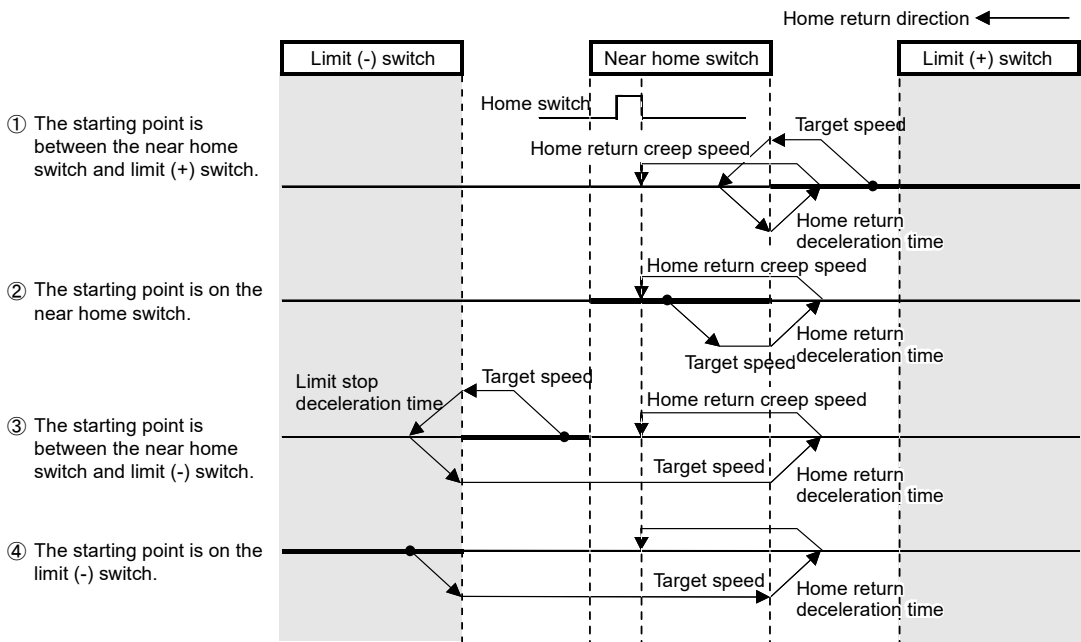

■ DOG method 2 (Edge detection of near home switch)

The leading edge of the near home switch is detected and it is set as a home position.

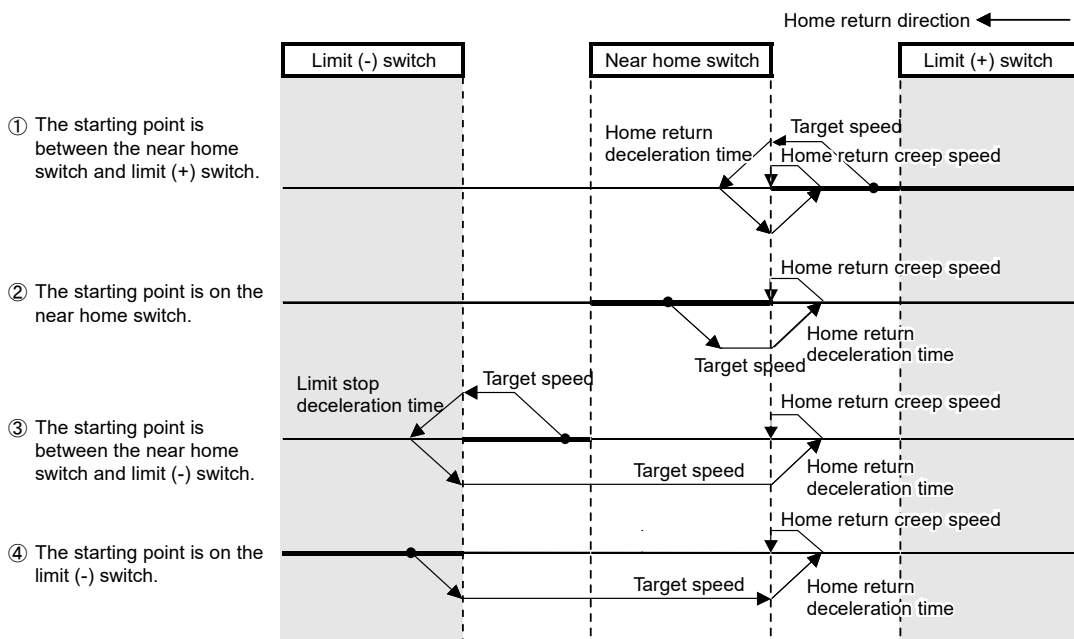

■ DOG method 3 (Edge detection of near home switch + Home switch, based on back end)

The leading edge of the first home switch in the home return direction is set as a home position after the detection of the trailing edge (back end) of the near home switch.

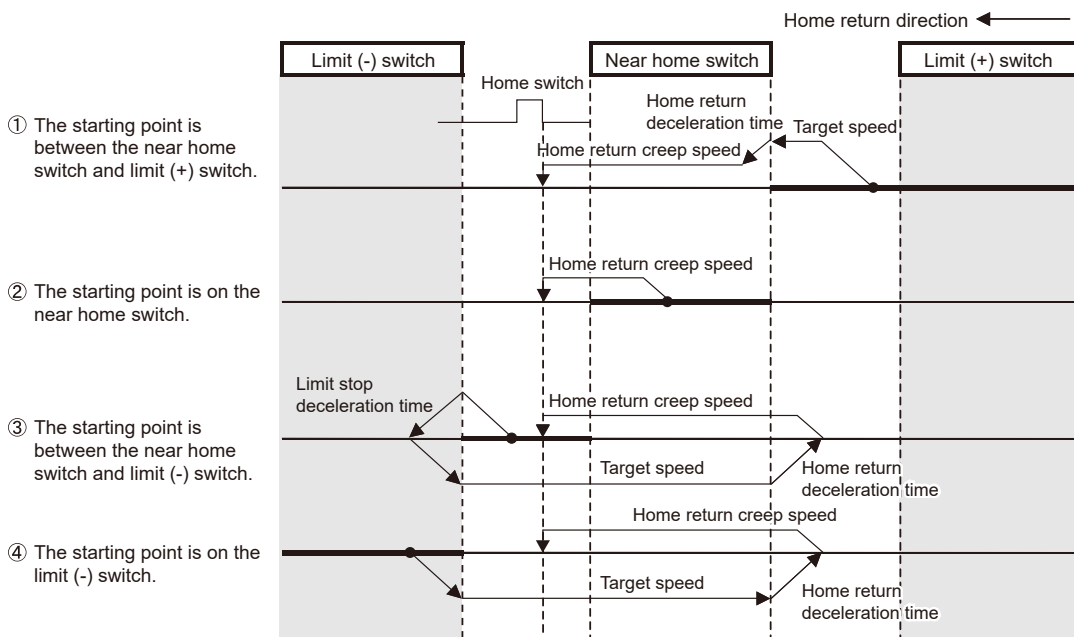

5.3 Home Return

■ Home position method (Edge detection of home switch)

Moves the current position to the home return direction, and stops at the position where the leading edge of the first home switch is detected. This coordinate is set as a home position.

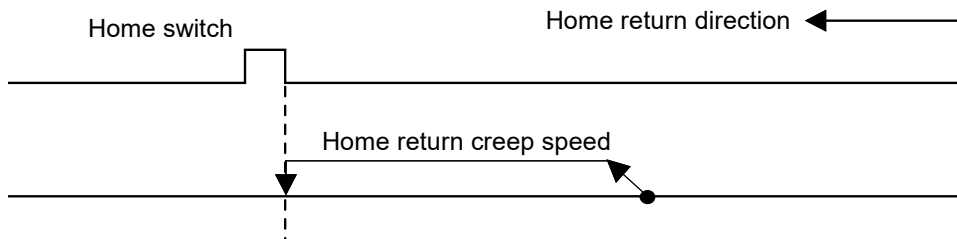

■ Data set method

Performs the home return based on the home coordinate values in the axis setting area of positioning memory.

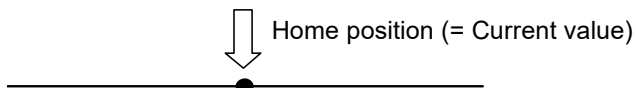

i Info.

- For details of addresses and settings of positioning memory, refer to "[11.3 Positioning Memory](#)".

5.3.3 Settings and Operations of Home Return

- The parameters for home return operations are specified in the positioning parameter setting menus of Configuration PMX.
- When the home return start instruction (F382 ORGST) is executed, the pulse output will start and the home return operation will be performed.
- In the following example, the DOG1 method is selected. After the start, it moves at a target speed and reverses at the time of near home detection. After the redetection of near home input, it moves at a creep speed until the home position is detected.

■ Operation diagram

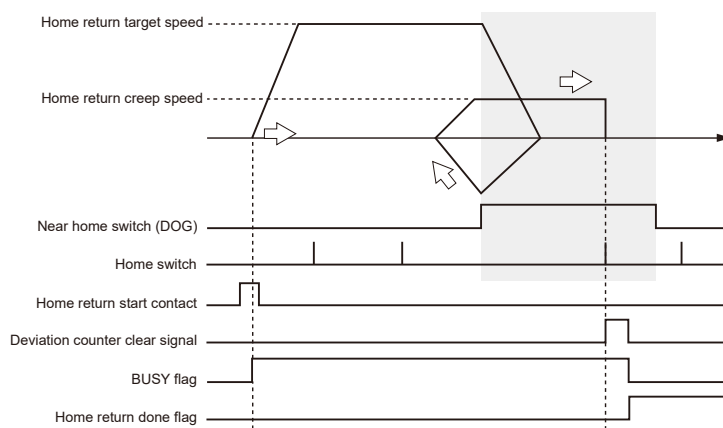

■ Operations of each contact

- The BUSY flags (X28 to X2D), which indicate that the motor is running, will turn ON when the home return operation starts, and they will turn OFF when the operation completes.
- The deviation counter clear signal will turn ON after the completion of the home return operation. The ON time is set in the axis setting area of the positioning memory.
- The home return done flags (X48 to X4D), which indicate the completion of home return operation, will turn ON when the current operation is completed, and they will be held until any operation of the positioning control, JOG operation and home return operation starts. The timing of turning ON the flags is on the completion of the home return.

■ Settings

Item	Setting example	
Axis setting area	Home return method	DOG method 1
	Home return direction	Over limit (-) direction
	Home return acceleration time (ms)	100 ms
	Home return deceleration time (ms)	100 ms
	Home return target speed	10000 pps
	Home return creep speed	1000 pps
	Deviation counter clear time (ms)	1 ms

5.3 Home Return

■ Configurator PMX settings

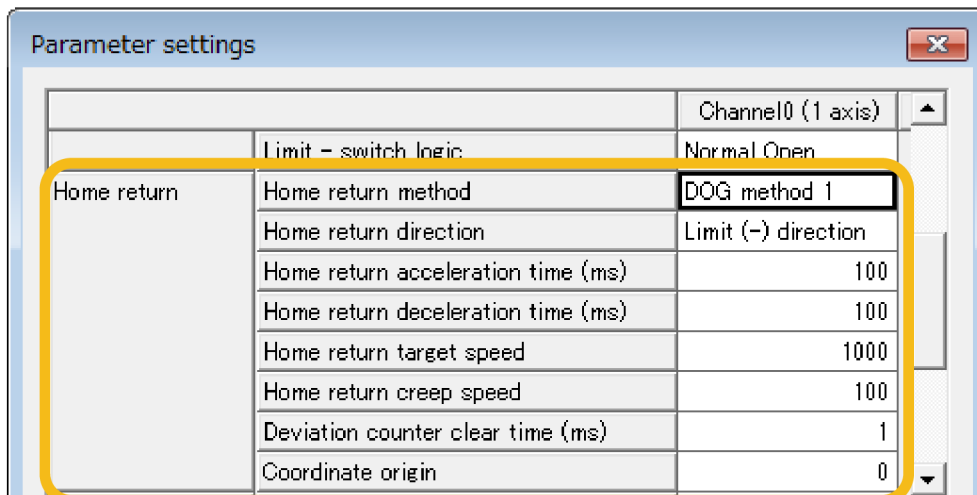

■ Sample program

The execution condition is differential execution. For details of instructions, refer to "7 Instruction References".

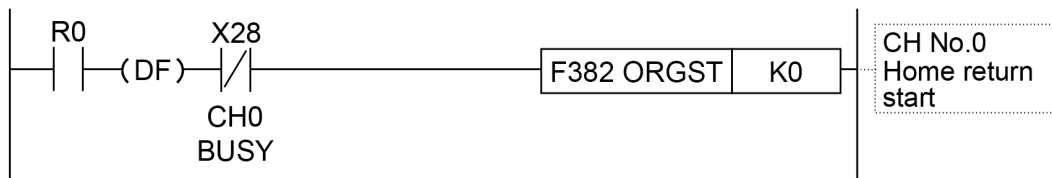

■ Operation at over limit input

Conditions	Direction	Limit status	Operation
At startup	Forward	Over limit input (+): ON	Executable ^{(Note 2)(Note 3)}
		Over limit input (-): ON	Executable ^(Note 3)
	Reverse	Over limit input (+): ON	Executable ^(Note 3)
		Over limit input (-): ON	Executable ^{(Note 2)(Note 3)}
During operation	Forward	Over limit input (+): ON	Automatic reverse operation ^(Note 4)
		Over limit input (-): ON edge ^(Note 1)	Limit stops, Error occurs.
	Reverse	Over limit input (+): ON edge ^(Note 1)	Limit stops, Error occurs.
		Over limit input (-): ON	Automatic reverse operation ^(Note 4)

(Note 1) Only when an edge signal is detected, the limit stop is performed.

(Note 2) In the case of home position method, it cannot be executed.

(Note 3) In the case of data set method, it cannot be executed.

- (Note 4) In accordance with situations, "Limit stops or Error occurs." (Example) When the limit input is enabled during deceleration after near home detection, the over limit stop is performed without reverse operation.

5.4 Positioning Control

5.4 Positioning Control

5.4.1 Types of Positioning Control

■ Operation pattern

Name	Time chart	Operation and application	Repeat	Interpolation
E-point control		<ul style="list-style-type: none"> This is a method of control which is initiated up to an end point, and is referred to as "E-point control". This method is used for a first speed acceleration/deceleration. 	•	•
P-point control		<ul style="list-style-type: none"> This refers to control which passes through a "Pass Point", and is called "P-point control". This method is used for a second speed acceleration/deceleration. After the pulse output is performed for a specified movement amount, it shifts to the E-point control. 	•	•
C-point control		<ul style="list-style-type: none"> This refers to control which passes through a "Continuance Point", and is called "C-point control". This method is used for performing two successive first speed positioning control with different target speeds or acceleration/deceleration times. The time taken for transmitting from the C-point control to E-point control is specified as a dwell time. 	•	•
J-point control	<p>No speed change</p>	<ul style="list-style-type: none"> This refers to control which passes through a speed point "JOG Operation Point", and is called "J-point control". After the start, it is controlled at specified speeds. Once the J-point positioning contact turns on, the positioning control starts. When the J-point control speed change flag is set, the speed changes. 	—	—
	<p>Speed changes</p>			

■ Selection of positioning operation modes

Positioning operation modes are selected on Configurator PMX.

- For the E-point control, enter settings in one row.
- For P-point, C-point and J-point controls, they should be combined with E-point control of the next step as a pair and the setting should be input in two rows.

Table number	Operation p...	Control method	X axis (CH)	Accelerati...	Acceleration...	Deceleration...	Target...	Dwell time (ms)
1	E: End point	I: Increment	0	L: Linear	100	100	1000	0
2	E: End point	I: Increment	0	L: Linear	100	100	1000	0
3	E: End point	I: Increment	0	L: Linear	100	100	1000	0
4	E: End point	I: Increment	0	L: Linear	100	100	1000	0
5	E: End point	I: Increment	0	L: Linear	100	100	1000	0

i Info.

- When E: End point is not selected in the next row of P: Pass point, C: Continuance point or J: Speed point, the self-diagnostic error (error code 44: positioning error) is detected.

■ Settings of J-point control

- For J-point control, only "Increment" can be selected as a control method.
- For changing speed during J-point control, set the target speed after the change in the positioning parameter dialog box.

5.4.2 E-point Control (Single-Speed Positioning)

- The parameters for position control operations are specified in the positioning parameter setting menus and data tables of Configurator PMX.
- When the positioning table start instruction (F380 POSST) or positioning simultaneous start instruction (F383 MPOST) is executed, the pulse output will start and the positioning control operation will be performed.

■ Operation diagram

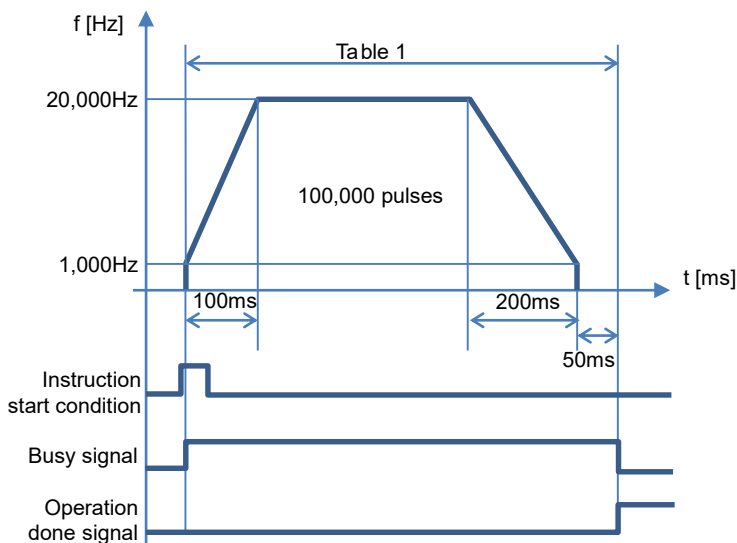

5.4 Positioning Control

■ Operations of each contact

- The BUSY flags (X28 to X2D), which indicate that the motor is running, will turn ON when the positioning control starts, and it will turn OFF when the operation completes.
- The operation done flags (X30 to X35), which indicate the completion of operation, will turn ON when the current operation is completed, and they will be held until the next positioning control, JOG operation or home return operation starts.

■ Settings

Item		Setting example
Axis setting area	Startup speed	1,000 Hz
Table area	Table number	Table 1
	Control method	Increment mode
	Operation pattern	E-point control (End point control)
	Positioning acceleration time	100 ms
	Positioning deceleration time	200 ms
	Positioning target speed	20,000 Hz
	Positioning movement amount	100,000 pulse
	Dwell time	50 ms

■ Configurator PMX settings

Table number	Operation p...	Control method	X axis (CH0)_	Accelerati...	Acceleration ...	Deceleration time (ms)	Target speed	Dwell time (ms)
1	E: End point	I: Increment	100000	L: Linear	100	200	20000	50

■ Sample program

The execution condition is differential execution. For details of instructions, refer to "7 Instruction References".

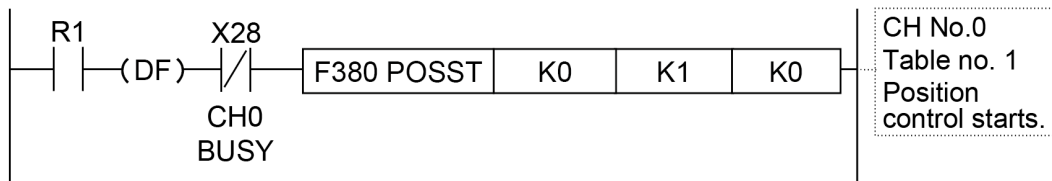

5.4.3 P-point Control (Double-Speed Positioning)

- The parameters for position control operations are specified in the positioning parameter setting menus and data tables of Configurator PMX.

- When the positioning table start instruction (F380 POSST) or positioning simultaneous start instruction (F383 MPOST) is executed, the pulse output will start and the positioning control operation will be performed.

■ Operation diagram

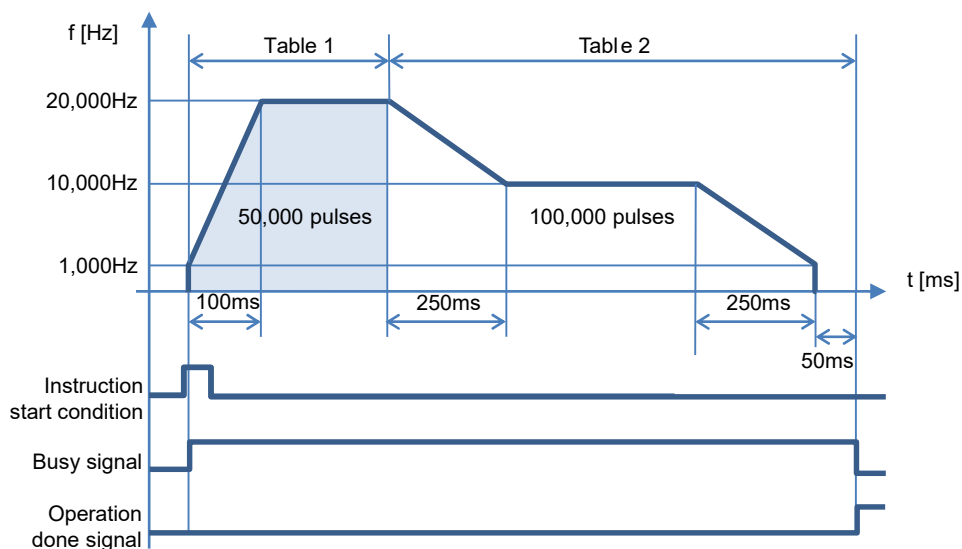

■ Operations of each contact

- The BUSY flags (X28 to X2D), which indicate that the motor is running, will turn ON when the positioning control starts, and it will turn OFF when the operation completes.
- The operation done flags (X30 to X35), which indicate the completion of operation, will turn ON when the current operation is completed, and they will be held until the next positioning control, JOG operation or home return operation starts.

■ Settings

Item		Setting example	
Axis setting area	Startup speed	1,000 Hz	
Table area	Table number	Table 1	Table 2
	Control method	Increment mode	Increment mode
	Operation pattern	P-point control (Pass point control)	E-point control (End point control)
	Positioning acceleration time	100 ms	150 ms
	Positioning deceleration time	200 ms	250 ms
	Positioning target speed	20,000 Hz	10,000 Hz
	Positioning movement amount	50,000 pulse	100,000 pulse
	Dwell time	-	50 ms

5.4 Positioning Control

■ Configurator PMX settings

Table number	Operation p...	Control method	X axis (CH0) ...	Acceler...	Acceleration time...	Deceleration time ...	Target speed	Dwell time (ms)
1	P: Pass point	I Increment	50000	L: Linear	100	200	20000	0
2	E: End point	I Increment	100000	L: Linear	150	250	10000	50

■ Sample program

The execution condition is differential execution. For details of instructions, refer to "7 Instruction References".

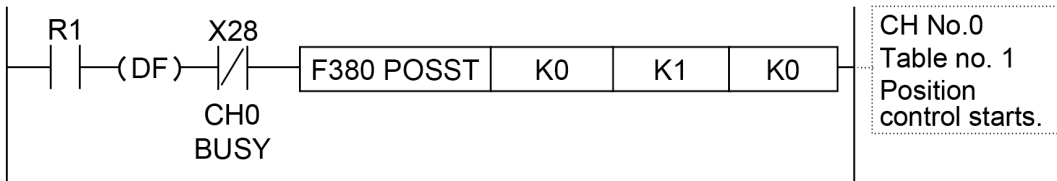

5.4.4 C-point Control

- The parameters for position control operations are specified in the positioning parameter setting menus and data tables of Configurator PMX.
- When the positioning table start instruction (F380 POSST) or positioning simultaneous start instruction (F383 MPOST) is executed, the pulse output will start and the positioning control operation will be performed.

■ Operation diagram

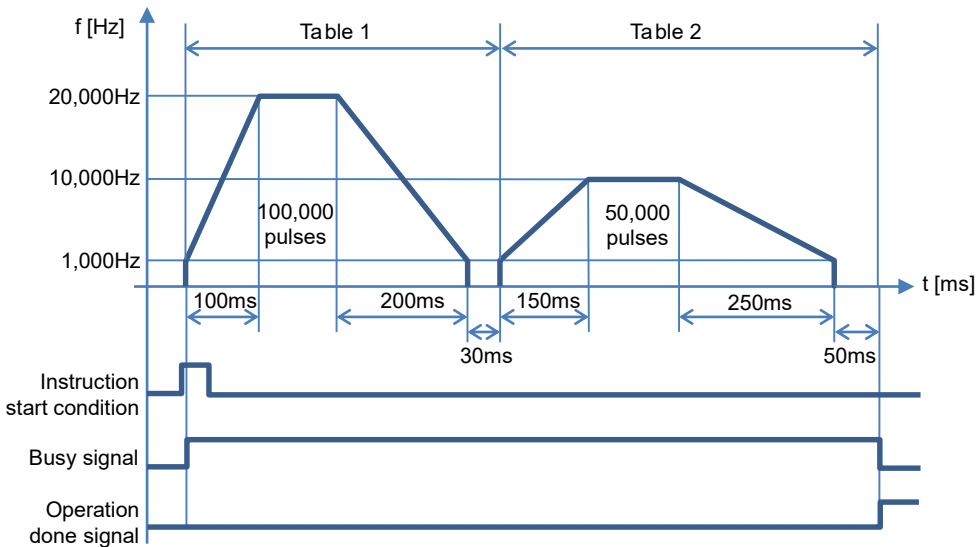

■ Operations of each contact

- The BUSY flags (X28 to X2D), which indicate that the motor is running, will turn ON when the positioning control starts, and it will turn OFF when the operation completes.
- The operation done flags (X30 to X35), which indicate the completion of operation, will turn ON when the current operation is completed, and they will be held until the next positioning control, JOG operation or home return operation starts.

■ Settings

Item		Setting example	
Axis setting area	Startup speed	1,000 Hz	
Table area	Table number	Table 1	Table 2
	Control method	Increment mode	Increment mode
	Operation pattern	C-point control (Continuance point control)	E-point control (End point control)
	Positioning acceleration time	100 ms	150 ms
	Positioning deceleration time	200 ms	250 ms
	Positioning target speed	20,000 Hz	10,000 Hz
	Positioning movement amount	100,000 pulse	50,000 pulse
	Dwell time	30 ms	50 ms

■ Configurator PMX settings

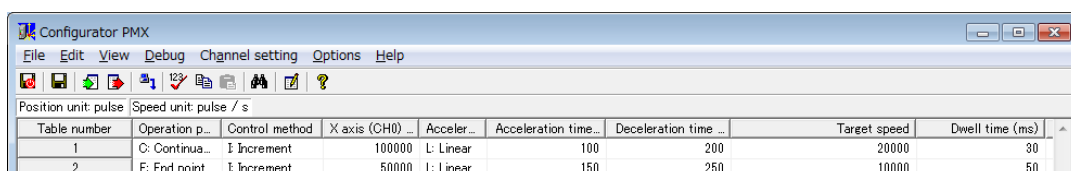
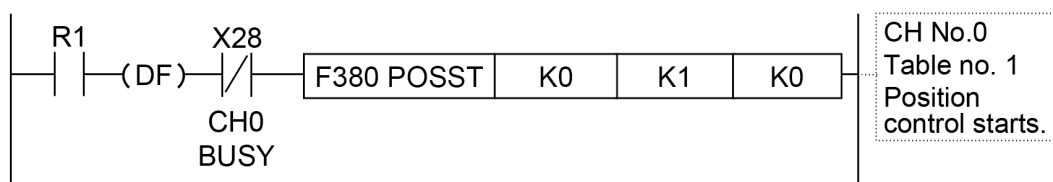

Table number	Operation p...	Control method	X axis (CH0) ...	Acceler...	Acceleration time...	Deceleration time ...	Target speed	Dwell time (ms)
1	C: Continua...	I: Increment	100000	L: Linear	100	200	20000	30
2	E: End point	I: Increment	50000	L: Linear	150	250	10000	50

■ Sample program

The execution condition is differential execution. For details of instructions, refer to "[7 Instruction References](#)".



5.4 Positioning Control

5.4.5 J-point Control (JOG Positioning)

- The parameters for position control operations are specified in the positioning parameter setting menus and data tables of Configurator PMX.
- When the positioning table start instruction (F380 POSST) or positioning simultaneous start instruction (F383 MPOST) is executed, the pulse output will start. In the J-point control, the unit operates at a target speed after the startup, and will start the position control when the J-point positioning start contacts (X0 and X1) turn ON.

i Info.

- In the system register no. 400, select "J-point positioning start input of pulse output CH*" of the channel to perform the J-point control.

■ Operation diagram

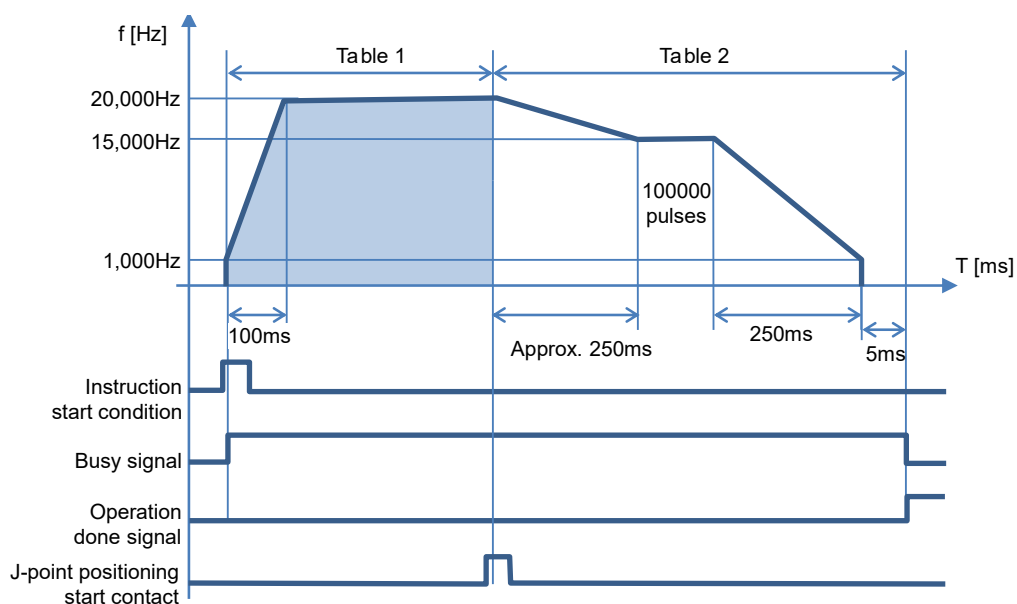

■ Operations of each contact

- The BUSY flags (X28 and X29) will turn ON when the operation starts and turn OFF when the operation is completed.
- The operation done flags (X30 and X31), which indicate the completion of operation, will turn ON when the current operation is completed, and they will be held until the next positioning control, JOG operation or home return operation starts.
- Positioning control will start when J-point positioning start contacts (X0 and X1) turn ON.

■ Settings

Item		Setting example	
Axis setting area	Startup speed	1,000 Hz	
	J-point change speed	10,000 Hz	
Table area	Table number	Table 1	Table 2

Item		Setting example	
	Control method	Increment mode	Increment mode
	Operation pattern	J-point control (Speed control)	E-point control (End point control)
	Positioning acceleration time	100 ms	150 ms
	Positioning deceleration time	200 ms	250 ms
	Positioning target speed	20,000 Hz	15,000 Hz
	Positioning movement amount	-	100,000 pulse
	Dwell time	30 ms	5 ms

■ Configurator PMX settings

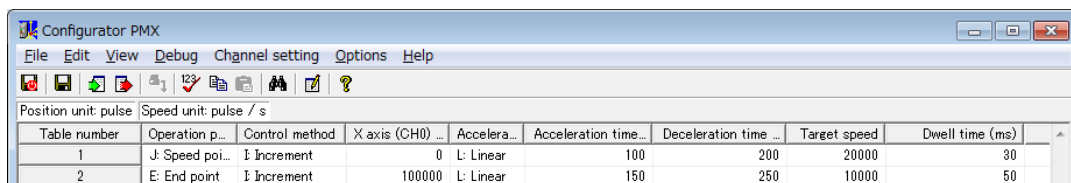
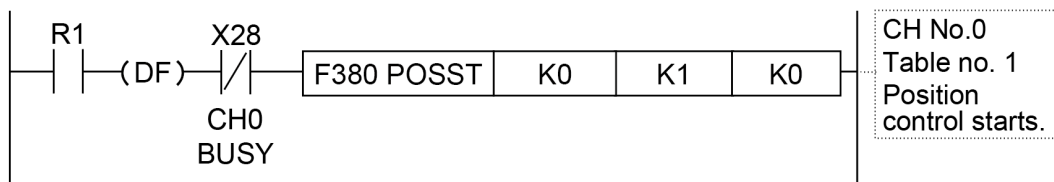

Table number	Operation p...	Control method	X axis (CH0) ...	Accelera...	Acceleration time...	Deceleration time ...	Target speed	Dwell time (ms)
1	J: Speed poi...	I: Increment	0	L: Linear	100	200	20000	30
2	E: End point	I: Increment	100000	L: Linear	150	250	10000	50

■ Sample program

The execution condition is differential execution. For details of instructions, refer to "7 Instruction References".



5.4.6 J-point Control (JOG Positioning: Speed Changes)

- In the J-point control, the speed can be changed while controlling the speed after the start.
- After starting the J-point control, the unit operates at the speed specified in the positioning parameters of Configurator PMX.
- The speed changes when the J-point control speed change contacts (Y60 and Y61) turn ON.

i Info.

- In the system register no. 400, select "J-point positioning start input of pulse output CH*" of the channel to perform the J-point control.

5.4 Positioning Control

■ Operation diagram

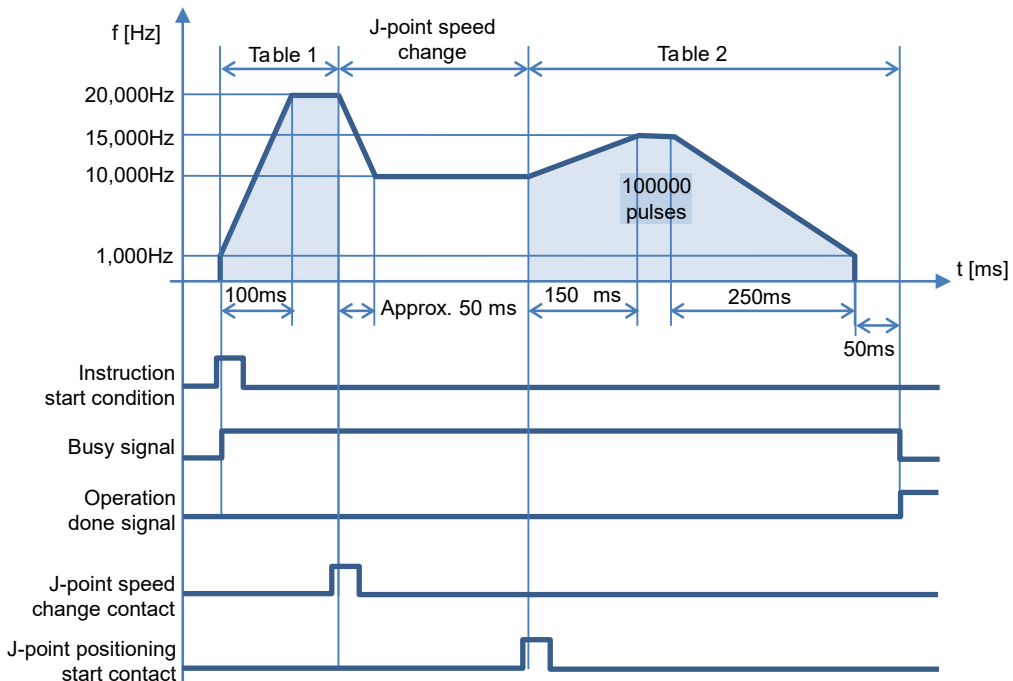

■ Operations of each contact

- The BUSY flags (X28 and X29) will turn ON when the operation starts and turn OFF when the operation is completed.
- The operation done flags (X30 and X31), which indicate the completion of operation, will turn ON when the current operation is completed, and they will be held until the next positioning control, JOG operation or home return operation starts.
- The target speed will be changed when the J-point speed change contacts (Y60 and Y61) turn ON. The change will be enabled at the edge where the contact turns ON.
- Positioning control will start when J-point positioning start contacts (X0 and X1) turn ON.

■ Characteristics of acceleration / deceleration zone when changing speeds

- The speed of speed change zone changes for each scan when changing the speed in the J-point control. The speed variation is obtained by the following formula.

$$\frac{(\text{J-point table target speed} - \text{Startup speed})}{(\text{J-point table acceleration time or J-point table deceleration time})}$$

■ Settings

Item		Setting example	
Axis setting area	Startup speed	1,000 Hz	
	J-point change speed	10,000 Hz	
Table area	Table number	Table 1	Table 2
	Control method	Increment mode	Increment mode

Item		Setting example	
	Operation pattern	J-point control (Speed control)	E-point control (End point control)
	Positioning acceleration time	100 ms	150 ms
	Positioning deceleration time	200 ms	250 ms
	Positioning target speed	20,000 Hz	15,000 Hz
	Positioning movement amount	-	100,000 pulse
	Dwell time	30 ms	50 ms

(Note 1) For the J-point control, the set acceleration time and deceleration time is converted as a time between 0 Hz to 100 kHz, and the speed tables in the acceleration and deceleration sections are calculated. Therefore, when the target speed is below 100 kHz, the actual acceleration / deceleration time is shorter than the set values.

■ Configurator PMX settings

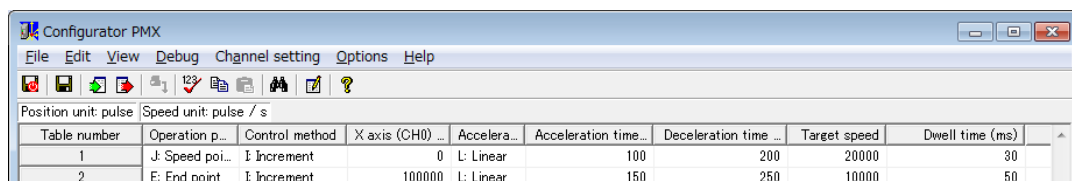
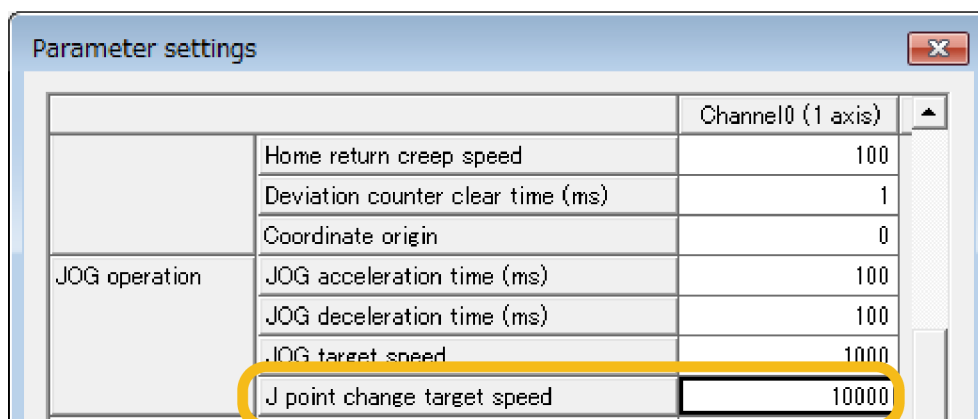

Table number	Operation p...	Control method	X axis (CH0) ...	Accelera...	Acceleration time...	Deceleration time ...	Target speed	Dwell time (ms)
1	J: Speed poi...	I: Increment	0	L: Linear	100	200	20000	30
2	E: End point	I: Increment	100000	L: Linear	150	250	10000	50



Parameter settings		Channel0 (1 axis)
	Home return creep speed	100
	Deviation counter clear time (ms)	1
	Coordinate origin	0
JOG operation	JOG acceleration time (ms)	100
	JOG deceleration time (ms)	100
	JOG target speed	10000
	J point change target speed	10000

■ Sample program

The execution condition is differential execution. For details of instructions, refer to "7 Instruction References".

5.4 Positioning Control

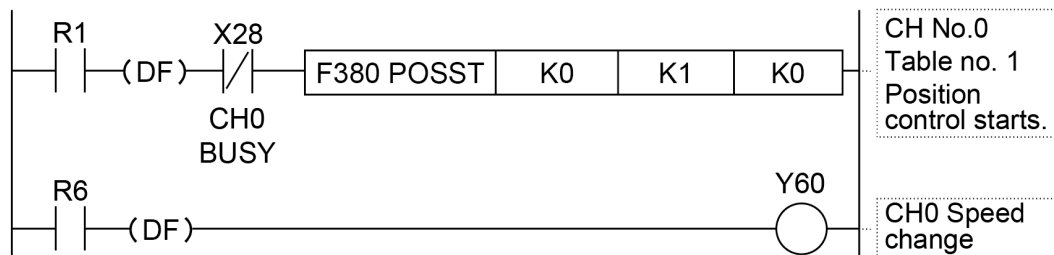

Behaviors when the speed change contact turns ON during acceleration or deceleration

- A speed change is possible during J-point control, but impossible during acceleration or deceleration.
- A speed change will be made after the unit goes to constant speed when the speed change signal turns ON during acceleration or deceleration.

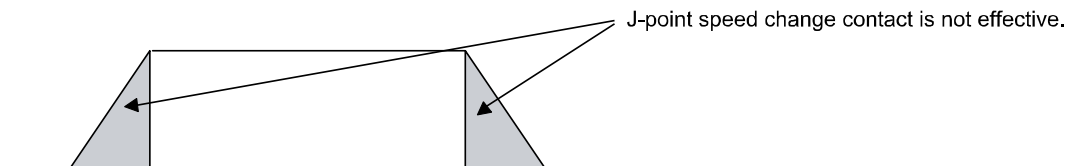

Info.

- Specify parameters for the start of operation in the positioning data table. The parameters for changing speeds are specified in “Channel setting” > “Parameter settings” menu.
- J-point control can be used for single-axis control only. It is not available for interpolation control.
- Set the unit to increment mode to implement E-point control with positions specified after J-point control is implemented.
- Speed control is performed while the positioning unit is in J-point control, in which case, be sure to input the amount of movement for positioning with a value that can secure a target constant-speed area.

5.4.7 Programming Cautions

Programming cautions

- The last table should be set to E: End point.
- If any value such as a movement amount, acceleration time, deceleration time or target speed is out of the specified range, a positioning error will occur when the position control starts.
- The startup contact and flag numbers vary depending on channel numbers (axis numbers).

Operation at limit input

Conditions	Direction	Limit status	Operation
When each control starts	Forward	Over limit input (+): ON	Not executable, Error occurs.

Conditions	Direction	Limit status	Operation
	Reverse	Over limit input (-): ON	Not executable, Error occurs.
		Over limit input (+): ON	Not executable, Error occurs.
		Over limit input (-): ON	Not executable, Error occurs.
When each control is performed	Forward	Over limit input (+): ON	Limit stops, Error occurs.
		Over limit input (-): ON	Limit stops, Error occurs.
	Reverse	Over limit input (+): ON	Limit stops, Error occurs.
		Over limit input (-): ON	Limit stops, Error occurs.

5.5 Repeat Operation

5.5 Repeat Operation

5.5.1 Overview of Repeat Operation

- The repeat count is specified for executing the repeat control in Configurator PMX.
- When the position control start instruction F380 is executed, the unit repeats the operation set in the positioning table.

■ Conditions of repeat control

Item	Repeat control is available	Repeat control is unavailable
Operation pattern	E-point control, P-point control + E-point control C-point control + E-point control	JOG operation, J-point control, Interpolation control
Control method	Increment mode	Absolute mode
Dwell time setting	Set the table of E-point control to 1 ms or more.	When setting 0 ms.

■ Operation diagram (Setting operation on the table)

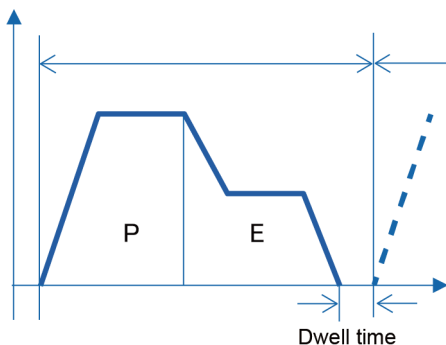

■ Operation diagram (Repeat operation)

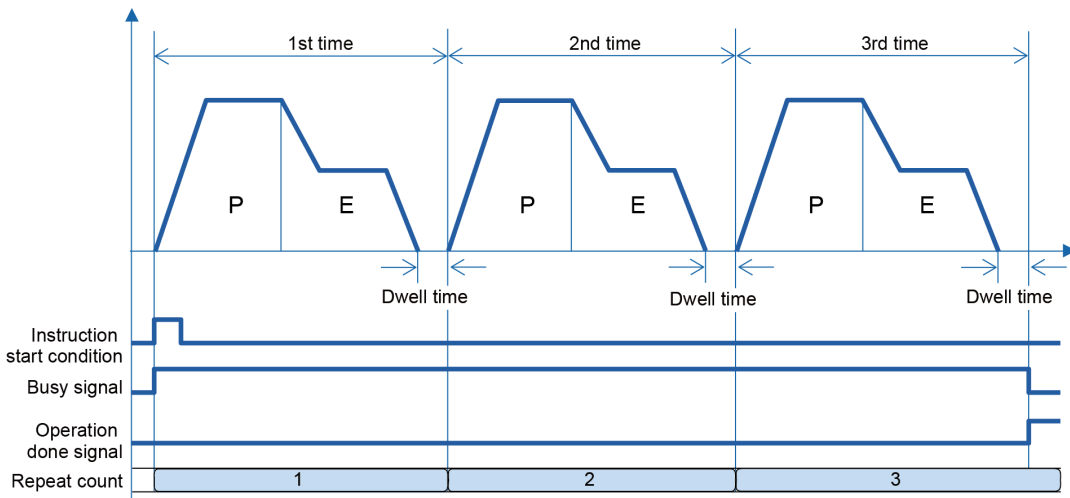

■ Configurator PMX setting items

Parameter name	Unit	Default	Settings	
Positioning repeat count	times	0	0 or 1	Not repeat an operation.
			2 to 254	Repeat an operation for a specified number of times.
			255	Repeat an operation infinitely.

■ Configurator PMX settings

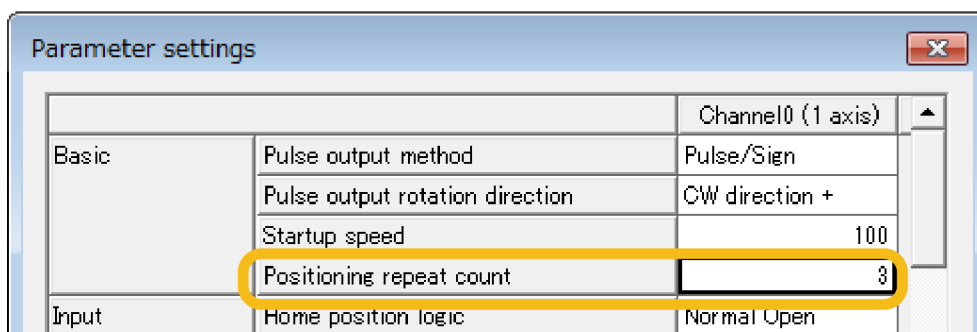

i Info.

- When selecting “255: Repeat infinitely” in the parameter of positioning repeat count, create a program to stop the operation using the deceleration stop function.

5.5.2 Settings and Operations of Repeat Operation

- The parameter for the repeat count is specified in the positioning parameter setting menus of Configurator PMX.
- When the positioning table start instruction (F380 POSST) or positioning simultaneous start instruction (F383 MPOST) is executed, the pulse output will start.
- After starting the instruction, the unit executes the pulse output for a specified repeat count and then stops the operation. For setting to execute the operation infinitely, use this function in combination with the deceleration stop function.

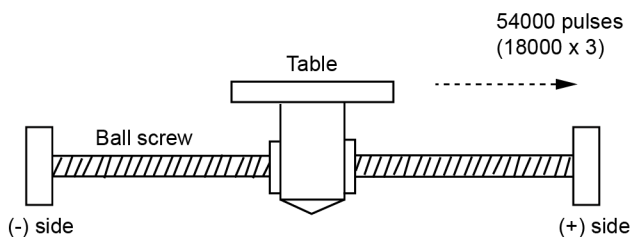

5.5 Repeat Operation

■ Operation diagram

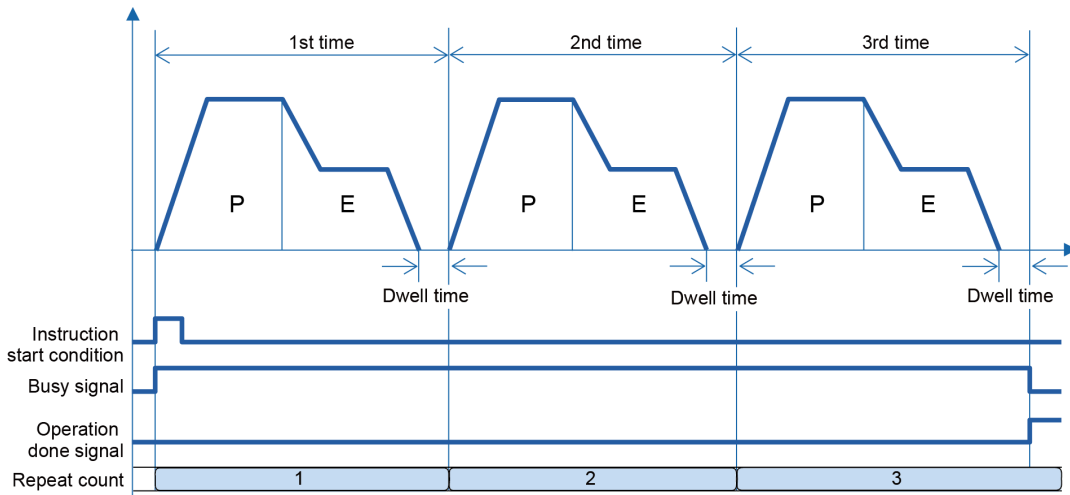

■ Operations of each contact

- The BUSY flags (X28 to X2D), which indicate that the motor is running, will turn ON when the positioning control starts, and they will turn OFF when the set repeat operation completes.
- The operation done flags (X30 to X35), which indicate the completion of operation, will turn ON when the current operation is completed, and they will be held until the next positioning control, JOG operation or home return operation starts. Those flags do not turn OFF in the middle of the repeat operation.

■ Settings

Item		Setting example	
Common area	Axis setting	Turn ON the single axis setting for an appropriate axis.	
	Positioning repeat count	3	
Axis setting area	Pulse output control code	Set in accordance with system configuration.	
	Startup speed	1,000 Hz	
Table area	Table number	Table 1	Table 2
	Control method	Increment mode	Increment mode
	Operation pattern	P-point control (Pass point control)	E-point control (End point control)
	Positioning acceleration time	100 ms	150 ms
	Positioning deceleration time	200 ms	250 ms
	Positioning target speed	20,000 Hz	10,000 Hz
	Positioning movement amount	5,000 pulse	10,000 pulse
	Dwell time	-	50 ms

■ Configurator PMX settings

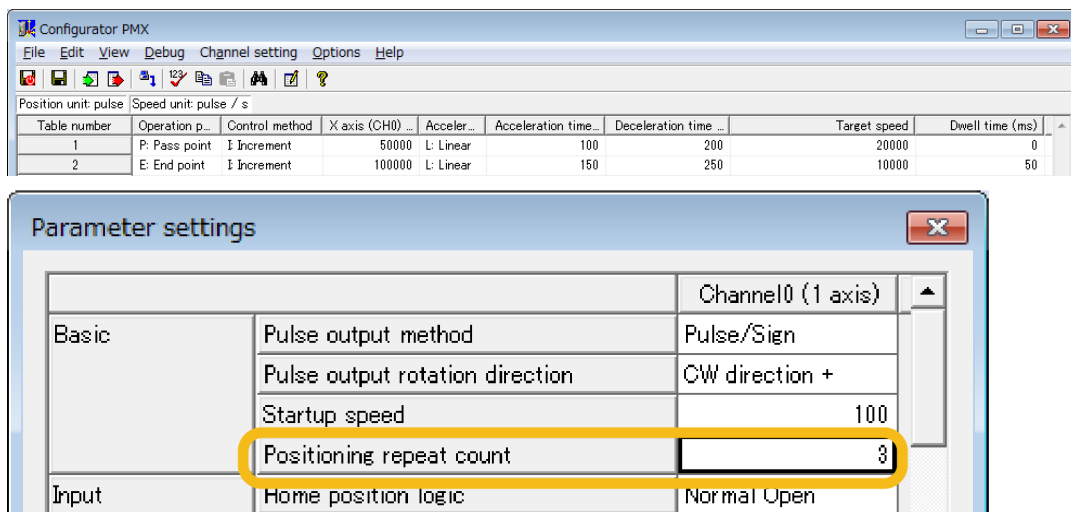

■ Sample program

The execution condition is differential execution. For details of instructions, refer to "7 Instruction References".

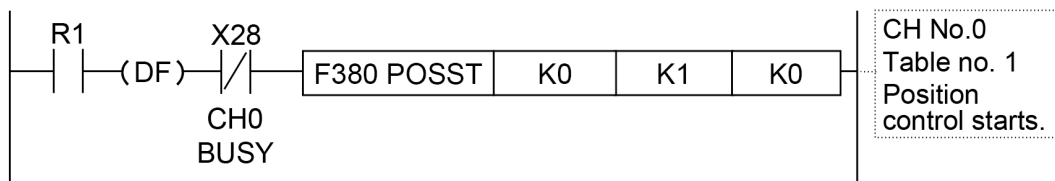

5.5.3 Stop Operation During Repeat Operation

- When setting the repeat function, the operation at the time of deceleration stop varies as follows.

■ Operation at the time of deceleration stop (Repeating E-point control)

When the unit detects a deceleration stop, the unit will come to a stop after repeating positioning control $N+2$ times. However, the unit will stop the control when reaching the set repeat count.

5.5 Repeat Operation

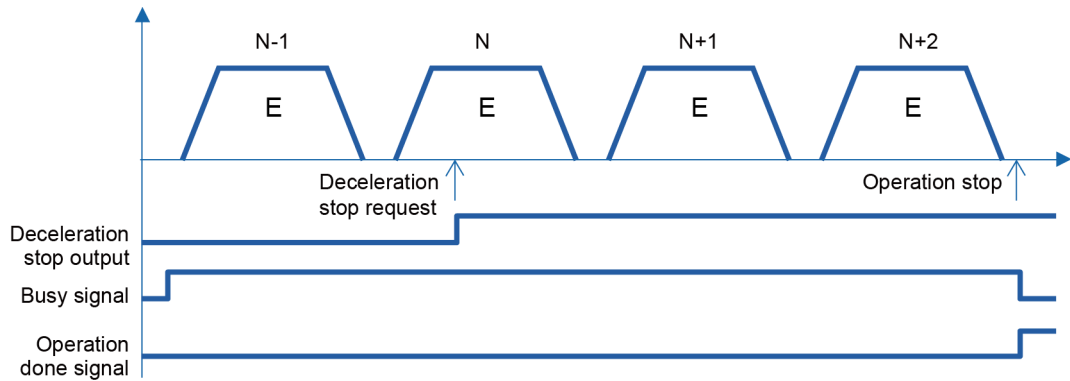

■ Operation at the time of deceleration stop (Repeating P-point control, C-point control)

When the unit detects a deceleration stop, it stops the operation after repeating the positioning control N+1 times. However, the unit will stop the control when reaching the set repeat count.

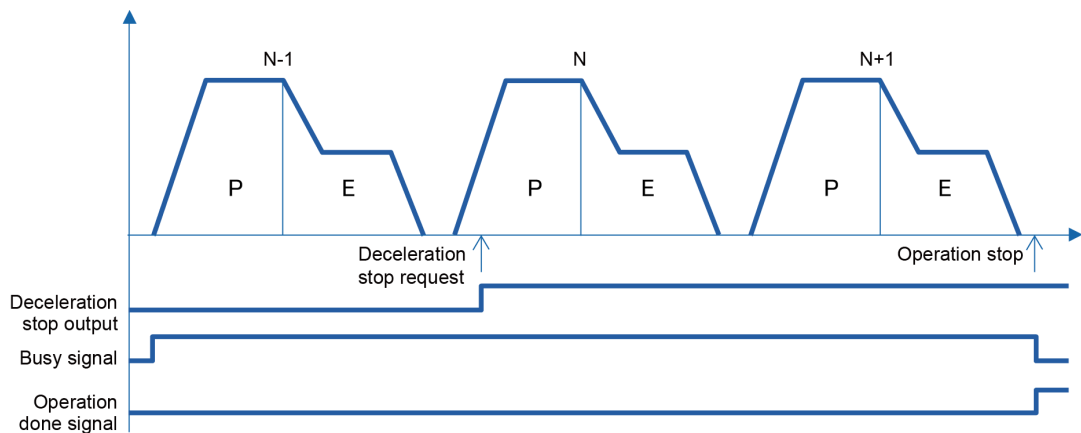

i Info.

- When a system stop is executed, the unit will stop the pulse output immediately without repetitive operations.
- When an emergency stop is executed, the unit will stop the pulse output after a specified emergency stop setting time without repetitive operations.

5.6 Linear Interpolation Control

5.6.1 Overview

The interpolation control is available under the following conditions.

■ Combinations of interpolation control

Model		Interpolation axis 1		Interpolation axis 2		Interpolation axis 3	
		X-axis	Y-axis	X-axis	Y-axis	X-axis	Y-axis
Transistor output type	C14T	CH0	CH1	-		-	
	C30T	CH0	CH1	CH2	CH3	-	
	C60T	CH0	CH1	CH2	CH3	CH4	CH5
Relay output type (When using the pulse I/O cassette)	C14R	-		-		-	
	C30R	CH0	CH1	-		-	
	C60R	CH0	CH1	-		-	

(Note 1) In case of the relay output type Control Unit, two pulse I/O cassettes are required.

■ Conditions of interpolation control

Item	Condition under which interpolation control is executable	
	Available	Not available
Operation pattern	E-point control P-point control + E-point control C-point control + E-point control	JOG operation Home return ^(Note 1) J-point control
Control method	Increment mode, Absolute mode	-
Dwell time setting	Set the E-point control to 1 ms or more.	When set to 0 ms, the positioning error occurs.

(Note 1) In the home return operation, the home return start instruction (F382 ORGST) is executed for each channel corresponding to X and Y axes. The trajectory is not linear interpolation.

■ Setting method of speed

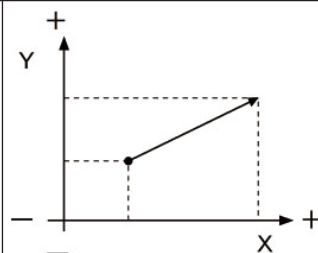
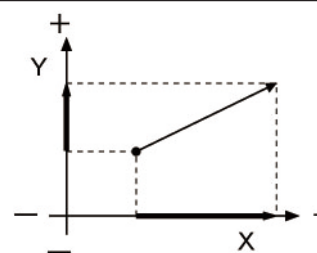
Item	Composite speed	Long axis
Operation		
Setting method	Specify the speed combining the speed of X and Y axes.	Specify the speed for the axis whose movement amount is large.

(Note 1) When specifying the same value, the long axis speed is faster than the composite speed.

5.6 Linear Interpolation Control

5.6.2 Settings and Operations of Linear Interpolation

The example below is a case of E-point control with the unit installed in slot 1. The X axis is set to the 1st axis and the Y axis is set to the 2nd axis. The movement amount setting is the increment method, and the unit is set to pulse.

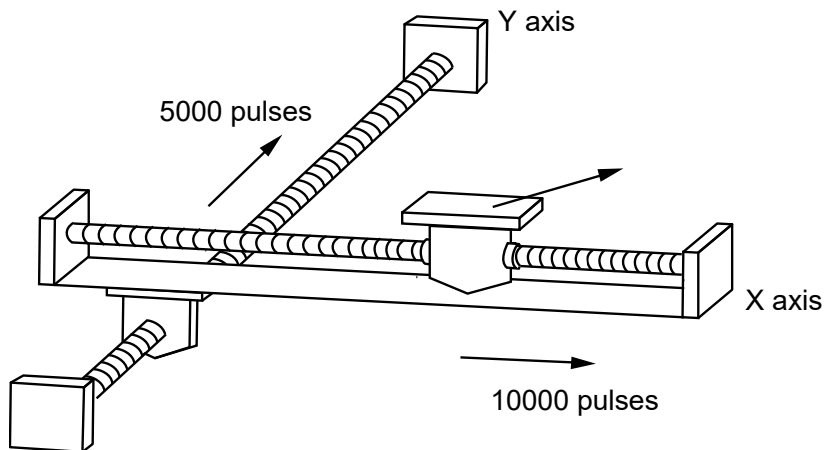

■ Operation diagram

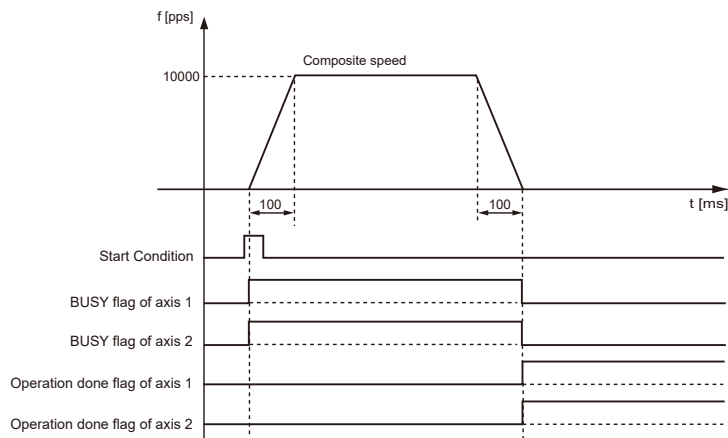

■ Operations of each contact

- The BUSY flags of axes 1 and 2 (X28 and X29), which indicate that the motor is running, will turn ON when the positioning control starts, and it will turn OFF when the operation completes.
- The operation done flags of axes 1 and 2 (X30 and X31), which indicate the completion of operation, will turn ON when the current operation is completed, and it will be held until the next positioning control, JOG operation or home return operation starts.

■ Settings

Item		Setting example
Common area	Axis setting	Turn ON the single axis setting for an appropriate axis.

Item		Setting example
	Positioning repeat count	0
Axis setting area	Pulse output control code	Set in accordance with system configuration.
	Startup speed	1,000 Hz
Table area	Operation pattern	E: End point
	Interpolation operation	0: Linear (composite speed)
	Control method	I: Incremental
	X-axis movement amount	10,000 pulse
	Y-axis movement amount	5,000 pulse
	Acceleration / deceleration method	L: Linear
	Acceleration time (ms)	100 ms
	Deceleration time (ms)	100 ms
	Interpolation speed	10000 pps
	Dwell time	0 ms

■ Sample program

The execution condition is differential execution. For details of instructions, refer to "7 Instruction References".

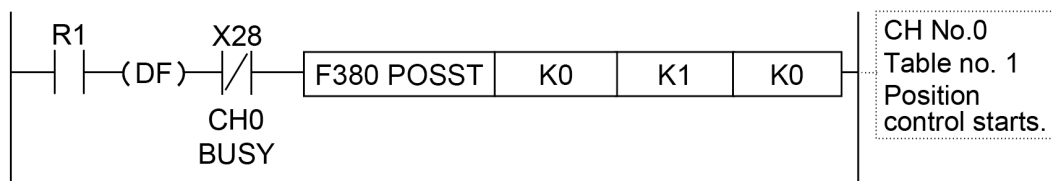

■ Notes on programming

- Specify a smaller channel number in the same group for starting the interpolation control.
- If any value such as a movement amount, acceleration time, deceleration time or target speed is out of the specified range, a positioning error will occur when the position control starts.
- The startup contact and flag numbers vary depending on channel numbers (axis numbers).

(MEMO)

6 Operating Characteristics

6.1 Operational Difference Between Parameters	6-2
6.1.1 Startup speed.....	6-2
6.1.2 When Target Speed/Startup Speed is Less Than 50Hz	6-2
6.1.3 Operation Patterns and Start Speed Settings.....	6-3
6.2 Other Characteristics	6-5
6.2.1 Backup of Positioning Memory	6-5
6.2.2 Activation of Each Operation	6-5
6.2.3 Operation When PLC Mode Changes From RUN To PROG.....	6-5

6.1 Operational Difference Between Parameters

6.1 Operational Difference Between Parameters

6.1.1 Startup speed

- The startup speed is the parameter for setting the initial speed when starting each operation and the speed when finishing each operation.
- The startup speed is common to each control of the JOG operation, home return, E-point control, P-point control, C-point control and J-point control operations. It is set for each channel number (axis number).

■ Setting method of startup speed

It is set in the “Parameter settings” dialog box of Configurator PMX.

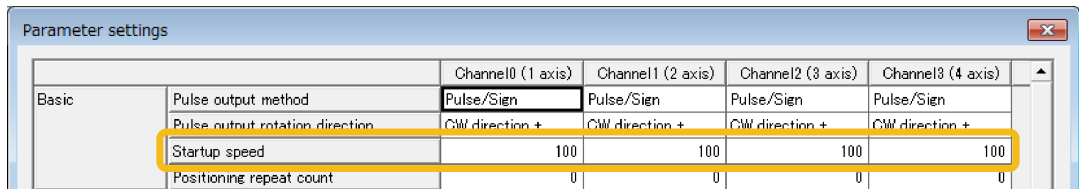

■ Precautions when setting the startup speed

- The home return creep speed setting is not influenced by the startup speed in the home return operation.
- The target speed of each operation is not influenced by the startup speed. Each operation is performed at each specified target speed regardless of the setting of startup speed.

6.1.2 When Target Speed/Startup Speed is Less Than 50Hz

■ Operation

Operation pattern	Speed setting	Operation
E-point control	When target speed is less than 50 Hz	Operation is performed with the set target speed. The startup speed setting is invalid and the acceleration/ deceleration operation is not performed.
	When startup speed is less than 50 Hz	When the target speed is set to 50 Hz or more, the startup speed is corrected to 50 Hz and the table operation is performed.
P-point control C-point control	When target speed is less than 50 Hz	The target speed is corrected to 50 Hz and the table operation is performed.
J-point control JOG operation	When startup speed is less than 50 Hz	The startup speed is corrected to 50 Hz and the table operation is performed.

6.1.3 Operation Patterns and Start Speed Settings

Operation pattern	Startup speed setting		
JOG operation		(1)	Startup speed
		(2)	Target speed
Home return		(1)	Startup speed
		(2)	Target speed
		(3)	Creep speed
E-point control		(1)	Startup speed
		(2)	Target speed
P-point control		(1)	Startup speed
		(2)	P-point target speed
		(3)	E-point target speed
C-point control		(1)	Startup speed
		(2)	C-point target speed
		(3)	E-point target speed

6.1 Operational Difference Between Parameters

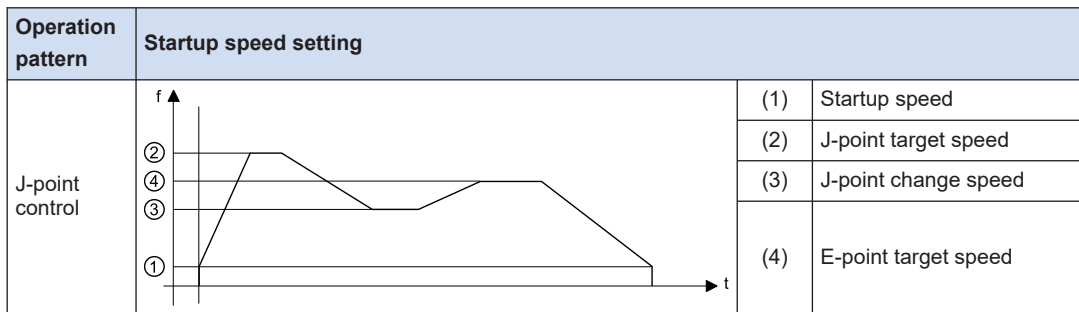

6.2 Other Characteristics

6.2.1 Backup of Positioning Memory

- The positioning parameters and positioning table data set in the unit will be also held in the memories of the control unit when the control unit is powered off. They will be also held when the mode is switched from RUN to PROG.
- The elapsed value area (current value of position data) in the axis information area will be reset to zero when the unit is powered off. However, when the RUN mode is switched to PROG. mode, the latest value will be held.

6.2.2 Activation of Each Operation

- When any of the JOG operation, home return and position control is activated, it does not transit to other operation even if an instruction to activate the other instruction turns ON. Create a program in the user program to confirm the busy signals (X28 to X2D) allocated to each axis and to start instructions.
- Stop operations (system stop, emergency stop, limit stop, deceleration stop) have priority even during other operations. Each operation is executed by turning on the stop signal allocated to each axis.

6.2.3 Operation When PLC Mode Changes From RUN To PROG.

- When the mode of CPU Unit changes from RUN to PROG. after starting the JOG operation, home return or position control (E-point control, P-point control, C-point control, J-point control), each operation stops.
- As well as the execution of the system stop, the unit stops the pulse output immediately.

(MEMO)

7 Instruction References

7.1 Table Setting Mode Control Instruction	7-2
7.1.1 [F380 POSST] Positioning Table Start Instruction	7-2
7.1.2 [F381 JOGST] JOG Operation Start Instruction	7-3
7.1.3 [F382 ORGST] Home Return Start Instruction	7-4
7.1.4 [F383 MPOST] Positioning Table Simultaneous Start Instruction	7-5
7.1.5 [F384 PTBLR] Positioning Parameter Read Instruction.....	7-7
7.1.6 [F385 PTBLW] Positioning Parameter Write Instruction	7-8
7.2 FP-X Compatible Instruction Mode Control Instruction.....	7-10
7.2.1 [F171 (SPDH)] Pulse Output (Trapezoidal Control)	7-10
7.2.2 [F171 (SPDH)] Pulse Output (Home Return).....	7-15
7.2.3 [F172 (PLSH)] Pulse Output (JOG operation)	7-19
7.2.4 [F174 (SP0H)] Pulse Output (Selectable Data Table Control Operation)	7-22
7.2.5 [F175 (SPSH)] Pulse Output (Linear Interpolation).....	7-26

7.1 Table Setting Mode Control Instruction

7.1 Table Setting Mode Control Instruction

7.1.1 [F380 POSST] Positioning Table Start Instruction

Starts the positioning operation according to the data specified in the positioning memory (positioning table area). This instruction is used to start the E-point control, P-point control, C-point control, J-point control or linear interpolation control.

■ Instruction format

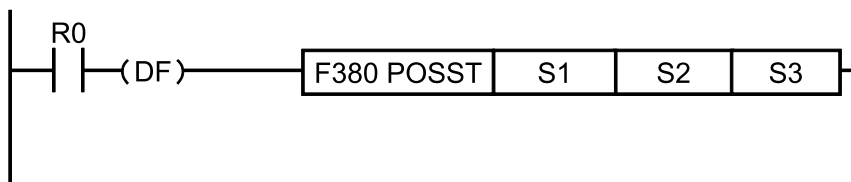

■ Operand

Operand	Settings	Setting range
S1	Channel number to start the positioning operation (Unsigned 16-bit integer)	0 to 5
S2	Table number to start (Unsigned 16-bit integer)	1 to 20
S3	Output assignment	0 (Pulse output), 1 (Calculation only)

■ Memory area type that can be specified

Operand	WX	WY	WR	WL	SV	EV	DT	LD	I	Constant		Index modifier
										K	H	
S1	•	•	•	•	•	•	•	•	•	•	•	•
S2	•	•	•	•	•	•	•	•	•	•	•	•
S3	•	•	•	•	•	•	•	•	•	•	•	•

■ Outline of operation

- Starts the positioning operation according to the data specified in the positioning memory (positioning table area).
- When Calculation only is specified for [S3], only the table calculation is executed. When starting the positioning operation for the same channel and the same table from the next scan after executing the calculation, the startup time of the positioning control is reduced.

■ Precautions during programming

- If an operand is an out-of-range value, an operation error occurs.
- The stop operation has priority when the conditions of system stop, emergency stop, limit stop and deceleration stop are satisfied.
- An operation error occurs when the system register of a specified channel is other than "Pulse output [Table setting mode]".

7.1 Table Setting Mode Control Instruction

- A self-diagnostic error (positioning operation error) occurs when the set value or the value of the positioning memory (axis setting area) is abnormal.
- When the channel to be started has been already operating, the positioning control does not start and it terminates.

■ Flag operations

Name	Description
R9007 R9008 (ER)	When the area is exceeded at the time of index modification
	When the [S1] value is outside the set range
	When the [S2] value is outside the set range
	When the pulse output (table operation) has not been set in the system register

7.1.2 [F381 JOGST] JOG Operation Start Instruction

Starts the JOG operation according to the parameters specified in the positioning memory (axis setting area).

■ Instruction format

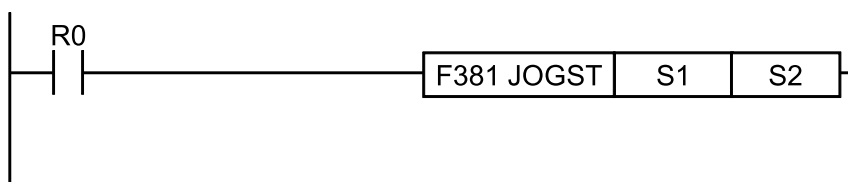

■ Operand

Operand	Settings	Setting range
S1	Channel number to start the JOG operation (Unsigned 16-bit integer)	0 to 5
S2	Operating direction (Unsigned 16-bit integer)	0 (Forward), 1 (Reverse)

■ Memory area type that can be specified

Operand	WX	WY	WR	WL	SV	EV	DT	LD	I	Constant		Index modifier
										K	H	
S1	•	•	•	•	•	•	•	•	•	•	•	•
S2	•	•	•	•	•	•	•	•	•	•	•	•

■ Outline of operation

- Executes the JOG operation according to the JOG operation parameters specified in the positioning memory (axis setting area). While the execution condition is valid, the JOG operation continues.

7.1 Table Setting Mode Control Instruction

- The target speed can be changed by rewriting the positioning parameter area with a user program. The change is executed after it becomes a constant speed.

■ Precautions during programming

- If an operand is an out-of-range value, an operation error occurs.
- The stop operation has priority when the conditions of system stop, emergency stop, limit stop and deceleration stop are satisfied.
- An operation error occurs when the system register of a specified channel is other than “Pulse output [Table setting mode]”.
- A self-diagnostic error (positioning operation error) occurs when the set value or the value of the positioning memory (axis setting area) is abnormal.
- The JOG operation needs to be stopped for switching between the forward rotation and reverse rotation.
- In case of changing a speed, when the target speed after the change is an out-of-range value, the speed change is not executed and the operation continues.

■ Flag operations

Name	Description
R9007 R9008 (ER)	When the area is exceeded at the time of index modification
	When the [S1] value is outside the set range
	When the [S2] value is outside the set range
	When the pulse output (table operation) has not been set in the system register

7.1.3 [F382 ORGST] Home Return Start Instruction

Starts the home return operation according to the parameters specified in the positioning memory (axis setting area).

■ Instruction format

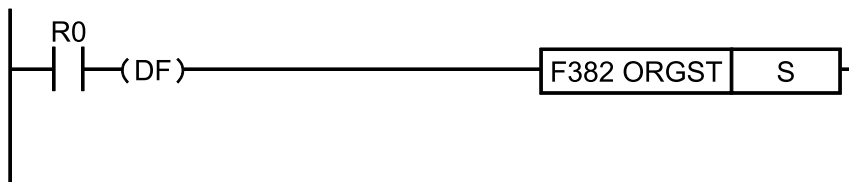

■ Operand

Operand	Settings	Setting range
S	Channel number to start the home return (Unsigned 16-bit integer)	0 to 5

■ Memory area type that can be specified

Operand	WX	WY	WR	WL	SV	EV	DT	LD	I	Constant		Index modifier
										K	H	
S	•	•	•	•	•	•	•	•	•	•	•	•

■ Outline of operation

- Starts the home return operation according to the home return parameters specified in the positioning memory (axis setting area).

■ Precautions during programming

- If an operand is an out-of-range value, an operation error occurs.
- The stop operation has priority when the conditions of system stop, emergency stop, limit stop and deceleration stop are satisfied.
- An operation error occurs when the system register of a specified channel is other than "Pulse output [Table setting mode]".
- An operation error occurs when the home return pattern is set to either "DOG method 1", "DOG method 3", or "Home position method" unless the home input is set in the system register.
- The home return operation is started when the home return pattern is set to either "DOG method 2" or "Data set method" even if the home input is not set.
- A self-diagnostic error (positioning operation error) occurs when the set value or the value of the positioning memory (axis setting area) is abnormal.

■ Flag operations

Name	Description
R9007	When the area is exceeded at the time of index modification
R9008	When the [S] value is outside the set range
(ER)	When the pulse output (table operation) has not been set in the system register

7.1.4 [F383 MPOST] Positioning Table Simultaneous Start Instruction

Starts the positioning tables for multiple axes specified on Configurator PMX. The tables of the E-point control, P-point control and C-point control can be started.

■ Instruction format

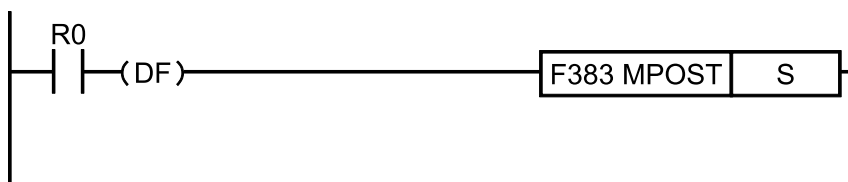

7.1 Table Setting Mode Control Instruction

■ Operand

Operand	Settings
S	The starting area of the data register storing the data table numbers (unsigned 16-bit integer) to be started simultaneously

■ Memory area type that can be specified

Operand	WX	WY	WR	WL	SV	EV	DT	LD	I	Constant		Index modifier
										K	H	
S	-	-	-	-	-	-	•	-	-	-	-	•

■ Outline of operation

- Starts the positioning table numbers of the channels specified in the area starting with [S] simultaneously.
- Positioning tables that can be specified are those for the single-axis control only.
- Table numbers are specified in the range of 0 to 20. In the case of 0, the table is not executed simultaneously with other tables.

S	Output specification (0: Pulse output, 1: Calculation only)
S+1	CH0 Positioning table number (0 to 20)
S+2	CH1 Positioning table number (0 to 20)
S+3	CH2 Positioning table number (0 to 20)
S+4	CH3 Positioning table number (0 to 20)
S+5	CH4 Positioning table number (0 to 20)
S+6	CH5 Positioning table number (0 to 20)

■ Precautions during programming

- If an operand is an out-of-range value, an operation error occurs.
- The stop operation has priority when the conditions of system stop, emergency stop, limit stop and deceleration stop are satisfied.
- An operation error occurs when the system register of a specified channel is other than "Pulse output [Table setting mode]".
- Only when all the specified channels can be started, they are executed simultaneously. When the BUSY flag of any channel is on, tables are not started simultaneously and the process is terminated.
- Use F380 POSST instruction to start linear interpolation. When the table of the interpolation axis control has been specified with F383 MPOST instruction, a self-diagnostic error (positioning operation error) occurs.

■ Flag operations

Name	Description
R9007	When the area is exceeded at the time of index modification
R9008	When the [S] data table exceeds the area
(ER)	When the [S] value is outside the set range

Name	Description
	When the pulse output (table operation) has not been set in the system register

7.1.5 [F384 PTBLR] Positioning Parameter Read Instruction

Reads the positioning parameter data stored in the positioning memory of the unit to the operation memory area.

■ Instruction format



■ Operand

Operand	Settings
S1	Specification of channel numbers and positioning memory area
	(Higher 8 bits) channel no.: H0 to H5 (Lower 8 bits) Area no.: H00 (Common area), H01 (Axis information area), H02 (Axis setting area), H03 (Positioning table area)
S2	Starting address of the positioning memory storing read data (offset address) or operation memory area storing the starting address
n	No. of read words
D	Operation memory storing read data

(Note 1) When reading the common area, the setting of channel numbers is invalid.

(Note 2) The operand S1 is specified using a combination of hexadecimal numbers. For the axis information area of channel number 3, specify H301.

■ Memory area type that can be specified

Operand	WX	WY	WR	WL	SV	EV	DT	LD	I	Constant		Index modifier
										K	H	
S1	•	•	•	•	•	•	•	•	•	•	•	•
S2	•	•	•	•	•	•	•	•	•	•	•	•
n	•	•	•	•	•	•	•	•	•	•	•	•
D	-	•	•	•	•	•	•	•	•	-	-	•

■ Outline of operation

- Reads [n] words of the data stored in the positioning memory starting with [S2], and stores it in the operation memory area starting with [D].
- Channel numbers and the type of positioning memory are specified by [S1].

7.1 Table Setting Mode Control Instruction

■ Precautions during programming

- If an operand is an out-of-range value, an operation error occurs.

■ Flag operations

Name	Description
R9007 R9008 (ER)	When the [S1] value is outside the set range
	When the [S2] value exceeds the positioning area specified by [S1]
	When the no. of read words is "0"
	When the read data exceeds the area of [D]

7.1.6 [F385 PTBLW] Positioning Parameter Write Instruction

This instruction is used to write positioning parameters and positioning table data with user programs.

■ Instruction format

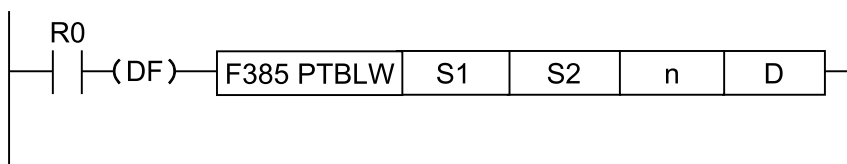

■ Operand

Operand	Settings	
S1	Specification of channel numbers and positioning memory area	
	(Higher 8 bits) channel no.:	H0 to H5
	(Lower 8 bits) Area no.:	H00 (Common area), H01 (Axis information area), H02 (Axis setting area), H03 (Positioning table area)
S2	Operation memory area storing written data	
n	No. of written data	
D	Starting address of the positioning memory storing data (offset address) or operation memory area storing the starting address	

(Note 1) When writing data to the common area, the setting of channel numbers is invalid.

(Note 2) The operand S1 is specified using a combination of hexadecimal numbers. For the axis setting area of channel number 3, specify H302.

■ Memory area type that can be specified

Operand	WX	WY	WR	WL	SV	EV	DT	LD	I	Constant		Index modifier
										K	H	
S1	•	•	•	•	•	•	•	•	•	•	•	•

Operand	WX	WY	WR	WL	SV	EV	DT	LD	I	Constant		Index modifier
										K	H	
S2	•	•	•	•	•	•	•	•	•	-	-	•
n	•	•	•	•	•	•	•	•	•	•	•	•
D	•	•	•	•	•	•	•	•	•	•	•	•

■ Outline of operation

- Reads [n] words of the data stored in the area starting with [S2], and stores it in the positioning memory area starting with [D].
- Channel numbers and the type of positioning memory are specified by [S1].

■ Precautions during programming

- If an operand is an out-of-range value, an operation error occurs.

Info.

- For details of positioning memory, refer to "[11.3 Positioning Memory](#)".

■ Flag operations

Name	Description
R9007 R9008 (ER)	When the [S1] value is outside the set range
	When the [D] value exceeds the positioning area specified by [S1]
	When the range of the data written from [D] exceeds the positioning area specified by [S1]
	When the no. of written data is "0"
	When the written data exceeds the area of [S2]

7.2 FP-X Compatible Instruction Mode Control Instruction

7.2 FP-X Compatible Instruction Mode Control Instruction

7.2.1 [F171 (SPDH)] Pulse Output (Trapezoidal Control)

This instruction outputs pulses from a specified pulse output channel according to specified parameters.

■ Instruction format

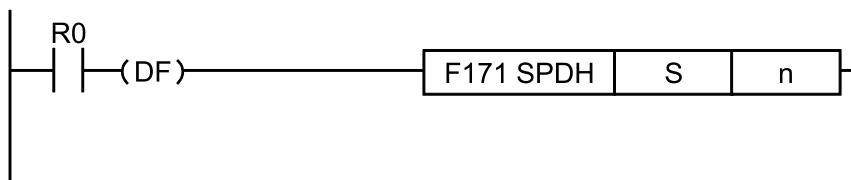

■ Operand

Operand	Settings
S	Starting number of the area in which data tables are registered
n	Target channel for pulse output

■ Memory area type that can be specified

Operand	WX	WY	WR	WL	SV	EV	DT	LD	I	Constant		Index modifier
										K	H	
S	-	-	-	-	-	-	•	-	-	-	-	•
n	-	-	-	-	-	-	-	-	-	•	•	-

■ Outline of operation

- Outputs pulses from a specified channel when a corresponding control active flag is OFF and the execution condition is ON.
- The control code, initial speed, maximum speed, acceleration / deceleration time, and target value are specified by creating data tables [S] to [S+11] described on the next page using a user program.
- Switches the frequency from the initial speed to the maximum speed in the specified acceleration / deceleration time. At the time of deceleration, switches the frequency with the same inclination as that for acceleration.
- For setting the frequency to 50 kHz or more, specify the duty of 1/4 (25%).

■ Operation mode

Incremental <Relative value control>

Outputs the pulses set with the target value.

7.2 FP-X Compatible Instruction Mode Control Instruction

Target value	Selection			Elapsed value
	CW / CCW	PLS+SIGN Forward OFF Reverse ON	PLS+SIGN Forward ON Reverse OFF	
Positive value	Pulse output from CW	Pulse output when direction output is OFF	Pulse output when direction output is ON	Addition
Negative value	Pulse output from CCW	Pulse output when direction output is ON	Pulse output when direction output is OFF	Subtraction

Absolute <Absolute value control>

Outputs the pulses of the difference between the set target value and current value.

Target value	Selection			Elapsed value
	CW / CCW	PLS+SIGN Forward OFF Reverse ON	PLS+SIGN Forward ON Reverse OFF	
When target value is larger than current value	Pulse output from CW	Pulse output when direction output is OFF	Pulse output when direction output is ON	Addition
When target value is smaller than current value	Pulse output from CCW	Pulse output when direction output is ON	Pulse output when direction output is OFF	Subtraction

■ Data table settings

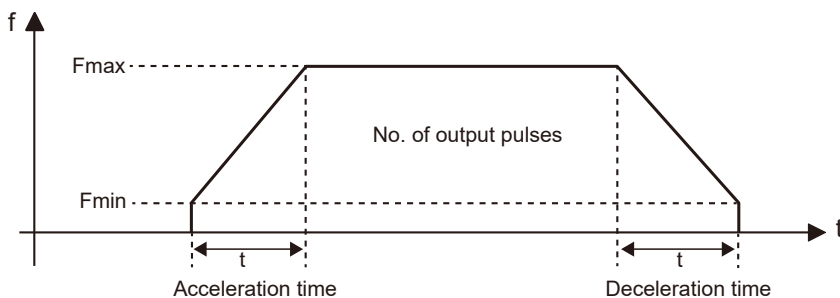

7.2 FP-X Compatible Instruction Mode Control Instruction

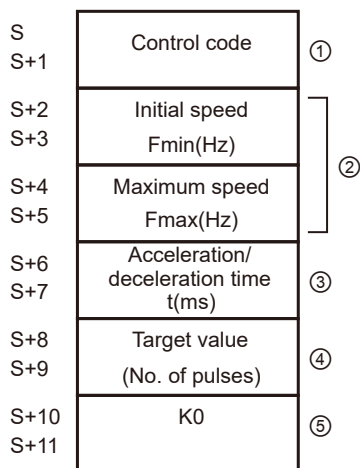

	Operand	Settings	Description									
(1)	S, S+1	Control code	<p>Specify the control code by setting the H constant.</p> <p style="text-align: right;">H <input type="checkbox"/><input type="checkbox"/><input type="checkbox"/><input type="checkbox"/><input type="checkbox"/><input type="checkbox"/><input type="checkbox"/><input type="checkbox"/><input type="checkbox"/><input type="checkbox"/><input type="checkbox"/></p> <p>0: Fixed</p> <p>Acceleration/deceleration time setting 0: Normal 1: Acceleration/deceleration time priority</p> <p>Output setting 0: Pulse output 1: Calculate only</p> <p>Acceleration/deceleration steps 0: 30 steps 1: 60 steps</p> <p>Duty (on width) 0: Duty 1/2 (50%) 1: Duty 1/4 (25%)</p> <p>Frequency range Not used</p> <p>Operation mode and output method 0: Incremental CW/CCW 2: Incremental PLS+SIGN (forward off/reverse on) 3: Incremental PLS+SIGN (forward on/reverse off) 10: Absolute CW/CCW 12: Absolute PLS+SIGN (forward off/reverse on) 13: Absolute PLS+SIGN (forward on/reverse off)</p>									
(2)	S+2, S+3	Initial speed Fmin (Hz)	<p>The setting range of the settable maximum speed varies according to the setting of the initial speed as shown in the table below.</p> <table border="1"> <thead> <tr> <th>Range</th> <th>Initial speed</th> <th>Maximum speed</th> </tr> </thead> <tbody> <tr> <td>Low speed</td> <td>K1 to K49 (1 to 49 Hz)</td> <td>Initial speed to K22000 (to 22 kHz)</td> </tr> <tr> <td>High-speed</td> <td>K50 to K100000 (50 Hz to 100 kHz)</td> <td>Initial speed to K100000 (to 100 kHz)</td> </tr> </tbody> </table>	Range	Initial speed	Maximum speed	Low speed	K1 to K49 (1 to 49 Hz)	Initial speed to K22000 (to 22 kHz)	High-speed	K50 to K100000 (50 Hz to 100 kHz)	Initial speed to K100000 (to 100 kHz)
	Range	Initial speed		Maximum speed								
	Low speed	K1 to K49 (1 to 49 Hz)		Initial speed to K22000 (to 22 kHz)								
High-speed	K50 to K100000 (50 Hz to 100 kHz)	Initial speed to K100000 (to 100 kHz)										
S+4, S+5	Maximum speed Fmax (Hz)											

7.2 FP-X Compatible Instruction Mode Control Instruction

	Operand	Settings	Description
			When the initial speed is set to low speed, an operation error occurs if a value exceeding K22000 is specified for the maximum speed.
(3)	S+6, S+7	Acceleration / deceleration time t (ms)	Acceleration / deceleration time (ms) With 30 steps: K30 to K32760 (Specify in 30 ms increments.) With 60 steps: K60 to K32760 (Specify in 60 ms increments.) (Note 1) When the time is not specified in 30 ms nor 60 ms increments, it will be automatically corrected to the multiple value (larger value) of 30 ms or 60 ms.
(4)	S+8, S+9	Target value	Target value K-2147483648 to K2147483647 pulse
(5)	S+10, S+11	K0	Set K0 to the last two words of the data table.

■ Example of program

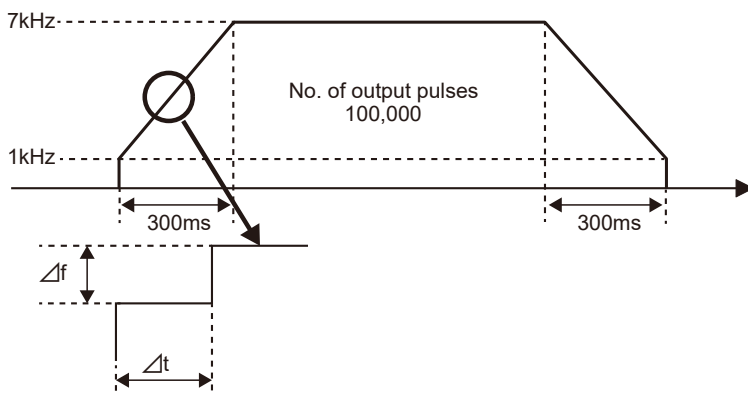
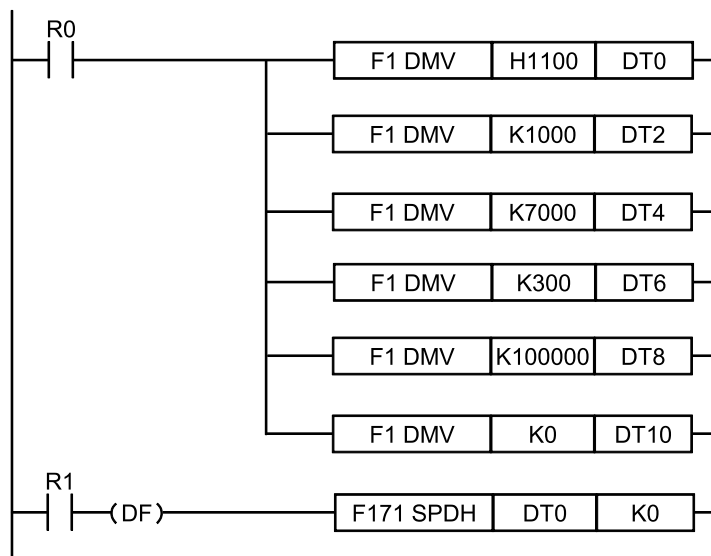

7.2 FP-X Compatible Instruction Mode Control Instruction

- With 30 steps:
 $\Delta f = (7000 - 1000) / 30 \text{ steps} = 200 \text{ (Hz)}$
 $\Delta t = 300 \text{ ms} / 30 \text{ steps} = 10 \text{ ms}$
- With 60 steps:
 $\Delta f = (7000 - 1000) / 60 \text{ steps} = 100 \text{ (Hz)}$
 $\Delta t = 300 \text{ ms} / 60 \text{ steps} = 5 \text{ ms}$

■ Regarding the specification of acceleration / deceleration time

For specifying acceleration / deceleration time, No. of steps and initial speed, set the value to be calculated by the formula below. Specify acceleration / deceleration time in 30 ms increments with 30 steps, and in 60 ms increments with 60 steps. When the time is not specified in 30 ms nor 60 ms increments, it will be automatically corrected to the multiple value (larger value) of 30 ms or 60 ms.

Acceleration / deceleration time t [ms] \geq (No. of steps \times 1000) / Initial speed f_0 [Hz]

- When "Acceleration / deceleration time priority" is specified for the control code, the initial speed is corrected according to the time.
The corrected speed is stored in the correction speed area of initial speed of special data registers (from DT90400).
(Example): When the initial speed is 10 Hz, and acceleration / deceleration time is 1 msec, the initial speed is corrected to 1000 Hz.
- When the corrected initial speed exceeds the maximum speed, the initial speed is corrected to the maximum speed.
(Example): When the initial speed is 10 Hz, the maximum speed is 500 Hz, acceleration / deceleration time is 1 msec, and acceleration / deceleration time priority is specified, it takes 100 msec for outputting one pulse at the initial speed and it exceeds 1 msec of acceleration / deceleration time.
Although the initial speed is corrected to 1000 Hz as "Acceleration / deceleration time priority" is specified, it is corrected to 500 Hz because it exceeds the maximum speed.

■ Supplement to pulse output operation

When outputting pulses with the PLS+SIGN (direction output) method, pulses will be output approx. 300 μ s later after the output of direction signal (SIGN). (The characteristics of a motor driver are considered.)

■ Precautions during programming

- When describing the same channel in both the normal program and the interrupt program, be sure to program not to execute them simultaneously.
- This instruction cannot be executed when a control active flag corresponding to each channel is ON.
- Select "Pulse output" for the channel setting corresponding to the system register no. 402.
- By performing the rewriting during RUN while outputting pulses, more pulses than the setting may be output.

Info.

- For details of the allocations of I/O and flags, refer to "Allocation of Memory Areas".

REFERENCE

11.2.2 When Using Pulse Output Function (FP-X Compatible Instruction Mode)

7.2.2 [F171 (SPDH)] Pulse Output (Home Return)

This instruction outputs pulses from a specified pulse output channel according to specified parameters.

■ Instruction format

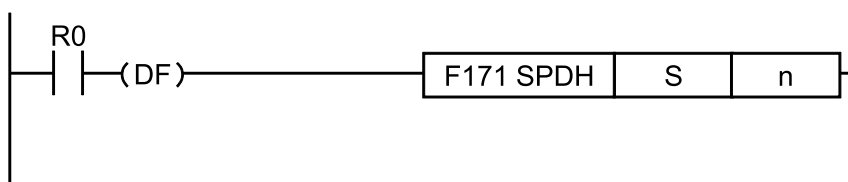

■ Operand

Operand	Settings
S	Starting number of the area in which data tables are registered
n	Target channel for pulse output

■ Memory area type that can be specified

Operand	WX	WY	WR	WL	SV	EV	DT	LD	I	Constant		Index modifier
										K	H	
S	-	-	-	-	-	-	•	-	-	-	-	•
n	-	-	-	-	-	-	-	-	-	•	•	-

■ Outline of operation

- Outputs pulses from a specified channel when a corresponding control active flag is OFF and the execution condition is ON.
- The control code, initial speed, maximum speed, acceleration / deceleration time, and deviation counter clear signal are specified by creating data table described on the next page using a user program.
- Switches the frequency from the initial speed to the maximum speed in the specified acceleration / deceleration time. At the time of deceleration, switches the frequency with the same inclination as that for acceleration.
- For setting the frequency to 50 kHz or more, specify the duty of 1/4 (25%).

■ Explanation of operation mode

Home return

The pulses are continuously output until the home input (X2 or X5) is enabled. To shift to deceleration operation when detecting the near home, turn the corresponding bit of special

7.2 FP-X Compatible Instruction Mode Control Instruction

data register DT90052 to OFF→ON→OFF by the near home input. The value in the elapsed value area during the home return operation differs from the current value.

Home return mode I (Home return by near home input and home input)

When the near home input is enabled, deceleration will be performed, and the pulse output will stop after the home input. The operation varies according to the setting of the control code (low byte) described on the next page.

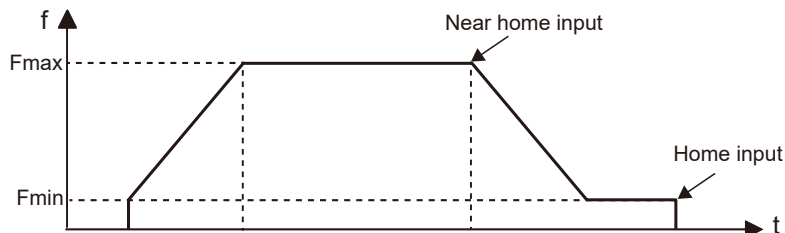

Home return mode II (Home return by home input only)

When the home input is enabled, the pulse output will stop. Set the control code (low byte) on the next page to H20 to H27.

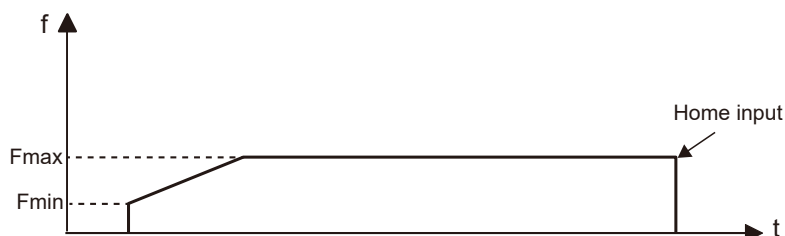

■ Data table settings

S	Control code	①
S+1		
S+2	Initial speed Fmin(Hz)	②
S+3		
S+4	Maximum speed Fmax(Hz)	③
S+5		
S+6	Acceleration/ deceleration time t(ms)	④
S+7		
S+8	Deviation counter clear signal output time t_r (ms)	⑤
S+9		

	Operand	Settings	Description
(1)	S, S+1	Control code	Specify the control code by setting the H constant.

7.2 FP-X Compatible Instruction Mode Control Instruction

	Operand	Settings	Description									
			<div style="text-align: right;">H <input type="checkbox"/> <input type="checkbox"/> <input type="checkbox"/> <input type="checkbox"/> <input type="checkbox"/> <input type="checkbox"/> <input type="checkbox"/> <input type="checkbox"/> <input type="checkbox"/> <input type="checkbox"/></div> <p>0: Fixed</p> <p>Acceleration/deceleration time setting 0: Normal 1: Acceleration/deceleration time priority</p> <p>Output setting 0: Pulse output 1: Calculate only</p> <p>Acceleration/deceleration steps 0: 30 steps 1: 60 steps</p> <p>Duty (on width) 0: Duty 1/2 (50%) 1: Duty 1/4 (25%)</p> <p>Frequency range Not used</p> <p>Operation mode and output method 20: Homing mode 1 CW 21: Homing mode 1 CCW 22: Homing mode 1 Directional output off 23: Homing mode 1 Directional output on 24: Homing mode 1 CW + deviation counter reset 25: Homing mode 1 CCW + deviation counter reset 26: Homing mode 1 Direction output off + deviation counter reset 27: Homing mode 1 Direction output on + deviation counter reset 30: Homing mode 2 CW 31: Homing mode 2 CCW 32: Homing mode 2 Directional output off 33: Homing mode 2 Direction output on 34: Homing mode 2 CW + deviation counter reset 35: Homing mode 2 CCW + deviation counter reset 36: Homing mode 2 Direction output off + deviation counter reset 37: Homing mode 2 Direction output on + deviation counter reset</p>									
(2)	S+2, S+3	Initial speed Fmin (Hz)	<p>The setting range of the settable maximum speed varies according to the setting of the initial speed as shown in the table below.</p> <table border="1"> <thead> <tr> <th>Range</th> <th>Initial speed</th> <th>Maximum speed</th> </tr> </thead> <tbody> <tr> <td>Low speed</td> <td>K1 to K49 (1 to 49 Hz)</td> <td>Initial speed to K22000 (to 22 kHz)</td> </tr> <tr> <td>High-speed</td> <td>K50 to K100000 (50 Hz to 100 kHz)</td> <td>Initial speed to K100000 (to 100 kHz)</td> </tr> </tbody> </table> <p>When the initial speed is set to low speed, an operation error occurs if a value exceeding K22000 is specified for the maximum speed.</p>	Range	Initial speed	Maximum speed	Low speed	K1 to K49 (1 to 49 Hz)	Initial speed to K22000 (to 22 kHz)	High-speed	K50 to K100000 (50 Hz to 100 kHz)	Initial speed to K100000 (to 100 kHz)
	Range	Initial speed		Maximum speed								
Low speed	K1 to K49 (1 to 49 Hz)	Initial speed to K22000 (to 22 kHz)										
High-speed	K50 to K100000 (50 Hz to 100 kHz)	Initial speed to K100000 (to 100 kHz)										
	S+4, S+5	Maximum speed Fmax (Hz)										
(3)	S+6, S+7	Acceleration / deceleration time t (ms)	Acceleration / deceleration time (ms) With 30 steps: K30 to K32760 With 60 steps: K60 to K32760									
(4)	S+8, S+9	Deviation counter clear signal output time tr (ms)	Set the output time of the deviation counter clear signal. 0.5 ms to 100 ms [K0 to K100] Setting value + error (0.5 ms or less) When this signal is not used or the time is set to less than 0.5 ms, specify K0.									

7.2 FP-X Compatible Instruction Mode Control Instruction

■ Example of program

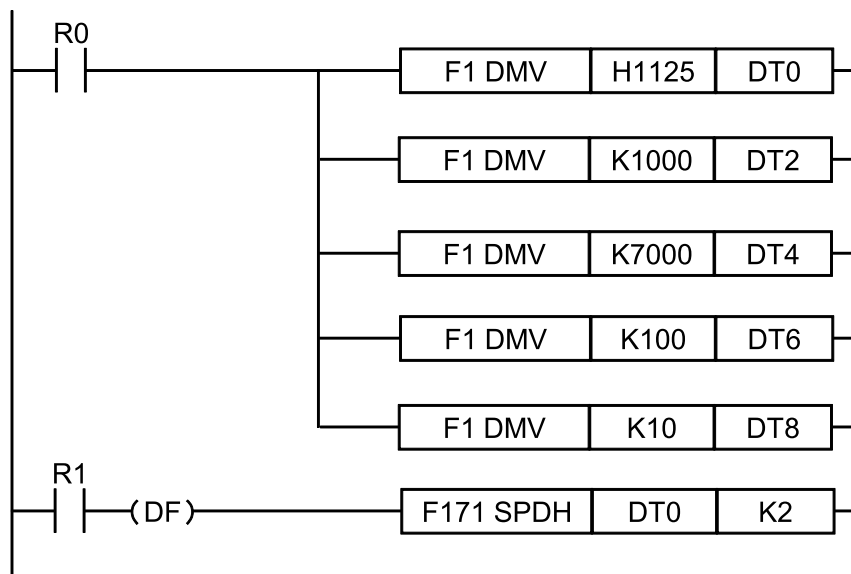

■ Regarding the specification of acceleration / deceleration time

For specifying acceleration / deceleration time, No. of steps and initial speed, set the value to be calculated by the formula below. Specify acceleration / deceleration time in 30 ms increments with 30 steps, and in 60 ms increments with 60 steps. When the time is not specified in 30 ms nor 60 ms increments, it will be automatically corrected to the multiple value (larger value) of 30 ms or 60 ms.

Acceleration / deceleration time t [ms] \geq (No. of steps \times 1000) / Initial speed f_0 [Hz]

- When "Acceleration / deceleration time priority" is specified for the control code, the initial speed is corrected according to the time.
The corrected speed is stored in the correction speed area of initial speed of special data registers (from DT90400).
(Example): When the initial speed is 10 Hz, and acceleration / deceleration time is 1 msec, the initial speed is corrected to 1000 Hz.
- When the corrected initial speed exceeds the maximum speed, the initial speed is corrected to the maximum speed.
(Example): When the initial speed is 10 Hz, the maximum speed is 500 Hz, acceleration / deceleration time is 1 msec, and acceleration / deceleration time priority is specified, it takes 100 msec for outputting one pulse at the initial speed and it exceeds 1 msec of acceleration / deceleration time.
Although the initial speed is corrected to 1000 Hz as "Acceleration / deceleration time priority" is specified, it is corrected to 500 Hz because it exceeds the maximum speed.

■ Supplement to pulse output operation

When outputting pulses with the PLS+SIGN (direction output) method, pulses will be output approx. 300 μ s later after the output of direction signal (SIGN). (The characteristics of a motor driver are considered.)

■ Precautions during programming

- When the control code (low byte) is H20 to H27 (home return mode I), the home input is enabled even after the near home input, the completion of deceleration, or in the middle of deceleration.
- When the control code (low byte) is H30 to H37 (home return mode II), the home input is enabled only after the near home input and the completion of deceleration up to the value of initial speed.
- Even when the home input is enabled, the pulse output starts by the execution of this instruction.
- When the near home input is enabled during acceleration, the deceleration operation will start.
- When describing the same channel in both the normal program and the interrupt program, be sure to program not to execute them simultaneously.
- This instruction cannot be executed when a control active flag corresponding to each channel is ON.
- Select "Pulse output" for the channel setting corresponding to the system register no. 402.
- By performing the rewriting during RUN while outputting pulses, more pulses than the setting may be output.
- For performing the software reset, disabling the counting, stopping the pulse output or near home processing, refer to the F0 (MV) instruction, pulse output control.

i Info.

- For details of the allocations of I/O and flags, refer to "Allocation of Memory Areas".

— REFERENCE —

[11.2.2 When Using Pulse Output Function \(FP-X Compatible Instruction Mode\)](#)

7.2.3 [F172 (PLSH)] Pulse Output (JOG operation)

This instruction outputs pulses from a specified pulse output channel according to specified parameters.

■ Instruction format

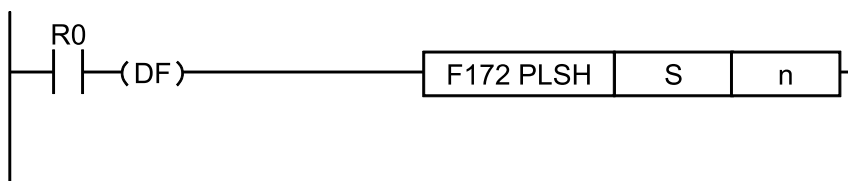

■ Operand

Operand	Settings
S	Starting number of the area in which data tables are registered
n	Target channel for pulse output

7.2 FP-X Compatible Instruction Mode Control Instruction

Memory area type that can be specified

Operand	WX	WY	WR	WL	SV	EV	DT	LD	I	Constant		Index modifier
										K	H	
S	-	-	-	-	-	-	•	-	-	-	-	•
n	-	-	-	-	-	-	-	-	-	•	•	-

Outline of operation

- Outputs pulses from a specified channel when a corresponding control active flag is OFF and the execution condition is ON. The output is performed when the execution condition is ON.
- By specifying the addition counting or subtraction counting mode for the control code, it can be used for the instruction for activating JOG operation.
- The frequency can be changed in each scan, or the target value can be changed asynchronously. However, the control code cannot be changed during the execution of an instruction.
- For setting the frequency to 50 kHz or more, specify the duty of 1/4 (25%).

Data table settings

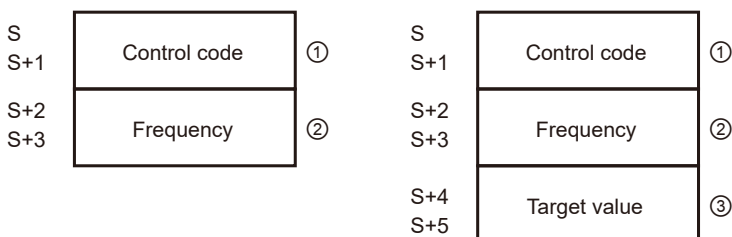

	Operand	Settings	Description
(1)	S, S+1	Control code	<p>Specify the control code by setting the H constant.</p> <p style="text-align: right;">H <input type="checkbox"/><input type="checkbox"/><input type="checkbox"/><input type="checkbox"/><input type="checkbox"/><input type="checkbox"/><input type="checkbox"/><input type="checkbox"/><input type="checkbox"/><input type="checkbox"/><input type="checkbox"/></p> <p>0: Fixed</p> <p>Acceleration/deceleration steps 0: Mode with no target value 1: Target value match stop mode</p> <p>Duty (on width) 0: Duty 1/2 (50%) 1: Duty 1/4 (25%)</p> <p>Frequency range Not used</p> <p>Output method 00: No counting CW 01: No counting CCW 10: Addition counting CW 12: Addition counting Directional output off 13: Addition counting Directional output on 21: Subtraction counting CW 22: Subtraction counting Directional output off 23: Subtraction counting Directional output on</p>

7.2 FP-X Compatible Instruction Mode Control Instruction

	Operand	Settings	Description									
(2)	S+2, S+3	Frequency	<p>The setting range of the settable change speed varies according to the setting of the initial speed as shown in the table below.</p> <table border="1"> <thead> <tr> <th>Range</th> <th>Initial speed</th> <th>Change speed</th> </tr> </thead> <tbody> <tr> <td>Low speed</td> <td>K1 to K49 (1 to 49 Hz)</td> <td>K1 to K22000 (1 Hz to 22 kHz)</td> </tr> <tr> <td>High-speed</td> <td>K50 to K100000 (50 Hz to 100 kHz)</td> <td>K1 to K100000 (1 Hz to 100 kHz)</td> </tr> </tbody> </table> <p>When the initial speed is set to low speed, it is corrected to 22 kHz even when specifying a value exceeding K22000 for the change speed.</p>	Range	Initial speed	Change speed	Low speed	K1 to K49 (1 to 49 Hz)	K1 to K22000 (1 Hz to 22 kHz)	High-speed	K50 to K100000 (50 Hz to 100 kHz)	K1 to K100000 (1 Hz to 100 kHz)
Range	Initial speed	Change speed										
Low speed	K1 to K49 (1 to 49 Hz)	K1 to K22000 (1 Hz to 22 kHz)										
High-speed	K50 to K100000 (50 Hz to 100 kHz)	K1 to K100000 (1 Hz to 100 kHz)										
(3)	S+4, S+5	Target value	<p>Target value (absolute value) It is used when setting the target value match stop mode. (Absolute only)</p> <p>Specify the target value in the following range. If a value outside of the range is specified, the number of pulses different from the specified value is output. When specifying the no counting mode, the target value setting is ignored.</p> <table border="1"> <thead> <tr> <th>Output method</th> <th>Settable range of target value</th> </tr> </thead> <tbody> <tr> <td>Addition counting</td> <td>Values larger than the current value</td> </tr> <tr> <td>Subtraction counting</td> <td>Values smaller than the current value</td> </tr> </tbody> </table>	Output method	Settable range of target value	Addition counting	Values larger than the current value	Subtraction counting	Values smaller than the current value			
Output method	Settable range of target value											
Addition counting	Values larger than the current value											
Subtraction counting	Values smaller than the current value											

■ Supplement to pulse output operation

When outputting pulses with the PLS+SIGN (direction output) method, pulses will be output approx. 300 μs later after the output of direction signal (SIGN). (The characteristics of a motor driver are considered.)

■ Precautions during programming

- This instruction cannot be executed when a control active flag corresponding to each channel is ON.
- When describing the same channel in both the normal program and the interrupt program, be sure to program not to execute them simultaneously.
- Select "Pulse output" for the channel setting corresponding to the system register no. 402.
- When rewriting during RUN is performed during the operation, the pulse output stops while a program is being rewritten.
- Even if the control code is changed after starting the instruction, the change is invalid. It does not affect on the operation.
- When the frequency is changed to a value outside of the settable range after executing the instruction, the operation is performed with the minimum or maximum value in the specification range without causing an operation error.

i Info.

- For details of the allocations of I/O and flags, refer to "Allocation of Memory Areas".

7.2 FP-X Compatible Instruction Mode Control Instruction

REFERENCE

11.2.2 When Using Pulse Output Function (FP-X Compatible Instruction Mode)

7.2.4 [F174 (SP0H)] Pulse Output (Selectable Data Table Control Operation)

This instruction outputs pulses from a specified pulse output channel according to a specified data table.

■ Instruction format

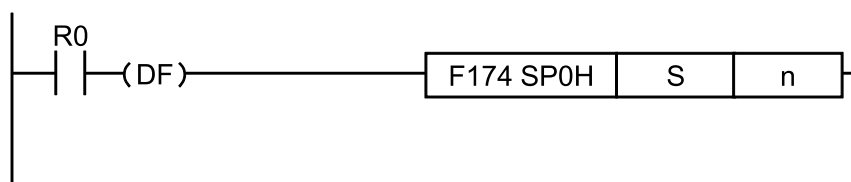

■ Operand

Operand	Settings
S	Starting number of the area in which data tables are registered
n	Target channel for pulse output

■ Memory area type that can be specified

Operand	WX	WY	WR	WL	SV	EV	DT	LD	I	Constant		Index modifier
										K	H	
S	-	-	-	-	-	-	•	-	-	-	-	•
n	-	-	-	-	-	-	-	-	-	•	•	-

■ Outline of operation

- Outputs pulses from a specified channel according to the settings specified in the data table starting with the address specified by [S] when a corresponding control active flag is OFF and the execution condition is ON.
- Switches the pulse frequency when the elapsed value of the high-speed counter reaches the target value set in the data table. (It is performed by the interrupt processing.)
- Stops the pulse output when the elapsed value reaches the final target value.
- For setting the frequency to 50 kHz or more, specify the duty of 1/4 (25%).

■ Data table settings

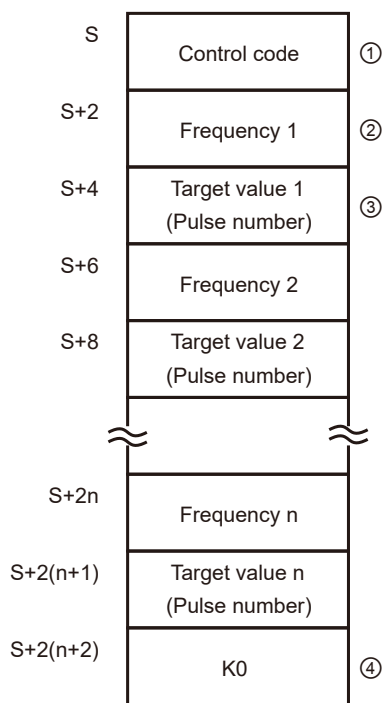

	Operand	Settings	Description						
(1)	S	Control code	<p>Specify the control code by setting the H constant.</p> <div style="text-align: right; margin-bottom: 10px;"> H <input type="checkbox"/><input type="checkbox"/><input type="checkbox"/><input type="checkbox"/><input type="checkbox"/><input type="checkbox"/><input type="checkbox"/><input type="checkbox"/><input type="checkbox"/><input type="checkbox"/><input type="checkbox"/> </div> <p>0: Fixed</p> <p>Duty (on width)</p> <p>0: Duty 1/2 (50%)</p> <p>1: Duty 1/4 (25%)</p> <p>Frequency range</p> <p>Not used</p> <p>Operation mode</p> <p>0: Specify Incremental movement amount (pulse no.).</p> <p>1: Specify Absolute target value (absolute value).</p> <p>Output method</p> <p>0: Addition counting CW</p> <p>1: Subtraction counting CCW</p> <p>2: Addition counting PLS+SIGN (forward off)</p> <p>3: Subtraction counting PLS+SIGN (reverse on)</p> <p>4: Addition counting PLS+SIGN (forward on)</p> <p>5: Subtraction counting PLS+SIGN (reverse off)</p>						
(2)	S+2, S+2n	Frequency n	<p>The setting range of the settable maximum speed varies according to the setting of the initial speed as shown in the table below.</p> <table border="1" style="width: 100%; border-collapse: collapse; margin-top: 10px;"> <thead> <tr style="background-color: #d9e1f2;"> <th style="width: 15%;">Range</th> <th style="width: 35%;">Initial speed</th> <th style="width: 50%;">Maximum speed</th> </tr> </thead> <tbody> <tr> <td style="text-align: center;">Low speed</td> <td style="text-align: center;">K1 to K49 (1 to 49 Hz)</td> <td style="text-align: center;">Initial speed to K22000 (to 22 kHz)</td> </tr> </tbody> </table>	Range	Initial speed	Maximum speed	Low speed	K1 to K49 (1 to 49 Hz)	Initial speed to K22000 (to 22 kHz)
Range	Initial speed	Maximum speed							
Low speed	K1 to K49 (1 to 49 Hz)	Initial speed to K22000 (to 22 kHz)							

7.2 FP-X Compatible Instruction Mode Control Instruction

	Operand	Settings	Description																	
			Range	Initial speed	Maximum speed															
			High-speed	K50 to K100000 (50 Hz to 100 kHz)	Initial speed to K100000 (to 100 kHz)															
			<p>When the frequency 1 (initial speed) is the low speed range and the frequency n is not in the range between 1 Hz to 22 kHz, the pulse output stops.</p> <p>When the frequency 1 (initial speed) is the high speed range and the frequency n is not in the range between 50 Hz to 100 kHz, the pulse output stops.</p>																	
(3)	S+4, S+2(n+1)	Target value n	<p>Target value (K-2147483648 to K2147483647)</p> <p>The values of 32-bit data specified as target values should be within the range as shown in the table below.</p> <table border="1"> <thead> <tr> <th colspan="2">Control code setting</th> <th rowspan="2">Settable range of target value</th> </tr> <tr> <th>Operation mode</th> <th>Output method</th> </tr> </thead> <tbody> <tr> <td rowspan="2">Incremental</td> <td>Addition counting</td> <td>Positive values</td> </tr> <tr> <td>Subtraction counting</td> <td>Negative values</td> </tr> <tr> <td rowspan="2">Absolute</td> <td>Addition counting</td> <td>Values larger than the current value</td> </tr> <tr> <td>Subtraction counting</td> <td>Values smaller than the current value</td> </tr> </tbody> </table>			Control code setting		Settable range of target value	Operation mode	Output method	Incremental	Addition counting	Positive values	Subtraction counting	Negative values	Absolute	Addition counting	Values larger than the current value	Subtraction counting	Values smaller than the current value
Control code setting		Settable range of target value																		
Operation mode	Output method																			
Incremental	Addition counting	Positive values																		
	Subtraction counting	Negative values																		
Absolute	Addition counting	Values larger than the current value																		
	Subtraction counting	Values smaller than the current value																		
(4)	S+2(n+2)	K0	End of table (Pulse output stop setting)																	

■ Example of program

[Operation]

- (1) Starts the pulse output at 1000 Hz from the specified channel ch0 when the execution condition R10 of F174 (SP0H) instruction turns ON.
- (2) Switches the frequency to 2500 Hz when 1000 pulses are counted at 1000 Hz.
- (3) Switches the frequency to 5000 Hz when 3000 pulses are counted at 2500 Hz.
- (4) Switches the frequency to 1000 Hz when 8000 pulses are counted at 5000 Hz.
- (5) Stops the pulse output when 10000 pulses are counted.

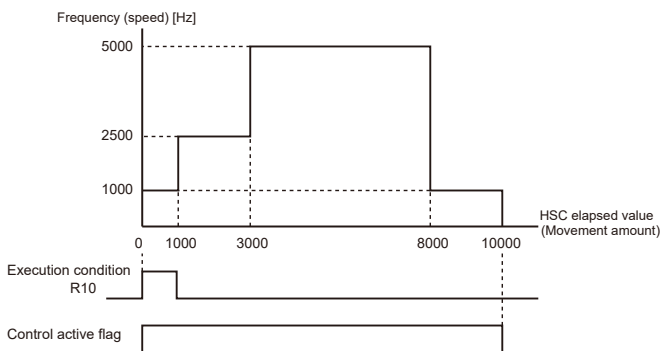

7.2 FP-X Compatible Instruction Mode Control Instruction

(Note 1) When the execution condition R10 of F174 (SP0H) instruction turns ON, the control active flag will turn ON. When the elapsed value reaches 10000 and the pulse output stops, the control active flag will turn OFF.

[Settings and program]

Set the frequency range to 191 Hz to 100 kHz and duty 1/4 (25%), and the operation mode to Incremental and the output method to CW.

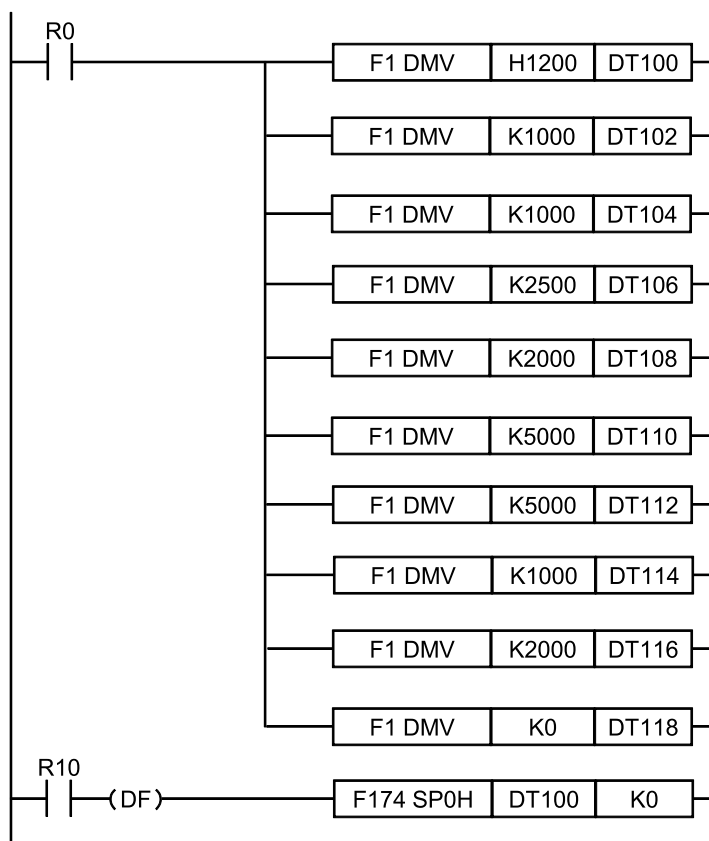

■ Supplement to pulse output operation

When outputting pulses with the PLS+SIGN (direction output) method, pulses will be output approx. 300 μ s later after the output of direction signal (SIGN). (The characteristics of a motor driver are considered.)

■ Precautions during programming

- The control active flag turns ON until the pulse output stops after the execution condition of F174 (SP0H) instruction has turned ON.
- This instruction cannot be executed when a control active flag corresponding to each channel is ON.
- Select "Pulse output" for the channel setting corresponding to the system register no. 402.
- When the control code or frequency 1 is any value outside of the settable range, an operation error occurs. (When the data of the frequency 1 is 0, nothing is executed and the operation ends.)

7.2 FP-X Compatible Instruction Mode Control Instruction

- When the frequency after the second step is 0 or outside of the settable range, the pulse output stops.
- When the table pointer exceeds the area of data registers DT during the pulse output, the pulse output control will be canceled and the control active flag will turn OFF.
- The target values should be set in the range shown on the next page. If a value outside of the range is specified, the number of pulses different from the specified value is output.

i Info.

- For details of the allocations of I/O and flags, refer to “Allocation of Memory Areas”.

REFERENCE

[11.2.2 When Using Pulse Output Function \(FP-X Compatible Instruction Mode\)](#)

7.2.5 [F175 (SPSH)] Pulse Output (Linear Interpolation)

Pulses are output from channel for 2 pulse output, in accordance with the parameters in the designated data table, so that the path to the target position forms a straight line.

■ Instruction format

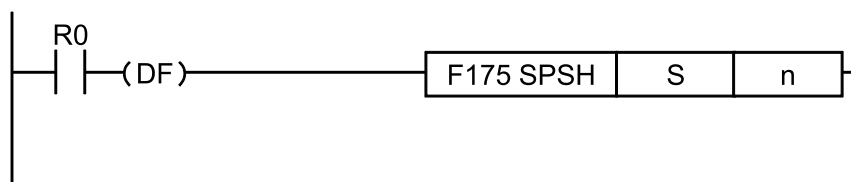

■ Operand

Operand	Settings
S	Starting number of the area in which data tables are registered
n	0 or 2

■ Memory area type that can be specified

Operand	WX	WY	WR	WL	SV	EV	DT	LD	I	Constant		Index modifier
										K	H	
S	-	-	-	-	-	-	•	-	-	-	-	•
n	-	-	-	-	-	-	-	-	-	•	•	-

■ Outline of operation

- Outputs pulses from a specified channel when a corresponding control active flag is OFF and the execution condition is ON.
- The control code, initial speed, maximum speed, acceleration / deceleration time, and target value are specified by creating data tables [S] to [S+11] described on the next page using a user program.

7.2 FP-X Compatible Instruction Mode Control Instruction

- For setting the frequency to 40 kHz or more, specify the duty of 1/4 (25%).

■ Data table settings

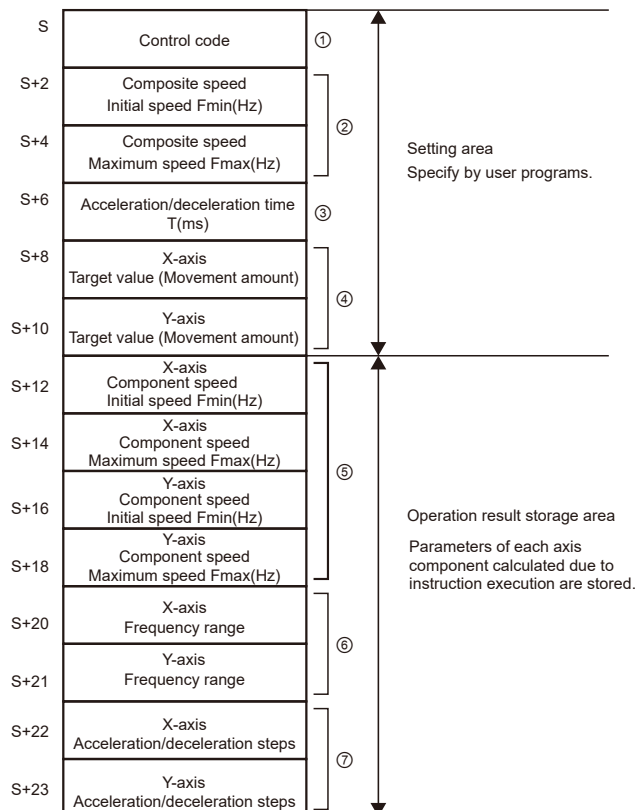

Setting area

	Operand	Settings	Description
(1)	S	Control code	<p>Specify the control code by setting the H constant.</p> <div style="text-align: center;"> </div> <p>0: Fixed</p> <p>Duty (on width) 0: Duty 1/2 (50%) 1: Duty 1/4 (25%)</p> <p>0: Fixed</p> <p>Operation mode and output method 00: Incremental CW/CCW 02: Incremental PLS+SIGN (forward off/reverse on) 03: Incremental PLS+SIGN (forward on/reverse off) 10: Absolute CW/CCW 12: Absolute PLS+SIGN (forward off/reverse on) 13: Absolute PLS+SIGN (forward on/reverse off)</p>

7.2 FP-X Compatible Instruction Mode Control Instruction

	Operand	Settings	Description
(2)	S+2	Composite speed Initial speed Fmin (Hz)	<p>Composite speed (Initial speed, maximum speed) (Hz) <K constant> 1.5 Hz to 100 kHz [K1 to K100000] (However, for 1.5 Hz, the angle is 0 degree or 90 degrees only. Also, for specifying 1.5 Hz, specify K1.)</p> <ul style="list-style-type: none"> When the component speed becomes lower than the minimum speed in each frequency range, it will be a corrected component speed. Do not set 60 kHz or more when using any two of the high-speed counter, periodical interrupt and PLC link are used simultaneously. When the initial speed is set to the maximum speed, the pulse output is performed without acceleration and deceleration. Specify the composite speed to make the component speed of each axis be 1.5 Hz or more. Composite speed (Initial speed): 30 kHz or less <p>Notes on the specification of composite speed (initial speed) When each initial component speed of CH0 and CH2 is not 1.5 Hz or more by the following arithmetic expression, the path may not be linear. (When the following formula is not satisfied)</p> $f \geq \frac{1.5 \sqrt{(\Delta X^2 + \Delta Y^2)}}{\Delta X}$ <p>Δx: Channel whose distance of (target value - current value) is short Δy: Channel whose distance of (target value - current value) is long</p>
	S+4	Composite speed Maximum speed Fmax (Hz)	
(3)	S+6	Acceleration / deceleration time T (ms)	<p>Acceleration / deceleration time (ms) <K constant> K0 to K32767</p> <p>In the case of 0, the pulse output is performed at the initial speed (composite speed) without acceleration and deceleration.</p>
(4)	S+8	X-axis Target value (Movement amount)	<p>K-8388608 to K8388607</p> <p>When only one axis is activated;</p> <ol style="list-style-type: none"> For the incremental mode, set the target value of the axis that is not activated to 0. For the absolute mode, set the target value of the axis that is not activated to the same as the current value. <p>(Note): In the case of linear interpolation, infinite rotation cannot be performed.</p>
	S+10	Y-axis Target value (Movement amount)	

Operation result storage area

	Operand	Settings	Description
(5)	S+12	X-axis component speed Initial speed Fxmin	<p>The component speed (initial speed and maximum speed of each axis) is stored as 2 words in real type.</p> $\text{X-axis component speed} = \frac{(\text{Composite speed}) \times (\text{X-axis movement amount})}{\sqrt{((\text{X-axis movement amount})^2 + (\text{Y-axis movement amount})^2)}}$ $\text{Y-axis component speed} = \frac{(\text{Composite speed}) \times (\text{Y-axis movement amount})}{\sqrt{((\text{X-axis movement amount})^2 + (\text{Y-axis movement amount})^2)}}$ <p>Example) Even when the initial speed is corrected, the calculated value is stored as is in the operation result storage area.</p>
	S+14	X-axis component speed	

7.2 FP-X Compatible Instruction Mode Control Instruction

	Operand	Settings	Description
		Maximum speed Fmax	
	S+16	Y-axis component speed Initial speed Fymin	
	S+18	Y-axis component speed Maximum speed Fmax (Hz)	
(6)	S+20	X-axis Frequency range	The frequency ranges are automatically selected by the system for the components of each axis 0: Low speed range (1 Hz to 22 kHz) 1: High speed range (50 Hz to 100 kHz)
	S+21	Y-axis Frequency range	When the initial speed (X / Y axis) is the low speed range and the maximum speed (X / Y axis) exceeds 22 kHz, the initial speed (X / Y axis) is corrected to 50 Hz. When the initial speed (X / Y axis) is less than 1 and the maximum speed (X / Y axis) exceeds 22 kHz or less, the initial speed (X / Y axis) is corrected to 1 Hz.
(7)	S+22	X-axis Acceleration / Deceleration steps	The acceleration / deceleration steps are automatically calculated by the system in the range of 0 to 60 steps. <ul style="list-style-type: none"> When the operation result is 0, the pulse output is performed at the initial speed (composite speed) without acceleration and deceleration. The acceleration / deceleration steps are calculated by the following formula; Acceleration / deceleration time (ms) x Initial component speed (Hz).
	S+23	Y-axis Acceleration / Deceleration steps	Example) When the settings are as follows; Incremental, Initial speed = 300 Hz, maximum speed = 5 kHz, Acceleration / deceleration time=0.5 s, CH0 target value = 1000, and CH2 target value = 50. $\text{CH0 Initial component speed} = \frac{300 \times 1000}{\sqrt{(1000^2 + 50^2)}} = 299.626 \text{ Hz}$ $\text{CH2 Initial component speed} = \frac{300 \times 50}{\sqrt{(1000^2 + 50^2)}} = 14.981 \text{ Hz}$ CH0 Acceleration/deceleration steps = $500 \times 10^{-3} \times 299.626 \approx 147.8 \rightarrow 60$ steps CH2 Acceleration/deceleration steps = $500 \times 10^{-3} \times 14.981 \approx 7.4 \rightarrow 7$ steps

7.2 FP-X Compatible Instruction Mode Control Instruction

■ Supplement to pulse output operation

When outputting pulses with the PLS+SIGN (direction output) method, pulses will be output approx. 300 μ s later after the output of direction signal (SIGN). (The characteristics of a motor driver are considered.)

■ Precautions during programming

- Set the target value and movement amount to be within the following range.
-8,388,608 to +8,388,607
When using this instruction in combination with other positioning instructions such as F171, also set the target values for those instructions to be within the above range.
- When using this instruction for a purpose for which high accuracy is required, confirm the operation using a real machine.
- When describing the same channel in both the normal program and the interrupt program, be sure to program not to execute them simultaneously.
- Select "Pulse output" for the channel setting corresponding to the system register no. 402.
- By performing the rewriting during RUN while outputting pulses, more pulses than the setting may be output.

Info.

- For details of the allocations of I/O and flags, refer to "Allocation of Memory Areas".

REFERENCE

[11.2.2 When Using Pulse Output Function \(FP-X Compatible Instruction Mode\)](#)

8 Troubleshooting

8.1 Self-diagnosis Function.....	8-2
8.1.1 Operation Monitor LEDs of Control Unit	8-2
8.1.2 Operation Mode When an Error Occurs	8-2
8.2 What to Do If an Error Occurs.....	8-4
8.2.1 ERR / ALM LED Flashes	8-4
8.2.2 What to Do When Positioning Error Occurs.....	8-5
8.2.3 Motor Does Not Rotate/Move (Output LED Flashes or is ON)	8-7
8.2.4 Motor Does Not Rotate/Move (Output LED is OFF)	8-7
8.2.5 Rotation/Movement Direction is Reversed.....	8-8

8.1 Self-diagnosis Function

8.1 Self-diagnosis Function

8.1.1 Operation Monitor LEDs of Control Unit

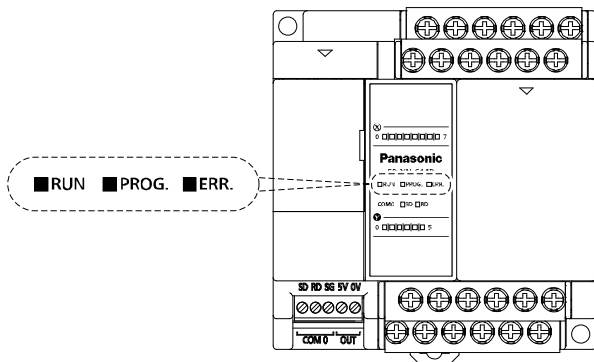

- The Control Unit has a self-diagnostic function which identifies errors and stops operation if necessary.
- When an error occurs, the status of the operation monitor LEDs on the Control Unit vary, as shown in the table below.

■ LEDs related to self-diagnostic errors

	LED display			Description	Operation status
	RUN	PROG.	ERR.		
In normal condition	ON	OFF	OFF	Normal operation	Operating
	OFF	ON	OFF	Program mode LED does not flash even if the forcing output is performed in program mode.	Stop
	Flashes	Flashes	OFF	Forcing input/output in Run mode "RUN" and "PROG." LEDs flash alternately.	Operating
In abnormal condition	ON	OFF	Flashes	Self-diagnostic error (During operation)	Operating
	OFF	ON	Flashes	Self-diagnostic error (During stop)	Stop
	OFF	ON	ON	System watchdog timer has been activated	Stop

8.1.2 Operation Mode When an Error Occurs

- Normally, when an error occurs, the operation stops.
- For some errors, the user may select whether operation is to be continued or stopped by setting the system registers.

■ "PLC Configuration" dialog box of FPWIN GR7

To specify the steps to be taken by the FPWIN GR7 if a PLC error occurs, select **Option (O)>PLC System register settings** from the menu bar, and click on the "Action on Error" tab. The screen shown below is displayed.

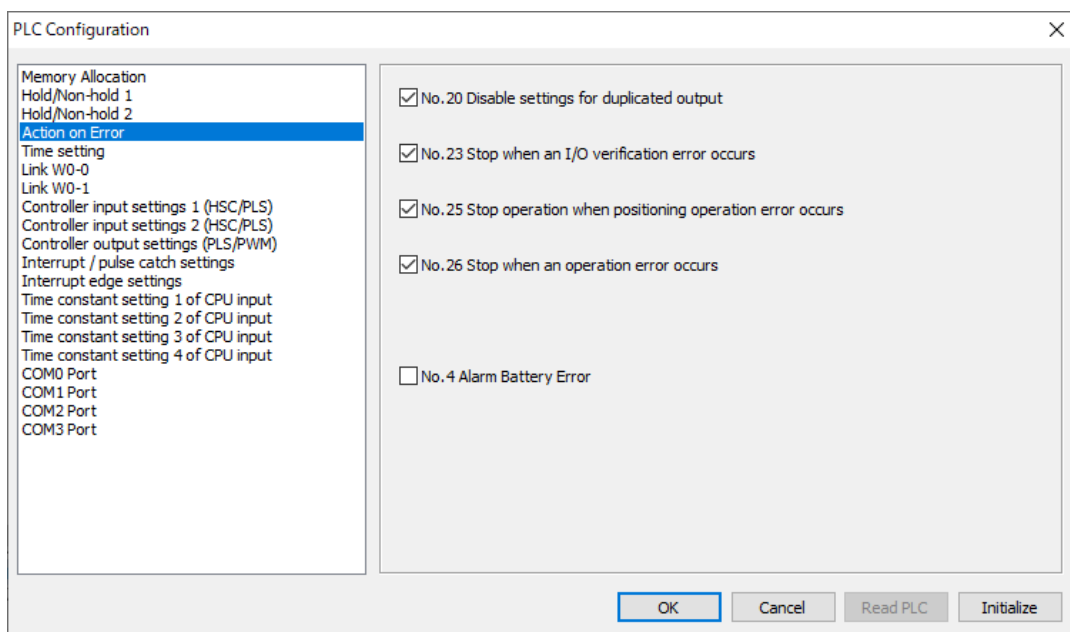
**i Info.**

- When the checkbox of the system register no. 25 "Stop operation when positioning operation error occurs" is unchecked, only the operation of the axis in which the positioning error occurs stops and the operations of other axes continue.

8.2 What to Do If an Error Occurs

8.2 What to Do If an Error Occurs

8.2.1 ERR / ALM LED Flashes

■ Situation

A syntax error or self-diagnostic error has occurred. The following shows the procedure when a positioning error has occurred.

■ Solution

1. Check the error code using the programming tool.

If a PLC error occurs during programming or debugging, the "Status Display" dialog box will appear automatically.

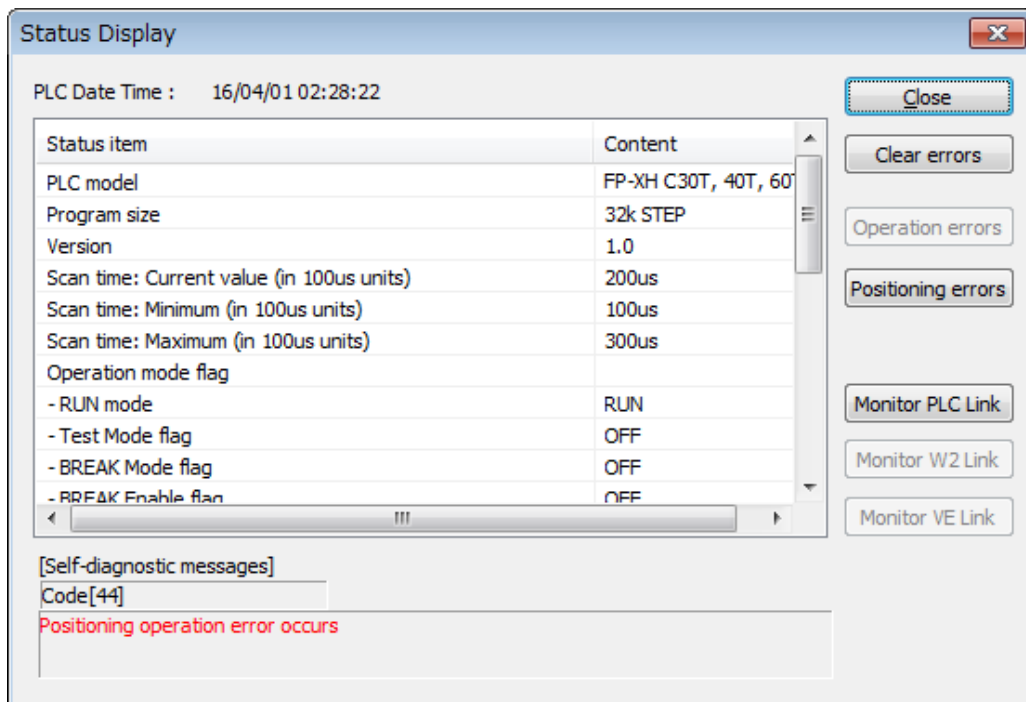

2. In the case of the positioning operation error, press the [Positioning errors] button. The channel number where the positioning error has occurred and the error code occurred when using the table setting mode appears.

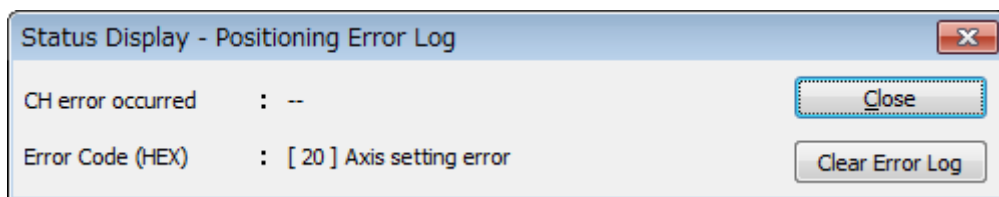

Press the [Clear Error Log] button to clear the positioning error log.

3. Press the [Close] button.

It returns to the "Status Display" dialog box.

4. Press the [Clear errors] button.
The display of the self-diagnostic error message will be cleared.
5. Correct the positioning parameters or positioning tables according to the positioning error code confirmed in step 2.
6. Download the corrected positioning parameters or positioning table data.

Error codes and how to handle them

Error code	Situation	Solution
1 to 9	Syntax error occurs.	<ul style="list-style-type: none"> • Change to PROG. mode and clear the error. • Execute a total-check function using FPWIN GR7 to determine the location of the syntax error and correct the program.
20 or more	Self-diagnostic error occurs.	<ul style="list-style-type: none"> • For errors other than the positioning error, refer to 12.7 <i>Error Code List</i> in the <i>FP-XH User's Manual (Basic)</i> and correct settings and programs. • Use the programming tool in PROG. mode to clear the error.

i Info.

- In the case of an error code 43 or higher, the error can be cleared by pressing the [Clear errors] button in the "Status Display" dialog box. In the PROG. mode, the power supply can be turned OFF and then ON again to clear the error, but all of the contents of the operation memory except hold type data will be cleared.
- When the positioning error (error code 44) occurs, the detailed information on the error can be confirmed. Press the [Positioning errors] button to check the error code.
- When an operation error (error code 45) occurs, the address at which the error occurred is stored in special data registers DT90017 and DT90018. If this happens, click on the [Operation errors] button in the dialog box and confirm the address at which the error occurred before canceling the error.
- For the solution of the positioning error (error code 44), refer to the following.

8.2.2 What to Do When Positioning Error Occurs

The following are the solutions when the self-diagnostic error (error code 44: positioning error) occurs.

■ Positioning error code

Error code	Error name	Description	Operation when an error occurs and solution
10H	Limit + signal detection	The input on the plus side of the limit turned on. (Note 1)	The operation stops in the limit stop time specified in the axis setting area. After the stop, execute the home return or JOG operation in the reverse direction.
11H	Limit - signal detection	The input on the minus side of the limit turned on. (Note 1)	
12H	Limit signal error	Both inputs on the plus and minus sides of the limit turned on.	

8.2 What to Do If an Error Occurs

Error code	Error name	Description	Operation when an error occurs and solution
			Correct the setting of the parameter.
20H	Axis setting error	The axis setting is incorrect.	Each control operation does not start. Correct the setting of the parameter.
21H	Limit stop deceleration time error	The set value of the limit stop deceleration time is out of the range.	
22H	Emergency stop deceleration time error	The set value of the emergency stop deceleration time is out of the range.	
23H	Startup speed error	The set value of the startup speed is out of the range.	
24H	Home return setting code error	The set value of the home return setting code is out of the range.	
25H	Home return target speed error	The set value of the home return target speed is out of the range.	
26H	Home return acceleration time error	The set value of the home return acceleration time is out of the range.	
27H	Home return deceleration time error	The set value of the home return deceleration time is out of the range.	
28H	Home return creep speed error	The set value of the home return creep speed is out of the range.	
29H	Home return direction error	The set value of the home return direction is out of the range.	
30H	JOG operation target speed error	The set value of the JOG operation target speed is out of the range.	
31H	JOG operation acceleration time error	The set value of the JOG operation acceleration time is out of the range.	
32H	JOG operation deceleration time error	The set value of the JOG operation deceleration time is out of the range.	
41H	Table setting error	The combination of tables is incorrect.	
42H	Operation pattern error	The set value of the operation pattern is incorrect.	
43H	Positioning acceleration time error	The set value of the positioning acceleration time is out of the range.	
44H	Positioning deceleration time error	The set value of the positioning deceleration time is out of the range.	
45H	Positioning target speed error	The set value of the positioning target speed is out of the range.	
46H	Positioning movement amount error	The set value of the positioning movement amount is out of the range.	
47H	Dwell time error	The set value of the dwell time is out of the range.	
48H	J point control setting error	The J-point control is set on the interpolation axis table.	
60H	Repeat operation dwell time setting error	The dwell time of the E table which performs repetitive operations is 0 ms.	

(Note 1) The error occurs only when the condition of the limit stop is satisfied.

■ Error code 41: Occurrence condition of table setting error

- The last table of the positioning setting tables is not the E point. (e.g. The P point, C point and J point are set continuously.)
- The control method of the J-point control table is absolute.
- The tables whose control method is absolute are set repeatedly.
- The opposite pulse output directions (forward/reverse) are set on the consecutive tables of P +E points.
- Axes to which the interpolation operation setting is made are selected for the F383 simultaneous start instruction.

8.2.3 Motor Does Not Rotate/Move (Output LED Flashes or is ON)

■ Solution 1: For servo motor

Check to make sure the servo on input is set to “ON”.

■ Solution 2

Check to make sure the power supplies for the servo amplifier and motor driver are ON.

■ Solution 3

Check to make sure the servo amplifier and motor driver are connected to the unit correctly.

■ Solution 4

Check to make sure the settings for the pulse output method (CW/CCW method or Pulse/Sign method) are appropriate.

8.2.4 Motor Does Not Rotate/Move (Output LED is OFF)

■ Solution

Review the program.

Info.

Point to check

- Check to make sure the I/O numbers are appropriate.
- Check non-rewriting of the start flag in the program.
- Check the input valid logic of the over limit switch. In this case, the error LED flashes.

8.2.5 Rotation/Movement Direction is Reversed

■

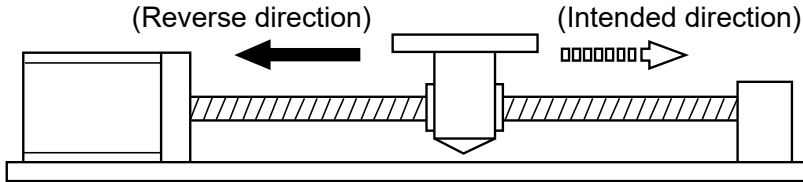

■ Solution 1

Check to make sure the servo amplifier and motor driver are connected to the unit correctly.

i Info.

Point to check

Check to make sure the CW/CCW output or the Pulse/Sign output is connected to the pertinent input of the servo amplifier and motor driver.

■ Solution 2

Change the pulse output rotation direction of the parameters for each axis, and set it to the reverse direction.

9 PWM output function

9.1 PWM output function.....	9-2
9.1.1 Overview of PWM Output Function.....	9-2
9.1.2 System Register Settings.....	9-2
9.1.3 [F173 PWMH] PWM Output Instruction (Frequency Specification) .	9-4
9.1.4 [F173 PWMH] PWM Output Instruction (Control Code Specification)	9-5

9.1 PWM output function

9.1 PWM output function

9.1.1 Overview of PWM Output Function

The pulse output of an arbitrary duty ratio can be performed.

- If the pulse width value is increased:

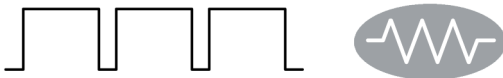

- If the pulse width value is decreased:

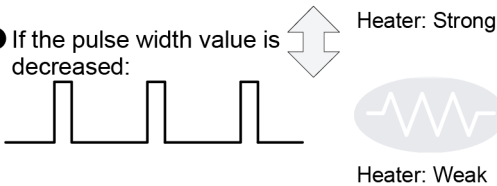

■ Comparison of functions and performances

Channel no.	Transistor output type		Relay output type		
	Output no.	Control active flag	Output no.	Control active flag	Installation position
CH0	Y0	R911C	Y100	R911C	Cassette mounting part 1
CH1	Y2	R911D	Y200	R911D	Cassette mounting part 2
CH2	Y4	R911E	-	-	
CH3	Y6	R911F	-	-	

(Note 1) Functions, channel numbers and I/O numbers used are set in the tool software.

(Note 2) I/O numbers used for each function should be allocated so that they do not overlap.

9.1.2 System Register Settings

Functions to be used are allocated in the "System register settings" dialog box. The following procedure is explained on the condition that the FPWIN GR7 has already started.

1.2 Procedure

1. Select **Options>System register settings** from the menu bar.
The "PLC Configuration" dialog box appears.
2. Select "Controller output setting (PLS / PWM)" from the left pane.
The setting menu for the system register "No. 402" appears.

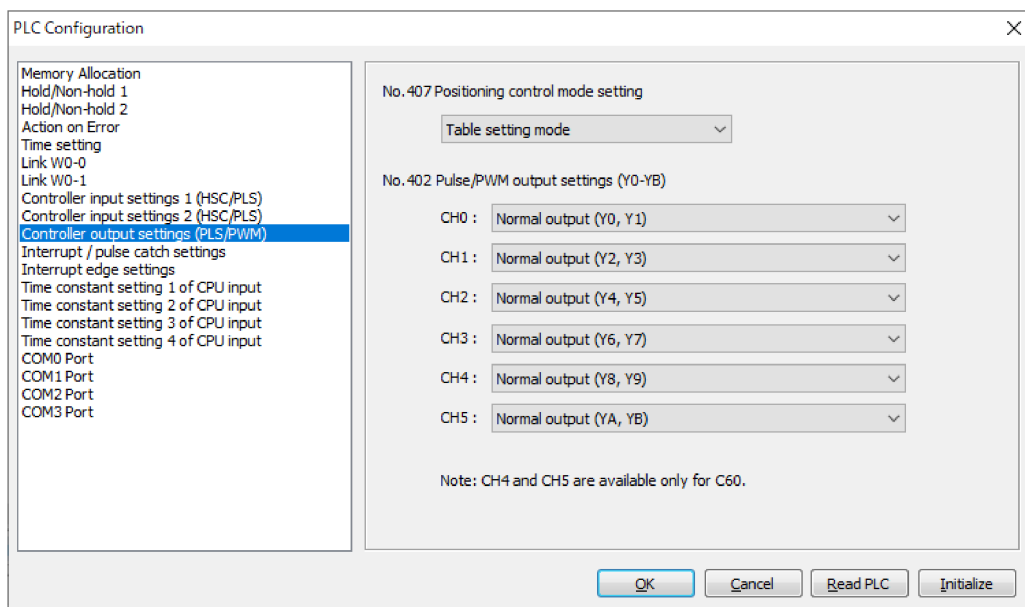

3. Change the settings for the channels used for the PWM output.

4. Press the [OK] button.

The screen returns to the ladder edit screen. The settings will be downloaded to the PLC together with programs and comments.

System register relating to PWM output

Classification	No. and setting item	Settings	
Transistor output type Control Unit output settings (PLS / PWM)	402 Pulse / PWM output setting (Y0 to YB)	CH0	Set the PWM output (Y0) and normal output (Y1).
		CH1	Set the PWM output (Y2) and normal output (Y3).
		CH2	Set the PWM output (Y4) and normal output (Y5).
		CH3	Set the PWM output (Y6) and normal output (Y7).
		CH4	The PWM output cannot be allocated.
		CH5	
Relay output type Pulse I/O setting (PLS / PWM)	Pulse output setting (Y100 and Y101)	CH0	Set the PWM output (Y100) and normal output (Y101).
	Pulse output setting (Y200 and Y201)	CH1	Set the PWM output (Y200) and normal output (Y201).

(Note 1) Displayed items and ranges vary depending on models of the Control Unit.

(Note 2) Select "Normal output" for the output that is not used for the pulse output function or PWM output function.

9.1 PWM output function

9.1.3 [F173 PWMH] PWM Output Instruction (Frequency Specification)

The PWM output is performed according to the set parameters.

■ Instruction format

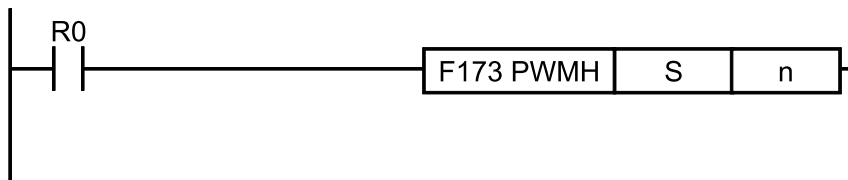

■ Operand

Operand	Settings	
	Starting address of the memory area storing the parameters of the PWM output.	
S	S	Specify the control code HFF.
	S+1	Specify the output frequency in 2-word 32-bit data.
	S+2	Setting range: K1 to K100000 (1 Hz to 100 kHz: in 1 Hz increments)
	S+3	Duty ratio (Resolution of 1000 or 100) For the output frequencies K1 to K70000, Setting range: K0 to K1000 (0.0% to 100.0%) For the output frequencies K70001 to K100000, Setting range: K0 to K1000 (0% to 100%)
n	Channel nos. used for PWM output: K0 (CH0: Y0), K1 (CH1: Y2), K2 (CH3: Y4), K3 (CH4: Y6)	

■ Memory area type that can be specified

Operand	WX	WY	WR	WL	SV	EV	DT	LD	I	Constant		Index modifier
										K	H	
S	-	-	-	-	-	-	•	-	-	-	-	•
n	-	-	-	-	-	-	-	-	-	•	•	-

■ Outline of operation

- The PWM output is performed from a specified output. The output is performed when the execution condition is ON.
- The output frequency and duty ratio are specified in the operands [S1+1] to [S1+3].

■ Precautions during programming

- This instruction cannot be executed when a control active flag corresponding to each channel is ON.
- The duty may be different from the set ratio according to the load voltage and load current especially in the vicinity of minimum and maximum values. The duty can be changed for each scan. However, the control code cannot be changed during the execution of an instruction.

- When rewriting during RUN is performed during the operation, the PWM output stops while a program is being rewritten.

■ **Example of program**

The following sample shows the program for performing the PWM output with 10 kHz and the duty ratio of 50% from CH0 (Y0).

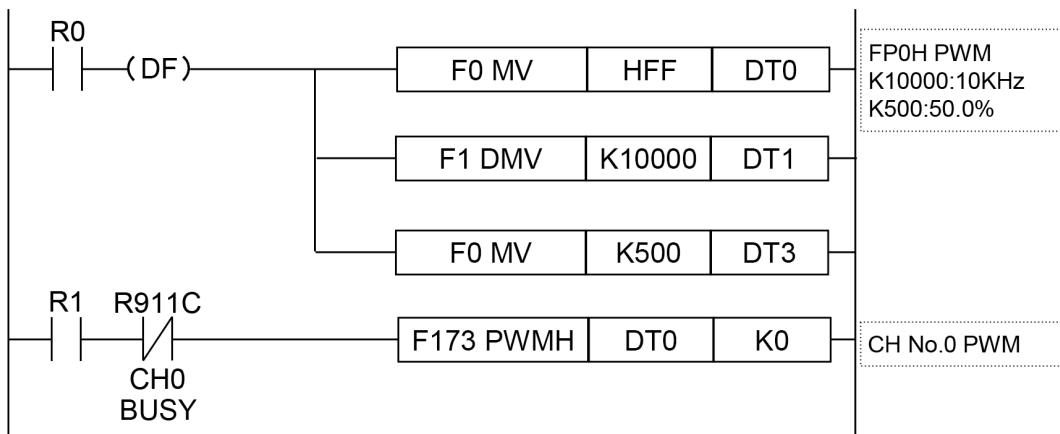

Info.

- For details of the allocations of I/O and flags, refer to “Allocation of Memory Areas”.

REFERENCE

11.2.3 When Using PWM Output Function

9.1.4 [F173 PWMH] PWM Output Instruction (Control Code Specification)

The PWM output is performed according to the set parameters.

■ **Instruction format**

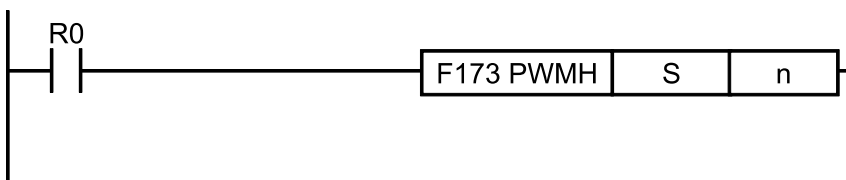

■ **Operand**

Operand	Settings
S	Starting address of the memory area storing the parameters of the PWM output.
	S Specify the control code. K0 to K30

9.1 PWM output function

Operand	Settings
	S+1 Duty ratio (Resolution of 1000 or 100) For the control codes K0 to K27, Setting range: K0 to K1000 (0.0% to 100.0%) For the control codes K28 to K30, Setting range: K0 to K1000 (0% to 100%)
n	Channel nos. used for PWM output: K0 (CH0: Y0), K1 (CH1: Y2), K2 (CH3: Y4), K3 (CH4: Y6)

Memory area type that can be specified

Operand	WX	WY	WR	WL	SV	EV	DT	LD	I	Constant		Index modifier
										K	H	
S	-	-	-	-	-	-	•	-	-	-	-	•
n	-	-	-	-	-	-	-	-	-	•	•	-

Outline of operation

- The PWM output is performed from a specified output. The output is performed when the execution condition is ON.
- The output frequency and cycle are determined by a specified control code. The duty ratio is specified in the operand [S1+1].

Precautions during programming

- This instruction cannot be executed when a control active flag corresponding to each channel is ON.
- The duty may be different from the set ratio according to the load voltage and load current especially in the vicinity of minimum and maximum values. The duty can be changed for each scan. However, the control code cannot be changed during the execution of an instruction.
- When rewriting during RUN is performed during the operation, the PWM output stops while a program is being rewritten.

Control code

S	Frequency (Hz)	Cycle (ms)	Resolution	S	Frequency (Hz)	Cycle (ms)	Resolution n
K0	1.5	666.67	1000	K16	2000.0	0.50	1000
K1	2.0	500.00		K17	3000.0	0.33	
K2	4.0	250.00		K18	6000.0	0.17	
K3	6.0	166.67		K19	12500.0	0.08	
K4	8.0	125.00		K20	15000.0	0.067	
K5	10.0	100.00		K21	20000.0	0.050	
K6	20.0	50.00		K22	25000.0	0.040	
K7	50.0	20.00		K23	30000.0	0.033	
K8	100.0	10.00		K24	40000.0	0.025	
K9	200.0	5.00		K25	50000.0	0.020	
K10	400.0	2.50	K26	60000.0	0.017		

S	Frequency (Hz)	Cycle (ms)	Resolution	S	Frequency (Hz)	Cycle (ms)	Resolution
K11	500.0	2.00		K27	70000.0	0.0143	100
K12	700.0	1.48		K28	80000.0	0.0125	
K13	1000.0	1.00		K29	90000.0	0.0111	
K14	1300.0	0.77		K30	100000.0	0.010	
K15	1600.0	0.625		-			

■ Example of program

The following sample shows the program for performing the PWM output with 1 kHz and the duty ratio of 50% from CH0 (Y0).

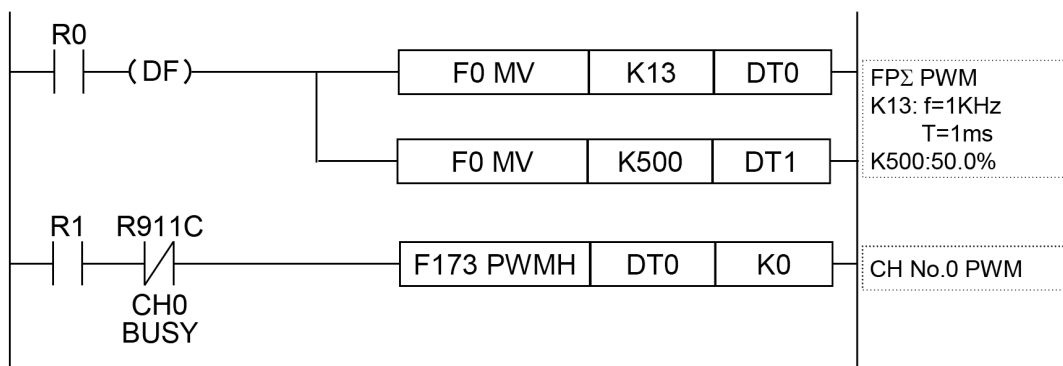

i Info.

- For details of the allocations of I/O and flags, refer to “Allocation of Memory Areas”.

— REFERENCE —

11.2.3 When Using PWM Output Function

(MEMO)

10 High-speed Counter Function

10.1 Overview of High-speed Counter Function	10-2
10.1.1 Overview of High-speed Counter Function	10-2
10.1.2 Counting Range and Elapsed Value (Current Value) Area	10-2
10.1.3 Areas Used For High-speed Counter Function	10-3
10.1.4 Input Mode Type	10-4
10.1.5 Minimum Input Pulse Width	10-5
10.2 System Register Settings.....	10-7
10.2.1 System Register Settings (Transistor Output Type).....	10-7
10.2.2 System Register Settings (Relay Output Type)	10-8
10.3 High-speed Counter Instruction	10-11
10.3.1 [F0 MV] High-speed Counter Control Instruction	10-11
10.3.2 [F1 DMV] Elapsed Value Write / Read Instruction	10-12
10.3.3 [F166 HC1S] High-speed Counter Target Value Match ON Instruction and [F167 HC1R] High-speed Counter Target Value Match OFF Instruction	10-14
10.3.4 Sample Program (Positioning Operation With Inverter: Single- Speed)	10-15
10.3.5 Sample Program (Positioning Operation With Inverter: Double- Speed)	10-17
10.4 High-speed Counter Cam Control Instruction	10-20
10.4.1 [F165 CAM0] High-speed Counter Cam Control Instruction	10-20
10.4.2 Sample Program (Upper Limit Control, Reset, Addition)	10-24
10.4.3 Sample Program (Upper Limit Control, Instruction Clear, Addition).....	10-26
10.4.4 Sample Program (Upper Limit Control, Subtraction)	10-28
10.5 Interrupt Program Activation	10-31
10.5.1 Overview of Function	10-31
10.5.2 Interrupt Activation When F165 (CAM0) is Executed	10-32

10.1 Overview of High-speed Counter Function

10.1 Overview of High-speed Counter Function

10.1.1 Overview of High-speed Counter Function

- This function allows the counting of input signals from external devices such as a sensor and encoder at high speed .
- Dedicated instructions (F166 and F167) are provided for turning ON or OFF arbitrary outputs (Y0 to Y29F) in the interrupt processing when the elapsed value matches the target value. The output turned ON or OFF by an instruction is used by presetting with an instruction such as the SET / RET instructions. The instruction (F165) which enables the cam output up to 32 points to be acquired according to the elapsed value.
- Channels and inputs to be used are specified by system registers. The output when the values match is specified by the operand of the instruction.

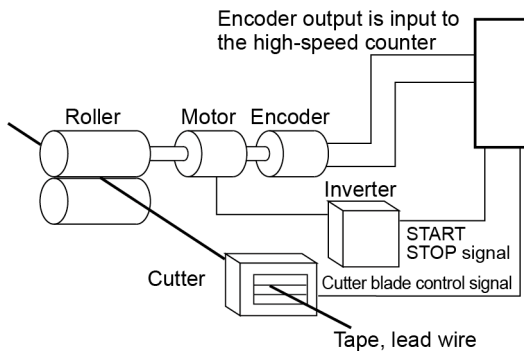

10.1.2 Counting Range and Elapsed Value (Current Value) Area

- The elapsed value of the high-speed counter is stored in a special data register as 2-word 32-bit data.
- The elapsed value area will be reset when the power supply turns off. It will be held when switching the mode from RUN to PROG.
- The high-speed counter is a ring counter. When the counted value exceeds the maximum value, it returns to the minimum value. When the counted value exceeds the minimum value, it returns to the maximum value.

■ Counting range of elapsed value (current value) area

Section	Range	
High-speed counter control	K-2,147,483,648 to K2,147,483,647	

10.1.3 Areas Used For High-speed Counter Function

The usable combinations vary according to the unit type.

■ List of used areas

Channel No.	Transistor output type		Relay output type			Control active flag	Elapsed value area	Target value area
	Input no.		Input no.		Installation position			
	Single-phase	2-phase	Single-phase	2-phase				
CH0	X0	X0, X1	X0	X0, X1	Control Unit input	R9110	DT90300 DT90301	DT90302 DT90303
CH1	X1	-	X1	-	Control Unit input	R9111	DT90304 DT90305	DT90306 DT90307
CH2	X2	X2, X3	X2	X2, X3	Control Unit input	R9112	DT90308 DT90309	DT90310 DT90311
CH3	X3	-	X3	-	Control Unit input	R9113	DT90312 DT90313	DT90314 DT90315
CH4	X4	X4, X5	X4	X4, X5	Control Unit input	R9114	DT90316 DT90317	DT90318 DT90319
CH5	X5	-	X5	-	Control Unit input	R9115	DT90320 DT90321	DT90322 DT90323
CH6	X6	X6, X7	X6	X6, X7	Control Unit input	R9116	DT90324 DT90325	DT90326 DT90327

10.1 Overview of High-speed Counter Function

Channel No.	Transistor output type		Relay output type			Control active flag	Elapsed value area	Target value area
	Input no.		Input no.		Installation position			
	Single-phase	2-phase	Single-phase	2-phase				
CH7	X7	-	X7	-	Control Unit input	R9117	DT90328 DT90329	DT90330 DT90331
CH8	-	-	X100	X100 X101	Cassette mounting part 1	R9118	DT90332 DT90333	DT90334 DT90335
CH9	-	-	X101	-	Cassette mounting part 1	R9119	DT90336 DT90337	DT90338 DT90339
CHA	-	-	X200	X200 X201	Cassette mounting part 2	R911A	DT90340 DT90341	DT90342 DT90343
CHB	-	-	X201	-	Cassette mounting part 2	R911B	DT90344 DT90345	DT90346 DT90347

(Note 1) Functions, channel numbers and I/O numbers used are set in the tool software.

(Note 2) I/O numbers used for each function should be allocated so that they do not overlap. Refer to "1.2 Restrictions on Combinations and Functions".

(Note 3) In the case of the input on the relay output type Control Unit, there is no combination of the individual input and the direction distinction input.

i Info.

- The performance such as the maximum counting speed varies depending on the combination used. Refer to Performance Specifications.

10.1.4 Input Mode Type

■ Input modes and count operation

Mode	Range
Addition input	<p>X0 (X1~X7)</p>
Subtraction input	<p>X0 (X1~X7)</p>

10.1 Overview of High-speed Counter Function

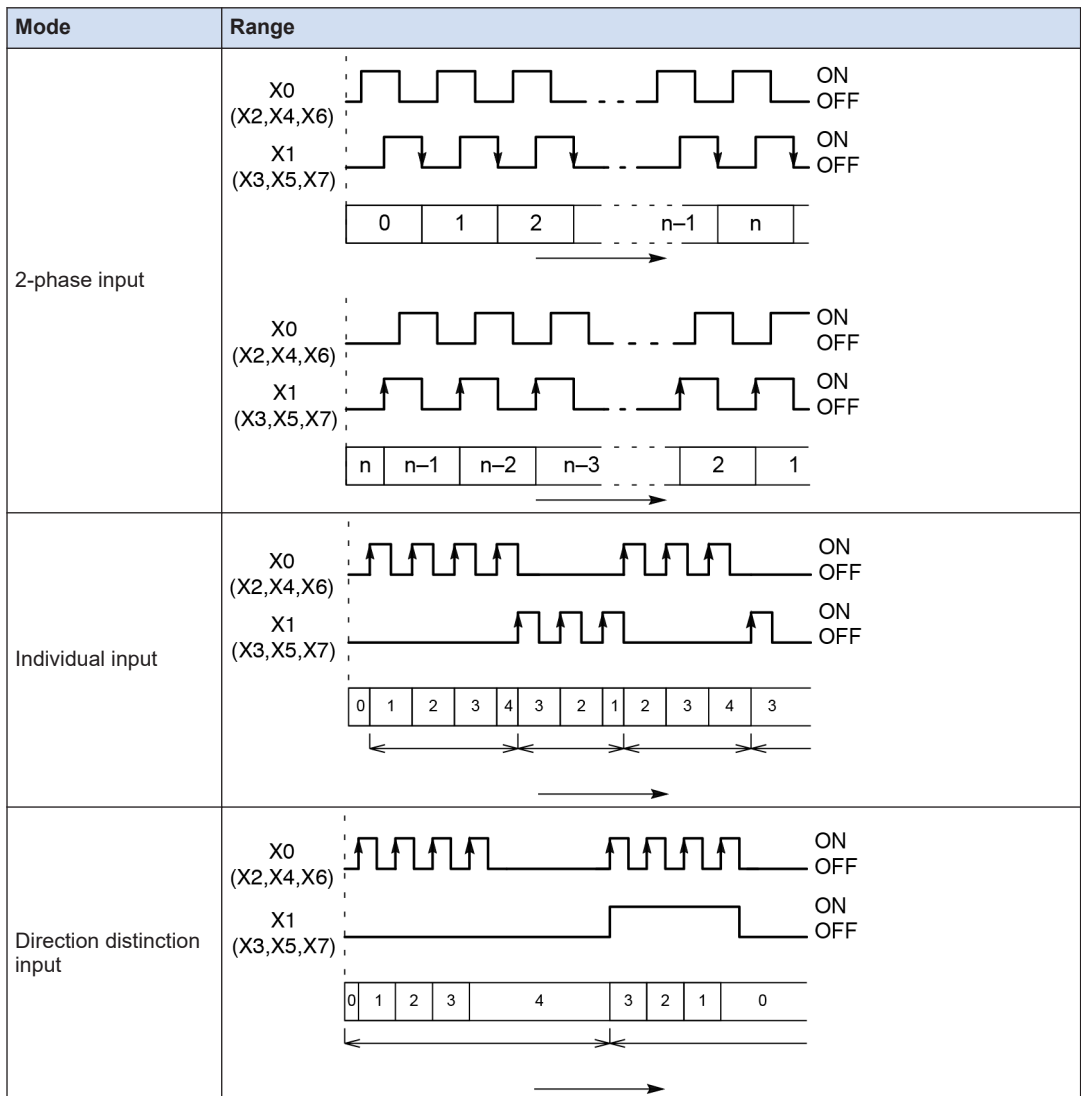

(Note 1) In the case of the input on the relay output type Control Unit, there is no combination of the individual input and the direction distinction input.

10.1.5 Minimum Input Pulse Width

For the period T, the following minimum input pulse width is required.

10.1 Overview of High-speed Counter Function

■ Min. input pulse width

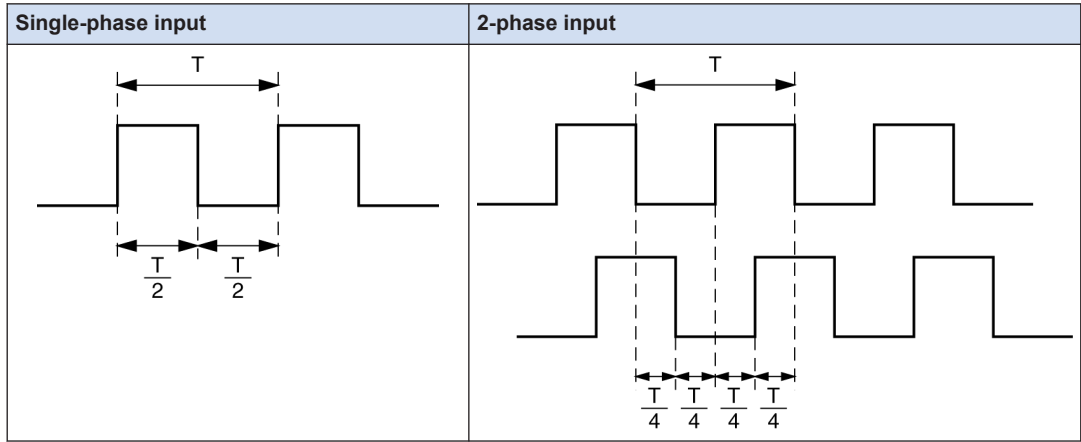

10.2 System Register Settings

10.2.1 System Register Settings (Transistor Output Type)

Functions to be used are allocated in the "System register settings" dialog box. The following procedure is explained on the condition that the FPWIN GR7 has already started.

1 2 Procedure

1. Select **Options>System register settings** from the menu bar.
The "PLC Configuration" dialog box appears.
2. Select "Controller input setting 1 (HSC / PLS)" or "Controller input setting 2 (HSC / PLS)" from the left pane.
The setting menu for the system register "No. 400" or "No. 401" appears.
3. Change the settings for the channels used for the high-speed counter.
The following figure shows the case when 2-phase input (X0, X1) is allocated to CH0.

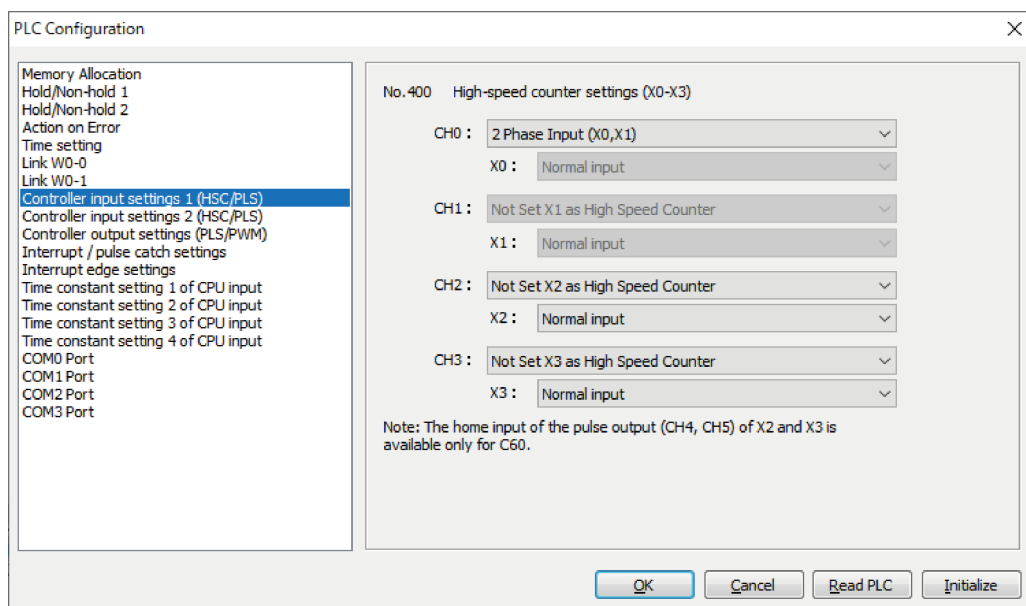

4. Press the [OK] button.
The screen returns to the ladder edit screen. The settings will be downloaded to the PLC together with programs and comments.

System register relating to high-speed counter output

Classification	No. and setting item		Settings
Control Unit input settings 1 (HSC / PLS)	400 High-speed counter setting (X0 to X3)	CH0	Select either Addition input (X0), Subtraction input (X0), 2-phase input (X0, X1), Individual input (X0, X1), or Direction distinction input (X0, X1).

10.2 System Register Settings

Classification	No. and setting item	Settings	
		CH1	Select either Addition input (X1) or Subtraction input (X1).
		CH2	Select either Addition input (X2), Subtraction input (X2), 2-phase input (X2, X3), Individual input (X2, X3), or Direction distinction input (X2, X3).
		CH3	Select either Addition input (X3) or Subtraction input (X3).
Control Unit input settings 2 (HSC / PLS)	401 High-speed counter pulse output setting (X4 to X7)	CH4	Select either Addition input (X4), Subtraction input (X4), 2-phase input (X4, X5), Individual input (X4, X5), or Direction distinction input (X4, X5).
		CH5	Select either Addition input (X5) or Subtraction input (X5).
		CH6	Select either Addition input (X6), Subtraction input (X6), 2-phase input (X6, X7), Individual input (X6, X7), or Direction distinction input (X6, X7).
		X6	To use the external reset input, select the reset input of high-speed counter CH0.
		CH7	Select either Addition input (X7) or Subtraction input (X7).
		X7	To use the external reset input, select the reset input of high-speed counter CH2.

(Note 1) Displayed items and ranges vary depending on models of the Control Unit.

(Note 2) Select "Not set XX as High Speed Counter" for the input that is not used for the high-speed counter function.

10.2.2 System Register Settings (Relay Output Type)

Functions to be used are allocated in the "System register settings" dialog box. The following procedure is explained on the condition that the FPWIN GR7 has already started.

1.2 Procedure

1. Select **Options>System register settings** from the menu bar.
The "PLC Configuration" dialog box appears.
2. Select "Pulse I/O cassette setting (HSC / PLS)" or "Controller input setting (HSC / PLS)" from the left pane.
The setting menu for the system register "No. 400 to 401" or "No. 402" appears.
3. Change the settings for the channels used for the high-speed counter.
The following figure shows the case when the Control Unit input setting (HSC) is selected and 2-phase input (X0, X1) is allocated to CH0.

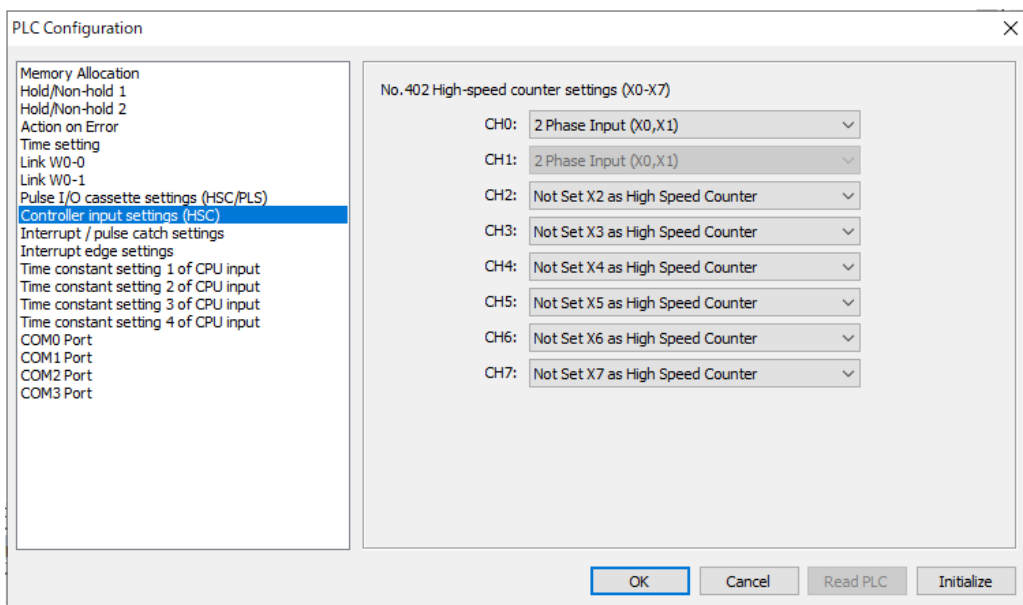

4. Press the [OK] button.

The screen returns to the ladder edit screen. The settings will be downloaded to the PLC together with programs and comments.

System register relating to high-speed counter output

Classification	No. and setting item	Settings	
Pulse I/O cassette setting (HSC / PLS)	400 High-speed counter setting (X100 to X102)	CH8	Select either Addition input (X100), Subtraction input (X100), 2-phase input (X100, X101), Individual input (X100, X101), or Direction distinction input (X100, X101). You can also select a combination with Reset input (X102).
		CH9	Select either Addition input (X101) or Subtraction input (X101). You can also select a combination with Reset input (X102).
	401 High-speed counter setting (X200 to X202)	CHA	Select either Addition input (X200), Subtraction input (X200), 2-phase input (X200, X201), Individual input (X200, X201), or Direction distinction input (X200, X201). You can also select a combination with Reset input (X202).
		CHB	Select either Addition input (X201) or Subtraction input (X201). You can also select a combination with Reset input (X102).
Control Unit input settings (HSC)	402 High-speed counter (X0 to X7)	CH0	Select either Addition input (X0), Subtraction input (X0), or 2-phase input (X0, X1).
		CH1	Select either Addition input (X1) or Subtraction input (X1).
		CH2	Select either Addition input (X2), Subtraction input (X2), or 2-phase input (X2, X3).
		CH3	Select either Addition input (X3) or Subtraction input (X3).

10.2 System Register Settings

Classification	No. and setting item	Settings
	CH4	Select either Addition input (X4), Subtraction input (X4), or 2-phase input (X4, X5).
	CH5	Select either Addition input (X5) or Subtraction input (X5).
	CH6	Select either Addition input (X6), Subtraction input (X6), or 2-phase input (X6, X7).
	CH7	Select either Addition input (X7) or Subtraction input (X7).

(Note 1) Displayed items and ranges vary depending on models of the Control Unit.

(Note 2) Select "Not set XX as High Speed Counter" for the input that is not used for the high-speed counter function.

10.3 High-speed Counter Instruction

10.3.1 [F0 MV] High-speed Counter Control Instruction

Performs the controls such as the software reset, disabling the count and clearing the high-speed counter instruction.

■ Instruction format

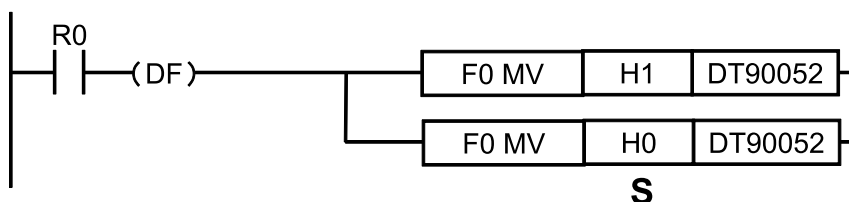

■ Operand

Operand	Settings
S	Area storing the control code of the high-speed counter or constant data

■ Memory area type that can be specified

Operand	WX	WY	WR	WL	SV	EV	DT	LD	I	Constant		Index modifier
										K	H	
S	•	•	•	•	•	•	•	•	•	•	•	•

■ Outline of operation

- Performs the high-speed counter control according to the control code specified by [S].
- This instruction is used when performing the following operations with the high-speed counter.
 1. When performing the software reset
 2. When disabling the count
 3. When disabling the reset input by an external input temporarily
 4. When canceling the control executed by the high-speed counter instruction F165 (CAM0) / F166 (HC1S) / F167 (HC1R) or when clearing the target value match interrupt
- The control codes once written are held until the next writing.
- The control code written by the F0 (MV) instruction is written to the special data register DT90052. At the same time, it is written to the control code monitor area. The written data is the data for lower 8 bits only.

■ Precautions during programming

- The setting of disabling the rest input is valid only when allocating the reset input in the system register.
- In the external reset input setting for the transistor output type, the reset input (X6 or X7) allocated to the Control Unit input is switched between enable and disable. In the reset input setting for the relay output type, the pulse I/O cassette reset input (X102 or X202) allocated

10.3 High-speed Counter Instruction

in the high-speed counter setting of the system register is switched between enable and disable.

■ Allocation of control codes

- The following bits are allocated according to the specified channel and functions

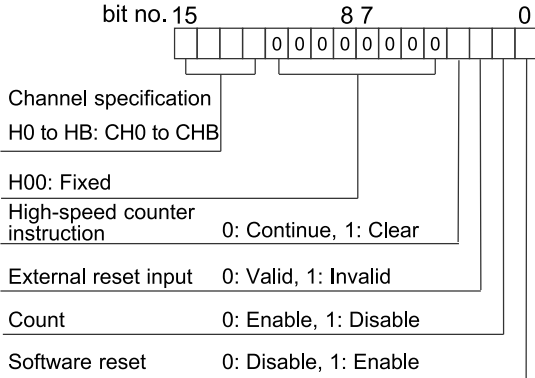

- When controlling the above functions using external inputs, arbitrary inputs can be allocated.

■ Example of program

The following example shows the program for performing the software reset of the high-speed counter CH0 using the input X7.

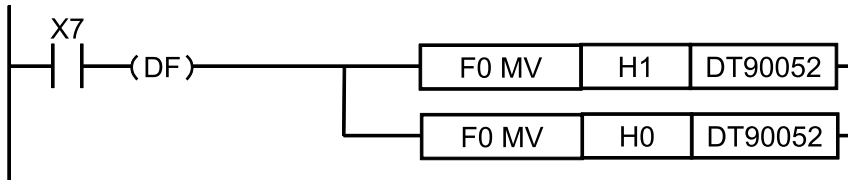

i Info.

- For details of the allocations of I/O and flags, refer to "Allocation of Memory Areas".

REFERENCE

[11.2.4 When Using High-speed Counter Function](#)

10.3.2 [F1 DMV] Elapsed Value Write / Read Instruction

Writes and reads the elapsed value of the high-speed counter.

■ Instruction format

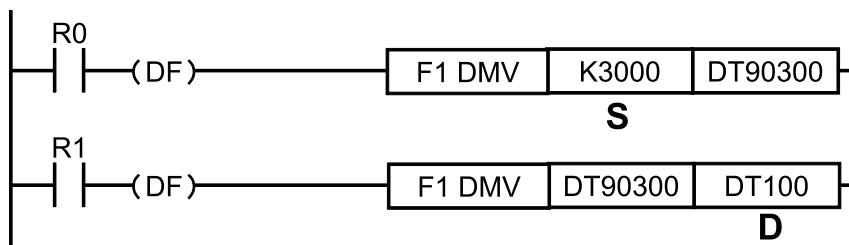

■ Operand

Operand	Settings
S	When setting: Area storing the elapsed value (32-bit) set in the high-speed counter or constant data K-2,147,483,648 to K2,147,483,647
D	When reading: Area reading the elapsed value of the high-speed counter

■ Memory area type that can be specified

Operand	WX	WY	WR	WL	SV	EV	DT	LD	I	Constant		Index modifier
										K	H	
S	•	•	•	•	•	•	•	•	•	•	•	•
D	-	•	•	•	•	•	•	•	•	-	-	•

■ Outline of operation (Reading elapsed value)

- Reads the content of the special data register storing the elapsed value of the high-speed counter and writes to the area specified by [D].

■ Outline of operation (Setting elapsed value)

- At the same time as writing the value to the elapsed value area of the high-speed counter which uses 32-bit data specified by [S], sets it in the elapsed value area of the high-speed counter used within the system.

■ Precautions during programming

- Only F1 (DMV) instruction can perform the writing. The writing cannot be performed by other high-level instructions such as transfer instruction F0 (MV) and arithmetic instructions.
- Specify the memory area of [S] or [D] with the memory area number for the lower 16 bits.

i Info.

- For details of the allocations of I/O and flags, refer to “Allocation of Memory Areas”.

REFERENCE

11.2.4 When Using High-speed Counter Function

10.3 High-speed Counter Instruction

10.3.3 [F166 HC1S] High-speed Counter Target Value Match ON Instruction and [F167 HC1R] High-speed Counter Target Value Match OFF Instruction

Turns ON or OFF the specified output when the elapsed value of the high-speed counter matches the target value set by the operand.

■ Instruction format

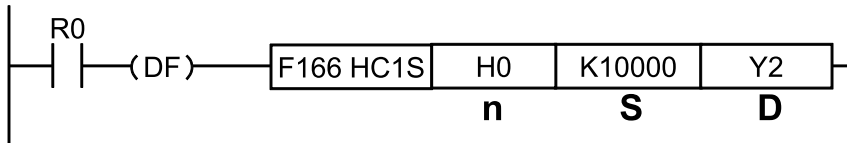

■ Operand

Operand	Settings
n	Target channel number of the high-speed counter for the match output
S	Target value data of the high-speed counter or the starting number of the area storing data
D	Output coil which turns ON or OFF when the values match (Y0 to Y29F)

■ Memory area type that can be specified

Operand	WX	WY	WR	WL	SV	EV	DT	LD	I	Constant		Index modifier
										K	H	
n	-	-	-	-	-	-	-	-	-	•	•	-
S	•	•	•	•	•	•	•	•	•	•	•	•
D	-	-	-	-	-	-	-	-	-	-	-	-

■ Outline of operation

- Sets the value specified by [S] as the target value of the high-speed counter, and controls the specified output [Yn] when the elapsed value matches the target value. This operation is executed as an interrupt processing.
- In the case of [F166 HC1S] instruction, the output turns ON from OFF. In the case of [F167 HC1R] instruction, the output turns OFF from ON.
- Stores the value of [S] in the target value area when the instruction is executed.
- Clears the setting of the target value and the control of the target value match output when the value matches the target value.
- For resetting the output turned ON/OFF when the values match, use the RST instruction or F0 (MV) instruction, or use the F166 (HC1R) instruction and F167 (HC1R) instruction in a pair.

■ Example of program

The following example shows the program for setting the output Y0 when the elapsed value of the high-speed counter CH0 matches K10000.

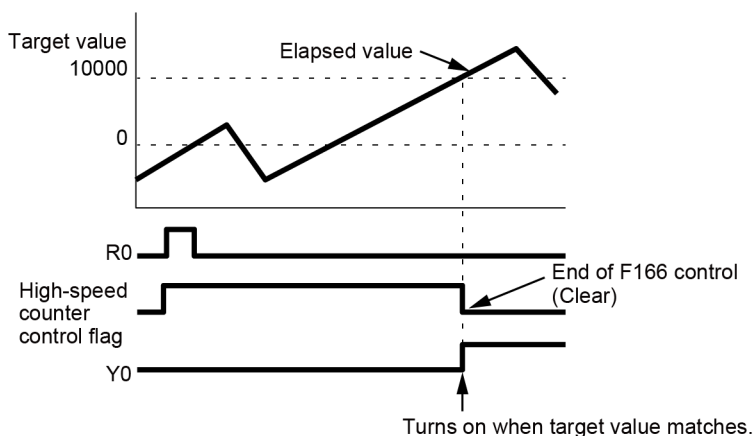
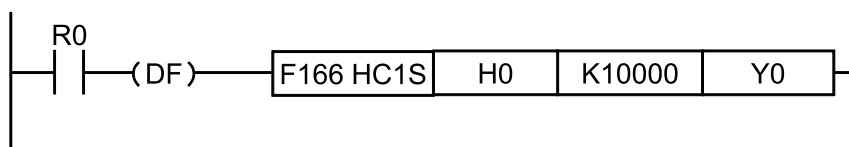

■ Precautions during programming

- The high-speed counter control active flag turns ON until the value matches the target value after the execution condition of the instruction has turned ON. During this processing, the high-speed counter instruction F165 (CAM0) / F166 (HC1S) / F167 (HC1R) cannot be executed for the high-speed counter of the same channel.
- When the hardware reset is performed before the elapsed value matches the target value, the elapsed value will be reset. However, the settings of the target value and the target value match output will not be cleared.
- For the output Y specified for the target value match output, it is not checked whether the output is overlapped with the OT, KP and other high-level instructions.
- When describing the same channel in both the normal program and the interrupt program, be sure to program not to execute them simultaneously.

i Info.

- For details of the allocations of I/O and flags, refer to "Allocation of Memory Areas".

REFERENCE

11.2.4 When Using High-speed Counter Function

10.3.4 Sample Program (Positioning Operation With Inverter: Single-Speed)

Counts the feedback signals from the encoder with the high-speed counter. The operation of the inverter stops when the count value reaches 5000.

10.3 High-speed Counter Instruction

■ Wiring example

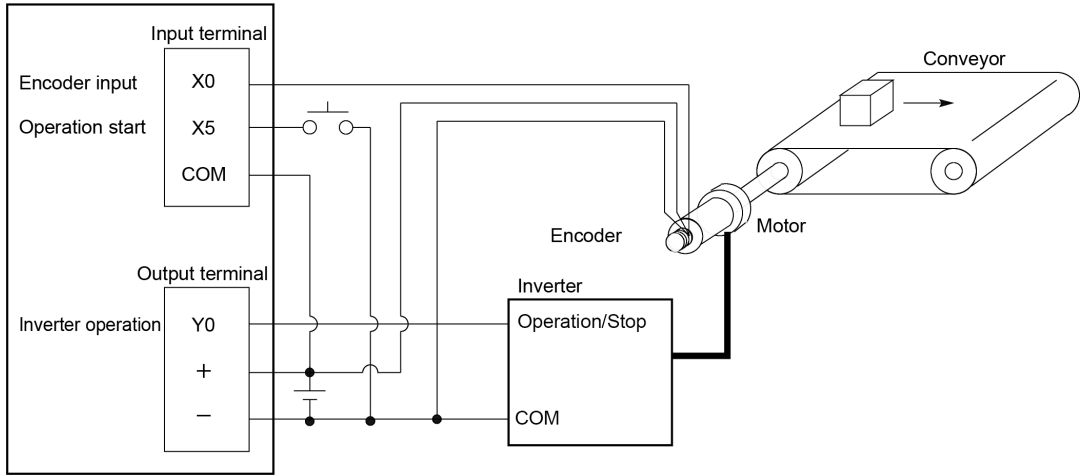

■ Operation chart

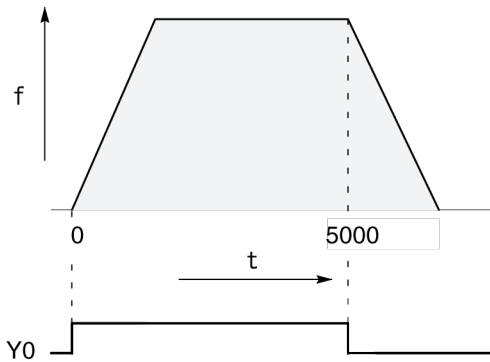

■ I/O allocation table

I/O No.	Description	I/O No.	Description
X0	Encoder input	R100	Positioning operation is running
X5	Operation start signal	R101	Positioning operation starts
Y0	Inverter operation signal	R102	Positioning done pulse
-		R9110	High-speed counter CH0 control active flag

■ Sample program

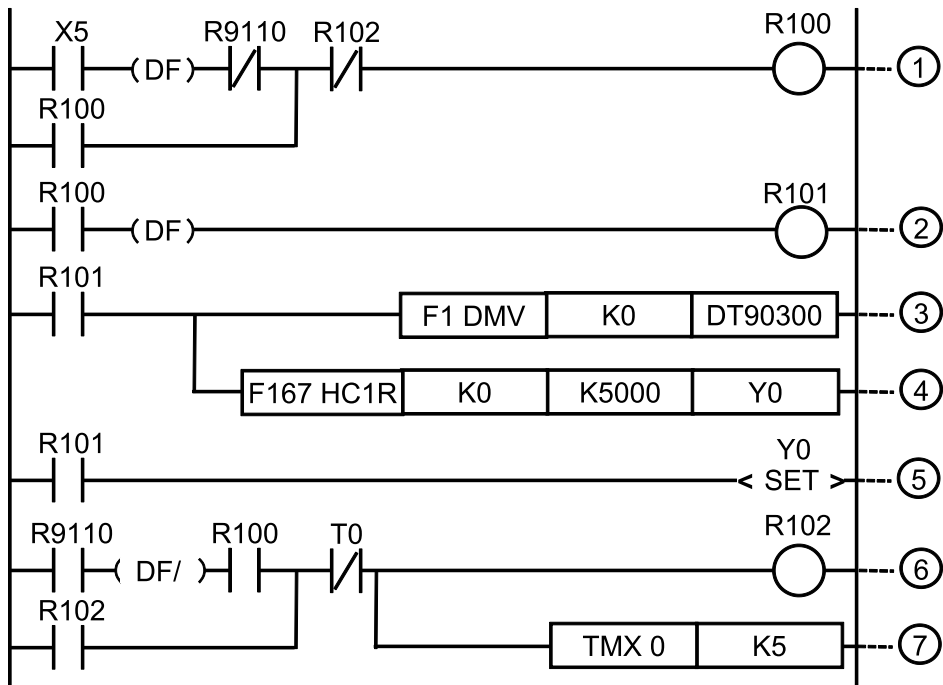

(1)	Positioning operation is running
(2)	Positioning operation starts
(3)	Resets the elapsed value of the high-speed counter CH0.
(4)	Target value match OFF instruction: Y0 turns OFF when the elapsed value of the high-speed counter reaches 5000 pulses.
(5)	Sets the inverter operation signal Y0.
(6)	Positioning done pulse (0.5 sec)
(7)	Sets 0.5 sec with 0.1-second timer.

10.3.5 Sample Program (Positioning Operation With Inverter: Double-Speed)

Counts the feedback signals from the encoder with the high-speed counter. Switches the inverter operation to low speed operation when the count value reaches 4500. The operation of the inverter stops when the count value reaches 5000.

10.3 High-speed Counter Instruction

■ Wiring example

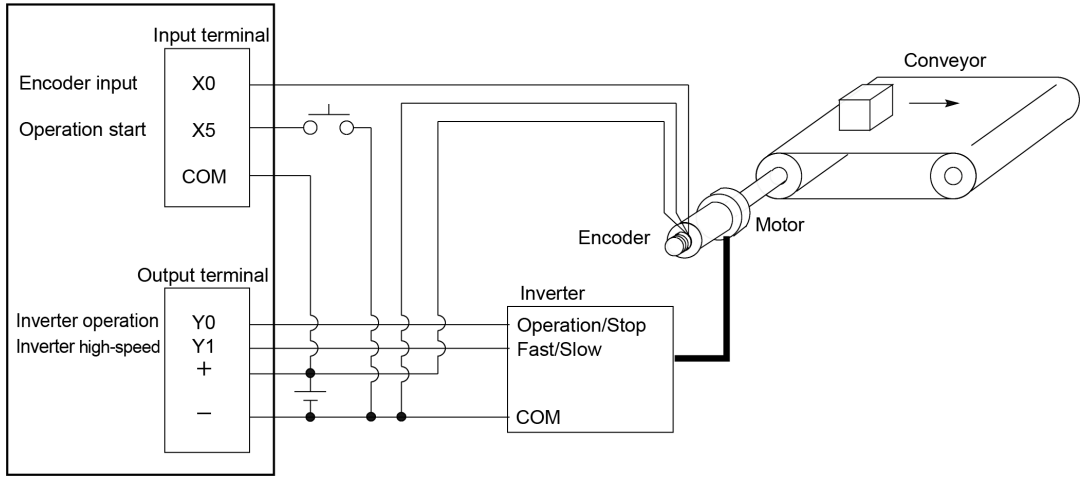

■ Operation chart

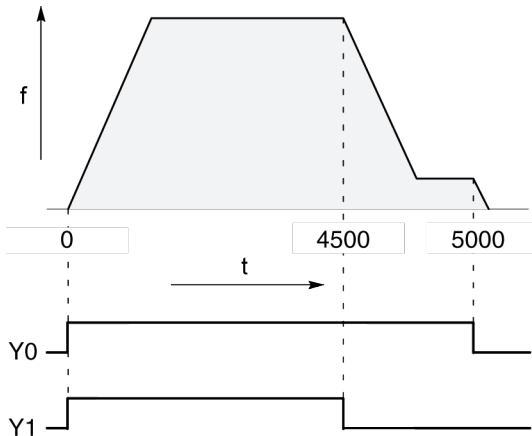

■ I/O allocation table

I/O No.	Description	I/O No.	Description
X0	Encoder input	R100	Positioning operation is running
X5	Operation start signal	R101	Arrival at deceleration point
Y0	Inverter operation signal	R102	Positioning operation starts
Y1	Inverter high-speed signal	R103	Positioning done pulse
-		R900C	Comparison instruction < Flag
-		R9110	High-speed counter CH0 control active flag

■ Sample program

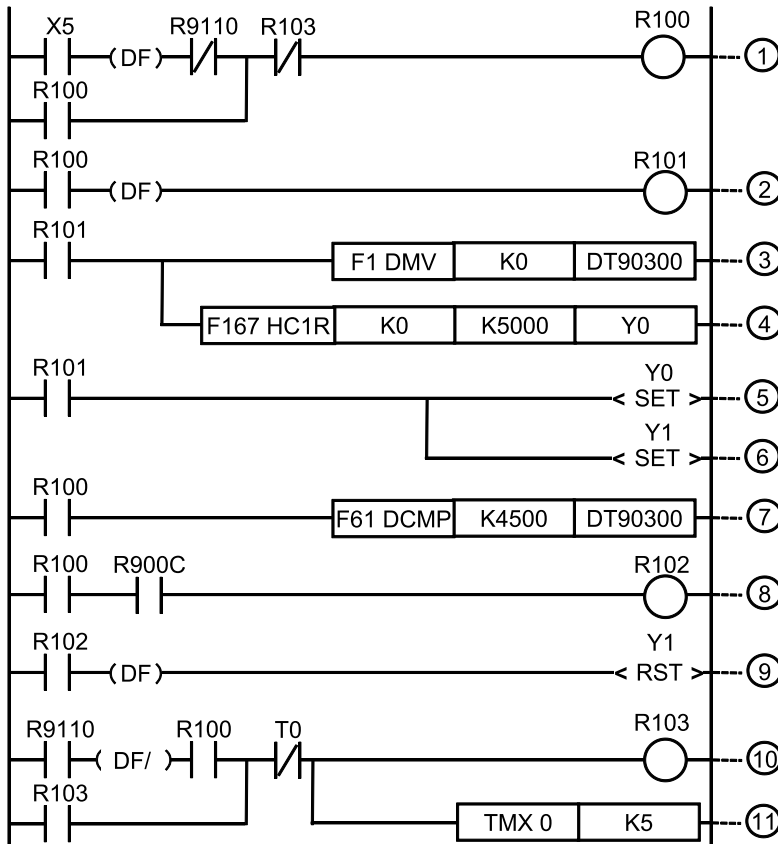

(1)	Positioning operation is running
(2)	Positioning operation starts
(3)	Resets the elapsed value of the high-speed counter CH0.
(4)	Target value match OFF instruction: Y0 turns OFF when the elapsed value of the high-speed counter reaches 5000 pulses.
(5)	Sets Y0 (inverter operation signal).
(6)	Sets Y1 (inverter high-speed signal).
(7)	32-bit data comparison instruction: R900C turns ON when the elapsed value of the high-speed counter CH0 is larger than 4500 pulses.
(8)	Arrival at deceleration point
(9)	Resets Y1 (inverter high-speed signal).
(10)	Positioning done pulse (0.5 sec)
(11)	0.1-second timer: Sets K5. It is used as 0.5-second timer.

10.4 High-speed Counter Cam Control Instruction

10.4 High-speed Counter Cam Control Instruction

10.4.1 [F165 CAM0] High-speed Counter Cam Control Instruction

Performs the cam output up to a maximum of 32 points (ON / OFF) according to the elapsed value of the high-speed counter.

■ Instruction format

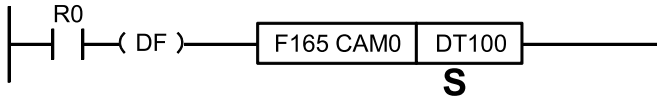

■ Operand

Operand	Settings
S	Starting number of data table

■ Memory area type that can be specified

Operand	WX	WY	WR	WL	SV	EV	DT	LD	I	Constant		Index modifier
										K	H	
S	-	-	-	-	-	-	•	-	-	-	-	•

■ Outline of operation

- Performs the cam output up to a maximum of 32 points (ON/OFF) according to the elapsed value of the high-speed counter in the pattern specified for the data table starting with [S]. The output device can be selected from internal relay, output relay and link relay.
- The ON set value and OFF set value can be arbitrarily specified as a paired target values for a single cam output regardless of the magnitude of target values or the order for one cam output. The pattern of ON/OFF varies according to the setting.

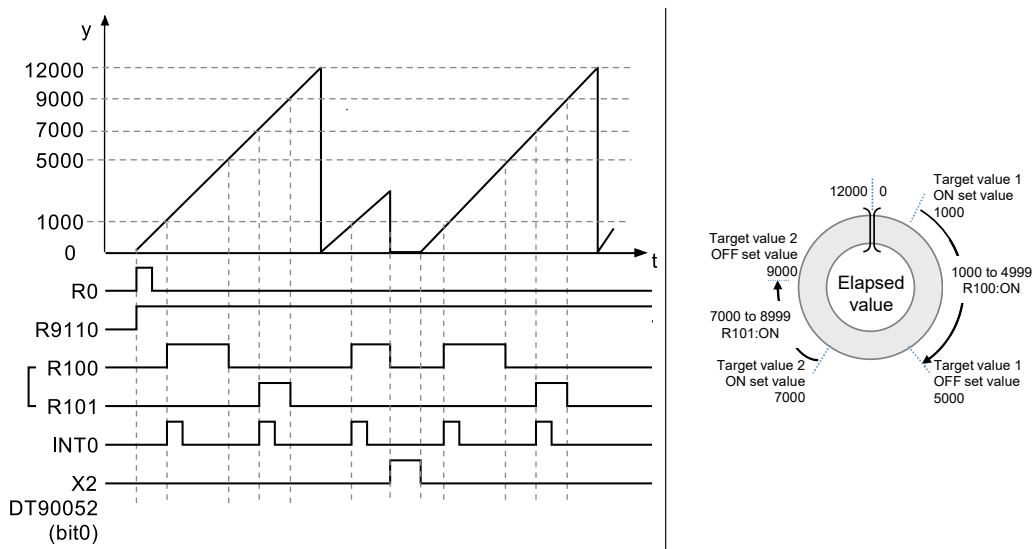

■ Upper limit control

With the F165 (CAM0) instruction, the control with a specified upper limit can be performed. The settings for enabling / disabling the upper limit control and the upper limit are specified in the data table.

		Upper limit control: Enable	Upper limit control: Disable
Counting range		0 to Upper limit	Negative min. value to Positive max. value
Operation when exceeding the counting range	When added	When the elapsed value exceeds the upper limit, it returns to 0.	When the elapsed value exceeds the positive maximum value, it returns to the negative minimum value.
	When subtracted	When the elapsed value falls below 0, it returns to the upper limit.	When the elapsed value falls below the negative minimum value, it returns to the positive maximum value.

■ Data table settings

Operand	Settings	Description
S, S+1	High-speed counter channel Upper and lower limit control	Specify the high-speed counter channel where the cam control is performed and whether or not to execute the upper and lower limit control as a hexadecimal constant. <div style="text-align: center;"> <p>H 0 0 0 0 0 0</p> </div> <p>H0000: Fixed H00: Fixed Upper limit control 0: Disable, 1: Enable Channel specification H0 to HB: CH0 to CHB</p>
S+2, S+3	Output device type (Note 1)	Specify the device type set for the cam output. H0: Link relay (L), H1: Internal relay (R), H2: Output relay (Y)

10.4 High-speed Counter Cam Control Instruction

Operand	Settings	Description
S+4, S+5	Starting word no. of output device	Specify the starting word number of the device set for the cam output. ^(Note 2)
S+6, S+7	No. of target values	Settable range: K1 to K32 ^(Note 2)
S+8, S+9	Target value 1: ON set value	Set the ON set value and OFF set value according to the number of target values. ^(Note 3) Settable range: K-2147483647 to K2147483646 (H80000001 to H7FFFFFFE) The cam output described in the next page is acquired according to the magnitude of the ON set values and elapsed value.
S+10, S+11	Target value 1: ON set value	
S+12, S+13	Target value 2: ON set value	
S+14, S+15	Target value 2: ON set value	
-----	-----	
S+(m-1)x4+8 S+(m-1)x4+9	Target value m: ON set value	
S+(m-1)x4+10 S+(m-1)x4+11	Target value m: OFF set value	
S+(m-1)x4+12 S+(m-1)x4+13	Upper limit ^(Note 4)	Settable range: K1 to K2147483646 (H1 to H7FFFFFFE)

(Note 1) When specifying the output relay (Y), values are also output to the Control Unit output as well as operation memories.

(Note 2) When the number of target values [S+6, S+7] is set to 1-16, the cam output is allocated to one word of output device. When set to 17-32, it is allocated to two words of output device. Refer to the next page for details.

(Note 3) The number of target values specified after [S+8, S+9] varies according to the number of target values specified in [S+6, S+7].

(Note 4) The upper limit of the data table end is valid only when the upper limit control is set to "Yes" in [S, S+1]. This setting can be omitted when the upper limit control is set to "No".

(Note 5) The data table varies in the range of 12 to 138 words according to the number of target values and the specified upper limit setting

■ Specification of output device: [S+2] to [S+5]

- When the number of target values is set to 1-16, one word is used. When the number of target values is set to 17-32, two words are used.
- One device is allocated to a paired target values (ON set value and OFF set value).

(Example): When the output device type is set to "Internal relay", the starting word number of output device is set to "0", and the number of target values is set to "32", R0 to R1F are allocated as the device for the cam output.

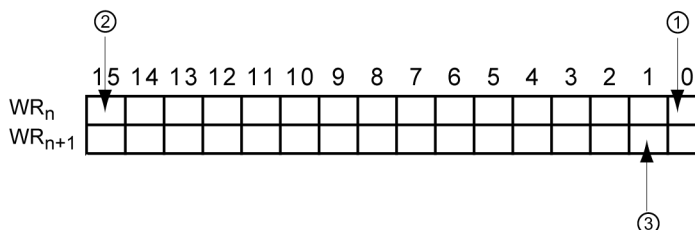

10.4 High-speed Counter Cam Control Instruction

(1)	When the elapsed value reaches the target value 1, R0 turns ON or OFF.
(2)	When the elapsed value reaches the target value 16, RF turns ON or OFF.
(3)	When the elapsed value reaches the target value 18, R11 turns ON or OFF.

■ Specification of target values: From [S+8]

The acquired output varies according to the ON set value and OFF set value.

	ON set value < OFF set value	ON set value > OFF set value	ON set value = OFF set value
When added			
When subtracted			
Description	When the elapsed value is larger than or equal to the ON set value and smaller than the OFF set value, the corresponding output bit turns ON. When the elapsed value is out of the range, the corresponding bit turns off.	When the elapsed value is smaller than the ON set value and larger than or equal to the OFF set value, the corresponding output bit turns off. When the elapsed value is out of the range, the corresponding bit turns ON.	The corresponding bit always turns off.

■ Notes on programming

- This instruction cannot be used when the high-speed counter function is not used. Allocate arbitrary channels and contacts in the system register "high-speed counter setting"
- The high-speed counter control active flag corresponding to the specified channel turns ON until the execution of the high-speed counter control instruction F0 (MV) is cleared after the execution condition of the F165 (CAM0) instruction has turned ON. When the high-speed counter control active flag is on, the high-speed counter control instruction F165 (CAM0) / F166 (HC1S) / F167 (HC1R) for which the same channel is specified cannot be executed.
- This instruction can be activated for up to two channels simultaneously.
- To stop the control of this instruction, execute "Clear high-speed counter instruction" by the high-speed counter control instruction F0 (MV). Even when executing "Clear high-speed counter instruction", the output allocated to the cam output is held. Also, the counting of the high-speed counter continues and the upper limit control becomes disabled.
- Reset or preset the high-speed counter elapsed value before executing the instruction.
- Do not rewrite the elapsed value for the control using the F1 (DMV) instruction after the execution of the instruction. After the execution of the instruction, the setting of the active target values do not change even if the operation memory of the specified target values (ON set value/OFF set value) is changed.

10.4 High-speed Counter Cam Control Instruction

- When controlling the output device using the main program, set each target value so that "minimum moving time between each target value" is larger than "1 scan time".
- When controlling the output device using an interrupt program, set each target value so that "minimum moving time between each target value" is larger than "maximum execution time of interrupt program".
- When the maximum value control and the hardware / software reset is used at the same time, do not operate them intensively in a short time.
- When hardware / software reset is used, set the minimum target value to an integer value that is 1 or more.
- When the hardware reset or software reset is executed during the high-speed counter control, the high-speed counter elapsed value is reset to 0. The output allocated to the cam output will be the output according to the elapsed value 0.
- It is also possible to start the interrupt program INTn every time the elapsed value reaches each target value. For this operation, the activation of the interrupt program should be permitted by the interrupt control instruction ICTL.

i Info.

- For details of the allocations of I/O and flags, refer to "Allocation of Memory Areas".

REFERENCE

11.2.4 When Using High-speed Counter Function

10.4.2 Sample Program (Upper Limit Control, Reset, Addition)

The following shows the program for performing two cam outputs (R100, R101) according to the elapsed value of the high-speed counter CH0. When the elapsed value reaches the target value (ON set value), the cam output turns ON, and when it reaches the target value (OFF set value), it turns OFF. When it reaches the target value (ON set value), the interrupt program is started. When the elapsed value exceeds the upper limit, it returns to 0.

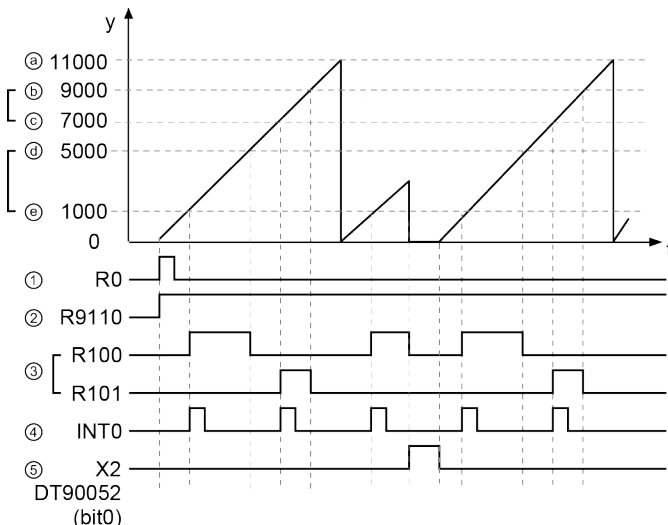

10.4 High-speed Counter Cam Control Instruction

Code	Value	Description
(a)	Upper limit	When the elapsed value exceeds the upper limit, it returns to 0.
(b)	Target value 2: OFF set value	The cam output is performed according to the target values. In this example, the ON set value is smaller than the OFF set value for each target value. Therefore, When added: When the elapsed value reaches the ON set value, the cam output turns ON, and when it reaches the OFF set value, it turns OFF.
(c)	Target value 2: ON set value	
(d)	Target value 1: OFF set value	When subtracted: When the elapsed value falls below the OFF set value, the cam output turns ON, and when it falls below the ON set value, it turns OFF.
(e)	Target value 1: ON set value	
(1)	Execution condition	When the execution condition turns ON from OFF, the instruction is executed and the cam control starts.
(2)	High-speed counter instruction active flag	The high-speed counter instruction active flag turns ON during the execution of the instruction. Even when the reset signal exists, the execution of the instruction continues.
(3)	Cam output	The output turns ON/OFF according the set values.
(4)	Interrupt	When the elapsed value reaches the ON set value, the interrupt program starts.
(5)	Reset signal	When the hardware reset (X2) or software reset DT90052 (bit 0) turns ON, the elapsed value of the high-speed counter is rest to 0. The outputs corresponding to the elapsed value 0 (both R100 and R101 in the above example) become OFF.

(Note 1) It shows the hardware reset input (X2) for the high-speed counter CH0.

■ Sample program

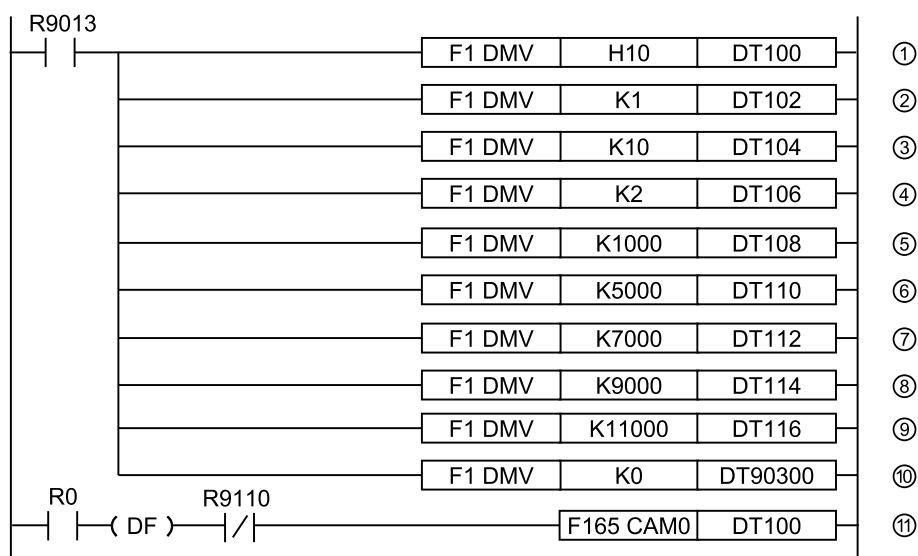

Code	Description
(1)	High-speed counter channel H10: Performs the upper limit control, CH0
(2)	Cam output device type K1: Internal relay (R)
(3)	Word number of cam output device K10

10.4 High-speed Counter Cam Control Instruction

Code	Description
(4)	Specification of the number of target values K2
(5)	Target value 1: ON set value K1000
(6)	Target value 1: OFF set value K5000
(7)	Target value 2: ON set value K7000
(8)	Target value 2: OFF set value K9000
(9)	Upper limit + K11000
(10)	Presets 0 as the elapsed value.
(11)	Executes the F165 (CAM0) instruction and starts the cam control.

10.4.3 Sample Program (Upper Limit Control, Instruction Clear, Addition)

The following shows the program for performing two cam outputs (R100, R101) according to the elapsed value of the high-speed counter CH0. In the case of addition, when the elapsed value reaches the target value (ON set value), the cam output turns ON, and when it reaches the target value (OFF set value), it turns OFF. When it reaches the target value (ON set value), the interrupt program is started. When the elapsed value exceeds the upper limit, it returns to 0. The instruction is cleared by the high-speed counter control instruction F0 (MV).

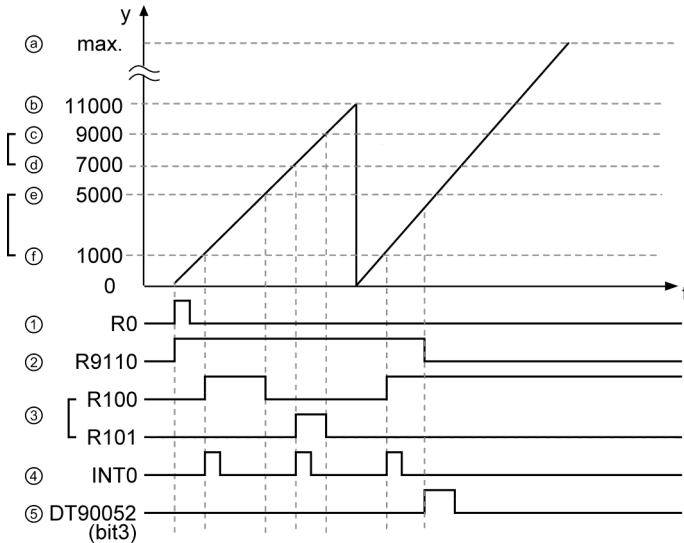

Code	Value	Description
(a)	Positive maximum value	When the instruction clear is executed, the upper limit control is canceled and the counting continues up to the positive maximum value.
(b)	Upper limit	When the elapsed value exceeds the upper limit, it returns to 0.
(c)	Target value 2: OFF set value	The cam output is performed according to the target values. In this example, the ON set value is smaller than the OFF set value for each target value.
(d)	Target value 2: ON set value	Therefore, When added: When the elapsed value reaches the ON set value, the cam output turns ON, and when it reaches the OFF set value, it turns OFF.

10.4 High-speed Counter Cam Control Instruction

Code	Value	Description
(e)	Target value 1: OFF set value	When subtracted: When the elapsed value falls below the OFF set value, the cam output turns ON, and when it falls below the ON set value, it turns OFF.
(f)	Target value 1: ON set value	
(1)	Execution condition	When the execution condition turns ON from OFF, the instruction is executed and the cam control starts.
(2)	High-speed counter instruction active flag	The high-speed counter instruction active flag turns ON during the execution of the instruction. When the high-speed counter control instruction F0 (MV) is executed, it turns OFF.
(3)	Cam output	The output turns ON/OFF according the set values.
(4)	Interrupt	In the case of addition, when the elapsed value reaches the ON set value, the interrupt program is started.
(5)	Clear high-speed counter instruction	By the high-speed counter control instruction F0 (MV), when the bit 3 of the special data register DT90052 turns ON from OFF, the executed F165 (CAM0) instruction is cleared.

■ Sample program

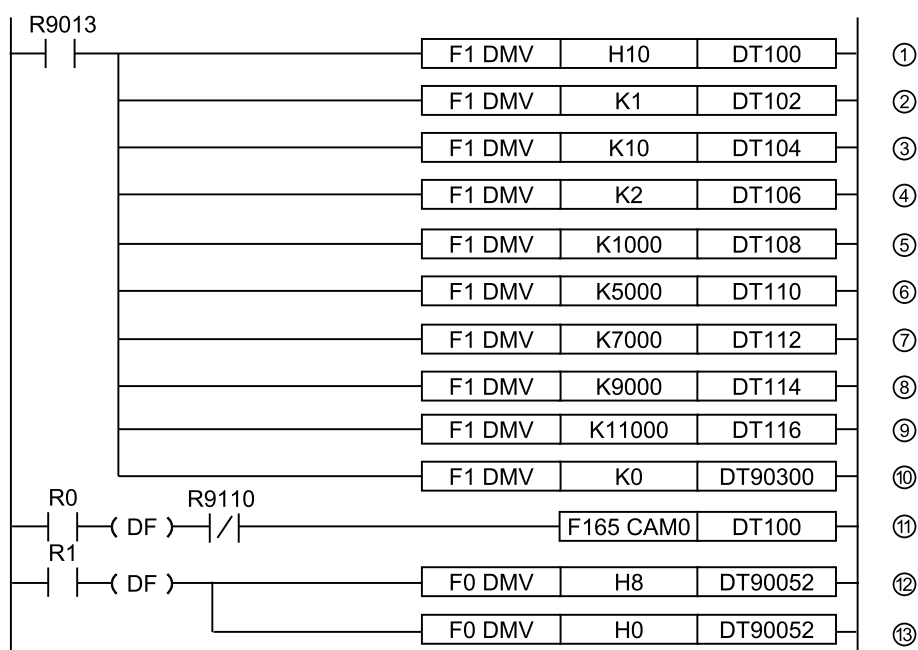

Code	Description
(1)	High-speed counter channel H10: Performs the upper limit control, CH0
(2)	Cam output device type K1: Internal relay (R)
(3)	Word number of cam output device K10
(4)	Specification of the number of target values K2
(5)	Target value 1: ON set value K1000
(6)	Target value 1: OFF set value K5000

10.4 High-speed Counter Cam Control Instruction

Code	Description
(7)	Target value 2: ON set value K7000
(8)	Target value 2: ON set value K9000
(9)	Upper limit + K11000
(10)	Presets 0 as the elapsed value.
(11)	Executes the F165 (CAM0) instruction and starts the cam control.
(12)	Clears the executed F165 (CAM0) instruction by turning the DT90052 (bit 3) OFF → ON → OFF.

10.4.4 Sample Program (Upper Limit Control, Subtraction)

The following shows the program for performing three cam outputs (R100-R102) according to the elapsed value of the high-speed counter CH0. In the case of subtraction, when the elapsed value falls below the target value (OFF set value), the cam output turns ON, and when it falls below the target value (ON set value) the cam output turns OFF. When it falls below the target value (OFF set value), the interrupt program is started. When the elapsed value falls below 0, it returns to the upper limit.

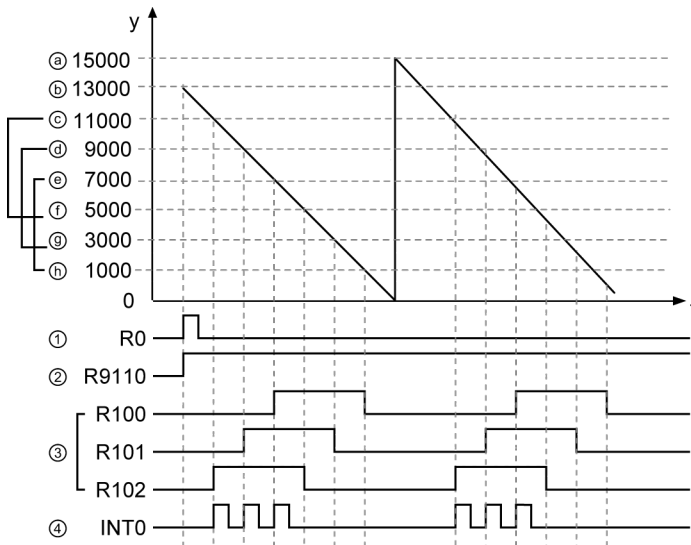

Code	Value	Description
(a)	Upper limit	When the high-speed counter elapsed value falls below 0, it returns to the upper limit.
(b)	Elapsed value	The control is started from the elapsed value when executed. In this example, the elapsed value 13000 is preset.
(c)	Target value 3: OFF set value	The cam output is performed according to the target values. In this example, the ON set value is smaller than the OFF set value for each target value.
(d)	Target value 2: OFF set value	When subtracted: When the elapsed value falls below the OFF set value, the cam output turns ON, and when it falls below the ON set value, it turns OFF.
(e)	Target value 1: OFF set value	When added: When the elapsed value reaches the ON set value, the cam output turns ON, and when it reaches the OFF set value, it turns OFF.

10.4 High-speed Counter Cam Control Instruction

Code	Value	Description
(f)	Target value 3: ON set value	
(g)	Target value 2: ON set value	
(h)	Target value 1: ON set value	
(1)	Execution condition	When the execution condition turns ON from OFF, the instruction is executed and the cam control starts.
(2)	High-speed counter instruction active flag	The high-speed counter instruction active flag turns ON during the execution of the instruction.
(3)	Cam output	The output turns ON/OFF according the set values.
(4)	Interrupt program activation	In the case of subtraction, when the elapsed value falls below the OFF set value, the interrupt program is started.

■ Sample program

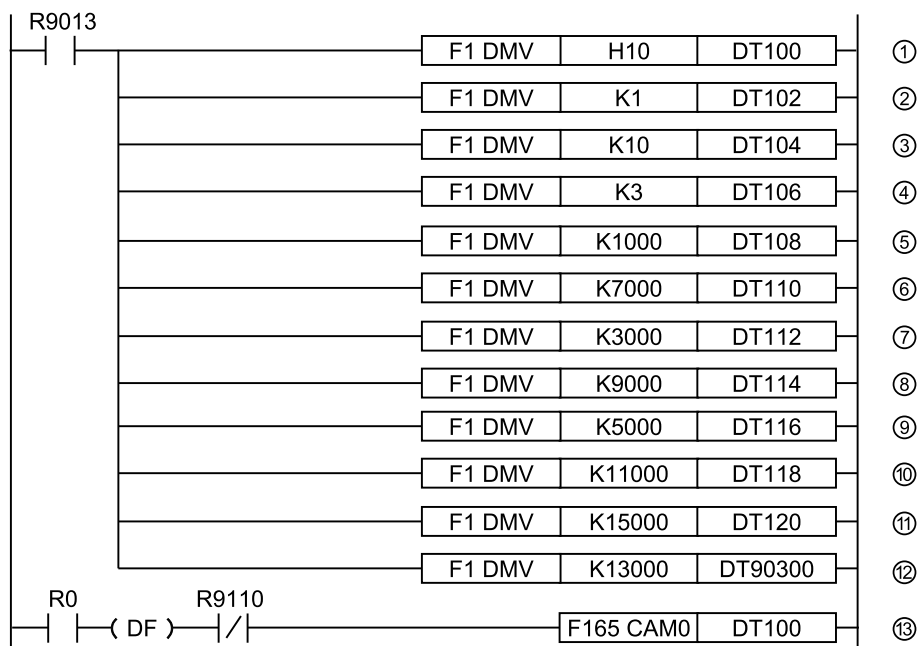

Code	Description
(1)	High-speed counter channel H10: Performs the upper limit control, CH0
(2)	Cam output device type K1: Internal relay (R)
(3)	Word number of cam output device K10
(4)	Specification of the number of target values K3
(5)	Target value 1: ON set value K1000
(6)	Target value 1: OFF set value K7000
(7)	Target value 2: ON set value K3000

10.4 High-speed Counter Cam Control Instruction

Code	Description
(8)	Target value 2: OFF set value K9000
(9)	Target value 3: ON set value K5000
(10)	Target value 3: OFF set value K11000
(11)	Upper limit value K15000
(12)	Presets 13000 as the elapsed value.
(13)	Executes the F165 (CAM0) instruction and starts the cam control.

10.5 Interrupt Program Activation

10.5.1 Overview of Function

When the elapsed value reaches the target value while the high-speed counter instruction F165 (CAM0) / F166 (HC1S) / F167 (HC1R) is being executed, the interrupt program can be activated.

■ Execution method

- Make the setting for the high-speed counter by system registers. There is no need to make the setting of interrupt input.
- Describe the interrupt program as a sub program.
- Allow the execution of a corresponding interrupt program number by the ICTL instruction in the main program.
- Execute the F165 (CAM0) / F166 (HC1S) / F167 (HC1R) instruction. When the elapsed value of the high-speed counter reaches the target value, the interrupt program is activated.

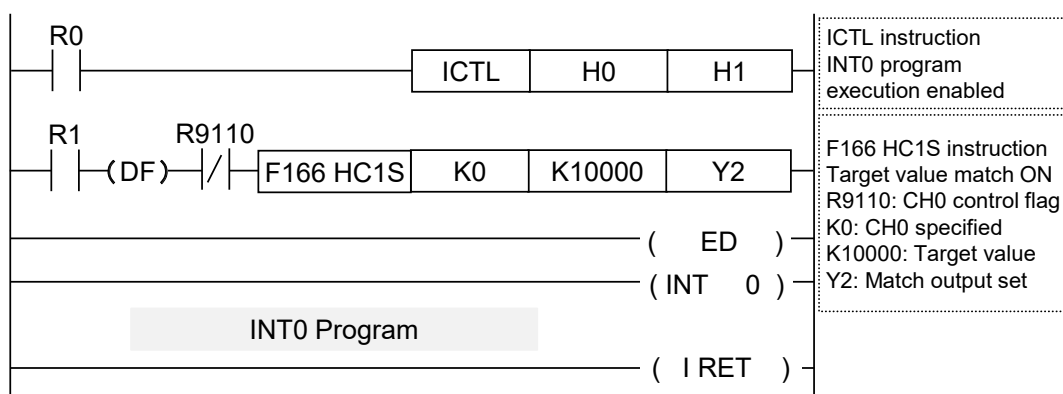

■ Corresponding channel numbers and interrupt program numbers

Channel No.	INT number
CH0	INT0
CH1	INT1
CH2	INT3
CH3	INT4
CH4	INT5
CH5	INT6
CH6	INT7
CH7	INT8
CH8	INT9
CH9	INT10
CHA	INT11
CHB	INT12

10.5 Interrupt Program Activation

10.5.2 Interrupt Activation When F165 (CAM0) is Executed

For the cam control instruction F165 (CAM0), the start condition varies according to the magnitude of the ON set value and OFF set value. Also, the interrupt program is activated with each target value of up to 32 points.

■ Activation of interrupt program

	ON set value < OFF set value	ON set value > OFF set value	ON set value = OFF set value
When added			
When subtracted			
Description	When the elapsed value is larger than or equal to the ON set value and smaller than the OFF set value, the interrupt program is activated.	When the elapsed value is smaller than the ON set value and larger than or equal to the OFF set value, the interrupt program is activated.	When the elapsed value reaches the ON set value (= OFF set value), the interrupt program is activated.

11 Specifications

11.1 Specifications	11-2
11.1.1 General Specifications	11-2
11.1.2 Performance Specifications.....	11-2
11.2 Allocation of Memory Areas	11-5
11.2.1 When Using Pulse Output Table Setting Mode	11-5
11.2.2 When Using Pulse Output Function (FP-X Compatible Instruction Mode).....	11-7
11.2.3 When Using PWM Output Function	11-8
11.2.4 When Using High-speed Counter Function.....	11-9
11.3 Positioning Memory.....	11-12
11.3.1 Configuration of Memory Map	11-12
11.3.2 Common Area (Memory Area No. 0).....	11-13
11.3.3 Axis Information Area (Memory Area No. 1)	11-14
11.3.4 Axis Setting Area (Memory Area No. 2)	11-15
11.3.5 Positioning Table Area (Memory Area No. 3).....	11-17

11.1 Specifications

11.1 Specifications

11.1.1 General Specifications

For details of the general specifications, refer to *FP-XH User's Manual (Basic)*.

11.1.2 Performance Specifications

■ High-speed counter / Pulse output / PWM output specifications

Item		Specifications	
		Relay type	Transistor type
High-speed counter	Control Unit input	Single-phase 8 channels or 2-phase 4 channels Single-phase 8 channels: 10 kHz each 2-phase 4 channels: 5 kHz each	Single-phase 8 channels or 2-phase 4 channels High-speed single-phase (4 channels): 100 kHz each Medium-speed single-phase (4 channels): 10 kHz each High-speed 2-phase (2 channels): 50 kHz each Medium-speed 2-phase (2 channels): 10 kHz each
	Pulse I/O cassette installed	C14: Single-phase 2 channels (2-phase 1 channel) C30/60: Single-phase 4 channels (2-phase 2 channels) With single-phase 2 channels (100 kHz), with 2-phase 1 channel (50 kHz) With single-phase 4 channels (100 kHz), with 2-phase 2 channels (10 kHz)	Uninstallable
Pulse output / PWM output	Control Unit output	None	Pulse output: 100 kHz each C14: 3 channels C30: 4 channels C60: 6 channels
			PWM: C14: 3 channels C30 / 60: 4 channels 1 to 70 kHz (Resolution of 1000) 70001 to 100 kHz (Resolution of 100)
	Pulse I/O cassette installed	Pulse output: 100 kHz each C14: 1 channel C30 / 60: 2 channels * With two cassettes installed	Uninstallable
PWM output: 2 channels 1 to 70 kHz (Resolution of 1000)			

Item	Specifications	
	Relay type	Transistor type
	70001 to 100 kHz (Resolution of 100)	

(Note 1) For details of combinations, refer to "1.2 Restrictions on Combinations and Functions".

■ Pulse output function specifications

Item	Specifications			
	Table setting mode	FP-X compatible instruction mode		
Number of axes controlled	C14T: maximum 3 axes, C30T : Max. 4 axes, C60T: Max. 6 axes C14R: Max. 1 axis (When using the pulse I/O cassette) C30R / C60R: Max. 2 axes (When using two pulse I/O cassettes)			
Common specifications	Position setting mode	Increment, Absolute		
	Output interface	Transistor open-collector output		
	Pulse output method	Pulse + Sign, CW+CCW		
	Max. output frequency	100,000 Hz		
	Output pulse duty ratio	25% (Fixed) 25% / 50% (Select by instruction)		
	Control unit	Pulse		
Position control	Position setting range	-1,073,741,824 to 1,073,741,823 pulses For the interpolation control, -8,388,608 to +8,388,607 pulses		
	Speed command range	Pulse: 1 to 100,000 Hz		
	Max. operation speed	100 kHz		
	Acceleration / deceleration method	Linear acceleration / deceleration		
	Acceleration time	1 to 10,000 ms (Settable by 1 ms)	30 to 32760 ms (Specify by instruction. Acceleration time and deceleration time cannot be set separately.)	
	Deceleration time	1 to 10,000 ms (Settable by 1 ms)		
	Number of positioning tables	20 tables for each axis	Arbitrary (Set by user program)	
	Control method	Single axis	PTP control (E-point control, C-point control), CP control (P-point control), JOG positioning control (J-point control)(Note 1)(Note 2)	
		2-axis linear interpolation	E-, P-, C-point control; composite speed or major axis speed specification	
	Dwell time	0 to 32,767 ms (Settable by 1 ms)		No setting
JOG operation	Speed command range	Pulse: 1 to 100,000 Hz(Note 2)		
	Acceleration / deceleration method	Linear acceleration / deceleration		
	Acceleration time	0 to 10,000 ms (Settable by 1 ms)		
	Deceleration time	0 to 10,000 ms (Settable by 1 ms)		
		Acceleration / deceleration cannot be specified. (F172 instruction)		

11.1 Specifications

Item		Specifications	
		Table setting mode	FP-X compatible instruction mode
Home return	Speed command range	Pulse: 1 to 100,000 Hz	DOG method x 1, Home return method x 1 Selected by F171 instruction
	Acceleration / deceleration method	Linear acceleration / deceleration	
	Acceleration time	1 to 10,000 ms (Settable by 1 ms)	
	Deceleration time	1 to 10,000 ms (Settable by 1 ms)	
	Return method	DOG methods (3 types), Home return method, Data set method	
Stop function	Deceleration stop	Each axis stops in the deceleration time of a running operation.	Each axis stops in the deceleration time of a running operation. (Executed by F0 instruction)
	Emergency stop	Each axis stops in the deceleration time specified in the positioning parameter.	
	Limit stop	Each axis stops in the deceleration time specified for the over limit input.	
	System stop	All axes stop.	
Memory backup		Positioning parameters and positioning table data are stored in F-ROM (without battery).	Data is stored in arbitrary data registers by user programs.

(Note 1) The J-point control can be executed only for the two axes of CH0 and CH1.

(Note 2) When performing the J-point control or JOG operation, the speed can be changed after the startup.

11.2 Allocation of Memory Areas

11.2.1 When Using Pulse Output Table Setting Mode

■ Control unit (transistor output type)

Channel no.		Input / output contact number used									Memory area used		
		CW or Pulse output	CCW or Sign output	Deviation counter clear output			Home input (Note 1)	Near home input (Note 2)	Over limit input (Note 3)	J-point positioning start input	BUSY flag	Elapsed value area	
				C14	C30	C60							
Independent	CH0	Y0	Y1	Y4	Y8	YC	X4	(Y70)	(Y80) (Y81)	X0	X28	(Note 4)	
	CH1	Y2	Y3	Y5	Y9	YD	X5	(Y71)	(Y82) (Y83)	X1	X29		
	CH2	Y4	Y5	-	YA	Y10	X6	(Y72)	(Y84) (Y85)	-	X2A		
	CH3	Y6	Y7	-	YB	Y11	X7	(Y73)	(Y86) (Y87)	-	X2B		
	CH4	Y8	Y9	-	-	Y12	X2	(Y74)	(Y88) (Y89)	-	X2C		
	CH5	YA	YB	-	-	Y13	X3	(Y75)	(Y8A) (Y8B)	-	X2D		
Linear interpolation (Note 1)	CH0	X-axis	Y0	Y1	Y4	Y8	YC	X4	(Y70)	(Y80) (Y81)	-	X28	(Note 4)
		Y-axis	Y2	Y3	Y5	Y9	YD	X5	(Y71)	(Y82) (Y83)		X29	
	CH2	X-axis	Y4	Y5	-	YA	Y10	X6	(Y72)	(Y84) (Y85)		X2A	
		Y-axis	Y6	Y7	-	YB	Y11	X7	(Y73)	(Y86) (Y87)		X2B	
	CH4	X-axis	Y8	Y9	-	-	Y12	X2	(Y74)	(Y88) (Y89)		X2C	
		Y-axis	YA	YB	-	-	Y13	X3	(Y75)	(Y8A) (Y8B)		X2D	

(Note 1) Even when setting the linear interpolation, the interpolation operation is not performed for the home return. Execute the operation for X axes and Y axes separately.

(Note 2) The near home input will be valid when arbitrary inputs are allocated and the output relays indicated in the above table turn ON.

(Note 3) The over limit input (+) and over limit input (-) will be valid when arbitrary inputs are allocated and the output relays indicated in the above table turn ON. The I/O numbers in the upper rows (Y80 to Y8A) in the above table are over limit input (+), the I/O numbers in the lower rows (Y81 to Y8B) are over limit input (-).

11.2 Allocation of Memory Areas

(Note 4) The elapsed values are stored in the axis information area of the positioning memory. They can be read by user programs using the F384 instruction.

■ Control unit (relay output type)

Channel no.		Input / output contact number used							Memory area used	
		CW or Pulse output	CCW or Sign output	Deviation counter clear output	Home input (Note 1)	Near home input (Note 2)	Over limit input (Note 3)	J-point positioning start input	BUSY flag	Elapsed value area
Independent	CH0	Y100	Y101	Y102	X102	(Y70)	(Y80) (Y81)	X100	X28	(Note 4)
	CH1	Y200	Y201	Y202	X202	(Y71)	(Y82) (Y83)	X200	X29	
Linear interpolation (Note 1)		Y100 Y200	Y101 Y201	Y102	X102	(Y70)	(Y80) (Y81)	-	X28	(Note 4)
				Y202	X202	(Y71)	(Y82) (Y83)		X29	

(Note 1) Even when setting the linear interpolation, the interpolation operation is not performed for the home return. Execute the operation for X axes and Y axes separately.

(Note 2) The near home input will be valid when arbitrary inputs are allocated and the output relays indicated in the above table turn ON.

(Note 3) The over limit input (+) and over limit input (-) will be valid when arbitrary inputs are allocated and the output relays indicated in the above table turn ON. The I/O numbers in the upper rows (Y80 to Y8A) in the above table are over limit input (+), the I/O numbers in the lower rows (Y81 to Y8B) are over limit input (-).

(Note 4) The elapsed values are stored in the axis information area of the positioning memory. They can be read by user programs using the F384 instruction.

11.2.2 When Using Pulse Output Function (FP-X Compatible Instruction Mode)

■ Control Unit (transistor output type)

Channel no.	Input / output contact number used								Memory area used					
	CW or Pulse output	CCW or Sign output	Deviation counter clear output			Home input (Note 1)	Near home input (Note 2)	Over limit input (Note 3)	J-point positioning start input (Note 4)	BUSY flag (Control active flag)	Elapsed value area (Note 5)	Target value area		
			C14	C30	C60									
Independent	CH0	Y0	Y1	Y4	Y8	YC	X4	DT 90052 bit4	-	-	R911C	DT90348 DT90349	DT90350 DT90351	
	CH1	Y2	Y3	Y5	Y9	YD	X5				R911D	DT90352 DT90353	DT90354 DT90355	
	CH2	Y4	Y5	-	YA	Y10	X6				R911E	DT90356 DT90357	DT90358 DT90359	
	CH3	Y6	Y7	-	YB	Y11	X7				R911F	DT90360 DT90361	DT90362 DT90363	
	CH4	Y8	Y9	-	-	Y12	X2				R9120	DT90364 DT90365	DT90366 DT90367	
	CH5	YA	YB	-	-	Y13	X3				R9121	DT90368 DT90369	DT90370 DT90371	
Linear interpolation (Note 1)	CH0	X-axis	Y0	Y1	Y4	Y8	YC	DT 90052 bit4	-	-	R911C	DT90348 DT90349	DT90350 DT90351	
		Y-axis	Y2	Y3	Y5	Y9	YD				X5	R911D	DT90352 DT90353	DT90354 DT90355
	CH2	X-axis	Y4	Y5	-	YA	Y10				X6	R911E	DT90356 DT90357	DT90358 DT90359
		Y-axis	Y6	Y7	-	YB	Y11				X7	R911F	DT90360 DT90361	DT90362 DT90363
	CH4	X-axis	Y8	Y9	-	-	Y12				X2	R9120	DT90364 DT90365	DT90366 DT90367
		Y-axis	YA	YB	-	-	Y13				X3	R9121	DT90368 DT90369	DT90370 DT90371

(Note 1) Even when setting the linear interpolation, the interpolation operation is not performed for the home return. Execute the operation for X axes and Y axes separately.

(Note 2) The near home input will be valid when an arbitrary input is allocated and the bit 4 of the special data register DT90052 turns ON.

11.2 Allocation of Memory Areas

(Note 3) In the FP-X compatible instruction mode, the stop function using the over limit input and the home return function using the limit input are available.

(Note 4) In the FP-X compatible instruction mode, the J-point control function is not available.

(Note 5) Only F1 (DMV) instruction can perform the reading and writing of elapsed value area.

■ Control Unit (relay output type)

Channel no.		Input / output contact number used							Memory area used		
		CW or Pulse Output	CCW or Sign output	Deviation counter clear output	Home input (Note 1)	Near home input (Note 2)	Over limit input (Note 3)	J-point positioning start input (Note 4)	BUSY flag (Control active flag)	Elapsed value area (Note 5)	Target value area
Independent	CH0	Y100	Y101	Y102	X102	DT 90052 bit4	-	-	R911C	DT90348 DT90349	DT90350 DT90351
	CH1	Y200	Y201	Y202	X202	DT 90052 bit4	-	-	R911D	DT90352 DT90353	DT90354 DT90355
Linear interpolation (Note 1)		Y100 Y200	Y101 Y201	Y102	X102	DT 90052 bit4	-	-	R911C	DT90348 DT90349	DT90350 DT90351
				Y202	X202	DT 90052 bit4	-		R911D	DT90352 DT90353	DT90354 DT90355

(Note 1) Even when setting the linear interpolation, the interpolation operation is not performed for the home return. Execute the operation for X axes and Y axes separately.

(Note 2) The near home input will be valid when arbitrary inputs are allocated and the output relays indicated in the above table turn ON.

(Note 3) In the FP-X compatible instruction mode, the stop function using the over limit input and the home return function using the limit input are available.

(Note 4) In the FP-X compatible instruction mode, the J-point control function is not available.

(Note 5) Only F1 (DMV) instruction can perform the reading and writing of elapsed value area.

11.2.3 When Using PWM Output Function

■ Control Unit (transistor output type)

Channel no.	Output no.	Control active flag	Output frequency (duty)
CH0	Y0	R911C	1.0 Hz to 70 kHz: Resolution of 1000 (0.0% to 100.0%) 70001 Hz to 100 kHz: Resolution of 100 (0% to 100%)
CH1	Y2	R911D	
CH2	Y4	R911E	
CH3	Y6	R911F	

■ Control Unit (relay output type)

Channel no.	Output no.	Control active flag	Output frequency (duty)
CH0	Y100	R911C	1.0 Hz to 70 kHz: Resolution of 1000 (0.0% to 100.0%)
CH1	Y200	R911D	70001 Hz to 100 kHz: Resolution of 100 (0% to 100%)

■ Maximum output frequency of pulse output / PWM output

These values are available only when the conditions of each item (such as output method or channels) are executed. These values are available when the operations such as the high-speed counter, pulse output function or other interrupt controls are not performed. For details of the performance achieved when these functions are used simultaneously, refer to the attached *High-speed Counter Maximum Counting Speed Reference Table (FP-XH)*.

11.2.4 When Using High-speed Counter Function

■ Control Unit (transistor output type)

Channel no.		Count Input	Hardware reset input	Memory area used			Performance specifications		
				Control active flag	Elapsed value area	Target value area	Minimum input pulse width	Maximum counting speed	
[Single phase] Addition input Subtraction input	High-speed	CH0	X0	X6	R9110	DT90300 DT90301	DT90302 DT90303	High-speed input 5 μs	100 kHz
		CH1	X1	-	R9111	DT90304 DT90305	DT90306 DT90307		
		CH2	X2	X7	R9112	DT90308 DT90309	DT90310 DT90311		
		CH3	X3	-	R9113	DT90312 DT90313	DT90314 DT90315		
	Medium-speed	CH4	X4	-	R9114	DT90316 DT90317	DT90318 DT90319	Medium-speed input 50 μs	10 kHz
		CH5	X5	-	R9115	DT90320 DT90321	DT90322 DT90323		
		CH6	X6	-	R9116	DT90324 DT90325	DT90326 DT90327		
[2-phase] 2-phase input Individual input Direction distinction	High-speed	CH0	X0 X1	X6	R9110	DT90300 DT90301	DT90302 DT90303	High-speed input 10 μs	50 kHz
		CH2	X2 X3	X7	R9112	DT90308 DT90309	DT90310 DT90311		
	Medium-speed	CH4	X4 X5	-	R9114	DT90316 DT90317	DT90318 DT90319	Medium-speed input	10 kHz

11.2 Allocation of Memory Areas

Channel no.		Count Input	Hardware reset input	Memory area used			Performance specifications	
				Control active flag	Elapsed value area	Target value area	Minimum input pulse width	Maximum counting speed
	CH6	X6 X7	-	R9116	DT90324 DT90325	DT90326 DT90327	100 μs	

(Note 1) X6 can be used either as the count input for CH6 or the reset input for CH0. X7 can be used either as the count input for CH7 or the reset input for CH2.

(Note 2) Only F1 (DMV) instruction can perform the reading and writing of elapsed value area.

■ Maximum counting speed

These values are available only when the conditions of each item (such as counting method or channels) are executed. These values are available when the high-speed counter match ON (F166) instruction, high-speed counter match OFF (F167) instruction, pulse output function or other interrupt controls are not performed. For details of the performance achieved when these functions are used simultaneously, please contact us.

■ Control Unit (relay output type Control Unit input)

Channel no.		Count Input	Memory area used			Performance Specifications	
			Control active flag	Elapsed value area	Target value area	Minimum input pulse width	Maximum counting speed
[Single phase] Addition input Subtraction input	CH0	X0	R9110	DT90300 DT90301	DT90302 DT90303	50 μs	10 kHz
	CH1	X1	R9111	DT90304 DT90305	DT90306 DT90307		
	CH2	X2	R9112	DT90308 DT90309	DT90310 DT90311		
	CH3	X3	R9113	DT90312 DT90313	DT90314 DT90315		
	CH4	X4	R9114	DT90316 DT90317	DT90318 DT90319		
	CH5	X5	R9115	DT90320 DT90321	DT90322 DT90323		
	CH6	X6	R9116	DT90324 DT90325	DT90326 DT90327		
	CH7	X7	R9117	DT90328 DT90329	DT90330 DT90331		
[2-phase] Phase differential input Individual input direction distinction	CH0	X0 X1	R9110	DT90300 DT90301	DT90302 DT90303	100 μs	5 kHz
	CH2	X2 X3	R9112	DT90308 DT90309	DT90310 DT90311		

Channel no.		Count Input	Memory area used			Performance Specifications	
			Control active flag	Elapsed value area	Target value area	Minimum input pulse width	Maximum counting speed
	CH4	X4 X5	R9114	DT90316 DT90317	DT90318 DT90319		
	CH6	X6 X7	R9116	DT90324 DT90325	DT90326 DT90327		

(Note 1) Only F1 (DMV) instruction can perform the reading and writing of elapsed value area.

■ When using the relay output type pulse I/O cassette

Channel no.		Input contact (Note 1)	Memory area used			Performance specifications	
			Control active flag	Elapsed value area	Target value area	Minimum input pulse width	Maximum counting speed
[Single phase] Addition input Subtraction input	CH8	X100 (X102)	R9118	DT90332 DT90333	DT90334 DT90335	6.25 μ s (100 μ s)	Single-phase 2 channels 100 kHz Single-phase 4 channels 100 kHz
	CH9	X101 (X102)	R9119	DT90336 DT90337	DT90338 DT90339		
	CHA (Note 2)	X200 (X202)	R911A	DT90340 DT90341	DT90342 DT90343		
	CHB (Note 2)	X201 (X202)	R911B	DT90344 DT90345	DT90346 DT90347		
[2-phase] Phase differential input	CH0	X100 X101 (X102)	R9118	DT90332 DT90333	DT90334 DT90335	16.7 μ s (100 μ s)	2-phase 1 channel 50 kHz 2-phase 2 channels 10 kHz
Individual input direction distinction	CH2 (Note 2)	X200 X201 (X202)	R911A	DT90340 DT90341	DT90342 DT90343		

(Note 1) The I/O numbers shown in parentheses can be used as the hardware reset input for one of the channels.

(Note 2) CHA or CHB can be used when two pulse I/O cassettes are installed.

(Note 3) Only F1 (DMV) instruction can perform the reading and writing of elapsed value area.

11.3 Positioning Memory

11.3 Positioning Memory

11.3.1 Configuration of Memory Map

The positioning memory consists of four areas.

■ Whole memory map

Area		Absolute address (Decimal)	No. of words and configuration			
No.	Name					
0	Common area	0000 to 0029	30 words			
1	Axis information area	0030 to 0039	For CH0	10 words for each channel		
		0040 to 0049	For CH1			
		0050 to 0059	For CH2			
		0060 to 0069	For CH3			
		0070 to 0079	For CH4			
		0080 to 0089	For CH5			
		0090 to 0099	Reserved for system			
2	Axis setting area	0100 to 0129	For CH0	30 words for each channel		
		0130 to 0159	For CH1			
		0160 to 0189	For CH2			
		0190 to 0219	For CH3			
		0220 to 0249	For CH4			
		0250 to 0279	For CH5			
					0280 to 0299	Reserved for system
3	Positioning table area	0300 to 0549	For CH0	250 words for each channel		
			0300 to 0309	Table 1	10 words for each table	
			0490 to 0499	Table 20		
			0500 to 0549	Reserved for system		
				0550 to 0799	For CH1	250 words for each channel
				0800 to 1049	For CH2	
		1050 to 1299	For CH3			
		1300 to 1549	For CH4			
		1550 to 1799	For CH5			

(Note 1) The addresses in the table are the addresses which indicate the configurations in the positioning memory. For reading / writing data using user programs, use an area number and offset address in combination for specification.

■ Reading from positioning memory

- It is possible to read the areas which are shown with "Available" in the "R" column in the following table using the F384 (PTBLR) instruction in user programs during RUN. The operand of the instruction is specified using the combination of the channel number, area number and offset address.

■ Writing to positioning memory

- When the mode changes from PROG. to RUN, the contents set by the tool software Configurator PMX will be stored.
- It is possible to rewrite the areas which are shown with "Available" in the "W" column in the following table using the F385 (PTBLW) instruction in user programs during RUN. The operand of the instruction is specified using the combination of the channel number, area number and offset address.
- Be sure not to execute writing in the reserved areas for the system.

11.3.2 Common Area (Memory Area No. 0)

- : Available, -: Not available

Address	Name	Default	Description	R	W																						
0000	Axis setting	H0	Stores used channels (axes) and usage methods. Monitor using binary display.	•	•																						
			<table border="1"> <thead> <tr> <th>bit no.</th> <th>Settings</th> </tr> </thead> <tbody> <tr> <td>0</td> <td>Not use CH0 (0) / Use CH0 (1)</td> </tr> <tr> <td>1</td> <td>Not use CH1 (0) / Use CH1 (1)</td> </tr> <tr> <td>2</td> <td>Not use CH2 (0) / Use CH2 (1)</td> </tr> <tr> <td>3</td> <td>Not use CH3 (0) / Use CH0 (1)</td> </tr> <tr> <td>4</td> <td>Not use CH4 (0) / Use CH3 (1)</td> </tr> <tr> <td>5</td> <td>Not use CH5 (0) / Use CH3 (1)</td> </tr> <tr> <td>6 to 7</td> <td>Disable the setting</td> </tr> <tr> <td>8</td> <td>Use CH0 and CH1 as an interpolation axis Not use (0) / Use (1)</td> </tr> <tr> <td>9</td> <td>Use CH2 and CH3 as an interpolation axis Not use (0) / Use (1)</td> </tr> <tr> <td>10 to 15</td> <td>Disable the setting</td> </tr> </tbody> </table>			bit no.	Settings	0	Not use CH0 (0) / Use CH0 (1)	1	Not use CH1 (0) / Use CH1 (1)	2	Not use CH2 (0) / Use CH2 (1)	3	Not use CH3 (0) / Use CH0 (1)	4	Not use CH4 (0) / Use CH3 (1)	5	Not use CH5 (0) / Use CH3 (1)	6 to 7	Disable the setting	8	Use CH0 and CH1 as an interpolation axis Not use (0) / Use (1)	9	Use CH2 and CH3 as an interpolation axis Not use (0) / Use (1)	10 to 15	Disable the setting
			bit no.			Settings																					
			0			Not use CH0 (0) / Use CH0 (1)																					
			1			Not use CH1 (0) / Use CH1 (1)																					
			2			Not use CH2 (0) / Use CH2 (1)																					
			3			Not use CH3 (0) / Use CH0 (1)																					
			4			Not use CH4 (0) / Use CH3 (1)																					
			5			Not use CH5 (0) / Use CH3 (1)																					
			6 to 7			Disable the setting																					
8	Use CH0 and CH1 as an interpolation axis Not use (0) / Use (1)																										
9	Use CH2 and CH3 as an interpolation axis Not use (0) / Use (1)																										
10 to 15	Disable the setting																										
0001	Positioning repeat count (CH0)	K0	Stores the repeat count in decimal when using the repeat control in the position control.	•	•																						
0002	Positioning repeat count (CH1)	K0	<table border="1"> <thead> <tr> <th>Set value</th> <th>Operation</th> </tr> </thead> <tbody> <tr> <td>0 or 1</td> <td>Not repeat an operation.</td> </tr> <tr> <td>2 to 254</td> <td>Repeat an operation for a specified number of times.</td> </tr> </tbody> </table>	Set value	Operation	0 or 1	Not repeat an operation.	2 to 254	Repeat an operation for a specified number of times.	•	•																
			Set value	Operation																							
0 or 1	Not repeat an operation.																										
2 to 254	Repeat an operation for a specified number of times.																										

11.3 Positioning Memory

Address	Name	Default	Description	R	W	
0003	Positioning repeat count (CH2)	K0		•	•	
			Set value			Operation
0004	Positioning repeat count (CH3)	K0	255 or more	Repeat an operation infinitely.	•	•
0005	Positioning repeat count (CH4)	-	-	•	•	
0006	Positioning repeat count (CH5)			•	•	
0007	Error code	H0	Stores a generated positioning error code in Hex format (hexadecimal) when using the pulse output function (table setting mode). The higher 8 bits indicate channel number. The lower 8 bits indicate error code.	•	-	
0008 to 0029	Reserved for system	-	-	-	-	

11.3.3 Axis Information Area (Memory Area No. 1)

●: Available, -: Not available

Offset address	Name	Default	Description	R	W
0000	Active or execution done table	K0	Stores the monitor values of the positioning table numbers during the execution or on the completion of each channel. Stored value: 0-20	•	-
0001	Repeat count current value	K0	Stores the repeat count during the operation of each channel. The execution start time is counted as "1". When the repeat count exceeds the upper limit, it returns to "0". When the repeat operation is not enabled, "0" is stored at the positioning control start time. Stored value: 0-65535	•	-
0002 -0003	Elapsed value (Current value coordinate)	K0	Stores the elapsed values (current value coordinate) of each channel. Range: -1,073,741,824 to 1,073,741,823 For the interpolation control, the setting range is as follows. -8,388,608 to +8,388,607	•	•
0004 -0009	Reserved for system	-	-	-	-

11.3.4 Axis Setting Area (Memory Area No. 2)

●: Available, -: Not available

Offset address	Name	Default	Description	R	W																					
0000	Pulse output control code	H0	Stores the settings of pulse output, home position, near home position, and limit signal of each channel. Monitor in binary format.																							
			<table border="1"> <thead> <tr> <th>bitno.</th> <th>Item</th> <th>Settings</th> </tr> </thead> <tbody> <tr> <td>0</td> <td>Pulse output method</td> <td>0 : Pulse/Sign 1 : CW/CCW</td> </tr> <tr> <td>1</td> <td>Pulse output rotation direction</td> <td>0: Elapsed value + Direction is CW (Forward OFF/Reverse ON) 1: Elapsed value + Direction is CCW (Forward ON/Reverse OFF)</td> </tr> <tr> <td>2</td> <td>Home position logic</td> <td rowspan="4">0: Normal Open (A contact) 1: Normal Close (B contact)</td> </tr> <tr> <td>3</td> <td>Home position proximity logic</td> </tr> <tr> <td>4</td> <td>Limit (+) switch logic</td> </tr> <tr> <td>5</td> <td>Limit (-) switch logic</td> </tr> <tr> <td>6-15</td> <td>Disable the setting</td> <td></td> </tr> </tbody> </table>	bitno.	Item	Settings	0	Pulse output method	0 : Pulse/Sign 1 : CW/CCW	1	Pulse output rotation direction	0: Elapsed value + Direction is CW (Forward OFF/Reverse ON) 1: Elapsed value + Direction is CCW (Forward ON/Reverse OFF)	2	Home position logic	0: Normal Open (A contact) 1: Normal Close (B contact)	3	Home position proximity logic	4	Limit (+) switch logic	5	Limit (-) switch logic	6-15	Disable the setting		●	●
			bitno.	Item	Settings																					
			0	Pulse output method	0 : Pulse/Sign 1 : CW/CCW																					
			1	Pulse output rotation direction	0: Elapsed value + Direction is CW (Forward OFF/Reverse ON) 1: Elapsed value + Direction is CCW (Forward ON/Reverse OFF)																					
			2	Home position logic	0: Normal Open (A contact) 1: Normal Close (B contact)																					
			3	Home position proximity logic																						
4	Limit (+) switch logic																									
5	Limit (-) switch logic																									
6-15	Disable the setting																									
0001 -0002	Startup speed	K100	Stores the settings of the startup speed for each operation of each channel in decimal. Setting range: 1 to 100,000	●	●																					
0003	Home return method	HFF	Stores the settings of home return patterns of each channel. H0: DOG method 1 H1: DOG method 2 H2: DOG method 3 H3: Setting error H4: Setting error H5: Home position method (Z phase method) H6: Data set method HFF: Not use	●	●																					
0004	Home return direction	K0	Stores the settings of home return operation direction in decimal. 0: Elapsed value decreasing direction (Limit - direction) 1: Elapsed value increasing direction (Limit + direction)	●	●																					
0005	Home return acceleration time	K100	Stores the settings of the acceleration time for the home return of each channel in decimal. It indicates the time from the startup speed to the home return target speed. Setting range: 1-10,000 (ms)	●	●																					

11.3 Positioning Memory

Offset address	Name	Default	Description	R	W
0006	Home return deceleration time	K100	Stores the settings of the deceleration time for the home return of each channel in decimal. It indicates the time from the home return target speed to the startup speed. Setting range: 1-10,000 (ms)	•	•
0007 -0008	Home return target speed	K1000	Stores the settings of the target speed for the home return of each channel in decimal. Setting range: 1 to 100,000	•	•
0009 -0010	Home return creep speed	K100	Stores the settings of the creep speed for the home return of each channel in decimal. Setting range: 1 to 100,000	•	•
0011	Deviation counter clear time	K1	Stores the settings of the deviation counter clear signal ON time after the completion of home return of each channel in decimal. Setting range: 1 to 100 (ms) In the case of 0, no deviation counter clear signal is output. In the case of 100 or more, the ON time is set to 100 ms.	•	•
0012 -0013	Coordinate origin	K0	Stores the elapsed values (current value) after the home return. Range: -1,073,741,824 to 1,073,741,823 For the interpolation control, the setting range is as follows. -8,388,608 to +8,388,607	•	•
0014	JOG acceleration time	K0	Stores the settings of the acceleration time for the JOG operation of each channel in decimal. It indicates the acceleration time from startup speed to JOG operation target speed. Setting range: 0 to 10,000 (ms)	•	•
0015	JOG deceleration time	K0	Stores the settings of the deceleration time for the JOG operation of each channel in decimal. It indicates the deceleration time from JOG operation target speed to startup speed. Setting range: 0 to 10,000 (ms)	•	•
0016 -0017	JOG target speed	K1000	Stores the settings of the target speed for the JOG operation of each channel in decimal. Setting range: 1 to 100,000	•	•
0018 -0019	J point change target speed	K1000	Stores the settings of the target speed for changing the J-point control speed for each channel in decimal. Setting range: 1 to 100,000	•	•
0020	Emergency stop deceleration time	K100	Stores the settings of the deceleration time for the emergency stop operation of each channel in decimal. It indicates the deceleration time from 100 kHz to 0 Hz. Setting range: 0 to 10,000 (ms)	•	•
0021	Limit stop deceleration time	K100	Stores the settings of the deceleration time for the limit stop operation of each channel in decimal. It indicates the deceleration time from 100 kHz to 0 Hz. Setting range: 0 to 10,000 (ms)	•	•
0022 -0029	Reserved for system	-	-	-	-

(Note 1) The emergency stop deceleration time and limit stop deceleration time indicates the deceleration time in the section from 100 kHz to 0 Hz. When the speed during the operation is less than 100 kHz, the actual deceleration time is shorter than the set time.

11.3.5 Positioning Table Area (Memory Area No. 3)

●: Available, -: Not available

Offset address	Name	Default	Description	R	W									
0000	Control code	H0	<p>Stores the settings of the position specification method for the positioning operation.</p> <table border="1" style="width: 100%; border-collapse: collapse;"> <thead> <tr> <th>bit no.</th> <th>Item</th> <th>Settings</th> </tr> </thead> <tbody> <tr> <td>0</td> <td>Control method</td> <td>0 : Increment mode 1 : Absolute mode</td> </tr> <tr> <td>1-15</td> <td>Disable the setting</td> <td></td> </tr> </tbody> </table>	bit no.	Item	Settings	0	Control method	0 : Increment mode 1 : Absolute mode	1-15	Disable the setting		●	●
bit no.	Item	Settings												
0	Control method	0 : Increment mode 1 : Absolute mode												
1-15	Disable the setting													
0001	Control pattern	H0	<p>Stores the settings of single axis and interpolation operation pattern of positioning operation. In the interpolation operation, the setting for the axis with the smallest number in an axis group is effective.</p> <p style="text-align: center;"> </p> <p>Channel specification H00: Linear interpolation (composite speed) H01: Linear interpolation (major axis speed)</p> <p>Control pattern H00: E-point control (End point control) H01: P-point control (Pass point control) H02: C-point control (Continuance point control) H03: J-point control (Speed point control)</p>	●	●									
0002	Positioning acceleration time	K100	<p>Stores the settings of the acceleration time for the positioning operation. It indicates the acceleration time from the startup speed to the target speed. Setting range: 1 to 10,000 (ms)</p>	●	●									
0003	Positioning deceleration time	K100	<p>Stores the settings of the deceleration time for the positioning operation. It indicates the deceleration time from the target speed to the startup speed. Setting range: 1 to 10,000 (ms)</p>	●	●									
0004 -0005	Positioning target speed	K1000	<p>Stores the settings of the target speed for the positioning operation. In the interpolation operation, the setting for the axis with the smallest number in an axis group is effective. Setting range: 1 to 100,000</p>	●	●									
0006 -0007	Positioning movement amount	K0	<p>Stores the settings of the movement amount for the positioning operation. Setting range: -1,073,741,824 to 1,073,741,823 For the interpolation control, the setting range is as follows.</p>	●	●									

11.3 Positioning Memory

Offset address	Name	Default	Description	R	W
			-8,388,608 to +8,388,607		
0008	Dwell time	K0	Stores the setting of dwell time. Setting range: 0 to 32,767ms	•	•
0009	Reserved for system	-	-	-	-

(Note 1) The offset addresses in the above table are for the table no. 0. They vary according to the table numbers as described on the next page.

■ Offset addresses

Table no.	Control code	Control pattern	Positioning acceleration time	Positioning deceleration time	Positioning target speed	Positioning movement amount	Dwell time
1	0	1	2	3	4-5	6-7	8
2	10	11	12	13	14-15	16-17	18
3	20	21	22	23	24-25	26-27	28
4	30	31	32	33	34-35	36-37	38
5	40	41	42	43	44-45	46-47	48
6	50	51	52	53	54-55	56-57	58
7	60	61	62	63	64-65	66-67	68
8	70	71	72	73	74-75	76-77	78
9	80	81	82	83	84-85	86-87	88
10	90	91	92	93	94-95	96-97	98
11	100	101	102	103	104-105	106-107	108
12	110	111	112	113	114-115	116-117	118
13	120	121	122	123	124-125	126-127	128
14	130	131	132	133	134-135	136-137	138
15	140	141	142	143	144-145	146-147	148
16	150	151	152	153	154-155	156-157	158
17	160	161	162	163	164-165	166-167	168
18	170	171	172	173	174-175	176-177	178
19	180	181	182	183	184-185	186-187	188
20	190	191	192	193	194-195	196-197	198

(Note 1) For the positioning target speed and positioning movement amount, specify the lower address number of 2-word area.

Record of Changes

Manual numbers can be found at the bottom of the manual cover.

Date	Manual No.	Record of Changes
Oct. 2020	WUME-FPXHPOSG-01	1st Edition

Order Placement Recommendations and Considerations

The Products and Specifications listed in this document are subject to change (including specifications, manufacturing facility and discontinuing the Products) as occasioned by the improvements of Products. Consequently, when you place orders for these Products, Panasonic Industrial Devices SUNX asks you to contact one of our customer service representatives and check that the details listed in the document are commensurate with the most up-to-date information.

[Safety precautions]

Panasonic Industrial Devices SUNX is consistently striving to improve quality and reliability. However, the fact remains that electrical components and devices generally cause failures at a given statistical probability. Furthermore, their durability varies with use environments or use conditions. In this respect, check for actual electrical components and devices under actual conditions before use. Continued usage in a state of degraded condition may cause the deteriorated insulation. Thus, it may result in abnormal heat, smoke or fire. Carry out safety design and periodic maintenance including redundancy design, design for fire spread prevention, and design for malfunction prevention so that no accidents resulting in injury or death, fire accidents, or social damage will be caused as a result of failure of the Products or ending life of the Products.

The Products are designed and manufactured for the industrial indoor environment use. Make sure standards, laws and regulations in case the Products are incorporated to machinery, system, apparatus, and so forth. With regard to the mentioned above, confirm the conformity of the Products by yourself.

Do not use the Products for the application which breakdown or malfunction of Products may cause damage to the body or property.

- i) usage intended to protect the body and ensure security of life
 - ii) application which the performance degradation or quality problems, such as breakdown, of the Products may directly result in damage to the body or property
- It is not allowed the use of Products by incorporating into machinery and systems indicated below because the conformity, performance, and quality of Products are not guaranteed under such usage.
- i) transport machinery (cars, trains, boats and ships, etc.)
 - ii) control equipment for transportation
 - iii) disaster-prevention equipment / security equipment
 - iv) control equipment for electric power generation
 - v) nuclear control system
 - vi) aircraft equipment, aerospace equipment, and submarine repeater
 - vii) burning appliances
 - viii) military devices
 - ix) medical devices (except for general controls)
 - x) machinery and systems which especially require the high level of reliability and safety

[Acceptance inspection]

In connection with the Products you have purchased from us or with the Products delivered to your premises, please perform an acceptance inspection with all due speed and, in connection with the handling of our Products both before and during the acceptance inspection, please give full consideration to the control and preservation of our Products.

[Warranty period]

Unless otherwise stipulated by both parties, the warranty period of our Products is 3 years after the purchase by you or after their delivery to the location specified by you. The consumable items such as battery, relay, filter and other supplemental materials are excluded from the warranty.

[Scope of warranty]

In the event that Panasonic Industrial Devices SUNX confirms any failures or defects of the Products by reasons solely attributable to Panasonic Industrial Devices SUNX during the warranty period, Panasonic Industrial Devices SUNX shall supply the replacements of the Products, parts or replace and/or repair the defective portion by free of charge at the location where the Products were purchased or delivered to your premises as soon as possible.

However, the following failures and defects are not covered by warranty and we are not responsible for such failures and defects.

- (1) When the failure or defect was caused by a specification, standard, handling method, etc. which was specified by you.
- (2) When the failure or defect was caused after purchase or delivery to your premises by an alteration in construction, performance, specification, etc. which did not involve us.
- (3) When the failure or defect was caused by a phenomenon that could not be predicted by the technology at purchasing or contracted time.
- (4) When the use of our Products deviated from the scope of the conditions and environment set forth in the instruction manual and specifications.
- (5) When, after our Products were incorporated into your products or equipment for use, damage resulted which could have been avoided if your products or equipment had been equipped with the functions, construction, etc. the provision of which is accepted practice in the industry.
- (6) When the failure or defect was caused by a natural disaster or other force majeure.
- (7) When the equipment is damaged due to corrosion caused by corrosive gases etc. in the surroundings.

The above terms and conditions shall not cover any induced damages by the failure or defects of the Products, and not cover your production items which are produced or fabricated by using the Products. In any case, our responsibility for compensation is limited to the amount paid for the Products.

[Scope of service]

The cost of delivered Products does not include the cost of dispatching an engineer, etc. In case any such service is needed, contact our sales representative.

Panasonic Industrial Devices S U N X Co., Ltd.

(MEMO)

Please contact

Panasonic Corporation

Panasonic Industrial Devices SUNX Co., Ltd.
<https://panasonic.net/id/pidsx/global>

Please visit our website for inquiries and about our sales network.

Panasonic Industrial Devices SUNX Co., Ltd. 2020
October, 2020

WUME-FPXHPOSG-01