



# High-definition & Tough

Panasonic programmable display support various sites.

## High-definition

### Highest image quality!

High quality display improves screen readability and overall user experience.

### Optimized interface for easier operation!

Capable of displaying 4 times the visible data on one single screen.  
Reduce screen hierarchy and simplify use.



3.8 inch monochrome  
high quality display  
GT703



4.6 inch monochrome  
high quality display  
GT704

## Tough **Tough**

### Excellent Visibility and Environmental Resistance

High visibility display even in bright environments, it's also compact.  
The Programmable Display "Tough Model" with excellent environmental resistance



3.5 inch Environmentally-  
resistant Tough model  
GT03T-E



5.7 inch Environmentally-  
resistant Tough model  
GT32T-E

# Difference you can see. High-definition model for superior high image quality and easier operation

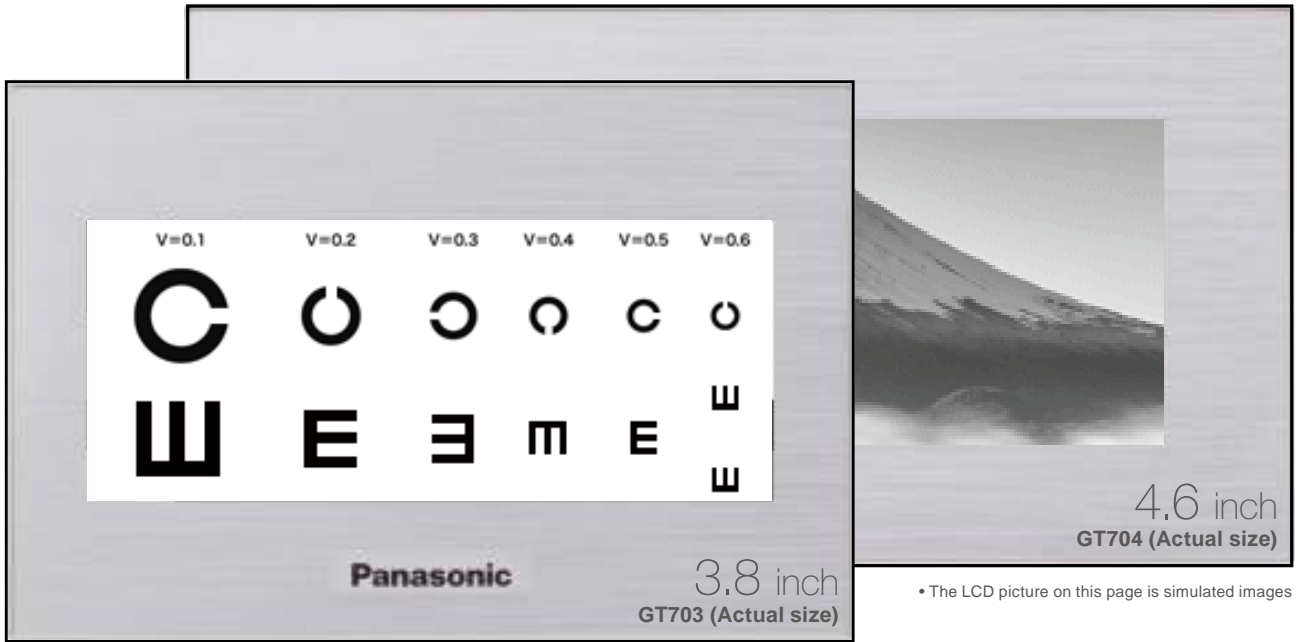

## Common Features for High-definition Model

High quality display improves screen readability and overall user experience. High image quality

**Outstanding image quality!**

Resolution is four times higher than before.

Standard displays	[3.8 inch] 240 × 96 dots 2-gray scale [4.6 inch] 320 × 120 dots 8-gray scale
New GT	[GT703] 480 × 192 dots 64-gray scale [GT704] 640 × 240 dots 64-gray scale

Capable of displaying 4 times the visible data on one single screen. Reduce screen hierarchy and simplify use. Optimized interface for easier operation

**4 times visual performance**

Data that previously required four screens can now be displayed on one.

Standard displays	320 × 120 dots
New GT	320 × 120 dots on a quarter screen

**No need to switch screens!**

Simplify screen hierarchy to improve operation efficiency. Reduce labor time lost to screen refreshing.

Standard displays	Switching between four screens
New GT	Four screens displayed on a single screen

## Connect up to 64 PLC units (our PLCs or other company's PLCs) via Ethernet

In addition to our PLC, Mitsubishi Electric MC protocol and Modbus-TCP protocol are also supported. Also with COM. port (serial connection), connection up to 4 protocols / 64 PLCs is possible.

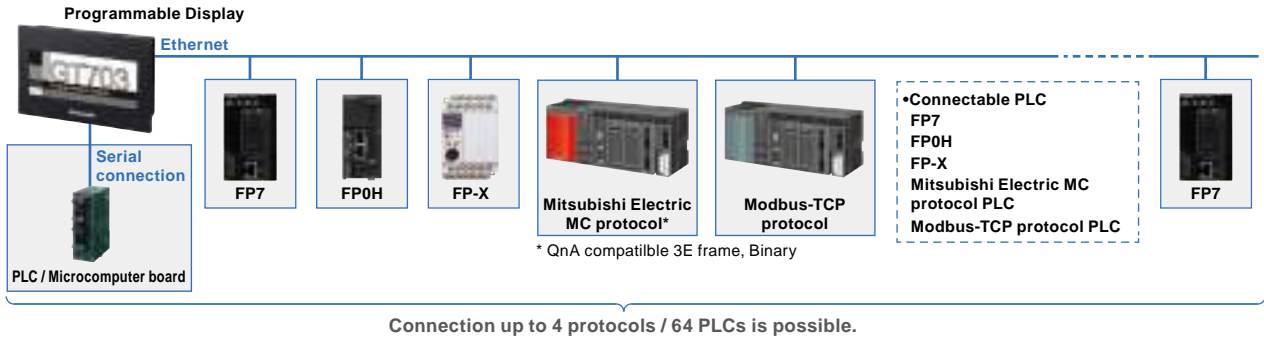

## Screens & PLC program can be edited via Ethernet. (pass through capability)

Multiple programmable displays and PLC units can be edited via Ethernet.

Besides being able to update the firmware and transfer screen data using GTWIN, it is now possible to use FPWIN to edit our "FP series" PLC programming directly through the programmable displays by using the built-in Ethernet port.

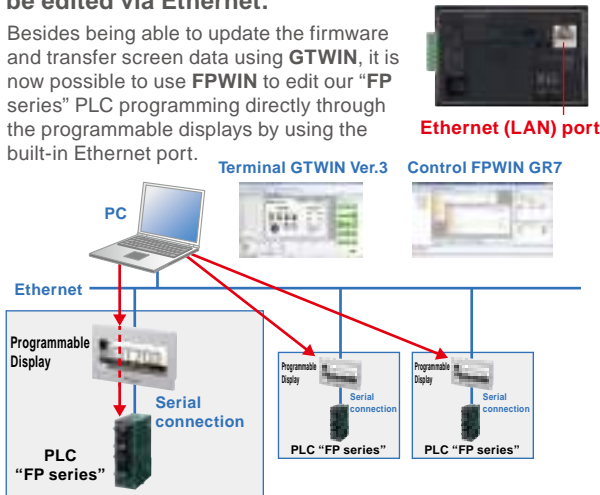

## FTP(S) server function\* to easily acquire data from SD memory card port. \* Supports SSL / TLS.

Information from multiple devices can be linked to IoT.

Information from SD memory card can be transferred to a single host PC via Ethernet.

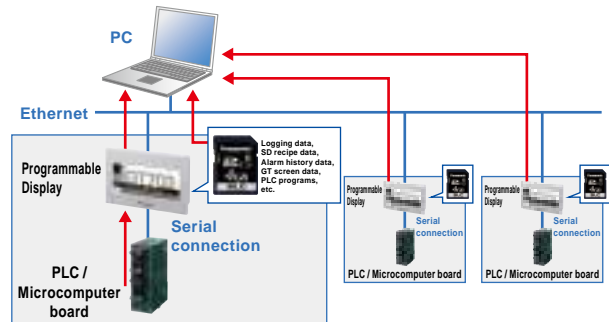

## Confirm PLC wiring and operation status simply and efficiently!

Whether the PLC is installed inside the equipment where it is not visible or in a remote location you can still monitor PLC input/output status

With simply drag and drop functionality, from PLC templates found in the parts library registered in GTWIN, you can easily verify the wiring and operation status.

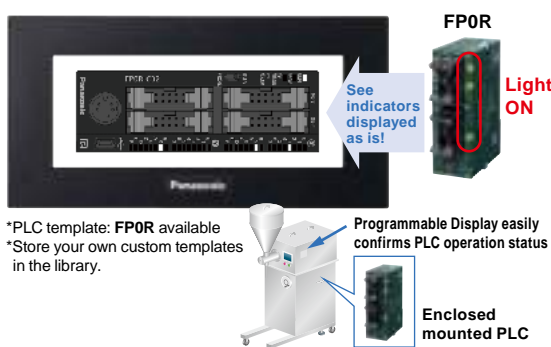

## Device monitor function shows PLC status without a PC

You can directly monitor multiple PLC devices from the programmable display without having to use a PC (FPWIN GR / FPWIN GR7). The device monitor can be accessed from the system menu, eliminating the need to create additional screens.

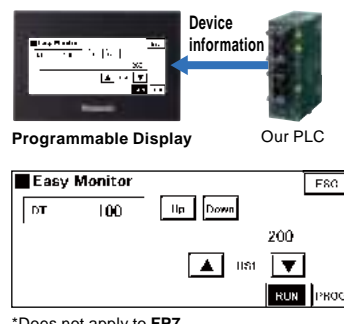

## Battery free Data backup

By eliminating the battery routine equipment maintenance can be reduced. You can also turn off the power to save energy without hesitation.

**Battery** ○: Available

Item	Without battery	With battery
Device maintenance <sup>(Note)</sup>	○	○
Calendar timer operation	—	○

Note: With PLC devices, up to 24 words can be displayed.

# GT703

Programmable Display

Difference you can see.

High image quality and easier operation!

3.8 inch



High image quality model

Pure black



GT703G

Silver



GT703M

112 mm  
4.409 in

74 mm  
2.913 in

## High quality display improves screen readability and overall user experience.

Resolution is four times higher than before.

Outstanding image quality!

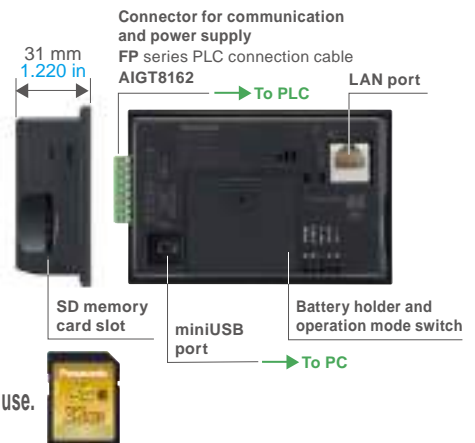
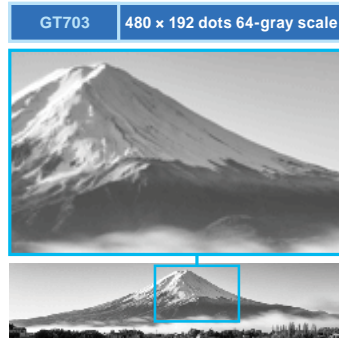
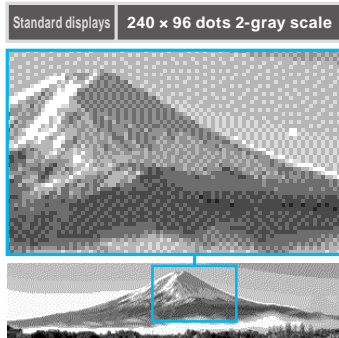

Capable of displaying 4 times the visible data on one single screen. Reduce screen hierarchy and simplify use.

Data that previously required four screens can now be displayed on one.

4 times visual performance

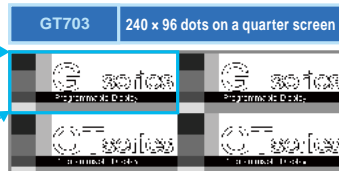

## Connect up to 64 PLC units (our PLCs or other company's PLCs) via Ethernet

In addition to our PLC, Mitsubishi Electric MC protocol and Modbus-TCP protocol are also supported. Also with COM. port (serial connection), connection up to 4 protocols / 64 PLCs is possible.

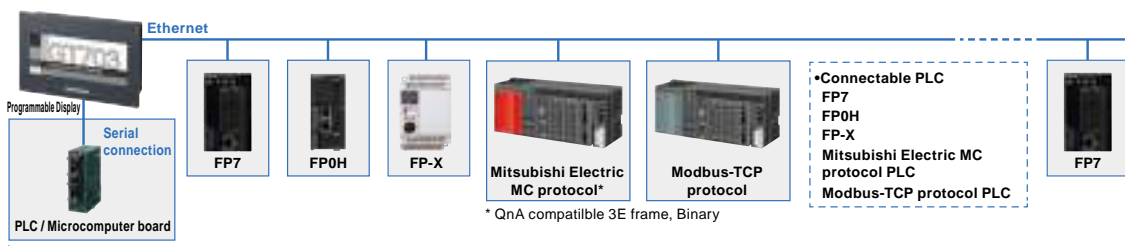

Connection up to 4 protocols / 64 PLCs is possible.



• The LCD picture on this page is simulated images  
• The panel face protection sheet for the GT series is available as an option.

# GT704

Programmable Display

Difference you can see.

High image quality and easier operation!

4.6 inch   

High image quality model

Pure black



GT704G

Silver



GT704M

146 mm  
5.748 in

74 mm  
2.913 in

## High quality display improves screen readability and overall user experience.

Resolution is four times higher than before.

Outstanding image quality!

Standard displays 320 × 120 dots 8-gray scale

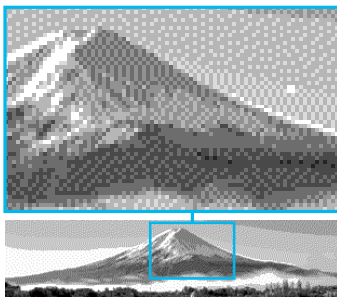

GT704 640 × 240 dots 64-gray scale

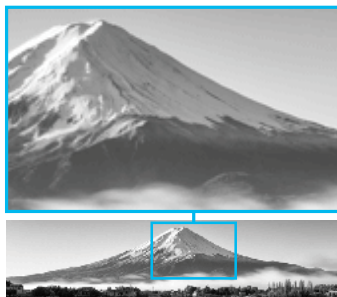

Capable of displaying 4 times the visible data on one single screen. Reduce screen hierarchy and simplify use.

Data that previously required four screens can now be displayed on one.

4 times visual performance

Standard displays 320 × 120 dots



GT704 320 × 120 dots on a quarter screen

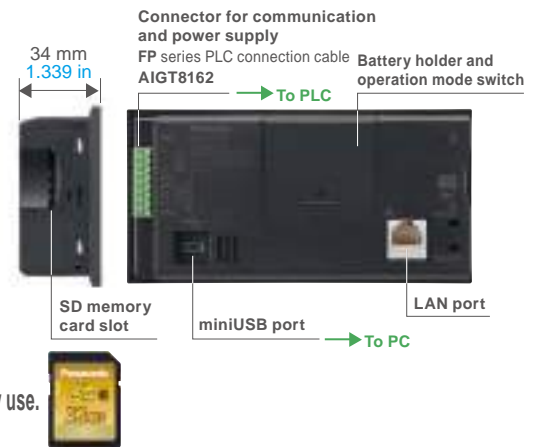

## Connect up to 64 PLC units (our PLCs or other company's PLCs) via Ethernet

In addition to our PLC, Mitsubishi Electric MC protocol and Modbus-TCP protocol are also supported.

Also with COM. port (serial connection), connection up to 4 protocols / 64 PLCs is possible.

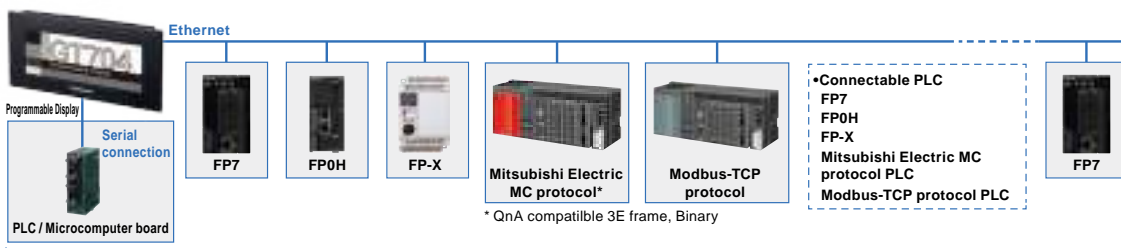

Connection up to 4 protocols / 64 PLCs is possible.



• The LCD picture on this page is simulated images  
• The panel face protection sheet for the GT series is available as an option.

# GT **Tough** Model with Excellent Environmental Resistance

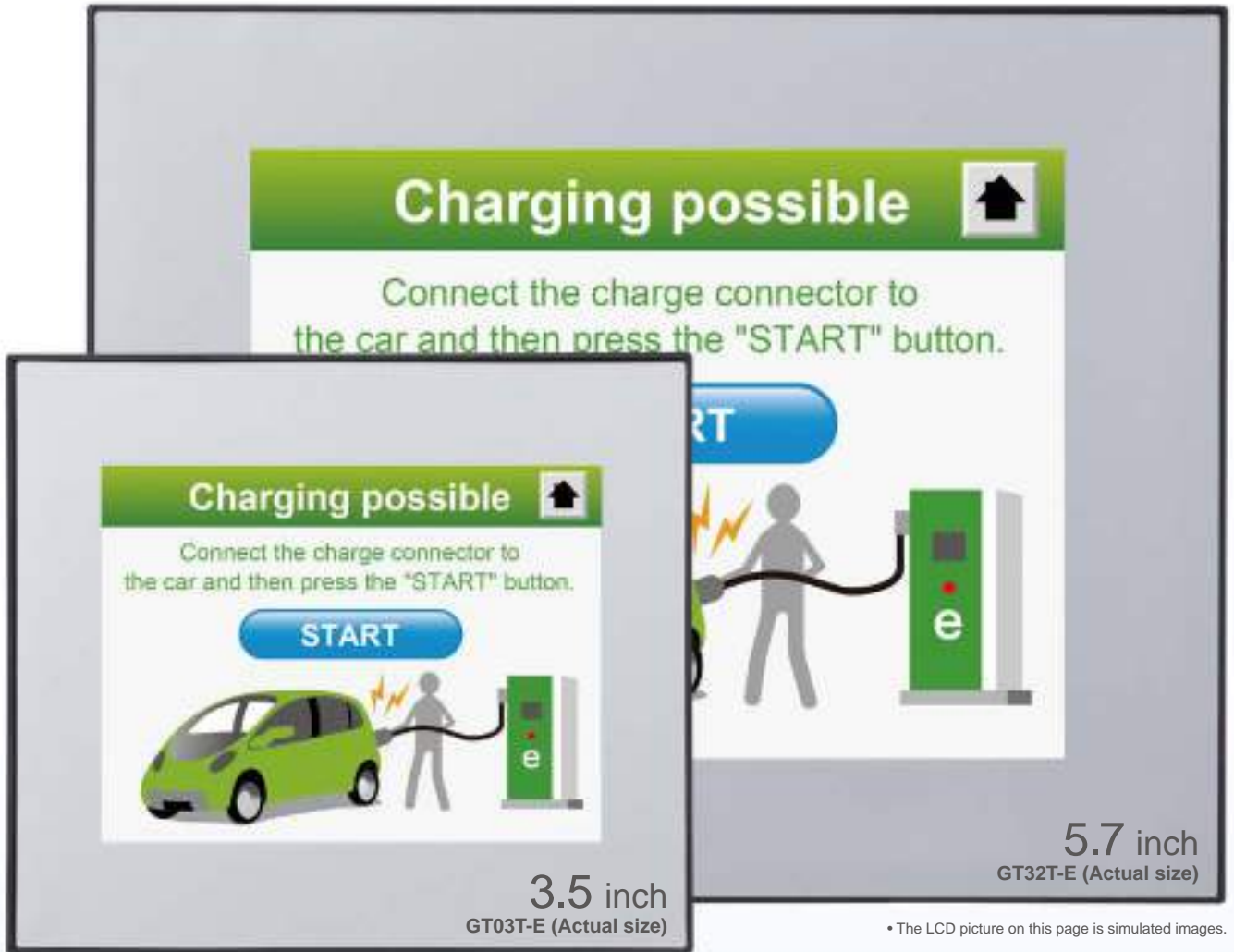

• The LCD picture on this page is simulated images.

- 20 to +60°C**  
**-4 to +140°F**

**The wide operating temperature range allows for use in various environments.**  
 (-20 to +55 °C -4 to +131 °F when horizontally installed, vertically installed in a portrait orientation, upside down installed and when using battery.)
- UV Reduction**

**Resistant to UV Rays!**  
 The two-layer front protection sheet deduces UV rays in two-stage.
- IP67**

**High waterproof performance allows for use in environments exposed to splashing water.**  
 The front panel has a protective structure rated IP67.
- Low power consumption**

**Color type (GT03T-E): 3.1 W or less**  
**Monochrome type (GT03M-E): 1.9 W or less**

- Improved visibility**

**High visibility display even in bright environments!**  
 High in brightness and contrast and anti-glare coating provides exceptional viewing characteristics. Monochrome type uses a TFT LCD that's bright and uses deep black for great visibility.
- High-definition**

**Same resolution [320 (W) × 240 (H) dots] as the 5.7 inch model (GT32-E) GT03-E**  
 Screen data of GT32-E can be used on the smaller display.
- Smallest**

**The smallest class body among 3.5 inch screen GT03-E**

See page 8 for details. ▶

## Applications

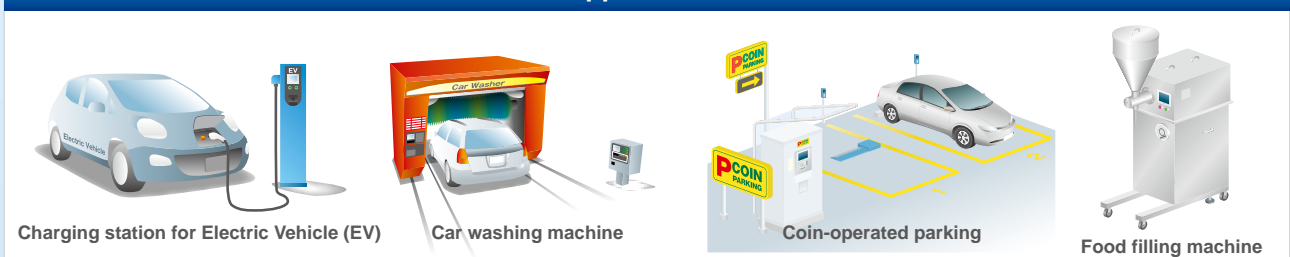

## Superior visibility even in sunlight

### Color type



Tough model GT32T-E



Conventional model

### Monochrome type



Tough model GT32M-E



Conventional model

- **High contrast TFT LCD:** Achieved higher contrast and visibility.
- **High brightness backlight:** Achieved greater brightness and visibility than the conventional model.

The monochrome type, in particular, is greater brightness than the conventional model and is way easier to view in bright environments thanks to the “deep black”.

## Anti-glare, High visibility display

- **A front protection layer has an anti-glare coating to prevent unwanted reflections**  
(Fingerprints are made less noticeable even in outdoor use)

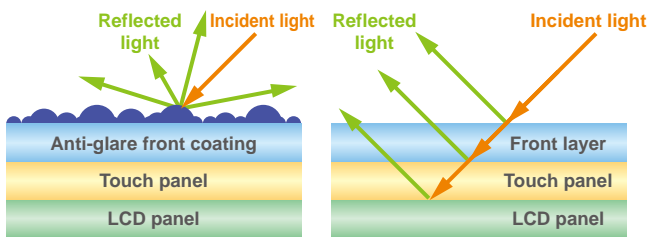

Anti-glare front coating

No anti-glare front coating

### Comparison of reflection



Tough model GT32T-E



Conventional model

## No risk of product deterioration due to UV exposure

- The front sheet is made of a material that does not transmit UV rays.
- A combination of a UV cutting layer and a UV absorbing layer performs two-stage UV blocking.  
The LCD and touch panel can be protected from deterioration.

### UV ray transmittance performance

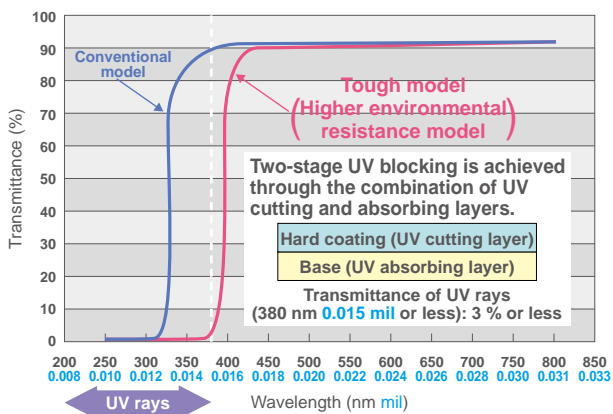

- The LCD images on this page are actual photographs.

## Excellent water resistance

- The front panel has a protective structure rated IP67.  
Safe to use outdoors or in a location exposed to splashing water.
- Added protection has been applied to the rear of the unit for a more rugged overall construction.

## Wide operating temperature range

- Usable in a range of  $-20\text{ }^{\circ}\text{C}$  to  $+60\text{ }^{\circ}\text{C}$   $-4\text{ }^{\circ}\text{F}$  to  $+140\text{ }^{\circ}\text{F}$   
( $-20\text{ }^{\circ}\text{C}$  to  $+55\text{ }^{\circ}\text{C}$   $-4\text{ }^{\circ}\text{F}$  to  $+131\text{ }^{\circ}\text{F}$  when horizontally installed, vertically installed in a portrait orientation, upside down installed) and when using battery.
- The TFT LCD can quickly switch screens even at a low temperature.
- The life of the LED backlight does not decrease even at a low power consumption.
- It is not necessary to prepare a heater for use at a low temperature.

## Reduced power consumption

- Compact color type (GT03T-E): 3.1 W or less
- Compact monochrome type (GT03M-E): 1.9 W or less
- Color type (GT32T-E): 7.2 W or less
- Monochrome type (GT32M-E): 4.8 W or less

# GT03-E

**Tough**

Programmable Display

The smallest class body among 3.5 inch screen

Color display uses 3.1 W or less for low power consumption!

3.5 inch CE UL US

Tough model



GT03T-E

GT03T-E

**3.5 inch, 4,096 colors TFT color LCD equipped with long life LED backlight**

**Built-in SD / SDHC memory card slot \*1**

Easy to copy, back up, and restore screen data.

\*1: Class 10 compatible with a card of up to 32 GB.

GT03M-E

**3.5 inch, 16-gray scale TFT monochrome LCD equipped with long life LED backlight**

Through use of a TFT LCD with contrast ratio of 1,000 : 1, the "deep black" on a bright display means incredible visibility even in bright environments.

**Common features**

**Superior visibility even in sunlight**

The brightness and contrast ratio have been improved.

**Wide range of operating temperature that covers outdoor use**

The improved environmental resistance allows for use in a wider operating temperature range of -20 to +60 °C **-4 to +140 °F**.

**UV resistant, anti-glare front panel**

A front protection layer reduces the intensity of UV rays and has an anti-glare coating.

**Impressive water resistance makes usage possible in areas prone to water contact.**

The front panel is IP67 rated with added protection applied to the rear of the unit for a more rugged overall construction.

**Integrated USB Interface**

You can connect your PC and **GT03-E** using your USB cable to transfer screen data. When used with our **FP** series PLC, this display supports the pass through function, which allows simultaneous debugging of the PLC and the display.

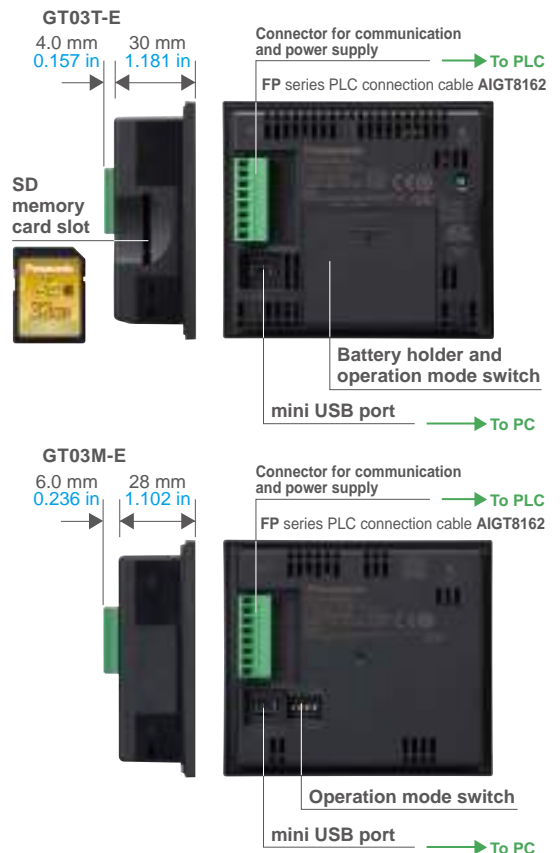



# GT32-E

**Tough**

Programmable Display

Outdoor use made possible by significantly improved environmental resistance and visibility

5.7 inch



Tough model

Silver



GT32T-E

GT32T-E

Silver



GT32M-E

163.2 mm  
6.425 in

128.8 mm  
5.071 in

## 5.7 inch, 4,096 colors TFT color LCD equipped with long life LED backlight

Great visibility even in bright environments is possible thanks to use of a TFT LCD with contrast ratio of 500 : 1.

GT32M-E

## 5.7 inch, 16-gray scale TFT monochrome LCD equipped with long life LED backlight

Through use of a TFT LCD with contrast ratio of 400 : 1, the "deep black" on a bright display means incredible visibility even in bright environments.

### Common features

#### Superior visibility even in sunlight

The brightness, contrast ratio, and viewing angle have been improved.

#### Wide range of operating temperature that covers outdoor use

The improved environmental resistance allows for use in a wider operating temperature range of -20 to +60 °C -4 to +140 °F.

#### UV Resistant, Anti-glare front panel

A front protection layer reduces the intensity of UV rays and has an anti-glare coating.

#### Impressive water resistance makes usage possible in areas prone to water contact.

The front panel is IP67 rated with added protection applied to the rear of the unit for a more rugged overall construction.

#### Built-in SD / SDHC memory card slot \*1

Easy to copy, back up, and restore screen data.

\*1: Class 10 compatible with a card of up to 32 GB.

#### Integrated USB Interface

You can connect your PC and GT32-E using your USB cable to transfer screen data.

When used with our FP series PLC, this display supports the pass through function, which allows simultaneous debugging of the PLC and the display.

#### Transformer-isolated power supply

The isolated power supply enhances the reliability.

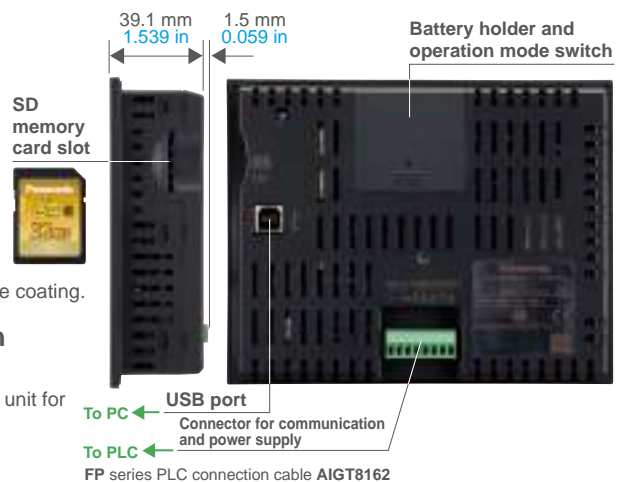

GT32M-E GT32T-E

# SD Solutions only Panasonic can provide

## Links and expansion via SD

As small-size touch panels have significantly improved their image quality, easy to read displays with sharp characters are no longer special features these days. Instead, programmable displays will evolve with maximum "user-friendliness" in various applications with PCs or other devices.

As shown below, our touch panels exchange and store data using SD memory card, data for many applications.

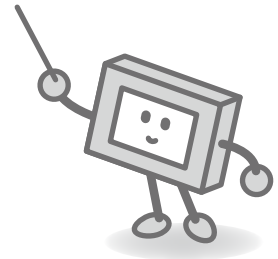

**Industrial grade SD memory cards**  
Panasonic offers high-reliability industrial SD memory cards.

**Links via SD**

- ▶▶ SD recipe function (Data table management)
- ▶▶ Transfer of PLC program data

**Expansion via SD**

- ▶▶ Saving alarm history data on an SD
- ▶▶ Logging function
- ▶▶ Display of graphs of stored data

# PLC program transfer without the use of a PC

\* Our FP series, excluding FP7.

It is possible to modify PLC ladder programs as well as the GT screen programs by using an SD / SDHC memory card. SD / SDHC memory card enables everyone to easily modify programs.

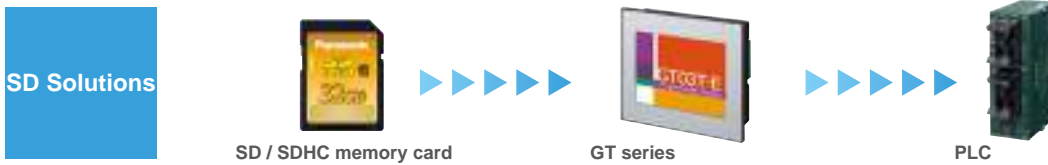

## SD memory card data transfer function

Log and other data saved on a SD memory card inserted into the GT's onboard SD memory card slot can now be sent to a PC using a USB connection.



GT\_SD\_Reader software must be installed in order to read from the USB port. This software is installed simultaneously with Terminal GTWIN. For GT703 / GT704, data can be read from the Ethernet port using FTP client software on a PC. In order to do this, the FTP server function setting is required on the GT unit beforehand.

## SD logging function to produce data "Visualization"

Capable of automatically collecting electrical power readings of Eco-POWER METERS and displaying them in a real time graph, allowing users to take quick actions for solutions.

- The GT unit can collect data, such as electrical power on an SD / SDHC memory card, and display the log data in a real time graph. You can make data "Visualization" without using a PC as a display or Data logger for collecting data.
- One bar graph has a maximum of eight bars and can be combined with line graphs.
- The following three conditions can be selected to trigger an operation to save log data.
  - (1) Specified time
  - (2) Specified cycle (1 sec. to 24 hrs.)
  - (3) Specified condition
- Large volumes of data can be saved on an SD / SDHC memory card, which can be carried with you.



## SD recipe function

For high-mix production, recipe data up to 64 types and 4,096 devices in total, can be easily set on a PC. The created recipe data is saved on an SD / SDHC memory card, and the specified data can be written or read from a PLC.

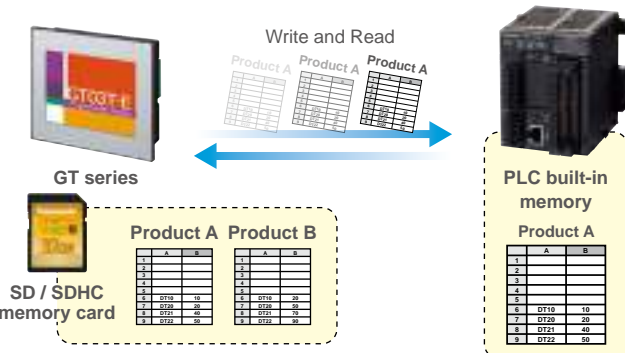

## Saving alarm history data on an SD / SDHC memory card

The alarm history data stored in the GT built-in memory can be saved on an SD / SDHC memory card, making it possible to easily control problems on a PC.

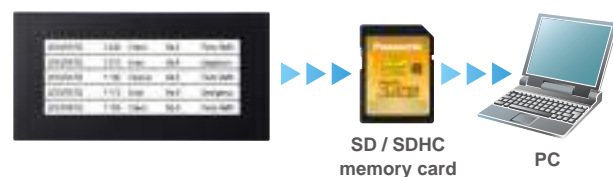

• The LCD images on this page are composites.

# High Visibility and Excellent Operability

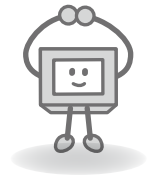

## Three-color LED backlight allows for checking machine status at a glance

(GT02M / GT02G / GT703M / GT703G / GT05M / GT05G / GT12M / GT12G / GT704M / GT704G)

The monochrome display\* has a three-color LED backlight. It allows operators to check the equipment status at a glance by changing the background color.

Example: green under normal conditions, orange during operation, and red in emergency situations.

\* Excluding GT03M-E, GT32M-E, GT32M-R and GT02L

GT05G



(Normal)

GT12G

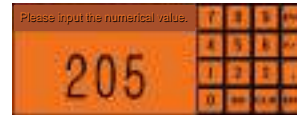

(In operation)

GT02G



(Emergency)

## Highly flexible screen design!

GT series displays use an analog-touch panel where locations of parts and characters can be adjusted in increments of one dot. The adoption of the Windows® font has widened the character size selection (10 to 240 dots), making the screen design more flexible. \*The maximum size varies depending on the model.

### “Analog-touch design”

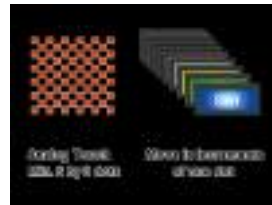
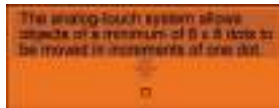

### “TrueType fonts”

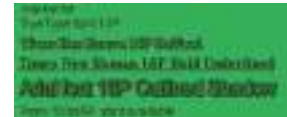

The adoption of the Windows® font has made it possible to choose a font focusing on the screen image and visual quality.



## Graph function

One bar graph has a maximum of eight bars and can be combined with line graphs.

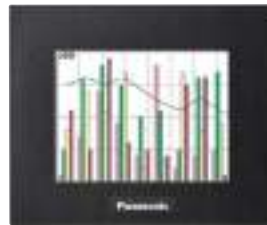

## Flow display function

A flowing message of up to 64 characters (two-byte) can be displayed at the bottom of the screen. (128 messages)



## Portrait display ideal for narrow spaces

The unit can display screens in portrait orientation and can therefore be installed in narrow spaces, expanding system design possibilities and contributing to size reduction. The portrait display is also ideal for slim equipment without enough space to install a display.



## Multi-function switches

Multiple operations are possible. For example, screens can be switched by setting multiple values.

## 4,096-color parts libraries

(GT05S / GT32T-R / GT03T-E / GT32T-E)

3D-design buttons with higher visibility and operability are available.



• The LCD images on this page are composites.



# GT series

	Power supply	Display							External interface	
		Screen size	Display type	Display color	Resolution	Backlight	Displayable characters (Note)	Memory capacity (F-ROM)	USB port	SD / SDHC memory card
<b>Tough</b> Environmentally-resistant Tough model	P.8 24 V DC	3.5 inch	TFT monochrome LCD	2 colors (black / white) (16-gray scale)	320(W) × 240(H) dots	White LED	768 characters	6 Mbyte	○ (mini)	—
		3.5 inch	TFT color LCD	4,096 colors	320(W) × 240(H) dots	White LED	768 characters	12 Mbyte	○ (mini)	○
	P.9 24 V DC	5.7 inch	TFT monochrome LCD	2 colors (black / white) (16-gray scale)	320(W) × 240(H) dots	White LED	768 characters	12 Mbyte	○	○
		5.7 inch	TFT color LCD	4,096 colors	320(W) × 240(H) dots	White LED	768 characters	12 Mbyte	○	○
High image quality model	P.4 5 V DC 24 V DC	3.8 inch	TFT monochrome LCD	2 colors (black / white) (64-gray scale)	480(W) × 192(H) dots		GT703M: 3-color LED (white / pink / red)	16 Mbyte	○ (mini)	○
							GT703G: 3-color LED (green / orange / red)			
	P.5 24 V DC	4.6 inch	TFT monochrome LCD	2 colors (black / white) (64-gray scale)	640(W) × 240(H) dots		GT704M: 3-color LED (white / pink / red)	16 Mbyte	○ (mini)	○
							GT704G: 3-color LED (green / orange / red)			
General-purpose model	P.18 5 V DC 24 V DC	3.8 inch	TFT monochrome LCD	2 colors (black / white)	240(W) × 96(H) dots		GT02M: 3-color LED (white / pink / red)	2 Mbyte	○ (mini)	○ AIG02MQ2-D and AIG02GQ2-D only
							GT02G: 3-color LED (green / orange / red)			
	P.19 24 V DC	4.6 inch	TFT monochrome LCD	2 colors (black / white) (8-gray scale)	320(W) × 120(H) dots		GT12M: 3-color LED (white / pink / red)	2 Mbyte	○ (mini)	○ AIG12MQ1-D and AIG12GQ1-D only
							GT12G: 3-color LED (green / orange / red)			
P.20	24 V DC	3.5 inch	TFT monochrome LCD	2 colors (black / white)	320(W) × 240(H) dots		GT05M: 3-color LED (white / pink / red)	2 Mbyte	○	○
							GT05G: 3-color LED (green / orange / red)			
							<b>GT05S</b>			
	24 V DC	3.5 inch	TFT color LCD	4,096 colors	320(W) × 240(H) dots	White LED	768 characters	12 Mbyte	○	○

Note: With the 10-dot font.

# GT series

	Power supply	Display							External interface		
		Screen size	Display type	Display color	Resolution	Backlight	Displayable characters (Note)	Memory capacity (F-ROM)	USB port	SD / SDHC memory card	
General-purpose model	GT32M-R P.21	24 V DC	5.7 inch	TFT monochrome LCD	2 colors (black / white) (16-gray scale)	320(W) × 240(H) dots	White LED	768 characters	12 Mbyte	○	○
	GT32T-R P.21	24 V DC	5.7 inch	TFT color LCD	4,096 colors	320(W) × 240(H) dots	White LED	768 characters	12 Mbyte	○	○
Entry-level model	GT707 P.16	24 V DC	7 inch widescreen	TFT color LCD	65,536 colors	800(W) × 480(H) dots	White LED	600 characters	76 Mbyte	○ (mini)	○
	GT02L P.17	5 V DC	3.7 inch	STN monochrome LCD	2 colors (black / white)	160(W) × 64(H) dots	White LED	96 characters	704 kbyte	○ (mini)	—

\*Note: With the 10-dot font (For GT707: 32-dot font)

## Product types

Choose what you are looking for by screen size and price.

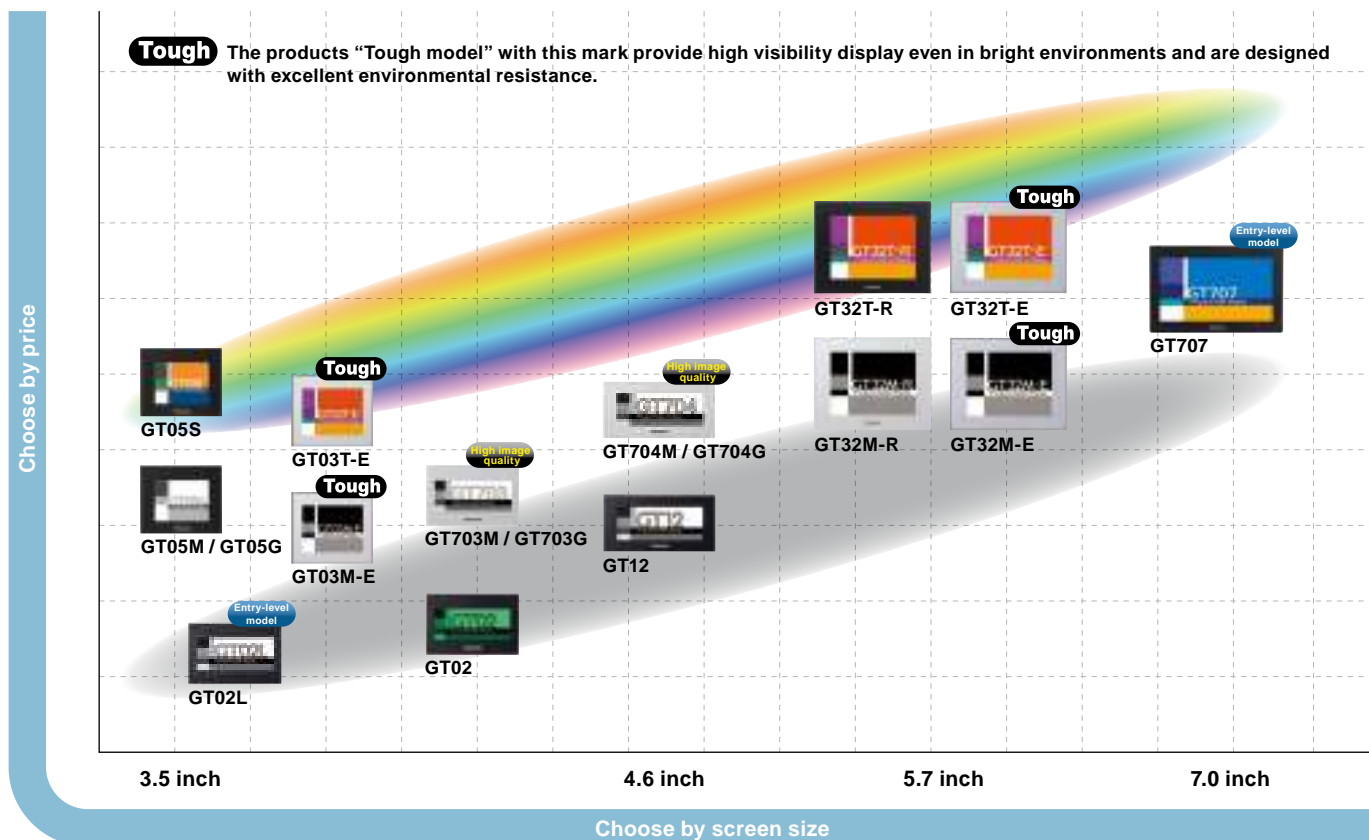

# GT707

Programmable Display

Wide screen, small body

7 inch widescreen in space of a 5.7 inch!

7 inch Widescreen  

Entry-level model

Black



## 7 inch type can be placed in the space of a 5.7 inch type.

Since 7 inch type can fit in a 5.7 inch type space, the screen shows more and the product looks greater.

**Usable screen comparison**

<b>Conventional model</b> 5.7 inch <b>GT32T-R</b> Screen dimensions: W115.2 × H86.4 mm W4.535 × H3.402 in	<b>NEW</b> 7 inch <b>GT707</b> Screen dimensions: W153.8 × H85.6 mm W6.055 × H3.370 in
<b>Resolution:</b> 800 × 480 dots	<b>5 times over previous</b>
<b>Display color:</b> 65,536 colors	<b>16 times over previous</b>

## 7 inch, 65,536 colors TFT color LCD equipped with long life LED backlight

Easy-to-view screen thanks to use of a TFT LCD with contrast ratio of 500 : 1.

## Built-in SD / SDHC memory card slot

Easy to copy, back up, and restore screen data. Data logging possible.

## Device monitor shows PLC status without a PC

You can directly check PLC devices from the Programmable Display without having to use a PC (FPWIN GR / FPWIN GR7).

The device monitor is easily viewed from the system menu, which eliminates the bother of screen creation.



## Confirm PLC wiring and operation status simply and efficiently!

Whether the PLC is installed inside the equipment where it is not visible or in a remote location you can still monitor PLC input/output status. With simply drag and drop functionality, from PLC templates found in the parts library registered in GTWIN, you can easily verify the wiring and operation status.

## Transfer programs from Programmable Display to PLC

Transfer of PLC ladder programs and Programmable Display screen data is possible from a SD memory card without using a PC. Also, PLC ladder programs and Programmable Display screen data can be backed up inside the Programmable Display and restored at any time.

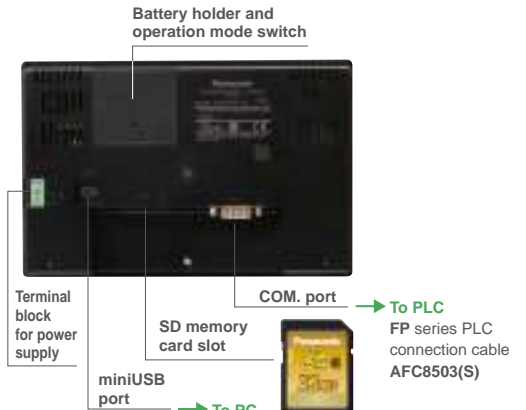

7 inch Width	TFT 65,536 colors	White LED	40 chars. x 15 lines (32-dot font)	800 × 480 dots	mini USB	SD HC	Portrait	IP65	24 V DC
--------------	-------------------	-----------	------------------------------------	----------------	----------	-------	----------	------	---------

\* The panel face protection sheet for the GT series is available as an option.



# GT02L

Programmable Display

Entry-level Model Touch Panel

3.7 inch  

Entry-level model

Black



## For replacing your touch panel

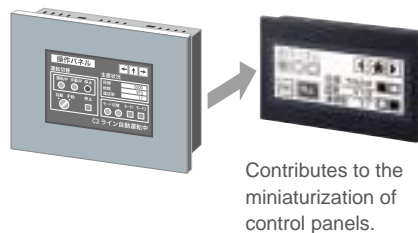

## For replacement of your membrane-type switch panel

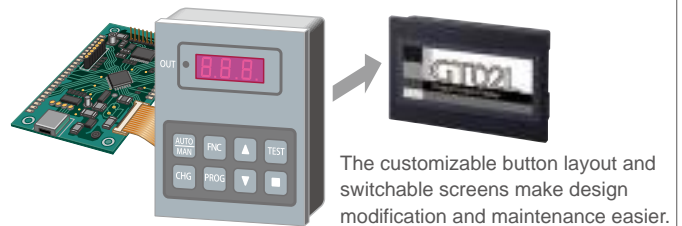

## Compact body with a wide LCD that is the largest size in its class

The small body of 74 mm 2.913 in high and 112 mm 4.409 in wide is equipped with a 3.7 inch large LCD. The analog touch system does not display any annoying visible dots or lines.

## MiniUSB interface as standard equipment

Supports the through function using a USB cable, allowing simultaneous debugging of PLC and GT.

## Flexible sizing and layout available for switches and characters

Switches of a minimum of 8 × 8 dots can be moved in increments of one dot. A wide range of character fonts and sizes (10 to 64 dots) are supported.

## Portrait orientation ideal for narrow spaces

Installation in narrow spaces is possible, enhancing the degree of system design freedom.

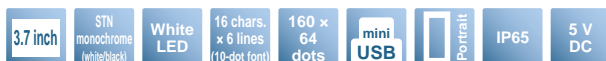
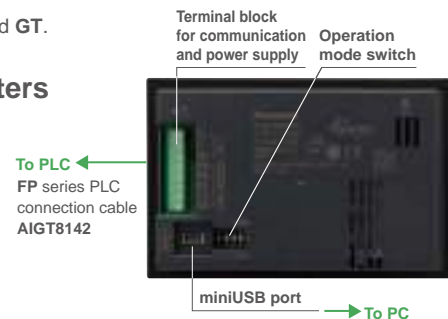

• The panel face protection sheet for the GT series is available as an option.

• The LCD images on this page are composites.

# GT02

Programmable Display

Compact advanced display with 3.8 inch high-contrast monochrome LCD (for clear and vivid images)

3.8 inch



General-purpose model

Pure black



GT02G

Hairline silver



GT02M

112 mm  
4.409 in

74 mm  
2.913 in

## 3.8 inch high-contrast monochrome LCD provides top-level viewability.

High-definition 240 × 96 dots LCD produces crisp images. The analog touch screen technology does not display any annoying visible dots or lines.

## Bright three-color LED backlight indicates the equipment status.

The color combination is white / pink / red or green / orange / red. The backlight ensures both operability and visibility.

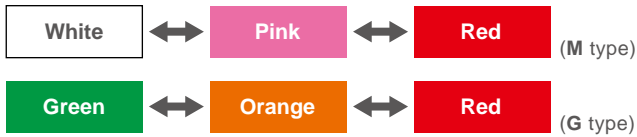

27 mm  
1.063 in



Connector for communication and power supply

Battery holder and operation mode switch

## SD / SDHC memory card slot as equipment\*1

AIG02MQ2\*D and AIG02GQ2\*D are equipped with an SD / SDHC memory card slot. Easy to copy, back up, and restore screen data.

\*1: Class 10 compatible with a card of up to 32 GB.

To PLC  
FP series PLC connection cable AIGT8162 and AIGT8142



SD memory card slot

miniUSB port → To PC

## MiniUSB interface as standard equipment

Supports the through function using a USB cable, allowing simultaneous debugging of PLC and GT.

## Flexible sizing and layout available for switches and characters

Switches of a minimum of 8 × 8 dots can be moved in increments of one dot. A wide range of character fonts and sizes (10 to 96 dots) are supported.

## Equipped with IP67-rated body and newly designed bracket

## Portrait orientation ideal for narrow spaces

Installation in narrow spaces is possible, enhancing the degree of system design freedom.

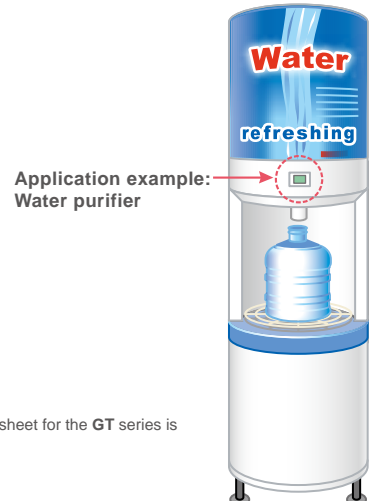

Application example: Water purifier



\* The panel face protection sheet for the GT series is available as an option.

# GT12

Programmable Display

Slim body equipped with a 4.6 inch half-QVGA LCD  
The highest visual quality in its class

4.6 inch CE UL US

General-purpose model

Pure black



GT12M

Hairline silver



GT12G

4.6 inch TFT high-contrast monochrome half-QVGA LCD with a wide viewing angle provides top-level viewability<sup>\*1</sup>.

High-definition half-QVGA (320 × 120) LCD produces crisp images. The analog touch screen technology does not display any annoying visible dots or lines.

<sup>\*1</sup>: The display has been changed STN LCD to TFT LCD from production in November 2016.

**Bright three-color LED backlight indicates the equipment status.**

The color combination is white / pink / red or green / orange / red. The backlight ensures both operability and visibility.

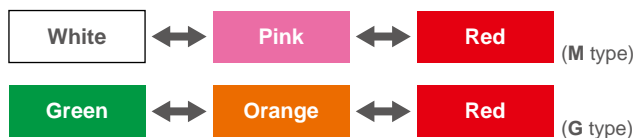

**SD / SDHC memory card slot as equipment<sup>\*2</sup>**

AIG12MQ1\*D and AIG12GQ1\*D are equipped with an SD / SDHC memory card slot. Easy to copy, back up, and restore screen data.

<sup>\*2</sup>: Class 10 compatible with a card of up to 32 GB.

**MiniUSB interface as standard equipment**

Supports the through function using a USB cable, allowing simultaneous debugging of PLC and GT.



**Flexible sizing and layout available for switches and characters**

Switches of a minimum of 8 × 8 dots can be moved in increments of one dot. A wide range of character fonts and sizes (10 to 120 dots) are supported.

**Transformer-isolated power supply**

The isolated power supply enhances the reliability.

**Equipped with IP67-rated body**

**Portrait orientation ideal for narrow spaces**

Installation in narrow spaces is possible, enhancing the degree of system design freedom.

Application example:  
Business dishwasher

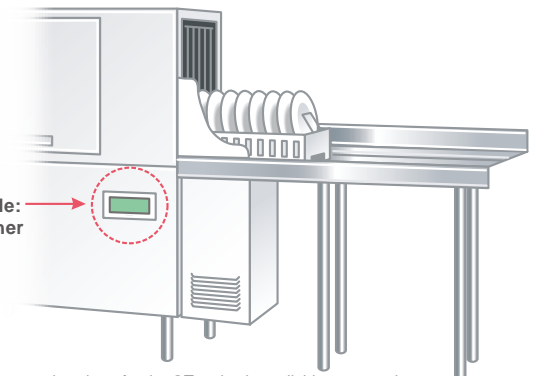

<sup>\*</sup> The panel face protection sheet for the GT series is available as an option.

# GT05

Programmable Display

Compact size and equipped with a QVGA LCD

Both the color and monochrome types display striking images

3.5 inch



General-purpose model

Pure black



GT05M

Hairline silver



GT05G

Pure black



GT05S

92.2 mm  
3.630 in

110 mm  
4.331 in



GT05M: red

GT05M: pink



GT05G: orange

GT05G: red

## GT05M / GT05G

**3.5 inch TFT high-contrast monochrome QVGA LCD with a wide viewing angle<sup>\*1</sup>**

<sup>\*1</sup>: The display has been changed STN LCD to TFT LCD from production in March 2016.

**Bright LED backlight adopted**

GT05M displays screens in white, red, and pink, and GT05G in green, orange, and red, ensuring both operability and visibility.

## Common features

**SD / SDHC memory card slot as standard equipment<sup>\*3</sup>**

Easy to copy, back up, and restore screen data.

<sup>\*3</sup>: Class 10 compatible with a card of up to 32 GB.

**USB interface as standard equipment**

Supports the through function using a USB cable, allowing simultaneous debugging of PLC and GT.

**Characters of a 240 dots maximum size can be displayed.**

Capable of displaying several fine 10-dot characters or one 240 dots character in full screen.

**Transformer-isolated power supply**

The isolated power supply enhances the reliability.

## GT05S

**3.5 inch TFT 4,096 colors QVGA LCD with a wide viewing angle<sup>\*2</sup>**

<sup>\*2</sup>: The display has been changed STN LCD to TFT LCD from production in December 2011.

**Bright LED backlight adopted**

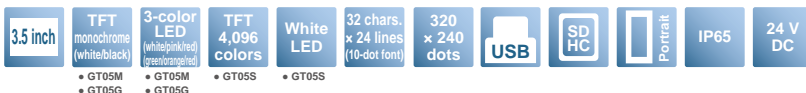
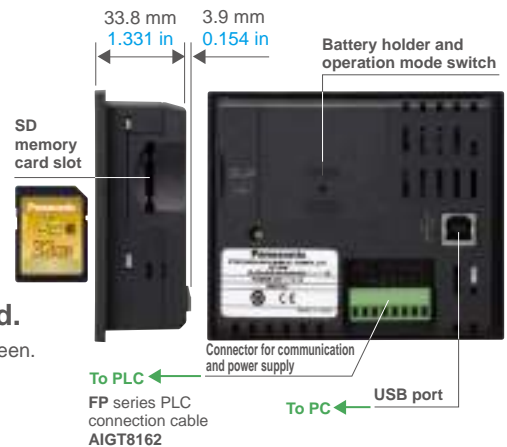

<sup>\*</sup>The panel face protection sheet for the GT series is available as an option.

# GT32-R

Programmable Display

GT32M/T now with improved performance!



5.7 inch



General-purpose model

Pure black



GT32T-R

GT32T-R

Hairline silver

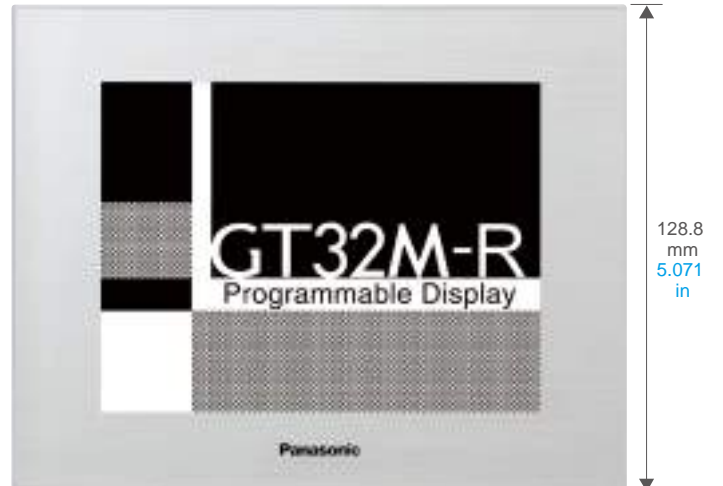

GT32M-R

163.2 mm  
6.425 in

## 5.7 inch, 4,096 colors TFT color LCD equipped with long life LED backlight

Great visibility even in bright environments is possible thanks to use of a TFT LCD with contrast ratio of 500 : 1.

GT32M-R

## 5.7 inch, 16-gray scale TFT monochrome LCD equipped with long life LED backlight

Through use of a TFT LCD with contrast ratio of 400 : 1, the "deep black" on a bright display means incredible visibility even in bright environments.

### Common features

#### Slim frame and body

Designed for easy installation with slim frame and body compared to LCD.

#### Built-in SD / SDHC memory card slot \*1

Easy to copy, back up, and restore screen data.  
Data logging possible.

\*1: Class 10 compatible with a card of up to 32 GB.

#### Integrated USB Interface

You can connect your PC and GT32-R using your USB cable to transfer screen data.

When used with our FP series PLC, this display supports the pass through function, which allows simultaneous debugging of the PLC and the display.

#### Transformer-isolated power supply

The isolated power supply enhances the reliability.

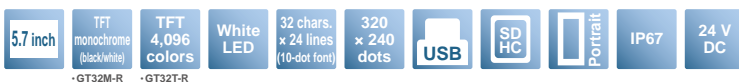
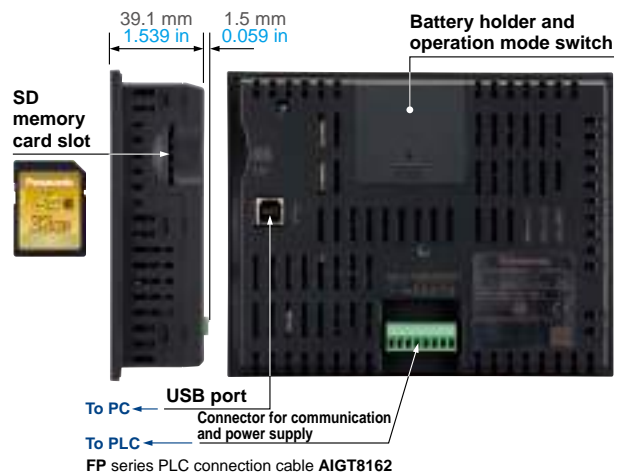

\* The panel face protection sheet for the GT series is available as an option.

# Terminal GTWIN Ver.3

Screen Creation Tool for the GT series

Easier to use with upgraded user interface!

**File manager window**  
Map format makes it easy to grasp the main and edit-in-progress screens. Switching to list or thumbnail format is possible. Display of all function trees such as configuration settings and logging can be switched using tabs.

**Toolbar**  
Commonly used functions can be executed with the single click of an icon.

**Part library window**  
Select library easily from dropdown menu. Verify ON / OFF status in the library window before pasting.

**Search results and text string list window**  
Edit the screen while viewing device search results and text string list.

**Screen edit window**  
Use drag and drop to create screen.

**Part edit screen**  
Switch designs are also changed instantly. Just a single click can also change between switches and lamps.

\*Some functions are not supported in GT series other than GT703 / GT704 / GT707.

## Common to both GTWIN Ver. 2 and Ver. 3

### Compatible with Windows® 8 / 8.1 / 10

(Also supports 64-bit version.)

### Compatible with the nine languages for the menu

English

The menu can be indicated in Japanese, English, Simplified Chinese, Traditional Chinese (Note), Korean (Note), German (Note), Italian (Note), Spanish (Note) and French (Note).  
Note: Ver.2 only

Japanese

Simplified Chinese

German

### Screen copy in bitmap form

You can output screen images in bitmap form and use them in off-the-shelf applications. This is useful for preparing equipment operation manuals.

### Simply drag-and-drop parts



You can easily create screens by just dragging parts from the library and dropping them anywhere you want.

### Function to turn on / off the display of keyboard parts on the base screen

### Indications of data parts in Japanese, Simplified Chinese, Traditional Chinese, and Korean

### Now supports installation in a portrait orientation of all GT series models

### Reduced site licensing fee and bother

The licensing fee and extra work that was involved in license (serial code) management have been greatly reduced.

WIN 2000 (Ver.2 only)	WIN XP (Ver.2 only)	WIN Vista	WIN 7	WIN 8	WIN 8.1	WIN 10	Required disk space 800 MB min.
--------------------------	------------------------	-----------	-------	-------	---------	--------	---------------------------------

\* The 64-bit version is not supported except for Windows® 10, Windows® 8.1, Windows® 8 or Windows® 7.  
\* Windows is registered trademark or trademark of Microsoft Corporation in the United States and other countries.

# GTseries | PLC COMPATIBILITY TABLE

Models listed are the models that have been evaluated as of March, 2018.

Company name	Series	Model	RS-232C type	RS-422 / RS-485 type <sup>2</sup>	
Our company	FP series	FP7	○	○	
		FP0H	○	○	
		FP-X	○	○	
		FP-X0	○	○	
		FPΣ	○	○	
		FP-e	○	○	
		FP0	○	○	
		FP0R	○	○	
		FP2	○	○	
		FP2SH	○	○	
Mitsubishi Electric <sup>1</sup>	FX series	FX0N	○	○	
		FX1S	○	○	
		FX1N	○	○	
		FX1NC	○	○	
		FX2N	○	○	
		FX2NC	○	○	
		FX3UC	○	○	
		FX3U	○	○	
		FX3G	○	○	
		FX3GC	○	○	
		FX5U	○	○	
		FX5UC	○	○	
		Q series	Q00CPU	○	
			Q01CPU	○	
	Q00JCPU		○		
	Q00HCPU		○		
	Q00JCPU		○		
	Q26UDHCPU		○	○	
	Q25HCPU		○		
	Q12HCPU		○		
	Q06HCPU		○		
	Q02HCPU		○		
	Q02CPU	○			
	A series (Except GT7□□)	A1N	○		
		A2N	○		
		A3N	○		
		A1S	○		
		A1SJ	○		
A2SH		○			
A1SH		○			
L series	L26CPU-BT	○	○		
	L02SCPU	○	○		
Omron <sup>11</sup>	C series	C200H	○		
		C200HS	○		
		C500	○		
		C500F	○		
		C1000H	○		
		C2000	○		
		C2000H	○		
		C1000HF	○		
		C20H	○		
		C28H	○		
		C40H	○		
		C120	○		
		C120F	○		
		CQM1-CPU42	○		
		SRM1-C02	○		
		CPM2A	○		
		CPM1-20CDR-A	○		
		CQM1H-CPU21	○		
		CPM2C	○		
		CPM2B	○		
		α series	C200HE-CPU32(-Z)	○	
			C200HG-CPU33(-Z)	○	
			C200HG-CPU53(-Z)	○	
			C200HX-CPU34(-Z)	○	
			C200HX-CPU54(-Z)	○	
			C200HE-CPU42(-Z)	○	
			C200HG-CPU43(-Z)	○	
			C200HG-CPU63(-Z)	○	
	C200HX-CPU44(-Z)		○		
	C200HX-CPU64(-Z)		○		
	C200HX-CPU65-Z		○		
	C200HX-CPU85-Z		○		
	CV series		CV500	○	
			CV1000	○	
		CVM1	○		

Company name	Series	Model	RS-232C type	RS-422 / RS-485 type <sup>2</sup>
Omron <sup>11</sup>	CS1 series	CS1H-CPU67	○	
		CS1H-CPU66	○	
		CS1H-CPU65	○	
		CS1H-CPU64	○	
		CS1H-CPU63	○	
		CS1G-CPU45	○	
		CS1G-CPU44	○	
		CS1G-CPU43	○	
		CS1G-CPU42	○	
		CJ series	CJ1H	○
	CJ1M		○	
	CJ1G		○	
	CJ2H		○	
	CJ2M		○	
	CP1H		○	
	CP1L		○	
	CP1E		○ <sup>4</sup>	○
	Toshiba Machine <sup>11</sup>	TC mini series		Models with RS-232C port
Yokogawa Electric <sup>11</sup>	FA-M3 series	F3SP59-7S	○	
		F3SP58-6S	○	
		F3SP58-6H	○	
		F3SP53-4S	○	
		F3SP53-4H	○	
		F3SP38-6S	○	
		F3SP38-6N	○	
		F3SP35-5N	○	
		F3SP28-3S	○	
		F3SP28-3N	○	
		F3SP25-2N	○	
		F3SP21-0N	○	
		KEYENCE <sup>11</sup>	KV series	KV Nano series
KV-10/16/24/40	○			
KV700	○			○
KV1000	○			○
KV3000	○			○
Hitachi Industrial Equipment Systems <sup>11</sup>	EH-150 EHV series	EHV-CPU128	○	○
		EHV-CPU64	○	○
		EHV-CPU32	○	○
		EHV-CPU16	○	○
	EH150 series	EH-CPU104A	○	○
		EH-CPU208A	○	○
		EH-CPU316A	○	○
		EH-CPU516	○	○
		EH-CPU548	○	○
		MICRO-EH series	10-point	
14 / 20-point	○			
23 / 28-point	○		○	
Web controller	40 / 64-point	○		
	10-point	○		
Rockwell Automation <sup>11</sup> (Allen-Bradley) Models that support DF protocol	MicroLogix series	MicroLogix500	○	
		MicroLogix1000	○	
		MicroLogix1100	○	
SLC-500 series	SLC-5/03	○		
	SLC-5/04	○		
Siemens <sup>11</sup>	S7-200 series	CPU222	○	○
		CPU216	○	○
		CPU215	○	○
		CPU214	○	○
		CPU212	○	○
LS Industrial Systems <sup>11</sup>	MASTER-K series	80S / 200S	○	
		300S / 1000S	○	
Modbus <sup>11</sup>	Models that support RTU protocol	*3	○	○
		General-purpose serial	*3	○

\*1: PLCs other than our FP series may be limited in the type of device that can be used and addresses. Please see manual for details.  
\*2: Communication may not be possible when using RS-485 depending on the sending and receiving timing with the other device.  
\*3: We cannot specify what other device you should use; therefore, please test it using the actual equipment before using.  
\*4: Available for models equipped with on RS-232C port.  
○: Direct connection is possible to the CPU unit of the PLC.  
○: Connection is possible using the communications unit or a signal conversion cable, etc.  
(Example: The QJ71C24N or QJ71C24N-R2 calculator link unit is required when using the Mitsubishi Q Series.)  
x: Connection is not possible  
Blank: Not evaluated.  
Refer to the HELP of the latest version of tool software "Terminal GTWIN", or GT series Connection with other companies' PLC's Manual for more details such as usable devices and addresses. Information on how to connect our programmable display and PLC is available. The manual can be downloaded from our website.

## Main Unit and Tool Software

Type	Product name	Description						Part No.				
		LCD	Screen size	Power supply	Communication port	Color of front panel	SD memory card slot (Note)					
<b>Tough</b> Environmentally-resistant Tough model	<b>GT03M-E</b>	TFT monochrome LCD (white backlight)	3.5 inch	24 V DC	RS-232C	Silver	Not available	<b>AIG03MQ03DE</b>				
	<b>GT03T-E</b>	TFT color LCD (white backlight)			RS-422 / RS-485			Available	<b>AIG03MQ05DE</b>			
		<b>GT32M-E</b>	TFT monochrome LCD (white backlight)		RS-232C	Available	<b>AIG03TQ13DE</b>					
	<b>GT32T-E</b>		TFT color LCD (white backlight)		RS-422 / RS-485		Available	<b>AIG03TQ15DE</b>				
		High image quality model	<b>GT703M</b>	TFT monochrome LCD (white / pink / red backlight)	3.8 inch	5 V DC		RS-232C	Pure black	Available	<b>AIG703WMN1B5</b>	
	RS-422 / RS-485						Silver	<b>AIG703WMN1S5</b>				
	24 V DC					RS-232C	Pure black	Available	<b>AIG703WMN1B2</b>			
						RS-422 / RS-485	Silver		<b>AIG703WMN1S2</b>			
<b>GT703G</b>	TFT monochrome LCD (green / orange / red backlight)		3.8 inch	5 V DC	RS-232C	Pure black	Available	<b>AIG703WGN1B5</b>				
					RS-422 / RS-485	Silver		<b>AIG703WGN1S5</b>				
				24 V DC	RS-232C	Pure black		Available	<b>AIG703WGN1B2</b>			
					RS-422 / RS-485	Silver			<b>AIG703WGN1S2</b>			
<b>GT704M</b>	TFT monochrome LCD (white / pink / red backlight)	4.6 inch	24 V DC	RS-232C	Pure black	Available	<b>AIG703WGNMB5</b>					
				RS-422 / RS-485	Silver		<b>AIG703WGNMS5</b>					
				RS-232C	Pure black		<b>AIG703WGNMB2</b>					
				RS-422 / RS-485	Silver		<b>AIG703WGNMS2</b>					
<b>GT704G</b>	TFT monochrome LCD (green / orange / red backlight)	4.6 inch	24 V DC	RS-232C	Pure black	Available	<b>AIG703WGNB5</b>					
				RS-422 / RS-485	Silver		<b>AIG703WGNB2</b>					
				RS-232C	Pure black		<b>AIG703WGNMS2</b>					
				RS-422 / RS-485	Silver		<b>AIG703WGNMS2</b>					
General-purpose model	<b>GT02M</b>	TFT monochrome LCD (white / pink / red backlight)	3.8 inch	5 V DC	RS-232C	Pure black	Not available	<b>AIG02MQ02D</b>				
					RS-422 / RS-485	Hairline silver		<b>AIG02MQ03D</b>				
					RS-422 / RS-485	Pure black		<b>AIG02MQ04D</b>				
					RS-422 / RS-485	Hairline silver		<b>AIG02MQ05D</b>				
					24 V DC	RS-232C		Pure black	<b>AIG02MQ12D</b>			
						RS-422 / RS-485		Hairline silver	<b>AIG02MQ13D</b>			
				RS-422 / RS-485		Pure black		<b>AIG02MQ14D</b>				
				RS-422 / RS-485		Hairline silver		<b>AIG02MQ15D</b>				
				RS-232C		Pure black		<b>AIG02MQ22D</b>				
				RS-422 / RS-485		Hairline silver		<b>AIG02MQ23D</b>				
				<b>GT02G</b>	TFT monochrome LCD (green / orange / red backlight)	3.8 inch		5 V DC	RS-232C	Pure black	Not available	<b>AIG02MQ24D</b>
									RS-422 / RS-485	Hairline silver		<b>AIG02MQ25D</b>
	RS-422 / RS-485	Pure black	<b>AIG02GQ02D</b>									
	RS-422 / RS-485	Hairline silver	<b>AIG02GQ03D</b>									
	24 V DC	RS-232C	Pure black				<b>AIG02GQ04D</b>					
		RS-422 / RS-485	Hairline silver				<b>AIG02GQ05D</b>					
		RS-232C	Pure black				<b>AIG02GQ12D</b>					
		RS-422 / RS-485	Hairline silver				<b>AIG02GQ13D</b>					
		RS-422 / RS-485	Pure black				<b>AIG02GQ14D</b>					
		RS-422 / RS-485	Hairline silver				<b>AIG02GQ15D</b>					
	<b>GT05M</b>	TFT monochrome LCD (white / pink / red backlight)	3.5 inch				24 V DC	RS-232C	Pure black	Available		<b>AIG02GQ22D</b>
								RS-422 / RS-485	Hairline silver			<b>AIG02GQ23D</b>
				RS-422 / RS-485	Pure black	<b>AIG02GQ24D</b>						
				RS-422 / RS-485	Hairline silver	<b>AIG02GQ25D</b>						
RS-232C				Pure black	<b>AIG05MQ02D</b>							
RS-422 / RS-485				Hairline silver	<b>AIG05MQ03D</b>							
<b>GT05G</b>	TFT monochrome LCD (green / orange / red backlight)	3.5 inch	24 V DC	RS-232C	Pure black	Available	<b>AIG05MQ04D</b>					
				RS-422 / RS-485	Hairline silver		<b>AIG05MQ05D</b>					
				RS-232C	Pure black		<b>AIG05GQ02D</b>					
				RS-422 / RS-485	Hairline silver		<b>AIG05GQ03D</b>					
<b>GT05S</b>	TFT color LCD (white backlight)	3.5 inch	24 V DC	RS-232C	Pure black	Available	<b>AIG05GQ04D</b>					
				RS-422 / RS-485	Hairline silver		<b>AIG05GQ05D</b>					
				RS-232C	Pure black		<b>AIG05SQ02D</b>					
				RS-422 / RS-485	Hairline silver		<b>AIG05SQ03D</b>					
							<b>AIG05SQ04D</b>					
							<b>AIG05SQ05D</b>					

Note: The model of the "Available" have a built-in clock.



## Main Unit and Tool Software



Type	Product name	Description					Part No.		
		LCD	Screen size	Power supply	Communication port	Color of front panel		SD memory card slot (Note)	
General-purpose model	<b>GT12M</b>	TFT monochrome LCD (white / pink / red backlight)	4.6 inch	24 V DC	RS-232C	Pure black	Not available	<b>AIG12MQ02D</b>	
						Hairline silver		<b>AIG12MQ03D</b>	
					RS-422 / RS-485	Pure black		<b>AIG12MQ04D</b>	
						Hairline silver		<b>AIG12MQ05D</b>	
					RS-232C	Pure black		Available	<b>AIG12MQ12D</b>
						Hairline silver			<b>AIG12MQ13D</b>
	RS-422 / RS-485	Pure black	<b>AIG12MQ14D</b>						
		Hairline silver	<b>AIG12MQ15D</b>						
	<b>GT12G</b>	TFT monochrome LCD (green / orange / red backlight)	4.6 inch	24 V DC	RS-232C	Pure black	Not available		<b>AIG12GQ02D</b>
						Hairline silver			<b>AIG12GQ03D</b>
					RS-422 / RS-485	Pure black		<b>AIG12GQ04D</b>	
						Hairline silver		<b>AIG12GQ05D</b>	
					RS-232C	Pure black		Available	<b>AIG12GQ12D</b>
						Hairline silver			<b>AIG12GQ13D</b>
	RS-422 / RS-485	Pure black	<b>AIG12GQ14D</b>						
		Hairline silver	<b>AIG12GQ15D</b>						
<b>GT32M-R</b>	TFT monochrome LCD (white backlight)	5.7 inch	24 V DC	RS-232C	Pure black	Available	<b>AIG32MQ02DR</b>		
					Hairline silver		<b>AIG32MQ03DR</b>		
				RS-422 / RS-485	Pure black		<b>AIG32MQ04DR</b>		
					Hairline silver		<b>AIG32MQ05DR</b>		
<b>GT32T-R</b>	TFT color LCD (white backlight)	5.7 inch	24 V DC	RS-232C	Pure black	Available	<b>AIG32TQ02DR</b>		
					Hairline silver		<b>AIG32TQ03DR</b>		
				RS-422 / RS-485	Pure black		<b>AIG32TQ04DR</b>		
					Hairline silver		<b>AIG32TQ05DR</b>		
Entry-level model	<b>GT707</b>	TFT color LCD (white backlight)	7 inch widescreen	24 V DC	RS-232C	Black	Available	<b>AIG707WCL1G2</b>	
	<b>GT02L</b>	STN monochrome LCD (white backlight)	3.7 inch	5 V DC	RS-232C RS-422 / RS-485	Black	Not available	<b>AIG02LQ02D</b> <b>AIG02LQ04D</b>	
<b>Terminal GTWIN Ver.2</b>		Japanese version	<b>Terminal GTWIN CD-ROM</b>				<b>AIGT8000V2</b>		
<b>Terminal GTWIN Ver.2</b>		English version	<b>Terminal GTWIN CD-ROM</b>				<b>AIGT8001V2</b>		
<b>Terminal GTWIN Ver.2</b>		Japanese version	<b>Terminal GTWIN CD-ROM</b>				<b>AIGT8000V2R</b>		
<b>Upgrade version<sup>*1</sup></b>		English version	<b>Terminal GTWIN CD-ROM</b>				<b>AIGT8001V2R</b>		
<b>Terminal GTWIN Ver.3<sup>*2</sup></b>		Japanese version	<b>Terminal GTWIN CD-ROM</b>				<b>AIGSGT7JP</b>		
		English version	<b>Terminal GTWIN CD-ROM</b>				<b>AIGSGT7EN</b>		

Note: The model of the "Available" have a built-in clock.

\*1: For upgrading **Terminal GTWIN** Ver. 1 to Ver. 2.

\*2: Some functions are not supported in **GT** series other than **GT703 / GT704 / GT707**.

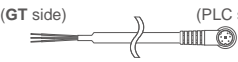
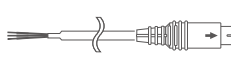
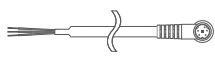
## Cables | PLC connection cable

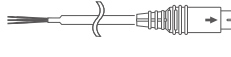
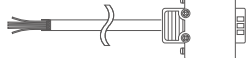
Power supply and communication port	Connection cable	PLC
5 V DC RS-232C	 Part No.: <b>AIGT8142<sup>*1</sup></b> PLC connection cable (2 m <b>6.562 ft</b> ) 5-pin mini DIN connector — 4 single wires + shielding wire	Our <b>FP</b> series (except <b>FP7</b> ) <sup>*2</sup>
5 V DC RS-422 / RS-485	 Part No.: <b>AIGT8152<sup>*1</sup></b> PLC connection cable (2 m <b>6.562 ft</b> ) 8-pin mini DIN connector — 6 single wires + shielding wire	Mitsubishi Electric FX series
24 V DC RS-232C	 Part No.: <b>AIGT8162</b> PLC connection cable (2 m <b>6.562 ft</b> ) 5-pin mini DIN connector — 3 single wires + shielding wire <b>AIGT8165</b> (5 m <b>16.404 ft</b> ) and <b>AIGT8160</b> (10 m <b>32.808 ft</b> ) are also available.	Our <b>FP</b> series (except <b>FP7</b> ) <sup>*2</sup>
24 V DC RS-232C	 Part No.: <b>AFC8503</b> For <b>GT707</b> , PLC connection cable (L type: 3 m <b>9.843 ft</b> ) 9-pin D-SUB connector — 5-pin mini DIN connector	Our <b>FP</b> series (except <b>FP7</b> ) <sup>*3</sup>
24 V DC RS-232C	 Part No.: <b>AFC8503S</b> For <b>GT707</b> , PLC connection cable (straight type: 3 m <b>9.843 ft</b> ) 9-pin D-SUB connector — 5-pin mini DIN connector	Our <b>FP</b> series (except <b>FP7</b> ) <sup>*3</sup>
24 V DC RS-422 / RS-485	 Part No.: <b>AIGT8175</b> PLC connection cable (5 m <b>16.4 ft</b> ) 8-pin mini DIN connector — 4 single wires + shielding wire	Mitsubishi Electric FX series
24 V DC RS-232C	 Part No.: <b>AIP81842</b> PLC connection cable (2 m <b>6.562 ft</b> ) 9-pin D-SUB connector — 6 single wires	<b>FP2 / FP2SH</b> COM port, CCU (Computer Communication Unit)

\*1: This cable is exclusively designed for the **GT** series (5 V DC) and is powered by PLC.

\*2: For **FP7** series, please use a commercially available discrete wire cable.

\*3: For **FP7** series, please use commercially available D-SUB 9-pin (female) connector cable with discrete wire.

## Options

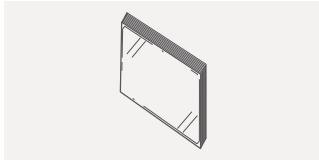

■ **Panel face protection sheets**  
10 sheets in a set (option)

For GT02L / GT02 / GT703	Part No.: AIG02800
For GT05	Part No.: AIG05800
For GT12 / GT704	Part No.: AIG12800
For GT32-R	Part No.: AIG32800
For GT707	Part No.: AIG7A07S01

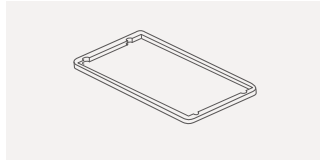

■ **Waterproof packing**  
Waterproof packing (for replacement), 10 pieces in a set  
Package includes one piece.

For GT02L / GT02 / GT703	Part No.: AIG02810
For GT03-E	Part No.: AIG03810E
For GT05	Part No.: AIG05810
For GT12 / GT704	Part No.: AIG12810
For GT32-R/E	Part No.: AIG32810E

\* The waterproof packing for GT02(L) is different from the GT02L main unit accessory.

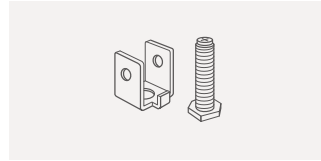

■ **GT02 / GT02L / GT703 / GT03-E / GT12 / GT704 mounting parts**  
5 sets of mounting parts (4 parts / set)  
Package includes one set.

Part No.: AIG12830
--------------------

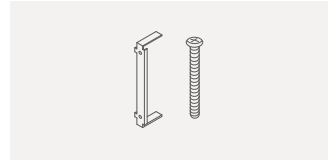

■ **GT05 / GT32-R / GT32-E mounting parts**  
5 sets of mounting parts (2 parts / set)  
Package includes one set.

Part No.: AIGT28321 For GT05
------------------------------

Part No.: AIG32830 For GT32-R/E
---------------------------------

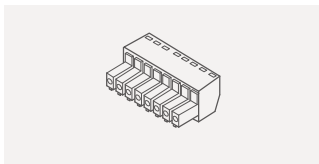

■ **Spare connector**  
5 connectors for communication and power supply in a set  
Package includes one set.

Part No.: AIGT084
-------------------



■ **GT02 / GT703 / GT03-E / GT05 / GT12 / GT704 / GT32-R / GT32-E backup battery**

Part No.: AFPX-BATT
---------------------

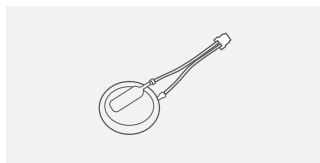

■ **GT707 backup battery**

Part No.: AFPABAT001
----------------------

Product name		GT03M-E		GT03T-E		GT32M-E		GT32T-E	
		RS-232C	RS-422 / RS-485	RS-232C	RS-422 / RS-485	RS-232C	RS-422 / RS-485	RS-232C	RS-422 / RS-485
CE marking directive compliance	Type	EMC Directive, RoHS Directive							
Power supply		24 V DC							
Operating voltage range		21.6 to 26.4 V DC							
Power consumption		1.9 W or less		3.1 W or less		4.8 W or less		7.2 W or less	
Power supply unit isolation method						Transformer isolation			
Ambient temperature		-20 to +60 °C <b>-4 to +140 °F</b> (Note 1)							
Ambient humidity		10 to 90 % RH (at +25 °C <b>+77 °F</b> ), (No dew condensation allowed)							
Storage temperature		-20 to +60 °C <b>-4 to +140 °F</b>							
Storage humidity		10 to 90 % RH (at +25 °C <b>+77 °F</b> ), (No dew condensation allowed)							
Vibration resistance		5 to 8.4 Hz, amplitude 3.5 mm <b>0.138 in</b> , 8.4 to 150 Hz, acceleration 9.8 m/s <sup>2</sup> , 10 sweeps each in X, Y and Z directions (1 octave/min.)							
Shock resistance		147 m/s <sup>2</sup> , 3 times in each of the X, Y and Z directions							
Superposed noise suppression		1,000 V [P-P] or more, pulse width of 50 ns, 1 μs between power supply terminals (by a noise simulator)							
Environmental resistance		IP67 (in the initial stages), Dust-proof and drip-proof from the front of the panel only (Rubber packing is attached to the panel contact surface.) (Note 2)							
Net weight		170 g approx.				470 g approx.			
Display	Display device	TFT monochrome LCD		TFT color LCD		TFT monochrome LCD		TFT color LCD	
	Resolution	320 (W) × 240 (H) dots							
	Display color	2 colors (black / white, 16-gray scale)		4,096 colors		2 colors (black / white, 16-gray scale)		4,096 colors	
	Displayable area	70.6 (W) × 52.9 (H) mm <b>2.780 (W) × 2.083 (H) in</b>				115.2 (W) × 86.4 (H) mm <b>4.535 (W) × 3.402 (H) in</b>			
	Backlight	White LED							
Functions	Font types	Fixed ( <b>GTWIN</b> ) : 1/4 width (8 × 8), half width (16 × 8), full width (16 × 16), Characters can be displayed in the 1, 2, 4, or 8 times width or height. True Type ( <b>GTWIN</b> ): 10 to 240 dots, Windows <sup>®</sup> : 10 to 240 dots							
	Languages	Japanese, English, Simplified Chinese, Traditional Chinese, Korean, German, Italian, Spanish, French, Turkish, Russian, Vietnamese							
	Graphics	Straight lines, Continuous straight lines, Squares, Circles, Ovals, Arcs, Elliptic arcs, Fan shapes, Elliptic fan shapes, Beveled squares, Bitmaps							
	Number of screens (Note 3)	230 screens approx.				180 screens approx.			
	Screen setting No.	Base screens: No. 0 to 3FF, Key board screens: No. 0 to 7, Login screens: No. 0 to F							
	Part functions	Messages, Lamps, Switches, Function switches, Data, Bar graphs, Clocks, Keyboards, Line graphs, Alarm list, Alarm history (Note 4), Custom parts (messages, lamps, switches)							
	Other functions	Recipe, Flow display, Write device, Multiple PLC connection, <b>FP</b> monitor, Language switching, <b>GT</b> link, Operation security, Data logging, SD recipe (Note 5)							
	Clock function	Displayed by referencing PLC clock		Provided with a built-in clock. (Can also refer to and display a PLC clock.) * Buy the backup battery ( <b>AFPX-BATT</b> ).					
	Backlight brightness adjustment	Can be set on the menu screen, via the <b>GT</b> configuration screen of <b>GTWIN</b> , or via PLC.							
	Contrast adjustment	Unnecessary							
	Buzzer	Installed							
	Automatic communication settings	The communication speed (baud rate) is automatically changed if there is no response from the target equipment.							
	Through function	<b>GT</b> connected between PC and PLC allows PLC to be debugged without a direct connection to a PC.							
Screen creation	Dedicated software should be used. Applicable OS: Windows <sup>®</sup> 2000 / XP / Vista / 7 / 8 / 8.1 / 10 (Note 6)								
Touch key resolution		Free layout (8 dots min.)							
Touch key operation force		0.8 N or less							
Touch key life		1 million operations or more (at +25 °C <b>+77 °F</b> )							
COM. port	Communication standard	Conforms to RS-232C	Conforms to RS-422 / RS-485	Conforms to RS-232C	Conforms to RS-422 / RS-485	Conforms to RS-232C	Conforms to RS-422 / RS-485	Conforms to RS-232C	Conforms to RS-422 / RS-485
	External communication conditions	Baud rate: 9,600 bps, 19,200 bps, 38,400 bps, 57,600 bps, 115,200 bps Data bits: 7 or 8 bits, Parity: None, Odd, Even, Stop bits: 1 bit							
	Protocol	Our <b>FP</b> series supported, General-purpose serial interface supported, and Other companies' PLC supported (Refer to the ' <b>PLC COMPATIBILITY TABLE</b> ' on p.23 for manufacturers and models.)							
	Connector	Connector terminal block (8 pins)							
Screen data transfer interface	Communication standard	USB1.1							
	Protocol	Our dedicated protocol							
	Connector	USB Mini-B				USB TYPE-B			
User's memory	Memory	F-ROM							
	Capacity	6 Mbyte		12 Mbyte					
Memory backup	Memory	SRAM							
	Backup battery	Lithium battery (replaceable) <b>AFPX-BATT</b> (Does not include with product.)							

## Conformance to the UL / cUL standards

UL / cUL file No.	E96300
UL standard No.	UL508

- Notes: 1) Please use within a temperature range of - 20 to + 55 °C **- 4 to + 131 °F** when horizontally installed and vertically installed in a portrait orientation, upside down installed and when using battery.  
 2) This protective structure condition applies to the front surface of the installed panel. This condition does not guarantee usage in all environments provided by users. When reattaching the panel, replace the waterproof packing.  
 3) The number of screens that can be registered varies according to the registered contents.  
 4) The alarm history function is not supported for the **GT03M-E**.  
 5) The data logging and SD recipe functions are available with only models equipped with an SD / SDHC memory card slot.  
 6) The 64-bit version is not supported except for Windows<sup>®</sup> 7 / 8 / 8.1 / 10. Windows is registered trademark of Microsoft Corporation in the United States and other countries.

# GTseries | SPECIFICATIONS

Product name		GT02L		GT02				GT05M / GT05G		GT05S	
Item	Type	5 V, RS-232C	5 V, RS-422 / RS-485	5 V, RS-232C	5 V, RS-422 / RS-485	24 V, RS-232C	24 V, RS-422 / RS-485	RS-232C	RS-422 / RS-485	RS-232C	RS-422 / RS-485
CE marking directive compliance		EMC Directive, RoHS Directive									
Power supply		5 V DC					24 V DC				
Operating voltage range		4.5 to 5.5 V DC					21.6 to 26.4 V DC				
Power consumption		1 W or less			1.9 W or less		2.4 W or less		3.6 W or less		
Power supply unit isolation method							Transformer isolation				
Ambient temperature		0 to +50 °C +32 to +122 °F									
Ambient humidity		20 to 85 % RH (at +25 °C +77 °F), (No dew condensation allowed)									
Storage temperature		-20 to +60 °C -4 to +140 °F									
Storage humidity		10 to 85 % RH (at +25 °C +77 °F), (No dew condensation allowed)									
Vibration resistance		5 to 8.4 Hz, amplitude 3.5 mm 0.138 in, 8.4 to 150 Hz, acceleration 9.8 m/s <sup>2</sup> , 10 sweeps each in X, Y and Z directions (1 octave/min.)					10 to 55 Hz (1 minute cycle), Double amplitude 0.75 mm 0.030 in, 10 minutes in each of the X, Y, and Z directions				
Shock resistance		147 m/s <sup>2</sup> , 3 times in each of the X, Y and Z directions					98 m/s <sup>2</sup> , 4 times in each of the X, Y, and Z directions				
Superposed noise suppression		1,000 V [P-P] or more, pulse width of 50 ns, 1 μs between power supply terminals (by a noise simulator) (Note 1)									
Environmental resistance		IP65 (in the initial stages) (Note 2)		IP67 (in the initial stages) (Note 2)				IP65 (in the initial stages) (Note 2)			
Net weight		150 g approx.		170 g approx.				230 g approx.			
Display	Display device	STN monochrome LCD		TFT monochrome LCD (Note 3)				TFT monochrome LCD (Note 4)		TFT color LCD (Note 5)	
	Resolution	160 (W) × 64 (H) dots		240 (W) × 96 (H) dots				320 (W) × 240 (H) dots			
	Display color	2 colors (black / white)									4,096 colors
	Displayable area	88.0 (W) × 35.2 (H) mm 3.465 (W) × 1.386 (H) in		88.5 (W) × 35.4 (H) mm 3.484 (W) × 1.394 (H) in				70.6 (W) × 52.9 (H) mm 2.780 (W) × 2.083 (H) in		70.3 (W) × 52.7 (H) mm 2.768 (W) × 2.075 (H) in	
	Backlight	White LED		GT02M: 3-color LED (white / pink / red) GT02G: 3-color LED (green / orange / red)				GT05M: 3-color LED (white / pink / red) GT05G: 3-color LED (green / orange / red)		White LED	
Functions	Font types	Fixed (GTWIN) : 1/4 width (8 × 8), half width (16 × 8), full width (16 × 16) Characters can be displayed in the 1, 2, 4, or 8 times width or height. TrueType (GTWIN): 10 to 64 dots Windows®: 10 to 64 dots		Fixed (GTWIN) : 1/4 width (8 × 8), half width (16 × 8), full width (16 × 16) Characters can be displayed in the 1, 2, 4, or 8 times width or height. TrueType (GTWIN): 10 to 96 dots				Fixed (GTWIN) : 1/4 width (8 × 8), half width (16 × 8), full width (16 × 16) Characters can be displayed in the 1, 2, 4, or 8 times width or height. TrueType (GTWIN): 10 to 240 dots, Windows®: 10 to 240 dots			
	Languages	Japanese, English, Simplified Chinese, Traditional Chinese, Korean, German, Italian, Spanish, French, Turkish, Russian, Vietnamese									
	Graphics	Straight lines, Continuous straight lines, Squares, Circles, Ovals, Arcs, Elliptic arcs, Fan shapes, Elliptic fan shapes, Beveled squares, Bitmaps									
	Number of screens (Note 6)	80 screens approx.		250 screens approx.				240 screens approx.		180 screens approx.	
	Screen setting No.	No. 0 to 3FF									
	Part functions	Messages, Lamps, Switches, Function switches, Data, Bar graphs, Clocks, Keyboards, Line graphs, Alarm list, Alarm history (Note 7), Custom parts (messages, lamps, switches)									
	Other functions	Recipe, Flow display, Write device, Language switching, GT link, Operation security, Data logging, SD recipe (Note 8)									
	Clock function	Displayed by referencing PLC clock					Provided with a built-in clock. (Can also refer to and display a PLC clock.) (Note 9) *Buy the backup battery (AFPX-BATT).				
	Contrast adjustment	Contrast can be adjusted by using the touch panel,		Unnecessary				Unnecessary			
	Buzzer						Installed				
	Automatic communication settings	The communication speed (baud rate) is automatically changed if there is no response from the target equipment.									
	Through function	GT connected between PC and PLC allows PLC to be debugged without a direct connection to a PC.									
Screen creation	Dedicated software should be used. Applicable OS: Windows® 2000 / XP / Vista / 7 / 8 / 8.1 / 10 (Note 10)										
Touch key resolution		Free layout (8 dots min.)									
Touch key operation force		0.8 N or less									
Touch key life		1 million operations or more (at +25 °C +77 °F)									
COM. port	Communication standard	Conforms to RS-232C	Conforms to RS-422 / RS-485	Conforms to RS-232C	Conforms to RS-422 / RS-485	Conforms to RS-232C	Conforms to RS-422 / RS-485	Conforms to RS-232C	Conforms to RS-422 / RS-485	Conforms to RS-232C	Conforms to RS-422 / RS-485
	External communication conditions	Baud rate: 9,600 bps, 19,200 bps, 38,400 bps, 57,600 bps, 115,200 bps Data bits: 7 or 8 bits, Parity: None, Odd, Even, Stop bits: 1 bit									
	Protocol	Our FP series supported, General-purpose serial interface supported, Other companies' PLC supported (Refer to the "PLC COMPATIBILITY TABLE" on p.23 for manufacturers and models.)									
	Connector	Connector terminal block (8 pins)									
Screen data transfer interface	Communication standard	USB1.1									
	Protocol	Our dedicated protocol									
	Connector	USB Mini-B					USB TYPE-B				
User's memory	Memory	F-ROM									
	Capacity	704 Kbyte		2 Mbyte				12 Mbyte			
Memory backup	Memory	SRAM									
	Backup battery	Lithium battery (replaceable) AFPX-BATT (Does not include with product.) (Note 9)									

## Conformance to the UL / cUL standards

UL / cUL file No.	E96300
UL standard No.	UL508

- Notes: 1) AIG02MQ03D and AIG02GQ02D incorporate ferrite included in our PLC connection cable (AIGT8142).  
2) This protective structure condition applies to the front surface of the installed panel. This condition does not guarantee usage in all environments provided by users. When reattaching the panel, replace the waterproof packing.  
3) The display has been changed STN LCD to TFT LCD from production in February 2017.  
4) The display has been changed STN LCD to TFT LCD from production in March 2016.  
5) The display has been changed STN LCD to TFT LCD from production in December 2011.  
6) The number of screens that can be registered varies according to the registered contents.  
7) The alarm history function is not supported for the GT02L and GT02 memory backup not support type.  
8) The data logging and SD recipe functions are available with only models equipped with an SD / SDHC memory card slot.  
9) Among GT02 series, available for GT02M2 and GT02G2 only.  
10) The 64-bit version is not supported except for Windows® 7 / 8 / 8.1 / 10. Windows is registered trademark of Microsoft Corporation in the United States and other countries.

Item	Product name Type	GT703M				GT703G				GT704M		GT704G		GT707	
		5 V, RS-232C	5 V, RS-422 / RS-485	24 V, RS-232C	24 V, RS-422 / RS-485	5 V, RS-232C	5 V, RS-422 / RS-485	24 V, RS-232C	24 V, RS-422 / RS-485	24 V, RS-232C	24 V, RS-422 / RS-485	24 V, RS-232C	24 V, RS-422 / RS-485	24 V, RS-232C	
CE marking directive compliance		EMC Directive, RoHS Directive													
Power supply		5 V DC	24 V DC	5 V DC	24 V DC	24 V DC						24 V DC			
Operating voltage range		4.5 to 5.5 V DC	21.6 to 26.4 V DC	4.5 to 5.5 V DC	21.6 to 26.4 V DC	21.6 to 26.4 V DC						21.6 to 26.4 V DC			
Power consumption		2 W or less (Note 1)	2.4 W or less	2 W or less (Note 1)	2.4 W or less	2.4 W or less						6 W or less			
Power supply unit isolation method		Transformer isolation													
Ambient temperature		0 to +50 °C <b>+32 to +122 °F</b>													
Ambient humidity		20 to 85 % RH (at +25 °C +77 °F) (No dew condensation allowed)													
Storage temperature		-20 to +60°C <b>-4 to +140 °F</b>													
Storage humidity		10 to 85 % RH (at 25°C <b>+77 °F</b> ) (No dew condensation allowed)													
Vibration resistance		5 to 8.4 Hz, amplitude 3.5 mm <b>0.138 in</b> , 8.4 to 150 Hz, acceleration 9.8 m/s <sup>2</sup> , 10 sweeps each in X, Y and Z directions (1 octave/min.)													
Shock resistance		147 m/s <sup>2</sup> , 3 times in each of the X, Y and Z directions													
Superposed noise suppression		1,000 V [P-P] or more, pulse width of 50 ns, 1 μs between power supply terminals (by a noise simulator)													
Environmental resistance		IP67 (in the initial stages) (Note 2)												IP65 (in the initial stages) (Note 2)	
Net weight		180 g approx.						240 g approx.						360 g approx.	
Display	Display device	TFT monochrome LCD						TFT color LCD						TFT color LCD	
	Resolution	480 (W) × 192 (H) dots						640 (W) × 240 (H) dots						800 (W) × 480 (H) dots	
	Display color	2 colors (black / white, 64-gray scale)						2 colors (black / white, 64-gray scale)						65,536 colors	
	Displayable area	88.5 (W) × 35.4 (H) mm <b>3.484 (W) × 1.394 (H) in</b>						108.8 (W) × 40.8 (H) mm <b>3.484 (W) × 1.394 (H) in</b>						153.8 (W) × 85.6 (H) mm <b>6.055 (W) × 3.370 (H) in</b>	
	Backlight	3-color LED (white / pink / red)		3-color LED (green / orange / red)		3-color LED (white / pink / red)		3-color LED (green / orange / red)		3-color LED (white / pink / red)		3-color LED (green / orange / red)		White LED	
Functions	Font types	Fixed ( <b>GTWIN</b> ) : 1/4 width (8 × 8), half width (16 × 8), full width (16 × 16), Characters can be displayed in the 1, 2, 4, 8 or 16 times width or height. True Type ( <b>GTWIN</b> ): 10 to 192 dots, Windows®: 10 to 240 dots												True Type ( <b>GTWIN</b> ): 10 to 240 dots, Windows®: 10 to 240 dots	
	Languages	Japanese, English, Simplified Chinese, Traditional Chinese, Korean, German, Italian, Spanish, French, Turkish, Russian, Vietnamese													
	Graphics	Straight lines, Continuous straight lines, Squares, Circles, Arcs, Curves, Fan shapes, Polygons, Fill, Bitmaps													
	Number of screens (Note 3)	250 screens approx.						250 screens approx.						230 screens approx.	
	Screen setting No.	Base screens: No. 0 to 3FF, Key board screens: No. 0 to 7, Login screens: No. 0 to F													
	Part functions	Lamps, Switches, Data, Bar graphs, Clocks, Keyboards, Line graphs, Alarm list, Alarm history													
	Other functions	Recipe, Flow display, Write device, Multiple PLC connection, <b>FP</b> monitor, Multi language exchange, <b>GT</b> link, Operation security, Data logging, SD recipe												Recipe, Flow display, Write device, Multi language exchange, Operation security, Data logging, SD recipe	
	Clock function	Provided with a built-in clock. (Can also refer to and display a PLC clock.) * Buy the backup battery [ <b>AFPX-BATT(GT707: AFPABAT001)</b> ].													
	Backlight brightness adjustment	Can be set on the menu screen, via the <b>GT</b> configuration screen of <b>GTWIN</b> , or via PLC. (There are some minor variations in the backlight brightness.)													
	Contrast adjustment	Unnecessary													
	Buzzer	Installed													
	Automatic communication settings	The communication speed (baud rate) is automatically changed if there is no response from the target equipment.													
	Through function	<b>GT</b> connected between PC and PLC allows PLC to be debugged without a direct connection to a PC.													
Screen creation	Dedicated software should be used. Applicable OS: Windows® Vista / 7 / 8 / 8.1 / 10 (Note 4)														
Touch key resolution	Free layout (8 dots min.)														
Touch key operation force	0.8 N or less														
Touch key life	1 million operations or more (at +25 °C <b>+77 °F</b> )														
COM. port	Communication standard	Conforms to RS-232C	Conforms to RS-422 / RS-485	Conforms to RS-232C	Conforms to RS-422 / RS-485	Conforms to RS-232C	Conforms to RS-422 / RS-485	Conforms to RS-232C	Conforms to RS-422 / RS-485	Conforms to RS-232C	Conforms to RS-422 / RS-485	Conforms to RS-232C	Conforms to RS-422 / RS-485	Conforms to RS-232C	
	External communication conditions	Baud rate: 9,600 bps, 19,200 bps, 38,400 bps, 57,600 bps, 115,200 bps Data bits: 7 or 8 bits, Parity: None, Odd, Even, Stop bits: 1 bit													
	Protocol	Our <b>FP</b> series supported, General-purpose serial interface supported, Modbus RTU mode protocol (Master / Slave) supported and Other companies' PLC supported (Refer to the " <b>PLC COMPATIBILITY TABLE</b> " on p.23 for manufacturers and models.)												Our <b>FP</b> series supported, General-purpose serial interface supported, and Other companies' PLC supported (Refer to the " <b>PLC COMPATIBILITY TABLE</b> " on p.23 for manufacturers and models.)	
	Connector	Connector terminal block (8 pins)												D-SUB connector (9 pins)	
Screen data transfer interface	Communication standard	USB2.0													
	Protocol	Our dedicated protocol													
	Connector	USB Mini-B													
User's memory	Memory	F-ROM													
	Capacity	16 Mbyte												76 Mbyte	
Memory backup	Memory	SRAM													
	Backup battery														

## Conformance to the UL / cUL standards

UL / cUL file No.	E96300
UL standard No.	UL508

- Notes: 1) Power cannot be supplied from TOOL port of PLC (CPU unit).  
2) This protective structure condition applies to the front surface of the installed panel. This condition does not guarantee usage in all environments provided by users. When reattaching the panel, replace the waterproof packing.  
3) The number of screens that can be registered varies according to the registered contents.  
4) The 64-bit version is not supported except for Windows® 7 / 8 / 8.1 / 10. Windows is registered trademark or trademark of Microsoft Corporation in the United States and other countries.

# GTseries | SPECIFICATIONS

Item	Product name Type	GT12		GT32M-R		GT32T-R	
		RS-232C	RS-422 / RS-485	RS-232C	RS-422 / RS-485	RS-232C	RS-422 / RS-485
CE marking directive compliance	EMC Directive, RoHS Directive						
Power supply	24 V DC						
Operating voltage range	21.6 to 26.4 V DC						
Power consumption	1.7 W or less		4.8 W or less		7.2 W or less		
Power supply unit isolation method	Transformer isolation						
Ambient temperature	0 to +50 °C <b>+32 to +122 °F</b>						
Ambient humidity	20 to 85 % RH (at +25 °C <b>+77 °F</b> ), (No dew condensation allowed)						
Storage temperature	-20 to +60 °C <b>-4 to +140 °F</b>						
Storage humidity	10 to 85 % RH (at +25 °C <b>+77 °F</b> ), (No dew condensation allowed)						
Vibration resistance	5 to 9 Hz, amplitude 3.5 mm <b>0.138 in</b> , 9 to 150 Hz, acceleration 9.8 m/s <sup>2</sup> , 10 sweeps each in X, Y and Z directions (1 octave/min.)			5 to 8.4 Hz, amplitude 3.5 mm <b>0.138 in</b> , 8.4 to 150 Hz, acceleration 9.8 m/s <sup>2</sup> , 10 sweeps each in X, Y and Z directions (1 octave/min.)			
Shock resistance	147 m/s <sup>2</sup> , 3 times in each of the X, Y and Z directions						
Superposed noise suppression	1,000 V [P-P] or more, pulse width of 50 ns, 1 μs between power supply terminals (by a noise simulator)						
Environmental resistance	IP67 (in the initial stages) (Note 1)			IP67 (in the initial stages), Dust-proof and drip-proof from the front of the panel only (Rubber packing is attached to the panel contact surface.) (Note 1)			
Net weight	240 g approx.			470 g approx.			
Display	Display device	TFT monochrome LCD (Note 2)		TFT monochrome LCD		TFT color LCD	
	Resolution	320 (W) × 120 (H) dots		320 (W) × 240 (H) dots			
	Display color	2 colors (black / white, 8-gray scale)		2 colors (black / white, 16-gray scale)		4,096 colors	
	Displayable area	108.8 (W) × 40.8 (H) mm <b>4.283 (W) × 1.606 (H) in</b>		115.2 (W) × 86.4 (H) mm <b>4.535 (W) × 3.402 (H) in</b>			
	Backlight	<b>GT12M</b> : 3-color LED (white / pink / red) <b>GT12G</b> : 3-color LED (green / orange / red)		White LED			
Functions	Font types	Fixed ( <b>GTWIN</b> ) : 1/4 width (8 × 8), half width (16 × 8), full width (16 × 16) Characters can be displayed in the 1, 2, 4, or 8 times width or height. True Type ( <b>GTWIN</b> ): 10 to 120 dots		Fixed ( <b>GTWIN</b> ) : 1/4 width (8 × 8), half width (16 × 8), full width (16 × 16), Characters can be displayed in the 1, 2, 4, or 8 times width or height. True Type ( <b>GTWIN</b> ): 10 to 240 dots, Windows®: 10 to 240 dots			
	Languages	Japanese, English, Simplified Chinese, Traditional Chinese, Korean, German, Italian, Spanish, French, Turkish, Russian, Vietnamese					
	Graphics	Straight lines, Continuous straight lines, Squares, Circles, Ovals, Arcs, Elliptic arcs, Fan shapes, Elliptic fan shapes, Beveled squares, Bitmaps					
	Number of screens (Note 3)	2-gray scale: 250 screens approx. 8-gray scale: 200 screens approx.		180 screens approx.			
	Screen setting No.	No. 0 to 3FF		Base screens: No. 0 to 3FF, Key board screens: No. 0 to 7, Login screens: No. 0 to F			
	Part functions	Messages, Lamps, Switches, Function switches, Data, Bar graphs, Clocks, Keyboards, Line graphs, Alarm list, Alarm history, Custom parts (messages, lamps, switches)					
	Other functions	Recipe, Flow display, Write device, Multiple PLC connection, <b>FP</b> monitor, Language switching, <b>GT</b> link, Operation security, Data logging, SD recipe (Note 4)					
	Clock function	Provided with a built-in clock. (Can also refer to and display a PLC clock.) *Buy the backup battery ( <b>AFPX-BATT</b> ).					
	Contrast adjustment	Unnecessary					
	Buzzer	Installed					
	Automatic communication settings	The communication speed (baud rate) is automatically changed if there is no response from the target equipment.					
	Through function	<b>GT</b> connected between a PC and PLC allows the PLC to be debugged without a direct connection with the PC.					
Screen creation	Dedicated software should be used. Applicable OS: Windows® 2000 / XP / Vista / 7 / 8 / 8.1 / 10 (Note 5)						
Touch key resolution	Free layout (8 dots min.)						
Touch key operation force	0.8 N or less						
Touch key life	1 million operations or more (at +25 °C <b>+77 °F</b> )						
COM. port	Communication standard	Conforms to RS-232C	Conforms to RS-422 / RS-485	Conforms to RS-232C	Conforms to RS-422 / RS-485	Conforms to RS-232C	Conforms to RS-422 / RS-485
	External communication conditions	Baud rate: 9,600 bps, 19,200 bps, 38,400 bps, 57,600 bps, 115,200 bps Data bits: 7 or 8 bits, Parity: None, Odd, Even, Stop bits: 1 bit					
	Protocol	Our <b>FP</b> series supported, General-purpose serial interface supported, Other companies' PLC supported (Refer to the " <b>PLC COMPATIBILITY TABLE</b> " on p.23 for manufacturers and models.)					
	Connector	Connector terminal block (8 pins)					
Screen data transfer interface	Communication standard	USB1.1					
	Protocol	Our dedicated protocol					
	Connector	USB Mini-B			USB TYPE-B		
User's memory	Memory	F-ROM					
	Capacity	2 Mbyte		12 Mbyte			
Memory backup	Memory	SRAM					
	Backup battery	Lithium battery (replaceable) <b>AFPX-BATT</b> (Does not include with product.)					

## Conformance to the UL / cUL standards

UL / cUL file No.	E96300
UL standard No.	UL508

- Notes: 1) This protective structure condition applies to the front surface of the installed panel. This condition does not guarantee usage in all environments provided by users. When reattaching the panel, replace the waterproof packing.  
2) The display has been changed STN LCD to TFT LCD from production in November 2016.  
3) The number of screens that can be registered varies according to the registered contents.  
4) The data logging and SD recipe functions are available with only models equipped with an SD / SDHC memory card slot.  
5) The 64-bit version is not supported except for Windows® 7 / 8 / 8.1 / 10. Windows is registered trademark of Microsoft Corporation in the United States and other countries.

The CAD data can be downloaded from our website.

## GT02L

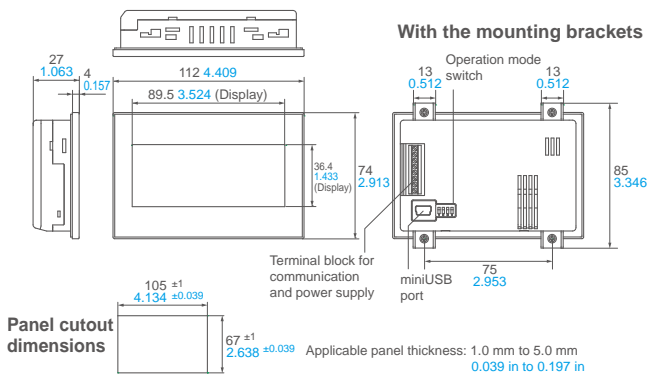

## GT02

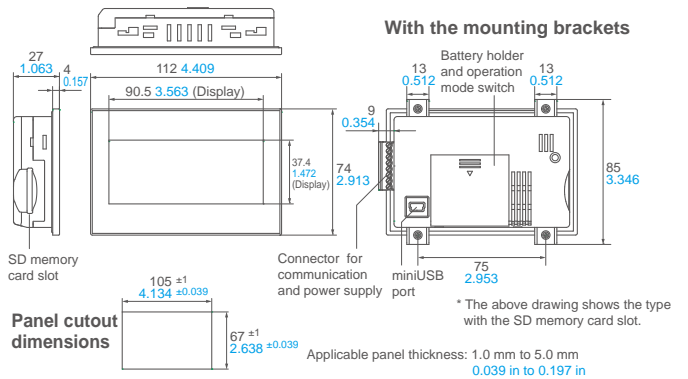

## GT703

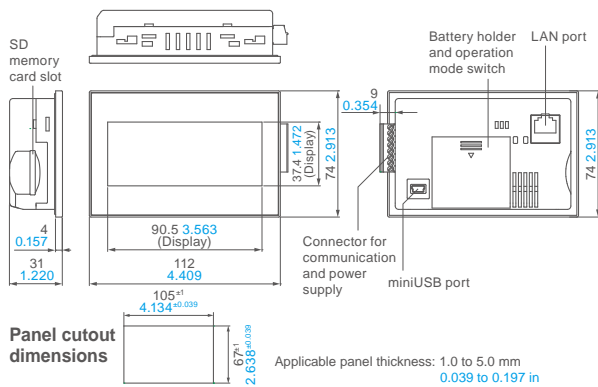

## GT03M-E

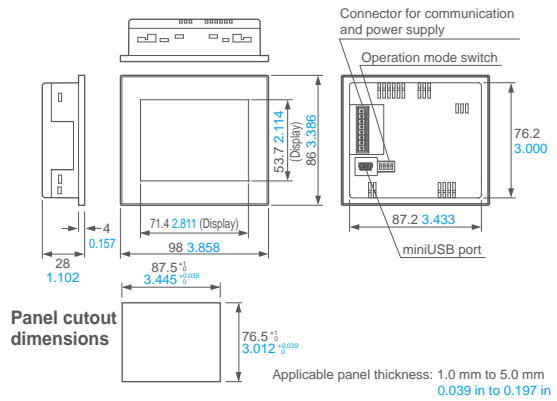

## GT03T-E

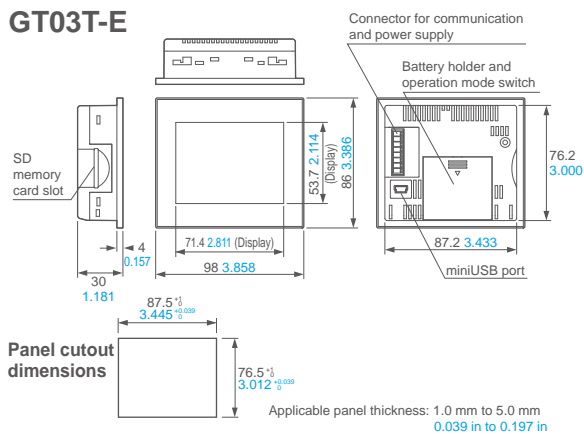

## GT05

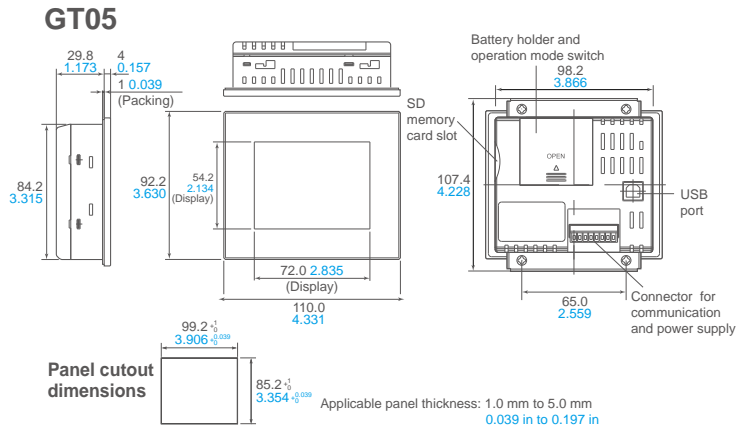

## GT704

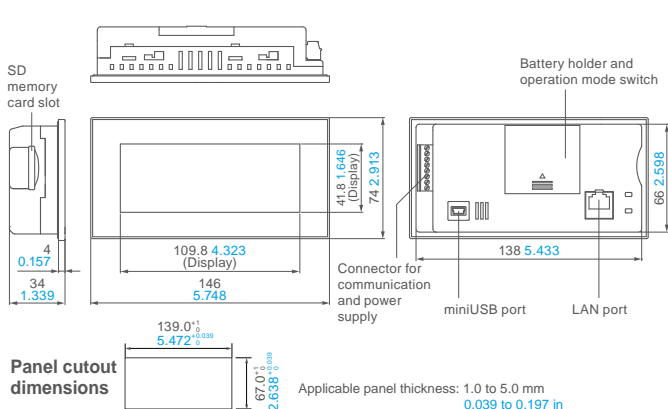

## GT12

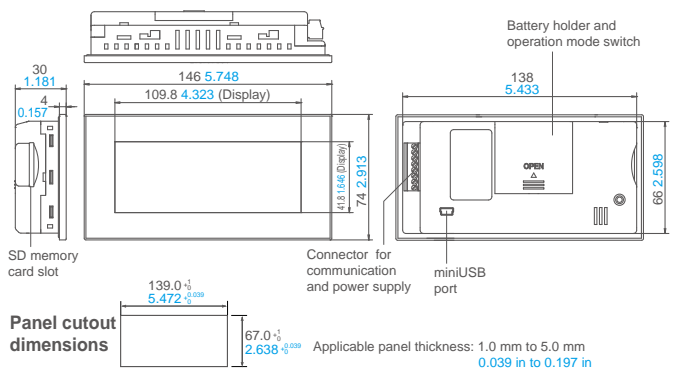

## GT32-E GT32-R

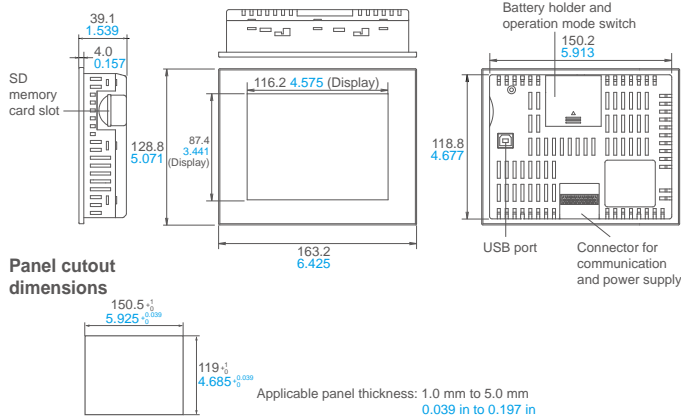

## GT707

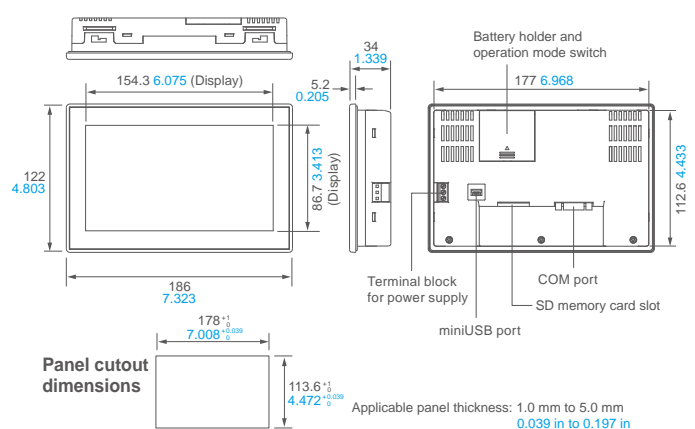

## Information on a program controller

### Programmable Controller FP7



### Automation Controls + Information Panasonic PLCs also control information

- Use the Web server function to check accumulated data in the FP7 with a browser.



- Ethernet/IP\* compatibility Easy connection with all kinds of robots and PLCs enables control and communication. \*Ethernet/IP is a trademark of ODVA, Inc.
- Can be expanded with a cassette for serial communication and analog function. Reduces unit cost and footprint.
- Without the requirement of a power supply unit or backplane, you can reduce the cost and footprint of your PLC configuration.

### Programmable Controller FP0H

**NEW**



### Built-in dual Ethernet ports Multiple interfaces that connect with various devices

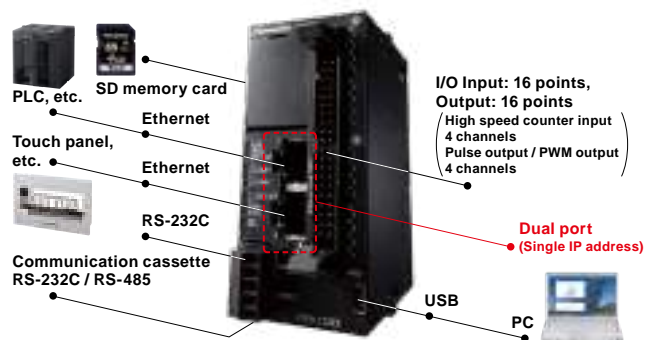

- Up to 384 I/O points FP0H / FPΣ / FP0R units can be added.
- Use Ethernet to share data among controllers. Distributed control is possible for each control.
- With support for Ethernet/IP, Modbus-TCP and MC protocol, a variety of devices can be connected.
- Despite being super miniature, basic performance has greatly increased.

Please contact .....

## Panasonic Corporation

Electromechanical Control Business Division  
 ■ 1006, Oaza Kadoma, Kadoma-shi, Osaka 571-8506, Japan  
[industrial.panasonic.com/ac/e/](http://industrial.panasonic.com/ac/e/)

# Panasonic®

©Panasonic Corporation 2018