

GT series  
Connection with other  
companies' PLCs  
**Manual**

---

# Safety Precautions

Observe the following notices to ensure personal safety or to prevent accidents.  
To ensure that you use this product correctly, read this User's Manual thoroughly before use.  
Make sure that you fully understand the product and information on safety.  
This manual uses two safety flags to indicate different levels of danger.

## **WARNING**

**If critical situations that could lead to user's death or serious injury is assumed by mishandling of the product:**

- Always take precautions to ensure the overall safety of your system, so that the whole system remains safe in the event of failure of this product or other external factor.
- DO NOT USE THE PROGRAMMABLE DISPLAY TO CONTROL SAFETY FEATURES OR OTHER CRITICAL OPERATIONS OF EQUIPMENT OR SYSTEMS. A COMMUNICATION ERROR (FOR ANY REASON) MIGHT PREVENT SUCH SAFETY FEATURES OR CRITICAL OPERATIONS FROM FUNCTIONING PROPERLY.
- Do not use this product in areas with inflammable gas. It could lead to an explosion.
- Exposing this product to excessive heat or open flames could cause damage to the lithium battery or other electronic parts.
- Battery may explode if mistreated. Do not recharge, disassemble or dispose of fire.

## **CAUTION**

**If critical situations that could lead to user's injury or only property damage is assumed by mishandling of the product.**

- To prevent excessive exothermic heat or smoke generation, use this product at the values less than the maximum of the characteristics and performance that are assured in these specifications.
- Do not dismantle or remodel the product. It could cause excessive exothermic heat or smoke generation.
- Do not touch the terminal while turning on electricity. It could lead to an electric shock.
- Use the external devices to function the emergency stop and interlock circuit.
- Connect the wires or connectors securely.  
The loose connection could cause excessive exothermic heat or smoke generation.
- Do not allow foreign matters such as liquid, flammable materials, metals to go into the inside of the product. It could cause excessive exothermic heat or smoke generation.
- Do not undertake construction (such as connection and disconnection) while the power supply is on. It could lead to an electric shock.
- The control force of the touch switches should be less than the specification of the product. Failure to do so could lead to a damage to the product or a personal injury.
- These touch switches operate using analog resistance membrane. Do not press more than one point on the screen at a time. Doing so might operate a switch located in the middle of the points pressed if one exists, and could lead to a damage to the facility or an accident.

# Copyright / Trademarks

- This manual and its contents are copyrighted.
- You may not copy this manual in whole or part, without written consent of Panasonic Industrial Devices SUNX Co., Ltd.
- Windows is a registered trademark of Microsoft Corporation in the United States and other countries.
- Ethernet is a registered trademark of Fuji Xerox Co., Ltd. and Xerox Corp.
- SDHC logo and SD logo are trademarks.
- All other company names and product names are trademarks or registered trademarks of their respective owners.

# Table of Contents

---

## Applicable PLCs Manufactured by Various Companies Selecting the PLC Model

<b>1. Connection With Mitsubishi PLCs.....</b>	<b>1-1</b>
<b>1.1 MELSEC-FX1S/ FX1N/ FX1NC Series.....</b>	<b>1-2</b>
1.1.1 Direct connection to the TOOL port .....	1-3
1.1.2 Using an Adapter .....	1-4
<b>1.2 MELSEC-FX2N/ FX2NC/ FX3U/ FX3UC/ FX3G / FX3GC Series .....</b>	<b>1-5</b>
1.2.1 Direct connection to the TOOL port .....	1-7
1.2.2 Using an Adapter .....	1-8
<b>1.3 MELSEC-L (Serial communication) Series .....</b>	<b>1-9</b>
1.3.1 MELSEC-L (Serial communication) series .....	1-12
1.3.2 MELSEC-L (Serial communication) series (RS422) .....	1-12
<b>1.4 MELSEC-L (CPU) Series .....</b>	<b>1-13</b>
1.4.1 MELSEC-L (CPU) Series .....	1-16
<b>1.5 MELSEC-Q (Serial communication) Series .....</b>	<b>1-17</b>
1.5.1 MELSEC-Q (Serial communication) series (RS232C).....	1-20
1.5.2 MELSEC-Q (Serial communication) series (RS422) .....	1-20
1.5.3 When directly connecting to the RS232C port of Q00CPU/ Q00UJCPU/ Q01CPU	1-21
<b>1.6 MELSEC-Q (CPU) Series.....</b>	<b>1-22</b>
1.6.1 MELSEC-Q (CPU) Series .....	1-23
<b>1.7 MELSEC-A (Computer Link) Series .....</b>	<b>1-24</b>
1.7.1 MELSEC-A (Computer Link) Series.....	1-25
<b>2. Connection With Omron PLCs.....</b>	<b>2-1</b>
<b>2.1 Omron SYSMAC-C Series (C/α/CV/CP1) .....</b>	<b>2-2</b>
2.1.1 SYSMAC C series (using link interface) (RS232C) .....	2-5
2.1.2 SYSMAC α series (using link interface) (RS232C).....	2-8
2.1.3 SYSMAC CV series (using link interface) (RS232C).....	2-9
2.1.4 SYSMAC CP1 series (using link interface) (RS232C).....	2-10
2.1.5 SYSMAC CP1 series (RS422/RS485).....	2-11
2.1.6 SYSMAC CP1 series (Built-in RS232C port type) .....	2-11
2.1.7 When using the peripheral port of CPM2C .....	2-12
<b>2.2 Omron SYSMAC-CS/CJ Series.....</b>	<b>2-14</b>
2.2.1 SYSMAC CS1 series (1:1) (RS232C).....	2-18
2.2.2 SYSMAC CJ1 series (1:1) (RS232C) .....	2-19
2.2.3 SYSMAC CS1/CJ1 series (1:1) (RS422/RS485).....	2-20

2.2.4 SYSMAC CJ2M series (1:1) (RS232C) .....	2-21
2.2.5 SYSMAC CJ2M series (RS422/RS485) .....	2-21
2.2.6 When using the peripheral port .....	2-22
<b>3. Connection With Toshiba Machine PLCs .....</b>	<b>3-1</b>
<b>3.1 PROVISOR TCmini Series .....</b>	<b>3-2</b>
3.1.1 RS232C Connection .....	3-3
3.1.2 RS485 connection .....	3-4
<b>4. Connection With Rockwell Automation (Allen-Bradley) PLCs.....</b>	<b>4-1</b>
<b>4.1 Allen-Bradley SLC500 MicroLogix Series .....</b>	<b>4-2</b>
4.1.1 SLC500 series(using link interface on the CPU unit).....	4-5
4.1.2 MicroLogix1000/1100 .....	4-6
<b>5. Connection With Siemens PLCs.....</b>	<b>5-1</b>
<b>5.1 Siemens S7-200 Series.....</b>	<b>5-2</b>
5.1.1 RS232C Connection (Connected with PC/PPI Cable).....	5-3
5.1.2 RS422 Connection .....	5-4
<b>6. Connection With LS Industrial Systems PLCs .....</b>	<b>6-1</b>
<b>6.1 MASTER-K (Cnet) Series.....</b>	<b>6-2</b>
6.1.1 Connection Method .....	6-3
<b>7. Connection With Yokogawa PLCs.....</b>	<b>7-1</b>
<b>7.1 FA-M3 Series .....</b>	<b>7-2</b>
7.1.1 Connection Using PC Link Module .....	7-4
7.1.2 CPU Direct Connection .....	7-5
<b>8. Connection With Keyence PLCs.....</b>	<b>8-1</b>
<b>8.1 KV-10/16/24/40 Series.....</b>	<b>8-2</b>
8.1.1 Connection Method .....	8-3
<b>8.2 KV-700 Series.....</b>	<b>8-4</b>
8.2.1 Connection Method .....	8-5
<b>8.3 KV-700 Series Connected using Unit KV-L20R/V .....</b>	<b>8-6</b>
8.3.1 Connection Method .....	8-7
<b>8.4 KV-1000 Series.....</b>	<b>8-8</b>
8.4.1 Connection Method .....	8-9
<b>8.5 KV-1000 Series Connected using Unit KV-L20R/V .....</b>	<b>8-10</b>

8.5.1 Connection Method .....	8-12
<b>8.6 KV-3000 Series .....</b>	<b>8-13</b>
8.6.1 Connection Method .....	8-14
<b>8.7 KV-3000/5000 Series Connected using Unit KV-L20R/V .....</b>	<b>8-15</b>
8.7.1 Connection Method .....	8-17
<b>8.8 KV Nano Series .....</b>	<b>8-18</b>
8.8.1 Connection Method .....	8-19
<b>8.9 KV Nano Series Connected using Unit KV-L20R/V .....</b>	<b>8-20</b>
8.9.1 Connection Method .....	8-22
<b>9. Connection With Hitachi PLCs .....</b>	<b>9-1</b>
<b>9.1 EH-150/EHV Series .....</b>	<b>9-2</b>
9.1.1 RS232C Connection .....	9-5
9.1.2 RS422 Connection .....	9-9
9.1.3 RS485 Connection .....	9-10
<b>9.2 MICRO-EH Series .....</b>	<b>9-11</b>
9.2.1 RS232C Connection .....	9-13
<b>9.3 Web Controller Series .....</b>	<b>9-15</b>
9.3.1 RS232C Connection .....	9-17
9.3.2 RS422 Connection .....	9-19
9.3.3 RS485 Connection .....	9-20
<b>10. Connection in Modbus (RTU Mode) .....</b>	<b>10-1</b>
<b>10.1 Modbus (RTU Mode   modicon PLC) .....</b>	<b>10-2</b>
<b>10.2 Modbus (RTU Mode).....</b>	<b>10-3</b>
<b>10.3 Modbus (RTU Mode) for Temperature Control Unit, etc.....</b>	<b>10-4</b>
<b>10.4 Connection Method (Example).....</b>	<b>10-6</b>

## Record of changes



# Applicable PLCs Manufactured by Various Companies

## PLC Compatibility

Corresponding PLC is as follows.

Models listed are the models that have been evaluated as of June, 2017.

Manufacturer	Series	Model	RS232C type	RS422 (RS485) type
Panasonic Corporation	FP series	FP-X	◎	○
		FP-Σ	◎	○
		FP-e	◎	○
		FP0/FP0R	◎	○
		FP2	◎	○
		FP2SH	◎	○
Mitsubishi Electric Corporation *1	FX series *2	FX0N	○	◎
		FX1S	○	◎
		FX1N	○	◎
		FX1NC	○	◎
		FX2N	○	◎
		FX2NC	○	◎
		FX3UC	○	◎
		FX3U	○	◎
		FX3G	○	◎
		FX3GC		◎
	L series	L26CPU-BT	○	○
		L02CPU	◎	○
	Q series *2	Q00CPU	◎	
		Q01CPU	◎	
		Q00JCPU	○	
		Q00HCPU	○	
		Q00UJCPU	◎	
		Q26UDHCPU	○	○
		Q25HCPU	◎	
		Q12HCPU	◎	
Q06HCPU		◎		
Q02HCPU		◎		
Q02CPU	◎			

◎: Direct connection is possible to the CPU unit of the PLC.

○: Connection is possible using the communications unit or a signal conversion cable, etc.

Blank: Not evaluated.

\*1. PLCs other than FP series of Panasonic may be limited in the type of device that can be used and addresses. Please see each wiring diagram for details.

\*2 The connection with RS485 is not available for Mitsubishi FX series.

Manufacturer	Series	Model	RS232C type	RS422 (RS485) type
Mitsubishi Electric Corporation *1	A series	A1N	○	
		A2N	○	
		A3N	○	
		A1S	○	
		A1SJ	○	
		A1SH	○	
		A2SH	○	
		A2CCPU24	◎	
OMRON Corporation *1	C series	C20H	◎	
		C28H	◎	
		C40H	◎	
		C120	○	
		C120F	○	
		C200H	○	
		C200HS	◎	
		C500	○	
		C500F	○	
		C1000H	○	
		C1000HF	○	
		C2000	○	
		C2000H	○	
		CPM1-20CDR-A	◎	
		CPM2A	◎	
		CPM2B	◎	
		CPM2C	◎	
		CQM1H-CPU21	○	
CQM1-CPU42	◎			
SRM1-C02	◎			

◎: Direct connection is possible to the CPU unit of the PLC.

○: Connection is possible using the communications unit or a signal conversion cable, etc.

Blank: Not evaluated.

\*1. PLCs other than FP series of Panasonic may be limited in the type of device that can be used and addresses. Please see each wiring diagram for details.



Manufacturer	Series	Model	RS232C type	RS422 (RS485) type
OMRON Corporation *1	α series	C200HE-CPU32-Z	○	
		C200HE-CPU32	○	
		C200HG-CPU33-Z	○	
		C200HG-CPU33	○	
		C200HG-CPU53-Z	○	
		C200HG-CPU53	○	
		C200HX-CPU34-Z	○	
		C200HX-CPU34	○	
		C200HX-CPU54-Z	○	
		C200HX-CPU54	○	
		C200HE-CPU42-Z	◎	
		C200HE-CPU42	◎	
		C200HG-CPU43-Z	◎	
		C200HG-CPU43	◎	
		C200HG-CPU63-Z	◎	
		C200HG-CPU63	◎	
		C200HX-CPU44-Z	◎	
		C200HX-CPU44	◎	
		C200HX-CPU64-Z	○	
		C200HX-CPU64	◎	
	C200HX-CPU65-Z	◎		
	C200HX-CPU85-Z	◎		
	CV series	CV500	◎	
		CV1000	◎	
		CVM1	◎	
	CS1 series	CS1H-CPU67	◎	
		CS1H-CPU66	◎	
		CS1H-CPU65	◎	
		CS1H-CPU64	◎	
		CS1H-CPU63	◎	
		CS1G-CPU45	◎	
		CS1G-CPU44	◎	
		CS1G-CPU43	◎	
CS1G-CPU42	◎			
CJ series	CJ1H	◎		
	CJ1M	◎		
	CJ1G	◎		
	CJ2H	◎		
	CJ2M	◎	○	

◎: Direct connection is possible to the CPU unit of the PLC.

○: Connection is possible using the communications unit or a signal conversion cable, etc.

Blank: Not evaluated.

\*1. PLCs other than FP series of Panasonic may be limited in the type of device that can be used and addresses. Please see each wiring diagram for details.

Manufacturer	Series	Model	RS232C type	RS422 (RS485) type
OMRON Corporation *1	CP1 series	CP1H	○	
		CP1L	○	
		CP1E	◎ Models with RS232C port	○
Toshiba Machine Co., Ltd. *1	TC mini series		◎ Models with RS232C port	◎ Models with RS485 port
Yokogawa Electric Corporation *1	FA-M3 series	F3SP59-7S	◎	
		F3SP58-6S	◎	
		F3SP58-6H	◎	
		F3SP53-4S	◎	
		F3SP53-4H	◎	
		F3SP38-6S	◎	
		F3SP38-6N	◎	
		F3SP35-5N	◎	
		F3SP28-3S	◎	
		F3SP28-3N	◎	
		F3SP25-2N	◎	
		F3SP21-0N	◎	
KEYENCE Corporation *1	KV series	KV-10/16/24/40	◎	
		KV700	◎	○
		KV1000	◎	○
		KV3000	◎	○
		KV5000	○	○
		KV Nano	◎	

◎: Direct connection is possible to the CPU unit of the PLC.

○: Connection is possible using the communications unit or a signal conversion cable, etc.

Blank: Not evaluated.

\*1. PLCs other than FP series of Panasonic may be limited in the type of device that can be used and addresses. Please see each wiring diagram for details.

Manufacturer	Series	Model	RS232C type	RS422 (RS485) type
Hitachi Industrial Equipment Systems Co., Ltd. *1	EH-150EHV series	EHV-CPU128	◎	◎
		EHV-CPU64	◎	◎
		EHV-CPU32	◎	◎
		EHV-CPU16	◎	◎
	EH150 series	EHV-CPU104A	◎	◎
		EHV-CPU208A	◎	◎
		EHV-CPU316A	◎	◎
		EHV-CPU516	◎	◎
		EHV-CPU548	◎	◎
	MICRO-EH series	10 points		
		14 points	◎	
		20 points	◎	
		23 points	◎	◎
		28 points	◎	◎
40 points		◎		
64 points		◎		
Web Controller	10 points	◎		
	23 points	◎	◎	
Rockwell Automation Inc. (Allen-Bradley Models that support protocol *1	MicroLogix	MicroLogix500	◎	
		MicroLogix1000	◎	
		MicroLogix1100	◎	
	SLC-500 series	SLC-5/03	◎	
		SLC-5/04	◎	
Siemens *1	S7-200 series	CPU222	○	◎
		CPU216	○	◎
		CPU215	○	◎
		CPU214	○	◎
		CPU212	○	◎
LS Industrial Systems Co., Ltd. *1	MASTER-K series	80S	◎	
		200S	◎	
		300S	○	
		1000S	○	
Modbus *1	Models that support RTU protocol	*2	◎	◎
General-purpose serial *1	MEW dedicated protocol	*2	◎	◎

◎: Direct connection is possible to the CPU unit of the PLC.

○: Connection is possible using the communications unit or a signal conversion cable, etc.

Blank: Not evaluated.

\*1. PLCs other than FP series of Panasonic may be limited in the type of device that can be used and addresses. Please see each wiring diagram for details.

\*2. We cannot specify what other device you should use; therefore, please test it using the actual equipment before using.

## Selecting the PLC Model

### PLC Model selection with GTWIN

Select the model of PLC being used from among the list of candidates

PLC Model	Usable GT		
	GT01,GT02,GT02L,GT03-E, GT05,GT11,GT12,GT21, GT32,GT32-R,GT32-E, GT703,GT704,GT707	GT10	GT30
Panasonic FP series	○	○	○
Panasonic FP7 series	○ (Except GT01,GT11,GT21)	○	○
General-Purpose Serial (General-purpose RS232C device, such as a personal computer or a microcomputer board.)	○	○	○
Mitsubishi MELSEC-FX series (MELSEC-FX1N series)	○	○	○
Mitsubishi MELSEC-FX2N series (MELSEC-FX2N/FX3UC/FX3U series)	○	○	○
Mitsubishi MELSEC-Q (Serial communication) series	○		
Mitsubishi MELSEC-Q (CPU) series	○		
Mitsubishi MELSEC-A (Computer Link) series	○ (Except GT7 series)	○	○
Omron SYSMAC-C series (SYSMAC-C/α/CV/CP1 series)	○	○	○
Omron SYSMAC CS/CJ/CP series (SYSMAC-CS/CJ series)	○		
Rockwell Automation (Allen-Bradley SLC500 MicroLogix series)	○	○	○
Siemens S7-200 series	○	○	○
LS Industrial Systems MASTER-K (Cnet) series	○	○	○
Modbus Slave (RTU mode)	○		
Modbus(RTU Mode) (PLC which supports Modbus RTU mode protocol)	○	○	○
Modbus(RTU Mode   modicon PLC) (PLC which supports Modbus RTU   modicon PLC mode protocol)	○	○	○
MODBUS(RTU mode   Temperature control unit, etc)	○ (GT02, GT02L, GT03-E, GT05, GT12, GT32 and GT32-E only)		
Yokogawa FA-M3 series	○	○	○
TOSHIBA MACHINE PROVISOIR TCmini series	○	○	
Keyence KV10/16/24/40 series	○		
Keyence KV700 series	○		
Keyence KV1000 series	○		
Keyence KV3000 / 5000 series	○		
HITACHI EH/EHV series (EH-150/EHV/MICRO-EH/Web controller series)	○		

○: Available, No mark: Not available

# Chapter 1

---

## Connection With Mitsubishi PLCs

# 1.1 MELSEC-FX1S/ FX1N/ FX1NC Series

## PLC model selection

Select "Mitsubishi MELSEC-FX Series".

## Usable devices

	Bit/Word Device	No.	Memo
Bit Device	Input Relay	X0000-X0337	
	Output Relay	Y0000-Y0337	
	Internal Relay	M0000-M1535	
	State	S0000-S0999	
	Timer(contact)	TS0000-TS0255	
	Counter(contact)	CS0000-CS0255	
Word Device	Input Relay	X0000-X0320	Specify address expression every 20
	Output Relay	Y0000-Y0320	Specify address expression every 20
	Internal Relay	M0000-M1520	Specify address expression every 16 multiples
	State	S0000-S0976	Specify address expression every 16 multiples
	Timer(current)	TN0000-TN0255	
	16 Bits Counter(current)	CN0000-CN0199	
	32 Bits Counter(current)	CN0200-CN0255	
	Data Register	D0000-D0999	

Note1) The addresses you can use may differ depending on the model. For details, please see the manual for the PLC you are using.

Note2) If using an input relay, output relay and auxiliary relay in word units, please set the address in 16 point increments from 000. (X000, X020, X040 ..., M000, M016, M032).

## Communication Parameters Settings

The example of communication settings of GT and PLC is shown below.

Setting Values for GT (Set in the configuration setting of GTWIN.)

Item	Setting
Baud Rate	9600bps
Data Length	7
Stop Bits	1
Parity	Even

## Setting the communication conditions for the PLC

"0" should be stored in D8120. ("0" is the default value, so this setting should not need to be entered by the user.)

### 1.1.1 Direct connection to the TOOL port

#### For 5V DC type

CPU	I/F	Wiring diagram	GT Series																																													
FX1S FX1N FX1NC	TOOL port of PLC Mini-DIN 8-pin loose-wire cable (AIGT8152)	<p>Mitsubishi Electric PLC TOOL port side</p> <table border="1"> <thead> <tr> <th>Pin No.</th> <th>Signal name</th> <th>Cable color</th> </tr> </thead> <tbody> <tr><td>1</td><td>-RD</td><td>Green</td></tr> <tr><td>2</td><td>+RD</td><td>Yellow</td></tr> <tr><td>3</td><td>-SD</td><td>Brown</td></tr> <tr><td>4</td><td>-SD</td><td>Orange</td></tr> <tr><td>5</td><td>+5V</td><td>White</td></tr> <tr><td>6</td><td>-</td><td>-</td></tr> <tr><td>7</td><td>+SD</td><td>Red</td></tr> <tr><td>8</td><td>-</td><td>-</td></tr> </tbody> </table> <p>GT side</p> <table border="1"> <thead> <tr> <th>Pin No.</th> <th>Signal name</th> </tr> </thead> <tbody> <tr><td>1</td><td>+5V</td></tr> <tr><td>2</td><td>GND</td></tr> <tr><td>3</td><td>NC</td></tr> <tr><td>4</td><td>+SD</td></tr> <tr><td>5</td><td>-SD</td></tr> <tr><td>6</td><td>+RD</td></tr> <tr><td>7</td><td>-RD</td></tr> <tr><td>8</td><td>E Terminal station setting (120W resistor built in)</td></tr> </tbody> </table>	Pin No.	Signal name	Cable color	1	-RD	Green	2	+RD	Yellow	3	-SD	Brown	4	-SD	Orange	5	+5V	White	6	-	-	7	+SD	Red	8	-	-	Pin No.	Signal name	1	+5V	2	GND	3	NC	4	+SD	5	-SD	6	+RD	7	-RD	8	E Terminal station setting (120W resistor built in)	RS422 5V DC type
Pin No.	Signal name	Cable color																																														
1	-RD	Green																																														
2	+RD	Yellow																																														
3	-SD	Brown																																														
4	-SD	Orange																																														
5	+5V	White																																														
6	-	-																																														
7	+SD	Red																																														
8	-	-																																														
Pin No.	Signal name																																															
1	+5V																																															
2	GND																																															
3	NC																																															
4	+SD																																															
5	-SD																																															
6	+RD																																															
7	-RD																																															
8	E Terminal station setting (120W resistor built in)																																															



#### Note:

- Keep the cable no longer than 2 m
- The power consumption of GT01/GT02/GT02L corresponds to that of Mitsubishi's F920 (5 V type) display device. When using, adhere to the conditions of use (number of units that can be expanded on a PLC, etc.) for the F920 (5 V type).

#### For 24V DC type

CPU	I/F	Wiring diagram	GT Series																																													
FX1S FX1N FX1NC	TOOL port of PLC Mini-DIN 8-pin loose-wire cable (AIGT8175)	<p>Mitsubishi Electric PLC TOOL port side</p> <table border="1"> <thead> <tr> <th>Pin No.</th> <th>Signal name</th> <th>Cable color</th> </tr> </thead> <tbody> <tr><td>1</td><td>-RD</td><td>Green</td></tr> <tr><td>2</td><td>+RD</td><td>Yellow</td></tr> <tr><td>3</td><td>-</td><td>-</td></tr> <tr><td>4</td><td>-SD</td><td>Orange</td></tr> <tr><td>5</td><td>-</td><td>-</td></tr> <tr><td>6</td><td>-</td><td>-</td></tr> <tr><td>7</td><td>+SD</td><td>Red</td></tr> <tr><td>8</td><td>-</td><td>-</td></tr> </tbody> </table> <p>To power supply</p> <p>GT side</p> <table border="1"> <thead> <tr> <th>Pin No.</th> <th>Signal name</th> </tr> </thead> <tbody> <tr><td>1</td><td>+24V</td></tr> <tr><td>2</td><td>GND</td></tr> <tr><td>3</td><td>NC</td></tr> <tr><td>4</td><td>+SD</td></tr> <tr><td>5</td><td>-SD</td></tr> <tr><td>6</td><td>+RD</td></tr> <tr><td>7</td><td>-RD</td></tr> <tr><td>8</td><td>E Terminal station setting (120W resistor built in)</td></tr> </tbody> </table>	Pin No.	Signal name	Cable color	1	-RD	Green	2	+RD	Yellow	3	-	-	4	-SD	Orange	5	-	-	6	-	-	7	+SD	Red	8	-	-	Pin No.	Signal name	1	+24V	2	GND	3	NC	4	+SD	5	-SD	6	+RD	7	-RD	8	E Terminal station setting (120W resistor built in)	RS422 24V DC type
Pin No.	Signal name	Cable color																																														
1	-RD	Green																																														
2	+RD	Yellow																																														
3	-	-																																														
4	-SD	Orange																																														
5	-	-																																														
6	-	-																																														
7	+SD	Red																																														
8	-	-																																														
Pin No.	Signal name																																															
1	+24V																																															
2	GND																																															
3	NC																																															
4	+SD																																															
5	-SD																																															
6	+RD																																															
7	-RD																																															
8	E Terminal station setting (120W resistor built in)																																															

## 1.1.2 Using an Adapter

CPU	Adapter	Wiring diagram	GT Series																																								
FX1S FX1N FX1NC	FX1N-232-BD	<p>Mitsubishi Electric PLC adapter side</p> <table border="1"> <thead> <tr> <th>Pin No.</th> <th>Signal name</th> </tr> </thead> <tbody> <tr><td>1</td><td>CD</td></tr> <tr><td>2</td><td>RD</td></tr> <tr><td>3</td><td>SD</td></tr> <tr><td>4</td><td>ER</td></tr> <tr><td>5</td><td>SG</td></tr> <tr><td>6</td><td>DR</td></tr> <tr><td>7</td><td>-</td></tr> <tr><td>8</td><td>-</td></tr> <tr><td>9</td><td>-</td></tr> </tbody> </table> <p>To power supply</p> <p>GT side</p> <table border="1"> <thead> <tr> <th>Pin No.</th> <th>Signal name</th> </tr> </thead> <tbody> <tr><td>1</td><td>+</td></tr> <tr><td>2</td><td>-</td></tr> <tr><td>3</td><td>FG</td></tr> <tr><td>4</td><td>SD</td></tr> <tr><td>5</td><td>RD</td></tr> <tr><td>6</td><td>NC</td></tr> <tr><td>7</td><td>NC</td></tr> <tr><td>8</td><td>SG</td></tr> </tbody> </table>	Pin No.	Signal name	1	CD	2	RD	3	SD	4	ER	5	SG	6	DR	7	-	8	-	9	-	Pin No.	Signal name	1	+	2	-	3	FG	4	SD	5	RD	6	NC	7	NC	8	SG	GT series RS232C 24 V DC type*1 *2		
Pin No.	Signal name																																										
1	CD																																										
2	RD																																										
3	SD																																										
4	ER																																										
5	SG																																										
6	DR																																										
7	-																																										
8	-																																										
9	-																																										
Pin No.	Signal name																																										
1	+																																										
2	-																																										
3	FG																																										
4	SD																																										
5	RD																																										
6	NC																																										
7	NC																																										
8	SG																																										
		<p>Mitsubishi Electric PLC adapter side</p> <table border="1"> <thead> <tr> <th>Pin No.</th> <th>Signal name</th> </tr> </thead> <tbody> <tr><td>1</td><td>CD</td></tr> <tr><td>2</td><td>RD</td></tr> <tr><td>3</td><td>SD</td></tr> <tr><td>4</td><td>ER</td></tr> <tr><td>5</td><td>SG</td></tr> <tr><td>6</td><td>DR</td></tr> <tr><td>7</td><td>-</td></tr> <tr><td>8</td><td>-</td></tr> <tr><td>9</td><td>-</td></tr> </tbody> </table> <p>GT side</p> <table border="1"> <thead> <tr> <th>Pin No.</th> <th>Signal name</th> </tr> </thead> <tbody> <tr><td>1</td><td>N.C.</td></tr> <tr><td>2</td><td>RD</td></tr> <tr><td>3</td><td>SD</td></tr> <tr><td>4</td><td>N.C.</td></tr> <tr><td>5</td><td>SG</td></tr> <tr><td>6</td><td>N.C.</td></tr> <tr><td>7</td><td>RS</td></tr> <tr><td>8</td><td>CS</td></tr> <tr><td>9</td><td>N.C.</td></tr> </tbody> </table>	Pin No.	Signal name	1	CD	2	RD	3	SD	4	ER	5	SG	6	DR	7	-	8	-	9	-	Pin No.	Signal name	1	N.C.	2	RD	3	SD	4	N.C.	5	SG	6	N.C.	7	RS	8	CS	9	N.C.	GT707
Pin No.	Signal name																																										
1	CD																																										
2	RD																																										
3	SD																																										
4	ER																																										
5	SG																																										
6	DR																																										
7	-																																										
8	-																																										
9	-																																										
Pin No.	Signal name																																										
1	N.C.																																										
2	RD																																										
3	SD																																										
4	N.C.																																										
5	SG																																										
6	N.C.																																										
7	RS																																										
8	CS																																										
9	N.C.																																										

\*1: Although nos.6 and 7 of the models except GT01 are RS/CS, they can be used in the above connection.

\*2: This is for RS232C type of GT01/GT02/GT02L/GT03-E/GT05/GT11/GT12/GT21/GT32/GT32-E/GT703/GT704.



## 1.2 MELSEC-FX2N/ FX2NC/ FX3U/ FX3UC/ FX3G / FX3GC Series

### Applicable versions of GTWIN and GT series

	Applicable versions of GTWIN and GT series	
	FX2N • FX2NC • FX3U • FX3UC • FX3G	FX3GC
GT01	Ver.1.10 or later	Cannot be used
GT02	Ver.1.00 or later	Ver.1.62 or later
GT02L	Ver.1.00 or later	Ver.1.52 or later
GT03-E	Ver.1.00 or later	Ver.1.02 or later
GT05	Ver.1.00 or later	Ver.2.22 or later
GT11	Ver.1.00 or later	Cannot be used
GT12	Ver.1.00 or later	Ver.1.92 or later
GT21	Ver.1.00 or later	Cannot be used
GT32	Ver.1.00 or later	Ver.2.32 or later
GT32-E	Ver.1.00 or later	Ver.1.32 or later
GTWIN	Ver.2.40 or later	Ver.2.E1 or later

### PLC model selection

Select " Mitsubishi MELSEC-FX2N Series".

### Usable devices

Bit/Word Device	Device	No.	Memo
Bit Device	Input Relay	X0000-X0337	
	Output Relay	Y0000-Y0337	
	Internal Relay	M0000-M3071	
	State	S0000-S0999	
	Timer(contact)	TS0000-TS0255	
	Counter(contact)	CS0000-CS0255	
Word Device	Input Relay	X0000-X0320	Specify address expression every 20
	Output Relay	Y0000-Y0320	Specify address expression every 20
	Internal Relay	M0000-M3056	Specify address expression every 16 multiples
	State	S0000-S0976	Specify address expression every 16 multiples
	Timer(current)	TN0000-TN0255	
	16 Bits Counter(current)	CN0000-CN0199	
	32 Bits Counter(current)	CN0200-CN0255	
	Data Register	D0000-D7999	

Note1) The addresses you can use may differ depending on the model. For details, please see the manual for the PLC you are using.

Note2) If using an input relay, output relay and auxiliary relay in word units, please set the address in 16 point increments from 000. (X000, X020, X040 ..., M000, M016, M032).

### Communication Parameters Settings

The example of communication settings of GT and PLC is shown below.

Setting Values for GT (Set in the configuration setting of GTWIN.) Setting Values for GT

Item	Setting
Baud Rate	9600bps
Data Length	7
Stop Bits	1
Parity	Even

### Setting Values for PLC (Computer link unit)

Specify 0 to D8120

Uncheck the box of "Operate Communication Setting".

## 1.2.1 Direct connection to the TOOL port

### For RS422 5V DC type

CPU	I/F	Wiring diagram	GT Series
FX2N FX2NC	TOOL port of PLC Mini-DIN 8-pin loose-wire cable (AIGT8152)		RS422 5V DC type
FX3U FX3UC			
FX3G FX3GC			



#### Note:

- Keep the cable no longer than 2 m
- The power consumption of GT01/GT02/GT02L corresponds to that of Mitsubishi's F920 (5 V type) display device. When using, adhere to the conditions of use (number of units that can be expanded on a PLC, etc.) for the F920 (5 V type).

### For RS422 24V DC type

CPU	I/F	Wiring diagram	GT Series
FX2N FX2NC	TOOL port of PLC Mini-DIN 8-pin loose-wire cable (AIGT8175)		RS422 24V DC type
FX3U FX3UC			
FX3G FX3GC			

## 1.2.2 Using an Adapter

CPU	Adapter	Wiring diagram	GT Series																																								
FX2N FX2NC	FX2N-232-BD	<p>Mitsubishi Electric PLC adapter side</p> <table border="1"> <thead> <tr> <th>Pin No.</th> <th>Signal name</th> </tr> </thead> <tbody> <tr><td>1</td><td>CD</td></tr> <tr><td>2</td><td>RD</td></tr> <tr><td>3</td><td>SD</td></tr> <tr><td>4</td><td>ER</td></tr> <tr><td>5</td><td>SG</td></tr> <tr><td>6</td><td>DR</td></tr> <tr><td>7</td><td>-</td></tr> <tr><td>8</td><td>-</td></tr> <tr><td>9</td><td>-</td></tr> </tbody> </table> <p>To power supply</p> <table border="1"> <thead> <tr> <th>Pin No.</th> <th>Signal name</th> </tr> </thead> <tbody> <tr><td>1</td><td>+</td></tr> <tr><td>2</td><td>-</td></tr> <tr><td>3</td><td>FG</td></tr> <tr><td>4</td><td>SD</td></tr> <tr><td>5</td><td>RD</td></tr> <tr><td>6</td><td>NC</td></tr> <tr><td>7</td><td>NC</td></tr> <tr><td>8</td><td>SG</td></tr> </tbody> </table>	Pin No.	Signal name	1	CD	2	RD	3	SD	4	ER	5	SG	6	DR	7	-	8	-	9	-	Pin No.	Signal name	1	+	2	-	3	FG	4	SD	5	RD	6	NC	7	NC	8	SG	GT series RS232C 24 V DC type*1 *2		
Pin No.	Signal name																																										
1	CD																																										
2	RD																																										
3	SD																																										
4	ER																																										
5	SG																																										
6	DR																																										
7	-																																										
8	-																																										
9	-																																										
Pin No.	Signal name																																										
1	+																																										
2	-																																										
3	FG																																										
4	SD																																										
5	RD																																										
6	NC																																										
7	NC																																										
8	SG																																										
FX3U FX3UC	FX3UC-232-BD FX3U-232-ADP																																										
FX3G	FX3G-232-BD	<p>Mitsubishi Electric PLC adapter side</p> <table border="1"> <thead> <tr> <th>Pin No.</th> <th>Signal name</th> </tr> </thead> <tbody> <tr><td>1</td><td>CD</td></tr> <tr><td>2</td><td>RD</td></tr> <tr><td>3</td><td>SD</td></tr> <tr><td>4</td><td>ER</td></tr> <tr><td>5</td><td>SG</td></tr> <tr><td>6</td><td>DR</td></tr> <tr><td>7</td><td>-</td></tr> <tr><td>8</td><td>-</td></tr> <tr><td>9</td><td>-</td></tr> </tbody> </table> <table border="1"> <thead> <tr> <th>Pin No.</th> <th>Signal name</th> </tr> </thead> <tbody> <tr><td>1</td><td>N.C.</td></tr> <tr><td>2</td><td>RD</td></tr> <tr><td>3</td><td>SD</td></tr> <tr><td>4</td><td>N.C.</td></tr> <tr><td>5</td><td>SG</td></tr> <tr><td>6</td><td>N.C.</td></tr> <tr><td>7</td><td>RS</td></tr> <tr><td>8</td><td>CS</td></tr> <tr><td>9</td><td>N.C.</td></tr> </tbody> </table>	Pin No.	Signal name	1	CD	2	RD	3	SD	4	ER	5	SG	6	DR	7	-	8	-	9	-	Pin No.	Signal name	1	N.C.	2	RD	3	SD	4	N.C.	5	SG	6	N.C.	7	RS	8	CS	9	N.C.	GT707
Pin No.	Signal name																																										
1	CD																																										
2	RD																																										
3	SD																																										
4	ER																																										
5	SG																																										
6	DR																																										
7	-																																										
8	-																																										
9	-																																										
Pin No.	Signal name																																										
1	N.C.																																										
2	RD																																										
3	SD																																										
4	N.C.																																										
5	SG																																										
6	N.C.																																										
7	RS																																										
8	CS																																										
9	N.C.																																										

\*1: Although nos.6 and 7 of the models except GT01 are RS/CS, they can be used in the above connection.

\*2: This is for RS232C type of GT01/GT02/GT02L/GT03-E/GT05/GT11/GT12/GT21/GT32/GT32-E/GT703/GT704.

## 1.3 MELSEC-L (Serial communication) Series

---

### PLC model selection

Select " Mitsubishi MELSEC-Q (Serial communication) series".

### Usable devices

	Bit/Word Device	No.
Bit Device	Input Relay	X000000-X001FFF
	Output Relay	Y000000-Y001FFF
	Internal Relay	M000000-M032767
	Latch relay	L000000-L032767
	Annunciator	F000000-F032767
	Edge relay	V000000-V032767
	Link Relay	B000000-B007FFF
	Special relay	SM000000-SM002047
	Link special relay	SB000000-SB0007FF
	Step relay	S000000-S008191
	Direct access input	DX000000-DX001FFF
	Direct access output	DY000000-DY001FFF
	Timer(contact)	TS000000-TS023087
	Timer(coil)	TC000000-TC023087
	Retentive timer(contact)	SS000000-SS023087
	Retentive timer(coil)	SC000000-SC023087
	Counter(contact)	CS000000-CS023087
Counter(coil)	CC000000-CC023087	

Bit/Word Device		No.	Memo
Word Device	Input Relay	X000000-X001FF	Specify address expression every 0
	Output Relay	Y000000-Y001FF0	Specify address expression every 0
	Internal Relay	M000000-M032752	Specify address expression every 16 multiples
	Latch relay	L000000-L032752	
	Annunciator	F000000-F032752	
	Edge relay	V000000-V032752	
	Link Relay	B000000-B007FF0	Specify address expression every 10
	Special relay	SM000000-SM002032	
	Link special relay	SB000000-SB0007F0	
	Step relay	S000000-S008176	
	Direct access input	DX000000-DX001FFF	
	Direct access output	DY000000-DY001FFF	
	Timer(current)	TN000000-TN023087	
	Retentive timer(Current value)	SN000000-SN023087	
	Counter(current)	CN000000-CN023087	
	Data Register	D000000-D025983	
	Link Register	W000000-W00657F	
	Link special register	SW000000-SW0007FF	
	Index register	Z0-Z15	
	File Register(for block number)	R000000-R032767	
File register(for sequential number)	ZR000000-ZR1042431		
Special register	SD000000-SD002047		



**Note:**

- The maximum value that can be set with the GT is described.
- The range of usable addresses differs depending on the model. For details, please consult the manual for the PLC you will use.
- When you use a serial communication module, you will set some parameters (Slot No., Module type, I/O points and Start address etc). Input and output relay from the start address for set points can't be used.
- Although "Mitsubishi MELSEC-A (Computer Link) Series" can be used, the address range is the same as the one for "Mitsubishi MELSEC-A (Computer Link) Series".

### Communication Parameters Settings

The example of communication settings of GT and PLC is shown below.

#### Setting Values for GT (Set in the configuration setting of GTWIN.)

Item	Setting
PLC Unit No.	0
Baud Rate	19200bps
Data Length	8
Stop Bits	1
Parity	Odd
Sum Check	Yes

\*GT series supports the format 4 of QnA compatible 4C frame.

#### Setting Values for PLC (Serial communication unit)

Item	Setting
Station Number	0
Baud Rate	19200bps
Data Length	8
Stop Bits	1
Parity	Odd
Sum Check	Yes
Interface	RS232C
Communication protocol	MC protocol (Format 4)
Online change	Enable

### 1.3.1 MELSEC-L (Serial communication) series

CPU	Serial communication module	Wiring diagram	GT Series																																								
L26CPU-BT L02SCPU	LJ71C24	<p>Mitsubishi Electric PLC Serial communication side</p> <table border="1"> <thead> <tr> <th>Pin No.</th> <th>Signal name</th> </tr> </thead> <tbody> <tr><td>1</td><td>CD</td></tr> <tr><td>2</td><td>RD</td></tr> <tr><td>3</td><td>SD</td></tr> <tr><td>4</td><td>DTR(ER)</td></tr> <tr><td>5</td><td>SG</td></tr> <tr><td>6</td><td>SDR(DR)</td></tr> <tr><td>7</td><td>RS</td></tr> <tr><td>8</td><td>CS</td></tr> <tr><td>9</td><td>RI</td></tr> </tbody> </table> <p>To power supply</p> <table border="1"> <thead> <tr> <th>Pin No.</th> <th>Signal name</th> </tr> </thead> <tbody> <tr><td>1</td><td>+</td></tr> <tr><td>2</td><td>-</td></tr> <tr><td>3</td><td>FG</td></tr> <tr><td>4</td><td>SD</td></tr> <tr><td>5</td><td>RD</td></tr> <tr><td>6</td><td>NC</td></tr> <tr><td>7</td><td>NC</td></tr> <tr><td>8</td><td>SG</td></tr> </tbody> </table>	Pin No.	Signal name	1	CD	2	RD	3	SD	4	DTR(ER)	5	SG	6	SDR(DR)	7	RS	8	CS	9	RI	Pin No.	Signal name	1	+	2	-	3	FG	4	SD	5	RD	6	NC	7	NC	8	SG	GT series RS232C type*1 *2		
		Pin No.	Signal name																																								
1	CD																																										
2	RD																																										
3	SD																																										
4	DTR(ER)																																										
5	SG																																										
6	SDR(DR)																																										
7	RS																																										
8	CS																																										
9	RI																																										
Pin No.	Signal name																																										
1	+																																										
2	-																																										
3	FG																																										
4	SD																																										
5	RD																																										
6	NC																																										
7	NC																																										
8	SG																																										
		<p>Mitsubishi Electric PLC Serial communication side</p> <table border="1"> <thead> <tr> <th>Pin No.</th> <th>Signal name</th> </tr> </thead> <tbody> <tr><td>1</td><td>CD</td></tr> <tr><td>2</td><td>RD</td></tr> <tr><td>3</td><td>SD</td></tr> <tr><td>4</td><td>DTR(ER)</td></tr> <tr><td>5</td><td>SG</td></tr> <tr><td>6</td><td>SDR(DR)</td></tr> <tr><td>7</td><td>RS</td></tr> <tr><td>8</td><td>CS</td></tr> <tr><td>9</td><td>RI</td></tr> </tbody> </table> <table border="1"> <thead> <tr> <th>Pin No.</th> <th>Signal name</th> </tr> </thead> <tbody> <tr><td>1</td><td>N.C.</td></tr> <tr><td>2</td><td>RD</td></tr> <tr><td>3</td><td>SD</td></tr> <tr><td>4</td><td>N.C.</td></tr> <tr><td>5</td><td>SG</td></tr> <tr><td>6</td><td>N.C.</td></tr> <tr><td>7</td><td>RS</td></tr> <tr><td>8</td><td>CS</td></tr> <tr><td>9</td><td>N.C.</td></tr> </tbody> </table>	Pin No.	Signal name	1	CD	2	RD	3	SD	4	DTR(ER)	5	SG	6	SDR(DR)	7	RS	8	CS	9	RI	Pin No.	Signal name	1	N.C.	2	RD	3	SD	4	N.C.	5	SG	6	N.C.	7	RS	8	CS	9	N.C.	GT707
Pin No.	Signal name																																										
1	CD																																										
2	RD																																										
3	SD																																										
4	DTR(ER)																																										
5	SG																																										
6	SDR(DR)																																										
7	RS																																										
8	CS																																										
9	RI																																										
Pin No.	Signal name																																										
1	N.C.																																										
2	RD																																										
3	SD																																										
4	N.C.																																										
5	SG																																										
6	N.C.																																										
7	RS																																										
8	CS																																										
9	N.C.																																										

\*1: Although nos.6 and 7 of the models except GT01 are RS/CS, they can be used in the above connection.

\*2: This is for RS232C type of GT01/GT02/GT02L/GT03-E/GT05/GT11/GT12/GT21/GT32/GT32-E/GT703/GT704.

### 1.3.2 MELSEC-L (Serial communication) series (RS422)

CPU	Serial communication module	Wiring diagram	GT Series																										
L02SCPU	LJ71C24	<p>Mitsubishi Electric PLC Serial communication side</p> <table border="1"> <thead> <tr> <th>Signal name</th> </tr> </thead> <tbody> <tr><td>SDA</td></tr> <tr><td>SDB</td></tr> <tr><td>RDA</td></tr> <tr><td>RDB</td></tr> <tr><td>SG</td></tr> <tr><td>FG</td></tr> <tr><td>FG</td></tr> </tbody> </table> <p>To power supply</p> <table border="1"> <thead> <tr> <th>Pin No.</th> <th>Signal name</th> </tr> </thead> <tbody> <tr><td>1</td><td>+</td></tr> <tr><td>2</td><td>-</td></tr> <tr><td>3</td><td>NC(or FG)</td></tr> <tr><td>4</td><td>+SD</td></tr> <tr><td>5</td><td>-SD</td></tr> <tr><td>6</td><td>+RD</td></tr> <tr><td>7</td><td>-RD</td></tr> <tr><td>8</td><td>E</td></tr> </tbody> </table>	Signal name	SDA	SDB	RDA	RDB	SG	FG	FG	Pin No.	Signal name	1	+	2	-	3	NC(or FG)	4	+SD	5	-SD	6	+RD	7	-RD	8	E	RS422/ RS485 type
Signal name																													
SDA																													
SDB																													
RDA																													
RDB																													
SG																													
FG																													
FG																													
Pin No.	Signal name																												
1	+																												
2	-																												
3	NC(or FG)																												
4	+SD																												
5	-SD																												
6	+RD																												
7	-RD																												
8	E																												



## 1.4 MELSEC-L (CPU) Series

---

### PLC model selection

Select " Mitsubishi MELSEC-Q (Serial communication) series".

### Usable devices

	Bit/Word Device	No.
Bit Device	Input Relay	X000000-X001FFF
	Output Relay	Y000000-Y001FFF
	Internal Relay	M000000-M032767
	Latch relay	L000000-L032767
	Annunciator	F000000-F032767
	Edge relay	V000000-V032767
	Link Relay	B000000-B007FFF
	Special relay	SM000000-SM002047
	Link special relay	SB000000-SB0007FF
	Step relay	S000000-S008191
	Direct access input	DX000000-DX001FFF
	Direct access output	DY000000-DY001FFF
	Timer(contact)	TS000000-TS023087
	Timer(coil)	TC000000-TC023087
	Retentive timer(contact)	SS000000-SS023087
	Retentive timer(coil)	SC000000-SC023087
	Counter(contact)	CS000000-CS023087
Counter(coil)	CC000000-CC023087	

Bit/Word Device	No.	Memo	
Word Device	Input Relay	X000000-X001FF	Specify address expression every 0
	Output Relay	Y000000-Y001FF0	Specify address expression every 0
	Internal Relay	M000000-M032752	Specify address expression every 16 multiples
	Latch relay	L000000-L032752	
	Annunciator	F000000-F032752	
	Edge relay	V000000-V032752	
	Link Relay	B000000-B007FF0	Specify address expression every 10
	Special relay	SM000000-SM002032	
	Link special relay	SB000000-SB0007F0	
	Step relay	S000000-S008176	
	Direct access input	DX000000-DX001FFF	
	Direct access output	DY000000-DY001FFF	
	Timer(current)	TN000000-TN023087	
	Retentive timer(Current value)	SN000000-SN023087	
	Counter(current)	CN000000-CN023087	
	Data Register	D000000-D025983	
	Link Register	W000000-W00657F	
	Link special register	SW000000-SW0007FF	
	Index register	Z0-Z15	
	File Register(for block number)	R000000-R032767	
File register(for sequential number)	ZR000000-ZR1042431		
Special register	SD000000-SD002047		



**Note:**

- The maximum value that can be set with the GT is described.
- The range of usable addresses differs depending on the model. For details, please consult the manual for the PLC you will use.
- When you use a serial communication module, you will set some parameters (Slot No., Module type, I/O points and Start address etc). Input and output relay from the start address for set points can't be used.
- Although "Mitsubishi MELSEC-A (Computer Link) Series" can be used, the address range is the same as the one for "Mitsubishi MELSEC-A (Computer Link) Series".

### Communication Parameters Settings

The example of communication settings of GT and PLC is shown below.

#### Setting Values for GT (Set in the configuration setting of GTWIN.)

Item	Setting
PLC Unit No.	0
Baud Rate	19200bps
Data Length	8
Stop Bits	1
Parity	Odd
Sum Check	Yes

\*GT series supports the format 4 of QnA compatible 4C frame.

#### Setting Values for PLC (Serial communication module)

Item	Setting
Station Number	0
Baud Rate	19.2 Kbps
Data Length	8
Stop Bits	1
Parity	Odd
Sum Check	Check
Interface	RS232C
Use Serial Communication	Check
Online change	Enable

## 1.4.1 MELSEC-L (CPU) Series

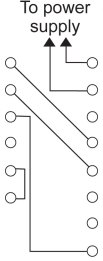
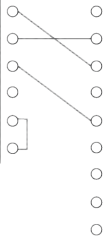
CPU	Link I/F	Wiring diagram	GT Series																																
L02SCPU	RS232C port on CPU unit	<p>Mitsubishi Electric PLC side Mini-Din 6-pin</p> <table border="1" data-bbox="467 388 677 575"> <thead> <tr> <th>Pin No.</th> <th>Signal name</th> </tr> </thead> <tbody> <tr><td>1</td><td>RD</td></tr> <tr><td>2</td><td>SD</td></tr> <tr><td>3</td><td>SG</td></tr> <tr><td>4</td><td>-</td></tr> <tr><td>5</td><td>DR</td></tr> <tr><td>6</td><td>ER</td></tr> </tbody> </table>  <p>To power supply</p> <table border="1" data-bbox="786 388 996 625"> <thead> <tr> <th>Pin No.</th> <th>Signal name</th> </tr> </thead> <tbody> <tr><td>1</td><td>+</td></tr> <tr><td>2</td><td>-</td></tr> <tr><td>3</td><td>FG</td></tr> <tr><td>4</td><td>SD</td></tr> <tr><td>5</td><td>RD</td></tr> <tr><td>6</td><td>RS</td></tr> <tr><td>7</td><td>CS</td></tr> <tr><td>8</td><td>SG</td></tr> </tbody> </table>	Pin No.	Signal name	1	RD	2	SD	3	SG	4	-	5	DR	6	ER	Pin No.	Signal name	1	+	2	-	3	FG	4	SD	5	RD	6	RS	7	CS	8	SG	GT series RS232C type*1
		Pin No.	Signal name																																
1	RD																																		
2	SD																																		
3	SG																																		
4	-																																		
5	DR																																		
6	ER																																		
Pin No.	Signal name																																		
1	+																																		
2	-																																		
3	FG																																		
4	SD																																		
5	RD																																		
6	RS																																		
7	CS																																		
8	SG																																		
<p>Mitsubishi Electric PLC side Mini-Din 6-pin</p> <table border="1" data-bbox="485 749 701 937"> <thead> <tr> <th>Pin No.</th> <th>Signal name</th> </tr> </thead> <tbody> <tr><td>1</td><td>RD</td></tr> <tr><td>2</td><td>SD</td></tr> <tr><td>3</td><td>SG</td></tr> <tr><td>4</td><td>-</td></tr> <tr><td>5</td><td>DR</td></tr> <tr><td>6</td><td>ER</td></tr> </tbody> </table>  <table border="1" data-bbox="810 749 1002 1020"> <thead> <tr> <th>Pin No.</th> <th>Signal name</th> </tr> </thead> <tbody> <tr><td>1</td><td>N.C.</td></tr> <tr><td>2</td><td>RD</td></tr> <tr><td>3</td><td>SD</td></tr> <tr><td>4</td><td>N.C.</td></tr> <tr><td>5</td><td>SG</td></tr> <tr><td>6</td><td>N.C.</td></tr> <tr><td>7</td><td>RS</td></tr> <tr><td>8</td><td>CS</td></tr> <tr><td>9</td><td>N.C.</td></tr> </tbody> </table>	Pin No.	Signal name	1	RD	2	SD	3	SG	4	-	5	DR	6	ER	Pin No.	Signal name	1	N.C.	2	RD	3	SD	4	N.C.	5	SG	6	N.C.	7	RS	8	CS	9	N.C.	GT707
Pin No.	Signal name																																		
1	RD																																		
2	SD																																		
3	SG																																		
4	-																																		
5	DR																																		
6	ER																																		
Pin No.	Signal name																																		
1	N.C.																																		
2	RD																																		
3	SD																																		
4	N.C.																																		
5	SG																																		
6	N.C.																																		
7	RS																																		
8	CS																																		
9	N.C.																																		

\*1: This is for RS232C type of GT01/GT02/GT02L/GT03-E/GT05/GT11/GT12/GT21/GT32/GT32-E/GT703/GT704.

## 1.5 MELSEC-Q (Serial communication) Series

### PLC model selection

Select " Mitsubishi MELSEC-Q (Serial communication) Series".

\*When directly connecting to the RS232C port of Q00CPU or Q01CPU

Select "Mitsubishi MELSEC-Q (Serial communication) Series" for the PLC model.

### Usable devices

	Bit/Word Device	No.
Bit Device	Input Relay	X000000-X001FFF
	Output Relay	Y000000-Y001FFF
	Internal Relay	M000000-M032767
	Latch relay	L000000-L032767
	Annunciator	F000000-F032767
	Edge relay	V000000-V032767
	Link Relay	B000000-B007FFF
	Special relay	SM000000-SM002047
	Link special relay	SB000000-SB0007FF
	Step relay	S000000-S008191
	Direct access input	DX000000-DX001FFF
	Direct access output	DY000000-DY001FFF
	Timer(contact)	TS000000-TS023087
	Timer(coil)	TC000000-TC023087
	Retentive timer(contact)	SS000000-SS023087
	Retentive timer(coil)	SC000000-SC023087
	Counter(contact)	CS000000-CS023087
Counter(coil)	CC000000-CC023087	

Bit/Word Device	No.	Memo	
Word Device	Input Relay	X000000-X001FF	Specify address expression every 0
	Output Relay	Y000000-Y001FF0	Specify address expression every 0
	Internal Relay	M000000-M032752	Specify address expression every 16 multiples
	Latch relay	L000000-L032752	
	Annunciator	F000000-F032752	
	Edge relay	V000000-V032752	
	Link Relay	B000000-B007FF0	Specify address expression every 10
	Special relay	SM000000-SM002032	
	Link special relay	SB000000-SB0007F0	
	Step relay	S000000-S008176	
	Direct access input	DX000000-DX001FFF	
	Direct access output	DY000000-DY001FFF	
	Timer(current)	TN000000-TN023087	
	Retentive timer(Current value)	SN000000-SN023087	
	Counter(current)	CN000000-CN023087	
	Data Register	D000000-D025983	
	Link Register	W000000-W00657F	
	Link special register	SW000000-SW0007FF	
	Index register	Z0-Z15	
	File Register(for block number)	R000000-R032767	
File register(for sequential number)	ZR000000-ZR1042431		
Special register	SD000000-SD002047		



**Note:**

- The maximum value that can be set with the GT is described.
- The range of usable addresses differs depending on the model. For details, please consult the manual for the PLC you will use.
- When you use a serial communication module, you will set some parameters (Slot No., Module type, I/O points and Start address etc). Input and output relay from the start address for set points can't be used.
- Although "Mitsubishi MELSEC-A (Computer Link) Series" can be used, the address range is the same as the one for "Mitsubishi MELSEC-A (Computer Link) Series".

### Communication Parameters Settings

The example of communication settings of GT and PLC is shown below.

#### Setting Values for GT (Set in the configuration setting of GTWIN.)

Item	Setting
PLC Unit No.	0
Baud Rate	19200bps
Data Length	8
Stop Bits	1
Parity	Odd
Sum Check	Yes

\*GT series supports the format 4 of QnA compatible 4C frame.

#### Setting Values for PLC (Serial communication module)

Item	Setting
Station Number	0
Baud Rate	19200bps
Data Length	8
Stop Bits	1
Parity	Odd
Sum Check	Yes
Interface	RS232C
Communication protocol	Format 4

## 1.5.1 MELSEC-Q (Serial communication) series (RS232C)

CPU	Serial communication module	Wiring diagram	GT Series																																								
Q02CPU Q02HCPU Q06HCPU Q12HCPU Q25HCPU Q00CPU Q00HCPU Q01CPU Q00JCPU Q26UDHCPU	QJ71C24N QJ71C24-R2 QJ71C24N-R2	<p>Mitsubishi Electric PLC Serial communication side</p> <table border="1"> <thead> <tr> <th>Pin No.</th> <th>Signal name</th> </tr> </thead> <tbody> <tr><td>1</td><td>CD</td></tr> <tr><td>2</td><td>RD</td></tr> <tr><td>3</td><td>SD</td></tr> <tr><td>4</td><td>DTR(ER)</td></tr> <tr><td>5</td><td>SG</td></tr> <tr><td>6</td><td>SDR(DR)</td></tr> <tr><td>7</td><td>RS</td></tr> <tr><td>8</td><td>CS</td></tr> <tr><td>9</td><td>RI</td></tr> </tbody> </table> <p>To power supply</p> <p>GT side</p> <table border="1"> <thead> <tr> <th>Pin No.</th> <th>Signal name</th> </tr> </thead> <tbody> <tr><td>1</td><td>+</td></tr> <tr><td>2</td><td>-</td></tr> <tr><td>3</td><td>FG</td></tr> <tr><td>4</td><td>SD</td></tr> <tr><td>5</td><td>RD</td></tr> <tr><td>6</td><td>NC</td></tr> <tr><td>7</td><td>NC</td></tr> <tr><td>8</td><td>SG</td></tr> </tbody> </table>	Pin No.	Signal name	1	CD	2	RD	3	SD	4	DTR(ER)	5	SG	6	SDR(DR)	7	RS	8	CS	9	RI	Pin No.	Signal name	1	+	2	-	3	FG	4	SD	5	RD	6	NC	7	NC	8	SG	GT series RS232C type*1 *2		
Pin No.	Signal name																																										
1	CD																																										
2	RD																																										
3	SD																																										
4	DTR(ER)																																										
5	SG																																										
6	SDR(DR)																																										
7	RS																																										
8	CS																																										
9	RI																																										
Pin No.	Signal name																																										
1	+																																										
2	-																																										
3	FG																																										
4	SD																																										
5	RD																																										
6	NC																																										
7	NC																																										
8	SG																																										
		<p>Mitsubishi Electric PLC Serial communication side</p> <table border="1"> <thead> <tr> <th>Pin No.</th> <th>Signal name</th> </tr> </thead> <tbody> <tr><td>1</td><td>CD</td></tr> <tr><td>2</td><td>RD</td></tr> <tr><td>3</td><td>SD</td></tr> <tr><td>4</td><td>DTR(ER)</td></tr> <tr><td>5</td><td>SG</td></tr> <tr><td>6</td><td>SDR(DR)</td></tr> <tr><td>7</td><td>RS</td></tr> <tr><td>8</td><td>CS</td></tr> <tr><td>9</td><td>RI</td></tr> </tbody> </table> <p>GT side</p> <table border="1"> <thead> <tr> <th>Pin No.</th> <th>Signal name</th> </tr> </thead> <tbody> <tr><td>1</td><td>N.C.</td></tr> <tr><td>2</td><td>RD</td></tr> <tr><td>3</td><td>SD</td></tr> <tr><td>4</td><td>N.C.</td></tr> <tr><td>5</td><td>SG</td></tr> <tr><td>6</td><td>N.C.</td></tr> <tr><td>7</td><td>RS</td></tr> <tr><td>8</td><td>CS</td></tr> <tr><td>9</td><td>N.C.</td></tr> </tbody> </table>	Pin No.	Signal name	1	CD	2	RD	3	SD	4	DTR(ER)	5	SG	6	SDR(DR)	7	RS	8	CS	9	RI	Pin No.	Signal name	1	N.C.	2	RD	3	SD	4	N.C.	5	SG	6	N.C.	7	RS	8	CS	9	N.C.	GT707
Pin No.	Signal name																																										
1	CD																																										
2	RD																																										
3	SD																																										
4	DTR(ER)																																										
5	SG																																										
6	SDR(DR)																																										
7	RS																																										
8	CS																																										
9	RI																																										
Pin No.	Signal name																																										
1	N.C.																																										
2	RD																																										
3	SD																																										
4	N.C.																																										
5	SG																																										
6	N.C.																																										
7	RS																																										
8	CS																																										
9	N.C.																																										

\*1: Although nos.6 and 7 of the models except GT01 are RS/CS, they can be used in the above connection.

\*2: This is for RS232C type of GT01/GT02/GT02L/GT03-E/GT05/GT11/GT12/GT21/GT32/GT32-E/GT703/GT704.

## 1.5.2 MELSEC-Q (Serial communication) series (RS422)

CPU	Serial communication module	Wiring diagram	GT Series																										
Q26UDHCPU	QJ71C24N	<p>Mitsubishi Electric PLC Serial communication side</p> <table border="1"> <thead> <tr> <th>Signal name</th> </tr> </thead> <tbody> <tr><td>SDA</td></tr> <tr><td>SDB</td></tr> <tr><td>RDA</td></tr> <tr><td>RDB</td></tr> <tr><td>SG</td></tr> <tr><td>FG</td></tr> <tr><td>FG</td></tr> </tbody> </table> <p>To power supply</p> <p>GT side</p> <table border="1"> <thead> <tr> <th>Pin No.</th> <th>Signal name</th> </tr> </thead> <tbody> <tr><td>1</td><td>+</td></tr> <tr><td>2</td><td>-</td></tr> <tr><td>3</td><td>NC(or FG)</td></tr> <tr><td>4</td><td>+SD</td></tr> <tr><td>5</td><td>-SD</td></tr> <tr><td>6</td><td>+RD</td></tr> <tr><td>7</td><td>-RD</td></tr> <tr><td>8</td><td>E</td></tr> </tbody> </table>	Signal name	SDA	SDB	RDA	RDB	SG	FG	FG	Pin No.	Signal name	1	+	2	-	3	NC(or FG)	4	+SD	5	-SD	6	+RD	7	-RD	8	E	RS422/ RS485 type
Signal name																													
SDA																													
SDB																													
RDA																													
RDB																													
SG																													
FG																													
FG																													
Pin No.	Signal name																												
1	+																												
2	-																												
3	NC(or FG)																												
4	+SD																												
5	-SD																												
6	+RD																												
7	-RD																												
8	E																												

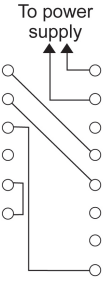
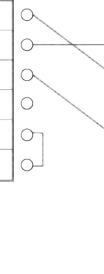

### 1.5.3 When directly connecting to the RS232C port of Q00CPU/ Q00UJCPU/ Q01CPU

CPU	Link I/F	Wiring diagram	GT Series																																		
Q00CPU Q00UJCPU Q01CPU	RS232C port on CPU unit	<p>Mitsubishi Electric PLC side Mini-Din 6-pin</p> <table border="1" data-bbox="514 434 747 627"> <thead> <tr> <th>Pin No.</th> <th>Signal name</th> </tr> </thead> <tbody> <tr><td>1</td><td>RD</td></tr> <tr><td>2</td><td>SD</td></tr> <tr><td>3</td><td>SG</td></tr> <tr><td>4</td><td>-</td></tr> <tr><td>5</td><td>DR</td></tr> <tr><td>6</td><td>ER</td></tr> </tbody> </table>  <p>To power supply</p> <table border="1" data-bbox="850 434 1083 685"> <thead> <tr> <th>Pin No.</th> <th>Signal name</th> </tr> </thead> <tbody> <tr><td>1</td><td>+</td></tr> <tr><td>2</td><td>-</td></tr> <tr><td>3</td><td>FG</td></tr> <tr><td>4</td><td>SD</td></tr> <tr><td>5</td><td>RD</td></tr> <tr><td>6</td><td>NC</td></tr> <tr><td>7</td><td>NC</td></tr> <tr><td>8</td><td>SG</td></tr> </tbody> </table>	Pin No.	Signal name	1	RD	2	SD	3	SG	4	-	5	DR	6	ER	Pin No.	Signal name	1	+	2	-	3	FG	4	SD	5	RD	6	NC	7	NC	8	SG	GT series RS232C type*1 *2		
Pin No.	Signal name																																				
1	RD																																				
2	SD																																				
3	SG																																				
4	-																																				
5	DR																																				
6	ER																																				
Pin No.	Signal name																																				
1	+																																				
2	-																																				
3	FG																																				
4	SD																																				
5	RD																																				
6	NC																																				
7	NC																																				
8	SG																																				
		<p>Mitsubishi Electric PLC side Mini-Din 6-pin</p> <table border="1" data-bbox="514 821 747 1033"> <thead> <tr> <th>Pin No.</th> <th>Signal name</th> </tr> </thead> <tbody> <tr><td>1</td><td>RD</td></tr> <tr><td>2</td><td>SD</td></tr> <tr><td>3</td><td>SG</td></tr> <tr><td>4</td><td>-</td></tr> <tr><td>5</td><td>DR</td></tr> <tr><td>6</td><td>ER</td></tr> </tbody> </table>  <p>GT side</p> <table border="1" data-bbox="850 821 1083 1130"> <thead> <tr> <th>Pin No.</th> <th>Signal name</th> </tr> </thead> <tbody> <tr><td>1</td><td>N.C.</td></tr> <tr><td>2</td><td>RD</td></tr> <tr><td>3</td><td>SD</td></tr> <tr><td>4</td><td>N.C.</td></tr> <tr><td>5</td><td>SG</td></tr> <tr><td>6</td><td>N.C.</td></tr> <tr><td>7</td><td>RS</td></tr> <tr><td>8</td><td>CS</td></tr> <tr><td>9</td><td>N.C.</td></tr> </tbody> </table>	Pin No.	Signal name	1	RD	2	SD	3	SG	4	-	5	DR	6	ER	Pin No.	Signal name	1	N.C.	2	RD	3	SD	4	N.C.	5	SG	6	N.C.	7	RS	8	CS	9	N.C.	GT707
Pin No.	Signal name																																				
1	RD																																				
2	SD																																				
3	SG																																				
4	-																																				
5	DR																																				
6	ER																																				
Pin No.	Signal name																																				
1	N.C.																																				
2	RD																																				
3	SD																																				
4	N.C.																																				
5	SG																																				
6	N.C.																																				
7	RS																																				
8	CS																																				
9	N.C.																																				

\*1: Although nos.6 and 7 of the models except GT01 are RS/CS, they can be used in the above connection.

\*2: This is for RS232C type of GT01/GT02/GT02L/GT03-E/GT05/GT11/GT12/GT21/GT32/GT32-E/GT703/GT704.

## 1.6 MELSEC-Q (CPU) Series

### PLC model selection

Select "MELSEC-Q (CPU) series".

### Usable devices

	Bit/Word Device	No.	Memo
Bit Device	Input Relay	X000000-X001FFF	
	Output Relay	Y000000-Y001FFF	
	Internal Relay	M000000-M032767	
	Latch relay	L000000-L032767	
	Annunciator	F000000-F032767	
	Edge relay	V000000-V032767	
	Link Relay	B000000-B007FFF	
	Special relay	SM000000-SM002047	
	Link special relay	SB000000-SB0007FF	
	Step relay	S000000-S008191	
	Timer(contact)	TS000000-TS023087	
	Timer(coil)	TC000000-TC023087	
	Retentive timer(contact)	SS000000-SS023087	
	Retentive timer(coil)	SC000000-SC023087	
	Counter(contact)	CS000000-CS023087	
Counter(coil)	CC000000-CC023087		
Word Device	Input Relay	X000000-X001FF0	Specify address expression every 0
	Output Relay	Y000000-Y001FF0	Specify address expression every 0
	Internal Relay	M000000-M032752	Specify address expression every 16 multiples
	Latch relay	L000000-L032752	
	Annunciator	F000000-F032752	
	Edge relay	V000000-V032752	
	Link Relay	B000000-B007FF0	Specify address expression every 0
	Special relay	SM000000-SM002032	
	Link special relay	SB000000-SB0007F0	
	Step relay	S000000-S008176	
	Timer(current)	TN000000-TN023087	
	Retentive timer(Current value)	SN000000-SN023087	
	Counter(current)	CN000000-CN023087	
	Data Register	D000000-D025983	
	Link Register	W000000-W00657F	
	Link special register	SW000000-SW0007FF	
	File Register(for block number)	R000000-R032767	
File register(for sequential number)	ZR000000-ZR1042431		
Special register	SD000000-SD002047		

### Communication Parameters Settings

The example of communication settings of GT and PLC is shown below.  
Setting Values for GT (Set in the configuration setting of GTWIN.)

Item	Setting
PLC Unit No.	0
Baud Rate	19200bps
Data Length	8
Stop Bits	1
Parity	Odd

The communication condition setting at the PLC side is not required.  
Uncheck the box of "Use Serial Communication".

### 1.6.1 MELSEC-Q (CPU) Series

CPU	Link I/F	Wiring diagram	GT Series																																		
Q02CPU Q02HCPU Q06HCPU Q12HCPU Q25HCPU	RS232C port on CPU unit	<p>Mitsubishi Electric PLC side Mini-Din 6-pin</p> <table border="1"> <thead> <tr> <th>Pin No.</th> <th>Signal name</th> </tr> </thead> <tbody> <tr><td>1</td><td>RD</td></tr> <tr><td>2</td><td>SD</td></tr> <tr><td>3</td><td>SG</td></tr> <tr><td>4</td><td>-</td></tr> <tr><td>5</td><td>DR</td></tr> <tr><td>6</td><td>ER</td></tr> </tbody> </table> <p>To power supply</p> <table border="1"> <thead> <tr> <th>Pin No.</th> <th>Signal name</th> </tr> </thead> <tbody> <tr><td>1</td><td>+</td></tr> <tr><td>2</td><td>-</td></tr> <tr><td>3</td><td>FG</td></tr> <tr><td>4</td><td>SD</td></tr> <tr><td>5</td><td>RD</td></tr> <tr><td>6</td><td>RS</td></tr> <tr><td>7</td><td>CS</td></tr> <tr><td>8</td><td>SG</td></tr> </tbody> </table>	Pin No.	Signal name	1	RD	2	SD	3	SG	4	-	5	DR	6	ER	Pin No.	Signal name	1	+	2	-	3	FG	4	SD	5	RD	6	RS	7	CS	8	SG	GT series RS232C type*1		
Pin No.	Signal name																																				
1	RD																																				
2	SD																																				
3	SG																																				
4	-																																				
5	DR																																				
6	ER																																				
Pin No.	Signal name																																				
1	+																																				
2	-																																				
3	FG																																				
4	SD																																				
5	RD																																				
6	RS																																				
7	CS																																				
8	SG																																				
		<p>Mitsubishi Electric PLC side Mini-Din 6-pin</p> <table border="1"> <thead> <tr> <th>Pin No.</th> <th>Signal name</th> </tr> </thead> <tbody> <tr><td>1</td><td>RD</td></tr> <tr><td>2</td><td>SD</td></tr> <tr><td>3</td><td>SG</td></tr> <tr><td>4</td><td>-</td></tr> <tr><td>5</td><td>DR</td></tr> <tr><td>6</td><td>ER</td></tr> </tbody> </table> <table border="1"> <thead> <tr> <th>Pin No.</th> <th>Signal name</th> </tr> </thead> <tbody> <tr><td>1</td><td>N.C.</td></tr> <tr><td>2</td><td>RD</td></tr> <tr><td>3</td><td>SD</td></tr> <tr><td>4</td><td>N.C.</td></tr> <tr><td>5</td><td>SG</td></tr> <tr><td>6</td><td>N.C.</td></tr> <tr><td>7</td><td>RS</td></tr> <tr><td>8</td><td>CS</td></tr> <tr><td>9</td><td>N.C.</td></tr> </tbody> </table>	Pin No.	Signal name	1	RD	2	SD	3	SG	4	-	5	DR	6	ER	Pin No.	Signal name	1	N.C.	2	RD	3	SD	4	N.C.	5	SG	6	N.C.	7	RS	8	CS	9	N.C.	GT707
Pin No.	Signal name																																				
1	RD																																				
2	SD																																				
3	SG																																				
4	-																																				
5	DR																																				
6	ER																																				
Pin No.	Signal name																																				
1	N.C.																																				
2	RD																																				
3	SD																																				
4	N.C.																																				
5	SG																																				
6	N.C.																																				
7	RS																																				
8	CS																																				
9	N.C.																																				

\*1: This is for RS232C type of GT01/GT02/GT02L/GT03-E/GT05/GT11/GT12/GT21/GT32/  
GT32-E/GT703/GT704.

## 1.7 MELSEC-A (Computer Link) Series

GT703/GT704/GT707 cannot be used.

### PLC model selection

Select "Mitsubishi MELSEC-A (Computer Link) Series".

### Usable devices

Bit/Word Device		No.	Memo
Bit Device	Input Relay	X0000-X07FF	
	Output Relay	Y0000-Y07FF	
	Internal Relay	M0000-M2047	
	Link Relay	B0000-B03FF	
	Timer(contact)	TS0000-TS0255	
	Counter(contact)	CS0000-CS0255	
Word Device	Input Relay	X0000-X07F0	Specify address expression every 0
	Output Relay	Y0000-Y07F0	Specify address expression every 0
	Internal Relay	M0000-M2032	Specify address expression every 16 multiples
	Link Relay	B0000-B03F0	Specify address expression every 0
	Timer(current)	TN0000-TN0255	
	Counter(current)	CN0000-CN0255	
	Data Register	D0000-D1023	
	Link Register	W0000-W03FF	
	File Register	R0000-R8191	



### Note:

- The maximum value that can be specified on GT is mentioned.
- The usable range of addresses varies depending on PLC models. For the details, refer to the manual for the PLC in use.

### Communication Parameters Settings

The example of communication settings of GT and PLC is shown below.

Setting Values for GT (Set in the configuration setting of GTWIN.)

Item	Setting
PLC Unit No.	0
Baud Rate	19200bps
Data Length	7
Stop Bits	1
Parity	Even

Setting Values for PLC (Computer Link)

Item	Setting
Station Number	0
Baud Rate	19200bps
Data Length	7
Stop Bits	1
Parity	Even
Sum Check	Yes
Interface	RS232C
Mode Setup	4

## 1.7.1 MELSEC-A (Computer Link) Series

CPU	Computer Link module	Wiring diagram	GT Series																																						
A1N A2N A3N	AJ71C24 AJ71C24-S3 AJ71C24-S6 AJ71C24-S8 AJ71UC24 (Only A2N)	<p>Mitsubishi Electric Computer Link side</p> <table border="1"> <thead> <tr> <th>Pin No.</th> <th>Signal name</th> </tr> </thead> <tbody> <tr><td>1</td><td>FG</td></tr> <tr><td>2</td><td>SD</td></tr> <tr><td>3</td><td>RD</td></tr> <tr><td>4</td><td>RS</td></tr> <tr><td>5</td><td>CS</td></tr> <tr><td>6</td><td>DR</td></tr> <tr><td>7</td><td>SG</td></tr> <tr><td>8</td><td>CD</td></tr> <tr><td>20</td><td>ER</td></tr> </tbody> </table> <p>To power supply</p> <p>GT side</p> <table border="1"> <thead> <tr> <th>Pin No.</th> <th>Signal name</th> </tr> </thead> <tbody> <tr><td>1</td><td>+</td></tr> <tr><td>2</td><td>-</td></tr> <tr><td>3</td><td>FG</td></tr> <tr><td>4</td><td>SD</td></tr> <tr><td>5</td><td>RD</td></tr> <tr><td>6</td><td>NC</td></tr> <tr><td>7</td><td>NC</td></tr> <tr><td>8</td><td>SG</td></tr> </tbody> </table>	Pin No.	Signal name	1	FG	2	SD	3	RD	4	RS	5	CS	6	DR	7	SG	8	CD	20	ER	Pin No.	Signal name	1	+	2	-	3	FG	4	SD	5	RD	6	NC	7	NC	8	SG	GT series RS232C type*1
Pin No.	Signal name																																								
1	FG																																								
2	SD																																								
3	RD																																								
4	RS																																								
5	CS																																								
6	DR																																								
7	SG																																								
8	CD																																								
20	ER																																								
Pin No.	Signal name																																								
1	+																																								
2	-																																								
3	FG																																								
4	SD																																								
5	RD																																								
6	NC																																								
7	NC																																								
8	SG																																								
A1S	A1SJ71C24-R2 A1SJ71UC24-R2	<p>Mitsubishi Electric Computer Link side</p> <table border="1"> <thead> <tr> <th>Pin No.</th> <th>Signal name</th> </tr> </thead> <tbody> <tr><td>1</td><td>CD</td></tr> <tr><td>2</td><td>RD</td></tr> <tr><td>3</td><td>SD</td></tr> <tr><td>4</td><td>ER</td></tr> <tr><td>5</td><td>SG</td></tr> <tr><td>6</td><td>DR</td></tr> <tr><td>7</td><td>RS</td></tr> <tr><td>8</td><td>CS</td></tr> <tr><td>9</td><td>-</td></tr> </tbody> </table> <p>To power supply</p> <p>GT side</p> <table border="1"> <thead> <tr> <th>Pin No.</th> <th>Signal name</th> </tr> </thead> <tbody> <tr><td>1</td><td>+</td></tr> <tr><td>2</td><td>-</td></tr> <tr><td>3</td><td>FG</td></tr> <tr><td>4</td><td>SD</td></tr> <tr><td>5</td><td>RD</td></tr> <tr><td>6</td><td>NC</td></tr> <tr><td>7</td><td>NC</td></tr> <tr><td>8</td><td>SG</td></tr> </tbody> </table>	Pin No.	Signal name	1	CD	2	RD	3	SD	4	ER	5	SG	6	DR	7	RS	8	CS	9	-	Pin No.	Signal name	1	+	2	-	3	FG	4	SD	5	RD	6	NC	7	NC	8	SG	
Pin No.	Signal name																																								
1	CD																																								
2	RD																																								
3	SD																																								
4	ER																																								
5	SG																																								
6	DR																																								
7	RS																																								
8	CS																																								
9	-																																								
Pin No.	Signal name																																								
1	+																																								
2	-																																								
3	FG																																								
4	SD																																								
5	RD																																								
6	NC																																								
7	NC																																								
8	SG																																								
A1SJ A2SH A1SH	A1SJ71UC24-R2																																								
A2CCPU24	RS232C port on CPU unit																																								

\*1: Although nos.6 and 7 of the models except GT01 are RS/CS, they can be used in the above connection.



# Chapter 2

---

## Connection With Omron PLCs

## 2.1 Omron SYSMAC-C Series (C/α/CV/CP1)

### PLC model selection

Select "Omron SYSMAC-C series."

### Usable devices

	Bit/Word Device	No.
Bit Device	I/O Relay Internal Hold Relay Special Auxiliary Relay	000000-614315
	Data link Relay	LR00000-LR19915
	Auxiliary Memory Relay	AR00000-AR95915
	Hold Relay	HR00000-HR51115
	Timer(contact)	TIM0000-TIM4095
	Counter(contact)	CNT0000-CNT4095
Word Device	I/O Relay Internal Hold Relay Special Auxiliary Relay	0000-6143
	Data link Relay	LR000-LR199
	Auxiliary Memory Relay	AR000-AR959
	Hold Relay	HR000-HR511
	Timer(current)	TIM0000-TIM4095
	Counter(current)	CNT0000-CNT4095
	Data Memory	DM0000-DM9999

\*For details, please consult the manual for the PLC you will use.



#### Note:

- The maximum value that can be set with the GT is described.
- The range of usable addresses differs depending on the model. For details, please consult the manual for the PLC you will use.
- It is used with CS1 or CJ1, but the timer (TIM) and counter (CNT) cannot be used.  
Set the PLC model to "Omron SYSMAC-CS/SJ Series" for using it.



### Communication Parameters Settings

The example of communication settings of GT and PLC is shown below.

#### Setting Values for GT (Set in the configuration setting of GTWIN.)

Item	Setting
Baud Rate	19200bps
Data Bits	7
Stop Bits	1
Parity	Even

#### Setting Values for PLC

Item	Setting
Mode of PLC	Monitor Mode
Mode Selection	Higher Order Link
Baud Rate	19200bps
Data Bits	7
Stop Bits	1
Parity	Even
Station Number	0
CTS Setup	Normally ON
DC +5V power supply	No
Type of Communication	RS232C*

\*Models that allow RS232C or RS485 communication with the adapter or unit are available.

For almost all models the PLC communication setting method is as follows. However, differences may arise depending on the model. For details, please consult the manual for the PLC you will use when making the settings.

**To communicate using the RS232C port of the CPU unit**

Set the system area as follows.

Address	Value set	Setting
DM6600	0201 (HEX)	Setting of PLC main unit mode (monitor mode)
DM6645	0001 (HEX)	Mode setting of RS232C port (high link)
DM6646	0004 (HEX)	Setting of communication conditions (19200 bps, 7 bits, even, 1 bit)
DM6648	0000 (HEX)	Setting of device number (Device No. 0)

**To communicate using the communication port**

Set the system area as follows.

**To communicate with port A**

Address	Value set	Setting
DM6600	0201 (HEX)	Setting of PLC main unit mode (monitor mode)
DM6550	0001 (HEX)	Mode setting of RS232C port (high link)
DM6551	0004 (HEX)	Setting of communication conditions (19200 bps, 7 bits, even, 1 bit)

**To communicate with port B**

Address	Value set	Setting
DM6600	0201 (HEX)	Setting of PLC main unit mode (monitor mode)
DM6555	0001 (HEX)	Mode setting of RS232C port (high link)
DM6556	0004 (HEX)	Setting of communication conditions (19200 bps, 7 bits, even, 1 bit)

**To communicate using the high link I/F unit**

Make sure set the CPU mode to monitor mode.

Use the DIP switch or rotary switch on the link I/F unit to make settings such as the baud rate.

For details please refer to the manual for the unit you are using.

**To communicate using the peripheral port**

Set the system area as follows.

Address	Value set	Setting
DM6600	0201 (HEX)	Setting of PLC main unit mode (monitor mode)
DM6550	0001 (HEX)	Mode setting of RS232C port (high link)
DM6551	0004 (HEX)	Setting of communication conditions (19200 bps, 7 bits, even, 1 bit)

## 2.1.1 SYSMAC C series (using link interface) (RS232C)

CPU	Link I/F	Wiring diagram	GT series																																								
C200H	C200H-LK201 *1 C120-LK201-V1 *2	<p>Omron PLC side D-sub 25-pin</p> <table border="1"> <thead> <tr> <th>Pin No.</th> <th>Signal name</th> </tr> </thead> <tbody> <tr><td>1</td><td>FG</td></tr> <tr><td>2</td><td>SD</td></tr> <tr><td>3</td><td>RD</td></tr> <tr><td>4</td><td>RS</td></tr> <tr><td>5</td><td>CS</td></tr> <tr><td>6</td><td>-</td></tr> <tr><td>7</td><td>SG</td></tr> <tr><td>:</td><td></td></tr> <tr><td>20</td><td>ER</td></tr> </tbody> </table> <p>To power supply</p> <table border="1"> <thead> <tr> <th>Pin No.</th> <th>Signal name</th> </tr> </thead> <tbody> <tr><td>1</td><td>+</td></tr> <tr><td>2</td><td>-</td></tr> <tr><td>3</td><td>NC(or FG)</td></tr> <tr><td>4</td><td>SD</td></tr> <tr><td>5</td><td>RD</td></tr> <tr><td>6</td><td>NC</td></tr> <tr><td>7</td><td>NC</td></tr> <tr><td>8</td><td>SG</td></tr> </tbody> </table>	Pin No.	Signal name	1	FG	2	SD	3	RD	4	RS	5	CS	6	-	7	SG	:		20	ER	Pin No.	Signal name	1	+	2	-	3	NC(or FG)	4	SD	5	RD	6	NC	7	NC	8	SG	GT series RS232C type*5 *6		
		Pin No.	Signal name																																								
1	FG																																										
2	SD																																										
3	RD																																										
4	RS																																										
5	CS																																										
6	-																																										
7	SG																																										
:																																											
20	ER																																										
Pin No.	Signal name																																										
1	+																																										
2	-																																										
3	NC(or FG)																																										
4	SD																																										
5	RD																																										
6	NC																																										
7	NC																																										
8	SG																																										
		<p>Omron PLC side D-sub 25-pin</p> <table border="1"> <thead> <tr> <th>Pin No.</th> <th>Signal name</th> </tr> </thead> <tbody> <tr><td>1</td><td>FG</td></tr> <tr><td>2</td><td>SD</td></tr> <tr><td>3</td><td>RD</td></tr> <tr><td>4</td><td>RS</td></tr> <tr><td>5</td><td>CS</td></tr> <tr><td>6</td><td>-</td></tr> <tr><td>7</td><td>SG</td></tr> <tr><td>:</td><td></td></tr> <tr><td>20</td><td>ER</td></tr> </tbody> </table> <table border="1"> <thead> <tr> <th>Pin No.</th> <th>Signal name</th> </tr> </thead> <tbody> <tr><td>1</td><td>N C</td></tr> <tr><td>2</td><td>RD</td></tr> <tr><td>3</td><td>SD</td></tr> <tr><td>4</td><td>N C</td></tr> <tr><td>5</td><td>SG</td></tr> <tr><td>6</td><td>N C</td></tr> <tr><td>7</td><td>RS</td></tr> <tr><td>8</td><td>CS</td></tr> <tr><td>9</td><td>N C</td></tr> </tbody> </table>	Pin No.	Signal name	1	FG	2	SD	3	RD	4	RS	5	CS	6	-	7	SG	:		20	ER	Pin No.	Signal name	1	N C	2	RD	3	SD	4	N C	5	SG	6	N C	7	RS	8	CS	9	N C	GT707
Pin No.	Signal name																																										
1	FG																																										
2	SD																																										
3	RD																																										
4	RS																																										
5	CS																																										
6	-																																										
7	SG																																										
:																																											
20	ER																																										
Pin No.	Signal name																																										
1	N C																																										
2	RD																																										
3	SD																																										
4	N C																																										
5	SG																																										
6	N C																																										
7	RS																																										
8	CS																																										
9	N C																																										
C200HS	C200H-LK201 *1 C120-LK201-V1 *2	<p>Omron PLC side D-sub 25-pin</p> <table border="1"> <thead> <tr> <th>Pin No.</th> <th>Signal name</th> </tr> </thead> <tbody> <tr><td>1</td><td>FG</td></tr> <tr><td>2</td><td>SD</td></tr> <tr><td>3</td><td>RD</td></tr> <tr><td>4</td><td>RS</td></tr> <tr><td>5</td><td>CS</td></tr> <tr><td>6</td><td>-</td></tr> <tr><td>7</td><td>SG</td></tr> <tr><td>:</td><td></td></tr> <tr><td>20</td><td>ER</td></tr> </tbody> </table> <p>To power supply</p> <table border="1"> <thead> <tr> <th>Pin No.</th> <th>Signal name</th> </tr> </thead> <tbody> <tr><td>1</td><td>+</td></tr> <tr><td>2</td><td>-</td></tr> <tr><td>3</td><td>NC(or FG)</td></tr> <tr><td>4</td><td>SD</td></tr> <tr><td>5</td><td>RD</td></tr> <tr><td>6</td><td>NC</td></tr> <tr><td>7</td><td>NC</td></tr> <tr><td>8</td><td>SG</td></tr> </tbody> </table>	Pin No.	Signal name	1	FG	2	SD	3	RD	4	RS	5	CS	6	-	7	SG	:		20	ER	Pin No.	Signal name	1	+	2	-	3	NC(or FG)	4	SD	5	RD	6	NC	7	NC	8	SG	GT series RS232C type*5 *6		
		Pin No.	Signal name																																								
	1	FG																																									
	2	SD																																									
3	RD																																										
4	RS																																										
5	CS																																										
6	-																																										
7	SG																																										
:																																											
20	ER																																										
Pin No.	Signal name																																										
1	+																																										
2	-																																										
3	NC(or FG)																																										
4	SD																																										
5	RD																																										
6	NC																																										
7	NC																																										
8	SG																																										
		<p>Omron PLC side D-sub 25-pin</p> <table border="1"> <thead> <tr> <th>Pin No.</th> <th>Signal name</th> </tr> </thead> <tbody> <tr><td>1</td><td>FG</td></tr> <tr><td>2</td><td>SD</td></tr> <tr><td>3</td><td>RD</td></tr> <tr><td>4</td><td>RS</td></tr> <tr><td>5</td><td>CS</td></tr> <tr><td>6</td><td>-</td></tr> <tr><td>7</td><td>SG</td></tr> <tr><td>:</td><td></td></tr> <tr><td>20</td><td>ER</td></tr> </tbody> </table> <table border="1"> <thead> <tr> <th>Pin No.</th> <th>Signal name</th> </tr> </thead> <tbody> <tr><td>1</td><td>N C</td></tr> <tr><td>2</td><td>RD</td></tr> <tr><td>3</td><td>SD</td></tr> <tr><td>4</td><td>N C</td></tr> <tr><td>5</td><td>SG</td></tr> <tr><td>6</td><td>N C</td></tr> <tr><td>7</td><td>RS</td></tr> <tr><td>8</td><td>CS</td></tr> <tr><td>9</td><td>N C</td></tr> </tbody> </table>	Pin No.	Signal name	1	FG	2	SD	3	RD	4	RS	5	CS	6	-	7	SG	:		20	ER	Pin No.	Signal name	1	N C	2	RD	3	SD	4	N C	5	SG	6	N C	7	RS	8	CS	9	N C	GT707
Pin No.	Signal name																																										
1	FG																																										
2	SD																																										
3	RD																																										
4	RS																																										
5	CS																																										
6	-																																										
7	SG																																										
:																																											
20	ER																																										
Pin No.	Signal name																																										
1	N C																																										
2	RD																																										
3	SD																																										
4	N C																																										
5	SG																																										
6	N C																																										
7	RS																																										
8	CS																																										
9	N C																																										
	Link interface on the CPU unit *3	<p>Omron PLC side D-sub 9-pin</p> <table border="1"> <thead> <tr> <th>Pin No.</th> <th>Signal name</th> </tr> </thead> <tbody> <tr><td>1</td><td>FG</td></tr> <tr><td>2</td><td>SD</td></tr> <tr><td>3</td><td>RD</td></tr> <tr><td>4</td><td>RS</td></tr> <tr><td>5</td><td>CS</td></tr> <tr><td>6</td><td>-</td></tr> <tr><td>7</td><td>-</td></tr> <tr><td>8</td><td>-</td></tr> <tr><td>9</td><td>SG</td></tr> </tbody> </table> <p>To power supply</p> <table border="1"> <thead> <tr> <th>Pin No.</th> <th>Signal Name</th> </tr> </thead> <tbody> <tr><td>1</td><td>+</td></tr> <tr><td>2</td><td>-</td></tr> <tr><td>3</td><td>NC(or FG)</td></tr> <tr><td>4</td><td>SD</td></tr> <tr><td>5</td><td>RD</td></tr> <tr><td>6</td><td>NC</td></tr> <tr><td>7</td><td>NC</td></tr> <tr><td>8</td><td>SG</td></tr> </tbody> </table>	Pin No.	Signal name	1	FG	2	SD	3	RD	4	RS	5	CS	6	-	7	-	8	-	9	SG	Pin No.	Signal Name	1	+	2	-	3	NC(or FG)	4	SD	5	RD	6	NC	7	NC	8	SG	GT series RS232C type*5 *6		
Pin No.		Signal name																																									
1	FG																																										
2	SD																																										
3	RD																																										
4	RS																																										
5	CS																																										
6	-																																										
7	-																																										
8	-																																										
9	SG																																										
Pin No.	Signal Name																																										
1	+																																										
2	-																																										
3	NC(or FG)																																										
4	SD																																										
5	RD																																										
6	NC																																										
7	NC																																										
8	SG																																										
		<p>Omron PLC side D-sub 9-pin</p> <table border="1"> <thead> <tr> <th>Pin No.</th> <th>Signal name</th> </tr> </thead> <tbody> <tr><td>1</td><td>FG</td></tr> <tr><td>2</td><td>SD</td></tr> <tr><td>3</td><td>RD</td></tr> <tr><td>4</td><td>RS</td></tr> <tr><td>5</td><td>CS</td></tr> <tr><td>6</td><td>-</td></tr> <tr><td>7</td><td>-</td></tr> <tr><td>8</td><td>-</td></tr> <tr><td>9</td><td>SG</td></tr> </tbody> </table> <table border="1"> <thead> <tr> <th>Pin No.</th> <th>Signal Name</th> </tr> </thead> <tbody> <tr><td>1</td><td>N C</td></tr> <tr><td>2</td><td>RD</td></tr> <tr><td>3</td><td>SD</td></tr> <tr><td>4</td><td>N C</td></tr> <tr><td>5</td><td>SG</td></tr> <tr><td>6</td><td>N C</td></tr> <tr><td>7</td><td>RS</td></tr> <tr><td>8</td><td>CS</td></tr> <tr><td>9</td><td>N C</td></tr> </tbody> </table>	Pin No.	Signal name	1	FG	2	SD	3	RD	4	RS	5	CS	6	-	7	-	8	-	9	SG	Pin No.	Signal Name	1	N C	2	RD	3	SD	4	N C	5	SG	6	N C	7	RS	8	CS	9	N C	GT707
Pin No.	Signal name																																										
1	FG																																										
2	SD																																										
3	RD																																										
4	RS																																										
5	CS																																										
6	-																																										
7	-																																										
8	-																																										
9	SG																																										
Pin No.	Signal Name																																										
1	N C																																										
2	RD																																										
3	SD																																										
4	N C																																										
5	SG																																										
6	N C																																										
7	RS																																										
8	CS																																										
9	N C																																										

CPU	Link I/F	Wiring diagram	GT series																																								
C500 C500F C1000H C2000 C2000H	C120-LK201-V1 *2 C500-LK201-V1 *1 C500-LK203 *1	<p>Omron PLC side D-sub 25-pin</p> <table border="1"> <thead> <tr> <th>Pin No.</th> <th>Signal name</th> </tr> </thead> <tbody> <tr><td>1</td><td>FG</td></tr> <tr><td>2</td><td>SD</td></tr> <tr><td>3</td><td>RD</td></tr> <tr><td>4</td><td>RS</td></tr> <tr><td>5</td><td>CS</td></tr> <tr><td>6</td><td>-</td></tr> <tr><td>7</td><td>SG</td></tr> <tr><td>·</td><td></td></tr> <tr><td>20</td><td>ER</td></tr> </tbody> </table> <p>To power supply</p> <p>GT side</p> <table border="1"> <thead> <tr> <th>Pin No.</th> <th>Signal name</th> </tr> </thead> <tbody> <tr><td>1</td><td>+</td></tr> <tr><td>2</td><td>-</td></tr> <tr><td>3</td><td>NC(or FG)</td></tr> <tr><td>4</td><td>SD</td></tr> <tr><td>5</td><td>RD</td></tr> <tr><td>6</td><td>NC</td></tr> <tr><td>7</td><td>NC</td></tr> <tr><td>8</td><td>SG</td></tr> </tbody> </table>	Pin No.	Signal name	1	FG	2	SD	3	RD	4	RS	5	CS	6	-	7	SG	·		20	ER	Pin No.	Signal name	1	+	2	-	3	NC(or FG)	4	SD	5	RD	6	NC	7	NC	8	SG	GT series RS232C type*5 *6		
Pin No.	Signal name																																										
1	FG																																										
2	SD																																										
3	RD																																										
4	RS																																										
5	CS																																										
6	-																																										
7	SG																																										
·																																											
20	ER																																										
Pin No.	Signal name																																										
1	+																																										
2	-																																										
3	NC(or FG)																																										
4	SD																																										
5	RD																																										
6	NC																																										
7	NC																																										
8	SG																																										
C1000HF	C500-LK203 *1	<p>Omron PLC side D-sub 25-pin</p> <table border="1"> <thead> <tr> <th>Pin No.</th> <th>Signal name</th> </tr> </thead> <tbody> <tr><td>1</td><td>FG</td></tr> <tr><td>2</td><td>SD</td></tr> <tr><td>3</td><td>RD</td></tr> <tr><td>4</td><td>RS</td></tr> <tr><td>5</td><td>CS</td></tr> <tr><td>6</td><td>-</td></tr> <tr><td>7</td><td>SG</td></tr> <tr><td>·</td><td></td></tr> <tr><td>20</td><td>ER</td></tr> </tbody> </table> <p>GT side</p> <table border="1"> <thead> <tr> <th>Pin No.</th> <th>Signal name</th> </tr> </thead> <tbody> <tr><td>1</td><td>N.C.</td></tr> <tr><td>2</td><td>RD</td></tr> <tr><td>3</td><td>SD</td></tr> <tr><td>4</td><td>N.C.</td></tr> <tr><td>5</td><td>SG</td></tr> <tr><td>6</td><td>N.C.</td></tr> <tr><td>7</td><td>RS</td></tr> <tr><td>8</td><td>CS</td></tr> <tr><td>9</td><td>N.C.</td></tr> </tbody> </table>	Pin No.	Signal name	1	FG	2	SD	3	RD	4	RS	5	CS	6	-	7	SG	·		20	ER	Pin No.	Signal name	1	N.C.	2	RD	3	SD	4	N.C.	5	SG	6	N.C.	7	RS	8	CS	9	N.C.	GT707
Pin No.	Signal name																																										
1	FG																																										
2	SD																																										
3	RD																																										
4	RS																																										
5	CS																																										
6	-																																										
7	SG																																										
·																																											
20	ER																																										
Pin No.	Signal name																																										
1	N.C.																																										
2	RD																																										
3	SD																																										
4	N.C.																																										
5	SG																																										
6	N.C.																																										
7	RS																																										
8	CS																																										
9	N.C.																																										
C20H C28H C40H	Link interface on the CPU unit *3	<p>Omron PLC side D-sub 9-pin</p> <table border="1"> <thead> <tr> <th>Pin No.</th> <th>Signal name</th> </tr> </thead> <tbody> <tr><td>1</td><td>FG</td></tr> <tr><td>2</td><td>SD</td></tr> <tr><td>3</td><td>RD</td></tr> <tr><td>4</td><td>RS</td></tr> <tr><td>5</td><td>CS</td></tr> <tr><td>6</td><td>-</td></tr> <tr><td>7</td><td>SG</td></tr> <tr><td>8</td><td>-</td></tr> <tr><td>9</td><td>-</td></tr> </tbody> </table> <p>To power supply</p> <p>GT side</p> <table border="1"> <thead> <tr> <th>Pin No.</th> <th>Signal name</th> </tr> </thead> <tbody> <tr><td>1</td><td>+</td></tr> <tr><td>2</td><td>-</td></tr> <tr><td>3</td><td>NC(or FG)</td></tr> <tr><td>4</td><td>SD</td></tr> <tr><td>5</td><td>RD</td></tr> <tr><td>6</td><td>NC</td></tr> <tr><td>7</td><td>NC</td></tr> <tr><td>8</td><td>SG</td></tr> </tbody> </table>	Pin No.	Signal name	1	FG	2	SD	3	RD	4	RS	5	CS	6	-	7	SG	8	-	9	-	Pin No.	Signal name	1	+	2	-	3	NC(or FG)	4	SD	5	RD	6	NC	7	NC	8	SG	GT series RS232C type*5 *6		
Pin No.	Signal name																																										
1	FG																																										
2	SD																																										
3	RD																																										
4	RS																																										
5	CS																																										
6	-																																										
7	SG																																										
8	-																																										
9	-																																										
Pin No.	Signal name																																										
1	+																																										
2	-																																										
3	NC(or FG)																																										
4	SD																																										
5	RD																																										
6	NC																																										
7	NC																																										
8	SG																																										
C120 C120F	C120-LK201-V1 *2	<p>Omron PLC side D-sub 25-pin</p> <table border="1"> <thead> <tr> <th>Pin No.</th> <th>Signal name</th> </tr> </thead> <tbody> <tr><td>1</td><td>FG</td></tr> <tr><td>2</td><td>SD</td></tr> <tr><td>3</td><td>RD</td></tr> <tr><td>4</td><td>RS</td></tr> <tr><td>5</td><td>CS</td></tr> <tr><td>6</td><td>-</td></tr> <tr><td>7</td><td>SG</td></tr> <tr><td>·</td><td></td></tr> <tr><td>20</td><td>ER</td></tr> </tbody> </table> <p>To power supply</p> <p>GT side</p> <table border="1"> <thead> <tr> <th>Pin No.</th> <th>Signal name</th> </tr> </thead> <tbody> <tr><td>1</td><td>+</td></tr> <tr><td>2</td><td>-</td></tr> <tr><td>3</td><td>NC(or FG)</td></tr> <tr><td>4</td><td>SD</td></tr> <tr><td>5</td><td>RD</td></tr> <tr><td>6</td><td>NC</td></tr> <tr><td>7</td><td>NC</td></tr> <tr><td>8</td><td>SG</td></tr> </tbody> </table>	Pin No.	Signal name	1	FG	2	SD	3	RD	4	RS	5	CS	6	-	7	SG	·		20	ER	Pin No.	Signal name	1	+	2	-	3	NC(or FG)	4	SD	5	RD	6	NC	7	NC	8	SG	GT series RS232C type*5 *6		
Pin No.	Signal name																																										
1	FG																																										
2	SD																																										
3	RD																																										
4	RS																																										
5	CS																																										
6	-																																										
7	SG																																										
·																																											
20	ER																																										
Pin No.	Signal name																																										
1	+																																										
2	-																																										
3	NC(or FG)																																										
4	SD																																										
5	RD																																										
6	NC																																										
7	NC																																										
8	SG																																										
		<p>Omron PLC side D-sub 25-pin</p> <table border="1"> <thead> <tr> <th>Pin No.</th> <th>Signal name</th> </tr> </thead> <tbody> <tr><td>1</td><td>FG</td></tr> <tr><td>2</td><td>SD</td></tr> <tr><td>3</td><td>RD</td></tr> <tr><td>4</td><td>RS</td></tr> <tr><td>5</td><td>CS</td></tr> <tr><td>6</td><td>-</td></tr> <tr><td>7</td><td>SG</td></tr> <tr><td>·</td><td></td></tr> <tr><td>20</td><td>ER</td></tr> </tbody> </table> <p>GT side</p> <table border="1"> <thead> <tr> <th>Pin No.</th> <th>Signal name</th> </tr> </thead> <tbody> <tr><td>1</td><td>N.C.</td></tr> <tr><td>2</td><td>RD</td></tr> <tr><td>3</td><td>SD</td></tr> <tr><td>4</td><td>N.C.</td></tr> <tr><td>5</td><td>SG</td></tr> <tr><td>6</td><td>N.C.</td></tr> <tr><td>7</td><td>RS</td></tr> <tr><td>8</td><td>CS</td></tr> <tr><td>9</td><td>N.C.</td></tr> </tbody> </table>	Pin No.	Signal name	1	FG	2	SD	3	RD	4	RS	5	CS	6	-	7	SG	·		20	ER	Pin No.	Signal name	1	N.C.	2	RD	3	SD	4	N.C.	5	SG	6	N.C.	7	RS	8	CS	9	N.C.	GT707
Pin No.	Signal name																																										
1	FG																																										
2	SD																																										
3	RD																																										
4	RS																																										
5	CS																																										
6	-																																										
7	SG																																										
·																																											
20	ER																																										
Pin No.	Signal name																																										
1	N.C.																																										
2	RD																																										
3	SD																																										
4	N.C.																																										
5	SG																																										
6	N.C.																																										
7	RS																																										
8	CS																																										
9	N.C.																																										

CPU	Link I/F	Wiring diagram	GT series
CQM1-CPU42	RS232C port on CPU unit		GT series RS232C type*5 *6
SRM1-C02 CPM2A	CPM1-CIF01 RS232C port on CPU unit		
CPM1-20CDR-A	CPM1-CIF01		
CQM1H-CPU21	RS232C port on CPU unit		GT707
CPM2C *4	CPM2C-CIF01-V1 CPM2C-CIF11 CPM2C-CIF21		GT series RS232C type*5 *6
CPM2B	RS232C port on CPU unit		

\*1: Base mounting type

\*2: CPU mounting type

\*3: Connecting to the RS232C port

\*4: A connection cable for peripherals is required for the connection to the peripheral port

\*5: Although nos.6 and 7 of the models except GT01 are RS/CS, they can be used in the above connection.

\*6: This is for RS232C type of GT01/GT02/GT02L/GT03-E/GT05/GT11/GT12/GT21/GT32/GT32-E/GT703/GT704.

## 2.1.2 SYSMAC α series (using link interface) (RS232C)

For GT01, GT05, GT11, GT21 and GT32

CPU	Link I/F	Wiring diagram	GT series																																								
C200HE-CPU32-Z C200HE-CPU32 C200HG-CPU33-Z C200HG-CPU33 C200HG-CPU53-Z C200HG-CPU53 C200HX-CPU34-Z C200HX-CPU34 C200HX-CPU54-Z C200HX-CPU54	C200HW-COM02-V1 C200HW-COM04-V1 C200HW-COM05-V1 C200HW-COM06-V1	<p>Omron PLC side D-sub 9-pin</p> <table border="1"> <thead> <tr> <th>Pin No.</th> <th>Signal name</th> </tr> </thead> <tbody> <tr><td>1</td><td>FG</td></tr> <tr><td>2</td><td>SD</td></tr> <tr><td>3</td><td>RD</td></tr> <tr><td>4</td><td>RS</td></tr> <tr><td>5</td><td>CS</td></tr> <tr><td>6</td><td>-</td></tr> <tr><td>7</td><td>-</td></tr> <tr><td>8</td><td>-</td></tr> <tr><td>9</td><td>SG</td></tr> </tbody> </table> <p>To power supply</p> <p>GT side</p> <table border="1"> <thead> <tr> <th>Pin No.</th> <th>Signal Name</th> </tr> </thead> <tbody> <tr><td>1</td><td>+</td></tr> <tr><td>2</td><td>-</td></tr> <tr><td>3</td><td>NC(or FG)</td></tr> <tr><td>4</td><td>SD</td></tr> <tr><td>5</td><td>RD</td></tr> <tr><td>6</td><td>NC</td></tr> <tr><td>7</td><td>NC</td></tr> <tr><td>8</td><td>SG</td></tr> </tbody> </table>	Pin No.	Signal name	1	FG	2	SD	3	RD	4	RS	5	CS	6	-	7	-	8	-	9	SG	Pin No.	Signal Name	1	+	2	-	3	NC(or FG)	4	SD	5	RD	6	NC	7	NC	8	SG	GT series RS232C type*1 *2		
Pin No.	Signal name																																										
1	FG																																										
2	SD																																										
3	RD																																										
4	RS																																										
5	CS																																										
6	-																																										
7	-																																										
8	-																																										
9	SG																																										
Pin No.	Signal Name																																										
1	+																																										
2	-																																										
3	NC(or FG)																																										
4	SD																																										
5	RD																																										
6	NC																																										
7	NC																																										
8	SG																																										
C200HE-CPU42-Z C200HE-CPU42 C200HG-CPU43-Z C200HG-CPU43 C200HG-CPU63-Z C200HG-CPU63 C200HX-CPU44-Z C200HX-CPU44 C200HX-CPU64-Z C200HX-CPU64 C200HX-CPU65-Z C200HX-CPU85-Z	RS232C port on CPU unit	<p>Omron PLC side D-sub 9-pin</p> <table border="1"> <thead> <tr> <th>Pin No.</th> <th>Signal name</th> </tr> </thead> <tbody> <tr><td>1</td><td>FG</td></tr> <tr><td>2</td><td>SD</td></tr> <tr><td>3</td><td>RD</td></tr> <tr><td>4</td><td>RS</td></tr> <tr><td>5</td><td>CS</td></tr> <tr><td>6</td><td>-</td></tr> <tr><td>7</td><td>-</td></tr> <tr><td>8</td><td>-</td></tr> <tr><td>9</td><td>SG</td></tr> </tbody> </table> <p>GT side</p> <table border="1"> <thead> <tr> <th>Pin No.</th> <th>Signal Name</th> </tr> </thead> <tbody> <tr><td>1</td><td>N.C.</td></tr> <tr><td>2</td><td>RD</td></tr> <tr><td>3</td><td>SD</td></tr> <tr><td>4</td><td>N.C.</td></tr> <tr><td>5</td><td>SG</td></tr> <tr><td>6</td><td>N.C.</td></tr> <tr><td>7</td><td>RS</td></tr> <tr><td>8</td><td>CS</td></tr> <tr><td>9</td><td>N.C.</td></tr> </tbody> </table>	Pin No.	Signal name	1	FG	2	SD	3	RD	4	RS	5	CS	6	-	7	-	8	-	9	SG	Pin No.	Signal Name	1	N.C.	2	RD	3	SD	4	N.C.	5	SG	6	N.C.	7	RS	8	CS	9	N.C.	GT707
Pin No.	Signal name																																										
1	FG																																										
2	SD																																										
3	RD																																										
4	RS																																										
5	CS																																										
6	-																																										
7	-																																										
8	-																																										
9	SG																																										
Pin No.	Signal Name																																										
1	N.C.																																										
2	RD																																										
3	SD																																										
4	N.C.																																										
5	SG																																										
6	N.C.																																										
7	RS																																										
8	CS																																										
9	N.C.																																										
C200HX-CPU64-Z	C200-LK201-V1	<p>Omron PLC side D-sub 25-pin</p> <table border="1"> <thead> <tr> <th>Pin No.</th> <th>Signal name</th> </tr> </thead> <tbody> <tr><td>1</td><td>FG</td></tr> <tr><td>2</td><td>SD</td></tr> <tr><td>3</td><td>RD</td></tr> <tr><td>4</td><td>RS</td></tr> <tr><td>5</td><td>CS</td></tr> <tr><td>6</td><td>-</td></tr> <tr><td>7</td><td>SG</td></tr> <tr><td>:</td><td></td></tr> <tr><td>20</td><td>ER</td></tr> </tbody> </table> <p>To power supply</p> <p>GT side</p> <table border="1"> <thead> <tr> <th>Pin No.</th> <th>Signal name</th> </tr> </thead> <tbody> <tr><td>1</td><td>+</td></tr> <tr><td>2</td><td>-</td></tr> <tr><td>3</td><td>NC(or FG)</td></tr> <tr><td>4</td><td>SD</td></tr> <tr><td>5</td><td>RD</td></tr> <tr><td>6</td><td>NC</td></tr> <tr><td>7</td><td>NC</td></tr> <tr><td>8</td><td>SG</td></tr> </tbody> </table>	Pin No.	Signal name	1	FG	2	SD	3	RD	4	RS	5	CS	6	-	7	SG	:		20	ER	Pin No.	Signal name	1	+	2	-	3	NC(or FG)	4	SD	5	RD	6	NC	7	NC	8	SG	GT series RS232C type*1 *2		
Pin No.	Signal name																																										
1	FG																																										
2	SD																																										
3	RD																																										
4	RS																																										
5	CS																																										
6	-																																										
7	SG																																										
:																																											
20	ER																																										
Pin No.	Signal name																																										
1	+																																										
2	-																																										
3	NC(or FG)																																										
4	SD																																										
5	RD																																										
6	NC																																										
7	NC																																										
8	SG																																										
C200HX-CPU64-Z	C200-LK201-V1	<p>Omron PLC side D-sub 25-pin</p> <table border="1"> <thead> <tr> <th>Pin No.</th> <th>Signal name</th> </tr> </thead> <tbody> <tr><td>1</td><td>FG</td></tr> <tr><td>2</td><td>SD</td></tr> <tr><td>3</td><td>RD</td></tr> <tr><td>4</td><td>RS</td></tr> <tr><td>5</td><td>CS</td></tr> <tr><td>6</td><td>-</td></tr> <tr><td>7</td><td>SG</td></tr> <tr><td>:</td><td></td></tr> <tr><td>20</td><td>ER</td></tr> </tbody> </table> <p>GT side</p> <table border="1"> <thead> <tr> <th>Pin No.</th> <th>Signal name</th> </tr> </thead> <tbody> <tr><td>1</td><td>N.C.</td></tr> <tr><td>2</td><td>RD</td></tr> <tr><td>3</td><td>SD</td></tr> <tr><td>4</td><td>N.C.</td></tr> <tr><td>5</td><td>SG</td></tr> <tr><td>6</td><td>N.C.</td></tr> <tr><td>7</td><td>RS</td></tr> <tr><td>8</td><td>CS</td></tr> <tr><td>9</td><td>N.C.</td></tr> </tbody> </table>	Pin No.	Signal name	1	FG	2	SD	3	RD	4	RS	5	CS	6	-	7	SG	:		20	ER	Pin No.	Signal name	1	N.C.	2	RD	3	SD	4	N.C.	5	SG	6	N.C.	7	RS	8	CS	9	N.C.	GT707
Pin No.	Signal name																																										
1	FG																																										
2	SD																																										
3	RD																																										
4	RS																																										
5	CS																																										
6	-																																										
7	SG																																										
:																																											
20	ER																																										
Pin No.	Signal name																																										
1	N.C.																																										
2	RD																																										
3	SD																																										
4	N.C.																																										
5	SG																																										
6	N.C.																																										
7	RS																																										
8	CS																																										
9	N.C.																																										

\*1: Although nos.6 and 7 of the models except GT01 are RS/CS, they can be used in the above connection.

\*2: This is for RS232C type of GT01/GT02/GT02L/GT03-E/GT05/GT11/GT12/GT21/GT32/GT32-E/GT703/GT704.

## 2.1.3 SYSMAC CV series (using link interface) (RS232C)

CPU	Link I/F	Wiring diagram	GT series																																																																																
CV500 CV1000 CVM1	CV500-LK201	<p style="text-align: center;"><b>Communication port 1 connections</b></p> <p>Omron PLC side D-sub 25-pin</p> <table border="1" style="display: inline-table; margin-right: 20px;"> <thead> <tr> <th>Pin No.</th> <th>Signal name</th> </tr> </thead> <tbody> <tr><td>1</td><td>FG</td></tr> <tr><td>2</td><td>SD</td></tr> <tr><td>3</td><td>RD</td></tr> <tr><td>4</td><td>RS</td></tr> <tr><td>5</td><td>CS</td></tr> <tr><td>6</td><td>-</td></tr> <tr><td>7</td><td>SG</td></tr> <tr><td>:</td><td></td></tr> <tr><td>20</td><td>ER</td></tr> </tbody> </table> <p style="text-align: center;">To power supply</p> <p style="text-align: right;">GT side</p> <table border="1" style="display: inline-table;"> <thead> <tr> <th>Pin No.</th> <th>Signal name</th> </tr> </thead> <tbody> <tr><td>1</td><td>+</td></tr> <tr><td>2</td><td>-</td></tr> <tr><td>3</td><td>NC(or FG)</td></tr> <tr><td>4</td><td>SD</td></tr> <tr><td>5</td><td>RD</td></tr> <tr><td>6</td><td>NC</td></tr> <tr><td>7</td><td>NC</td></tr> <tr><td>8</td><td>SG</td></tr> </tbody> </table> <p style="text-align: center;"><b>Communication port 2 connections</b></p> <p>Omron PLC side D-sub 9-pin</p> <table border="1" style="display: inline-table; margin-right: 20px;"> <thead> <tr> <th>Pin No.</th> <th>Signal name</th> </tr> </thead> <tbody> <tr><td>1</td><td>FG</td></tr> <tr><td>2</td><td>SD</td></tr> <tr><td>3</td><td>RD</td></tr> <tr><td>4</td><td>RS</td></tr> <tr><td>5</td><td>CS</td></tr> <tr><td>6</td><td>-</td></tr> <tr><td>7</td><td>-</td></tr> <tr><td>8</td><td>-</td></tr> <tr><td>9</td><td>SG</td></tr> </tbody> </table> <p style="text-align: center;">To power supply</p> <p style="text-align: right;">GT side</p> <table border="1" style="display: inline-table;"> <thead> <tr> <th>Pin No.</th> <th>Signal Name</th> </tr> </thead> <tbody> <tr><td>1</td><td>+</td></tr> <tr><td>2</td><td>-</td></tr> <tr><td>3</td><td>NC(or FG)</td></tr> <tr><td>4</td><td>SD</td></tr> <tr><td>5</td><td>RD</td></tr> <tr><td>6</td><td>NC</td></tr> <tr><td>7</td><td>NC</td></tr> <tr><td>8</td><td>SG</td></tr> </tbody> </table>	Pin No.	Signal name	1	FG	2	SD	3	RD	4	RS	5	CS	6	-	7	SG	:		20	ER	Pin No.	Signal name	1	+	2	-	3	NC(or FG)	4	SD	5	RD	6	NC	7	NC	8	SG	Pin No.	Signal name	1	FG	2	SD	3	RD	4	RS	5	CS	6	-	7	-	8	-	9	SG	Pin No.	Signal Name	1	+	2	-	3	NC(or FG)	4	SD	5	RD	6	NC	7	NC	8	SG	GT series RS232C type*2 *3				
		Pin No.	Signal name																																																																																
1	FG																																																																																		
2	SD																																																																																		
3	RD																																																																																		
4	RS																																																																																		
5	CS																																																																																		
6	-																																																																																		
7	SG																																																																																		
:																																																																																			
20	ER																																																																																		
Pin No.	Signal name																																																																																		
1	+																																																																																		
2	-																																																																																		
3	NC(or FG)																																																																																		
4	SD																																																																																		
5	RD																																																																																		
6	NC																																																																																		
7	NC																																																																																		
8	SG																																																																																		
Pin No.	Signal name																																																																																		
1	FG																																																																																		
2	SD																																																																																		
3	RD																																																																																		
4	RS																																																																																		
5	CS																																																																																		
6	-																																																																																		
7	-																																																																																		
8	-																																																																																		
9	SG																																																																																		
Pin No.	Signal Name																																																																																		
1	+																																																																																		
2	-																																																																																		
3	NC(or FG)																																																																																		
4	SD																																																																																		
5	RD																																																																																		
6	NC																																																																																		
7	NC																																																																																		
8	SG																																																																																		
		<p style="text-align: center;"><b>Communication port 1 connections</b></p> <p>Omron PLC side D-sub 25-pin</p> <table border="1" style="display: inline-table; margin-right: 20px;"> <thead> <tr> <th>Pin No.</th> <th>Signal name</th> </tr> </thead> <tbody> <tr><td>1</td><td>FG</td></tr> <tr><td>2</td><td>SD</td></tr> <tr><td>3</td><td>RD</td></tr> <tr><td>4</td><td>RS</td></tr> <tr><td>5</td><td>CS</td></tr> <tr><td>6</td><td>-</td></tr> <tr><td>7</td><td>SG</td></tr> <tr><td>:</td><td></td></tr> <tr><td>20</td><td>ER</td></tr> </tbody> </table> <p style="text-align: right;">GT side</p> <table border="1" style="display: inline-table;"> <thead> <tr> <th>Pin No.</th> <th>Signal name</th> </tr> </thead> <tbody> <tr><td>1</td><td>N.C.</td></tr> <tr><td>2</td><td>RD</td></tr> <tr><td>3</td><td>SD</td></tr> <tr><td>4</td><td>N.C.</td></tr> <tr><td>5</td><td>SG</td></tr> <tr><td>6</td><td>N.C.</td></tr> <tr><td>7</td><td>RS</td></tr> <tr><td>8</td><td>CS</td></tr> <tr><td>9</td><td>N.C.</td></tr> </tbody> </table> <p style="text-align: center;"><b>Communication port 2 connections</b></p> <p>Omron PLC side D-sub 9-pin</p> <table border="1" style="display: inline-table; margin-right: 20px;"> <thead> <tr> <th>Pin No.</th> <th>Signal name</th> </tr> </thead> <tbody> <tr><td>1</td><td>FG</td></tr> <tr><td>2</td><td>SD</td></tr> <tr><td>3</td><td>RD</td></tr> <tr><td>4</td><td>RS</td></tr> <tr><td>5</td><td>CS</td></tr> <tr><td>6</td><td>-</td></tr> <tr><td>7</td><td>-</td></tr> <tr><td>8</td><td>-</td></tr> <tr><td>9</td><td>SG</td></tr> </tbody> </table> <p style="text-align: right;">GT side</p> <table border="1" style="display: inline-table;"> <thead> <tr> <th>Pin No.</th> <th>Signal Name</th> </tr> </thead> <tbody> <tr><td>1</td><td>N.C.</td></tr> <tr><td>2</td><td>RD</td></tr> <tr><td>3</td><td>SD</td></tr> <tr><td>4</td><td>N.C.</td></tr> <tr><td>5</td><td>SG</td></tr> <tr><td>6</td><td>N.C.</td></tr> <tr><td>7</td><td>RS</td></tr> <tr><td>8</td><td>CS</td></tr> <tr><td>9</td><td>N.C.</td></tr> </tbody> </table>	Pin No.	Signal name	1	FG	2	SD	3	RD	4	RS	5	CS	6	-	7	SG	:		20	ER	Pin No.	Signal name	1	N.C.	2	RD	3	SD	4	N.C.	5	SG	6	N.C.	7	RS	8	CS	9	N.C.	Pin No.	Signal name	1	FG	2	SD	3	RD	4	RS	5	CS	6	-	7	-	8	-	9	SG	Pin No.	Signal Name	1	N.C.	2	RD	3	SD	4	N.C.	5	SG	6	N.C.	7	RS	8	CS	9	N.C.	GT707
Pin No.	Signal name																																																																																		
1	FG																																																																																		
2	SD																																																																																		
3	RD																																																																																		
4	RS																																																																																		
5	CS																																																																																		
6	-																																																																																		
7	SG																																																																																		
:																																																																																			
20	ER																																																																																		
Pin No.	Signal name																																																																																		
1	N.C.																																																																																		
2	RD																																																																																		
3	SD																																																																																		
4	N.C.																																																																																		
5	SG																																																																																		
6	N.C.																																																																																		
7	RS																																																																																		
8	CS																																																																																		
9	N.C.																																																																																		
Pin No.	Signal name																																																																																		
1	FG																																																																																		
2	SD																																																																																		
3	RD																																																																																		
4	RS																																																																																		
5	CS																																																																																		
6	-																																																																																		
7	-																																																																																		
8	-																																																																																		
9	SG																																																																																		
Pin No.	Signal Name																																																																																		
1	N.C.																																																																																		
2	RD																																																																																		
3	SD																																																																																		
4	N.C.																																																																																		
5	SG																																																																																		
6	N.C.																																																																																		
7	RS																																																																																		
8	CS																																																																																		
9	N.C.																																																																																		

CPU	Link I/F	Wiring diagram	GT series																																								
CV500 CV1000 CVM1	Link interface on the CPU unit *1	<p>Omron PLC side D-sub 9-pin</p> <table border="1"> <thead> <tr> <th>Pin No.</th> <th>Signal name</th> </tr> </thead> <tbody> <tr><td>1</td><td>FG</td></tr> <tr><td>2</td><td>SD</td></tr> <tr><td>3</td><td>RD</td></tr> <tr><td>4</td><td>RS</td></tr> <tr><td>5</td><td>CS</td></tr> <tr><td>6</td><td>-</td></tr> <tr><td>7</td><td>-</td></tr> <tr><td>8</td><td>-</td></tr> <tr><td>9</td><td>SG</td></tr> </tbody> </table> <p>To power supply</p> <table border="1"> <thead> <tr> <th>Pin No.</th> <th>Signal Name</th> </tr> </thead> <tbody> <tr><td>1</td><td>+</td></tr> <tr><td>2</td><td>-</td></tr> <tr><td>3</td><td>NC(or FG)</td></tr> <tr><td>4</td><td>SD</td></tr> <tr><td>5</td><td>RD</td></tr> <tr><td>6</td><td>NC</td></tr> <tr><td>7</td><td>NC</td></tr> <tr><td>8</td><td>SG</td></tr> </tbody> </table>	Pin No.	Signal name	1	FG	2	SD	3	RD	4	RS	5	CS	6	-	7	-	8	-	9	SG	Pin No.	Signal Name	1	+	2	-	3	NC(or FG)	4	SD	5	RD	6	NC	7	NC	8	SG	GT series RS232C type*2 *3		
		Pin No.	Signal name																																								
1	FG																																										
2	SD																																										
3	RD																																										
4	RS																																										
5	CS																																										
6	-																																										
7	-																																										
8	-																																										
9	SG																																										
Pin No.	Signal Name																																										
1	+																																										
2	-																																										
3	NC(or FG)																																										
4	SD																																										
5	RD																																										
6	NC																																										
7	NC																																										
8	SG																																										
		<p>Omron PLC side D-sub 9-pin</p> <table border="1"> <thead> <tr> <th>Pin No.</th> <th>Signal name</th> </tr> </thead> <tbody> <tr><td>1</td><td>FG</td></tr> <tr><td>2</td><td>SD</td></tr> <tr><td>3</td><td>RD</td></tr> <tr><td>4</td><td>RS</td></tr> <tr><td>5</td><td>CS</td></tr> <tr><td>6</td><td>-</td></tr> <tr><td>7</td><td>-</td></tr> <tr><td>8</td><td>-</td></tr> <tr><td>9</td><td>SG</td></tr> </tbody> </table> <table border="1"> <thead> <tr> <th>Pin No.</th> <th>Signal Name</th> </tr> </thead> <tbody> <tr><td>1</td><td>N C</td></tr> <tr><td>2</td><td>RD</td></tr> <tr><td>3</td><td>SD</td></tr> <tr><td>4</td><td>N C</td></tr> <tr><td>5</td><td>SG</td></tr> <tr><td>6</td><td>N C</td></tr> <tr><td>7</td><td>RS</td></tr> <tr><td>8</td><td>CS</td></tr> <tr><td>9</td><td>N C</td></tr> </tbody> </table>	Pin No.	Signal name	1	FG	2	SD	3	RD	4	RS	5	CS	6	-	7	-	8	-	9	SG	Pin No.	Signal Name	1	N C	2	RD	3	SD	4	N C	5	SG	6	N C	7	RS	8	CS	9	N C	GT707
Pin No.	Signal name																																										
1	FG																																										
2	SD																																										
3	RD																																										
4	RS																																										
5	CS																																										
6	-																																										
7	-																																										
8	-																																										
9	SG																																										
Pin No.	Signal Name																																										
1	N C																																										
2	RD																																										
3	SD																																										
4	N C																																										
5	SG																																										
6	N C																																										
7	RS																																										
8	CS																																										
9	N C																																										

\*1: Connect to the HOSTLINK port.

\*2: Although nos.6 and 7 of the models except GT01 are RS/CS, they can be used in the above connection.

\*3: This is for RS232C type of GT01/GT02/GT02L/GT03-E/GT05/GT11/GT12/GT21/GT32/GT32-E/GT703/GT704.

## 2.1.4 SYSMAC CP1 series (using link interface) (RS232C)

CPU	Link I/F	Wiring diagram	GT series																																								
CP1H	RS232C option board CP1W-CIF01	<p>Omron PLC side D-sub 9-pin</p> <table border="1"> <thead> <tr> <th>Pin No.</th> <th>Signal name</th> </tr> </thead> <tbody> <tr><td>1</td><td>FG</td></tr> <tr><td>2</td><td>SD</td></tr> <tr><td>3</td><td>RD</td></tr> <tr><td>4</td><td>RS</td></tr> <tr><td>5</td><td>CS</td></tr> <tr><td>6</td><td>-</td></tr> <tr><td>7</td><td>-</td></tr> <tr><td>8</td><td>-</td></tr> <tr><td>9</td><td>SG</td></tr> </tbody> </table> <p>To power supply</p> <table border="1"> <thead> <tr> <th>Pin No.</th> <th>Signal Name</th> </tr> </thead> <tbody> <tr><td>1</td><td>+</td></tr> <tr><td>2</td><td>-</td></tr> <tr><td>3</td><td>NC(or FG)</td></tr> <tr><td>4</td><td>SD</td></tr> <tr><td>5</td><td>RD</td></tr> <tr><td>6</td><td>NC</td></tr> <tr><td>7</td><td>NC</td></tr> <tr><td>8</td><td>SG</td></tr> </tbody> </table>	Pin No.	Signal name	1	FG	2	SD	3	RD	4	RS	5	CS	6	-	7	-	8	-	9	SG	Pin No.	Signal Name	1	+	2	-	3	NC(or FG)	4	SD	5	RD	6	NC	7	NC	8	SG	GT series RS232C type*1 *2		
		Pin No.	Signal name																																								
1	FG																																										
2	SD																																										
3	RD																																										
4	RS																																										
5	CS																																										
6	-																																										
7	-																																										
8	-																																										
9	SG																																										
Pin No.	Signal Name																																										
1	+																																										
2	-																																										
3	NC(or FG)																																										
4	SD																																										
5	RD																																										
6	NC																																										
7	NC																																										
8	SG																																										
		<p>Omron PLC side D-sub 9-pin</p> <table border="1"> <thead> <tr> <th>Pin No.</th> <th>Signal name</th> </tr> </thead> <tbody> <tr><td>1</td><td>FG</td></tr> <tr><td>2</td><td>SD</td></tr> <tr><td>3</td><td>RD</td></tr> <tr><td>4</td><td>RS</td></tr> <tr><td>5</td><td>CS</td></tr> <tr><td>6</td><td>-</td></tr> <tr><td>7</td><td>-</td></tr> <tr><td>8</td><td>-</td></tr> <tr><td>9</td><td>SG</td></tr> </tbody> </table> <table border="1"> <thead> <tr> <th>Pin No.</th> <th>Signal Name</th> </tr> </thead> <tbody> <tr><td>1</td><td>N C</td></tr> <tr><td>2</td><td>RD</td></tr> <tr><td>3</td><td>SD</td></tr> <tr><td>4</td><td>N C</td></tr> <tr><td>5</td><td>SG</td></tr> <tr><td>6</td><td>N C</td></tr> <tr><td>7</td><td>RS</td></tr> <tr><td>8</td><td>CS</td></tr> <tr><td>9</td><td>N C</td></tr> </tbody> </table>	Pin No.	Signal name	1	FG	2	SD	3	RD	4	RS	5	CS	6	-	7	-	8	-	9	SG	Pin No.	Signal Name	1	N C	2	RD	3	SD	4	N C	5	SG	6	N C	7	RS	8	CS	9	N C	GT707
Pin No.	Signal name																																										
1	FG																																										
2	SD																																										
3	RD																																										
4	RS																																										
5	CS																																										
6	-																																										
7	-																																										
8	-																																										
9	SG																																										
Pin No.	Signal Name																																										
1	N C																																										
2	RD																																										
3	SD																																										
4	N C																																										
5	SG																																										
6	N C																																										
7	RS																																										
8	CS																																										
9	N C																																										

\*1: Although nos.6 and 7 of the models except GT01 are RS/CS, they can be used in the above connection.

\*2: This is for RS232C type of GT01/GT02/GT02L/GT03-E/GT05/GT11/GT12/GT21/GT32/GT32-E/GT703/GT704.



## 2.1.5 SYSMAC CP1 series (RS422/RS485)

Connected with Adapter or Unit

CPU	Link I/F	Wiring diagram	GT series																														
CP1H	RS422/485 optional board CP1W/CIF11	<p>Omron PLC adapter side</p> <table border="1"> <thead> <tr> <th>Pin No.</th> <th>Signal name</th> </tr> </thead> <tbody> <tr> <td>1</td> <td>RDA-</td> </tr> <tr> <td>2</td> <td>RDB+</td> </tr> <tr> <td>3</td> <td>SDA-</td> </tr> <tr> <td>4</td> <td>SDB+</td> </tr> <tr> <td>5</td> <td>FG</td> </tr> </tbody> </table> <p>GT side</p> <table border="1"> <thead> <tr> <th>Pin No.</th> <th>Signal name</th> </tr> </thead> <tbody> <tr> <td>1</td> <td>+</td> </tr> <tr> <td>2</td> <td>-</td> </tr> <tr> <td>3</td> <td>NC(or FG)</td> </tr> <tr> <td>4</td> <td>+SD</td> </tr> <tr> <td>5</td> <td>-SD</td> </tr> <tr> <td>6</td> <td>+RD</td> </tr> <tr> <td>7</td> <td>-RD</td> </tr> <tr> <td>8</td> <td>E</td> </tr> </tbody> </table>	Pin No.	Signal name	1	RDA-	2	RDB+	3	SDA-	4	SDB+	5	FG	Pin No.	Signal name	1	+	2	-	3	NC(or FG)	4	+SD	5	-SD	6	+RD	7	-RD	8	E	RS422/RS485 type
Pin No.	Signal name																																
1	RDA-																																
2	RDB+																																
3	SDA-																																
4	SDB+																																
5	FG																																
Pin No.	Signal name																																
1	+																																
2	-																																
3	NC(or FG)																																
4	+SD																																
5	-SD																																
6	+RD																																
7	-RD																																
8	E																																

Refer to the figures below for the settings of the dip switches of RS422/RS485 conversion adapter CJ1W-CIF11.

Adapter or unit	Dip switches
RS422/485 optional board CP-CIF11	

## 2.1.6 SYSMAC CP1 series (Built-in RS232C port type)

CPU	Link I/F	Wiring diagram	GT series																																								
CP1E	N/NA type	<p>Omron PLC side D-sub 9-pin</p> <table border="1"> <thead> <tr> <th>Pin No.</th> <th>Signal name</th> </tr> </thead> <tbody> <tr> <td>1</td> <td>FG</td> </tr> <tr> <td>2</td> <td>SD</td> </tr> <tr> <td>3</td> <td>RD</td> </tr> <tr> <td>4</td> <td>RS</td> </tr> <tr> <td>5</td> <td>CS</td> </tr> <tr> <td>6</td> <td>-</td> </tr> <tr> <td>7</td> <td>-</td> </tr> <tr> <td>8</td> <td>-</td> </tr> <tr> <td>9</td> <td>SG</td> </tr> </tbody> </table> <p>GT side</p> <table border="1"> <thead> <tr> <th>Pin No.</th> <th>Signal Name</th> </tr> </thead> <tbody> <tr> <td>1</td> <td>+</td> </tr> <tr> <td>2</td> <td>-</td> </tr> <tr> <td>3</td> <td>NC(or FG)</td> </tr> <tr> <td>4</td> <td>SD</td> </tr> <tr> <td>5</td> <td>RD</td> </tr> <tr> <td>6</td> <td>NC</td> </tr> <tr> <td>7</td> <td>NC</td> </tr> <tr> <td>8</td> <td>SG</td> </tr> </tbody> </table>	Pin No.	Signal name	1	FG	2	SD	3	RD	4	RS	5	CS	6	-	7	-	8	-	9	SG	Pin No.	Signal Name	1	+	2	-	3	NC(or FG)	4	SD	5	RD	6	NC	7	NC	8	SG	GT series RS232C type*1*2		
		Pin No.	Signal name																																								
1	FG																																										
2	SD																																										
3	RD																																										
4	RS																																										
5	CS																																										
6	-																																										
7	-																																										
8	-																																										
9	SG																																										
Pin No.	Signal Name																																										
1	+																																										
2	-																																										
3	NC(or FG)																																										
4	SD																																										
5	RD																																										
6	NC																																										
7	NC																																										
8	SG																																										
		<p>Omron PLC side D-sub 9-pin</p> <table border="1"> <thead> <tr> <th>Pin No.</th> <th>Signal name</th> </tr> </thead> <tbody> <tr> <td>1</td> <td>FG</td> </tr> <tr> <td>2</td> <td>SD</td> </tr> <tr> <td>3</td> <td>RD</td> </tr> <tr> <td>4</td> <td>RS</td> </tr> <tr> <td>5</td> <td>CS</td> </tr> <tr> <td>6</td> <td>-</td> </tr> <tr> <td>7</td> <td>-</td> </tr> <tr> <td>8</td> <td>-</td> </tr> <tr> <td>9</td> <td>SG</td> </tr> </tbody> </table> <p>GT side</p> <table border="1"> <thead> <tr> <th>Pin No.</th> <th>Signal Name</th> </tr> </thead> <tbody> <tr> <td>1</td> <td>N.C.</td> </tr> <tr> <td>2</td> <td>RD</td> </tr> <tr> <td>3</td> <td>SD</td> </tr> <tr> <td>4</td> <td>N.C.</td> </tr> <tr> <td>5</td> <td>SG</td> </tr> <tr> <td>6</td> <td>N.C.</td> </tr> <tr> <td>7</td> <td>RS</td> </tr> <tr> <td>8</td> <td>CS</td> </tr> <tr> <td>9</td> <td>N.C.</td> </tr> </tbody> </table>	Pin No.	Signal name	1	FG	2	SD	3	RD	4	RS	5	CS	6	-	7	-	8	-	9	SG	Pin No.	Signal Name	1	N.C.	2	RD	3	SD	4	N.C.	5	SG	6	N.C.	7	RS	8	CS	9	N.C.	GT707
Pin No.	Signal name																																										
1	FG																																										
2	SD																																										
3	RD																																										
4	RS																																										
5	CS																																										
6	-																																										
7	-																																										
8	-																																										
9	SG																																										
Pin No.	Signal Name																																										
1	N.C.																																										
2	RD																																										
3	SD																																										
4	N.C.																																										
5	SG																																										
6	N.C.																																										
7	RS																																										
8	CS																																										
9	N.C.																																										

\*1: Although nos.6 and 7 of the models except GT01 are RS/CS, they can be used in the above connection.

\*2: This is for RS232C type of GT01/GT02/GT02L/GT03-E/GT05/GT11/GT12/GT21/GT32/GT32-E/GT703/GT704.

## 2.1.7 When using the peripheral port of CPM2C

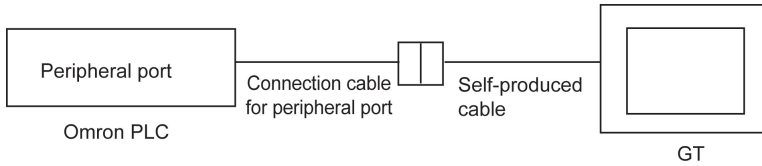

The wiring diagrams vary according to the connection cables for the peripheral port to be used.

Omron PLC	Connection cable for peripheral port made by Omron	Wiring diagram	GT series																																						
CPM2	CS1W-CN118 (D-sub 9-pin) COM2C-CN111	<p>Omron PLC side D-sub 9-pin</p> <table border="1" data-bbox="509 633 701 871"> <thead> <tr> <th>Pin No.</th> <th>Signal name</th> </tr> </thead> <tbody> <tr><td>1</td><td>FG</td></tr> <tr><td>2</td><td>SD</td></tr> <tr><td>3</td><td>RD</td></tr> <tr><td>4</td><td>RS</td></tr> <tr><td>5</td><td>CS</td></tr> <tr><td>6</td><td>-</td></tr> <tr><td>7</td><td>-</td></tr> <tr><td>8</td><td>-</td></tr> <tr><td>9</td><td>SG</td></tr> </tbody> </table> <p>To power supply</p> <table border="1" data-bbox="797 633 989 846"> <thead> <tr> <th>Pin No.</th> <th>Signal Name</th> </tr> </thead> <tbody> <tr><td>1</td><td>+</td></tr> <tr><td>2</td><td>-</td></tr> <tr><td>3</td><td>NC(or FG)</td></tr> <tr><td>4</td><td>SD</td></tr> <tr><td>5</td><td>RD</td></tr> <tr><td>6</td><td>NC</td></tr> <tr><td>7</td><td>NC</td></tr> <tr><td>8</td><td>SG</td></tr> </tbody> </table> <p>GT side</p>	Pin No.	Signal name	1	FG	2	SD	3	RD	4	RS	5	CS	6	-	7	-	8	-	9	SG	Pin No.	Signal Name	1	+	2	-	3	NC(or FG)	4	SD	5	RD	6	NC	7	NC	8	SG	GT series RS232C type*1 *2
		Pin No.	Signal name																																						
	1	FG																																							
	2	SD																																							
3	RD																																								
4	RS																																								
5	CS																																								
6	-																																								
7	-																																								
8	-																																								
9	SG																																								
Pin No.	Signal Name																																								
1	+																																								
2	-																																								
3	NC(or FG)																																								
4	SD																																								
5	RD																																								
6	NC																																								
7	NC																																								
8	SG																																								
<p>Omron PLC side D-sub 9-pin</p> <table border="1" data-bbox="518 942 710 1174"> <thead> <tr> <th>Pin No.</th> <th>Signal name</th> </tr> </thead> <tbody> <tr><td>1</td><td>FG</td></tr> <tr><td>2</td><td>SD</td></tr> <tr><td>3</td><td>RD</td></tr> <tr><td>4</td><td>RS</td></tr> <tr><td>5</td><td>CS</td></tr> <tr><td>6</td><td>-</td></tr> <tr><td>7</td><td>-</td></tr> <tr><td>8</td><td>-</td></tr> <tr><td>9</td><td>SG</td></tr> </tbody> </table> <p>GT side</p> <table border="1" data-bbox="806 942 975 1174"> <thead> <tr> <th>Pin No.</th> <th>Signal Name</th> </tr> </thead> <tbody> <tr><td>1</td><td>N.C.</td></tr> <tr><td>2</td><td>RD</td></tr> <tr><td>3</td><td>SD</td></tr> <tr><td>4</td><td>N.C.</td></tr> <tr><td>5</td><td>SG</td></tr> <tr><td>6</td><td>N.C.</td></tr> <tr><td>7</td><td>RS</td></tr> <tr><td>8</td><td>CS</td></tr> <tr><td>9</td><td>N.C.</td></tr> </tbody> </table>	Pin No.	Signal name	1	FG	2	SD	3	RD	4	RS	5	CS	6	-	7	-	8	-	9	SG	Pin No.	Signal Name	1	N.C.	2	RD	3	SD	4	N.C.	5	SG	6	N.C.	7	RS	8	CS	9	N.C.	GT707
Pin No.	Signal name																																								
1	FG																																								
2	SD																																								
3	RD																																								
4	RS																																								
5	CS																																								
6	-																																								
7	-																																								
8	-																																								
9	SG																																								
Pin No.	Signal Name																																								
1	N.C.																																								
2	RD																																								
3	SD																																								
4	N.C.																																								
5	SG																																								
6	N.C.																																								
7	RS																																								
8	CS																																								
9	N.C.																																								
CS1W-CN225 CS1W-CN625	<p>25-pin connecting cable side for peripheral port</p> <table border="1" data-bbox="509 1246 701 1483"> <thead> <tr> <th>Pin No.</th> <th>Signal name</th> </tr> </thead> <tbody> <tr><td>1</td><td>FG</td></tr> <tr><td>2</td><td>RD</td></tr> <tr><td>3</td><td>SD</td></tr> <tr><td>4</td><td>CS</td></tr> <tr><td>5</td><td>RS</td></tr> <tr><td>6</td><td>-</td></tr> <tr><td>7</td><td>SG</td></tr> <tr><td>·</td><td>-</td></tr> <tr><td>25</td><td>-</td></tr> </tbody> </table> <p>To power supply</p> <table border="1" data-bbox="797 1246 989 1458"> <thead> <tr> <th>Pin No.</th> <th>Signal name</th> </tr> </thead> <tbody> <tr><td>1</td><td>+</td></tr> <tr><td>2</td><td>-</td></tr> <tr><td>3</td><td>NC(or FG)</td></tr> <tr><td>4</td><td>SD</td></tr> <tr><td>5</td><td>RD</td></tr> <tr><td>6</td><td>NC</td></tr> <tr><td>7</td><td>NC</td></tr> <tr><td>8</td><td>SG</td></tr> </tbody> </table> <p>GT side</p>	Pin No.	Signal name	1	FG	2	RD	3	SD	4	CS	5	RS	6	-	7	SG	·	-	25	-	Pin No.	Signal name	1	+	2	-	3	NC(or FG)	4	SD	5	RD	6	NC	7	NC	8	SG	GT series RS232C type*1 *2	
	Pin No.	Signal name																																							
1	FG																																								
2	RD																																								
3	SD																																								
4	CS																																								
5	RS																																								
6	-																																								
7	SG																																								
·	-																																								
25	-																																								
Pin No.	Signal name																																								
1	+																																								
2	-																																								
3	NC(or FG)																																								
4	SD																																								
5	RD																																								
6	NC																																								
7	NC																																								
8	SG																																								
<p>25-pin connecting cable side for peripheral port</p> <table border="1" data-bbox="518 1555 710 1792"> <thead> <tr> <th>Pin No.</th> <th>Signal name</th> </tr> </thead> <tbody> <tr><td>1</td><td>FG</td></tr> <tr><td>2</td><td>RD</td></tr> <tr><td>3</td><td>SD</td></tr> <tr><td>4</td><td>CS</td></tr> <tr><td>5</td><td>RS</td></tr> <tr><td>6</td><td>-</td></tr> <tr><td>7</td><td>SG</td></tr> <tr><td>·</td><td>-</td></tr> <tr><td>25</td><td>-</td></tr> </tbody> </table> <p>GT side</p> <table border="1" data-bbox="806 1555 975 1792"> <thead> <tr> <th>Pin No.</th> <th>Signal name</th> </tr> </thead> <tbody> <tr><td>1</td><td>N.C.</td></tr> <tr><td>2</td><td>RD</td></tr> <tr><td>3</td><td>SD</td></tr> <tr><td>4</td><td>N.C.</td></tr> <tr><td>5</td><td>SG</td></tr> <tr><td>6</td><td>N.C.</td></tr> <tr><td>7</td><td>RS</td></tr> <tr><td>8</td><td>CS</td></tr> <tr><td>9</td><td>N.C.</td></tr> </tbody> </table>	Pin No.	Signal name	1	FG	2	RD	3	SD	4	CS	5	RS	6	-	7	SG	·	-	25	-	Pin No.	Signal name	1	N.C.	2	RD	3	SD	4	N.C.	5	SG	6	N.C.	7	RS	8	CS	9	N.C.	GT707
Pin No.	Signal name																																								
1	FG																																								
2	RD																																								
3	SD																																								
4	CS																																								
5	RS																																								
6	-																																								
7	SG																																								
·	-																																								
25	-																																								
Pin No.	Signal name																																								
1	N.C.																																								
2	RD																																								
3	SD																																								
4	N.C.																																								
5	SG																																								
6	N.C.																																								
7	RS																																								
8	CS																																								
9	N.C.																																								

Omron PLC	Connection cable for peripheral port made by Omron	Wiring diagram	GT series																																								
CPM2	CS1W-CN226 CS1W-CN626	<p>Omron PLC side D-sub 9-bin</p> <table border="1" data-bbox="550 359 742 595"> <thead> <tr> <th>Pin No.</th> <th>Signal name</th> </tr> </thead> <tbody> <tr><td>1</td><td>-</td></tr> <tr><td>2</td><td>RD</td></tr> <tr><td>3</td><td>SD</td></tr> <tr><td>4</td><td>ER</td></tr> <tr><td>5</td><td>SG</td></tr> <tr><td>6</td><td>DR</td></tr> <tr><td>7</td><td>RS</td></tr> <tr><td>8</td><td>CS</td></tr> <tr><td>9</td><td>-</td></tr> </tbody> </table> <p style="text-align: center;">To power supply</p> <p>GT side</p> <table border="1" data-bbox="834 359 1026 571"> <thead> <tr> <th>Pin No.</th> <th>Signal name</th> </tr> </thead> <tbody> <tr><td>1</td><td>+</td></tr> <tr><td>2</td><td>-</td></tr> <tr><td>3</td><td>NC(or FG)</td></tr> <tr><td>4</td><td>SD</td></tr> <tr><td>5</td><td>RD</td></tr> <tr><td>6</td><td>NC</td></tr> <tr><td>7</td><td>NC</td></tr> <tr><td>8</td><td>SG</td></tr> </tbody> </table>	Pin No.	Signal name	1	-	2	RD	3	SD	4	ER	5	SG	6	DR	7	RS	8	CS	9	-	Pin No.	Signal name	1	+	2	-	3	NC(or FG)	4	SD	5	RD	6	NC	7	NC	8	SG	GT series RS232C type*1 *2		
		Pin No.	Signal name																																								
1	-																																										
2	RD																																										
3	SD																																										
4	ER																																										
5	SG																																										
6	DR																																										
7	RS																																										
8	CS																																										
9	-																																										
Pin No.	Signal name																																										
1	+																																										
2	-																																										
3	NC(or FG)																																										
4	SD																																										
5	RD																																										
6	NC																																										
7	NC																																										
8	SG																																										
		<p>Omron PLC side D-sub 9-bin</p> <table border="1" data-bbox="559 680 751 915"> <thead> <tr> <th>Pin No.</th> <th>Signal name</th> </tr> </thead> <tbody> <tr><td>1</td><td>-</td></tr> <tr><td>2</td><td>RD</td></tr> <tr><td>3</td><td>SD</td></tr> <tr><td>4</td><td>ER</td></tr> <tr><td>5</td><td>SG</td></tr> <tr><td>6</td><td>DR</td></tr> <tr><td>7</td><td>RS</td></tr> <tr><td>8</td><td>CS</td></tr> <tr><td>9</td><td>-</td></tr> </tbody> </table> <p>GT side</p> <table border="1" data-bbox="843 680 1016 915"> <thead> <tr> <th>Pin No.</th> <th>Signal name</th> </tr> </thead> <tbody> <tr><td>1</td><td>N.C</td></tr> <tr><td>2</td><td>RD</td></tr> <tr><td>3</td><td>SD</td></tr> <tr><td>4</td><td>N.C</td></tr> <tr><td>5</td><td>SG</td></tr> <tr><td>6</td><td>N.C</td></tr> <tr><td>7</td><td>RS</td></tr> <tr><td>8</td><td>CS</td></tr> <tr><td>9</td><td>N.C</td></tr> </tbody> </table>	Pin No.	Signal name	1	-	2	RD	3	SD	4	ER	5	SG	6	DR	7	RS	8	CS	9	-	Pin No.	Signal name	1	N.C	2	RD	3	SD	4	N.C	5	SG	6	N.C	7	RS	8	CS	9	N.C	GT707
Pin No.	Signal name																																										
1	-																																										
2	RD																																										
3	SD																																										
4	ER																																										
5	SG																																										
6	DR																																										
7	RS																																										
8	CS																																										
9	-																																										
Pin No.	Signal name																																										
1	N.C																																										
2	RD																																										
3	SD																																										
4	N.C																																										
5	SG																																										
6	N.C																																										
7	RS																																										
8	CS																																										
9	N.C																																										

\*1: Although nos.6 and 7 of the models except GT01 are RS/CS, they can be used in the above connection.

\*2: This is for RS232C type of GT01/GT02/GT02L/GT03-E/GT05/GT11/GT12/GT21/GT32/GT32-E/GT703/GT704.

## 2.2 Omron SYSMAC-CS/CJ Series

### PLC model selection

Select "Omron SYSMAC-CS/CJ series".

Usable devices vary according to the version of GTWIN.

There is a restriction on the version of GT firmware if the GTWIN is Ver2.96 or later.

GT Series	GTWIN Version	GT Version
GT01	Ver.2.96 or later	Ver.1.343 or later
GT05		Ver.1.00 or later
GT11		Ver.1.241 or later
GT21		Ver.1.141 or later
GT32		Ver.1.03 or later
GT02	Ver.2.A0 or later	Ver.1.00 or later
GT12	Ver.2.97 or later	Ver.1.00 or later
GT02L	Ver.2.B0 or later	Ver.1.00 or later
GT32-E	Ver.2.C0 or later	Ver.1.00 or later
GT03-E	Ver.2.D0 or later	Ver.1.00 or later

### Usable devices(When the version of GTWIN is Ver.2.96 or later)

	Bit/Word Device	No.	Memo
Bit Device	I/O Relay Internal Hold Relay Special Auxiliary Relay Analog setting value storage area	0000.00~9999.15	*1
	Data link Relay	L 0000.00~L 9999.15	*1
	Auxiliary Memory Relay	A 0000.00~A 9999.15	*1
	Hold Relay	H0000.00~H 9999.15	*1
	Timer(contact)	T 0000~T 4095	*1
	Counter(contact)	C 0000~C 4095	*1
	Data memory	D 00000.00~D 32767.15	*1
	Internal auxiliary relay	W 0000.00~W 9999.15	*1
	Extended data memory (Current bank)	EW 00000.00~EW 32767.15	*1
	Extended data memory (Bank designation)	E 0-00000.00~E 18-32767.15	*2
Task flag	TK 00~TK 31	*1	
Word Device	I/O Relay Internal Hold Relay Special Auxiliary Relay Analog setting value storage area	0000~9999	
	Data link Relay	L 0000~L 9999	
	Auxiliary Memory Relay	A 0000~A 9999	
	Hold Relay	H 0000~H 9999	
	Timer(current)	T 0000~T 4095	
	Counter(current)	C 0000~C 4095	
	Data Memory	D 00000~D 32767	
	Internal auxiliary relay	W 0000~W 9999	
	Extended data memory (Current bank)	EM 00000~EM 32767	
Extended data memory (Bank designation)	E 0-00000~E 18-32767	*3	
Double Word Device	Index register	IR 00~IR 15	

\* 1 The input in GTWIN is as follows:

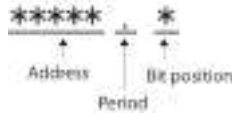

\* 2 The input in GTWIN is as follows:

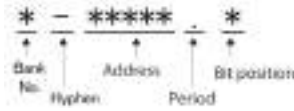

\* 3 The input in GTWIN is as follows:

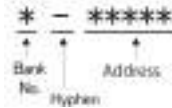

\* 4 For details, please consult the manual for the PLC you will use.

### Usable devices (When the version of GTWIN is 2.95 or older)

There is no restriction on the version of GT firmware if the version of GTWIN is older than Ver2.95.

Bit/Word Device		No.
Bit Device	I/O Relay Internal Hold Relay Special Auxiliary Relay	000000-614315
	Data link Relay	LR00000-LR19915
	Auxiliary Memory Relay	AR00000-AR95915
	Hold Relay	HR00000-HR51115
	Timer(contact)	TIM0000-TIM2047
	Counter(contact)	CNT0000-CNT2047
Word Device	I/O Relay Internal Hold Relay Special Auxiliary Relay	0000-6143
	Data link Relay	LR000-LR199
	Auxiliary Memory Relay	AR000-AR959
	Hold Relay	HR000-HR511
	Timer(current)	TIM0000-TIM2047
	Counter(current)	CNT0000-CNT2047
	Data Memory	DM0000-DM9999

\*For details, please consult the manual for the PLC you will use.



#### Note:

- The maximum value that can be set with the GT is described.
- The range of usable addresses differs depending on the model. For details, please consult the manual for the PLC you will use.

### Communication Parameters Settings

The example of communication settings of GT and PLC is shown below.

#### Setting Values for GT (Set in the configuration setting of GTWIN.)

Item	Setting
Baud Rate	19200bps
Data Bits	7
Stop Bits	1
Parity	Even

#### Setting Values for PLC

Item	Setting
Mode of PLC	Monitor Mode
Mode Selection	Higher Order Link
Baud Rate	19200bps
Data Bits	7
Stop Bits	1
Parity	Even
Station Number	0
CTS Setup	Normally ON
DC +5V power supply	No
Type of Communication	RS232C*

\*Models that allow RS232C or RS485 communication with the adapter or unit are available.

For almost all models the PLC communication setting method is as follows. However, differences may arise depending on the model. For details, please consult the manual for the PLC you will use when making the settings.

#### To communicate using the RS232C port of the CPU unit

Set the system area as follows.

Address	Value set	Setting
DM6600	0201 (HEX)	Setting of PLC main unit mode (monitor mode)
DM6645	0001 (HEX)	Mode setting of RS232C port (high link)
DM6646	0004 (HEX)	Setting of communication conditions (19200 bps, 7 bits, even, 1 bit)
DM6648	0000 (HEX)	Setting of device number (Device No. 0)

#### To communicate using the communication port

Set the system area as follows.

##### To communicate with port A

Address	Value set	Setting
DM6600	0201 (HEX)	Setting of PLC main unit mode (monitor mode)
DM6550	0001 (HEX)	Mode setting of RS232C port (high link)
DM6551	0004 (HEX)	Setting of communication conditions (19200 bps, 7 bits, even, 1 bit)

##### To communicate with port B

Address	Value set	Setting
DM6600	0201 (HEX)	Setting of PLC main unit mode (monitor mode)
DM6555	0001 (HEX)	Mode setting of RS232C port (high link)
DM6556	0004 (HEX)	Setting of communication conditions (19200 bps, 7 bits, even, 1 bit)

#### To communicate using the high link I/F unit

Make sure set the CPU mode to monitor mode.

Use the DIP switch or rotary switch on the link I/F unit to make settings such as the baud rate.

For details please refer to the manual for the unit you are using.

#### To communicate using the peripheral port

Set the system area as follows.

Address	Value set	Setting
DM6600	0201 (HEX)	Setting of PLC main unit mode (monitor mode)
DM6550	0001 (HEX)	Mode setting of RS232C port (high link)
DM6551	0004 (HEX)	Setting of communication conditions (19200 bps, 7 bits, even, 1 bit)

## 2.2.1 SYSMAC CS1 series (1:1) (RS232C)

CPU	Link I/F	Wiring diagram	GT series
CS1H-CPU67 CS1H-CPU66 CS1H-CPU65 CS1H-CPU64 CS1H-CPU63 CS1G-CPU45 CS1G-CPU44 CS1G-CPU43 CS1G-CPU42	RS232C port on CPU unit		GT series RS232C type*2 *3
	CS1W-SCU21-V1 CS1W-SCB21-V1		
	CS1W-SCB41-V1		GT707

\*1: A connection cable for peripherals is required for the connection to the peripheral port.

\*2: Although nos.6 and 7 of the models except GT01 are RS/CS, they can be used in the above connection.

\*3: This is for RS232C type of GT01/GT02/GT02L/GT03-E/GT05/GT11/GT12/GT21/GT32/GT32-E/GT703/GT704.



## 2.2.2 SYSMAC CJ1 series (1:1) (RS232C)

CPU	Link I/F	Wiring diagram	GT series																																								
CJ1H CJ1M CJ1G	RS232C port on the CPU unit	<p>Omron PLC side D-sub 9-pin</p> <table border="1" data-bbox="591 363 776 591"> <thead> <tr> <th>Pin No.</th> <th>Signal name</th> </tr> </thead> <tbody> <tr><td>1</td><td>FG</td></tr> <tr><td>2</td><td>SD</td></tr> <tr><td>3</td><td>RD</td></tr> <tr><td>4</td><td>RS</td></tr> <tr><td>5</td><td>CS</td></tr> <tr><td>6</td><td>-</td></tr> <tr><td>7</td><td>-</td></tr> <tr><td>8</td><td>-</td></tr> <tr><td>9</td><td>SG</td></tr> </tbody> </table> <p>To power supply</p> <p>GT side</p> <table border="1" data-bbox="865 363 1050 571"> <thead> <tr> <th>Pin No.</th> <th>Signal Name</th> </tr> </thead> <tbody> <tr><td>1</td><td>+</td></tr> <tr><td>2</td><td>-</td></tr> <tr><td>3</td><td>NC(or FG)</td></tr> <tr><td>4</td><td>SD</td></tr> <tr><td>5</td><td>RD</td></tr> <tr><td>6</td><td>NC</td></tr> <tr><td>7</td><td>NC</td></tr> <tr><td>8</td><td>SG</td></tr> </tbody> </table>	Pin No.	Signal name	1	FG	2	SD	3	RD	4	RS	5	CS	6	-	7	-	8	-	9	SG	Pin No.	Signal Name	1	+	2	-	3	NC(or FG)	4	SD	5	RD	6	NC	7	NC	8	SG	GT series RS232C type*2 *3		
Pin No.	Signal name																																										
1	FG																																										
2	SD																																										
3	RD																																										
4	RS																																										
5	CS																																										
6	-																																										
7	-																																										
8	-																																										
9	SG																																										
Pin No.	Signal Name																																										
1	+																																										
2	-																																										
3	NC(or FG)																																										
4	SD																																										
5	RD																																										
6	NC																																										
7	NC																																										
8	SG																																										
		<p>Omron PLC side D-sub 9-pin</p> <table border="1" data-bbox="600 691 786 929"> <thead> <tr> <th>Pin No.</th> <th>Signal name</th> </tr> </thead> <tbody> <tr><td>1</td><td>FG</td></tr> <tr><td>2</td><td>SD</td></tr> <tr><td>3</td><td>RD</td></tr> <tr><td>4</td><td>RS</td></tr> <tr><td>5</td><td>CS</td></tr> <tr><td>6</td><td>-</td></tr> <tr><td>7</td><td>-</td></tr> <tr><td>8</td><td>-</td></tr> <tr><td>9</td><td>SG</td></tr> </tbody> </table> <p>GT side</p> <table border="1" data-bbox="884 691 1050 929"> <thead> <tr> <th>Pin No.</th> <th>Signal Name</th> </tr> </thead> <tbody> <tr><td>1</td><td>N.C.</td></tr> <tr><td>2</td><td>RD</td></tr> <tr><td>3</td><td>SD</td></tr> <tr><td>4</td><td>N.C.</td></tr> <tr><td>5</td><td>SG</td></tr> <tr><td>6</td><td>N.C.</td></tr> <tr><td>7</td><td>RS</td></tr> <tr><td>8</td><td>CS</td></tr> <tr><td>9</td><td>N.C.</td></tr> </tbody> </table>	Pin No.	Signal name	1	FG	2	SD	3	RD	4	RS	5	CS	6	-	7	-	8	-	9	SG	Pin No.	Signal Name	1	N.C.	2	RD	3	SD	4	N.C.	5	SG	6	N.C.	7	RS	8	CS	9	N.C.	GT707
Pin No.	Signal name																																										
1	FG																																										
2	SD																																										
3	RD																																										
4	RS																																										
5	CS																																										
6	-																																										
7	-																																										
8	-																																										
9	SG																																										
Pin No.	Signal Name																																										
1	N.C.																																										
2	RD																																										
3	SD																																										
4	N.C.																																										
5	SG																																										
6	N.C.																																										
7	RS																																										
8	CS																																										
9	N.C.																																										

\*1: A connection cable for peripherals is required for the connection to the peripheral port.

\*2: Although nos.6 and 7 of the models except GT01 are RS/CS, they can be used in the above connection.

\*3: This is for RS232C type of GT01/GT02/GT02L/GT03-E/GT05/GT11/GT12/GT21/GT32/GT32-E/GT703/GT704.

## 2.2.3 SYSMAC CS1/CJ1 series (1:1) (RS422/RS485)

Connected with Adapter, or Unit

CPU	Link I/F	Wiring diagram	GT series
CS1 series	RS422 conversion adapter CJ1W-CIF11		RS422/RS485 type
CJ1 series	RS422 conversion unit NT-AL001		



### Note:

Refer to the figures below for the settings of the dip switches of RS422/485 optional board CPW-CFIF11 and RS422 conversion unit NT-AL001.

Adapter or unit	Dip switches
RS422 conversion adapter CJ1W-CIF11	
RS422 conversion unit NT-AL001	

The RS422 conversion adapter CJ1W-CIF11 is a non-insulated type, and the RS422 conversion adapter NT-AL001 is a isolated type.

When the transmission distance is long, use the isolated type.

## 2.2.4 SYSMAC CJ2M series (1:1) (RS232C)

CPU	Link I/F	Wiring diagram	GT series																																								
CJ2M-CPU1□	RS232C port on the CPU unit	<p>Omron PLC side D-sub 9-pin</p> <table border="1"> <thead> <tr> <th>Pin No.</th> <th>Signal name</th> </tr> </thead> <tbody> <tr><td>1</td><td>FG</td></tr> <tr><td>2</td><td>SD</td></tr> <tr><td>3</td><td>RD</td></tr> <tr><td>4</td><td>RS</td></tr> <tr><td>5</td><td>CS</td></tr> <tr><td>6</td><td>-</td></tr> <tr><td>7</td><td>-</td></tr> <tr><td>8</td><td>-</td></tr> <tr><td>9</td><td>SG</td></tr> </tbody> </table> <p>To power supply</p> <p>GT side</p> <table border="1"> <thead> <tr> <th>Pin No.</th> <th>Signal Name</th> </tr> </thead> <tbody> <tr><td>1</td><td>+</td></tr> <tr><td>2</td><td>-</td></tr> <tr><td>3</td><td>NC(or FG)</td></tr> <tr><td>4</td><td>SD</td></tr> <tr><td>5</td><td>RD</td></tr> <tr><td>6</td><td>NC</td></tr> <tr><td>7</td><td>NC</td></tr> <tr><td>8</td><td>SG</td></tr> </tbody> </table>	Pin No.	Signal name	1	FG	2	SD	3	RD	4	RS	5	CS	6	-	7	-	8	-	9	SG	Pin No.	Signal Name	1	+	2	-	3	NC(or FG)	4	SD	5	RD	6	NC	7	NC	8	SG	GT series RS232C type*1 *2		
Pin No.	Signal name																																										
1	FG																																										
2	SD																																										
3	RD																																										
4	RS																																										
5	CS																																										
6	-																																										
7	-																																										
8	-																																										
9	SG																																										
Pin No.	Signal Name																																										
1	+																																										
2	-																																										
3	NC(or FG)																																										
4	SD																																										
5	RD																																										
6	NC																																										
7	NC																																										
8	SG																																										
CJ2M-CPU3□	RS232C option board CP1W-CIF01	<p>Omron PLC side D-sub 9-pin</p> <table border="1"> <thead> <tr> <th>Pin No.</th> <th>Signal name</th> </tr> </thead> <tbody> <tr><td>1</td><td>FG</td></tr> <tr><td>2</td><td>SD</td></tr> <tr><td>3</td><td>RD</td></tr> <tr><td>4</td><td>RS</td></tr> <tr><td>5</td><td>CS</td></tr> <tr><td>6</td><td>-</td></tr> <tr><td>7</td><td>-</td></tr> <tr><td>8</td><td>-</td></tr> <tr><td>9</td><td>SG</td></tr> </tbody> </table> <p>GT side</p> <table border="1"> <thead> <tr> <th>Pin No.</th> <th>Signal Name</th> </tr> </thead> <tbody> <tr><td>1</td><td>N.C.</td></tr> <tr><td>2</td><td>RD</td></tr> <tr><td>3</td><td>SD</td></tr> <tr><td>4</td><td>N.C.</td></tr> <tr><td>5</td><td>SG</td></tr> <tr><td>6</td><td>N.C.</td></tr> <tr><td>7</td><td>RS</td></tr> <tr><td>8</td><td>CS</td></tr> <tr><td>9</td><td>N.C.</td></tr> </tbody> </table>	Pin No.	Signal name	1	FG	2	SD	3	RD	4	RS	5	CS	6	-	7	-	8	-	9	SG	Pin No.	Signal Name	1	N.C.	2	RD	3	SD	4	N.C.	5	SG	6	N.C.	7	RS	8	CS	9	N.C.	GT707
Pin No.	Signal name																																										
1	FG																																										
2	SD																																										
3	RD																																										
4	RS																																										
5	CS																																										
6	-																																										
7	-																																										
8	-																																										
9	SG																																										
Pin No.	Signal Name																																										
1	N.C.																																										
2	RD																																										
3	SD																																										
4	N.C.																																										
5	SG																																										
6	N.C.																																										
7	RS																																										
8	CS																																										
9	N.C.																																										

\*1: Although nos.6 and 7 of the models except GT01 are RS/CS, they can be used in the above connection.

\*2: This is for RS232C type of GT01/GT02/GT02L/GT03-E/GT05/GT11/GT12/GT21/GT32/GT32-E/GT703/GT704.

## 2.2.5 SYSMAC CJ2M series (RS422/RS485)

Connected with Adapter or Unit

CPU	Link I/F	Wiring diagram	GT series																														
CJ2M-CPU3□	RS422/485 optional board CP1W-CIF11	<p>Omron PLC adapter side</p> <table border="1"> <thead> <tr> <th>Pin No.</th> <th>Signal name</th> </tr> </thead> <tbody> <tr><td>1</td><td>RDA-</td></tr> <tr><td>2</td><td>RDB+</td></tr> <tr><td>3</td><td>SDA-</td></tr> <tr><td>4</td><td>SDB+</td></tr> <tr><td>5</td><td>FG</td></tr> </tbody> </table> <p>GT side</p> <table border="1"> <thead> <tr> <th>Pin No.</th> <th>Signal name</th> </tr> </thead> <tbody> <tr><td>1</td><td>+</td></tr> <tr><td>2</td><td>-</td></tr> <tr><td>3</td><td>NC(or FG)</td></tr> <tr><td>4</td><td>+SD</td></tr> <tr><td>5</td><td>-SD</td></tr> <tr><td>6</td><td>+RD</td></tr> <tr><td>7</td><td>-RD</td></tr> <tr><td>8</td><td>E</td></tr> </tbody> </table>	Pin No.	Signal name	1	RDA-	2	RDB+	3	SDA-	4	SDB+	5	FG	Pin No.	Signal name	1	+	2	-	3	NC(or FG)	4	+SD	5	-SD	6	+RD	7	-RD	8	E	RS422/RS485 type
Pin No.	Signal name																																
1	RDA-																																
2	RDB+																																
3	SDA-																																
4	SDB+																																
5	FG																																
Pin No.	Signal name																																
1	+																																
2	-																																
3	NC(or FG)																																
4	+SD																																
5	-SD																																
6	+RD																																
7	-RD																																
8	E																																



### Note:

Refer to the figures below for the settings of the dip switches of RS422/RS485 conversion adapter CJ1W-CIF11.

Adapter or unit	Dip switches																					
RS422/485 optional board CP-CIF11	<table border="1"> <tbody> <tr><td>1</td><td><input type="checkbox"/></td><td>Q</td></tr> <tr><td>2</td><td><input type="checkbox"/></td><td>N</td></tr> <tr><td>3</td><td><input type="checkbox"/></td><td></td></tr> <tr><td>4</td><td><input type="checkbox"/></td><td></td></tr> <tr><td>5</td><td><input type="checkbox"/></td><td></td></tr> <tr><td>6</td><td><input type="checkbox"/></td><td>Q</td></tr> <tr><td></td><td></td><td>N</td></tr> </tbody> </table>	1	<input type="checkbox"/>	Q	2	<input type="checkbox"/>	N	3	<input type="checkbox"/>		4	<input type="checkbox"/>		5	<input type="checkbox"/>		6	<input type="checkbox"/>	Q			N
1	<input type="checkbox"/>	Q																				
2	<input type="checkbox"/>	N																				
3	<input type="checkbox"/>																					
4	<input type="checkbox"/>																					
5	<input type="checkbox"/>																					
6	<input type="checkbox"/>	Q																				
		N																				

## 2.2.6 When using the peripheral port

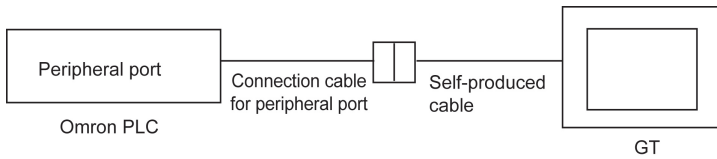

The wiring diagrams vary according to the connection cables for the peripheral port to be used.

Omron PLC	Connection cable for peripheral port made by Omron	Wiring diagram	GT series																																								
CS1H-CPU67 CS1H-CPU66 CS1H-CPU65 CS1H-CPU64 CS1H-CPU63 CS1G-CPU45 CS1G-CPU44 CS1G-CPU43 CS1G-CPU42 CJ1H CJ1M CJ1G	CS1W-CN118 (D-sub9-pin) COM2C-CN111	<p>Omron PLC side D-sub 9-pin</p> <table border="1" data-bbox="536 664 728 900"> <thead> <tr> <th>Pin No.</th> <th>Signal name</th> </tr> </thead> <tbody> <tr><td>1</td><td>FG</td></tr> <tr><td>2</td><td>SD</td></tr> <tr><td>3</td><td>RD</td></tr> <tr><td>4</td><td>RS</td></tr> <tr><td>5</td><td>CS</td></tr> <tr><td>6</td><td>-</td></tr> <tr><td>7</td><td>-</td></tr> <tr><td>8</td><td>-</td></tr> <tr><td>9</td><td>SG</td></tr> </tbody> </table> <p style="text-align: center;">To power supply</p> <p>GT side</p> <table border="1" data-bbox="824 664 1016 877"> <thead> <tr> <th>Pin No.</th> <th>Signal Name</th> </tr> </thead> <tbody> <tr><td>1</td><td>+</td></tr> <tr><td>2</td><td>-</td></tr> <tr><td>3</td><td>NC(or FG)</td></tr> <tr><td>4</td><td>SD</td></tr> <tr><td>5</td><td>RD</td></tr> <tr><td>6</td><td>NC</td></tr> <tr><td>7</td><td>NC</td></tr> <tr><td>8</td><td>SG</td></tr> </tbody> </table>	Pin No.	Signal name	1	FG	2	SD	3	RD	4	RS	5	CS	6	-	7	-	8	-	9	SG	Pin No.	Signal Name	1	+	2	-	3	NC(or FG)	4	SD	5	RD	6	NC	7	NC	8	SG	GT series RS232C type*1		
Pin No.	Signal name																																										
1	FG																																										
2	SD																																										
3	RD																																										
4	RS																																										
5	CS																																										
6	-																																										
7	-																																										
8	-																																										
9	SG																																										
Pin No.	Signal Name																																										
1	+																																										
2	-																																										
3	NC(or FG)																																										
4	SD																																										
5	RD																																										
6	NC																																										
7	NC																																										
8	SG																																										
		<p>Omron PLC side D-sub 9-pin</p> <table border="1" data-bbox="536 983 728 1219"> <thead> <tr> <th>Pin No.</th> <th>Signal name</th> </tr> </thead> <tbody> <tr><td>1</td><td>FG</td></tr> <tr><td>2</td><td>SD</td></tr> <tr><td>3</td><td>RD</td></tr> <tr><td>4</td><td>RS</td></tr> <tr><td>5</td><td>CS</td></tr> <tr><td>6</td><td>-</td></tr> <tr><td>7</td><td>-</td></tr> <tr><td>8</td><td>-</td></tr> <tr><td>9</td><td>SG</td></tr> </tbody> </table> <p>GT side</p> <table border="1" data-bbox="824 983 1016 1219"> <thead> <tr> <th>Pin No.</th> <th>Signal Name</th> </tr> </thead> <tbody> <tr><td>1</td><td>N.C.</td></tr> <tr><td>2</td><td>RD</td></tr> <tr><td>3</td><td>SD</td></tr> <tr><td>4</td><td>N.C.</td></tr> <tr><td>5</td><td>SG</td></tr> <tr><td>6</td><td>N.C.</td></tr> <tr><td>7</td><td>RS</td></tr> <tr><td>8</td><td>CS</td></tr> <tr><td>9</td><td>N.C.</td></tr> </tbody> </table>	Pin No.	Signal name	1	FG	2	SD	3	RD	4	RS	5	CS	6	-	7	-	8	-	9	SG	Pin No.	Signal Name	1	N.C.	2	RD	3	SD	4	N.C.	5	SG	6	N.C.	7	RS	8	CS	9	N.C.	GT707
Pin No.	Signal name																																										
1	FG																																										
2	SD																																										
3	RD																																										
4	RS																																										
5	CS																																										
6	-																																										
7	-																																										
8	-																																										
9	SG																																										
Pin No.	Signal Name																																										
1	N.C.																																										
2	RD																																										
3	SD																																										
4	N.C.																																										
5	SG																																										
6	N.C.																																										
7	RS																																										
8	CS																																										
9	N.C.																																										

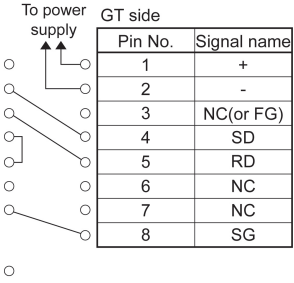
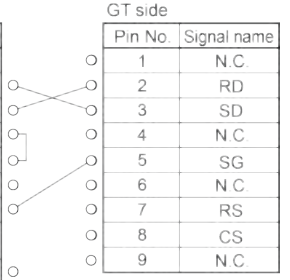
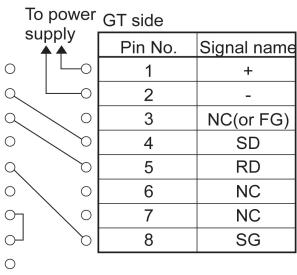
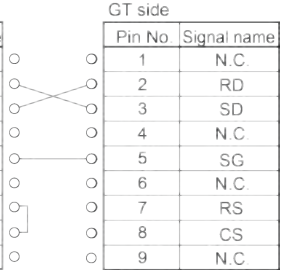
Omron PLC	Connection cable for peripheral port made by Omron	Wiring diagram	GT series																																							
CS1H-CPU67 CS1H-CPU66 CS1H-CPU65 CS1H-CPU64 CS1H-CPU63 CS1G-CPU45 CS1G-CPU44 CS1G-CPU43 CS1G-CPU42 CJ1H CJ1M CJ1G	CS1W-CN225 CS1W-CN625	<p>25-pin connecting cable side for peripheral port</p> <table border="1" data-bbox="569 407 765 662"> <thead> <tr> <th>Pin No.</th> <th>Signal name</th> </tr> </thead> <tbody> <tr><td>1</td><td>FG</td></tr> <tr><td>2</td><td>RD</td></tr> <tr><td>3</td><td>SD</td></tr> <tr><td>4</td><td>CS</td></tr> <tr><td>5</td><td>RS</td></tr> <tr><td>6</td><td>-</td></tr> <tr><td>7</td><td>SG</td></tr> <tr><td>·</td><td></td></tr> <tr><td>25</td><td>-</td></tr> </tbody> </table>  <table border="1" data-bbox="861 407 1057 627"> <thead> <tr> <th>Pin No.</th> <th>Signal name</th> </tr> </thead> <tbody> <tr><td>1</td><td>+</td></tr> <tr><td>2</td><td>-</td></tr> <tr><td>3</td><td>NC(or FG)</td></tr> <tr><td>4</td><td>SD</td></tr> <tr><td>5</td><td>RD</td></tr> <tr><td>6</td><td>NC</td></tr> <tr><td>7</td><td>NC</td></tr> <tr><td>8</td><td>SG</td></tr> </tbody> </table>	Pin No.	Signal name	1	FG	2	RD	3	SD	4	CS	5	RS	6	-	7	SG	·		25	-	Pin No.	Signal name	1	+	2	-	3	NC(or FG)	4	SD	5	RD	6	NC	7	NC	8	SG	GT series RS232C type*1	
	Pin No.	Signal name																																								
1	FG																																									
2	RD																																									
3	SD																																									
4	CS																																									
5	RS																																									
6	-																																									
7	SG																																									
·																																										
25	-																																									
Pin No.	Signal name																																									
1	+																																									
2	-																																									
3	NC(or FG)																																									
4	SD																																									
5	RD																																									
6	NC																																									
7	NC																																									
8	SG																																									
	<p>25-pin connecting cable side for peripheral port</p> <table border="1" data-bbox="573 736 775 991"> <thead> <tr> <th>Pin No.</th> <th>Signal name</th> </tr> </thead> <tbody> <tr><td>1</td><td>FG</td></tr> <tr><td>2</td><td>RD</td></tr> <tr><td>3</td><td>SD</td></tr> <tr><td>4</td><td>CS</td></tr> <tr><td>5</td><td>RS</td></tr> <tr><td>6</td><td>-</td></tr> <tr><td>7</td><td>SG</td></tr> <tr><td>·</td><td></td></tr> <tr><td>25</td><td>-</td></tr> </tbody> </table>  <table border="1" data-bbox="875 736 1053 987"> <thead> <tr> <th>Pin No.</th> <th>Signal name</th> </tr> </thead> <tbody> <tr><td>1</td><td>N.C.</td></tr> <tr><td>2</td><td>RD</td></tr> <tr><td>3</td><td>SD</td></tr> <tr><td>4</td><td>N.C.</td></tr> <tr><td>5</td><td>SG</td></tr> <tr><td>6</td><td>N.C.</td></tr> <tr><td>7</td><td>RS</td></tr> <tr><td>8</td><td>CS</td></tr> <tr><td>9</td><td>N.C.</td></tr> </tbody> </table>	Pin No.	Signal name	1	FG	2	RD	3	SD	4	CS	5	RS	6	-	7	SG	·		25	-	Pin No.	Signal name	1	N.C.	2	RD	3	SD	4	N.C.	5	SG	6	N.C.	7	RS	8	CS	9	N.C.	GT707
Pin No.	Signal name																																									
1	FG																																									
2	RD																																									
3	SD																																									
4	CS																																									
5	RS																																									
6	-																																									
7	SG																																									
·																																										
25	-																																									
Pin No.	Signal name																																									
1	N.C.																																									
2	RD																																									
3	SD																																									
4	N.C.																																									
5	SG																																									
6	N.C.																																									
7	RS																																									
8	CS																																									
9	N.C.																																									
CS1W-CN226 CS1W-CN626	CS1W-CN226 CS1W-CN626	<p>Omron PLC side D-sub 9-bin</p> <table border="1" data-bbox="566 1072 765 1319"> <thead> <tr> <th>Pin No.</th> <th>Signal name</th> </tr> </thead> <tbody> <tr><td>1</td><td>-</td></tr> <tr><td>2</td><td>RD</td></tr> <tr><td>3</td><td>SD</td></tr> <tr><td>4</td><td>ER</td></tr> <tr><td>5</td><td>SG</td></tr> <tr><td>6</td><td>DR</td></tr> <tr><td>7</td><td>RS</td></tr> <tr><td>8</td><td>CS</td></tr> <tr><td>9</td><td>-</td></tr> </tbody> </table>  <table border="1" data-bbox="861 1072 1060 1296"> <thead> <tr> <th>Pin No.</th> <th>Signal name</th> </tr> </thead> <tbody> <tr><td>1</td><td>+</td></tr> <tr><td>2</td><td>-</td></tr> <tr><td>3</td><td>NC(or FG)</td></tr> <tr><td>4</td><td>SD</td></tr> <tr><td>5</td><td>RD</td></tr> <tr><td>6</td><td>NC</td></tr> <tr><td>7</td><td>NC</td></tr> <tr><td>8</td><td>SG</td></tr> </tbody> </table>	Pin No.	Signal name	1	-	2	RD	3	SD	4	ER	5	SG	6	DR	7	RS	8	CS	9	-	Pin No.	Signal name	1	+	2	-	3	NC(or FG)	4	SD	5	RD	6	NC	7	NC	8	SG	GT series RS232C type*1	
	Pin No.	Signal name																																								
1	-																																									
2	RD																																									
3	SD																																									
4	ER																																									
5	SG																																									
6	DR																																									
7	RS																																									
8	CS																																									
9	-																																									
Pin No.	Signal name																																									
1	+																																									
2	-																																									
3	NC(or FG)																																									
4	SD																																									
5	RD																																									
6	NC																																									
7	NC																																									
8	SG																																									
	<p>Omron PLC side D-sub 9-bin</p> <table border="1" data-bbox="573 1392 775 1640"> <thead> <tr> <th>Pin No.</th> <th>Signal name</th> </tr> </thead> <tbody> <tr><td>1</td><td>-</td></tr> <tr><td>2</td><td>RD</td></tr> <tr><td>3</td><td>SD</td></tr> <tr><td>4</td><td>ER</td></tr> <tr><td>5</td><td>SG</td></tr> <tr><td>6</td><td>DR</td></tr> <tr><td>7</td><td>RS</td></tr> <tr><td>8</td><td>CS</td></tr> <tr><td>9</td><td>-</td></tr> </tbody> </table>  <table border="1" data-bbox="875 1392 1053 1640"> <thead> <tr> <th>Pin No.</th> <th>Signal name</th> </tr> </thead> <tbody> <tr><td>1</td><td>N.C.</td></tr> <tr><td>2</td><td>RD</td></tr> <tr><td>3</td><td>SD</td></tr> <tr><td>4</td><td>N.C.</td></tr> <tr><td>5</td><td>SG</td></tr> <tr><td>6</td><td>N.C.</td></tr> <tr><td>7</td><td>RS</td></tr> <tr><td>8</td><td>CS</td></tr> <tr><td>9</td><td>N.C.</td></tr> </tbody> </table>	Pin No.	Signal name	1	-	2	RD	3	SD	4	ER	5	SG	6	DR	7	RS	8	CS	9	-	Pin No.	Signal name	1	N.C.	2	RD	3	SD	4	N.C.	5	SG	6	N.C.	7	RS	8	CS	9	N.C.	GT707
Pin No.	Signal name																																									
1	-																																									
2	RD																																									
3	SD																																									
4	ER																																									
5	SG																																									
6	DR																																									
7	RS																																									
8	CS																																									
9	-																																									
Pin No.	Signal name																																									
1	N.C.																																									
2	RD																																									
3	SD																																									
4	N.C.																																									
5	SG																																									
6	N.C.																																									
7	RS																																									
8	CS																																									
9	N.C.																																									

\*1: This is for RS232C type of GT01/GT02/GT02L/GT03-E/GT05/GT11/GT12/GT21/GT32/GT32-E/GT703/GT704.



## **Chapter 3**

---

# **Connection With Toshiba Machine PLCs**

## 3.1 PROVISOR TCmini Series

### PLC model selection

Select "TOSHIBA MACHINE PROVISOR Tcmini Series".

### Usable devices

	Bit/Word Device	No.
Bit Device	Input	X0000-X0F7F
	Output	Y0000-Y0F7F
	Internal Relay	R0000-R077F
	Timer Relay	T0000-T077F
	Counter Relay	C0000-C077F
	Latch Relay	L0000-L007F
	Edge Relay	E0000-E077F
	Special Auxiliary Relay	A0000-A016F
Word Device	Input	X0000W-X00F7W
	Output	Y0000W-Y00F7W
	Internal Relay	R0000W-R0077W
	Timer Relay	T0000W-T0077W
	Counter Relay	C0000W-C0077W
	Latch Relay	L0000W-L0007W
	Edge Relay	E0000W-E0077W
	Special Auxiliary Relay	A0000W-A0016W
	Data Register	D0000-D0F7F
	Timer Counter (current)	P0000-P077F
	Timer Counter (set value)	V0000-V077F

The following list illustrates each expression of PLC device in GTWIN.

When you enter a value of devices, follow below expression.

	Expression in PLC	Expression in GTWIN
Bit Device	R120	R120
Word Device	R12W/X12W/Y12W	RW12/XW12/YW12



## Communication Parameters Settings

The example of communication settings of GT and PLC is shown below.

### Setting Values for GT (Set in the configuration setting of GTWIN.)

Item	Setting
Baud Rate	19200bps
Length of Bits	8
Stop Bits	1
Parity	None

### 3.1.1 RS232C Connection

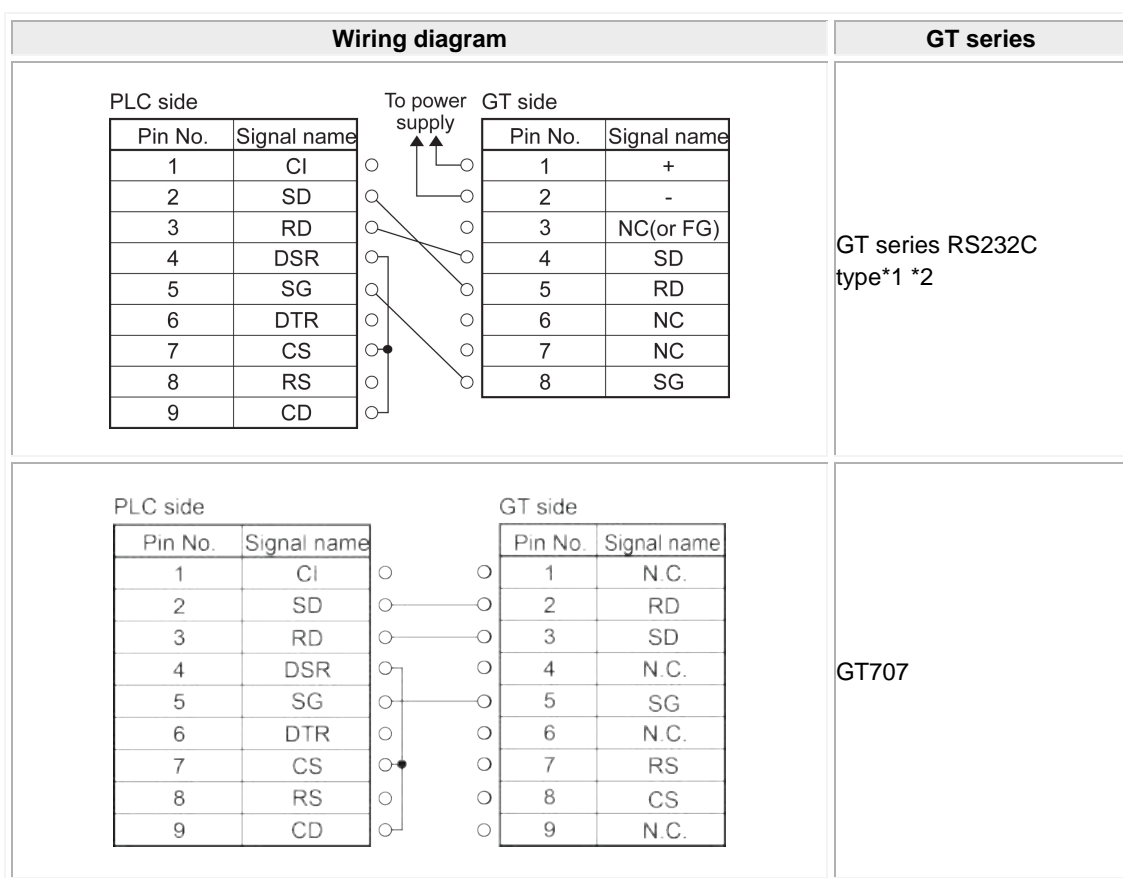

\*1: Although nos.6 and 7 of the models except GT01 are RS/CS, they can be used in the above connection.

\*2: This is for RS232C type of GT01/GT02/GT02L/GT03-E/GT05/GT11/GT12/GT21/GT32/GT32-E/GT703/GT704.

### 3.1.2 RS485 connection

#### Communication mode on PLC side

Set it to the host communication protocol connection mode.

\* For information on the setting method, refer to the “Tcmini” manual.

#### In case of 7 pins

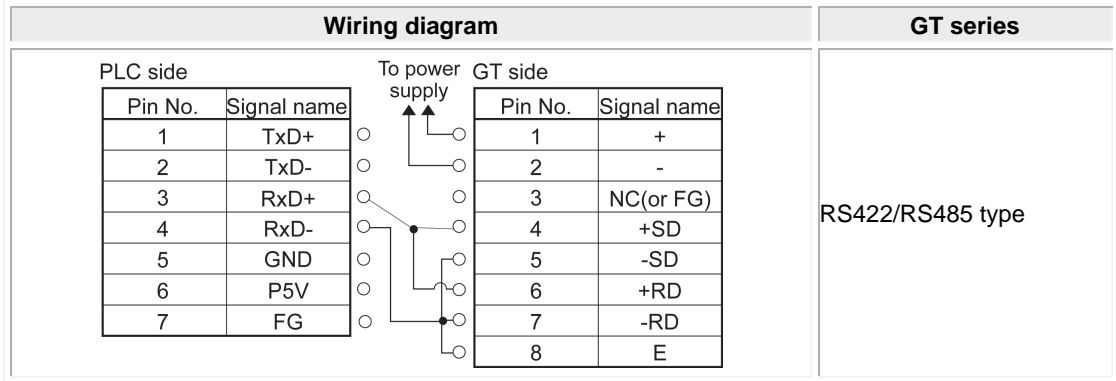

#### In case of 8 pins

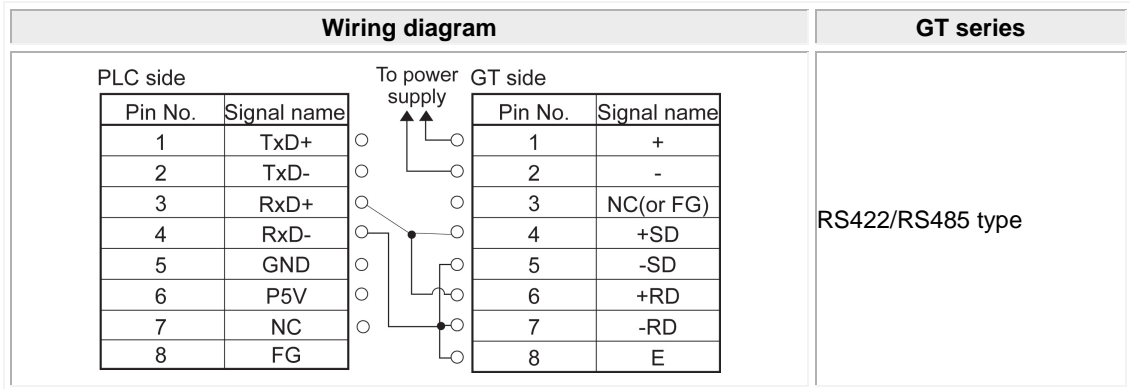

#### Note:

Confirm the appropriate versions of GTWIN and GT to connect with RS485 type.

GT series	GTWIN Version	GT Version
GT01	Ver.2.71 or later	Ver.1.3 or later
GT02	Ver.2.A0 or later	Ver.1.00 or later
GT02L	Ver.2.B0 or later	Ver.1.00 or later
GT03-E	Ver.2.D0 or later	Ver.1.00 or later
GT05	Ver.2.90 or later	Ver.1.0 or later
GT11	Ver.2.71 or later	Ver.1.20 or later
GT12	Ver.2.97 or later	Ver.1.00 or later
GT21	Ver.2.71 or later	Ver.1.10 or later
GT32	Ver.2.80 or later	Ver.1.00 or later
GT32-E	Ver.2.C0 or later	Ver.1.00 or later

## **Chapter 4**

---

# **Connection With Rockwell Automation (Allen-Bradley) PLCs**

## 4.1 Allen-Bradley SLC500 MicroLogix Series

### PLC model selection

Select "Allen-Bradley SLC500 MicroLogix Series".

Usable devices vary according to the version of GTWIN.

### Usable devices (When the version of GTWIN is Ver.2.96 or later)

Bit/Word Device		No.
Bit Device	Bit	B 3:0/0~B 255:255/15
	Input	I: 0.0/0~I: 30.255/15
	Output	O: 0.0/0~O: 30.255/15
	Status	S 0/0~S 164/15
	Timer (Effective bit)	T/EN 3:0~T/EN 255:255
	Timer (Clock bit)	T/TT 3:0~T/TT 255:255
	Timer (Completion bit)	T/DN 3:0~T/DN 255:255
	Counter (Up counter)	C/CU 3:0~C/CU 255:255
	Counter (Down counter)	C/CD 3:0~C/CD 255:255
	Counter (Completion bit)	C/DN 3:0~C/DN 255:255
	Counter (Overflow bit)	C/OV 3:0~C/OV 255:255
	Counter (Underflow bit)	C/UN 3:0~C/UN 255:255
	Counter (Accumulator update bit)	C/UA 3:0~C/UA 255:255
	Integer	N 7:/0~N 255:255/15
	Control (Effective bit)	R/EN 6:0~R/EN 255:255
	Control (Unload effective bit)	R/EU6:0~R/EU 255:255
	Control (Completion bit)	R/DN 6:0~R/DN 255:255
	Control (Stack empty bit)	R/EM 6:0~R/EM 255:255
	Control (Error bit)	R/ER 6:0~R/ER 255:255
	Control (Unload bit)	R/UL 6:0~R/UL 255:255
Control (Prohibition bit)	R/IN 6:0~R/IN 255:255	
Control (Detection bit)	R/FD 6:0~R/FD 255:255	
Word Device	Bit	B 3:0~B 255:255
	Input	I: 0.0~I: 30.255
	Output	O: 0.0~O: 30.255
	Status	S 0~S 164
	Timer (Setting value)	T.ACC 3:0~T.ACC 255:255
	Timer (Current value)	T.PRE 3:0~T.PRE 255:255
	Counter (Setting value)	C.ACC 3:0~C.ACC 255:255
	Counter (Current value)	C.PER 7:0~C.PER 255:255
	Integer	N 7:0~N 255:255
	ASCII	A 8:0~A 255:255
	Control (Position)	R.POS 6:0~C.POS 255:255
	Control (Length)	R.LEN 6:0~R.LEN 255:255
Double Word Device	Floating decimal point	F 8:0~F 255:255
	Long word (2-word integer)	L 9:0~C.PER 255:255
Character string Device	Character string	ST 9:0~ST 255:255



**Note:**

**Restrictions on character string device**

- When using the ST (character string) of character string device, it is used only as a character string. When referring devices, use the data format "ASCII" of data parts.
- When writing character strings from GT, specify the number of characters for the sub-element 0 on the PLC side.
- If a number larger than 3 is specified for "No. of displayed digits" when using the data format "ASCII" of data parts, the settable maximum element number is restricted.
- Set "Address" to "Low -> High" and "Word" to "High -> Low" in "Reference Order" under "Option" of the attribute edit with the data format "ASCII" of data parts.

The following list illustrates each expression of PLC device in GTWIN.

When you enter a value of devices, follow below expression.

Bit/Word Device	Expression in PLC	Expression in GTWIN
Bit Device	<p>T 4 : 0 / EN</p> <p>Bit number Element File number File type</p>	<p>T / EN 4 : 0</p> <p>Element File number Bit number File type</p>
Word Device	<p>T 4 : 0 . Acc</p> <p>Sub-element number Element File number File type</p>	<p>T . Acc 4 : 0</p> <p>Element File number Sub-element number File type</p>

**Usable devices (When the version of GTWIN is 2.95 or older)**

Bit/Word Device		No.
Bit Device	Bit	B3:000/ 0-B3:255/ 15
Word Device	Bit	B3:000-B3:255
	Integer	N7:000-N7:255

The following list illustrates each expression of PLC device in GTWIN.  
When you enter a value of devices, follow below expression.

	Expression in PLC	Expression in GTWIN
Bit Device	<p><b>B 3 : 2 0 0 / 1 0</b></p> <p>Bit number Bit delimiter Element Element delimiter File number File type</p>	<p><b>B 3 : 2 0 0 - 1 0</b></p> <p>Bit number Element File type + Number</p>
Word Device	<p><b>N 7 : 2 0 0</b></p> <p>Element Element delimiter File number File type</p>	<p><b>N 7 : 2 0 0</b></p> <p>Element File type + number</p>

**Communication Parameters Settings**

The example of communication settings of GT and PLC is shown below.

**Setting Values for GT (Set in the configuration setting of GTWIN.)**

Item	Setting
GT Unit No.	01
PLC Unit No.	00
Baud Rate	19200bps
Data Bits	8
Stop Bits	1
Parity	None

**Setting Values for PLC**

Item	Setting
Baud Rate	192000bps
Parity	None
Stop Bits	1
Data Bits	8
Communication Driver	DF1 Full Duplex
Control Line	No Handshaking
Error Detection	CRC
Embedded Responses	Enabled
Duplicate Packet Detect	Enable

### 4.1.1 SLC500 series(using link interface on the CPU unit)

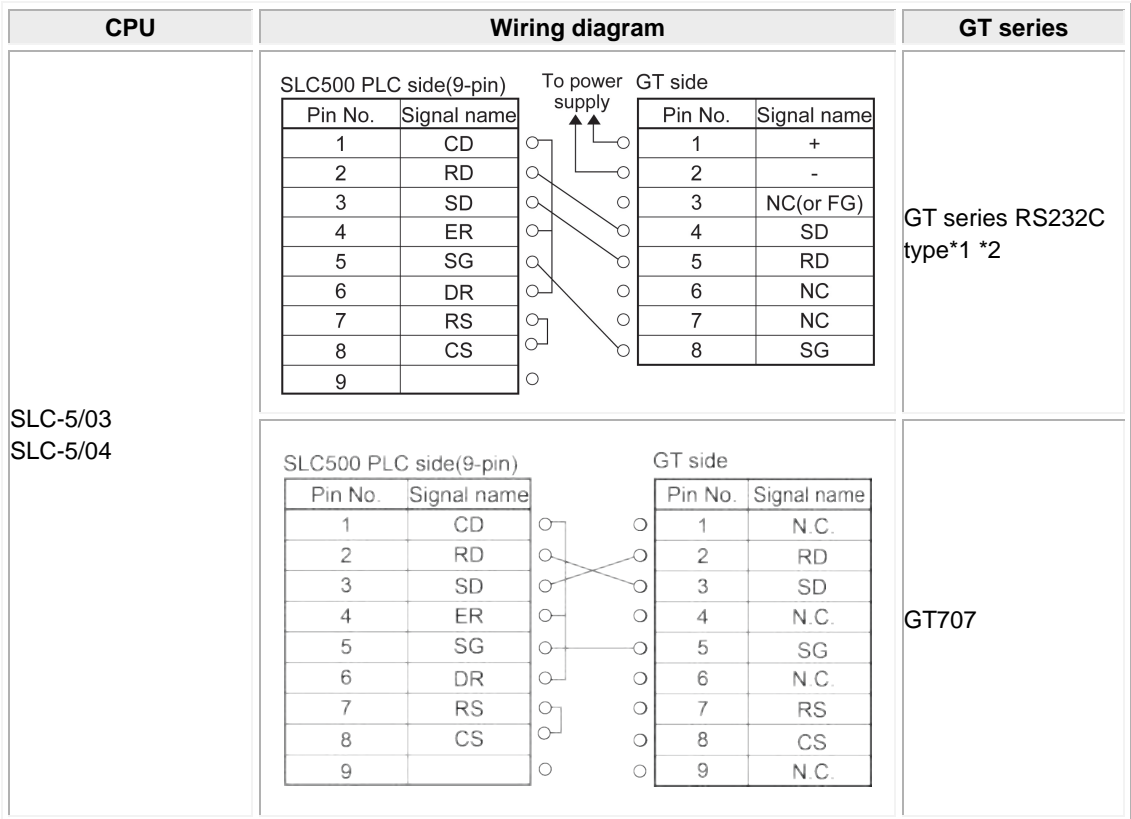

\*1: Although nos.6 and 7 of the models except GT01 are RS/CS, they can be used in the above connection.

\*2: This is for RS232C type of GT01/GT02/GT02L/GT03-E/GT05/GT11/GT12/GT21/GT32/GT32-E/GT703/GT704.

## 4.1.2 MicroLogix1000/1100

MicroLogix1000/1100 and PC TO MICROLOGIX COMMS. CABLE are connected as follows, then connect to GT by the cable of following wiring diagram.

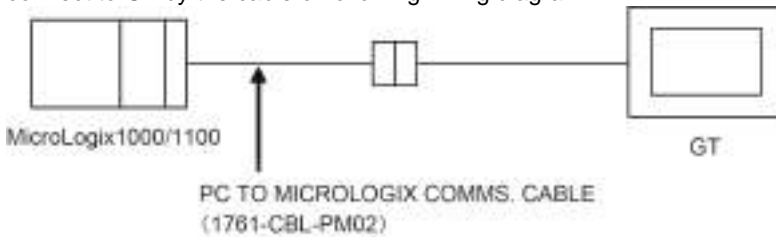

CPU	Wiring diagram	GT series																																								
MicroLogix1000/1100	<p>Connection cable for the tool port(9-pin)</p> <table border="1"> <thead> <tr> <th>Pin No.</th> <th>Signal name</th> </tr> </thead> <tbody> <tr><td>1</td><td></td></tr> <tr><td>2</td><td>SD</td></tr> <tr><td>3</td><td>RD</td></tr> <tr><td>4</td><td></td></tr> <tr><td>5</td><td>SG</td></tr> <tr><td>6</td><td></td></tr> <tr><td>7</td><td></td></tr> <tr><td>8</td><td></td></tr> <tr><td>9</td><td></td></tr> </tbody> </table> <p>To power supply</p> <table border="1"> <thead> <tr> <th>Pin No.</th> <th>Signal name</th> </tr> </thead> <tbody> <tr><td>1</td><td>+</td></tr> <tr><td>2</td><td>-</td></tr> <tr><td>3</td><td>NC(or FG)</td></tr> <tr><td>4</td><td>SD</td></tr> <tr><td>5</td><td>RD</td></tr> <tr><td>6</td><td>NC</td></tr> <tr><td>7</td><td>NC</td></tr> <tr><td>8</td><td>SG</td></tr> </tbody> </table>	Pin No.	Signal name	1		2	SD	3	RD	4		5	SG	6		7		8		9		Pin No.	Signal name	1	+	2	-	3	NC(or FG)	4	SD	5	RD	6	NC	7	NC	8	SG	GT series RS232C type*1 *2		
	Pin No.	Signal name																																								
1																																										
2	SD																																									
3	RD																																									
4																																										
5	SG																																									
6																																										
7																																										
8																																										
9																																										
Pin No.	Signal name																																									
1	+																																									
2	-																																									
3	NC(or FG)																																									
4	SD																																									
5	RD																																									
6	NC																																									
7	NC																																									
8	SG																																									
	<p>Connection cable for the tool port (9-pin)</p> <table border="1"> <thead> <tr> <th>Pin No.</th> <th>Signal name</th> </tr> </thead> <tbody> <tr><td>1</td><td></td></tr> <tr><td>2</td><td>SD</td></tr> <tr><td>3</td><td>RD</td></tr> <tr><td>4</td><td></td></tr> <tr><td>5</td><td>SG</td></tr> <tr><td>6</td><td></td></tr> <tr><td>7</td><td></td></tr> <tr><td>8</td><td></td></tr> <tr><td>9</td><td></td></tr> </tbody> </table> <p>GT side</p> <table border="1"> <thead> <tr> <th>Pin No.</th> <th>Signal name</th> </tr> </thead> <tbody> <tr><td>1</td><td>N.C.</td></tr> <tr><td>2</td><td>RD</td></tr> <tr><td>3</td><td>SD</td></tr> <tr><td>4</td><td>N.C.</td></tr> <tr><td>5</td><td>SG</td></tr> <tr><td>6</td><td>N.C.</td></tr> <tr><td>7</td><td>RS</td></tr> <tr><td>8</td><td>CS</td></tr> <tr><td>9</td><td>N.C.</td></tr> </tbody> </table>	Pin No.	Signal name	1		2	SD	3	RD	4		5	SG	6		7		8		9		Pin No.	Signal name	1	N.C.	2	RD	3	SD	4	N.C.	5	SG	6	N.C.	7	RS	8	CS	9	N.C.	GT707
Pin No.	Signal name																																									
1																																										
2	SD																																									
3	RD																																									
4																																										
5	SG																																									
6																																										
7																																										
8																																										
9																																										
Pin No.	Signal name																																									
1	N.C.																																									
2	RD																																									
3	SD																																									
4	N.C.																																									
5	SG																																									
6	N.C.																																									
7	RS																																									
8	CS																																									
9	N.C.																																									

\*1: Although nos.6 and 7 of the models except GT01 are RS/CS, they can be used in the above connection.

\*2: This is for RS232C type of GT01/GT02/GT02L/GT03-E/GT05/GT11/GT12/GT21/GT32/GT32-E/GT703/GT704.



# Chapter 5

---

## Connection With Siemens PLCs

## 5.1 Siemens S7-200 Series

### PLC model selection

Select "Siemens S7-200 series".

### Usable devices

Bit/Word Device		No.	Memo
Bit Device	Input	I00-I77	
	Output	Q00-Q77	
	Bit Memory	M00-M317	
	Timer(contact)	T00-T255	
	Counter(contact)	C00-C255	
	Special Memory	SM00-SM1947	
	Sequence Control Relay	S00-S317	
Word Device	Input	IW0-IW6	Address should be an even number
	Output	QW0-QW6	Address should be an even number
	Bit Memory	MW0-MW30	Address should be an even number
	Timer(current)	T0-T255	Address should be an even number
	Counter(current)	C0-C255	Address should be an even number
	Special Memory	SMW0-SMW193	Address should be an even number
	Sequence Control Relay	SW0-SW30	Address should be an even number
	Variable Memory	VW0-VW5118	Address should be an even number

The following list illustrates each expression of PLC device in GTWIN.

When you enter a value of devices, follow below expression.

	Expression in PLC	Expression in GTWIN
Bit Device	Q3.2	Q3-2
Word Device	VW100	VW100

### Communication Parameters Settings

The example of communication settings of GT and PLC is shown below.

#### Setting Values for GT

Item	Setting
GT Unit No.	01
PLC Unit No.	02
Baud Rate	9600bps
Data Bits	8
Stop Bits	1
Parity	Even

#### Setting Values for PLC

Item	Setting
PLC Unit No.	02

## 5.1.1 RS232C Connection (Connected with PC/PPI Cable)

S7-200 and PC/PPI Cable are connected as follows, then connect to GT by the cable of following wiring diagram.

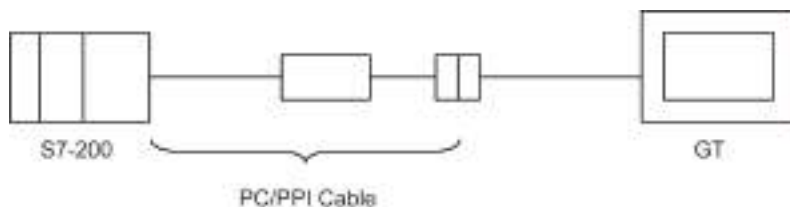

CPU	Wiring diagram	GT series																																								
CPU212 CPU214 CPU215 CPU216 CPU222	<p>PC/PPI cable side (9-pin)</p> <table border="1"> <thead> <tr> <th>Pin No.</th> <th>Signal name</th> </tr> </thead> <tbody> <tr><td>1</td><td></td></tr> <tr><td>2</td><td>SD</td></tr> <tr><td>3</td><td>RD</td></tr> <tr><td>4</td><td></td></tr> <tr><td>5</td><td>SG</td></tr> <tr><td>6</td><td></td></tr> <tr><td>7</td><td>RS</td></tr> <tr><td>8</td><td>CS</td></tr> <tr><td>9</td><td></td></tr> </tbody> </table> <p>GT side</p> <table border="1"> <thead> <tr> <th>Pin No.</th> <th>Signal name</th> </tr> </thead> <tbody> <tr><td>1</td><td>+</td></tr> <tr><td>2</td><td>-</td></tr> <tr><td>3</td><td>NC(or FG)</td></tr> <tr><td>4</td><td>SD</td></tr> <tr><td>5</td><td>RD</td></tr> <tr><td>6</td><td>NC</td></tr> <tr><td>7</td><td>NC</td></tr> <tr><td>8</td><td>SG</td></tr> </tbody> </table>	Pin No.	Signal name	1		2	SD	3	RD	4		5	SG	6		7	RS	8	CS	9		Pin No.	Signal name	1	+	2	-	3	NC(or FG)	4	SD	5	RD	6	NC	7	NC	8	SG	GT series RS232C type*1 *2		
Pin No.	Signal name																																									
1																																										
2	SD																																									
3	RD																																									
4																																										
5	SG																																									
6																																										
7	RS																																									
8	CS																																									
9																																										
Pin No.	Signal name																																									
1	+																																									
2	-																																									
3	NC(or FG)																																									
4	SD																																									
5	RD																																									
6	NC																																									
7	NC																																									
8	SG																																									
	<p>PC/PPI cable side (9-pin)</p> <table border="1"> <thead> <tr> <th>Pin No.</th> <th>Signal name</th> </tr> </thead> <tbody> <tr><td>1</td><td></td></tr> <tr><td>2</td><td>SD</td></tr> <tr><td>3</td><td>RD</td></tr> <tr><td>4</td><td></td></tr> <tr><td>5</td><td>SG</td></tr> <tr><td>6</td><td></td></tr> <tr><td>7</td><td>RS</td></tr> <tr><td>8</td><td>CS</td></tr> <tr><td>9</td><td></td></tr> </tbody> </table> <p>GT side</p> <table border="1"> <thead> <tr> <th>Pin No.</th> <th>Signal name</th> </tr> </thead> <tbody> <tr><td>1</td><td>N.C.</td></tr> <tr><td>2</td><td>RD</td></tr> <tr><td>3</td><td>SD</td></tr> <tr><td>4</td><td>N.C.</td></tr> <tr><td>5</td><td>SG</td></tr> <tr><td>6</td><td>N.C.</td></tr> <tr><td>7</td><td>RS</td></tr> <tr><td>8</td><td>CS</td></tr> <tr><td>9</td><td>N.C.</td></tr> </tbody> </table>	Pin No.	Signal name	1		2	SD	3	RD	4		5	SG	6		7	RS	8	CS	9		Pin No.	Signal name	1	N.C.	2	RD	3	SD	4	N.C.	5	SG	6	N.C.	7	RS	8	CS	9	N.C.	GT707
Pin No.	Signal name																																									
1																																										
2	SD																																									
3	RD																																									
4																																										
5	SG																																									
6																																										
7	RS																																									
8	CS																																									
9																																										
Pin No.	Signal name																																									
1	N.C.																																									
2	RD																																									
3	SD																																									
4	N.C.																																									
5	SG																																									
6	N.C.																																									
7	RS																																									
8	CS																																									
9	N.C.																																									

\*1: Although nos.6 and 7 of the models except GT01 are RS/CS, they can be used in the above connection.

\*2: This is for RS232C type of GT01/GT02/GT02L/GT03-E/GT05/GT11/GT12/GT21/GT32/GT32-E/GT703/GT704.

## 5.1.2 RS422 Connection

CPU	Wiring diagram	GT series																																						
CPU212 CPU214 CPU215 CPU216 CPU222	<div style="display: flex; justify-content: space-between;"> <div style="width: 45%;"> <p>PLC side</p> <table border="1" style="width: 100%; border-collapse: collapse;"> <thead> <tr> <th>Pin No.</th> <th>Signal name</th> </tr> </thead> <tbody> <tr><td>1</td><td>FG</td></tr> <tr><td>2</td><td>SG</td></tr> <tr><td>3</td><td>RxD/TxD+</td></tr> <tr><td>4</td><td>RS(TTL)</td></tr> <tr><td>5</td><td>SG</td></tr> <tr><td>6</td><td>+5V</td></tr> <tr><td>7</td><td>+24V</td></tr> <tr><td>8</td><td>RxD/TxD-</td></tr> <tr><td>9</td><td>N.C.</td></tr> </tbody> </table> </div> <div style="width: 10%; text-align: center;"> <p>To power supply</p> </div> <div style="width: 45%;"> <p>GT side</p> <table border="1" style="width: 100%; border-collapse: collapse;"> <thead> <tr> <th>Pin No.</th> <th>Signal name</th> </tr> </thead> <tbody> <tr><td>1</td><td>+</td></tr> <tr><td>2</td><td>-</td></tr> <tr><td>3</td><td>NC(or FG)</td></tr> <tr><td>4</td><td>+SD</td></tr> <tr><td>5</td><td>-SD</td></tr> <tr><td>6</td><td>+RD</td></tr> <tr><td>7</td><td>-RD</td></tr> <tr><td>8</td><td>E</td></tr> </tbody> </table> </div> </div>	Pin No.	Signal name	1	FG	2	SG	3	RxD/TxD+	4	RS(TTL)	5	SG	6	+5V	7	+24V	8	RxD/TxD-	9	N.C.	Pin No.	Signal name	1	+	2	-	3	NC(or FG)	4	+SD	5	-SD	6	+RD	7	-RD	8	E	RS422/RS485 type
Pin No.	Signal name																																							
1	FG																																							
2	SG																																							
3	RxD/TxD+																																							
4	RS(TTL)																																							
5	SG																																							
6	+5V																																							
7	+24V																																							
8	RxD/TxD-																																							
9	N.C.																																							
Pin No.	Signal name																																							
1	+																																							
2	-																																							
3	NC(or FG)																																							
4	+SD																																							
5	-SD																																							
6	+RD																																							
7	-RD																																							
8	E																																							

# Chapter 6

---

## Connection With LS Industrial Systems PLCs

## 6.1 MASTER-K (Cnet) Series

---

### PLC model selection

Select "LG MASTER-K (Cnet) Series".

### Usable devices

Bit/Word Device		No.
Bit Device	Input/Output	P0000-P063F
	Internal Relay	M0000-M191F
Word Device	Input/Output	PW0000-PW0063
	Internal Relay	MW0000-MW0191
	Data Register	D0000-D9999

### Communication Parameters Settings

The example of communication settings of GT and PLC is shown below.

#### Setting Values for GT (Set in the configuration setting of GTWIN.)

Item	Setting
Baud Rate	19200bps
Data Bits	8
Stop Bits	1
Parity	Non

#### Setting Values for PLC

Item	Setting
Station Number	00
Baud Rate	19200bps
Data Bits	8
Stop Bits	1
Parity	Non

## 6.1.1 Connection Method

CPU	Link I/F	Wiring diagram	GT series																																								
80S	RS232C port on CPU unit	<p>PLC side</p> <table border="1"> <thead> <tr> <th>Pin No.</th> <th>Signal name</th> </tr> </thead> <tbody> <tr><td>1</td><td>+5V</td></tr> <tr><td>2</td><td>RD1</td></tr> <tr><td>3</td><td>SD1</td></tr> <tr><td>4</td><td>RD2</td></tr> <tr><td>5</td><td>SG</td></tr> <tr><td>6</td><td>+5V</td></tr> <tr><td>7</td><td>SD2</td></tr> <tr><td>8</td><td>SG</td></tr> <tr><td>9</td><td>SG</td></tr> </tbody> </table> <p>To power supply</p> <p>GT side</p> <table border="1"> <thead> <tr> <th>Pin No.</th> <th>Signal name</th> </tr> </thead> <tbody> <tr><td>1</td><td>+</td></tr> <tr><td>2</td><td>-</td></tr> <tr><td>3</td><td>NC(or FG)</td></tr> <tr><td>4</td><td>SD</td></tr> <tr><td>5</td><td>RD</td></tr> <tr><td>6</td><td>NC</td></tr> <tr><td>7</td><td>NC</td></tr> <tr><td>8</td><td>SG</td></tr> </tbody> </table>	Pin No.	Signal name	1	+5V	2	RD1	3	SD1	4	RD2	5	SG	6	+5V	7	SD2	8	SG	9	SG	Pin No.	Signal name	1	+	2	-	3	NC(or FG)	4	SD	5	RD	6	NC	7	NC	8	SG	GT series RS232C type*1 *2		
Pin No.	Signal name																																										
1	+5V																																										
2	RD1																																										
3	SD1																																										
4	RD2																																										
5	SG																																										
6	+5V																																										
7	SD2																																										
8	SG																																										
9	SG																																										
Pin No.	Signal name																																										
1	+																																										
2	-																																										
3	NC(or FG)																																										
4	SD																																										
5	RD																																										
6	NC																																										
7	NC																																										
8	SG																																										
200S	RS232C port on CPU unit	<p>PLC side</p> <table border="1"> <thead> <tr> <th>Pin No.</th> <th>Signal name</th> </tr> </thead> <tbody> <tr><td>1</td><td>+5V</td></tr> <tr><td>2</td><td>RD1</td></tr> <tr><td>3</td><td>SD1</td></tr> <tr><td>4</td><td>RD2</td></tr> <tr><td>5</td><td>SG</td></tr> <tr><td>6</td><td>+5V</td></tr> <tr><td>7</td><td>SD2</td></tr> <tr><td>8</td><td>SG</td></tr> <tr><td>9</td><td>SG</td></tr> </tbody> </table> <p>GT side</p> <table border="1"> <thead> <tr> <th>Pin No.</th> <th>Signal name</th> </tr> </thead> <tbody> <tr><td>1</td><td>N.C.</td></tr> <tr><td>2</td><td>RD</td></tr> <tr><td>3</td><td>SD</td></tr> <tr><td>4</td><td>N.C.</td></tr> <tr><td>5</td><td>SG</td></tr> <tr><td>6</td><td>N.C.</td></tr> <tr><td>7</td><td>RS</td></tr> <tr><td>8</td><td>CS</td></tr> <tr><td>9</td><td>N.C.</td></tr> </tbody> </table>	Pin No.	Signal name	1	+5V	2	RD1	3	SD1	4	RD2	5	SG	6	+5V	7	SD2	8	SG	9	SG	Pin No.	Signal name	1	N.C.	2	RD	3	SD	4	N.C.	5	SG	6	N.C.	7	RS	8	CS	9	N.C.	GT707
Pin No.	Signal name																																										
1	+5V																																										
2	RD1																																										
3	SD1																																										
4	RD2																																										
5	SG																																										
6	+5V																																										
7	SD2																																										
8	SG																																										
9	SG																																										
Pin No.	Signal name																																										
1	N.C.																																										
2	RD																																										
3	SD																																										
4	N.C.																																										
5	SG																																										
6	N.C.																																										
7	RS																																										
8	CS																																										
9	N.C.																																										
200S	G6L-CUEB	<p>PLC side</p> <table border="1"> <thead> <tr> <th>Pin No.</th> <th>Signal name</th> </tr> </thead> <tbody> <tr><td>1</td><td>CD</td></tr> <tr><td>2</td><td>RD</td></tr> <tr><td>3</td><td>SD</td></tr> <tr><td>4</td><td>DTR</td></tr> <tr><td>5</td><td>SG</td></tr> <tr><td>6</td><td>DSG</td></tr> <tr><td>7</td><td>RTS</td></tr> <tr><td>8</td><td>CTS</td></tr> <tr><td>9</td><td>RI</td></tr> </tbody> </table> <p>To power supply</p> <p>GT side</p> <table border="1"> <thead> <tr> <th>Pin No.</th> <th>Signal name</th> </tr> </thead> <tbody> <tr><td>1</td><td>+</td></tr> <tr><td>2</td><td>-</td></tr> <tr><td>3</td><td>NC(or FG)</td></tr> <tr><td>4</td><td>SD</td></tr> <tr><td>5</td><td>RD</td></tr> <tr><td>6</td><td>NC</td></tr> <tr><td>7</td><td>NC</td></tr> <tr><td>8</td><td>SG</td></tr> </tbody> </table>	Pin No.	Signal name	1	CD	2	RD	3	SD	4	DTR	5	SG	6	DSG	7	RTS	8	CTS	9	RI	Pin No.	Signal name	1	+	2	-	3	NC(or FG)	4	SD	5	RD	6	NC	7	NC	8	SG	GT series RS232C type*1 *2		
Pin No.	Signal name																																										
1	CD																																										
2	RD																																										
3	SD																																										
4	DTR																																										
5	SG																																										
6	DSG																																										
7	RTS																																										
8	CTS																																										
9	RI																																										
Pin No.	Signal name																																										
1	+																																										
2	-																																										
3	NC(or FG)																																										
4	SD																																										
5	RD																																										
6	NC																																										
7	NC																																										
8	SG																																										
300S	G4L-CUEA																																										
1000S	G3L-CUEA	<p>PLC side</p> <table border="1"> <thead> <tr> <th>Pin No.</th> <th>Signal name</th> </tr> </thead> <tbody> <tr><td>1</td><td>CD</td></tr> <tr><td>2</td><td>RD</td></tr> <tr><td>3</td><td>SD</td></tr> <tr><td>4</td><td>DTR</td></tr> <tr><td>5</td><td>SG</td></tr> <tr><td>6</td><td>DSG</td></tr> <tr><td>7</td><td>RTS</td></tr> <tr><td>8</td><td>CTS</td></tr> <tr><td>9</td><td>RI</td></tr> </tbody> </table> <p>GT side</p> <table border="1"> <thead> <tr> <th>Pin No.</th> <th>Signal name</th> </tr> </thead> <tbody> <tr><td>1</td><td>N.C.</td></tr> <tr><td>2</td><td>RD</td></tr> <tr><td>3</td><td>SD</td></tr> <tr><td>4</td><td>N.C.</td></tr> <tr><td>5</td><td>SG</td></tr> <tr><td>6</td><td>N.C.</td></tr> <tr><td>7</td><td>RS</td></tr> <tr><td>8</td><td>CS</td></tr> <tr><td>9</td><td>N.C.</td></tr> </tbody> </table>	Pin No.	Signal name	1	CD	2	RD	3	SD	4	DTR	5	SG	6	DSG	7	RTS	8	CTS	9	RI	Pin No.	Signal name	1	N.C.	2	RD	3	SD	4	N.C.	5	SG	6	N.C.	7	RS	8	CS	9	N.C.	GT707
Pin No.	Signal name																																										
1	CD																																										
2	RD																																										
3	SD																																										
4	DTR																																										
5	SG																																										
6	DSG																																										
7	RTS																																										
8	CTS																																										
9	RI																																										
Pin No.	Signal name																																										
1	N.C.																																										
2	RD																																										
3	SD																																										
4	N.C.																																										
5	SG																																										
6	N.C.																																										
7	RS																																										
8	CS																																										
9	N.C.																																										

\*1: Although nos.6 and 7 of the models except GT01 are RS/CS, they can be used in the above connection.

\*2: This is for RS232C type of GT01/GT02/GT02L/GT03-E/GT05/GT11/GT12/GT21/GT32/GT32-E/GT703/GT704.





# Chapter 7

---

## Connection With Yokogawa PLCs

## 7.1 FA-M3 Series

### PLC model selection

Select "Yokogawa FA-M3 Series"

### Usable devices

Bit/Word Device		No.	Memo
Bit Device	Input Relay	X00201-X71664	Specify by slot number(1 digit) + unit number(2 digit) + terminal number(2 digit)
	Output Relay	Y00201-Y71164	Specify by slot number(1 digit) + unit number(2 digit) + terminal number(2 digit)
	Internal Relay	I00001-I65535	
	Link Relay	L00001-L78192	Specify by system number(1 digit) + link relay number(4 digit)
	Timer	T0001-T3072	
	Counter	C0001-C3072	
Word Device	Input Relay	X00201-X71649	Specify address by the lower 2 digits: 17, 33, or 49.
	Output Relay	Y00201-Y71649	Specify address by the lower 2 digits: 17, 33, or 49.
	Internal Relay	I00001-I65521	Specify in single units of remainder after dividing the address by 16.
	Link Relay	L00001-L78177	Specify in single units of remainder after dividing the lower 4 digits of the address by 16.
	Data Register	D00001-D65535	
	Link Register	W00001-W78192	Specify by system number(1 digit) + link register number(4 digit)
	Timer(current)	TP0001-TP3072	
	Counter(current)	CP0001-CP3072	
	File Register	B000001-B099999	

### Communication Parameters Settings

The example of communication settings of GT and PLC is shown below.

#### Setting values for GT (Set in the configuration setting of GTWIN.)

Item	Setting
PLC Unit No.	1
Baud Rate	19200bps
Length of Bits	8
Stop Bits	1
Parity	None

#### Setting Values for PLC (Link I/F)

Item	Setting
Station Number	1
Baud Rate	19200bps
Length of Bits	8
Stop Bits	1
Parity	None
Check Sum	No
Specify End Character	Yes
Protect Function	No

## 7.1.1 Connection Using PC Link Module

CPU	PC link module	Wiring diagram	GT series
F3SP21-0N F3SP25-2N F3SP28-3N F3SP28-3S F3SP35-5N F3SP38-6N F3SP38-6S F3SP53-4H F3SP53-4S F3SP58-6H F3SP58-6S F3SP59-7S	F3LC11-1N F3LC11-1F F3LC12-1F		GT series RS232C type*1 *2
			GT707

\*1: Although nos.6 and 7 of the models except GT01 are RS/CS, they can be used in the above connection.

\*2: This is for RS232C type of GT01/GT02/GT02L/GT03-E/GT05/GT11/GT12/GT21/GT32/GT32-E/GT703/GT704.

## 7.1.2 CPU Direct Connection

PLC and a cable for a programming tool (KM11-2T) are connected as follows, then connect to GT by the cable of following wiring diagram.

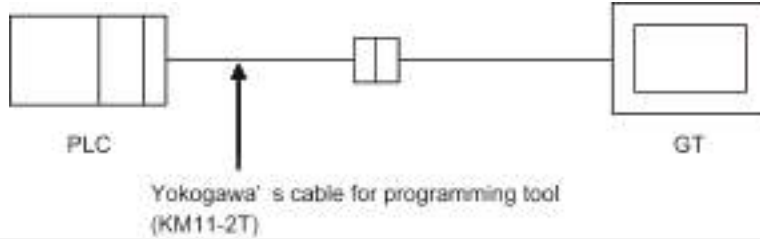

CPU	Conversion cable	Wiring diagram	GT series																																								
F3SP21-0N F3SP25-2N F3SP28-3N F3SP28-3S F3SP35-5N F3SP38-6N F3SP38-6S F3SP53-4H F3SP53-4S F3SP58-6H F3SP58-6S F3SP59-7S	KM11-2T	<p>Cable side</p> <table border="1"> <thead> <tr> <th>Pin No.</th> <th>Signal name</th> </tr> </thead> <tbody> <tr><td>1</td><td>-</td></tr> <tr><td>2</td><td>SD</td></tr> <tr><td>3</td><td>RD</td></tr> <tr><td>4</td><td>DR</td></tr> <tr><td>5</td><td>SG</td></tr> <tr><td>6</td><td>ER</td></tr> <tr><td>7</td><td>CS</td></tr> <tr><td>8</td><td>RS</td></tr> <tr><td>9</td><td>-</td></tr> </tbody> </table> <p>To power supply</p> <p>GT side</p> <table border="1"> <thead> <tr> <th>Pin No.</th> <th>Signal name</th> </tr> </thead> <tbody> <tr><td>1</td><td>+</td></tr> <tr><td>2</td><td>-</td></tr> <tr><td>3</td><td>NC(or FG)</td></tr> <tr><td>4</td><td>SD</td></tr> <tr><td>5</td><td>RD</td></tr> <tr><td>6</td><td>NC</td></tr> <tr><td>7</td><td>NC</td></tr> <tr><td>8</td><td>SG</td></tr> </tbody> </table>	Pin No.	Signal name	1	-	2	SD	3	RD	4	DR	5	SG	6	ER	7	CS	8	RS	9	-	Pin No.	Signal name	1	+	2	-	3	NC(or FG)	4	SD	5	RD	6	NC	7	NC	8	SG	GT series RS232C type*1 *2		
Pin No.	Signal name																																										
1	-																																										
2	SD																																										
3	RD																																										
4	DR																																										
5	SG																																										
6	ER																																										
7	CS																																										
8	RS																																										
9	-																																										
Pin No.	Signal name																																										
1	+																																										
2	-																																										
3	NC(or FG)																																										
4	SD																																										
5	RD																																										
6	NC																																										
7	NC																																										
8	SG																																										
		<p>Cable side</p> <table border="1"> <thead> <tr> <th>Pin No.</th> <th>Signal name</th> </tr> </thead> <tbody> <tr><td>1</td><td>-</td></tr> <tr><td>2</td><td>SD</td></tr> <tr><td>3</td><td>RD</td></tr> <tr><td>4</td><td>DR</td></tr> <tr><td>5</td><td>SG</td></tr> <tr><td>6</td><td>ER</td></tr> <tr><td>7</td><td>CS</td></tr> <tr><td>8</td><td>RS</td></tr> <tr><td>9</td><td>-</td></tr> </tbody> </table> <p>GT side</p> <table border="1"> <thead> <tr> <th>Pin No.</th> <th>Signal name</th> </tr> </thead> <tbody> <tr><td>1</td><td>N.C.</td></tr> <tr><td>2</td><td>RD</td></tr> <tr><td>3</td><td>SD</td></tr> <tr><td>4</td><td>N.C.</td></tr> <tr><td>5</td><td>SG</td></tr> <tr><td>6</td><td>N.C.</td></tr> <tr><td>7</td><td>RS</td></tr> <tr><td>8</td><td>CS</td></tr> <tr><td>9</td><td>N.C.</td></tr> </tbody> </table>	Pin No.	Signal name	1	-	2	SD	3	RD	4	DR	5	SG	6	ER	7	CS	8	RS	9	-	Pin No.	Signal name	1	N.C.	2	RD	3	SD	4	N.C.	5	SG	6	N.C.	7	RS	8	CS	9	N.C.	GT707
Pin No.	Signal name																																										
1	-																																										
2	SD																																										
3	RD																																										
4	DR																																										
5	SG																																										
6	ER																																										
7	CS																																										
8	RS																																										
9	-																																										
Pin No.	Signal name																																										
1	N.C.																																										
2	RD																																										
3	SD																																										
4	N.C.																																										
5	SG																																										
6	N.C.																																										
7	RS																																										
8	CS																																										
9	N.C.																																										

\*1: Although nos.6 and 7 of the models except GT01 are RS/CS, they can be used in the above connection.

\*2: This is for RS232C type of GT01/GT02/GT02L/GT03-E/GT05/GT11/GT12/GT21/GT32/GT32-E/GT703/GT704.



# Chapter 8

---

## Connection With Keyence PLCs

## 8.1 KV-10/16/24/40 Series

### PLC model selection

Select "Keyence KV-10/16/24/40 series".

Confirm the appropriate versions of GTWIN and GT to connect with Keyence KV-10/16/24/40 series.

GT series	GTWIN Version	GT Version
GT01	Ver.2.80 or later	Ver.1.31 or later
GT02	Ver.2.A0 or later	Ver.1.00 or later
GT02L	Ver.2.B0 or later	Ver.1.00 or later
GT03-E	Ver.2.E0 or later	Ver.1.00 or later
GT05	Ver.2.90 or later	Ver.1.00 or later
GT11	Ver.2.80 or later	Ver.1.21 or later
GT12	Ver.2.97 or later	Ver.1.00 or later
GT21	Ver.2.80 or later	Ver.1.11 or later
GT32	Ver.2.80 or later	Ver.1.00 or later
GT32-E	Ver.2.C0 or later	Ver.1.00 or later

### Usable devices

Bit/Word Device		No.	Memo
Bit Device	Relay	00000-17915	
	Timer	T000-T249	
	Counter	C000-C249	
	High-speed Counter/CTH	CTH0-CTH1	
	High-speed Counter Comparator	CTC0-CTC3	It is not possible to output it.
Word Device	Data Memory	DM0000-DM1999	
	Temporary Data Memory	DM0000-DM1999	
	Digital Trimmer	AT0-AT1	
	Timer(current value)	TC000-TC249	
	Counter(current value)	CC000-CC249	
	High-speed counter/CTH (current value)	CTHC0-CTHC1	
	High-speed Counter Comparator(current Value)	CTCC0-CTCC3	
	Timer(set value)	TS000-TS249	
	Counter(set value)	CS000-CS249	
	High-speed counter/CTH (set value)	CTHS0-CTHS1	
	High-speed Counter Comparator(set value)	CTCS0-CTCS3	

Note1) The high-speed counter comparator cannot output.

Note2) It takes some time for communicating due to limitations of PLC communication protocol.

Therefore, the speed of screen change may be slower, or the response of the touch switches may be worse.



## Communication Parameters Settings

The example of communication settings of GT and PLC is shown below.

### Setting Values for GT (Set in the configuration setting of GTWIN.)

Item	Setting
Baud Rate	9600bps
Data Bits	8
Stop Bits	1
Parity	Even

## 8.1.1 Connection Method

Wiring diagram		GT series																																		
<p>PLC side</p> <table border="1"> <thead> <tr> <th>Pin No.</th> <th>Signal name</th> </tr> </thead> <tbody> <tr><td>1</td><td>-</td></tr> <tr><td>2</td><td>-</td></tr> <tr><td>3</td><td>RD</td></tr> <tr><td>4</td><td>SG</td></tr> <tr><td>5</td><td>SD</td></tr> <tr><td>6</td><td>-</td></tr> </tbody> </table> <p>To power supply</p> <p>GT side</p> <table border="1"> <thead> <tr> <th>Pin No.</th> <th>Signal name</th> </tr> </thead> <tbody> <tr><td>1</td><td>+</td></tr> <tr><td>2</td><td>-</td></tr> <tr><td>3</td><td>NC(or FG)</td></tr> <tr><td>4</td><td>SD</td></tr> <tr><td>5</td><td>RD</td></tr> <tr><td>6</td><td>NC</td></tr> <tr><td>7</td><td>NC</td></tr> <tr><td>8</td><td>SG</td></tr> </tbody> </table> <p>Modular connector</p> <p>1 2 3 4 5 6</p>		Pin No.	Signal name	1	-	2	-	3	RD	4	SG	5	SD	6	-	Pin No.	Signal name	1	+	2	-	3	NC(or FG)	4	SD	5	RD	6	NC	7	NC	8	SG	GT series RS232C type*2 *3		
Pin No.	Signal name																																			
1	-																																			
2	-																																			
3	RD																																			
4	SG																																			
5	SD																																			
6	-																																			
Pin No.	Signal name																																			
1	+																																			
2	-																																			
3	NC(or FG)																																			
4	SD																																			
5	RD																																			
6	NC																																			
7	NC																																			
8	SG																																			
<p>PLC side</p> <table border="1"> <thead> <tr> <th>Pin No.</th> <th>Signal name</th> </tr> </thead> <tbody> <tr><td>1</td><td>-</td></tr> <tr><td>2</td><td>-</td></tr> <tr><td>3</td><td>RD</td></tr> <tr><td>4</td><td>SG</td></tr> <tr><td>5</td><td>SD</td></tr> <tr><td>6</td><td>-</td></tr> </tbody> </table> <p>GT side</p> <table border="1"> <thead> <tr> <th>Pin No.</th> <th>Signal name</th> </tr> </thead> <tbody> <tr><td>1</td><td>N.C.</td></tr> <tr><td>2</td><td>RD</td></tr> <tr><td>3</td><td>SD</td></tr> <tr><td>4</td><td>N.C.</td></tr> <tr><td>5</td><td>SG</td></tr> <tr><td>6</td><td>N.C.</td></tr> <tr><td>7</td><td>RS</td></tr> <tr><td>8</td><td>CS</td></tr> <tr><td>9</td><td>N.C.</td></tr> </tbody> </table> <p>Modular connector</p> <p>1 2 3 4 5 6</p>		Pin No.	Signal name	1	-	2	-	3	RD	4	SG	5	SD	6	-	Pin No.	Signal name	1	N.C.	2	RD	3	SD	4	N.C.	5	SG	6	N.C.	7	RS	8	CS	9	N.C.	GT707
Pin No.	Signal name																																			
1	-																																			
2	-																																			
3	RD																																			
4	SG																																			
5	SD																																			
6	-																																			
Pin No.	Signal name																																			
1	N.C.																																			
2	RD																																			
3	SD																																			
4	N.C.																																			
5	SG																																			
6	N.C.																																			
7	RS																																			
8	CS																																			
9	N.C.																																			

\*1: The numbers of module connector on the PLC show the pin numbers on the unit.

\*2: Although nos.6 and 7 of the models except GT01 are RS/CS, they can be used in the above connection.

\*3: This is for RS232C type of GT01/GT02/GT02L/GT03-E/GT05/GT11/GT12/GT21/GT32/GT32-E/GT703/GT704.

## 8.2 KV-700 Series

### PLC model selection

Select "Keyence KV-700 Series".

### Usable devices

Bit/Word Device		No.	Memo
Bit Device	Relay	00000-59915	
	Control Relay	CR0000-CR3915	
	Timer	T000-T511	
	Counter	C000-C511	
	High-speed Counter Comparator	CTC0-CTC3	It is not possible to output it.
Word Device	Data Memory	DM00000-DM39999	
	Control Memory	CM0000-CM3999	
	Temporary Data Memory	TM000-TM511	
Double Word Device	Digital Trimmer	AT0-AT7	
	Timer(set Value)	T/TC000-T/TC511	
	Counter(set Value)	C/CC000-C/CC511	
	High-speed Counter Comparator(set Value)	CTH0-CTH1	
	Timer(current)	T/TS000-T/TS511	
	Counter(current)	C/CS000-C/CS511	
	High-speed Counter Comparator(current)	CTC0-CTC3	

### Communication Parameters Settings

The example of communication settings of GT and PLC is shown below.

#### Setting Values for GT (Set in the configuration setting of GTWIN.)

Item	Setting
Baud Rate	9600bps
Data Bits	8
Stop Bits	1
Parity	Even

## 8.2.1 Connection Method

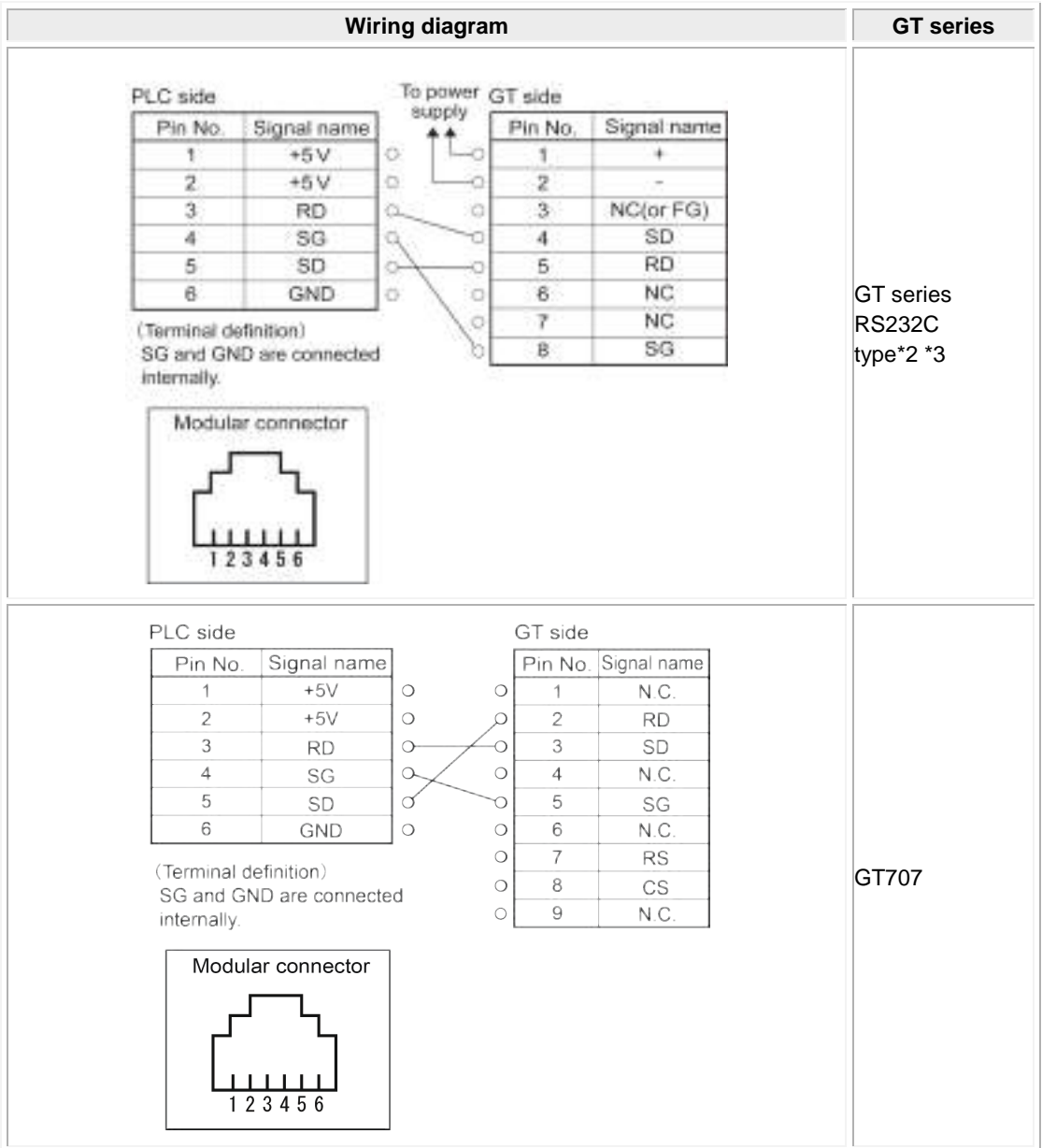

GT series  
RS232C  
type\*2 \*3

GT707

\*1: The numbers of module connector on the PLC show the pin numbers on the unit.

\*2: Although nos.6 and 7 of the models except GT01 are RS/CS, they can be used in the above connection.

\*3: This is for RS232C type of GT01/GT02/GT02L/GT03-E/GT05/GT11/GT12/GT21/GT32/GT32-E/GT703/GT704.

## 8.3 KV-700 Series Connected using Unit KV-L20R/V

### PLC model selection

Select "Keyence KV-700 Series".

### Usable devices

Bit/Word Device		No.	Memo
Bit Device	Relay	00000-59915	
	Control Relay	CR0000-CR3915	
	Timer	T000-T511	
	Counter	C000-C511	
	High-speed Counter Comparator	CTC0-CTC3	It is not possible to output it.
Word Device	Data Memory	DM00000-DM39999	
	Control Memory	CM0000-CM3999	
	Temporary Data Memory	TM000-TM511	
Double Word Device	Digital Trimmer	AT0-AT7	
	Timer(set Value)	T/TC000-T/TC511	
	Counter(set Value)	C/CC000-C/CC511	
	High-speed Counter Comparator(set Value)	CTH0-CTH1	
	Timer(current)	T/TS000-T/TS511	
	Counter(current)	C/CS000-C/CS511	
	High-speed Counter Comparator(current)	CTC0-CTC3	

### Communication Parameters Settings

The example of communication settings of GT and PLC is shown below.

#### Setting Values for GT (Set in the configuration setting of GTWIN.)

Item	Setting
Baud Rate	9600, 19200, 38400, 57600, 115200 bps
Data Bits	8
Stop Bits	1
Parity	Even

#### KV-L20R Setting (Port1)

Item	Setting
Operation	KV mode(high link)
Baud rate	9600, 19200, 38400, 57600, 115200 bps
RS/CS flow control	Not used



#### Note:

- Use the port 1.
- Use a unit editor supplied with the KV BUILDER for the settings of the KV-L20R/V.

### 8.3.1 Connection Method

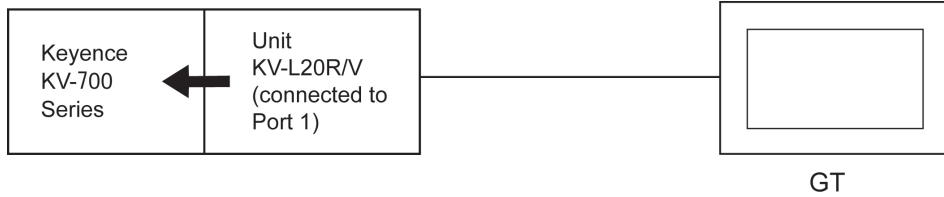

Wiring diagram		GT Series																																								
<p>KV-L20R/V side D-sub 9-pin</p> <table border="1"> <thead> <tr> <th>Pin No.</th> <th>Signal name</th> </tr> </thead> <tbody> <tr><td>1</td><td>-</td></tr> <tr><td>2</td><td>RD</td></tr> <tr><td>3</td><td>SD</td></tr> <tr><td>4</td><td>-</td></tr> <tr><td>5</td><td>SG</td></tr> <tr><td>6</td><td>-</td></tr> <tr><td>7</td><td>RS</td></tr> <tr><td>8</td><td>CS</td></tr> <tr><td>9</td><td>-</td></tr> </tbody> </table>	Pin No.	Signal name	1	-	2	RD	3	SD	4	-	5	SG	6	-	7	RS	8	CS	9	-	<p>To power supply</p> <p>GT side</p> <table border="1"> <thead> <tr> <th>Pin No.</th> <th>Signal Name</th> </tr> </thead> <tbody> <tr><td>1</td><td>+</td></tr> <tr><td>2</td><td>-</td></tr> <tr><td>3</td><td>NC(or FG)</td></tr> <tr><td>4</td><td>SD</td></tr> <tr><td>5</td><td>RD</td></tr> <tr><td>6</td><td>NC</td></tr> <tr><td>7</td><td>NC</td></tr> <tr><td>8</td><td>SG</td></tr> </tbody> </table>	Pin No.	Signal Name	1	+	2	-	3	NC(or FG)	4	SD	5	RD	6	NC	7	NC	8	SG	<p>GT series RS232C type*1 *2</p>		
Pin No.	Signal name																																									
1	-																																									
2	RD																																									
3	SD																																									
4	-																																									
5	SG																																									
6	-																																									
7	RS																																									
8	CS																																									
9	-																																									
Pin No.	Signal Name																																									
1	+																																									
2	-																																									
3	NC(or FG)																																									
4	SD																																									
5	RD																																									
6	NC																																									
7	NC																																									
8	SG																																									
<p>KV-L20R/V side D-sub 9-pin</p> <table border="1"> <thead> <tr> <th>Pin No.</th> <th>Signal name</th> </tr> </thead> <tbody> <tr><td>1</td><td>-</td></tr> <tr><td>2</td><td>RD</td></tr> <tr><td>3</td><td>SD</td></tr> <tr><td>4</td><td>-</td></tr> <tr><td>5</td><td>SG</td></tr> <tr><td>6</td><td>-</td></tr> <tr><td>7</td><td>RS</td></tr> <tr><td>8</td><td>CS</td></tr> <tr><td>9</td><td>-</td></tr> </tbody> </table>	Pin No.	Signal name	1	-	2	RD	3	SD	4	-	5	SG	6	-	7	RS	8	CS	9	-	<p>GT side</p> <table border="1"> <thead> <tr> <th>Pin No.</th> <th>Signal Name</th> </tr> </thead> <tbody> <tr><td>1</td><td>N.C.</td></tr> <tr><td>2</td><td>RD</td></tr> <tr><td>3</td><td>SD</td></tr> <tr><td>4</td><td>N.C.</td></tr> <tr><td>5</td><td>SG</td></tr> <tr><td>6</td><td>N.C.</td></tr> <tr><td>7</td><td>RS</td></tr> <tr><td>8</td><td>CS</td></tr> <tr><td>9</td><td>N.C.</td></tr> </tbody> </table>	Pin No.	Signal Name	1	N.C.	2	RD	3	SD	4	N.C.	5	SG	6	N.C.	7	RS	8	CS	9	N.C.	<p>GT707</p>
Pin No.	Signal name																																									
1	-																																									
2	RD																																									
3	SD																																									
4	-																																									
5	SG																																									
6	-																																									
7	RS																																									
8	CS																																									
9	-																																									
Pin No.	Signal Name																																									
1	N.C.																																									
2	RD																																									
3	SD																																									
4	N.C.																																									
5	SG																																									
6	N.C.																																									
7	RS																																									
8	CS																																									
9	N.C.																																									

\*1: Although nos.6 and 7 of the models except GT01 are RS/CS, they can be used in the above connection.

\*2: This is for RS232C type of GT01/GT02/GT02L/GT03-E/GT05/GT11/GT12/GT21/GT32/GT32-E/GT703/GT704.

## 8.4 KV-1000 Series

### PLC model selection

Select "Keyence KV-1000 Series".

### Usable devices

	Bit/Word Device	No.	Memo
Bit Device	Relay	00000-59915	
	Control Relay	CR0000-CR3915	
	Internal Hold Relay	MR00000-MR99915	
	Latch Relay	LR00000-LR99915	
	Timer	T0000-T3999	
	Counter	C0000-C3999	
	High-speed Counter Comparator	CTC0-CTC3	It is not possible to output it.
Word Device	Data Memory	DM00000-DM65534	
	Control Memory	CM00000-CM11998	
	Temporary Data Memory	TM000-TM511	
	Enhancing Data Memory	EM00000-FM65534	
	Enhancing Data Memory	FM00000-FM32766	
	Index Register	Z01-Z12	
Double Word Device	Digital Trimmer	AT0-AT7	
	Timer(set Value)	T/TC0000-T/TC3999	
	Counter(set Value)	C/CC0000-C/CC3999	
	High-speed Counter Comparator(set Value)	CTH0-CTH1	
	Timer(current)	T/TS0000-T/TS3999	
	Counter(current)	C/CS0000-C/CS3999	
	High-speed Counter Comparator(current)	CTC0-CTC3	

### Communication Parameters Settings

The example of communication settings of GT and PLC is shown below.

#### Setting Values for GT (Set in the configuration setting of GTWIN.)

Item	Setting
Baud Rate	9600, 19200, 38400, 57600, 115200 bps
Data Bits	8
Stop Bits	1
Parity	Even

### 8.4.1 Connection Method

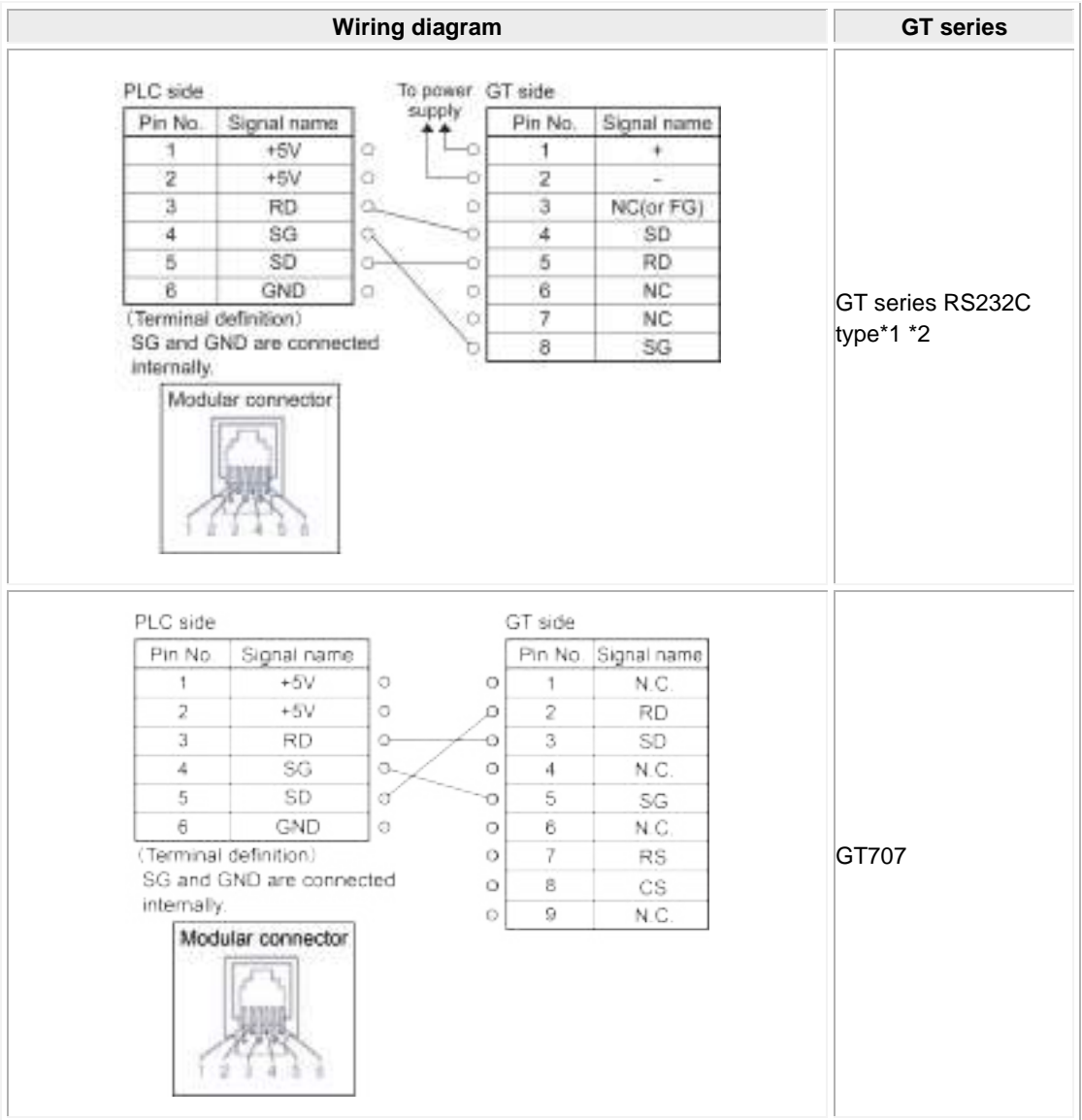

\*1: Although nos.6 and 7 of the models except GT01 are RS/CS, they can be used in the above connection.

\*2: This is for RS232C type of GT01/GT02/GT02L/GT03-E/GT05/GT11/GT12/GT21/GT32/GT32-E/GT703/GT704.

## 8.5 KV-1000 Series Connected using Unit KV-L20R/V

### PLC model selection

Select "Keyence KV-1000 Series".

The following version of GTWIN is required to select "Keyence KV-1000 series" from the PLC model selection. When the version of your GTWIN is older than the one below, select "Keyence KV-700 series". In that case, the range of usable devices is the same as the one for Keyence KV-700 series.

GT	GTWIN Version	GT Version
GT01	Ver.2.90 or later	Ver.1.33 or later
GT02	Ver.2.A0 or later	Ver.1.00 or later
GT02L	Ver.2.B0 or later	Ver.1.00 or later
GT03-E	Ver.2.E0 or later	Ver.1.00 or later
GT05	Ver.2.90 or later	Ver.1.00 or later
GT11	Ver.2.90 or later	Ver.1.23 or later
GT12	Ver.2.97 or later	Ver.1.00 or later
GT21	Ver.2.90 or later	Ver.1.13 or later
GT32	Ver.2.90 or later	Ver.1.00 or later
GT32-E	Ver.2.C0 or later	Ver.1.00 or later

### Usable devices

	Bit/Word Device	No.	Memo
Bit Device	Relay	00000-59915	
	Control Relay	CR0000-CR3915	
	Timer	T000-T511	
	Counter	C000-C511	
	High-speed Counter Comparator	CTC0-CTC3	It is not possible to output it.
Word Device	Data Memory	DM00000-DM39999	
	Control Memory	CM0000-CM3999	
	Temporary Data Memory	TM000-TM511	
Double Word Device	Digital Trimmer	AT0-AT7	
	Timer(set Value)	T/TC000-T/TC511	
	Counter(set Value)	C/CC000-C/CC511	
	High-speed Counter Comparator(set Value)	CTH0-CTH1	
	Timer(current)	T/TS000-T/TS511	
	Counter(current)	C/CS000-C/CS511	
	High-speed Counter Comparator(current)	CTC0-CTC3	



### Communication Parameters Settings

The example of communication settings of GT and PLC is shown below.

#### Setting Values for GT (Set in the configuration setting of GTWIN.)

Item	Setting
Baud Rate	9600/19200/38400/57600/115200 bps
Data Bits	8
Stop Bits	1
Parity	Even

#### KV-L20R Setting (Port1)

Item	Setting
Operation	KV mode(high link)
Baud rate	9600/19200/38400/57600/115200 bps
RS/CS flow control	Not used



#### Note:

- Use the port 1.
- Use a unit editor supplied with the KV BUILDER for the settings of the KV-L20R/V.

## 8.5.1 Connection Method

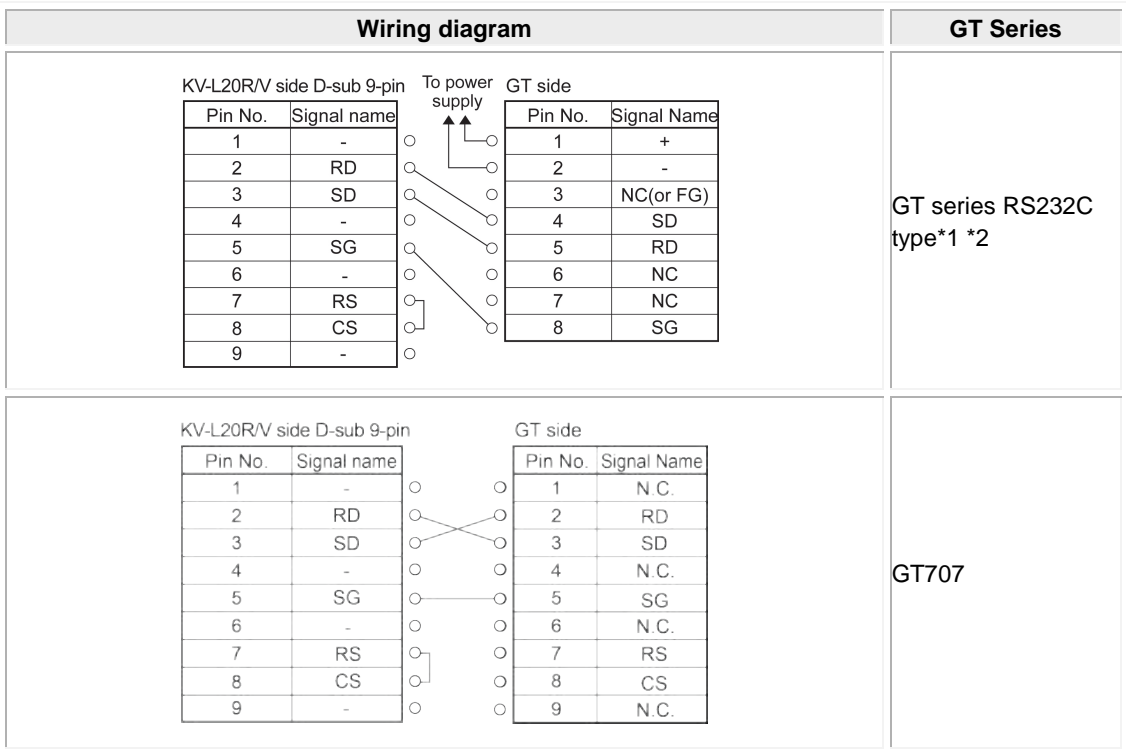
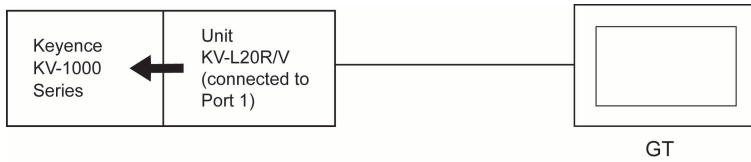

\*1: Although nos.6 and 7 of the models except GT01 are RS/CS, they can be used in the above connection.

\*2: This is for RS232C type of GT01/GT02/GT02L/GT03-E/GT05/GT11/GT12/GT21/GT32/GT32-E/GT703/GT704.

## 8.6 KV-3000 Series

### PLC model selection

Select "Keyence KV-3000/5000 Series".  
KV-5000 series cannot be connected to CPU directly.

### Usable devices

Bit/Word Device		No.	Memo
Bit Device	Input Relay Output Relay Internal Auxiliary Relay	R 0000~R 99915	
	Link Relay	B 0000~B 3FFF	
	Control Relay	CR0000~CR3915	
	Internal Hold Relay	MR00000~MR99915	
	Latch Relay	LR00000~LR99915	
	Work Relay	VB 0000~VB 3FFF	
	Timer(contact)	T0000~T3999	
	Counter(contact)	C0000~C3999	
	High-speed Counter Comparator(contact)	CTC0~CTC3	It is not possible to output it.
Word Device	Data Memory	DM00000~DM65534	
	Control Memory	CM 00000~CM 05999	
	Temporary Data Memory	TM000~TM511	
	Enhancing Data Memory	EM 00000~EM 65534	
	File register (Current bank system)	FM 00000~FM 32767	
	File register (Serial number system)	ZF 000000~ZF 131071	
	Link register	W 0000~W 3FFF	
	Work memory	VM 00000~VM 59999	
Double Word Device	Digital Trimmer	TRM 0~TRM 7	It is not possible to output it.
	Timer(set Value)	TC 0000~TC 3999	
	Counter(set Value)	CC 0000~CC 3999	
	High-speed Counter Comparator(set Value)	CTH 0~CTH 1	
	Timer(current)	TS 0000~TS 3999	
	Counter(current)	CS 0000~CS 3999	
		High-speed Counter Comparator(current)	CTC 0~CTC 3
	Index register	Z 01~Z 12	

### Communication Parameters Settings

The example of communication settings of GT and PLC is shown below.

#### Setting Values for GT (Set in the configuration setting of GTWIN.)

Item	Setting
Baud Rate	9600/19200/38400/57600/115200 bps
Data Bits	8
Stop Bits	1
Parity	Even

## 8.6.1 Connection Method

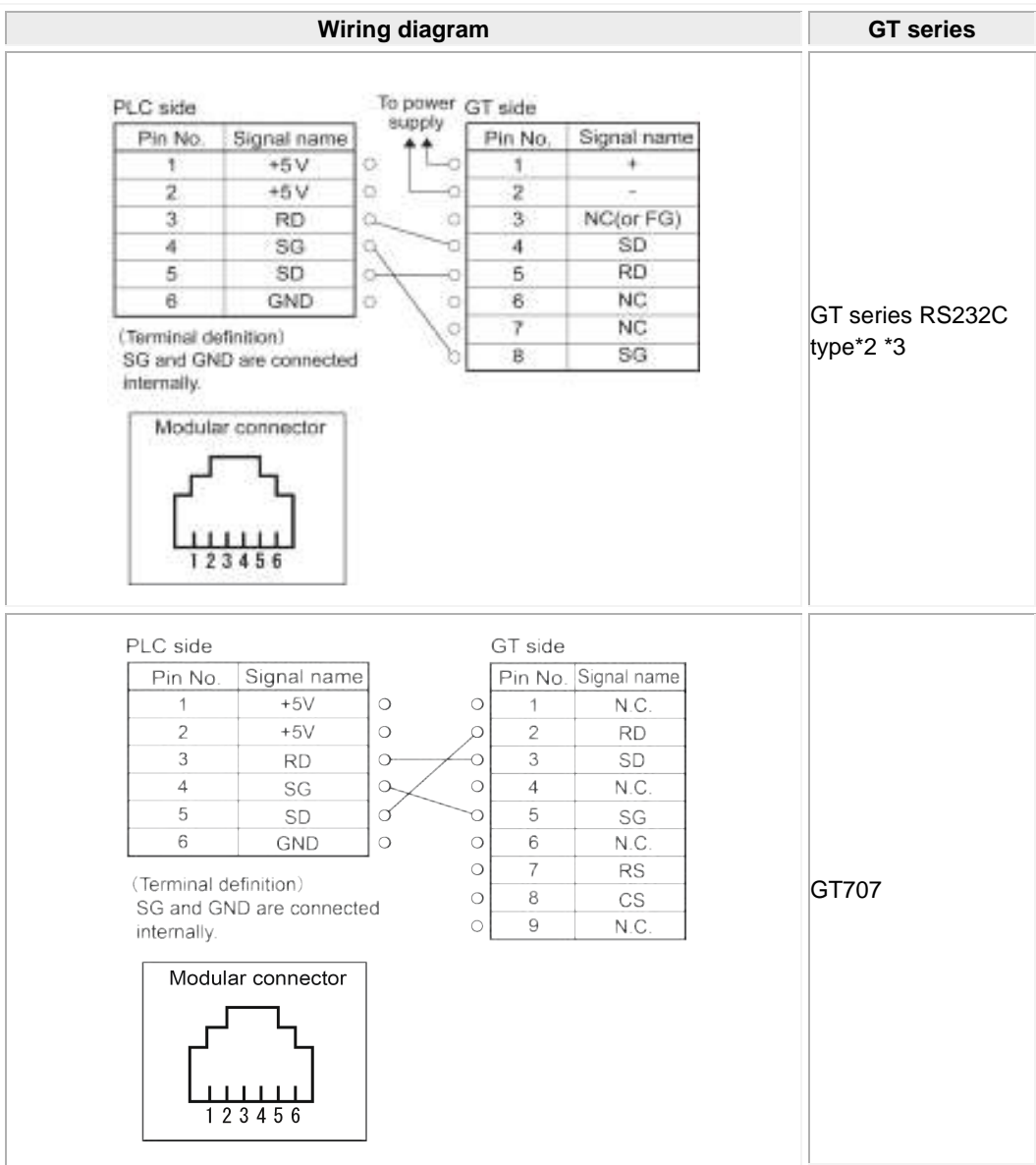

\*1: The numbers of module connector on the PLC show the pin numbers on the unit.

\*2: Although nos.6 and 7 of the models except GT01 are RS/CS, they can be used in the above connection.

\*3: This is for RS232C type of GT01/GT02/GT02L/GT03-E/GT05/GT11/GT12/GT21/GT32/GT32-E/GT703/GT704.

## 8.7 KV-3000/5000 Series Connected using Unit KV-L20R/V

### PLC model selection

Select "Keyence KV-3000/5000 Series".

### Usable devices

Bit/Word Device		No.	Memo
Bit Device	Input Relay Output Relay Internal Auxiliary Relay	R 0000~R 99915	
	Link Relay	B 0000~B 3FFF	
	Control Relay	CR0000~CR3915	
	Internal Hold Relay	MR00000~MR99915	
	Latch Relay	LR00000~LR99915	
	Work Relay	VB 0000~VB 3FFF	
	Timer(contact)	T0000~T3999	
	Counter(contact)	C0000~C3999	
	High-speed Counter Comparator(contact)	CTC0~CTC3	It is not possible to output it.
	Word Device	Data Memory	DM00000~DM65534
Control Memory		CM 00000~CM 05999	
Temporary Data Memory		TM000~TM511	
Enhancing Data Memory		EM 00000~EM 65534	
File register (Current bank system)		FM 00000~FM 32767	
File register (Serial number system)		ZF 000000~ZF 131071	
Link register		W 0000~W 3FFF	
Work memory		VM 00000~VM 59999	
Double Word Device	Digital Trimmer	TRM 0~TRM 7	It is not possible to output it.
	Timer(set Value)	TC 0000~TC 3999	
	Counter(set Value)	CC 0000~CC 3999	
	High-speed Counter Comparator(set Value)	CTH 0~CTH 1	
	Timer(current)	TS 0000~TS 3999	
	Counter(current)	CS 0000~CS 3999	
	High-speed Counter Comparator(current)	CTC 0~CTC 3	
	Index register	Z 01~Z 12	

### Communication Parameters Settings

The example of communication settings of GT and PLC is shown below.

#### Setting values for GT (Set in the configuration setting of GTWIN.)

Item	Setting
Baud Rate	9600/19200/38400/57600/115200 bps
Data Bits	8
Stop Bits	1
Parity	Even

#### KV-L20R Setting (Port1)

Item	Setting
Operation	KV mode(high link)
Baud rate	9600/19200/38400/57600/115200 bps
RS/CS flow control	Not used



**Note:**

- Use the port 1.
- Use a unit editor supplied with the KV BUILDER for the settings of the KV-L20R/V.

## 8.7.1 Connection Method

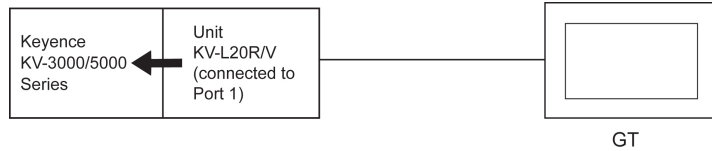

Wiring diagram		GT Series																																							
<p>KV-L20R/V side D-sub 9-pin</p> <table border="1"> <thead> <tr> <th>Pin No.</th> <th>Signal name</th> </tr> </thead> <tbody> <tr><td>1</td><td>-</td></tr> <tr><td>2</td><td>RD</td></tr> <tr><td>3</td><td>SD</td></tr> <tr><td>4</td><td>-</td></tr> <tr><td>5</td><td>SG</td></tr> <tr><td>6</td><td>-</td></tr> <tr><td>7</td><td>RS</td></tr> <tr><td>8</td><td>CS</td></tr> <tr><td>9</td><td>-</td></tr> </tbody> </table> <p>To power supply</p> <p>GT side</p> <table border="1"> <thead> <tr> <th>Pin No.</th> <th>Signal Name</th> </tr> </thead> <tbody> <tr><td>1</td><td>+</td></tr> <tr><td>2</td><td>-</td></tr> <tr><td>3</td><td>NC(or FG)</td></tr> <tr><td>4</td><td>SD</td></tr> <tr><td>5</td><td>RD</td></tr> <tr><td>6</td><td>NC</td></tr> <tr><td>7</td><td>NC</td></tr> <tr><td>8</td><td>SG</td></tr> </tbody> </table>	Pin No.	Signal name	1	-	2	RD	3	SD	4	-	5	SG	6	-	7	RS	8	CS	9	-	Pin No.	Signal Name	1	+	2	-	3	NC(or FG)	4	SD	5	RD	6	NC	7	NC	8	SG	<p>GT series RS232C type*1 *2</p>		
Pin No.	Signal name																																								
1	-																																								
2	RD																																								
3	SD																																								
4	-																																								
5	SG																																								
6	-																																								
7	RS																																								
8	CS																																								
9	-																																								
Pin No.	Signal Name																																								
1	+																																								
2	-																																								
3	NC(or FG)																																								
4	SD																																								
5	RD																																								
6	NC																																								
7	NC																																								
8	SG																																								
<p>KV-L20R/V side D-sub 9-pin</p> <table border="1"> <thead> <tr> <th>Pin No.</th> <th>Signal name</th> </tr> </thead> <tbody> <tr><td>1</td><td>-</td></tr> <tr><td>2</td><td>RD</td></tr> <tr><td>3</td><td>SD</td></tr> <tr><td>4</td><td>-</td></tr> <tr><td>5</td><td>SG</td></tr> <tr><td>6</td><td>-</td></tr> <tr><td>7</td><td>RS</td></tr> <tr><td>8</td><td>CS</td></tr> <tr><td>9</td><td>-</td></tr> </tbody> </table> <p>GT side</p> <table border="1"> <thead> <tr> <th>Pin No.</th> <th>Signal Name</th> </tr> </thead> <tbody> <tr><td>1</td><td>N.C.</td></tr> <tr><td>2</td><td>RD</td></tr> <tr><td>3</td><td>SD</td></tr> <tr><td>4</td><td>N.C.</td></tr> <tr><td>5</td><td>SG</td></tr> <tr><td>6</td><td>N.C.</td></tr> <tr><td>7</td><td>RS</td></tr> <tr><td>8</td><td>CS</td></tr> <tr><td>9</td><td>N.C.</td></tr> </tbody> </table>	Pin No.	Signal name	1	-	2	RD	3	SD	4	-	5	SG	6	-	7	RS	8	CS	9	-	Pin No.	Signal Name	1	N.C.	2	RD	3	SD	4	N.C.	5	SG	6	N.C.	7	RS	8	CS	9	N.C.	<p>GT707</p>
Pin No.	Signal name																																								
1	-																																								
2	RD																																								
3	SD																																								
4	-																																								
5	SG																																								
6	-																																								
7	RS																																								
8	CS																																								
9	-																																								
Pin No.	Signal Name																																								
1	N.C.																																								
2	RD																																								
3	SD																																								
4	N.C.																																								
5	SG																																								
6	N.C.																																								
7	RS																																								
8	CS																																								
9	N.C.																																								

\*1: Although nos.6 and 7 of the models except GT01 are RS/CS, they can be used in the above connection.

\*2: This is for RS232C type of GT01/GT02/GT02L/GT03-E/GT05/GT11/GT12/GT21/GT32/GT32-E/GT703/GT704.

## 8.8 KV Nano Series

### Applicable versions of GTWIN and GT series

GT series	Applicable versions
GT01	Cannot be used
GT02	Ver.1.00 or later
GT02L	Ver.1.00 or later
GT03-E	Ver.1.00 or later
GT05	Ver.1.00 or later
GT11	Cannot be used
GT12	Ver.1.00 or later
GT21	Cannot be used
GT32	Ver.1.00 or later
GT32-E	Ver.1.00 or later
GTWIN	Ver.2.E1 or later

### PLC model selection

Select "Keyence KV-3000/5000 Series".

### Usable devices

Bit/Word Device		No.	Memo
Bit Device	Input Relay Output Relay Internal Auxiliary Relay	R 000~R 59915	
	Link Relay	B 0~B 1FFF	
	Control Relay	CR 000~CR 8915	
	Internal Hold Relay	MR 000~MR 59915	
	Latch Relay	LR 000~LR 19915	
	Work Relay	VB 0000~VB 1FFF	
	Timer(contact)	T 0~T 511	
	Counter(contact)	C 0~C 255	
	High-speed Counter Comparator(contact)	CTC 0~CTC 7	It is not possible to output it.
Word Device	Data Memory	DM 0~DM 32767	
	Control Memory	CM 0~CM 8999	
	Temporary Data Memory	TM 0~TM 511	
	Link register	W 0~W 3FFF	
	Work memory	VM 00000~VM 9999	
Double Word Device	Timer(current)	TC 0~TC 511	
	Counter (current)	CC 0~CC 255	
	High-speed counter (current)	CTH 0~CTH 3	
	Timer(set Value)	TS 0~TS 511	
	Counter(set Value)	CS 0~CS 255	
	High-speed Counter Comparator(set Value)	CTC 0~CTC 7	
	Index register	Z 01~Z 12	



### Communication Parameters Settings

The example of communication settings of GT and PLC is shown below.

#### Setting Values for GT (Set in the configuration setting of GTWIN.)

Item	Setting
Baud Rate	9600/19200/38400/57600/115200 bps
Data Bits	8
Stop Bits	1
Parity	Even

#### PLC Setting

Item	Setting
Operation	KV mode(high link)
Baud rate	9600/19200/38400/57600/115200 bps
RS/CS flow control	Not used

## 8.8.1 Connection Method

Wiring diagram	GT series																																		
<p>PLC side</p> <table border="1"> <thead> <tr> <th>Pin No.</th> <th>Signal name</th> </tr> </thead> <tbody> <tr><td>1</td><td>-</td></tr> <tr><td>2</td><td>-</td></tr> <tr><td>3</td><td>RD</td></tr> <tr><td>4</td><td>SG</td></tr> <tr><td>5</td><td>SD</td></tr> <tr><td>6</td><td>-</td></tr> </tbody> </table> <p>To power supply</p> <p>GT side</p> <table border="1"> <thead> <tr> <th>Pin No.</th> <th>Signal name</th> </tr> </thead> <tbody> <tr><td>1</td><td>+</td></tr> <tr><td>2</td><td>-</td></tr> <tr><td>3</td><td>NC(or FG)</td></tr> <tr><td>4</td><td>SD</td></tr> <tr><td>5</td><td>RD</td></tr> <tr><td>6</td><td>NC</td></tr> <tr><td>7</td><td>NC</td></tr> <tr><td>8</td><td>SG</td></tr> </tbody> </table> <p>Modular connector</p> <p>1 2 3 4 5 6</p>	Pin No.	Signal name	1	-	2	-	3	RD	4	SG	5	SD	6	-	Pin No.	Signal name	1	+	2	-	3	NC(or FG)	4	SD	5	RD	6	NC	7	NC	8	SG	<p>GT series RS232C type*2 *3</p>		
Pin No.	Signal name																																		
1	-																																		
2	-																																		
3	RD																																		
4	SG																																		
5	SD																																		
6	-																																		
Pin No.	Signal name																																		
1	+																																		
2	-																																		
3	NC(or FG)																																		
4	SD																																		
5	RD																																		
6	NC																																		
7	NC																																		
8	SG																																		
<p>PLC side</p> <table border="1"> <thead> <tr> <th>Pin No.</th> <th>Signal name</th> </tr> </thead> <tbody> <tr><td>1</td><td>-</td></tr> <tr><td>2</td><td>-</td></tr> <tr><td>3</td><td>RD</td></tr> <tr><td>4</td><td>SG</td></tr> <tr><td>5</td><td>SD</td></tr> <tr><td>6</td><td>-</td></tr> </tbody> </table> <p>GT side</p> <table border="1"> <thead> <tr> <th>Pin No.</th> <th>Signal name</th> </tr> </thead> <tbody> <tr><td>1</td><td>N.C.</td></tr> <tr><td>2</td><td>RD</td></tr> <tr><td>3</td><td>SD</td></tr> <tr><td>4</td><td>N.C.</td></tr> <tr><td>5</td><td>SG</td></tr> <tr><td>6</td><td>N.C.</td></tr> <tr><td>7</td><td>RS</td></tr> <tr><td>8</td><td>CS</td></tr> <tr><td>9</td><td>N.C.</td></tr> </tbody> </table> <p>Modular connector</p> <p>1 2 3 4 5 6</p>	Pin No.	Signal name	1	-	2	-	3	RD	4	SG	5	SD	6	-	Pin No.	Signal name	1	N.C.	2	RD	3	SD	4	N.C.	5	SG	6	N.C.	7	RS	8	CS	9	N.C.	<p>GT707</p>
Pin No.	Signal name																																		
1	-																																		
2	-																																		
3	RD																																		
4	SG																																		
5	SD																																		
6	-																																		
Pin No.	Signal name																																		
1	N.C.																																		
2	RD																																		
3	SD																																		
4	N.C.																																		
5	SG																																		
6	N.C.																																		
7	RS																																		
8	CS																																		
9	N.C.																																		

\*1: The numbers of module connector on the PLC show the pin numbers on the unit.

\*2: Although nos.6 and 7 of the models except GT01 are RS/CS, they can be used in the above connection.

\*3: This is for RS232C type of GT01/GT02/GT02L/GT03-E/GT05/GT11/GT12/GT21/GT32/GT32-E/GT703/GT704.

## 8.9 KV Nano Series Connected using Unit KV-L20R/V

### Applicable versions of GTWIN and GT series

GT series	Applicable versions
GT01	Cannot be used
GT02	Ver.1.00 or later
GT02L	Ver.1.00 or later
GT03-E	Ver.1.00 or later
GT05	Ver.1.00 or later
GT11	Cannot be used
GT12	Ver.1.00 or later
GT21	Cannot be used
GT32	Ver.1.00 or later
GT32-E	Ver.1.00 or later
GTWIN	Ver.2.E1 or later

### PLC model selection

Select "Keyence KV-3000/5000 Series".

### Usable devices

Bit/Word Device		No.	Memo
Bit Device	Input Relay Output Relay Internal Auxiliary Relay	R 000~R 59915	
	Link Relay	B 0~B 1FFF	
	Control Relay	CR 000~CR 8915	
	Internal Hold Relay	MR 000~MR 59915	
	Latch Relay	LR 000~LR 19915	
	Work Relay	VB 0000~VB 1FFF	
	Timer(contact)	T 0~T 511	
	Counter(contact)	C 0~C 255	
	High-speed Counter Comparator(contact)	CTC 0~CTC 7	It is not possible to output it.
Word Device	Data Memory	DM 0~DM 32767	
	Control Memory	CM 0~CM 8999	
	Temporary Data Memory	TM 0~TM 511	
	Link register	W 0~W 3FFF	
	Work memory	VM 00000~VM 9999	
Double Word Device	Timer(current)	TC 0~TC 511	
	Counter (current)	CC 0~CC 255	
	High-speed counter (current)	CTH 0~CTH 3	
	Timer(set Value)	TS 0~TS 511	
	Counter(set Value)	CS 0~CS 255	
	High-speed Counter Comparator(set Value)	CTC 0~CTC 7	
	Index register	Z 01~Z 12	

### Communication Parameters Settings

The example of communication settings of GT and PLC is shown below.

#### Setting Values for GT (Set in the configuration setting of GTWIN.)

Item	Setting
Baud Rate	9600/19200/38400/57600/115200 bps
Data Bits	8
Stop Bits	1
Parity	Even

#### KV-N10L Setting (port 1)

Item	Setting
Operation	KV mode(high link)
Baud rate	9600/19200/38400/57600/115200 bps
RS/CS flow control	Not used



**Note:**

- Use the port 1.
- Use a unit editor supplied with the KV BUILDER for the settings of the KV-N10L.

## 8.9.1 Connection Method

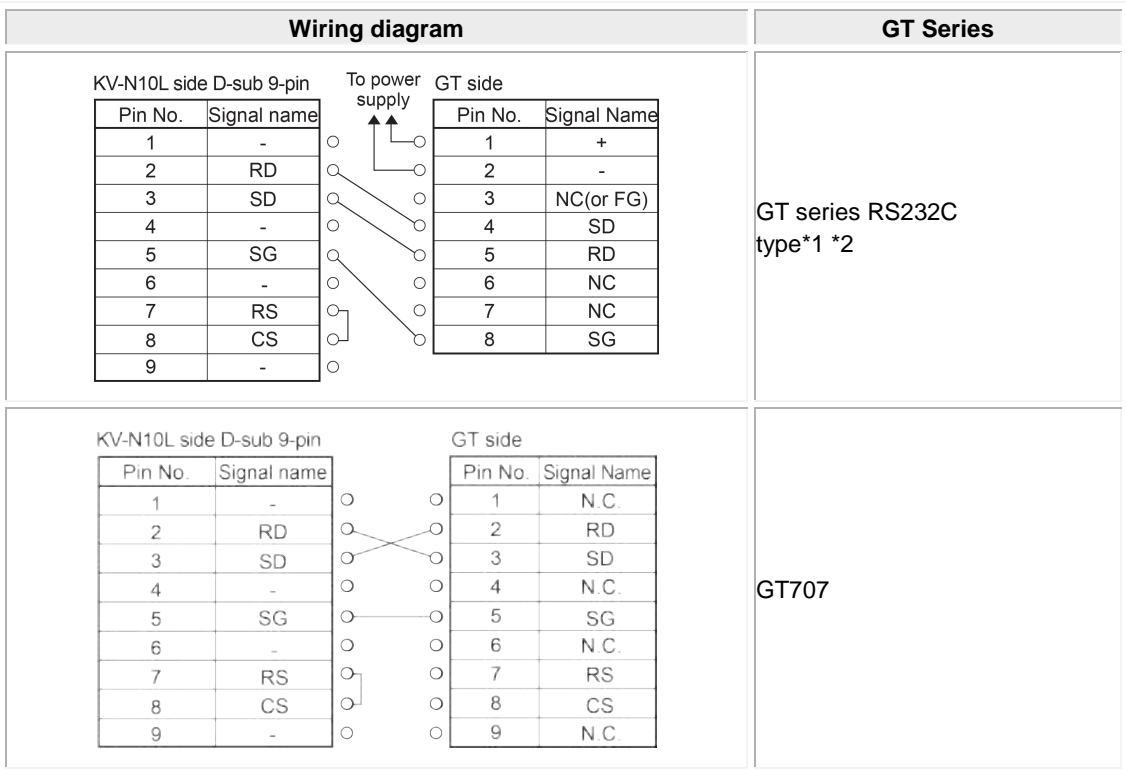
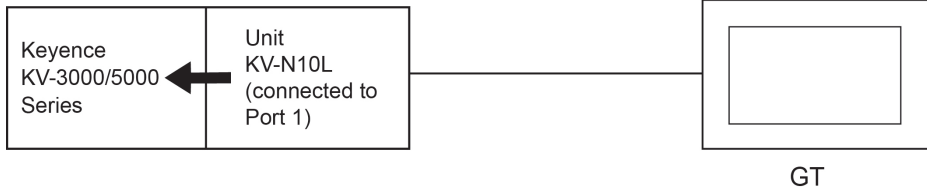

\*1: Although nos.6 and 7 of the models except GT01 are RS/CS, they can be used in the above connection.

\*2: This is for RS232C type of GT01/GT02/GT02L/GT03-E/GT05/GT11/GT12/GT21/GT32/GT32-E/GT703/GT704.

# Chapter 9

---

## Connection With Hitachi PLCs

## 9.1 EH-150/EHV Series

### PLC model selection

Select "Hitachi EH/EHV series".

### Usable devices

	Bit/Word Device	No.	Memo
Bit Device	External input	X 0000~X 4FF95	
	External output	Y 0000~Y 4FF95	
	Internal output	R 000~R FFF	
	Internal output	WR 0000.0~WR FFFF.F	*
	CPU link	L 00000~L 73FFF	
	Internal output	WN 00000.0~WN 1FFFF.F	*
	Data area	M 00000~M 7FFFF	
	Extended external input	EX 00000~EX 5A7FF	
	Extended external output	EY 00000~EY 5A7FF	
	On delay timer	TD 0000~TD 2559	
	Off delay timer	TDN 0000~TDN 2559	
	Single shot	SS 0000~SS 2559	
	Monostable timer	MS 0000~MS 2559	
	Integrating timer	TMR 0000~TMR 2559	
	Watchdog timer	WDT 0000~WTD 2559	
	Counter	CU 0000~CU 2047	
	Ring counter	RCU 00000~RCU 2047	
	Updown counter	CT 00000~CT 2047	
Word Device	External input	WX 0000~WX 4FF5	
	External output	WY 0000~WY 4FF5	
	Internal output	WR 0000~WR FFFF	
	CPU link	WL 0000~WL 73FF	
	Internal output	WN 00000~WN 1FFFF	
	Data area	WM 0000~WM 7FFF	
	Extended external input	WEX 0000~WEX 5A7F	
	Extended external output	WEY 0000~WEY 5A7F	
	Timer/Counter current value	TC 0000~TC 2559	

\* The input in GTWIN is as follows:

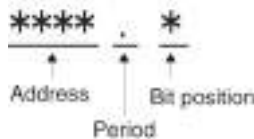

### Note:

- The maximum value that can be set with the GT is described.
- The range of usable addresses differs depending on the model. For details, please consult the manual for the PLC you will use.

## Communication Parameters Settings

The example of communication settings of GT and PLC is shown below.

### Setting Values for GT (Set in the configuration setting of GTWIN.)

Item	Setting
Baud Rate	19200bps
Data Length	7
Stop Bits	1
Parity Bit	Even

### Setting Values for PLC

#### Setting for -CPU104A/EH-CPU208A/EH-CPU316A/EH-CPU516/EH-CPU548

##### When using Port 1

The settings for the dip switches and special internal output are required.

Set the dip switches of CPU module as follows.

Item	Setting
Port type	Setting for special port
Baud rate	19200 bps

Set the special internal output as follows.

Item	Setting
Interface *1	For RS232C connection: RS232C
	For RS422 connection: RS422 internal terminating resistance function is ON.
	For RS485 connection: RS422 internal terminating resistance function is ON.
Procedure of communication control	Procedure 1 of transmission control (No unit No.) *2

\*1 It varies according to the communication method.

\*2 The procedure 1 of transmission control with unit number cannot be used.

\*3 For the details of the method of communication setting, refer to the "EH-150 Application Manual".

##### When using Port 2

The setting of the dip switches is required.

The PHL switch must be "ON". It cannot be used if the switch is "OFF".

Set the dip switches of CPU module as follows.

Item	Setting
Port type	Setting for special port *1
Baud rate	19200bps
Procedure of communication control	Procedure 1 of transmission control (No unit No.)

\*1 As it is fixed, the setting is not required.

\*2 For the details of the method of communication setting, refer to the "EH-150 Application Manual".

### Setting for EHV-CPU128/EHV-CPU64/EHV-CPU32/EHV-CPU16

It should be specified with a programming tool.

Specify the setting for the serial port as below with a programming tool.

Item	Setting
Type	Special port
Port type *1	For RS232C connection: RS232C
	For RS422 connection: RS422/485
	For RS485 connection: RS422/485
Baud rate	19200bps
Communication procedure	Procedure 1 of transmission control (No unit No.) 1:1 communication
Unit No.	No unit No.
With modem connection	Not check

\*1 It varies according to the communication method.

\*2 For the details of the method of communication setting, refer to the "EH-150EHV series Ladder Programming Software Control Editor Instruction Manual".

### Setting for EH-SIO

#### Port 1 or Port 2

The setting for the dip switches and the ladder program to perform the default setting is required.

Specify as below with the dip switches for each port.

Item	Setting
Baud Rate	19200bps
Data Length	1
Parity Bit	Even
Stop Bits	7

Specify the setting for the communication port of EH-SIO with a ladder program as below.

Item	Setting
Default setting of communication mode	Hi-Protocol mode
Communication procedure	Procedure 1 of transmission control (No unit No.)
Unit No.	No

\* For the details of the method of communication setting, refer to the "EH-150 Application Manual".



## 9.1.1 RS232C Connection

### When connecting with EH-RS05 and a self-produced cable

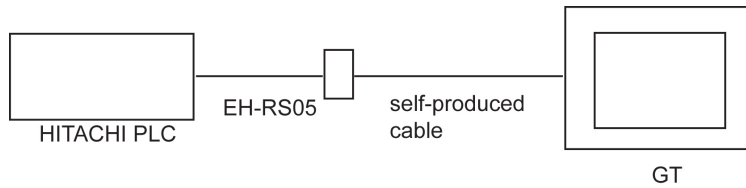

CPU	Link I/F	Wiring diagram	GT series																																																				
EH-CPU104A EH-CPU208A EH-CPU316A EH-CPU516 EH-CPU548	Port 1 or Port 2 on CPU	<p>Cable side D-sub 15-bin</p> <table border="1"> <thead> <tr> <th>Pin No.</th> <th>Signal name</th> </tr> </thead> <tbody> <tr><td>1</td><td>-</td></tr> <tr><td>2</td><td>SD</td></tr> <tr><td>3</td><td>RD</td></tr> <tr><td>4</td><td>RS</td></tr> <tr><td>5</td><td>CS</td></tr> <tr><td>6</td><td>-</td></tr> <tr><td>7</td><td>DR</td></tr> <tr><td>8</td><td>-</td></tr> <tr><td>9</td><td>PG</td></tr> <tr><td>10</td><td>PG</td></tr> <tr><td>11</td><td>CD</td></tr> <tr><td>12</td><td>CD</td></tr> <tr><td>13</td><td>ER1</td></tr> <tr><td>14</td><td>ER2</td></tr> <tr><td>15</td><td>-</td></tr> </tbody> </table> <p>To power supply</p> <p>GT side</p> <table border="1"> <thead> <tr> <th>Pin No.</th> <th>Signal name</th> </tr> </thead> <tbody> <tr><td>1</td><td>+</td></tr> <tr><td>2</td><td>-</td></tr> <tr><td>3</td><td>NC(or FG)</td></tr> <tr><td>4</td><td>SD</td></tr> <tr><td>5</td><td>RD</td></tr> <tr><td>6</td><td>RS</td></tr> <tr><td>7</td><td>CS</td></tr> <tr><td>8</td><td>SG</td></tr> </tbody> </table>	Pin No.	Signal name	1	-	2	SD	3	RD	4	RS	5	CS	6	-	7	DR	8	-	9	PG	10	PG	11	CD	12	CD	13	ER1	14	ER2	15	-	Pin No.	Signal name	1	+	2	-	3	NC(or FG)	4	SD	5	RD	6	RS	7	CS	8	SG	GT series RS232C type*2		
Pin No.	Signal name																																																						
1	-																																																						
2	SD																																																						
3	RD																																																						
4	RS																																																						
5	CS																																																						
6	-																																																						
7	DR																																																						
8	-																																																						
9	PG																																																						
10	PG																																																						
11	CD																																																						
12	CD																																																						
13	ER1																																																						
14	ER2																																																						
15	-																																																						
Pin No.	Signal name																																																						
1	+																																																						
2	-																																																						
3	NC(or FG)																																																						
4	SD																																																						
5	RD																																																						
6	RS																																																						
7	CS																																																						
8	SG																																																						
EHV-CPU128 EHV-CPU64 EHV-CPU32 EHV-CPU16	Serial port on CPU	<p>Cable side D-sub 15-bin</p> <table border="1"> <thead> <tr> <th>Pin No.</th> <th>Signal name</th> </tr> </thead> <tbody> <tr><td>1</td><td>-</td></tr> <tr><td>2</td><td>SD</td></tr> <tr><td>3</td><td>RD</td></tr> <tr><td>4</td><td>RS</td></tr> <tr><td>5</td><td>CS</td></tr> <tr><td>6</td><td>-</td></tr> <tr><td>7</td><td>DR</td></tr> <tr><td>8</td><td>-</td></tr> <tr><td>9</td><td>PG</td></tr> <tr><td>10</td><td>PG</td></tr> <tr><td>11</td><td>CD</td></tr> <tr><td>12</td><td>CD</td></tr> <tr><td>13</td><td>ER1</td></tr> <tr><td>14</td><td>ER2</td></tr> <tr><td>15</td><td>-</td></tr> </tbody> </table> <p>GT side</p> <table border="1"> <thead> <tr> <th>Pin No.</th> <th>Signal name</th> </tr> </thead> <tbody> <tr><td>1</td><td>N.C.</td></tr> <tr><td>2</td><td>RD</td></tr> <tr><td>3</td><td>SD</td></tr> <tr><td>4</td><td>N.C.</td></tr> <tr><td>5</td><td>SG</td></tr> <tr><td>6</td><td>N.C.</td></tr> <tr><td>7</td><td>RS</td></tr> <tr><td>8</td><td>CS</td></tr> <tr><td>9</td><td>N.C.</td></tr> </tbody> </table>	Pin No.	Signal name	1	-	2	SD	3	RD	4	RS	5	CS	6	-	7	DR	8	-	9	PG	10	PG	11	CD	12	CD	13	ER1	14	ER2	15	-	Pin No.	Signal name	1	N.C.	2	RD	3	SD	4	N.C.	5	SG	6	N.C.	7	RS	8	CS	9	N.C.	GT707
Pin No.	Signal name																																																						
1	-																																																						
2	SD																																																						
3	RD																																																						
4	RS																																																						
5	CS																																																						
6	-																																																						
7	DR																																																						
8	-																																																						
9	PG																																																						
10	PG																																																						
11	CD																																																						
12	CD																																																						
13	ER1																																																						
14	ER2																																																						
15	-																																																						
Pin No.	Signal name																																																						
1	N.C.																																																						
2	RD																																																						
3	SD																																																						
4	N.C.																																																						
5	SG																																																						
6	N.C.																																																						
7	RS																																																						
8	CS																																																						
9	N.C.																																																						

\*1: The settings vary according to the ports and communication methods. Refer to the above settings for communication conditions.

\*2: This is for RS232C type of GT01/GT02/GT02L/GT03-E/GT05/GT11/GT12/GT21/GT32/GT32-E/GT703/GT704.

**When connecting with EH-RS05 and a self-produced cable using EH-SIO unit**

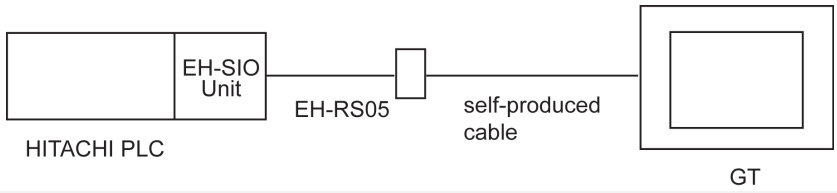

CPU	Unit	Wiring diagram	GT series																																																			
EH-CPU104A EH-CPU208A EH-CPU316A EH-CPU516 EH-CPU548	Port 1 or Port 2 of EH-SIO	<p>Cable side D-sub 15-bin</p> <table border="1"> <thead> <tr> <th>Pin No.</th> <th>Signal name</th> </tr> </thead> <tbody> <tr><td>1</td><td>-</td></tr> <tr><td>2</td><td>SD</td></tr> <tr><td>3</td><td>RD</td></tr> <tr><td>4</td><td>RS</td></tr> <tr><td>5</td><td>CS</td></tr> <tr><td>6</td><td>-</td></tr> <tr><td>7</td><td>DR</td></tr> <tr><td>8</td><td>-</td></tr> <tr><td>9</td><td>PG</td></tr> <tr><td>10</td><td>PG</td></tr> <tr><td>11</td><td>CD</td></tr> <tr><td>12</td><td>CD</td></tr> <tr><td>13</td><td>ER1</td></tr> <tr><td>14</td><td>ER2</td></tr> <tr><td>15</td><td>-</td></tr> </tbody> </table> <p>To power supply</p> <table border="1"> <thead> <tr> <th>Pin No.</th> <th>Signal name</th> </tr> </thead> <tbody> <tr><td>1</td><td>+</td></tr> <tr><td>2</td><td>-</td></tr> <tr><td>3</td><td>NC(or FG)</td></tr> <tr><td>4</td><td>SD</td></tr> <tr><td>5</td><td>RD</td></tr> <tr><td>6</td><td>RS</td></tr> <tr><td>7</td><td>CS</td></tr> <tr><td>8</td><td>SG</td></tr> </tbody> </table>	Pin No.	Signal name	1	-	2	SD	3	RD	4	RS	5	CS	6	-	7	DR	8	-	9	PG	10	PG	11	CD	12	CD	13	ER1	14	ER2	15	-	Pin No.	Signal name	1	+	2	-	3	NC(or FG)	4	SD	5	RD	6	RS	7	CS	8	SG	GT series RS232C type*2	
Pin No.		Signal name																																																				
1	-																																																					
2	SD																																																					
3	RD																																																					
4	RS																																																					
5	CS																																																					
6	-																																																					
7	DR																																																					
8	-																																																					
9	PG																																																					
10	PG																																																					
11	CD																																																					
12	CD																																																					
13	ER1																																																					
14	ER2																																																					
15	-																																																					
Pin No.	Signal name																																																					
1	+																																																					
2	-																																																					
3	NC(or FG)																																																					
4	SD																																																					
5	RD																																																					
6	RS																																																					
7	CS																																																					
8	SG																																																					
EHV-CPU128 EHV-CPU64 EHV-CPU32 EHV-CPU16	<p>Cable side D-sub 15-bin</p> <table border="1"> <thead> <tr> <th>Pin No.</th> <th>Signal name</th> </tr> </thead> <tbody> <tr><td>1</td><td>-</td></tr> <tr><td>2</td><td>SD</td></tr> <tr><td>3</td><td>RD</td></tr> <tr><td>4</td><td>RS</td></tr> <tr><td>5</td><td>CS</td></tr> <tr><td>6</td><td>-</td></tr> <tr><td>7</td><td>DR</td></tr> <tr><td>8</td><td>-</td></tr> <tr><td>9</td><td>PG</td></tr> <tr><td>10</td><td>PG</td></tr> <tr><td>11</td><td>CD</td></tr> <tr><td>12</td><td>CD</td></tr> <tr><td>13</td><td>ER1</td></tr> <tr><td>14</td><td>ER2</td></tr> <tr><td>15</td><td>-</td></tr> </tbody> </table> <table border="1"> <thead> <tr> <th>Pin No.</th> <th>Signal name</th> </tr> </thead> <tbody> <tr><td>1</td><td>N.C.</td></tr> <tr><td>2</td><td>RD</td></tr> <tr><td>3</td><td>SD</td></tr> <tr><td>4</td><td>N.C.</td></tr> <tr><td>5</td><td>SG</td></tr> <tr><td>6</td><td>N.C.</td></tr> <tr><td>7</td><td>RS</td></tr> <tr><td>8</td><td>CS</td></tr> <tr><td>9</td><td>N.C.</td></tr> </tbody> </table>	Pin No.	Signal name	1	-	2	SD	3	RD	4	RS	5	CS	6	-	7	DR	8	-	9	PG	10	PG	11	CD	12	CD	13	ER1	14	ER2	15	-	Pin No.	Signal name	1	N.C.	2	RD	3	SD	4	N.C.	5	SG	6	N.C.	7	RS	8	CS	9	N.C.	GT707
Pin No.	Signal name																																																					
1	-																																																					
2	SD																																																					
3	RD																																																					
4	RS																																																					
5	CS																																																					
6	-																																																					
7	DR																																																					
8	-																																																					
9	PG																																																					
10	PG																																																					
11	CD																																																					
12	CD																																																					
13	ER1																																																					
14	ER2																																																					
15	-																																																					
Pin No.	Signal name																																																					
1	N.C.																																																					
2	RD																																																					
3	SD																																																					
4	N.C.																																																					
5	SG																																																					
6	N.C.																																																					
7	RS																																																					
8	CS																																																					
9	N.C.																																																					

\*1: The settings vary according to the ports and communication methods. Refer to the above settings for communication conditions.

\*2: This is for RS232C type of GT01/GT02/GT02L/GT03-E/GT05/GT11/GT12/GT21/GT32/GT32-E/GT703/GT704.

**When connecting with self-produced cable using a RJ45 connector**

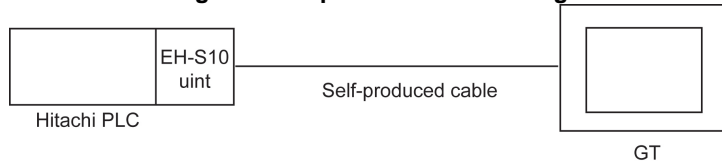

**RJ45 modular port**

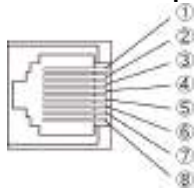

Port 1 viewed from the front of the module (socket side)

CPU	Link I/F	Wiring diagram	GT series																																						
EH-CPU104A EH-CPU208A EH-CPU316A EH-CPU516 EH-CPU548	Port 1 or Port 2 on CPU	<p>HITACHI PLC side RJ45 connector</p> <table border="1"> <thead> <tr> <th>Pin No.</th> <th>Signal name</th> </tr> </thead> <tbody> <tr><td>1</td><td>SG</td></tr> <tr><td>2</td><td>CD</td></tr> <tr><td>3</td><td>ER1</td></tr> <tr><td>4</td><td>ER2</td></tr> <tr><td>5</td><td>SD</td></tr> <tr><td>6</td><td>RD</td></tr> <tr><td>7</td><td>DR</td></tr> <tr><td>8</td><td>RS</td></tr> </tbody> </table> <p>To power supply</p> <p>GT side</p> <table border="1"> <thead> <tr> <th>Pin No.</th> <th>Signal name</th> </tr> </thead> <tbody> <tr><td>1</td><td>+</td></tr> <tr><td>2</td><td>-</td></tr> <tr><td>3</td><td>NC(or FG)</td></tr> <tr><td>4</td><td>SD</td></tr> <tr><td>5</td><td>RD</td></tr> <tr><td>6</td><td>NC</td></tr> <tr><td>7</td><td>NC</td></tr> <tr><td>8</td><td>SG</td></tr> </tbody> </table>	Pin No.	Signal name	1	SG	2	CD	3	ER1	4	ER2	5	SD	6	RD	7	DR	8	RS	Pin No.	Signal name	1	+	2	-	3	NC(or FG)	4	SD	5	RD	6	NC	7	NC	8	SG	GT series RS232C type*2		
Pin No.	Signal name																																								
1	SG																																								
2	CD																																								
3	ER1																																								
4	ER2																																								
5	SD																																								
6	RD																																								
7	DR																																								
8	RS																																								
Pin No.	Signal name																																								
1	+																																								
2	-																																								
3	NC(or FG)																																								
4	SD																																								
5	RD																																								
6	NC																																								
7	NC																																								
8	SG																																								
EHV-CPU128 EHV-CPU64 EHV-CPU32 EHV-CPU16	Serial port on CPU	<p>HITACHI PLC side RJ45 connector</p> <table border="1"> <thead> <tr> <th>Pin No.</th> <th>Signal name</th> </tr> </thead> <tbody> <tr><td>1</td><td>SG</td></tr> <tr><td>2</td><td>CD</td></tr> <tr><td>3</td><td>ER1</td></tr> <tr><td>4</td><td>ER2</td></tr> <tr><td>5</td><td>SD</td></tr> <tr><td>6</td><td>RD</td></tr> <tr><td>7</td><td>DR</td></tr> <tr><td>8</td><td>RS</td></tr> </tbody> </table> <p>GT side</p> <table border="1"> <thead> <tr> <th>Pin No.</th> <th>Signal name</th> </tr> </thead> <tbody> <tr><td>1</td><td>N.C.</td></tr> <tr><td>2</td><td>RD</td></tr> <tr><td>3</td><td>SD</td></tr> <tr><td>4</td><td>N.C.</td></tr> <tr><td>5</td><td>SG</td></tr> <tr><td>6</td><td>N.C.</td></tr> <tr><td>7</td><td>RS</td></tr> <tr><td>8</td><td>CS</td></tr> <tr><td>9</td><td>N.C.</td></tr> </tbody> </table>	Pin No.	Signal name	1	SG	2	CD	3	ER1	4	ER2	5	SD	6	RD	7	DR	8	RS	Pin No.	Signal name	1	N.C.	2	RD	3	SD	4	N.C.	5	SG	6	N.C.	7	RS	8	CS	9	N.C.	GT707
Pin No.	Signal name																																								
1	SG																																								
2	CD																																								
3	ER1																																								
4	ER2																																								
5	SD																																								
6	RD																																								
7	DR																																								
8	RS																																								
Pin No.	Signal name																																								
1	N.C.																																								
2	RD																																								
3	SD																																								
4	N.C.																																								
5	SG																																								
6	N.C.																																								
7	RS																																								
8	CS																																								
9	N.C.																																								

\*1: The settings vary according to the ports and communication methods. Refer to the above settings for communication conditions.

\*2: This is for RS232C type of GT01/GT02/GT02L/GT03-E/GT05/GT11/GT12/GT21/GT32/GT32-E/GT703/GT704.

**When connecting with a self-produced cable using a RJ45 connector with EH-SIO unit**



\* Refer to the above drawing of RJ45 modular port.

CPU	Unit	Wiring diagram	GT series																																						
EH-CPU104A EH-CPU208A EH-CPU316A EH-CPU516 EH-CPU548	Port 1 or Port 2 of EH-SIO	<p>HITACHI PLC side RJ45 connector</p> <table border="1"> <thead> <tr> <th>Pin No.</th> <th>Signal name</th> </tr> </thead> <tbody> <tr><td>1</td><td>SG</td></tr> <tr><td>2</td><td>CD</td></tr> <tr><td>3</td><td>ER1</td></tr> <tr><td>4</td><td>ER2</td></tr> <tr><td>5</td><td>SD</td></tr> <tr><td>6</td><td>RD</td></tr> <tr><td>7</td><td>DR</td></tr> <tr><td>8</td><td>RS</td></tr> </tbody> </table> <p>To power supply</p> <p>GT side</p> <table border="1"> <thead> <tr> <th>Pin No.</th> <th>Signal name</th> </tr> </thead> <tbody> <tr><td>1</td><td>+</td></tr> <tr><td>2</td><td>-</td></tr> <tr><td>3</td><td>NC(or FG)</td></tr> <tr><td>4</td><td>SD</td></tr> <tr><td>5</td><td>RD</td></tr> <tr><td>6</td><td>NC</td></tr> <tr><td>7</td><td>NC</td></tr> <tr><td>8</td><td>SG</td></tr> </tbody> </table>	Pin No.	Signal name	1	SG	2	CD	3	ER1	4	ER2	5	SD	6	RD	7	DR	8	RS	Pin No.	Signal name	1	+	2	-	3	NC(or FG)	4	SD	5	RD	6	NC	7	NC	8	SG	GT series RS232C type*2		
Pin No.		Signal name																																							
1	SG																																								
2	CD																																								
3	ER1																																								
4	ER2																																								
5	SD																																								
6	RD																																								
7	DR																																								
8	RS																																								
Pin No.	Signal name																																								
1	+																																								
2	-																																								
3	NC(or FG)																																								
4	SD																																								
5	RD																																								
6	NC																																								
7	NC																																								
8	SG																																								
EHV-CPU128 EHV-CPU64 EHV-CPU32 EHV-CPU16		<p>HITACHI PLC side RJ45 connector</p> <table border="1"> <thead> <tr> <th>Pin No.</th> <th>Signal name</th> </tr> </thead> <tbody> <tr><td>1</td><td>SG</td></tr> <tr><td>2</td><td>CD</td></tr> <tr><td>3</td><td>ER1</td></tr> <tr><td>4</td><td>ER2</td></tr> <tr><td>5</td><td>SD</td></tr> <tr><td>6</td><td>RD</td></tr> <tr><td>7</td><td>DR</td></tr> <tr><td>8</td><td>RS</td></tr> </tbody> </table> <p>GT side</p> <table border="1"> <thead> <tr> <th>Pin No.</th> <th>Signal name</th> </tr> </thead> <tbody> <tr><td>1</td><td>N.C.</td></tr> <tr><td>2</td><td>RD</td></tr> <tr><td>3</td><td>SD</td></tr> <tr><td>4</td><td>N.C.</td></tr> <tr><td>5</td><td>SG</td></tr> <tr><td>6</td><td>N.C.</td></tr> <tr><td>7</td><td>RS</td></tr> <tr><td>8</td><td>CS</td></tr> <tr><td>9</td><td>N.C.</td></tr> </tbody> </table>	Pin No.	Signal name	1	SG	2	CD	3	ER1	4	ER2	5	SD	6	RD	7	DR	8	RS	Pin No.	Signal name	1	N.C.	2	RD	3	SD	4	N.C.	5	SG	6	N.C.	7	RS	8	CS	9	N.C.	GT707
Pin No.	Signal name																																								
1	SG																																								
2	CD																																								
3	ER1																																								
4	ER2																																								
5	SD																																								
6	RD																																								
7	DR																																								
8	RS																																								
Pin No.	Signal name																																								
1	N.C.																																								
2	RD																																								
3	SD																																								
4	N.C.																																								
5	SG																																								
6	N.C.																																								
7	RS																																								
8	CS																																								
9	N.C.																																								

\*1: The settings vary according to the ports and communication methods. Refer to the above settings for communication conditions.

\*2: This is for RS232C type of GT01/GT02/GT02L/GT03-E/GT05/GT11/GT12/GT21/GT32/GT32-E/GT703/GT704.

## 9.1.2 RS422 Connection

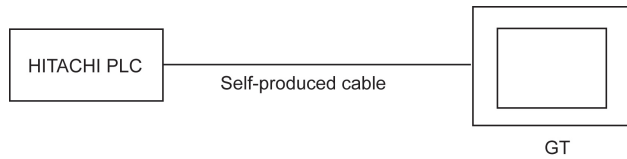

\* Refer to the above drawing of RJ45 modular port.

### When connecting with a self-produced cable

CPU	Link I/F	Wiring diagram	GT series																																				
EH-CPU104A EH-CPU208A EH-CPU316A EH-CPU516 EH-CPU548	Port 1 on CPU	<p>HITACHI PLC RS422 CPU port side RJ45 connector</p> <table border="1"> <thead> <tr> <th>Pin No.</th> <th>Signal name</th> </tr> </thead> <tbody> <tr><td>1</td><td>SG</td></tr> <tr><td>2</td><td>--</td></tr> <tr><td>3</td><td>--</td></tr> <tr><td>4</td><td>SD+</td></tr> <tr><td>5</td><td>SD-</td></tr> <tr><td>6</td><td>RD-</td></tr> <tr><td>7</td><td>RD+</td></tr> <tr><td>8</td><td>--</td></tr> </tbody> </table> <p>To power supply</p> <table border="1"> <thead> <tr> <th>Pin No.</th> <th>Signal name</th> </tr> </thead> <tbody> <tr><td>1</td><td>+24V</td></tr> <tr><td>2</td><td>GND</td></tr> <tr><td>3</td><td>NC</td></tr> <tr><td>4</td><td>+SD</td></tr> <tr><td>5</td><td>-SD</td></tr> <tr><td>6</td><td>+RD</td></tr> <tr><td>7</td><td>-RD</td></tr> <tr><td>8</td><td>E Terminal station setting (120Ω resistor built in)</td></tr> </tbody> </table>	Pin No.	Signal name	1	SG	2	--	3	--	4	SD+	5	SD-	6	RD-	7	RD+	8	--	Pin No.	Signal name	1	+24V	2	GND	3	NC	4	+SD	5	-SD	6	+RD	7	-RD	8	E Terminal station setting (120Ω resistor built in)	RS422/ RS485 type
Pin No.	Signal name																																						
1	SG																																						
2	--																																						
3	--																																						
4	SD+																																						
5	SD-																																						
6	RD-																																						
7	RD+																																						
8	--																																						
Pin No.	Signal name																																						
1	+24V																																						
2	GND																																						
3	NC																																						
4	+SD																																						
5	-SD																																						
6	+RD																																						
7	-RD																																						
8	E Terminal station setting (120Ω resistor built in)																																						
EHV-CPU128 EHV-CPU64 EHV-CPU32 EHV-CPU16	Serial port on CPU																																						

\* The settings vary according to the ports and communication methods. Refer to the above settings for communication conditions.

### When connecting with a self-produced cable using EH-SIO unit



CPU	Link I/F	Wiring diagram	GT series																																
EH-CPU104A EH-CPU208A EH-CPU316A EH-CPU516 EH-CPU548	Port 2 of EH-SIO (connector for RS-422/485)	<p>HITACHI PLC RS422 CPU port side connector for RS-422/485</p> <table border="1"> <thead> <tr> <th>Pin No.</th> <th>Signal name</th> </tr> </thead> <tbody> <tr><td>1</td><td>SD+</td></tr> <tr><td>2</td><td>SD-</td></tr> <tr><td>3</td><td>RD+</td></tr> <tr><td>4</td><td>RD-</td></tr> <tr><td>5</td><td>TERM</td></tr> <tr><td>6</td><td>SG</td></tr> </tbody> </table> <p>To power supply</p> <table border="1"> <thead> <tr> <th>Pin No.</th> <th>Signal name</th> </tr> </thead> <tbody> <tr><td>1</td><td>+24V</td></tr> <tr><td>2</td><td>GND</td></tr> <tr><td>3</td><td>NC</td></tr> <tr><td>4</td><td>+SD</td></tr> <tr><td>5</td><td>-SD</td></tr> <tr><td>6</td><td>+RD</td></tr> <tr><td>7</td><td>-RD</td></tr> <tr><td>8</td><td>E Terminal station setting (120Ω resistor built in)</td></tr> </tbody> </table>	Pin No.	Signal name	1	SD+	2	SD-	3	RD+	4	RD-	5	TERM	6	SG	Pin No.	Signal name	1	+24V	2	GND	3	NC	4	+SD	5	-SD	6	+RD	7	-RD	8	E Terminal station setting (120Ω resistor built in)	RS422/ RS485 type
Pin No.		Signal name																																	
1	SD+																																		
2	SD-																																		
3	RD+																																		
4	RD-																																		
5	TERM																																		
6	SG																																		
Pin No.	Signal name																																		
1	+24V																																		
2	GND																																		
3	NC																																		
4	+SD																																		
5	-SD																																		
6	+RD																																		
7	-RD																																		
8	E Terminal station setting (120Ω resistor built in)																																		
EHV-CPU128 EHV-CPU64 EHV-CPU32 EHV-CPU16																																			

\* The settings vary according to the ports and communication methods. Refer to the above settings for communication conditions.

### 9.1.3 RS485 Connection

#### When connecting with a self-produced cable

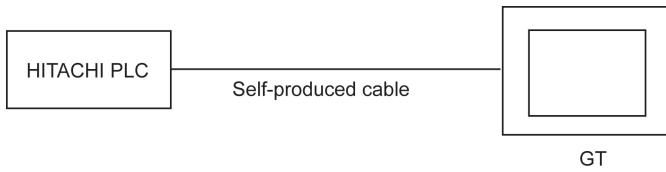

\* Refer to the above drawing of RJ45 modular port.

CPU	Link I/F	Wiring diagram	GT series
EH-CPU104A EH-CPU208A EH-CPU316A EH-CPU516 EH-CPU548	Port 1 on CPU		RS422/ RS485 type
EHV-CPU128 EHV-CPU64 EHV-CPU32 EHV-CPU16	Serial port on CPU		

\* The settings vary according to the ports and communication methods. Refer to the above settings for communication conditions.

#### When connecting with a self-produced cable using EH-SIO unit

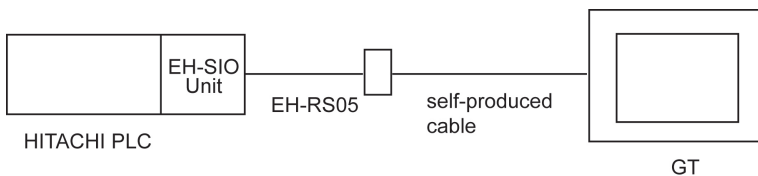

CPU	Link I/F	Wiring diagram	GT series
EH-CPU104A EH-CPU208A EH-CPU316A EH-CPU516 EH-CPU548	Port 2 of EH-SIO (connector for RS- 422/485)		RS422/ RS485 type
EHV-CPU128 EHV-CPU64 EHV-CPU32 EHV-CPU16			

\* The settings vary according to the ports and communication methods. Refer to the above settings for communication conditions.

## 9.2 MICRO-EH Series

### PLC model selection

Select "Hitachi EH/EHV series".

### Usable devices

	Bit/Word Device	No.	Memo
Bit Device	External input	X 0000~X 4FF95	
	External output	Y 0000~Y 4FF95	
	Internal output	R 000~R FFF	
	Internal output	WR 0000.0~WR FFFF.F	*
	CPU link	L 00000~L 73FFF	
	Internal output	WN 00000.0~WN 1FFFF.F	*
	Data area	M 00000~M 7FFFF	
	Extended external input	EX 00000~EX 5A7FF	
	Extended external output	EY 00000~EY 5A7FF	
	On delay timer	TD 0000~TD 2559	
	Off delay timer	TDN 0000~TDN 2559	
	Single shot	SS 0000~SS 2559	
	Monostable timer	MS 0000~MS 2559	
	Integrating timer	TMR 0000~TMR 2559	
	Watchdog timer	WDT 0000~WTD 2559	
	Counter	CU 0000~CU 2047	
	Ring counter	RCU 00000~RCU 2047	
Updown counter	CT 00000~CT 2047		
Word Device	External input	WX 0000~WX 4FF5	
	External output	WY 0000~WY 4FF5	
	Internal output	WR 0000~WR FFFF	
	CPU link	WL 0000~WL 73FF	
	Internal output	WN 00000~WN 1FFFF	
	Data area	WM 0000~WM 7FFF	
	Extended external input	WEX 0000~WEX 5A7F	
	Extended external output	WEY 0000~WEY 5A7F	
	Timer/Counter current value	TC 0000~TC 2559	

\* The input in GTWIN is as follows:

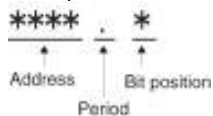

#### Note:

- The maximum value that can be set with the GT is described.
- The range of usable addresses differs depending on the model. For details, please consult the manual for the PLC you will use.

### Communication Parameters Settings

The example of communication settings of GT and PLC is shown below.

#### Setting Values for GT (Set in the configuration setting of GTWIN.)

Item	Setting
Baud Rate	19200bps
Data Length	7
Stop Bits	1
Parity Bit	Even

#### Setting Values for PLC

##### Setting for MICRO-EH

##### Port1

The settings for the dip switches and the special internal output are required.

Specify as follows

Item	Setting
Port type	Setting for special port
Procedure of communication control	Procedure 1 of transmission control (No unit No.)
Baud rate	19200 bps

\* For the details of the method of communication setting, refer to the "EH-SIO Application Manual".



## 9.2.1 RS232C Connection

When connecting with EH-RS05 and a self-produced cable

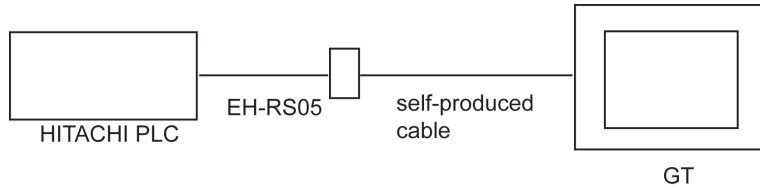

### MICRO-EH series

PLC type	Link I/F	Wiring diagram	GT series																																																				
14 points 20 points 23 points 28 points 40 points 64 points	Port 1 on CPU	<p>Cable side D-sub 15-bin</p> <table border="1"> <thead> <tr> <th>Pin No.</th> <th>Signal name</th> </tr> </thead> <tbody> <tr><td>1</td><td>-</td></tr> <tr><td>2</td><td>SD</td></tr> <tr><td>3</td><td>RD</td></tr> <tr><td>4</td><td>RS</td></tr> <tr><td>5</td><td>CS</td></tr> <tr><td>6</td><td>-</td></tr> <tr><td>7</td><td>DR</td></tr> <tr><td>8</td><td>-</td></tr> <tr><td>9</td><td>PG</td></tr> <tr><td>10</td><td>PG</td></tr> <tr><td>11</td><td>CD</td></tr> <tr><td>12</td><td>CD</td></tr> <tr><td>13</td><td>ER1</td></tr> <tr><td>14</td><td>ER2</td></tr> <tr><td>15</td><td>-</td></tr> </tbody> </table> <p>To power supply</p> <p>GT side</p> <table border="1"> <thead> <tr> <th>Pin No.</th> <th>Signal name</th> </tr> </thead> <tbody> <tr><td>1</td><td>+</td></tr> <tr><td>2</td><td>-</td></tr> <tr><td>3</td><td>NC(or FG)</td></tr> <tr><td>4</td><td>SD</td></tr> <tr><td>5</td><td>RD</td></tr> <tr><td>6</td><td>RS</td></tr> <tr><td>7</td><td>CS</td></tr> <tr><td>8</td><td>SG</td></tr> </tbody> </table>	Pin No.	Signal name	1	-	2	SD	3	RD	4	RS	5	CS	6	-	7	DR	8	-	9	PG	10	PG	11	CD	12	CD	13	ER1	14	ER2	15	-	Pin No.	Signal name	1	+	2	-	3	NC(or FG)	4	SD	5	RD	6	RS	7	CS	8	SG	GT series RS232C type*2		
Pin No.	Signal name																																																						
1	-																																																						
2	SD																																																						
3	RD																																																						
4	RS																																																						
5	CS																																																						
6	-																																																						
7	DR																																																						
8	-																																																						
9	PG																																																						
10	PG																																																						
11	CD																																																						
12	CD																																																						
13	ER1																																																						
14	ER2																																																						
15	-																																																						
Pin No.	Signal name																																																						
1	+																																																						
2	-																																																						
3	NC(or FG)																																																						
4	SD																																																						
5	RD																																																						
6	RS																																																						
7	CS																																																						
8	SG																																																						
		<p>Cable side D-sub 15-bin</p> <table border="1"> <thead> <tr> <th>Pin No.</th> <th>Signal name</th> </tr> </thead> <tbody> <tr><td>1</td><td>-</td></tr> <tr><td>2</td><td>SD</td></tr> <tr><td>3</td><td>RD</td></tr> <tr><td>4</td><td>RS</td></tr> <tr><td>5</td><td>CS</td></tr> <tr><td>6</td><td>-</td></tr> <tr><td>7</td><td>DR</td></tr> <tr><td>8</td><td>-</td></tr> <tr><td>9</td><td>PG</td></tr> <tr><td>10</td><td>PG</td></tr> <tr><td>11</td><td>CD</td></tr> <tr><td>12</td><td>CD</td></tr> <tr><td>13</td><td>ER1</td></tr> <tr><td>14</td><td>ER2</td></tr> <tr><td>15</td><td>-</td></tr> </tbody> </table> <p>GT side</p> <table border="1"> <thead> <tr> <th>Pin No.</th> <th>Signal name</th> </tr> </thead> <tbody> <tr><td>1</td><td>N.C.</td></tr> <tr><td>2</td><td>RD</td></tr> <tr><td>3</td><td>SD</td></tr> <tr><td>4</td><td>N.C.</td></tr> <tr><td>5</td><td>SG</td></tr> <tr><td>6</td><td>N.C.</td></tr> <tr><td>7</td><td>RS</td></tr> <tr><td>8</td><td>CS</td></tr> <tr><td>9</td><td>N.C.</td></tr> </tbody> </table>	Pin No.	Signal name	1	-	2	SD	3	RD	4	RS	5	CS	6	-	7	DR	8	-	9	PG	10	PG	11	CD	12	CD	13	ER1	14	ER2	15	-	Pin No.	Signal name	1	N.C.	2	RD	3	SD	4	N.C.	5	SG	6	N.C.	7	RS	8	CS	9	N.C.	GT707
Pin No.	Signal name																																																						
1	-																																																						
2	SD																																																						
3	RD																																																						
4	RS																																																						
5	CS																																																						
6	-																																																						
7	DR																																																						
8	-																																																						
9	PG																																																						
10	PG																																																						
11	CD																																																						
12	CD																																																						
13	ER1																																																						
14	ER2																																																						
15	-																																																						
Pin No.	Signal name																																																						
1	N.C.																																																						
2	RD																																																						
3	SD																																																						
4	N.C.																																																						
5	SG																																																						
6	N.C.																																																						
7	RS																																																						
8	CS																																																						
9	N.C.																																																						

\*1: The settings vary according to the ports and communication methods. Refer to the above settings for communication conditions. The 10-point type cannot be used.

\*2: This is for RS232C type of GT01/GT02/GT02L/GT03-E/GT05/GT11/GT12/GT21/GT32/GT32-E/GT703/GT704.

**When connecting with self-produced cable using a RJ45 connector**

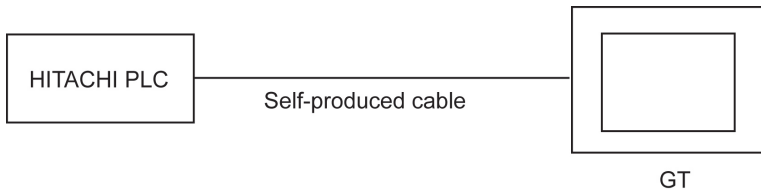

**RJ45 modular port**

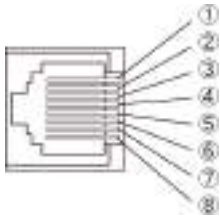

**Port 1 viewed from the front of the module (socket side)**

**MICRO-EH series**

PLC type	Link I/F	Wiring diagram	GT series																																						
14 points 20 points 23 points 28 points 40 points 64 points	Port 1 on CPU	<p>HITACHI PLC side RJ45 connector</p> <table border="1"> <thead> <tr> <th>Pin No.</th> <th>Signal name</th> </tr> </thead> <tbody> <tr><td>1</td><td>SG</td></tr> <tr><td>2</td><td>CD</td></tr> <tr><td>3</td><td>ER1</td></tr> <tr><td>4</td><td>ER2</td></tr> <tr><td>5</td><td>SD</td></tr> <tr><td>6</td><td>RD</td></tr> <tr><td>7</td><td>DR</td></tr> <tr><td>8</td><td>RS</td></tr> </tbody> </table> <p>To power supply</p> <p>GT side</p> <table border="1"> <thead> <tr> <th>Pin No.</th> <th>Signal name</th> </tr> </thead> <tbody> <tr><td>1</td><td>+</td></tr> <tr><td>2</td><td>-</td></tr> <tr><td>3</td><td>NC(or FG)</td></tr> <tr><td>4</td><td>SD</td></tr> <tr><td>5</td><td>RD</td></tr> <tr><td>6</td><td>NC</td></tr> <tr><td>7</td><td>NC</td></tr> <tr><td>8</td><td>SG</td></tr> </tbody> </table>	Pin No.	Signal name	1	SG	2	CD	3	ER1	4	ER2	5	SD	6	RD	7	DR	8	RS	Pin No.	Signal name	1	+	2	-	3	NC(or FG)	4	SD	5	RD	6	NC	7	NC	8	SG	GT series RS232C type*2		
Pin No.	Signal name																																								
1	SG																																								
2	CD																																								
3	ER1																																								
4	ER2																																								
5	SD																																								
6	RD																																								
7	DR																																								
8	RS																																								
Pin No.	Signal name																																								
1	+																																								
2	-																																								
3	NC(or FG)																																								
4	SD																																								
5	RD																																								
6	NC																																								
7	NC																																								
8	SG																																								
		<p>HITACHI PLC side RJ45 connector</p> <table border="1"> <thead> <tr> <th>Pin No.</th> <th>Signal name</th> </tr> </thead> <tbody> <tr><td>1</td><td>SG</td></tr> <tr><td>2</td><td>CD</td></tr> <tr><td>3</td><td>ER1</td></tr> <tr><td>4</td><td>ER2</td></tr> <tr><td>5</td><td>SD</td></tr> <tr><td>6</td><td>RD</td></tr> <tr><td>7</td><td>DR</td></tr> <tr><td>8</td><td>RS</td></tr> </tbody> </table> <p>GT side</p> <table border="1"> <thead> <tr> <th>Pin No.</th> <th>Signal name</th> </tr> </thead> <tbody> <tr><td>1</td><td>N.C.</td></tr> <tr><td>2</td><td>RD</td></tr> <tr><td>3</td><td>SD</td></tr> <tr><td>4</td><td>N.C.</td></tr> <tr><td>5</td><td>SG</td></tr> <tr><td>6</td><td>N.C.</td></tr> <tr><td>7</td><td>RS</td></tr> <tr><td>8</td><td>CS</td></tr> <tr><td>9</td><td>N.C.</td></tr> </tbody> </table>	Pin No.	Signal name	1	SG	2	CD	3	ER1	4	ER2	5	SD	6	RD	7	DR	8	RS	Pin No.	Signal name	1	N.C.	2	RD	3	SD	4	N.C.	5	SG	6	N.C.	7	RS	8	CS	9	N.C.	GT707
Pin No.	Signal name																																								
1	SG																																								
2	CD																																								
3	ER1																																								
4	ER2																																								
5	SD																																								
6	RD																																								
7	DR																																								
8	RS																																								
Pin No.	Signal name																																								
1	N.C.																																								
2	RD																																								
3	SD																																								
4	N.C.																																								
5	SG																																								
6	N.C.																																								
7	RS																																								
8	CS																																								
9	N.C.																																								

\*1:1 The settings vary according to the ports and communication methods. Refer to the above settings for communication conditions. The 10-point type cannot be used.

\*2: This is for RS232C type of GT01/GT02/GT02L/GT03-E/GT05/GT11/GT12/GT21/GT32/GT32-E/GT703/GT704.

## 9.3 Web Controller Series

### PLC model selection

Select "Hitachi EH/EHV series".

### Usable devices

	Bit/Word Device	No.	Memo
Bit Device	External input	X 0000~X 4FF95	
	External output	Y 0000~Y 4FF95	
	Internal output	R 000~R FFF	
	Internal output	WR 0000.0~WR FFFF.F	*
	CPU link	L 00000~L 73FFF	
	Internal output	WN 0000.0~WN 1FFFF.F	*
	Data area	M 00000~M 7FFFF	
	Extended external input	EX 00000~EX 5A7FF	
	Extended external output	EY 00000~EY 5A7FF	
	On delay timer	TD 0000~TD 2559	
	Off delay timer	TDN 0000~TDN 2559	
	Single shot	SS 0000~SS 2559	
	Monostable timer	MS 0000~MS 2559	
	Integrating timer	TMR 0000~TMR 2559	
	Watchdog timer	WDT 0000~WTD 2559	
	Counter	CU 0000~CU 2047	
	Ring counter	RCU 00000~RCU 2047	
	Updown counter	CT 00000~CT 2047	
Word Device	External input	WX 0000~WX 4FF5	
	External output	WY 0000~WY 4FF5	
	Internal output	WR 0000~WR FFFF	
	CPU link	WL 0000~WL 73FF	
	Internal output	WN 00000~WN 1FFFF	
	Data area	WM 0000~WM 7FFF	
	Extended external input	WEX 0000~WEX 5A7F	
	Extended external output	WEY 0000~WEY 5A7F	
	Timer/Counter current value	TC 0000~TC 2559	

\* The input in GTWIN is as follows:

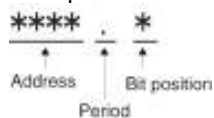

#### Note:

- The maximum value that can be set with the GT is described.
- The range of usable addresses differs depending on the model. For details, please consult the manual for the PLC you will use.

### Communication Parameters Settings

The example of communication settings of GT and PLC is shown below.

#### Setting Values for GT (Set in the configuration setting of GTWIN.)

Item	Setting
Baud Rate	19200bps
Data Length	7
Stop Bits	1
Parity Bit	Even

#### Setting Values for PLC

##### Setting for Web Controller

##### Serial port

For setting the serial port, start a Web browser on a PC, and access the page of the system configurator of Web Controller.

Specify as follows.

Item	Setting
Protocol	Passive-HIPROTOCOL
Interface*1	For RS232C connection: RS-232C
	For RS422 connection: RS-422/RS-485
	For RS485 connection: RS-422/RS-485
Procedure of communication control	Procedure of transmission control 1 (No unit No.) 1:1 communication
Transfer rate	19200 bps

\*1 It varies according to the communication method.

\*2 For the details of the method of communication setting, refer to the "Web Controller User's Manual".

### 9.3.1 RS232C Connection

When connecting with EH-RS05 and a self-produced cable

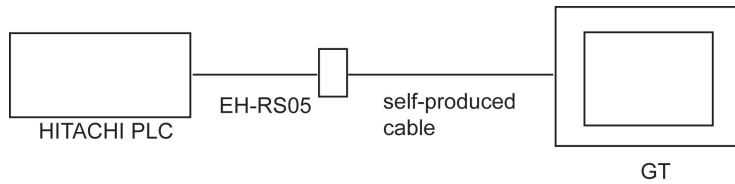

PLC type	Link I/F	Wiring diagram	GT series																																																				
10 points (EH-WD10DR)	Serial port on CPU	<p>Cable side D-sub 15-bin</p> <table border="1"> <thead> <tr> <th>Pin No.</th> <th>Signal name</th> </tr> </thead> <tbody> <tr><td>1</td><td>-</td></tr> <tr><td>2</td><td>SD</td></tr> <tr><td>3</td><td>RD</td></tr> <tr><td>4</td><td>RS</td></tr> <tr><td>5</td><td>CS</td></tr> <tr><td>6</td><td>-</td></tr> <tr><td>7</td><td>DR</td></tr> <tr><td>8</td><td>-</td></tr> <tr><td>9</td><td>PG</td></tr> <tr><td>10</td><td>PG</td></tr> <tr><td>11</td><td>CD</td></tr> <tr><td>12</td><td>CD</td></tr> <tr><td>13</td><td>ER1</td></tr> <tr><td>14</td><td>ER2</td></tr> <tr><td>15</td><td>-</td></tr> </tbody> </table> <p>To power supply</p> <p>GT side</p> <table border="1"> <thead> <tr> <th>Pin No.</th> <th>Signal name</th> </tr> </thead> <tbody> <tr><td>1</td><td>+</td></tr> <tr><td>2</td><td>-</td></tr> <tr><td>3</td><td>NC(or FG)</td></tr> <tr><td>4</td><td>SD</td></tr> <tr><td>5</td><td>RD</td></tr> <tr><td>6</td><td>RS</td></tr> <tr><td>7</td><td>CS</td></tr> <tr><td>8</td><td>SG</td></tr> </tbody> </table>	Pin No.	Signal name	1	-	2	SD	3	RD	4	RS	5	CS	6	-	7	DR	8	-	9	PG	10	PG	11	CD	12	CD	13	ER1	14	ER2	15	-	Pin No.	Signal name	1	+	2	-	3	NC(or FG)	4	SD	5	RD	6	RS	7	CS	8	SG	GT series RS232C type*1		
Pin No.		Signal name																																																					
1	-																																																						
2	SD																																																						
3	RD																																																						
4	RS																																																						
5	CS																																																						
6	-																																																						
7	DR																																																						
8	-																																																						
9	PG																																																						
10	PG																																																						
11	CD																																																						
12	CD																																																						
13	ER1																																																						
14	ER2																																																						
15	-																																																						
Pin No.	Signal name																																																						
1	+																																																						
2	-																																																						
3	NC(or FG)																																																						
4	SD																																																						
5	RD																																																						
6	RS																																																						
7	CS																																																						
8	SG																																																						
23 points (EH-WD23DR)		<p>Cable side D-sub 15-bin</p> <table border="1"> <thead> <tr> <th>Pin No.</th> <th>Signal name</th> </tr> </thead> <tbody> <tr><td>1</td><td>-</td></tr> <tr><td>2</td><td>SD</td></tr> <tr><td>3</td><td>RD</td></tr> <tr><td>4</td><td>RS</td></tr> <tr><td>5</td><td>CS</td></tr> <tr><td>6</td><td>-</td></tr> <tr><td>7</td><td>DR</td></tr> <tr><td>8</td><td>-</td></tr> <tr><td>9</td><td>PG</td></tr> <tr><td>10</td><td>PG</td></tr> <tr><td>11</td><td>CD</td></tr> <tr><td>12</td><td>CD</td></tr> <tr><td>13</td><td>ER1</td></tr> <tr><td>14</td><td>ER2</td></tr> <tr><td>15</td><td>-</td></tr> </tbody> </table> <p>GT side</p> <table border="1"> <thead> <tr> <th>Pin No.</th> <th>Signal name</th> </tr> </thead> <tbody> <tr><td>1</td><td>N.C.</td></tr> <tr><td>2</td><td>RD</td></tr> <tr><td>3</td><td>SD</td></tr> <tr><td>4</td><td>N.C.</td></tr> <tr><td>5</td><td>SG</td></tr> <tr><td>6</td><td>N.C.</td></tr> <tr><td>7</td><td>RS</td></tr> <tr><td>8</td><td>CS</td></tr> <tr><td>9</td><td>N.C.</td></tr> </tbody> </table>	Pin No.	Signal name	1	-	2	SD	3	RD	4	RS	5	CS	6	-	7	DR	8	-	9	PG	10	PG	11	CD	12	CD	13	ER1	14	ER2	15	-	Pin No.	Signal name	1	N.C.	2	RD	3	SD	4	N.C.	5	SG	6	N.C.	7	RS	8	CS	9	N.C.	GT707
Pin No.	Signal name																																																						
1	-																																																						
2	SD																																																						
3	RD																																																						
4	RS																																																						
5	CS																																																						
6	-																																																						
7	DR																																																						
8	-																																																						
9	PG																																																						
10	PG																																																						
11	CD																																																						
12	CD																																																						
13	ER1																																																						
14	ER2																																																						
15	-																																																						
Pin No.	Signal name																																																						
1	N.C.																																																						
2	RD																																																						
3	SD																																																						
4	N.C.																																																						
5	SG																																																						
6	N.C.																																																						
7	RS																																																						
8	CS																																																						
9	N.C.																																																						

\*1: This is for RS232C type of GT01/GT02/GT02L/GT03-E/GT05/GT11/GT12/GT21/GT32/GT32-E/GT703/GT704.

**When connecting with self-produced cable using a RJ45 connector**

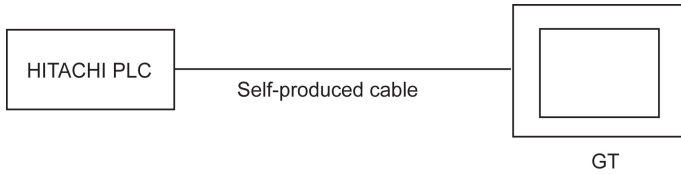

**RJ45 modular port**

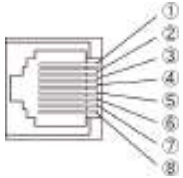

**Port 1 viewed from the front of the module (socket side)**

PLC type	Link I/F	Wiring diagram	GT series																																						
10 points (EH-WD10DR)	Serial port on CPU	<p>HITACHI PLC side RJ45 connector</p> <table border="1"> <thead> <tr> <th>Pin No.</th> <th>Signal name</th> </tr> </thead> <tbody> <tr><td>1</td><td>SG</td></tr> <tr><td>2</td><td>CD</td></tr> <tr><td>3</td><td>ER1</td></tr> <tr><td>4</td><td>ER2</td></tr> <tr><td>5</td><td>SD</td></tr> <tr><td>6</td><td>RD</td></tr> <tr><td>7</td><td>DR</td></tr> <tr><td>8</td><td>RS</td></tr> </tbody> </table> <p>To power supply</p> <p>GT side</p> <table border="1"> <thead> <tr> <th>Pin No.</th> <th>Signal name</th> </tr> </thead> <tbody> <tr><td>1</td><td>+</td></tr> <tr><td>2</td><td>-</td></tr> <tr><td>3</td><td>NC(or FG)</td></tr> <tr><td>4</td><td>SD</td></tr> <tr><td>5</td><td>RD</td></tr> <tr><td>6</td><td>NC</td></tr> <tr><td>7</td><td>NC</td></tr> <tr><td>8</td><td>SG</td></tr> </tbody> </table>	Pin No.	Signal name	1	SG	2	CD	3	ER1	4	ER2	5	SD	6	RD	7	DR	8	RS	Pin No.	Signal name	1	+	2	-	3	NC(or FG)	4	SD	5	RD	6	NC	7	NC	8	SG	GT series RS232C type*1		
Pin No.		Signal name																																							
1	SG																																								
2	CD																																								
3	ER1																																								
4	ER2																																								
5	SD																																								
6	RD																																								
7	DR																																								
8	RS																																								
Pin No.	Signal name																																								
1	+																																								
2	-																																								
3	NC(or FG)																																								
4	SD																																								
5	RD																																								
6	NC																																								
7	NC																																								
8	SG																																								
23 points (EH-WD23DR)		<p>HITACHI PLC side RJ45 connector</p> <table border="1"> <thead> <tr> <th>Pin No.</th> <th>Signal name</th> </tr> </thead> <tbody> <tr><td>1</td><td>SG</td></tr> <tr><td>2</td><td>CD</td></tr> <tr><td>3</td><td>ER1</td></tr> <tr><td>4</td><td>ER2</td></tr> <tr><td>5</td><td>SD</td></tr> <tr><td>6</td><td>RD</td></tr> <tr><td>7</td><td>DR</td></tr> <tr><td>8</td><td>RS</td></tr> </tbody> </table> <p>GT side</p> <table border="1"> <thead> <tr> <th>Pin No.</th> <th>Signal name</th> </tr> </thead> <tbody> <tr><td>1</td><td>N.C.</td></tr> <tr><td>2</td><td>RD</td></tr> <tr><td>3</td><td>SD</td></tr> <tr><td>4</td><td>N.C.</td></tr> <tr><td>5</td><td>SG</td></tr> <tr><td>6</td><td>N.C.</td></tr> <tr><td>7</td><td>RS</td></tr> <tr><td>8</td><td>CS</td></tr> <tr><td>9</td><td>N.C.</td></tr> </tbody> </table>	Pin No.	Signal name	1	SG	2	CD	3	ER1	4	ER2	5	SD	6	RD	7	DR	8	RS	Pin No.	Signal name	1	N.C.	2	RD	3	SD	4	N.C.	5	SG	6	N.C.	7	RS	8	CS	9	N.C.	GT707
Pin No.	Signal name																																								
1	SG																																								
2	CD																																								
3	ER1																																								
4	ER2																																								
5	SD																																								
6	RD																																								
7	DR																																								
8	RS																																								
Pin No.	Signal name																																								
1	N.C.																																								
2	RD																																								
3	SD																																								
4	N.C.																																								
5	SG																																								
6	N.C.																																								
7	RS																																								
8	CS																																								
9	N.C.																																								

\*1: This is for RS232C type of GT01/GT02/GT02L/GT03-E/GT05/GT11/GT12/GT21/GT32/GT32-E/GT703/GT704.

## 9.3.2 RS422 Connection

When connecting with self-produced cable using a RJ45 connector

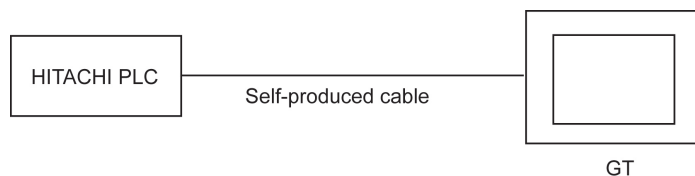

\* Refer to the above drawing of RJ45 modular port.

PLC type	Link I/F	Wiring diagram	GT series																																				
23 points (EH-WD23DR)	Serial port on CPU	<p>HITACHI PLC RS422 CPU port side RJ45 connector</p> <table border="1"> <thead> <tr> <th>Pin No.</th> <th>Signal name</th> </tr> </thead> <tbody> <tr><td>1</td><td>SG</td></tr> <tr><td>2</td><td>-</td></tr> <tr><td>3</td><td>-</td></tr> <tr><td>4</td><td>SD+</td></tr> <tr><td>5</td><td>SD-</td></tr> <tr><td>6</td><td>RD-</td></tr> <tr><td>7</td><td>RD+</td></tr> <tr><td>8</td><td>-</td></tr> </tbody> </table> <p>To power supply</p> <table border="1"> <thead> <tr> <th>Pin No.</th> <th>Signal name</th> </tr> </thead> <tbody> <tr><td>1</td><td>+24V</td></tr> <tr><td>2</td><td>GND</td></tr> <tr><td>3</td><td>NC</td></tr> <tr><td>4</td><td>+SD</td></tr> <tr><td>5</td><td>-SD</td></tr> <tr><td>6</td><td>+RD</td></tr> <tr><td>7</td><td>-RD</td></tr> <tr><td>8</td><td>E Terminal string (120V resistor built in)</td></tr> </tbody> </table>	Pin No.	Signal name	1	SG	2	-	3	-	4	SD+	5	SD-	6	RD-	7	RD+	8	-	Pin No.	Signal name	1	+24V	2	GND	3	NC	4	+SD	5	-SD	6	+RD	7	-RD	8	E Terminal string (120V resistor built in)	RS422/ RS485 type
Pin No.	Signal name																																						
1	SG																																						
2	-																																						
3	-																																						
4	SD+																																						
5	SD-																																						
6	RD-																																						
7	RD+																																						
8	-																																						
Pin No.	Signal name																																						
1	+24V																																						
2	GND																																						
3	NC																																						
4	+SD																																						
5	-SD																																						
6	+RD																																						
7	-RD																																						
8	E Terminal string (120V resistor built in)																																						

### 9.3.3 RS485 Connection

When connecting with self-produced cable using a RJ45 connector

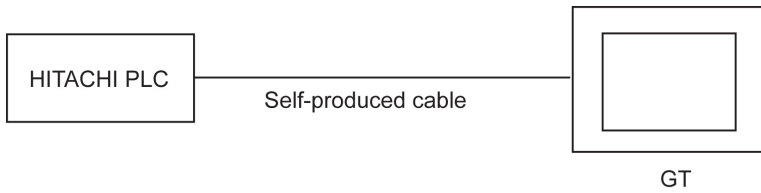

\* Refer to the above drawing of RJ45 modular port.

PLC type	Link I/F	Wiring diagram	GT series																																				
23 points (EH-WD23DR)	Serial port on CPU	<p>HITACHI PLC RS485 CPU port side RJ45 connector</p> <table border="1" data-bbox="408 681 614 909"> <thead> <tr> <th>Pin No.</th> <th>Signal name</th> </tr> </thead> <tbody> <tr><td>1</td><td>SG</td></tr> <tr><td>2</td><td>-</td></tr> <tr><td>3</td><td>-</td></tr> <tr><td>4</td><td>SD+</td></tr> <tr><td>5</td><td>SD-</td></tr> <tr><td>6</td><td>RD-</td></tr> <tr><td>7</td><td>RD+</td></tr> <tr><td>8</td><td>-</td></tr> </tbody> </table> <p style="text-align: center;">To power supply</p> <table border="1" data-bbox="710 681 1048 948"> <thead> <tr> <th>Pin No.</th> <th>Signal name</th> </tr> </thead> <tbody> <tr><td>1</td><td>+24V</td></tr> <tr><td>2</td><td>GND</td></tr> <tr><td>3</td><td>NC</td></tr> <tr><td>4</td><td>+SD</td></tr> <tr><td>5</td><td>-SD</td></tr> <tr><td>6</td><td>+RD</td></tr> <tr><td>7</td><td>-RD</td></tr> <tr><td>8</td><td>E Terminal station setting (120Ω resistor built in)</td></tr> </tbody> </table>	Pin No.	Signal name	1	SG	2	-	3	-	4	SD+	5	SD-	6	RD-	7	RD+	8	-	Pin No.	Signal name	1	+24V	2	GND	3	NC	4	+SD	5	-SD	6	+RD	7	-RD	8	E Terminal station setting (120Ω resistor built in)	RS422/ RS485 type
Pin No.	Signal name																																						
1	SG																																						
2	-																																						
3	-																																						
4	SD+																																						
5	SD-																																						
6	RD-																																						
7	RD+																																						
8	-																																						
Pin No.	Signal name																																						
1	+24V																																						
2	GND																																						
3	NC																																						
4	+SD																																						
5	-SD																																						
6	+RD																																						
7	-RD																																						
8	E Terminal station setting (120Ω resistor built in)																																						



# **Chapter 10**

---

## **Connection in Modbus (RTU Mode)**

## 10.1 Modbus (RTU Mode | modicon PLC)

### PLC model selection

-For the PLC made by Modicon

-Device setting: Start No. \*\*\*\*\*1

Select "Modbus (RTU Mode | modicon PLC)".

### Usable devices

Bit/Word Device		No.	Memo
Bit Device	Input	100001-165536	
	Coil	000001-065536	
Word Device	Input	100001-165536	Specify address expression every 16 multiples
	Coil	000001-065536	Specify address expression every 16 multiples
	Input Register	300001-365536	
	Holding Register	400001-465536	

### Communication Parameters Settings

The example of communication settings of GT and PLC is shown below.

#### Setting Values for GT (Set in the configuration setting of GTWIN.)

Item	Setting
PLC Unit No.	1
Baud Rate	19200bps
Length of Bits	8
Stop Bits	1
Parity	Even

#### Setting Values for PLC

Item	Setting
Station Address	1
Mode	RTU
Baud Rate	19200bps
Length of Bits	8
Stop Bits	1
Parity	Even

### Other companies' PLCs to be used

Make sure to check on the actual equipment to be used.

## 10.2 Modbus (RTU Mode)

### PLC model selection

**Device setting: Start No. \*\*\*\*\*0**

Select "Modbus (RTU Mode)".

### Usable devices

Bit/Word Device		No.	Memo
Bit Device	Input	100000-165535	
	Coil	000000-065535	
Word Device	Input	100000-165535	Specify address expression every 16 multiples
	Coil	000000-065535	Specify address expression every 16 multiples
	Input Register	300000-365535	
	Holding Register	400000-465535	

### Communication Parameters Settings

The example of communication settings of GT and PLC is shown below.

#### Setting Values for GT (Set in the configuration setting of GTWIN.)

Item	Setting
PLC Unit No.	1
Baud Rate	19200bps
Length of Bits	8
Stop Bits	1
Parity	Even

#### Setting Values for PLC

Item	Setting
Station Address	1
Mode	RTU
Baud Rate	19200bps
Length of Bits	8
Stop Bits	1
Parity	Even

### Other companies' PLCs to be used

Make sure to check on the actual equipment to be used.

PLC checked on the actual equipment: DL05 made by Koyo Electronics Industries Co., Ltd

## 10.3 Modbus (RTU Mode) for Temperature Control Unit, etc

---

### PLC model selection

**Device setting: Start No. \*\*\*\*\*0**

Select "Modbus (RTU mode | Temperature control unit, etc)

### Overview of communication

Only function codes "03" and "06" which are the command to read/write the contents of the holding registers are used. The function code "03" is a message to enable the contents of multiple holding registers to be read, however, GT reads the number of holding registers by 1 word.

For outputting bit, read the value of the holding register to be output and change the bit before writing.

### Usable devices

Bit/Word Device		No.
Bit Device	Holding register	400000.0-465535.F
Word Device	Holding Register	400000-465535

### Communication Parameters Settings

The example of communication settings of GT and a device such as temperature control unit is shown below.

#### Setting Values for GT (Set in the configuration setting of GTWIN.)

Item	Setting
PLC Unit No.	1
Baud Rate	19200bps
Length of Bits	8
Stop Bits	1
Parity	Even

#### Setting Values for Temperature control unit, etc

Item	Setting
Station Address	1
Mode	RTU
Baud Rate	19200bps
Length of Bits	8
Stop Bits	1
Parity	Even

### Precautions when making communication settings

When connecting the GT via RS485, set the transmission delay in GT Configuration to 5 ms or more. (The appropriate values vary according to equipment to be connected. Check with actual equipment.)

**Function code****Function code 03 (Read Holding Registers)****Command**

GT unit No.	Function code 03H	Starting No. (Higher)	Starting No. (Lower)	No. of read 00(H)	No. of read 01(H)	Error check (Higher)	Error check (Lower)
1 byte	1 byte	1 byte	1 byte	1 byte	1 byte	1 byte	1 byte

**Response**

GT unit No.	Function code 03H	No. of data 02(H)	Data (Higher)	Data (Lower)	Error check (Higher)	Error check (Lower)
1 byte	1 byte	1 byte	1 byte	1 byte	1 byte	1 byte

**Function code 06 (Write to Single Holding Register)****Command**

GT unit No.	Function code 06H	No. (Higher)	No. (Lower)	Write data (Higher)	Write data (Lower)	Error check (Higher)	Error check (Lower)
1 byte	1 byte	1 byte	1 byte	1 byte	1 byte	1 byte	1 byte

**Response**

GT unit No.	Function code 06H	No. (Higher)	No. (Lower)	Write data (Higher)	Write data (Lower)	Error check (Higher)	Error check (Lower)
1 byte	1 byte	1 byte	1 byte	1 byte	1 byte	1 byte	1 byte

# 10.4 Connection Method (Example)

## RS232C connection

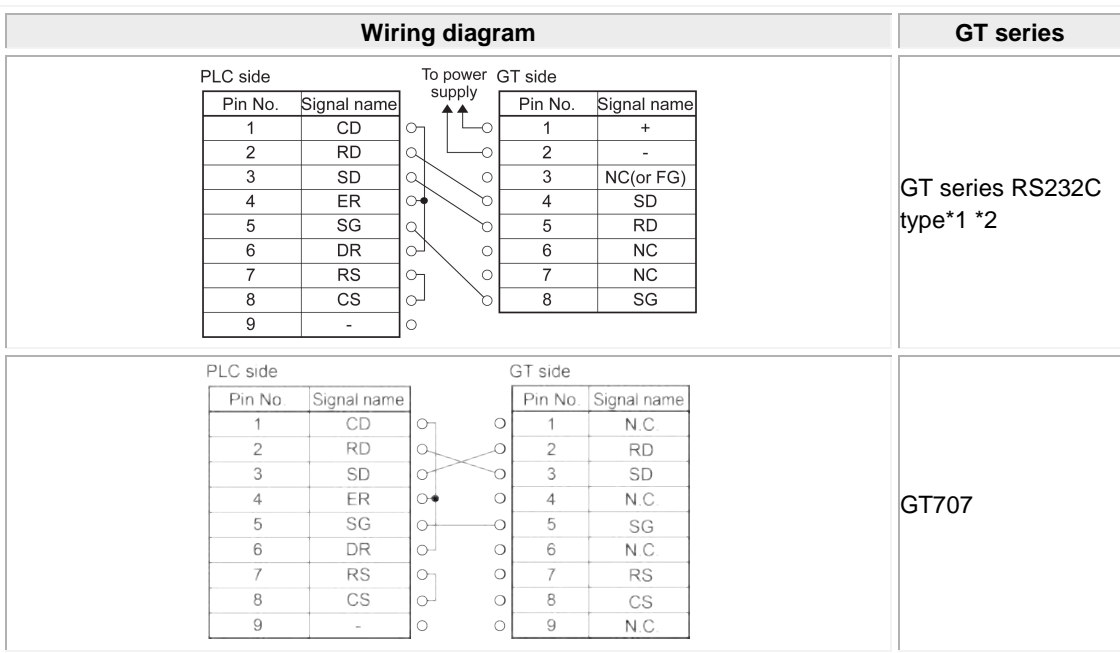

\*1: Although nos.6 and 7 of the models except GT01 are RS/CS, they can be used in the above connection.

\*2: This is for RS232C type of GT01/GT02/GT02L/GT03-E/GT05/GT11/GT12/GT21/GT32/GT32-E/GT703/GT704.

## RS485 connection

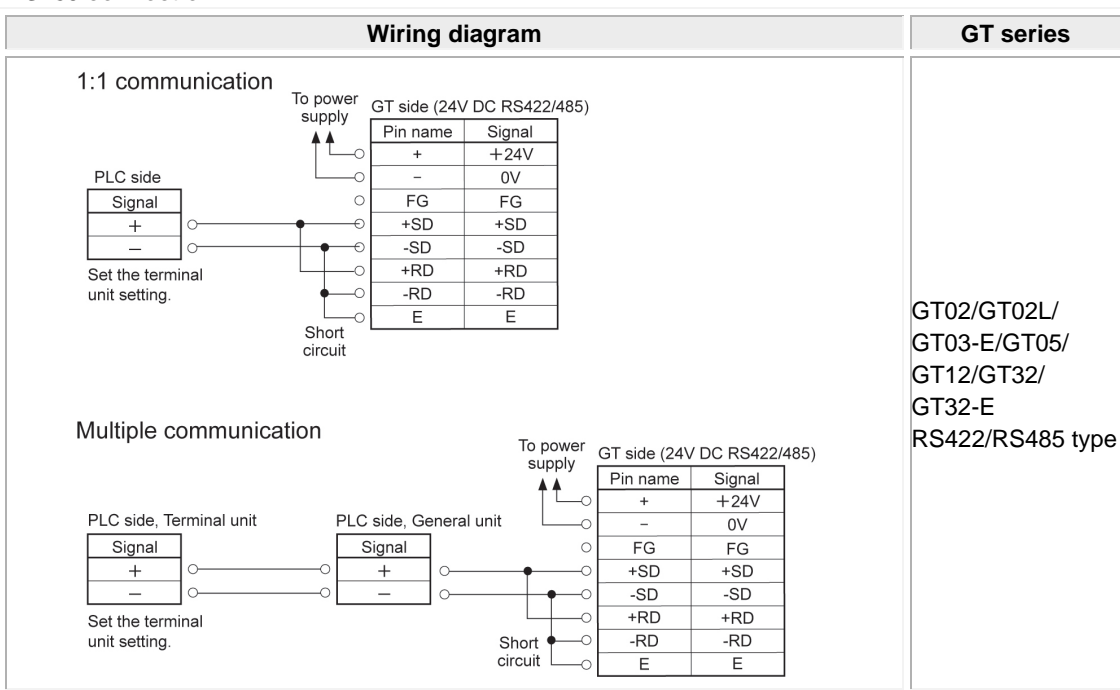

## Record of changes

Manual No.	Date	Description of changes
ARCT1F449E	Aug.2008	First Edition
ARCT1F449E-1	Aug.2008	2 <sup>nd</sup> Edition
ARCT1F449E-2	Feb.2009	3 <sup>rd</sup> Edition - Change in Corporate name
ARCT1F449E-3	Jul.2009	4 <sup>th</sup> Edition
ARCT1F449E-4	Sep.2009	5 <sup>th</sup> Edition
ARCT1F449E-5	Feb.2010	6 <sup>th</sup> Edition
ARCT1F449E-6	May.2010	7 <sup>th</sup> Edition
ARCT1F449E-7	Jun.2010	8 <sup>th</sup> Edition
ARCT1F449E-8	Dec.2010	9 <sup>th</sup> Edition
ARCT1F449E-9	Dec.2011	10 <sup>th</sup> Edition
ARCT1F449E-10	Jul.2013	11 <sup>th</sup> Edition - Additions: GT03-E
ARCT1F449E-11	Nov.2013	12 <sup>th</sup> Edition
ARCT1F449E-12	Jul.2017	13 <sup>th</sup> Edition - Additions: GT707

Please contact .....

## Panasonic Industrial Devices SUNX Co., Ltd.

■ Overseas Sales Division (Head Office): 2431-1 Ushiyama-cho, Kasugai-shi, Aichi, 486-0901, Japan

■ Telephone: +81-568-33-7861 ■ Facsimile: +81-568-33-8591

[panasonic.net/id/pidsx/global](http://panasonic.net/id/pidsx/global)

About our sale network, please visit our website.