

Thank you very much for purchasing Panasonic products. Please read this Instruction Manual carefully and thoroughly for the correct and optimum use of this product. Kindly keep this manual in a convenient place for quick reference.

⚠ WARNING

- This product is for the sensing (determination and measurement) of objects. Do not use this product to secure safety, such as accident prevention which may affect human life and property.
- Do not stare directly into the laser beam, or through observation optical equipment, such as lenses or etc. as it is dangerous.

1 INTENDED PRODUCTS FOR CE MARKING

- This product complies with the following standards / regulations.

<EU Directive>
 EMC Directive
 <Standards in US / Canada>
 CAN/CSA-C22.2 NO. 60947-5-2-14



2 CONFIRMATION OF PACKED CONTENTS

- Sensor 1 pc.
- Laser warning label (JIS Standards, GB Standards) 1 set
- FDA certification label 1 pc.
- Instruction Manual (Japanese, English) 1 pc. each language
- General Information for Safety, Compliance, and Instructions (23 languages) 1 pc.

3 SAFE USE OF LASER PRODUCT

- For the purpose of preventing any injury which may occur to the user by the use of the laser product in advance, the following standards have been established by the IEC Standards, JIS Standards, GB Standards and FDA Standards.

IEC : IEC 60825-1-2014
 JIS : JIS C 6802-2014
 GB : GB 7247.1-2012
 FDA : PART 1040.10

These standards classifies laser products according to the level of hazard and provide the safety measures for respective classes.

• **WARNING label**

In Japanese



In English



• **FDA certification label**



In Chinese



<Label position>

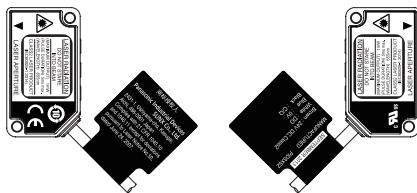

- An English warning label is attached to this product. When this product is used in Japan or China, peel off the English warning label, and attach the Japanese or Chinese warning label.
- When exporting this product to the United State of America attach the FDA certification label to the cable close to the sensing device.

4 PART DESCRIPTION

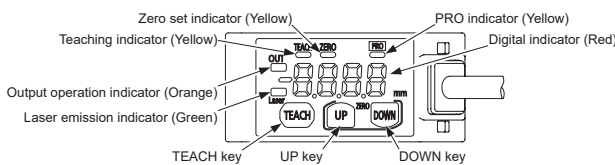

Name	Function
Zero set indicator (Yellow)	Lights when zero set function is enabled.
Teaching indicator (Yellow)	Lights when teaching is in process.
Output operation indicator (Orange)	Lights when output is ON.
Laser emission indicator (Green)	Lights when laser beam is ON.
PRO indicator (Yellow)	<During IO-Link non communication> • Lamp OFF when in normal status • Lights when in PRO mode <During IO-Link communication> • Flashes when in normal status • Lights when in PRO mode

5 MOUNTING

Mounting the Main Unit

- When mounting this product, use M3 screws (prepare separately). Use a tightening torque of 0.5N·m for mounting.
- When mounting this product using the sensor mounting bracket (optional), also use a tightening torque of 0.5N·m.

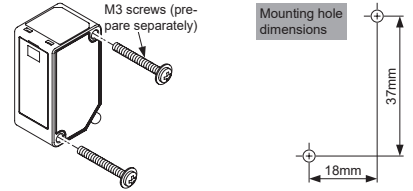

Mounting the Main Unit

If the fixed ring loosens, the connector will come off, causing this product to generate a communication error. Before use, be sure to check that the fixed ring is not loose.

- Firmly tighten the fixed ring by rotating it.

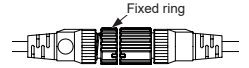

Mounting Direction

- **Direction to a movable body**
 <When there are differences in material and color>

- When performing measurements of moving objects with excessively different materials and colors, mount the product per the following directions to minimize measurement errors.

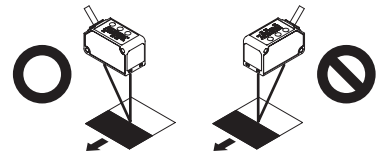

<Measurement of rotating objects>

- When measuring rotating objects, mount the product as follows. Measurement can be performed with minimized effect on the object caused by up / down deflection, position deviation and etc.

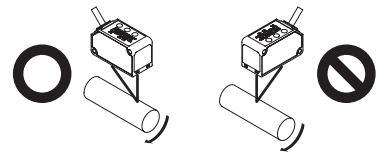

<When there is a step>

- When there is a step in the moving object, mount the product as follows. Measurement can be performed with minimized effect from the edges of the steps.

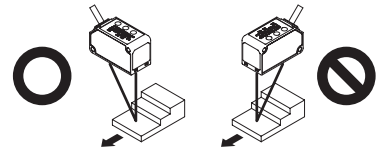

• **Measuring of narrow locations and recesses**

- When measuring in narrow locations or inside holes, mount the product so that optical path to light-receiving part is not interrupted.

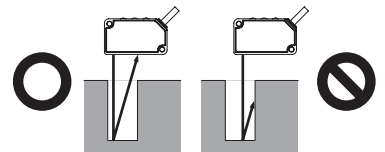

• **Mounting the sensor to a wall**

- Mount the product as follows, so that the multiple light reflections on the wall do not emit to the light-receiving part. When the reflection factor on a wall is high, it is effective to use a dull black color.

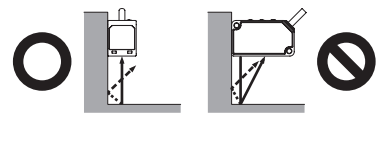

6 WIRING

• **When used as general-purpose sensor**

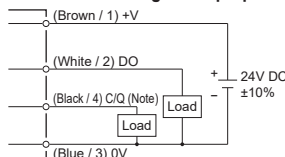

• **When connected to IO-Link master**

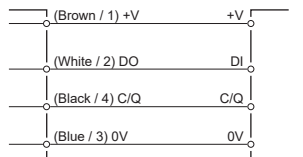

Note: When the product is used as a general-purpose sensor, the IO-Link communication (C/Q) is generated in the same way as control output (DO).

<Terminal arrangement of M12 connector type>



Terminal No.	Terminal name
1	+V
2	Control output (DO)
3	0V
4	IO-Link communication (C/Q)

- Recommended Extension cable with connectors on both ends XSSW series [OMRON Corporation]

7 LIST OF FUNCTIONS

Function	Setting on main unit	IO-Link communication setting
Teaching	Teaching input	Index2
	Limit-teaching (UP key)	Index2
	Limit-teaching (DOWN key)	Index2
	Teaching cancel	Index2
Sensing output setting	Normal sensing mode	Index61_2
	Window comparator mode (1/2/3-point)	Index61_2
Threshold setting	Threshold 1_SL	Index60_1
	Threshold 2_SL	Index60_2
Differential mode	Span setting	Index67_1
	Threshold setting	Index67_2
Peak / Bottom hold function	Setting	Index84
	Release	Index2
Zero set function	Save in nonvolatile memory	Index2
	Execute	Index2
Key lock function	Release of non-volatile memory	Index2
	Setting / Release	Index12
Response Speed Setting	10ms / 5ms / 1.5ms	Index66
Output operation setting	Light-ON / Dark-ON	Index61_1
	Hysteresis setting	Index61_3
	Shift setting	Index74_1
	Shift amount setting	Index74_2
	Timer setting	Index64_1
	Timer period setting	Index64_2
	Display setting	Index83
	Hold setting	Index85_1
	ECO setting	Index80
	Reset setting	Index2
	Emission halt	Index70
	Instability detection threshold	Index160
	Instability detection delay time	Index162
	Operating time	Index163
Number of data save operations	Index164	
Notification flag setting	Index168	
Notification event code	Index169	

Note: For the IO-Link communication setting, refer to the attached sheet, "Index List."

8 TEACHING

If settings are configured simultaneously on the main unit side and on the IO-Link communication side, the settings that are applied last will be enabled.

2-point teaching

- This is the basic teaching method.

Distance

Background Sensing object

Threshold 1_SL

ON

OFF

- Press the TEACH key in the background present condition. (System command / Index2: 0x4D)
- Press the TEACH key in the sensing object present condition. (System command / Index2: 0x4D)

Stable sensing is possible

Stable sensing is not possible

Limit-teaching

- This is teaching method in case small object or object in background are existing.

<When an object in background is used as reference>

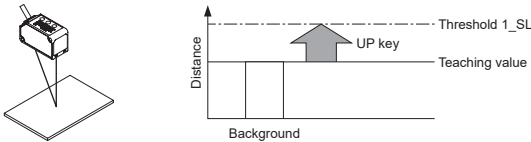

<When a sensing object is used as reference>

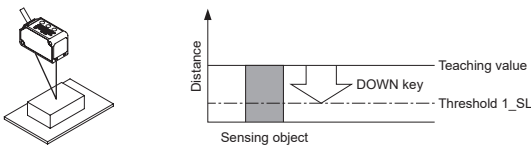

- Press the TEACH key in the background present condition or the sensing object present condition. (System command / Index2: 0x4D)
- When an object in the background is used as a reference, press the UP key to set the threshold on the sensor side. (System command / Index2: 0x4B)
When a sensing object is used as a reference, press the DOWN key to set the threshold on the sensing object side. (System command / Index2: 0x4C)
- Teaching is completed.

Automatic

1-point teaching (Window comparator mode)

- This mode is used for setting the threshold range for the distance from the reference value of the sensing object, by performing 1-point teaching. This mode is used for sensing within the threshold range.
- When performing 1-point teaching (window comparator mode), preset "Window comparator mode 1" in the sensing output setting of the PRO mode. For the setting method, refer to "PRO MODE SETTING."

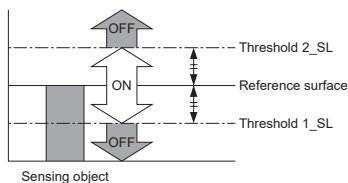

- Press the TEACH key twice in the sensing object present condition. (1st time: TEACH mode, 2nd time: Teaching) [System command / Index2: 0x4D (Two times)]
- Teaching is completed.

Automatic

2-point teaching (Window comparator mode)

- This is method to set the threshold range by conducting the 2-point teaching.
- When performing 2-point teaching (window comparator mode), preset "Window comparator mode 2" in the sensing output setting of the PRO mode. For the setting, refer to "PRO MODE SETTING."
- When conducting teaching, use sensing objects (P-1 and P-2) whose distance are different from each other.

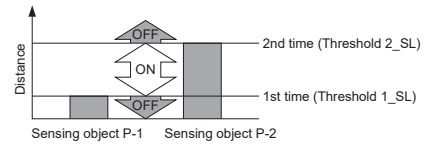

- Press the TEACH key in the sensing object P-1 present condition. (1st time) (System command / Index2: 0x4D)
- Press the TEACH key in the sensing object P-2 present condition. (2nd time) (System command / Index2: 0x4D)

Stable sensing is possible

Stable sensing is not possible

3-point teaching (Window comparator mode)

- This is the method to perform 3-point teaching (P-1, P-2, P-3) and to set the threshold range by setting threshold 1_SL in the mid-point between the 1st time and 2nd time, and threshold 2_SL in the mid-point between the 2nd time and 3rd time as shown in the following figure.
- When performing 3-point teaching (window comparator mode), preset "Window comparator mode 3" in the sensing output setting of the PRO mode. For the setting, refer to "PRO MODE SETTING."
- When performing teaching, use sensing objects (P-1, P-2, P-3) with different distance.
- After teaching, P-1, P-2 and P-3 will be automatically rearranged from the smaller value.

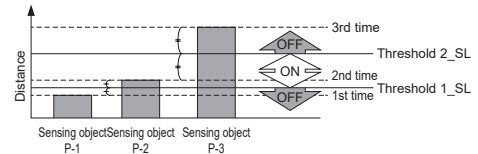

- Press the TEACH key in the sensing object P-1 present condition. (1st time) (System command / Index2: 0x4D)
- Press the TEACH key in the sensing object P-2 present condition. (2nd time) (System command / Index2: 0x4D)
- Press the TEACH key in the sensing object P-3 present condition. (3rd time) (System command / Index2: 0x4D)

Stable sensing is possible

Stable sensing is not possible

Span adjustment in rising differential mode or trailing differential mode

- This mode is used to cancel the gradual changes in the measured value, and to only detect sudden changes.
- When performing rising differential mode or trailing differential mode, preset "Rising differential mode" or "Trailing differential mode" in the sensing output setting of the PRO mode. For the setting method, refer to "PRO MODE SETTING."
- The threshold can be set by using the threshold value fine adjustment function. For the threshold value fine adjustment function, refer to "THRESHOLD VALUE FINE ADJUSTMENT FUNCTION."

- Press the TEACH key.
- Press the UP key or DOWN key to select the span.
Short span: $d-01 \rightarrow d-02 \rightarrow \dots \rightarrow d-07 \rightarrow d-08$
Long span
- Press the TEACH key to set.

9 THRESHOLD VALUE FINE ADJUSTMENT FUNCTION

- Fine adjustment of the threshold can be performed in the measurement display.
- Fine adjustment of the threshold can be performed even after teaching.

<Normal sensing mode, rising differential mode or trailing differential mode>

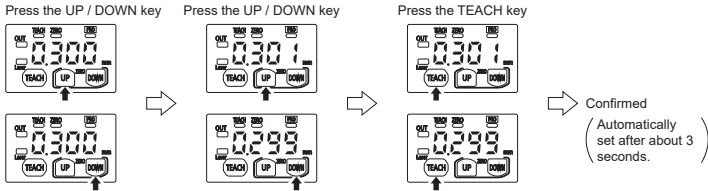

<Window comparator mode>

- When the sensing output is set to window comparator mode, the display of " 1.5L " and " 2.5L " can be changed by pressing the TEACH key for 1 second.

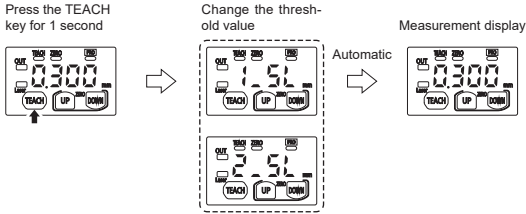

- When performing a fine adjustment of the threshold of " 1.5L " or " 2.5L ", press the UP key or DOWN key. After " 1.5L " or " 2.5L " is displayed, the fine adjustment of the threshold can be performed.

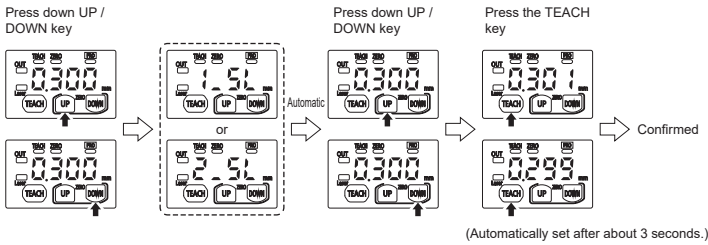

10 PEAK / BOTTOM HOLD FUNCTION

- The peak / bottom hold function, is for displaying the peak value and bottom value.
- When the zero set function is executed while the peak / bottom hold function is set to "Peak hold" or "Bottom hold", the held measured value will be reset.

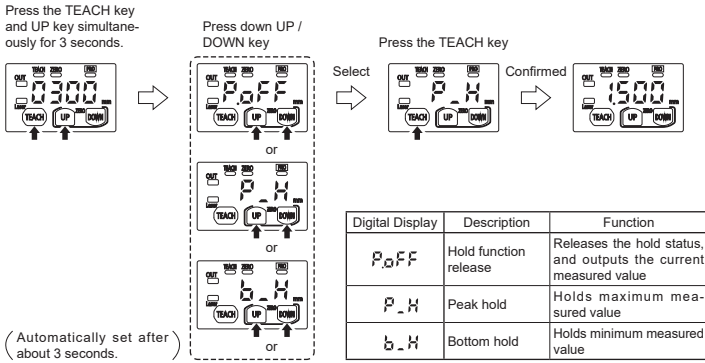

11 ZERO SET FUNCTION

- The zero set function is the function to compulsorily set the measured value to "zero".
- The zero set indicator (yellow) will turn ON when the zero set is valid.
- When the zero set function is executed while the peak / bottom hold function is valid, the held measured value will be reset.
- When the display setting is set to Offset, the zero set function cannot be set.

<Zero set setting>

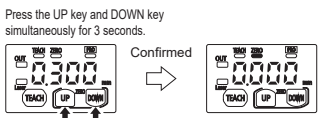

<Zero set release>

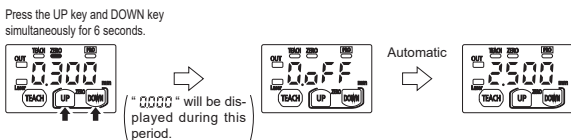

12 KEY LOCK FUNCTION

- The key lock function is to prevent acceptance of key operations, so that the conditions set in each setting mode are not changed accidentally.
- When key operation is performed after the key lock is set, " L.LCK " will be displayed on the digital display.

<Key lock setting>

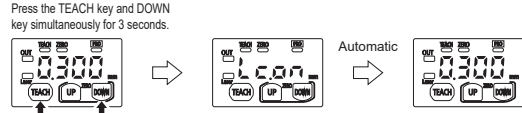

<Key lock release>

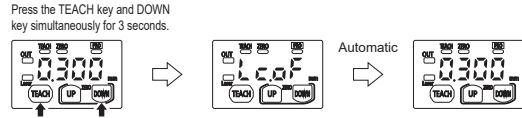

13 ERROR INDICATION

- In case of errors, attempt the following measures.

Error indication	Description	Remedy
<Hold OFF> ----- <Hold ON> Measured value blinks	Insufficient amount of reflected light. The sensing object is out of the sensing range.	Confirm that the sensing distance is within the specification range. Adjust the installation angle of the sensor.
E-01	Nonvolatile memory is damaged or passed its life expectancy.	Please contact our office.
E-11	Load of the sensing output is short-circuited causing an over-current to flow.	Turn OFF the power and check the load.
E-21	The semiconductor laser is damaged or passed its life expectancy.	Please contact our office.
E-31	• When zero set is set, the measurement is not performed normally. • Since the display setting is set to "Offset", the zero set function cannot be used.	• Confirm that the sensing distance is within the specification range. • Set the display to any setting except "Offset."
E-41	During teaching, the measurement is not performed normally.	Confirm that the sensing distance is within the specification range.
E-90 E-91 E-92 E-93	System error	Please contact our office.

14 SPECIFICATIONS

Type	Measurement center 30mm type	Measurement center 50mm type	Measurement center 100mm type	Measurement center 200mm type	Measurement center 400mm type
Model No.	Discrete wire M12 connector type	HG-C1030L3-P HG-C1050L3-P	HG-C1100L3-P HG-C1050L3-P	HG-C1200L3-P HG-C1200L3-P	HG-C1400L3-P HG-C1400L3-P
Measurement center distance	30mm	50mm	100mm	200mm	400mm
Measurement range	±5mm	±15mm	±35mm	±80mm	±200mm
Repeatability	10µm	30µm	70µm	200µm	300µm (measurement distance 200 to 400mm) 800µm (measurement distance 400 to 600mm)
Linearity		±0.1%F.S.		±0.2%F.S.	±0.2%F.S. (measurement distance 200 to 400mm) ±0.3%F.S. (measurement distance 400 to 600mm)
Temperature characteristic	0.03%F.S./°C				
Light source	Red semiconductor laser Class 2 [JIS / IEC / FDA (Note 2)] Max. output: 1mW, Emission peak wavelength: 655nm				
Beam diameter (Note 3)	Approx. ø50µm	Approx. ø70µm	Approx. ø120µm	Approx. ø300µm	Approx. ø500µm
Supply voltage	24V DC ±10%, Ripple P-P 10% or less				
Power consumption	40mA or less (at 24V DC supply voltage)				
Control output	PNP open-collector transistor • Maximum source current: 50mA • Applied voltage: same as supply voltage (Between control output to +V) • Residual voltage: 1.5V or less (At 50mA source current) • Leakage current: 0.1 mA or less				
Output operation	Switchable either Light-ON or Dark-ON				
Short-circuit protection	Incorporated (Auto reset type)				
Response time	Switchable between 1.5ms / 5ms / 10ms				
IO-Link communication	• IO-Link specification: Ver1.1 • Baudrate: COM3 (230.4kbps) • Process data length: 4byte				
Protection	IP67 (IEC)				
Degree of pollution	2				
Ambient temperature	-10 to +45°C (No dew condensation or icing allowed), Storage: -20 to +60°C				
Ambient humidity	35 to 85% RH, Storage: 35 to 85% RH				
Ambient illuminance	Incandescent lamp: Acceptance surface illuminance 3,000lx or less				
Operating altitude	2,000m or less (Note 4)				
Cable	Discrete wire: 0.2mm ² 4-core PVC cable, 2m long M12 connector type: 0.2mm ² 4-core PVC cable, 0.3m long with connector				
Material	Enclosure: Aluminum die-cast, Front cover: Acrylic				
Weight	Discrete wire: Approx. 30g (without cable), Approx. 80g (including cable) M12 connector type: Approx. 30g (without cable), Approx. 50g (including cable)				

- Notes: 1) Supply voltage: 24V DC, ambient temperature: +20°C, response time: 10ms, and measurement center distance are used for unspecified measurement conditions. The subject is white ceramics.
2) This is based on the FDA Standard, according to Laser Notice No. 50 of the FDA Standard.
3) This is the size in the measurement center distance. These values were defined by using 1/e² (approx. 13.5%) of the center light intensity. Due to leak light outside the specified area, the reflectance around the detecting point may be higher than at the point and this may affect the measurement value.
4) Do not use or store in an environment pressurized to atmospheric pressure or higher at an altitude of 0m.

15 CAUTIONS

- This product has been developed / produced for industrial use only.
- Make sure that the power supply is OFF before starting the wiring.
- If the wiring is performed incorrectly, it will cause a failure.
- Do not run the wires together with high-voltage lines or power lines, or put them in the same raceway. This can cause malfunction due to induction.
- Verify that the supply voltage variation is within the rating.
- If power is supplied from a commercial switching regulator, ensure that the frame ground (F.G.) terminal of the power supply is connected to an actual ground.
- If noise generating devices (switching regulators, inverter motors, etc.) are used around the sensor mounting area, make sure to connect the frame ground (FG) terminal of the device.
- Do not use this product during the transient state when the power supply is turned ON.
- The overall length of the cable can be extended to 20m maximum with a cable size of 0.3mm² or more.
- Make sure that stress by forcible bend or pulling is not applied to the sensor cable joint.
- Although it depends on the type, light from rapid start type or high frequency lighting type fluorescent lights, sunlight and etc. may affect the sensing, therefore make sure to prevent direct incident light.
- This product is suitable for indoor use only.
- Keep water, oil, fingerprints and etc. which reflect light, or dust, particles or etc. which interrupts the light, away from the emitting / receiving surfaces of this product. If contaminants adhere to the surface, wipe off with a dust-free soft cloth, or lens cleaning paper.
- Avoid dust, dirt, and steam.
- Do not use this sensor in places where it may come in contact with corrosive gas, etc.
- Ensure that the product does not come into contact with organic solvents such as thinner.
- Ensure that the product does not come into contact with strong acid or alkaline.
- Ensure that the product does not come into contact with oil or grease.
- Make sure to turn OFF the power supply, before cleaning the light emitting / receiving windows of the sensor head.
- There is a certain deviation in the directionality of this product. Install the product using a mounting bracket or similar fitting to allow the adjustment of optical axis.
- The internal memory (nonvolatile) of this product has a service life. Settings cannot be configured more than 100,000 times.

16 PRO MODE SETTING

If settings are configured simultaneously on the main unit side and on the IO-Link communication side, the settings that are applied last will be enabled.

Part description

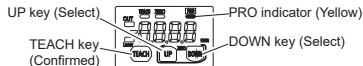

Arrow description in figures

- ←→ : Press the TEACH key
- ↕ : Press UP key or DOWN key
- ⬇️ : Press DOWN key

- The PRO indicator (yellow) will turn ON when the PRO mode is set.
- When the DOWN key is pressed for 3 seconds or more in the middle of the PRO MODE setting, the display returns to the measurement display.

Item	Default setting	Description
Response speed setting	Hr50	Set the response time. * Hr50: High precision 10ms, * 5td: Standard 5ms * FR5t: High speed 1.5ms
Output operation setting	L-on	Select the control output operation mode. * L-on: Light-ON, * d-on: Dark-ON
Sensing output setting	--f--	Set the sensing output. * --f--: Normal sensing mode * .n.1: 1-point teaching (Window comparator mode) * .n.2: 2-point teaching (Window comparator mode) * .n.3: 3-point teaching (Window comparator mode) * d.r.f: Rising differential mode * d.t.l: Trailing differential mode
Hysteresis setting	0010 003	Set the hysteresis width. HG-C1030L3-P: 0.001 to 5.00mm HG-C1050L3-P: 0.01 to 15.00mm HG-C1100L3-P: 0.02 to 35.00mm HG-C1200L3-P: 0.1 to 80.0mm HG-C1400L3-P: 0.2 to 200.0mm
Shift amount setting	0020 006	Set shift amount of threshold value in limit teaching. Set the shift amount to a value that is twice the value of hysteresis or more. HG-C1030L3-P: 0.002 to 10.00mm HG-C1050L3-P: 0.02 to 30.00mm HG-C1100L3-P: 0.04 to 70.00mm HG-C1200L3-P: 0.2 to 160.0mm HG-C1400L3-P: 0.4 to 400.0mm
Timer setting	non	Set the timer operation. * non: No timer, * ofd: OFF-delay timer * ond: ON-delay timer, * o5d: One-shot timer
Timer period setting	5	Set the timer period when the timer setting is set to "OFF-delay timer", "ON-delay timer" or "One-shot timer." * 5: 5ms, * 10: 10ms, * 25: 25ms, * 50: 50ms, * 100: 100ms, * 250: 250ms, * 500: 500ms, * 1000: 1,000ms, * 5000: 5,000ms
Display setting	5td	The display of the measured value can be changed. * 5td: Normal, * inv: Invert, * of5t: Offset
Hold setting	off	Set the control output operation when a measurement error occurs (insufficient light intensity, saturation of light intensity, out of measurement range). * off: Hold OFF, * on: Hold ON
ECO setting	off	The digital display can be set to go OFF when key operation is not performed for 30 seconds. Current consumption can be reduced. * off: ECO OFF, * on: ECO ON
Reset setting	na	Return to the default setting (factory setting). * na: Reset NG, * 4E5: Reset OK

Procedure

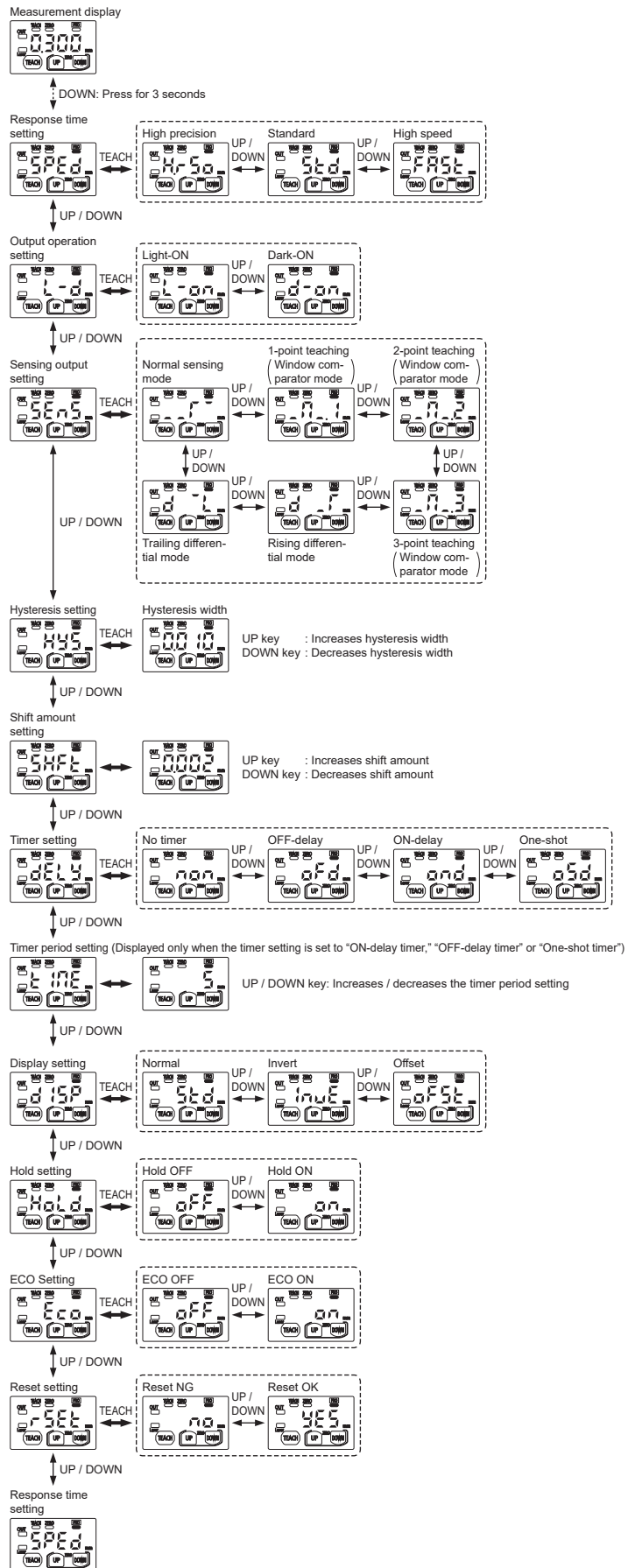

Panasonic Industrial Devices SUNX Co., Ltd.

<http://panasonic.net/id/pidsx/global>

Overseas Sales Division (Head Office)

2431-1 Ushiyama-cho, Kasugai-shi, Aichi, 486-0901, Japan

Phone: +81-568-33-7861 FAX: +81-568-33-8591

For sales network, please visit our website.

PRINTED IN CHINA

© Panasonic Industrial Devices SUNX Co., Ltd. 2018