

KE1 [Communication Slave]

Smart Monitoring Device

KE1-DRT-FLK DeviceNet Communication Unit

EN INSTRUCTION SHEET

Thank you for purchasing this product. This manual describes the functions, performance, and application methods needed for optimum use of the product. Please observe the following items when using the product.

- This product is designed for use by qualified personnel with a knowledge of electrical systems.
- Before using the product, thoroughly read and understand this manual to ensure correct use.
- Keep this manual in a safe location so that it is available for reference whenever required.

OMRON Corporation

©All Rights Reserved

9907888-4 A

PRECAUTIONS ON SAFETY

● Meanings of Signal Words



CAUTION

Indicates a potentially hazardous situation which, if not avoided, will result in minor or moderate injury, or there may be property damage.

● Signal Words

CAUTION

Property damage may occur due to fire. Tighten the terminal screws to the specified torques. Recommended terminal screw tightening torque: 0.69 to 0.88 N·m. After tightening the screw, check that the screw is not tilted.

Minor or moderate injury or property damage may occur due to explosion. Do not use the product in locations where explosive or flammable gasses may be present.

Breakdown or explosion may occasionally occur. Use the power-supply voltage and loads of the specified range.

Electric shock may occasionally occur. Do not touch the terminals while energized.

Doing so may occasionally result in electric shock, minor injury, fire, or malfunction of products. Do not try to disassemble, repair, or modify the product.



PRECAUTIONS FOR SAFE USE

In order to prevent malfunction, false operation or adverse effect on performance/functions, observe the following matters.

- 1) Do not store, install or use the product in the following environment.
 - Locations subject to vibration or strong shocks.
 - Locations where the Unit is unstable.
 - Locations subject to temperature or humidity beyond the specifications.
 - Locations subject to extreme change in temperature and humidity, resulting in icing or condensation. Locations subject to vibration or strong shocks.
 - Locations subject to direct sunlight.
 - Outdoors or locations exposed to the elements.
 - Locations subject to static electricity or noise.
 - Locations splashed with water and oil, and locations subject to exposure to salt water
 - Locations subject to corrosive gases (in particular, sulfide gas and ammonia gas).
 - Locations subject to dust (including iron dust).
 - Locations subject to a electric field or a magnetic field.
- 2) Install DIN rails using screws without looseness. Furthermore, install the DIN rails and body assuredly. Looseness may cause the DIN rails, product body and wiring to unfasten due to vibration, impact and so on.
- 3) Use 35mm width DIN rails (Omron, Form PFP-50N/-100N).
- 4) Wire the product using crimp terminals for M3.5 screws.
- 5) Make sure of proper specification and wiring prior to conduction.
- 6) Before operating or performing maintenance of the product, read this Instruction Manual thoroughly to acquire sufficient knowledge of the product. Otherwise electric shock, injury, accident, or malfunction may occur.
- 7) Install and clearly mark a switch or circuit breaker conforming to requirement in IEC60947-1 and IEC60947-3, to enable immediate power OFF by the operator.
- 8) Understand instructions of a manual before setting up equipment.
- 9) When installing the product, allow as much space as possible from the equipments that generate powerful high frequency noises, such as high-frequency welders, high-frequency sewing machines or motors, or devices that generate surges.
- 10) Be sure to touch grounded metal as a measure against electrostatic prior to touching of the product.
- 11) Separate the product wiring from high-voltage or high-current power lines to prevent inductive noise, and do not place the product wiring parallel to or in the same ducts or conduits as power lines. Use separate ducts, separate conduits, or shielded cables.
- 12) Do not install the product close to heat-producing devices, a coil for instance.
- 13) Do not make metals, conductors or chips during installation and machining penetrate into products.
- 14) Do not use thinner or similar merical alcohol.
- 15) Use the specified power supply and wires for the supply of control power or inputs. Product failure, burns, or electric shock may occur.
- 16) Install wall surface using screws without looseness. Looseness may cause the product body and wiring to unfastendue to vibration, impact, and so on.
- 17) When using multiple units, slide the horizontally combining hook unit a clicking sound is heard.
- 18) When mounting the unit on the DIN rail, slide the DIN hook unit a clicking sound is heard.
- 19) This Product cannot be used to measure the inverter's secondary side. Do not block the area around the product, or the ventilation holes on the product.
- 20) Allow for proper ventilation. Do not block the area around the product, or the ventilation holes on the product.
- 21) Make sure to wire properly after confirming the terminal number. Do not connect anything with terminals that are not used.
- 22) This is a class A product. In residential areas it may cause radio interference, in which case the user may be required to take adequate measures to reduce interference.

Ratings

Power supply	Rated power supply voltage	100 to 240 VAC, 50/60 Hz
	Allowable power supply voltage range	85% to 110% of rated supply voltage
	Power supply frequency variation range	45 to 65Hz
	Power consumption	10VA max
Ambient operating temperature	-10 to 55°C (with no icing or condensation)	
Conservation temperature	-25 to 65°C (with no icing or condensation)	
Ambient operating humidity	Relative humidity 25% to 85%	
Conservation humidity	Relative humidity 25% to 85%	
Altitude	2,000 m max.	
Installation environment	Overvoltage category: II, Degree of contamination: 2, Measurement category: II	
Applicable standards	IEC61010-2-030, EN61326-1	

Features

- This unit does not work alone. Please connect it to a measurement master.
- This unit enables DeviceNet communication when it is connected to KE1-DRT-FLK.
- DeviceNet communication allows the higher level devices to control the operation, collect various measurement data, and write various parameters.
- KE1-DRT-FLK works with two kinds of communication methods, i.e. remote I/O communication and Explicit message communication.
- Remote I/O communication enables automatic data exchange between KE1-DRT-FLK and the higher level devices with high-speed I/O without the need for programming of the abovementioned devices.
- Explicit message refers to a communication method with a command-response system.

Basic operating procedure

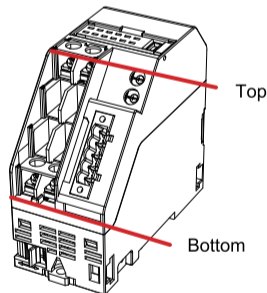
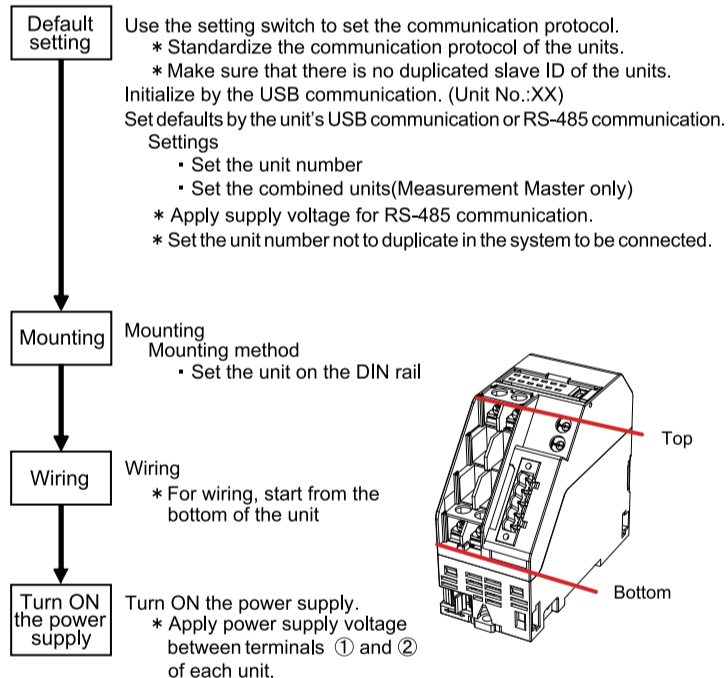

Setting switch

The communication protocol and simple allocation can be set by the DIP switch.

- Switch 1: OFF Simple allocation
ON Manually allocation
- Switch 2: OFF CompoWay/F
ON Modbus



- * Make sure to set the switch only when the power is OFF. The settings will be enabled only when the power is turned on and any change made during current application will not be reflected. To change the settings, turn off the power first and make necessary changes. Then, turn on the power again.

Node address

Specify a node address as a slave within the DeviceNet network in decimal numbers in the range of 0-63. (The numbers 64-99 are not available for the setting.) Set the ones place with the lower rotary switch ($\times 10^0$), and set the tens place with the upper rotary switch ($\times 10^1$). Make sure node addresses do not overlap.

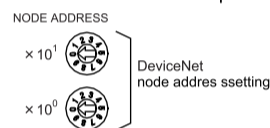

Display screen

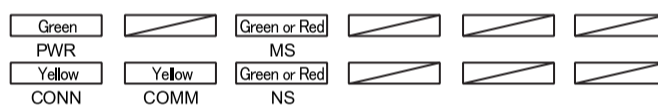

- PWR : Lighting when the power is ON. Blinking at the time of errors.
CONN : Lighting when the multiple units are connected.
MS (Module Status) : The status of the unit is displayed.
NS (Network Status) : The status of the network is shown.
* To understand the status represented by MS and NS, please download from our homepage and refer to "Type KE-1 DeviceNet Communication Unit User's Manual" (catalog number SGTE-713A).

USB port

The setting and measurement values can be read by connecting KM1/KE1 with a USB cable. Although the Power is off, the settings can be changed via USB connection. Be sure to turn on the power when using multiple units. To make measurement values read, make sure to turn on KM1/KE1 first and connect the USB cable. When the power is ON with multiple units connected, the settings of the combined units can be read and written by connecting the USB cable with the Measurement Master.
* Use a mini-USB B cable
* Download the setting tools and ".inf" files necessary for communication from the website: <http://www.ia.omron.com/>

Precautions for Correct Use

- 1) Set the parameters of the product so that they are suitable for the system being measured.
- 2) Do not pull the unit with a cable.
- 3) Dispose of this product in accordance with local and national disposal regulations.
- 4) Always use varistors to between the line of power supply and the line of voltage input when this product installed under over-voltage category III.

DeviceNet connector

A communication cable of the DeviceNet network is connected to this connector. The DeviceNet communication power supply is also supplied through this connector. Please use FCK2.5/5-STF-5.08AU (manufactured by Phoenix Contact) as the connecting connector.

Dimensions (unit: mm)

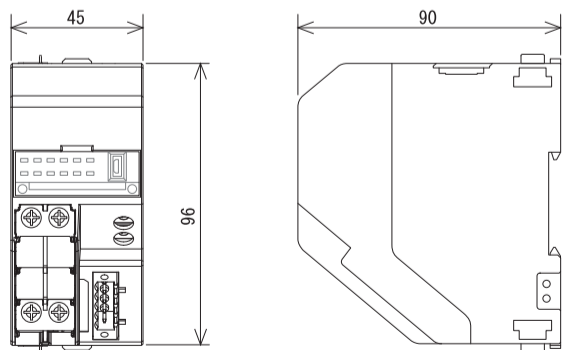

Connect

When using multiple units, fix the adjacent units using a horizontally combining hook and connect them using the attached Combining connector. Slide the horizontally combining hook until a clicking sound is heard.

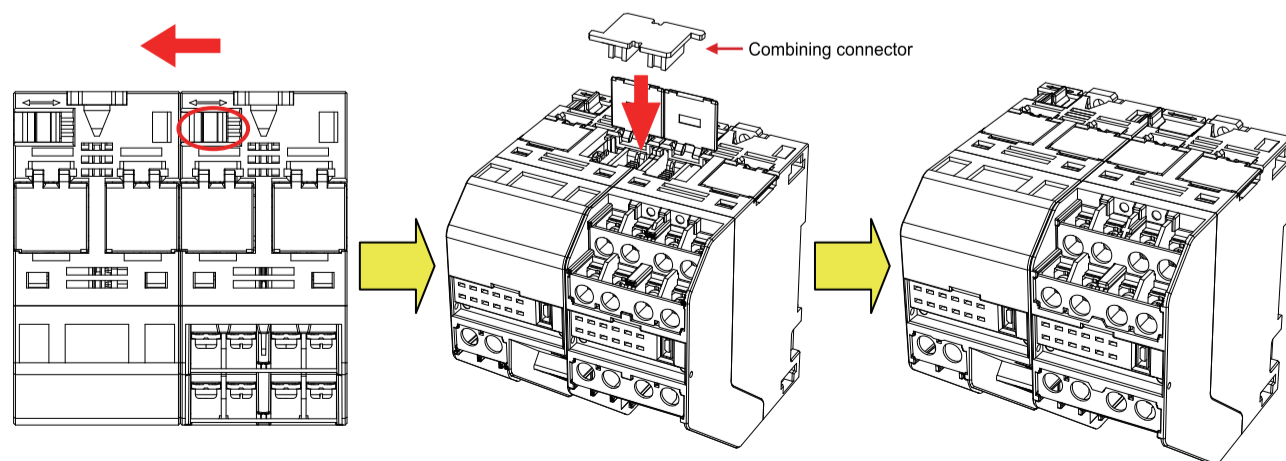

- To separate the units, follow the combining procedure backwards.
- * To remove the Combining connector, use a flathead screwdriver.
- * The Communication slave can be only connected to the measurement master.

Nomenclature

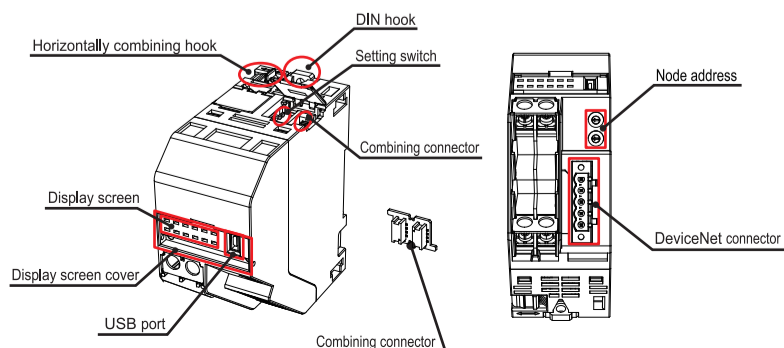

■ Mounting of the unit on the DIN rail

To install the DIN rail, place at least three screws vertically against the ground (within the control panel)

After the installation, set the end plates on both sides of the product so that the DIN rail is firmly fixed.

• Recommended DIN rail

Model	Dimension
PFP-100N	1,000mm
PFP-50N	500mm

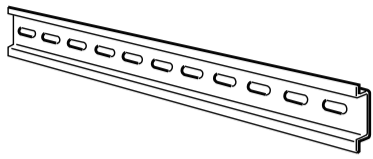

• End plates (PFP-M)

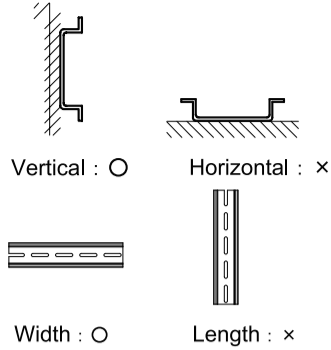
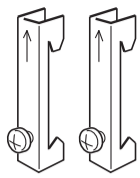

• Mounting of the product

Pull down the DIN hook of bottom side and put the top rail on the DIN rail. Push the unit until the DIN hook can be locked and then lock the DIN hook.

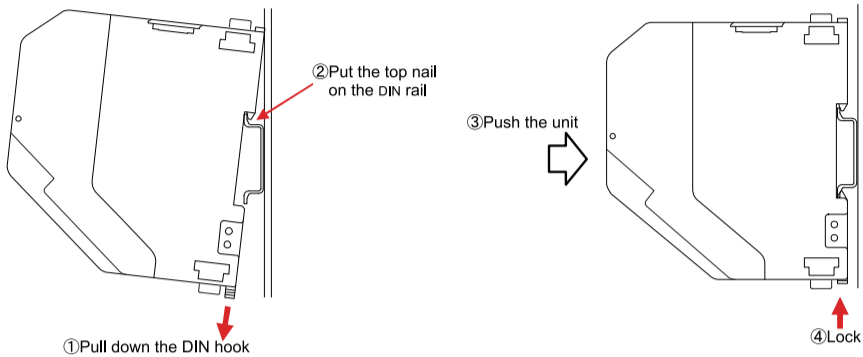

To remove the product, use a flathead screwdriver by pulling down the DIN hook.

■ Preparation of DeviceNet communication cable

Prepare a communication cable and attach it to the connector as shown below.

- Remove the outer jacket of the cable for about 30-80 mm from the end, while exercising caution so as to minimize damage to the shield net. Do not remove an excessive amount of the jacket, as it will cause problems such as a short circuit.

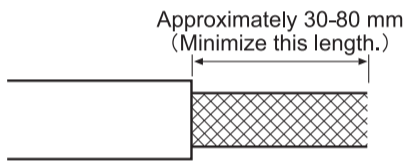

- Loosen the shield net carefully. You will find one bare and twisted shielding wire in addition to a signal line and a power line. (Feel for the shielding wire; it is a little harder than the net.)

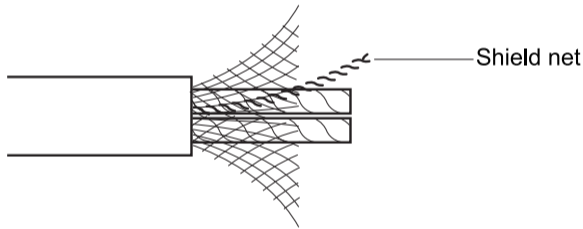

- Cut off the excess of the shield net, and remove the aluminum tape wrapped around the signal line and the power line. Then remove the jackets of the signal wires and the power wires to fit crimp terminals. Twist firmly each bare end of the signal wires and power wires.

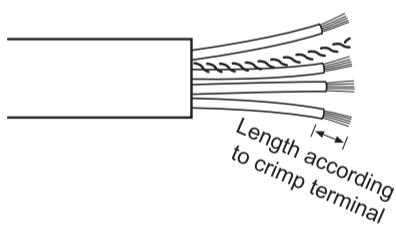

- Attach a crimp terminal to each bare end of the wires and treat them with vinyl tape or heat shrinkable tubing.

Then, while paying attention to the orientation of the connector, connect the signal wires, the power wires, and the shielding wire into the respective sockets of the connector. As shown by colors in the figure below, the order of the connection is black, blue, the shield, white, and red from the top.

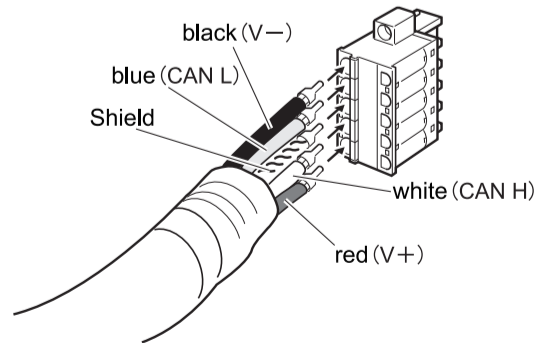

Stickers with colors according to that of the cables are attached on the PLC and the DeviceNet communication unit. Make sure that the connection is correct by checking the colors of the cables against that of the units.

The following shows the colors and the cables.

colors	Signal type
red	Power cable +side (V+)
white	Communication data High side (CAN H)
-	Shield
blue	Communication data Low side (CAN L)
black	Power cable -side (V-)

■ Terminal diagram

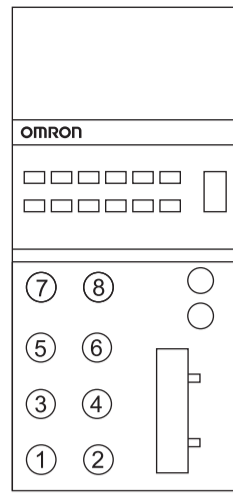

Terminal number	KE1-DRT-FLK DeviceNet Communication Unit
①	Power supply voltage
②	Power supply voltage
③	NC
④	NC
⑤	NC
⑥	NC
⑦	RS-485 A(-)
⑧	RS-485 B(+)

■ Wiring diagram

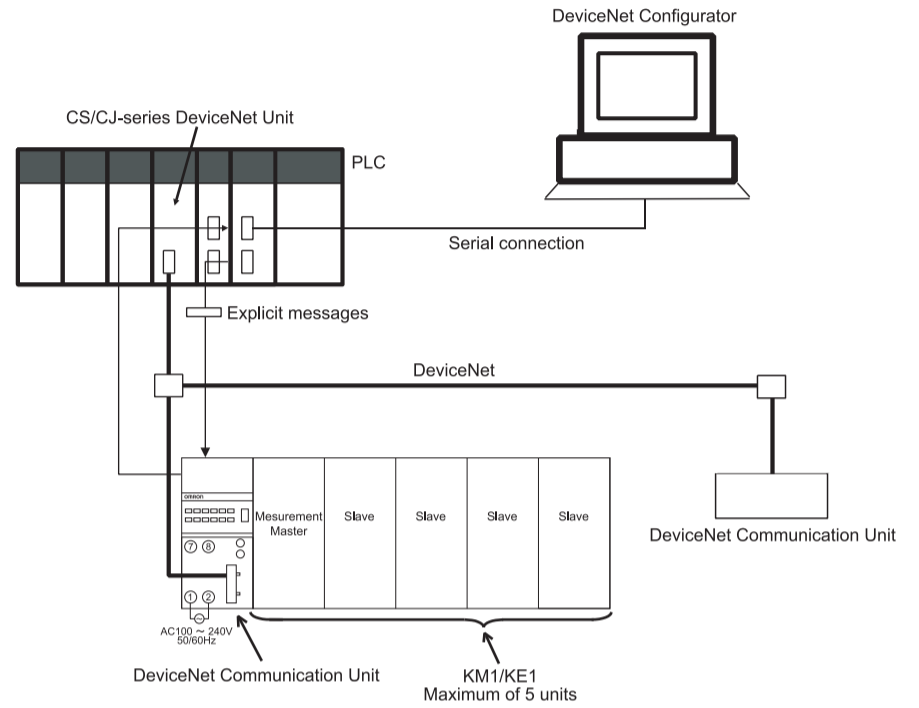

■ Connection to DeviceNet communication unit

Align the orientation of the connector of the DeviceNet communication unit and the cable connector. Connect the connectors and push the cable connector until its protruded portion is completely inside the connector of the DeviceNet communication unit. Make sure to secure the connectors with screws. The appropriate tightening torque is 0.25 - 0.30 N·m.

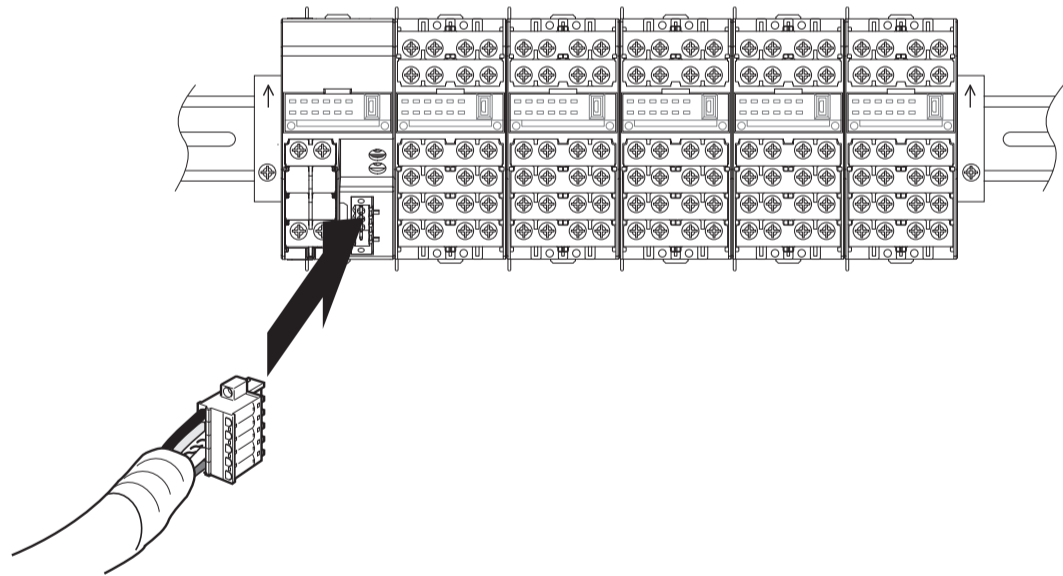

■ Communication RS-485

- Protocol can be chosen between CompoWay/F and Modbus. Number of KM1/KE1 connectable (excluding the host equipment) is 31 in CompoWay/F or 99 in Modbus.
- The maximum transmission distance is 500 m.
- Use shielded twist pair cable of AWG 24 to AWG 14.
- Mount a terminating resistor to the devices including a host device connected to both ends of the transmission line.
- For the Product connected to a terminating resistor, connect a terminating resistor of 120 Ω (1/2 W) between terminal number 7 and 8.
- When connecting multiple wires to the same terminal, screws may not be fully tightened. Therefore, we recommend crimping all wires together to one crimp-type terminal.

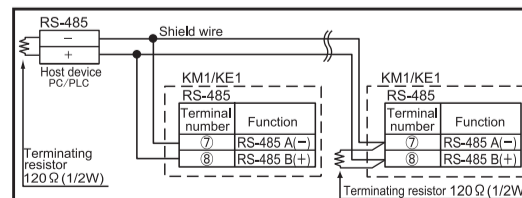

Suitability for Use

The warranty period for an OMRON Product is one year from either the date of purchase or the date on which the OMRON Product is delivered to the specified location. OMRON shall not be responsible for conformity with any standards, codes, or regulations that apply to the combination of the products in the customer's application or use of the product. Take all necessary steps to determine the suitability of the product for the systems, machines, and equipment with which it will be used. Know and observe all prohibitions of use applicable to this product. NEVER USE THE PRODUCTS FOR AN APPLICATION INVOLVING SERIOUS RISK TO LIFE OR PROPERTY WITHOUT ENSURING THAT THE SYSTEM AS A WHOLE HAS BEEN DESIGNED TO ADDRESS THE RISKS, AND THAT THE OMRON PRODUCT IS PROPERLY RATED AND INSTALLED FOR THE INTENDED USE WITHIN THE OVERALL EQUIPMENT OR SYSTEM. See also product catalog for Warranty and Limitation of Liability.

Contact Information

OMRON ELECTRONICS LLC.
One Commerce Drive Schaumburg, IL 60173-5302 U.S.A
Phone: 1-847-843-7900 Fax: 1-847-843-7787

OMRON EUROPE B.V.
Wegalaan 67-69, 2132 JD Hoofddorp The Netherlands
Phone: 31-23-56-81-300 Fax: 31-23-56-81-388

OMRON ASIA-PACIFIC PTE. LTD.
No.438A Alexandra Road #05-05/08(Lobby 2), Alexandra Technopark, Singapore 119967
Phone: 65-6835-3011 Fax: 65-6835-2711

OMRON CORPORATION
3-4-10 Toranomon Minato-ku, Tokyo, 105-0001 Japan
Phone: 81-3-3436-7260 Fax: 81-3-3436-7261