

Panasonic

NEW

FAYb Laser Marker

LP-RF SERIES

FDA
Conforming to
FDA regulations

GB
Conforming to
7247.1



Simple & High Quality

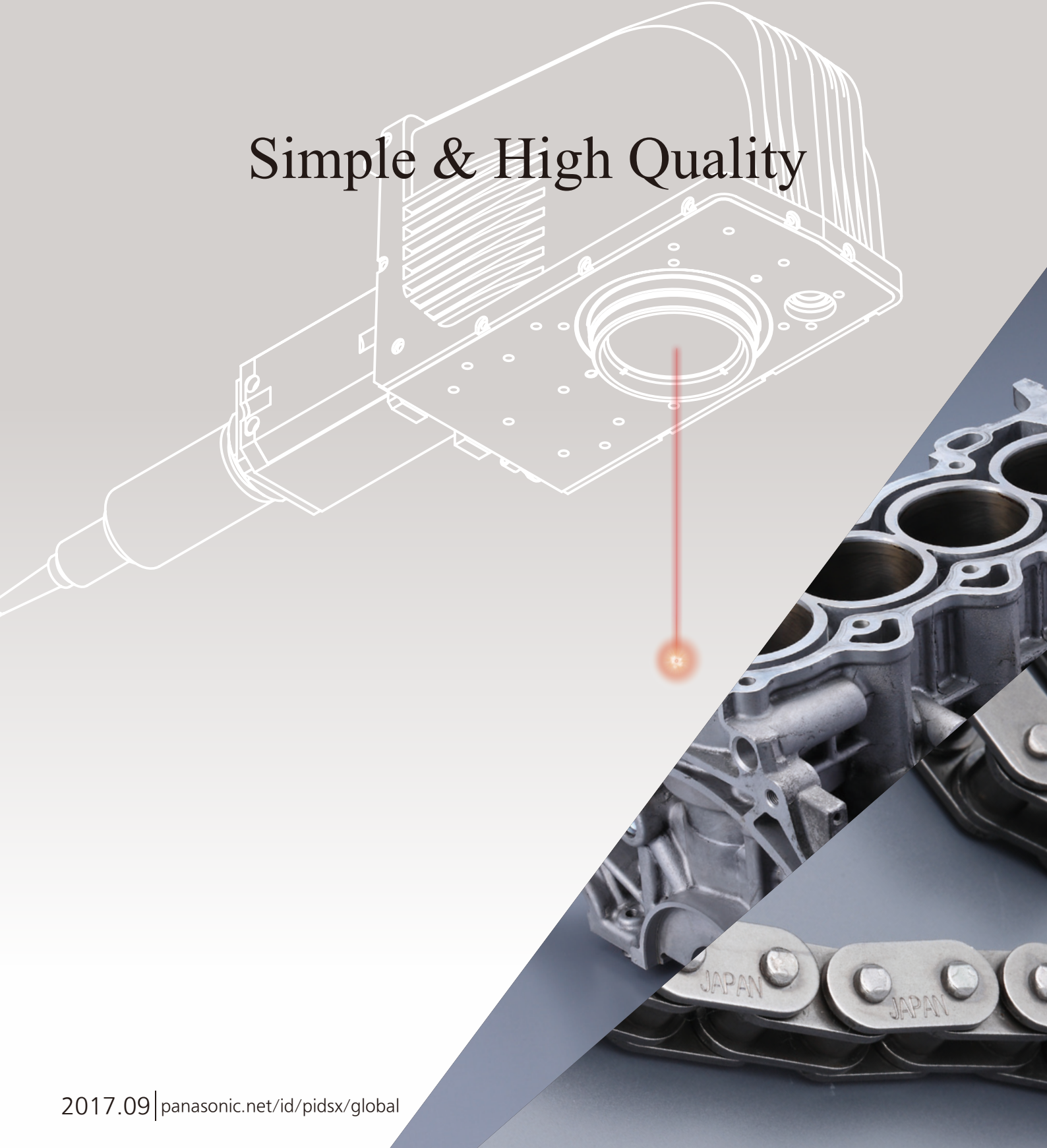

Simple & High Quality

In 1999, we introduced the **LP-F** series FAYb laser markers, the world's first laser markers equipped with a fiber laser oscillator. Since then, the company has advanced the product function to respond to customers' needs and released four unique FAYb laser marker series. The company recently reexamined the essentials of a laser marker, and added a simple model to the lineup. Panasonic Industrial Devices SUNX's new laser marker sets a new choice for "simple" laser markers and responds to customers' needs.



LP-V/W SERIES



This short pulse laser marker is suitable for high contrast marking on resin surfaces. (**LP-V** series)
Equipped with a CW oscillator, this model is ideal for applications such as semiconductor package production. (**LP-W** series)



LP-Z SERIES

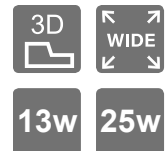

This all-round laser marker features 3D marking capability and wide 300 x 300 mm (11.811 x 11.811 in) marking area.

Pulse oscillation fiber laser marker (FAYb laser)

What is FAYb laser?

In a revolutionary method, the FAYb laser amplifies a weak laser beam from a master oscillator as it passes through a fiber treated with the element ytterbium to emit a strong laser beam.

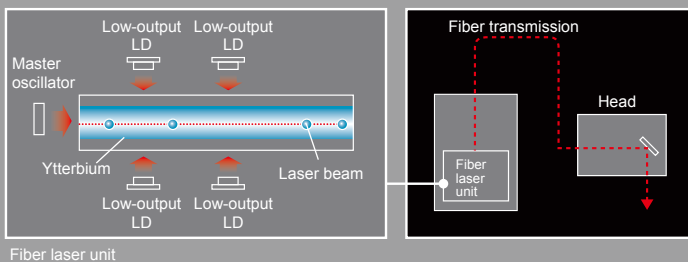

Long life and high reliability

The LD contains reliable and durable InGaAs (gallium indium arsenide). Since the LD lights only during marking, the heat load remains minimal and the product provides a long life.

High efficiency and energy saving

Because laser amplification takes place inside the fiber containing ytterbium, high beam-to-beam conversion efficiency of approximately 50 % is achieved.

Compact head

The amplification section is contained inside the oscillator unlike solid lasers such as YVO4, so the head is compact and contributes to the reduction of equipment size.



NEW

LP-RF SERIES



- Compact head featuring IP64 rating
- Controller offering high resistance to noise
- Removable head
- Smart condition setting function
- Direct linkage with image processing device



LP-S/SW SERIES



The head features an IP67G rating. This model can be used for a marking operation under a harsh condition such as an environment containing oil mist. The head is removable.



LP-M SERIES



This high-end model features a head with an IP64 rating and is capable of 3D marking. The laser interception mechanism and interlock are redundantly equipped. This model realizes high productivity and safety.



Bearing



Gear



Molded resin part



Battery pack



Tool



Camshaft



Sheath cutting

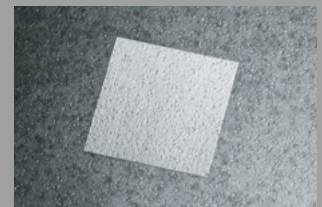

Cleaning process

Important considerations in selecting a laser marker

Based on the many years of experience in developing, manufacturing and marketing laser markers, Panasonic Industrial Devices SUNX examined four typical laser marker usage conditions and determined the essentials of laser markers, and then developed a simple model with a focus on those essentials.

Installation

▶ P.6

Installation in any region and any environment

Installation with minimal man-hours

Laser markers are used in a wide range of industrial fields and in various regions around the world, so they are required to provide their function in all types of work environment. In developing the new model, we even considered work environments in which the laser marker was exposed to water drops and dust particles as well as unfavorable power supply conditions. Furthermore, we ensured ease of installation to equipment in designing the product.

Configuration

▶ P.8

No more hesitation in selecting settings

Laser marking / processing exactly as intended

The user interface enables the user to quickly enter parameters to achieve laser marking or processing exactly as intended. The provided software offers the same operational ease as general-purpose drawing software and allows intuitive setting of laser parameters.

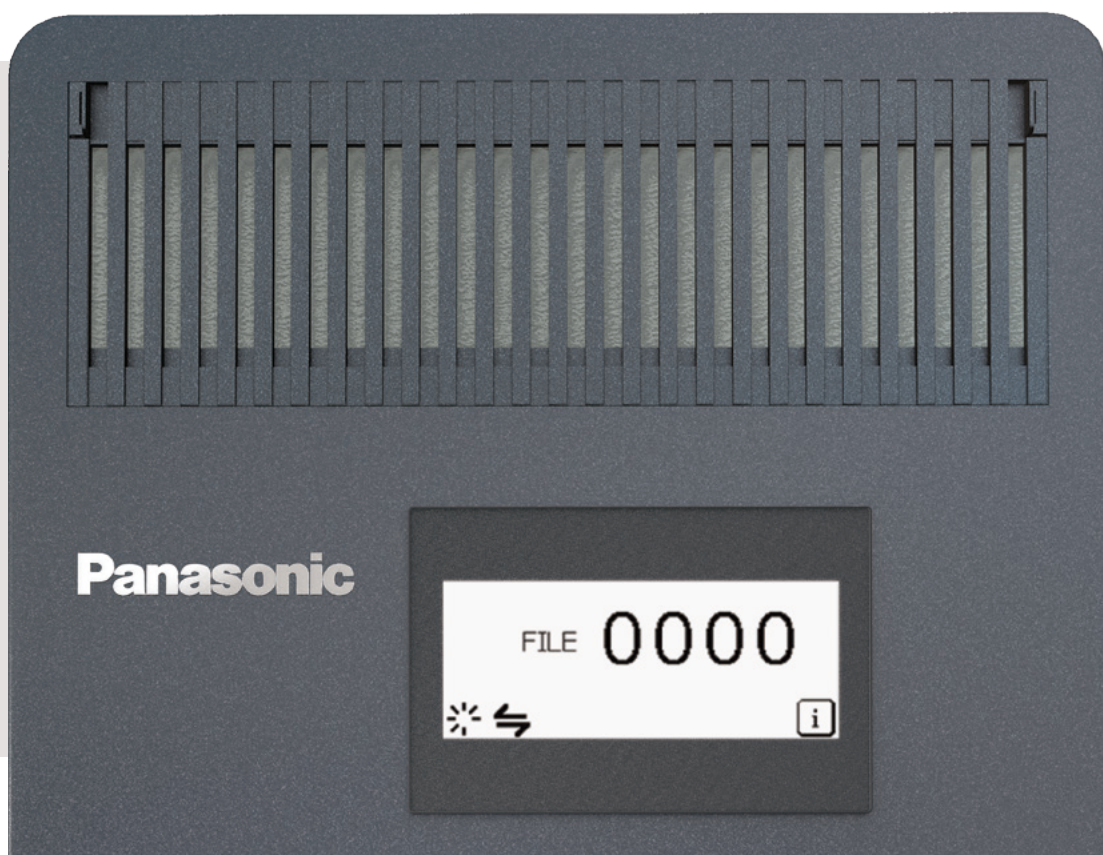

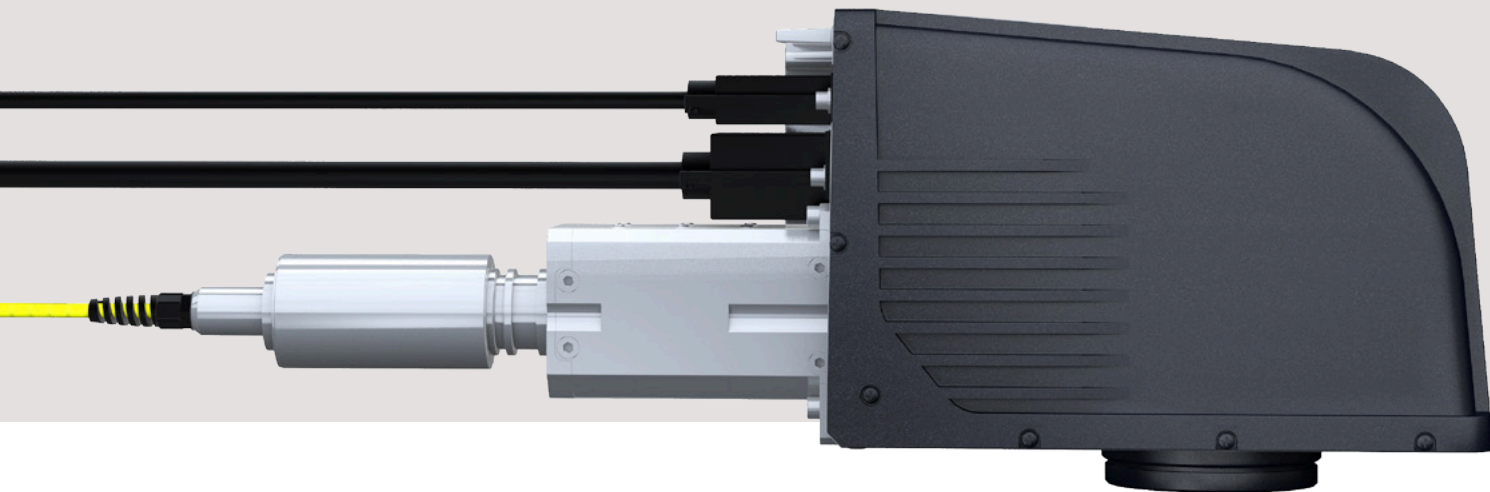

Running

▶ P.10

Safe and stable operation

Prevention of defects from leaving the factory

Safe production, stable quality and high productivity are the common goal of manufacturers. To meet these needs, we paid close attention to the performance, safety and function during the design stage.

Maintenance

▶ P.12

Easy maintenance

Long-term reliable operation

The LP-RF series boasts excellent long-term maintainability. Parts can be easily replaced by the user for preventive maintenance, so the laser marker offers reliable operation over a long period of time.





Installation

Installation in any region and any environment
Installation with minimal man-hours

Tough enough
for use in any
environment

Compact fan-less head with IP64 rating

The head was developed based on the fan-less head equipped in the **LP-M** series, so it is tough. There will be no entry of water drop and dust particles to cause problems.

Controller offering high resistance to noise

The controller is equipped with a power transformer and noise suppression parts to provide high resistance to noise. It helps prevent unexpected problems caused by sudden electrical noise.

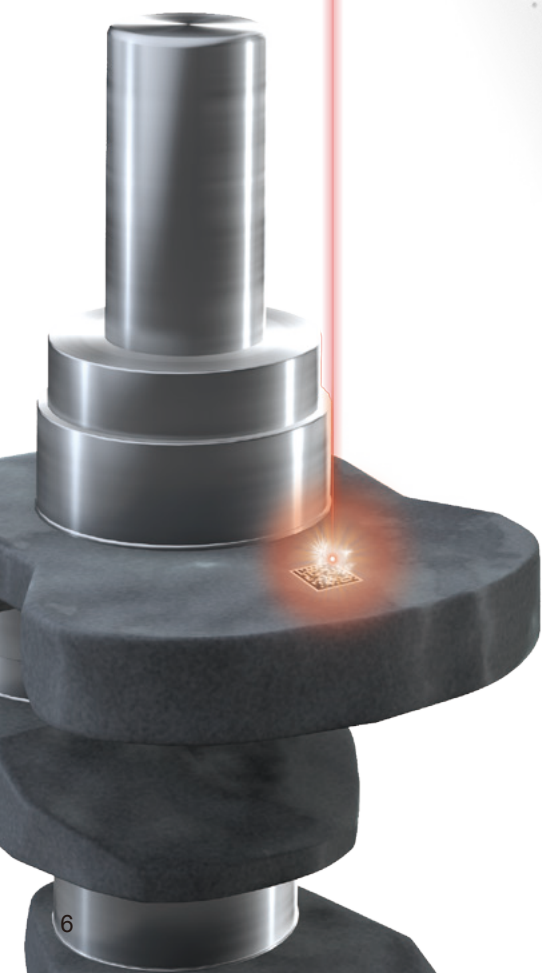

No more cumbersome installation work

Removable head

With a conventional model, the head cannot be separated from the controller. Therefore, installation or maintenance work requires the handling of the head that weighs more than 10 kg. The LP-RF series features a removable head, thus allowing the installation of the controller and head individually. This contributes to the reduction of man-hours required for installation and maintenance.

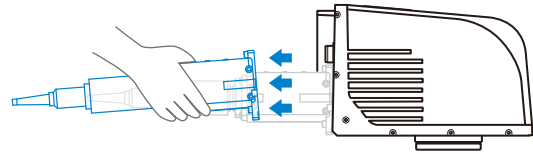

The head unit has to be moved through the clearance in the equipment.

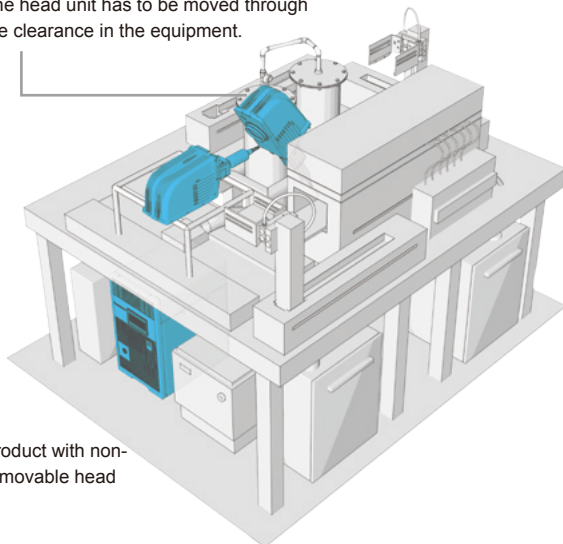

Product with non-removable head

Only the removable unit needs to be moved through the clearance in the equipment.

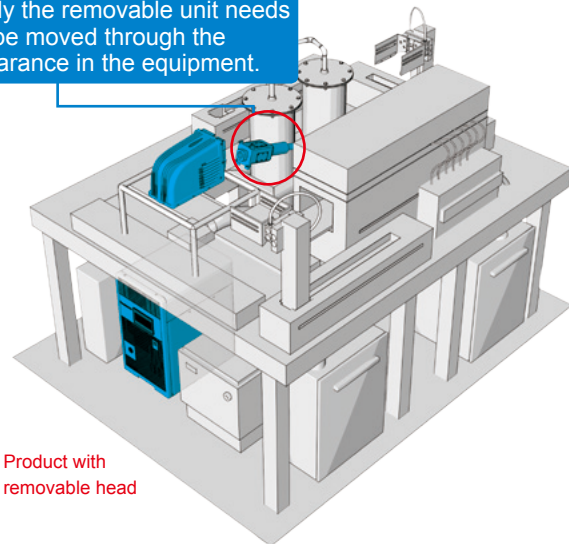

Product with removable head

Focal point adjustment pointer

A red laser pointer is provided to facilitate the adjustment and confirmation of focal distance between the laser marker and workpiece. The focal distance can be easily set by adjusting the height until the pointer is positioned at the center of the crosshair guide mark shown on the workpiece.

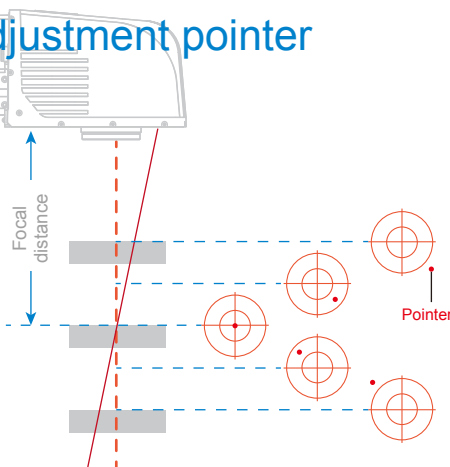

Marking area indication

The red guide beam indicates the laser irradiation area of the laser marker in installed condition. This allows visual check of the equipment interference and positional relationship with a workpiece.

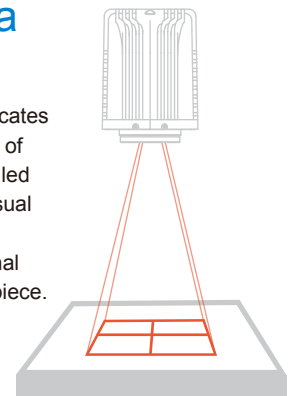

COLUMN

Measure against power supply noise

Electrical noise produced by equipment using a large amount of electrical current or generated in the surrounding area can affect the operation of the internal parts of the equipment and causes problems. Therefore, UPSs (uninterruptible power supply units) are installed to equipment in many production facilities as a measure against power supply noise. The laser marker controller of the LP-RF series is equipped with anti-noise parts such as a power transformer and varistor to ensure safe and reliable use of the laser marker on the production floor. This protects the internal parts of the laser marker from electrical noise and prevents problems caused by noise.

FT noise Reduced by 90 %
Surge noise Reduced by 70 %

(Typical values)

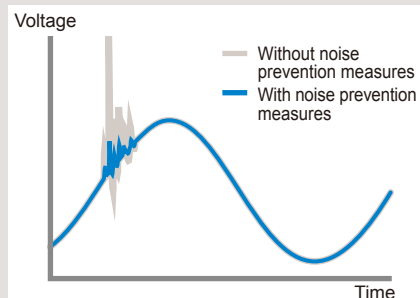

Configuration

No more hesitation in selecting settings
Laser marking / processing exactly as intended

Laser marking of design image in a simple way

Laser Marker NAVI Smart

The new "Laser Marker NAVI Smart" software, which was supplied with the **LP-GS** CO₂ laser marker and highly acclaimed, is provided with the product. Using the software, characters and logo marks and 2D code can be set and arranged on a PC or tablet. The screen layout can be customized to suit each work environment. The screen can be switched according to the purpose of use, such as for parameter setting or for workers.

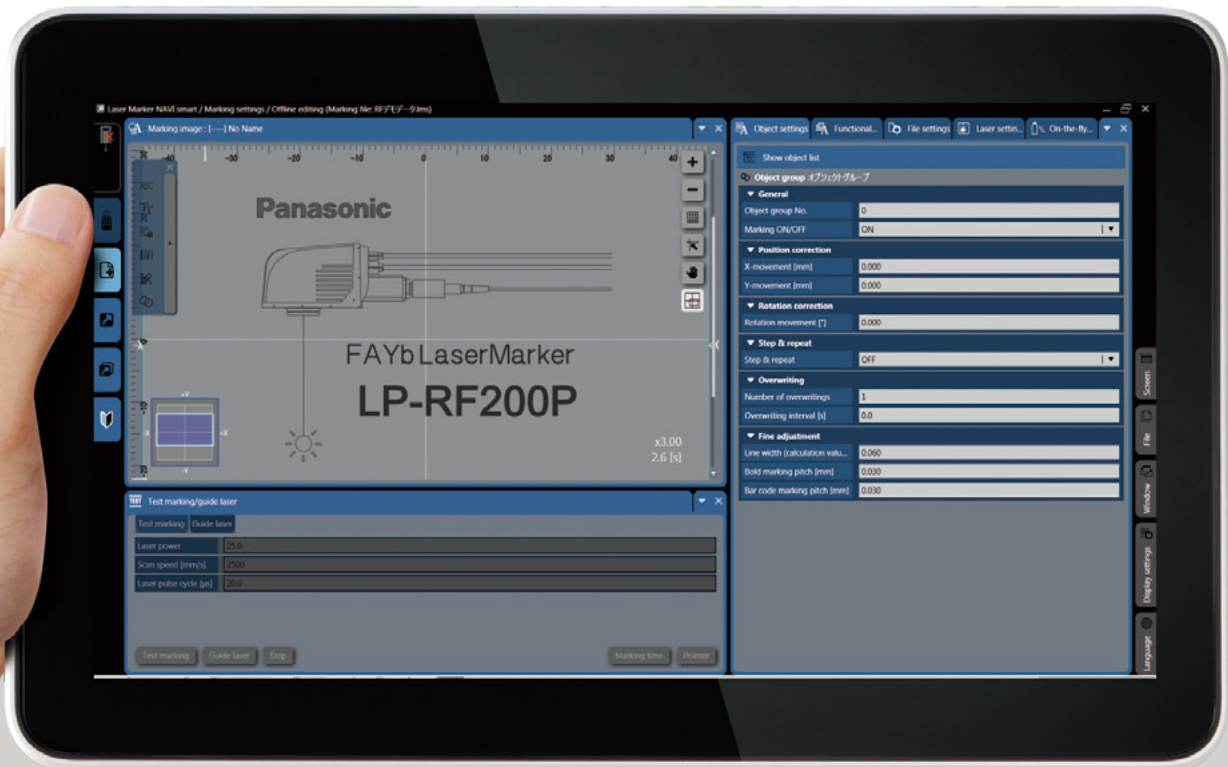

Simple 3-step setting

(1) Arrange the characters and figures to be marked.

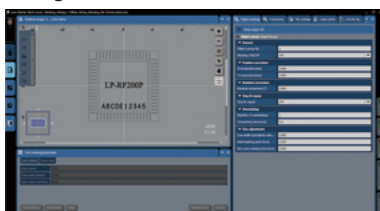

(2) Set the laser irradiation condition.

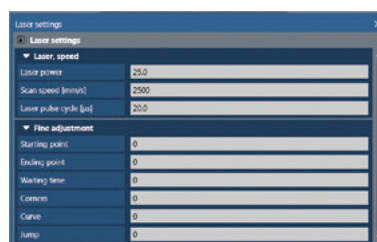

(3) Irradiate the laser beam using the test marking function.

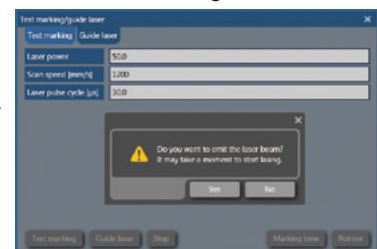

Navigation for attaining optimal marking result

Smart condition setting function

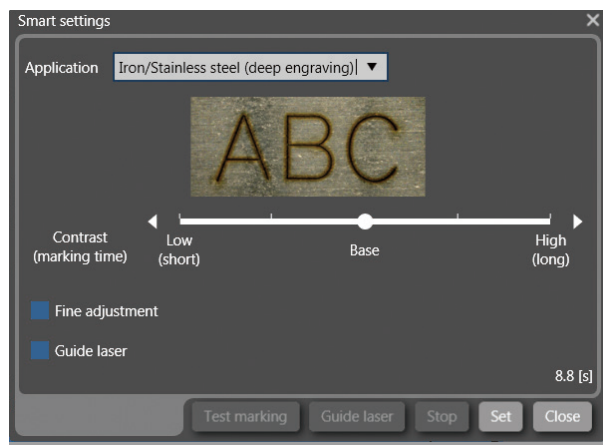

The one-touch function is packed with our extensive know-how of laser marking parameters such as laser power, scan speed and pulse oscillation frequency. The user can select a desired marking result from 16 types of material and image.



Step-and-repeat function

For laser marking on multiple molded resin parts on a tray, batch marking can be conducted by simply setting the row and column. When combined with the counter function, it enables automatic marking of sequential numbers.

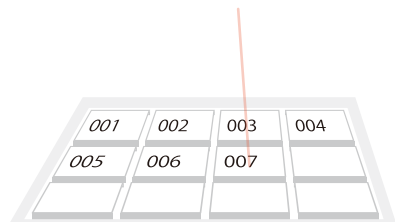

AI data conversion plug-in

The supplied plug-in software converts AI data prepared with Adobe® Illustrator®* to marking data for use by the laser marker. This lets the user to flexibly design the characters to be marked.

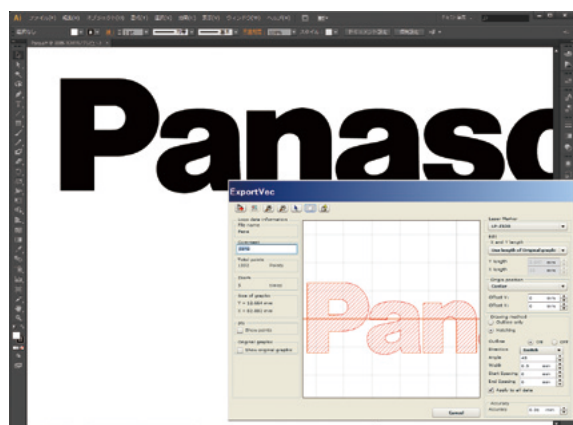

* Installation of Adobe® Illustrator® (for Windows) is required for the use of the plug-in. Regarding the supported versions of Adobe® Illustrator®, contact our company.

Automatic update function

The main unit has a built-in counter and clock so that the characters to be marked can be automatically updated. The lot marking function allows the replacement of the counter value and date and time with desired character strings. This enables the use of only the laser marker's internal function for generating and marking a sequential number necessary for serial-number-based product management.

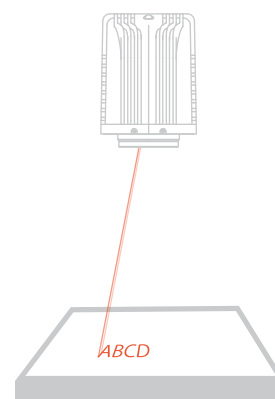

Guide laser

The bright red guide laser beam traces and indicates the characters to be marked and the marking position to let the user make fine adjustments of the marking area and marking position while visually confirming the adjustment result before actually performing the marking operation.

Display of estimated marking time

The software displays approximate marking / processing time estimated based on the entered marking data and laser condition. This enables the calculation of the tact time without actually operating the equipment for off-line parameter data production.

True Type font marking capability

The LP-RF series can directly mark the True Type fonts set with Laser Marker NAVI Smart.

Running

Safe and stable operation
Prevention of defects from leaving the factory

High-speed, high-quality marking

High-performance galvano scanner

The galvano controller and algorithm are designed to achieve optimum balance with the galvano scanner and mirror housed in the compact head. They provide beautiful and stable marking results even when the laser marking is conducted at high speed.



Safety consideration

Duplicate interlock circuit

The interlock circuit using a contactor features a duplicate configuration. It reliably shuts off the laser power source unit in the event an abnormality occurs. In addition, the **LP-RF** series is complete with safety features such as the broken line notification function and erroneous irradiation detection function.

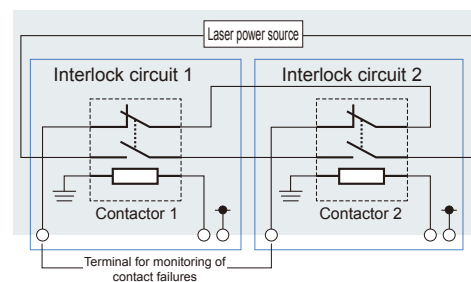

Direct linkage with image processing device

Automatic marking position correction and scan check

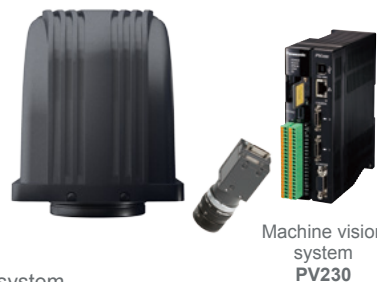

Machine vision system PV230

The LP-RF series can be connected directly to the PV230 series machine vision system. This enables the execution of a series of operations, such as detection of the position of approximately placed workpiece, correction of the laser irradiation position, laser marking, and cross-checking of scanned information of marked QR code, etc., without using a PLC.

Automatic marking position correction

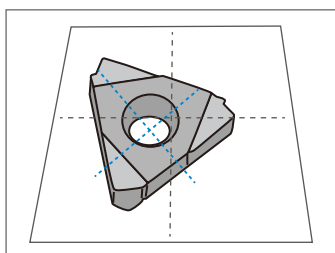

The PV230 scans and detects the position of the workpiece placed in the equipment.

Laser marking

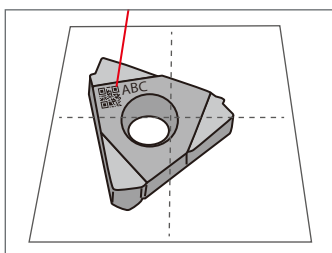

The angle is corrected based on the scanned position information before the LP-RF irradiates laser beam.

Cross-check of scanned code information

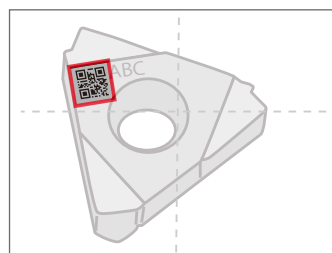

Whether the marked 2D code can be scanned properly is checked, and the scanned information is cross-checked with the marking data.

Moving workpiece marking function

The moving workpiece marking function enables laser marking on a workpiece moving at high speed. This eliminates the need to keep the line stationary for laser marking.

External control

In addition to the connector for I/O control, RS-232C and Ethernet connectors are provided to support serial connection. Therefore, an external device such as a PLC or PC can be used for automatic control of the laser marker.

Error history display

Displays a history of errors as well as the time and date of occurrence. Errors are listed not only as codes, but with an explanation so that an operator can confirm the type of error and when it occurred.

I/O check monitor

The ON / OFF status of the input and output terminals can be confirmed on the monitor. I/O signals can be quickly checked at equipment startup.



Maintenance

Easy maintenance
Long-term reliable operation

For long and stable operation of your laser markers, Panasonic Industrial Devices SUNX offers a full lineup of maintenance parts. They expand the range of maintenance work that can be performed by the user.

[Daily maintenance]

When the laser marker is used in an environment full of oil mist or dust, it is recommended to wipe the lens protection glass on the laser head with a dry cloth and clean or replace the fan filters in the controller.

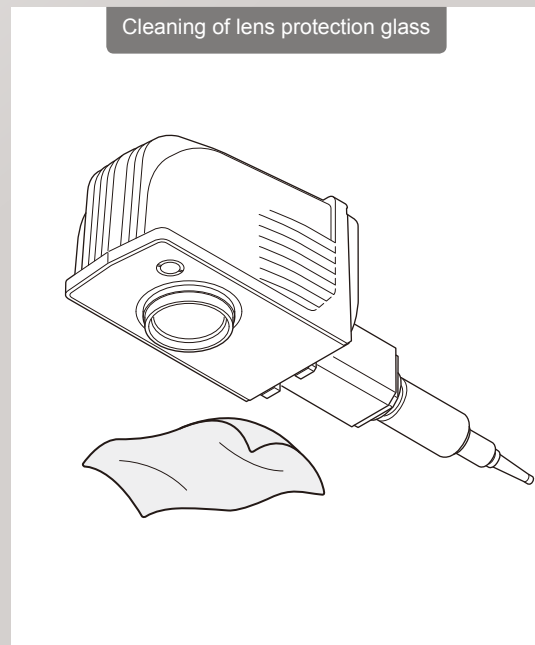
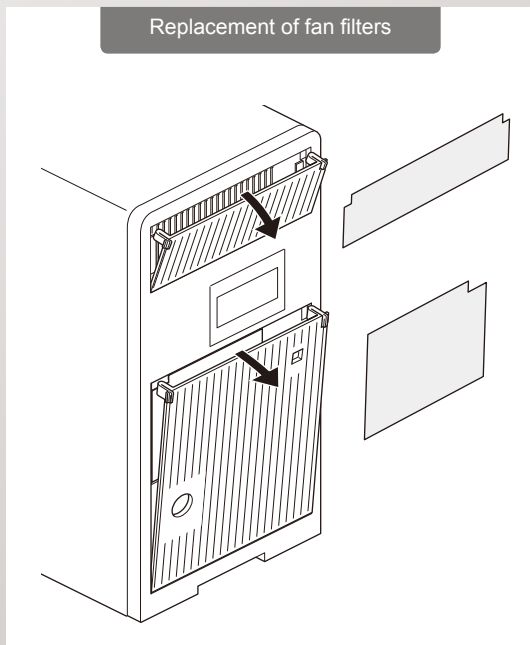

[User-replaceable limited-life parts and consumable parts]

It is recommended to replace long-term maintenance parts (replacement interval of several years) such as the physically moving drive section, sections exposed to oil mist and dust particles, and consumable parts.

Those parts in our previous products had to be replaced by our service personnel, but the mechanisms in the **LP-RF** series were redesigned to allow replacement by the user.

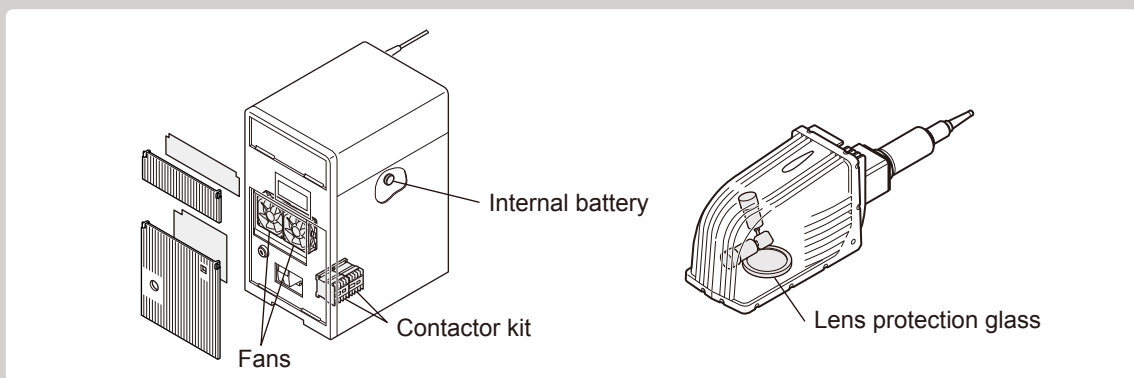

Global Network

Panasonic's sales network extends to various parts of the world, including Asia, the United States and Europe.

Based on the concept of "local production, local consumption," Panasonic Industrial Devices SUNX is strengthening the local production and development functions in order to meet diversifying market needs and accelerating the global business expansion.



Panasonic Devices SUNX production bases



Panasonic Industrial Devices SUNX Co., Ltd. (Aichi, Japan)



Panasonic Industrial Devices SUNX Tatsuno Co., Ltd. (Tatsuno, Japan)



Panasonic Industrial Devices SUNX Kyushu Co., Ltd. (Kagoshima, Japan)



Panasonic Industrial Devices SUNX Suzhou Co., Ltd. (China)



Panasonic Industrial Devices SUNX (Thailand) Co., Ltd. (Ayutthaya)

Laser marker installation process flow

1 Consultation

We propose the most suitable model according to the details of the customer's request pertaining to the laser marking / processing operation, cycle time and budget and based on the record of actual applications of our products.



2 Testing and reporting of test results

We conduct a laser marking test with the workpiece supplied by the customer and check the laser marking / processing result. After the test, we return the workpiece together with the test report.



3 Demonstration using actual equipment

We can take our laser marker to the customer's facility to conduct a marking / processing demonstration with actual equipment so that the customer can check the marking quality and deepen the understanding of laser marker operation.

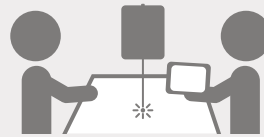

4 Discussion with the customer

If the customer is considering installation of a laser marker to equipment, we discuss with the customer regarding the equipment specifications and laser marker communication specifications.



5 Attendance during commissioning, explanation of operating procedures

We can provide support during the commissioning of equipment and explain the operating procedures to operators when so requested by the customer.

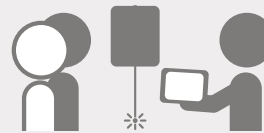

6 After-sales service

When requested by the customer, we conduct maintenance at the installation site or change the customer's laser marker with a substitute unit and take the customer's unit to our service center for detailed inspection and maintenance.

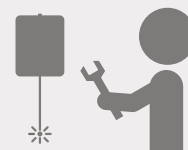

Specifications

Item		Model No.	LP-RF200P
Marking laser	Laser type	Yb fiber laser; λ= 1,064 nm 0.0419 mil Class4 laser	
	Average oscillator output	20 W	
	Average output at processing point (Note 1)	17 W (±5 %) Pulse oscillation	
Guide laser / pointer		Red semiconductor laser; λ= 655 nm 0.026 mil ; Class 2 laser: Maximum output 1 mW or less	
Scanning method		Galvano scanning method	
Marking field		90 mm × 90 mm 3.543 in × 3.543 in	
Workpiece distance (Note 2)		190 mm 7.480 in	
Scan speed (Note 3, 4)		Maximum 12,000 mm/sec. 472.441 in/sec.	
Compatible line speed (Note 4)		Maximum 240 m/min. 787.402 ft/min.	
Character types		English uppercase letters, English lowercase letters, numerals, katakana, hiragana, kanji (JIS No. 1 and No. 2 standards), symbols, user-registered characters (up to 50), True type	
Barcodes		Code39, Code128 (GS1-128), ITF, NW-7, EAN/UPC/JAN GS1 DataBar Limited, GS1 DataBar Stacked, GS1 DataBar Limited CC-A, GS1 DataBar Stacked CC-A	
2D codes		QR Code, Micro QR Code, iQR Code, Data Matrix, GS1 Data Matrix, PDF417	
Figure data (Note 5)		VEC, DXF, HPGL, BMP, JPEG, AI, EPS	
Input / output port		I/O terminal block (40 pins), I/O connector (40 pins)	
Interface		EIA-RS-232C, Ethernet	
Cooling method		Head: Naturally air cooling, Controller: Forced air cooling	
Power supply (Note 6)		180 - 264 V AC (including power voltage fluctuation of ±10%), 50/60 Hz	
Power consumption (Note 7)		370 VA or less (2.1 A or less)	
Protection		Head: IP64	
Ambient temperature (Note 8, 9)		0 to +40 °C +32 to +104 °F	
Ambient temperature for storage (Note 8)		-10 to +60 °C +14 to +140 °F	
Ambient humidity (Note 8)		35 to 85 % RH	
Net weight	Head	8 kg approx.	
	Controller	37 kg approx.	
Applicable standards		FDA regulations, GB standard, KC mark	
Supplied software		Laser Marker Smart Utility (Laser Marker NAVI Smart, logo data editing software, ExportVec, font maker software)	
Laser Marker NAVI smart display language		Japanese, English, Chinese (simplified Chinese character), German	
OS supported by the supplied software (Note 10)		Windows® 10 Pro (32 bit, 64 bit), Windows® 8 Pro (32 bit, 64 bit), Windows® 7 Professional SP1 (32 bit, 64 bit)	

- Notes: 1) This indicates the output power at processing point when maximum power is set. (Factory default)
 2) There may be an individual difference of approximately ±0.5 mm **±0.02 in** in the work distance.
 3) The indicated values show the allowable setting range. The setting values that can maintain the marking / processing quality vary depending on the marking condition and target material.
 4) Depending on the setting data, the scan speed may be subject to upper-limit restriction in some cases.
 5) VEC is a figure file format designed exclusively for laser markers. If figure files in the AI or EPS format are used, they must be converted to VEC-format files in advance using the ExportVEC software provided with the product.
 6) Frequency is selected and set automatically.
 7) The rush current (typical value) at startup is as follows: 220 V AC (current flowing time of 10 ms or less): 50 A
 8) Common to the controller and head. There must be no dew condensation or icing.
 9) Laser power setting of 46 or higher: 0 to +36 °C **+32 to +97 °F**, Laser power setting of 1 to 45: 0 to +40°C **+32 to +104 °F**
 10) Microsoft and Windows are registered trademarks or trademarks of Microsoft Corporation in the United States and other countries.

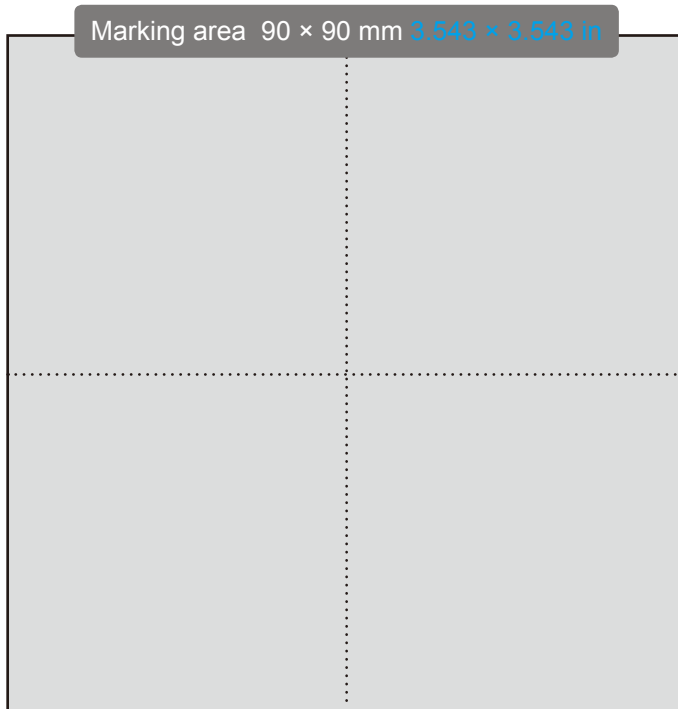

DIMENSIONS (Unit: mm in)

LP-RF200P Head

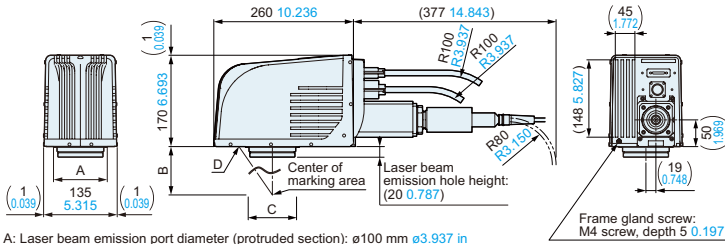

A: Laser beam emission port diameter (protruded section): $\phi 100$ mm $\phi 3.937$ in
 B: Work distance: 190 mm 7.480 in
 C: Marking field (X, Y): 90 mm \times 90 mm 3.543 in \times 3.543 in (lens section: $\phi 20$ mm $\phi 0.787$ in)
 D: Laser pointer beam emission port diameter: $\phi 26$ mm $\phi 1.024$ in

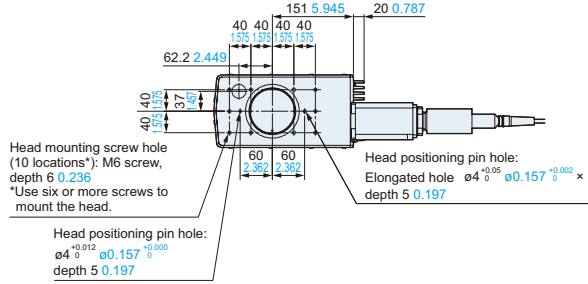

LP-RF200P Controller

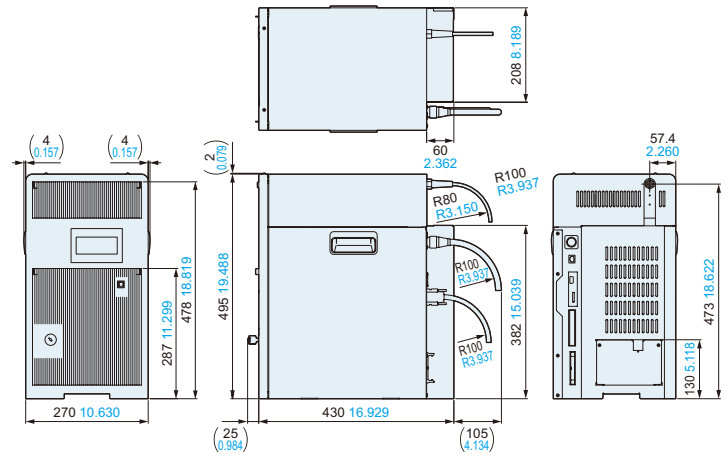

Controller mounting screw hole (4 locations): M5 screw, depth 10 0.394

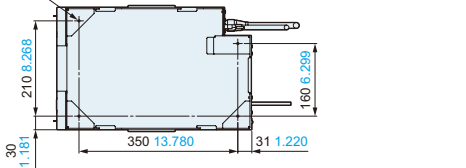

LP-RF200P Fiber unit

With fiber unit removed

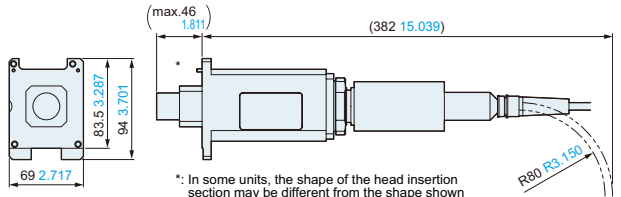

*: In some units, the shape of the head insertion section may be different from the shape shown in the diagram above.

[Precautions]

Laser safety

- This product is classified as a Class 4 Laser Product in IEC/JIS/FDA regulations 21 CFR 1040.10 and 1040.11. Never look at or touch the direct laser beam and its reflection.
- The following labels are attached to the LP-RF series. Handle the product according to the instruction given on the warning labels. (Warning labels are not shown in the product photographs in this catalog.)
- The laser used by this product generates infrared light that is invisible to the human eye. Use particular caution when the laser is operating.



Warning/instruction labels

Recommended use of a dust collector

- Depending on the object being marked, harmful gasses or smoke that have a detrimental effect on the human body or the laser marker may be generating during marking. If your application falls under this description, use a dust collector. For more information, contact your sales representative.

Disclaimer

The applications described in the catalog are all intended for examples only. The purchase of our products described in the catalog shall not be regarded as granting of a license to use our products in the described applications. We do NOT warrant that we have obtained some intellectual properties, such as patent rights, with respect to such applications, or that the described applications may not infringe any intellectual property rights, such as patent rights, of a third party.

Please contact:

Panasonic Industrial Devices SUNX Co., Ltd.

2431-1 Ushiyama-cho, Kasugai-shi, Aichi, 486-0901, Japan
 Global Sales Department
 ■Telephone: +81-568-33-7861 ■Facsimile: +81-568-33-8591
 panasonic.net/id/pidsx/global

