

Panasonic

INDUSTRY

NEW

FAYb Laser Marker

LP-RV SERIES

FDA
Conforming to
FDA regulations

CE

GB
Conforming to
GB 7247.1



Short Pulse Fiber Laser

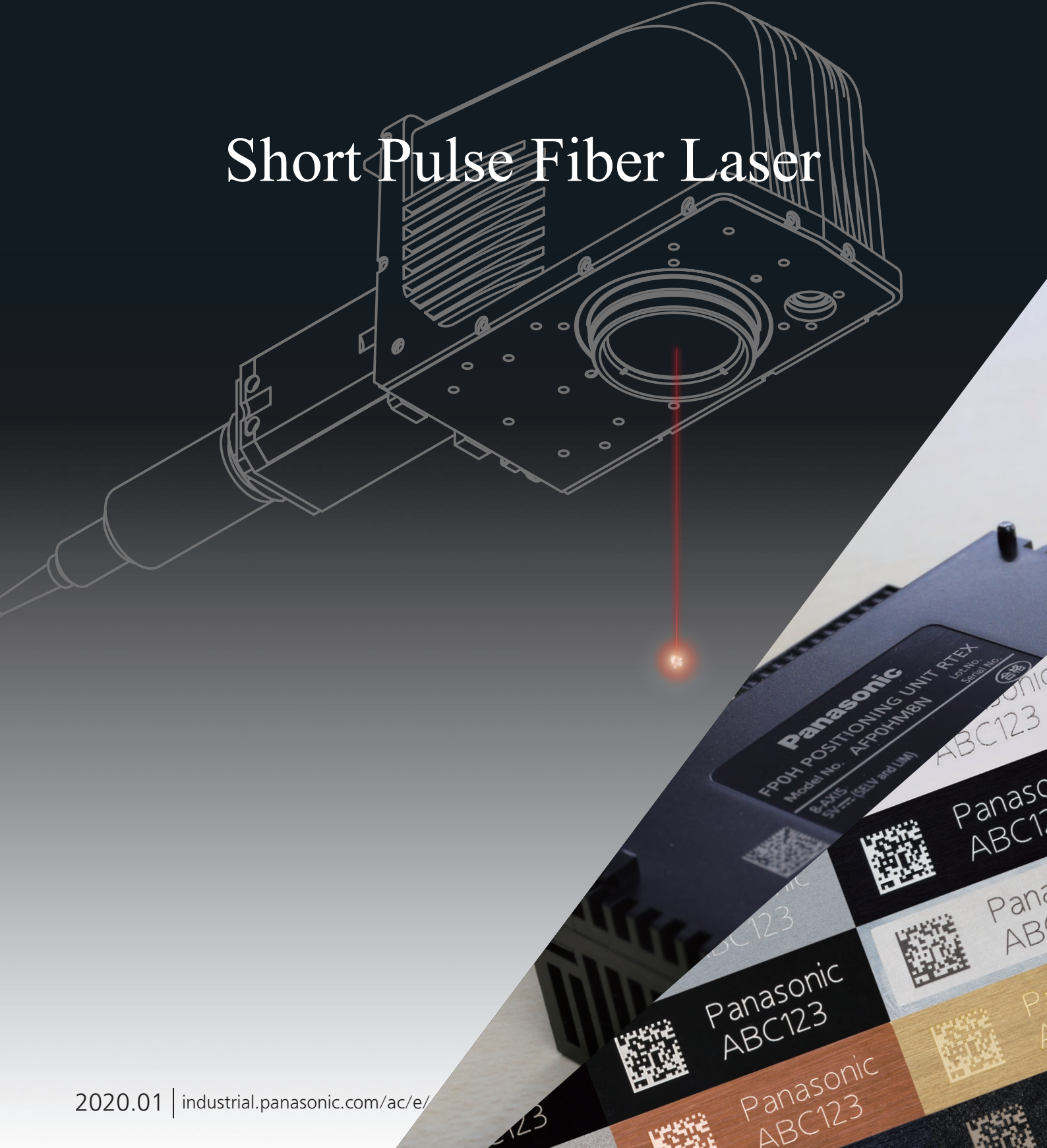

Short Pulse Fiber Laser

In 1999, we introduced the FAYb laser marker **LP-F** series, the world's first laser markers equipped with a fiber oscillator. Since then, we have launched various product lineups as a leading manufacturer of fiber laser markers for approximately 20 years. The fiber oscillation system is recognized as an ecological system because its consumption power is low and the laser diode service life is long compared with YAG or YVO4. However, there was a problem that it's difficult to generate short pulse laser.

Through adopting a new three-unit configuration, the **LP-RV** series with fiber oscillation system has realized a short pulse with the pulse duration of 1 ns.

This will contribute to providing overwhelming improvement on expressive power and application needs.

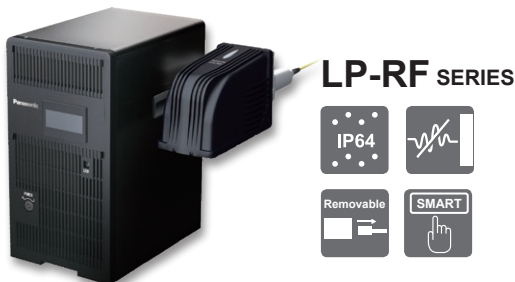

The head features an IP64 rating. This is an entry model of the FAYb laser marker with basic functionality.



This all-round laser marker features 3D marking capability and wide 330 × 330 mm 12.992 × 12.992 in marking area.

Pulse oscillation fiber laser marker (FAYb laser)

What is FAYb laser?

In a revolutionary method, the FAYb laser amplifies a weak laser beam from a master oscillator as it passes through a fiber treated with the element ytterbium to emit a strong laser beam.

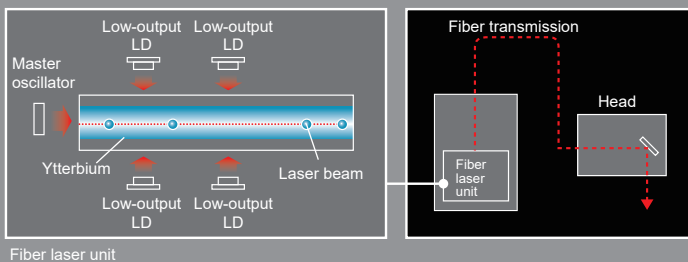

Long life and high reliability

The LD contains reliable and durable InGaAs (gallium indium arsenide). Since the LD lights only during marking, the heat load remains minimal and the product provides a long life.

High efficiency and energy saving

Because laser amplification takes place inside the fiber containing ytterbium, high beam-to-beam conversion efficiency of approximately 50 % is achieved.

Compact head

The amplification section is contained inside the oscillator unlike solid lasers such as YVO4, so the head is compact and contributes to the reduction of equipment size.



NEW

LP-RV SERIES



- Short pulse laser
- Compact head featuring IP64 rating
- Controller offering high resistance to noise
- Removable head
- Smart condition setting function
- Direct linkage with machine vision system
- 3-unit configuration



LP-S/SW SERIES

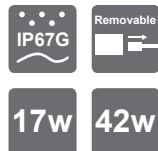

The head features an IP67G rating. This model can be used for a marking operation under a harsh condition such as an environment containing oil mist. The head is removable.



LP-M/MA SERIES



This high-end model features a head with an IP64 rating and is capable of 3D marking. The laser interception mechanism and interlock are redundantly equipped. This model realizes high productivity and safety.



Small electronic part



Nameplate



Resin mold

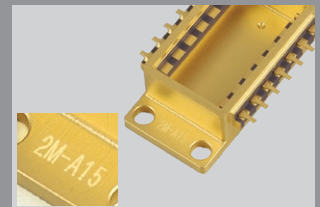

Gold plating peeling



IC package



Illuminated switch



Metal part

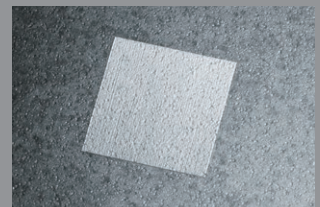

Cleaning process

Short Pulse Laser

Through adopting our new technology, the new series with fiber system has achieved to generate a short pulse with the pulse duration of 1 ns. The expressive power has been overwhelmingly improved.

Small thermal effect

As the thermal effect caused by the short pulse laser on the workpiece is small, burning, discoloration, or deformation due to heat is minimized. Therefore, the short pulse laser can be used as an optimal laser marker for devices where the thermal effect need to be suppressed such as ICs or thin metals or for high contrast marking on resin surfaces.

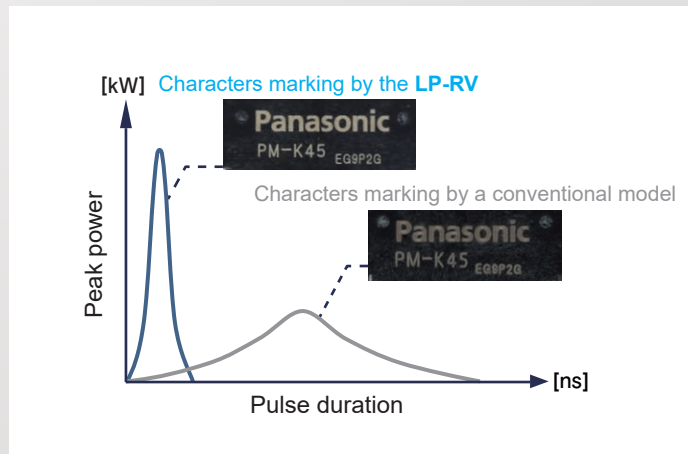

High repetition pulse oscillation

As the LP-RV can generate a short pulse laser beam in high repetition pulse oscillation, even if the laser beam is scanned at a higher speed, marking or processing is possible without spaces between laser-irradiated dots as shown on the right figure. This contributes to shortening the laser marking or processing takt time and to improving the quality.

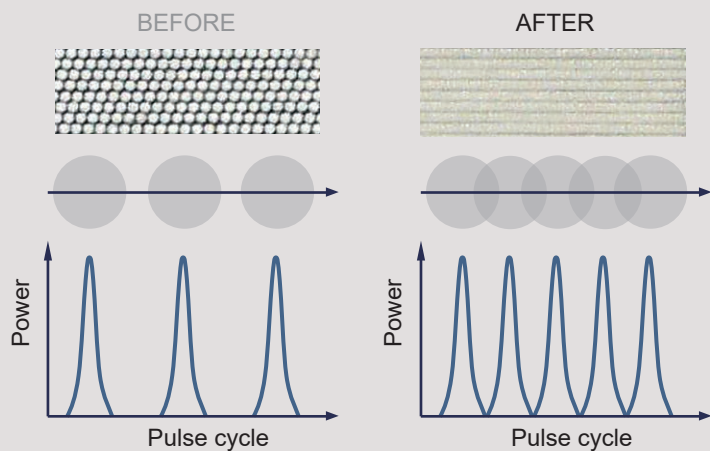

Marking extra small characters

As the short pulse laser can prevent heat from spreading when laser is irradiated on a workpiece, it allows marking characters in much finer line segment.

It is possible to mark characters as small as 0.15 mm × 0.15 mm 0.006 in × 0.006 in. Marked characters are highly visible, not illegible at all.



Rich marking expressions

LP-RV series short pulse laser not only allows color marking on resin materials, but also provides higher marking quality for various materials and faster marking speed. The following section shows parameters for marking condition as reference.

- * Each parameter value is given for reference. Marking state varies depending on the surface condition, etc. of the material used.
- * Note that corrections may have been applied to some of the laser settings given below with respect to marking conditions for surface preparation, characters, and 2D codes. For further details about the parameter values, please contact us.

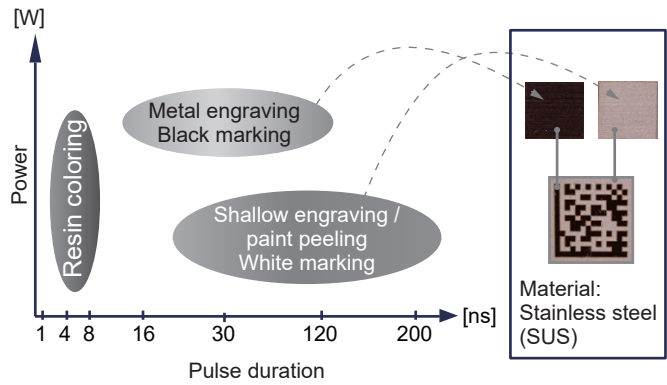

Marking conditions
2D code: Data Matrix
(Overall size: 6.24 mm 0.246 in,
Cell size: 0.24 mm 0.009 in)
Character size: 1.8 mm 0.071 in

ABS

Power: 35 %, Scan speed: 1,000 mm/s
39.370 in/s
Pulse duration: 4 ns, Pulse cycle: 9 μs
Marking takt: 0.9 sec.

PBT

Power: 50 %, Scan speed: 1,000 mm/s
39.370 in/s
Pulse duration: 4 ns, Pulse cycle: 8 μs
Marking takt: 0.7 sec.

PET

Power: 40 %, Scan speed: 1,000 mm/s
39.370 in/s
Pulse duration: 4 ns, Pulse cycle: 17 μs
Marking takt: 2.1 sec.

POM

Power: 40 %, Scan speed: 1,000 mm/s
39.370 in/s
Pulse duration: 200 ns, Pulse cycle: 40 μs
Marking takt: 0.6 sec.

Elastomer

Power: 70 %, Scan speed: 1,000 mm/s
39.370 in/s
Pulse duration: 8 ns, Pulse cycle: 24 μs
Marking takt: 0.6 sec.

PA66

Power: 70 %, Scan speed: 1,000 mm/s
39.370 in/s
Pulse duration: 4 ns, Pulse cycle: 12 μs
Marking takt: 0.6 sec.

PEEK

Power: 80 %, Scan speed: 1,000 mm/s
39.370 in/s
Pulse duration: 16 ns, Pulse cycle: 6.2 μs
Marking takt: 0.9 sec.

Acrylic

Power: 80 %, Scan speed: 1,500 mm/s
59.055 in/s
Pulse duration: 200 ns, Pulse cycle: 90 μs
Marking takt: 0.6 sec.

LCP (Liquid Crystal Polymer)

Power: 35 %, Scan speed: 1,000 mm/s
39.370 in/s
Pulse duration: 4 ns, Pulse cycle: 9 μs
Marking takt: 0.9 sec.

ADC12

Power: 80 %, Scan speed: 1,000 mm/s
39.370 in/s
Pulse duration: 16 ns, Pulse cycle: 6.2 μs
Marking takt: 4.6 sec.

AZ31 (rolled): Mg alloy

Power: 80 %, Scan speed: 1,000 mm/s
39.370 in/s
Pulse duration: 8 ns, Pulse cycle: 6.2 μs
Marking takt: 4.6 sec.

Stainless steel (SUS302)

Power: 80 %, Scan speed: 60 mm/s
2.362 in/s
Pulse duration: 16 ns, Pulse cycle: 0.7 μs
Marking takt: 18.4 sec.

Copper

Power: 40 %, Scan speed: 1,000 mm/s
39.370 in/s
Pulse duration: 120 ns, Pulse cycle: 20 μs
Marking takt: 0.9 sec.

Alumite

Power: 60 %, Scan speed: 100 mm/s
3.937 in/s
Pulse duration: 16 ns, Pulse cycle: 6.2 μs
Marking takt: 0.7 sec.

Brass

Power: 25 %, Scan speed: 1,000 mm/s
39.370 in/s
Pulse duration: 120 ns, Pulse cycle: 30 μs
Marking takt: 0.6 sec.

Titanium

Power: 35 %, Scan speed: 1,000 mm/s
39.370 in/s
Pulse duration: 4 ns, Pulse cycle: 9 μs
Marking takt: 0.9 sec.

Easy to install

The **LP-RV** is configured to provide not only superior environmental resistance, but also easy installation and maintenance for quick recovery from a possible problem so that it can be used at ease any place in the world.

Removable head

With a conventional model, the head cannot be separated from the controller. Therefore, installation or maintenance work requires the handling of the head that weighs more than 10 kg. The **LP-RV** series features a removable head, thus allowing the installation of the controller and head individually. This contributes to the reduction of man-hours required for installation and maintenance.

The head unit has to be moved through the clearance in the equipment.

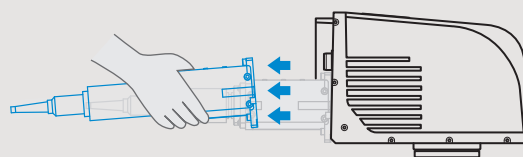

Only the removable unit needs to be moved through the clearance in the equipment.

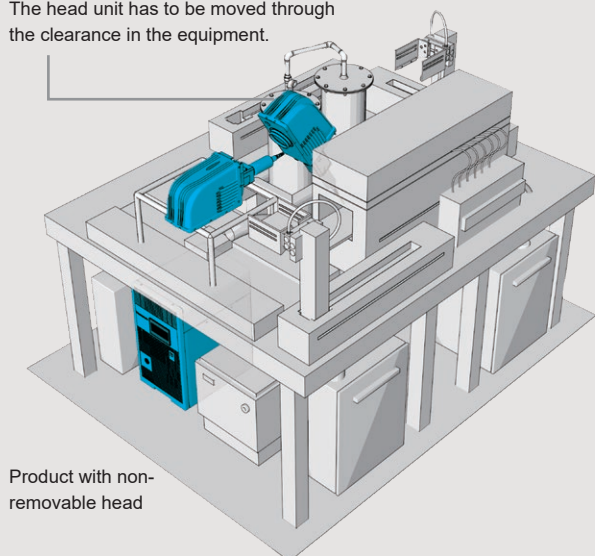

Product with non-removable head

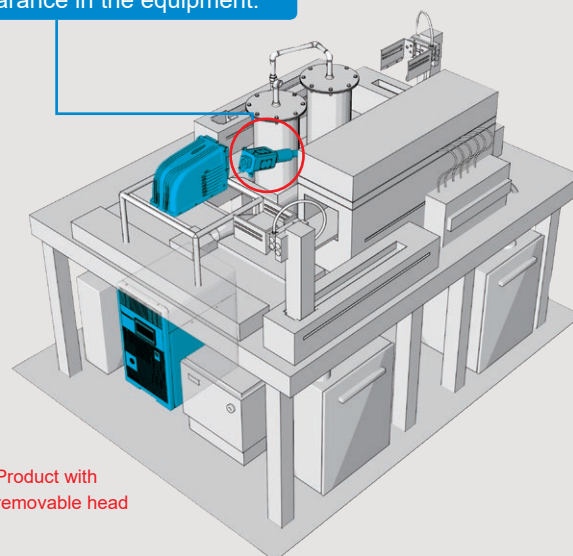

Product with removable head

Three-unit configuration

The laser marker features a three-unit configuration that allows each one of the three individual units to be separately removed and replaced depending on the problem in case any problem occurs. It contributes to shortening the down time.

* Before removing the unit, please contact your sales representative.

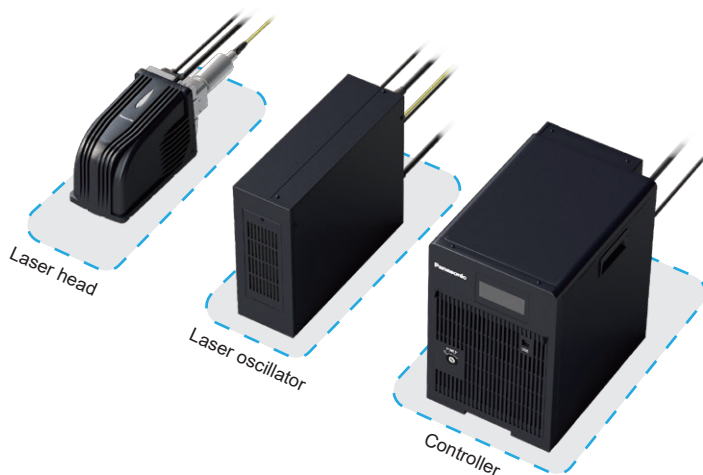



IP64 rating Fanless compact head

It has inherited the rugged laser head achieved by the **LP-M** series with the fanless structure. It prevents moisture or dust from entering inside the head and thus eliminates the possible cause of problems.

Duplicate interlock circuit

The interlock circuit using a contactor features a duplicate configuration. It reliably shuts off the laser power source unit in the event an abnormality occurs. Also, the laser excitation time is one second or less, which contributes to shortening the reset time. In addition, the **LP-RV** series is complete with safety features such as the broken line notification function and erroneous irradiation detection function.

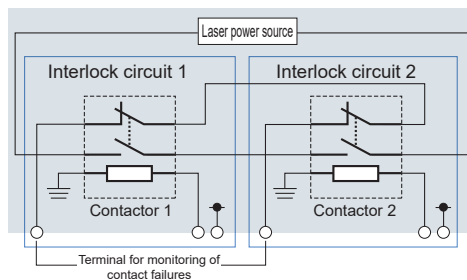

Controller offering high resistance to noise

The controller is equipped with a power transformer and noise suppression parts to provide high resistance to noise. It helps prevent unexpected problems caused by sudden electrical noise.



COLUMN

Measure against power supply noise

Electrical noise produced by equipment using a large amount of electrical current or generated in the surrounding area can affect the operation of the internal parts of the equipment and causes problems. Therefore, UPSs (uninterruptible power supply units) are installed to equipment in many production facilities as a measure against power supply noise. The laser marker controller of the **LP-RV** series is equipped with anti-noise parts such as a power transformer and varistor to ensure safe and reliable use of the laser marker on the production floor. This protects the internal parts of the laser marker from electrical noise and prevents problems caused by noise.

FT noise Reduced by 90 %
Surge noise Reduced by 70 %

(Typical values)

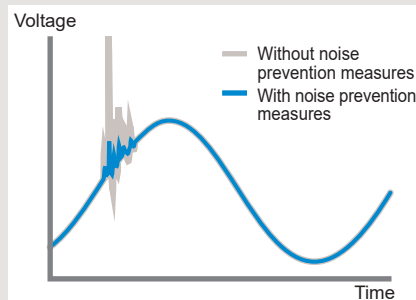

Easy setting

"Non-confusing setting with parameters"

"Marking or processing as you imagine"

Its user interface allows users to set the desired laser marking or processing in the shortest time.

A software which provides operability of ordinary drawing software and allows intuitive laser setting is mounted as standard feature.

Laser Marker NAVI smart

Using the software, characters, logo marks, and 2D code can be set and arranged on a PC or tablet. The screen layout can be customized to suit each work environment. The screen can be switched according to the purpose of use, such as for parameter setting or for workers.



Simple 3-step setting

(1) Arrange the characters and figures to be marked.



(2) Set the laser irradiation condition.



(3) Irradiate the laser beam using the test marking function.

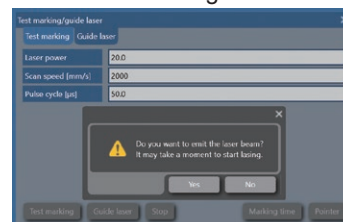

Navigation for attaining optimal marking result

Smart condition setting function

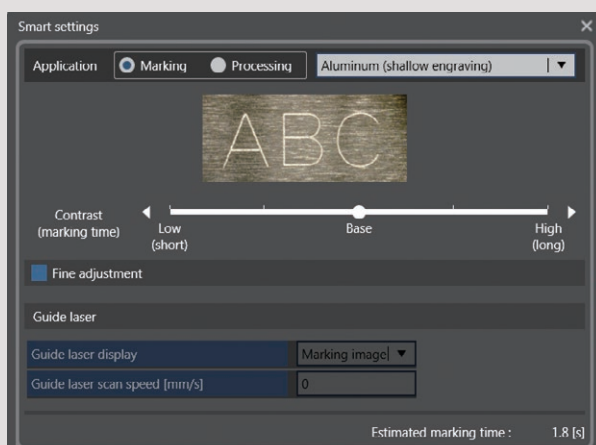

The one-touch function is packed with our extensive know-how of laser marking parameters such as laser power, scan speed and pulse oscillation frequency. The user can select a desired marking result from 14 types of material and image.

Iron, stainless steel (shallow engraving)



Iron, stainless steel (deep engraving)



Aluminum (deep engraving)

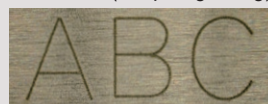

ABS (white)



PC (white)



PP (black)

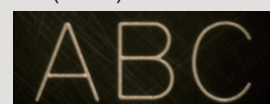

Open network connection (optional)

If you connect EtherNet/IP or PROFINET to the laser marker using the laser marker communication unit*, marking contents or laser parameters can be set via the open network.

- * Optional
- LP-ANW10:** EtherNet/IP
- LP-ANW11:** PROFINET

PROFINET is a registered trademark of PROFIBUS and PROFINET International.
EtherNet/IP is a registered trademark of ODVA (Open DeviceNet Vendor Association Inc.).

AI data conversion plug-in

The supplied plug-in software converts AI data prepared with Adobe® Illustrator®* to marking data for use by the laser marker. This lets the user to flexibly design the characters to be marked.

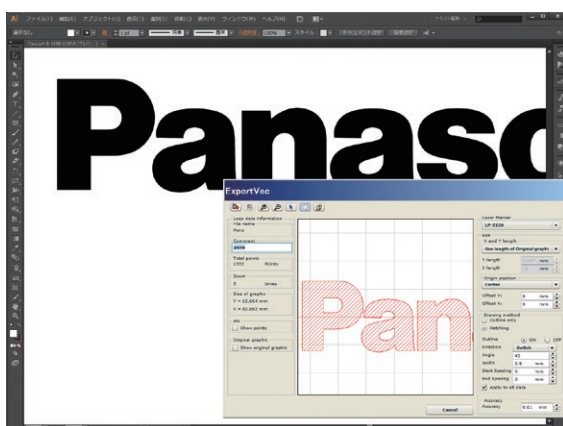

* Installation of Adobe® Illustrator® (for Windows) is required for the use of the plug-in. Regarding the supported versions of Adobe® Illustrator®, contact our company. Adobe® Illustrator® are registered trademarks or trademarks of Adobe Systems Incorporated in the United States and other countries.

Automatic update function

The main unit has a built-in counter and clock so that the characters to be marked can be automatically updated. The lot marking function allows the replacement of the counter value, date, and time with desired character strings. This enables the use of only the laser marker's internal function for generating and marking a sequential number necessary for serial-number-based product management.

Display of estimated marking time

The software displays approximate marking / processing time estimated based on the entered marking data and laser condition. This enables the calculation of the takt time without actually operating the equipment for off-line parameter data production.

True Type font marking capability

The LP-RV series can directly mark the True Type fonts set with Laser Marker NAVI smart.

Direct linkage with machine vision system

Automatic marking position correction and scan check

The LP-RV series can be connected directly to the PV230 series machine vision system. This enables the execution of a series of operations, such as detection of the position of approximately placed workpiece, correction of the laser irradiation position, laser marking, and cross-checking of scanned information of marked QR code, etc., without using a PLC.

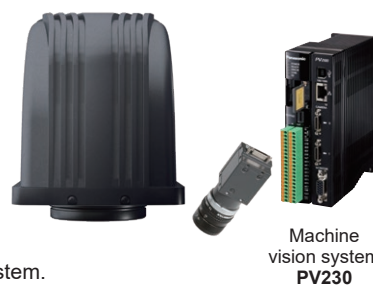

Machine vision system PV230

Automatic marking position correction

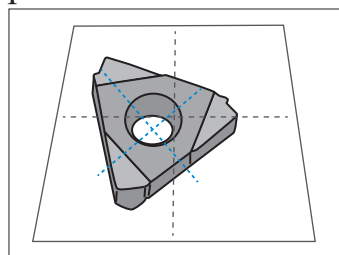

The PV230 scans and detects the position of the workpiece placed in the equipment.

Laser marking

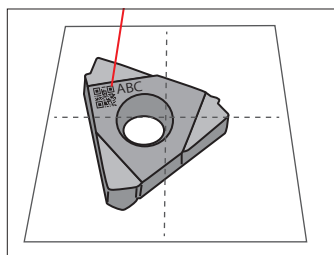

The angle is corrected based on the scanned position information before the LP-RV irradiates laser beam.

Cross-check of scanned code information

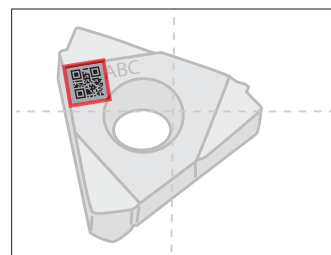

Whether the marked 2D code can be scanned properly is checked, and the scanned information is cross-checked with the marking data.

Maintenance

Easy maintenance
Long-term reliable operation

For long and stable operation of your laser markers, Panasonic offers a full lineup of maintenance parts. They expand the range of maintenance work that can be performed by the user.

[Daily maintenance]

When the laser marker is used in an environment full of oil mist or dust, it is recommended to wipe the lens protection glass on the laser head with a dry cloth and clean or replace the fan filters in the controller.

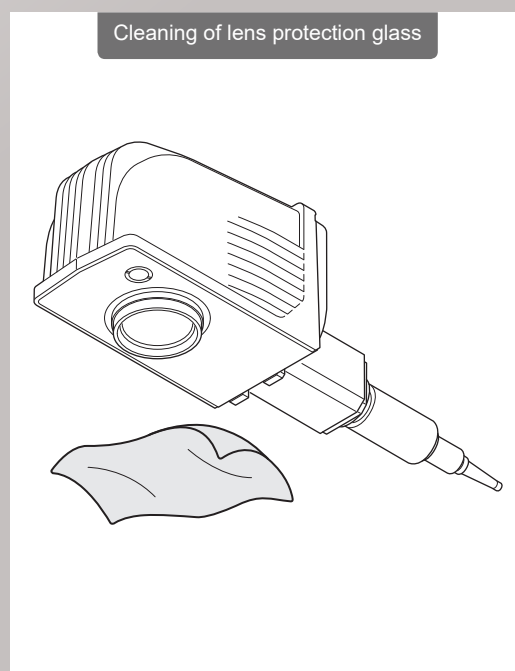
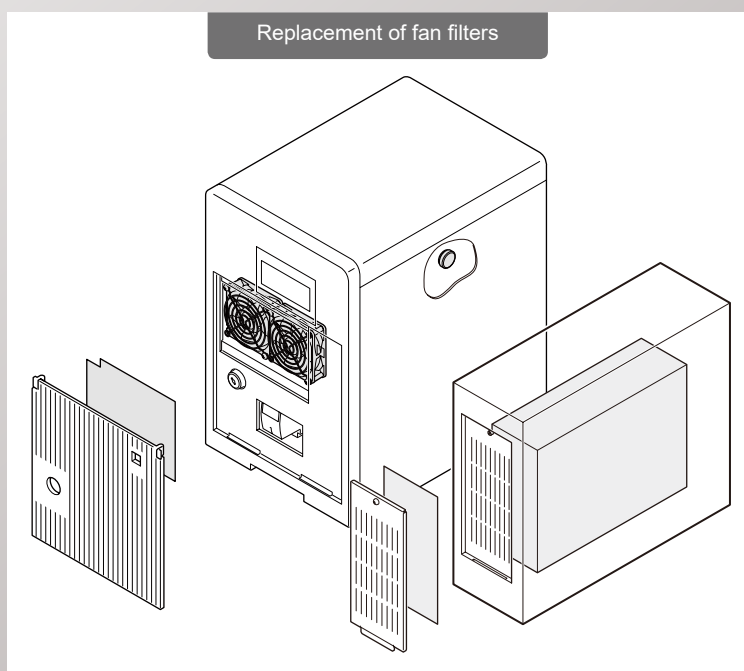

[User-replaceable limited-life parts and consumable parts]

It is recommended to replace long-term maintenance parts (replacement interval of several years) such as the physically moving drive section, sections exposed to oil mist and dust particles, and consumable parts.

Those parts in our previous products had to be replaced by our service personnel, but the mechanisms in the **LP-RV** series were redesigned to allow replacement by the user.

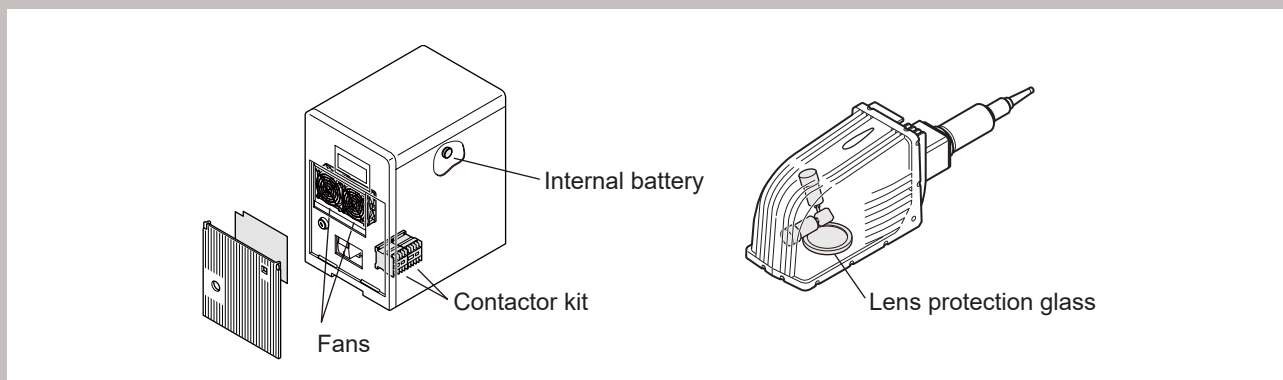

Laser marker installation process flow

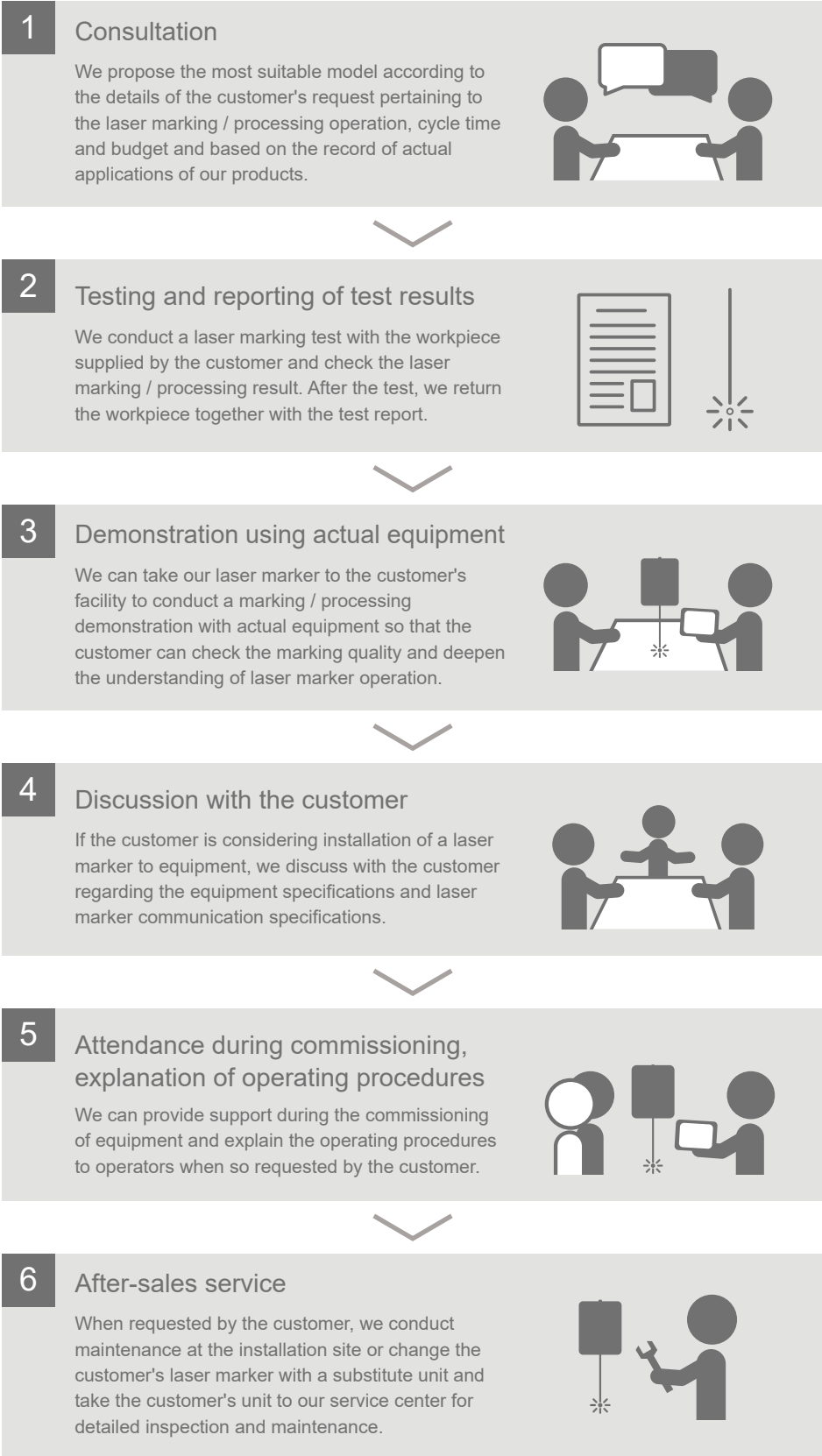

Global Network

Panasonic's sales network extends to various parts of the world, including Asia, the United States and Europe.

Based on the concept of "local production, local consumption," Panasonic is strengthening the local production and development functions in order to meet diversifying market needs and accelerating the global business expansion.

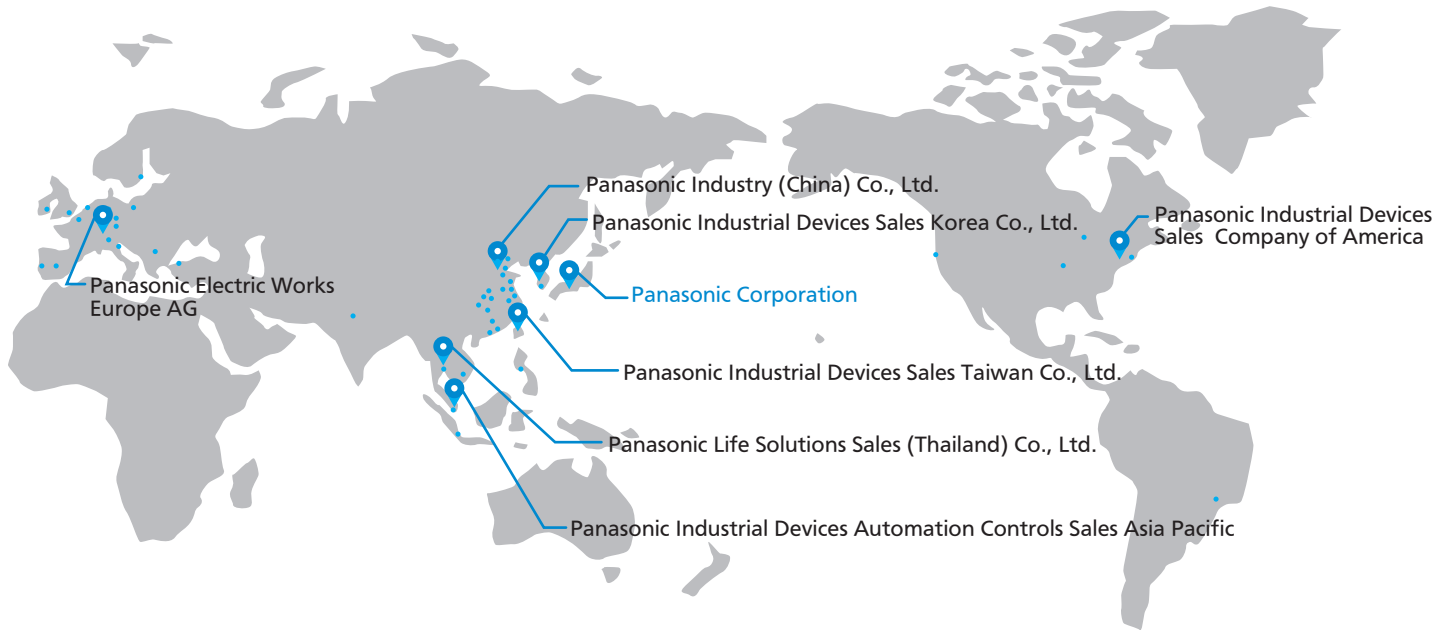

Global Bases of Panasonic Industrial Device Business Division

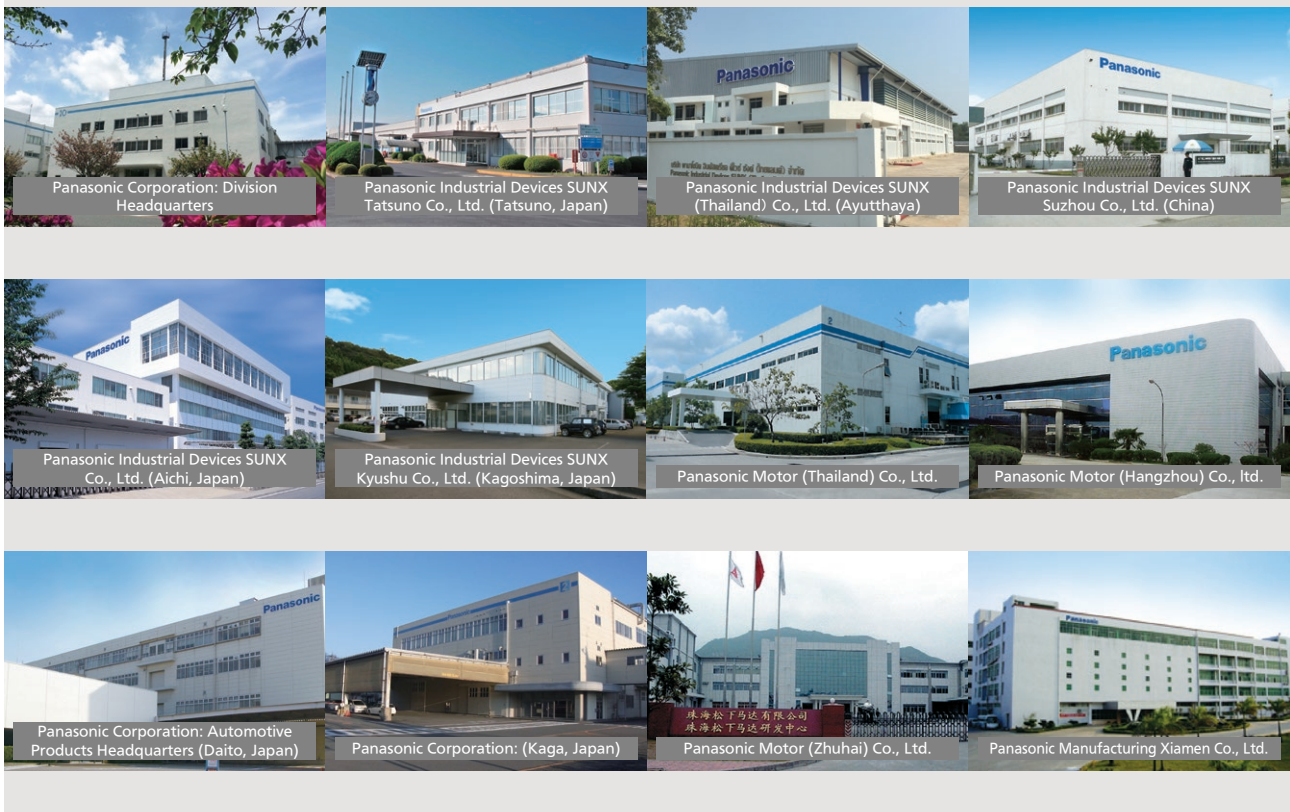

Product Lineup of Industrial Device Business Division

FA sensors

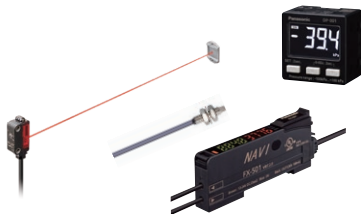

The lineup includes various sensors such as optical, proximity, or pressure sensors available depending on the sensing targets (workpieces).

Safety light curtains and Safety devices

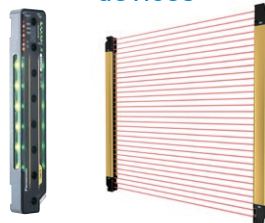

The lineup includes safety light curtains, safety switches, or safety controllers designed to secure safety of workers.

Programmable controllers



We provide compact yet high performance PLCs ranging from small-scale models with fewer I/O points to large-scale models for applications from controlling machines to collecting information.

Machine vision systems



These are used together with cameras to inspect dimensions, profiles, damage or stains. They can be also used for reading various 2D codes or recognizing characters.

Measurement sensors

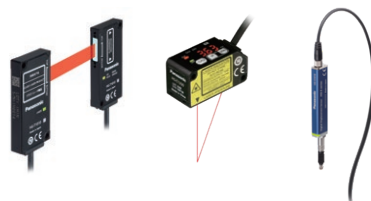

Dimensions of a workpiece or a distance to the workpiece are detected in ultra-high speed with high accuracy. They can be used for various detection applications such as high resolution detection for objects 0.01 μm or less.

Static removers (ionizers)



These are used to eliminate troubles caused by static electricity in various processes. Different models such as spot ionizers, wide-area ionizers, or fan ionizers are available for you to select suitable ones depending on your applications.

Programmable displays



Touch panel displays that interface between people and machines. They are used in various markets such as factories, buildings, or outdoor equipment.

Energy Management Solutions



These devices measure power or air consumption and "visualize" energy consumption to support energy saving.

AC servo motors



Compact, lightweight, and high speed AC servo motors. With the high-speed network motion such as the RTEK, these servo motors contribute to improving performance of customers' devices.

Brushless motors and geared motors



The lineup of geared motors includes induction motors, reversible motors, motors with electromagnetic brakes, and 2-pole round shaft motors. The lineup of brushless motors includes speed control models and position control models.

Motors for facility / home appliance & automotive



Compact, lightweight, low noise, and low vibration motors are available to meet customers' application needs.

Specifications

Item		LP-RV200P
Marking laser	Laser type	Yb fiber laser; $\lambda = 1,064 \text{ nm}$ 0.0419 mil Class4 laser
	Average oscillator output	20 W
	Average output at processing point (Note 1)	17 W ($\pm 5\%$)
	Laser oscillation system	Pulse oscillation
	Pulse duration	1 ns, 4 ns, 8 ns, 16 ns, 30 ns, 120 ns, 200 ns (switchable in seven steps)
	Pulse cycle (Note 2)	0.5 μs to 500 μs
Guide laser / pointer	Red semiconductor laser; $\lambda = 655 \text{ nm}$ 0.026 mil , Class 2 laser, Maximum output; 1 mW or less	
Scanning method	Galvano scanning method	
Beam shielding device	Shutter (mounted inside the head)	
Marking field (X, Y) (Note3)	90 mm \times 90 mm 3.543 in \times 3.543 in	
Work distance (Note 3)	190 mm 7.480 in	
Marking workpiece status	Stationary object, moving object	
Scan speed (Note 4, 5)	Maximum 12,000 mm/s 472.441 in/s	
Moving object line speed (Note 4)	Maximum 240 m/min 787.402 ft/min	
Number of registered files	10,000 files	
Number of marking data (number of registered objects)	2,000 items/file	
Marking object types	Character types	Capital and small letter of alphabet, numeric, symbol, user defined characters (up to 50 characters can be set) Japanese characters: Katakana, Hiragana, Kanji (JIS level-1 and level-2) Simplified Chinese characters: GB 2312 level-1 and level-2
	Barcodes	CODE39, CODE93, CODE128 (GS1-128), ITF, NW-7, EAN/UPC/JAN GS1 DataBar Limited, GS1 DataBar Stacked, GS1 DataBar Limited CC-A, GS1 DataBar Stacked CC-A
	2D codes	QR Code, Micro QR Code, iQR Code, Data Matrix, GS1 Data Matrix, PDF417
	Graphic data (Note 6)	VEC, DXF, HPGL, BMP, JPEG, AI, EPS
	TrueType	TrueType Font on a PC where the Laser Marker NAVI smart is installed (Note 7)
	Data for processing	Point radiation
Character height and width (Note 4)	0.1 mm to 90 mm 0.004 in to 3.543 in (Set in increments of 0.001 mm 0.0394 mil)	
I/O port	I/O terminal block (40 pins), I/O connector (40 pins)	
Communication interface	EIA-RS-232C, Ethernet, EtherNet/IP (Note 8), PROFINET (Note 8)	
Supplied software	Laser Marker NAVI smart, logo data editing software, ExportVec, font maker software	
OS supported by the supplied software (Note 9)	Windows [®] 10 Pro (32-bit, 64-bit), Windows [®] 8.1 Pro (32-bit, 64-bit), Windows [®] 7 Professional SP1 (32-bit, 64-bit)	
Laser Marker NAVI smart connection method	USB, Ethernet	
Laser Marker NAVI smart display language	Japanese, English, Simplified Chinese character, Traditional Chinese character, German, Korean	
System startup time	10 sec. approx.	
Laser excitation time	1 sec. approx.	
Power supply (Note 10)	180 - 264 V AC (including power voltage fluctuation of $\pm 10\%$), 50/60 Hz	
Consumption power (consumption current) (Note 11)	310 VA or less (2.1 A or less)	
Cooling method	Head: Naturally air cooling, Controller / oscillator unit: Forced air cooling	
Ambient temperature (Note 12, 13)	0 to +40 °C +32 to +104 °F	
Ambient temperature for storage (Note 13)	-10 to +60 °C +14 to +140 °F	
Ambient humidity (Note 13)	35 to 85 % RH	
Head protective structure (Note 14)	IP64	
Compliance standards and certificates	FDA Regulations, GB Standard, KC mark, Machinery Directive (Declaration of Incorporation), EMC Directive, RoHS Directive	
Fiber cable length	2.0 m \pm 0.2 m 6.562 ft \pm 0.656 ft , Minimum bending radius 80 mm 3.15 in	
Net weight	Head	8.0 kg approx.
	Oscillator unit	13 kg approx.
	Controller	28 kg approx.

- Notes:
- 1) Indicates the output for the following settings: laser power: 100, pulse duration: 4 ns, and pulse cycle: 1.6 μs . (Factory default)
 - 2) The pulse cycle setting range varies depending on the pulse duration.
 - 3) There is an individual difference of approximately $\pm 0.5 \text{ mm}$ **0.020 in** for every product.
 - 4) The indicated values show the allowable setting range. The setting values that can maintain the marking / processing quality vary depending on the marking condition and target material.
 - 5) Depending on the setting data, the scan speed may be subject to upper-limit restriction in some cases.
 - 6) VEC is a figure file format designed exclusively for laser markers. If figure files in the AI or EPS format are used, they must be converted to VEC-format files in advance using the ExportVEC software provided with the product.
 - 7) Depending on the character type, it may not be possible to use the laser marker. Letters written from right to left (Arabic letters, Hebrew letters, etc.) and letters that use ligature (Indian letters, etc.) cannot be marked using the laser marker.
 - 8) For communication, prepare optional items separately. **LP-ANW10**: EtherNet/IP, **LP-ANW11**: PROFINET
 - 9) The OS versions for which Microsoft terminated its support are excluded from supported OS.
 - 10) Frequency is selected and set automatically.
 - 11) The rush current (typical value) at startup is as follows: 220 V AC (current flowing time of 10 ms or less): 60 A
 - 12) Laser power setting of 46 or higher: 0 to +36 °C **+32 to +97 °F**, Laser power setting of 1 to 45: 0 to +40 °C **+32 to +104 °F**
 - 13) Common to the controller, head, and oscillator unit. There must be no dew condensation or icing. If there is a temperature difference between the storage place and the operating place, gradually adapt the devices to the ambient temperature to prevent condensation.
 - 14) The oscillator and controller are not designed as protective structures. The protective structure of the head exhibits its performance only when the fiber unit, laser beam emission port protection glass, various cables, and cable connector covers are all properly mounted.

PROFINET is a registered trademark of PROFIBUS and PROFINET International.
EtherNet/IP is a registered trademark of ODVA (Open DeviceNet Vendor Association Inc.).
Windows is a registered trademark or trademark of Microsoft Corporation in the United States and other countries.

DIMENSIONS (Unit: mm in)

LP-RV200P

Head

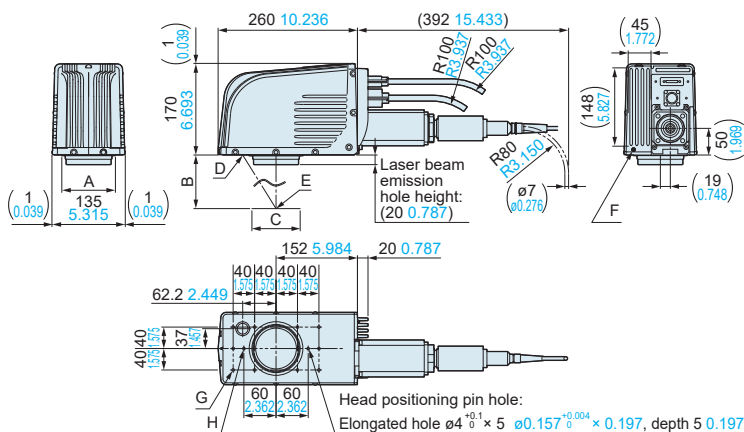

- A: Laser beam emission port diameter (protuded section): $\phi 100\text{ mm } \phi 3.937\text{ in}$
 - B: Work distance: $190\text{ mm } 7.480\text{ in}$
 - C: Marking field (X, Y): $90 \times 90\text{ mm } 3.543 \times 3.543\text{ in}$
 - D: Laser pointer beam emission port diameter: $\phi 26\text{ mm } \phi 1.024\text{ in}$ (lens section: $\phi 20\text{ mm } \phi 0.787\text{ in}$)
 - E: Center of marking area
 - F: Frame grounding screw: M4 screw, depth $5\ 0.197\text{ in}$
 - G: Head mounting screw hole (10 locations)*: M6 screw, depth $6\ 0.236\text{ in}$
 - H: Head positioning pin hole: $\phi 4^{+0.1} \phi 0.157^{+0.004} \times 5\ 0.197$, depth $5\ 0.197\text{ in}$
- *Use six or more screws to mount the head

LP-RV200P

Controller

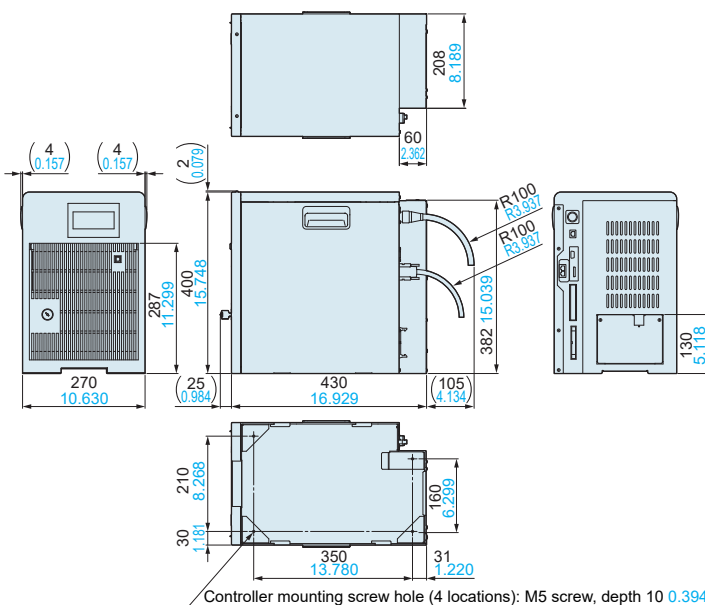

* AC power cable is not attached to the laser marker body. (Sold separately)

LP-RV200P

Oscillator

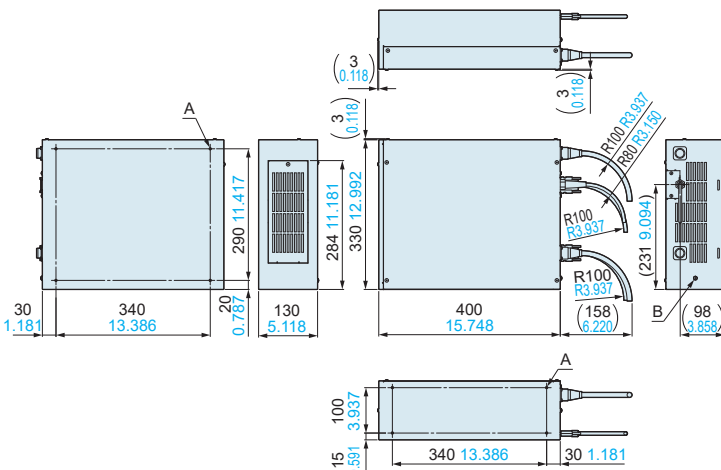

- A: Oscillator securing screw holes (4 holes each in the bottom and on the left side (facing the front)): M5 screws, depth $6\ 0.236\text{ in}$
- B: Frame grounding screw: M4 screw, depth $5\ 0.197\text{ in}$

LP-RV200P

Fiber unit

With fiber unit removed

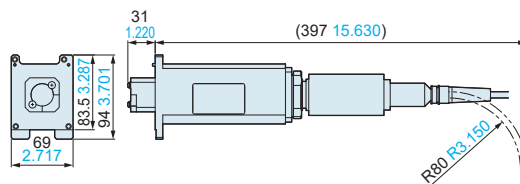

Marking example



[Precautions]

Laser safety

- This product is classified as a Class 4 Laser Product in IEC/JIS/ FDA regulations 21 CFR 1040.10 and 1040.11. Never look at or touch the direct laser beam and its reflection.
- The labels shown on the right are attached to the product. Handle the product according to the instruction given on the warning labels. (Warning labels are not shown in the product photographs in this catalog.)
- The laser used by this product generates infrared light that is invisible to the human eye. Use particular caution when the laser is operating.

ANGER—VISIBLE AND INVISIBLE LASER RADIATION
 AVOID EYE OR SKIN EXPOSURE TO DIRECT OR SCATTERED RADIATION

λ (Wavelength): 1000nm ~ 1200nm | λ (Wavelength): 655nm
 Po (Maximum Output): 50W | Po (Maximum Output): 1mW CW
 Pp (Maximum Peak Power): 200kW | Pp (Maximum Peak Power): 1000W
 τ (Pulse Duration): 1ns ~ 1000ns | τ (Pulse Duration): 1ns ~ 1000ns

CLASS 4 LASER PRODUCT IEC60825-1:2014

危険—可視及び不可視レーザー放射
 ビームや散乱光の目又は皮膚への照射を避けること

波長: 1000nm ~ 1200nm | 波長: 655nm
 最大出力: 50W | 最大出力: 1mW CW
 最大ピーク電力: 200kW | 最大ピーク電力: 1000W
 パルス幅: 1ns ~ 1000ns | パルス幅: 1ns ~ 1000ns

クラス4 レーザ製品 JIS C6802:2014

可見及不可見激光辐射
 目或皮膚直接照射激光的直射光或反射光有危险！
 不要直视或接触激光

波长: 1000nm ~ 1200nm | 波长: 655nm
 最大输出功率: 50W | 最大输出功率: 1mW 连续波
 脉冲峰值功率: 200kW | 脉冲峰值功率: 1000W

4类 激光产品 GB7247.1-2012

Warning / instruction labels

Recommended use of a dust collector

- Depending on the object being marked, harmful gasses or smoke that have a detrimental effect on the human body or the laser marker may be generating during marking. If your application falls under this description, use a dust collector. For more information, contact your sales representative.

Disclaimer

The applications described in the catalog are all intended for examples only. The purchase of our products described in the catalog shall not be regarded as granting of a license to use our products in the described applications. We do NOT warrant that we have obtained some intellectual properties, such as patent rights, with respect to such applications, or that the described applications may not infringe any intellectual property rights, such as patent rights, of a third party.

Please contact

Panasonic Corporation

Industrial Device Business Division

■ 1006, Oaza Kadoma, Kadoma-shi, Osaka 571-8506, Japan
industrial.panasonic.com/ac/e/

Panasonic[®]

©Panasonic Corporation 2020