

# M4NS/M4YS

## DIN W48×H24mm, W72×H36mm Loop Powered Digital Scaling Meter

### ■ Features

- Loop powered type: Power from measured input
- Measurement input: DC4-20mA
- Max. display range: -1999 to 9999
- High/low-limit display scale function
- Decimal point change function
- High/low-limit input correction function
- Display Max./Min. value monitoring function
- Changeable delay time of monitoring Max./Min. value  
(Selectable 0.5 sec/1 sec/2 sec/3 sec/4 sec/5 sec)
- Error display function

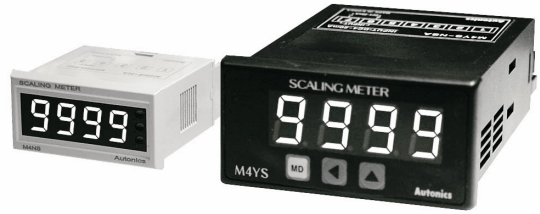

**⚠** Please read "Safety Considerations" in operation manual before using.

### ■ Ordering Information

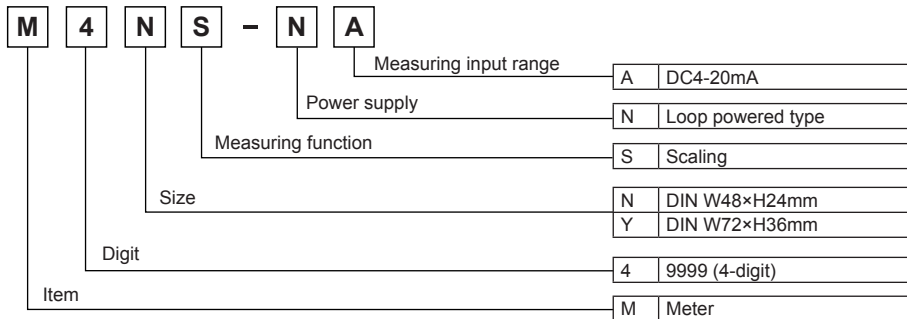

### ■ Specifications

Model	M4NS-NA	M4YS-NA
Power supply	Loop powered type	
Display method	7-segment LED display (red)	
Character height	10mm	14mm
Display accuracy <sup>※1</sup>	F.S. 0.3% rdg ±1-digit	
Display cycle	0.5 sec/1 sec/2 sec/3 sec/4 sec/5 sec	
Resolution	12,000 resolution	
Max. display range	-1999 to 9999	
Setting type	Setting type with the front keys	
Measuring input range <sup>※2</sup>	DC4-20mA	
Self-diagnosis function	Error display function	
Insulation resistance	Over 100MΩ (at 500VDC megger)	
Dielectric strength	2,000VAC 50/60Hz for 1 min	
Vibration	Mechanical	0.75mm amplitude at frequency of 10 to 55Hz (for 1 min) in each X, Y, Z direction for 1 hour
	Malfuction	0.5mm amplitude at frequency of 10 to 55Hz (for 1 min) in each X, Y, Z direction for 10 min
Shock	Mechanical	300m/s <sup>2</sup> (approx. 30G) in each X, Y, Z direction for 3 times
	Malfuction	100m/s <sup>2</sup> (approx. 10G) in each X, Y, Z direction for 3 times
Environ-ment	Ambient temperature	-10 to 50°C, storage: -25 to 60°C
	Ambient humidity	35 to 85%RH, storage: 35 to 85%RH
Unit weight	Approx. 44g	Approx. 110g

※1: Ambient temperature (25°C±5°C): F.S. 0.3% rdg of ±1-digit (-10 to 50°C: F.S. 0.4% rdg ±1-digit)

※2: Impedance between input lines: Max. 600Ω (based on 24VDC)

Please be aware that activating input power is based on 24VDC, and the recommended impedance also will be lowered if the activating power is lower.

※Environment resistance is rated at no freezing or condensation.

# Loop Powered Scaling Meter

## Unit Description

### M4NS-NA

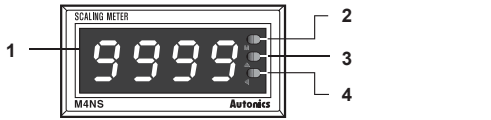

1. Display value, parameter, error display
2. M, MD key: When enter into parameter group, return to RUN mode, after completing parameter setting

### M4YS-NA

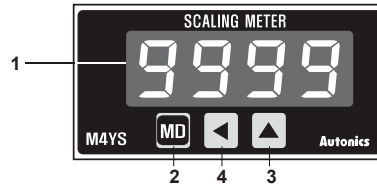

3. ▲, ▲ key: When enter into the status of parameter setting
4. ▲, ◀ key: When enter into the status of parameter setting and move digit

## Connections

### M4NS-NA

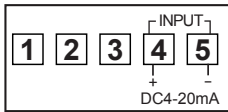

### M4YS-NA

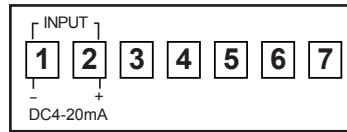

## Dimensions

### M4NS-NA

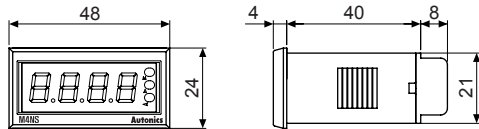

### M4YS-NA

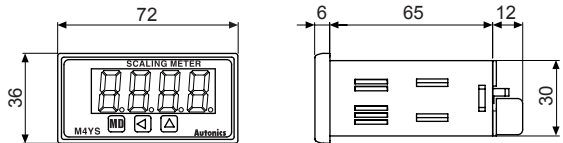

(unit: mm)

### Bracket

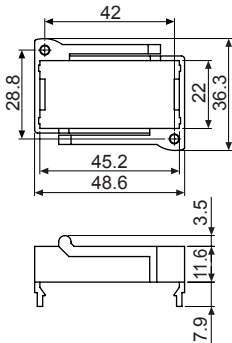

### Panel cut-out

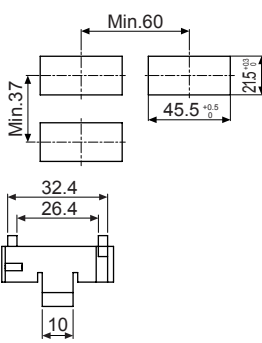

### Bracket

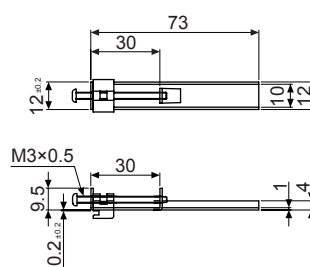

### Panel cut-out

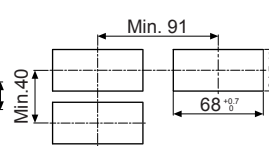

## Parameter

Display	Function	Setting range
L - 5 C	Low scale Low limit display value for 4mA input	-1.999 to 9.999, -19.99 to 99.99, -199.9 to 999.9, -1999 to 9999
H - 5 C	High scale High limit display value for 20mA input	0000, 000.0, 00.00, 0.000
d o t	Decimal point Set Decimal point position	0000, 000.0, 00.00, 0.000
i n b.L	Input bias low Correct the Low-limit value of display value (digit)	-100 to 100
i n b.H	Input bias high Correct the High-limit value of display value (%)	0.900 to 1.100
P E L t	Max./Min. time See the Max./Min. value monitoring delay time (sec)	0 to 30
d i S t	Display time Selectable sampling period (sec)	0.5/1.0/2.0/ 3.0/4.0/5.0
E.P.C t	Error % Set % of HHHH/LLLL display range	0, 1, 2, 3, 4
L o C	Lock Set the lock function	ON, OFF

## Factory Default Setting

Parameter	Parameter display	Factory default
Low limit display value for 4mA input	L - 5 C	0400
Hi limit display value for 20mA input	H - 5 C	2000
Set Dot position	d o t	0000
Correction of Low limit value input	i n b.L	0000
Correction of Hi limit value input	i n b.H	1.000
Max./Min. value monitoring delay time	P E L t	0 1 5
Display cycle	d i S t	0 5 5
Set % of HHHH/LLLL display range	E.P.C t	3
Lock setting	L o C	o F F

(A) Photoelectric Sensors

(B) Fiber Optic Sensors

(C) Door/Area Sensors

(D) Proximity Sensors

(E) Pressure Sensors

(F) Rotary Encoders

(G) Connectors/  
Connector Cables/  
Sensor Distribution  
Boxes/Sockets

(H) Temperature Controllers

(I) SSRs / Power Controllers

(J) Counters

(K) Timers

(L) Panel Meters

(M) Tacho / Speed / Pulse Meters

(N) Display Units

(O) Sensor Controllers

(P) Switching Mode Power Supplies

(Q) Stepper Motors & Drivers & Controllers

(R) Graphic/ Logic Panels

(S) Field Network Devices

(T) Software

## Parameter 0 Group (Monitoring Mode)

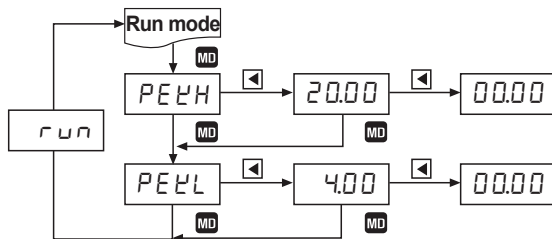

1. Pressing **MD** key to enter monitoring mode in RUN mode.
2. Each Max./Min. value will be shown by pressing **◀** key in monitoring mode and Max./Min. value will be initialized by pressing **▶** key once more.
3. If no key touched for 60 sec, it will return to RUN mode.
4. When do not use monitoring function, set **00 5** for **PEEL** in parameter setting.

## Parameter 1 Group

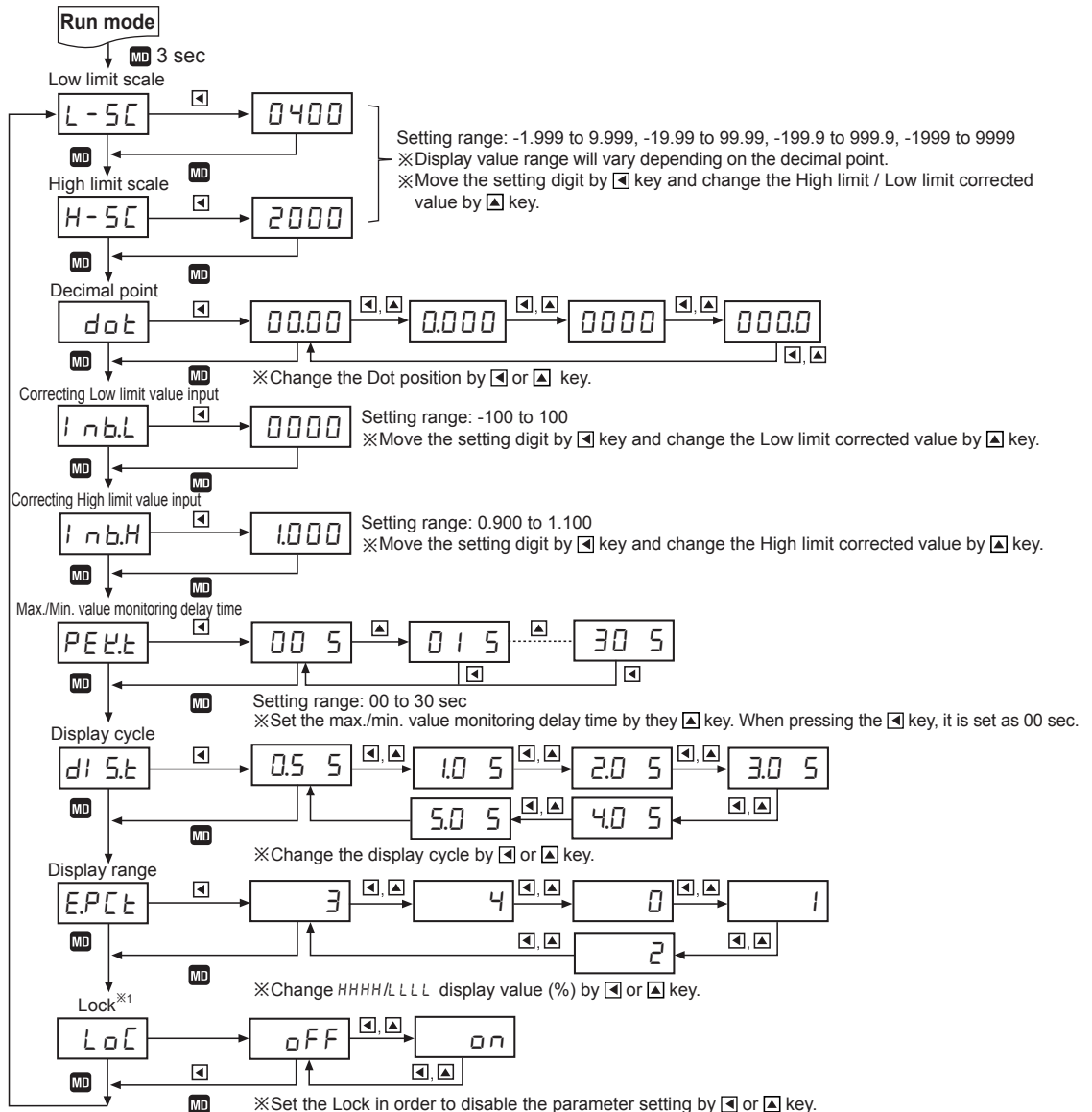

- ※ Press the **MD** key after changing the setting value of the parameter, the setting value is saved and it moves to next parameter.
- ※ After entering setting parameter, hold the **MD** key for 3 sec, it displays **run** and returns to RUN mode
- ※ If any key is untouched for 60 sec, it will return to RUN mode.
- ※ 1: Lock **oFF**: Enable to change or set Parameter.  
**oN**: Disable to change or set Parameter but enable to check the setting value in Parameter group.  
 Disable to enter into the status of change setting value by pressing **◀**, **▶** keys.

# Loop Powered Scaling Meter

## Application Of Connections

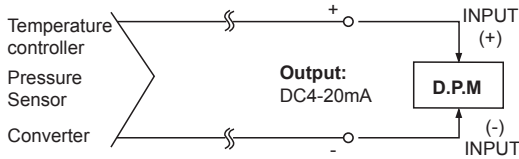

## Functions

### High/low-limit display scale [L - 5C / H - 5C]

This function is to display the value setting certain Hi/Low limit value against DC4-20mA input. For example if set a=DC4mA, b=DC20mA and A, B as display value, it will be displayed a=A, b=B.

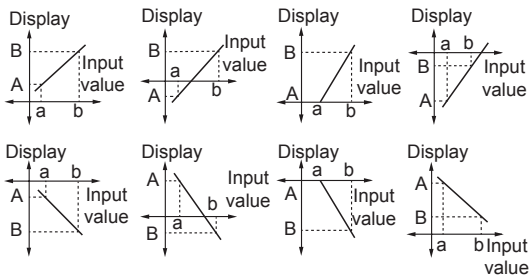

### Decimal point setting [dot]

This function is to set the decimal point position of display value (set in Parameter setting group).

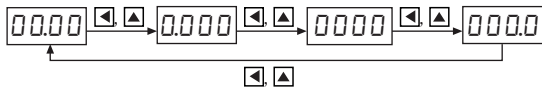

### Correction [InbH / InbL]

This function is to adjust the error of display value after calculating scale value for measuring input and also correct the input error of sensor etc.

InbL: -100 to 100 [Adjust deviation of low value]

InbH: 0.900 to 1.100 [Correct gradient (%) of high value]

E.g.) When display value is 0.0 to 500.0 against 4-20mA input, if the display value is "1.2" for 4mA input, set -12 (ignore the decimal point) as InbL value to display "0.0". It is able to remove offset of Low display value.

※ When completed above Low value setting then apply 20mA, if the display value is "500.5", the correction value will be  $5005/5000=0.999$ , set 0.999 as InbH value then enable to correct High value is  $5005 \times 0.999 = 5000$ . It is also ignore the decimal point.

### Display cycle delay

It is difficult to display when the measuring input value is fluctuating. In this case it is able to make display value stable by delaying display cycle. Display cycle can be changed in d1 5c mode of Parameter 2 (0.5s/1.0s/2.0s/3.0s/4.0s/5.0s).

If select 5.0 5, it will be the measuring input value on an average for 5 sec, then display it every 5 sec.

### Error display [E.P.C.E.]

#### Error display

- When LLLL flashes,
  - Input current is lower than 3% in 4-20ADC (16mA scale) LLLL will flash when it is under 3.52mA [ $16\text{mA} \times 3\% = 0.48\text{mA}$ ]  $\rightarrow 4\text{mA} - 0.48\text{mA} = 3.52\text{mA}$
  - When it is beyond Min. display value (-1999) [by display value]
- When HHHH flashes,
  - Input current is higher than 3% in 4-20ADC (16mA scale) HHHH flash [ $16\text{mA} \times 3\% = 0.48\text{mA}$ ]  $\rightarrow 20\text{mA} + 0.48\text{mA} = 20.48\text{mA}$ .
  - When it is higher than 20.48mA. When it is beyond Max. display value (9999) [by display value]

#### Turn Error display off

LLLL and HHHH are displayed when input is out of measuring range, therefore it will be disappeared automatically when input returns to measuring range

#### Error setting and sort

It will display the error message according to the setting value which set % value against analog input range and set it in E.P.C.E. mode by [left arrow], [right arrow] key.

Display	Description
E.P.C.E. 1	LLLL / HHHH are displayed when it is over 0% out DC4-20mA range
E.P.C.E. 2	LLLL / HHHH are displayed when it is over 1% out DC4-20mA range
E.P.C.E. 3	LLLL / HHHH are displayed when it is over 2% out DC4-20mA range
E.P.C.E. 4	LLLL / HHHH are displayed when it is over 3% out DC4-20mA range
E.P.C.E. 5	L - 5C / H - 5C are displayed always when it is out of DC4-20mA range

### Display Max./Min. value monitoring [PEEH / PEEL]

This function is to monitor Max. value and Min. value by current display value then display its Data in PEEH mode and PEEL mode.

Enable to set delay time in PEEL mode to protect the wrong Data by initial over current and settable from 0 to 30 sec and start to monitor after delay time.

(A)	Photoelectric Sensors
(B)	Fiber Optic Sensors
(C)	Door/Area Sensors
(D)	Proximity Sensors
(E)	Pressure Sensors
(F)	Rotary Encoders
(G)	Connectors/ Connector Cables/ Sensor Distribution Boxes/Sockets
(H)	Temperature Controllers
(I)	SSRs / Power Controllers
(J)	Counters
(K)	Timers
(L)	Panel Meters
(M)	Tacho / Speed / Pulse Meters
(N)	Display Units
(O)	Sensor Controllers
(P)	Switching Mode Power Supplies
(Q)	Stepper Motors & Drivers & Controllers
(R)	Graphic/ Logic Panels
(S)	Field Network Devices
(T)	Software