

M4Y/M4W/M5W/M4M Series

■ Panel Meter Selection II

※This panel meter selection is except MT4N / MT4Y / MT4W Series.

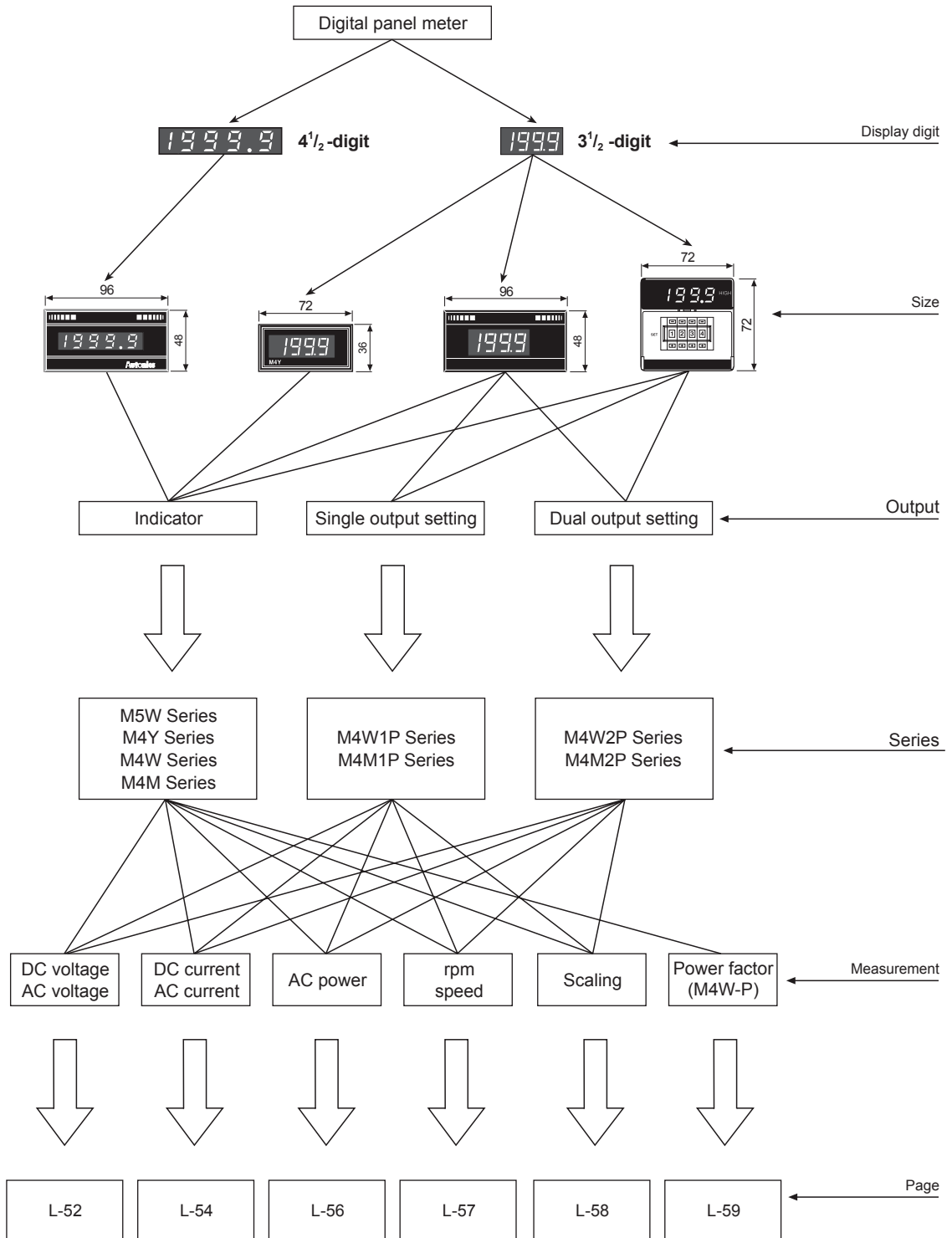

Specifications

Classification		Indicator		Single preset output type	Dual preset output type
Measurement	DC, AC voltage	M4Y-DV-□ M4Y-AV□-□ M5W-DV-□ M5W-AV-□	M4W-DV-□ M4W-AV□-□ M4M-DV-□ M4M-AV□-□	M4W1P-DV-□ M4W1P-AV□-□ M4M1P-DV-□ M4M1P-AV□-□	M4W2P-DV-□ M4W2P-AV□-□ M4M2P-DV-□ M4M2P-AV□-□
	DC, AC current	M4Y-DA-□ M4Y-AA□-□ M5W-DA-□ M5W-AA-□	M4W-DA-□ M4W-AA□-□ M4M-DA-□ M4M-AA□-□	M4W1P-DA-□ M4W1P-AA□-□ M4M1P-DA-□ M4M1P-AA□-□	M4W2P-DA-□ M4W2P-AA□-□ M4M2P-DA-□ M4M2P-AA□-□
	AC power (0-10VDC)	M4Y-W-□ M5W-W-□	M4W-W-□ M4M-W-□	M4W1P-W-□ M4M1P-W-□	M4W2P-W M4M2P-W
	rpm, speed (0-10VDC) (0-10VAC)	M4Y-T□-□ M4Y-S□-□ M5W-T-□ M5W-S-□	M4W-T□-□ M4W-S□-□ M4M-T-□ M4M-S-□	M4W1P-T□-□ M4W1P-S□-□ M4M1P-T-□ M4M1P-S-□	M4W2P-T□-□ M4W2P-S□-□ M4M2P-T-□ M4M2P-S-□
	Power factor (DC4-20mA)	—	M4W-P (refer to L-59)	—	—
Max. allowable input		150% for each input specification (at 400VAC:120%)			
Power supply	AC power	100-240VAC~ 50/60Hz	110/220VAC~ 50/60Hz 100-240VAC~ 50/60Hz ^{※1}		
	DC power	5VDC= (except for M5W) ^{※1} 24-70VDC= (except for M5W) ^{※1}	24-70VDC= ^{※1}		
Allowable voltage range		90 to 110% of rated voltage			
Power consumption	AC power	4VA		5VA	
	DC power	2W		3W	
Display method		7-segment LED display			
Character height		M4Y, M4W, M5W: 14mm / M4W1P, M4W2P, M4M, M4M1P, M4M2P: 10mm			
Display accuracy	AC power	F.S. ±0.5% rdg ±1-digit			
	DC power	F.S. ±0.2% rdg ±1-digit			
Sampling period		300ms			
A/D conversion method		Dual slope integral method			
Response time		2 sec (0 to max.)			
Display frequency		2.5 times/sec			
Contact capacity		—		Relay contact output: 250VAC~ 3A 1c, 150VDC= 3A 1c	Relay contact output: 250VAC~ 3A 1c, 150VDC= 3A 1c ×2
Insulation resistance		Over 100MΩ (at 500VDC megger)			
Dielectric strength		2000VAC 50/60Hz for 1 min			
Noise immunity		±1kV the square wave noise (pulse width: 1us) by the noise simulator			
Vibration	Mechanical	0.75mm amplitude at frequency of 10 to 55Hz (for 1 min) in each X, Y, Z direction for 1 hour			
	Malfunction	0.5mm amplitude at frequency of 10 to 55Hz (for 1 min) in each X, Y, Z direction for 10 min			
Shock	Mechanical	300m/s ² (approx. 30G) in each X, Y, Z direction for 3 times			
	Malfunction	100m/s ² (approx. 10G) in each X, Y, Z direction for 3 times			
Relay life cycle	Mechanical	—		Min. 10,000,000 operations	
	Malfunction	—		Min. 100,000 operations (250VAC 3A resistive load)	
Environment	Ambient temperature	-10 to 50°C, storage: -20 to 60°C			
	Ambient humidity	35 to 85%RH, storage: 35 to 85%RH			
Unit weight		M4Y: Approx. 144g M5W: Approx. 172g	M4W: Approx. 168g M4M: Approx. 262g (M4M-P: Approx. 268g)	M4W1P: Approx. 253g M4M1P: Approx. 290g	M4W2P: Approx. 278g M4M2P: Approx. 316g

※1: It is optional.(customizable)

※Environment resistance is rated at no freezing or condensation.

(A) Photoelectric Sensors

(B) Fiber Optic Sensors

(C) Door/Area Sensors

(D) Proximity Sensors

(E) Pressure Sensors

(F) Rotary Encoders

(G) Connectors/ Connector Cables/ Sensor Distribution Boxes/ Sockets

(H) Temperature Controllers

(I) SSRs / Power Controllers

(J) Counters

(K) Timers

(L) Panel Meters

(M) Tacho / Speed / Pulse Meters

(N) Display Units

(O) Sensor Controllers

(P) Switching Mode Power Supplies

(Q) Stepper Motors & Drivers & Controllers

(R) Graphic/ Logic Panels

(S) Field Network Devices

(T) Software

M4Y/M4W/M5W/M4M Series

■ Dimensions

(unit: mm)

● M4Y

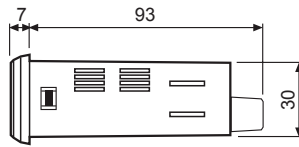
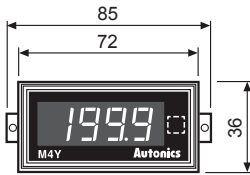

● Panel cut-out

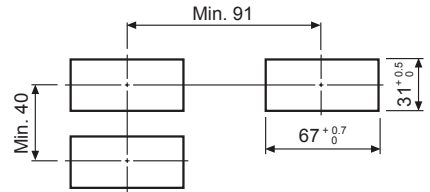

※Unit will be displayed in □ of front panel.

(unit: mm)

● M4W

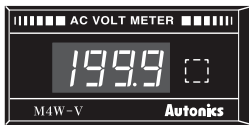

● M4W1P



● M4W2P



● M5W

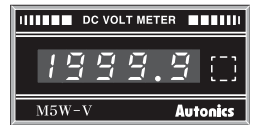

● Panel cut-out

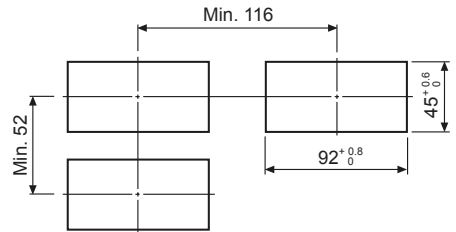
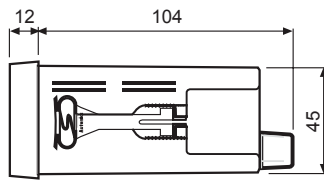
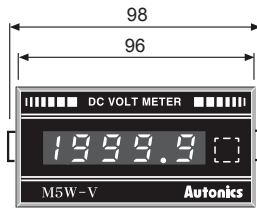

※Unit will be displayed in □ of front panel.

(unit: mm)

● M4M

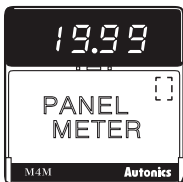

● M4M1P

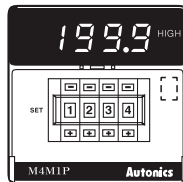

● M4M2P

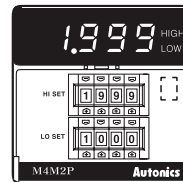

● Panel cut-out

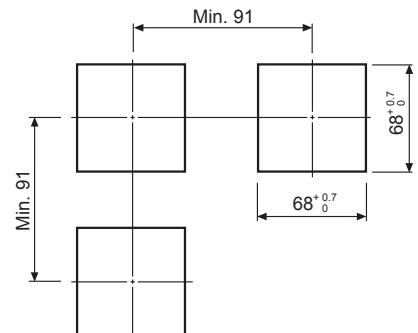
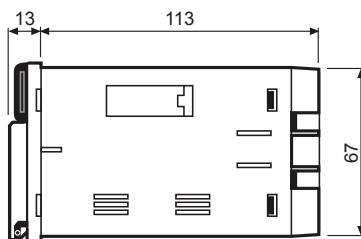
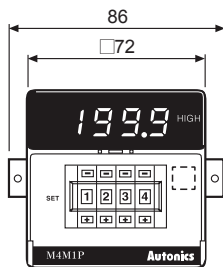

※Unit will be displayed in □ of front panel.

■ Connections

● M4Y

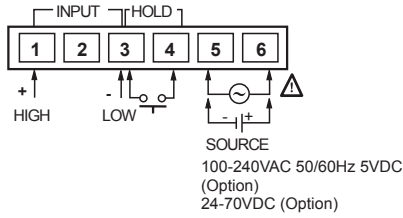

● M4W

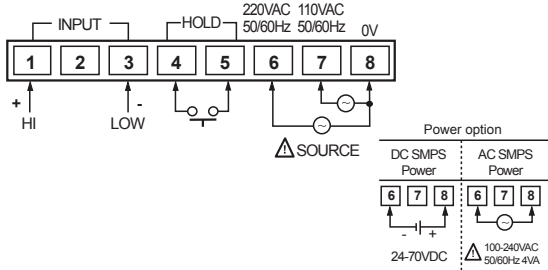

● M5W

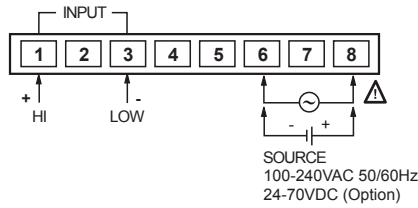

● M4W1P

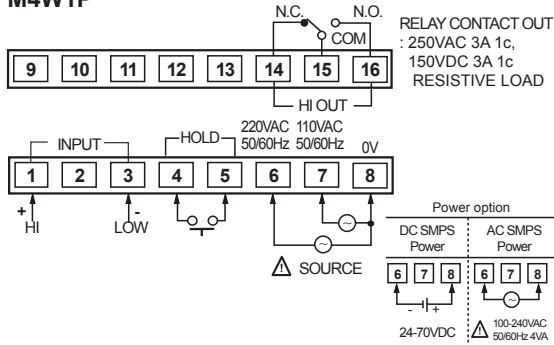

● M4W2P

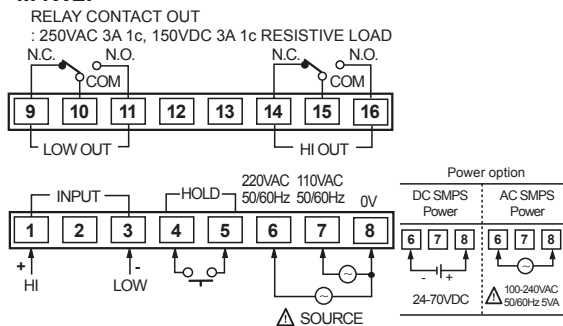

● M4M

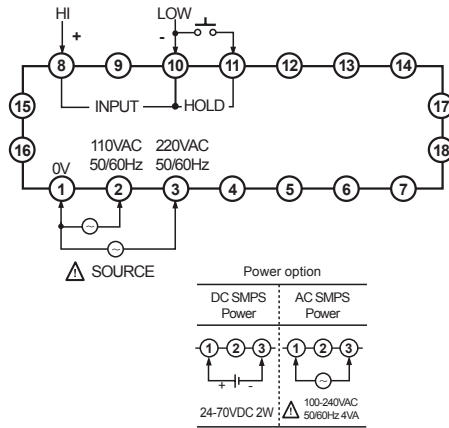

● M4M1P

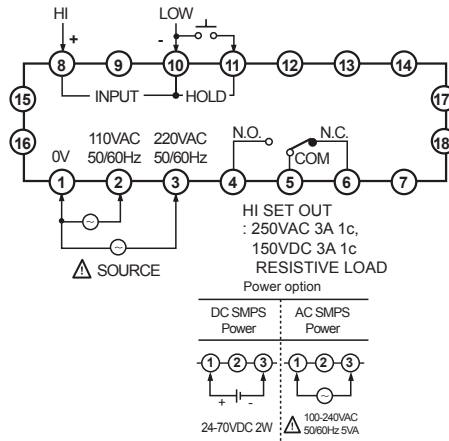

● M4M2P

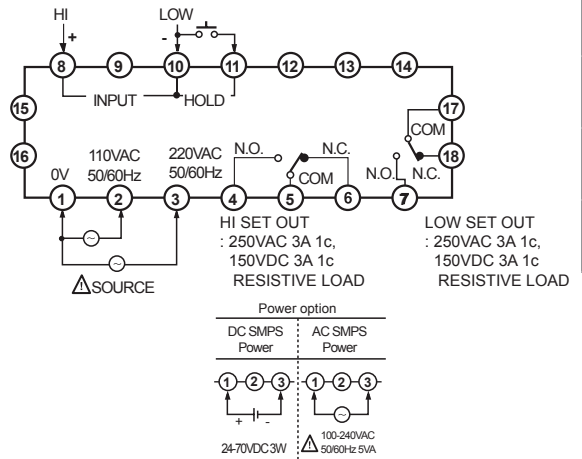

(A) Photoelectric Sensors

(B) Fiber Optic Sensors

(C) Door/Area Sensors

(D) Proximity Sensors

(E) Pressure Sensors

(F) Rotary Encoders

(G) Connectors/
Connector Cables/
Sensor Distribution
Boxes/ Sockets

(H) Temperature Controllers

(I) SSRs / Power Controllers

(J) Counters

(K) Timers

(L) Panel Meters

(M) Tacho / Speed / Pulse Meters

(N) Display Units

(O) Sensor Controllers

(P) Switching Mode Power Supplies

(Q) Stepper Motors & Drivers & Controllers

(R) Graphic/ Logic Panels

(S) Field Network Devices

(T) Software

M4Y/M4W/M5W/M4M Series

DIN W72×H36mm, W96×H48mm, W72×H72mm

Digital Panel Meter For Measuring Voltage

■ Features

- Max. display: 19999 (M5W), 1999 (others)
- Auto zero function or Hold function (except for M5W)
- Selectable RMS/AVG value (AC voltage)
- 7-segment LED display
- Case size by DIN specification
- Indicator, Single preset output type, Dual preset output type



 Please read "Caution for your safety" in operation manual before using.

■ Ordering Information

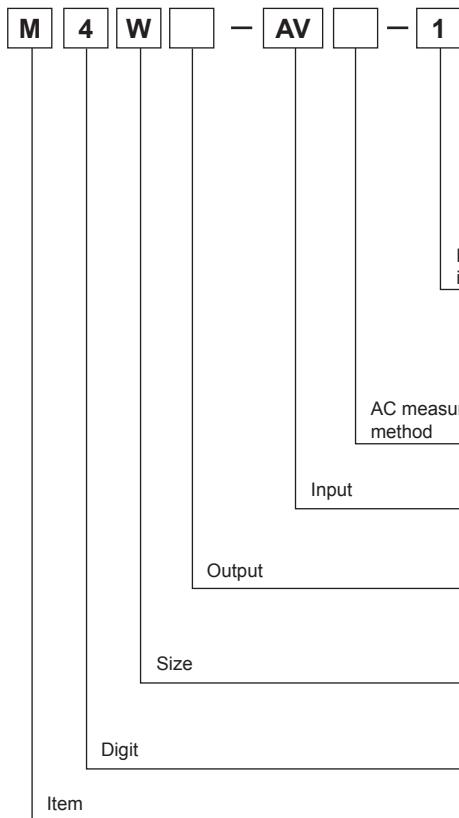

NO	M4Y / M4W / M4M		M5W	
	DC INPUT (F.S.)	AC INPUT (F.S.)	DC INPUT (F.S.)	AC INPUT (F.S.)
1	199.9mV	199.9mV	199.99mV	199.99mV
2	1.999V	1.999V	1.9999V	1.9999V
3	19.99V	19.99V	19.999V	19.999V
4	199.9V	199.9V	199.99V	199.99V
5 ^{※2}	300V	—	300.0V	400.0V
6 ^{※2}	—	400V	—	—
XX	Option		Option	
No mark	AVG value			
R ^{※3}	RMS value			
DV	DC voltage			
AV	AC voltage			
No mark	Indicator			
1P	Single setting			
2P	Dual setting			
Y ^{※4}	DIN W72×H36mm			
W ^{※4}	DIN W96×H48mm			
M	DIN W72×H72mm			
4	1999 (3½-digit)			
5	19999 (4½-digit)			
M	Meter			

※1: Measuring input and display are 1:1.

※2: Available input can be direct connection if under 300VDC, 400VAC.

※3: M5W AC measurement type has RMS only. It does not have "R" in model name.

※4: M4Y, M5W are indicator.

■ The Application Of Connections

◎ Measuring DC voltage

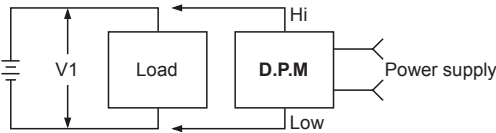

(Fig. 1) Measuring lower than 300VDC of measurement voltage (V1)

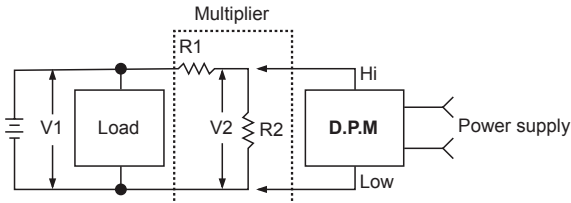

(Fig. 2) Measuring higher than 300VDC of measurement voltage

※When measuring voltage is higher than 300VDC, please select R1 and R2 with multiplying resistance on the external to make V2 less than max. measurement voltage.

$$V2 = \frac{R2}{R1 + R2} \times V1 \quad R1 > R2$$

E.g.)Ordering D.P.M for measuring 1000VDC
As above Fig. 2, select the R1 value to make 300VDC on R2.
(Generally R1 value will be higher than R2 value.)
Order the D.P.M indicating 1000V for 300VDC.

◎ Measuring AC voltage

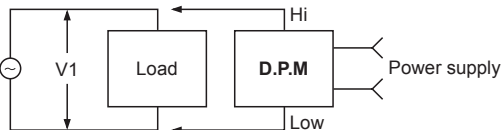

(Fig. 3) Measuring lower than 400VAC of measurement voltage (V1)

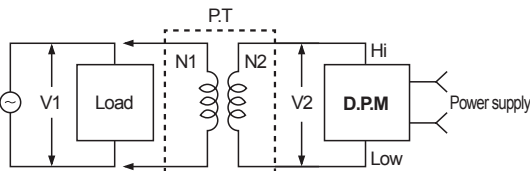

(Fig. 4) Measuring higher than 400VAC of measurement voltage (V1)

※When measuring voltage is higher than 400VAC, please use the P.T on the external. (V2 voltage must be lower than max. measurement voltage)

$$V2 = \frac{N2}{N1} \times V1$$

E.g.)Ordering D.P.M for measuring 1000VAC
Select the P.T having 1000VAC of 1st part voltage and 220VAC of 2nd part voltage and order the D.P.M indicating 1000V for 220VAC.

■ Proper Usage

- Please notice the product customized by requirement cannot be replaced.
- 5VDC Power supply should be insulated and limited voltage/current or Class 2, SELV power supply device.
- If it displays arbitrary number even though the power is ON, please remove the input signal and check whether it displays "000" after short the measurement terminal. (Checking auto zero function)

If it does not display "000", please connect to our A/S center.

Note)M5W Series does not have auto zero function.

- If it indicates "1999" or "-1999" during input signal is ON, please turn OFF the power and check the connection condition.

It is because the input signal is too low or high. Note) M5W Series indicates "19999" or "-19999".

- The specification of measurement input, which is indicated in ordering information, is a standard specification, 1:1 of measurement input and process value. When it is an optional specification of AC voltmeter, please mark the specification of P.T after select a model.

※Please notice P.T is not included.

- The D.P.M for measuring AC voltage has both AVG type and RMS type separately. Because it is produced with AVG type, please mark the model name accurately.

E.g.)In case of M4Y, M4W, M4M Series (Include setting type)

The model of RMS type: M4W-AVR-6

The model of AVG type: M4W-AV-6

※The specification will be set by sign "R".

※M5W Series has RMS type only, and it is not indicated "R" on the model name.

- In case of D.P.M for measuring AC voltage, please check if it is AVG type or RMS type when comparison measuring with other company's products.

(A)	Photoelectric Sensors
(B)	Fiber Optic Sensors
(C)	Door/Area Sensors
(D)	Proximity Sensors
(E)	Pressure Sensors
(F)	Rotary Encoders
(G)	Connectors/ Connector Cables/ Sensor Distribution Boxes/ Sockets
(H)	Temperature Controllers
(I)	SSRs / Power Controllers
(J)	Counters
(K)	Timers
(L)	Panel Meters
(M)	Tacho / Speed / Pulse Meters
(N)	Display Units
(O)	Sensor Controllers
(P)	Switching Mode Power Supplies
(Q)	Stepper Motors & Drivers & Controllers
(R)	Graphic/ Logic Panels
(S)	Field Network Devices
(T)	Software

M4Y/M4W/M5W/M4M Series

DIN W72×H36mm, W96×H48mm, W72×H72mm

Digital Panel Meter For Measuring Current

■ Features

- Max. display: 19999 (M5W), 1999 (others)
- Auto zero function or hold function (except for M5W)
- Selcetable RMS/AVG value (AC current)
- 7-segment LED display
- Case size by DIN specification
- Indicator, single preset output type, Dual preset output type



⚠ Please read "Caution for your safety" in operation manual before using.

■ Ordering Information

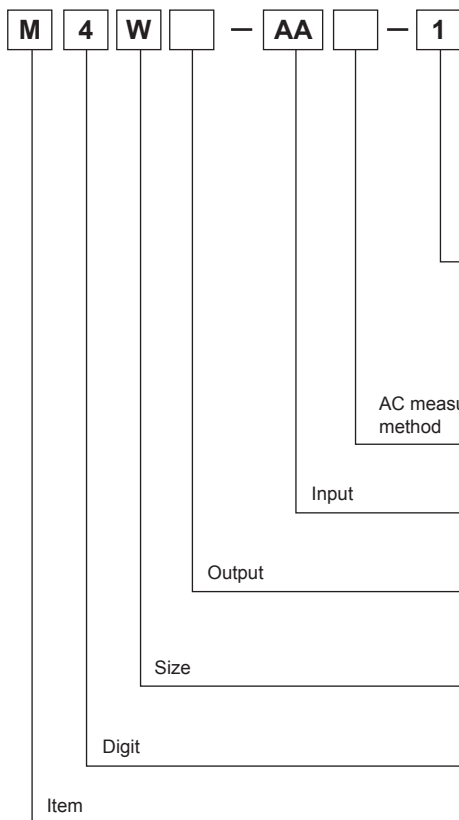

NO	M4Y / M4W / M4M		M5W	
	DC INPUT (F.S.)	AC INPUT (F.S.)	DC INPUT (F.S.)	AC INPUT (F.S.)
1	199.9μA	19.99mA	199.99μA	19.999mA
2	1.999mA	199.9mA	1.9999mA	199.99mA
3	19.99mA	1.999A	19.999mA	1.9999A
4	199.9mA	19.99A	199.99mA	19.999A
5	1.999A	199.9A	1.9999A	199.99A
6	19.99A	1999A	19.999A	1999.9A
7	199.9A	—	199.99A	—
8	1999A	—	1999.9A	—
XX	Option		Option	
No mark	AVG value			
R* ²	RMS value			
DA	DC current			
AA	AC current			
No mark	Indicator			
1P	Single setting			
2P	Dual setting			
Y* ³	DIN W72×H36mm			
W* ³	DIN W96×H48mm			
M	DIN W72×H72mm			
4	1999 (3½-digit)			
5	19999 (4½-digit)			
M	Meter			

※1: Measuring input and display is 1:1 for DC INPUT No.1to 5 and AC INPUT No.1 to 3, DC INPUT No.6 to 8 is used with 50mVDC Shunt, AC INPUT No.4 to 6 are used with C.T (current transformer)

※2: M5W AC measurement type has RMS only. It does not have "R" in model name.

※3: M4Y, M5W are indicator.

■ Connections

◎ Measuring DC current

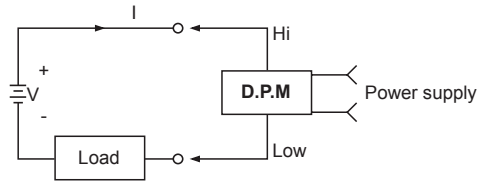

(Fig. 1) Measuring lower than DC2A of current

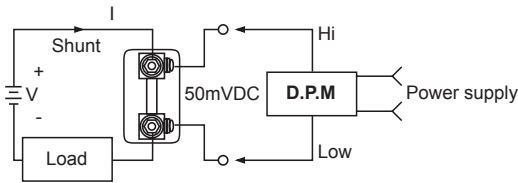

(Fig. 2) Measuring higher than DC2A of current

- ※ Higher than DC2A is using shunt for measuring current.
- ※ Basically the 2nd part of shunt value is 50mVDC.

E.g.) Ordering D.P.M in case of DC10A of measuring current:
Select DC10A/50mVDC of shunt and 50mVDC/DC10.00A of D.P.M.

◎ Measuring AC current

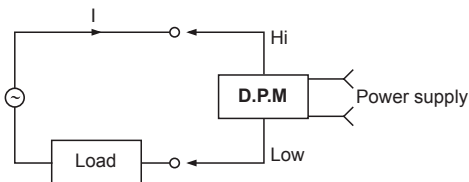

(Fig. 3) Measuring lower than AC5A of current

E.g.) Ordering D.P.M in case of lower than AC5A of measuring current: Select M4W-AA-XX AC5A/5.00A

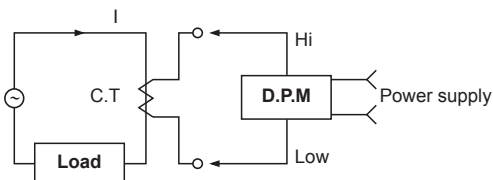

(Fig. 4) Measuring higher than AC5A of current

- ※ If the current is higher than AC5A, please use C.T.

E.g.) How to order D.P.M in case of AC300A of measuring current: Select AC300A/5A of C.T and AC5A/300A of D.P.M.

■ Proper Usage

- Please notice the product customized by requirement cannot be replaced.
- 5VDC Power supply should be insulated and limited voltage/current or Class 2, SELV power supply device.
- If it displays arbitrary number even though the power is ON, please remove the input signal and check whether it displays "000" after short the measurement terminal. (Checking auto Zero function)

If it does not display "000", please connect to our A/S center.

Note) M5W Series does not have auto zero function.

- If it indicates "1999" or "-1999" during input signal is ON, please turn OFF the power and check the connection condition.

It is because the input signal is too low or high.

Note) M5W Series indicates "19999" or "-19999".

- The specification of measurement input, which is indicated in ordering information, is a standard specification, 1:1 of measurement input and process value.

※ Please notice a shunt and C.T are not included.

- The D.P.M for measuring AC current has both AVG type and RMS type separately.

Because it is produced with AVG type, please mark the model name accurately.

E.g.) In case of M4Y, M4W, M4M Series (Include setting type)

The model of RMS type: M4W-AAR-5

The model of AVG type: M4W-AA-5

※ The specification will be set by sign "R".

※ M5W Series has RMS type only, and it is not indicated "R" on the model name.

- In case of D.P.M for measuring AC current, please check if it is AVG type or RMS type when comparison measuring with other company's products.

(A)	Photoelectric Sensors
(B)	Fiber Optic Sensors
(C)	Door/Area Sensors
(D)	Proximity Sensors
(E)	Pressure Sensors
(F)	Rotary Encoders
(G)	Connectors/ Connector Cables/ Sensor Distribution Boxes/ Sockets
(H)	Temperature Controllers
(I)	SSRs / Power Controllers
(J)	Counters
(K)	Timers
(L)	Panel Meters
(M)	Tacho / Speed / Pulse Meters
(N)	Display Units
(O)	Sensor Controllers
(P)	Switching Mode Power Supplies
(Q)	Stepper Motors & Drivers & Controllers
(R)	Graphic/ Logic Panels
(S)	Field Network Devices
(T)	Software

M4Y/M4W/M5W/M4M Series

DIN W72×H36mm, W96×H48mm, W72×H72mm

Digital Panel Meter For Displaying Power

■ Features

- Max. display: 19999 (M5W), 1999 (others)
- Display the output (0-10VDC) from transducer.
(It is available to correspond when output is DC4-20mA, 1-5VDC.)
- Auto zero function and hold function (except for M5W)
- 7-segment LED display
- Case size by DIN specification.
- Indicator, single preset output type, Dual preset output type

⚠ Please read "Caution for your safety" in operation manual before using.



■ Ordering Information

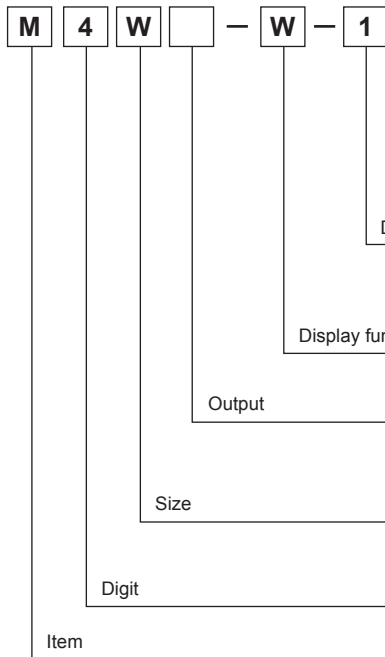

NO	M4Y / M4W / M4M	M5W
	DISPLAY (F.S.)	
1	199.9W	199.99W
2	1.999kW	1.9999kW
3	19.99kW	19.999kW
4	199.9kW	199.99kW
5	1999kW	1999.9kW
XX	Option	Option
W	Watt Meter	
No mark	Indicator	
1P	Single setting	
2P	Dual setting	
Y ^{※2}	DIN W72×H36mm	
W ^{※2}	DIN W96×H48mm	
M	DIN W72×H72mm	
4	1999 (3½-digit)	
5	19999 (4½-digit)	
M	Meter	

※If output specification of transducer or converter is DC4-20mA or 1-5VDC, please use scaling meter.

※1: When output specification of transducer is 0-10VDC, display value is maximum.

※2: M4Y, M5W are indicator.

■ Application Of Connection

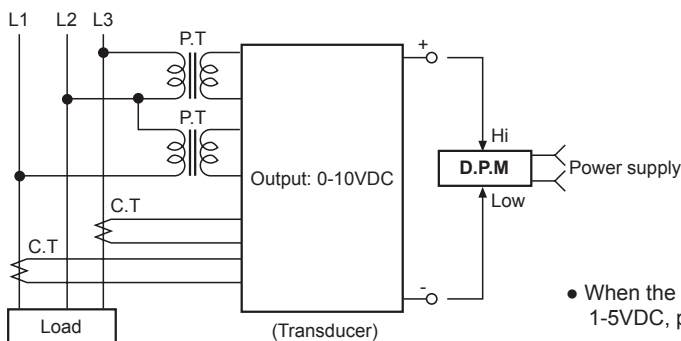

- When the output of transducer or converter is DC4-20mA or 1-5VDC, please use scaling meter.

DIN W72×H36mm, W96×H48mm, W72×H72mm

Digital Panel Meter For Measuring Revolution/Speed

■ Features

- Max. display: 19999 (M5W), 1999 (others)
- Auto zero function or hold function (except for M5W)
- Selcetable RMS/AVG value (AC voltage)
- 7-segment LED display
- Case size by DIN specification
- Indicator, single preset output type, Dual preset output type

 Please read "Caution for your safety" in operation manual before using.



■ Ordering Information

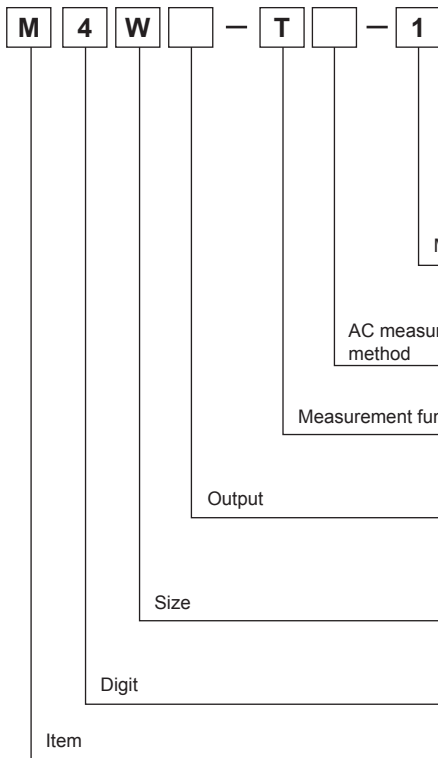

NO	M4Y / M4W / M4M	M5W
	INPUT (F.S.)	INPUT (F.S.)
1	0-10VDC / 1999	0-10VDC / 1999.9
2	0-10VAC / 1999	0-10VAC / 1999.9
DX	DC Input option	DC Input option
AX	AC Input option	AC Input option
No mark	AVG value	
R ^{※1}	RMS value	
T	Tachometer (rpm)	
S	Line Speed Meter (m/min)	
No mark	Indicator	
1P	Single setting output	
2P	Dual setting output	
Y ^{※2}	DIN W72×H36mm	
W ^{※2}	DIN W96×H48mm	
M	DIN W72×H72mm	
4	1999 (3½-digit)	
5	19999 (4½-digit)	
M	Meter	

※1: AC measuring type of M5W only applies to RMS and it is not marked with "R" in the model name.

※2: M4Y, M5W are indicator.

■ Application Of Connection

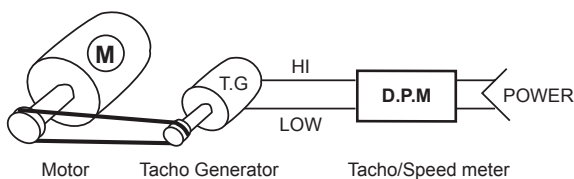

- Tacho Generator (T.G)
This generator makes a voltage in proportion to revolution speed of motor. The D.P.M receives the voltage and displays the number of revolution and please check the specification of T.G.
- The specification of measuring input indicated in ordering information, is display value when output specification is 0-10VDC and 0-10VAC. Different output specification of tacho generator is optional.

- (A) Photoelectric Sensors
- (B) Fiber Optic Sensors
- (C) Door/Area Sensors
- (D) Proximity Sensors
- (E) Pressure Sensors
- (F) Rotary Encoders
- (G) Connectors/ Connector Cables/ Sensor Distribution Boxes/ Sockets
- (H) Temperature Controllers
- (I) SSRs / Power Controllers
- (J) Counters
- (K) Timers
- (L) Panel Meters
- (M) Tacho / Speed / Pulse Meters
- (N) Display Units
- (O) Sensor Controllers
- (P) Switching Mode Power Supplies
- (Q) Stepper Motors & Drivers & Controllers
- (R) Graphic/ Logic Panels
- (S) Field Network Devices
- (T) Software

M4Y/M4W/M5W/M4M Series

DIN W72×H36mm, W96×H48mm, W72×H72mm

Digital Scaling Meter

■ Features

- Max. display: 19999 (M5W), 1999 (others)
- 7-segment LED display
- Case size by DIN specification
- Linear display function by INPUT specification
- Indicator, single preset output type, dual preset output type

 Please read "Caution for your safety" in operation manual before using.



■ Ordering Information

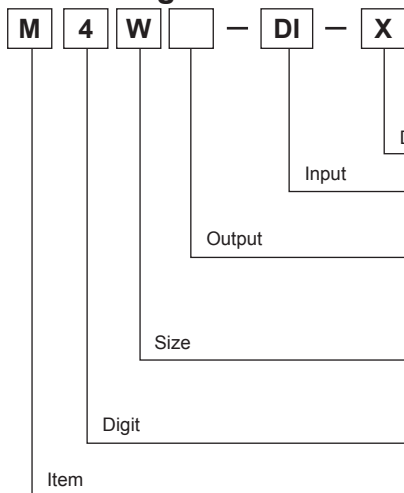

X	Display range (option)
DI	DC4-20mA (1-5VDC: option ^{*1})
No mark	Indicator
1P	Single setting
2P	Dual setting
Y ^{*2}	DIN W72×H36mm
W ^{*2}	DIN W96×H48mm
M	DIN W72×H72mm
4	1999 (3½-digit)
5	19999 (4½-digit)
M	Meter

※1: 1-5VDC of measuring input specification is available by option.

It will be a default value if there is no request for order.

※2: M4Y, M5W are indicator.

■ Application Of Connection

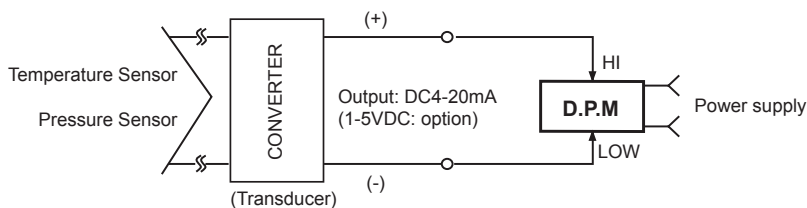

• The measurement input specification of ordering information, is an output specification of converter and DC4-20mA is the standard specification. In case, the output of converter is 1-5VDC, it is customizable.

• DC voltmeter can be produced by requirement, in case, it is out of the 1-5VDC output specification.

DIN W96×H48mm, Digital Panel Meter For Displaying Power Factor

■ Features

- Display indicator of power factor
- Input: DC4-20mA (Output specification of power factor transducer)
- Display: -0.50 to 1.00 to +0.50

⚠ Please read "Caution for your safety" in operation manual before using.

■ Ordering Information

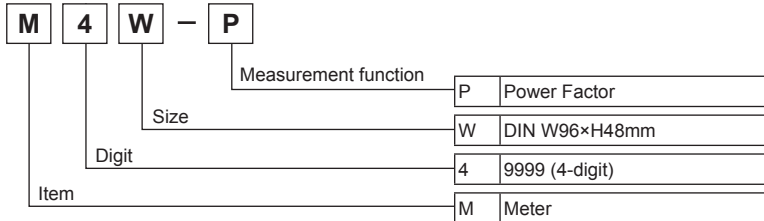

■ Specifications

Model	M4W-P	
Measurement function	Power factor	
Input	DC4-20mA	
Display	-0.50 to 1.00 to +0.50 cosφ	
Power supply	110/220VAC 50/60Hz	
Allowable voltage range	90 to 110% of rated voltage	
Power consumption	4VA	
Display method	7-segment LED display	
Character height	14mm	
Display accuracy	F.S: ±3% rdg ±1-digit	
Sampling period	300ms	
Response speed	2sec (0 to max.)	
Point display	Fixed point	
Insulation resistance	Over 100MΩ (at 500VDC megger)	
Dielectric strength	2000VAC 50/60Hz for 1 min	
Noise immunity	±1kV the square wave noise (pulse width: 1μs) by the noise simulator	
Vibration	Mechanical	0.75mm amplitude at frequency of 10 to 55Hz (for 1 min) in each X, Y, Z direction for 1 hour
	Malfunction	0.5mm amplitude at frequency of 10 to 55Hz (for 1 min) in each X, Y, Z direction for 10 min
Shock	Mechanical	300m/s ² (approx. 30G) in each X, Y, Z direction for 3 times
	Malfunction	100m/s ² (approx. 10G) in each X, Y, Z direction for 3 times
Environment	Ambient temperature	-10 to 50°C, storage: -25 to 60°C
	Ambient humidity	35 to 85%RH, storage: 35 to 85%RH
Unit weight	Approx. 317g	

※Environment resistance is rated at no freezing or condensation.

■ Dimension

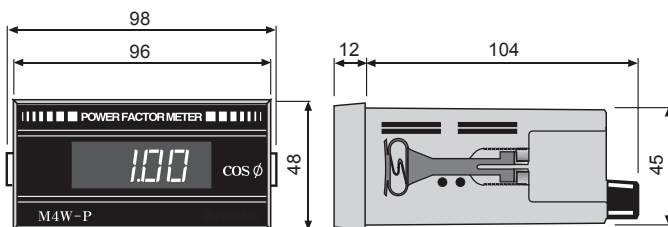

■ Connections

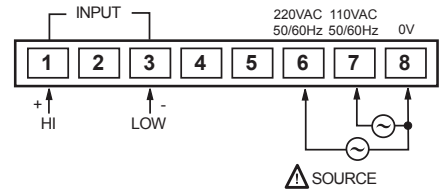

■ Application of connection

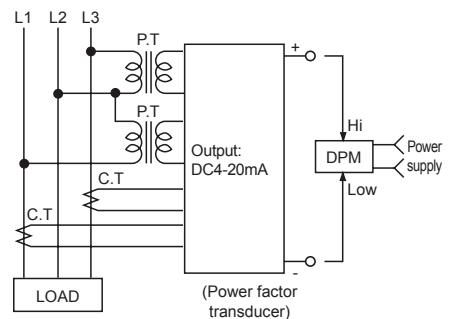

(unit: mm)

● Panel cut-out

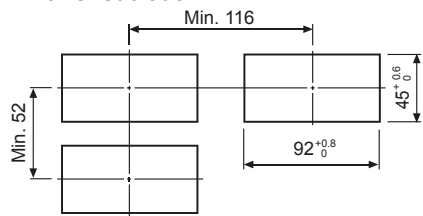

(A)	Photoelectric Sensors
(B)	Fiber Optic Sensors
(C)	Door/Area Sensors
(D)	Proximity Sensors
(E)	Pressure Sensors
(F)	Rotary Encoders
(G)	Connectors/ Connector Cables/ Sensor Distribution Boxes/ Sockets
(H)	Temperature Controllers
(I)	SSRs / Power Controllers
(J)	Counters
(K)	Timers
(L)	Panel Meters
(M)	Tacho / Speed / Pulse Meters
(N)	Display Units
(O)	Sensor Controllers
(P)	Switching Mode Power Supplies
(Q)	Stepper Motors & Drivers & Controllers
(R)	Graphic/ Logic Panels
(S)	Field Network Devices
(T)	Software