

MELSEC iQ-R Series
iQ Platform-compatible PAC



e-Factory

Bridging the next generation of automation

MELSEC iQ-R
series



evolutionary



GLOBAL IMPACT OF MITSUBISHI ELECTRIC



Through Mitsubishi Electric's vision, "Changes for the Better" are possible for a brighter future.

Changes for the Better

We bring together the best minds to create the best technologies. At Mitsubishi Electric, we understand that technology is the driving force of change in our lives. By bringing greater comfort to daily life, maximizing the efficiency of businesses and keeping things running across society, we integrate technology and innovation to bring changes for the better.

Mitsubishi Electric is involved in many areas including the following

Energy and Electric Systems

A wide range of power and electrical products from generators to large-scale displays.

Electronic Devices

A wide portfolio of cutting-edge semiconductor devices for systems and products.

Home Appliance

Dependable consumer products like air conditioners and home entertainment systems.

Information and Communication Systems

Commercial and consumer-centric equipment, products and systems.

Industrial Automation Systems

Maximizing productivity and efficiency with cutting-edge automation technology.



FA Integrated Platform
"iQ Platform" Movie

iQ Platform for maximum return on investment

Minimize TCO, Seamless integration, Maximize productivity, Transparent communications: these are common items that highlight the benefits of the iQ Platform and e-F@ctory. The iQ Platform minimizes TCO at all phases of the automation life cycle by improving development times, enhancing productivity, reducing maintenance costs, and making information more easily accessible across the plant. Together with e-F@ctory, offering various best-in-class solutions through its e-F@ctory alliance program, the capabilities of the manufacturing enterprise is enhanced even further realizing the next level for future intelligent manufacturing plants.

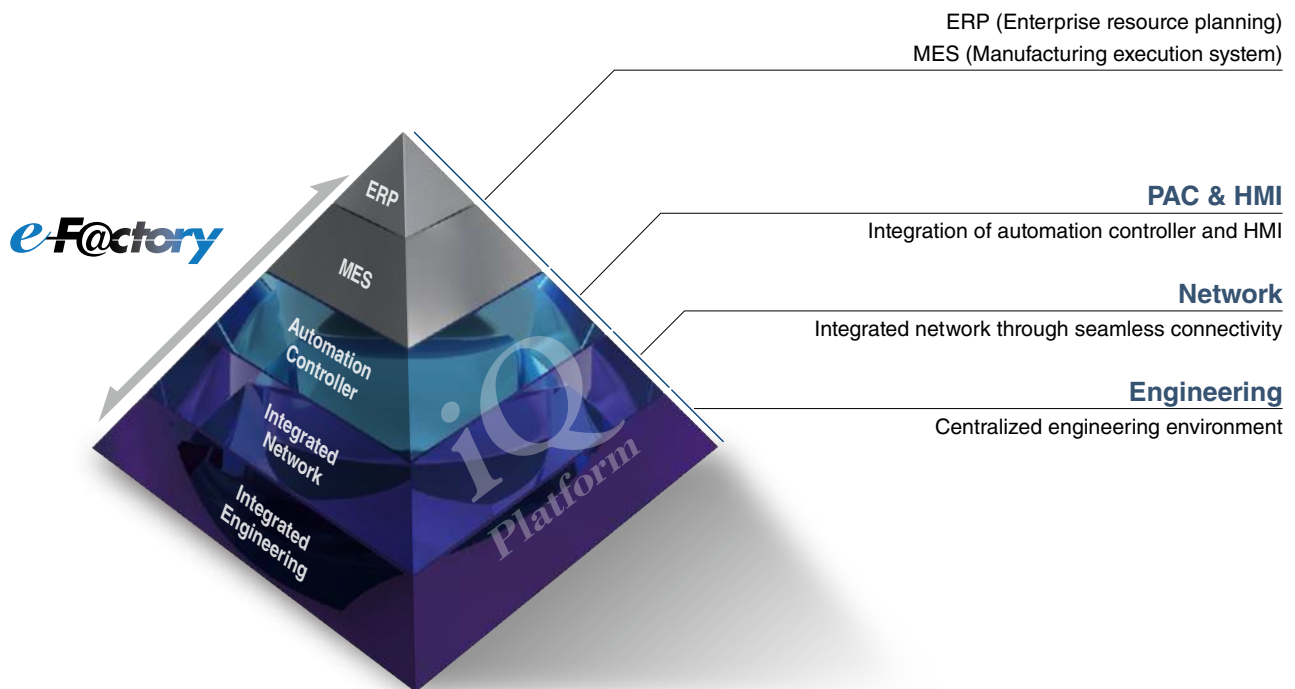

Further reduce TCO while securing your manufacturing assets

Automation Controller

Improve productivity and product quality

1. High-speed system bus realizing improved system performance
2. On-screen multi-touch control enabling smooth GOT (HMI) operations

Integrated Network

Best-in-class integrated network optimizing production capabilities

1. CC-Link IE supporting 1 Gbps high-speed communication
2. Seamless connectivity within all levels of manufacturing with SLMP

Centralized Engineering

Integrated engineering environment with system level features

1. Automatic generation of system configuration
2. Share parameters across multiple engineering software via MELSOFT Navigator
3. Changes to system labels are reflected between PAC and HMI



Revolutionary, next-generation controllers building a new era in automation

MELSEC iQ-R series

As the core for next-generation automation environment, realizing an automation controller with added value while reducing TCO*

To succeed in highly competitive markets, it's important to build automation systems that ensure high productivity and consistent product quality. The MELSEC iQ-R Series has been developed from the ground up based on common problems faced by customers and rationalizing them into seven key areas: Productivity, Engineering, Maintenance, Quality, Connectivity, Security and Compatibility. Mitsubishi Electric is taking a three-point approach to solving these problems: **Reducing TCO***, increasing **Reliability** and **Reusability** of existing assets.

As a bridge to the next generation in automation, the MELSEC iQ-R Series is a driving force behind **revolutionary** progress in the future of manufacturing.

*TCO: Total cost of ownership

Process

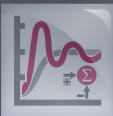

High availability process control in a scalable automation solution

- Extensive visualization and data acquisition
- High availability across multiple levels
- Integrated process control software simplifies engineering

Safety



System design flexibility with integrated safety control

- Integrated generic and safety control
- Consolidated network topology
- Complies with international safety standards

Productivity



Improve productivity through advanced performance/ functionality

- New high-speed system bus realizing shorter production cycle
- Super-high-accuracy motion control utilizing advanced multiple CPU features
- Inter-modular synchronization resulting in increased processing accuracy

Maintenance



Reduce maintenance costs and downtime utilizing easier maintenance features

- Visualize entire plant data in real-time
- Extensive preventative maintenance functions embedded into modules

Engineering

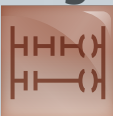

Reducing development costs through intuitive engineering

- Intuitive engineering environment covering the product development cycle
- Simple point-and-click programming architecture
- Understanding globalization by multiple language support

Quality



Reliable and trusted MELSEC product quality

- Robust design ideal for harsh industrial environments
- Improve and maintain actual manufacturing quality
- Conforms to main international standards



Mitsubishi Electric PAC MELSEC iQ-R
"Promotion" Movie



Intelligence



Extensive data handling from shop floor to business process systems

- Direct data collection and analysis
- C/C++ based programming
- Collect factory data in real-time
- Expand features using third party partner applications

Connectivity

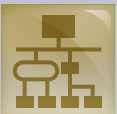

Seamless network reduces system costs

- Seamless connectivity within all levels of manufacturing
- High-speed and large data bandwidth ideal for large-scale control systems
- Easy connection of third-party components utilizing device library

Compatibility



Extensive compatibility with existing products

- Utilize existing assets while taking advantage of cutting-edge technology
- Compatible with most existing MELSEC-Q Series I/O

Security



Robust security that can be relied on

- Protect intellectual property
- Unauthorized access protection across distributed control network



Mitsubishi Electric FA Global website
MELSEC iQ-R Series concept

MELSEC iQ-R

Search

www.mitsubishielectric.com/fa/products/cnt/plcr/pmerit/concept/index.htm

The viewable page may vary depending on web browser and/or device (smartphone or tablet) used.



Mitsubishi Electric PAC MELSEC iQ-R
"Process" Movie



Process

High-available process control in a scalable automation solution

MELSEC iQ-R Series process CPU modules are designed to cover wide-ranging process control applications, from small- to large-scale. All models provide high-speed performance coupled with the ability to handle large PID loops utilizing embedded PID control algorithms; integrating both general and process control into one module. When paired with a redundant function MELSEC module, a redundant control system ideal for applications that require highly reliable control can be easily realized at a low cost.

Redundant power supply module

- Protects system control from power failure

Remote station

Redundant remote network head module

- Enables continuous data communications by switching control between modules

Remote station 1

Remote station 2

CC-Link IE Field

High availability system

- Highly scalable
- Fast system switching
- Dual tracking cable
- Minimize single-point failure
- High-temperature environments (0 to 60°C)

Control system

Standby system
Tracking cable

CC-Link IE Control

Ethernet

SCADA

Redundant Ethernet

- Redundant communication line
- Same IP address settable for both control and standby systems

MC Works⁶⁴



Extensive visualization and data acquisition

SCADA

Mitsubishi SCADA MC Works64*1 is a next generation supervisory control and data acquisition (SCADA) software providing extensive visualization with its enhanced interconnectivity with the MELSEC iQ-R Series. Advanced features such as energy management, scheduling, alarm and event management, trending, reporting, historian, and Geo-SCADA monitoring realize intuitive factory-wide control.

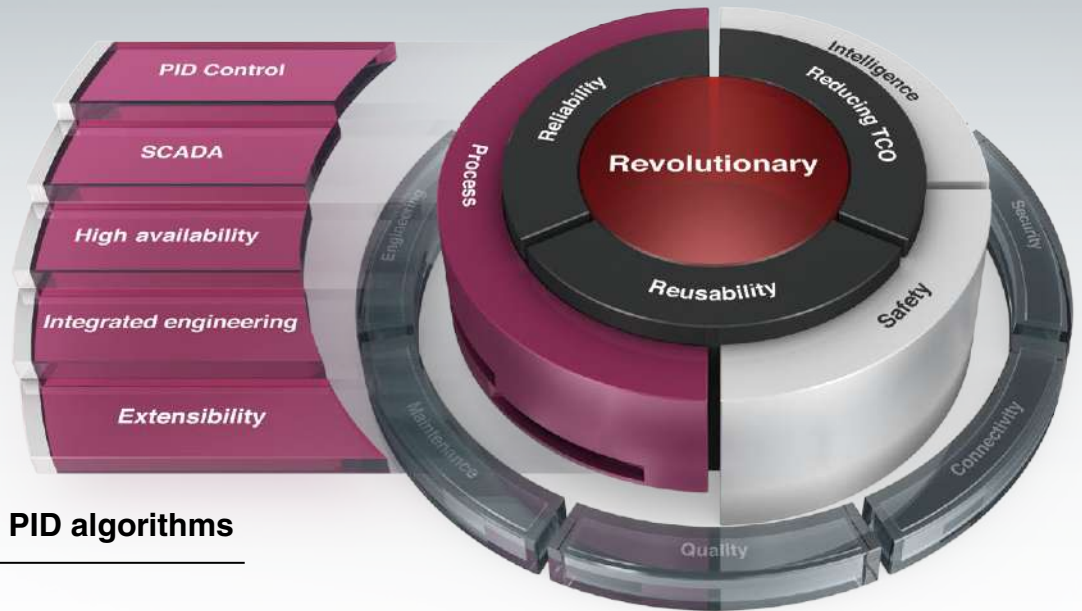

Embedded PID algorithms

PID control

The process CPU includes dedicated algorithms such as two-degree-of-freedom PID, sample PI, and auto-tuning support advanced process control.

Extension base unit

- Supports Q Series modules (RQ extension base)



Extension cable

Process control system

Process CPU

- Register up to 480 tags (execute up to 300 PID loops)
- Fast process program execution cycle (50 ms)



- I/O module supports disconnection detection
- Multi-channel analog module

CPU-embedded ECC memory

- Reliability improved by detection/correction of data corruption (within 1 bit)



Multi-level redundancy ensuring continuous control

High availability

Highly reliable control systems can be easily realized minimizing the possibility of single-point failure at the visualization (SCADA), control, and network levels, thereby avoiding system downtime and ensuring continuous control and operation of critical systems.

GX Works3

One Software, Many Possibilities



One package process control software

Integrated engineering

GX Works3, the standard integrated engineering software for the MELSEC iQ-R Series, makes programming redundant process control systems relatively easy. The program editor uses function block diagram (FBD) language for process control and simplifies system configuration with its intuitive features such as process tag label (variables) sharing, simple program structure, and easy project upload/download to the process CPU.

*1: Redundant Ethernet connection for MX OPC server will be supported in the future.



Mitsubishi Electric PAC MELSEC iQ-R
"Safety" Movie



Safety

Integrated safety control offering a total system solution

Ensuring the safety of personnel on the factory floor is a fundamental requirement of manufacturing plants and requires stringent safety regulations. To adhere to this safety code for control systems, the MELSEC iQ-R Series is equipped with a safety CPU that is compliant with international safety standards, enabling safety devices to be connected via the CC-Link IE Field network. The entire system can be programmed using GX Works3 programming software as standard.

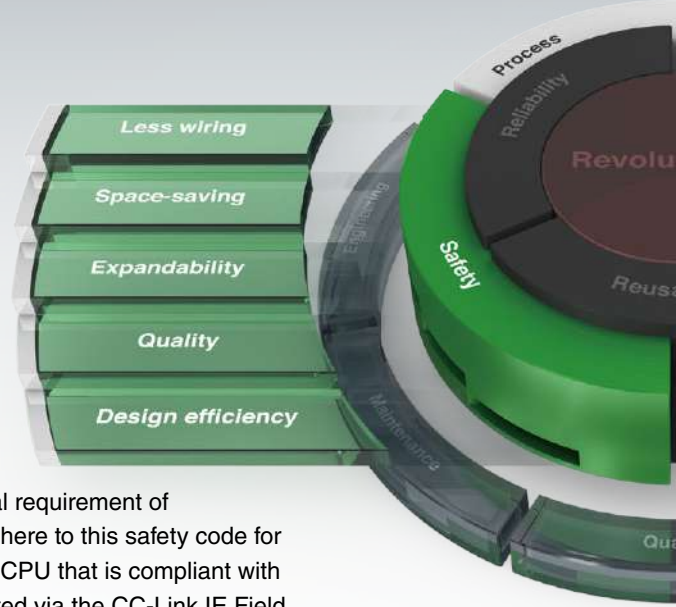

Safety CPU

CC-Link IE

CC-Link IE

Ethernet

Safety remote I/O

Generic remote I/O



Compliant with international safety standards
Quality

The Safety CPU is compliant with ISO 13849-1 PL e and IEC 61508 SIL 3 and is certified by TÜV Rheinland®.



Generic and safety control in one CPU
Space-saving

Safety CPU can be installed directly on the MELSEC iQ-R base rack realizing easy integration into an existing or new control system. Also, compact remote I/Os are available ideal for systems with limited space.

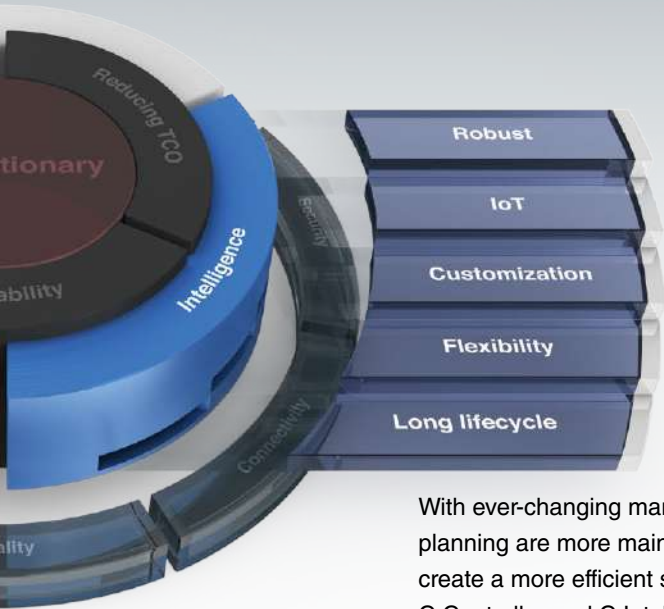

Mitsubishi Electric PAC MELSEC iQ-R "Intelligence" Movie



Intelligence

Extensive data handling from shop floor to business process systems

With ever-changing manufacturing trends, production data management, analysis, and planning are more mainstream helping to realize leaner operations, improve yield, and create a more efficient supply chain. The MELSEC iQ-R Series includes the MES Interface, C Controller and C Intelligent function, and High-speed data logger modules as part of the "Intelligence" lineup of interconnected advanced information products.

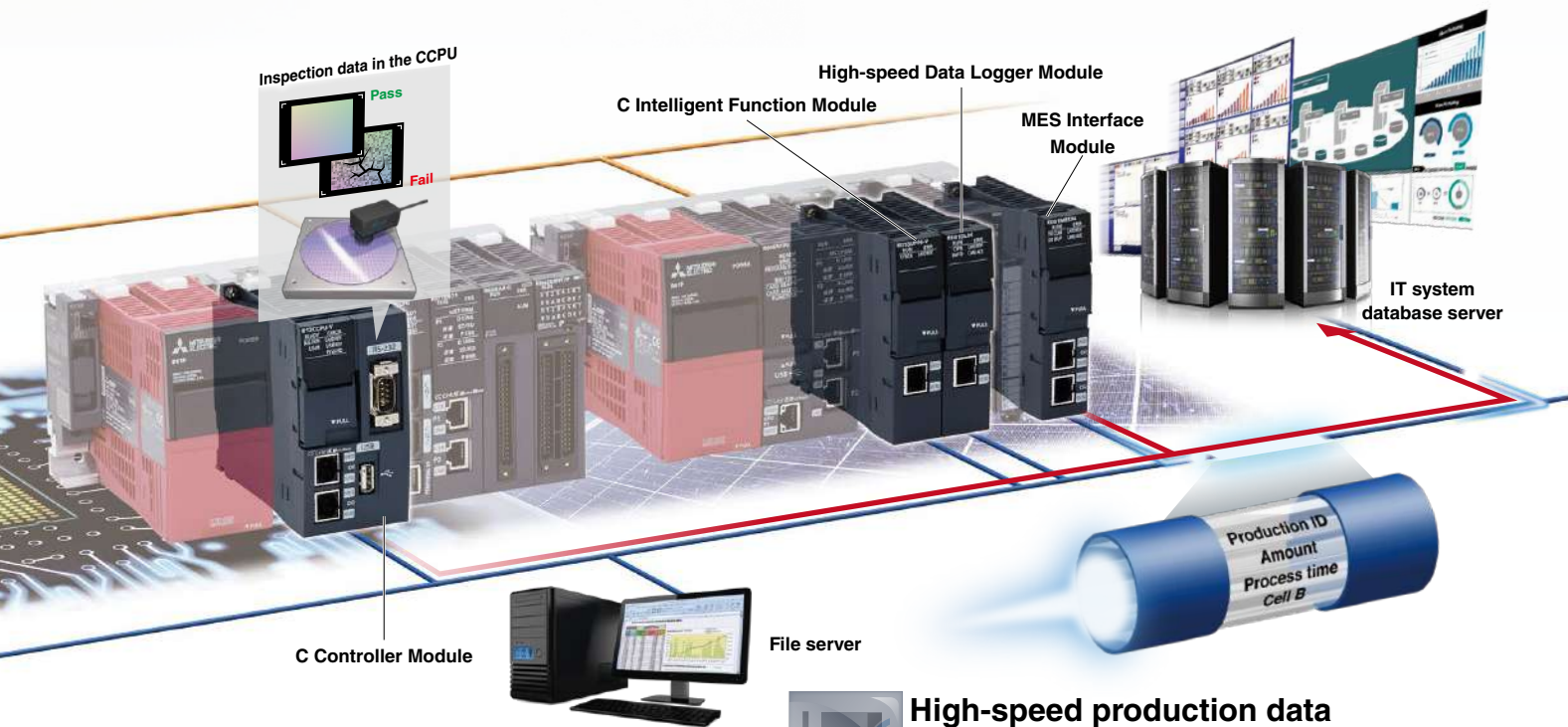

C/C++ based programming

Flexibility

Based on the ARM® dual-core Cortex A9 processor, the real-time OS VxWorks® C Controller CPU is ideal for high-end analytical requirements where raw data has to be processed, such as for in-line manufacturing quality testing. The C Intelligent Function Module, based on the same processor, is a versatile programmable module that can be used for installing industry-specific communications protocols; for example, plant-wide monitoring of wind power generation farms, building automation and industrial open fieldbus networks.



High-speed production data collection

Data logging

Enables high-speed data logging that can be synchronized with the controller scan time, as an alternative to a dedicated logging client computer. Includes features such as triggering and reporting that improve troubleshooting of the manufacturing process.



Direct access to IT system database servers

Information connection

Improve production management and recipe data handling via real-time direct access to IT system database servers such as Oracle® and Microsoft® (SQL Server®, Access®). Overall system cost is also reduced as additional programming, which can increase engineering time, and gateway computers are no longer required.



Productivity

Improve productivity through advanced performance/functionality

Integrating high-performance capabilities based on the high-end iQ-R system bus, high-speed network, and an advanced motion control system; applications requiring these characteristics can be easily realized using the MELSEC iQ-R Series as the core of the automation system.

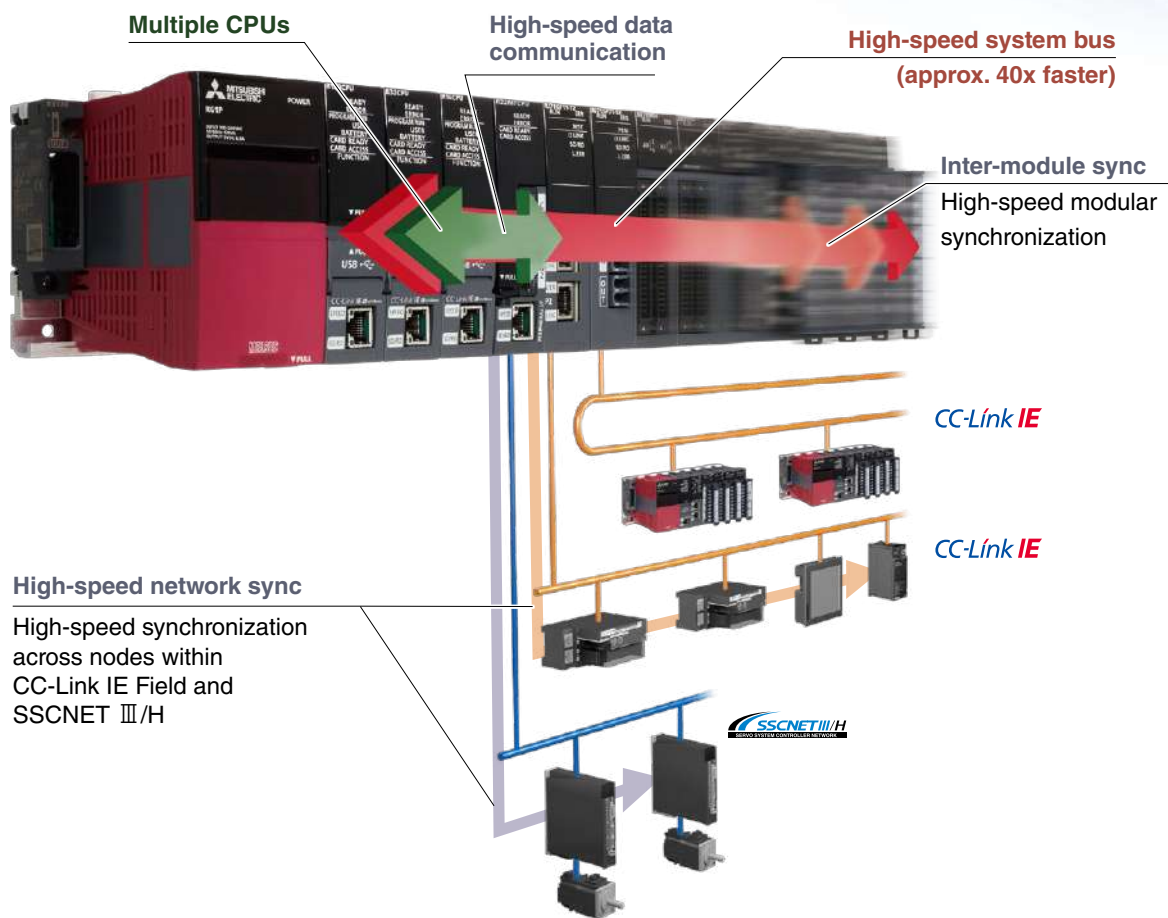

New high-speed system bus realizes improved production cycle

The newly developed high-speed system bus is 40-times faster compared to existing models, realizing very fast and large-capacity data processing between modules (network, I/O, multi-CPU, etc.), enabling the optimum utilization of MELSEC iQ-R Series performance and functionality.

High-speed system bus
40x faster*

Multi-CPU system realizes very accurate motion control

By supporting synchronized data communications between the programmable controller CPU and motion CPU via the high-speed system bus, performance is improved by up to four times compared to existing models, easily realizing super-high motion control accuracy.

Synchronized data exchange with motion CPU
4x faster*2

*1: Compared to MELSEC-Q Series.

*2: Compared to Q173DSCPU/Q172DSCPU.



Mitsubishi Electric PAC MELSEC iQ-R "Productivity" Movie

Inter-modular synchronization realizes increased processing accuracy

More flexible control over performance

Realizing high processing accuracy could not be any simpler when utilizing the inter-modular synchronization feature, which enables precise data synchronization between controller CPUs and various interface modules via the high-speed system bus (backplane). In addition, network level synchronization

(both CC-Link IE Field and SSCNET Ⅲ/H) is now possible, realizing deterministic performance by ensuring synchronization between nodes without being influenced by varying network transmission delays.

New controller performance architecture further reduces H/W costs

High-speed processing of structured programs

The processing performance of the controller CPU has been substantially enhanced thanks to the newly designed CPU engine. The memory consumption for program and internal devices used in function block (FB) and structured text (ST) programs have been improved. This results in one CPU being able to do the job that used to require several CPUs in order to achieve the expected performance level and memory capacity.

Built-in database eliminates the need for a PC-based database server

Recipe data and production results data, previously managed using a database server, can now be managed via the database in the programmable controller. Use of dedicated commands for the built-in database makes it easy to search, add and update data on the fly. Furthermore, the import/export correlation with spreadsheet software is made easier. Directly access CPU internal database data from a computer equipped with Microsoft® Access® or Excel® is also supported.

Realize high-speed system performance

Approx. **8X** faster than QCPU*3



- Realizes high-speed control performance
- Inherits MELSEC-Q Series functions
- Large-capacity memory ideal for large-scale control



Data management realized with built-in database

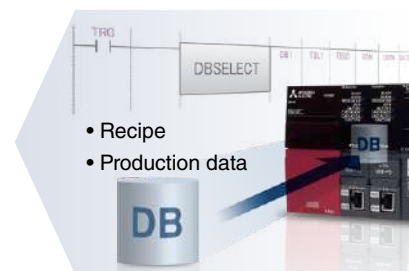

- Recipe
- Production data
- Easy to switch between recipes
- Realize product batch control
- Access database from computer

LD instruction speed	PC MIX**4 (instructions/μs)	Fixed-cycle interrupt program	ST instruction (IF text, bit condition)	Program capacity
0.98 ns	419	50 μs	8 ns	1200K steps

*3: Based on a typical application example, the system benchmark test measures the CPU scan time, taking into consideration the network refresh time and monitoring processing time with external devices as compared to Universal model QCPU (QnUDEHCPU).

*4: Average number of instructions such as for basic instructions and data processing executed in 1μs (the larger the value, the faster the processing speed).



Engineering

Reducing development costs through intuitive engineering

The engineering software is sometimes considered a fundamental part of the control system in addition to the hardware components. The core of the system, it includes various steps of the product life cycle, from the design stage all the way to commissioning and maintenance of the control system. Today, intuitive, easy-to-use software suites are expected as a standard for modern manufacturing needs. GX Works3 is the latest generation of programming and maintenance software offered by Mitsubishi Electric specifically designed for the MELSEC iQ-R Series control system. It includes many new features and technologies to ensure a trouble-free engineering environment solution.

Intuitive engineering software covering the product development cycle

Graphic-based configuration realizing easier programming

Various intuitive features such as graphic-based system configuration and an extensive module library (module label/FB) provided as standard.

Integrated motion-control system configuration

From setting simple motion module parameters and positioning data setup to servo amplifier configuration, everything is packaged into an easy-to-use engineering environment.

Conforms to IEC 61131-3

GX Works3 realizes structured programming such as ladder and ST, making project standardization across multiple users even easier.

Simple point and click programming architecture

System design / Programming / Debug/maintenance

Straightforward graphic based system configuration design

- Simply drag and drop from the module list to easily create system configuration
- Directly setup parameters for each module
- Automatically reflect changes in the layout to the module parameters

System design / Programming / Debug/maintenance

MELSOFT library enables efficient programming through "Module Label/FB"

- Assign convenient label names to internal devices, rather than manually entering a device name every time
- Simply drag & drop module FBs from the MELSOFT Library directly into the ladder program, making programming even easier

System design / Programming / Debug/maintenance

Extensive version control features

- Flexibly register program change (historical) save points
- Easily visualize and confirm program changes

Simple motion setting tool

Easily configure the simple motion module with this convenient integrated tool.

Tab view multiple editors

Conveniently work on multiple editors without having to switch between software screens.

Navigation window

Easily access project components
Organize program file list.

Module configuration

Easily parameterize each module directly from the configuration editor.

Module list

Simply drag & drop modules directly into the module configuration.



Mitsubishi Electric PAC MELSEC iQ-R
"Engineering" Movie

GX Works3

One Software, Many Possibilities

Reduce engineering time by 60%*1

Global realization by multi-language support

To adhere to today's global production needs, GX Works3 supports multi-language features at various levels, from the multiple language software menu system to device comment language switching features.

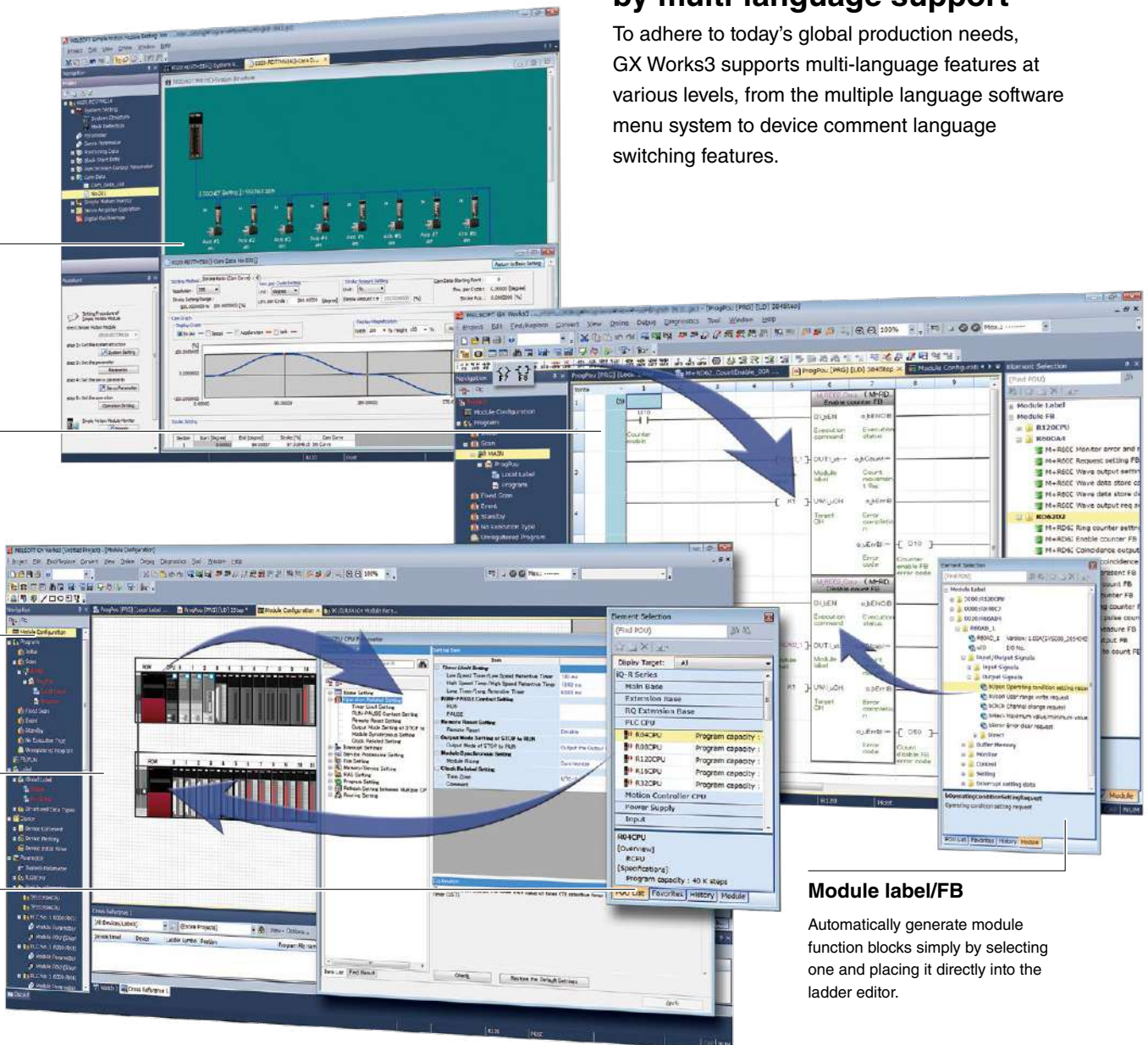

Module label/FB

Automatically generate module function blocks simply by selecting one and placing it directly into the ladder editor.

*1 Based on new project test benchmarks between GX Works2 and GX Works3.



Maintenance

Reduce maintenance costs and downtime utilizing easier maintenance features

A manufacturing plant is seldom stopped or taken offline and continuously produces the desired product or component. However, the control system occasionally requires maintenance; for example, at the time of a faulty product or system upgrade for manufacturing a new or updated component. At that time, thanks to the extensive maintenance functions embedded in the hardware and software, the user can trust the control system to handle transition into/out of the maintenance period for both preventive and post maintenance.



Preventive maintenance

CPU module

Visualize manufacturing data in real-time

- Monitor live manufacturing process data across the plant
- Very easy setup using the dedicated GX LogViewer monitoring tool

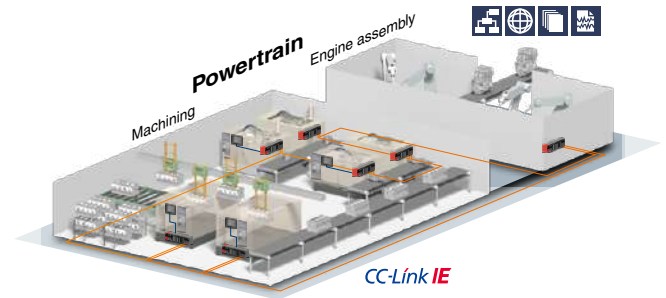
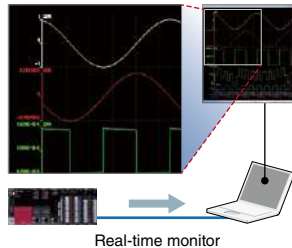

Preventive maintenance

Output module

Prevent system downtime with relay monitoring

- Monitors relay switching amount
- Check relay condition from GOT (HMI)
- Plan module maintenance prior to malfunction of relay



Preventive maintenance

MES interface module

Direct access to enterprise level

- Registers device values directly into database
- Visible shop floor data enables actions before event occurs

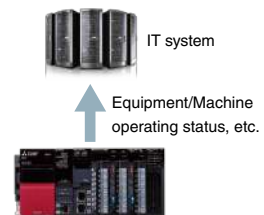

Corrective maintenance

CPU module

Web server enables monitoring of module status on a web browser

- Monitor various module status data:
 - CPU diagnostics
 - Device block monitor/watch
 - Event history
- Supports custom made web pages

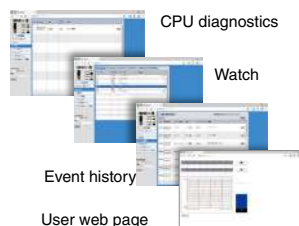

Corrective maintenance

CPU module

Memory dump enables confirmation of operation problems

- Saves block of device data when error occurs
- Root cause analysis by confirming data on device monitor screen and offline via program editing window

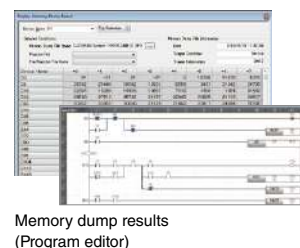



Mitsubishi Electric PAC MELSEC iQ-R "Maintenance" Movie

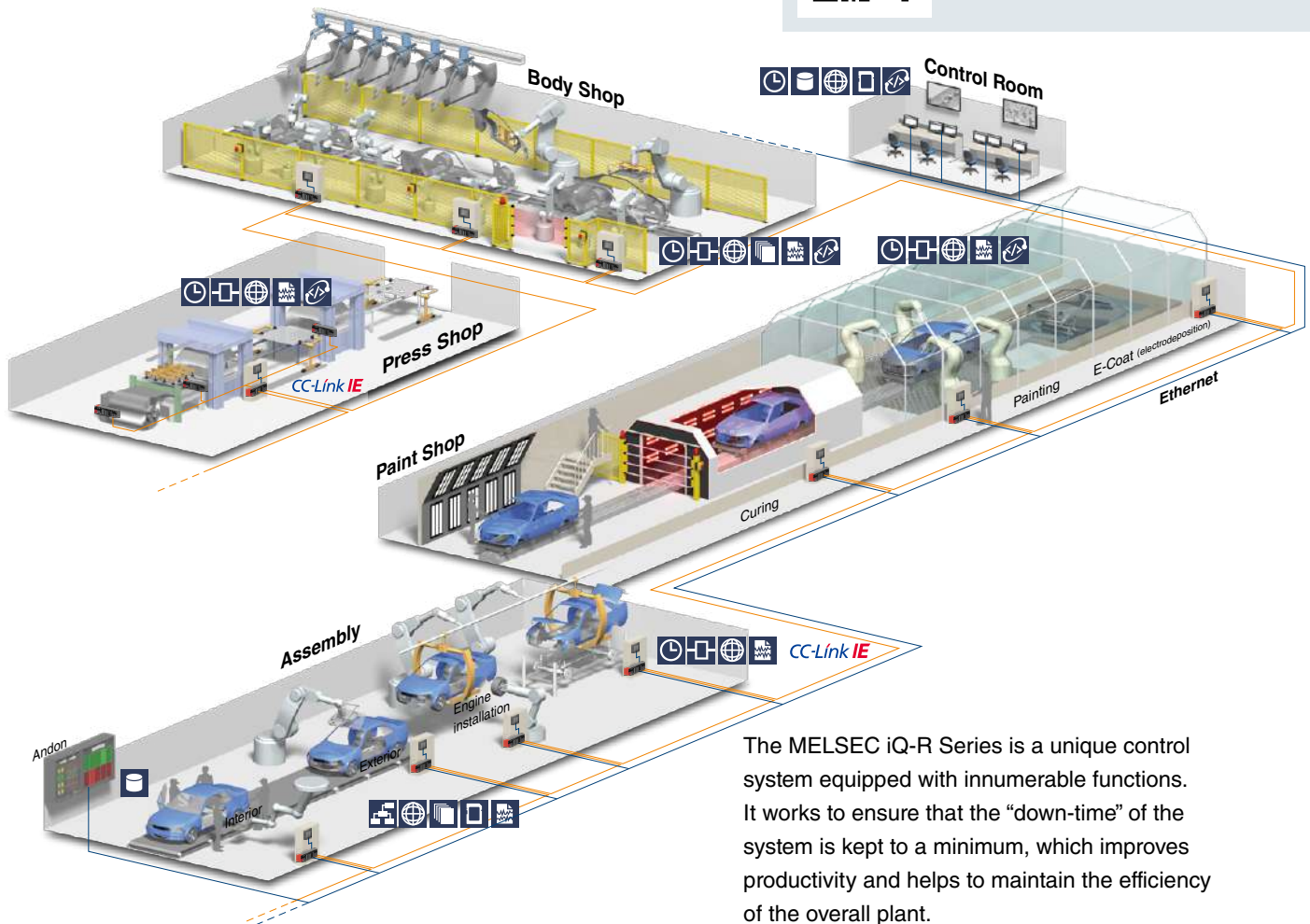

The MELSEC iQ-R Series is a unique control system equipped with innumerable functions. It works to ensure that the "down-time" of the system is kept to a minimum, which improves productivity and helps to maintain the efficiency of the overall plant.

Corrective maintenance CPU module

Efficient diagnostics with extensive event logging

- Logging of program change events, errors and when the power is turned off
- Event logging displayed in list form
- Quickly detect problems due to operating mistakes by multiple users

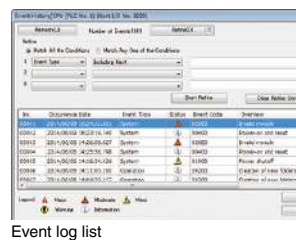

Event log list

Corrective maintenance GX Works3

Multi-language software improves global support

- Comment/label names can be registered in multiple languages
- Easy to switch between languages
- No need for multiple programs to satisfy regional requirements

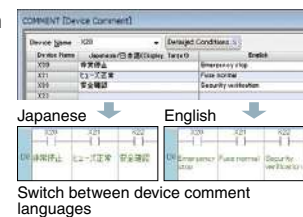

Switch between device comment languages

Corrective maintenance GX Works3

Quickly find network errors

- Visualize error location from network system image
- Easy network error corrective measures

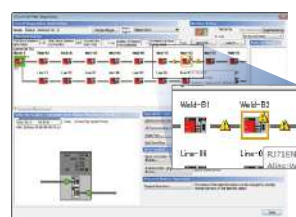

CC-Link IE Field diagnosis window

Corrective maintenance GX Works3

Simple troubleshooting, even for novice users

- Start diagnostics screen on GX Works3 just by connecting via USB
- Display detailed error information and corrective procedures



Automatically start diagnostics



Quality

Reliable and trusted MELSEC iQ-R product quality

The MELSEC iQ-R Series is based on two fundamental aspects of quality.

“Quality of product”

“Quality for application”

These two characteristics are part of the main principle behind the MELSEC iQ-R Series. This new control system includes various features designed-in to provide a solution that not only improves the overall manufacturing productivity, but also maintains a high level of industrial quality that is ideal for the harsh and rugged environments that it is subjected to on a daily basis.



Electromagnetic compatibility (EMC) testing room (simulated test)



Robust design ideal for harsh industrial environments

Synonymous with the Mitsubishi Electric name, the MELSEC iQ-R Series is designed with high quality and reliability, which is a prerequisite for industrial applications. In addition, the overall aesthetics and usability enable easier maintenance that customers routinely expect.

Classification according to IEC 60721-3-3 Class 3C2

For protection against aggressive atmosphere and gases, products with a conformal coating (IEC 60721-3-3 Class 3C2) are available on request*1

*1: Please contact your local Mitsubishi Electric office or representative for further details.

1. Conforms to stringent quality evaluations and tests that are based on robust industrial environments including EMC, LSI, temperature, vibration and HALT tests.
2. High manufacturing quality control through QR code based quality management system.
3. The front face has a wide and open design with an easy-to-use front cover.
4. High-quality CPU module manufacturing with in-line high-low temperature testing.
5. The base rack design includes a dedicated earth rail to prevent noise interference in low power supply conditions and a robust structure that enables easy installation without extensive damage to bus connectors.



Mitsubishi Electric PAC MELSEC iQ-R "Quality" Movie

Conforms to main international quality standards

The MELSEC iQ-R Series conforms to most of the main international standards that realizes applications requiring multiple global locations.

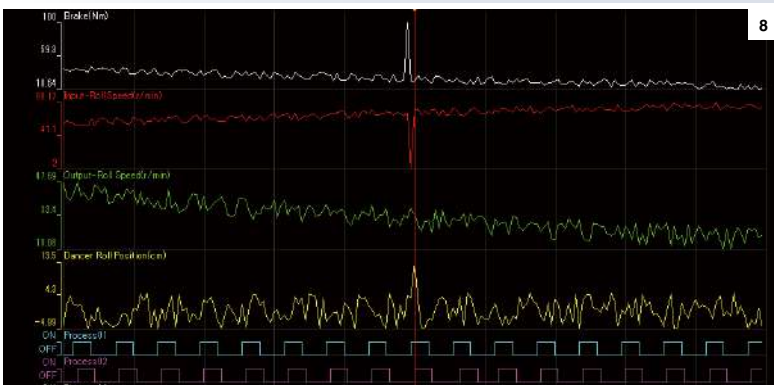
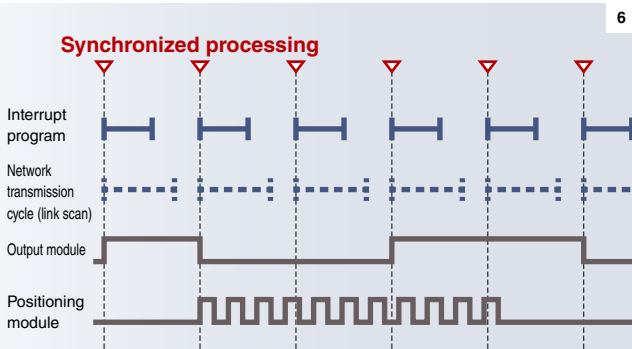

Improve and maintain actual manufacturing quality

Maintains product quality during manufacturing

With inter-module synchronization, it is now possible to precisely synchronize interrupt programs with the network communications cycle (link scan). Any variations in data transmission response time (network transmission delay time) between the controller and other devices on the network are eliminated, realizing high integrity between manufacturing processes that are dependent on each other, ensuring high performance and processing.

Realizes traceability through data logging

Simple settings enable the collection of production data needed for traceability. Furthermore, collected data can be analyzed easily using a dedicated viewer. Analyzing various data on production processes provides an indicator for quality improvements and manufacturing cost reductions, thereby supporting optimization of the production system.

6. Graph showing the signal synchronization between several modules.
7. Data required for traceability is collected on the SD memory card.
8. Collected data is analyzed using a dedicated viewer.



Connectivity

Seamless network reduces system costs

The MELSEC iQ-R Series is part of a family of products all interconnected across various levels of automation. Based on the seamless message protocol (SLMP*), data flows transparently between the sensor level and the management level across multiple industry-standard automation networks. CC-Link IE, Asia's No. 1 industrial network, realizes fast gigabit data transmission speeds, further optimizing the manufacturing cycle. In addition, the SSCNET III/H high-speed motion control network further enhance the factory-wide connectivity solution.



CC-Link IE embedded CPU



CC-Link IE Field Network compatible Simple Motion module

Cost-saving integrated network CPU module

The MELSEC iQ-R Series includes a lineup of CPUs with embedded industrial network connection ports (CC-Link IE and Ethernet). System costs can be further reduced by approximately 50% using the embedded network CPU module, which realizes the same features as a generic network interface module.

System hardware costs
Reduced 50%^{*2}

Integrate motion control into one network

The CC-Link IE Field Network compatible Simple Motion module can be used as a master station**3 on the network. System configuration cost can be reduced as only one module is required for both Motion control and network connectivity.

*1: Seamless Message Protocol (SLMP): A simple client-server common protocol that enables communication between Ethernet products and CC-Link IE-compatible machines.

*2: Cost comparison of using the MELSEC iQ-R Series R04CPU + RJ71EN71 modules.

*3: The sub-master and safety communication functions are not supported.



Mitsubishi Electric PAC MELSEC iQ-R
"Connectivity" Movie

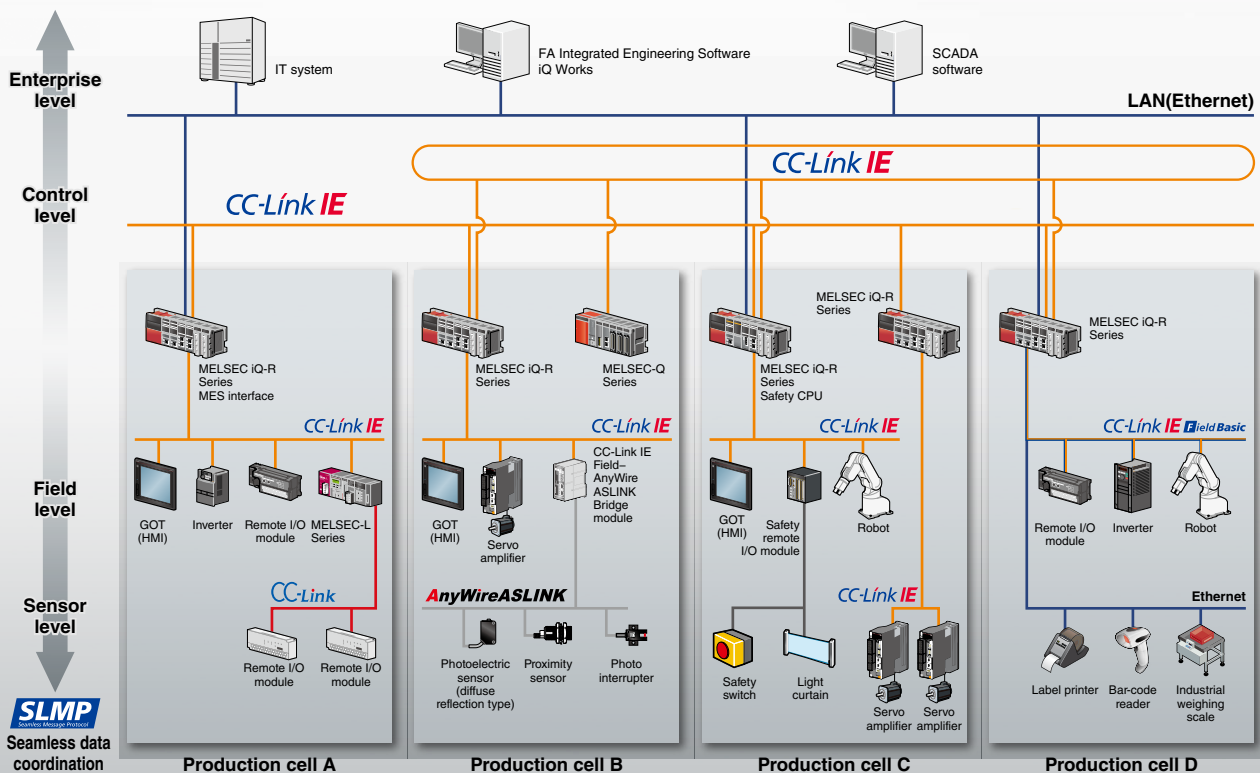

High-speed and large bandwidth ideal for large-scale control systems

The Ethernet-based open network CC-Link IE is an industry-leading 1 Gbps high-speed, large-capacity network. The division of 1 Gbps broadband into uses for distributed control and field data communications secures the reliability of control communications and realizes real-time data collection, which can be difficult with standard Ethernet.

Supporting Ethernet protocol stack realizing highly-flexible system

CC-Link IE Field Network Basic protocol is software-based (not requiring ASIC), operating on standard Ethernet protocol stack, which can be used together with TCP/IP communications. This allows CC-Link IE Field Network Basic compatible products and Ethernet compatible products to be connected on the same Ethernet communications line, enabling a highly-flexible and low cost system. MELSEC programmable controller CPUs with an embedded Ethernet port can be used as a master station, eliminating the need for an additional network module.



Security

Robust security that can be relied on

As technology becomes more complex and the distribution of manufacturing systems more global, the protection of intellectual property is even more significant. When shipping a finished product overseas, the last thing an OEM needs to consider is unauthorized copying or changing of the original project data. In addition to this, unauthorized access to the control system can have very serious implications to the control system and the end user, which can compromise the overall safety of the plant.

The MELSEC iQ-R Series has a number of embedded features that help to maintain these requirements, such as hardware and software keys to protect intellectual property, and multi-level user access password hierarchy to protect the project at the design stage.



Mitsubishi Electric PAC MELSEC iQ-R "Security" Movie

Powerful security features protecting intellectual property

Security key authentication protecting project data

The security key authentication prevents programs from being opened on personal computers where the security key has not been registered. Furthermore, because programs cannot be executed by CPU modules where the security key has not been registered, the integrity of customer technologies and other intellectual property is not compromised. The security key can also be registered on an extended SRAM cassette. Therefore, when replacing the CPU module, there is no need to re-register the security key, making replacement very simple.



Extended SRAM cassette with registered security key

Prevent unauthorized access across the network

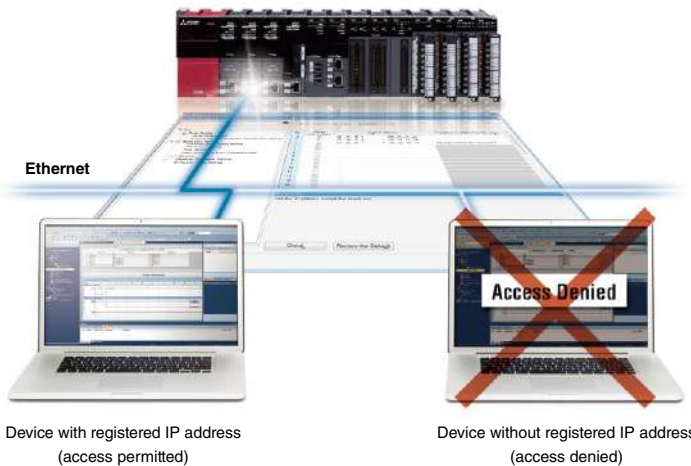

The IP filter can be used to register the IP addresses of devices permitted to access the CPU module. As a result, access from non-registered devices can be blocked, thereby lowering the risk of program hacking and unauthorized access by a third party. Another feature is a remote password function for password-based security. Passwords of up to 32 characters can be set to prevent unauthorized access to the CPU module via networks such as Ethernet.



Compatibility

Extensive compatibility with existing products

Whenever introducing a new system or technology into an existing manufacturing plant or control system, utilization of existing assets as much as feasibly possible is a mandatory requirement with today's manufacturing needs. The MELSEC iQ-R Series addresses these subtle but substantial needs with various system hardware support and engineering project compatibility to achieve an easy path to higher technology and improved performance capabilities.



Mitsubishi Electric PAC MELSEC iQ-R "Compatibility" Movie



Utilize existing MELSEC-Q Series assets

Current programs can be fully utilized

A simple conversion process*1 is all it takes to enable the use of MELSEC-Q Series programs with the MELSEC iQ-R Series. Customers can effectively use the program assets they have accumulated, thereby reducing the overall engineering time.

*1: For detailed information about converting to GX Works3 programs, please refer to the "GX Works3 Operating Manual".



MELSEC Q series



MELSEC iQ-R series



Variety of compatible modules

By utilizing the dedicated extension base, most MELSEC-Q Series modules*2 can be re-used. This makes it possible to introduce the high-performance MELSEC iQ-R Series while controlling the cost of supplementary equipment.

*2: For further details, please refer to the "MELSEC iQ-R Module Configuration Manual".

Possible to divert external device wiring

The MELSEC iQ-R Series I/O module, analog module, and counter module pin layouts and connectors are the same as those of the MELSEC-Q Series. Accordingly, existing external device wiring (connectors, terminal blocks) can be diverted without changes and wiring costs can be reduced.



Lineup

Power supply P.24

R61P	AC input
R62P	AC input (inc. 24 V DC output)
R64P	AC input (large capacity)
R63P	DC input
R63RP	DC input (Redundant)
R64RP	AC input (Redundant)

Base P.24

Main base	
R35B	5-slot
R38B	8-slot
R310RB	10-slot (Redundant)
R312B	12-slot
Extended temperature range main base	
R310B-HT	10-slot
R38RB-HT	8-slot (Redundant)
Extension base	
R65B	5-slot
R68B	8-slot
R610RB	10-slot (Redundant)
R612B	12-slot
Extended temperature range extension base	
R610B-HT	10-slot
R68RB-HT	8-slot (Redundant)
RQ extension base (MELSEC-Q Series)	
RQ65B	5-slot
RQ68B	8-slot
RQ612B	12-slot
Extension cable	
RC06B	0.6 m
RC12B	1.2 m
RC30B	3 m
RC50B	5 m
RC100B	10 m

CPU P.27

Programmable controller CPU	
R00CPU	10K steps
R01CPU	15K steps
R02CPU	20K steps
R04(EN)CPU	40K steps
R08(EN)CPU	80K steps
R16(EN)CPU	160K steps
R32(EN)CPU	320K steps
R120(EN)CPU	1200K steps
R□ENCPU is equipped with CC-Link IE Control/CC-Link IE Field network ports.	
Motion CPU	
R16MTCPU	16-axis
R32MTCPU	32-axis
R64MTCPU	64-axis
Safety CPU	
R08SFCPU-SET	80K steps
R16SFCPU-SET	160K steps
R32SFCPU-SET	320K steps
R120SFCPU-SET	1200K steps
Process CPU	
R08PCPU	80K steps
R16PCPU	160K steps
R32PCPU	320K steps
R120PCPU	1200K steps
SIL2 process CPU	
R08PSFCPU-SET	80K steps
R16PSFCPU-SET	160K steps
R32PSFCPU-SET	320K steps
R120PSFCPU-SET	1200K steps
Redundant function module	
R6RFM	Redundant function
C Controller	
R12CCPU-V	Memory capacity 256 MB

I/O P.46

AC input	
RX28	8-point
RX10	16-point
RX10-TS	16-point
DC input	
RX40C7	16-point
RX40C7-TS	16-point
RX41C4	32-point
RX41C4-TS	32-point
RX42C4	64-point
RX70C4	16-point
RX71C4	32-point
RX72C4	64-point
DC high-speed input	
RX40PC6H	Positive common, 16-point
RX40NC6H	Negative common, 16-point
RX41C6HS	Positive/negative common, 32-point
RX61C6HS	Positive/negative common, 32-point
DC (with diagnostic functions) input	
RX40NC6B	16-point
Relay output	
RY18R2A	8-point
RY10R2	16-point
RY10R2-TS	16-point
Triac output	
RY20S6	16-point
Transistor (sink) output	
RY40NT5P	16-point
RY40NT5P-TS	16-point
RY41NT2P	32-point
RY41NT2P-TS	32-point
RY42NT2P	64-point
High-speed transistor (sink) output	
RY41NT2H	32-point
Transistor (source) output	
RY40PT5P	16-point
RY40PT5P-TS	16-point
RY41PT1P	32-point
RY41PT1P-TS	32-point
RY42PT1P	64-point
High-speed transistor (source) output	
RY41PT2H	32-point
Transistor (with diagnostic functions) output	
RY40PT5B	16-point
I/O combined module	
DC input, transistor (sink) output	
RH42C4NT2P	32-point/32-point

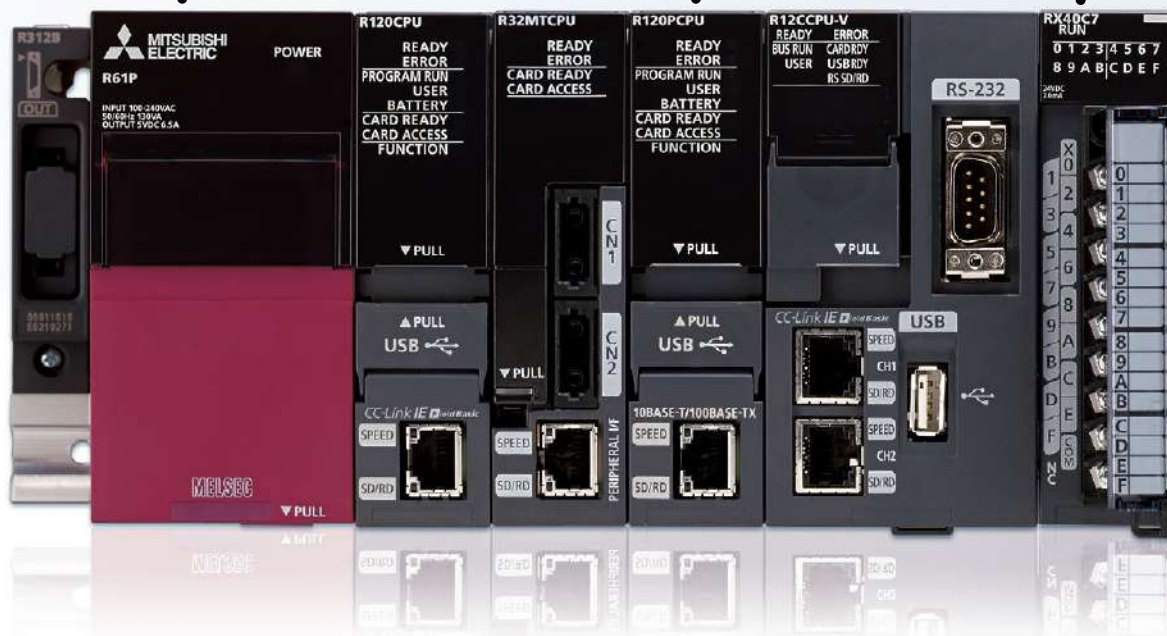

Analog P.52

- Analog input
 - R60AD4 4-channel (voltage or current)
 - R60ADV8 8-channel (voltage)
 - R60ADI8 8-channel (current)
- High-speed analog input
 - R60ADH4 4-channel (voltage or current)
- Analog input (channel isolated)
 - R60AD8-G 8-channel (voltage or current)
 - R60AD16-G .. 16-channel (voltage or current)
- Temperature input
 - R60TD8-G 8-channel (thermocouple)
 - R60RD8-G 8-channel (RTD)
- Temperature control
 - R60TCRT2TT2 2-channel multi-input, 2-channel thermocouple input
 - R60TCRT4 4-channel RTD input
 - R60TCRT2TT2BW ... 2-channel multi-input, 2-channel thermocouple input
 - R60TCRT4BW 4-channel RTD input
- Analog output
 - R60DA4 4-channel (voltage or current)
 - R60DAV8 8-channel (voltage)
 - R60DAI8 8-channel (current)
- High-speed analog output
 - R60DAH4 4-channel (voltage or current)
- Analog output (channel isolated)
 - R60DA8-G 8-channel (voltage or current)
 - R60DA16-G .. 16-channel (voltage or current)
- SIL2 analog control output
 - RY40PT5B-AS **NEW** 16-point

Motion, Positioning, Flexible high-speed I/O, High-speed counter P.61

- Simple motion
 - (Compatible with CC-Link IE Field network)
 - RD77GF4 4-axis
 - RD77GF8 8-axis
 - RD77GF16 16-axis
 - RD77GF32 32-axis
 - (Compatible with SSCNET III/H)
 - RD77MS2 2-axis
 - RD77MS4 4-axis
 - RD77MS8 8-axis
 - RD77MS16 16-axis
- Positioning
- Transistor output
 - RD75P2 2-axis
 - RD75P4 4-axis
- Differential driver output
 - RD75D2 2-axis
 - RD75D4 4-axis
- Flexible high-speed I/O
 - RD40PD01 I/P:12-point, O/P:14-point
- High-speed counter
- DC input/Transistor (sink) output
 - RD62P2 2-channel
- DC input/Transistor (source) output
 - RD62P2E 2-channel
- Differential input/Transistor (sink) output
 - RD62D2 2-channel

Network P.68

- Ethernet
 - RJ71EN71 1 G/100 M/10 Mbps
 - Multiple network type (Ethernet/CC-Link IE)
- CC-Link IE Control network
 - RJ71GP21(S)-SX*1 Control/Normal station optical cable
 - *1: RJ71GP21S-SX includes an external power supply input
- CC-Link IE Field network
 - RJ71GF11-T2 Master/Local station
 - RJ72GF15-T2 Remote station
- CC-Link
 - RJ61BT11 Master/Local station
 - CC-Link Ver.2
- AnyWireASLINK
 - RJ51AW12AL Master station
- BACnet®
 - RJ71BAC96 Controller/Workstation
- CANopen®
 - RJ71CN91 NMT master/NMT slave
- PROFINET® **NEW**
 - RJ71PN92 IO controller
- EtherNet/IP™ **NEW**
 - RJ71EIP91 Scanner
- PROFIBUS®-DP **NEW**
 - RJ71PB91V DP master/slave
- DeviceNet® **NEW**
 - RJ71DN91 Master/slave
- Serial communication
 - RJ71C24 RS-232, RS-422/485
 - RJ71C24-R2 RS-232 (2-channel)
 - RJ71C24-R4 RS-422/485 (2-channel)

Advanced information modules P.79

- MES Interface
 - RD81MES96 Database connection
- OPC UA server
 - RD81OPC96 Embedded OPC UA server
- High-speed data logger
 - RD81DL96 Data collection
- C Intelligent function module
 - RD55UP06-V C/C++ program execution
- Energy measuring module **NEW**
 - RE81WH Energy measurement

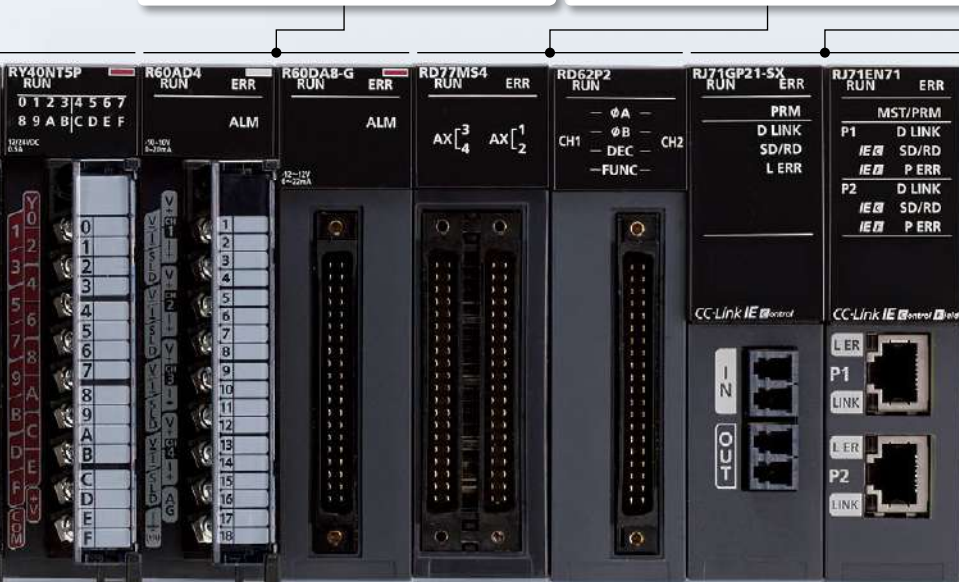

Flexible, interchangeable system architecture

The MELSEC iQ-R Series is a modular control system equipped with various modules such as CPUs, power supply, digital I/O, analog I/O and base unit and intelligent function modules, each having its own responsibility in the system. The core of the system is a base unit that interconnects all of the modules together and enables high-speed communications between each module. From small to large systems, scalability is simple. Up to seven extension bases can be connected and a maximum of 64 modules installed at any one time. An RQ extension base is also available, ensuring compatibility with existing MELSEC-Q Series modules.

Multiple CPU modules

Install up to four CPU modules together

- Programmable controller CPU
- CC-Link IE embedded CPU*1
- Motion CPU
- Process CPU
- SIL2 process CPU*2
- Safety CPU*3
- C Controller

*1: Multi-CPU is not supported.

*2: Product package includes a SIL2 process CPU and SIL2 function module.

*3: Product package includes a safety CPU and safety function module.

Base units

- Main base unit
- Extended temperature range main base unit



- Extension base unit
- Extended temperature range extension base unit

An extension base strictly for I/O and intelligent function modules.

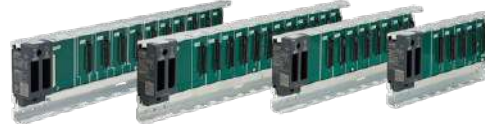

- RQ extension base unit

An extension base for MELSEC-Q Series modules (further extensions requiring the MELSEC-Q Series extension base version).



Power supply module

- Power supply module



I/O & Intelligent function modules

- Input module
- Output module
- I/O combined module
- Analog input module
- Temperature input module
- Temperature control module
- Analog output module
- Simple motion module
- Positioning module
- Flexible high-speed I/O control module
- High-speed counter module
- Ethernet interface module
- CC-Link IE Control Network module
- CC-Link IE Field Network master/local module
- CC-Link IE Field Network remote head module
- CC-Link system master/local module
- AnyWireASLINK master module
- BACnet module
- CANopen® module
- PROFINET® module **NEW**
- EtherNet/IP™ module **NEW**
- PROFIBUS®-DP module **NEW**
- DeviceNet® module **NEW**
- Serial communication module
- MES Interface module
- OPC UA server module
- High-speed data logger module
- C intelligent function module
- Energy measuring module **NEW**

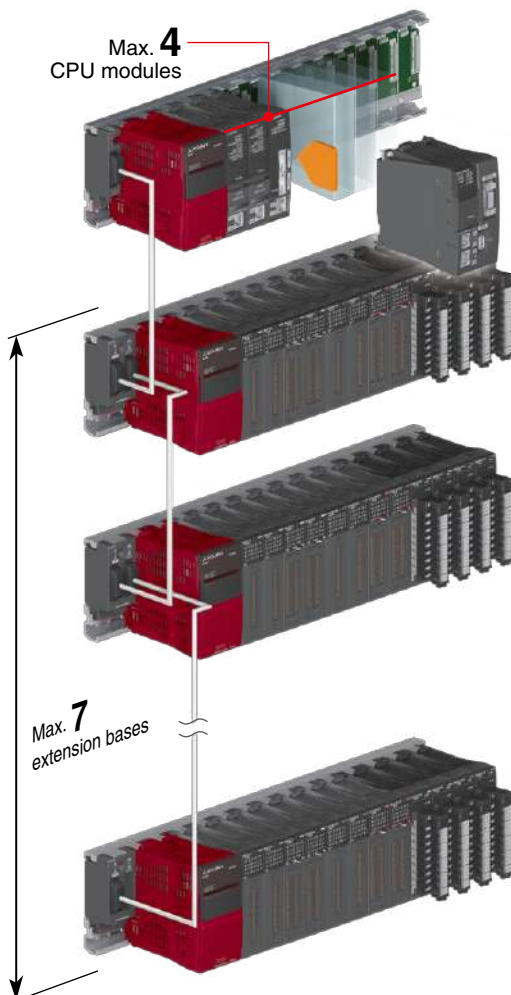

Integrated safety control

The MELSEC iQ-R Series safety control system consists of a safety CPU that is compliant with international safety standards, ISO 13849-1 PL e and IEC 61508 SIL 3, and can execute both safety and general logic in the same CPU. The CPU module can be installed on a standard base unit and when paired with the safety function module enables control of safety I/O, realizing easy integration into an existing or new control system. Safety I/O such as an emergency stop switch or light curtain is controlled via CC-Link IE Field network, which is connected to the safety remote I/O module.

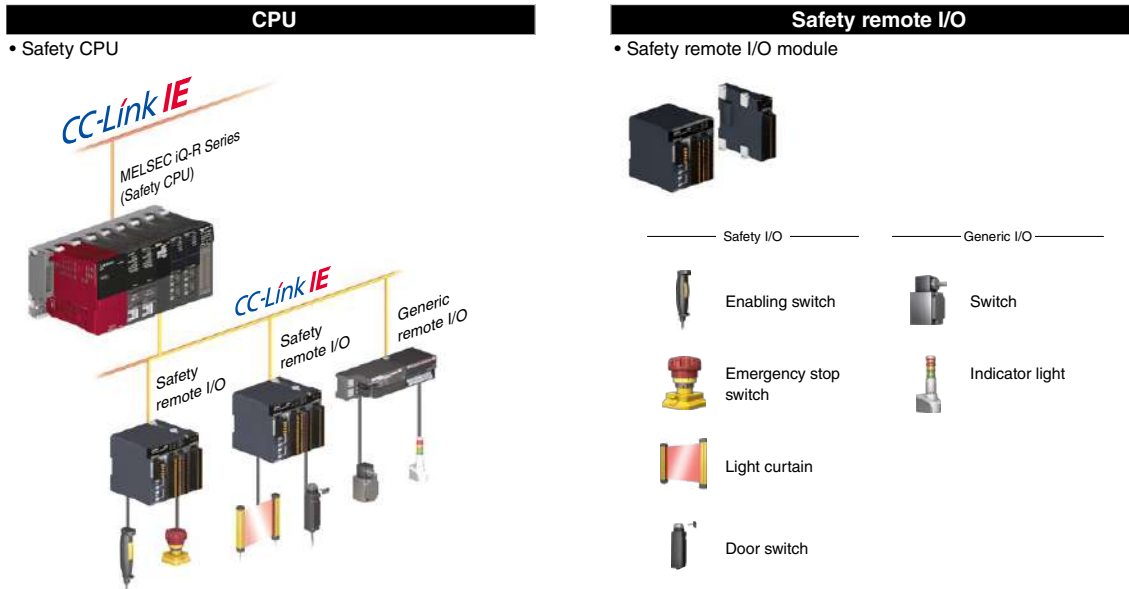

Highly scalable redundant control

The MELSEC iQ-R Series redundant control system is based on a dual-system architecture where all modules on a primary (control) system are duplicated onto a secondary (standby) system with a tracking cable connecting the systems together. Both systems are equipped with a process CPU module and redundant function module, with the former being able to execute standard logic and process control. Remote I/Os are controlled via the CC-Link IE Field network, and dedicated base units for supporting redundant power-supply modules are available in either standard or extended temperature models.

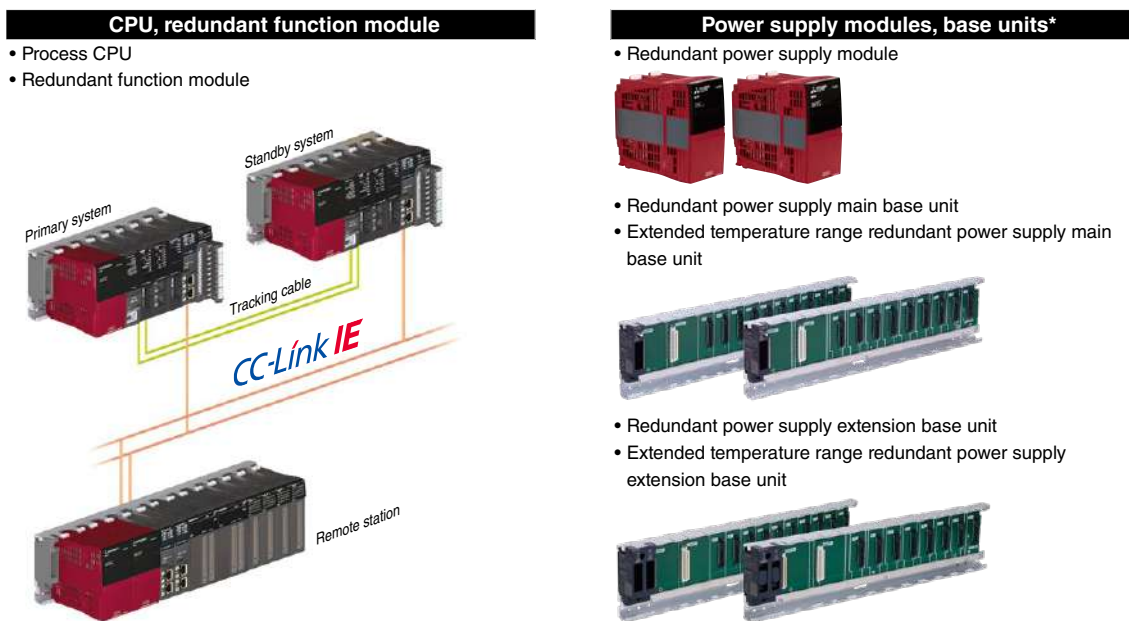

* Only these base units support redundant power supply modules. Can utilize standard MELSEC iQ-R Series modules.

System configuration
CPU
I/O
Analog
Motion, Positioning, Flexible high-speed I/O, High-speed counter
Network
Advanced information
Software

Highly accurate synchronization

The MELSEC iQ-R Series system provides highly accurate synchronization between modules on the control system, which is realized through inter-modular synchronization. Additionally, use of the CC-Link IE Field Network realizes network-level synchronization, providing node-level synchronization that ensures deterministic data flow void of any influence from data transmission delays. This is ideal for applications such as "cutting and folding" inside an offset printer, which requires synchronization between the printing quality sensor, high-speed rotary cutter, folding roller and conveyor.

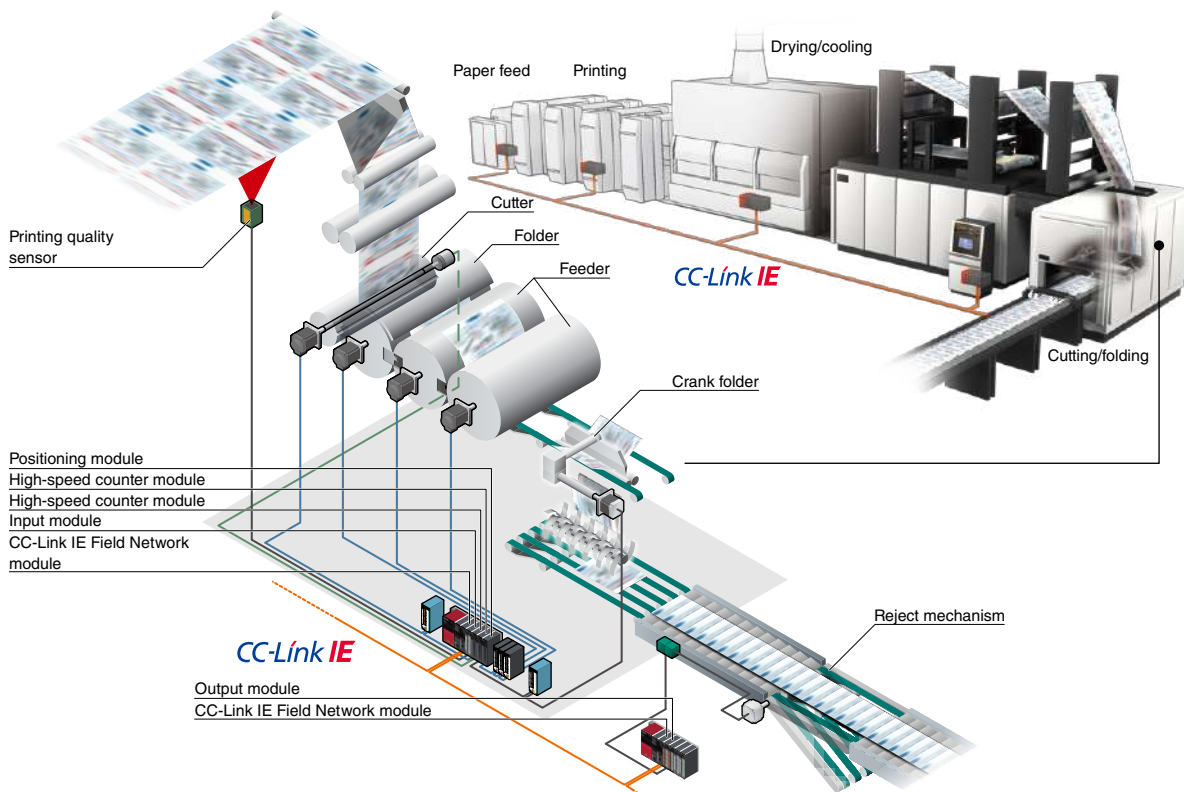

Power supply module

Item	R61P	R62P	R63P	R64P	R63RP	R64RP
Input power supply voltage	100...240 V AC (85...264 V AC)	100...240 V AC (85...264 V AC)	24 V DC (15.6...31.2 A DC)	100...240 V AC (85...264 V AC)	24 V DC (19.2...31.2 A DC)	100...240 V AC (85...264 V AC)
Input frequency	50/60 Hz ±5%	50/60 Hz ±5%	-	50/60 Hz ±5%	-	50/60 Hz ±5%
Max. input apparent power (VA)	130	120	-	160	-	160
Max. input power (W)	-	-	50	-	50	-
Rated output current (5 V DC, A)	6.5	3.5	6.5	9	6.5	9
Rated output current (24 V DC, A)	-	0.6	-	-	-	-
Redundant power supply	-	-	-	-	●	●

Main base unit (Standard, Extended temperature range)

Item	Main base unit (Standard)				Extended temp. range main base unit*1	
	R35B	R38B	R310RB	R312B	R310B-HT	R38RB-HT
Number of I/O modules installed	5	8	10	12	10	8
DIN rail mounting adapter type	R6DIN1	R6DIN1	R6DIN1	R6DIN1	R6DIN1	R6DIN1
External dimensions (H x W x D, mm)	101 x 245 x 32.5	101 x 328 x 32.5	101 x 439 x 32.5	101 x 439 x 32.5	101 x 439 x 32.5	101 x 439 x 32.5

Extension base unit (Standard, Extended temperature range)

Item	Extension base unit (Standard)				Extended temp. range extension base unit*1	
	R65B	R68B	R610RB	R612B	R610B-HT	R68RB-HT
Number of I/O modules installed	5	8	10	12	10	8
Applicable module	MELSEC iQ-R Series module					
DIN rail mounting adapter type	R6DIN1	R6DIN1	R6DIN1	R6DIN1	R6DIN1	R6DIN1
External dimensions (H x W x D, mm)	101 x 245 x 32.5	101 x 328 x 32.5	101 x 439 x 32.5	101 x 439 x 32.5	101 x 439 x 32.5	101 x 439 x 32.5

RQ extension base unit

Item	RQ extension base unit		
	RQ65B	RQ68B	RQ612B
Number of I/O modules installed	5	8	12
Applicable module	MELSEC-Q Series module		
DIN rail mounting adapter type	Q6DIN2	Q6DIN1	Q6DIN1
External dimensions (H x W x D, mm)	98 x 245 x 44.1	98 x 328 x 44.1	98 x 439 x 44.1

Extension cable

Item	RC06B	RC12B	RC30B	RC50B	RC100B
Cable length*2 (m)	0.6	1.2	3.0	5.0	10.0

*1: Enables standard MELSEC iQ-R Series modules to support extended operating ambient temperature of 0 to 60°C.

*2: Overall cable distance 20 m. 13.2 m with the RQ extension base.

The MELSEC iQ-R Series includes a wide range of programmable automation controllers capable of catering to diversified automation control needs, redesigned around the new MELSEC iQ-R high-speed system bus to ensure high performance and intelligent processing power. The lineup includes a high-performance, general-purpose controller (with an embedded CC-Link IE network model available) capable of variable memory capacities and a high-precision motion controller with variable controllable axes. In addition, application-specific CPUs are available; the Safety CPU (supporting functional safety standards), Process CPU (supporting high-speed PID control and hot-swap of I/O modules and when paired with a redundant function module realizes a high available control system), and the C Controller CPU, which provides C language programming ideal for converting from personal computer or micro-controller based systems.



Focus points

- ▶ Highly scalable with program capacities from 10K to 1200K steps
- ▶ Improved multi-CPU controller architecture
- ▶ Embedded gigabit network ports CPU
- ▶ Internal DB for simple batch recipe control
- ▶ Security embedded in hardware SRAM cassette
- ▶ Various motion control possible (position, speed, torque, advanced sync, etc.)
- ▶ International standard (ISO 13849-1 PL e, IEC 61508 SIL 3) safety CPU
- ▶ High-speed PID control, module replacement while online (hot-swap), supports highly reliable redundant system process CPU
- ▶ C/C++ programming ideal for PC/micro-controller based systems

Improved performance

Controller performance has been improved, resulting in increased processing power and the ability to handle larger amounts of data. The multi-CPU architecture has been further improved, enabling faster data exchange across the backplane. The core instruction processing speed has also been improved tenfold, helping to reduce the production cycle time. High-speed and large process control systems can be realized, supporting up to 500 loops.

Finely balanced control

Balancing of various different control needs can be done effectively utilizing the multi-CPU feature of the MELSEC iQ-R Series. Up to 192 servo axes can be controlled by incorporating three separate motion CPUs on the base unit, with a spare CPU slot required for controlling the general aspects of the system.

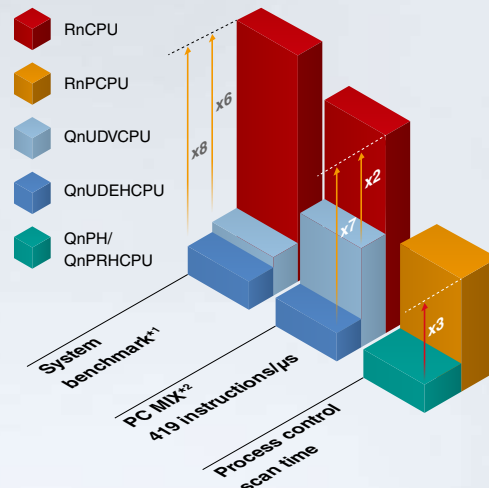

*1: Based on a typical application example, the system benchmark test measures the CPU scan time taking into consideration the network refresh time and processing time using external devices, (compared to universal model QCPU, QnUDEHCPU).

*2: Average number of instructions, such as basic instructions and data processing, executed in 1 μs (the larger the value, the faster the processing speed).

System configuration

CPU

I/O

Analog

Motion, Positioning, Flexible high-speed I/O, High-speed counter

Network

Advanced Information

Software

Programmable Controller CPU Modules

R00CPU

Program capacity 10K steps

R01CPU

Program capacity 15K steps

R02CPU

Program capacity 20K steps

R04CPU

Program capacity 40K steps

R08CPU

Program capacity 80K steps

R16CPU

Program capacity 160K steps

R32CPU

Program capacity 320K steps

R120CPU

Program capacity 1200K steps

R04ENCPU

Program capacity 40K steps, CC-Link IE embedded

R08ENCPU

Program capacity 80K steps, CC-Link IE embedded

R16ENCPU

Program capacity 160K steps, CC-Link IE embedded

R32ENCPU

Program capacity 320K steps, CC-Link IE embedded

R120ENCPU

Program capacity 1200K steps, CC-Link IE embedded

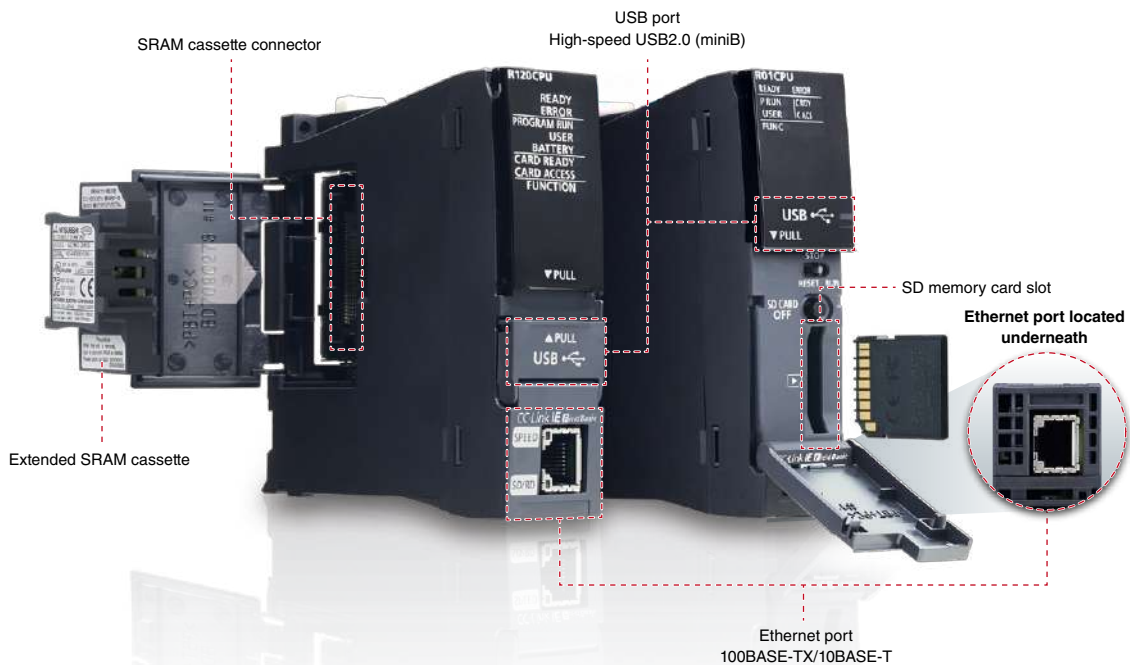

At the core of the MELSEC iQ-R Series is a programmable controller CPU. This CPU is the heart of the control system and includes various features for different applications. The most common CPU is the programmable controller CPU, into which various features are embedded, enabling it to perform a wide range of control tasks. The different CPUs are highly scalable with five types available, based on program capacity needs (10K to 1200K steps). In addition, a CC-Link IE embedded CPU is available, further reducing hardware costs as a separate network module is not required.

Built-in hardware features

Programmable controller CPUs are equipped with a built-in USB port (high-speed Ver. 2.0 Mini-B) and an Ethernet port (up to 100 Mbps) as standard, enabling connection to a general LAN network*1 or MELSOFT software. Two memory options are included as well, an external SRAM cassette that enables device/label memory to be increased and doubling up as a hardware security key, and an SD memory card which can be used for logging data, troubleshooting device values or as a memory database for recipe storage.

*1: General LAN connection supported by the Ethernet port only.

Flexible, large-capacity data storage

The MELSEC iQ-R Series programmable controller CPU is designed to allow an external SRAM cassette to be installed directly into the CPU module. This option makes it possible to increase internal device memory to an impressive 9882K words, expanding device/label memory even further. An SD memory card can be used at the same time, expanding data logging memory and the capacity of the internal database, which is ideal for large-scale systems. In general, management of programmable controller internal data is quite flexible, making programming even easier by allowing various data area allocations to be changed within the CPU memory and SRAM cassette.

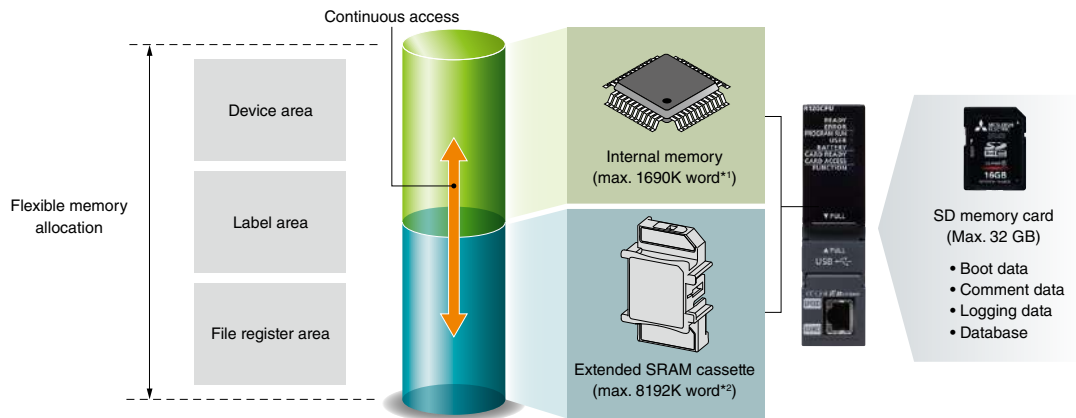

*1: Based on R120CPU.
*2: Based on NZ2MC-16MBS (16 MB).

Data management utilizing internal database (DB)

The CPU includes an internal database that can be installed into the SD memory card. This feature allows, for example, a selection of database commands that can add/delete/change records to be utilized for simple recipe functions. It is also much easier to import/export Unicode files for use in spreadsheets. Accessing the CPU internal database data from a computer equipped with Microsoft® Access® or Excel® is also supported. The CPU internal database is especially useful for the food and beverage industry where multiple product variations are produced using the same machine process.

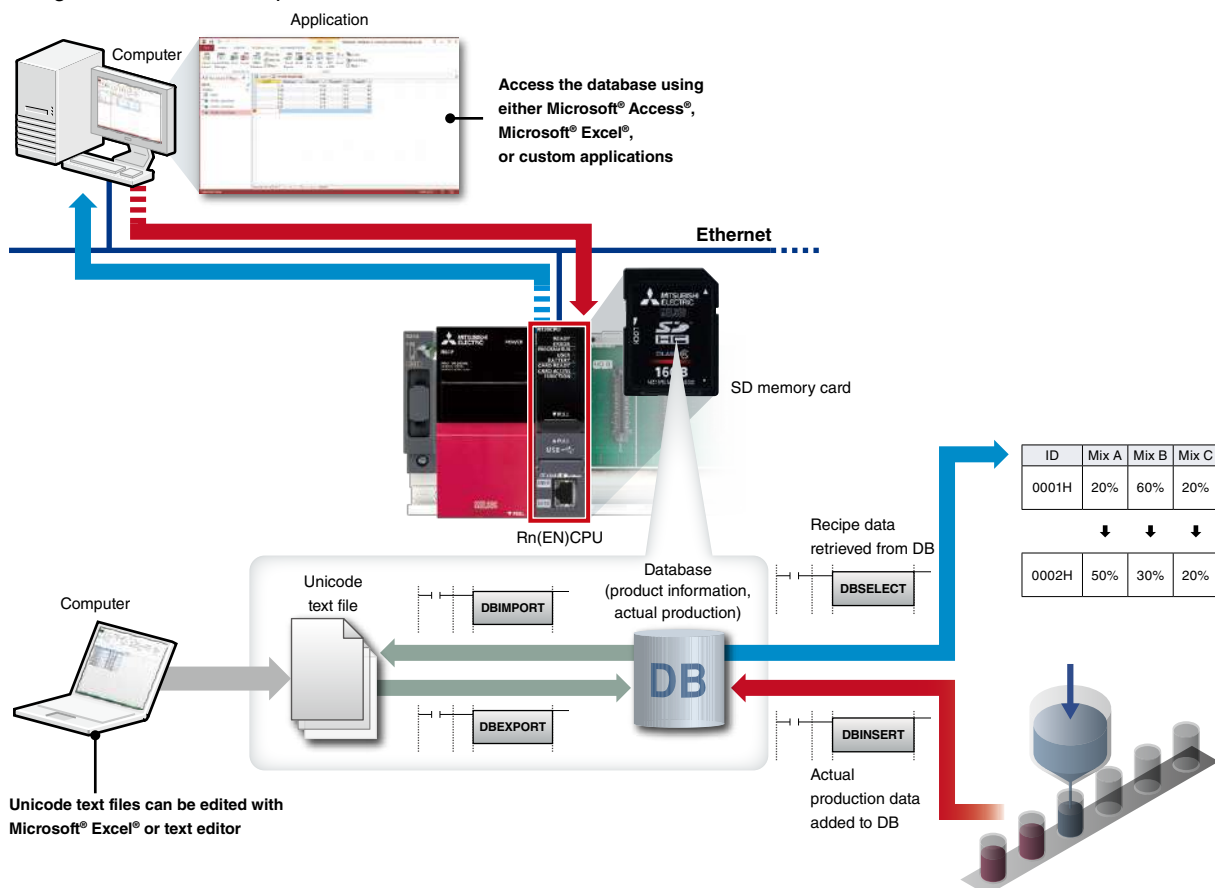

System configuration
CPU

I/O

Analog

Motion, Positioning,
Flexible high-speed I/O
High-speed counter

Network

Advanced information

Software

High-speed, event driven programs

Further improvements to CPU performance have resulted in the interval time between event driven programs (interrupt programs) reduced to 50 us. This has been realized by having multiple event driven programs able to be nested within other event driven programs and being triggered from already executing programs. This kind of performance is available with a standard input module and programmable controller CPU, without requiring a dedicated interrupt type input module, which helps to further reduce hardware costs while realizing a high-precision control system.

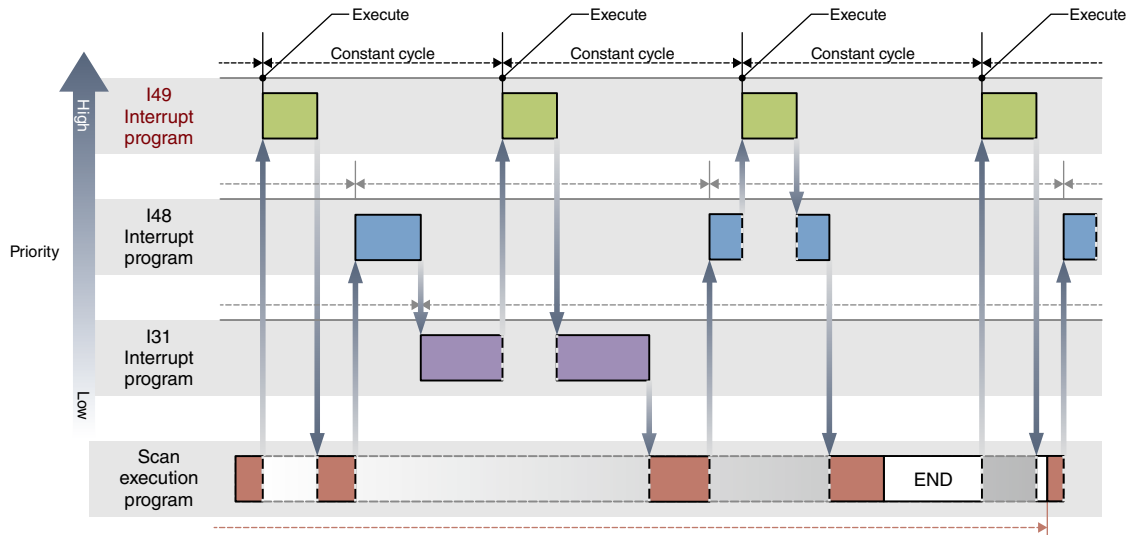

I/P module + ABS encoder accurately detect variable high-speed I/P signals.

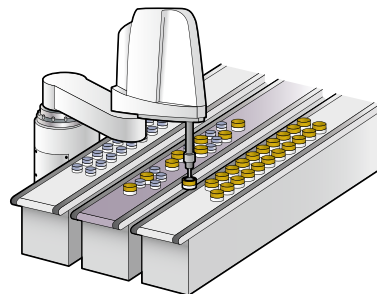
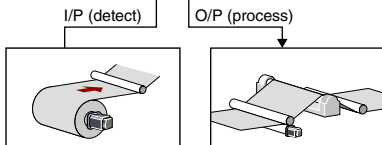

CPU program management data

Operation and system historical events are automatically recorded in the CPU module, allowing quick root cause analysis of system errors or management of program changes. Actual changes to the program, parameters and system errors are viewable using GX Works3 or can be exported as a CSV file for use by other third-party software.

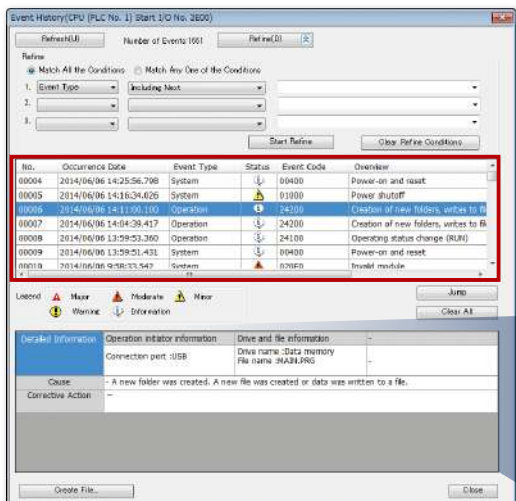

Detailed Information		
Operation initiator information	Drive and file information	
Connection port :USB	Drive name :Data memory	
	File name :MAIN.PRg	
Cause	- A new folder was created. A new file was created or data was	
Corrective Action	-	

View operations and system events with corresponding event/error codes, data can be sorted according to various attributes.

Corresponding explanatory text

Intuitive root cause analysis

When the SD memory card is installed, device data is saved automatically to the SD memory at the time of system failure. This data is useful for investigating the cause of the failure, enabling various data collected before and during the event to be analyzed. The data can be used in a situation such as when the origin of a machine is different than where the machine was actually being used, and the data can simply be sent by e-mail (for example) as a data file for analysis.

Overseas production site

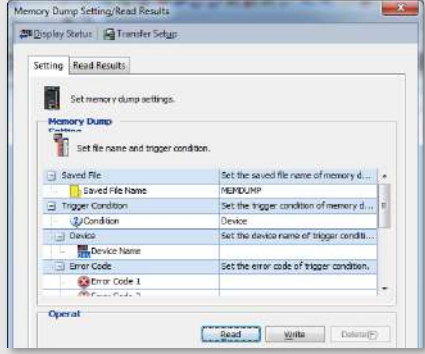

Easy setup just by setting trigger conditions

Data logged automatically when an error occurs

Domestic development dept.

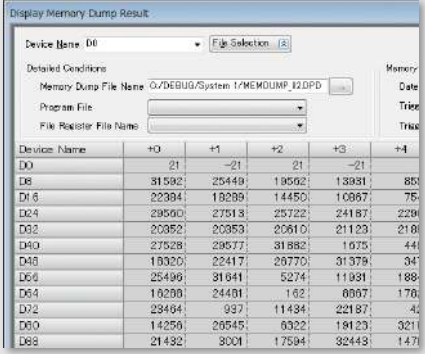

Visual representation of data when error occurs

Quicker root cause analysis

Data sent via email



SD memory card

Easily collect manufacturing data

Utilizing the installed SD memory card, CPU internal memory or a direct live connection to the CPU module, logging data (device/label) can be easily realized just by simply registering the parameters. In addition, logging can be automatically sent to a FTP server. Logged data can be utilized in a number of ways, such as using third-party spreadsheet software or as a real-time feed of data for analyzing various manufacturing processes. The real-time feature enables live feeds showing data as they happen in addition to historical trending. Logged historical trend files support the Unicode text file format, which is especially useful for Asian based applications as most languages in the region require Unicode compatibility for information to be legible.

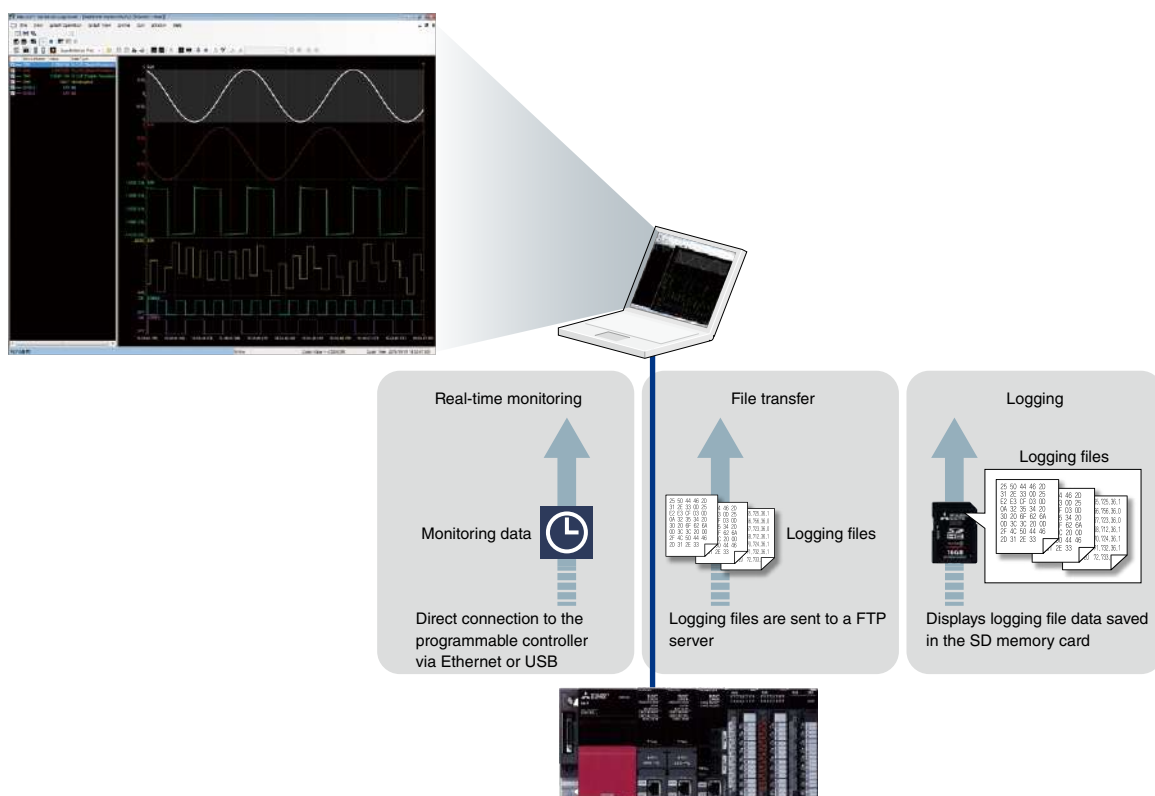

Real-time monitoring

Monitoring data

Direct connection to the programmable controller via Ethernet or USB

File transfer

Logging files

Logging files are sent to a FTP server

Logging

Logging files

Displays logging file data saved in the SD memory card

System configuration

CPU

I/O

Analog

Motion, Positioning, Flexible high-speed I/O, High-speed counter

Network

Advanced information

Software

Basic diagnostics utilizing CPU internal web server

CPU diagnostics and device monitoring can be easily done via a web browser on a computer or tablet computer, without requiring to install GX Works3 realizing easier diagnostics when an error occurs.

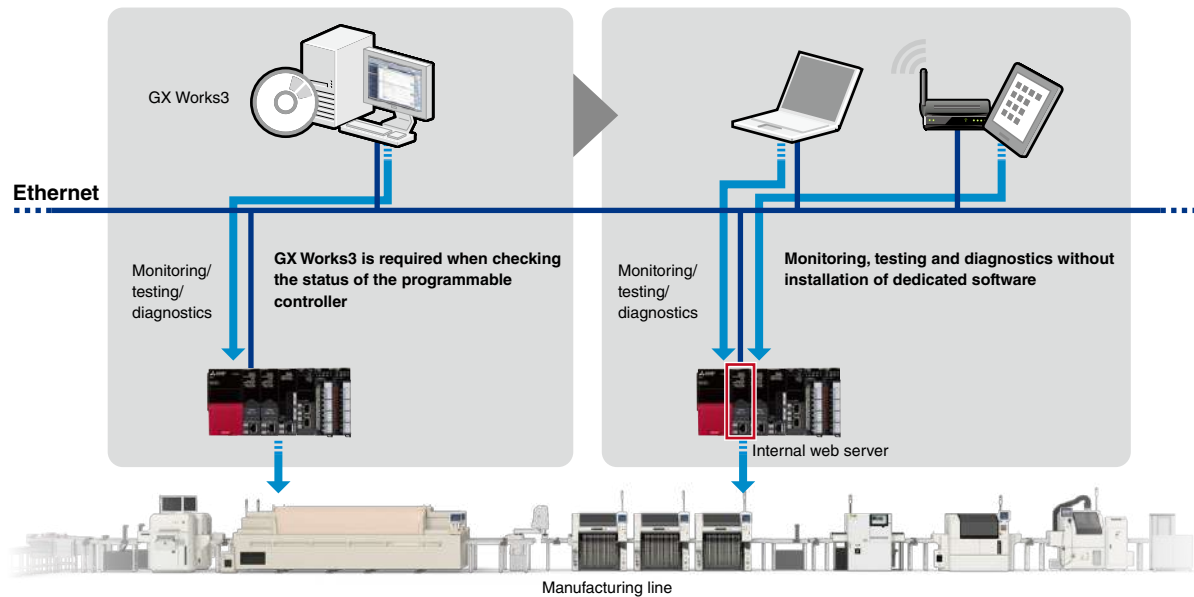

Device data transferring without programming

The CPU supports simple settings with GX Works3 enabling the transfer of device data, such as production data without requiring a program. Communications can be done between MELSEC iQ-R Series and with MELSEC-Q Series, MELSEC-L Series control systems.

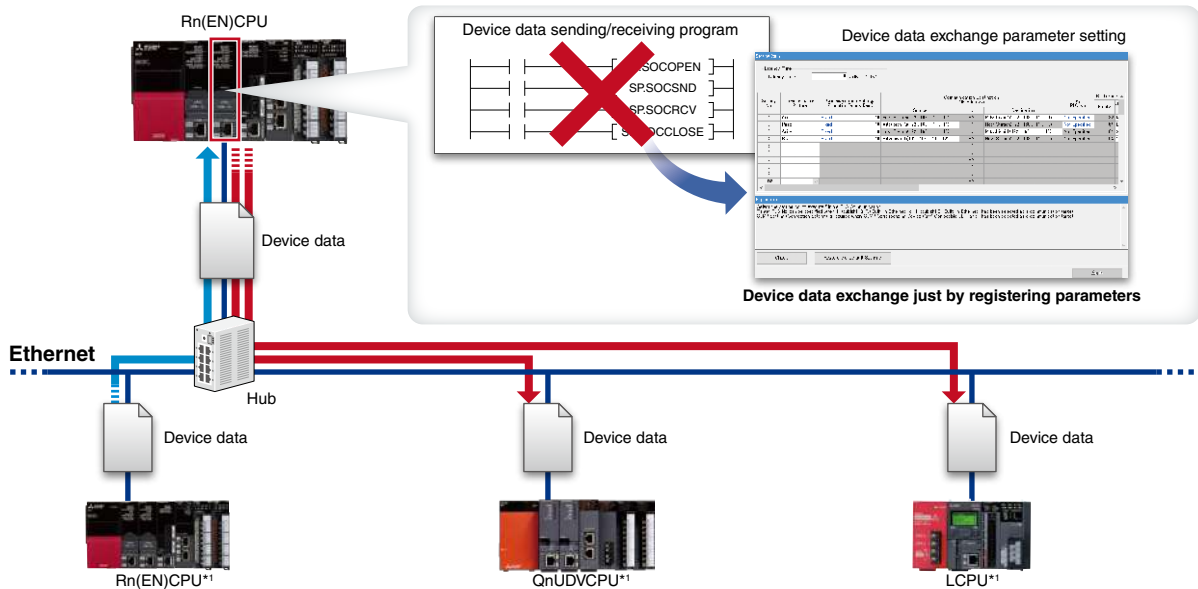

*1: Supported by the embedded Ethernet port only.

Programmable controller CPU module specifications

Item	R00CPU	R01CPU	R02CPU	R04(EN)CPU	R08(EN)CPU	R16(EN)CPU	R32(EN)CPU	R120(EN)CPU
Control method	Stored program cyclic operation							
I/O control mode	Refresh mode (Direct access I/O is available by specifying direct access I/O (DX, DY))							
Programming language	Ladder diagram (LD), structured text (ST), function block diagram (FBD), sequential function chart (SFC)							
Extended programming language	Function block (FB), label programming (system/local/global)							
Program execution type	Initial, scan, fixed scan, interrupt, standby							
Number of I/O points [X/Y] (point)	4096	4096	4096	4096	4096	4096	4096	4096
Constant scan (ms)	0.5...2000			0.2...2000				
(Function for keeping regular scan time)	(Setting available in 0.1 ms increments)			(Setting available in 0.1 ms increments)				
Memory capacity								
Program capacity (step)	10K	15K	20K	40K	80K	160K	320K	1200K
Program memory (byte)	40K	60K	80K	160K	320K	640K	1280K	4800K
Device/label memory*1 (byte)	252K	252K	252K	400K	1188K	1720K	2316K	3380K
Data memory (byte)	1.5M	1.5M	1.5M	2M	5M	10M	20M	40M
Instruction processing time								
LD instruction (ns)	31.36	31.36	3.92	0.98	0.98	0.98	0.98	0.98
MOV instruction (ns)	62.72	62.72	7.84	1.96	1.96	1.96	1.96	1.96
E + instruction (floating-point addition) (ns)	100.0	100.0	17.6	9.8	9.8	9.8	9.8	9.8
Structured text IF instruction*2 (ns)	31.36	31.36	3.92	1.96	1.96	1.96	1.96	1.96
Structured text FOR instruction*2 (ns)	31.36	31.36	3.92	1.96	1.96	1.96	1.96	1.96
PC MIX value*3 (instructions/μs)	19	19	146	419	419	419	419	419
Interface connection port								
High-speed USB2.0 (miniB)	●	●	●	●	●	●	●	●
Ethernet (100 BASE-TX/10 BASE-T)	●	●	●	●	●	●	●	●
CC-Link IE connection port								
Ethernet (1000BASE-T/100BASE-TX/10BASE-T)	-	-	-	●*4*5	●*4*5	●*4*5	●*4*5	●*4*5
CC-Link IE Field Network Basic connection port								
Ethernet (100BASE-TX/10BASE-T)	●	●	●	●	●	●	●	●
Memory interface								
SD memory card	-	●	●	●	●	●	●	●
Extended SRAM cassette	-	-	-	●	●	●	●	●
Function								
Multiple interrupt	●	●	●	●	●	●	●	●
Standard PID control	●	●	●	●	●	●	●	●
Internal database	-	-	-	●	●	●	●	●
Memory dump	-	●	●	●	●	●	●	●
Data logging	-	●*6	●*6	●	●	●	●	●
Real-time monitor	●	●	●	●	●	●	●	●
Security	●	●	●	●	●	●	●	●
Inter-modular synchronization	●	●	●	●	●	●	●	●
SLMP communication	●	●	●	●	●	●	●	●
Firmware update	-	●	●	●*7	●*7	●*7	●*7	●*7

*1: Extended SRAM cassette expands the device/label memory area.
 *2: The IF or FOR sentence of the structured text consists of several instructions, which may increase the processing time period.
 *3: Average number of instructions such as for basic instructions and data processing executed in 1 μs. The larger the value, the faster the processing speed.
 *4: Available with R□ENCPU. For details about network specifications, refer to the RJ71EN71 performance specifications on page 69.
 *5: The following networks are supported, Ethernet, CC-Link IE Control (twisted pair cable), and CC-Link IE Field (two simultaneous Ethernet networks and combined CC-Link IE Field and CC-Link IE Control networks are not supported).
 *6: Logging data can be saved in the SD memory card only.
 *7: R□ENCPU does not support firmware update function.

SD memory card*8 specifications

Item	NZ1MEM-2GBSD	NZ1MEM-4GBSD	NZ1MEM-8GBSD	NZ1MEM-16GBSD
Type	SD memory card	SDHC memory card	SDHC memory card	SDHC memory card
Capacity (byte)	2G	4G	8G	16G

*8: SD memory card is not supported for the R00CPU.

Extended SRAM cassette specifications

Item	NZ2MC-1MBS	NZ2MC-2MBS	NZ2MC-4MBS	NZ2MC-8MBS	NZ2MC-8MBSE	NZ2MC-16MBS
Capacity (byte)	1M	2M	4M	8M	8M	16M
Supported CPU modules						
Programmable controller CPU*9	●	●	●	●	-	●
Process CPU	-	-	-	-	●	-
SIL2 process CPU	-	-	-	-	●	-
Safety CPU	●	●	●	●	●	-

*9: Not supported for R00CPU, R01CPU, R02CPU.

Battery-less option cassette*10

Item	NZ1BLC
Type	Option cassette

*10: Supported for R04(EN)CPU, R08(EN)CPU, R16(EN)CPU, R32(EN)CPU, R120(EN)CPU.

System configuration

CPU

I/O

Analog

Motion, Positioning, Flexible high-speed I/O, High-speed counter

Network

Advanced information

Software

Motion CPU Modules

R16MTCPU

Up to 16-axis control

R32MTCPU

Up to 32-axis control

R64MTCPU

Up to 64-axis control



The motion CPU module is a dedicated high-precision control CPU module, designed solely for applications that require advanced motion control such as positioning control, synchronous control, and speed-torque control at a very high accuracy. The motion CPU is incorporated into the multiple CPU architecture of the MELSEC iQ-R Series complementing the programmable controller CPU.

High-speed data communication between CPUs

High-speed communication is realized between the two CPUs via a large bandwidth data buffer memory exchange. There are two types of buffer memory for data exchange: one that provides cyclic exchange at a cycle time as fast as 0.222 ms; and one for direct data exchange of event-driven buffer memory, which is useful for large data bandwidth requirements. High-speed communications are very useful when there is a need to instantaneously transfer a large amount of information such as cam data, thereby simplifying programming even further.

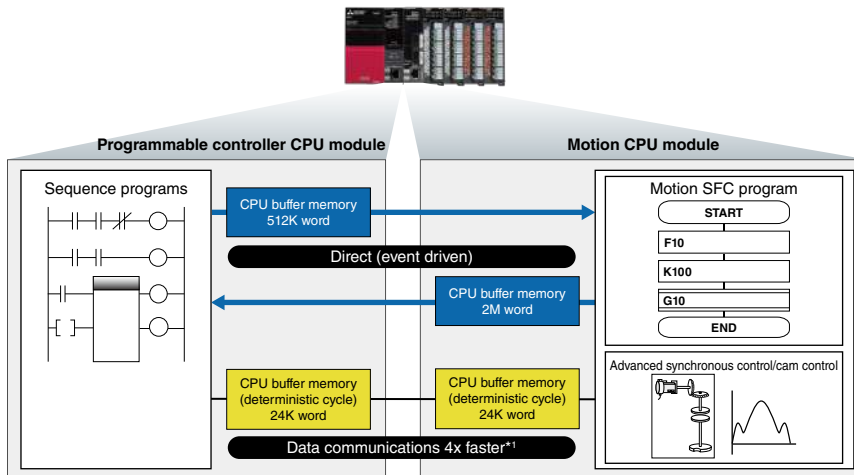

*1: As compared to current Mitsubishi Electric products.

Various different applications easily realized

Tension control can be maintained constantly enabling the unwinding of various rolled sheets, for example, with line synchronization realized via speed and advanced synchronous control.

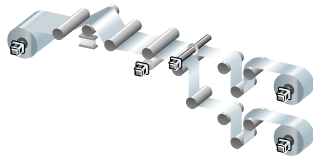

Converting equipment

The combination of a machine vision system and high-speed motion control enables highly accurate positional alignment.

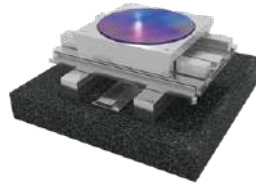

Positional alignment

Synchronization between different print heads has been achieved by speed and advanced synchronous control.



Offset printing

Multiple machine processes by SFC programming

The motion CPU module is programmed using the SFC (Sequential Function Chart) type language which enables programming in clearly identifiable steps. This is extremely useful where multiple machine processes have to be performed simultaneously.

■ Motion SFC Program

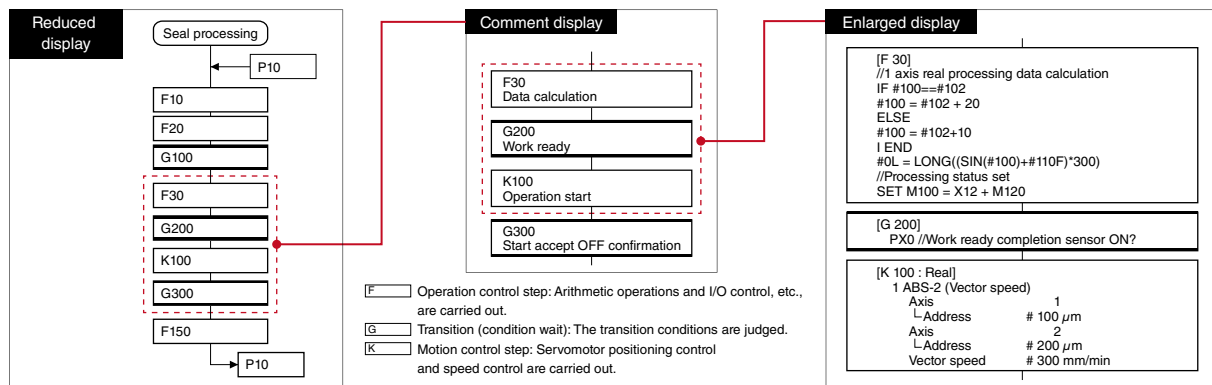

Motion CPU module specifications

Item	R16MTCPU	R32MTCPU	R64MTCPU
Number of control axes	16 axes	32 axes (16 axes x 2 lines)	64 axes (32 axes x 2 lines)
Operation cycle (ms)	0.222, 0.444, 0.888, 1.777, 3.555, 7.111	0.222, 0.444, 0.888, 1.777, 3.555, 7.111	0.222, 0.444, 0.888, 1.777, 3.555, 7.111
Programming language	Motion SFC, dedicated instruction	Motion SFC, dedicated instruction	Motion SFC, dedicated instruction
Servo program capacity (step)	32K	32K	32K
Number of positioning points (point)	6400 (positioning data can be designated indirectly)	6400 (positioning data can be designated indirectly)	6400 (positioning data can be designated indirectly)
Servo amplifier network	SSCNET III/H (1 line)	SSCNET III/H (2 lines)	SSCNET III/H (2 lines)
Max. distance between stations (m)	100	100	100
Interpolation			
Linear interpolation (axis)	2, 3, 4	2, 3, 4	2, 3, 4
Circular interpolation (axis)	2	2	2
Helical interpolation (axis)	3	3	3
Control mode			
PTP (Point To Point) control	●	●	●
Speed-position switching control	●	●	●
Continuous path control	●	●	●
Position follow-up control	●	●	●
Advanced synchronous control	●	●	●
Speed-torque control	●	●	●
Acceleration/deceleration control			
Trapezoidal acceleration/deceleration	●	●	●
S-curve acceleration/deceleration	●	●	●
Advanced S-curve acceleration/deceleration	●	●	●
Interface			
PERIPHERAL I/F	●	●	●
SD memory card	●	●	●
Function			
Absolute positioning system*1	●	●	●
Mark detection function	●	●	●
Security function	●	●	●
Digital oscilloscope function	●	●	●
Driver communication function	●	●	●

*1: A battery needs to be installed in the servo amplifier for home position backup.

System configuration

CPU

I/O

Analog

Motion, Positioning, Flexible high-speed I/O, High-speed counter

Network

Advanced information

Software

Process CPU Modules, SIL2 Process CPU, Redundant Function Module

R08PCPU

Program capacity 80K steps

R16PCPU

Program capacity 160K steps

R32PCPU

Program capacity 320K steps

R120PCPU

Program capacity 1200K steps

R08PSFCPU-SET

Program capacity 80K steps, SIL 2-compliant

R16PSFCPU-SET

Program capacity 160K steps, SIL 2-compliant

R32PSFCPU-SET

Program capacity 320K steps, SIL 2-compliant

R120PSFCPU-SET

Program capacity 1200K steps, SIL 2-compliant

R6RFM

Redundant function

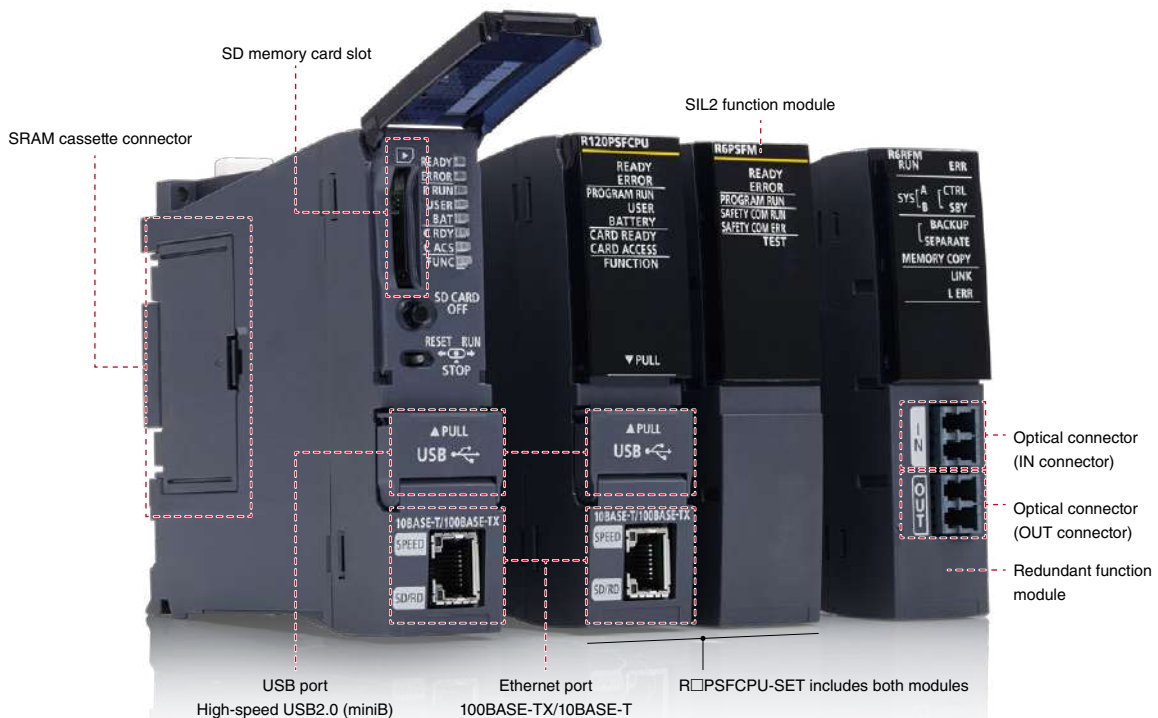

Redundant system when process CPU is paired with the redundant function module.

The process CPU module is part of the application-specific range in the MELSEC iQ-R Series and has four CPUs available with memory sizes from 80K to 1200K steps. It is designed specifically for medium- to large-scale process control systems requiring high-speed performance coupled with the handling of large PID loops. When paired with a redundant function module, a highly reliable (redundant) control system can be realized with a tracking data capacity of up to 1 M words between the control and standby systems supported. The SIL2 process CPU also realizes a redundant system conforming to IEC 61508 SIL 2 safety standard.

DCS style features in a cost-efficient automation control system

The specialized CPU inherits its high performance from the MELSEC iQ-R Series when used together with the centralized programming suite GX Works3 and iQ Works. The process control system incorporates a dedicated process instruction set (such as two-degree-of-freedom PID, sample PI, and auto-tuning), realizing algorithmic PID and highly reliable features such as being able to interchange (hot-swap) I/O modules while the system is still online and large-scale process control with a maximum of 500 loops, closely bringing it in line with DCS capabilities without the financial burden.

Redundant system remote location and high-speed switching

Optical-fiber tracking cables enable the standby system to be installed in a remote location up to 550 m from the control (primary) system. The tracking cables are immune to noise interference and support fast data transfer rates. System switching speed has also been improved to speeds of 10 ms or less, enabling high-speed switching of the control system to standby system further improving reliability.

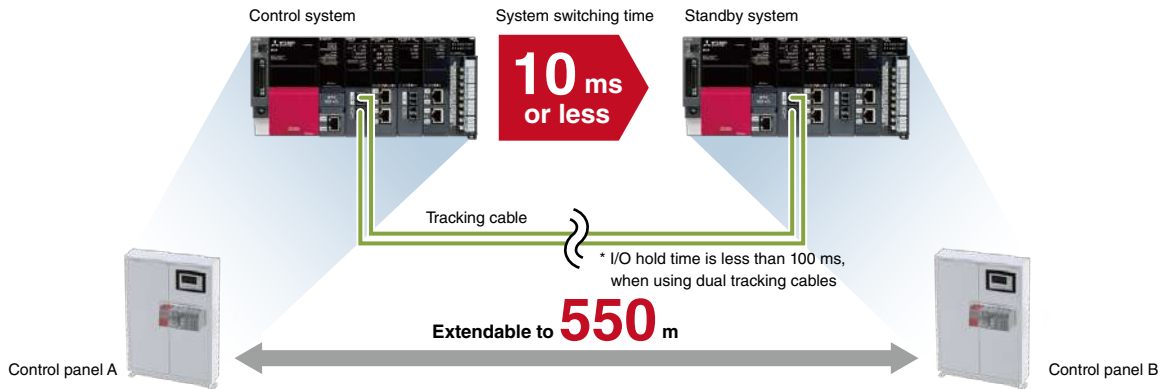

Improve reliability with reduced single-point failure

A multi-level redundant system can be realized by installing dual control systems consisting of the control (primary) and standby CPUs combined with a dual cable topology for the network cabling of the CC-Link IE Field networks, and dual remote stations minimizing the risk of single-point failure. The Ethernet module is equipped with two communications ports, enabling continuous information level communications with SCADA software even if an error occurs with one of the ports. Only one module is required per control and standby system, reducing overall hardware cost. Online replacement of modules (hot-swapping) is possible without stopping the operating control system.

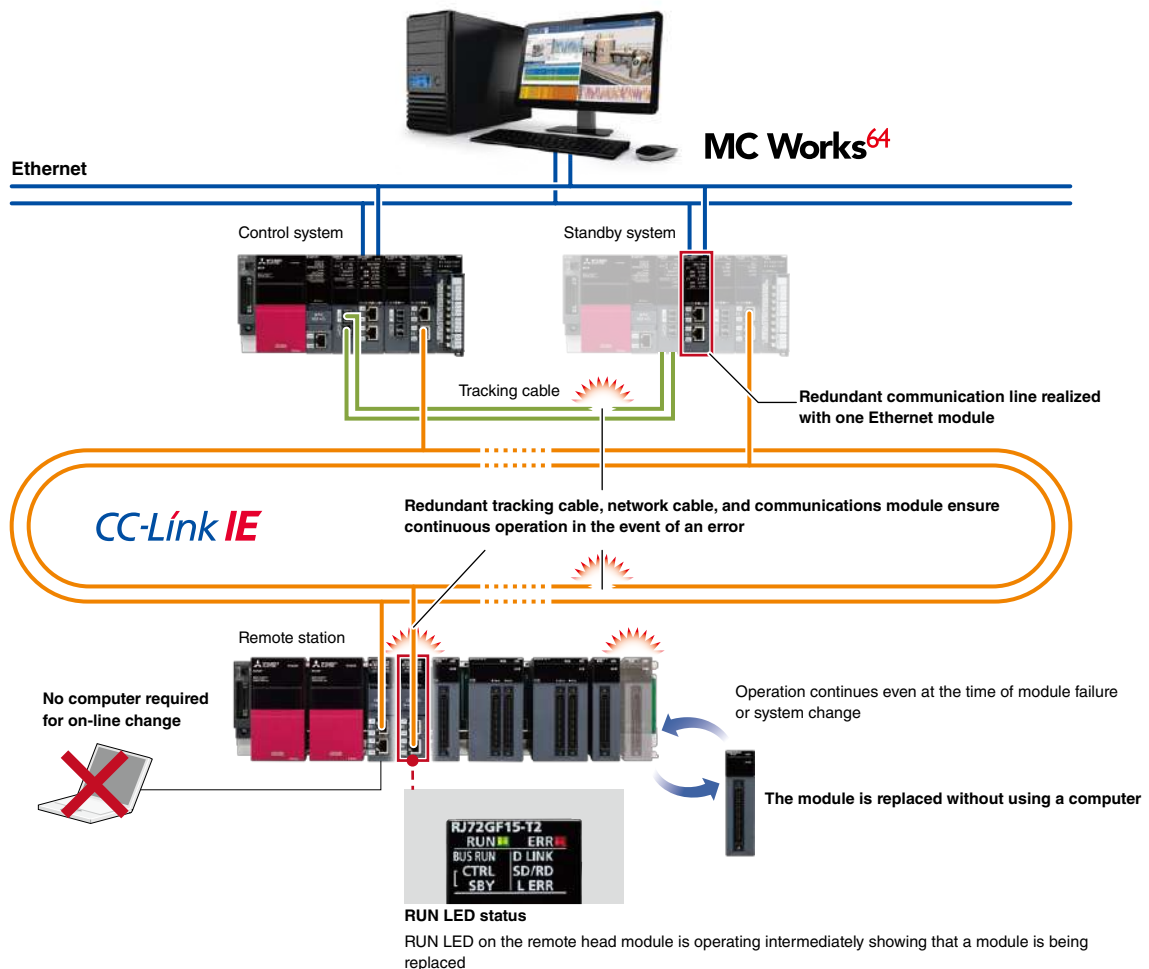

System configuration

CPU

I/O

Analog

Motion, Positioning, Flexible high-speed I/O, High-speed counter

Network

Advanced information



Software

Efficient engineering through extensive compatibility between software

An efficient and highly-scalable engineering environment can be realized by the extensive compatibility between GX Works3 together with SCADA software (MC Works64), monitoring software GT SoftGOT and GT Works3 [GOT (HMI)].

Highly scalable process control visualization

Process tag labels (variables) can be shared between GX Works3, Mitsubishi SCADA MC Works64, GT SoftGOT and GOT (HMI), realizing an efficient engineering environment that makes screen creation easier. In addition, a scalable SCADA control system can be realized combining these products.

Suitable for rugged environments	Computer-based GOT (HMI) screen monitoring	Web-based monitoring of server/client configuration
 <p>GOT2000</p> <p>Small</p>	 <p>GT SoftGOT 2000</p> <p>Medium</p>	 <p>MC Works⁶⁴</p> <p>Large-scale</p>
<p>Shop floor monitoring</p> <ul style="list-style-type: none"> Generation of GOT (HMI) screens Easily create process control monitoring screens (GOT2000/GOT1000) 	<p>Computer-based monitoring</p> <ul style="list-style-type: none"> Linkage with GT SoftGOT Monitor tool and GT SoftGOT compatibility enable screens to be called between each software 	<p>Integrated monitoring</p> <ul style="list-style-type: none"> Generating Mitsubishi SCADA MC Works64 screens Easily create screens using the process linkage tool <p>▶ System size</p>

Integrated engineering software realizing easy programming and maintenance

GX Works3 is a centralized programming environment supporting various programming, debug and maintenance features, thereby enabling efficient engineering. Multiple programming languages can be used within the same GX Works3 project, including function block diagram (process control programming), ladder, structured text and sequential function chart.

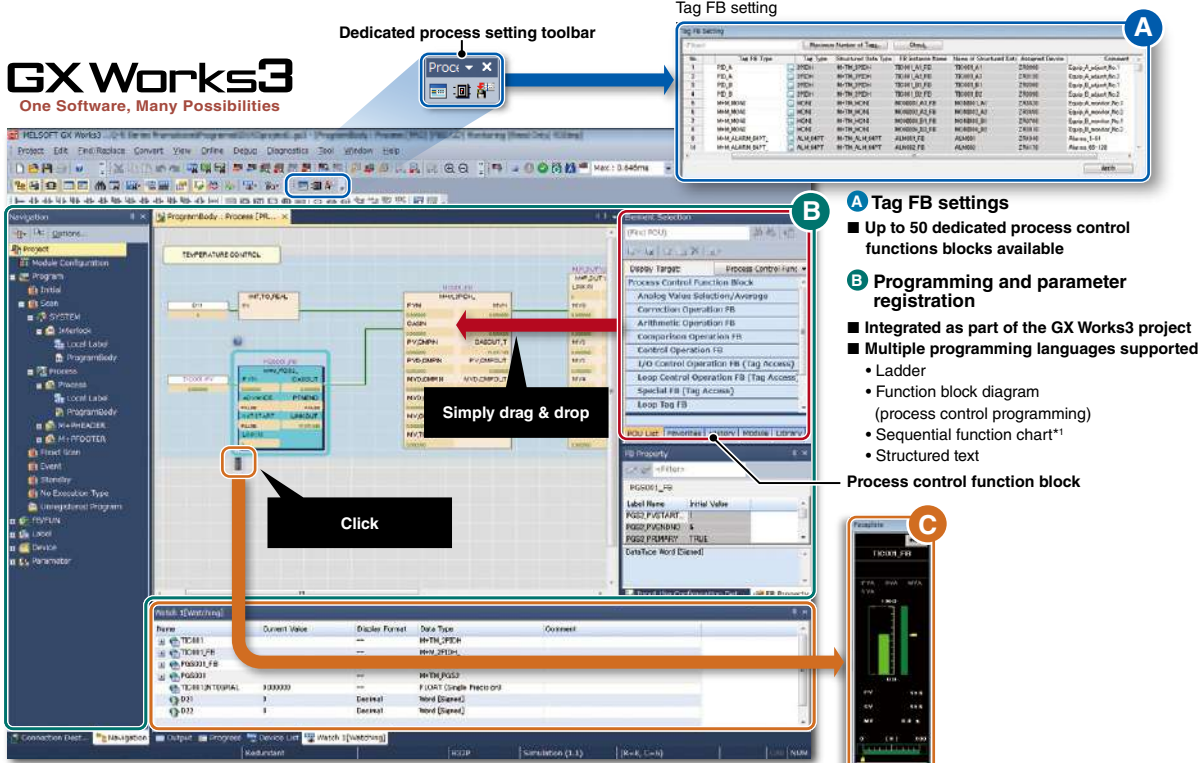

GX Works3
One Software, Many Possibilities

Dedicated process setting toolbar

Tag FB setting

A Tag FB settings

- Up to 50 dedicated process control functions blocks available

B Programming and parameter registration

- Integrated as part of the GX Works3 project
- Multiple programming languages supported:
 - Ladder
 - Function block diagram (process control programming)
 - Sequential function chart*
 - Structured text

Process control function block

C Tag FB monitoring and online tuning

- Debugging improved utilizing tag FB monitoring and online tuning

Simply drag & drop

Click

Faceplate

*1: SFC programming language is not supported when the Process CPU is being used in redundant mode (future support planned).

SIL 2-compliant redundant system configuration

A SIL 2-compliant redundant control system can be easily realized by utilizing various dedicated modules such as the SIL2 process CPU and digital I/O module (with diagnostic functions).

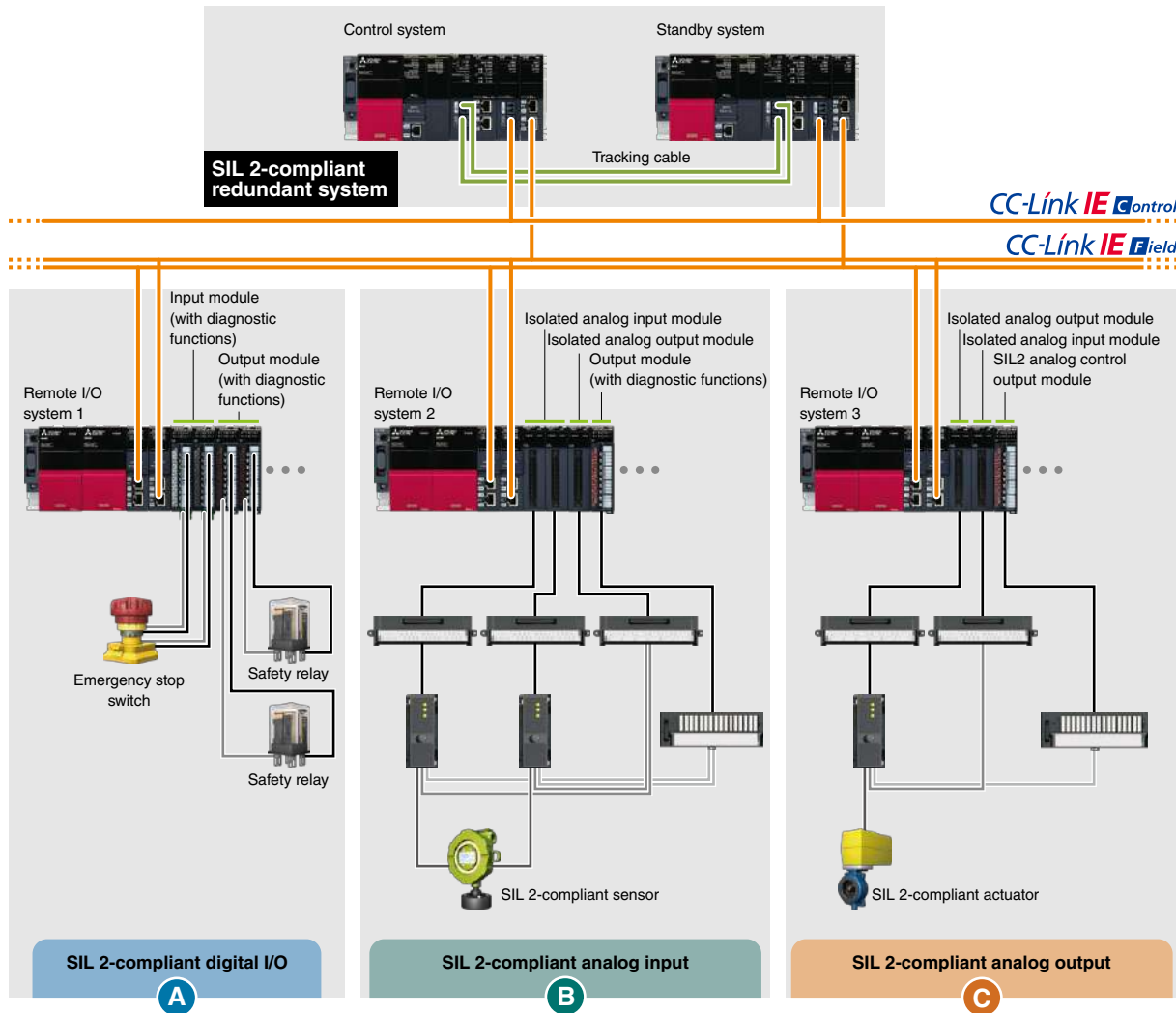

A SIL 2-compliant digital I/O

SIL 2-compliant safety inputs and outputs are configured by having a set of two input modules (RX40NC6B) and two output modules (RY40PT5B) with diagnostic functions.

B SIL 2-compliant analog input

SIL 2-compliant analog inputs are configured by having four modules in total. This consists of two analog input modules (R60AD8-G) with channel isolation, one analog output module (R60DA8-G) with channel isolation, and one digital output module (RY40PT5B) with diagnostic functions. The resulting digital value is verified with the calculated digital value.

C SIL 2-compliant analog output

SIL 2-compliant analog outputs are configured to have three modules in total. This consists of one analog output module (R60DA8-G) with channel isolation, one analog input module (R60AD8-G) with channel isolation, and one SIL2 analog control output module (RY40PT5B-AS). The resulting analog output value is verified with the set value.

System configuration
CPU
I/O
Analog
Motion, Positioning, Flexible high-speed I/O, High-speed counter
Network
Advanced information
Software

Process CPU module specifications

Item	R08PCPU	R16PCPU	R32PCPU	R120PCPU	R08PSFCPU -SET*1	R16PSFCPU -SET*1	R32PSFCPU -SET*1	R120PSFCPU -SET*1
Control method	Stored program cyclic operation							
I/O control mode	Refresh mode (Direct access I/O is available by specifying direct access I/O (DX, DY))							
Programming language	Ladder diagram (LD), structured text (ST)*2, function block diagram (FBD)*2, sequential function chart (SFC)*2*3							
Extended programming language	Function block (FB), label programming (system/local/global)							
Program execution type	Initial*2, scan*2, fixed scan, interrupt*2, standby*2							
Number of I/O points [X/Y](point)	4096	4096	4096	4096	4096	4096	4096	4096
Constant scan (ms) (Function for keeping regular scan time)	0.2...2000 (Setting available in 0.1 ms increments)							
Memory capacity								
Program capacity (step)	80K	160K	320K	1200K	80K*4	160K*4	320K*4	1200K*4
Program memory (byte)	320K	640K	1280K	4800K	320K	640K	1280K	4800K
Device/label memory (ECC type)*5 (byte)	1188K	1720K	2316K	3380K	1178K	1710K	2306K	3370K
Data memory (byte)	5M	10M	20M	40M	5M	10M	20M	40M
Instruction processing time								
LD instruction (ns)	0.98	0.98	0.98	0.98	0.98	0.98	0.98	0.98
MOV instruction (ns)	1.96	1.96	1.96	1.96	1.96	1.96	1.96	1.96
E + instruction (floating-point addition) (ns)	9.8	9.8	9.8	9.8	9.8	9.8	9.8	9.8
Structured text IF instruction*6 (ns)	1.96	1.96	1.96	1.96	1.96	1.96	1.96	1.96
Structured text FOR instruction*6 (ns)	1.96	1.96	1.96	1.96	1.96	1.96	1.96	1.96
PC MIX value*7 (instructions/μs)	419	419	419	419	419	419	419	419
Interface connection port								
High-speed USB2.0 (miniB)	●	●	●	●	●	●	●	●
Ethernet (100BASE-TX/10BASE-T)	●	●	●	●	●	●	●	●
Memory interface*8								
SD memory card	●	●	●	●	●	●	●	●
Extended SRAM cassette	●	●	●	●	●	●	●	●
Safety standard								
IEC 61508 SIL 2	-	-	-	-	●	●	●	●
Function*9								
Multiple interrupt	●	●	●	●	●	●	●	●
Standard PID control	●	●	●	●	●	●	●	●
Process control	●	●	●	●	●	●	●	●
Data logging	●	●	●	●	-	-	-	-
Security function	●	●	●	●	●	●	●	●
Inter-modular synchronization*10	●	●	●	●	-	-	-	-
SLMP communication	●	●	●	●	●	●	●	●
Online module change	●	●	●	●	●	●	●	●

*1: Product package includes a SIL2 process CPU (R□PSFCPU) and SIL2 function module (R6PSFM).

*2: Only for executing generic control programs.

*3: SFC programming language is not supported when the process CPU is used in redundant mode (future support).

*4: Program capacity of 40K steps is allocated for safety program.

*5: Extended SRAM cassette expands the device/label memory area. (NZ2MC-8MBSE expands the device/label memory area conforming to ECC type memory.)

*6: The IF or FOR sentence of the structured text consists of several instructions, which may increase the processing time period.

*7: Average number of instructions such as for basic instructions and data processing executed in 1 μs. The larger the value, the faster the processing speed.

*8: For more information please refer to the SD memory card and SRAM cassette specifications on page 33.

*9: Memory dump and real-time monitor are not supported.

*10: Inter-modular synchronization is not supported when used in redundant mode.

Redundant function module specifications

Item	R6RFM
Communication cable	Multi-mode optical cable
Max. distance (m)	550 (when the core outer diameter is 50 μm)
Tracking cable data capacity (word)	1M

Safety CPU

R08SFCPU-SET

Program capacity 80K steps

R16SFCPU-SET

Program capacity 160K steps

R32SFCPU-SET

Program capacity 320K steps

R120SFCPU-SET

Program capacity 1200K steps



System configuration
CPU
I/O
Analog
Motion, Positioning, Flexible high-speed I/O, High-speed counter
Network
Advanced information
Software

R□SFCPU-SET includes both modules as shown above

The safety CPU module enables control of both generic and safety programs in the same module and is easily programmed utilizing the intuitive features of GX Works3. Compliant with internationally recognized safety standards, the safety CPU enables safety devices such as safety light curtains, emergency switches, and door switches to be connected via the CC-Link IE Field network without requiring a separate dedicated network line. The safety CPU is easily programmed using GX Works3, and utilizes its intuitive features.

Generic and safety control in one CPU

The safety CPU can be installed directly on the MELSEC iQ-R Series base rack, and is easily integrated into an existing or new control system. Safety devices are connectable using the CC-Link IE Field network with safety communication integrated into the network protocol over a widely-available industrial Ethernet topology. The safety CPU is compliant with ISO 13849-1 PL e and IEC 61508 SIL 3 and is certified by TÜV Rheinland®.

Common engineering platform

In GX Works3, operation and safety programs are included in the same project folder, eliminating the need to manage multiple project folders. Various useful features of GX Works3 are also available for safety programs similar to other control programs.

The screenshot shows the GX Works3 interface with several callouts pointing to specific features:

- Safety CPU integrated into main system configuration:** Points to the 'Safety CPU' icon in the main system configuration window.
- Manage program files for safety control on GX Works3:** Points to the 'Program Files' folder in the project tree.
- Integrated safety CPU parameters:** Points to the 'Safety Parameters' folder in the project tree.
- Safety devices easily recognized as appended with "SA":** Points to a device labeled 'SA' in the ladder logic diagram.

Faster response times and handling of larger programs

Utilizing the high-performance capabilities of the MELSEC iQ-R Series and CC-Link IE Field network, productivity is enhanced as response times are even faster. Additionally, safety control program capacity has been increased by up to three times, to 40K steps, enabling the control of more complex programs.

■ Safety control response time

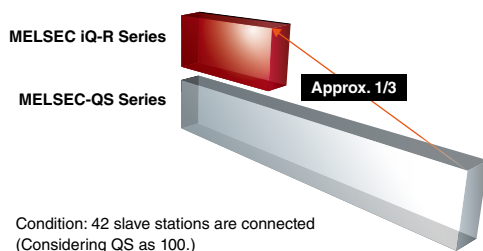

■ Safety program size

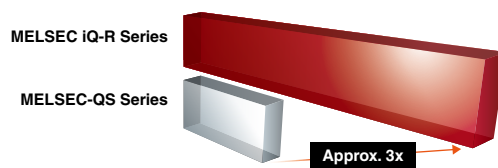

Safety CPU performance specifications

Item	R08SFCPU-SET*1	R16SFCPU-SET*1	R32SFCPU-SET*1	R120SFCPU-SET*1
Safety integrity level (SIL)	SIL 3 (IEC 61508)			
Performance level (PL)	PL e (EN/ISO 13849-1)			
Control method	Stored program cyclic operation			
I/O control mode	Refresh mode (Direct access I/O is available by specifying direct access I/O (DX, DY))			
Programming language	Ladder diagram (LD), structured text (ST)*2, function block diagram (FBD)*2			
Extended programming language	Function block (FB), label programming (local/global)			
Program execution type	Initial*2, scan*2, fixed scan, interrupt*2, standby*2			
Memory capacity				
Program capacity (step)	80K (40K for safety programs)	160K (40K for safety programs)	320K (40K for safety programs)	1200K (40K for safety programs)
Program memory (byte)	320K	640K	1280K	4800K
Device/label memory*3 (byte)	1178K	1710K	2306K	3370K
Data memory (byte)	5M	10M	20M	40M
SLMP communication	●	●	●	●

*1: Product package includes a safety CPU(R□SFCPU) and safety function module (R6SFM).

*2: Only for executing generic control programs.

*3: An extended SRAM cassette expands the device/label memory area.

C Controller Module
R12CCPU-V
 Memory capacity 256 MB

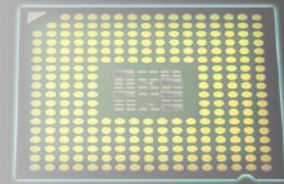

System configuration

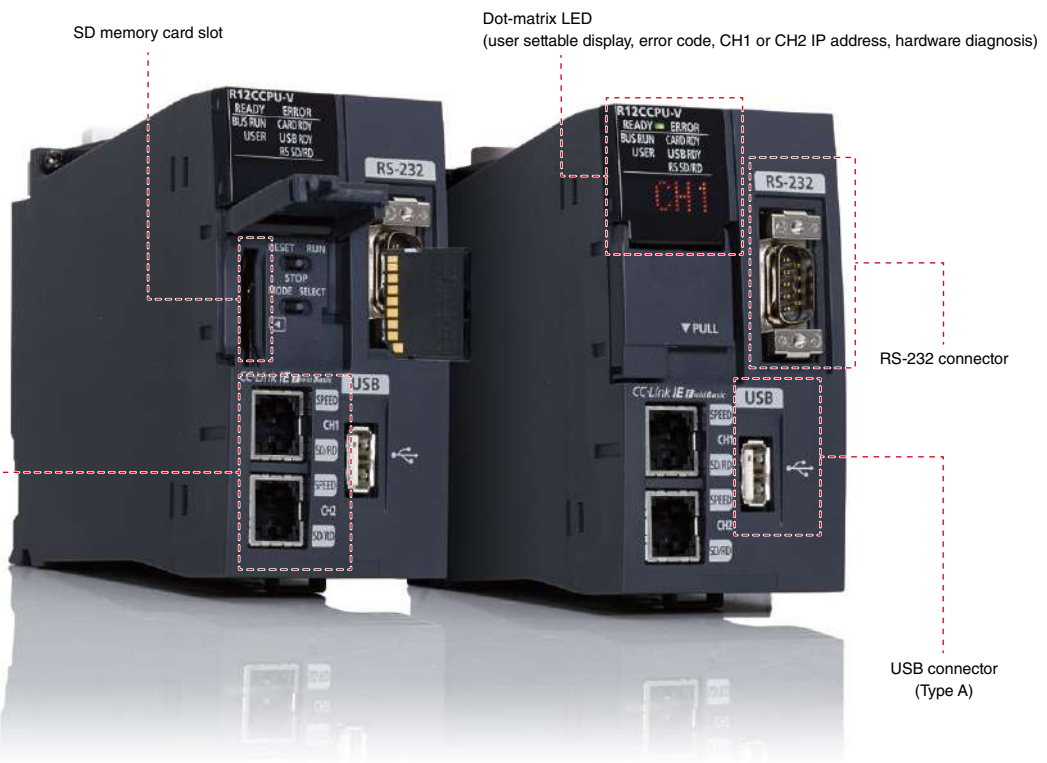

CPU

I/O

Analog

Motion, Positioning,
Flexible high-speed I/O
High-speed counter

Network

Advanced information

Software

The C Controller module is part of the application-specific range in the MELSEC iQ-R Series. The multi-core ARM®-based controller pre-installed with VxWorks® Version 6.9, realizes the simultaneous execution of programs, thereby providing a robust and deterministic alternative to computer based systems. Utilizing a fan-less hardware design, the C Controller is ideal for clean fab-based applications where dust circulation can be detrimental to the production environment. The C Controller utilizes the high-performance, flexible, and robust features of the MELSEC iQ-R Series to provide an industrial-grade automation control system.

Easy setup using three simple tools

Setup of the C Controller couldn't be simpler as the CPU is shipped with a pre-installed real-time OS with various drivers embedded. This eliminates the need to setup and install a separate OS and develop drivers, which can substantially add to the cost of implementation. The C Controller allows C language programming by using CW Workbench programming software, easy configuration using MELSOFT CW Configurator, and VxWorks® emulation using CW-Sim.

Programming without considering MPU

C Controller dedicated functions (CCPU functions) and MELSEC communication functions (MD functions) realize easy access to the C Controller, I/O, intelligent function, network, and programmable controller/motion CPU modules. Applications involving programmable controllers can be easily created using these functions.



Easy access to modules using dedicated functions

Parameter setup/diagnosis/monitoring with CW Configurator

CW Configurator enables parameter setup, module diagnosis and monitoring of various MELSEC iQ-R/Q Series intelligent, network and I/O modules*1 including the C Controller module. Using CW Configurator is as easy as using the MELSEC iQ-R engineering software GX Works3, which shares similar interfaces.

*1: For supported modules, please refer to the relevant manual of that module.

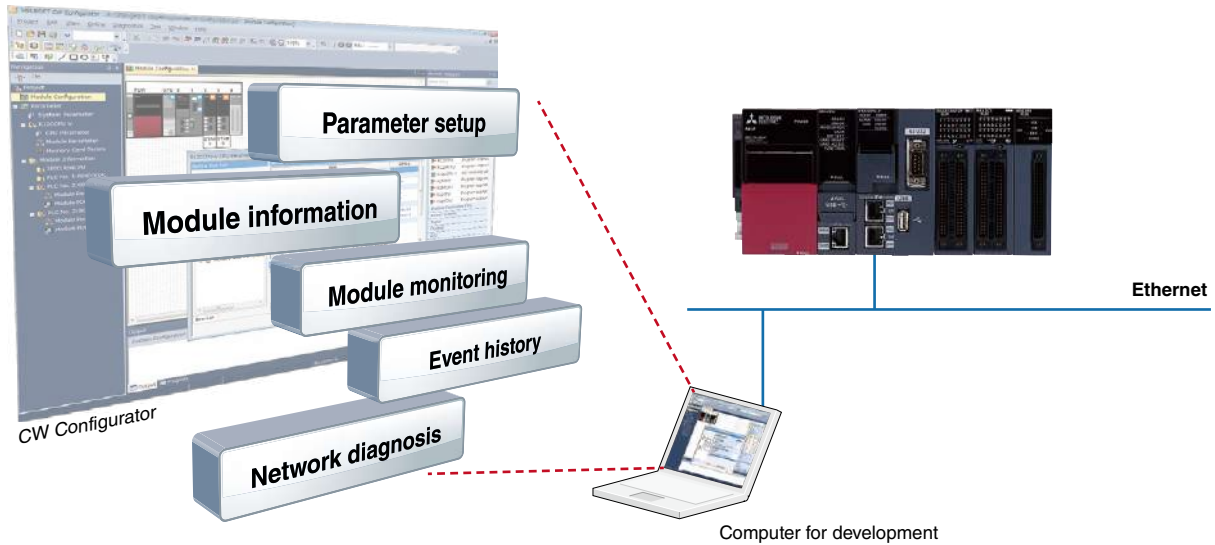

Application development in simple steps

Developing applications with the MELSEC C Controller is easy as no additional driver development is required, whilst providing a full-scale embedded development environment at a relatively low cost. CW Workbench is used as the main programming software in C/C++ with a VxWorks® emulator, CW-Sim/CW-Sim standalone, which allows debugging without requiring any hardware.

**No need to generate OS or drivers.
This program does it all.**

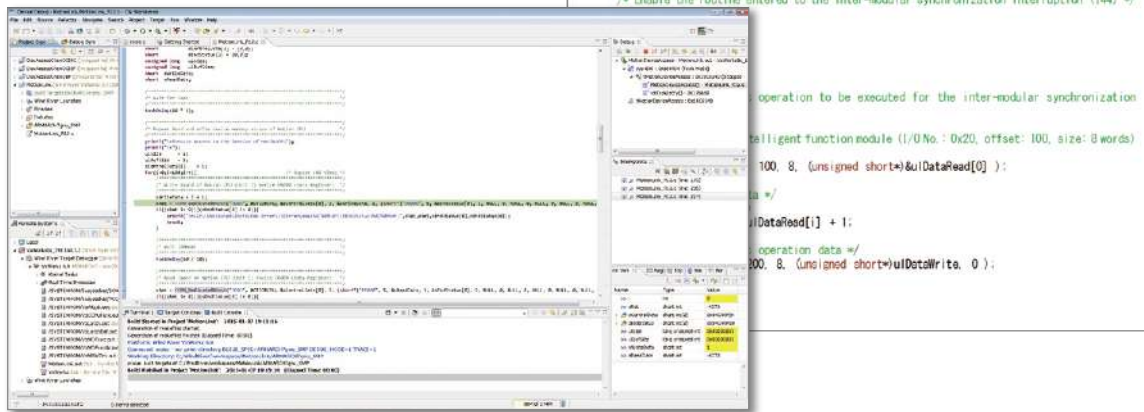

Engineering tool for C Controller
CW Workbench

C Controller module specifications

Item	R12CCPU-V
Hardware	
Endian format	Little endian
MPU	ARM® Cortex-A9 Dual Core
Working RAM	256 MB
ROM	16 MB
Backup RAM	4 MB
Software	
OS	VxWorks® Version 6.9
Programming language	C language (C/C++)
Programming development environment	CW Workbench/Wind River Workbench3.3
C Controller module setting/monitoring tool	CW Configurator (SW1DND-RCCPU)
Communication interface	
USB	●
Ethernet	2CH (1000BASE-T/100BASE-TX/10BASE-T)
RS-232	1CH (9600...115200 bps)
SD memory card slot	●

System configuration

CPU

I/O

Analog

Motion, Positioning,
Flexible high-speed I/O,
High-speed counter

Network

Advanced information

Software

Digital I/O modules are the senses of the automation system and provide an interface of various processes to the controller. Devices such as switches, indicator lamps, and sensors can be easily connected to the control system. The high-density terminal connections (up to 64 points) results in space-saving designs within the control cabinet further reducing installation costs. In addition, input interrupt functions and output relay health diagnosis are additional features embedded in this intelligent, yet small, compact module.



Focus points

- ▶ Input/output rating is printed at the front, reducing incorrect wiring
- ▶ Easy-to-use cable tie hook for tidy wiring*1
- ▶ Existing 16-point terminal blocks are reusable, eliminating rewiring
- ▶ Spring-clamp terminal block reduces wiring and maintenance tasks
- ▶ Simple confirmation by product serial no. printed on the front
- ▶ Alternating toggle switch used to display between 32-point LED signals*2
- ▶ Terminal signals are clearly labeled and color-coded*1
- ▶ Up to 32 LED signals clearly visible

*1: Related to 16-point type modules

*2: Related to 64-point type modules

Clear and easily legible

White and red labels clearly differentiate the input and output modules from each other, further improving safety awareness. The LED signal displays also labeled with clearly visible and easy to read I/O signal numbers printed on the cover. The wiring terminals of the 16-point modules are labeled with signal names, further reducing the possibility of wiring mistakes. Up to 32 LED signals can be displayed at one time, and a toggle switch enables alternation between the first- and second-half signal displays for the high-density 64-point modules. The input and output ratings are also clearly printed on the front and the serial number is at the bottom, making it easy to confirm product model and version.

Simple wiring and high-density I/O

I/O modules are available in a wide range of densities (16-, 32- and 64-points) depending on the I/O requirements and minimum use of space in the control cabinet. Modules with a screw terminal block, 40-pin connector or spring-clamp terminal block are available for high-density I/O wiring. The spring-clamp terminal block does not require any screws eliminating the need for tightening of screws or using a dedicated tool, reducing wiring and maintenance.

Input Modules

AC input

RX28

8 points
100 to 240 V AC (50/60 Hz)

RX10

16 points
100 to 120 V AC (50/60 Hz)

RX10-TS **NEW**

16 points
100 to 120 V AC (50/60 Hz)
Spring-clamp type

DC input

RX40C7

16 points
24 V DC, 7.0 mA

RX40C7-TS **NEW**

16 points
24 V DC, 7.0 mA
Spring-clamp type

DC input

RX41C4

32 points
24 V DC, 4.0 mA

RX41C4-TS **NEW**

32 points
24 V DC, 4.0 mA
Spring-clamp type

RX42C4

64 points
24 V DC, 4.0 mA

RX70C4 **NEW**

16 points
5 V DC, 1.7 mA; 12 V DC, 4.8 mA

RX71C4 **NEW**

32 points
5 V DC, 1.7 mA; 12 V DC, 4.8 mA

RX72C4 **NEW**

64 points
5 V DC, 1.7 mA; 12 V DC, 4.8 mA

DC high-speed input

RX40PC6H

16 points 24 V DC, 6.0 mA
Positive common type

RX40NC6H

16 points 24 V DC, 6.0 mA
Negative common type

RX41C6HS

32 points 24 V DC, 6.0 mA
Positive/negative common shared

RX61C6HS

32 points 5 V DC, 6.0 mA
Positive/negative common shared

DC input (with diagnostic functions)

RX40NC6B

16 points 24 V DC, 6.0 mA
Negative common type

Digital input modules like the 24 V direct-current (DC) power supply are among the most used input signals in the control industry. The robust design of the various modules in this diversified lineup makes them ideal for industrial use.

Multiple features integrated

A single MELSEC iQ-R input module can handle input response devices as fast as 0.1 ms, interrupt input devices and can be wired using either positive or negative (sink or source) common terminals. Since multiple modules are no longer required, a substantial reduction in overall footprint of up to 20% and a reduction in total system costs of up to 60% can be realized.

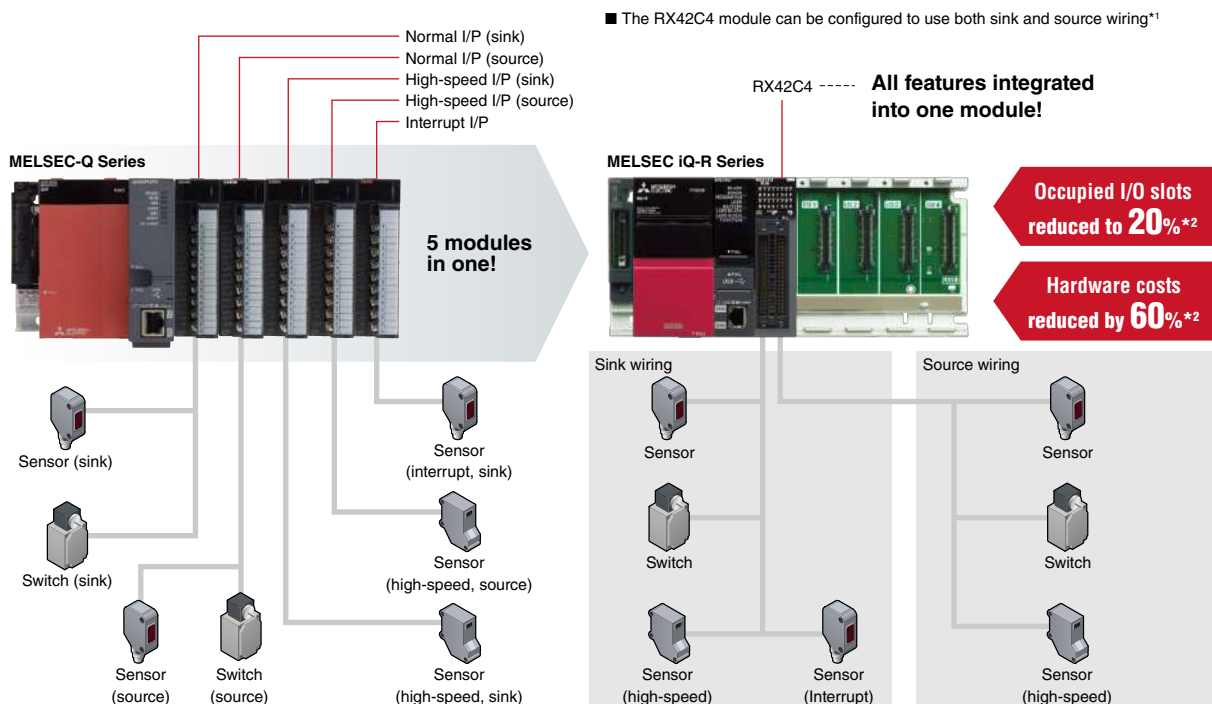

*1: The RX42C4 module can be configured to use both sink and source wiring (between the left and right sides of 32 point terminal).

*2: Based on a comparison with the MELSEC-Q Series

System configuration

CPU

I/O

Analog

Motion, Positioning, Flexible high-speed I/O, High-speed counter

Network

Advanced information

Software

Reduce downtime with disconnection detection

Similar to analog modules, the MELSEC iQ-R Series input module (with diagnostic functions) includes input disconnection detection which enables detection of inputs directly on the I/O module. When an error occurs, the control system can quickly highlight the fault via a monitoring system or on GX Works3 programming software, reducing system downtime and loss of production.

Input module specifications

Item	AC input		
	RX28	RX10	RX10-TS
Number of input points	8	16	16
Rated input voltage, frequency	100...240 V AC, 50/60 Hz	100...120 V AC, 50/60 Hz	100...120 V AC, 50/60 Hz
Rated input current (mA)	16.4 (200 V AC, 60 Hz) 13.7 (200 V AC, 50 Hz) 8.2 (100 V AC, 60 Hz) 6.8 (100 V AC, 50 Hz)	8.2 (100 V AC, 60 Hz) 6.8 (100 V AC, 50 Hz)	8.2 (100 V AC, 60 Hz) 6.8 (100 V AC, 50 Hz)
Response time (ms)	≤ 20	≤ 20	≤ 20
Common terminal arrangement (points/common)	8	16	16
Interrupt function	●	●	●
External interface*1			
18-point screw terminal block	●	●	-
Spring-clamp terminal block	-	-	●

Item	DC input							
	RX40C7	RX40C7-TS	RX41C4	RX41C4-TS	RX42C4	RX70C4	RX71C4	RX72C4
Number of input points	16	16	32	32	64	16	32	64
Rated input voltage (V DC)	24	24	24	24	24	5/12	5/12	5/12
Rated input current (mA, TYP.)	7.0	7.0	4.0	4.0	4.0	1.7 (5 V DC) 4.8 (12 V DC)	1.7 (5 V DC) 4.8 (12 V DC)	1.7 (5 V DC) 4.8 (12 V DC)
Response time (ms)	0.1...70	0.1...70	0.1...70	0.1...70	0.1...70	0.1...70	0.1...70	0.1...70
Common terminal arrangement (points/common)	16	16	32	32	32	16	32	32
Interrupt function	●	●	●	●	●	●	●	●
External interface*1								
18-point screw terminal block	●	-	-	-	-	●	-	-
40-pin connector	-	-	●	-	● (2x)	-	●	● (2x)
Spring-clamp terminal block	-	●	-	●	-	-	-	-

Item	DC high-speed input				DC input (with diagnostic functions)
	RX40PC6H	RX40NC6H	RX41C6HS	RX61C6HS	RX40NC6B
Number of input points	16	16	32	32	16
Rated input voltage (V DC)	24	24	24	5	24
Rated input current (mA)	6.0	6.0	6.0	6.0	6.0
Response time	5 μs...70 ms	5 μs...70 ms	1 μs...70 ms	1 μs...70 ms	1 ms...70 ms
Common terminal arrangement (points/common)	8 (positive common)	8 (negative common)	32 (positive/negative common)	32 (positive/negative common)	16 (negative common)
Interrupt function	●	●	●	●	●
SIL 2-compliant	-	-	-	-	●*2
Diagnostic function*3					
Disconnection detection	-	-	-	-	●
External interface*1					
18-point screw terminal block	●	●	-	-	●
40-pin connector	-	-	●	●	-

*1: For more information about external interface (for applicable options, please refer to the relevant product manual), please refer to the options list on page 103.

*2: When used together with a SIL 2 redundant control system (SIL 2 is supported in the module firmware version of "02" or later).

*3: For more information about diagnostic functions, please refer to the relevant product manual.

Output Modules

Relay output

RY18R2A

8 points
24 V DC, 240 V AC

RY10R2

16 points
24 V DC, 240 V AC

RY10R2-TS NEW

16 points
24 V DC, 240 V AC
Spring-clamp type

Triac output

RY20S6

16 points
100 to 240 V AC

Transistor (sink) output

RY40NT5P

16 points
12 to 24 V DC, 0.5 A

RY40NT5P-TS NEW

16 points
12 to 24 V DC, 0.5 A
Spring-clamp type

RY41NT2P

32 points
12 to 24 V DC, 0.2 A

RY41NT2P-TS NEW

32 points
12 to 24 V DC, 0.2 A
Spring-clamp type

RY42NT2P

64 points
12 to 24 V DC, 0.2 A

Transistor (source) output

RY40PT5P

16 points
12 to 24 V DC, 0.5 A

RY40PT5P-TS NEW

16 points
12 to 24 V DC, 0.5 A
Spring-clamp type

RY41PT1P

32 points
12 to 24 V DC, 0.1 A

RY41PT1P-TS NEW

32 points
12 to 24 V DC, 0.1 A
Spring-clamp type

RY42PT1P

64 points
12 to 24 V DC, 0.1 A

High-speed transistor (sink) output

RY41NT2H

32 points
5 to 24 V DC, 0.2 A

High-speed transistor (source) output

RY41PT2H

32 points
5 to 24 V DC, 0.2 A

Transistor-with diagnostic functions (source) output

RY40PT5B

16 points
24 V DC, 0.5 A

System configuration

A variety of digital output modules are available including relay, transistor sink (wired as positive common) and transistor source (wired as negative common). Load voltages include 240 V AC and 12 V to 24 V DC, with various current ratings.

Relay health diagnostics for preventive maintenance

Output modules (relay output and transistor-with diagnostic functions modules) keep track of how many times they're turned on and off. Utilizing this data, such as from embedded relay contacts in the relay output module or from relays connected externally to the transistor output module (with diagnostic functions), preventive maintenance can be carried out based on the known service of the relay.

Output module specifications

Item	Relay output			Triac output
	RY18R2A	RY10R2	RY10R2-TS	RY20S6
Number of output points	8	16	16	16
Rated switching voltage, current	24 V DC/2 A 240 V AC/2 A	24 V DC/2 A 240 V AC/2 A	24 V DC/2 A 240 V AC/2 A	100...240 V AC/0.6 A
Response time	≤ 12 ms	≤ 12 ms	≤ 12 ms	≤ 1 ms+0.5 cycle
Common terminal arrangement (points/common)	-	16	16	16
External interface*1				
18-point screw terminal block	●	●	-	●
Spring-clamp terminal block	-	-	●	-

Item	Transistor (sink) output					
	RY40NT5P	RY40NT5P-TS	RY41NT2P	RY41NT2P-TS	RY42NT2P	RY41NT2H
Number of output points	16	16	32	32	64	32
Rated load voltage (V DC)	12...24	12...24	12...24	12...24	12...24	5...24
Max. load current (A/point)	0.5	0.5	0.2	0.2	0.2	0.2
Response time	≤ 1 ms	≤ 1 ms	≤ 1 ms	≤ 1 ms	≤ 1 ms	≤ 2 μs
Common terminal arrangement (points/common)	16	16	32	32	32	32
Protection function (overload, overheat)	●	●	●	●	●	-
External interface*1						
18-point screw terminal block	●	-	-	-	-	-
40-pin connector	-	-	●	-	● (2x)	●
Spring-clamp terminal block	-	●	-	●	-	-

*1: For more information about external interface (for applicable options, please refer to the relevant product manual), please refer to the options list on page 103.

CPU

I/O

Analog

Motion, Positioning, Flexible high-speed I/O, High-speed counter

Network

Advanced information

Software

Output module specifications

Item	Transistor (source) output						Transistor- with diagnostic functions (source) output
	RY40PT5P	RY40PT5P-TS	RY41PT1P	RY41PT1P-TS	RY42PT1P	RY41PT2H	RY40PT5B
Number of output points	16	16	32	32	64	32	16
Rated load voltage (V DC)	12...24	12...24	12...24	12...24	12...24	5...24	24
Max. load current (A/point)	0.5	0.5	0.1	0.1	0.1	0.2	0.5
Response time	≤ 1 ms	≤ 1 ms	≤ 1 ms	≤ 1 ms	≤ 1 ms	≤ 2 μs	≤ 1.5 ms
Common terminal arrangement (points/common)	16	16	32	32	32	32	16
Protection function (overload, overheat)	●	●	●	●	●	-	●
SIL 2-compliant	-	-	-	-	-	-	●*1
Diagnostic function*2							
Output disconnection detection	-	-	-	-	-	-	●
Output short-circuit detection	-	-	-	-	-	-	●
External interface*3							
18-point screw terminal block	●	-	-	-	-	-	●
40-pin connector	-	-	●	-	● (2x)	●	-
Spring-clamp terminal block	-	●	-	●	-	-	-

*1: When used together with a SIL 2 redundant control system (SIL 2 is supported in the module firmware version of "02" or later).

*2: For more information about diagnostic functions, please refer to the relevant product manual.

*3: For more information about external interface (for applicable options, please refer to the relevant product manual), please refer to the options list on page 103.

I/O Combined Module

DC input, transistor (sink) output

RH42C4NT2P

32 points (input) 24 V DC, 4.0 mA
32 points (output) 12 to 24 V DC, 0.2 A



System configuration

In addition to dedicated digital input and output modules, if only a few I/O points are required, a combined I/O module is available. This is an excellent alternative for cost-sensitive applications.

CPU

I/O combined module specifications

Item	RH42C4NT2P
DC input	
Number of input points	32
Rated input voltage (V DC)	24
Rated input current (mA, TYP.)	4.0
Response time (ms)	0.1...70
Common terminal arrangement (points/common)	32
Interrupt function	●
Transistor (sink) output	
Number of output points	32
Rated load voltage (V DC)	12...24
Max. load current (A/point)	0.2
Response time (ms)	≤ 1
Common terminal arrangement (points/common)	32
Protection function (overload, overheat)	●
External interface*1	
40-pin connector	● (2x)

I/O

Analog

Motion, Positioning, Flexible high-speed I/O, High-speed counter

Network

Advanced information

Software

*1: For more information about external interface (for applicable options, please refer to the relevant product manual), refer to the options list on page 103.

Focus points

- ▶ 5 μ s high-speed sampling, 16-bit high resolution (1/32,000)
- ▶ Scaling and shifting operations using parameter settings
- ▶ Ideal for high-speed precision inspection applications
- ▶ Filtering of high-frequency noise
- ▶ Event driven performance asynchronous from main scan
- ▶ Generate or import pre-defined wave data
- ▶ Galvanic channel isolation
- ▶ Synchronization of multiple channels

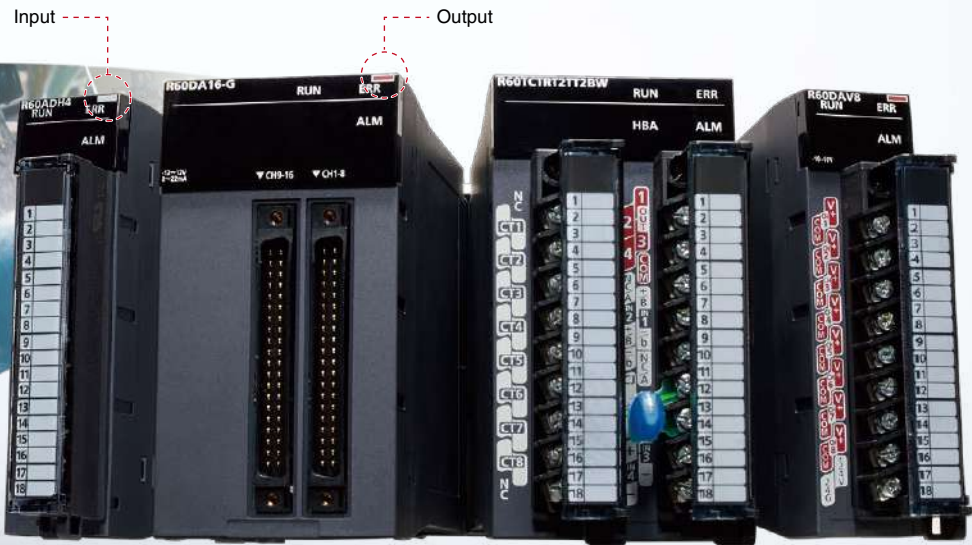

Similar to the digital I/O modules, analog modules are the main interface between the control process and the MELSEC iQ-R Series automation system. The main differences are that they have been designed to interface with sensors that process varying voltage and current signals instead of digital binary signals, and convert those signals into binary data that the control system can use. The MELSEC iQ-R Series range of analog modules includes features such as high-speed sampling (5 μ s/4CH) coupled with 16 bit high-resolution (1/32,000) digital output signals, simultaneous multi-channel conversion (no. of channels increased with inter-modular synchronization), galvanic channel isolation and disconnection detection, thereby enabling highly precise and stable analog signal processing.

Save on downtime cost with 'channel disconnection detection'

Channel input or output error threshold values are easily settable within GX Works3 ensuring the detection of disconnected channel(s), reducing downtime and saving on maintenance costs.

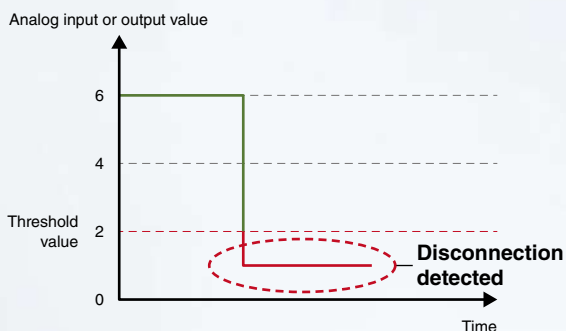

High signal integrity using galvanic isolation

The "-G" suffix modules include internal galvanic channel isolation that can improve noise interference capabilities without requiring an additional signal converter as well as protecting the internal module components from a short circuit.

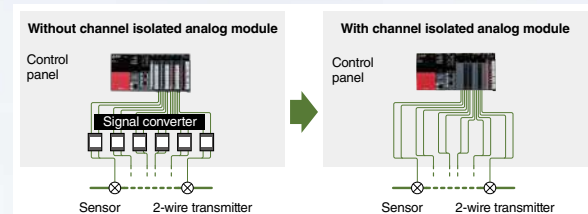

Electric disturbances such as current and noise can be isolated.

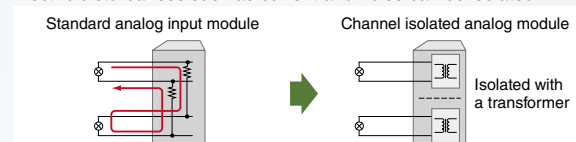

Analog Input Modules

R60AD4

4-channel (voltage or current)

R60ADV8

8-channel (voltage)

R60ADI8

8-channel (current)

R60AD8-G

8-channel (voltage or current), channel isolated

R60AD16-G

16-channel (voltage or current), channel isolated

R60TD8-G

8-channel, temperature input (thermocouple) channel isolated

R60RD8-G

8-channel, temperature input (RTD) channel isolated

R60ADH4

4-channel (voltage or current)

MELSEC iQ-R Series analog modules are ideal as the interface between external analog signals and the control system. Various modules are available to cover a wide range of requirements, such as galvanic isolation, thermocouple sensors, resistance temperature detectors (RTD), current, voltage and mixed channel applications.

High-frequency noise filtering

The analog modules include a first-order delay filter that eliminates high-frequency noise interference and improves the accuracy of input analog signals. This feature can be easily setup using the module's dedicated parameters, thereby improving the processing time as an additional setup program (ladder) is not required.

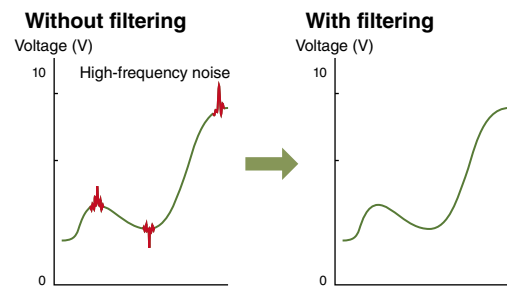
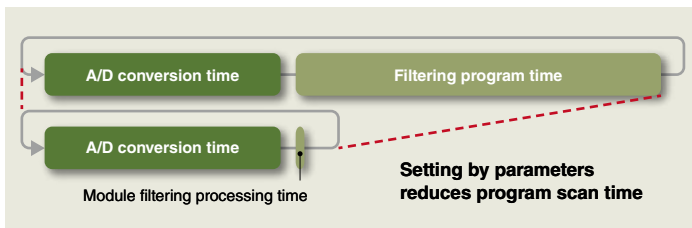

In-line level monitor

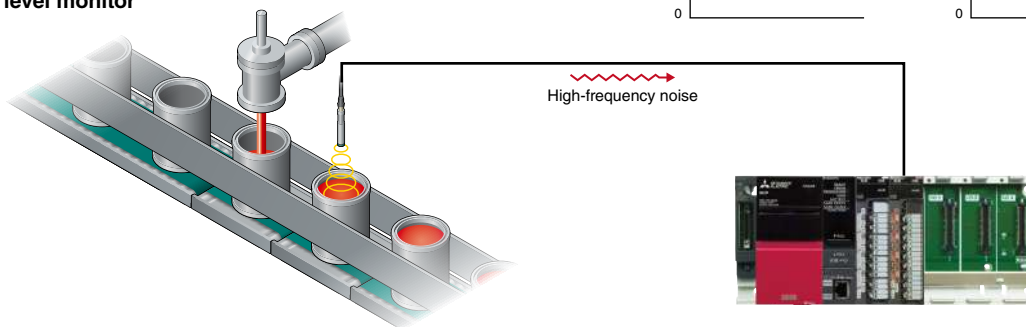

Enhanced alarm and warning features

Preventive maintenance procedures are simplified with the enhanced alarm and warning capabilities. Regardless of the program scan time, when an event such as the change rate of an analog signal exceeding the preset limit occurs, corrective interrupt procedures can be triggered or an alarm generated to notify responsible personnel or initiate proper countermeasures.

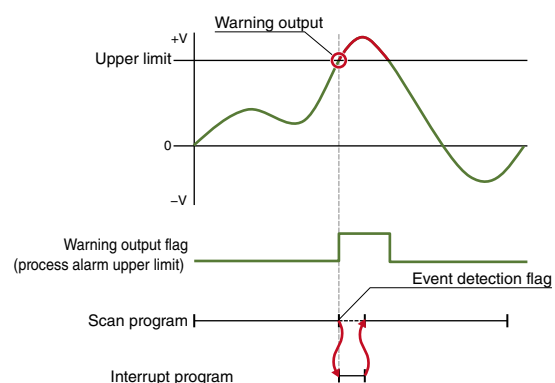

System configuration

CPU

I/O

Analog

Motion, Positioning, Flexible high-speed I/O, High-speed counter

Network

Advanced information

Software

Data logging faster than scan time

Analog modules are equipped with a data logging feature that's useful when a large amount of data (up to 10k points) is required within a specified period of time. Coupled with the high-speed analog-to-digital conversion time, event-driven triggers enable continuous logging even after an event occurrence and fast data logging sampling that is asynchronous to the control scan time. Data logging can be used in applications such as a motor inspection line, where motor performance can be logged at high speed and certain values such as voltage, current, torque and rotational speed analyzed through comparisons with different test patterns.

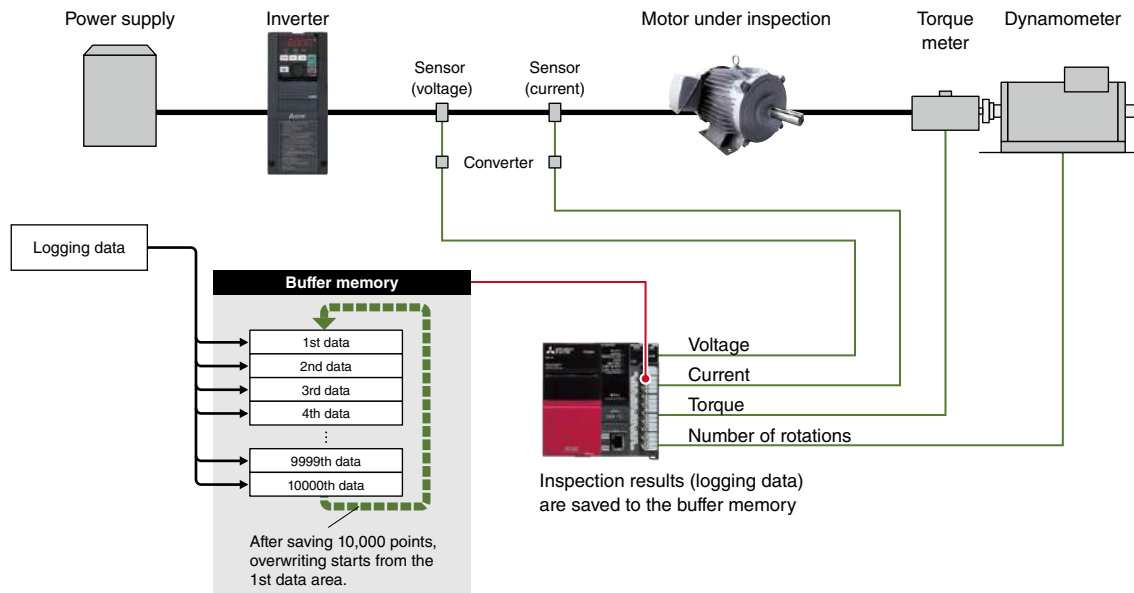

Scaling and shifting digital values without any programs

Scaling and shifting can be easily setup from only using the parameters. There is no need for additional programming, thereby realizing reductions in engineering costs and overall program size.

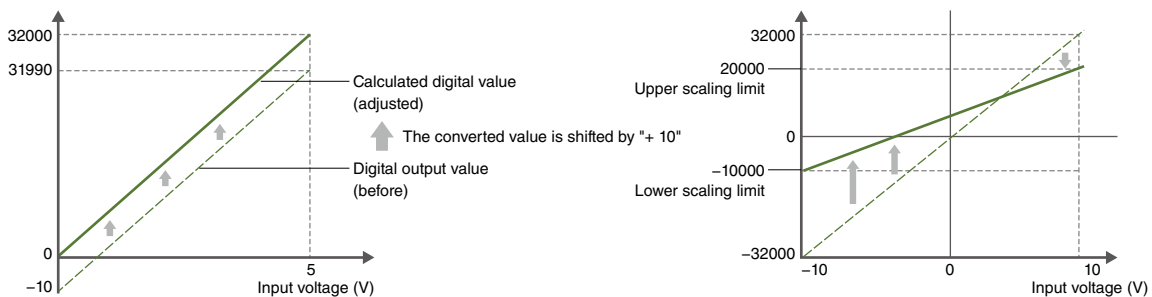

Upper and lower limits of scaling can range from -32000 to 32000.

Analog input module specifications

Item	R60AD4	R60ADV8	R60AD18	R60AD8-G	R60AD16-G
Number of analog input points (ch)	4	8	8	8	16
Accuracy					
Ambient temperature 25 ±5°C	±0.1%	±0.1%	±0.1%	±0.1%	±0.1%
Ambient temperature 0...55°C	±0.3%	±0.3%	±0.3%	-	-
Temperature coefficient	-	-	-	±35 ppm/°C	±35 ppm/°C
Common					
Conversion speed (ch)	80 μs	80 μs	80 μs	10 ms	10 ms
Channel isolation	-	-	-	Transformer isolation	Transformer isolation
Absolute max. input	±15 V, 30 mA	±15 V	30 mA	±15 V, 30 mA	±15 V, 30 mA
SIL 2-compliant	-	-	-	●*1	-
Voltage input					
Analog input voltage (V DC)	-10...10	-10...10	-	-10...10	-10...10
Digital output value	-32000...32000	-32000...32000	-	-32000...32000	-32000...32000
Current input					
Analog input current (mA DC)	0...20	-	0...20	0...20	0...20
Digital output value	0...32000	-	0...32000	0...32000	0...32000
External interface*2					
18-point screw terminal block	●	●	●	-	-
40-pin connector	-	-	-	●	● (2x)

System configuration

High-speed analog input module specifications

Item	R60ADH4
Number of analog input points (ch)	4
Accuracy	
Ambient temperature 25 ±5°C	±0.1%
Ambient temperature 0...55°C	±0.2%
Input specifications	
Operation mode (sampling cycle)	Normal mode (medium speed: 10 μs/CH) Normal mode (low speed: 20 μs/CH) Simultaneous conversion mode (5 μs/4CH)
Absolute max. input	±15 V, 30 mA
Voltage input	
Analog input voltage (V DC)	-10...10
Digital output value	-32000...32000
Current input	
Analog input current (mA DC)	0...20
Digital output value	0...32000
External interface*2	
18-point screw terminal block	●

CPU

I/O

Analog

Temperature input module specifications

Item	R60TD8-G	R60RD8-G
Number of analog input points (ch)	8	8
Cold junction temperature compensation accuracy	±1.0°C	-
Usable thermocouple	B, R, S, K, E, J, T, N	-
Usable RTD	-	Pt100, JPt100, Ni100, Pt50
Resolution	B, R, S, N: 0.3°C K, E, J, T: 0.1°C	0.1°C
Conversion speed (ch)	30 ms	10 ms
Channel isolation	Transformer isolation	Transformer isolation
Wire break detection	●	●
Output		
Measured temperature value (16-bit signed binary data)	-2700...18200	-2000...8500
Scaling value (16-bit signed binary data)	●	●
External interface*2		
40-pin connector	●	●

Motion, Positioning, Flexible high-speed I/O, High-speed counter

Network

Advanced information

Software

*1: When used together with a SIL 2 redundant control system (SIL 2 is supported in the module firmware version of "02" or later).

*2: For more information about external interface (for applicable options, please refer to the relevant product manual), refer to the options list on page 103.

Analog Output Modules

R60DA4

4-channel (voltage or current)

R60DAV8

8-channel (voltage)

R60DAI8

8-channel (current)

R60DA8-G

8-channel (voltage or current),
channel isolated

R60DA16-G

16-channel (voltage or current),
channel isolated

R60DAH4

4-channel (voltage or current)

RY40PT5B-AS **NEW**

16 points 24 V DC, 0.5 A
SIL2 analog control output

MELSEC iQ-R Series analog output modules reliably deliver accurate analog values to points where high-resolution digital inputs are required. A variety of modules (voltage, current, or mixed) are available to cover a wide range of application requirements, such as high-speed drive control or variable-speed control of the pressure applied to materials being fed into some kind of forming mechanism.

Faster, smoother predefined wave signal output

The analog output module enables pre-registration of waveforms easily using MELSOFT GX Works3, realizing a smoother continuous output that closely matches the precision required for the application, such as torque control for a press or injection molding machine. Registering the waveform in the module is simple and easy, and does not require a dedicated analog output program, such as for continuous line control, further reducing programming time.

GX Works3 wave output data setup

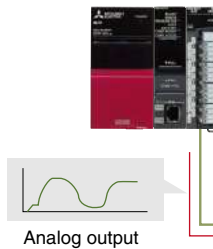
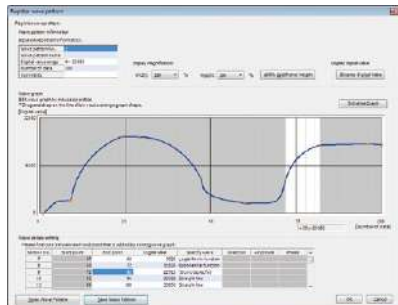

Pressure control of injection molding

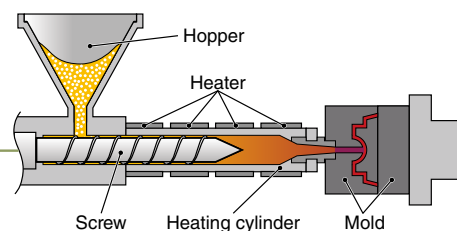

Shift operation and scaling without programs

Shift operation and scaling can be used without creating programs; they can be simply set on parameters. This simple setting minimizes program development cost as well as the program size.

Analog output module specifications

Item	R60DA4	R60DAV8	R60DAI8	R60DA8-G	R60DA16-G
Number of analog output points (ch)	4	8	8	8	16
Accuracy					
Ambient temperature 25 ±5°C	±0.1%	±0.1%	±0.1%	±0.1%	±0.1%
Ambient temperature 0...55°C	±0.3%	±0.3%	±0.3%	-	-
Temperature coefficient	-	-	-	±50 ppm/°C	±50 ppm/°C
Common					
Conversion speed (ch)	80 μs	80 μs	80 μs	1 ms	1 ms
Channel isolation	-	-	-	Transformer isolation	Transformer isolation
Output short-circuit protection	●	●	●	●	●
External supply power (V DC)	24	24	24	-	-
SIL 2-compliant	-	-	-	●*1	-
Voltage output					
Digital input value	-32000...32000	-32000...32000	-	-32000...32000	-32000...32000
Analog output voltage (V DC)	-10...10	-10...10	-	-12...12	-12...12
Current output					
Digital input value	0...32000	-	0...32000	0...32000	0...32000
Analog output current (mA DC)	0...20	-	0...20	0...20	0...20
External interface*2					
18-point screw terminal block	●	●	●	-	-
40-pin connector	-	-	-	●	● (2x)

System configuration

High-speed analog output module specifications

Item	R60DAH4
Number of channels	4
Accuracy	
Ambient temperature 25 ±5°C	±0.1%
Ambient temperature 0...55°C	±0.3%
Output specifications	
Operation mode	High-speed output mode (conversion speed: 1 μs/CH)
	Normal output mode (conversion speed: 10 μs/CH)
	Wave output mode (conversion speed: 20 μs/CH)
Voltage output	
Digital input value	-32000...32000
Analog output voltage (V DC)	-10...10
Current output	
Digital input value	0...32000
Analog output current (mA DC)	0...20
External interface*2	
18-point screw terminal block	●

CPU

I/O

Analog

SIL2 analog control output module specifications

Item	RY40PT5B-AS
Number of output points	16
Rated load voltage (V DC)	24
Max. load current (A/point)	0.5
Response time (ms)	≤ 1.5
Control cycle time (ms)	2
Common terminal arrangement (points/common)	16
External interface*2	
18-point screw terminal block	●

Motion, Positioning, Flexible high-speed I/O, High-speed counter

*1: When used together with a SIL 2 redundant control system (SIL 2 is supported in the module firmware version of "02" or later).

*2: For more information about external interface (for applicable options, please refer to the relevant product manual), please refer to the options list on page 103.

Network

Advanced information

Software

Temperature Control Modules

R60TCTRT2TT2

2-channel (multiple input) + 2-channel (thermocouple input)

R60TCRT4

4-channel (RTD input)

R60TCTRT2TT2BW

2-channel (multiple input) + 2-channel (thermocouple input)
With heater disconnection detection

R60TCRT4BW

4-channel (RTD input)
With heater disconnection detection



MELSEC iQ-R Series temperature control modules are ideal for applications requiring highly stable and responsive temperature control. The series comes with thermocouple and RTD input module types and are available with or without heater disconnection detection.

Controlled heating minimizes distortion in heating profile

Temperature fluctuations are attenuated at high speed through the external disturbance suppression function. This enables the preset temperature value to be maintained, ensuring a uniform heating profile not influenced by heating variations in the work. Due to its high-speed response capabilities, this function can be used in applications such as packaging machine sealing, injection molding, and for wafer plates in semiconductor manufacturing machines.

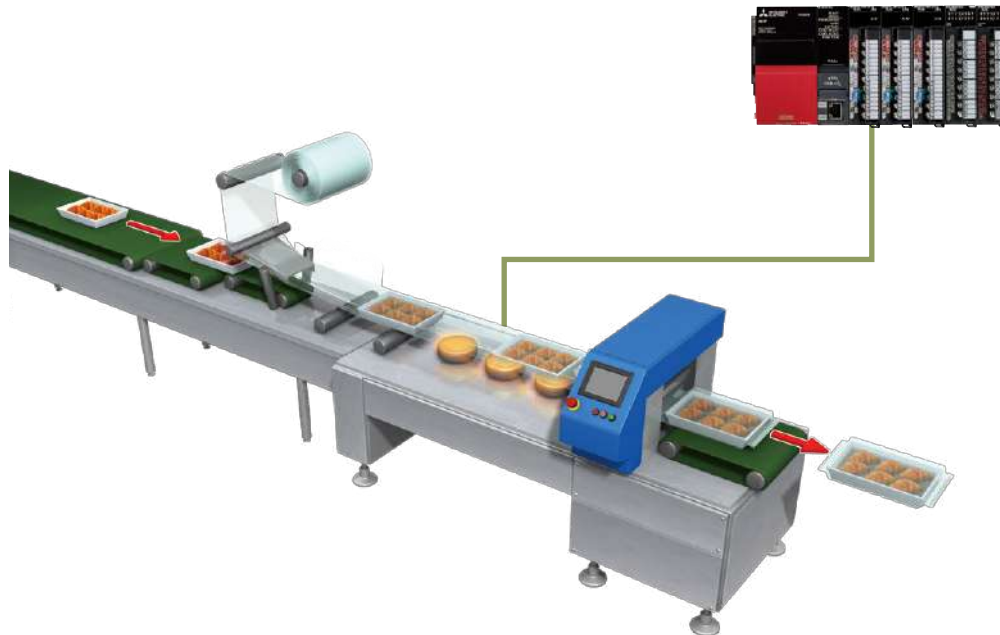

External disturbance suppression

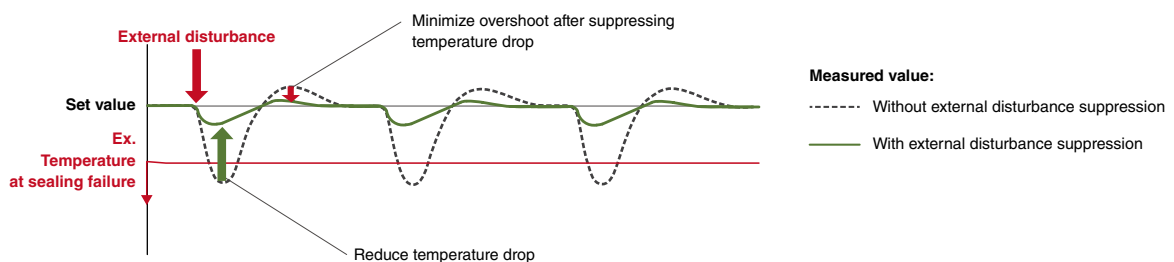

Coordination between multiple temperature control modules

Temperature control modules are equipped with features that enable coordination of up to 64 modules in one control system. The features that support this are as follows:

- Inter-module simultaneous temperature rise
- Inter-module peak current suppression

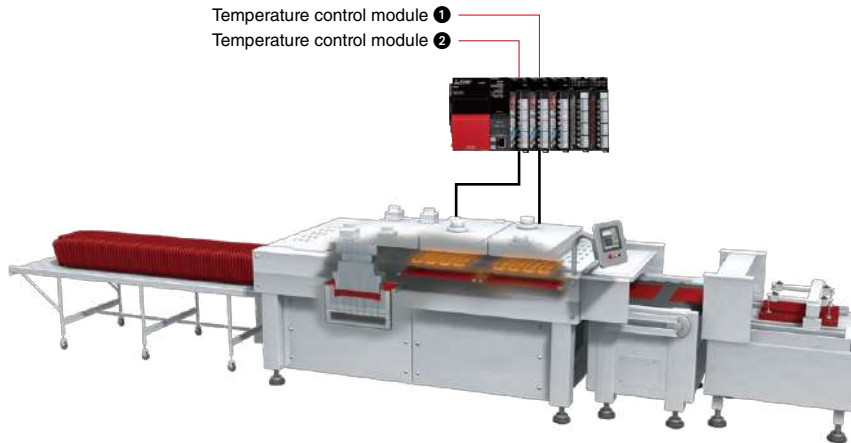

■ Inter-module simultaneous temperature rise

Temperature uniformity is realized by aligning the timing of multiple loops when reaching the set value, thereby bringing the temperature profile closer, ensuring a reduction in energy used controlled over multiple zones.

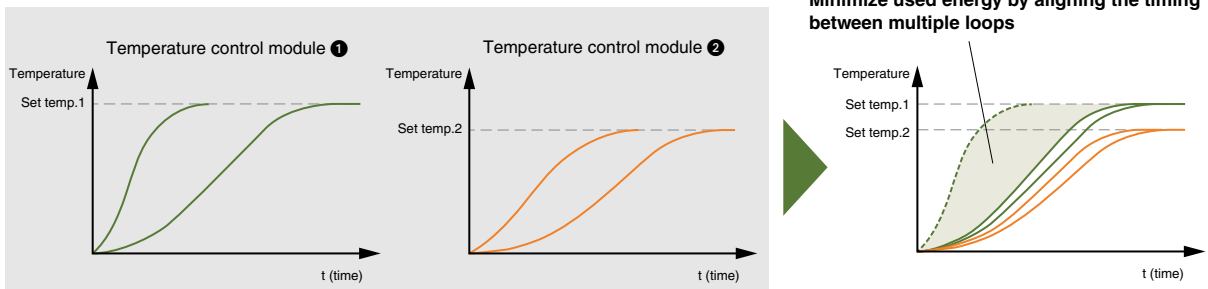

■ Inter-module peak current suppression

Peak current is reduced by spreading out the control output timing of transistors, thereby ensuring an energy-efficient power consumption cycle. High and low power usage periods are grouped together, realizing a lower peak current overall with up to five groups possible.

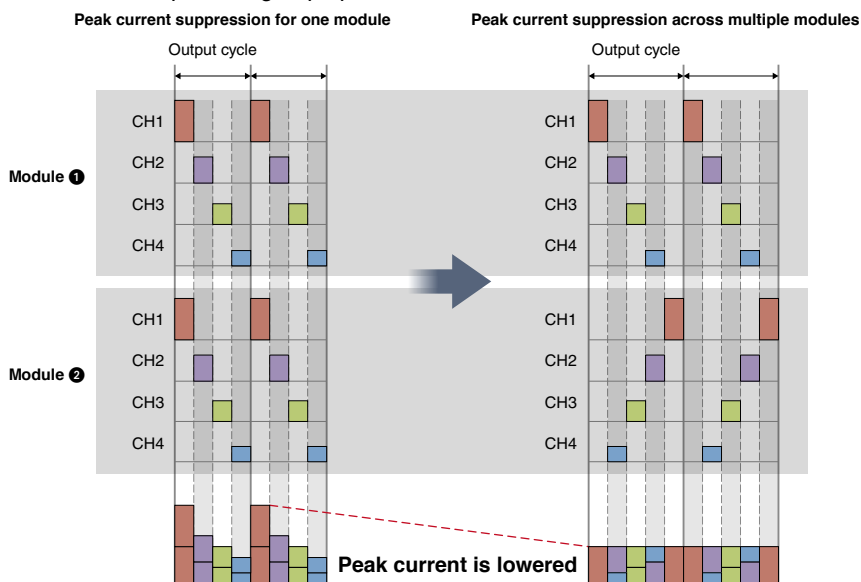

System configuration

CPU

I/O

Analog

Motion, Positioning, Flexible high-speed I/O, High-speed counter

Network

Advanced information

Software

Temperature trace realizing real-time temperature waveform monitoring

Setting parameters has been simplified when using the temperature trace feature of GX Works3. This simple-to-use feature enables tracing of various temperature values in real-time, helping to visualize the control performance while adjusting the parameters. Temperature values can also be exported as a CSV file.

Temperature waveform monitored in real-time

Adjust parameters against temperature waveform

Temperature trace window

Temperature data can be saved as a CSV file

Temperature control module performance specifications

Item	R60TCRT2T2	R60TCRT4	R60TCRT2T2BW	R60TCRT4BW
Number of analog input channels (ch)	4	4	4	4
Usable thermocouple	B, R, S, K, E, J, T, N, U, L, PL II, W5Re/W26Re	-	B, R, S, K, E, J, T, N, U, L, PL II, W5Re/W26Re	-
Usable RTD	Pt100, JPt100	Pt100, JPt100	Pt100, JPt100	Pt100, JPt100
Sampling cycle (4 ch, ms)	250/500	250/500	250/500	250/500
Control output cycle (s)	0.5...100.0	0.5...100.0	0.5...100.0	0.5...100.0
Input impedance (MΩ)	1	1	1	1
Input filter (0: Input filter OFF)	0...100 s	0...100 s	0...100 s	0...100 s
Sensor correction value setting	(-full scale of input range) to full scale of input range			
Operation at a sensor input disconnection	Upscale processing			
Temperature control method	PID ON/OFF pulse or two-position control			
Heater disconnection detection	-	-	●	●
Indication accuracy*1				
Ambient temperature 25±5°C	≤ ±0.3%	≤ ±0.3%	≤ ±0.3%	≤ ±0.3%
Ambient temperature 0...55°C	≤ ±0.7%	≤ ±0.7%	≤ ±0.7%	≤ ±0.7%
PID constants range	Setting by auto tuning is available.			
PID constants setting	<ul style="list-style-type: none"> When the input range unit is °C or °F: 0 (0.0)...full scale of input range (depending on the decimal point position) When the input range is another analog input unit: 0.0...1000.0% 			
Proportional band (P)	0...3600 s (Set 0 for P control and PD control.)			
Integral time (I)	0...3600 s (Set 0 for P control and PI control.)			
Derivative time (D)				
Transistor output				
Output signal	ON/OFF pulse	ON/OFF pulse	ON/OFF pulse	ON/OFF pulse
Rated load voltage (V DC)	10...30	10...30	10...30	10...30
Maximum load current (A)	0.1/point, 0.4/common	0.1/point, 0.4/common	0.1/point, 0.4/common	0.1/point, 0.4/common
Maximum inrush current	0.4 A, 10 ms	0.4 A, 10 ms	0.4 A, 10 ms	0.4 A, 10 ms
External interface*2				
18-point screw terminal block	●	●	● (2x)	● (2x)

*1: The accuracy is calculated in the following method. For details, please refer to the manual. (Only when it is not affected by noise.)

Accuracy (°C) = (full-scale) x (indication accuracy) x cold junction temperature compensation accuracy

*2: For more information about external interface (for applicable options, please refer to the relevant product manual), refer to the options list on page 103.



Focus points

- ▶ Wide range of modules for best-fit motion control needs
- ▶ Motion control programming simplified
- ▶ Software-based gear, shaft, transmission, and cam control
- ▶ 3-axis helical interpolation for large-diameter thread milling
- ▶ Normal, fast or multi-axis startup
- ▶ High-accuracy pulse measurement

MELSEC iQ-R Series simple motion, positioning, and high-speed counter modules are a distinct set of high-accuracy and fast control response intelligent modules that are ideal for applications requiring high-speed and precision.

Simple motion module

Simple motion modules are easy to setup similar to positional modules and offer high-precision motion controller performance. This is an easy-to-use module specifically designed for highly precise motion control applications, available with connection to either high-speed servo control network (SSCNET III/H) or CC-Link IE Field network depending on the model.

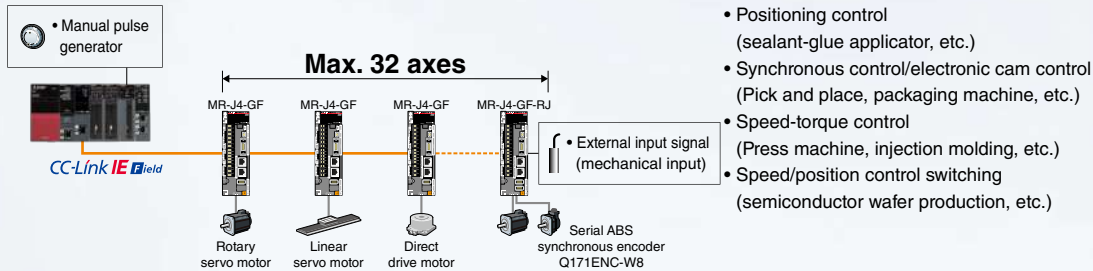

Positioning module

Capable of high-speed transmission (5M pulses/s*1), the positioning module can control up to four axes. This versatile module supports connection to a wide range of motion devices, such as pulse-train input servo amplifiers or stepping motor with a transistor (open collector), or differential driver input interface.

*1: Differential driver output

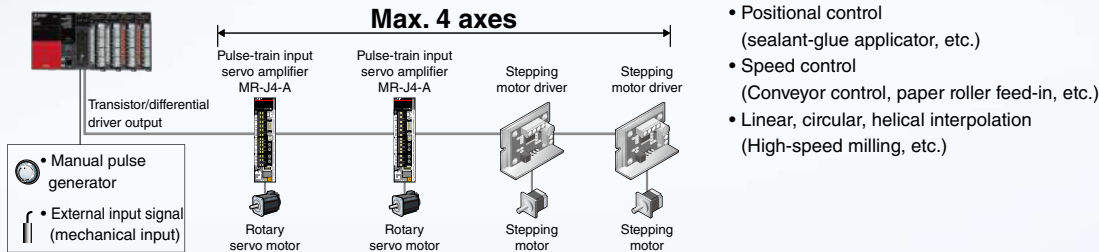

High-speed counter module

Capable of measurements at up to 8M pulses/s*2, the high-speed counter module is an ideal low-cost position control solution that provides precise positional tracking when used in combination with an incremental encoder.

*2: Differential input

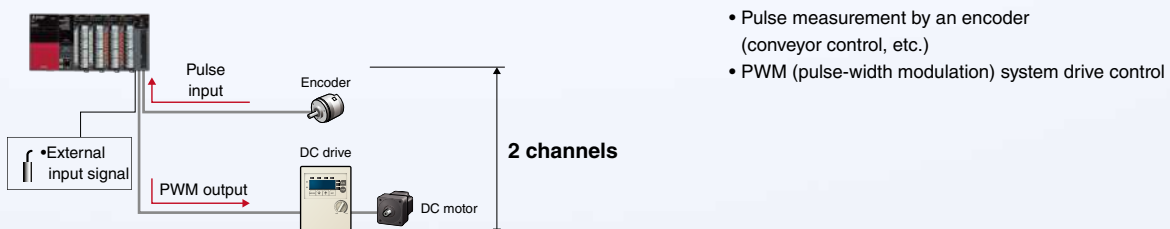

System configuration

CPU

I/O

Analog

Motion, Positioning, Flexible high-speed I/O, High-speed counter

Network

Advanced information

Software

Simple Motion Modules

Compatible with
CC-Link IE Field network

RD77GF4

Up to 4-axis control

RD77GF8

Up to 8-axis control

RD77GF16

Up to 16-axis control

RD77GF32

Up to 32-axis control

Compatible with
SSCNET III/H

RD77MS2

Up to 2-axis control

RD77MS4

Up to 4-axis control

RD77MS8

Up to 8-axis control

RD77MS16

Up to 16-axis control

Similar to positioning modules, simple motion modules are capable of a wide range of high-precision control such as positional control, advanced synchronous control, cam control, and speed-torque control. The module line-up includes 2-, 4-, 8-, 16-, and 32-axis models, with setup being done easily by parameters and programming.

Advanced synchronous control

Software-based synchronous control can be used as an alternative to mechanical control, such as gear, shaft, transmission and cam. In addition, cam control is even easier with cam auto-generation. Synchronous control can be simply operated (start/stop) for each axis, allowing synchronous and positional control axes within the same program.

■ Synchronous control

All axes are synchronized using a synchronous encoder or servo input axes. Up to 32 control axes can be synchronized when using the synchronous encoder, such as that used for packaging machines, for example.

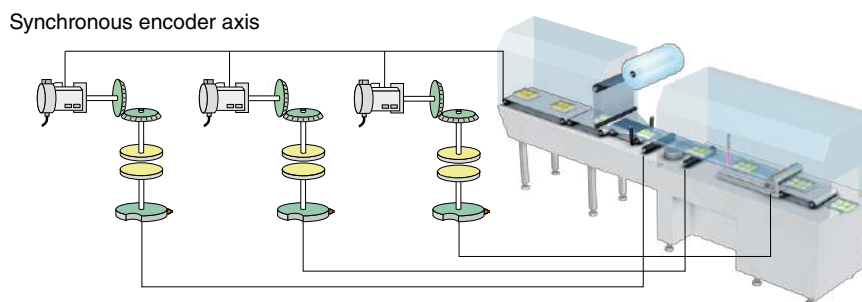

■ Cam auto-generation

Cam data for a rotary cutter can be generated automatically simply by registering the sheet length, synchronization width, rotary cutter axis dimensions, etc.

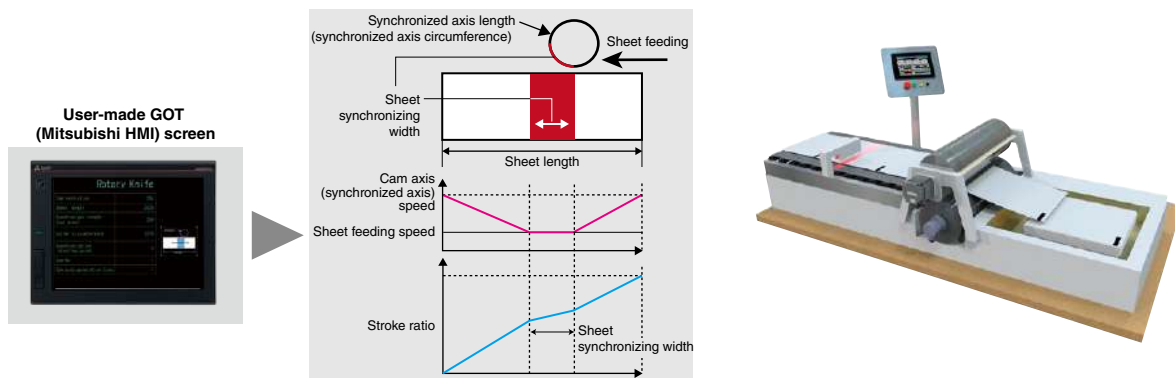

Mark detection

The actual position of the servo motor can be obtained based on the registration mark printed on the high-speed moving film. Compensation of the cutter axis position, based on the registration marks, keeps the constant cutting position.

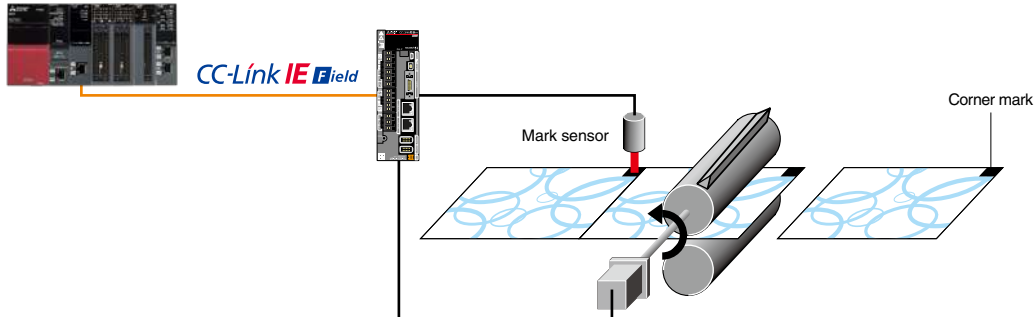

Speed-torque control (press-fit control)

The motor can be switched to torque control (press-fit mode) without stopping it during positioning. The current position is controlled during the speed/torque control. Therefore the positioning can be done smoothly even after switching back to position control.

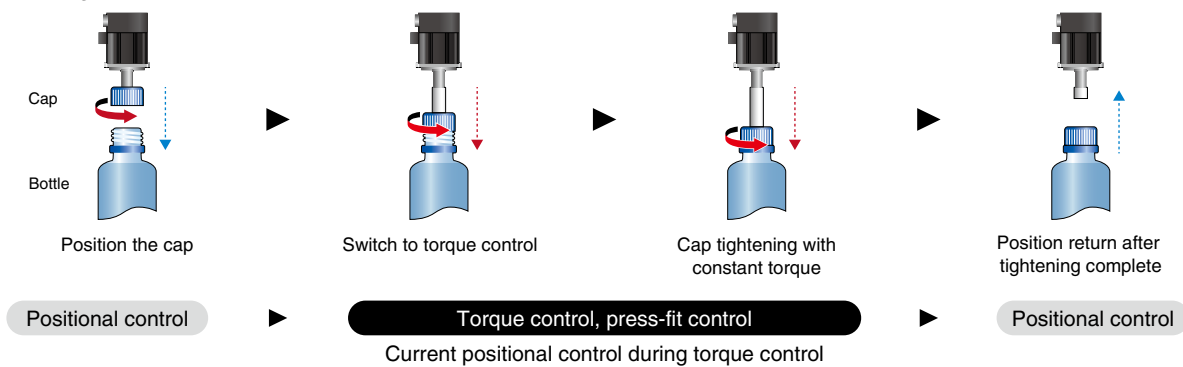

Simple motion module specifications

Item	RD77GF4	RD77GF8	RD77GF16	RD77GF32	RD77MS2	RD77MS4	RD77MS8	RD77MS16
Number of control axes (axis)	4	8	16	32	2	4	8	16
Operation cycle (ms)	0.5, 1.0, 2.0, 4.0	0.5, 1.0, 2.0, 4.0	0.5, 1.0, 2.0, 4.0	0.5, 1.0, 2.0, 4.0	0.444, 0.888, 1.777, 3.555	0.444, 0.888, 1.777, 3.555	0.444, 0.888, 1.777, 3.555	0.444, 0.888, 1.777, 3.555
Control unit	mm, inch, degree, pulse	mm, inch, degree, pulse	mm, inch, degree, pulse	mm, inch, degree, pulse	mm, inch, degree, pulse	mm, inch, degree, pulse	mm, inch, degree, pulse	mm, inch, degree, pulse
Positioning data (data/axis)	600	600	600	600	600	600	600	600
Servo amplifier	MR-J4-GF	MR-J4-GF	MR-J4-GF	MR-J4-GF	MR-J4-B	MR-J4-B	MR-J4-B	MR-J4-B
Max. distance between stations (m)	100	100	100	100	100	100	100	100
Servo amplifier connection system								
CC-Link IE Field	●	●	●	●	-	-	-	-
SSCNET III/H	-	-	-	-	●	●	●	●
External interface*1								
40-pin connector	-	-	-	-	●	● (2x)	● (2x)	● (2x)
Interpolation function								
Linear interpolation (axis)	2, 3, 4	2, 3, 4	2, 3, 4	2, 3, 4	2	2, 3, 4	2, 3, 4	2, 3, 4
Circular interpolation (axis)	2	2	2	2	2	2	2	2
Control system								
PTP (Point To Point) control	●	●	●	●	●	●	●	●
Trajectory control (linear, arc)	●	●	●	●	●	●	●	●
Speed control	●	●	●	●	●	●	●	●
Speed-position switching control	●	●	●	●	●	●	●	●
Speed-torque control	●	●	●	●	●	●	●	●
Pressure control	-	-	-	-	●	●	●	●
Advanced synchronous control	●	●	●	●	●	●	●	●
Acceleration/deceleration process								
Trapezoidal acceleration/deceleration	●	●	●	●	●	●	●	●
S-curve acceleration/deceleration	●	●	●	●	●	●	●	●
Function								
Absolute positioning system*2	●	●	●	●	●	●	●	●
Mark detection function	●	●	●	●	●	●	●	●

*1: For more information about external interface (for applicable options, please refer to the relevant product manual), refer to the options list on page 103.
 *2: A battery needs to be installed in the servo amplifier for home position backup.

System configuration

CPU

I/O

Analog

Motion, Positioning, Flexible high-speed I/O, High-speed counter

Network

Advanced information

Software

Positioning Modules

Transistor output

200k pulse/s

RD75P2

Up to 2-axis (linear/circular interpolation)

RD75P4

Up to 4-axis (linear/circular/helical interpolation)

Differential driver output

5M pulse/s

RD75D2

Up to 2-axis (linear/circular interpolation)

RD75D4

Up to 4-axis (linear/circular/helical interpolation)

The MELSEC iQ-R Series offers a choice of two positioning modules, transistor output or differential drive output, depending on the connected amplifier. The modules are capable of transmission speeds up to 5M pulses/s, and the differential driver output module supports wiring up to a distance of 10 m. It can be used in positional control or speed control, and features include linear, circular, and helical interpolation, which is a complex control required for deep-thread milling applications.

Various positional control

Various different positional control is performed by the module, from manual control, advanced control, to zero return control where it is required for the process position to return to its starting point. Automated sealing and gluing applicators tend to require extensive positional control as the interpolation may require a profile consisting of linear and circular paths that need to be followed accurately, such as in the automotive industry when glues are applied to the sealing portions of the doors.

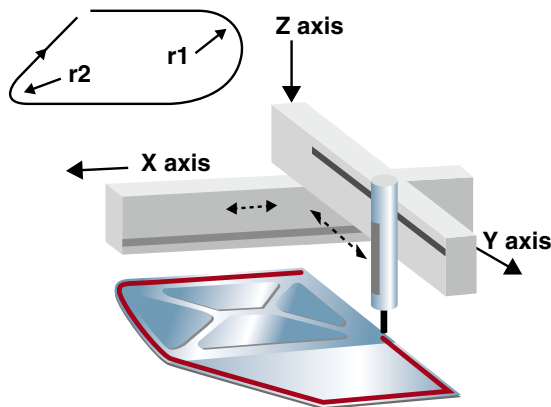

Multiple startup options

Positioning modules are capable of multiple different position-start options such as normal startup where the starting trigger command is activated from the command pulse; fast-start, where an event-driven trigger is asynchronous to the execution program data analysis; and multi-axis startup, where multiple axes can be executed simultaneously from an output pulse. In addition, block-start is where multiple sequential positioning data are executed by a single start trigger, which is used in control that follows the same repetitive path.

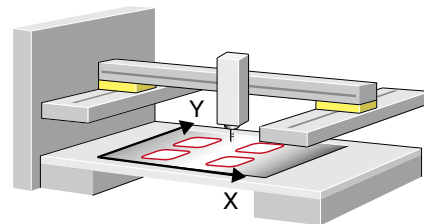

4 path profiles (P1...P4) being drawn in sequence.

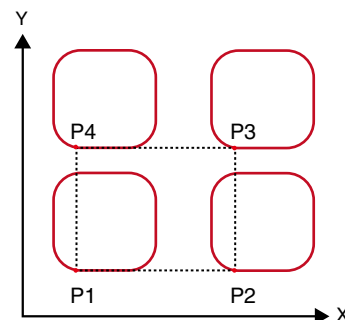

Realize helical interpolation

For applications that require the boring of deep, large holes, usually multiple interpolation control of three axes (X, Y and Z) or more must be taken into consideration. In such cases, the actual milling is done in a circle, with the X and Y axes synchronized to achieve the pre-set size. The depth of the hole is simultaneously controlled along the Z axis, ensuring minimal deviation in the cutting bit position. This type of positioning is usually quite difficult as the interpolation of the three axes can introduce some deviation when not utilizing a full-scale numerical control system.

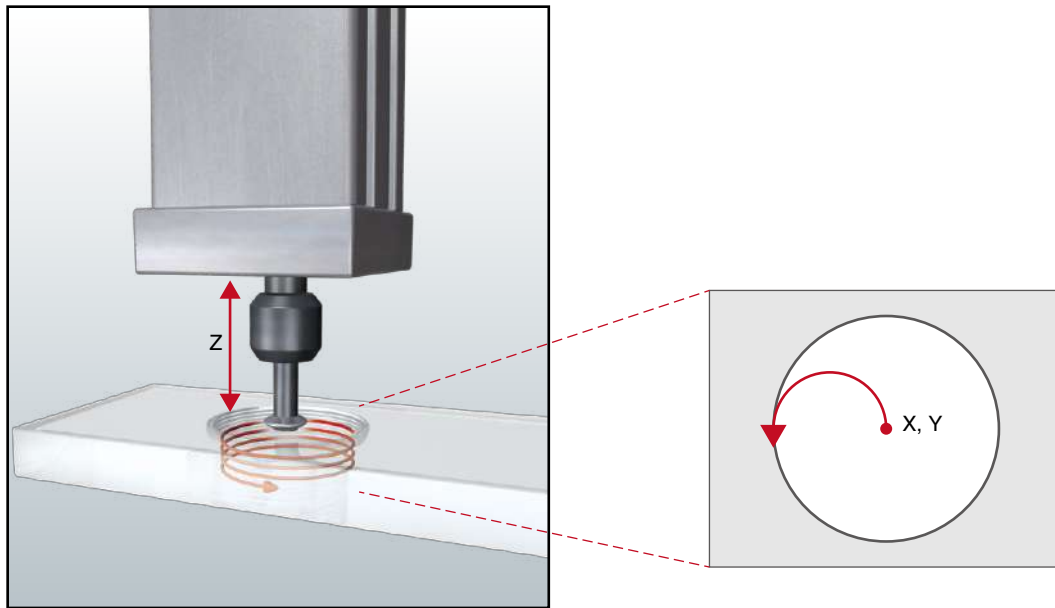

Positioning module specifications

Item	Transistor output		Differential driver output	
	RD75P2	RD75P4	RD75D2	RD75D4
Number of control axes (axis)	2	4	2	4
Control unit	mm, inch, degree, pulse	mm, inch, degree, pulse	mm, inch, degree, pulse	mm, inch, degree, pulse
Positioning data (data/axis)	600	600	600	600
Module backup function	Positioning data, and block start data can be saved on flash ROM (battery-less backup)			
Starting time (1 axis linear control) (ms)	0.3	0.3	0.3	0.3
Max. output pulse (pulse/s)	200,000	200,000	5,000,000	5,000,000
Max. connection distance between servos (m)	2	2	10	10
Interpolation				
Linear interpolation (axis)	2	2, 3, 4	2	2, 3, 4
Circular interpolation (axis)	2	2	2	2
Helical interpolation (axis)	-	3	-	3
Control system				
PTP (Point To Point) control	●	●	●	●
Path control (linear, arc, helical)	●	●	●	●
Speed control	●	●	●	●
Speed-position switching control	●	●	●	●
Position-speed switching control	●	●	●	●
Acceleration/deceleration process				
Trapezoidal acceleration/deceleration	●	●	●	●
S-curve acceleration/deceleration	●	●	●	●
Fast-start function				
Positioning start signal (μs)	8	8	8	8
External command signal (μs)	20	20	20	20
External interface*1				
40-pin connector	●	● (2x)	● (2x)	● (2x)

*1: For more information about external interface (for applicable options, please refer to the relevant product manual), refer to the option lists on page 103.

System configuration

CPU

I/O

Analog

Motion, Positioning, Flexible high-speed I/O High-speed counter

Network

Advanced information

Software

Flexible High-speed I/O Control Module

Differential input, DC input
differential output, DC output

RD40PD01

Input:12 points, output:14 points

The flexible high-speed I/O control module includes features such as the ability to program control logic and microsecond-fast asynchronous I/O response times to the programmable controller CPU and control bus, realizing stable machine performance minimizing processing speed fluctuation. Equipped with a field programmable gate array (FPGA), easy hardware logic design using the dedicated tool reduces development cost.

High-speed, stable I/O response

The flexible high-speed I/O control module provides highly accurate control of I/O timing owing to the asynchronous execution of internal control logic to the CPU and control bus. Variation in processing time is reduced to nanoseconds, thereby enabling sensors such as proximity lasers to trigger vision cameras accurately, which is required in product testing equipment in order to capture products moving at high-speed. Trigger input timing is adjustable to a minimum of 25 ns resolution.

FPGA logic design enables more freedom in customization

Equipped with a FPGA, control logic can be programmed easily using GX Works3. This low-cost alternative to HDL programming, logic synthesis and timing analysis reduces the design process, which is a common feature of general FPGA logic design.

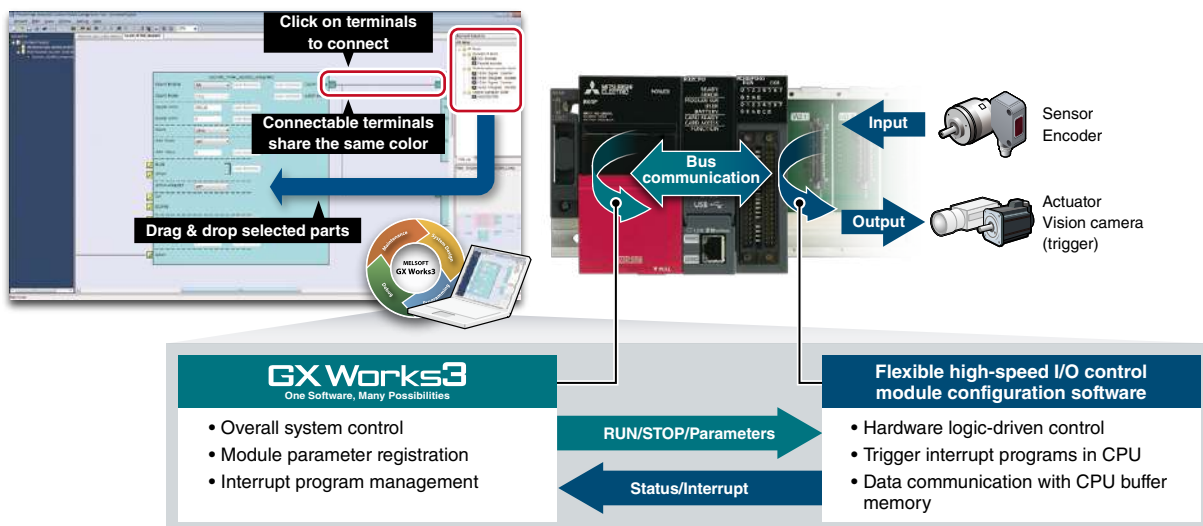

Flexible high-speed I/O control module specifications

Item	RD40PD01	
	DC	Differential
Number of input points (point)	12 (5/24 V DC/differential)	
Number of output points (point)	8 (5...24 V DC, 0.1 A/point)	6
Number of interrupts	8	
Input response time (μs)	≤ 1	
Output response time (μs)	≤ 1	
Max. pulse input speed (pulse/s)	200 k (200 kHz)	8 M (2 MHz)
Max. pulse output speed (pulse/s)	200 k (200 kHz)	8 M (2 MHz)
Main functions executable using main block combinations	Pulse count, coincidence detection, cam switch, highly-accurate pulse output, PWM output, ratio setting, pulse measurement, electrical interface conversion	
Main hardware logic processing time	Logic operation: Min. 875 ns, coincidence output: Min. 1375 ns, cam switch: Min. 262.5 ns	
External interface*1		
40-pin connector	● (2x)	

*1: For more information about external interface (for applicable options, please refer to the relevant product manual), refer to the option lists on page 103.

High-Speed Counter Modules

DC input,
transistor (sink) output

RD62P2
2-channel

DC input,
transistor (source) output

RD62P2E
2-channel

Differential input,
transistor (sink) output

RD62D2
2-channel

The MELSEC iQ-R Series counter modules are capable of 200k pulse/s for the DC input type, and 8M pulse/s for differential input. When used with a high-accuracy incremental encoder, positional tracking can also be realized. It also features a PWM output, which is ideal for applications requiring a measurement of pulse cycles.

Pulse measurement

The pulse measurement feature enables measuring of the pulse cycle, which is ideal for various applications such as in the food and beverage industry where proximity sensors are used to control flask position on the conveyor, or the renewable energy industry where the wind vane angle is controlled on a wind turbine.

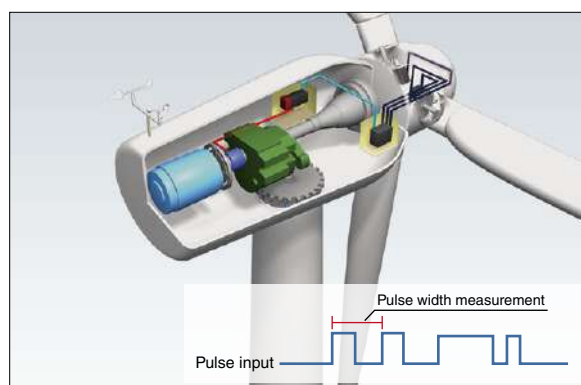
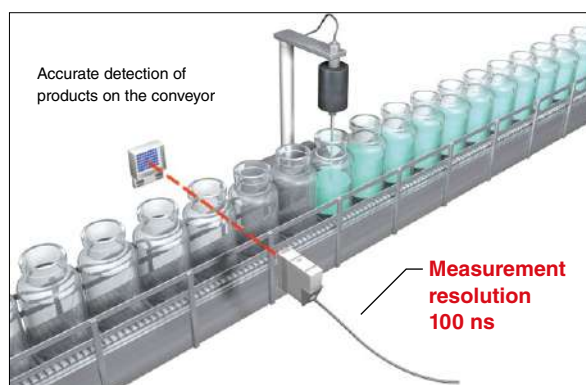

High-speed PWM output

The PWM output frequency can support up to 200 kHz with a minimum 100 ns pulse width (proportion to 'on' time) during the required duty cycle. The set values can be changed during operation without having to stop the system, such as in industrial-scale fan control.

High-speed counter module specifications

Item	RD62P2	RD62P2E	RD62D2
Number of channels (ch)	2	2	2
Count input signal			
1-phase input (1 multiple/2 multiples)	●	●	●
2-phase input (1 multiple/2 multiples/4 multiples)	●	●	●
CW/CCW input	●	●	●
Signal level (øA, øB)	2...5 mA at 5/12/24 V DC	2...5 mA at 5/12/24 V DC	EIA Standard RS-422-A Differential line driver level
Counter			
Counting speed (pulse/s)	10k...200k	10k...200k	10k...8M
Counting range (32-bit signed binary)	-2147483648...2147483647	-2147483648...2147483647	-2147483648...2147483647
External input			
Preset, function start	7...10 mA at 5/12/24 V DC	7...10 mA at 5/12/24 V DC	7...10 mA at 5/12/24 V DC
Digital filter (ms)	0, 0.1, 1, 10	0, 0.1, 1, 10	0, 0.1, 1, 10
Pulse measurement			
Resolution*1 (ns)	100	100	100
Number of points per channel	1	1	1
External output			
Coincidence output (2 points/channel)	Transistor (sink type) output, 12/24 V DC, 0.5 A/point	Transistor (source type) output, 12/24 V DC, 0.1 A/point	Transistor (sink type) output, 12/24 V DC, 0.5 A/point
PWM output			
Output frequency range (kHz)	0...200	0...200	0...200
Duty ratio	Multiples of 0.1 µs	Multiples of 0.1 µs	Multiples of 0.1 µs
Number of output points per channel	2	2	2
Setting change during operation	●	●	●
External interface*2			
40-pin connector	●	●	●

*1: Pulse measurement can be performed in the range of 2000 to 2147483647 (0.2 ms to approx. 214 s).

*2: For more information about external interface (for applicable options, please refer to the relevant product manual), refer to the option lists on page 103.

System
configuration

CPU

I/O

Analog

Motion, Positioning,
Flexible high-speed I/O
High-speed counter

Network

Advanced
information

Software

Focus points

- ▶ Various network-specific modules available
- ▶ 1 Gbps high-speed, large bandwidth of 128K word for CC-Link IE
- ▶ Connect to two separate networks using a single module
- ▶ Seamless networking (SLMP)
- ▶ Loop-back function ensures continuous communications
- ▶ Auto-return when faulty station is replaced
- ▶ Supports standard interfaces such as RS-232 and RS-422/485



The network and interface modules of the MELSEC iQ-R Series ensure a vast selection of interconnectivity possibilities with various protocols and network topologies providing the best-fit solution for various applications. At the core of the Series is the CC-Link IE network family which is a high-speed 1 Gbps control level and field level Ethernet topology industrial open network.

Seamless message protocol (SLMP*) network communications

With SLMP, it is possible to seamlessly access production management systems, programmable controllers and other devices using the same method, eliminating concerns about network hierarchies and boundaries. Tasks such as machine monitoring, data collection and maintenance can be performed from virtually anywhere on the network. Used together with the Ethernet module, SLMP-ready Ethernet devices such as a machine vision sensor or RFID controller can be interfaced to the CC-Link IE Field Network without further adding another network.

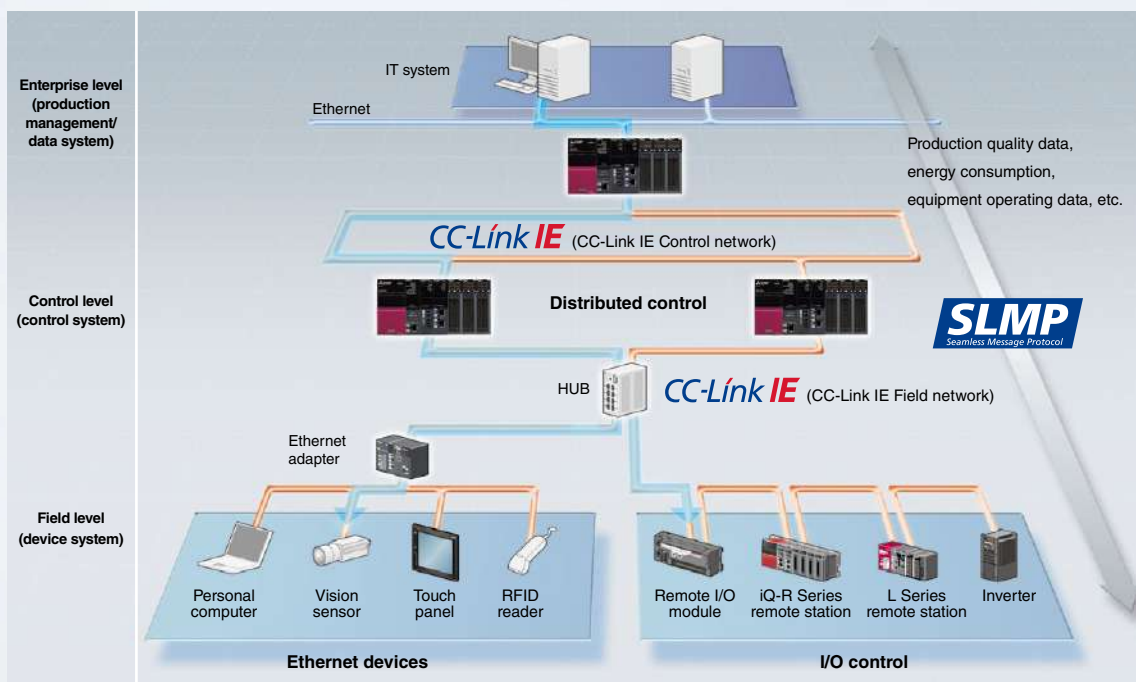

*1: SLMP (Seamless Message Protocol): Is a client/server protocol that enables communications between Ethernet-ready and CC-Link IE compatible devices.

Ethernet Interface Module

RJ71EN71

1 Gbps, 100/10 Mbps multiple network type

CC-Link IE

The MELSEC iQ-R Series Ethernet module is equipped with two ports that can be used as either a generic Ethernet, CC-Link IE Field or Control Network module. The module design incorporates an easy-to-read display and a dot-matrix LED providing a quick way to assess network conditions using the module.



Ethernet port (P1)

Ethernet port (P2)

Dual gigabit Ethernet ports

The number of connectable ports on the Ethernet module has been doubled and the number of connections per channel increased. By increasing the number of ports the module can be used effectively as a gateway, simultaneously connecting a generic Ethernet network to one port and using the second port for the CC-Link IE Field or Control network. Additionally, the number of connections per channel has been increased from 64 to 128, doubling the bandwidth for even more connectable devices.

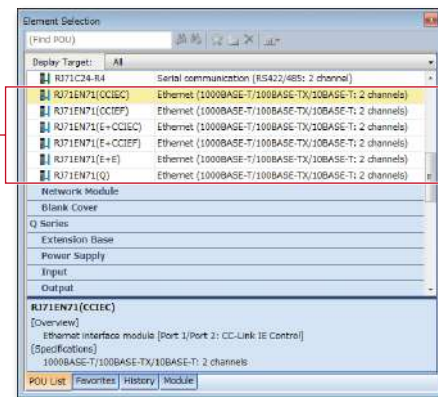
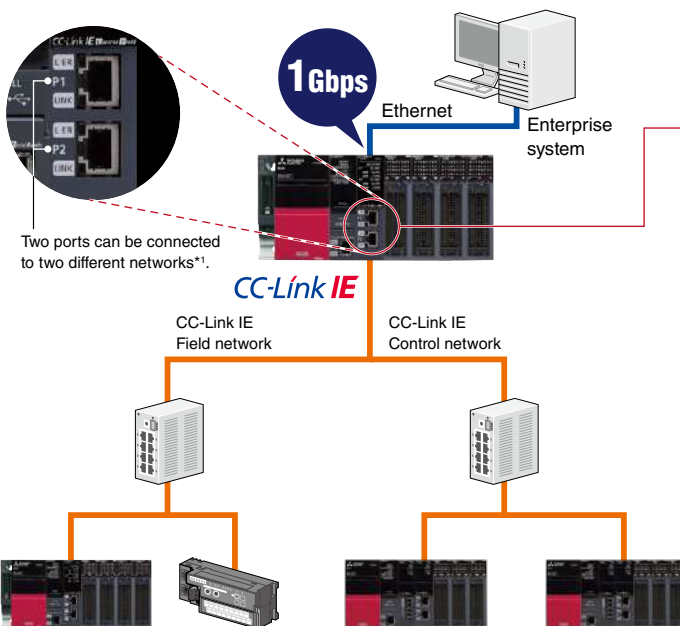

Select network combination from within GX Works3.

Network combination*1

P1	C	F	E	E	E
P2	C	F	C	F	E

C : CC-Link IE Control Network

F : CC-Link IE Field Network

E : Ethernet

*1: The CC-Link IE Field and CC-Link IE Control networks cannot be used together.

Ethernet interface module specifications

Item	RJ71EN71*2
Transmission specifications	
Data transmission speed	1 Gbps/100 Mbps/10 Mbps
Interface	RJ45 connector (Auto MDI/MDI-X)
Max. frame size (byte)	1518/9022 (when jumbo frames are used)
IP version	Compatible with IPv4
Sending/receiving data storage memory	
Number of simultaneous open connections	128
Fixed buffer	5K words x 16
Socket communications	• 5K words x 48 (when only P1 is used) • 5K words x 112 (when only P1/P2 is used)
Random access buffer	6K words x 1
CC-Link IE Field/Control cable specifications	
Communication cable	Ethernet cable (Category 5e or higher, double shielded/STP)

*2: The specifications differ for the Q Series compatible Ethernet mode.

System configuration

CPU

I/O

Analog

Motion, Positioning, Flexible high-speed I/O, High-speed counter

Network

Advanced information

Software

CC-Link IE Control Network Module

RJ71GP21S-SX NEW
1 Gbps optical cable, control/normal station (with external power supply)

RJ71GP21-SX
1 Gbps optical cable, control/normal station, (standard type)



CC-Link IE Control is a high-reliability distributed control network designed to handle very large data communications (128K word) over a high-speed (1 Gbps) dual-loop optical cable topology.

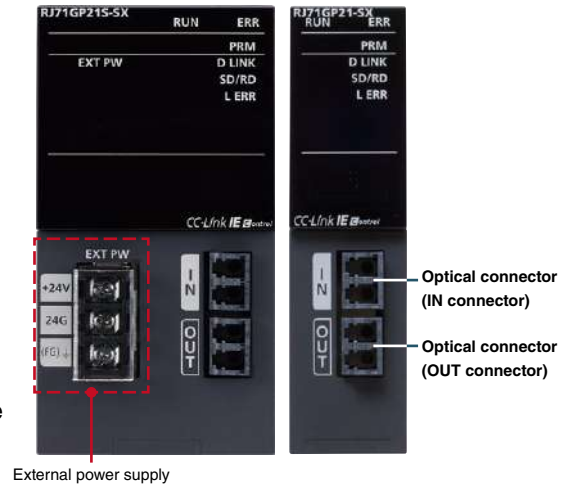

Continuous communications even when cable or stations are faulty

Utilizing a high-speed, noise resistant fiber-optic topology, the CC-Link IE Control Network supports a loop-back function that guarantees continuous communications even when a cable is disconnected or a station falls into a fault status. The dual-loop topology of the cable ensures that the data will find another route along the network without affecting overall network communications.

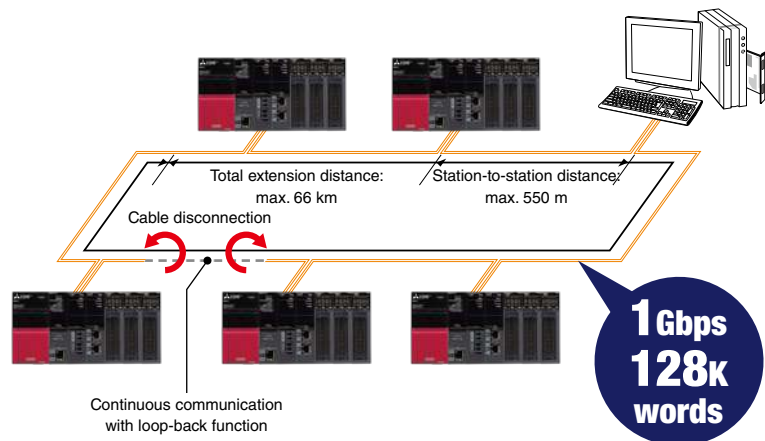

Extensive real-time network monitoring

The network status can be easily monitored directly from GX Works3 software enabling intuitive troubleshooting of network errors or viewing the operation of the network while in communications. This makes it possible to see the actual fault occurring in the network, thereby helping to reduce the overall downtime. In addition, error messages related to the faulty network module station can be viewed for further network diagnosis. All stations within the network can be monitored regardless of which station the software is connected too.

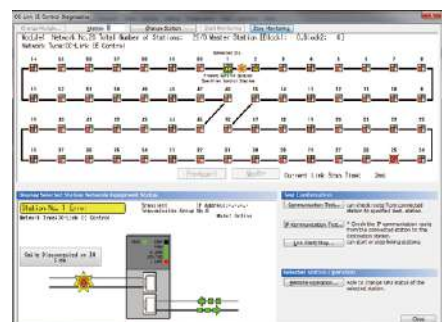

CC-Link IE Control monitoring window

CC-Link IE Control Network module specifications

Item	RJ71GP21(S)-SX
Communication speed	1 Gbps
Transmission path	Duplex loop
Communication cable	Optical fiber cable which satisfies 1000 BASE-SX standard: Multi-mode optical fiber (GI)
Max. station-to-station distance (m)	550 (when the core outer diameter is 50 μm) 275 (when the core outer diameter is 62.5 μm)
Overall cable distance (m)	66,000 (when 120 stations are connected and the core outer diameter is 50 μm) 33,000 (when 120 stations are connected and the core outer diameter is 62.5 μm)
Max. number of connectable stations	120 (control station: 1, normal station: 119)
Max. number of link points per network	
Link relay (LB)	32K points (32768 points, 4K bytes)
Link register (LW)	128K points (131072 points, 256K bytes)
Link input (LX), link output (LY)	8K points (8192 points, 1K bytes)

CC-Link IE Field Network Module

RJ71GF11-T2

1 Gbps, master/local station



Ethernet port (P1)

Ethernet port (P2)

CC-Link IE Field is a versatile gigabit Ethernet-based network integrating controller, I/O control, safety control, and motion control in a flexible wiring topology supporting star, ring, and line configurations.

Multiple topology variations

■ Star topology

Devices are connected via a switching hub allowing local stations to be added easily.

■ Line topology

Continuous connection of devices along the Ethernet line.

■ Ring topology

Connection is done in a continuous loop, which guarantees communications by isolating the faulty network station.

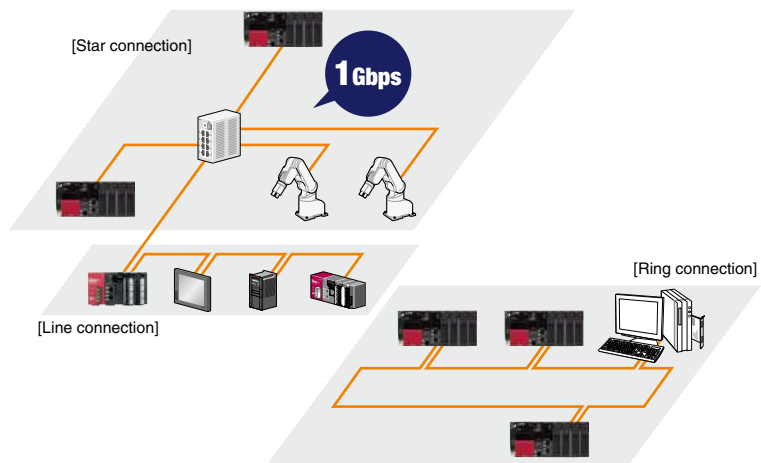

Synchronized network communications

The control cycle of local stations on the network can be synchronized with the master station.

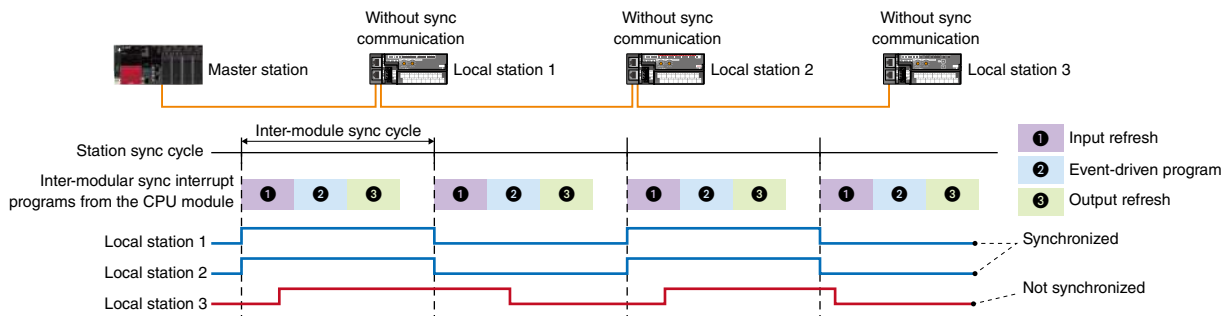

CC-Link IE Field Network module specifications

Item	RJ71GF11-T2
Transmission speed	1 Gbps
Network topology	Line topology, star topology (both types can be on the same line), and ring topology
Communication cable	Ethernet cable (Category 5e or higher, double shielded/STP)
Max. station-to-station distance (m)	100
Overall cable distance (m)	Line topology: 12,000 (when 121 stations are connected) Star topology: Depends on the system configuration Ring topology: 12,100 (when 121 stations are connected)
Max. number of connectable stations	121 (master station: 1, slave station: 120)
SIL 2-compliant	●*1
Max. number of link points per network	
Remote input (RX), remote output (RY)	16K points (16384 points, 2K bytes)
Remote register (RWw, RWr)	8K points (8192 points, 16K bytes)

*1: When used together with a SIL 2 redundant control system (SIL 2 is supported in the module firmware version of '23' or later.).

System configuration

CPU

I/O

Analog

Motion, Positioning, Flexible high-speed I/O, High-speed counter

Network

Advanced information

Software

CC-Link IE Field Network

Remote Head Module

RJ72GF15-T2

1 Gbps, remote station



The CC-Link IE Field head module can control the I/O and intelligent function modules directly when installed on the same base unit, and can operate as a network remote station. Installing two remote head modules improves network reliability by having redundant network lines, and supports online module replacement (hot-swap) when a module needs to be changed while the system is still in operation.

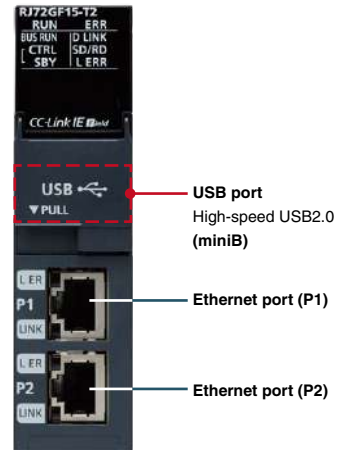

Distributed control or redundant system can be easily realized

■ Wiring and space saving distributed control system

Realize a highly scalable distributed control system by combining with various I/O and intelligent function modules.

■ Remote station with redundant head modules and network

Network system reliability can be improved by installing redundant head modules and redundant network cables; even if an error occurs in one of the head modules, the network standby module can take over without disrupting network communications and initiates the control system to switch to the standby system. In addition, if one of the head modules is replaced, the settings and parameters are automatically transferred to the standby module and re-initialized.

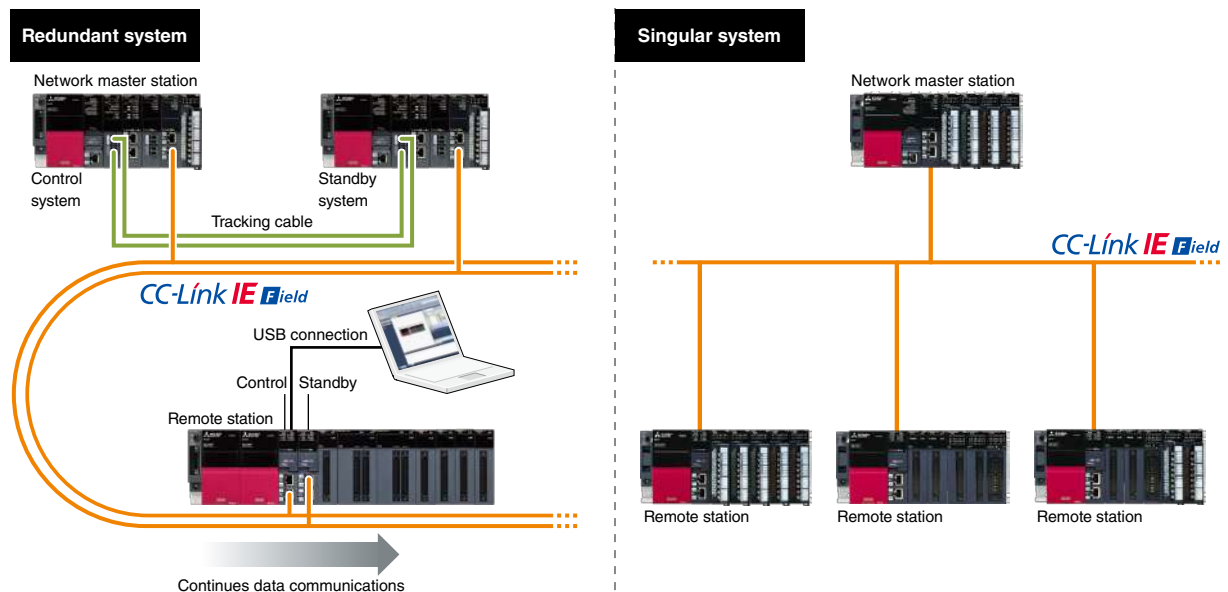

- Faulty network module automatically switches to standby when an error occurs
- Network data communications are continued
- Continue control of I/O and intelligent function module

- Connect engineering tool to remote head module via USB
- Directly register module parameters

CC-Link IE Field Network remote head module specifications

Item	RJ72GF15-T2
Transmission speed	1 Gbps
Network topology	Line topology, star topology (both types can be on the same line), and ring topology
Communication cable	Ethernet cable (Category 5e or higher, double shielded/STP)
Max. station-to-station distance (m)	100
Overall cable distance (m)	Line topology: 12,000 (when 121 stations are connected) Star topology: Depends on the system configuration Ring topology: 12,100 (when 121 stations are connected)
Max. number of connectable stations	121 (master station: 1, slave station: 120)
SIL 2-compliant	●*1
Max. number of link points per network	
Remote input (RX), remote output (RY)	16K points (16384 points, 2K bytes)
Remote register (RWw, RWr)	8K points (8192 points, 16K bytes)

*1: When used together with a SIL 2 redundant control system (SIL 2 is supported in the module firmware version of "04" or later.).

AnyWireASLINK Master Module

RJ51AW12AL

DigitalLinkSensor AnyWireASLINK system compatible

AnyWireASLINK



AnyWireASLINK is a sensor-level network that realizes a smaller installation space and reduces wiring owing to its easy wiring topology. The ability to monitor the network system from a centralized location reduces commissioning time and improves productivity.

Preventive maintenance by monitoring of sensor status

Using the AnyWireASLINK system, parameter settings of each sensor and actual measurement values can be monitored on the control system with changes reflected easily to sensors on the network.

AnyWireASLINK

Prevent intermittent stops

- Analyze the amount of incoming light
- Sensitivity threshold can be adjusted to keep operation up to the maintenance cycle

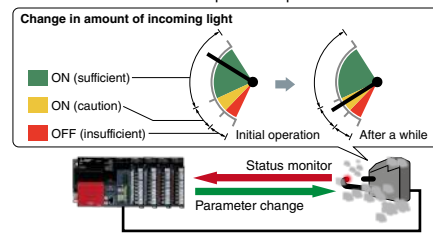

Various devices connected with less wiring

Overall wiring of various sensors can be reduced using the AnyWireASLINK connection system.

- ASLINKER (2-wire general-purpose I/O device)
- ASLINKTERMINAL (general-purpose I/O terminal for 4/8/16 points)
- ASLINKSENSOR (sensor directly connected to AnyWireASLINK)
- ASLINKKAMP (sensor amplifier connecting a general-purpose sensor head)

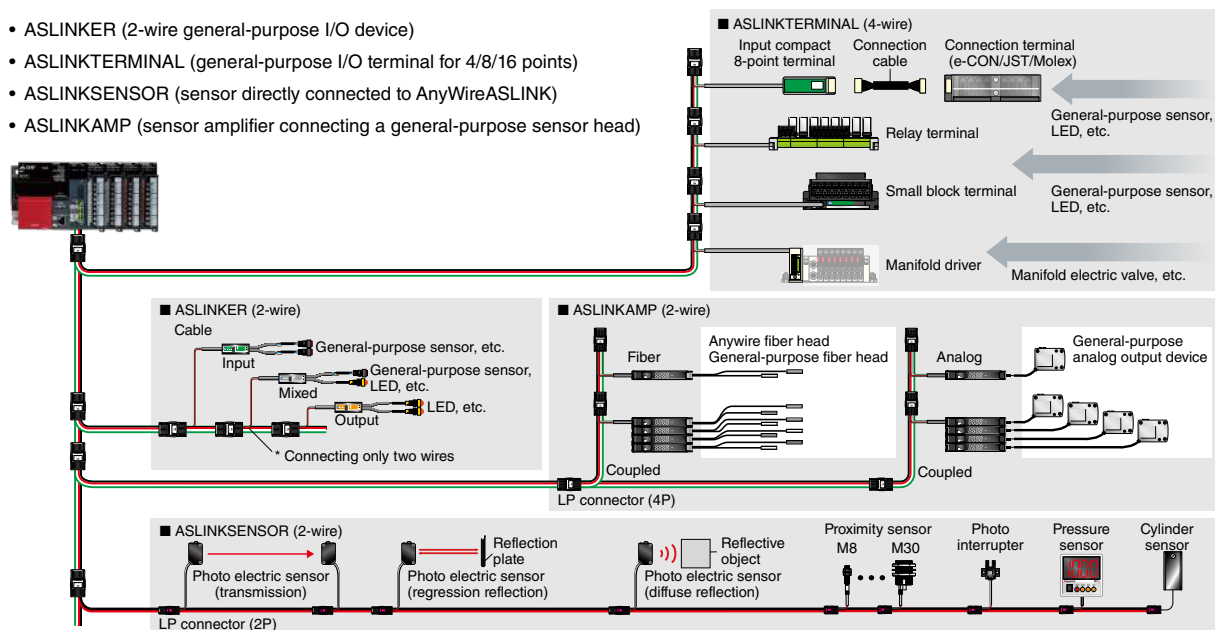

AnyWireASLINK master module specifications

Item	RJ51AW12AL
Max. number of I/O points	512 points (256 input points/256 output points)
Max. number of connectable modules	128 (varies according to each slave module's current consumption)
Overall cable distance*1 (m)	200*2
Topology	Bus (multi-drop, T-branch, tree branch)
Communication clock (kHz)	27.0
Max. communication cable supply current*1 (A)	2 (when using 1.25 mm ² cable) 1 (when using 0.75 mm ² cable)

*1: The allowable value varies depending on the transmission cable supply current, total distance, or transmission cable (DP, DN) wire diameter. For details, please refer to the user's manual.

*2: With the slave module having an integrated transmission cable (DP, DN) and module, the length of the transmission cable (DP, DN) is included in the overall length.

System configuration

CPU

I/O

Analog

Motion, Positioning, Flexible high-speed I/O, High-speed counter

Network

Advanced information

Software

BACnet Module

RJ71BAC96

BACnet® system compatible



BACnet® is a data communications protocol for building automation and control networks. It is utilized extensively in the building automation industry to allow the products of different manufacturers to communicate using a common protocol. The MELSEC iQ-R Series BACnet module supports the control of various automated building systems such as lighting control, HVAC and building security management. It realizes lower hardware costs, and improves the communications and maintenance between these different control systems.

Ideal for large-scale building automation

The MELSEC iQ-R Series BACnet module enables up to 4000 I/O object instances to be registered. It can monitor up to 10,000 points (RDMONB function), realizing large-scale automated building control systems capable of simultaneously managing many different devices such as sensors and drive equipment. It can be used in two modes, either controlling automated building devices as a BACnet® controller or managing/monitoring multiple controllers as a workstation.

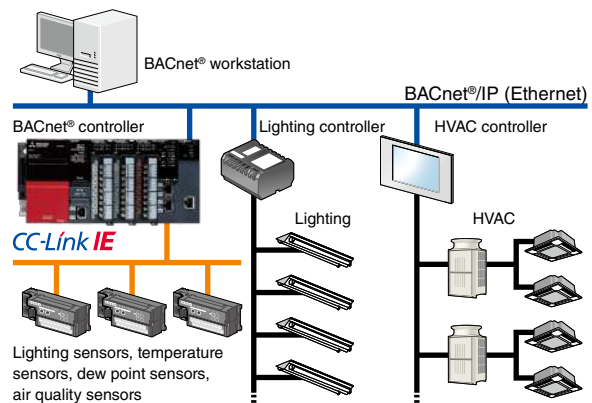

Improve maintenance with backup of property values

Maintenance can be improved by enabling the backup of property values when power is lost to the control system. The MELSEC iQ-R Series BACnet module is equipped with MRAM memory for saving property values during power failures. By ensuring that data values are saved immediately before a power failure, recovery time and system maintenance are minimal. Property values are stored permanently, ensuring that values are not cleared automatically and realizing a reduction in downtime, which reduces maintenance costs.

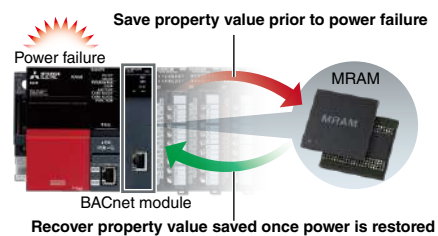

BACnet module specifications

Item	RJ71BAC96
Transmission specifications	
Transmission rate (bps)	100M/10M
Communication mode	Full-duplex/half-duplex
Transmission method	Base band
Maximum segment length (m)	100 (distance between switching hub and node)
IP version	IPv6/IPv4
BACnet®+1 specifications (number of registrations capable)	
Input/output objects*2	4000 Instance
CA objects	300 Instance
SC objects	100 Instance
TL objects	200 Instance
NC objects	50 Instance
BDABR	2176 points in total
BDABW	
RDMONB	10000 points in total
RCOVB	
REVTB	

*1: BACnet® complies with the following BACnet® standards: IEC61850-4 (ANSI/ASHRAE135-2001), IEC61850-5 (ANSI/ASHRAE135-2004), ANSI/ASHRAE135-2004 (ISO16484-5-2003) and ANSI/ASHRAE135-2010.

*2: For details on the input/output objects, please refer to the "MELSEC iQ-R BACnet Module User's Manual (Application)".

CANopen® Module

RJ71CN91

CANopen®, CAN system compatible



CANopen® is a CAN-based communication system developed and maintained by CAN in Automation (CiA®) users and manufacturers group. Based on the CAN bus, the module supports the open and reliable CANopen® network, combining low cost with high performance and can be used in industries such as industrial automation, medical equipment, transportation, and maritime electronics.

Integrated network configuration

Data flows transparently between the sensor level and the management level across multiple industry-standard automation networks. By utilizing the MELSEC iQ-R CANopen® network module, CANopen®-supported third-party devices can be easily integrated into the complete control system architecture.

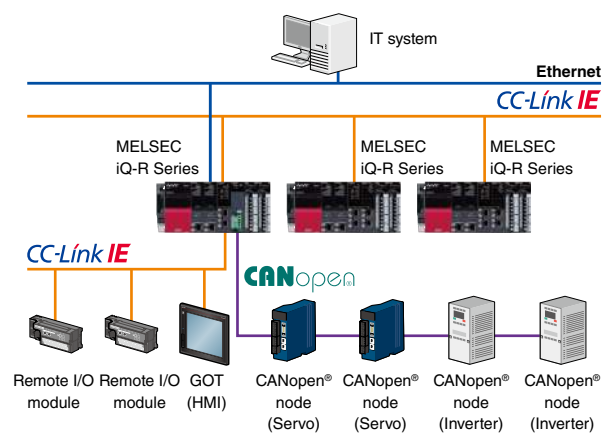

Reduce development time

The CANopen® module can be easily setup using the CANopen® configuration tool equipped with a graphic user interface that is familiar to CANopen® users, and supporting various functions, such as process data objects (PDO), service data objects (SDO), and network management (NMT). It can also be setup using the label (variable) programming and refresh setting of GX Works3. Connection to the module is simple using either a USB cable or an Ethernet connection from a computer, enabling programming and maintenance of the CANopen® network.

CANopen® module specifications

Item	RJ71CN91
Network topology	CAN bus network (RS-485, CSMA/CR)
Supported network protocol	CANopen®, CAN
Supported communication service*1	CiA®-301 V4.2, CiA®-302 V4.1, CiA®-305 V2.2
Supported device/application profile*1	CiA®-405 V2.0 (Interface and device profile for IEC 61131-3 programmable devices)
Remote transmit request (RTR)	CANopen 405 mode: Not supported for PDO 11-bit CAN-ID Layer 2 message mode and 29-bit CAN-ID Layer 2 message mode: Supported
Communication data size (CANopen®405 mode)	4 words x 256 (TPDO), 4 words x 256 (RPDO)
Selectable Node ID	1...127
Communication method	Acyclic, cyclic, or event-driven
Transmission speed (bps)	1M/800k/500k/250k/125k/100k/50k/20k/10k
Maximum cable length	5000 m (10 kbps), 2500 m (20 kbps), 1000 m (50 kbps), 600 m (100 kbps), 500 m (125 kbps), 250 m (250 kbps), 100 m (500 kbps), 50 m (800 kbps), 25 m (1 Mbps)
Interface	Two-piece pluggable terminal block
Setup software	
CANopen® configuration tool	SW1DNN-CANOPCT-BD*2

*1: Compliant with CiA® standards.

*2: To obtain the software, please contact your local Mitsubishi Electric office or representative.

System configuration

CPU

I/O

Analog

Motion, Positioning, Flexible high-speed I/O, High-speed counter

Network

Advanced information

Software

PROFINET® IO Controller Module

RJ71PN92 NEW

PROFINET® system compatible



PROFINET® is an industrial network developed and managed by PROFIBUS&PROFINET International (PI). PROFINET® is a well-known and widely used network originating from Europe.



Connection to PROFINET® IO devices

PROFINET® module operates as an IO controller and supports integration into control systems based on the PROFINET® network.

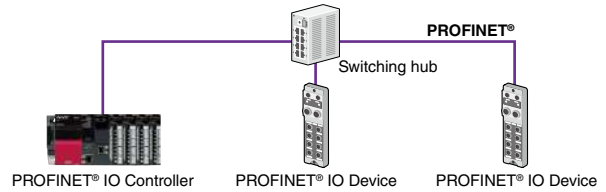

PROFINET® IO controller module specifications

Item	RJ71PN92
Data exchange	
Max. input data length per network (word)	4096
Max. output data length per network (word)	4096
Max. input data length per IO device (byte)	1437
Max. output data length per IO device (byte)	1437
Cycle time (ms)	512 (max.), 1 (min)*1
Service interface	
Maximum transmission capacity per request (byte)	4116
Maximum number of connectable IO devices	128
Data transmission speed*2 (bps)	1G/100M/10M

*1: The cycle time depends on the number of IO devices and the input/output data length.

*2: Data communications at 100 Mbps is recommended.

EtherNet/IP™ Scanner Module

RJ71EIP91 NEW

EtherNet/IP™ system compatible

EtherNet/IP™ is an open and global industrial network that adopts CIP™ (Common Industrial Protocol) to standard Ethernet. Widely used in the United States, EtherNet/IP™ and CIP™ technologies are managed by ODVA®, Inc.



Connection to EtherNet/IP™ compatible devices

EtherNet/IP™ module operates as a scanner, and supports both standard EtherNet/IP™ and tag communications. This enables simultaneous connection between sensors, actuators and programmable controllers with one module.

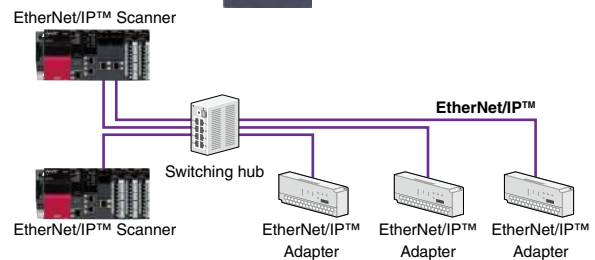

EtherNet/IP™ scanner module specifications

Item	RJ71EIP91
Class 1 communications	
Communication format	Standard EtherNet/IP™, tag communications
Number of connections*3	Standard EtherNet/IP™: 256, Tag communications: 256
Communication data size (byte)	1444 (per connection)
Connection type	Point-to-point, multicast
RPI (communication cycle)	0.5...60000 ms
Class 3 communications	
Communication format	Standard EtherNet/IP™
Number of connections	Server: 256*3, Client: None
Communication data size (byte)	1414 (per connection)
Connection type	Point-to-point
UCMM communications	
Communication format	Standard EtherNet/IP™
Number of connections (number of simultaneous executions)	Server: 96, Client: 32
Communication data size (byte)	1414
Connection type	Point-to-point

*3: The total number of connections for Class 1 and Class 3 communications is 256.

PROFIBUS®-DP Module

RJ71PB91V NEW

PROFIBUS® system compatible



PROFIBUS® is an industrial fieldbus developed and maintained by the PROFIBUS&PROFINET International (PI). PROFIBUS® is a well-known and widely used network originating from Europe.

Connection to PROFIBUS® compatible devices

This module can be used as a PROFIBUS®-DP master station supporting integration of compatible slave devices into the control system. In addition, the module can be used as a slave station in the PROFIBUS® system.

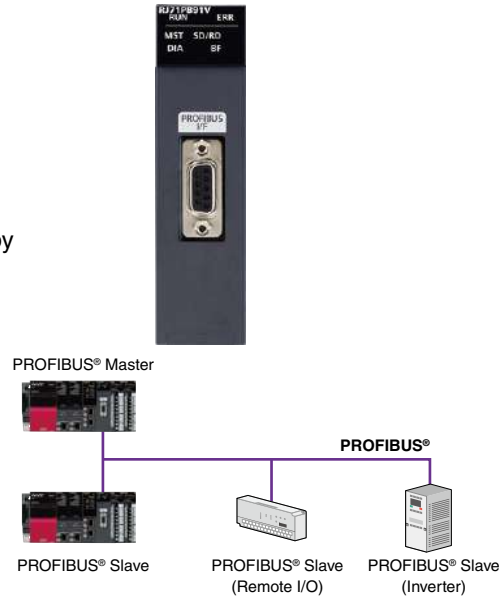

PROFIBUS®-DP module specifications

Item	RJ71PB91V	
PROFIBUS®-DP station type	Class 1 master or slave station (either one can be selected)	
Transmission speed (bps)	9.6k...12M	
Max. number of connectable modules (per segment)	32 (including repeaters)	
Max. number of connectable modules (per network)	126 (including master and slave stations)	
I/O data size		
Master station	Max. input data (byte)	8192 (max. 244 per slave station)
	Max. output data (byte)	8192 (max. 244 per slave station)
Slave station	Max. input data (byte)	244 (total I/O data: max. 384)
	Max. output data (byte)	244 (total I/O data: max. 384)
Setup software		
PROFIBUS® configuration tool	SW1DNN-PROFIBDCT-ED*1	

*1: To obtain the software, please contact your local Mitsubishi Electric office or representative.

DeviceNet® Master/Slave Module

RJ71DN91 NEW

DeviceNet® system compatible



DeviceNet® is a multi-drop network that connects programmable controllers and I/O devices, and is based on CAN (Controller Area Network) for its data link layer.

Connection to DeviceNet® compatible devices

The module can be implemented into DeviceNet® compatible devices as a DeviceNet® network and operate as either a master or slave station. Automatic configuration functionality enables the master station to detect slave stations on the network, thereby automatically creating the parameters.

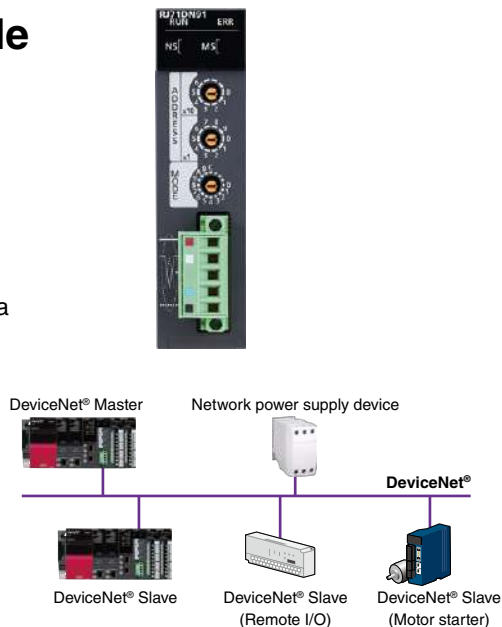

DeviceNet® master/slave module specifications

Item	RJ71DN91	
Operation mode	Master, slave, master/slave combined	
Settable station number	0...63	
Transmission speed (bps)	125k, 250k, 500k	
Master functions		
Node type	DeviceNet® master (Group2 only client)	
Max. number of message connections	63	
Max. message communication data size (byte)	240 (each for transmit/receive)	
I/O connection type	Polling, bit-strobe, change-of-state (COS), cyclic	
Max. I/O communication data size (byte)	512 (each for transmit/receive, max. 256 per station)	
Slave functions		
Node type	DeviceNet® slave (Group2 server)	
I/O connection type	Polling	
Max. I/O communication data size (byte)	128 (each for transmit/receive)	

System configuration

CPU

I/O

Analog

Motion, Positioning, Flexible high-speed I/O, High-speed counter

Network

Advanced information

Software

CC-Link System Module

RJ61BT11

Max. 10 Mbps, master/local station (CC-Link Ver.2)



CC-Link is a high-speed and highly reliable deterministic I/O control network that realizes reduced wiring while offering multi-vendor compatible products.

Multiple connectivity of field devices

CC-Link incorporates many different field devices that can be configured into a wire-saving communications network. Using the remote device net mode, it is possible to connect up to 64 remote devices, such as analog I/O modules.

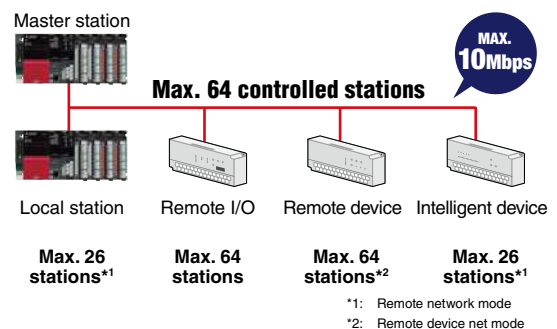

Item	RJ61BT11
Transmission speed (bps)	156k/625k/2.5M/5M/10M
Network topology	Bus (RS-485)
Communication cable	Ver.1.10-compatible CC-Link dedicated cable
Overall distance (m)	100 (10 Mbps)...1200 (156 kbps)
Max. number of connectable modules	65 stations (master station: 1, slave station: 64)
Max. number of link points per system (CC-Link Ver.2)	
Remote I/O (RX, RY)	8192 points
Remote register (RWw, RWr)	2048 points

Serial Communication Modules

RJ71C24

Max. 230.4 kbps, RS-232 (1 channel), RS-422/485 (1 channel)

RJ71C24-R2

Max. 230.4 kbps, RS-232 (2 channels)

RJ71C24-R4

Max. 230.4 kbps, RS-422/485 (2 channels)

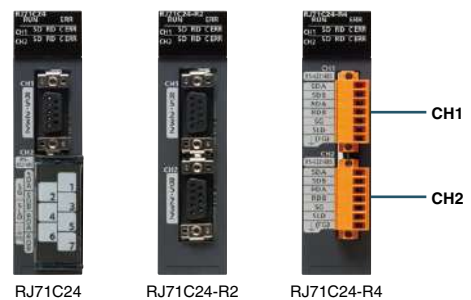

The serial communication module enables serial devices with up to 230.4 kbps transmission speeds to be connected per channel. Communications protocols such as MODBUS® are supported via the pre-defined protocol feature.

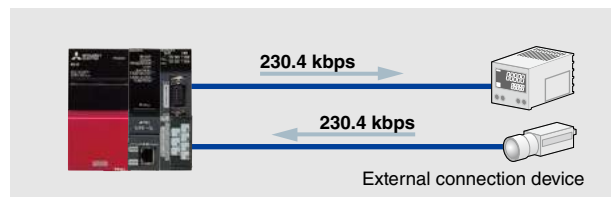

Item	RJ71C24	RJ71C24-R2	RJ71C24-R4
Transmission speed (bps)	1.2k/2.4k/4.8k/9.6k/14.4k/19.2k/28.8k/38.4k/57.6k/115.2k/230.4k		
Interface			
CH1	RS-232	RS-232	RS-422/485
CH2	RS-422/485	RS-232	RS-422/485
Overall transmission distance			
RS-232 (m)	15	15	-
RS-422/485 (m)	1,200	-	1,200

- ▶ Direct access to IT system database
- ▶ C/C++ based programming
- ▶ Installation of various communications protocols
- ▶ High-speed collection of shop floor data in real-time
- ▶ Utilize third-party partner applications



e-F@ctory is a solution from Mitsubishi Electric helping to optimize production systems through its direct connectivity between an IT system and the shop floor reducing cost over the entire product life cycle. Production data management, analysis and planning utilizing IoT* can be realized, improving productivity through preventive maintenance, operations management, traceability, and energy management. The MELSEC iQ-R Series includes a range of products that fulfill these various needs as part of the “Intelligence” lineup of interconnected e-F@ctory advanced information products.

* Internet of Things

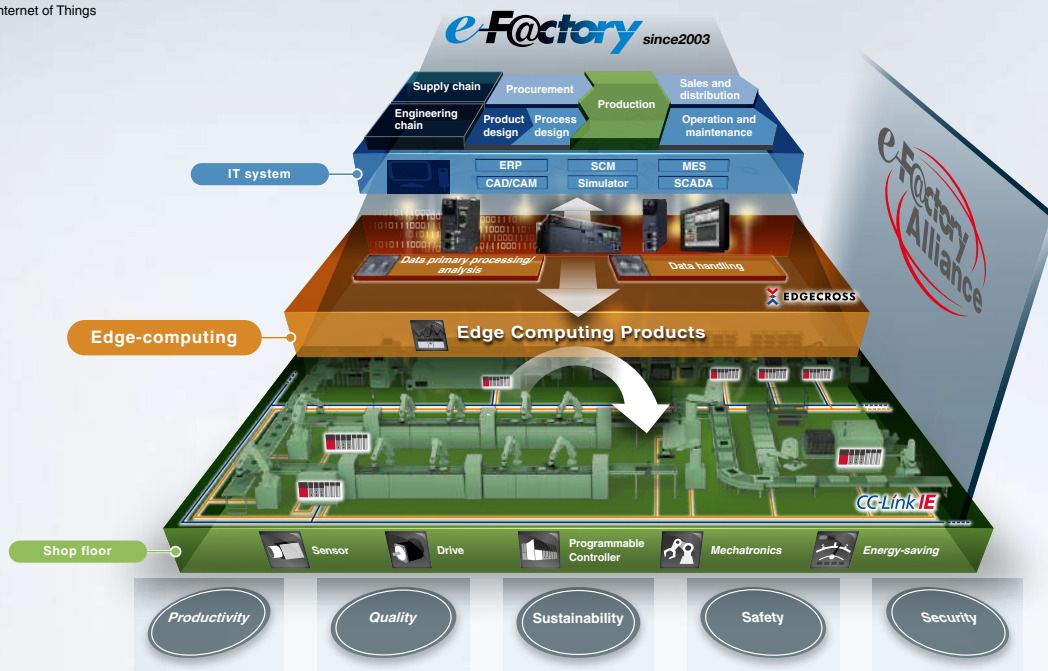

Direct access to IT system database

Realize improved production management and reduce overall system costs through real-time direct access to IT system database servers without requiring additional programming and gateway computers.

C/C++ based programming

Provides a robust and cost-efficient alternative from computer-based analytical and testing systems, enabling custom applications to be executed directly on the control system. In addition, various communications protocols can be installed directly.

High-speed data logging simplifies troubleshooting

Managing production line data, accurate identification of failures and keeping daily/monthly records can be realized at a low cost.

Note: For information about the C Controller, please refer to page 43

System configuration

CPU

I/O

Analog

Motion, Positioning, Flexible high-speed I/O, High-speed counter

Network

Advanced Information

Software

MES Interface Module

RD81MES96

Database connection

Along with ever-changing manufacturing trends, improving machine productivity and maintaining manufacturing quality through meticulous traceability have become a fundamental part of manufacturing. MES Interface modules address these requirements by providing direct database connectivity for IT systems and facilitating automatic SQL*1 text generation using intuitive configuration setup software. Modules allow production data from the shop floor to be inserted into database records directly; for example, providing real-time production status that enables quicker response to production-related problems.

*1: Structured Query Language is a programming language designed for managing data in a relational database.

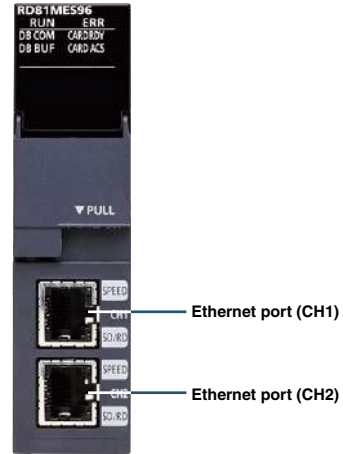

System configuration costs reduced by 65%*2

MES Interface modules enable direct connectivity between IT database servers and programmable controllers on the shop floor, eliminating the need for gateway computers or specified programs. Being much more reliable than computers, the MES Interface saves on maintenance costs typical of computers.

*2: Assumption based on a typical control architecture.

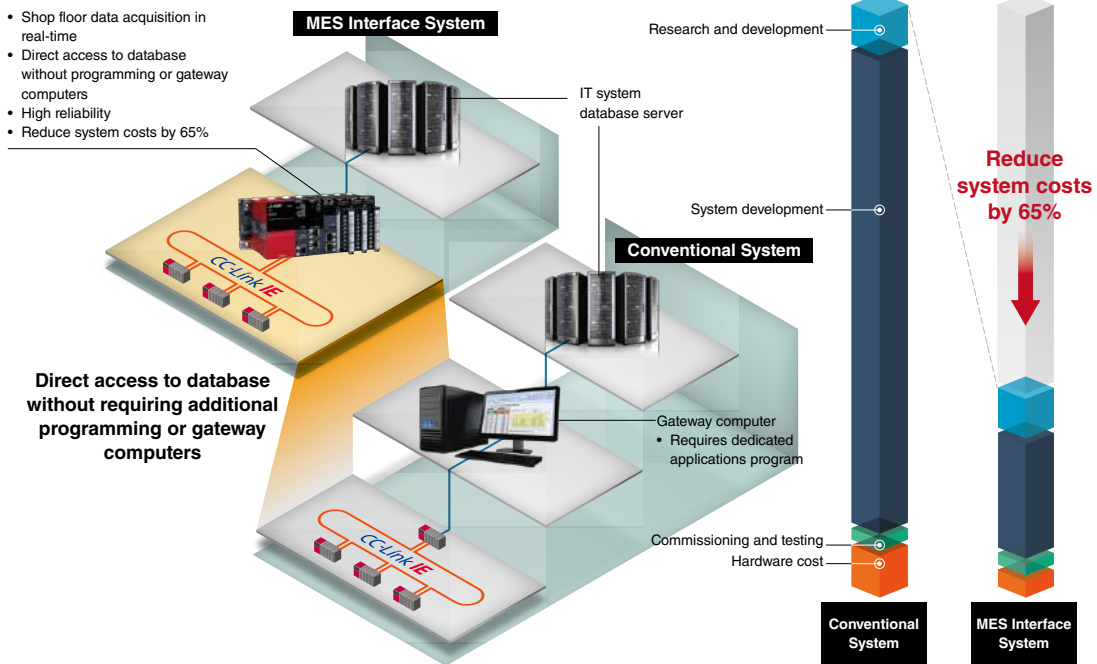

MES Interface module specifications

Item	RD81MES96
Database connection	
Supported database*3	Oracle® Database, Microsoft® SQL Server®, Microsoft® Access®, MySQL®, PostgreSQL
SQL text	SELECT, INSERT, UPDATE, DELETE, Multi-SELECT, STORED PROCEDURE
Database communication action field	65,536
Accessible CPU module*3	iQ-R Series (Direct, Remote), Q Series (Remote), L Series (Remote)
Data sampling interval	
High speed data sampling (ms)	Sequence scan time synchronization, 1...900 (up to 8K points)
General data sampling (s)	0.1...0.9, 1...3600
Function	
DB record read/write	Reads/writes data in the database of the host information system
Device memory read/write	Reads/writes device memory data of the CPU module
Trigger condition monitoring	Monitors values of the time or device tag components etc., and starts jobs when a trigger condition changes from false to true (the condition is satisfied)
Data operation and processing	Performs four arithmetic operations, obtains remainder, performs character string operation, etc.
Program execution	Executes a program on the server through a MES Interface module
DB buffering	Buffers the data sent to the database, and resend it after recovery, when the data cannot be linked due to the disconnection of the network between MES Interface module and the database or failure of the database etc.
REST server*4	Enables job-related operations and job information acquisition from the REST client (Also supports the XML process function for the MELSEC-Q Series MES interface module)

*3: For details, please refer to the relevant manual (for support related to the database, please contact the relevant database software company).

*4: REST: Representational state transfer

OPC UA Server Module

RD810PC96

Embedded OPC UA server

The MELSEC iQ-R Series OPC UA server module integrates the OPC UA server directly into the equipment control system as a robust alternative to a computer-based configuration. OPC Unified Architecture (OPC-UA) is a platform-independent communications standard developed by the OPC foundation that offers reliable and secure data communications between the manufacturing-level and IT-level systems.

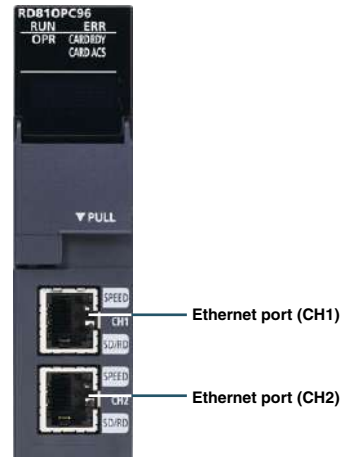

Embedded OPC UA server improves system reliability and reduces cost

The OPC UA server module can be installed directly on the MELSEC iQ-R Series base unit realizing an embedded OPC UA server within the machine. This improves reliability by eliminating the requirement for a computer-based server, which can be vulnerable to high security risks such as computer viruses. Less hardware maintenance is required, reducing overall system cost as industrial control systems have a longer product service life compared to computers. Efficient tag data management provided utilizing data structure format and storage of tag names within the equipment. Implementation of an IT system is improved such as with SCADA simply by selecting the stored tag.

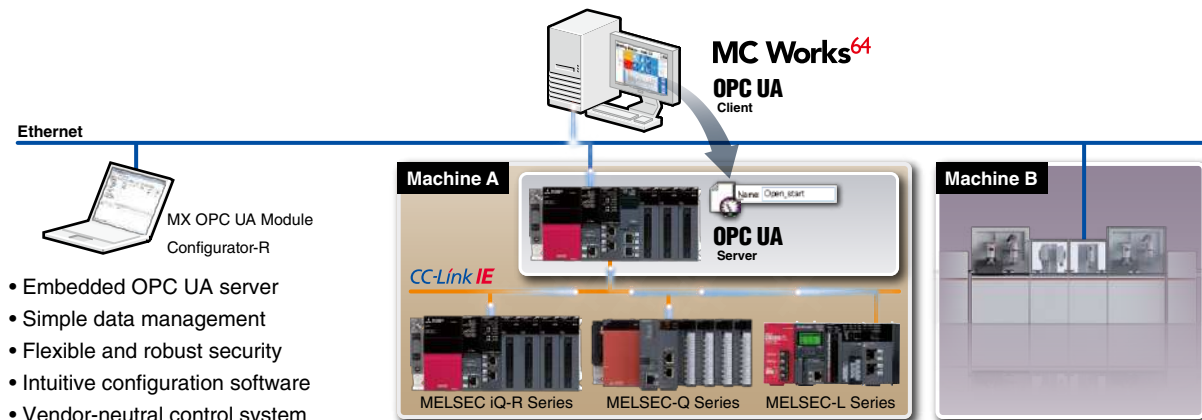

Robust security with protection against unauthorized data access

OPC UA security function such as certificate, encrypt and signature can be set based on system requirements. Security is enhanced by having two Ethernet ports, enabling separation of the IT and shop floor networks.

OPC UA server module software specifications

Item	RD810PC96	
Basic operating specifications		
Connection method	Ethernet IPv4	
Simultaneously connected configuration software	1	
Device memory input/output specifications		
Max. number of tags	10000	
Access device	Max. number	8
	Type	<ul style="list-style-type: none"> • RCPU • QCPU (Q mode) • LCPU
Data collection period	Max. number of definitions	8
	Setting cycle	200 ms...24 h
Max. number of conversion definitions	256	
Connected OPC UA clients		
Max. number of connections	15	
Connectable Ethernet port	CH1	

This product includes software developed by the OpenSSL Project for use in the OpenSSL Toolkit (<http://www.openssl.org/>).

System configuration

CPU

I/O

Analog

Motion, Positioning, Flexible high-speed I/O, High-speed counter

Network

Advanced information

Software

High-speed Data Logger Module RD81DL96 Data collection

The production process data acquisition feature of this high-speed data logger module contributes to improving production quality and efficiency, thereby realizing optimal production processes. The module enables logging of various data such as Unicode, CSV, and BIN text formats, which can be utilized for spreadsheet reporting owing to the automatic report generation feature: BIN text format data can be ported directly to Microsoft® Windows® Excel®. Logging files can also be automatically sent to a FTP server or directly into a Microsoft® Windows® share folder.

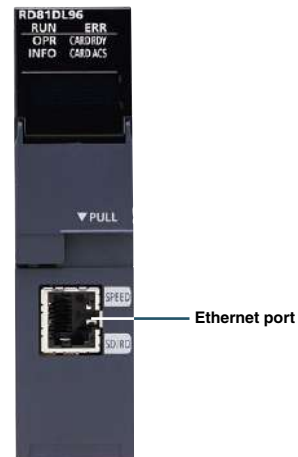

Data logging synchronized with control system scan time

Acquired data can be synchronized with the control system scan time and achieve sampling rates up to 0.5 ms, realizing a higher resolution that enables changes in control data to be captured.

High-speed data sampling function: 0.5 ms (max.)

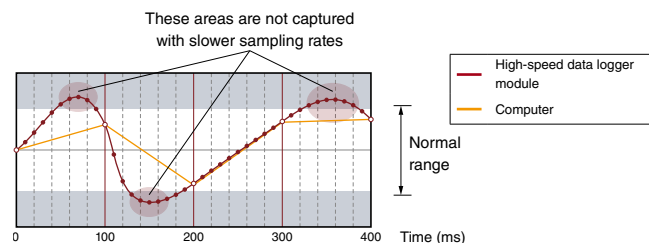

Easier root cause analysis

Event-driven data can be acquired right before and after the trigger occurrence, improving the recovery time of the control system.

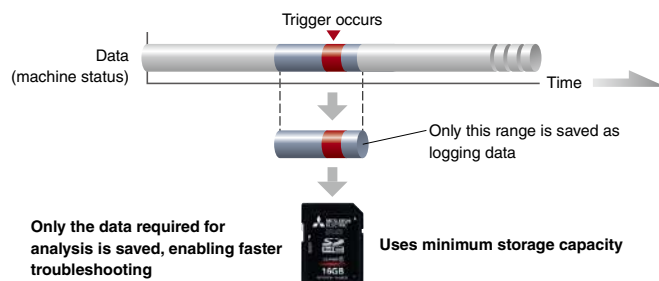

Utilize data for various analysis and maintenance processes

Various data, such as the frequency and duration of a specific operation that has been satisfied, can be utilized for preventative maintenance and machine operation/trend analysis.

High-speed data logger module specifications

Item	RD81DL96
Accessible CPU modules	iQ-R Series (Direct, Remote), Q Series (Remote), L Series (Remote)
Data sampling interval	
High-speed data sampling (ms)	<ul style="list-style-type: none"> Sequence scan time synchronization 0.5...0.9, 1...32767 (for trigger logging) 2...32767 (for continuous logging)
General data sampling (s)	<ul style="list-style-type: none"> 0.1...0.9, 1...32767 Time interval specification (specify hour/minute/second)
Amount of sampled data	
High-speed data sampling	<ul style="list-style-type: none"> Overall amount of data: 32768 (per setting: 1024) Overall number of device points: 32768 (per setting: 4096)
General data sampling	<ul style="list-style-type: none"> Overall amount of data: 65536 (per setting: 1024) Overall amount of data: 262144 (per setting: 4096)
Function	
Data logging	Logs CPU module device values at specified data sampling intervals.
Event logging	Monitors sampled device values from the CPU module, and logs events that occur.
Report	Outputs the data sampled by the high speed data logger module as an Excel® file.
Recipe	Executes the following operations using recipe files stored in the SD memory card: <ul style="list-style-type: none"> Transfer device values written on the recipe files to devices in the CPU module. Transfer device values in the CPU module to the recipe files.

C Intelligent Function Module

RD55UP06-V

C/C++ program execution

The C Intelligent function module is available with a multi-core ARM®-based controller pre-installed with VxWorks® Version 6.9, which realizes simultaneous execution of programs, thereby providing a robust and deterministic alternative to computer-based systems. Utilizing a fan-less hardware design, the C Intelligent function module is ideal for clean fab-based environments, where dust circulation can be detrimental to the production environment, and can be used for applications such as in-line production quality testing or as a gateway for various industry-specific communications protocols.

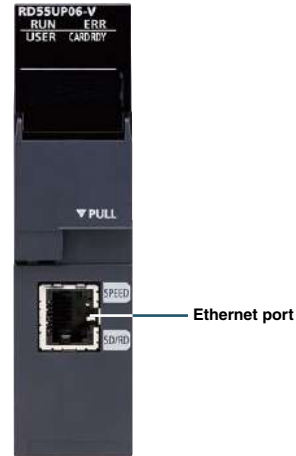

Realize complex arithmetic equations in C/C++

The C Intelligent Function module enables the execution of C/C++ programs when paired with a standard MELSEC iQ-R Series Programmable Controller CPU, emulating the same features as a standalone C Controller. Representing complex arithmetic and string equations in C/C++ programs is much easier than implementing in ladder form, thereby reducing overall development time and program size. Additionally, Intellectual property is simplified as the result of separating it from the ladder program.

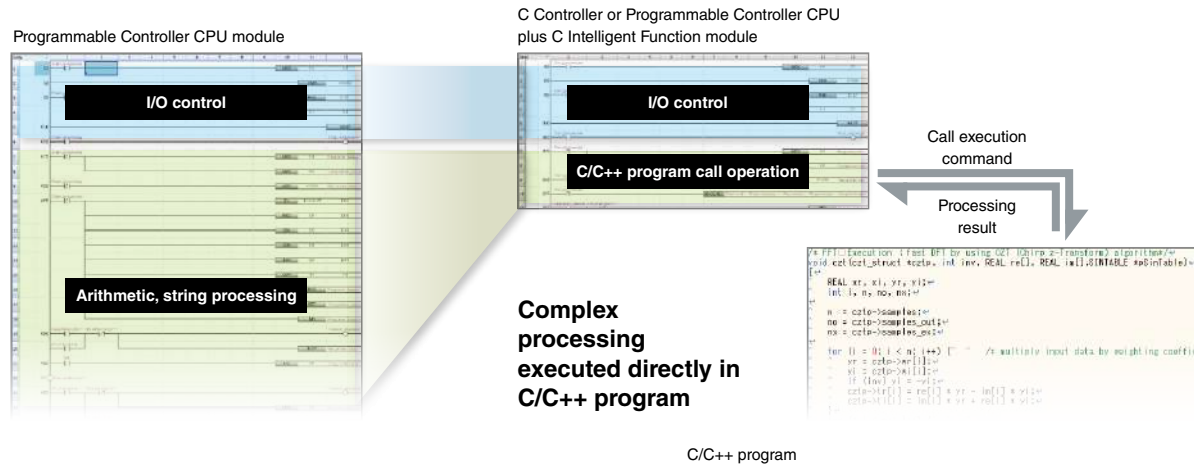

Application development in simple steps

CW Workbench*1 is used as the main programming software in C/C++ with a VxWorks® emulator, CW-Sim/CW-Sim standalone, which allows debugging without requiring any hardware.

*1: For more information, please refer to page 45.

C intelligent function module specifications

Item	RD55UP06-V
Hardware	
Endian format	Little endian
MPU	ARM® Cortex-A9 Dual Core
Working RAM	128 MB
ROM	12 MB
Software	
OS	VxWorks® Version 6.9
Programming language	C/C++
Programming development environment	CW Workbench/Wind River Workbench 3.3
Setting/monitoring tool	GX Works3 (SW1DND-GXW3-E)*2
Communication interface	
Ethernet (100BASE-T/100BASE-TX/10BASE-T)	1 CH
SD memory card slot	●

*2: Setting and monitoring of the module is integrated within the GX Works3 engineering software.

System configuration

CPU

I/O

Analog

Motion, Positioning, Flexible high-speed I/O, High-speed counter

Network

Advanced information

Software

Energy Measuring Module

RE81WH NEW
Energy Measuring



The energy measuring module can process measured data at a refresh cycle of 10 ms and is ideal for energy saving, facility monitoring, and quality control at the manufacturing site. Improved productivity of both equipment and the production line can be achieved by synchronizing the monitoring of consumed energy and specific energy consumption management with the control program.

Faster data measurement refresh cycle (10 ms)

Using only one module, highly detailed information such as electric energy (consumption and regeneration), reactive energy, current*1, voltage*1, electric power, power factor, frequency, harmonic current, and harmonic voltage can be measured for individual production equipment. With constant current monitoring of motors and other devices, it is possible to avoid line stoppages and downtime; thereby reducing delivery time issues due to production stoppages as well as maintenance related labor and costs. Moreover, by detecting abnormal voltage or current in manufacturing equipment and removing products manufactured during the time of abnormality, shipping defective products can be prevented.

*1: Waveform data for current and voltage can also be obtained. For further details, please refer to the product user's manual (detailed edition).

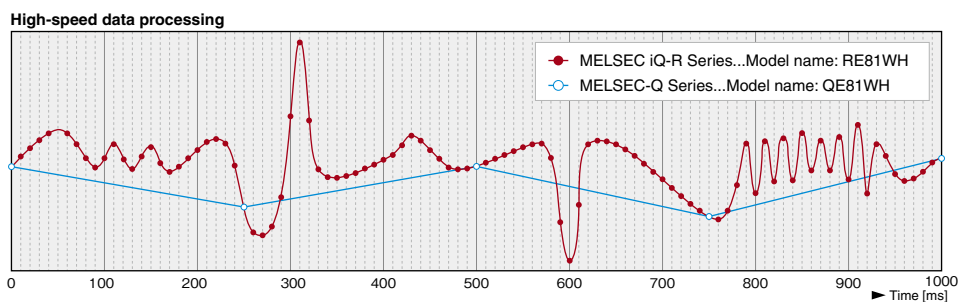

Modular design realizing compact size with minimal wiring

The energy measuring module requires minimal space and wiring, and can be installed directly on a vacant slot of the MELSEC iQ-R base unit, enabling measurement functions to be added without changing the layout in the control panel. Split-type current sensors can also be easily attached to pre-installed power cables. Engineering is improved as there is no need to create a separate communication program to interface the programmable controller.

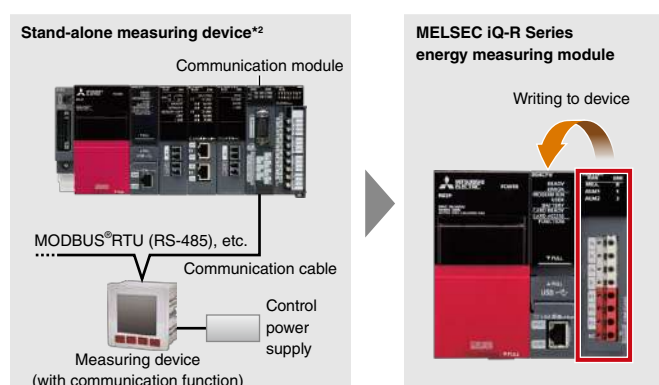

*2: A configuration where measurement data is collected using a programmable controller

Energy measuring module specifications

Item	RE81WH
Number of measurable circuits	1
Phase-wire systems	Single-phase 2-wire, single-phase 3-wire, three-phase 3-wire
Current circuit	5, 50, 100, 250, 400, 600 A AC (Using dedicated split-type current sensor. Each value indicates current sensor's primary current value.) 5 A AC (Using dedicated 5 A current sensor. 5 A current sensor is used with two-stage configuration in combination with current transformer (CT). Primary current value can be set up to 6,000 A.)
Voltage circuit	
Single-phase 2-wire, three-phase 3-wire	110, 220 V AC common
Single-phase 3-wire	110 (1-2 lines, 2-3 lines), 220 V AC (1-3 lines)
Measurement specifications	
Data refreshing cycle (ms)	10...10000 (able to set in increments of 10 ms)
Measurement items	Current, current demand, voltage, electric power, electric power demand, reactive power, apparent power, harmonic current, harmonic voltage, frequency, power factor, electric energy, reactive energy

FA Integrated Engineering Software MELSOFT iQ Works

MELSOFT iQ Works is an integrated software suite consisting of GX Works3, MT Works2, GT Works3, RT ToolBox3 and FR Configurator2, which are programming software for each respective product. Integration is further enhanced with MELSOFT Navigator as the central system configuration incorporating an easy-to-use, graphical user interface with additional project-sharing features such as system labels and parameters. The advantages of this powerful integrated software suite are that system design is made much easier with a substantial reduction in repetitious tasks, cutting down on errors while helping to reduce the overall TCO.

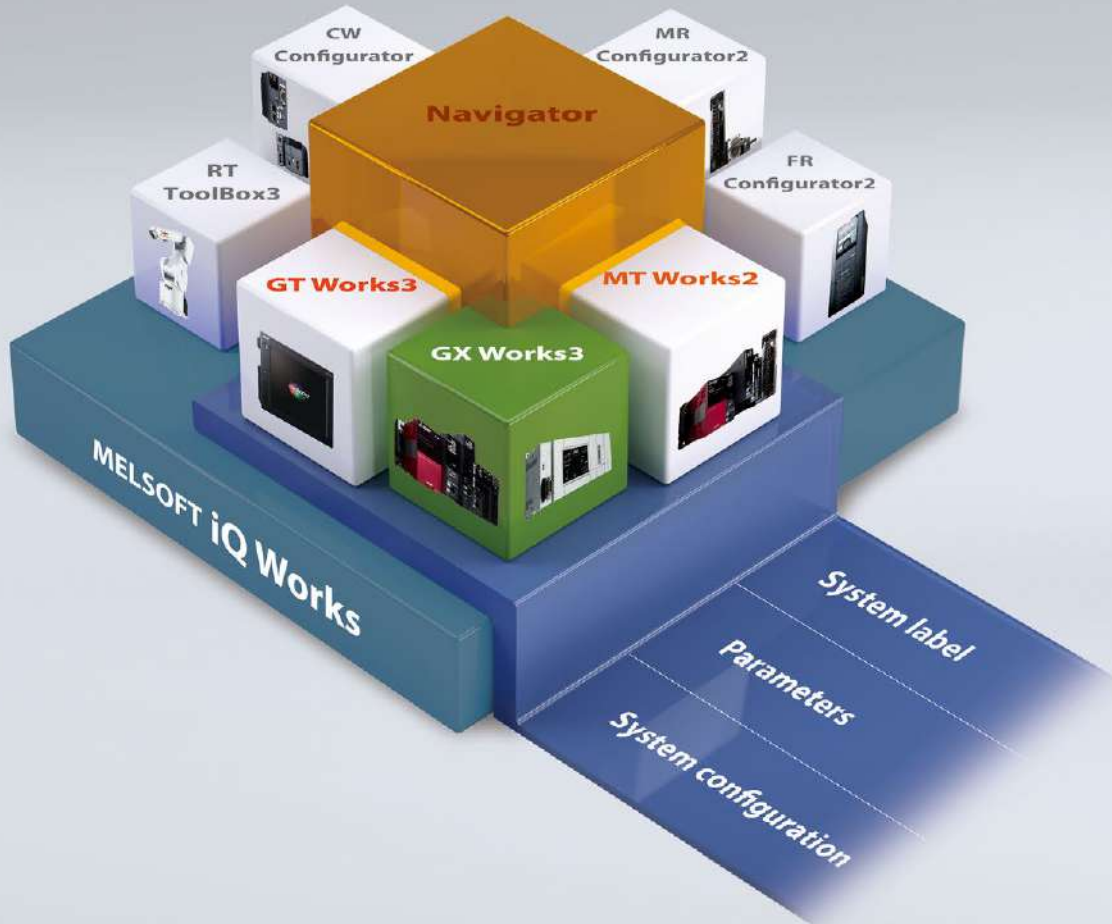

System management software

MELSOFT Navigator

System level graphic-based configuration tool that simplifies the system design by providing a visual representation of the system. System management features such as system-wide parameterization, labels and block reading of project data are also included.

Programmable controller engineering software

MELSOFT GX Works3

GX Works3 is the latest generation of programming and maintenance software offered by Mitsubishi Electric specifically designed for the MELSEC iQ-R Series control system. It includes many new features such as graphic-based system configuration, integrated motion control setup, multiple language support, providing an intuitive engineering environment solution.

HMI/GOT screen design software

MELSOFT GT Works3

This graphic operation terminal (GOT) screen creation software is designed with three main features—simplicity, graphics design and operation ease—that help to create graphic screens in fewer steps.

Motion controller engineering software

MELSOFT MT Works2

This motion control design and maintenance software includes intuitive graphic-based programming together with a digital oscilloscope simulator.

Robot engineering software

MELSOFT RT ToolBox3

Inverter setup software

MELSOFT FR Configurator2

C Controller setting and monitoring tool

MELSOFT CW Configurator

Servo setup software

MELSOFT MR Configurator2

System configuration

CPU

I/O

Analog

Motion, Positioning, Flexible high-speed I/O, High-speed counter

Network

Advanced information

Software

Total system centralized configuration

The correlation between the system configuration feature of MELSOFT Navigator and GX Works3, MT Works2 has been further improved. The system design console works in a bidirectional method, enabling the system configuration to be shared across all three software including network level integration without having to re-design the configuration from within the product level programming software(s).

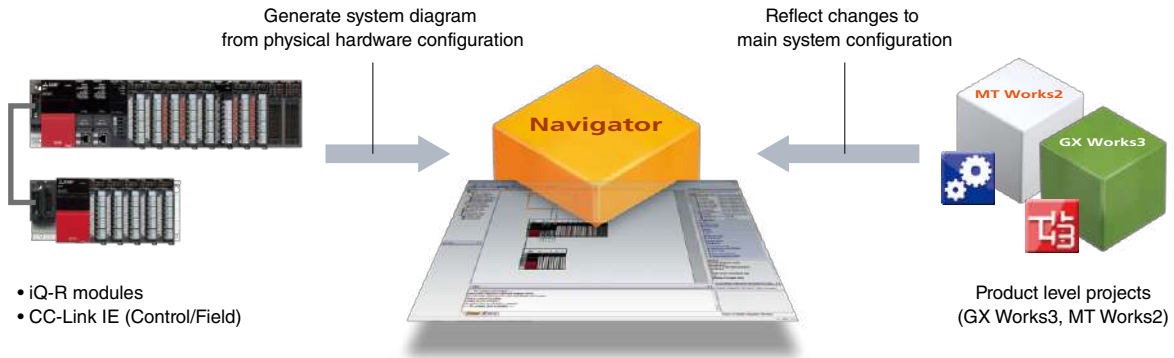

Effective parameter registration

Registration of module parameters within the system has been further enhanced with parameters being shared bidirectionally between MELSOFT Navigator and GX Works3, MT Works2. Upward registration of parameters to MELSOFT Navigator is also possible as changes are reflected from within the system configuration.

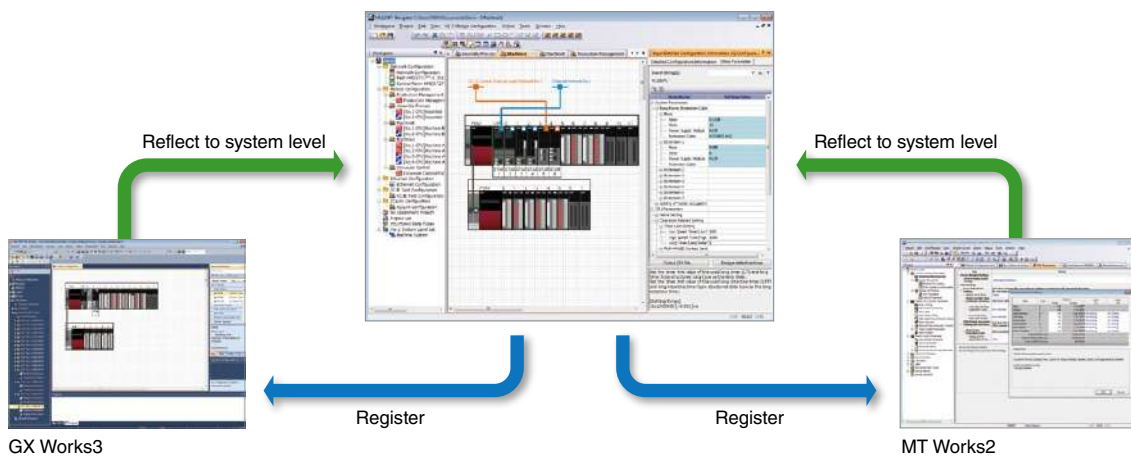

Unified system label database

The unified label database allows centralized management of global labels across both GX Works3 and GT Works3. The dynamic labeling structure enables system label sharing, which ensures that labels can be used without being conscious of the device associated with that label. The structure is also responsive to system configuration changes without having to modify the labels within the product programming tools.

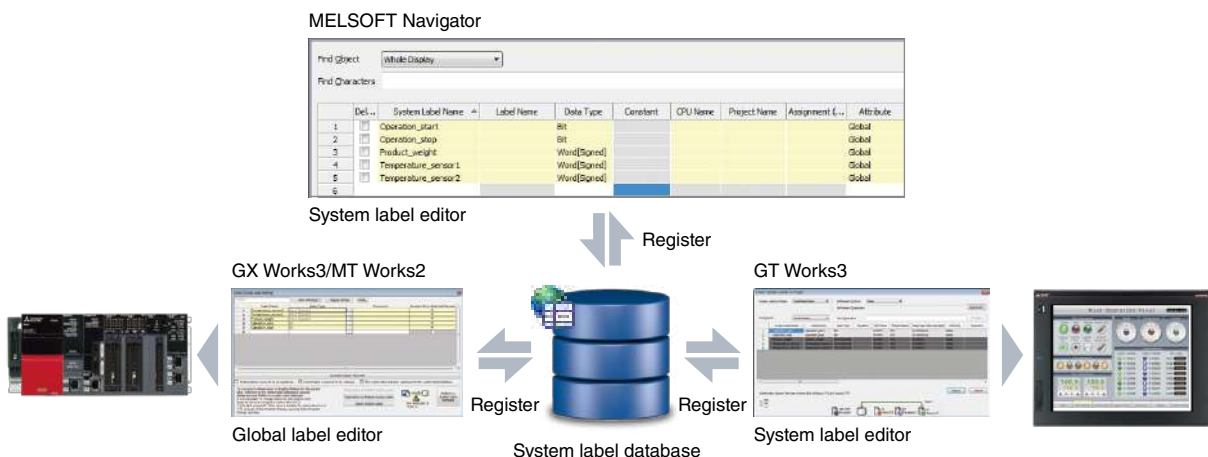

GX Works3

One Software, Many Possibilities



Mitsubishi Electric
MELSOFT GX Works3
Promotion Movie

GX Works3 consists of various different components that help to simplify project creation and maintenance tasks. A system design console that enables projects to be created at the system overview stage has been added. Additionally, the main programming languages are supported and their labels (variables) are shared, further simplifying programming. Various debug and maintenance features are also included.

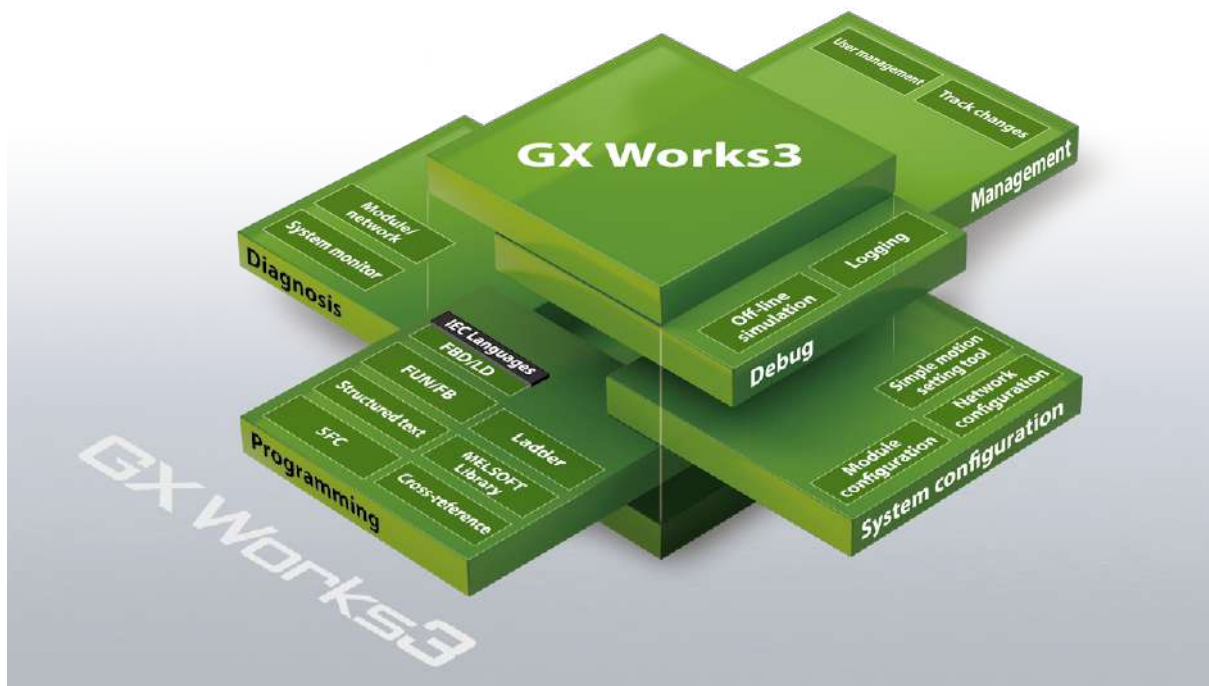

Project lifecycle engineering

Various features have been consolidated into an integrated engineering environment that enables easier project creation throughout the engineering process, ensuring consistency through every step.

- System-wide design
 - Easy system configuration with parts library
 - Direct module parameter registration
 - Integrated simple motion module setup
- Multiple programming languages
 - Conforms to IEC 61131-3
 - Supports main programming languages
 - Consistency between different programming tabs
- Simple to debug
 - Various online monitoring
 - Hardware simulator (emulator)
 - Data logging
- Straightforward maintenance
 - System monitoring
 - Module and network diagnostics
 - Multi-language commenting

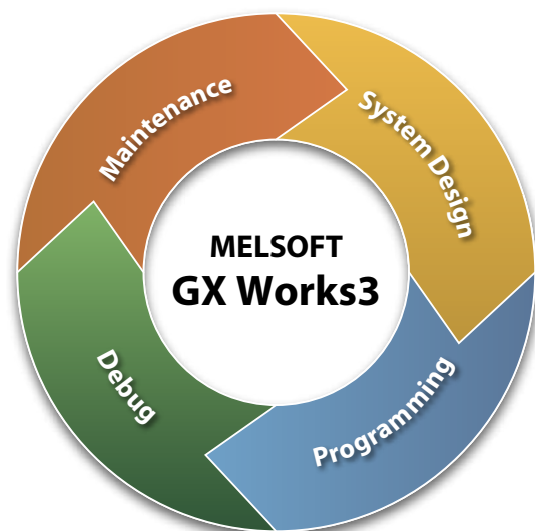

System configuration

CPU

I/O

Analog

Motion, Positioning,
Flexible high-speed I/O
High-speed counter

Network

Advanced information

Software



System Design

System design with a convenient parts library

Most projects start from system design, so having a software application that caters to this initial stage is important. GX Works3 incorporates a system design feature that enables system components to be assembled directly in the programming software. It includes a parts library consisting of MELSEC iQ-R Series modules that can be used to simplify system creation.

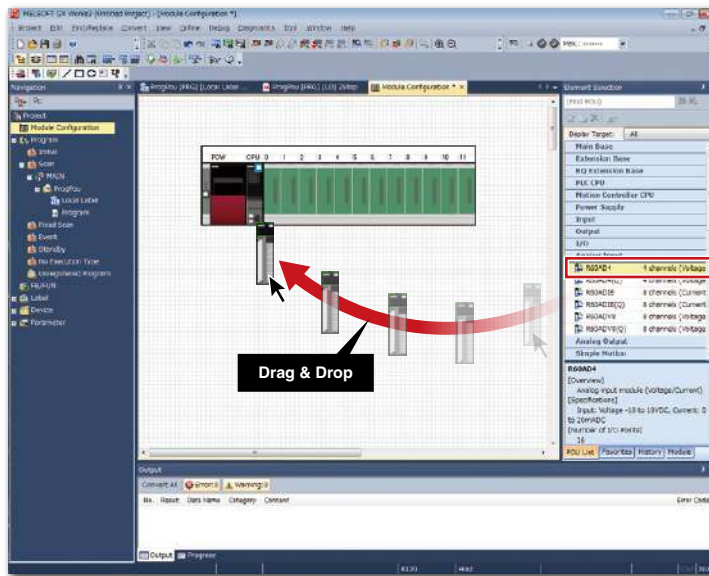

Register module parameters on the fly

Another useful feature is the ability to register parameters automatically. Simply double-click on the desired module and the corresponding parameters will be registered in the project. A window with an easy-to-use parameter settings screen opens, enabling module parameters to be modified as needed.

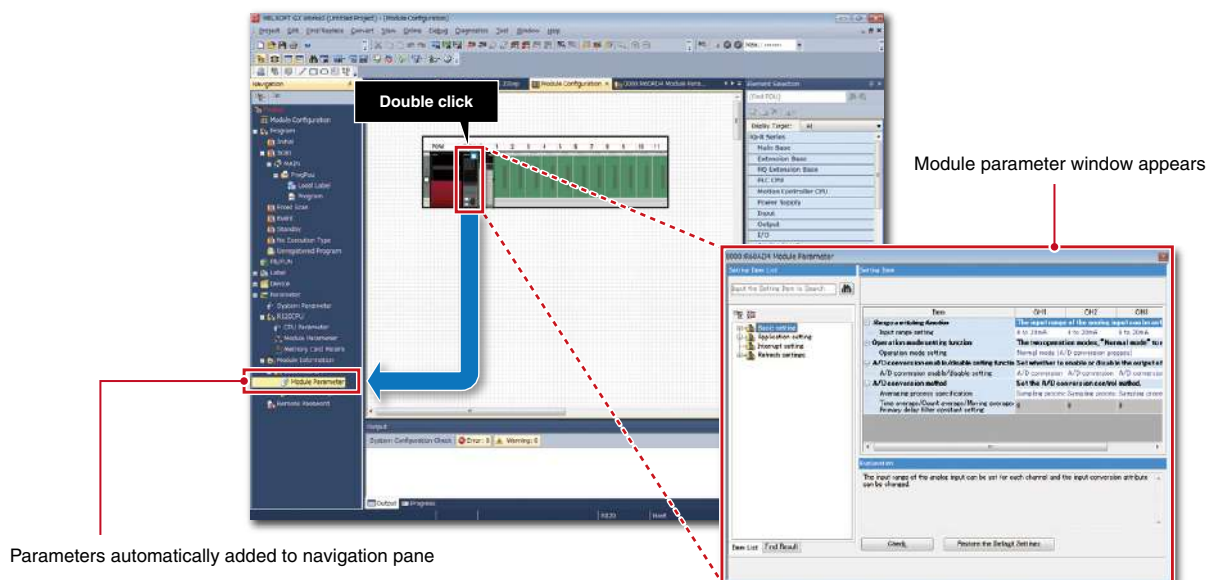

Integrated motion setup tool

GX Works3 is equipped with a special motion setup tool that makes it easy to change simple motion module settings such as module parameters, positioning data and servo parameters. Also, debugging is simplified using the fine-tuning cam data generation feature.

Project window

Easy to use navigation pane

Servo amplifier information

Quickly visualize type of servo amplifier and motor model

Servo amplifier setup

Select the servo amplifier and operation mode for each axis.

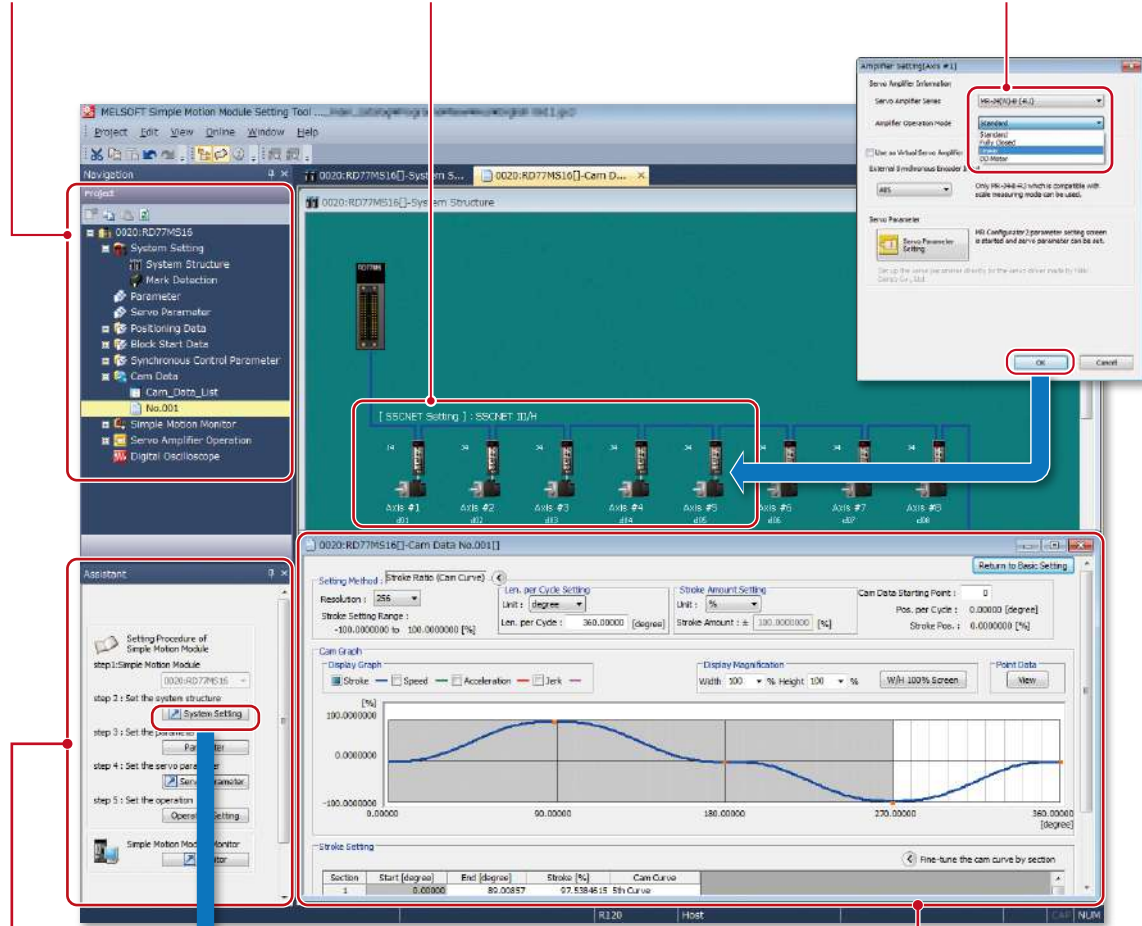

Assistant window

Selective tools further simplifying setup

Cam data

Fine-tune cam curve data

Basic parameters

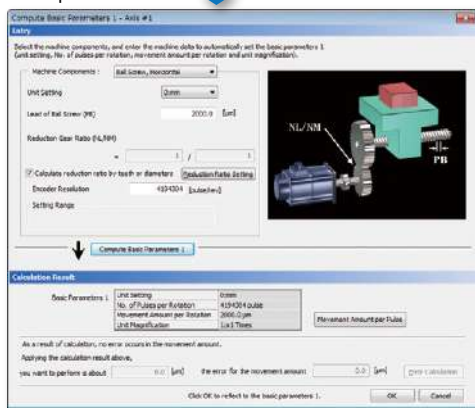

Synchronous parameters

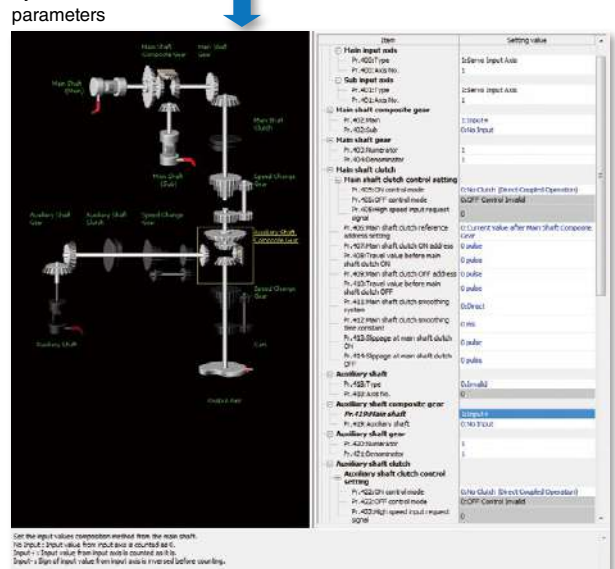

System configuration

CPU

I/O

Analog

Motion, Positioning, Flexible high-speed I/O, High-speed counter

Network

Advanced information

Software



Programming

Central parts library

GX Works3 comes with an updated object library pre-installed in the software consisting of a module library with current modules at time of software release although this can be added to as newer modules become available. A variety of other objects are available such as third-party partner function blocks. The library can be fully shared across multiple projects.



MELSOFT Library

■ 3rd party partner FBs



FB

Vision sensor



FB

RFID



FB

Laser displacement sensor

■ Module FBs (Mitsubishi Electric products)

Module Label

Module FB

- ▶ R120CPU
- ▶ R60DA4
- ▶ M+R60C Monitor error and
- ▶ M+R60C Request setting FB
- ▶ M+R60C Wave output setti

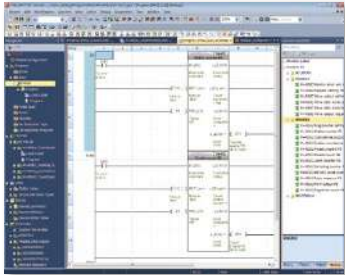

Just "select" to create a program

Reduce repetitive program tasks

Global and local variables (labels) are supported providing an easy way to share device names across multiple projects, other MELSOFT software and third party SCADA. The variables can be registered into either the current program, function block as a local variable or within the project as a global variable to share across multiple programs within the same project. Variables specific to a particular module are also available, and can be used immediately, further reducing engineering time and cost.

Global label editor

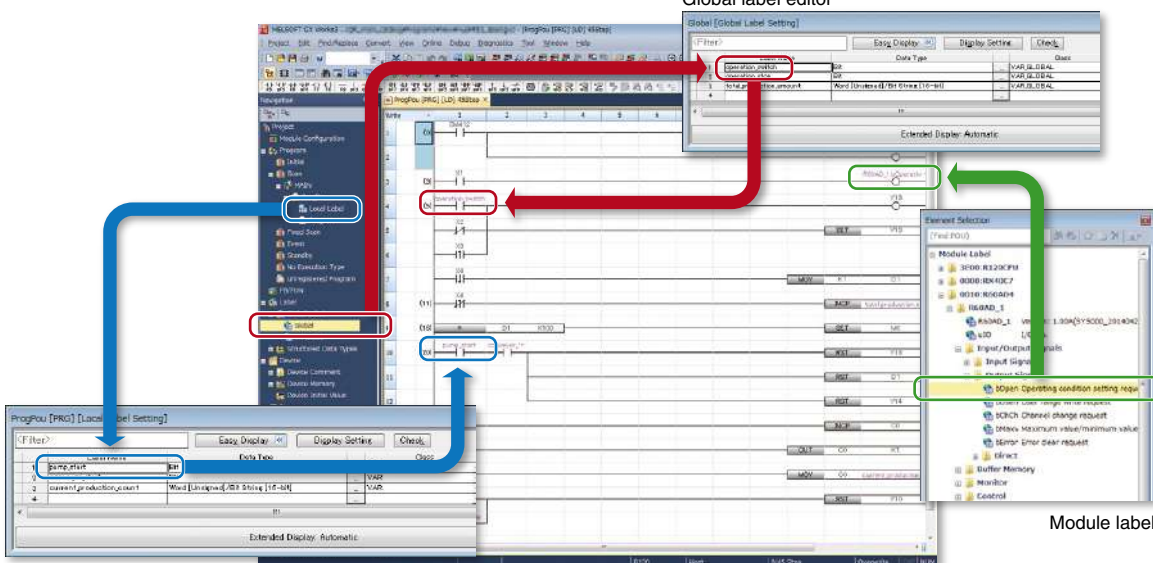

Local label editor

Module label

Main programming languages supported

The main IEC languages are supported by GX Works3. Various different programming languages can be used within the same project simultaneously and can be viewed easily via the menu tab. The variables and devices used in each program can be shared across multiple platforms, with user defined function blocks supported.

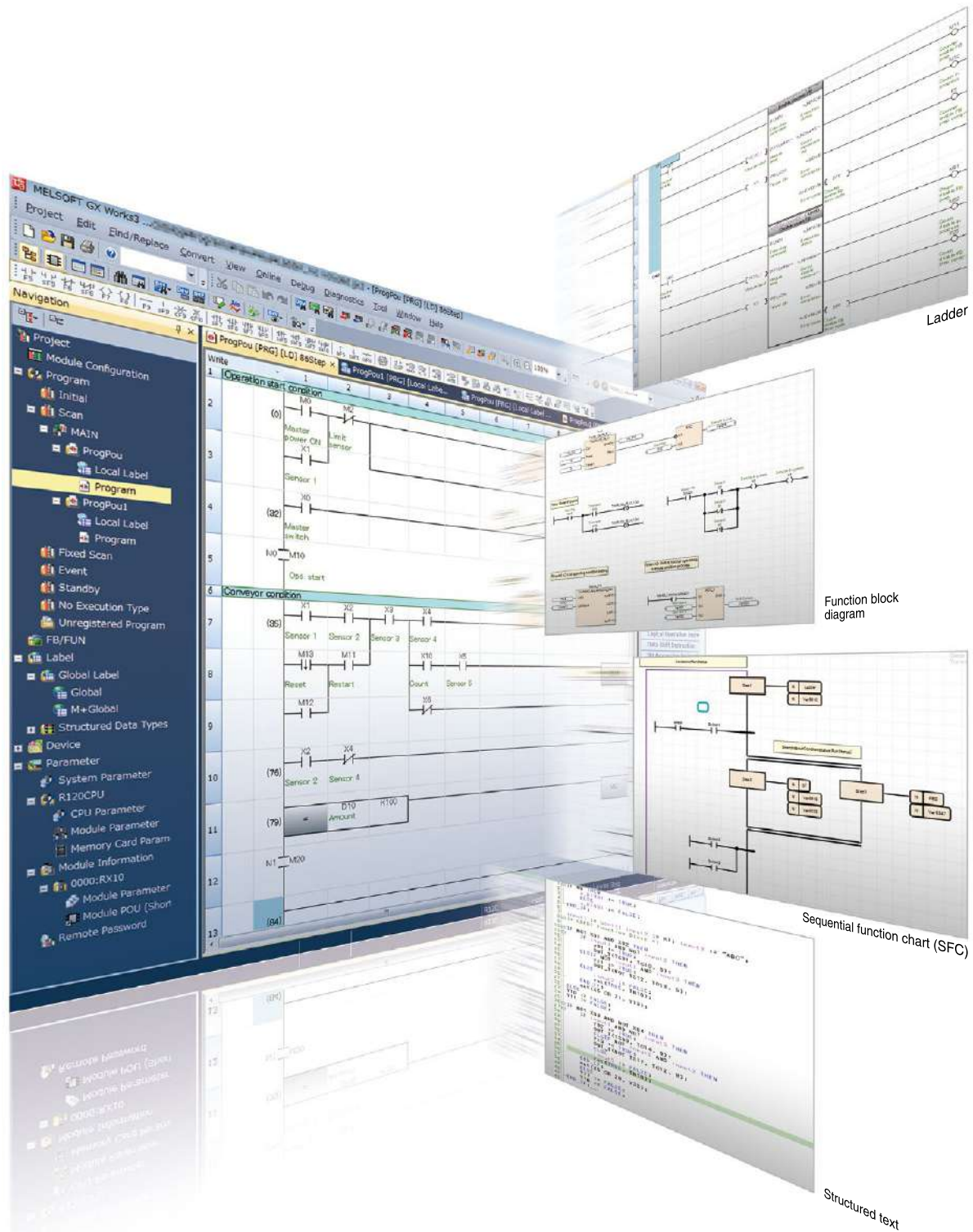

- System configuration
- CPU
- I/O
- Analog
- Motion, Positioning, Flexible high-speed I/O, High-speed counter
- Network
- Advanced information
- Software



Debug

Easy version management

Being able to visually see and manage different versions of the same project can help to reduce debugging processes. Even with a number of engineers are working on the same project, changes made are easily recognized directly from the program or as an automatically generated verification results list. This feature is available for locally stored projects on the computer, and between the program stored in the programmable controller CPU.

Online data operation

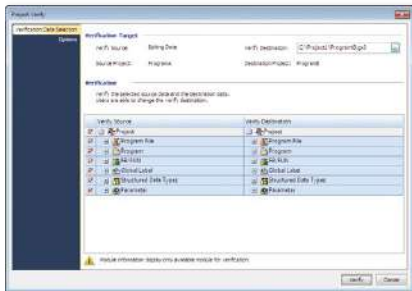

Verification results

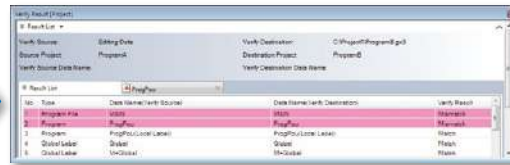

Graphical representation of differences

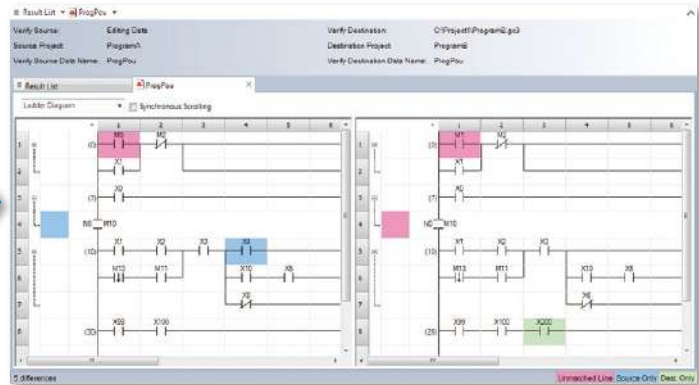

■ : Unmatched Line ■ : Source Only ■ : Dest. Only

Hardware simulation

GX Works3 features an integrated simulator which helps to visualize the operation of the program during the debugging process. Motion control CPU hardware can be simulated as well.

Offline debugging without a control CPU required

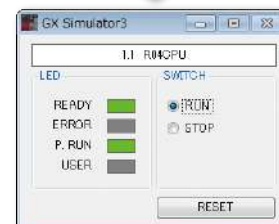
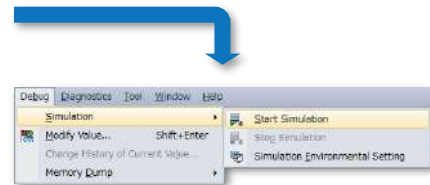
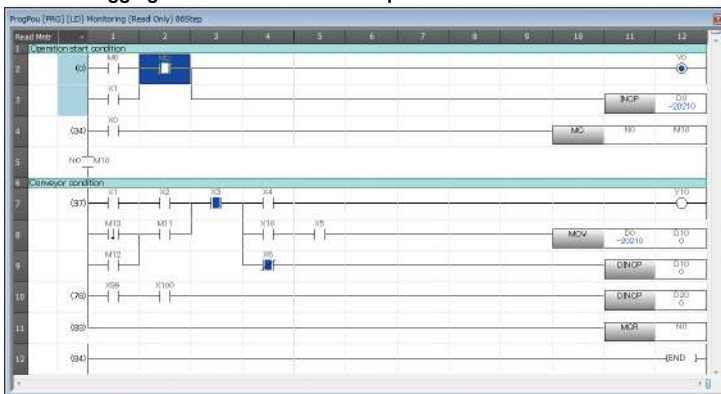

Directly debugging on the computer

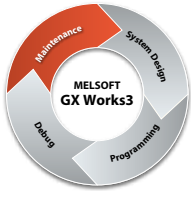

Maintenance

Simplified troubleshooting reduces downtime even further

GX Works3 incorporates various maintenance features helping to reduce downtime and keep productivity high. Various levels of maintenance are possible, from system-wide monitoring of errors and module status to monitoring at the network level; for example, detailed operations that show where programs or parameters have been changed in the CPU and the monitoring of system events, which also includes a useful historical function that can be exported as a CSV file.

System monitor

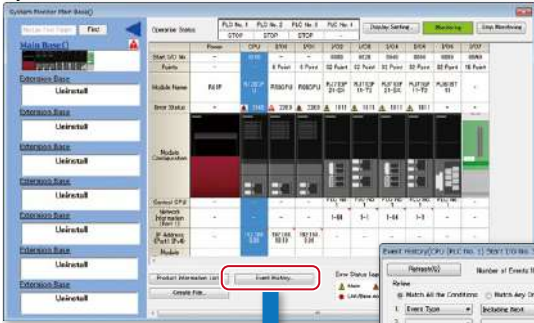

CC-Link IE Field diagnosis window

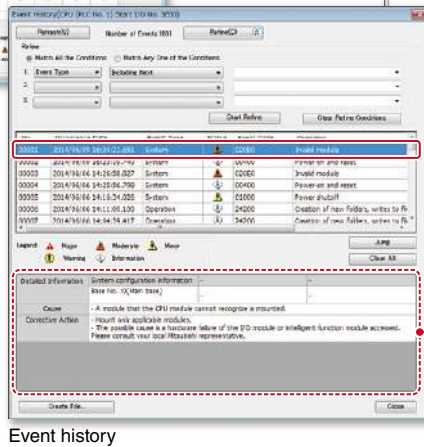
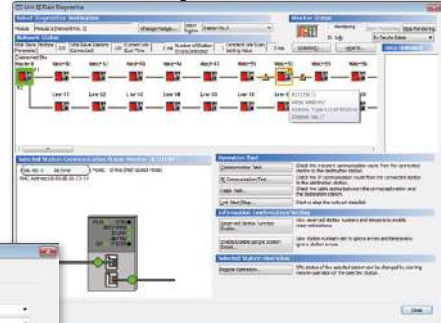

Detailed information including the cause and respective countermeasures are shown here

Event history

Multi-language menu, ideal for global support

The menu system can be switched between various languages, enabling different locations to work on the same project with the same programming software version. In addition, device comments within the project can be switched between various languages without having to create multiple copies of the same project to support the comments in different languages.

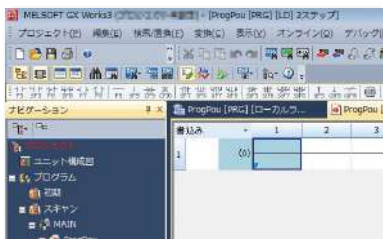

Menu language switch

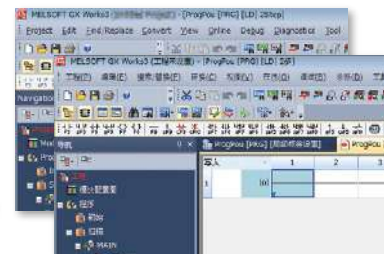

Language version of comments being switched

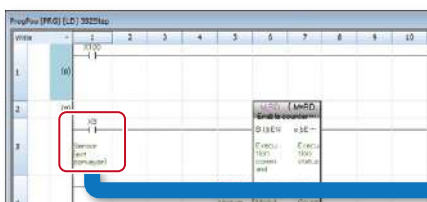

Device Name	Japanese/日本語	English(Display Target)
X0	運転スイッチ	Start operation
X1	センサ	Sensor
X2	緊急停止スイッチ	Start operation (out conveyor)
X3	センサ(増設コンベア)	Sensor (ext conveyor)

System configuration

CPU

I/O

Analog

Motion, Positioning, Flexible high-speed I/O, High-speed counter

Network

Advanced information

Software

Extensive global support coverage providing expert help whenever needed

■ Global FA centers

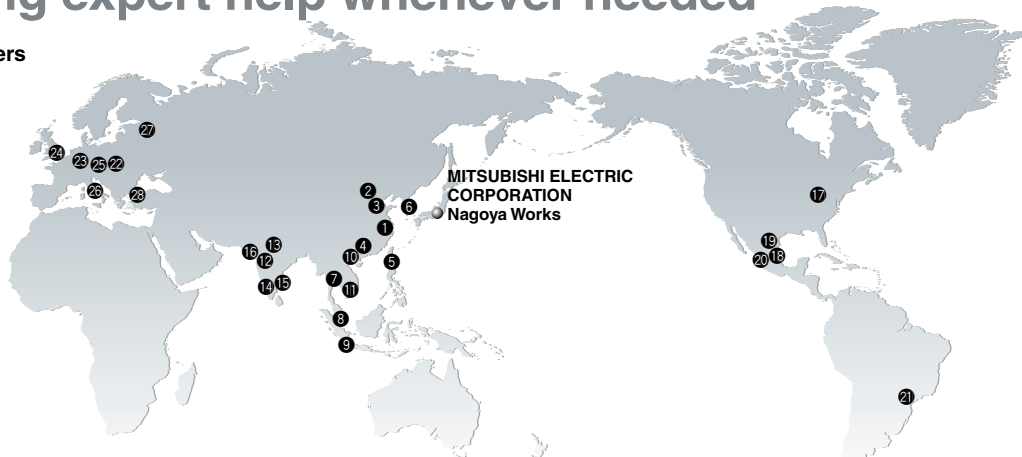

China

1 Shanghai FA Center

MITSUBISHI ELECTRIC AUTOMATION (CHINA) LTD. Shanghai FA Center

Mitsubishi Electric Automation Center, No.1386 Hongqiao Road, Shanghai, China
Tel: +86-21-2322-3030 / Fax: +86-21-2322-3000

2 Beijing FA Center

MITSUBISHI ELECTRIC AUTOMATION (CHINA) LTD. Beijing FA Center

Unit 901, Office Tower 1, Henderson Centre, 18 Jianguomennei Avenue, Dongcheng District, Beijing, China
Tel: +86-10-6518-8830 / Fax: +86-10-6518-2938

3 Tianjin FA Center

MITSUBISHI ELECTRIC AUTOMATION (CHINA) LTD. Tianjin FA Center

Room 2003 City Tower, No.35, Youyi Road, Hexi District, Tianjin, China
Tel: +86-22-2813-1015 / Fax: +86-22-2813-1017

4 Guangzhou FA Center

MITSUBISHI ELECTRIC AUTOMATION (CHINA) LTD. Guangzhou FA Center

Room 1609, North Tower, The Hub Center, No.1068, Xingang East Road, Haizhu District, Guangzhou, China
Tel: +86-20-8923-6730 / Fax: +86-20-8923-6715

Taiwan

5 Taipei FA Center

SETSUYO ENTERPRISE CO., LTD.

3F, No.105, Wugong 3rd Road, Wugu District, New Taipei City 24889, Taiwan
Tel: +886-2-2299-9917 / Fax: +886-2-2299-9963

Korea

6 Korea FA Center

MITSUBISHI ELECTRIC AUTOMATION KOREA CO., LTD.

8F, Gangseo Hangang Xi-tower A, 401, Yangcheon-ro, Gangseo-Gu, Seoul 07528, Korea
Tel: +82-2-3660-9632 / Fax: +82-2-3664-0475

Thailand

7 Thailand FA Center

MITSUBISHI ELECTRIC FACTORY AUTOMATION (THAILAND) CO., LTD.

12th Floor, SV.City Building, Office Tower 1, No. 896/19 and 20 Rama 3 Road, Kwaeng Bangpongpan, Knet Yannawa, Bangkok 10120, Thailand
Tel: +66-2682-6522-31 / Fax: +66-2682-6020

ASEAN

8 ASEAN FA Center

MITSUBISHI ELECTRIC ASIA PTE. LTD.

307 Alexandra Road, Mitsubishi Electric Building, Singapore 159943
Tel: +65-6470-2480 / Fax: +65-6476-7439

Indonesia

9 Indonesia FA Center

PT. MITSUBISHI ELECTRIC INDONESIA Cikarang Office

Jl. Kenari Raya Blok G2-07A Delta Silicon 5, Lippo Cikarang - Bekasi 17550, Indonesia
Tel: +62-21-2961-7797 / Fax: +62-21-2961-7794

Vietnam

10 Hanoi FA Center

MITSUBISHI ELECTRIC VIETNAM COMPANY LIMITED Hanoi Branch Office

6th Floor, Detech Tower, 8 Ton That Thuyet Street, My Dinh2 Ward, Nam Tu Liem District, Hanoi, Vietnam
Tel: +84-4-3937-8075 / Fax: +84-4-3937-8076

11 Ho Chi Minh FA Center

MITSUBISHI ELECTRIC VIETNAM COMPANY LIMITED

Unit 01-04, 10th Floor, Vincom Center, 72 Le Thanh Ton Street, District 1, Ho Chi Minh City, Vietnam
Tel: +84-8-3910-5945 / Fax: +84-8-3910-5947

India

12 India Pune FA Center

MITSUBISHI ELECTRIC INDIA PVT. LTD. Pune Branch

Emerald House, EL-3, J Block, M.I.D.C., Bhosari, Pune - 411026, Maharashtra, India
Tel: +91-20-2710-2000 / Fax: +91-20-2710-2100

13 India Gurgaon FA Center

MITSUBISHI ELECTRIC INDIA PVT. LTD. Gurgaon Head Office

2nd Floor, Tower A & B, Cyber Greens, DLF Cyber City, DLF Phase-III, Gurgaon-122002, Haryana, India
Tel: +91-124-463-0300 / Fax: +91-124-463-0399

14 India Bangalore FA Center

MITSUBISHI ELECTRIC INDIA PVT. LTD. Bangalore Branch

Prestige Emerald, 6th Floor, Municipal No.2, Madras Bank Road, Bangalore - 560001, Karnataka, India
Tel: +91-80-4020-1600 / Fax: +91-80-4020-1699

15 India Chennai FA Center

MITSUBISHI ELECTRIC INDIA PVT. LTD. Chennai Branch

Citilights Corporate Centre No. 1, Vivekananda Road, Srinivasa Nagar, Chetpet, Chennai - 600031, Tamil Nadu, India
Tel: +91-4445548772 / Fax: +91-4445548773

16 India Ahmedabad FA Center

MITSUBISHI ELECTRIC INDIA PVT. LTD. Ahmedabad Branch

B/4, 3rd Floor, SAFAL Profitaire, Corporate Road, Prahaladnagar, Satellite, Ahmedabad - 380015, Gujarat, India
Tel: +91-7965120063

Americas

17 North America FA Center

MITSUBISHI ELECTRIC AUTOMATION, INC.

500 Corporate Woods Parkway, Vernon Hills, IL 60061, U.S.A.
Tel: +1-847-478-2469 / Fax: +1-847-478-2253

18 Mexico City FA Center

MITSUBISHI ELECTRIC AUTOMATION, INC. Mexico Branch

Mariano Escobedo #69, Col.Zona Industrial, Tlalnepanitla Edo. Mexico, C.P.54030
Tel: +52-55-3067-7511

19 Mexico Monterrey FA Center

Mitsubishi Electric Automation, Inc. Monterrey Office

Plaza Mirage, Av. Gonzalitos 460 Sur, Local 28, Col. San Jeronimo, Monterrey, Nuevo Leon, C.P. 64640, Mexico
Tel: +52-55-3067-7521

20 Mexico FA Center

Mitsubishi Electric Automation, Inc. Queretaro Office

Parque Tecnológico Innovacion Queretaro Lateral Carretera Estatal 431, Km 2 200, Lote 91 Modulos 1 y 2 Hacienda la Machorra, CP 76246, El Marques, Queretaro, Mexico
Tel: +52-442-153-6014

Brazil

21 Brazil FA Center

MITSUBISHI ELECTRIC DO BRASIL COMÉRCIO E SERVIÇOS LTDA.

Avenida Adelino Cardana, 293, 21 andar, Bethaville, Barueri SP, Brazil
Tel: +55-11-4689-3000 / Fax: +55-11-4689-3016

Europe

22 Europe FA Center

MITSUBISHI ELECTRIC EUROPE B.V. Polish Branch

ul. Krakowska 50, 32-083 Balice, Poland
Tel: +48-12-347-65-81 / Fax: +48-12-630-47-01

23 Germany FA Center

MITSUBISHI ELECTRIC EUROPE B.V. German Branch

Mitsubishi-Electric-Platz 1, 40882 Ratingen, Germany
Tel: +49-2102-486-0 / Fax: +49-2102-486-1120

24 UK FA Center

MITSUBISHI ELECTRIC EUROPE B.V. UK Branch

Travellers Lane, Hatfield, Hertfordshire, AL10 8XB, U.K.
Tel: +44-1707-27-8780 / Fax: +44-1707-27-8695

25 Czech Republic FA Center

MITSUBISHI ELECTRIC EUROPE B.V. Czech Branch

Pekarska 621/7, 155 00 Praha 5, Czech Republic
Tel: +420-255 719 200

26 Italy FA Center

MITSUBISHI ELECTRIC EUROPE B.V. Italian Branch

Centro Direzionale Colleoni - Palazzo Sirio, Viale Colleoni 7, 20864 Agrate Brianza (Milano), Italy
Tel: +39-039-60531 / Fax: +39-039-6053-312

27 Russia FA Center

MITSUBISHI ELECTRIC (RUSSIA) LLC ST. Petersburg Branch

Piskarevsky pr. 2, bld 2, lit "Sch", BC "Benua", office 720; 195027, St. Petersburg, Russia
Tel: +7-812-633-3497 / Fax: +7-812-633-3499

28 Turkey FA Center

MITSUBISHI ELECTRIC TURKEY A.Ş Ümraniye Branch

Serifali Mahallesi Nutuk Sokak No:5, TR-34775 Ümraniye / Istanbul, Turkey
Tel: +90-216-526-3990 / Fax: +90-216-526-3995

Factory Automation Global website

Mitsubishi Electric Factory Automation provides a mix of services to support its customers worldwide. A consolidated global website is the main portal, offering a selection of support tools and a window to its local Mitsubishi Electric sales and support network.

■ From here you can find:

- Overview of available factory automation products
- Library of downloadable literature
- Support tools such as online e-learning courses, terminology dictionary, etc.
- Global sales and service network portal
- Latest news related to Mitsubishi Electric factory automation

Mitsubishi Electric Factory Automation
Global website:
www.MitsubishiElectric.com/fa



Online e-learning

An extensive library of e-learning courses covering the factory automation product range has been prepared. Courses from beginner to advanced levels of difficulty are available in various languages.

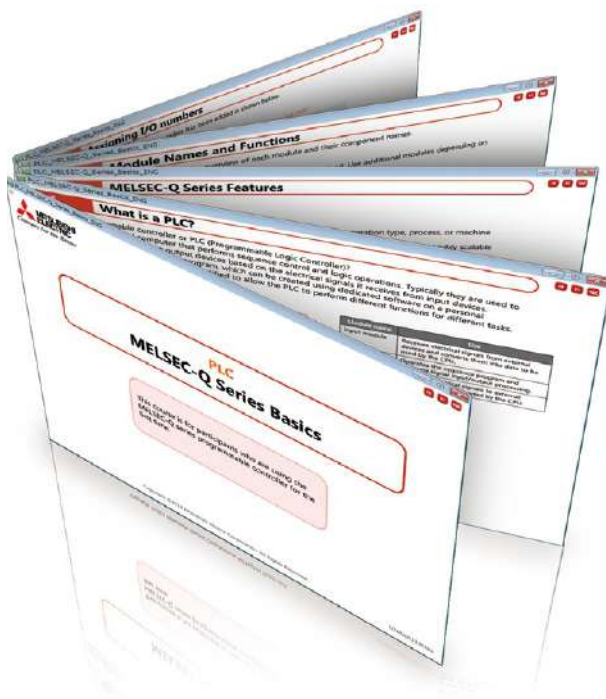

■ Beginner level

Designed for newcomers to Mitsubishi Electric Factory Automation products gaining a background of the fundamentals and an overview of various products related to the course.

■ Basic to Advanced levels

These courses are designed to provide education at all levels. Various different features are explained with application examples providing an easy and informative resource for in-house company training.

Innovative next-generation, e-Manual

The e-Manual viewer is a next-generation digital manual offered by Mitsubishi Electric that consolidates all manuals into an easy-to-use package with various useful features integrated into the viewer. The e-Manual is modeled around a centralized database allowing multiple manuals to be cross-searched at once, further reducing the time for reading individual product manuals when setting up a control system.



Key features include

- One-stop database containing all required manuals, with local file cache
- Included with GX Works3 engineering software
- Also available in tablet version
- Easily download manuals all at once
- Automatic update of manual versions
- Search information across multiple manuals
- Visual navigation from hardware diagram showing various specifications
- Customizable by adding user notes and bookmarks
- Directly port sample programs within manuals to GX Works3

MITSUBISHI ELECTRIC FA e-Manual (tablet version)



The e-Manual application is available on iOS and Android™ tablets. e-Manual files are provided as in-app downloads.



iOS
Version 8.1 or later

Download on the
App Store





Android™
Version 4.3/4.4/5.0

GET IT ON
Google Play



Supported versions

OS	OS version	Model
iOS	iOS 8.1 or later	Apple iPad 2, iPad (3rd generation), iPad (4th generation), iPad Air, iPad Air 2, iPad mini, iPad mini 2, iPad mini 3, iPad Pro (12.9 inch), iPad Pro (9.7 inch)
Android™	Android™ 4.3/4.4/5.0	ASUS Nexus7™ (2013)*1

*1: When using a tablet not listed above, 7-inch (resolution of 1920 x 1200 dots (WUXGA)) or better is recommended.

CC-Link Partner Association (CLPA) - Actively promoting worldwide adoption of CC-Link networks

Proactively supporting CC-Link, from promotion to specification development

The CC-Link Partner Association (CLPA) was established to promote the worldwide adoption of the CC-Link open-field network. By conducting promotional activities such as organizing trade shows and seminars, conducting conformance tests, and providing catalogs, brochures and website information, CLPA activities are successfully increasing the number of CC-Link partner manufacturers and CC-Link-compatible products. As such, CLPA is playing a major role in the globalization of CC-Link.



Seminar



Trade show



Conformance testing lab

Visit the CLPA website for the latest CC-Link information.

URL: www.cc-link.org



6F Ozone Front Bldg. 3-15-58 Ozone
 Kita-ku, Nagoya 462-0825, JAPAN
 TEL: +81-52-919-1588 FAX: +81-52-916-8655
 E-mail: info@cc-link.org



Global influence of CC-Link continues to spread

CC-Link is supported globally by CLPA. With offices throughout the world, support for partner companies can be found locally. Each regional CLPA office undertakes various support and promotional activities to further the influence of CC-Link/CC-Link IE in that part of the world. For companies looking to increase their presence in their local area, CLPA is well placed to assist these efforts through offices in all major regions.

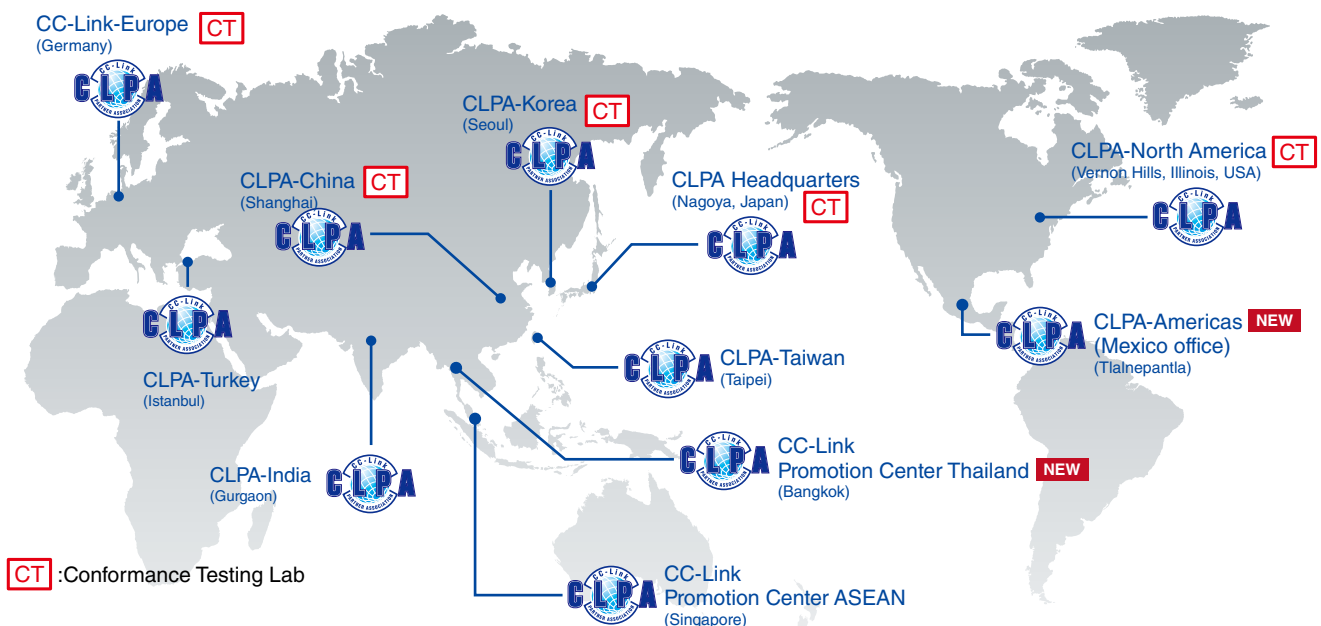

■ General specifications

Item	Specification	
Operating ambient temperature	0...55°C (when a base unit other than an extended temperature range base unit is used) 0...60°C (when an extended temperature range base unit is used)*1	
Storage ambient temperature	-25...75°C	
Operating ambient humidity	5...95% RH, non-condensing	
Storage ambient humidity	5...95% RH, non-condensing	
Vibration resistance	Compliant with JIS B 3502 and IEC 61131-2	
	-	
	Under intermittent vibration	Frequency: 5...8.4 Hz, 8.4...150 Hz Constant acceleration: - Half amplitude: 3.5 mm Sweep count: 10 times each in X, Y, Z directions
	Under continuous vibration	Frequency: 5...8.4 Hz, 8.4...150 Hz Constant acceleration: - Half amplitude: 1.75 mm Sweep count: -
Shock resistance	Compliant with JIS B 3502 and IEC 61131-2 (147 m/s ² , 3 times each in directions X, Y, Z)	
Operating atmosphere	No corrosive gases*5, no flammable gases, no excessive conductive dust	
Operating altitude*2	0...2000 m*6	
Installation location	Inside a control panel	
Overvoltage category*3	≤ II	
Pollution degree*4	≤ 2	
Equipment class	Class 2*7	

*1: Enables standard MELSEC iQ-R Series modules to support extended operating ambient temperature of 0 to 60°C, ensuring the same performance as the standard operating ambient temperature (0 to 55°C). When requiring to use in an ambient temperature environment higher than 60°C, please consult your local Mitsubishi Electric representative.

*2: Do not use or store the programmable controller under pressure higher than the atmospheric pressure of altitude 0 m. Doing so may cause malfunction. When using the programmable controller under pressure, please consult your local Mitsubishi Electric representative.

*3: This indicates the section of the power supply to which the equipment is assumed to be connected between the public electrical power distribution network and the machinery within premises. Category II applies to equipment for which electrical power is supplied from fixed facilities. The surge voltage withstand level for up to the rated voltage of 300 V is 2500 V.

*4: This index indicates the degree to which conductive material is generated in terms of the environment in which the equipment is used. Pollution level 2 is when only non-conductive pollution occurs. A temporary conductivity caused by condensing must be expected occasionally.

*5: The special coated product, which meets the regulation (JIS C 60721-3-3/IEC 60721-3-3 3C2) related to corrosive gas, is available for the use in a corrosive gas environment. For more details on the special coated product, please consult your local Mitsubishi Electric representative.

*6: When used at an altitude higher than 2000 m, the upper limits of the permissible voltage and the operating ambient temperature become lower. Please consult your local Mitsubishi Electric representative.

*7: Class 1 when the RQ extension base unit is used.

■ Software operating environment*8

Item	MELSOFT GX Works3, CW Configurator	MELSOFT MX MESInterface-R*9, MX OPC UA Module Configurator-R	CW Workbench, CW-Sim, CW-Sim Standalone
Personal computer	Windows® supported personal computer		
CPU	Intel® Core™ 2 Duo Processor 2 GHz or more		
Available hard disk capacity	5 GB	512 MB	4 GB or more
Display resolution	1024 x 768 pixels or higher		
Required memory			
64-bit edition	2 GB or more recommended	2 GB or more recommended	2 GB or more
32-bit edition	2 GB or more recommended	1 GB or more recommended	1 GB or more (2 GB or more recommended)
OS (English version)			
Microsoft® Windows® 10 Home Operating System	●	●	●
Microsoft® Windows® 10 Pro Operating System	●	●	●
Microsoft® Windows® 10 Enterprise Operating System	●	●	●
Microsoft® Windows® 10 Education Operating System	●	●	●
Microsoft® Windows® 8.1 Operating System	●	●	●*10
Microsoft® Windows® 8.1 Pro Operating System	●	●	●*10
Microsoft® Windows® 8.1 Enterprise Operating System	●	●	●*10
Microsoft® Windows® 8 Operating System	●	●	●*10
Microsoft® Windows® 8 Pro Operating System	●	●	●*10
Microsoft® Windows® 8 Enterprise Operating System	●	●	●*10
Microsoft® Windows® 7 Starter Operating System	●	-	-
Microsoft® Windows® 7 Home Premium Operating System	●	●	-
Microsoft® Windows® 7 Professional Operating System	●	●	●*11
Microsoft® Windows® 7 Ultimate Operating System	●	●	●*11
Microsoft® Windows® 7 Enterprise Operating System	●	●	●*11

*8: For information about software operating environment, refer to PX Developer Version 1 Operating Manual (Monitor Tool).

*9: Software operating environment when installing the MES Interface function configuration tool.

*10: Windows Touch is not supported.

*11: Windows® XP Mode is not supported.

■ MELSOFT GX Works3-supported CPU modules

Item	Model
Programmable controller CPU	R00CPU R08(EN)CPU
	R01CPU R16(EN)CPU
	R02CPU R32(EN)CPU
	R04(EN)CPU R120(EN)CPU
	R08PCPU R32PCPU
Process CPU	R16PCPU R120PCPU
	R08PSFCPU R32PSFCPU
SIL2 process CPU	R16PSFCPU R120PSFCPU
	R08SFCPU R32SFCPU
Safety CPU	R16SFCPU R120SFCPU
	R16SFCPU R120SFCPU

■ CW Workbench, CW-Sim, CW-Sim Standalone, MELSOFT CW Configurator-supported CPU modules

Item	Model
C Controller	R12CCPU-V

■ PX Developer monitor tool-supported CPU modules

Item	Model
Process CPU	R08PCPU R32PCPU
	R16PCPU R120PCPU
	R08PSFCPU R32PSFCPU
SIL2 process CPU	R16PSFCPU R120PSFCPU
	R16PSFCPU R120PSFCPU

■ MX MESInterface-R-supported module

Item	Model
MES Interface	RD81MES96

■ MX OPC UA Module Configurator-R-supported module

Item	Model
OPC UA server	RD81OPC96

Product List

Please check product compatibility and restrictions in the related manual(s) before purchasing.

■ CPU modules

Type	Model	Outline
Programmable controller CPU	R00CPU	Program capacity, 10K steps; basic operation processing speed (LD instruction), 31.36 ns
	R01CPU	Program capacity, 15K steps; basic operation processing speed (LD instruction), 31.36 ns
	R02CPU	Program capacity, 20K steps; basic operation processing speed (LD instruction), 3.92 ns
	R04CPU	Program capacity, 40K steps; basic operation processing speed (LD instruction), 0.98 ns
	R08CPU	Program capacity, 80K steps; basic operation processing speed (LD instruction), 0.98 ns
	R16CPU	Program capacity, 160K steps; basic operation processing speed (LD instruction), 0.98 ns
	R32CPU	Program capacity, 320K steps; basic operation processing speed (LD instruction), 0.98 ns
	R120CPU	Program capacity, 1200K steps; basic operation processing speed (LD instruction), 0.98 ns
	R04ENCPU	CC-Link IE embedded; program capacity, 40K steps; basic operation processing speed (LD instruction), 0.98 ns
	R08ENCPU	CC-Link IE embedded; program capacity, 80K steps; basic operation processing speed (LD instruction), 0.98 ns
	R16ENCPU	CC-Link IE embedded; program capacity, 160K steps; basic operation processing speed (LD instruction), 0.98 ns
	R32ENCPU	CC-Link IE embedded; program capacity, 320K steps; basic operation processing speed (LD instruction), 0.98 ns
R120ENCPU	CC-Link IE embedded; program capacity, 1200K steps; basic operation processing speed (LD instruction), 0.98 ns	
Motion CPU	R16MTCPU	Up to 16-axis control; operation cycle, ≤ 0.222 ms; SSCNET III/H connectivity
	R32MTCPU	Up to 32-axis control; operation cycle, ≤ 0.222 ms; SSCNET III/H connectivity
	R64MTCPU	Up to 64-axis control; operation cycle, ≤ 0.222 ms; SSCNET III/H connectivity
Safety CPU	R08SFPCU-SET	Program capacity, 80K steps (40K steps for safety programs); basic operation processing speed (LD instruction), 0.98 ns
	R16SFPCU-SET	Program capacity, 160K steps (40K steps for safety programs); basic operation processing speed (LD instruction), 0.98 ns
	R32SFPCU-SET	Program capacity, 320K steps (40K steps for safety programs); basic operation processing speed (LD instruction), 0.98 ns
	R120SFPCU-SET	Program capacity, 1200K steps (40K steps for safety programs); basic operation processing speed (LD instruction), 0.98 ns
Process CPU	R08PCPU	Program capacity, 80K steps; basic operation processing speed (LD instruction), 0.98 ns
	R16PCPU	Program capacity, 160K steps; basic operation processing speed (LD instruction), 0.98 ns
	R32PCPU	Program capacity, 320K steps; basic operation processing speed (LD instruction), 0.98 ns
	R120PCPU	Program capacity, 1200K steps; basic operation processing speed (LD instruction), 0.98 ns
SIL2 process CPU	R08PSFPCU-SET	Program capacity, 80K steps (40K steps for safety programs); basic operation processing speed (LD instruction), 0.98 ns
	R16PSFPCU-SET	Program capacity, 160K steps (40K steps for safety programs); basic operation processing speed (LD instruction), 0.98 ns
	R32PSFPCU-SET	Program capacity, 320K steps (40K steps for safety programs); basic operation processing speed (LD instruction), 0.98 ns
	R120PSFPCU-SET	Program capacity, 1200K steps (40K steps for safety programs); basic operation processing speed (LD instruction), 0.98 ns
Redundant function module	R6RFM	By combining with a process CPU or SIL2 process CPU, a redundant control system can be realized.
C Controller	R12CCPU-V	Endian format, little endian; OS, VxWorks® Version 6.9
SD memory card*1	NZ1MEM-2GBSD	SD memory card, 2G bytes
	NZ1MEM-4GBSD	SDHC memory card, 4G bytes
	NZ1MEM-8GBSD	SDHC memory card, 8G bytes
	NZ1MEM-16GBSD	SDHC memory card, 16G bytes
Extended SRAM cassette*3	NZ2MC-1MBS	1M bytes
	NZ2MC-2MBS	2M bytes
	NZ2MC-4MBS	4M bytes
	NZ2MC-8MBS	8M bytes
	NZ2MC-8MBSE*2	8M bytes
Battery-less option cassette	NZ2MC-16MBS	16M bytes
	NZ1BLC*3 NEW	Retain file register and latch device/label memory data without using a battery.
Battery	Q6BAT*4	Replacement battery
	Q7BAT*4	Replacement large-capacity battery
	Q7BAT-SET*4	Large-capacity battery with holder for mounting CPU
	FX3U-32BL*5	Long term backup battery for clock data

*1: Mitsubishi Electric shall not guarantee the operation of any third party products.

*2: ECC type for safety CPU and process CPU modules.

*3: Supports only R04(EN)CPU, R08(EN)CPU, R16(EN)CPU, R32(EN)CPU, R120(EN)CPU.

*4: Not supported for R00CPU, R01CPU, R02CPU.

*5: Supports only R00CPU, R01CPU, R02CPU.

■ Base unit

Type	Model	Outline
Main base	R35B	5 slots, for MELSEC iQ-R Series modules
	R38B	8 slots, for MELSEC iQ-R Series modules
	R312B	12 slots, for MELSEC iQ-R Series modules
Redundant power supply main base	R310RB	10 slots, for MELSEC iQ-R Series modules
Extended temperature range main base	R310B-HT	10 slots, for MELSEC iQ-R Series modules
Extended temperature range redundant power supply main base	R38RB-HT	8 slots, for MELSEC iQ-R Series modules
Extension base	R65B	5 slots, for MELSEC iQ-R Series modules
	R68B	8 slots, for MELSEC iQ-R Series modules
	R612B	12 slots, for MELSEC iQ-R Series modules
Redundant power supply extension base	R610RB	10 slots, for MELSEC iQ-R Series modules
Extended temperature range extension base	R610B-HT	10 slots, for MELSEC iQ-R Series modules
Extended temperature range redundant power supply extension base	R68RB-HT	8 slots, for MELSEC iQ-R Series modules
RQ extension base	RQ65B	5 slots, for MELSEC-Q Series modules
	RQ68B	8 slots, for MELSEC-Q Series modules
	RQ612B	12 slots, for MELSEC-Q Series modules
Extension cable	RC06B	0.6 m cable for extension and RQ extension base units
	RC12B	1.2 m cable for extension and RQ extension base units
	RC30B	3 m cable for extension and RQ extension base units
	RC50B	5 m cable for extension and RQ extension base units
	RC100B	10 m cable for extension and RQ extension base units
DIN rail mounting adapter	R6DIN1	For main and extension base units
	Q6DIN1	For RQ68B/RQ612B
	Q6DIN2	For RQ65B
	Q6DIN1A	For RQ extension base units (with vibration-proofing bracket sets)
Blank cover	RG60	For I/O slots of main and extension base units
	QG60	For I/O slots of RQ extension base units

■ Power supply module

Type	Model	Outline
Power supply	R61P	AC power supply; input, 100...240 V AC; output, 5 V DC/6.5 A
	R62P	AC power supply; input, 100...240 V AC; output, 5 V DC/3.5 A, 24 V DC/0.6 A
	R64P	AC power supply; input, 100...240 V AC; output, 5 V DC/9 A
	R63P	DC power supply; input, 24 V DC; output, 5 V DC/6.5 A
	R63RP	DC power supply; input, 24 V DC; output, 5 V DC/6.5 A, Redundant power supply function support
	R64RP	AC power supply; input, 100...240 V AC; output, 5 V DC/9 A, Redundant power supply function support

■ I/O modules

Type	Model	Outline
Input	RX28	AC input, 8 points: 100...240 V AC (50/60 Hz)
	RX10	AC input, 16 points: 100...120 V AC (50/60 Hz)
	RX10-TS NEW	AC input, 16 points: 100...120 V AC (50/60 Hz), Spring-clamp terminal block
	RX40C7	DC input, 16 points: 24 V DC, 7.0 mA
	RX40C7-TS NEW	DC input, 16 points: 24 V DC, 7.0 mA, Spring-clamp terminal block
	RX41C4	DC input, 32 points: 24 V DC, 4.0 mA
	RX41C4-TS NEW	DC input, 32 points: 24 V DC, 4.0 mA, Spring-clamp terminal block
	RX42C4	DC input, 64 points: 24 V DC, 4.0 mA
	RX70C4 NEW	DC input, 16 points: 5 V DC, 1.7 mA; 12 V DC, 4.8 mA
	RX71C4 NEW	DC input, 32 points: 5 V DC, 1.7 mA; 12 V DC, 4.8 mA
High-speed input	RX72C4 NEW	DC input, 64 points: 5 V DC, 1.7 mA; 12 V DC, 4.8 mA
	RX40PC6H	Positive common type DC input, 16 points: 24 V DC, 6.0 mA; minimum response time 5 μs
Input (with diagnostic functions)	RX40NC6H	Negative common type DC input, 16 points: 24 V DC, 6.0 mA; minimum response time 5 μs
	RX41C6HS	Positive/negative common type DC input, 32 points: 24 V DC, 6.0 mA; minimum response time 1 μs
	RX61C6HS	Positive/negative common type DC input, 32 points: 5 V DC, 6.0 mA; minimum response time 1 μs
Output	RX40NC6B	Negative common type DC input, 16 points: 24 V DC, 6.0 mA
	RY18R2A	Relay output, 8 points: 24 V DC/2 A, 240 V AC/2 A
	RY10R2	Relay output, 16 points: 24 V DC/2 A, 240 V AC/2 A
	RY10R2-TS NEW	Relay output, 16 points: 24 V DC/2 A, 240 V AC/2 A, Spring-clamp terminal block
	RY20S6	Triac output, 16 points: 100...240 V AC/0.6 A
	RY40NT5P	Transistor (sink) output, 16 points: 12...24 V DC, 0.5 A
	RY40NT5P-TS NEW	Transistor (sink) output, 16 points: 12...24 V DC, 0.5 A, Spring-clamp terminal block
	RY41NT2P	Transistor (sink) output, 32 points: 12...24 V DC, 0.2 A
	RY41NT2P-TS NEW	Transistor (sink) output, 32 points: 12...24 V DC, 0.2 A, Spring-clamp terminal block
	RY42NT2P	Transistor (sink) output, 64 points: 12...24 V DC, 0.2 A
	RY40PT5P	Transistor (source) output, 16 points: 12...24 V DC, 0.5 A
	RY40PT5P-TS NEW	Transistor (source) output, 16 points: 12...24 V DC, 0.5 A, Spring-clamp terminal block
High-speed output	RY41PT1P	Transistor (source) output, 32 points: 12...24 V DC, 0.1 A
	RY41PT1P-TS NEW	Transistor (source) output, 32 points: 12...24 V DC, 0.1 A, Spring-clamp terminal block
	RY42PT1P	Transistor (source) output, 64 points: 12...24 V DC, 0.1 A
Output (with diagnostic functions)	RY41NT2H	Transistor (sink) output, 32 points: 5...24 V DC, 0.2 A; minimum response time 2 μs
	RY41PT2H	Transistor (source) output, 32 points: 5...24 V DC, 0.2 A; minimum response time 2 μs
I/O combined	RY40PT5B	Transistor (source) output, 16 points: 24 V DC, 0.5 A
	RH42C4NT2P	DC input, 32 points: 24 V DC, 4.0 mA Transistor (sink) output, 32 points: 12...24 V DC, 0.2 A

■ Analog modules

Type	Model	Outline
Analog input	R60AD4	4 channels for voltage/current inputs -10...10 V DC, -32000...32000; 0...20 mA DC, 0...32000; 80 µs/CH
	R60ADH4	4 channels for voltage/current inputs -10...10 V DC, -32000...32000; 0...20 mA DC, 0...32000; 1 µs/CH
	R60ADV8	8 channels for voltage inputs -10...10 V DC, -32000...32000; 80 µs/CH
	R60ADI8	8 channels for current inputs 0...20 mA DC/0...32000; 80 µs/CH
	R60AD8-G	8 channels for voltage/current input, channel isolated -10...10 V DC/-32000...32000, 0...20 mA DC/0...32000, 10 ms/CH
	R60AD16-G	16 channels for voltage/current input, channel isolated -10...10 V DC/-32000...32000, 0...20 mA DC/0...32000, 10 ms/CH
Temperature input	R60TD8-G	Thermocouple (B, R, S, K, E, J, T, N), 8 channels for input, channel isolated, 30 ms/CH
	R60RD8-G	RTD (Pt100, JPt100, Ni100, Pt50), 8 channels for input, channel isolated, 10 ms/CH
Temperature control	R60TCTR2TT2	Thermocouple (B, R, S, K, E, J, T, N, U, L, PL II, W5Re/W26Re), 4 channels for input (2 channels can also be used for RTD input)
	R60TCRT4	RTD (Pt100, JPt100), 4 channels for input
	R60TCTR2TT2BW	Thermocouple (B, R, S, K, E, J, T, N, U, L, PL II, W5Re/W26Re), 4 channels for input (2 channels can also be used for RTD input), heater disconnection detection
	R60TCRT4BW	RTD (Pt100, JPt100), 4 channels for input, heater disconnection detection
Analog output	R60DA4	4 channels for voltage/current outputs -32000...32000, -10...10 V DC; 0...32000, 0...20 mA DC; 80 µs/CH
	R60DAH4	4 channels for voltage/current outputs -32000...32000, -10...10 V DC; 0...32000, 0...20 mA DC; 1 µs/CH
	R60DAV8	8 channels for voltage outputs -32000...32000, -10...10 V DC; 80 µs/CH
	R60DAI8	8 channels for current outputs 0...32000, 0...20 mA DC; 80 µs/CH
	R60DA8-G	8 channels for voltage/current output, channel isolated -32000...32000/-12...12 V DC, 0...32000/0...20 mA DC, 1 ms/CH
	R60DA16-G	16 channels for voltage/current output, channel isolated -32000...32000/-12...12 V DC, 0...32000/0...20 mA DC, 1 ms/CH
SIL2 analog control output	RY40PT5B-AS NEW	Output, 16 points; 24 V DC, 0.5 A

■ Motion/Positioning/Flexible high-speed I/O/High-speed counter modules

Type	Model	Outline
Simple motion	RD77GF4	4 axes, linear/circular interpolation, advanced synchronous control, CC-Link IE Field network compatible
	RD77GF8	8 axes, linear/circular interpolation, advanced synchronous control, CC-Link IE Field network compatible
	RD77GF16	16 axes, linear/circular interpolation, advanced synchronous control, CC-Link IE Field network compatible
	RD77GF32	32 axes, linear/circular interpolation, advanced synchronous control, CC-Link IE Field network compatible
	RD77MS2	2 axes, linear/circular interpolation, advanced synchronous control, SSCNET III/H compatible
	RD77MS4	4 axes, linear/circular interpolation, advanced synchronous control, SSCNET III/H compatible
	RD77MS8	8 axes, linear/circular interpolation, advanced synchronous control, SSCNET III/H compatible
	RD77MS16	16 axes, linear/circular interpolation, advanced synchronous control, SSCNET III/H compatible
Positioning	RD75P2	Transistor output, 2 axes; max. output, 200k pulse/s; linear/circular interpolation
	RD75P4	Transistor output, 4 axes; max. output, 200k pulse/s; linear/circular/helical interpolation
	RD75D2	Differential driver output, 2 axes; max. output, 5M pulse/s; linear/circular interpolation
	RD75D4	Differential driver output, 4 axes; max. output, 5M pulse/s; linear/circular/helical interpolation
Flexible high-speed I/O	RD40PD01	Input, 12 points (5/24 V DC/differential); max counting speed, 8M pulse/s (differential) Output, 14 points (5...24 V DC: 8 points, differential: 6 points); max. output, 8M pulse/s (differential)
High-speed counter	RD62P2	5/12/24 V DC input, 2 channels; max. counting speed, 200k pulse/s; external output, transistor (sink type)
	RD62P2E	5/12/24 V DC input, 2 channels; max. counting speed, 200k pulse/s; external output, transistor (source type)
	RD62D2	Differential input, 2 channels; max. counting speed, 8M pulse/s; external output, transistor (sink type)

Network modules

DB : Co-branded product^{*1}

Type	Model	Outline
Ethernet (built-in CC-Link IE)	RJ71EN71	1 Gbps/100 Mbps/10 Mbps, 2 ports Multi-network connectivity (Ethernet/CC-Link IE)
CC-Link IE Control	RJ71GP21-SX	1 Gbps, fiber-optic cable, control/normal station (standard type)
	RJ71GP21S-SX NEW	1 Gbps, fiber-optic cable, control/normal station (with external power supply)
CC-Link IE Field	RJ71GF11-T2	1 Gbps, master/local station
CC-Link IE Field Network remote head	RJ72GF15-T2	1 Gbps, remote station
CC-Link	RJ61BT11	Max. 10 Mbps, master/local station, CC-Link Ver.2 supported
AnyWireASLINK	RJ51AW12AL DB	DigitalLinkSensor AnyWireASLINK system compatible, master station
BACnet [®]	RJ71BAC96 DB	BACnet [®] system compatible, controller/workstation
CANopen [®]	RJ71CN91	CANopen [®] system compatible NMT master/NMT slave
PROFINET [®]	RJ71PN92 NEW	PROFINET [®] IO controller
EtherNet/IP [™]	RJ71EIP91 NEW	EtherNet/IP [™] system compatible, scanner
PROFIBUS [®] -DP	RJ71PB91V NEW	PROFIBUS [®] system compatible, DP master/slave
DeviceNet [®]	RJ71DN91 NEW	DeviceNet [®] system compatible, master/slave
Serial communication	RJ71C24	Max. 230.4 kbps; RS-232, 1 channel; RS-422/485, 1 channel
	RJ71C24-R2	Max. 230.4 kbps; RS-232, 2 channels
	RJ71C24-R4	Max. 230.4 kbps; RS-422/485, 2 channels

*1: General specifications and product guarantee conditions for co-branded products may vary from those of general MELSEC products.
For more information, please refer to the relevant product manuals or contact your local Mitsubishi Electric sales office/representative.

Advanced information modules

Type	Model	Outline
MES Interface	RD81MES96	Database connection (MX MESInterface-R is required)
OPC UA server	RD81OPC96	Embedded OPC UA server (MX OPC UA Module Configurator-R is required)
High-speed data logger	RD81DL96	Data collection (High-speed data logger module tool "SW1DNN-RDLUTL-E" is required) ^{*2}
C intelligent function module	RD55UP06-V	C/C++ program execution (Setting and monitoring tool is integrated within GX Works3)
Energy measuring module	RE81WH NEW	Energy measurement, 1 channel; data refresh cycle, 10...10000 ms (setting available in 10 ms increments)

*2: For information on how to obtain the software, please contact your local Mitsubishi Electric sales office or representative.

Software

Type	Model	Outline
MELSOFT iQ Works	SW2DND-IQWK-E (DVD-ROM edition)	FA engineering software ^{*3} <ul style="list-style-type: none"> System Management Software: MELSOFT Navigator Controller Programming Software: MELSOFT GX Works3^{*4}, GX Works2, GX Developer Motion Programming Software: MELSOFT MT Works2 HMI Programming Software: MELSOFT GT Works3 Robot Programming Software: MELSOFT RT ToolBox3^{*5} Inverter Setup Software: MELSOFT FR Configurator2 Servo setup software: MELSOFT MR Configurator2 C Controller setting and monitoring tool: MELSOFT CW Configurator MITSUBISHI ELECTRIC FA Library
	SW1DND-GXW3-E (DVD-ROM edition)	<ul style="list-style-type: none"> Controller Programming Software: MELSOFT GX Works3^{*4}, GX Works2, GX Developer, PX Developer^{*6} MITSUBISHI ELECTRIC FA Library

*3: For detailed information about supported modules, refer to the manuals of the relevant software package.

*4: The MELSOFT GX Works3 menu is switchable between Japanese, English, and simplified Chinese.

*5: RT ToolBox3 mini (simplified version) will be installed if iQ Works product ID is used. When RT ToolBox3 (with simulation function) is required, please purchase RT ToolBox3 product ID.

*6: Includes both programming tool and monitor tool for process control.

Type	Model	Outline
CW Workbench	SW1DND-CWWR-E	Engineering tool for C Controller module
	SW1DND-CWWR-EZ	Additional license for R12CCPU-V, RD55UP06-V
	SW1DND-CWWR-EVZ	Update license for R12CCPU-V, RD55UP06-V
CW-Sim	SW1DND-CWSIMR-EZ	VxWorks [®] simulation environment for CW Workbench, additional license
	SW1DNC-CWSIMSAR-E	VxWorks [®] simulation environment for CW Workbench, standalone type
MELSOFT CW Configurator	SW1DND-RCCPU-E	Setting and monitoring tool for C Controller
MX MESInterface-R	SW1DND-RMESIF-E	MES Interface function configuration tool
MX OPC UA Module Configurator-R	SW1DND-ROPCUA-E	OPC UA server module configuration tool
PX Developer monitor tool	SW1DNC-FBDQMON-E	Monitoring tool for process control

■ Option

Type	Model	Outline
40-pin connector	A6CON1	Soldering type
	A6CON2	Crimp-contact type
	A6CON3	Insulation-displacement (IDC) type
	A6CON4	Soldering type (cable protrusion: straight or diagonal 45° angle)
Spring-clamp terminal block	Q6TE-18SN	For 18-point screw terminal block type, 0.3...1.5 mm ² (22...16 AWG)
Connector/terminal block conversion module	A6TBXY36	For positive common input modules and sink/source output modules (standard type)
	A6TBXY54	For positive common input modules and sink/source output modules (2-wire type)
	A6TBX70	For positive common input modules (3-wire type)
Connector/terminal block conversion module cable	AC05TB	For A6TBXY36, A6TBXY54, and A6TBX70 (positive common/sink/source type), 0.5 m
	AC10TB	For A6TBXY36, A6TBXY54, and A6TBX70 (positive common/sink/source type), 1 m
	AC20TB	For A6TBXY36, A6TBXY54, and A6TBX70 (positive common/sink/source type), 2 m
	AC30TB	For A6TBXY36, A6TBXY54, and A6TBX70 (positive common/sink/source type), 3 m
	AC50TB	For A6TBXY36, A6TBXY54, and A6TBX70 (positive common/sink/source type), 5 m
	AC80TB	For A6TBXY36, A6TBXY54, and A6TBX70 (positive common/sink/source type), 8 m*
Relay terminal module	AC100TB	For A6TBXY36, A6TBXY54, and A6TBX70 (positive common/sink/source type), 10 m*
	A6TE2-16SRN	For 40-pin connector 24 V DC transistor output modules (sink type)
Relay terminal module cable	AC06TE	For A6TE2-16SRN, (sink type) 0.6 m
	AC10TE	For A6TE2-16SRN, (sink type) 1 m
	AC30TE	For A6TE2-16SRN, (sink type) 3 m
	AC50TE	For A6TE2-16SRN, (sink type) 5 m
	AC100TE	For A6TE2-16SRN, (sink type) 10 m

* Common current 0.5 A or lower

Android and Google Play are trademarks of Google Inc.
Apple, iPad, iPad Air, iPad mini, and App Store are trademarks of Apple Inc., registered in the U.S. and other countries.
ARM is a registered trademark of ARM Limited (or its subsidiaries) in the EU and/or elsewhere.
BACnet is a registered trademark of the American Society of Heating, Refrigerating and Air-Conditioning Engineers, Inc.
Ethernet is a trademark of Xerox Corporation.
EtherNet/IP and DeviceNet are trademarks of ODVA, Inc.
IOS is a trademark or registered trademark of Cisco in the U.S. and other countries and is used under license.
Microsoft, Windows, Excel, and Access are registered trademarks of Microsoft Corporation in the United States and other countries.
MODBUS is a registered trademark of Schneider Electric USA, Inc.
Oracle, Java, and MySQL are registered trademarks of Oracle Corporation and/or its affiliates.
PROFIBUS and PROFINET are trademarks of PROFIBUS Nutzerorganisation e.V.
QR Code is a trademark or a registered trademark of DENSO WAVE INCORPORATED in JAPAN, the United States and/or other countries.
SD/SDHC logo is a trademark of SD-3C, LLC.
TÜV is the registered trademark of TÜV Rheinland.
VxWorks is a registered trademark of Wind River Systems, Inc. in the United States and other countries.
All other company names and product names used in this document are trademarks or registered trademarks of their respective companies.

Precautions before use

This publication explains the typical features and functions of the products herein and does not provide restrictions or other information related to usage and module combinations. Before using the products, always read the product user manuals. Mitsubishi Electric will not be held liable for damage caused by factors found not to be the cause of Mitsubishi Electric; opportunity loss or lost profits caused by faults in Mitsubishi Electric products; damage, secondary damage, or accident compensation, whether foreseeable or not, caused by special factors; damage to products other than Mitsubishi Electric products; or any other duties.

For safe use

- To use the products given in this publication properly, always read the relevant manuals before beginning operation.
- The products have been manufactured as general-purpose parts for general industries, and are not designed or manufactured to be incorporated in a device or system used in purposes related to human life.
- Before using the products for special purposes such as nuclear power, electric power, aerospace, medicine or passenger-carrying vehicles, consult with Mitsubishi Electric.
- The products have been manufactured under strict quality control. However, when installing the products where major accidents or losses could occur if the products fail, install appropriate backup or fail-safe functions in the system.

YOUR SOLUTION PARTNER

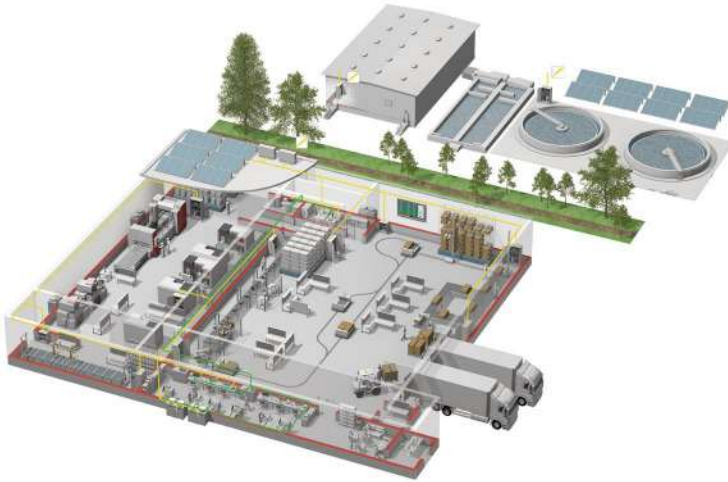

Mitsubishi Electric offers a wide range of automation equipment from PLCs and HMIs to CNC and EDM machines.

A NAME TO TRUST

Since its beginnings in 1870, some 45 companies use the Mitsubishi name, covering a spectrum of finance, commerce and industry.

The Mitsubishi brand name is recognized around the world as a symbol of premium quality.

Mitsubishi Electric Corporation is active in space development, transportation, semi-conductors, energy systems, communications and information processing, audio visual equipment and home electronics, building and energy management and automation systems, and has 237 factories and laboratories worldwide in over 121 countries.

This is why you can rely on Mitsubishi Electric automation solution - because we know first hand about the need for reliable, efficient, easy-to-use automation and control in our own factories.

As one of the world's leading companies with a global turnover of over 4 trillion Yen (over \$40 billion), employing over 100,000 people, Mitsubishi Electric has the resource and the commitment to deliver the ultimate in service and support as well as the best products.



Low voltage: MCCB, MCB, ACB



Medium voltage: VCB, VCC



Power monitoring, energy management



Compact and Modular Controllers



Inverters, Servos and Motors



Visualisation: HMIs



Numerical Control (NC)



Robots: SCARA, Articulated arm



Processing machines: EDM, Lasers, IDS



Transformers, Air conditioning, Photovoltaic systems

* Not all products are available in all countries.

Country/Region	Sales office	Tel/Fax
USA	MITSUBISHI ELECTRIC AUTOMATION, INC. 500 Corporate Woods Parkway, Vernon Hills, IL 60061, U.S.A.	Tel : +1-847-478-2100 Fax : +1-847-478-2253
Mexico	MITSUBISHI ELECTRIC AUTOMATION, INC. Mexico Branch Mariano Escobedo #69, Col. Zona Industrial, Tlalnepantla Edo. Mexico, C.P.54030	Tel : +52-55-3067-7500
Brazil	MITSUBISHI ELECTRIC DO BRASIL COMÉRCIO E SERVIÇOS LTDA. Avenida Adelino Cardana, 293, 21 andar, Bethaville, Barueri SP, Brazil	Tel : +55-11-4689-3000 Fax : +55-11-4689-3016
Germany	MITSUBISHI ELECTRIC EUROPE B.V. German Branch Mitsubishi-Electric-Platz 1, 40882 Ratingen, Germany	Tel : +49-2102-486-0 Fax : +49-2102-486-1120
UK	MITSUBISHI ELECTRIC EUROPE B.V. UK Branch Travellers Lane, Hatfield, Hertfordshire, AL10 8XB, U.K.	Tel : +44-1707-28-8780 Fax : +44-1707-27-8695
Ireland	MITSUBISHI ELECTRIC EUROPE B.V. Irish Branch Westgate Business Park, Ballymount, Dublin 24, Ireland	Tel : +353-1-4198800 Fax : +353-1-4198890
Italy	MITSUBISHI ELECTRIC EUROPE B.V. Italian Branch Centro Direzionale Colleoni - Palazzo Sirio, Viale Colleoni 7, 20864 Agrate Brianza (MB), Italy	Tel : +39-039-60531 Fax : +39-039-6053-312
Spain	MITSUBISHI ELECTRIC EUROPE, B.V. Spanish Branch Carretera de Rubí, 76-80-Apdo. 420, 08190 Sant Cugat del Vallés (Barcelona), Spain	Tel : +34-935-65-3131 Fax : +34-935-89-1579
France	MITSUBISHI ELECTRIC EUROPE B.V. French Branch 25, Boulevard des Bouvets, 92741 Nanterre Cedex, France	Tel : +33-1-55-68-55-68 Fax : +33-1-55-68-57-57
Czech Republic	MITSUBISHI ELECTRIC EUROPE B.V. Czech Branch Avenir Business Park, Radlicka 751/113e, 158 00 Praha 5, Czech Republic	Tel : +420-251-551-470 Fax : +420-251-551-471
Poland	MITSUBISHI ELECTRIC EUROPE B.V. Polish Branch ul. Krakowska 50, 32-083 Balice, Poland	Tel : +48-12-347-65-00 Fax : +48-12-630-47-01
Sweden	MITSUBISHI ELECTRIC EUROPE B.V. (Scandinavia) Fjellievägen 8, SE-22736 Lund, Sweden	Tel : +46-8-625-10-00 Fax : +46-46-39-70-18
Russia	MITSUBISHI ELECTRIC (RUSSIA) LLC St. Petersburg Branch Piskarevsky pr. 2, bld 2, lit "Sch", BC "Benua", office 720; 195027 St. Petersburg, Russia	Tel : +7-812-633-3497 Fax : +7-812-633-3499
Turkey	MITSUBISHI ELECTRIC TURKEY A.Ş Ümraniye Branch Serifali Mahallesi Nutuk Sokak No:5, TR-34775 Umraniye/Istanbul, Turkey	Tel : +90-216-526-3990 Fax : +90-216-526-3995
UAE	MITSUBISHI ELECTRIC EUROPE B.V. Dubai Branch Dubai Silicon Oasis, P.O.BOX 341241, Dubai, U.A.E.	Tel : +971-4-3724716 Fax : +971-4-3724721
South Africa	ADROIT TECHNOLOGIES 20 Waterford Office Park, 189 Witkoppen Road, Fourways, South Africa	Tel : +27-11-658-8100 Fax : +27-11-658-8101
China	MITSUBISHI ELECTRIC AUTOMATION (CHINA) LTD. Mitsubishi Electric Automation Center, No.1386 Hongqiao Road, Shanghai, China	Tel : +86-21-2322-3030 Fax : +86-21-2322-3000
Taiwan	SETSUYO ENTERPRISE CO., LTD. 6F, No.105, Wugong 3rd Road, Wugu District, New Taipei City 24889, Taiwan	Tel : +886-2-2299-2499 Fax : +886-2-2299-2509
Korea	MITSUBISHI ELECTRIC AUTOMATION KOREA CO., LTD. 7F-9F, Gangseo Hangang Xi-tower A, 401, Yangcheon-ro, Gangseo-Gu, Seoul 07528, Korea	Tel : +82-2-3660-9530 Fax : +82-2-3664-8372
Singapore	MITSUBISHI ELECTRIC ASIA PTE. LTD. 307 Alexandra Road, Mitsubishi Electric Building, Singapore 159943	Tel : +65-6473-2308 Fax : +65-6476-7439
Thailand	MITSUBISHI ELECTRIC FACTORY AUTOMATION (THAILAND) CO., LTD. 12th Floor, SV.City Building, Office Tower 1, No. 896/19 and 20 Rama 3 Road, Kwaeng Bangpongpan, Khet Yannawa, Bangkok 10120, Thailand	Tel : +66-2682-6522 Fax : +66-2682-6020
Vietnam	MITSUBISHI ELECTRIC VIETNAM CO., LTD. Unit 01-04, 10th Floor, Vincom Center, 72 Le Thanh Ton Street, District 1, Ho Chi Minh City, Vietnam	Tel : +84-8-3910-5945 Fax : +84-8-3910-5947
Indonesia	PT. MITSUBISHI ELECTRIC INDONESIA Gedung Jaya 11th Floor, JL. MH. Thamrin No.12, Jakarta Pusat 10340, Indonesia	Tel : +62-21-3192-6461 Fax : +62-21-3192-3942
India	MITSUBISHI ELECTRIC INDIA PVT. LTD. Pune Branch Emerald House, EL-3, J Block, M.I.D.C., Bhosari, Pune-411026, Maharashtra, India	Tel : +91-20-2710-2000 Fax : +91-20-2710-2100
Australia	MITSUBISHI ELECTRIC AUSTRALIA PTY. LTD. 348 Victoria Road, P.O. Box 11, Rydalmere, N.S.W 2116, Australia	Tel : +61-2-9684-7777 Fax : +61-2-9684-7245

Mitsubishi Electric Corporation Nagoya Works is a factory certified for ISO 14001 (standards for environmental management systems) and ISO 9001 (standards for quality assurance management systems).

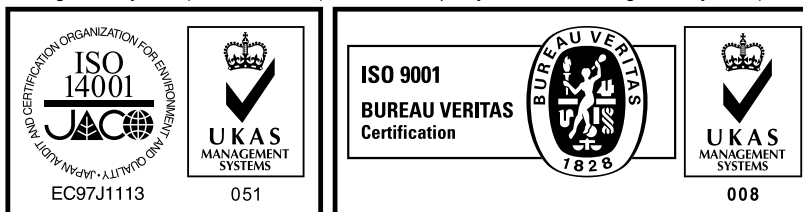

MITSUBISHI ELECTRIC CORPORATION

HEAD OFFICE: TOKYO BLDG., 2-7-3, MARUNOUCHI, CHIYODA-KU, TOKYO 100-8310, JAPAN
www.MitsubishiElectric.com