

NX-series Safety Controller

Stand-alone System

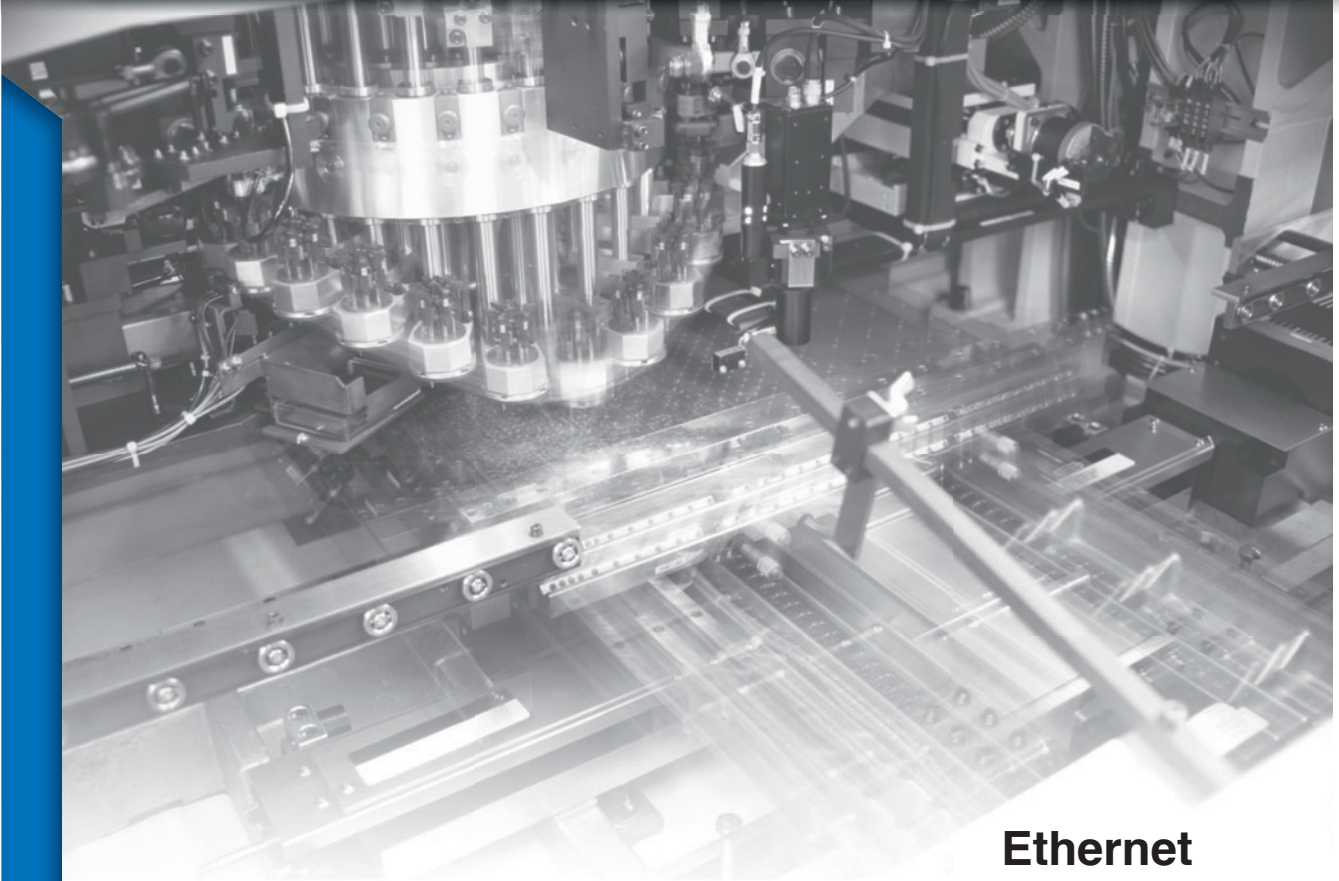

Ethernet
EtherNet/IP™

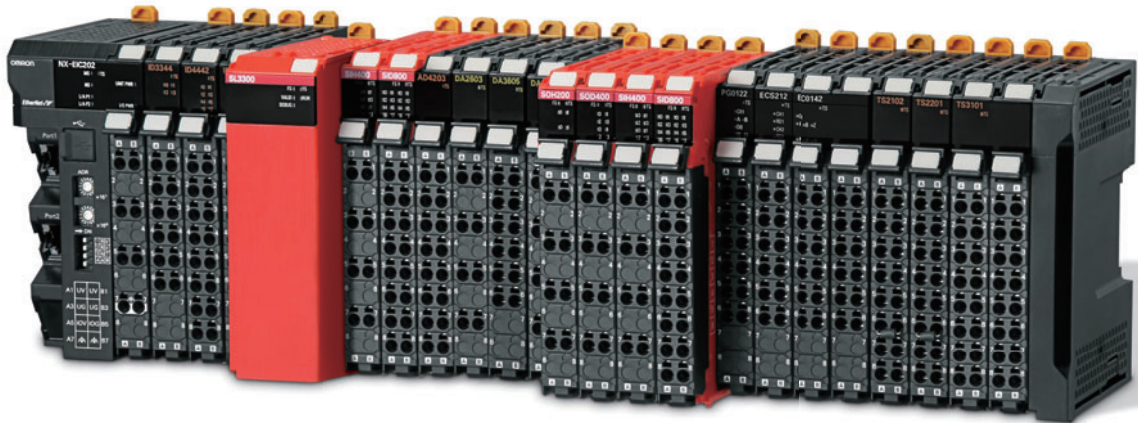

Directly connects to any PLC for monitoring and status

The safety solution for any application

The NX Stand-alone Safety Controller is a powerful and robust Safety System that reaches the PLe according to EN 13849-1 and SIL3 according to IEC 61508. The EtherNet/IP coupler unit allows for connection to almost any PLC via EtherNet/IP™ or standard Ethernet communications. The flexible hardware allows the NX safety I/O units to be mixed in any combination with standard NX I/O units. Sysmac Studio software allows for configuration, programming, simulation and monitoring functionality.

Safety	
	ISO 13849-1, Cat.4/PLe IEC 61508 SIL3 EN 62061 SIL3
PLC	
	IEC 61131-2 IEC 61131-3 PLCopen® FBD

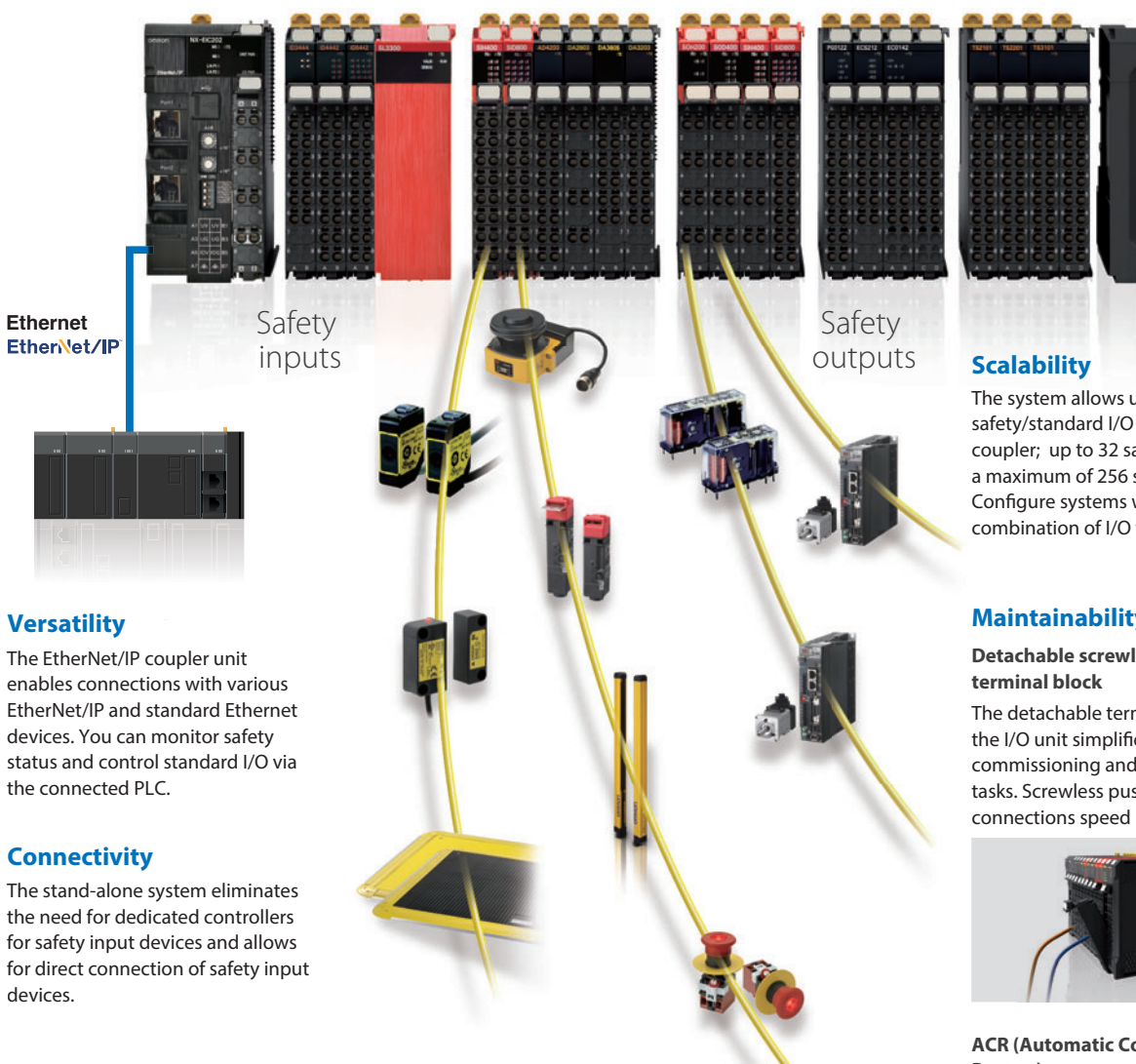

Versatility

The EtherNet/IP coupler unit enables connections with various EtherNet/IP and standard Ethernet devices. You can monitor safety status and control standard I/O via the connected PLC.

Connectivity

The stand-alone system eliminates the need for dedicated controllers for safety input devices and allows for direct connection of safety input devices.

Scalability

The system allows up to 63 safety/standard I/O units per coupler; up to 32 safety I/O units to a maximum of 256 safety I/O signals. Configure systems with the right combination of I/O to optimize cost.

Maintainability

Detachable screwless terminal block

The detachable terminal block of the I/O unit simplifies the commissioning and maintenance tasks. Screwless push-in connections speed up installation.



ACR (Automatic Configuration Restart)

When replacing a safety I/O Unit, just remove the old unit and insert a new unit. The setting data is automatically downloaded without using the programming software.

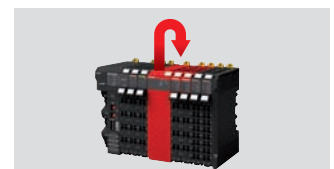

Intermediate Controller



Direct Connection

Flexibility and reusability of programming code

Standard programming with Sysmac Studio

Sysmac Studio is compliant to the IEC 61131-3 standard and utilizes PLCopen® function blocks. The safety controller provides a large program capacity of 512 KB (equivalent to more than 1,000 function blocks), visual setting of IO and automatic generating wiring diagram, variable style programming, reusable user-defined function blocks, offline simulation and simple automatic test.

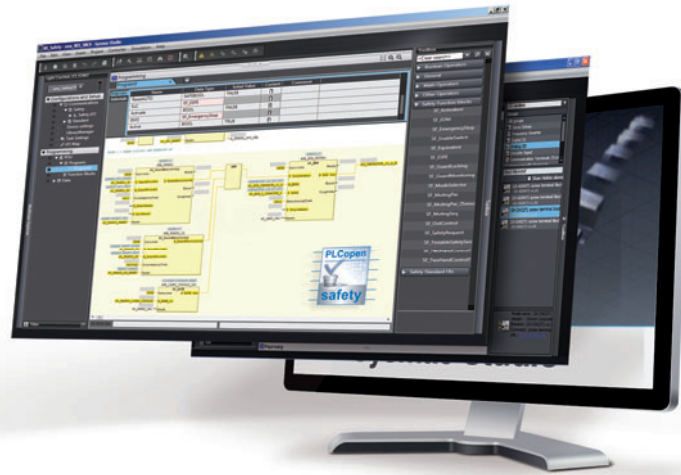

Visual setting of IO and automatic generating wiring diagram

By drag&drop the visual icon, the settings of I/Os are completed. Wiring diagrams are also automatically generated based on terminal settings. The wiring diagrams can be used for wiring check and Technical Construction Files (TCF).



Programming with variables

Unlike previous programming with physical addresses, programming with variables does not depend on the hardware configuration. You can use the same code for the machine with a different hardware configuration by flexibly changing connections between variable names and hardware memory addresses.

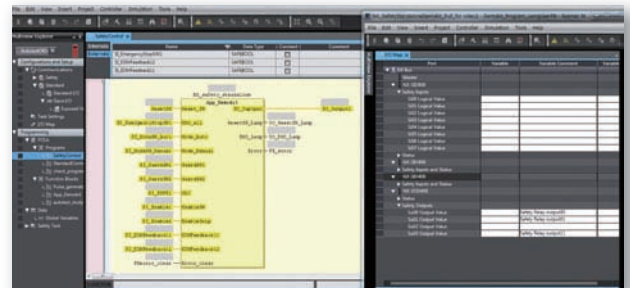

User-defined function blocks

You can define your own function blocks. Repeat use of user-defined function blocks cuts programming time and maintains consistency of quality. Secure the code with password protection and add user-defined help files to make re-using functions safe and easy.

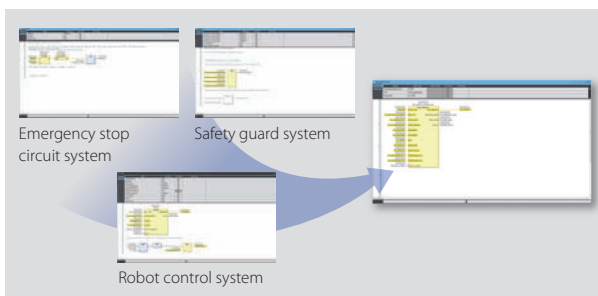

Offline simulation and simple automatic test

You can check operation on the Simulator without physical devices. Furthermore, basing on the relationship between inputs and outputs, program can be tested automatically. This significantly reduces program modification and debugging time.

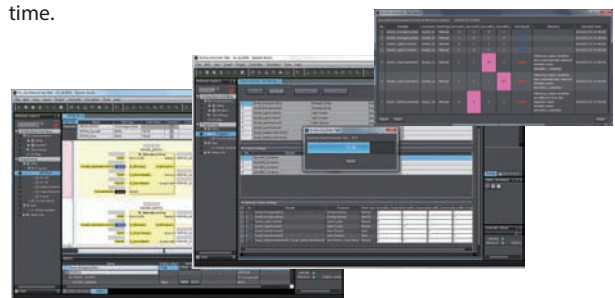

Sysmac is a trademark or registered trademark of OMRON Corporation in Japan and other countries for OMRON factory automation products. STI is a trademark or registered trademark of OMRON Corporation in Japan and other countries. EtherNet/IP™ is a trademark of ODVA. Other company names and product names in this document are the trademarks or registered trademarks of their respective companies. The product photographs and figures that are used in this catalog may vary somewhat from the actual products. Microsoft product screen shot(s) reprinted with permission from Microsoft Corporation.

System configuration

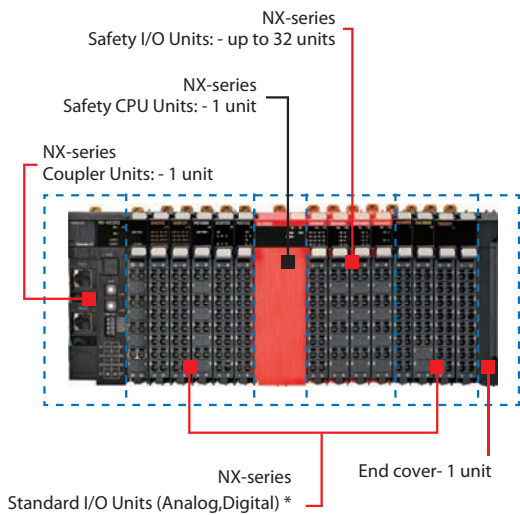

* Refer to your OMRON website for details.

NX-series EtherNet/IP Coupler Unit

NX Unit power consumption	Maximum I/O power supply current	Model
1.60 W max.	10A	NX-EIC202

Accessory: End cover

Safety CPU Unit

Maximum number of safety I/O points	Program capacity	Number of safety master connections	Model
256	512KB	32	NX-SL3300

Safety Input Unit

Number of safety input points	Number of test output points	Rated input voltage	OMRON special safety input devices	Model
4 points	2 points	24 VDC	Can be connected	NX-SIH400
8 points	2 points	24 VDC	Cannot be connected	NX-SID800

Safety Output Unit

Number of safety output points	Internal I/O common	Rated input voltage	Maximum load current	Model
2 points	Sourcing outputs(PNP)	24 VDC	2.0 A/point	NX-SOH200
4 points	Sourcing outputs(PNP)	24 VDC	0.5 A/point and 2.0 A/Unit	NX-SOD400

Automation Software Sysmac Studio

Licenses and DVDs are ordered separately.

Product name	Specifications	Number of licenses		Media	Model
		Number of licenses	Media		
Sysmac Studio NX-I/O Edition Ver.1.□□*	Sysmac Studio NX-I/O Edition is a limited license that provides selected functions required for EtherNet/IP Coupler settings.This product is a license only. You need the Sysmac Studio Standard Edition DVD media to install it.	1 license	—		SYSMAC-NE001L
Sysmac Studio Standard Edition Ver.1.□□	The Sysmac Studio is the software that provides an integrated environment for setting, programming, debugging and maintenance of machine automation controllers including the NJ/NX-series CPU Units, NY-series Industrial PC, EtherCAT Slave, and the HMI. Sysmac Studio runs on the following OS. Windows 7(32-bit/64-bit version)/Windows 8(32-bit/64-bit version)/ Windows 8.1(32-bit/64-bit version)/Windows 10(32-bit/64-bit version)	- (Media only)	DVD		SYSMAC-SE200D

* The Sysmac Studio Standard Edition license (SYSMAC-SE □□□L) includes functions that the NX-I/O Edition (SYSMAC-NE001L) provides.

OMRON Corporation Industrial Automation Company
Kyoto, JAPAN

Contact: www.ia.omron.com

Regional Headquarters

OMRON EUROPE B.V.
Wegalaan 67-69, 2132 JD Hoofddorp
The Netherlands
Tel: (31)2356-81-300/Fax: (31)2356-81-388

OMRON ELECTRONICS LLC
2895 Greenspoint Parkway, Suite 200
Hoffman Estates, IL 60169 U.S.A.
Tel: (1) 847-843-7900/Fax: (1) 847-843-7787

OMRON ASIA PACIFIC PTE. LTD.
No. 438A Alexandra Road # 05-05/08 (Lobby 2),
Alexandra Technopark,
Singapore 119967
Tel: (65) 6835-3011/Fax: (65) 6835-2711

OMRON (CHINA) CO., LTD.
Room 2211, Bank of China Tower,
200 Yin Cheng Zhong Road,
PuDong New Area, Shanghai, 200120, China
Tel: (86) 21-5037-2222/Fax: (86) 21-5037-2200

Authorized Distributor:

© OMRON Corporation 2016. All Rights Reserved.
In the interest of product improvement,
specifications are subject to change without notice.

CSM_1_3_0218
Cat. No. F100-E1-01

0316 (0316)