

Industrial PC Platform

NY-series

IPC Machine Controller

Industrial Panel PC / Industrial Box PC

Setup

User's Manual

NY532-1500

NY532-1400

NY532-1300

NY532-5400

NY512-1500

NY512-1400

NY512-1300

Industrial Panel PC
Industrial Box PC



NOTE

All rights reserved. No part of this publication may be reproduced, stored in a retrieval system, or transmitted, in any form, or by any means, mechanical, electronic, photocopying, recording, or otherwise, without the prior written permission of OMRON.

No patent liability is assumed with respect to the use of the information contained herein. Moreover, because OMRON is constantly striving to improve its high-quality products, the information contained in this manual is subject to change without notice. Every precaution has been taken in the preparation of this manual. Nevertheless, OMRON assumes no responsibility for errors or omissions. Neither is any liability assumed for damages resulting from the use of the information contained in this publication.

Trademarks

- Sysmac and SYSMAC are trademarks or registered trademarks of OMRON Corporation in Japan and other countries for OMRON factory automation products.
- Microsoft, Windows, Excel, and Visual Basic are either registered trademarks or trademarks of Microsoft Corporation in the United States and other countries.
- EtherCAT® is registered trademark and patented technology, licensed by Beckhoff Automation GmbH, Germany.
- ODVA, CIP, CompoNet, DeviceNet, and EtherNet/IP are trademarks of ODVA.
- The SD and SDHC logos are trademarks of SD-3C, LLC. 
- Intel and Intel Core are trademarks of Intel Corporation in the U.S. and / or other countries.

Other company names and product names in this document are the trademarks or registered trademarks of their respective companies.

Copyrights

Microsoft product screen shots reprinted with permission from Microsoft Corporation.

Introduction

Thank you for purchasing an NY-series IPC Machine Controller Industrial Panel PC / Industrial Box PC.

This manual provides a collective term of Industrial Panel PC and Industrial Box PC which are applicable products as the NY-series Industrial PC. This manual also provides the range of devices that are directly controlled by the Machine Automation Control Software embedded in the NY-series Industrial PC as the Controller.

This manual contains information that is necessary to use the NY-series Controller. Please read this manual and make sure you understand the functionality and performance of the NY-series Controller before you attempt to use it in a control system.

Keep this manual in a safe place where it will be available for reference during operation.

Intended Audience

This manual is intended for the following personnel, who must also have knowledge of electrical systems (an electrical engineer or the equivalent).

- Personnel in charge of introducing FA systems.
- Personnel in charge of designing FA systems.
- Personnel in charge of installing and maintaining FA systems.
- Personnel in charge of managing FA systems and facilities.

For programming, this manual is intended for personnel who understand the programming language specifications in international standard IEC 61131-3 or Japanese standard JIS B 3503.

Applicable Products

This manual covers the following products.

- NY-series IPC Machine Controller Industrial Panel PC
 - NY532-15□□
 - NY532-14□□
 - NY532-13□□
 - NY532-54□□
- NY-series IPC Machine Controller Industrial Box PC
 - NY512-15□□
 - NY512-14□□
 - NY512-13□□

Part of the specifications and restrictions for the Industrial PC are given in other manuals. Refer to *Relevant Manuals* on page 2 and *Related Manuals* on page 19.

Relevant Manuals

The following table provides the relevant manuals for the NY-series Controller. Read all of the manuals that are relevant to your system configuration and application before you use the NY-series Controller. Most operations are performed from the Sysmac Studio Automation Software. Refer to the *Sysmac Studio Version 1 Operation Manual (Cat. No. W504)* for information on the Sysmac Studio.

Purpose of use	Manual										
	Basic information					NY-series Industrial Panel PC / Industrial Box PC Software User's Manual	NY-series Industrial Panel PC / Industrial Box PC Motion Control User's Manual	NY-series Industrial Panel PC / Industrial Box PC Built-in EtherCAT Port User's Manual	NY-series Industrial Panel PC / Industrial Box PC Built-in EtherNet/IP Port User's Manual	NY-series NC Integrated Controller User's Manual	NY-series Troubleshooting Manual
	NY-series IPC Machine Controller Hardware User's Manual	NY-series IPC Machine Controller Hardware User's Manual	NY-series IPC Machine Controller Industrial Panel PC / Industrial Box PC Setup User's Manual	NY-series IPC Machine Controller Industrial Panel PC / Industrial Box PC Software User's Manual	NY-series Instructions Reference Manual						
Introduction to NY-series Panel PCs	○										
Introduction to NY-series Box PCs		○									
Setting devices and hardware											
Using motion control	○	○				○					
Using EtherCAT							○				
Using EtherNet/IP								○			
Making setup*1											
Making initial settings			○								
Preparing to use Controllers											
Software settings											
Using motion control						○					
Using EtherCAT				○			○				
Using EtherNet/IP								○			
Using numerical control									○		
Writing the user program											
Using motion control						○	○				
Using EtherCAT					○			○			
Using EtherNet/IP								○			
Using numerical control									○		
Programming error processing										○	
Testing operation and debugging											
Using motion control						○					
Using EtherCAT					○		○				
Using EtherNet/IP								○			
Using numerical control									○		
Learning about error management and corrections*2										○	

Purpose of use	Manual								
	Basic information				NY-series Industrial Panel PC / Industrial Box PC Motion Control User's Manual	NY-series IPC Machine Controller Industrial Panel PC / Industrial Box PC Built-in EtherCAT Port User's Manual	NY-series Motion Control Instructions Reference Manual	NY-series NC Integrated Controller User's Manual	NY-series Troubleshooting Manual
	NY-series IPC Machine Controller Industrial Panel PC Hardware User's Manual	NY-series IPC Machine Controller Industrial Box PC Hardware User's Manual	NY-series IPC Machine Controller Industrial Panel PC / Industrial Box PC Setup User's Manual	NY-series IPC Machine Controller Industrial Panel PC / Industrial Box PC Software User's Manual					
Maintenance									
Using motion control					○				
Using EtherCAT	○	○				○			
Using EtherNet/IP								○	

*1. Refer to the *NY-series Industrial Panel PC / Industrial Box PC Setup User's Manual (Cat. No. W568)* for how to set up and how to use the utilities on Windows.

*2. Refer to the *NY-series Troubleshooting Manual (Cat. No. W564)* for the error management concepts and the error items.

Manual Structure

Some of the descriptions of functions in this manual are common to NJ/NX-series. Therefore, note the following conditions.

- The same function names are used for the common functions of the NJ/NX/NY-series. If the term “CPU Unit” is included in the function names, such as the CPU Unit names, CPU Unit write protection, and other functions, it indicates the “Controller” in the NY-series.
- The “CPU Unit” that is described in a list of function specifications in this manual also indicates the “Controller” in the NY-series.

Page Structure

The following page structure is used in this manual.

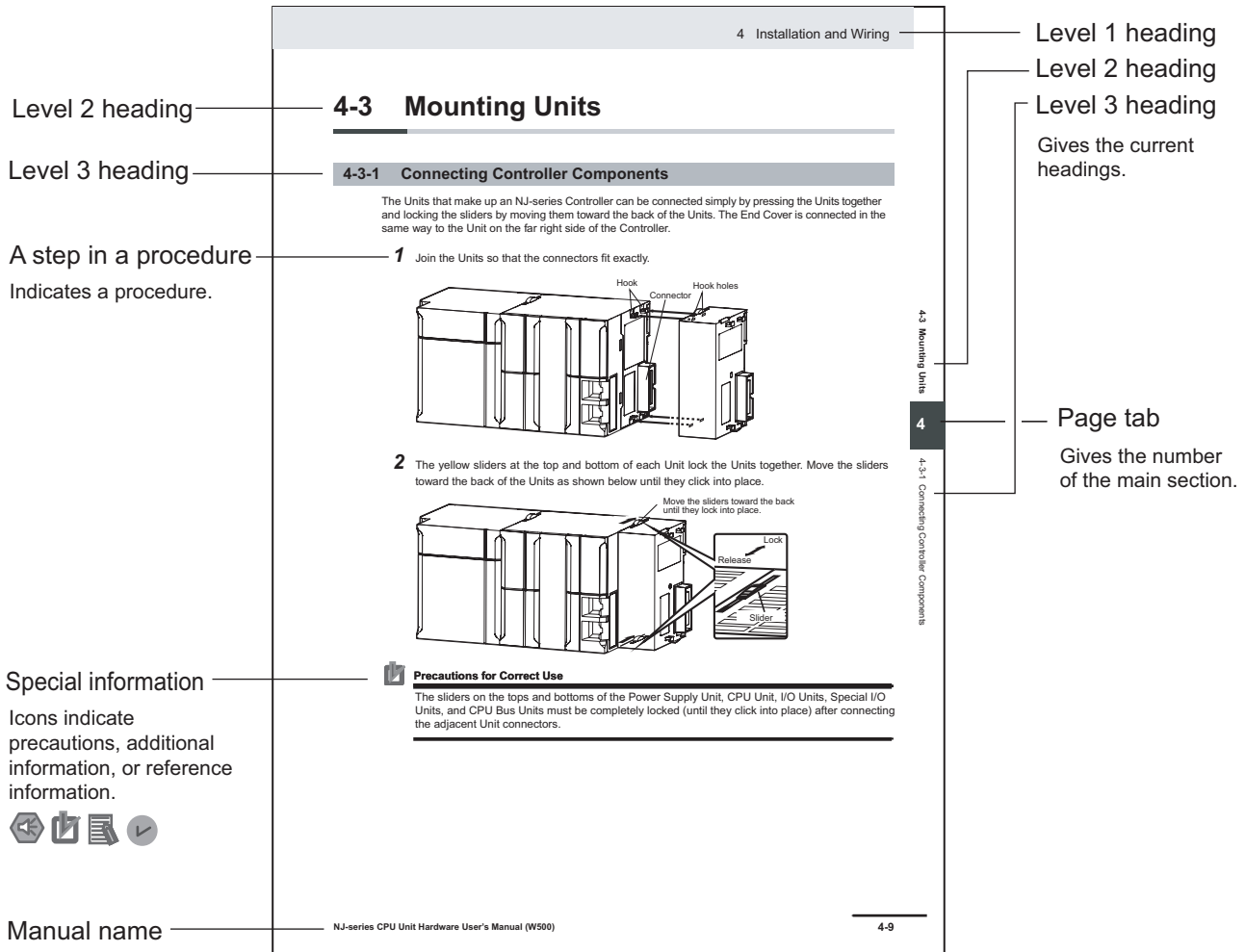

This illustration is provided only as a sample. It may not literally appear in this manual.

Special Information

Special information in this manual is classified as follows:



Precautions for Safe Use

Precautions on what to do and what not to do to ensure safe usage of the product.



Precautions for Correct Use

Precautions on what to do and what not to do to ensure proper operation and performance.



Additional Information

Additional information to read as required.

This information is provided to increase understanding or make operation easier.



Version Information

Information on differences in specifications and functionality for Controller with different unit versions and for different versions of the Sysmac Studio is given.

Precaution on Terminology

In this manual, “download” refers to transferring data from the Sysmac Studio to the physical Controller and “upload” refers to transferring data from the physical Controller to the Sysmac Studio.

For the Sysmac Studio, synchronization is used to both upload and download data. Here, “synchronize” means to automatically compare the data for the Sysmac Studio on the computer with the data in the physical Controller and transfer the data in the direction that is specified by the user.

CONTENTS

Introduction	1
Intended Audience	1
Applicable Products	1
Relevant Manuals	2
Manual Structure	4
Page Structure	4
Special Information	5
Precaution on Terminology	5
Terms and Conditions Agreement	11
Warranty, Limitations of Liability	11
Application Considerations	11
Disclaimers	12
Safety Precautions	13
Precautions for Safe Use	14
Precautions for Correct Use	15
Regulations and Standards	16
Conformance to EU Directives	16
Software Licenses and Copyrights	16
Versions	17
Checking Versions	17
Related Manuals	19
Revision History	23
Sections in this Manual	25

Section 1 Introduction to the Industrial PC

1-1 Features	1 - 2
1-2 Operation of the Operating System	1 - 3
1-2-1 Overview of Operating System Operation	1 - 3
1-2-2 Data Exchange between Operating Systems	1 - 3
1-2-3 External Interface for Each Operating System	1 - 5
1-3 Product Model Numbers	1 - 6
1-4 Application Procedures	1 - 7
1-4-1 Overall Procedure	1 - 7
1-5 Monitoring Function	1 - 9
1-5-1 Monitoring System Information	1 - 9
1-5-2 Monitoring Controller Status	1 - 10

Section 2 Initial settings

2-1 Initial Settings for Windows	2 - 2
2-1-1 Windows Settings.....	2 - 2
2-1-2 Creating Recovery Image of Initial State.....	2 - 3
2-1-3 Installing Software.....	2 - 3
2-1-4 User Account Settings.....	2 - 4
2-1-5 Customize Windows.....	2 - 4
2-2 Starting and Exiting	2 - 5
2-2-1 Starting.....	2 - 5
2-2-2 Exiting.....	2 - 6
2-2-3 Restarting.....	2 - 6
2-3 UPS Settings	2 - 8
2-4 Industrial Monitor Settings	2 - 9
2-4-1 Industrial Monitor Utility.....	2 - 9
2-4-2 Industrial Monitor Brightness Utility.....	2 - 11

Section 3 Controller Preparation

3-1 Internal Port Settings	3 - 2
3-2 Shared Folder Settings	3 - 3
3-2-1 Windows Settings.....	3 - 3
3-2-2 Controller Setup.....	3 - 7

Section 4 Industrial PC Support Utility

4-1 Outline of Industrial PC Support Utility	4 - 2
4-2 Starting the Industrial PC Support Utility	4 - 3
4-2-1 Starting the Industrial PC Support Utility.....	4 - 3
4-2-2 Screen of Industrial PC Support Utility.....	4 - 4
4-3 Displaying Production Information	4 - 6
4-4 System Monitor	4 - 7
4-5 Controller Monitor	4 - 9
4-6 Controller Operation	4 - 11
4-6-1 Mode Change.....	4 - 11
4-6-2 Resetting the Controller.....	4 - 12
4-6-3 Controller Backup.....	4 - 13
4-7 Network Settings for Controller	4 - 18
4-8 Virtual SD Memory Card Settings	4 - 21
4-9 Operation Authority Verification	4 - 23
4-10 Report Log	4 - 25

Section 5 NYCompolet

5-1 Outline of NYCompolet	5 - 2
5-2 How to Use the NYCompolet	5 - 3
5-3 Communications Setup	5 - 4
5-3-1 Communications Setup Procedure.....	5 - 4
5-3-2 Additional Functions to Communications Setup.....	5 - 4
5-4 NYCompolet Interface	5 - 6

5-4-1	Interface Members	5 - 6
5-4-2	Usage Method	5 - 7

Section 6 Industrial PC API

6-1	Outline of Industrial PC API	6 - 2
6-2	How to Use the Industrial PC API	6 - 3
6-3	Industrial PC System API	6 - 4
6-3-1	Members of the Industrial PC System API	6 - 4
6-3-2	Usage Method	6 - 4
6-4	Industrial PC Controller API	6 - 5
6-4-1	IPController class	6 - 5
6-4-2	ControllerAccessException Class	6 - 6
6-4-3	ControllerInternalExecuteException class	6 - 6
6-4-4	Usage Method	6 - 6

Section 7 Backup and Recovery

7-1	Backing up and Recovering the Industrial PC System	7 - 2
7-1-1	Outline of Rescue Disk Utility	7 - 2
7-1-2	Applicable Range of Backup Functions with the Rescue Disk Utility	7 - 2
7-1-3	Preparing the Rescue Disk Utility	7 - 3
7-1-4	Backup with the Rescue Disk Utility	7 - 4
7-1-5	Recovery with the Rescue Disk Utility	7 - 5
7-2	Backing Up, Restoring, and Comparing Controller Data	7 - 8

Section 8 Troubleshooting during Setup

8-1	Starting in Safe Mode	8 - 2
------------	------------------------------------	--------------

Appendices

A-1	Updating	A - 2
A-1-1	Updating Windows Software	A - 2
A-2	Changing the Internal Port Settings	A - 3
A-3	Changing Windows File Sharing Setting	A - 4
A-3-1	Procedure to Change	A - 4
A-3-2	Cautions When Using Virtual SD Memory Card	A - 4
A-4	Windows of Industrial PC	A - 5
A-4-1	Windows Operating System	A - 5
A-4-2	Supported Languages	A - 5
A-5	Software / Utilities	A - 6
A-5-1	Available Utilities	A - 6
A-5-2	Installed Software and Utilities	A - 6
A-6	Industrial PC Tray Utility	A - 7
A-6-1	Outline of Industrial PC Tray Utility	A - 7
A-6-2	Starting the Industrial PC Tray Utility	A - 7
A-6-3	Status Display on Icon	A - 7
A-6-4	Industrial PC Tray Utility Menu	A - 7
A-6-5	Notification Message Display	A - 8
A-7	Customize Windows	A - 9
A-7-1	Enhanced Write Filter	A - 9

A-7-2 File-Based Write Filter..... A - 10

Index

Terms and Conditions Agreement

Warranty, Limitations of Liability

Warranties

- **Exclusive Warranty**
Omron's exclusive warranty is that the Products will be free from defects in materials and workmanship for a period of twelve months from the date of sale by Omron (or such other period expressed in writing by Omron). Omron disclaims all other warranties, express or implied.
- **Limitations**
OMRON MAKES NO WARRANTY OR REPRESENTATION, EXPRESS OR IMPLIED, ABOUT NON-INFRINGEMENT, MERCHANTABILITY OR FITNESS FOR A PARTICULAR PURPOSE OF THE PRODUCTS. BUYER ACKNOWLEDGES THAT IT ALONE HAS DETERMINED THAT THE PRODUCTS WILL SUITABLY MEET THE REQUIREMENTS OF THEIR INTENDED USE.
Omron further disclaims all warranties and responsibility of any type for claims or expenses based on infringement by the Products or otherwise of any intellectual property right.
- **Buyer Remedy**
Omron's sole obligation hereunder shall be, at Omron's election, to (i) replace (in the form originally shipped with Buyer responsible for labor charges for removal or replacement thereof) the non-complying Product, (ii) repair the non-complying Product, or (iii) repay or credit Buyer an amount equal to the purchase price of the non-complying Product; provided that in no event shall Omron be responsible for warranty, repair, indemnity or any other claims or expenses regarding the Products unless Omron's analysis confirms that the Products were properly handled, stored, installed and maintained and not subject to contamination, abuse, misuse or inappropriate modification. Return of any Products by Buyer must be approved in writing by Omron before shipment. Omron Companies shall not be liable for the suitability or unsuitability or the results from the use of Products in combination with any electrical or electronic components, circuits, system assemblies or any other materials or substances or environments. Any advice, recommendations or information given orally or in writing, are not to be construed as an amendment or addition to the above warranty.
See <http://www.omron.com/global/> or contact your Omron representative for published information.

Limitation on Liability; Etc

OMRON COMPANIES SHALL NOT BE LIABLE FOR SPECIAL, INDIRECT, INCIDENTAL, OR CONSEQUENTIAL DAMAGES, LOSS OF PROFITS OR PRODUCTION OR COMMERCIAL LOSS IN ANY WAY CONNECTED WITH THE PRODUCTS, WHETHER SUCH CLAIM IS BASED IN CONTRACT, WARRANTY, NEGLIGENCE OR STRICT LIABILITY.

Further, in no event shall liability of Omron Companies exceed the individual price of the Product on which liability is asserted.

Application Considerations

Suitability of Use

Omron Companies shall not be responsible for conformity with any standards, codes or regulations which apply to the combination of the Product in the Buyer's application or use of the Product. At Buyer's request, Omron will provide applicable third party certification documents identifying ratings and limitations of use which apply to the Product. This information by itself is not sufficient for a complete determination of the suitability of the Product in combination with the end product, machine, system, or other application or use. Buyer shall be solely responsible for determining appropriateness of the particular Product with respect to Buyer's application, product or system. Buyer shall take application responsibility in all cases.

NEVER USE THE PRODUCT FOR AN APPLICATION INVOLVING SERIOUS RISK TO LIFE OR PROPERTY WITHOUT ENSURING THAT THE SYSTEM AS A WHOLE HAS BEEN DESIGNED TO ADDRESS THE RISKS, AND THAT THE OMRON PRODUCT(S) IS PROPERLY RATED AND INSTALLED FOR THE INTENDED USE WITHIN THE OVERALL EQUIPMENT OR SYSTEM.

Programmable Products

Omron Companies shall not be responsible for the user's programming of a programmable Product, or any consequence thereof.

Disclaimers

Performance Data

Data presented in Omron Company websites, catalogs and other materials is provided as a guide for the user in determining suitability and does not constitute a warranty. It may represent the result of Omron's test conditions, and the user must correlate it to actual application requirements. Actual performance is subject to the Omron's Warranty and Limitations of Liability.

Change in Specifications

Product specifications and accessories may be changed at any time based on improvements and other reasons. It is our practice to change part numbers when published ratings or features are changed, or when significant construction changes are made. However, some specifications of the Product may be changed without any notice. When in doubt, special part numbers may be assigned to fix or establish key specifications for your application. Please consult with your Omron's representative at any time to confirm actual specifications of purchased Product.

Errors and Omissions

Information presented by Omron Companies has been checked and is believed to be accurate; however, no responsibility is assumed for clerical, typographical or proofreading errors or omissions.

Safety Precautions

Refer to the following manuals for safety precautions.

- *NY-series Industrial Box PC Hardware User's Manual (Cat. No. W556)*
- *NY-series Industrial Panel PC Hardware User's Manual (Cat. No. W557)*
- *NY-series Industrial Panel PC / Industrial Box PC Software User's Manual (Cat. No. W558)*

Precautions for Safe Use

Refer to the following manuals for precautions for safe use.

- *NY-series Industrial Box PC Hardware User's Manual (Cat. No. W556)*
- *NY-series Industrial Panel PC Hardware User's Manual (Cat. No. W557)*
- *NY-series Industrial Panel PC / Industrial Box PC Software User's Manual (Cat. No. W558)*

Precautions for Correct Use

Refer to the following manuals for precautions for correct use.

- *NY-series Industrial Box PC Hardware User's Manual (Cat. No. W556)*
- *NY-series Industrial Panel PC Hardware User's Manual (Cat. No. W557)*
- *NY-series Industrial Panel PC / Industrial Box PC Software User's Manual (Cat. No. W558)*

Regulations and Standards

Conformance to EU Directives

Applicable Directives

- EMC Directive

Concepts

● EMC Directive

OMRON devices that comply with EU Directives also conform to the related EMC standards so that they can be more easily built into other devices or the overall machine. The actual products have been checked for conformity to EMC standards.*

Whether the products conform to the standards in the system used by the customer, however, must be checked by the customer. EMC-related performance of the OMRON devices that comply with EU Directives will vary depending on the configuration, wiring, and other conditions of the equipment or control panel on which the OMRON devices are installed. The customer must, therefore, perform the final check to confirm that devices and the overall machine conform to EMC standards.

*1. Applicable EMC (Electromagnetic Compatibility) standards are as follows:

EMS (Electromagnetic Susceptibility): EN 61131-2

EMI (Electromagnetic Interference): EN 61131-2

(Radiated emission: 10-m regulations)

● Conformance to EU Directives

The NY-series Controllers comply with EU Directives. To ensure that the machine or device in which the NY-series Controller is used complies with EU Directives, the Controller must be installed as follows:

- The NY-series Controller must be installed within a control panel.
- You must use the power supply in SELV specifications for the DC power supplies connected to DC Power Supply Units and I/O Units.
- NY-series Controllers that comply with EU Directives also conform to the Common Emission Standard (EN 61000-6-4). Radiated emission characteristics (10-m regulations) may vary depending on the configuration of the control panel used, other devices connected to the control panel, wiring, and other conditions.

You must therefore confirm that the overall machine or equipment complies with EC Directives.

Software Licenses and Copyrights

This product incorporates certain third party software. The license and copyright information associated with this software is available at http://www.fa.omron.co.jp/nj_info_e/.

Versions

Hardware revisions and unit versions are used to manage the hardware and software in NY-series Controllers and EtherCAT slaves. The hardware revision or unit version is updated each time there is a change in hardware or software specifications.

Even when two Units or EtherCAT slaves have the same model number, they will have functional or performance differences if they have different hardware revisions or unit versions.

Checking Versions

You can check versions on the ID information indications or with the Sysmac Studio.

Checking Unit Versions on ID Information Indications

The unit version is given on the ID information indication on the back side of the product. The ID information on an NY-series NY5□2-□□□□ Controller is shown below.

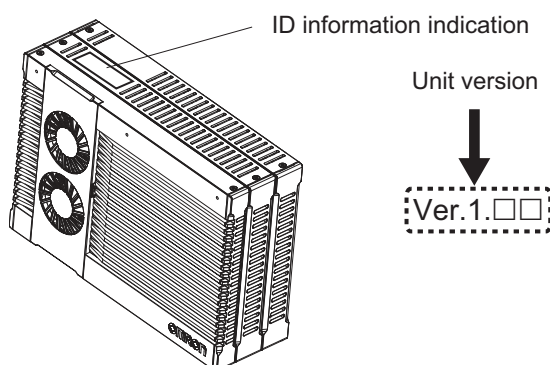

Checking Unit Versions with the Sysmac Studio

You can use the Sysmac Studio to check unit versions. The procedure is different for Units and for EtherCAT slaves.

● Checking the Unit Version of an NY-series Controller

You can use the Production Information while the Sysmac Studio is online to check the unit version of a Unit. You can only do this for the Controller.

- 1 Right-click **CPU Rack** under **Configurations and Setup - CPU/Expansion Racks** in the Multi-view Explorer and select **Production Information**.
The Production Information Dialog Box is displayed.

● Changing Information Displayed in Production Information Dialog Box

- 1 Click the **Show Detail** or **Show Outline** Button at the lower right of the Production Information Dialog Box.
The view will change between the production information details and outline.

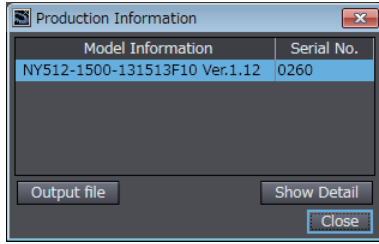

Outline View

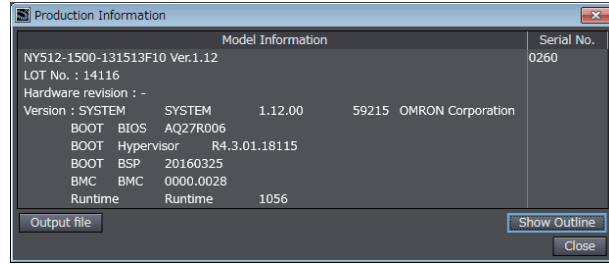

Detail View

The information that is displayed is different for the Outline View and Detail View. The Detail View displays the unit version, hardware revision, and other versions. The Outline View displays only the unit version.

● Checking the Unit Version of an EtherCAT Slave

You can use the Production Information while the Sysmac Studio is online to check the unit version of an EtherCAT slave.

Use the following procedure to check the unit version.

- 1 Double-click **EtherCAT** under **Configurations and Setup** in the Multiview Explorer. Or, right-click **EtherCAT** under **Configurations and Setup** and select **Edit** from the menu. The EtherCAT Tab Page is displayed.
- 2 Right-click the master on the EtherCAT Tab Page and select **Display Production Information**. The Production Information Dialog Box is displayed. The unit version is displayed after “Rev.”

● Changing Information Displayed in Production Information Dialog Box

- 1 Click the **Show Detail** or **Show Outline** Button at the lower right of the Production Information Dialog Box. The view will change between the production information details and outline.

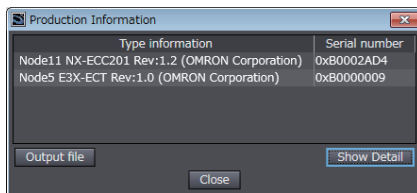

Outline View

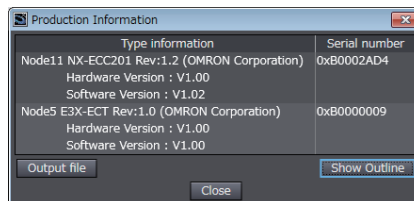

Detail View

Related Manuals

The following are the manuals related to this manual. Use these manuals for reference.

Manual name	Cat. No.	Model numbers	Application	Description
NY-series IPC Machine Controller Industrial Panel PC Hardware User's Manual	W557	NY532-□□□□	Learning the basic specifications of the NY-series Industrial Panel PCs, including introductory information, designing, installation, and maintenance. Mainly hardware information is provided.	An introduction to the entire NY-series system is provided along with the following information on the Industrial Panel PC. <ul style="list-style-type: none"> • Features and system configuration • Introduction • Part names and functions • General specifications • Installation and wiring • Maintenance and inspection
NY-series IPC Machine Controller Industrial Box PC Hardware User's Manual	W556	NY512-□□□□	Learning the basic specifications of the NY-series Industrial Box PCs, including introductory information, designing, installation, and maintenance. Mainly hardware information is provided.	An introduction to the entire NY-series system is provided along with the following information on the Industrial Box PC. <ul style="list-style-type: none"> • Features and system configuration • Introduction • Part names and functions • General specifications • Installation and wiring • Maintenance and inspection
NY-series IPC Machine Controller Industrial Panel PC / Industrial Box PC Setup User's Manual	W568	NY532-□□□□ NY512-□□□□	Learning the initial settings of the NY-series Industrial PCs and preparations to use Controllers.	The following information is provided on an introduction to the entire NY-series system. <ul style="list-style-type: none"> • Two OS systems • Initial settings • Industrial PC Support Utility • NYCompolet • Industrial PC API • Backup and recovery
NY-series IPC Machine Controller Industrial Panel PC / Industrial Box PC Software User's Manual	W558	NY532-□□□□ NY512-□□□□	Learning how to program and set up the Controller functions of an NY-series Industrial PC.	The following information is provided on the Controller function of an NY-series Controller. <ul style="list-style-type: none"> • Controller operation • Controller features • Controller settings • Programming based on IEC 61131-3 language specifications

Manual name	Cat. No.	Model numbers	Application	Description
NY-series Instructions Reference Manual	W560	NY532-□□□□ NY512-□□□□	Learning de- tailed specifica- tions on the ba- sic instructions of an NY-series Industrial PC.	The instructions in the instruction set (IEC 61131-3 specifications) are described.
NY-series IPC Machine Controller Industrial Panel PC / Indus- trial Box PC Motion Control User's Manual	W559	NY532-□□□□ NY512-□□□□	Learning about motion control settings and pro- gramming con- cepts of an NY- series Industrial PC.	The settings and operation of the Controller and programming con- cepts for motion control are de- scribed.
NY-series Motion Control Instructions Reference Manual	W561	NY532-□□□□ NY512-□□□□	Learning about the specifica- tions of the mo- tion control in- structions of an NY-series Indus- trial PC.	The motion control instructions are described.
NY-series IPC Machine Controller Industrial Panel PC / Indus- trial Box PC Built-in EtherCAT® Port User's Manual	W562	NY532-□□□□ NY512-□□□□	Using the built-in EtherCAT port in an NY-series In- dustrial PC.	Information on the built-in Ether- CAT port is provided. This manual provides an introduc- tion and provides information on the configuration, features, and setup.
NY-series IPC Machine Controller Industrial Panel PC / Indus- trial Box PC Built-in EtherNet/IP™ Port User's Manual	W563	NY532-□□□□ NY512-□□□□	Using the built-in EtherNet/IP port in an NY-series Industrial PC.	Information on the built-in Ether- Net/IP port is provided. Information is provided on the ba- sic setup, tag data links, and oth- er features.
NJ/NY-series NC Integrated Controller User's Manual	O030	NJ501-53□□ NY532-54□□	Performing nu- merical control with NJ/NY-ser- ies Controllers.	Describes the functionality to per- form the numerical control. Use this manual together with the NJ/NY-series G code Instructions Reference Manual (Cat. No. O031) when programming.
NJ/NY-series G code Instructions Refer- ence Manual	O031	NJ501-53□□ NY532-54□□	Learning about the specifica- tions of the G code/M code in- structions.	The G code/M code instructions are described. Use this manual together with the NJ/NY-series NC Integrated Controller User's Manual (Cat. No. O030) when programming.
NY-series Troubleshooting Manual	W564	NY532-□□□□ NY512-□□□□	Learning about the errors that may be detected in an NY-series Industrial PC.	Concepts on managing errors that may be detected in an NY-series Controller and information on indi- vidual errors are described.

Manual name	Cat. No.	Model numbers	Application	Description
Sysmac Studio Version 1 Operation Manual	W504	SYSMAC-SE2 □□□	Learning about the operating procedures and functions of the Sysmac Studio.	Describes the operating procedures of the Sysmac Studio.
CNC Operator Operation Manual	O032	SYSMAC-RTNC0□ □□D	Learning an introduction of the CNC Operator and how to use it.	An introduction of the CNC Operator, installation procedures, basic operations, connection operations, and operating procedures for main functions are described.
NX-series EtherCAT® Coupler Unit User's Manual	W519	NX-ECC□□□□	Learning how to use an NX-series EtherCAT Coupler Unit and EtherCAT Slave Terminals.	The following items are described: the overall system and configuration methods of an EtherCAT Slave Terminal (which consists of an NX-series EtherCAT Coupler Unit and NX Units), and information on hardware, setup, and functions to set up, control, and monitor NX Units through EtherCAT.
NX-series Safety Control Unit User's Manual	Z930	NX-SL□□□□ NX-SI□□□□ NX-SO□□□□	Learning how to use NX-series Safety Control Units	Describes the hardware, setup methods, and functions of the NX-series Safety Control Units.
Vision System FH/FZ5 series User's Manual	Z340	FH-1□□□ FH-3□□□ FZ5-L35□ FZ5-6□□ FZ5-11□□	Learning how to use the FH/FZ5-series Vision Systems.	Describes the software functions, setup and operating methods required for using the FH/FZ5-series system.
Vision Sensor FQ-M series Specialized Vision Sensors for Positioning User's Manual	Z314	FQ-MS12□	Learning how to use the Specialized Vision Sensors for Positioning.	Describes the hardware, setup methods and functions of the Specialized Vision Sensors for Positioning.
Vision Sensor FZ3 Series User's Manual	Z290	FZ3-□□□□	Learning how to use the FZ3-series Vision Sensors.	Describes the software functions, setup and operating methods of the FZ3-series Vision Sensors.
Displacement Sensor ZW series Confocal Fiber Type Dis- placement Sensor User's Manual	Z332	ZW-CE1 □	Learning how to use the ZW-series Displacement Sensors.	Describes the hardware, setup methods and functions of the ZW-series Displacement Sensors.
NA-series Programmable Terminal Software User's Manual	V118	NA5-□W□□□□	Learning about NA-series PT pages and object functions.	Describes the pages and object functions of the NA-series Programmable Terminals.
NS-series Programmable Terminals Programming Manual	V073	NS15-□□□□□ NS12-□□□□□ NS10-□□□□□ NS8-□□□□□ NS5-□□□□□	Learning how to use the NS-series Programmable Terminals.	Describes the setup methods, functions, etc. of the NS-series Programmable Terminals.

Manual name	Cat. No.	Model numbers	Application	Description
CX-Designer User's Manual	V099	---	Learning to create screen data for NS-series Programmable Terminals.	Describes operating procedures for the CX-Designer.

Revision History

A manual revision code appears as a suffix to the catalog number on the front and back covers of the manual.

Cat. No. W568-E1-03

↑
Revision code

Revision code	Date	Revised content
01	September 2016	Original production
02	April 2017	<ul style="list-style-type: none">• Made changes in specifications of Rescue Disk Utility.• Corrected mistakes.
03	October 2017	Added information on the functions supported by unit version 1.16 of the Controllers.

Sections in this Manual

1	Introduction to Industrial PC	I	Index	1	I
2	Initial Settings			2	
3	Controller Preparation			3	
4	Industrial PC Support Utility			4	
5	NYCompolet			5	
6	Industrial PC API			6	
7	Backup and Recovery			7	
8	Troubleshooting during Setup			8	
A	Appendices			A	

1

Introduction to the Industrial PC

This section describes the features, basic system, product models, and operating procedure of an Industrial PC Platform NY-series IPC Machine Controller Industrial Panel PC / Industrial Box PC.

1-1	Features	1 - 2
1-2	Operation of the Operating System.....	1 - 3
1-2-1	Overview of Operating System Operation	1 - 3
1-2-2	Data Exchange between Operating Systems	1 - 3
1-2-3	External Interface for Each Operating System	1 - 5
1-3	Product Model Numbers.....	1 - 6
1-4	Application Procedures	1 - 7
1-4-1	Overall Procedure	1 - 7
1-5	Monitoring Function.....	1 - 9
1-5-1	Monitoring System Information	1 - 9
1-5-2	Monitoring Controller Status	1 - 10

1-1 Features

Industrial PC Platform NY-series IPC Machine Controller Industrial Panel PC / Industrial Box PC (hereafter Industrial PC) is an industrial PC of the next generation. It accomplishes both high speed and high precision Controller function that is necessary for machine control, and safety, reliability, and maintainability as an industrial PC.

The Industrial PC provides the following features.

● Concurrent Operation of Windows and Real-Time OS

The Industrial PC is provided with two operating systems: Windows and Real-Time OS. It can concurrently perform both machine controls by using the Controller function on the Real-Time OS and the application processing on Windows. With one Industrial PC, you can control the equipment with the Controller, get the equipment data from the Windows application, and send it to the host PC.

● Ensuring Operating System Independency

Each of Windows and the Real-Time OS runs independently. The Controller on the Real-Time OS is not affected by the Windows operation. The Controller continues controlling even if Windows makes an unexpected stop.

● Data Exchange between Windows and Controller

Windows and the Controller on the Real-Time OS can exchange data while each makes an independent operation.

Through the shared folder on Windows, you can get data from and write data into the Controller. Also, you can shut down or restart Windows from the Controller.

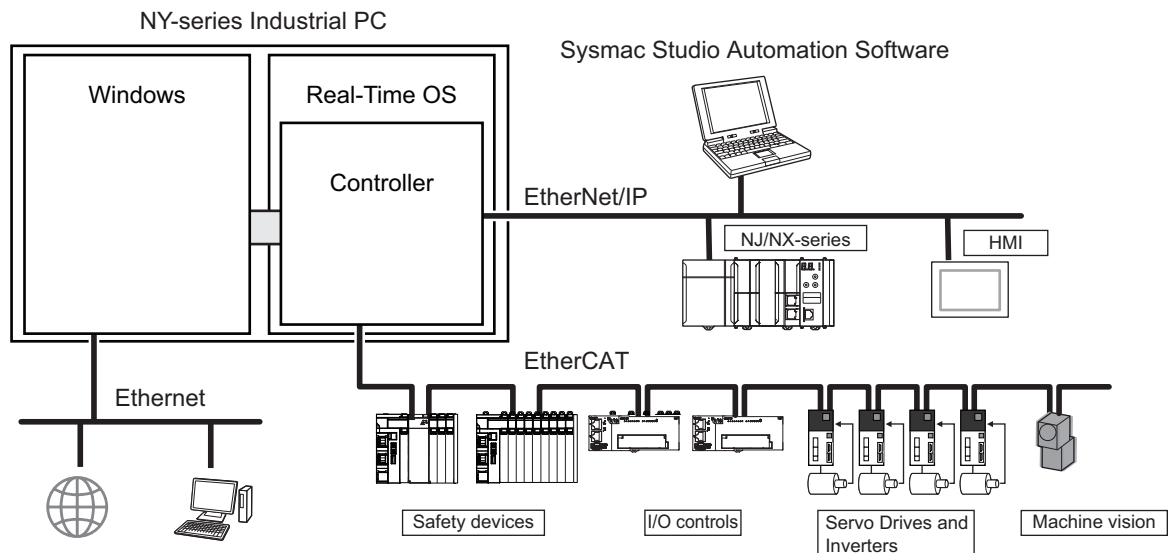

1-2 Operation of the Operating System

This section describes how the operating systems of the Industrial PC operate and how the two operating systems relate to.

1-2-1 Overview of Operating System Operation

An Industrial PC has two operating systems: Windows and Real-Time OS. Separate processor cores are allocated to each OS.

The Controller function is operated over Real-Time OS. Refer to the *NY-series Industrial Panel PC / Industrial Box PC Software User's Manual (Cat. No. W558)* for details on the Controller function and usage.

The Real-Time OS does not need any maintenance and settings.

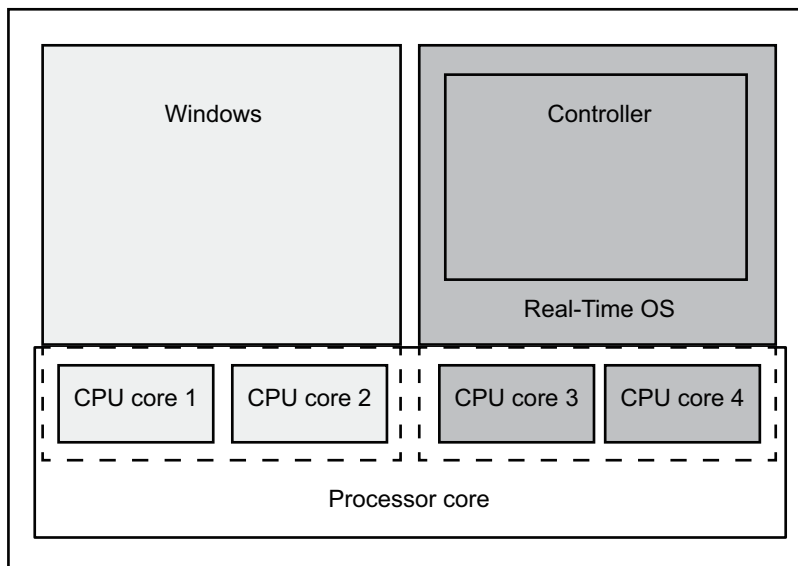

1-2-2 Data Exchange between Operating Systems

This section describes data exchange between Windows and the Real-Time OS.

There is a virtual network adapter for Windows. Each of Windows and the Real-Time OS (Controller function) has an internal port. The two OSs exchange data through the internal port and the internal network.

Accessing Windows from the Controller

You can use Windows shared folder as a Virtual SD Memory Card from the Controller, and backup and restore the Controller data.

You can access the shared folder, as usual, from Windows.

Also, you can shut down or restart Windows by using instructions in the Controller programs.

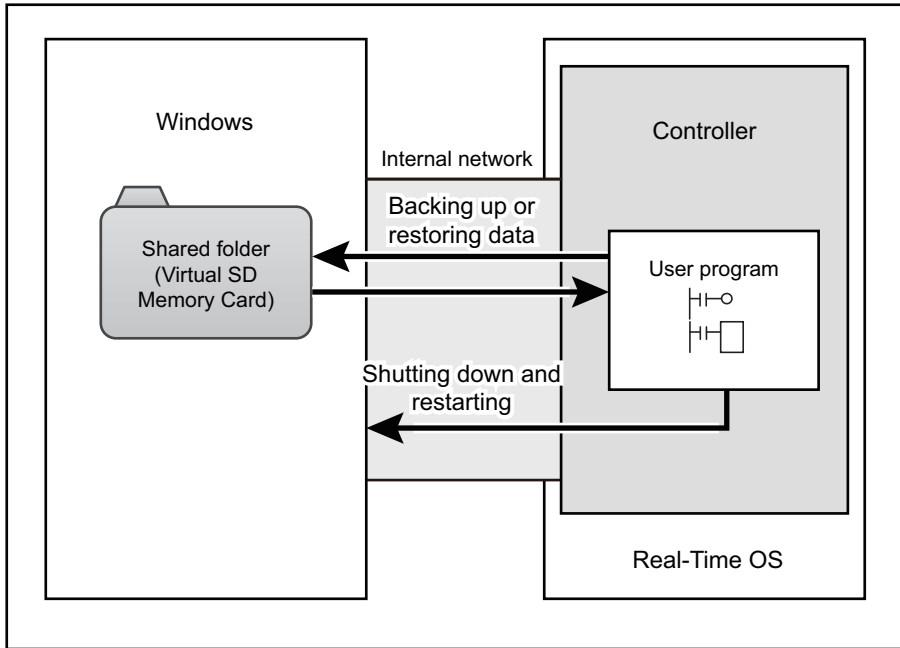

Accessing the Controller from Windows

You can get the Controller data with the support software or application that runs on Windows.

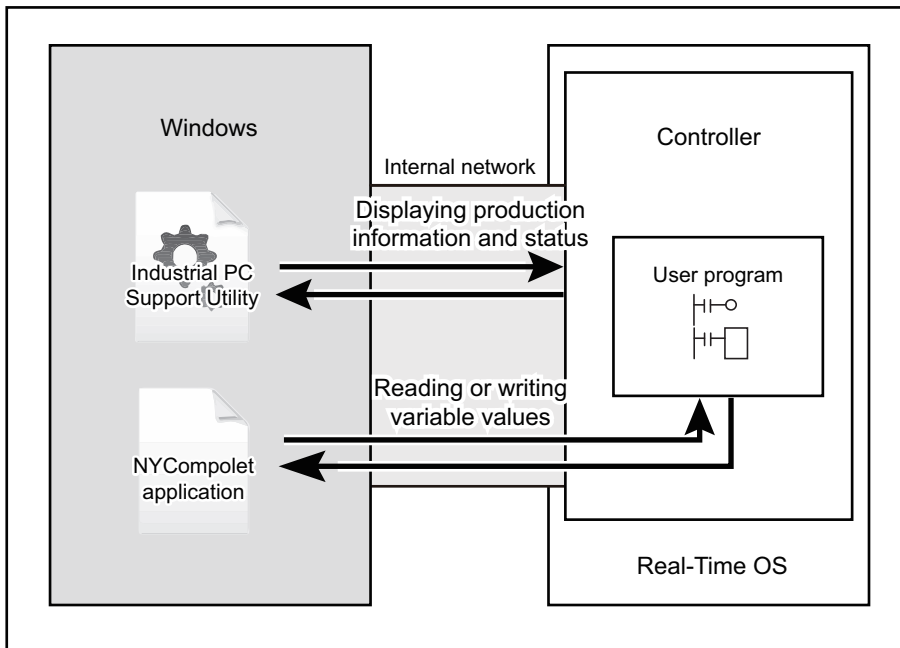

Item	Description
Industrial PC Support Utility	Displays the production information of the Industrial PC, and the status. Also, you can change the operating mode of the Controller, and back up the data. Refer to <i>Section 4 Industrial PC Support Utility</i> on page 4 - 1 for details.
Applications with the NYCompolet	The NYCompolet is a software component that provides the Windows application the functions to get and refresh the Controller data. You can get the Controller data by creating and using applications with the NYCompolet. Refer to <i>Section 5 NYCompolet</i> on page 5 - 1 for details on the NYCompolet.

1-2-3 External Interface for Each Operating System

External interfaces for Industrial PCs that are supported by Windows and Real-Time OS (Controller function) are given below.

You cannot access an interface which is supported by the other Operating System.

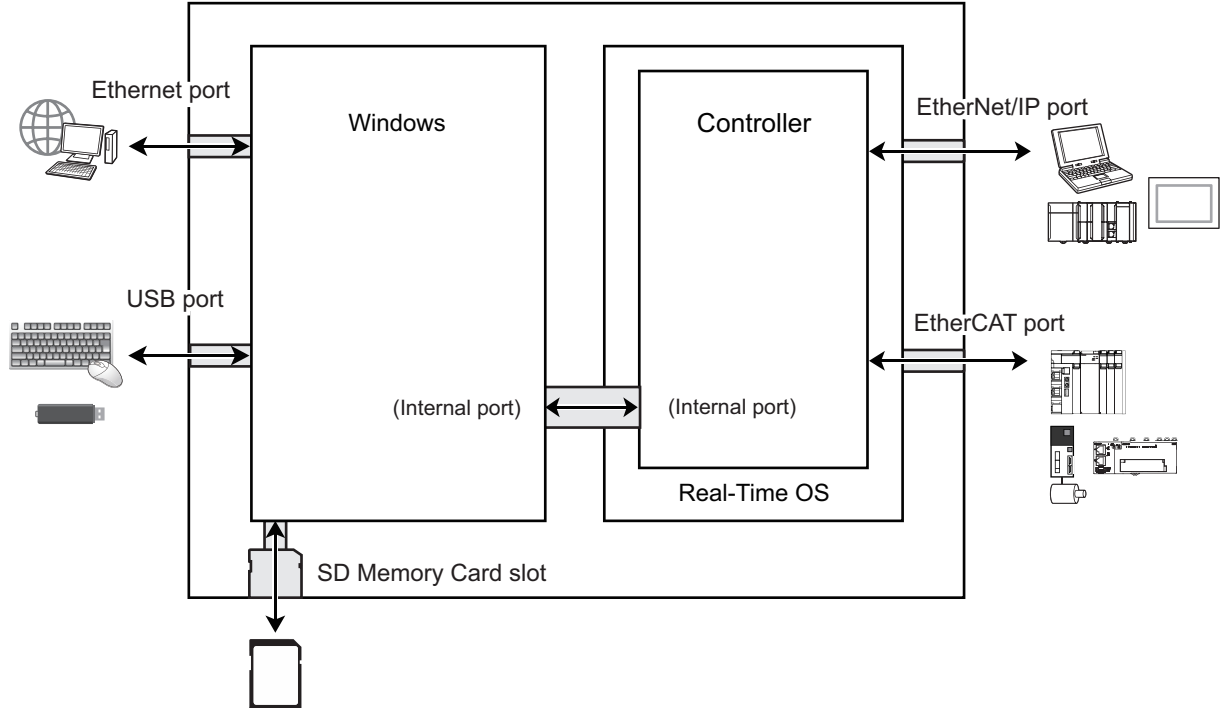

1-3 Product Model Numbers

The model numbers of Industrial PCs indicate a used operating system, the number of controlled axes on the Controller, and hardware configuration.

NY 5 3 2 - 1 5 0 0 - 1 1 2 2 1 3 C 2 2

1 2 3 4 5 6 7 8 9 10 11 12 13 14 15 16 17

Number	Item	Option
1	Series	NY : NY-series Industrial PC Platform
2	Controller specifications	5 : Large-scale, high-speed and high-precision controls with up to 64 axes
3	Model type	1 : Industrial Box PC
		3 : Industrial Panel PC
4	Sequential number	2 : Latest version
5	Function module	1 : Standard
6	Number of axes for motion control	3 : 16 axes
		4 : 32 axes
		5 : 64 axes
7	Additional function software module	0 : ---
8	Reserved	0 : ---
9	Expansion slots	1 : PCIe slot × 1
10	Frame type	1 : Aluminum frame, black, Projected Capacitive Touch type
		X : Without display (Industrial Box PC)
11	Display size	1 : 12.1 inches
		2 : 15.4 inches
		X : Without display (Industrial Box PC)
12	OS	1 : Windows Embedded Standard 7 32-bit
		2 : Windows Embedded Standard 7 64-bit
13	Processor	1 : Intel® Core™ i7-4700EQ Processor
14	Main memory	3 : 8GB Non-ECC
15	Storage	8 : 32GB SSD SLC
		9 : 64GB SSD SLC
		C : 320GB HDD
		K : 128GB SSD iMLC
16	Interface option	1 : RS-232C
		2 : DVI-D
17	Logo mark	0 : Omron
		2 : Custom
		X : Without display (Industrial Box PC)

1-4 Application Procedures

This section gives the operating procedure of the Industrial PCs. This manual gives the detailed descriptions in the same order as the following operating procedure.

1-4-1 Overall Procedure

1 Preparations

Perform procedures that are required to use the Industrial PC such as assembling, installation, and connection with peripheral devices including a UPS.

Refer to the *NY-series Industrial Box PC Hardware User's Manual (Cat. No. W556)* or the *NY-series Industrial Panel PC Hardware User's Manual (Cat. No. W557)* for details on assembling, installation, and wiring for the Industrial PC, and on the parts of the Industrial PC.

2 Initial Settings

Make the initial settings for Windows and settings for the Industrial Monitor.

Step	Description	Reference
Initial settings for the Windows	Make the settings including the Windows setup when Windows is started up for the first time. Also, back up the status immediately after the Windows setup is completed.	2-1 <i>Initial Settings for Windows</i> on page 2 - 2
Turing ON or OFF the power supply	Turn ON the power or shut down.	2-2 <i>Starting and Exiting</i> on page 2 - 5
UPS settings	Make the required UPS settings.	2-3 <i>UPS Settings</i> on page 2 - 8
Industrial Monitor settings*1	Adjust the brightness and contrast of the Industrial Monitor.	2-4 <i>Industrial Monitor Settings</i> on page 2 - 9

*1. The settings are required when you use the Industrial Panel PC or Industrial Monitor.

3 Preparing for the Controller

Make the settings required for the Controller to use Windows shared folder as a Virtual SD Memory Card.

Step	Description	Reference
Internal port settings	Make the settings required for the Controller and Windows to communicate.	3-1 <i>Internal Port Settings</i> on page 3 - 2
Shared folder settings	Set a shared folder used by the Controller as a Virtual SD Memory Card.	3-2 <i>Shared Folder Settings</i> on page 3 - 3

4 Controller Setup and Programming

Set up the Controller and create control programs. Refer to the *NY-series Industrial Panel PC / Industrial Box PC Software User's Manual (Cat. No. W558)* for details on the setting and programming methods.

5 Creating Applications that Run on Windows

Create required applications that run on Windows.

Step	Description	Reference
Creating applications with the NYCompolet	Use the API that operates the Controller, and create an application to obtain variable data of the Controller. Also, use the created application, and make the required communications settings to operate the Controller.	<i>Section 5 NYCompolet</i> on page 5 - 1
Creating applications with the Industrial PC API	Use the API prepared for the Industrial PC, and create an application that gets the system status information of the Industrial PC as well as the status information of the Controller.	<i>Section 6 Industrial PC API</i> on page 6 - 1

6 Backup and Recovery

Back up and recover the Windows data and the Controller data.

Step	Description	Reference
Backing up and recovering the entire Industrial PC system	Back up the data on the hard disk drive of the Industrial PC, and restore it in the USB storage.	<i>7-1 Backing up and Recovering the Industrial PC System</i> on page 7 - 2
Backing up and restoring the Controller	Use the backup and restore function of the Controller, and back up and restore the Controller setup, user programs, and variable data.	<i>7-2 Backing Up, Restoring, and Comparing Controller Data</i> on page 7 - 8

1-5 Monitoring Function

This section describes the monitoring function of the Industrial PC.

The function is used to monitor the system status and Controller status of the Industrial PC.

The Industrial PC Support Utility is used to obtain and display the system information of the Industrial PC and the status information of the Controller function.

Refer to *Section 4 Industrial PC Support Utility* on page 4 - 1 for details on the displaying procedures of and the displayed items by the Industrial PC Support Utility.



Precautions for Correct Use

The Industrial PC Support Utility obtains and displays the system information of the Industrial PC as well as the status information of the Controller function. But it does not support continuous monitoring. To obtain information continuously, use the Industrial PC API and separately create an application that obtains required information. Also, to obtain more information than the Industrial PC Support Utility can obtain and display, you have to create an application as well.

1-5-1 Monitoring System Information

To display the system status of the Industrial PC, start up the Industrial PC Support Utility and click the **System Status** tab.

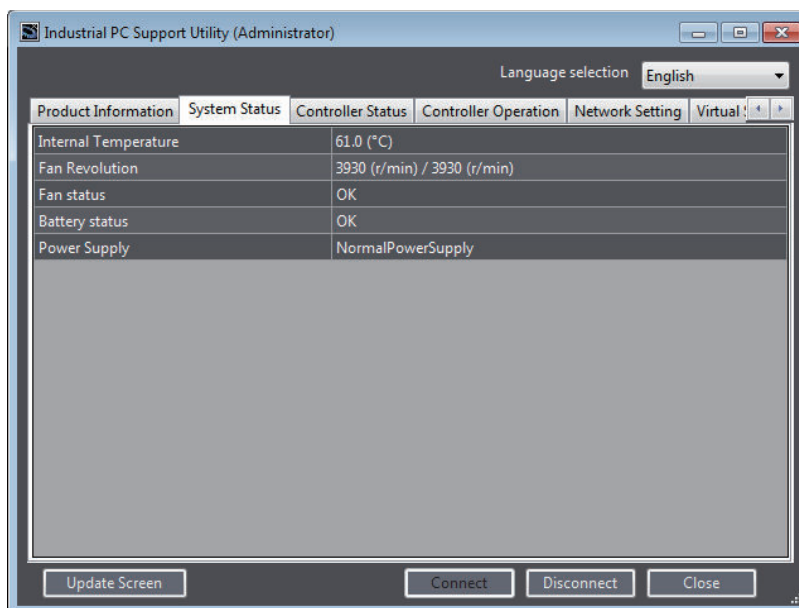

Item	Description
Internal Temperature	Displays the present internal temperature of the Industrial PC.
Fan Revolution	Displays the present revolution of the Fan Unit.
Fan status	Indicates the fan status. Displays "Low revolution speed" when the fan is disconnected or the fan revolution is decreased.
Battery status	Indicates the battery voltage status. Indicates "Low" when the battery is disconnected or the battery voltage is dropped.
Power Supply	Indicates the type of the power supply.

Refer to *4-4 System Monitor* on page 4 - 7 for details on each item.

1-5-2 Monitoring Controller Status

To display the Controller status, start up the Industrial PC Support Utility and click the **Controller Status** tab.

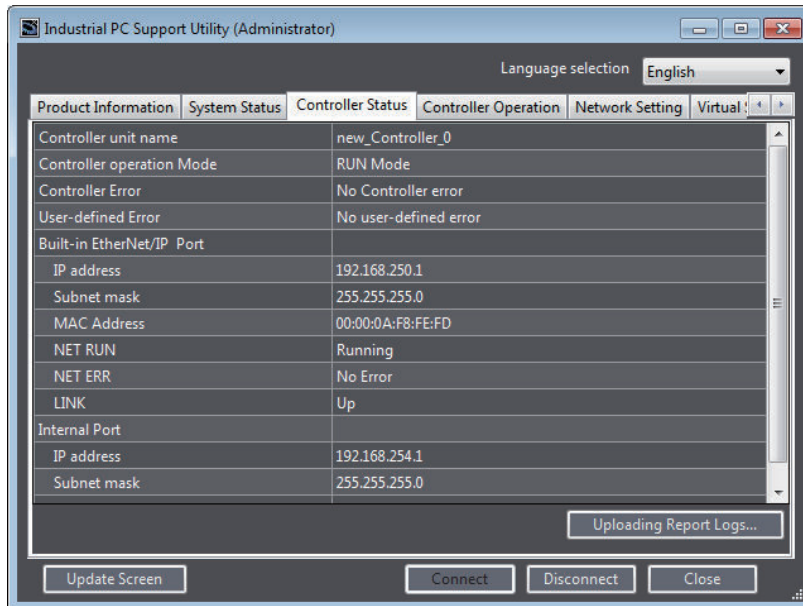

Item	Description
Unit name of the Controller	Displays the unit name that is set for the Controller.
Controller operation Mode	Displays the present operating mode of the Controller.
Controller Error	Displays current Controller errors.
User-defined Error	Displays current user-defined errors.
Built-in EtherNet/IP port	Displays the settings of the built-in EtherNet/IP port through which the Controller communicates with an external device of the Industrial PC.
IP address	Displays the present IP address, subnet mask, and MAC address.
Subnet mask	
MAC address	
NET RUN	Displays the CIP connection status of the EtherNet/IP network.
NET ERR	Displays the communications error status of the EtherNet/IP network.
LINK	Displays the link establishment status of the EtherNet/IP network.
Internal Port	Displays the settings of the internal port through which the Controller communicates with Windows on the Industrial PC.
IP address	Displays the present IP address, subnet mask, and MAC address.
Subnet mask	
Default Gateway	Displays the present default gateway.

Refer to *4-5 Controller Monitor* on page 4 - 9 for details on each item.



Additional Information

You can use the Controller Status function of the Sysmac Studio to monitor more detailed status of the Controller. Refer to the *Sysmac Studio Version 1 Operation Manual (Cat. No. W504)* for details on the Controller status of the Sysmac Studio.

2

Initial settings

This section describes the basic operation and initial settings of the Industrial PC. It also describes starting and exiting the Industrial PC, the initial settings for Windows after turning ON the power for the first time, the UPS settings, and the Industrial Monitor settings.

2-1	Initial Settings for Windows	2 - 2
2-1-1	Windows Settings	2 - 2
2-1-2	Creating Recovery Image of Initial State	2 - 3
2-1-3	Installing Software	2 - 3
2-1-4	User Account Settings	2 - 4
2-1-5	Customize Windows	2 - 4
2-2	Starting and Exiting	2 - 5
2-2-1	Starting	2 - 5
2-2-2	Exiting	2 - 6
2-2-3	Restarting	2 - 6
2-3	UPS Settings.....	2 - 8
2-4	Industrial Monitor Settings.....	2 - 9
2-4-1	Industrial Monitor Utility	2 - 9
2-4-2	Industrial Monitor Brightness Utility	2 - 11

2-1 Initial Settings for Windows

This section describes the setting items and procedures for Windows when the Industrial PC is started up for the first time.

A keyboard and mouse are required to make settings. Before turning on the power supply to the Industrial PC, connect a keyboard and mouse to the USB ports. Also, connect the Industrial Monitor when you use an Industrial Box PC.

Refer to *A-4 Windows of Industrial PC* on page A - 5 for the specifications of Windows for Industrial PCs.

2-1-1 Windows Settings

Perform the Windows setup when the Industrial PC is started up for the first time.

You can set the Windows language, region, and computer name in the following procedure.

It takes about 20 to 30 minutes to complete this procedure.



Precautions for Safe Use

- Choose an OS password that is not obvious to prevent unauthorized access.
- Remember the OS user name and password. The product is inaccessible without it.



Precautions for Correct Use

- Do not turn off the power supply during the Windows setup.
- Once you click the **Next** button on the language selection page, you cannot return to the page. Be careful not to select a wrong language.

- 1** Press and release the power button on the Industrial PC within 1 second.
The Industrial PC is started up and the **Set Up Windows** dialog box is displayed.
- 2** Select a language to use on the first page of the **Set Up Windows** dialog box, and then click the **Next** button.
The regional information page is displayed.
- 3** On the regional information page, select **Country or region**, **Time and currency**, and **Keyboard layout**, and then click the **Next** button.
The Create a new account page is displayed.
- 4** Enter **User name** and **Computer name**, and click the **Next** button.
The **Set a password for your account** page is displayed.
- 5** Enter a password and password hint, and click the **Next** button.
The **Please read the license terms** page is displayed.
- 6** Read the license terms carefully. Then, select the **I accept the license terms** check box and click the **Next** button.
The **Help protect your computer and improve Windows automatically** page is displayed.

- 7 Click **Use recommended settings**.
The **Review your time and date settings** page is displayed.
- 8 Set **Time zone**, **Date** and **Time**, and click **Next** button.
The **Select your computer's current location** page is displayed.
- 9 Click the network in which you use the computer.
After the computer is restarted automatically, the login screen is displayed. This completes the setup procedure.

2-1-2 Creating Recovery Image of Initial State

You can back up the Industrial PC in the state immediately after the Windows setup is completed. If Windows or Real-Time OS (Controller function) malfunctions while the Industrial PC is operated, with the backup data you can restore the Industrial PC to the state immediately after the Windows set-up is completed.

You can use the Rescue Disk Utility for backing up. Refer to *7-1 Backing up and Recovering the Industrial PC System* on page 7 - 2 for details and procedures on backing up and recovering with the Rescue Disk Utility.

2-1-3 Installing Software

When there is any software required for using the Industrial PC, you can install it.

- Internet browser
- Firewall software
- Anti-virus software



Precautions for Safe Use

To ensure security, it is strongly recommended to install firewall and anti-virus software and keep them updated in the latest state.



Precautions for Correct Use

Confirm the IT policy at your company for available software as well as for the security requirements and environment for the Industrial PC.

Installing Internet Browser

The Industrial PC does not have an internet browser pre-installed for security reasons. An executable file for browser installation is provided in D:\OMRON-NY\Installers.

Execute an installer that corresponds to the type of your Windows (32 or 64 bit) and your language (Japanese or English).



Precautions for Safe Use

Install all updates and ensure the browser stays up-to-date.

Installing Firewall Software

Install the firewall software that you are permitted to use in your company. The Industrial PC network must be separated from the office network.



Precautions for Safe Use

- Separate the machine network segment from the office network to avoid communication failures.
 - Install all updates and ensure the firewall stays up-to-date.
-

Installing Anti-virus Software

Windows is vulnerable for viruses. Anti-virus software should be installed on Windows.



Precautions for Safe Use

- Make sure that your OS environment is protected against malicious software and viruses.
 - Install all updates and ensure virus definitions stay up-to-date.
-

2-1-4 User Account Settings

The Controller function uses the Windows shared folder as a Virtual SD Memory Card.

To use this function, you must log onto Windows with the user account of the administrator, and access the shared folder.

When you create and use a user account other than one you set in **Windows Settings**, be sure to add the administrator's access right to it.

2-1-5 Customize Windows

Windows provides customization tools. Using these tools is only allowed for experienced software engineers.

Refer to *A-7 Customize Windows* on page A - 9 for details on the tools.

2-2 Starting and Exiting

This section gives the basic starting up and exiting operations of the Industrial PC, and the operation sequences.

2-2-1 Starting

During starting up, the Monitor displays the startup status. The following description assumes that you are using an Industrial Panel PC, or an Industrial Box PC to which a Monitor is connected.

Startup Operating Modes

The Industrial PC has the following startup operating modes.

Type	Description
Normal mode	The mode is used for normal startup. The Controller is started up in RUN mode.
Safe mode	The Controller is started up in PROGRAM mode. This mode is used to start up the Controller in PROGRAM mode even if the operating mode at power ON is set to <i>RUN mode</i> .

The Normal mode operation procedure is given below.

Refer to *8-1 Starting in Safe Mode* on page 8 - 2 for information on the Safe mode.

Normal Mode

- 1** Press and release the power button on the Industrial PC within 1 second.
The PWR LED lights, and the BIOS startup view is displayed on the Monitor.
- 2** Wait for the RUN LED to light.
The RUN LED flashes, and the Real-Time OS (Controller function) starts up in RUN mode.
When the Controller function is completely started up, the RUN LED lights, and then Windows starts up.



Additional Information

- The startup state of the Real-Time OS (Controller function) is not shown on the Monitor. The startup process of the Real-Time OS is completed at the time when the Windows startup view is displayed.
- Refer to *Section 8 Troubleshooting during Setup* on page 8 - 1 for details on errors that occur during startup.
- Other than pressing the power button, you can use an external input signal to start up the Industrial PC in Normal mode. After the external input signal is turned ON, the same operations as after the power button is pressed follow. Refer to the *NY-series Industrial Box PC Hardware User's Manual (Cat. No. W556)* or the *NY-series Industrial Panel PC Hardware User's Manual (Cat. No. W557)* for details on the startup procedure with an external input signal.

2-2-2 Exiting

This section gives procedures to shut down Windows and Real-Time OS (Controller function), and turn OFF the power supply to the Industrial PC.



Precautions for Safe Use

Before turning OFF the power supply to the Industrial PC, you must ensure that there is no program running on Windows, and that it is safe to shut down the system while the current program is running.

How to turn OFF the power supply to the Industrial PC depends on the trigger types as follows.

Trigger type	Description
Power button	Shutting down by pressing the power button on the Industrial PC. *1
Input signal from UPS	Shutting down with a signal input from UPS to the Industrial PC. The signal input is caused by an interruption of power supply which is connected to the UPS. *1
Shutdown instruction from the Controller	Shutting down in a desired timing when the shutdown instruction is executed in the Controller program. *2

*1. You can set the shutdown processing time on the Controller Setup. Refer to the *NY-series Industrial Panel PC / Industrial Box PC Software User's Manual (Cat. No. W558)* for details on the settings and shutdown processing.

*2. Refer to the *NY-series Instructions Reference Manual (Cat. No. W560)* for details on using the shutdown instruction.

The exiting procedure when the trigger is pressing the power button is given below.

1

Press and release the power button on the Industrial PC within 1 second.

The program running on the Controller is stopped, and the Real-Time OS (Controller function) is shut down. Then Windows is shut down, and the power supply to the Industrial PC is turned OFF.



Precautions for Correct Use

When you press the power button for five seconds or longer, the power is forcibly turned OFF without going through the normal shutting down process. Be careful to use this procedure. It may cause a loss of a program running on the Controller or data in a Windows application.



Additional Information

- You cannot shut down from the Windows start menu.
- Refer to the *NY-series Industrial Box PC Hardware User's Manual (Cat. No. W556)* or the *NY-series Industrial Panel PC Hardware User's Manual (Cat. No. W557)* for details on abnormal shutdowns by an interruption of power supply when a UPS is not used, or by overheating.

2-2-3 Restarting

The procedures to restart the Industrial PC are given below. The types of restarting depend on what is restarted as follows. Each is for a different target to restart.

Type	Description
Restarting Windows	Restarts only Windows. The Controller is not affected by the Windows restart.
Restarting the Controller	Restarts or resets only the Controller. Windows is not affected by the Controller restart.

Restarting Windows

To restart Windows, use the Restart OS instruction on the Controller. Refer to the *NY-series Instructions Reference Manual (Cat. No. W560)* for details on using the Restart OS instruction.

Restarting the Controller

Use the Sysmac Studio or Industrial PC Support Utility to restart the Controller.

- **Restarting the Controller with Sysmac Studio**

For how to restart (reset) the Controller with the Sysmac Studio, refer to the *Sysmac Studio Version 1 Operation Manual (Cat. No. W504)*.

- **Restarting the Controller with Industrial PC Support Utility**

When you restart (reset) the Controller from the Industrial PC Support Utility, use the **Reset** button in the **Controller Operation** tab page. Refer to *4-6-2 Resetting the Controller* on page 4 - 12 for details on the procedure.

2-3 UPS Settings

If necessary, set the UPS operating mode, Industrial PC's exiting processing during a power interruption, and I/O signal processing.

Refer to the manual for the UPS you use for details on the UPS settings.

2-4 Industrial Monitor Settings

This section describes how to set up the Industrial Panel PC and Industrial Monitor, and how to adjust their screens.

Use the following applications to set the screen of the Industrial Panel PC or Industrial Monitor.

- Industrial Monitor Utility
- Industrial Monitor Brightness Utility

The Industrial Panel PC and Industrial Monitor may collectively be called “the monitor” hereafter in this section.



Precautions for Correct Use

When you use the Industrial Monitor Utility or Industrial Monitor Brightness Utility to adjust the Industrial Monitors, connect them to the Industrial PC with a USB cable in advance.

2-4-1 Industrial Monitor Utility

The Industrial Monitor Utility is the application which displays the information on the model of the Industrial Panel PC screen and Industrial Monitor. It also changes the brightness of the screens and front LEDs.

You can start up the Industrial Monitor Utility with the following screen or menu.

- Start menu
- System tray (Industrial PC Tray Utility)

Refer to *A-6 Industrial PC Tray Utility* on page A - 7 for details on the Industrial PC Tray Utility.

Application Procedures

As an example, the procedure to start up from the Start menu is given below.

- 1 Select **OMRON - Industrial Monitor - Industrial Monitor Utility** from the Start menu. The **Industrial Monitor Utility** dialog box is displayed.

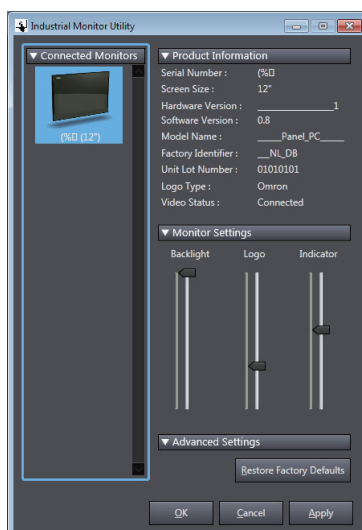

Refer to *Industrial Monitor Utility Dialog Box* on page 2 - 10 for details on the screens of the Industrial Monitor Utility as follows.

- 2** Select an Industrial Panel PC or Industrial Monitor and make the necessary setting. Click the **Apply** button.

The setting is applied to the Industrial Panel PC or Industrial Monitor.

Industrial Monitor Utility Dialog Box

The Industrial Monitor Utility dialog box provides the following functions.

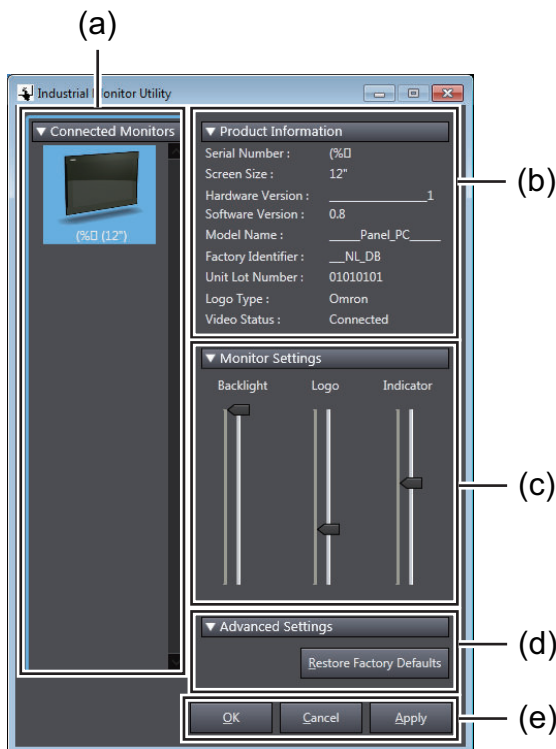

	Item	Details	Displayed information
(a)	Connected Monitors	Displays monitors that are connected to the Industrial PC. Click the icon of a monitor to display the monitor information and settings.	Monitor icon and monitor name
(b)	Product Information	Displays the product information of the monitor.	<ul style="list-style-type: none"> • Serial number • Screen Size • Hardware Version • Software Version • Model Name • Factory Identifier • Unit Lot Number • Logo Type • Video Status
(c)	Monitor Settings	Sets the brightness of the Monitors and front LEDs.	---
	Backlight	Adjusts the brightness of the screen back-lights.	Slider (0 to 100%)
	Logo	Adjusts the brightness of the front Logo LED.	Slider (0 to 100%)

	Item	Details	Displayed information
	Indicator	Adjusts the brightness of the front Status LED indicator.	Slider (0 to 100%)
(d)	Advanced Settings	Restores the factory default settings.	---
	Restore Factory Defaults button	Returns all settings of the screen backlight and front LED of the Industrial Panel PC or Industrial Monitor to the factory default settings.	---
(e)	OK button	Applies the current Industrial Monitor Utility settings to the Industrial Panel PC or Industrial Monitor and closes the dialog box.	---
	Cancel button	Closes the dialog box without applying the change.	---
	Apply button	Applies the current Industrial Monitor Utility settings to the Industrial Panel PC or Industrial Monitor.	---

2-4-2 Industrial Monitor Brightness Utility

The Industrial Monitor Brightness Utility simultaneously changes the brightness of multiple monitors that are connected to the Industrial PC.

You can start up the Industrial Monitor Brightness Utility with the following screen or menu.

- System tray (Industrial PC Tray Utility)

Refer to *A-6 Industrial PC Tray Utility* on page A - 7 for details on the Industrial PC Tray Utility.

Application Procedures

- 1 Right-click the Industrial PC Tray Utility icon to select **Monitor Brightness Utility**. The Industrial Monitor Brightness Utility is displayed.

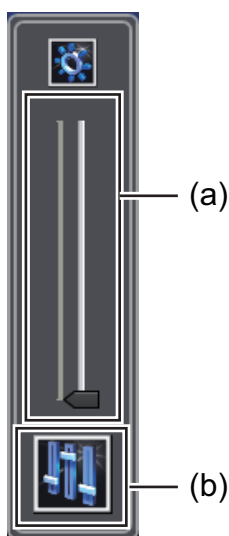

	Item	Details
(a)	Slider	Adjusts the brightness of the screen backlights of the Industrial Panel PC and Industrial Monitors.

	Item	Details
(b)	Industrial Monitor Utility button	Starts the Industrial Monitor Utility.

2

Adjust with the slider.

The brightness of the screen of the Industrial Panel PC and all Industrial Monitors connected to the Industrial PC are adjusted simultaneously.



Additional Information

You can start the Industrial Monitor Utility by clicking the **Industrial Monitor Utility** button. Refer to *2-4-1 Industrial Monitor Utility* on page 2 - 9 for details.

3

Controller Preparation

This section describes the settings and procedures for Windows and Controller that are required for using the Controller.

3-1	Internal Port Settings	3 - 2
3-2	Shared Folder Settings	3 - 3
3-2-1	Windows Settings	3 - 3
3-2-2	Controller Setup	3 - 7

3-1 Internal Port Settings

This section describes the settings of the internal port through which the Controller communicates with Windows.

Refer to *1-2-2 Data Exchange between Operating Systems* on page 1 - 3.

Windows Settings

An internal port is set on Windows by default as a virtual network adapter port. The factory setting for the internal port is given below.

Item	Value
Network adapter name	Real-Time Hypervisor PCI Network Adapter
IP address	192.168.254.2
Subnet mask	255.255.255.0
Public range of Windows file shared service	Internal network only

Controller Setup

The factory setting for the internal port on the Controller is given below.

Item	Value
IP address	192.168.254.1
Subnet mask	255.255.255.0

3-2 Shared Folder Settings

This section describes the settings required for the Controller to use the Windows shared folder as a Virtual SD Memory Card.

Refer to the *NY-series Industrial Panel PC / Industrial Box PC Software User's Manual (Cat. No. W558)* for details on the function of a Virtual SD Memory Card.

3-2-1 Windows Settings

Prepare a Windows user account with which you access the shared folder directly or through the Controller.

Create a user account first.

Creating a User Account

Create a new user account with which you access the shared folder through the Controller. First log onto Windows with a user account of administrator level that was created at the Windows settings, and then perform the following procedures.

- 1 Select **Control Panel** from the Windows start menu.

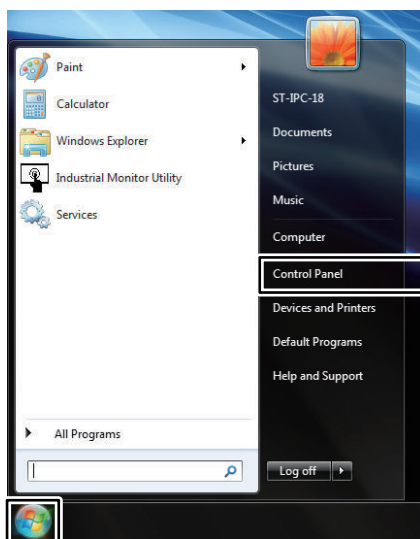

The Controller Panel is displayed.

- 2 Select **Add or remove user accounts** on the Control Panel.

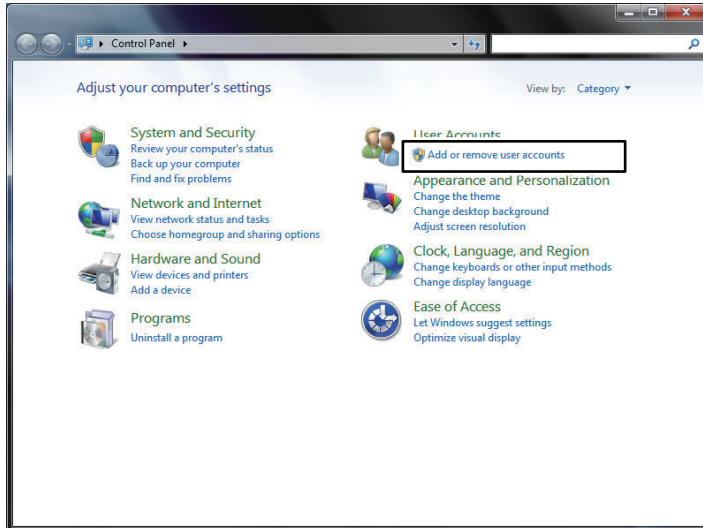

The **Manage accounts** view is displayed.

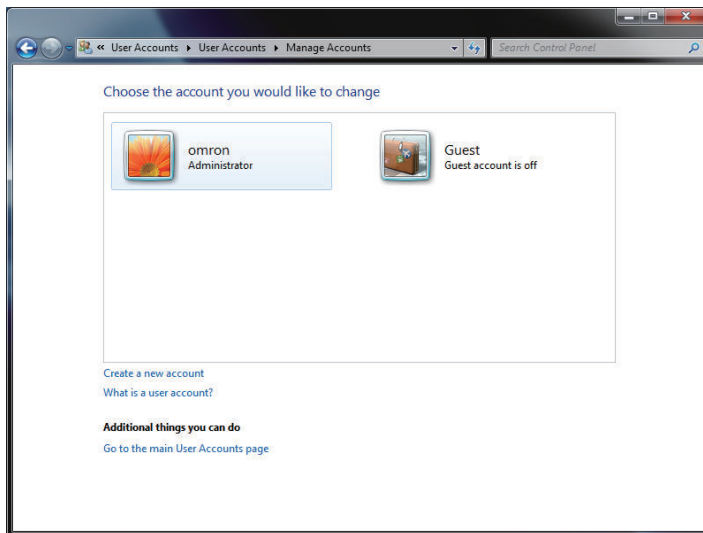

3 Select **Create a new account**.

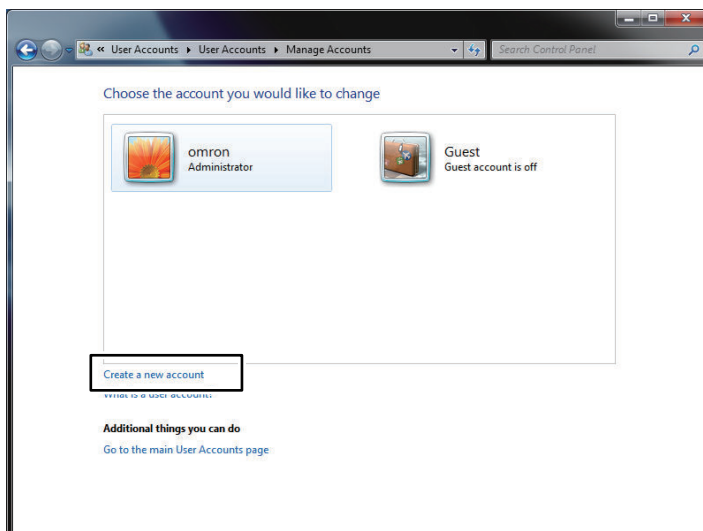

The **Create a new account view** is displayed.

4 Enter an account, select **Administrator**, and click the **Create Account** button. In the following example, enter *MachineController* as an account.

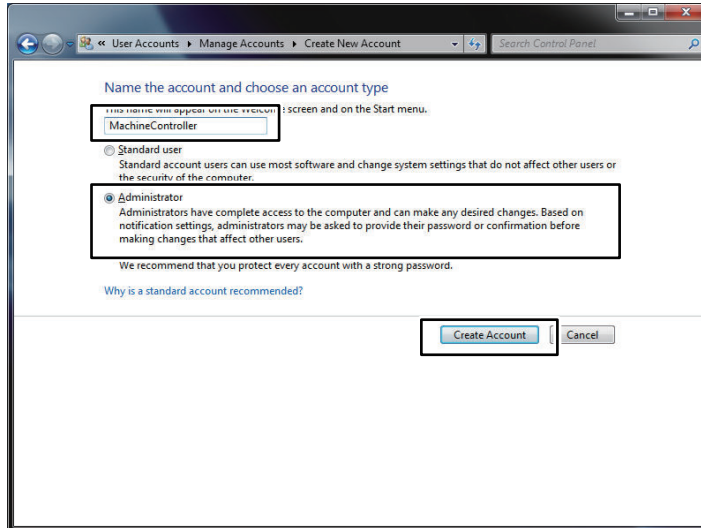

The new account is created.

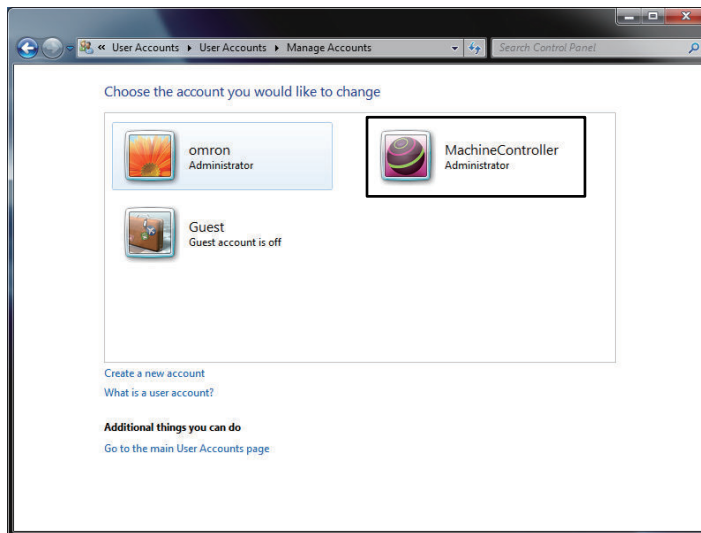

- 5** Click the account that you created on the **Manage accounts** view. Select **Created a password** on the displayed **Change account** view.

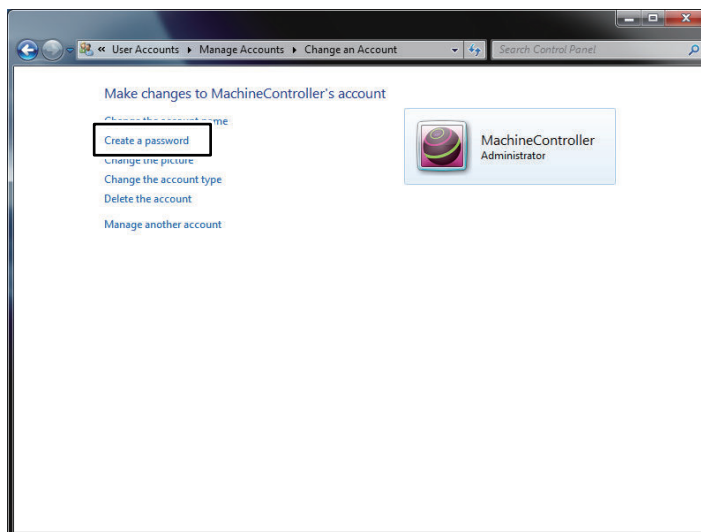

The **Create a password** view is displayed.

- 6 Enter a password, and then click the **Create a password** button. Enter a hint to the password, if necessary.

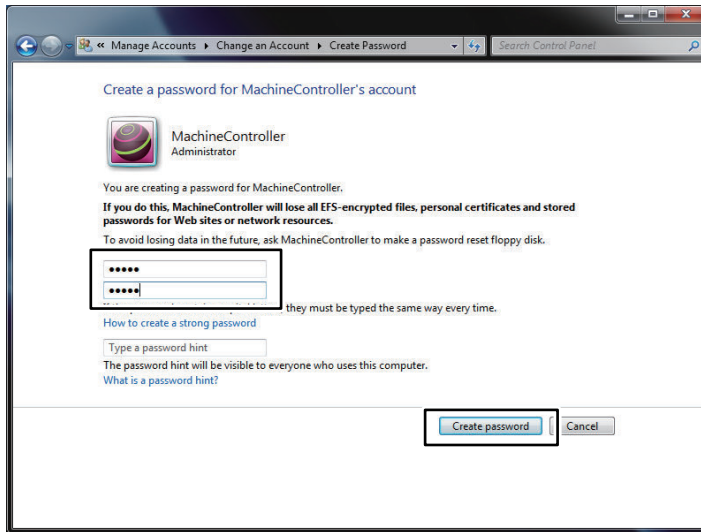

This completes an account creation.

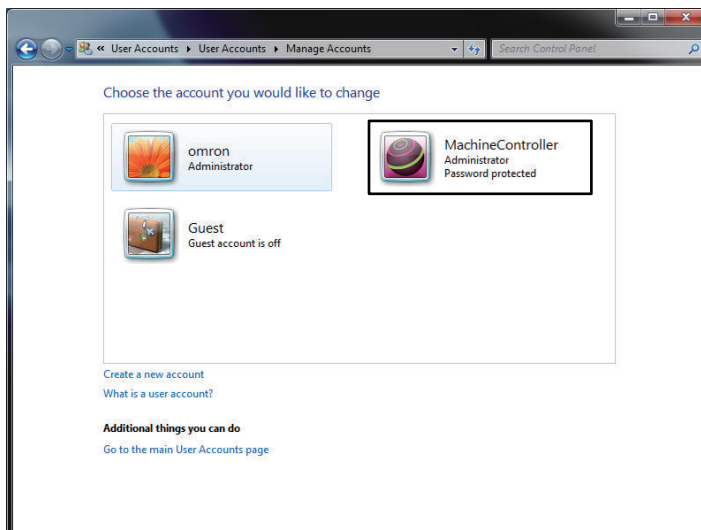

Precautions for Correct Use

- Characters that you can use for an account name range from 0 to 9, A to Z, a to z, and single-byte symbols (` , ! , # , \$, ^ , & , (,) , _ , - , { , } , \ , and '). The number of characters for an account is 1 to 274 (without Null). Case insensitive.
- Characters that you can use for a password range from 0 to 9, A to Z, a to z, and single-byte symbols (` , ! , @ , # , \$, % , ^ , & , * , (,) , _ , - , + , = , { , } , [,] , \ , | , ; , : , " , ' , < , > , . , ? , and /). The number of characters for a password is 8 to 32 (without Null). Case sensitive.

Shared Folder Settings

A shared folder that is used as a Virtual SD Memory Card is created by default. You can access the folder from a new account that you create.

The factory setting for the shared folder is given below.

Item	Value
The path for the shared folder	D:\OMRON-NY\VirtualSDCard

Item	Value
Shared folder name	VirtualSDCard
Shared with	Everyone
Permission level	Read/Write



Precautions for Correct Use

When you enable file sharing on external networks, change the accounts that are given access to the shared folder from **Everyone** to properly authorized accounts in order to protect the shared folder against information leaks or data modification.

Refer to A-3 *Changing Windows File Sharing Setting* on page A - 4 for file sharing on external networks.

3-2-2 Controller Setup

With **Controller Setup** on the Sysmac Studio, you can set a shared folder that is used by the Controller as a Virtual SD Memory Card.

The setting items are given below.

Item	Description	Set value	Initial value
Virtual SD Memory Card	Specify whether to use the Windows shared folder as a Virtual SD Memory Card.	Do not use. Use.	Do not use.
Computer name	Specify the Windows computer name.	Text string* ¹	Blank
IP address	Specify the IP address of the Windows internal port.	IPv4* ²	192.168.254.2
Shared folder name	Specify a shared folder name used as a Virtual SD Memory Card.	Text string* ³	VirtualSDCard
User name	Specify a shared name of the user who uses the shared folder as a Virtual SD Memory Card. Enter the account name that you set at "Account Settings" of "Windows Settings". * ⁴	Text string* ⁵	Blank
Password	Specify a password for the account you set for "User name".	Text string* ⁶	Blank

*1. Characters that you can use range from 0 to 9, A to Z, a to z, and a single-byte symbol (-). The number of characters is 1 to 15 (without Null). Case insensitive.

*2. You cannot specify the following IP addresses.

IP addresses that start with 127 (decimal)

Class-D IP addresses (224.0.0.0 to 239.255.255.255)

Class-E IP addresses (240.0.0.0 to 255.255.255.255)

*3. Characters that you can use range from 0 to 9, A to Z, a to z, and a single-byte symbol (-). The number of characters is 1 to 32 (without NULL). Case insensitive.

*4. Enter <.domain name>\< user name> to specify a domain. You can omit specifying a domain name when users with the same name do not exist as a domain user and local user.

*5. Characters that you can use range from 0 to 9, A to Z, a to z, and single-byte symbols (`, !, #, \$, ^, &, (,), _, -, {, }, \, and '). The number of characters is 1 to 274 (without Null). Case insensitive.

*6. Characters that you can use range from 0 to 9, A to Z, a to z, and single-byte symbols (`, !, @, #, \$, %, ^, &, *, (,), _, -, +, =, {, }, [,], \, |, :, ;, ", ', <, >, ., ?, and /). The number of characters is 8 to 32 (without NULL). Case sensitive.

The setting procedure is given below.

- 1 Start the Sysmac Studio, and create a project for the target NY-series Controller.

- 2** Double-click or right-click **Operation Settings** under **Configurations and Setup - Controller Setup** in the Multiview Explorer, and select **Edit** from the menu.
The **Operation Settings** view is displayed.

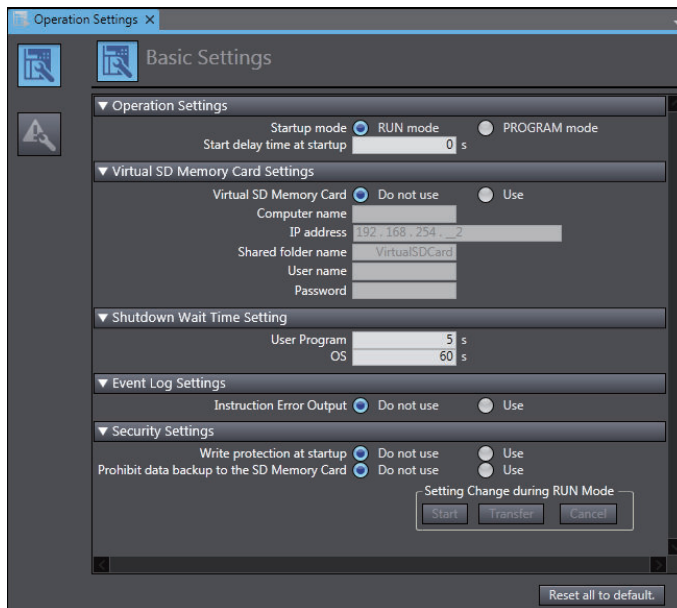

- 3** On the **Virtual SD Memory Card Settings** field of the **Basic Settings** view, select **Use** for **Virtual SD Memory Card** option, and enter required fields.
- 4** Go online with the target Controller from the Sysmac Studio, and transfer the Controller setup to the Controller by using the Synchronization function.

Refer to the *Sysmac Studio Version 1 Operation Manual (Cat. No. W504)* for details on how to create projects, to go online, and to synchronize on the Sysmac Studio.



Additional Information

You can perform Virtual SD Memory Card settings for the Controller with the Industrial PC Support Utility. Refer to *4-8 Virtual SD Memory Card Settings* on page 4 - 21 for details on the setting procedure with the Industrial PC Support Utility.

4

Industrial PC Support Utility

This section describes the functions and usage of the Industrial PC Support Utility.

4

4-1	Outline of Industrial PC Support Utility	4 - 2
4-2	Starting the Industrial PC Support Utility	4 - 3
4-2-1	Starting the Industrial PC Support Utility	4 - 3
4-2-2	Screen of Industrial PC Support Utility	4 - 4
4-3	Displaying Production Information	4 - 6
4-4	System Monitor	4 - 7
4-5	Controller Monitor	4 - 9
4-6	Controller Operation	4 - 11
4-6-1	Mode Change	4 - 11
4-6-2	Resetting the Controller	4 - 12
4-6-3	Controller Backup	4 - 13
4-7	Network Settings for Controller	4 - 18
4-8	Virtual SD Memory Card Settings	4 - 21
4-9	Operation Authority Verification	4 - 23
4-10	Report Log	4 - 25

4-1 Outline of Industrial PC Support Utility

An Industrial PC Support Utility displays the production information of the Industrial PC, and the system status as well as the Controller status, and it also backs up the Controller programs. It is pre-installed on Windows of the Industrial PC.

4-2 Starting the Industrial PC Support Utility

This section gives the procedures to start up the Industrial PC Support Utility, and also describes the screens.

4-2-1 Starting the Industrial PC Support Utility

You can start up the Industrial PC Support Utility with the following screen or menu.

- Start menu
- Control Panel
- Shortcut icon on the desktop
- System tray (Industrial PC Tray Utility)

Refer to *A-6 Industrial PC Tray Utility* on page A - 7 for details on the Industrial PC Tray Utility.

Procedure

As an example, the procedure to start up from the Start menu is given below.

- 1 Select **OMRON - Industrial PC - Industrial PC Support Utility** from the Start menu. The **Network Connection** dialog box is displayed.
- 2 Enter the IP address of the internal port on the Controller, and click the **Connect** button.

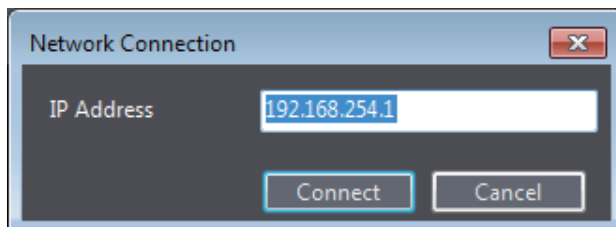

The Industrial PC Support Utility is connected to the Controller, and the **Industrial PC Support Utility** dialog box is displayed.

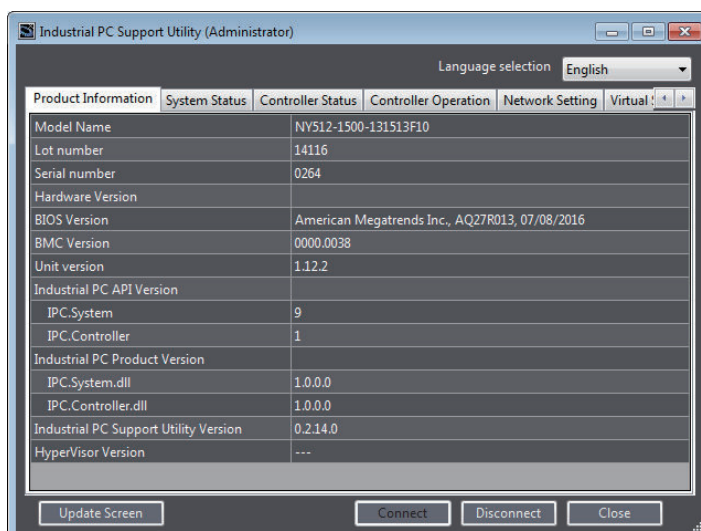

Refer to *3-1 Internal Port Settings* on page 3 - 2 for details on the IP address of the internal port on the Controller.



Additional Information

If the operation authority verification is set for the Controller, from the Sysmac Studio, you must enter the operation authority level and password to start up. Refer to *4-9 Operation Authority Verification* on page 4 - 23 for details.

4-2-2 Screen of Industrial PC Support Utility

When the Industrial PC Support Utility is started up, the following screen is displayed.

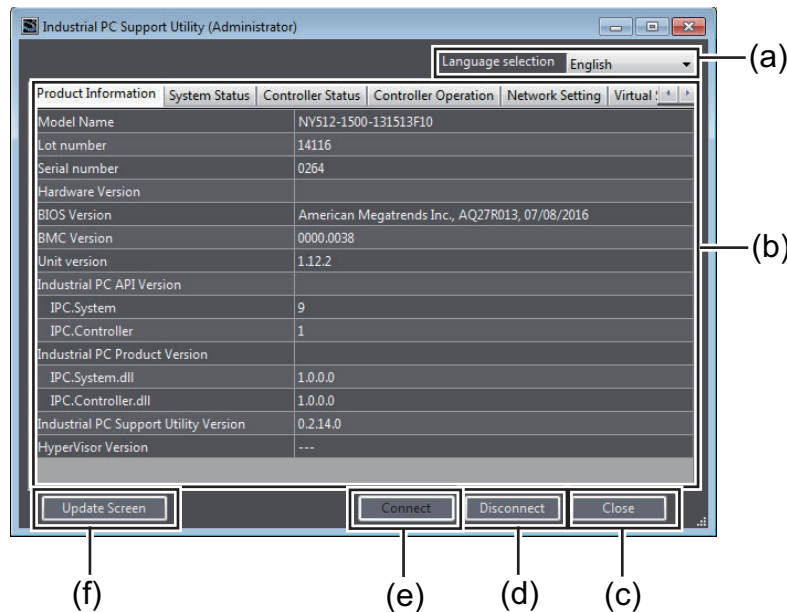

Item	Description	Reference
(a)	Language selection	Select a language to display the Industrial PC Support Utility from Japanese and English. ---
(b)	Display area	---
	Product Information	The Industrial PC Support Utility displays the model number, lot number, hardware version, and software version of the Industrial PC. <i>4-3 Displaying Production Information</i> on page 4 - 6
	System Status	Displays the internal temperature of the Industrial PC, fan revolution, and battery and UPS status. <i>4-4 System Monitor</i> on page 4 - 7
	Controller Status	The Industrial PC Support Utility displays the Controller status such as operating mode and current errors. <i>4-5 Controller Monitor</i> on page 4 - 9
	Controller Operation	Perform operations such as operating mode change, backup and restore for the Controller. <i>4-6 Controller Operation</i> on page 4 - 11
	Network Setting	Change the network settings such as EtherNet/IP port and internal port settings. <i>4-7 Network Settings for Controller</i> on page 4 - 18
	Virtual SD Memory Card Setting	Change the Virtual SD Memory Card settings. <i>4-8 Virtual SD Memory Card Settings</i> on page 4 - 21
(c)	Close	Closes the Industrial PC Support Utility. ---
(d)	Disconnect	Disconnects from the Controller. ---

	Item	Description	Reference
(e)	Connect	Connect to the Controller again. The Network Connection dialog box is displayed.	---
(f)	Update Screen	Gets information from the Industrial PC, and updates the contents to be displayed.	---

4-3 Displaying Production Information

The Industrial PC Support Utility displays the model number, lot number, hardware version, and software version of the Industrial PC. To display the information, click the **Product Information** tab.

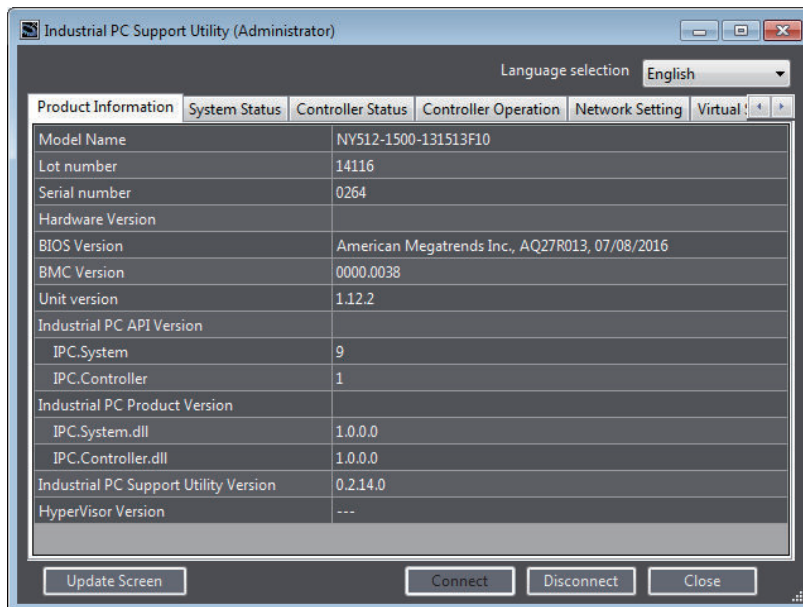

Item	Displayed information	Example
Model Name	The model number of the Industrial PC	NY512-1500-131513F10
Lot number	The lot number of the Industrial PC	14116
Serial number	The serial number of the Industrial PC	0264
Hardware Version	The hardware version of the Industrial PC	1.0
BIOS Version	The BIOS version of the Industrial PC	American Megatrend Inc. AQ27R013. 07/08/2016
BMC Version	The BMC version of the Industrial PC	0000.0039
Unit Version	The software version of the Controller	1.12.02
Industrial PC API Version	The version of API installed in Windows	---
IPC.System	The API for the Industrial PC system	9
IPC.Controller	The API for the Controller	1
Industrial PC Product Version	The product version of the library installed in Windows	---
IPC.System.dll	The library for the Industrial PC system	1.0.0.0
IPC.Controller.dll	The library for the Controller	1.0.0.0
Industrial PC Support Utility Version	The version of the Industrial PC Support Utility	1.0.0.0
HyperVisor Version	The version of the software that exchanges data between Windows and the Controller.	---

Each row of the displayed information can be copied, and pasted to a text editor. Right-click on a target row, and select **Copy** from the menu, or press the **Ctrl+C** key.

4-4 System Monitor

The Industrial PC Support Utility displays the internal temperature of the Industrial PC, fan revolution, and battery and UPS status.

To display the information, click the **System status** tab.

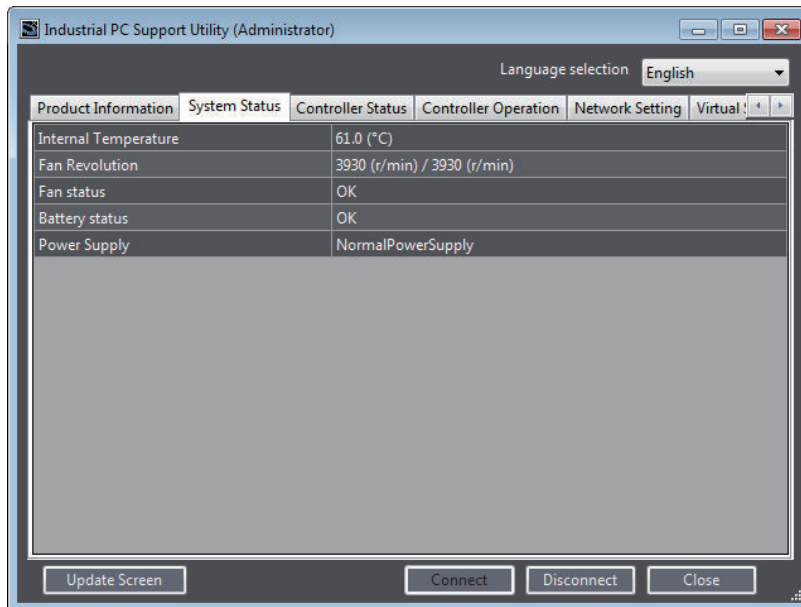

Item	Description	Displayed information
Internal Temperature	Displays the present internal temperature of the Industrial PC.	Current temperature [°C]
Fan Revolution	Displays the present revolution of the Fan Unit.	Revolution of the Fan Unit [r/min]
Fan status	Indicates the fan status. Displays "Low revolution speed" when the power supply connector of both or one of the fans is disconnected or the fan revolution is decreased.	OK, or Low revolution speed
Battery status	Indicates the battery voltage status. Indicates "Low" when the battery is disconnected or the battery voltage is dropped.	OK, or Low
Power Supply	Indicates the type of the power supply. "NormalPowerSupply" indicates that the power is supplied to the Industrial PC by the 24V power supply. "UpsPowerSupply" indicates that the power is supplied to the Industrial PC by the UPS battery.	NormalPowerSupply, or UpsPowerSupply

Display in Industrial PC Tray Utility

For the following items displayed on the **System Status** tab page, you can check the status by the icon in the Industrial PC Tray Utility.

Item	Status	Icon
Fan status	OK	Normal
	Low revolution speed	Warning
Battery status	OK	Normal
	Low	Warning

Item	Status	Icon
Power Supply	NormalPowerSupply	Normal
	UpsPowerSupply	Warning

Refer to *A-6 Industrial PC Tray Utility* on page A - 7 for details on the Industrial PC Tray Utility.

4-5 Controller Monitor

The Industrial PC Support Utility displays the Controller status such as operating mode and current errors.

To display the information, click the **Controller Status** tab.

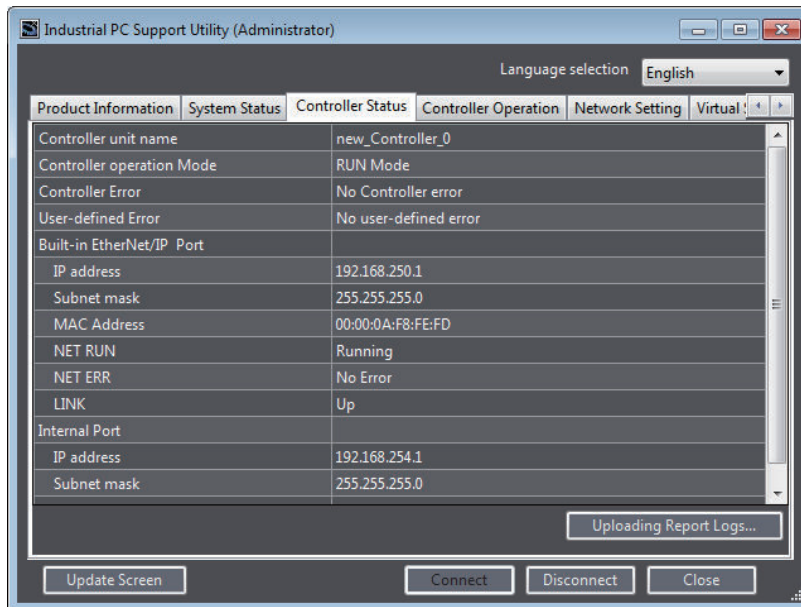

Item	Description	Displayed information
Controller unit name	Displays the unit name that is set for the Controller.	Controller name
Controller operation Mode	Displays the present operating mode of the Controller.	PROGRAM Mode or RUN Mode
Controller Error	Displays current Controller errors.	No Controller error, Partial or minor fault level Controller error occurs, or Major fault level Controller error occurs
User-defined Error	Displays current user-defined errors.	No user-defined error, or User-defined error occurs
Built-in EtherNet/IP port	Displays the settings of the built-in EtherNet/IP port through which the Controller communicates with an external device of the Industrial PC.	---
IP address	Displays the present IP address, subnet mask, and MAC address.	IP address
Subnet mask		Subnet mask
MAC address		MAC address
NET RUN	Displays the CIP connection status of the EtherNet/IP network.	Running/Connecting/Stop
NET ERR	Displays the communications error status of the EtherNet/IP network.	Critical Error/Error/No Error
LINK	Displays the link establishment status of the EtherNet/IP network.	Up/Down
Internal Port	Displays the settings of the internal port through which the Controller communicates with Windows on the Industrial PC.	---

Item	Description	Displayed information
IP address	Displays the present IP address and subnet mask.	IP address
Subnet mask		Subnet mask
Default Gateway	Displays the present default gateway.	IP address

Display in Industrial PC Tray Utility

For the following items displayed on the **Controller Status** tab page, you can check the status by the icon in the Industrial PC Tray Utility.

Item	Status	Icon
Controller operation Mode	RUN Mode	Normal
	PROGRAM Mode	Warning
Controller Error	No Controller error	Normal
	Partial or minor fault level Controller error occurs	Warning
	Major fault level Controller error occurs	Error
User-defined Error	No user-defined error	Normal
	User-defined error occurs	Error
NET ERR	No Error	Normal
	Error	Warning
	Critical Error	Error

Refer to *A-6 Industrial PC Tray Utility* on page A - 7 for details on the Industrial PC Tray Utility.

Report Log

If a problem occurs in the Controller, you can use the Report Log function to save information in a file to help solve the problem. You can start the Report Log function from the **Uploading Report Logs** button. Refer to *4-10 Report Log* on page 4 - 25 for details.

4-6 Controller Operation

You can perform operations such as operating mode change, backup and restore for the Controller. To display the operation screen, click the **Controller Operation** tab.

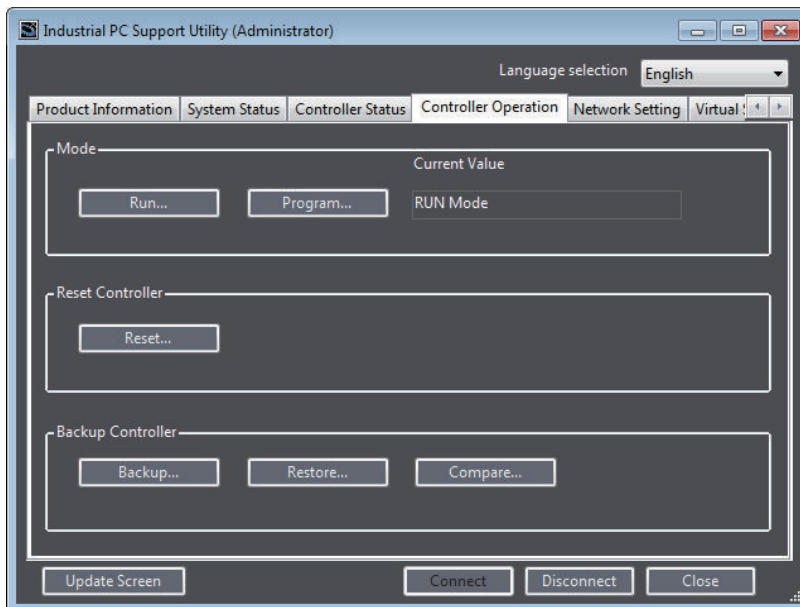

Item	Description	Displayed information
Mode	You can change the operating mode of the Controller. The present operating mode on the right.	RUN Mode, or PROGRAM Mode
Reset Controller	You can reset the Controller.	---
Backup Controller	You can back up and restore the Controller data, and compare the backed up data.	---

Refer to the *NY-series Industrial Panel PC / Industrial Box PC Software User's Manual (Cat. No. W558)* for details on the Controller operations.

4-6-1 Mode Change

You can change the Controller operating mode from RUN to PROGRAM mode or from PROGRAM to RUN mode. The procedure to change the operating mode is given below.

- 1 To change the operating mode from RUN to PROGRAM mode, click the **Program** button. A message box appears to confirm the change of the operating mode.

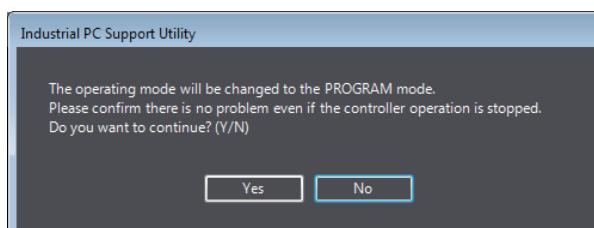

- 2 Confirm that no problem will occur even if you change the operating mode, and then click the **Yes** button. The Controller is changed to PROGRAM mode, and the **PROGRAM Mode** is displayed for the operating mode.

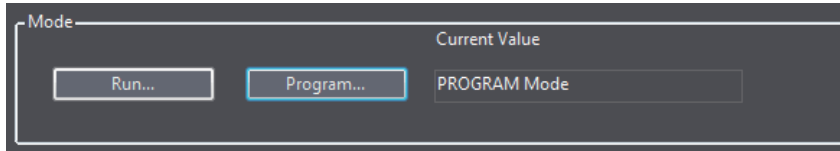

To change PROGRAM mode to RUN mode, click the **Run** button.

4-6-2 Resetting the Controller

When the Controller stops due to a major fault level Controller error, you can reset the Controller to restore from the error.

Always confirm the safety of the system before you reset the Controller.

The procedure to reset the Controller is given below.

- 1 Click the **Reset** button under **Reset Controller**.

The following dialog box is displayed if the Controller is in RUN mode.

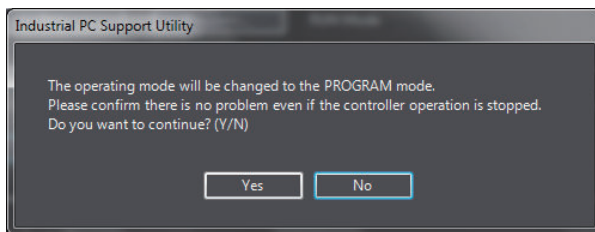

- 2 Confirm that no problem will occur even if you change the operating mode, and then click the **Yes** button.

A message box appears to confirm resetting the Controller.

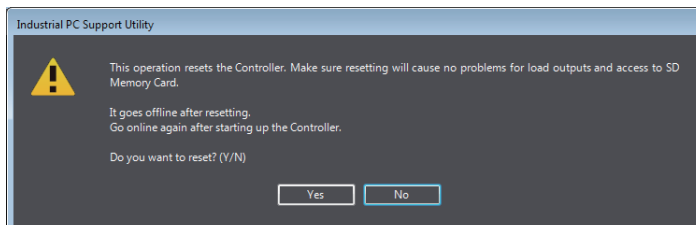

- 3 Confirm that no problem will occur even if you reset the Controller, and then click the **Yes** button. A message box appears again to confirm the resetting. Click the **Yes** button. When the Controller reset is completed, a completion message box is displayed.

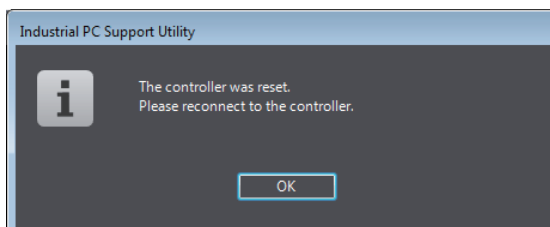

When you click the **OK** button, the **Network Connection** dialog box is displayed.

- 4 Enter the IP address again, and then click the **Connect** button.



Additional Information

When the Controller reset is executed, the Controller is restarted, and the connection between the Industrial PC Support Utility and the Controller is disconnected.

4-6-3 Controller Backup

You can back up the data from the Controller to a file, and compare or restore the contents of the backup file.

Refer to the *NY-series Industrial Panel PC / Industrial Box PC Software User's Manual (Cat. No. W558)* for details on the backup function and target data.



Additional Information

You can also back up the Controller from the Sysmac Studio. Refer to the *Sysmac Studio Version 1 Operation Manual (Cat. No. W504)* for details.

Backup

The procedure is given below.

- 1 Click the **Backup** button under the **Backup Controller**.
The **Browse For Folder** dialog box is displayed.

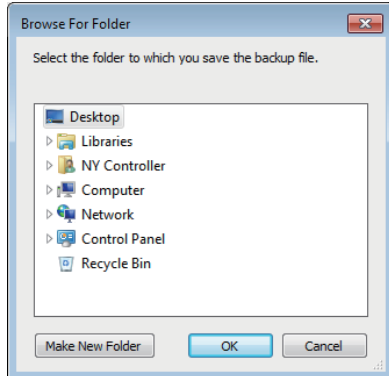

- 2 Select the folder in which to save the backup file and click the **OK** button.
The **Backup** dialog box is displayed.

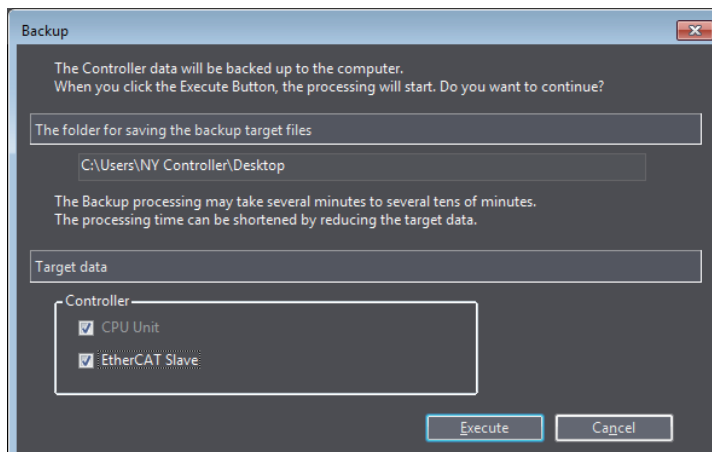

If there is already a backup file in the selected folder, a dialog box is displayed to confirm overwriting the backup file. Click the **Yes** button to overwrite. If you do not want to overwrite, click the **No** button to select another folder.

- 3 Select the check box for the target data to back up, and then click the **Execute** button. The backup is started. When the backup is completed, a message box is displayed.

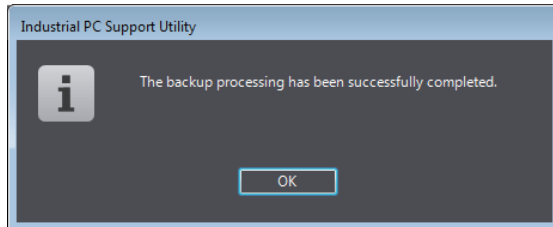

Additional Information

The name of the backup file is always "NYBackup.dat". You cannot change the file name.

Restoring

You can perform the restore operation only when the Controller is in PROGRAM mode. The procedure is given below.

- 1 Click the **Restore** button under the **Backup Controller**. The **Browse For Folder** dialog box is displayed.

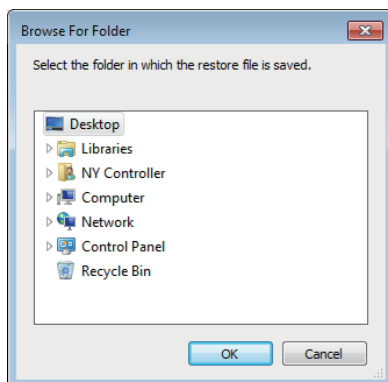

- 2 Select the folder that contains the backup file and click the **OK** button. The **Restore** dialog box is displayed.

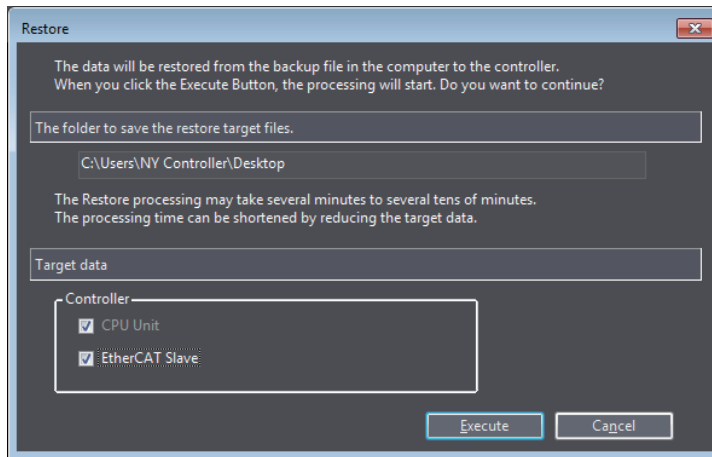

If there is no backup file in the selected folder, the following dialog box is displayed. Click the **OK** button to close the message box, and then select another folder.

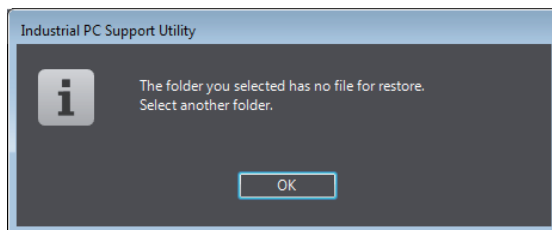

- 3** Select the check box for the target data to restore, and then click the **Execute** button. The following dialog box is displayed if the Controller is in RUN mode.

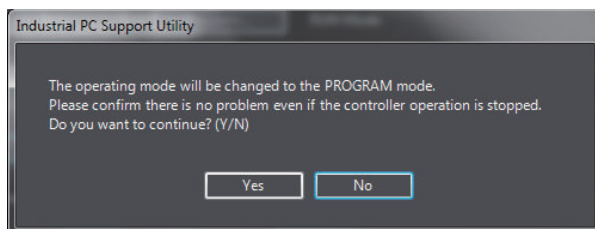

- 4** Confirm that no problem will occur even if you change the operating mode, and then click the **Yes** button.

A message box appears to indicate the absolute encoder home offset that will be applied.

- 5** To start restoring the data, click the **Yes** button. The restore operation is started. When the restore operation is completed, a message box is displayed.

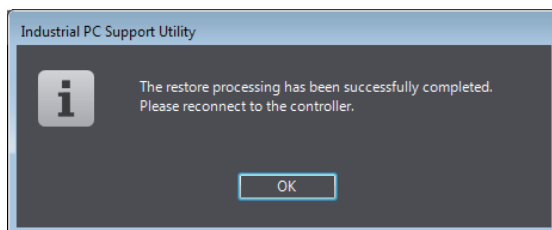

When you click the **OK** button, the **Network Connection** dialog box is displayed.

- 6** Enter the IP address again, and then click the **Connect** button.



Additional Information

- If restoring the data results in changing the IP address of the EtherNet/IP port or internal port, communications may be disconnected. Confirm that the system will not be adversely affected even if the IP address is changed, before you restore the data.
- You cannot cancel the operation once you started to restore the data.

Comparing

The procedure is given below.

- 1 Click the **Compare** button under the **Backup Controller**.
The **Browse For Folder** dialog box is displayed.

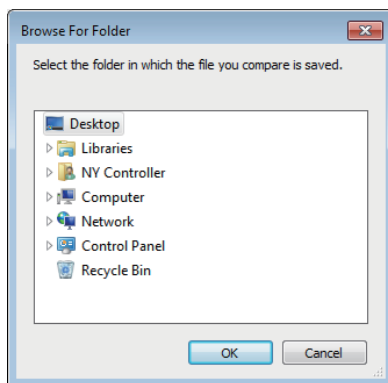

- 2 Select the folder that contains the backup file to compare and click the **OK** button.
The **Compare** dialog box is displayed.

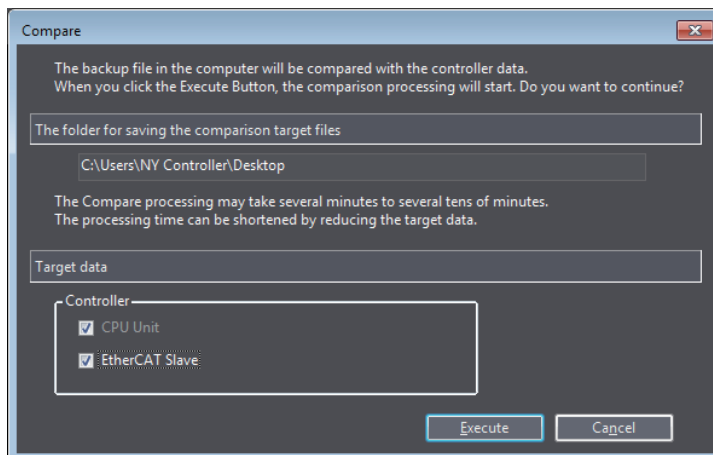

If there is no backup file in the selected folder, the following dialog box is displayed. Click the **OK** button to close the message box, and then select another folder.

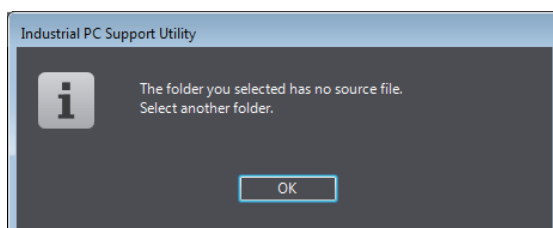

- 3 Select the check box for the target data to compare, and then click the **Execute** button.

The comparison is started. When the comparison is completed, the comparison result is displayed in the dialog box.

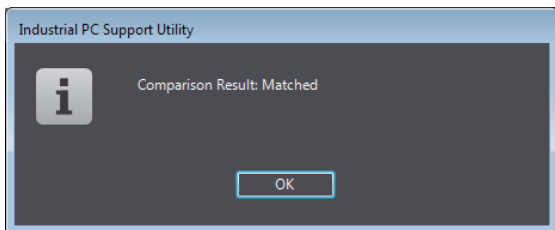

4-7 Network Settings for Controller

You can change the network settings for the Controller, such as EtherNet/IP port settings and internal port settings, that were set on the Sysmac Studio. This function is convenient to change the network settings alone without using the Sysmac Studio after you transferred programs or the network settings from the Sysmac Studio to the Controller.

You can make the change only when the Controller is in PROGRAM mode.

To display the screen, click the **Network Settings** tab.

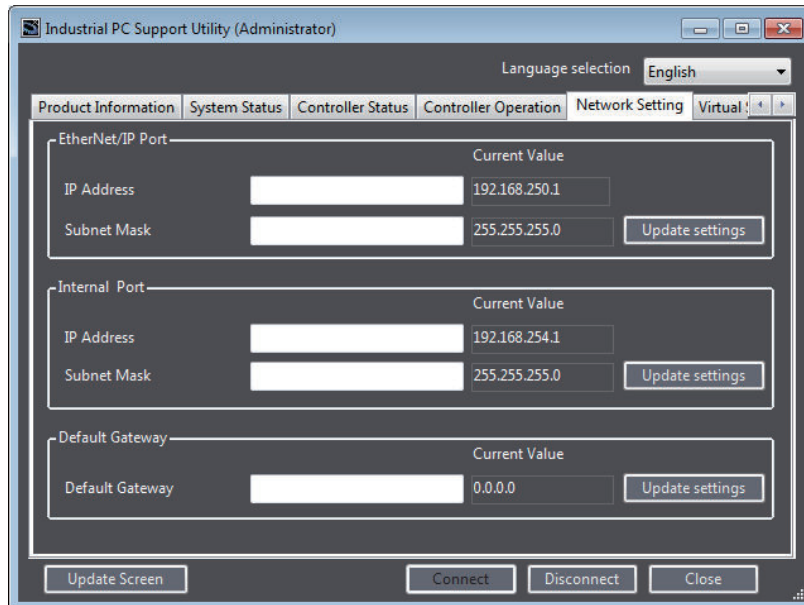

Item	Description	Set value	Initial value
EtherNet/IP port	Change the settings of the built-in EtherNet/IP port through which the Controller communicates with an external device of the Industrial PC.	---	---
IP Address*1	Enter the IP address to change to. The current IP address is displayed on the right of the entry box. If the IP address setting method is not the fixed setting, Not fixed setting is displayed and you cannot change this item.	Value as the address*2*3	Blank
Subnet Mask*1	Enter the subnet mask to change to. The current subnet mask is displayed on the right of the entry box. If the IP address setting method is not the fixed setting, Not fixed setting is displayed and you cannot change this item.	Subnet mask	Blank
Internal Port	Change the settings of the internal port through which the Controller communicates with Windows on the Industrial PC.	---	---
IP Address	Enter the IP address to change to. The current IP address is displayed on the right of the entry box.	Value as the address*2*3	Blank
Subnet Mask	Enter the subnet mask to change to. The current subnet mask is displayed on the right of the entry box.	Subnet mask	Blank

Item	Description	Set value	Initial value
Default Gateway	Enter the IP address of the default gateway to change to. This setting is not required when the default gateway is not used. The IP address of the current default gateway is displayed on the right of the entry box.	Value as the address ^{*2*3}	Blank
Update settings button	The values entered for the built-in EtherNet/IP port, internal port, and default gateway are reflected on the Controller.	---	---

- *1. It can be entered only when the IP address setting method is "Fixed setting". You can change the IP address setting method on the Sysmac Studio.
- *2. If the IP address is duplicated or not set correctly, communications are not possible via the built-in EtherNet/IP port or internal port.
- *3. The IP address range shown below is used by the system and cannot be specified.
 169.254.0.0 to 169.254.255.255
 192.168.255.0 to 192.168.255.255
 Due to Ethernet restrictions, you also cannot specify the IP addresses that are described below.
 An IP address that is all 0s or all 1s
 IP addresses that start with 127, 0, or 255 (decimal)
 Class-D IP addresses (224.0.0.0 to 239.255.255.255)
 Class-E IP addresses (240.0.0.0 to 255.255.255.255)

Refer to the *NY-series Industrial Panel PC / Industrial Box PC Built-in EtherNet/IP Port User's Manual (Cat. No. W563)* for details on each item.



Precautions for Correct Use

- Normally, you don't have to change the default internal port settings for the Controller. If you change the default settings, communication with the internal port for Windows may be disturbed or you may not be able to use the Virtual SD Memory Card. In this case, you must perform the internal port settings for Windows and the Virtual SD Memory Card settings again. Refer to *A-2 Changing the Internal Port Settings* on page A - 3 for details on the precautions and methods for changing the internal port settings for the Controller.
- Set IP addresses in such a way that the built-in EtherNet/IP port and the internal port belong to different networks.

Procedure to Change IP Addresses

The procedure to change an IP address is given below.

Before you change the address for the EtherNet/IP port, you must change the operating mode of the Controller to PROGRAM mode.

- 1** Enter the IP address and subnet mask for the target port to change, or the IP address of the default gateway, and click the **Update settings** button.

The IP address and subnet mask for the target port, or the IP address of the default gateway is reflected to the Controller. If there is an error for the entered IP address or subnet mask, the change is not reflected to the Controller, and an error message is displayed instead.

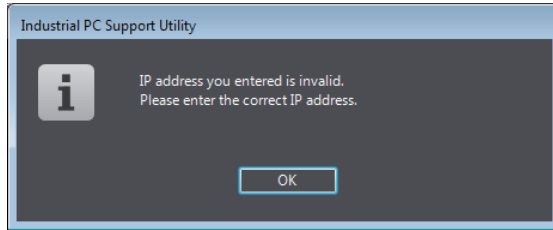

4-8 Virtual SD Memory Card Settings

You can change the Virtual SD Memory Card settings for the Controller. The function is convenient to change the Virtual SD Memory Card settings alone without using the Sysmac Studio.

You can make the change only when the Controller is in PROGRAM mode.

To display the screen, click the **Virtual SD Memory Card Setting** tab.

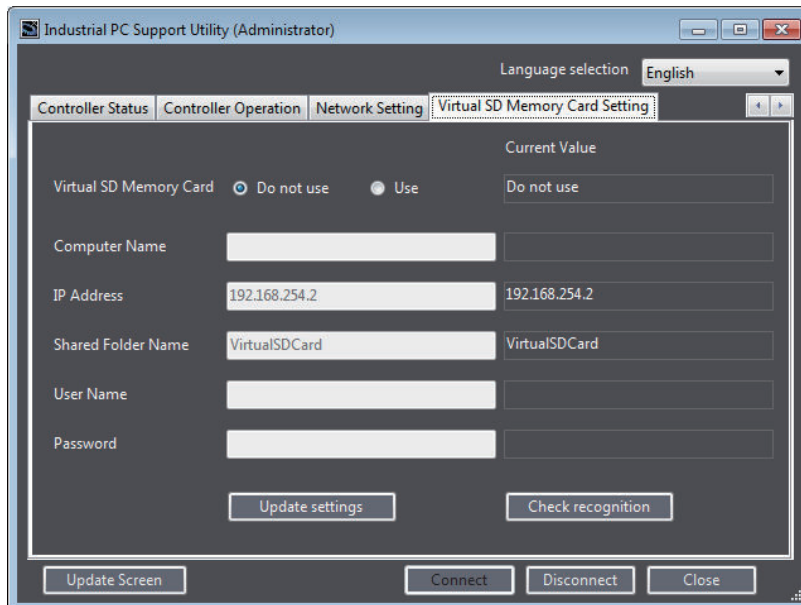

Item	Description	Set value	Initial value
Virtual SD Memory Card	Specify whether to use the Virtual SD Memory Card function or not. If you select Do not use , the Windows shared folder is not recognized as a Virtual SD Memory Card.	Use. Do not use.	Do not use.
Computer Name	Specify the Windows computer name.	Text string* ¹	Blank
IP Address	Specify the IP address of the Windows internal port.	IPv4* ²	192.168.254.2
Shared Folder Name	Specify the Windows shared folder name used as a Virtual SD Memory Card.	Text string* ³	VirtualSDCard
User Name	Specify a shared name of the user who uses the shared folder as a Virtual SD Memory Card. * ⁴	Text string* ⁵	Blank
Password	Set a password for the shared user who uses the shared folder.	Text string* ⁶	Blank
Update settings button	The values that are input are reflected in the Controller.	---	---
Check recognition button	Check whether the Virtual SD Memory Card is recognized by the Controller.	---	---

*1. Characters that you can use range from 0 to 9, A to Z, a to z, and a single-byte symbol (-). The number of characters is 1 to 15 (without Null). Case insensitive.

*2. You cannot specify the following IP addresses.
IP addresses that start with 127 (decimal)
Class-D IP addresses (224.0.0.0 to 239.255.255.255)
Class-E IP addresses (240.0.0.0 to 255.255.255.255)

*3. Characters that you can use range from 0 to 9, A to Z, a to z, and a single-byte symbol (-). The number of characters is 1 to 32 (without NULL). Case insensitive.

- *4. Enter <.domain name>\< user name> to specify a domain. You can omit specifying a domain name when users with the same name do not exist as a domain user and local user.
- *5. Characters that you can use range from 0 to 9, A to Z, a to z, and single-byte symbols (`, !, #, \$, ^, &, (,), _, -, {, }, \, and '). The number of characters is 1 to 274 (without NULL). Case insensitive.
- *6. Characters that you can use range from 0 to 9, A to Z, a to z, and single-byte symbols (`, !, @, #, \$, %, ^, &, *, (,), _, -, +, =, {, }, [,], \, |, ;, ;", ' , <, >, ., ?, and /). The number of characters is 8 to 32 (without NULL). Case sensitive.

The current value set for the Controller is displayed on the right of each entry box.

Procedure to Change Settings

The procedure to change the settings is given below.

- 1** Enter a set value to change to in each of the applicable entry boxes, and click the **Update settings** button.

The Virtual SD Memory Card settings for the Controller are updated.

4-9 Operation Authority Verification

The operation authority verification is the function to restrict the operations of the Industrial PC Support Utility according to the operation authority, and then to protect the user programs and data on the Controller.

The operation authority verification can be set for the Controller from the Sysmac Studio. Refer to the *Sysmac Studio Version 1 Operation Manual (Cat. No. W504)* for details on the function and setting method of the operation authority verification on the Sysmac Studio.

Operation Authority Types and Operable Functions

Operable functions depend on the types of operation authorities.

Operable functions for each type of operation authorities are given below.

○: Allowed, ×: Not allowed

Function	Adminis- trator	Designer	Maintainer	Operator	Observer
Displaying the production information tab page	○	○	○	○	○
Displaying the system status tab page	○	○	○	○	○
Displaying the Controller status tab page	○	○	○	○	○
Getting a report log	○	○	○	×	×
Displaying the Controller Operation tab page	○	○	○	○	○
Changing the operating mode	○	○	○	×	×
Resetting the Controller	○	○	○	○	○
Backup, restore, and compare operations	○	○	○	×	×
Changing the network settings	○	○	○	×	×
Changing the Virtual SD Memory Card settings	○	○	○	×	×

Operation Authority Verification at Startup

If the operation authority verification is set for the Controller from the Sysmac Studio, a dialog box is displayed to verify the operation authority when the Industrial PC Support Utility is started up. To continue the operation, you must select an operation authority and enter a password.

The procedure is given below.

- 1 Connect the Industrial PC Support Utility to the Controller.
The **Verification** dialog box is displayed.

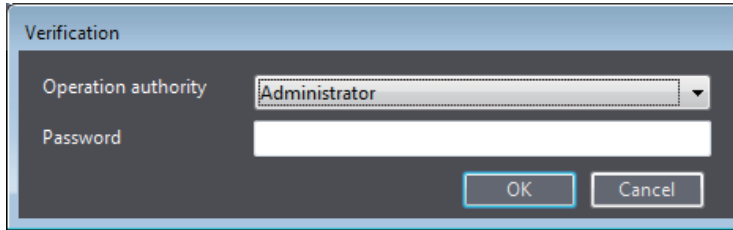

- 2** Select an applicable operation authority from the **Operation authority**, enter a correct password, and click the **OK** button.

When you pass the verification, the Industrial PC Support Utility dialog box is displayed. If the password is incorrect, the following error message is displayed. After that, you can operate only in the range allowed for "Observer".

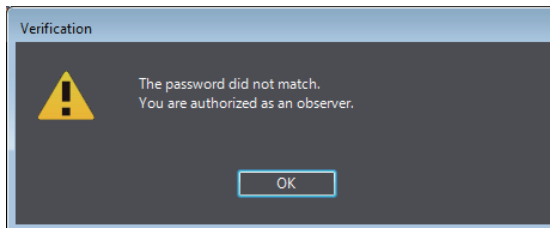

When you click the **Cancel** button on the **Verification** dialog box, the Industrial PC Support Utility starts up with the operation authority set for the "Operation authority when a password entry is omitted" on the Sysmac Studio.



Additional Information

To change to another operation authority, click the **Disconnect** button to disconnect from the Controller once. When you reconnect, the **Verification** dialog box is displayed.

Operation Lock

If you don't operate the Industrial PC Support Utility for a certain period, you can keep it locked to disable its operations. This function prevents users of different operation authorities from mistakenly performing operations.

When the Industrial PC Support Utility is in the locked state, the **Verification** dialog box is displayed. Enter the password to unlock.

You can enable operation locking and set the time to start locking from the Sysmac Studio. Refer to the *Sysmac Studio Version 1 Operation Manual (Cat. No. W504)* for details.

4-10 Report Log

If a problem occurs in the Controller, you can use the Report Log function to save information in a file to help solve the problem. Please provide the files that are saved to the OMRON support center when you request support.

Types of Available Logs

The types of log information that you can get are given below. Each of the following information is saved in a log file with an extension .zip.

Item	Description
Controller Event Log	This is the Controller event log. The user-defined events are not included.
Controller Analysis Log	This is the log to analyze the Controller errors.
Industrial PC Support Utility Operation Log	This is the log that records the operation of the Industrial PC Support Utility. It is recorded in the Windows event log.
Communication Middleware Operation Log	This is the log that records the communications of the communication middleware. It is recorded in the Windows event log.

A log file always save the following information.

- Information on the **Production Information** tab
- Information on the **System Status** tab
- Information on the **Controller Status** tab
- Information on the **Virtual SD Memory Card Setting** tab

Operation Procedure

The procedure to get a report log is given below.

- 1 Click the **Uploading Report Logs** button on the **Controller Status** tab page.

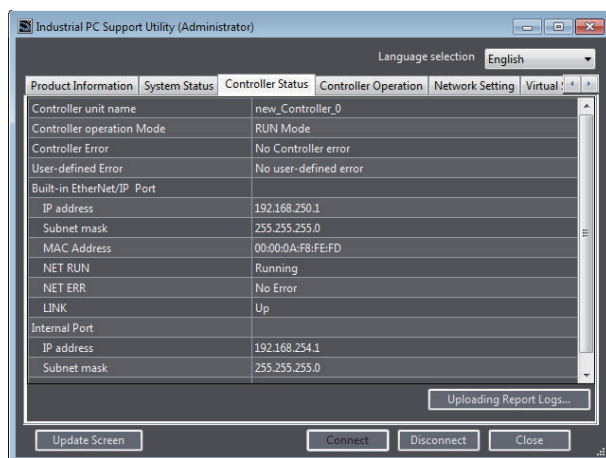

The **Report Log** dialog box is displayed.

- 2 Select the check box for the log to get, and click the **Save** button. Select the checkbox for the files to get according to the instructions provided by the OMRON support center.

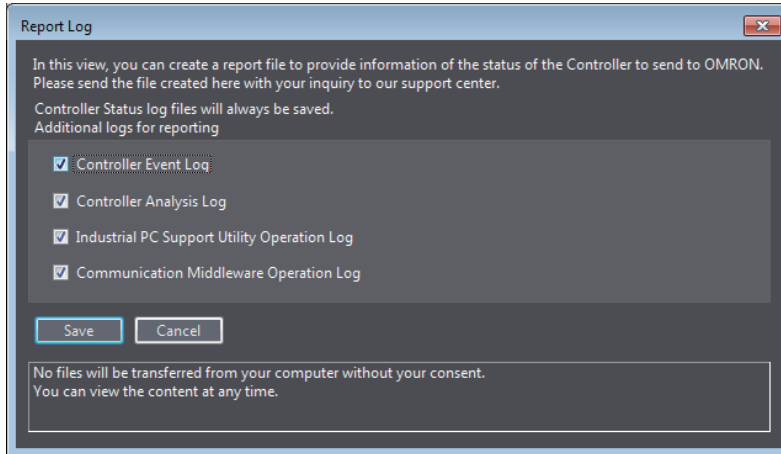

The **Save As** dialog box is displayed.

- 3** Select the folder in which to save the log files and click the **Save** button.

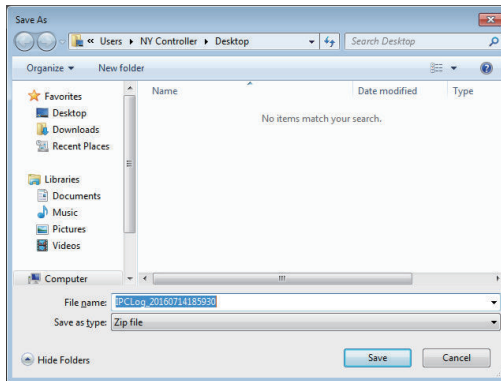

The log files are saved, and the contents saved in the folder are displayed. Send the log files to the support center.



Additional Information

- The obtained log files do not contain any information that can be used to identify you or any project files of yours (e.g., settings, configurations, and programs).
- The obtained log files will never be sent from your computer to any external party without getting your approval.

5

NYCompolet

This section describes the NYCompolet which is a software component used to create applications for operating the Controller.

5-1	Outline of NYCompolet	5 - 2
5-2	How to Use the NYCompolet.....	5 - 3
5-3	Communications Setup	5 - 4
5-3-1	Communications Setup Procedure	5 - 4
5-3-2	Additional Functions to Communications Setup	5 - 4
5-4	NYCompolet Interface.....	5 - 6
5-4-1	Interface Members	5 - 6
5-4-2	Usage Method	5 - 7

5-1 Outline of NYCompolet

The NYCompolet is a software component with which you can create applications to read variables from the Controller and write them to the Controller.

With the NYCompolet, you can create an application to get data such as the OK product ratio that is collected by the Controller and another application to overwrite the recipe data, in the Controller, for the production line. As the communications protocol between Windows and Controller are already provided, there is no need to build a communications command.

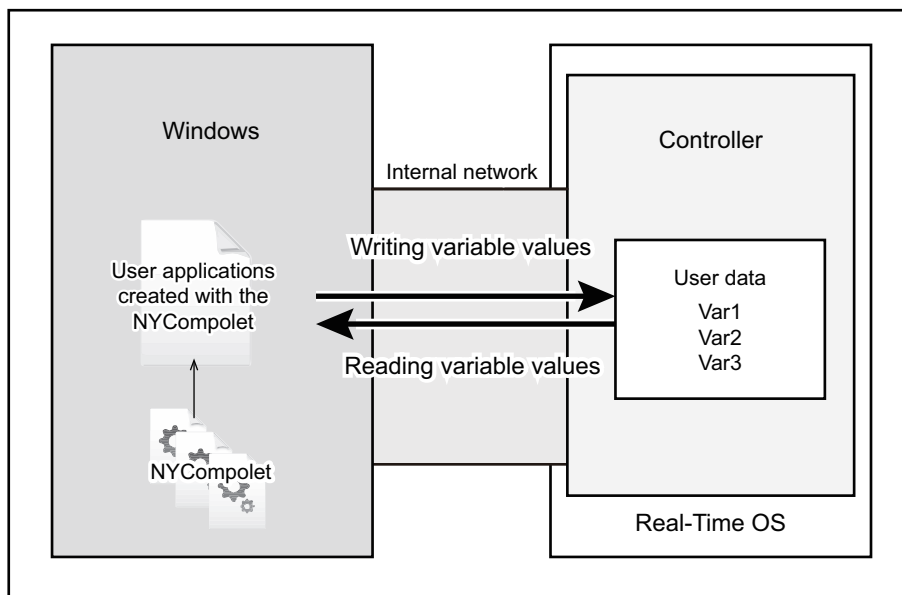

The NYCompolet is pre-installed in Windows of the Industrial PC. You can use it in development environment where Visual Basic or Visual C# is supported.

Development Environment

The following development environment is required to create applications with the NYCompolet.

● Integrated Development Environment

Microsoft Visual Studio 2010, 2012, 2013, or 2015

● Programming Languages

- Visual Basic
- Visual C#

Created applications can operate in an environment where Microsoft NET Framework 4.0 or higher is installed.

5-2 How to Use the NYCompolet

This section gives the operating procedure of the NYCompolet.

- 1** Preparation
Install the Microsoft Visual Studio to Windows of the Industrial PC.
- 2** Creating an Application
On the Microsoft Visual Studio, create an application program in Visual Basic or Visual C#. Use a method or property of the NYCompolet in the program, when necessary for the purpose. Refer to *5-4 NYCompolet Interface* on page 5 - 6 for the method and property types.
- 3** Communications Setup
Use the additional console function to make the required settings for the created application to communicate with the Controller. Refer to *5-3 Communications Setup* on page 5 - 4 for details.

5-3 Communications Setup

This section describes how to set up the communications between the Controller and the application that you created with the NYCompolet, as well as additional functions.

The SYSMAC Gateway Console is used to make the communications setup.

To start the SYSMAC Gateway Console, select **OMRON - SYSMAC Gateway - SYSMAC Gateway Console** from the Windows start menu.

5-3-1 Communications Setup Procedure

The communications setup procedures are given below.

- 1 Click the **Communication Network** tab on the left on the **SYSMAC Gateway Console** dialog box.

The **Communication Network** tab page is displayed.

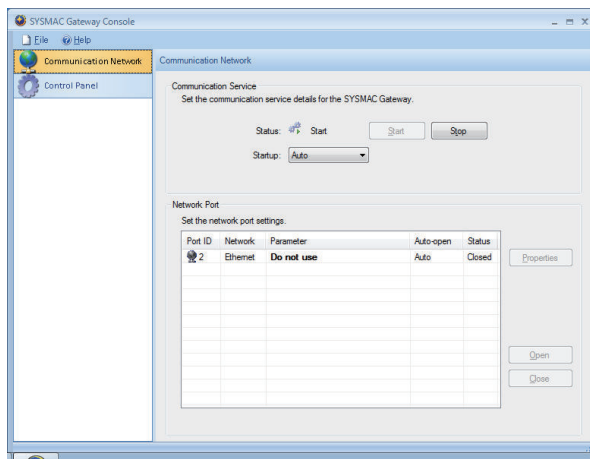

- 2 Click the **Start** button for the **Communications service**.
The communications service starts to allow communications between the Controller and the application that you created with the NYCompolet. To start the communications service automatically at Windows startup, select **Automatic** from the **Startup** drop-down list.
- 3 Select the Port ID: 2 Network Port from the **Network Port** list, and click the **Open** button.
The internal port on the Controller becomes open, and the communications between the application and the Controller start.

5-3-2 Additional Functions to Communications Setup

The **SYSMAC Gateway Console** is accompanied with the following additional functions.

Item	Description
Communication Test	You can confirm whether communications with the port selected on the Communication Network tag page is possible or not.
Tag Monitor	You can monitor or change variable values for the Controller.
Display Data Monitor	You can display the communications message log.

To display these items, click the **Control Panel** tab on the left on the **SYSMAC Gateway Console** dialog box.

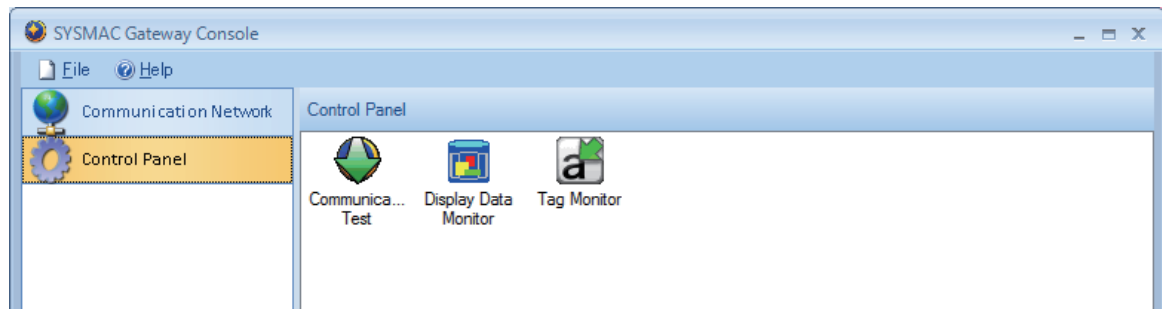

Refer to the help for the SYSMAC Gateway Console for details on each function. To display the help, select **OMRON - Industrial PC - SYSMAC Gateway Console - SYSMAC Gateway Console help** from the Windows start menu.

5-4 NYCompolet Interface

This section describes the NYCompolet interface members and the procedures to use them.

5-4-1 Interface Members

The NYCompolet interface is provided as the NYCompolet class that operates on the Microsoft NET Framework.

The NYCompolet class members are given below.

Refer to the NYCompolet help for details on each member.

To display the help, select **OMRON - Industrial PC - SYSMAC Gateway Console - NYCompolet help** from the Windows start menu.

Properties

Name	Meaning
Active	The value that indicates whether it is currently active or not.
ReceiveTimeLimit	Time until connection timeout
PeerAddress	IP address for the Controller
LocalPort	Port ID of the network port for the Controller
IsConnected	Indicates whether it is connected to the Controller or not.
DontFragment	Indicates whether fragments are prohibited in Read or Write.
TypeName	Controller model
Clock	Clock time of the Controller
UnitName	Unit name of the Controller
RunMode	Controller operation Mode
RunStatus	Operating status of the Controller
VariableNames	List of user-defined variable names for the Controller
SystemVariableNames	List of system-defined variable names for the Controller
PLCEncoding	Text string encoding for the Controller variables

Methods

Name	Meaning
ReadVariable	Reads the value of a variable.
ReadVariableMultiple	Read the values of multiple variables.
WriteVariable	Writes a value to a variable.
ReadRawData	Reads the binary data of a variable.
ReadRawDataMultiple	Reads the binary data of multiple variables.
WriteRawData	Writes a binary data to a variable.
GetVariableInfo	Reads the data type of a variable.

5-4-2 Usage Method

To use the NYCompolet members, you must declare the NYCompolet class in Visual Basic or Visual C#.

Refer to the manual or help for the Microsoft Visual Studio for the procedure to declare the class in Visual Basic or Visual C#.

Refer to the NYCompolet help for details on how to use each member of the NYCompolet.

6

Industrial PC API

This section describes the API prepared for the Industrial PC. The API is used to create an application that gets the system status information of the Industrial PC as well as the status information of the Controller.

6-1	Outline of Industrial PC API	6 - 2
6-2	How to Use the Industrial PC API	6 - 3
6-3	Industrial PC System API	6 - 4
6-3-1	Members of the Industrial PC System API	6 - 4
6-3-2	Usage Method	6 - 4
6-4	Industrial PC Controller API	6 - 5
6-4-1	IPController class	6 - 5
6-4-2	ControllerAccessException Class	6 - 6
6-4-3	ControllerInternalExecuteException class	6 - 6
6-4-4	Usage Method	6 - 6

6-1 Outline of Industrial PC API

The Industrial PC API is an API used to create an application that gets the system status information of the Industrial PC and operates the Controller.

The Industrial PC API is the collective term for the following two APIs.

Type of API	Description	Reference
Industrial PC System API	Gets information on the Industrial PC, such as production information, temperature, and battery status.	6-3 <i>Industrial PC System API</i> on page 6 - 4
Industrial PC Controller API	Gets the operating status of the Controller, and resets the Controller.	6-4 <i>Industrial PC Controller API</i> on page 6 - 5

The Industrial PC API is pre-installed in Windows of the Industrial PC. You can use it in the development environment where Visual C# is supported.

Development Environment

The following development environment is required to create applications with the Industrial PC API.

- **Integrated Development Environment**

Microsoft Visual Studio 2010, 2012, or 2013

- **Programming Languages**

Visual C#

6-2 How to Use the Industrial PC API

This section gives the operating procedure of the Industrial PC API.

1 Preparation

Install the Microsoft Visual Studio to Windows of the Industrial PC.

2 Creating an Application

On the Microsoft Visual Studio, create an application program in Visual C#. Call a method or property of the Industrial PC API in the program, when necessary for the purpose. Refer to *6-3 Industrial PC System API* on page 6 - 4 and *6-4 Industrial PC Controller API* on page 6 - 5 for the method and property types.

6-3 Industrial PC System API

This section describes the member types of the Industrial PC System API and how to use the members.

6-3-1 Members of the Industrial PC System API

The members of the Industrial PC System API are given below. Refer to the help for the Industrial PC API for details on each member.

Properties

Name	Meaning
Model	Model information
LotNumber	Lot number
SerialNumber	Serial number
HardwareVersion	Hardware Version
BIOSVersion	BIOS Version
BMCVersion	BMC Version
SoftwareVersions	List of version information on the software integrated in the Industrial PC
Temperature	Temperature of the Industrial PC
FanRevolution	Fan revolution of the Industrial PC
LowBattery	Low battery status of the Industrial PC
PowerSupply	Power supply status

6-3-2 Usage Method

To use the members of the Industrial PC System API, you must declare the IPCSystem class in Visual C#.

Refer to the manual or help for the Microsoft Visual Studio for the procedure to declare the class in Visual C#.

6-4 Industrial PC Controller API

This section describes the types of members of the Industrial PC Controller API and how to use them. The Industrial PC Controller API is constructed with the following classes.

- IPCController class
- ControllerAccessException class
- ControllerInternalExecuteException class

Refer to the help for the Industrial PC API for the usage of each member of the Industrial PC Controller API.

6-4-1 IPCController class

The IPCController class provides the function to access the Controller. The members for the IPCController class are given below.

Properties

Name	Meaning
ApiVersion	Version of the API interface
RuntimeVersion	Version of the Controller Runtime
RunMode	Controller operation Mode
ErrorStatus	Controller error status
CanResetController	Value that indicates whether the Controller can be reset
UnitName	Unit name of the Controller
UserErrorStatus	User-defined error
OperationLockTimer	Time until operation lock
IsEnabledOperationAuthority	Indicates whether the verification is enabled.
OperationAuthorityWithoutPassword	Default operation authority when the password entry is omitted
IsConnectionStarted	Indicates whether connection to the Controller is established.
PhysicalAddress	The MAC address of the built-in EtherNet/IP port
LedStatus	The status of the built-in EtherNet/IP network

Methods

Name	Meaning
GetInstance	Gets the only instance of IPCController.
ResetController	Resets the Controller.
GetIPAddress	Gets the IP address and subnet mask of the port specified by an argument.
GetDefaultGatewayAddress	Gets the default gateway address.
SetIPAddress	Changes the IP address and subnet mask of the port specified by an argument.
SetDefaultGatewayAddress	Changes the default gateway address.
Connect	Connects to the port of the specified IP address.
Disconnect	Execute disconnection.

Name	Meaning
VerifyPassword	Verify the password for the specified authority.

Enumerations

Name	Meaning
RunModeTypes	Gives the type of the operating mode.
ErrorStatusTypes	Gives whether a Controller error occurs.
UserDefineErrorStatusTypes	Gives whether a user-defined error occurs.
EthernetPortLedTypes	Gives the type of status of the built-in EtherNet/IP network to get.
EthernetPortLedStatus	Gives the status of the built-in EtherNet/IP network.
NetworkPort	Gives the type of the network port.
IPAddressSetType	Gives the method used to set the IP address of the built-in EtherNet/IP port.
OperationAuthorityTypes	Gives the type of the operation authority.

6-4-2 ControllerAccessException Class

The ControllerAccessException class notifies of errors that occur during communications with Controllers.

6-4-3 ControllerInternalExecuteException class

The ControllerInternalExecuteException notifies of execution errors that occur inside Controllers.

6-4-4 Usage Method

To use the members of a class for the Industrial PC Controller API, you must declare the class in Visual C#.

Refer to the manual or help for the Microsoft Visual Studio for the procedure to declare the class in Visual C#.

7

Backup and Recovery

This section describes backup and recovery procedures for the Industrial PC system, and backup, restoration, and comparison procedures for the Controller.

7-1	Backing up and Recovering the Industrial PC System	7 - 2
7-1-1	Outline of Rescue Disk Utility	7 - 2
7-1-2	Applicable Range of Backup Functions with the Rescue Disk Utility.....	7 - 2
7-1-3	Preparing the Rescue Disk Utility	7 - 3
7-1-4	Backup with the Rescue Disk Utility	7 - 4
7-1-5	Recovery with the Rescue Disk Utility	7 - 5
7-2	Backing Up, Restoring, and Comparing Controller Data	7 - 8

7-1 Backing up and Recovering the Industrial PC System

This section describes how to back up and recover the Industrial PC system. You can use the Rescue Disk Utility for backing up and recovery.

7-1-1 Outline of Rescue Disk Utility

The Rescue Disk Utility is a tool used to back up and recover data of Windows and Real-Time OS (Controller function) of the Industrial PC. The Rescue Disk Utility creates image files of HDD or SSD of the Industrial PC, and backs them up in a USB memory or other USB storage devices such as an external hard disk connected via USB. When Windows or Real-Time OS of the Industrial PC malfunctions, you can recover the Industrial PC with the backed up data. The Rescue Disk Utility is installed using the Rescue Disk Creator.



Precautions for Correct Use

- The unit version of Industrial PCs that create the backup data with the Rescue Disk Utility and the unit version of Industrial PCs to be recovered must match. If the unit version does not match, the relevant Industrial PCs may not start after the recovery.
If you updated the unit version of Industrial PCs, always create the new backup data for Industrial PCs with the Rescue Disk Utility. Do not use the backup data that was created before updating to recover Industrial PCs for which the unit version was updated.
To confirm the unit version of Industrial PCs, refer to *Checking Versions* on page 17 or *4-3 Displaying Production Information* on page 4 - 6.
- You can start the Rescue Disk Utility from the USB storage device. To use the Rescue Disk Utility, you must prepare an empty USB storage device. Refer to *7-1-3 Preparing the Rescue Disk Utility* on page 7 - 3 for details.
- The data that was backed up with the Rescue Disk Utility installed with Rescue Disk Creator version 1.0.830 can be used only to recover the Industrial PC from which you backed up the data. You cannot use the data to recover other Industrial PCs. You can select **Control Panel - Programs - Programs and Features** to confirm the version of Rescue Disk Creator.
The data that was backed up with the Rescue Disk Utility installed with Rescue Disk Creator version 1.1.1257 or higher can be recovered for an Industrial PC with the same unit version and the completely same model number. Refer to *1-3 Product Model Numbers* on page 1 - 6 for details on the model numbers.

7-1-2 Applicable Range of Backup Functions with the Rescue Disk Utility

The range of the Industrial PC system from which you can back up data with the Rescue Disk Utility is given below.

In a backup process, all data in the applicable range is backed up in a single backup file.

In a recovery process, you can select data to restore.

Applicable range	Description
Master Boot Record	The master boot record (MBR) for the Industrial PC
Boot Partition	The boot partition for the Industrial PC
Machine Control Partition	The data of the Real-Time OS (Controller function). The user data in the Controller is included.

Applicable range	Description
Windows Partition	The data of Windows OS*1

- *1. User data on Windows is not a target of this backup function. You must use another backup software to back up user data.

7-1-3 Preparing the Rescue Disk Utility

Preparation required for backing up data with the Rescue Disk Utility is given below.

Media Required for Backup

To use the Rescue Disk Utility, you must prepare a USB storage device with the following capacity.

- Capacity of Windows partition of the Industrial PC to be backed up + 16 GB
- For example, if you back up an Industrial PC which has the 200 GB Windows partition, you need a USB storage device of 216 GB or greater capacity.

Installing the Rescue Disk Utility

Install the Rescue Disk Utility to the USB storage device. The procedure is given below.



Precautions for Correct Use

- We recommend that you start the Rescue Disk Creator from Run as administrator. Otherwise, the Rescue Disk Creator cannot be installed correctly.
- Be aware that all data existing in the USB storage device to which you installed the Rescue Disk Utility will be lost by installing the Rescue Disk Utility.

- 1 Connect the USB storage device to the USB port on the Industrial PC.
- 2 From the Windows start menu, select **OMRON - Industrial PC**, right-click **Rescue Disk Creator**, and select **Run as administrator**.
The Rescue Disk Creator dialog box is displayed.

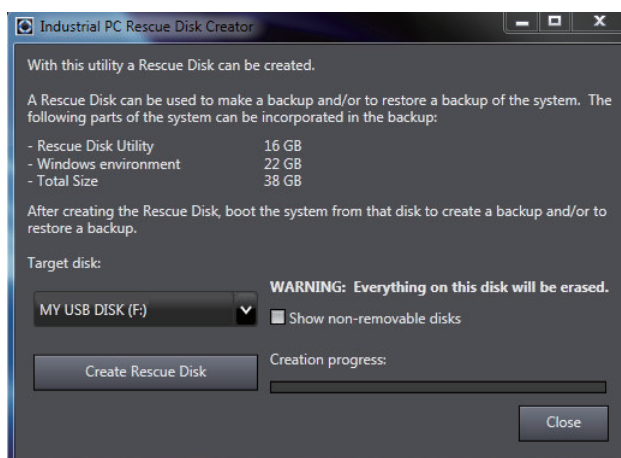

- 3 Select a USB storage device under **Target disk**, and click the **Create Rescue Disk** button. The Rescue Disk Utility is installed in the USB storage device.

- 4 Click the **Close** button to close the Rescue Disk Creator dialog box.

7-1-4 Backup with the Rescue Disk Utility

The backup procedure with the Rescue Disk Utility is given below.

- 1 Connect the USB storage device in which the Rescue Disk Utility is installed to the Industrial PC while the power to the Industrial PC is not supplied.
- 2 Press the power button on the Industrial PC and then the F11 key. The screen to select the device to start up is displayed.

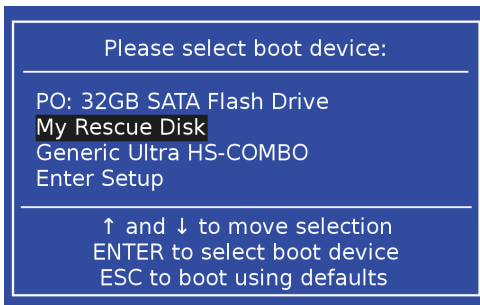

A name of a displayed USB storage device depends on the storage device. In this example, the screen displays the name as *My Rescue Disk*.

- 3 Select the USB storage device in which the Rescue Disk Utility was installed and press the Enter key. The Rescue Disk Utility starts up and the main menu is displayed.

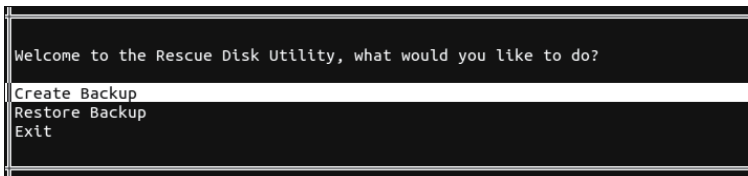

- 4 Select **Create Backup**, and press the Enter key. The screen shows a backup confirmation message.



- 5 Select **Continue**, and press the Enter key. The screen shows the backup processing.

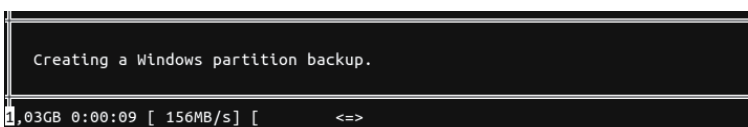

When the backup is completed, the screen shows Backup finished.



- 6** Press the Enter key.
You return to the main menu. This completes the backup process.
- 7** Select **Exit**, and press the Enter key.

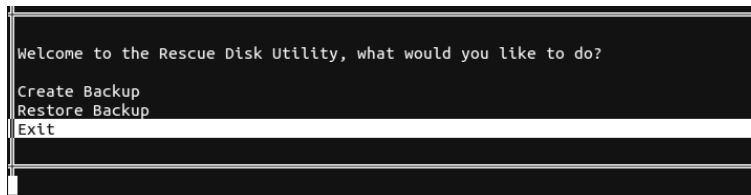

The power supply to the Industrial PC is turned OFF. Remove the USB storage device with the backup data and keep it in a safe place.



Additional Information

You can save only one set of backup data to one USB storage device. If a USB storage device already has a backup file and you select the backup file and press the Enter key, a screen shows to confirm overwriting the backup file.

7-1-5 Recovery with the Rescue Disk Utility

The recovery procedure with the Rescue Disk Utility is given below.



Precautions for Correct Use

- The unit version of Industrial PCs that create the backup data with the Rescue Disk Utility and the unit version of Industrial PCs to be recovered must match. If the unit version does not match, the relevant Industrial PCs may not start after the recovery.
If you updated the unit version of Industrial PCs, always create the new backup data for Industrial PCs with the Rescue Disk Utility. Do not use the backup data that was created before updating to recover Industrial PCs for which the unit version was updated.
To confirm the unit version of Industrial PCs, refer to *Checking Versions* on page 17 or *4-3 Displaying Production Information* on page 4 - 6.
- There are limits on recovery using the Rescue Disk Utility that is installed with Rescue Disk Creator version 1.0.830 as follows:
Recovery using the data that was backed up with the Rescue Disk Utility is possible only on the "individual" Industrial PC from which the data was backed up.
You cannot perform recovery using the backup data from an Industrial PC other than the Industrial PC to be recovered.
Differences in removable parts such as storage devices are not included in the meaning of "individual" Industrial PC. Even if the hard disk drive of a PC is replaced, it is recognized as the same PC.
- The data that was backed up with the Rescue Disk Utility installed with Rescue Disk Creator version 1.1.1257 or higher can be recovered for an Industrial PC with the same unit version and the completely same model number.

- 1** Connect the USB storage device which contains the backup data to the Industrial PC while the power to the Industrial PC is not supplied.

- 2 Press the power button on the Industrial PC and then the F11 key.
The screen to select the device to start up is displayed.
- 3 Select the USB storage device with the backup data and press the Enter key.
The Rescue Disk Utility starts up and the main menu is displayed.
- 4 Select **Restore Backup**, and press the Enter key.

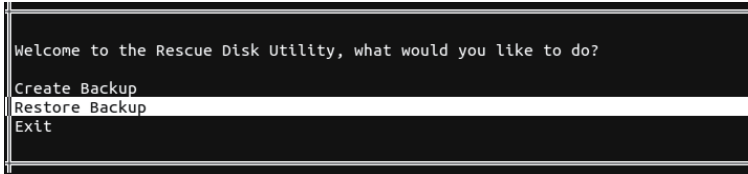

The screen to select the item to restore is displayed.

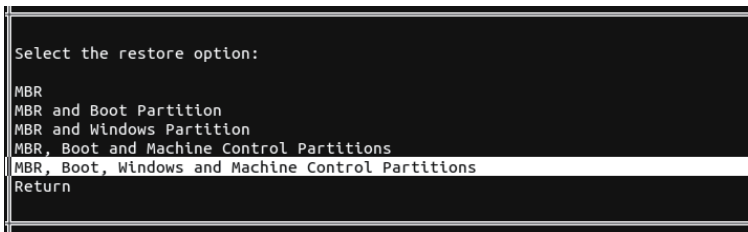

Item	Description
MBR	Restores the MBR of the Industrial PC.
Boot Partition	Restores the boot partition for the Industrial PC.
Machine Control Partition	Restores the data of the Real-Time OS (Controller function). The user data in the Controller is included.
Windows Partition	Restores the data of the Windows system.

- 5 Select the item to restore and press the Enter key.
The screen shows a restoration confirmation message.

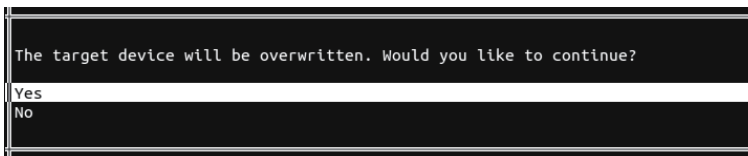

- 6 Select **Yes**, and press the Enter key.
The screen shows the restoration processing.

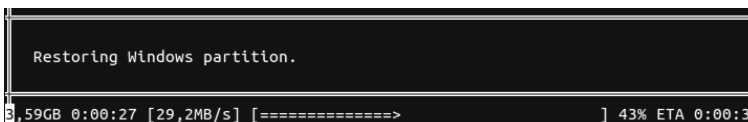

When the restoration is completed, the screen shows Restoration finished.



- 7 Press the Enter key.
You return to the main menu. This completes the recovery process.

- 8 Select **Exit**, and press the Enter key.

```
Welcome to the Rescue Disk Utility, what would you like to do?
Create Backup
Restore Backup
Exit
```

The power supply to the Industrial PC is turned OFF.

- 9 Remove the USB storage device and press the power button to start the Industrial PC.

7-2 Backing Up, Restoring, and Comparing Controller Data

You can use the Controller function to back up all of the data on the settings and user programs in the Controller to a Virtual SD Memory Card or a computer, and restore or compare the backed up data. Refer to the *NY-series Industrial Panel PC / Industrial Box PC Software User's Manual (Cat. No. W558)* for details on the Controller backup function.

You can back up, restore, and compare data in the Controller with the following procedures.

Type of function	Description	Reference
Industrial PC Support Utility backup function	Backs up the Controller data to Windows of the Industrial PC.	4-6-3 Controller Backup on page 4 - 13
Controller to SD Memory Card backup function	Backs up the Controller data to a Virtual SD Memory Card.	<i>NY-series Industrial Panel PC / Industrial Box PC Software User's Manual (Cat. No. W558)</i>
Sysmac Studio backup function	Backs up the Controller data to a computer on which the Sysmac Studio operates.	<i>Sysmac Studio Version 1 Operation Manual (Cat. No. W504)</i>

8

Troubleshooting during Setup

This section describes the typical errors that may occur during setup and the procedure for troubleshooting.

8-1	Starting in Safe Mode.....	8 - 2
------------	-----------------------------------	--------------

8-1 Starting in Safe Mode

In Safe mode, the Controller is started up in PROGRAM mode. The mode is used when the Sysmac Studio or the Industrial PC Support Utility cannot connect to the Controller and the Controller operating mode cannot be changed.

Use the following procedure for starting in Safe mode.

- 1** Pull out the power connector from the Industrial PC.
- 2** Press and hold the power button and connect the power connector.
- 3** Continue to hold down the power button for 10 seconds.
The PWR LED lights, and the BIOS startup view is displayed on the Monitor. Then, start the Controller and Windows in the same order as Normal mode. In this case, the Controller is started in PROGRAM mode.



Appendices

This section describes methods for updating the Industrial PC and for changing the internal port settings, and other supplemental information for the body of this manual.

A-1	Updating	A - 2
A-1-1	Updating Windows Software.....	A - 2
A-2	Changing the Internal Port Settings	A - 3
A-3	Changing Windows File Sharing Setting	A - 4
A-3-1	Procedure to Change.....	A - 4
A-3-2	Cautions When Using Virtual SD Memory Card	A - 4
A-4	Windows of Industrial PC	A - 5
A-4-1	Windows Operating System	A - 5
A-4-2	Supported Languages	A - 5
A-5	Software / Utilities	A - 6
A-5-1	Available Utilities.....	A - 6
A-5-2	Installed Software and Utilities.....	A - 6
A-6	Industrial PC Tray Utility	A - 7
A-6-1	Outline of Industrial PC Tray Utility	A - 7
A-6-2	Starting the Industrial PC Tray Utility	A - 7
A-6-3	Status Display on Icon	A - 7
A-6-4	Industrial PC Tray Utility Menu	A - 7
A-6-5	Notification Message Display.....	A - 8
A-7	Customize Windows	A - 9
A-7-1	Enhanced Write Filter	A - 9
A-7-2	File-Based Write Filter	A - 10

A-1 Updating

This section describes the Industrial PC software update.

A-1-1 Updating Windows Software

Always keep software installed on Windows at the latest released version to ensure stable operation. Especially, make sure that the following software stays up-to-date.

- Anti-virus software
- Firewall software
- Internet browser
- Windows security patches
- OMRON software



Precautions for Correct Use

After an OS update or a peripheral device driver update for the Industrial PC is executed, the PC behavior might be different. Confirm that operation is correct before you start actual operation.

A-2 Changing the Internal Port Settings

Communications between the Controller and Windows are enabled in the default setting for the internal ports on the Controller and Windows.

Normally, you do not have to change the internal port setting. However, you may need to change the initial IP address (192.168.254.*/24) in the following case.

- An IP address on an external network connected to the Industrial PC is the same as a network address in the internal network.

This section explains the method and precautions for changing the internal port settings for the Controller and Windows.

When you change the internal port setting for the Controller, you must also change the internal port setting for Windows to ensure communications between the Controller and Windows.

The procedure to change the settings is given below.

1 Changing Internal Port Setting for Controller

Change the IP address of the internal port for the Controller so that it does not overlap with a network address used on an external network.

Use the Industrial PC Support Utility or Sysmac Studio to change the internal port setting for the Controller.

Refer to *4-7 Network Settings for Controller* on page 4 - 18 or the *Sysmac Studio Version 1 Operation Manual (Cat. No. W504)* for details on the changing method.

2 Changing Internal Port Setting for Windows

Change the IP address of the internal port for Windows so that it is the same as the new network address of the internal port for the Controller.

To change the internal port setting for Windows, change the setting of a virtual network adapter. Refer to *3-1 Internal Port Settings* on page 3 - 2 for details on virtual network adapters.

3 Changing Virtual SD Memory Card Settings

When a Virtual SD Memory Card is used, the IP address setting for the Virtual SD Memory Card is updated with the new IP address of the internal port for Windows. Use the Industrial PC Support Utility or Sysmac Studio to change the Virtual SD Memory Card settings.

Refer to *4-8 Virtual SD Memory Card Settings* on page 4 - 21 or the *Sysmac Studio Version 1 Operation Manual (Cat. No. W504)* for details on the changing method.



Additional Information

When the IP address of the internal port for the Controller is changed, the connection with the Industrial PC Support Utility is disconnected. In the Network Connection dialog box of the Industrial PC Support Utility, enter the new IP address of the internal port to establish the connection again.

A-3 Changing Windows File Sharing Setting

In the factory setting, Windows file sharing is enabled only between Windows and Controllers. To share files on external networks to the Industrial PC, change the setting of the network adapter to use.

A-3-1 Procedure to Change

In the properties dialog box of the external network to use, select the network adapter, and select the *File and Printer Sharing for Microsoft Networks* check box.

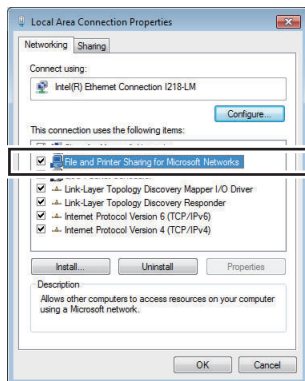

A-3-2 Cautions When Using Virtual SD Memory Card

When file sharing on an external network is enabled, the shared folder which is used by the Controller as a Virtual SD Memory Card is also published on the external network. The shared folder used as a Virtual SD Memory Card is set to be shared with **Everyone** by default. **Everyone** means there is no limit on access from external networks. To prevent unauthorized access to the Virtual SD Memory Card from terminals on external networks, perform proper management of the settings and accounts for terminals that are given access to the file.

For example, you can delete **Everyone** from the sharing settings for the shared folder used as a Virtual SD Memory Card, and register only accounts created with *Creating a User Account* on page 3 - 3 for Controllers.

A-4 Windows of Industrial PC

The types of Windows Operating Systems for the Industrial PC and supported languages are given below.

A-4-1 Windows Operating System

The available Windows Operating Systems are:

- Windows Embedded Standard 7 SP1 - 32 bit
- Windows Embedded Standard 7 SP1 - 64 bit

A-4-2 Supported Languages

The supported languages are:

- JA
- EN
- DE
- FR
- IT
- ES
- CN Traditional (zh-tw)
- CN Simplified (zh-cn)

A-5 Software / Utilities

A-5-1 Available Utilities

The settings for an NY-series Industrial PC or Industrial Monitor and the utilities used for monitors are given below.

Product name	Utility
Industrial Panel PC	Industrial Monitor Utility Industrial Monitor Brightness Utility Industrial PC Support Utility Industrial PC Tray Utility
Industrial Box PC	Industrial PC Support Utility Industrial PC Tray Utility
Industrial Monitor	Industrial Monitor Utility Industrial Monitor Brightness Utility Industrial PC Tray Utility

A-5-2 Installed Software and Utilities

The software and utilities that are installed in an NY-series Industrial PC are given below.

Name	Description
Industrial PC Support Utility	This is the utility to display the system status of Industrial PC and perform the settings of Industrial PC. Refer to <i>Section 4 Industrial PC Support Utility</i> on page 4 - 1 for details.
Industrial Monitor Utility	This is the utility to set the screen of the Industrial Panel PC and Industrial Monitor. Refer to <i>2-4-1 Industrial Monitor Utility</i> on page 2 - 9 for details.
Industrial Monitor Brightness Utility	This is the utility to adjust the brightness of Industrial Panel PC and Industrial Monitor. Refer to <i>2-4-2 Industrial Monitor Brightness Utility</i> on page 2 - 11 for details.
Industrial PC Tray Utility	This is the utility to be resident in the task tray and display the status of the Industrial PC. Refer to <i>A-6 Industrial PC Tray Utility</i> on page A - 7 for details.
Industrial Rescue Disk Creator	This is the utility to install Rescue Disk Utility. Refer to <i>Installing the Rescue Disk Utility</i> on page 7 - 3 for details.
Industrial PC System API	This is the API to get and set the system information of the Industrial PC. Refer to <i>6-3 Industrial PC System API</i> on page 6 - 4 for details.
Industrial PC Controller API	This is the API to get and set the Controller information of the Industrial PC. Refer to <i>6-4 Industrial PC Controller API</i> on page 6 - 5 for details.
NYCompolet	This is the software component to change values of the Controller variables for the Industrial PC. Refer to <i>Section 5 NYCompolet</i> on page 5 - 1 for details.
SYSMAC Gateway	This is the software used for communications of the NYCompolet. Refer to <i>5-3 Communications Setup</i> on page 5 - 4 for details.
congatec CGOS API	This is the API to operate the Industrial PC System API.
Microsoft .NET Framework 4.6	This is the software to operate the Industrial PC Tray Utility.

A-6 Industrial PC Tray Utility

This section provides an outline of the Industrial PC Tray Utility.

A-6-1 Outline of Industrial PC Tray Utility

The Industrial PC Tray Utility is an application that provides information about current status of the Industrial PC, related devices, and utilities such as the Industrial PC Support Utility and Industrial Monitor Utility.

The Industrial PC Tray Utility is pre-installed on Windows of the Industrial PC.

The Industrial PC Tray Utility provides the following features:

- Display the state of all utilities installed in the Industrial PC in the icon in the system tray area.
- Display a menu that can start utilities installed in the Industrial PC.
- Display notification messages in popup windows that inform the user about the state of utilities or hardware.

A-6-2 Starting the Industrial PC Tray Utility

The Industrial PC Tray Utility is configured to start automatically at Windows startup.

To manually (re)start the Industrial PC Tray Utility, select **OMRON - Omron Tray Application Framework** from the Windows start menu.

When the Industrial PC Tray Utility is active, its status icon is always displayed on the Windows system tray.

A-6-3 Status Display on Icon

The icon of the Industrial PC Tray Utility displays the following status.

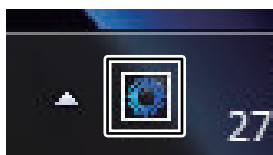

Type of status	Icon	Description
Normal		No utility of the Industrial PC has issued warning or error notifications.
Warning		At least one utility of the Industrial PC has issued a warning notification.
Error		At least one utility of the Industrial PC has issued an error notification.

A-6-4 Industrial PC Tray Utility Menu

Right-click the Industrial PC Tray Utility icon to display the menu.

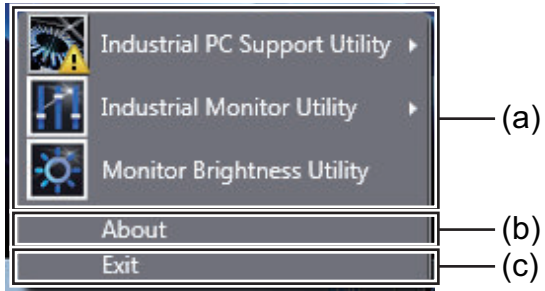

	Meaning
(a)	Displays the available utilities. Click any of the utilities to start.
(b)	Display the details on the Industrial PC Tray Utility.
(c)	Closes the Industrial PC Tray Utility.

A-6-5 Notification Message Display

Click the icon that shows a warning or error to display a popup message.
 Correct the warning or error by following the instruction given in the message.

A-7 Customize Windows

This section provides an overview of the tools to customize Windows.

A-7-1 Enhanced Write Filter

Enhanced Write Filter (EWF) intercepts disk changes and stores them into a memory overlay in RAM memory instead of applying them to the original volume.



Additional Information

- File-Based Write Filter (FBWF) provides a similar function, but operates at the file level, while EWF operates at the sector level.
- Refer to the Microsoft Developer Network (MSDN) for detailed information.

Application

EWF and FBWF provide the following benefits:

- Write-protect one or more partitions on a system.
- Make it possible to revert changes and revert to the original disk content.
- Enable booting from read-only media.

By redirecting all write requests to RAM, EWF and FBWF enable the run-time image to maintain the appearance of a writable run-time image.

- Improve the file system performance when using relatively slow storage.
- Minimize write actions to the disk.

For example, minimize write access to flash memory. Write cycles on flash memory are limited for technical reasons.

Usage

EWF is included in the Windows Embedded Standard 7 image and disabled by default.

The configuration of this component can be defined with the command line tool EWFMgr.EXE.

To run the EWF Manager, open the Command Prompt with Administrator rights.

Command	Function	Remarks
ewfmgr	Shows an overview with current status.	---
ewfmgr c:-enable	Enables the write filter for the drive C:.	The protection is not effective until the system is restarted.
ewfmgr c:-commit	Writes all the changes in the memory overlay to the physical disk during the next restart.	Committing the overlay can affect the speed of the boot process.
ewfmgr c:-commitanddisable	Writes all the changes in the memory overlay to the physical disk during the next restart, and disables the disk protection.	Committing the overlay can affect the speed of the boot process. The protection is not disabled until the system is restarted.

Command	Function	Remarks
ewfmgr c:-commitanddisable -live	Writes all the changes in the memory overlay to the physical disk immediately, and disables the disk protection.	Protection is also disabled immediately. No restart is required.
ewfmgr c:-disable	Disables the disk protection.	The protection is not disabled until the system is restarted.
ewfmgr /h	Displays a helpscreen that explains all commands and options available.	A complete reference can be found at the Microsoft Developer Network (MSDN).

Considerations

- EWF and FBWF cannot be used simultaneously.
- To prevent data loss in the event of a power failure, the use of a UPS is recommended.
- When the EWF function is enabled and a large amount of data is written, the system memory space will be reduced and operation may become unstable. To prevent this problem, it is recommended that a large amount of data be written to a different location.
- Automatic Adjustment of daylight saving time (DST) is incompatible with the Enhanced Write Filter (EWF).



Additional Information

Refer to the Microsoft Developer Network (MSDN) for DST details.

A-7-2 File-Based Write Filter

File-Based Write Filter (FBWF) intercepts file changes and stores them into a memory overlay in RAM memory instead of applying them to the original volume.

When FBWF is enabled, all files and folders of a partition are protected unless they are included in an exception list.



Additional Information

- Enhanced Write Filter (EWF) provides a similar function, but operates at the sector level, while FBWF operates at the file level. FBWF is more flexible in its configuration than EWF and allows immediate writing without rebooting.
- Refer to the Microsoft Developer Network (MSDN) for detailed information.

Application

EWF and FBWF provide the following benefits:

- Write-protect one or more partitions on a system.
- Make it possible to revert changes and revert to the original disk content.
- Enable booting from read-only media.

By redirecting all write requests to RAM, EWF and FBWF enable the run-time image to maintain the appearance of a writable run-time image.

- Improve the file system performance when using relatively slow storage.
- Minimize write actions to the disk.

For example, minimize write access to flash memory. Write cycles on flash memory are limited for technical reasons.

Usage

FBWF is included in the Windows Embedded Standard 7 image and disabled by default. The configuration of this component can be defined with the command line tool FBWFMGR.EXE.

To run the FBWF Manager, open the Command Prompt with Administrator rights.

Command	Function	Remarks
fbwfmgr	Shows an overview with current status.	---
fbwfmgr /displayconfig	Shows current configuration.	---
fbwfmgr /enable	Enables the write filter.	The protection is not effective until the system is restarted.
fbwfmgr /addvolume c:	Adds a volume to the protected volume list.	That volume will be protected after the next restart.
fbwfmgr /commit c:\Test.txt	Writes the changes to the protected file/folder.	---
fbwfmgr /addexclusion C:\Test.txt	Adds a write-through path to the exclusion list (file/folder).	The exclusion is active after the next restart.
fbwfmgr /removeexclusion C:\Test.txt	Removes the write-through path from the exclusion list (file/folder).	The exclusion is removed after the next restart.
fbwfmgr /h	Displays a helpscreen that explains all commands and options available.	A complete reference can be found at the Microsoft Developer Network (MSDN).



Additional Information

When specifying a file name, notice the space between drive name (c:) and file path (\Test.txt).

Considerations

- EWF and FBWF cannot be used simultaneously.
- FBWF can only protect formatted volumes. Do not move files between protected and unprotected volumes.
- When the FBWF function is enabled and a large amount of data is written, the system memory space will be reduced and operation may become unstable. To prevent this problem, it is recommended that a large amount of data be written to a different location.
- FBWF supports only NTFS and FAT32 file systems.
- Automatic Adjustment of daylight saving time (DST) is incompatible with the File-Based Write Filter (FBWF).



Additional Information

Refer to the Microsoft Developer Network (MSDN) for DST details.



Index



Index

A	
Account settings.....	2 - 4,3 - 3
B	
Backup.....	4 - 13,7 - 8
C	
Compare.....	4 - 16
Controller Operation.....	4 - 11
Controller status.....	4 - 9
E	
Exiting.....	2 - 5,2 - 6
I	
Industrial Monitor.....	2 - 9
Industrial Monitor Brightness Utility.....	2 - 11
Industrial Monitor Utility.....	2 - 9
Industrial PC.....	1 - 2,1 - 6
Industrial PC API.....	1 - 8,1 - 9,6 - 2
Industrial PC Controller API.....	6 - 5
Industrial PC Support Utility.....	4 - 2
Industrial PC System API.....	6 - 4
Industrial PC Tray Utility.....	A - 7
Internal network.....	1 - 3
Internal port.....	1 - 3,1 - 7,3 - 2,A - 3
N	
Network settings.....	4 - 18
Normal mode.....	2 - 5
NYCompolet.....	1 - 8,5 - 2
O	
Operating modes.....	2 - 5
Operation authority verification.....	4 - 23
Operation lock.....	4 - 24
P	
Production information.....	17,4 - 6
R	
Real-Time OS.....	1 - 2,1 - 3
Report Log.....	4 - 10
Rescue Disk Creator.....	7 - 3
Rescue Disk Utility.....	7 - 2
Reset Controller.....	4 - 12
Restore.....	4 - 14
S	
Safe mode.....	8 - 2
Shared folder.....	1 - 3,1 - 7,3 - 3,3 - 6
Shutdown.....	2 - 6
Starting.....	2 - 5
SYSMAC Gateway Console.....	5 - 4
System status.....	4 - 7
U	
Update.....	A - 2
UPS.....	1 - 7,2 - 8
V	
Versions.....	17
Virtual SD Memory Card.....	3 - 3,3 - 7
Virtual SD Memory Card settings.....	4 - 21
W	
Windows setup.....	2 - 2

OMRON Corporation Industrial Automation Company
Kyoto, JAPAN

Contact: www.ia.omron.com

Regional Headquarters

OMRON EUROPE B.V.

Wegalaan 67-69, 2132 JD Hoofddorp
The Netherlands
Tel: (31)2356-81-300/Fax: (31)2356-81-388

OMRON ELECTRONICS LLC

2895 Greenspoint Parkway, Suite 200
Hoffman Estates, IL 60169 U.S.A.
Tel: (1) 847-843-7900/Fax: (1) 847-843-7787

OMRON ASIA PACIFIC PTE. LTD.

No. 438A Alexandra Road # 05-05/08 (Lobby 2),
Alexandra Technopark,
Singapore 119967
Tel: (65) 6835-3011/Fax: (65) 6835-2711

OMRON (CHINA) CO., LTD.

Room 2211, Bank of China Tower,
200 Yin Cheng Zhong Road,
PuDong New Area, Shanghai, 200120, China
Tel: (86) 21-5037-2222/Fax: (86) 21-5037-2200

Authorized Distributor:

© OMRON Corporation 2016-2017 All Rights Reserved.
In the interest of product improvement,
specifications are subject to change without notice.

Cat. No. W568-E1-03

1017