

# PMC Panel Mount Power Supply

## 12V 60W 1 Phase, NEC Class 2 / PMC-12V060W1NA

# PMC

### Highlights & Features

- Universal AC input voltage without power de-rating
- Full corrosion resistant Aluminium chassis
- NEC Class 2 power supply and Limited Power Source (LPS) approvals
- High MTBF > 700,000 hrs. as per Telcordia SR-332
- Wide operating temperature range from -20°C to 70°C
- Conformal Coating (Class I, Div 2 Hazardous Locations Ready)

### Safety Standards



CB Certified for worldwide use

**Model Number:** PMC-12V060W1NA  
**Unit Weight:** 0.28 kg  
**Dimensions (L x W x D):** 128 x 97 x 38 mm

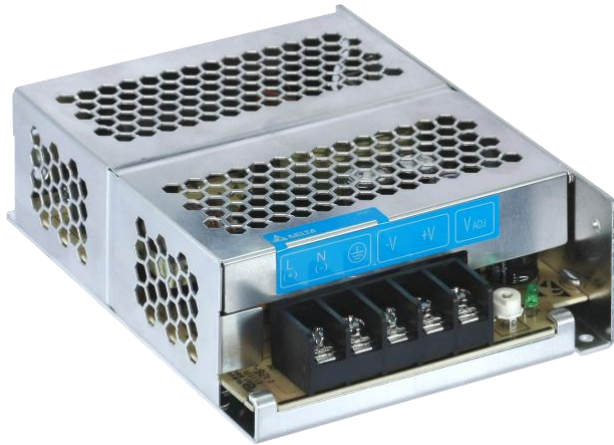

### General Description

The new PMC Panel Mount Power Supply is the latest offering from one of the world's largest power supply manufacturers and solution providers - Delta. The product offers a nominal output voltage of 12V, 60W output power ranging with NEC Class 2 power supply and Limited Power Source (LPS) approvals. The PMC-12V060W1NA comes with a wide temperature range from -20°C to +70°C and conformal coating on PCBA (Class I, Div 2 Hazardous Locations Ready) to protect against chemical and dust pollutants. Delta's Panel Mount Power Supply also offers overvoltage and overload protection. Using a wide input voltage range design, it is compatible worldwide. The input also includes DC operating voltage from 125-375Vdc. Best of all, this excellent design and quality does not come with a big price tag.

### Model Information

#### PMC Panel Mount Power Supply

Model Number	Input Voltage Range	Output Voltage	Output Current
PMC-12V060W1NA	85-264Vac (125-375Vdc)	12Vdc	5.00A

### Model Numbering

PM	C –	12V	060W	1	N	A
Panel Mount	Product Type C – Enclosed	Output Voltage	Output Power	Single Phase	NEC Class 2	Terminal Block Connector

# PMC Panel Mount Power Supply

## 12V 60W 1 Phase, NEC Class 2 / PMC-12V060W1NA

### Specifications

#### Input Ratings / Characteristics

Nominal Input Voltage	100-240Vac
Input Voltage Range	85-264Vac
Nominal Input Frequency	50-60Hz
Input Frequency Range	47-63Hz
Nominal DC Input Voltage	125-250Vdc
DC Input Voltage Range	125-375Vdc
Input Current	< 1.35A @ 115Vac, < 0.90A @ 230Vac
Efficiency at 100% Load	> 86.0% @ 115Vac, > 87.0% @ 230Vac
Max Inrush Current	< 50A @ 115Vac, < 100A @ 230Vac
Leakage Current	< 1mA @ 240Vac

#### Output Ratings / Characteristics

Nominal Output Voltage	12Vdc
Output Voltage Tolerance	± 2% (initial set point tolerance from factory)
Output Voltage Adjustment Range	12-14Vdc
Output Current	5.00A
Output Power	60W
Line Regulation	< 0.5% typ. (@ 85-264Vac input, 100% load)
Load Regulation	< 1% typ. (with rated input, 0-100% load)
PARD (20MHz)	< 100mVpp @ 25°C & 50°C < 150mVpp @ -10°C & -20°C
Rise Time	< 60ms @ nominal input (100% load)
Start-up Time	< 2500ms @ nominal input (100% load)
Hold-up Time	> 15ms @ 115Vac, > 80ms @ 230Vac (100% load)
Dynamic Response (Overshoot & Undershoot O/P Voltage)	± 5% @ 0-100% load
Start-up with Capacitive Loads	5,000µF Max

### Mechanical

Case Chassis / Cover	Aluminium	
Dimensions (L x W x D)	128 x 97 x 38 mm	
Unit Weight	0.28 kg	
Indicator	Green LED (DC OK)	
Cooling System	Convection	
Terminal	Input / Output	5 Pins (Rated 300V/15A)
Wire	Input / Output	AWG 22-14
Noise (1 Meter from power supply)		Sound Pressure Level (SPL) < 40dBA

# PMC Panel Mount Power Supply

## 12V 60W 1 Phase, NEC Class 2 / PMC-12V060W1NA

### Environment

Surrounding Air Temperature	Operating	-20°C to +70°C
	Storage	-25°C to +85°C
Power De-rating		< -10°C de-rate power by 2.0% / °C, > 50°C de-rate power by 2.5% / °C
Operating Humidity		< 95% RH
Operating Altitude		3,000 Meters
Shock Test (Non-Operating)		IEC 60068-2-27, 30G (300m/S <sup>2</sup> ) for a duration of 18ms, 1 times per direction, 2 times in total
Vibration (Non-Operating)		IEC 60068-2-6, 10Hz to 150Hz @ 50m/S <sup>2</sup> (5G peak); 20 min per axis for all X, Y, Z direction
Pollution Degree		2

### Protections

Overvoltage	< 17.6V, SELV Output, Non-Latching (Auto-Recovery)
Overload / Overcurrent	> 110-160% of rated load, Hicc-up Mode, Non-Latching (Auto-Recovery)
Over Temperature	< 75°C Surrounding Air Temperature @ 100% load, Non-Latching (Auto-Recovery)
Short Circuit	Hicc-up Mode, Non-Latching (Auto-Recovery when the fault is removed)
Protection Against Shock	Class I with PE* connection

\*PE: Primary Earth

### Reliability Data

MTBF	> 700,000 hrs. as per Telcordia SR-332
Expected Cap Life Time	10 years (115Vac & 230Vac, 50% load @ 40°C)

### Safety Standards / Directives

Electrical Safety	TUV Bauart to EN 60950-1, LPS UL/cUL recognized to UL 60950-1 and CSA C22.2 No. 60950-1, NEC Class 2 CB scheme to IEC 60950-1, LPS	
CE	In conformance with EMC Directive 2014/30/EU and Low Voltage Directive 2014/35/EU	
Material and Parts	RoHS Directive 2011/65/EU Compliant	
Galvanic Isolation	Input to Output	3.0KVac
	Input to Ground	1.5KVac
	Output to Ground	0.5KVac

# PMC Panel Mount Power Supply

## 12V 60W 1 Phase, NEC Class 2 / PMC-12V060W1NA

## EMC

EMC / Emissions		CISPR 32, EN 55032, FCC Title 47: Class B (Class A for DC input)
Immunity to		EN 55024
Electrostatic Discharge	IEC 61000-4-2	Level 4 Criteria A <sup>1)</sup> Air Discharge: 15kV Contact Discharge: 8kV
Radiated Field	IEC 61000-4-3	Level 3 Criteria A <sup>1)</sup> 80MHz-1GHz, 10V/M, 80% modulation (1KHz)
Electrical Fast Transient / Burst	IEC 61000-4-4	Level 3 Criteria A <sup>1)</sup> 2kV
Surge	IEC 61000-4-5	Level 3 Criteria A <sup>1)</sup> Common Mode <sup>2)</sup> : 2kV Differential Mode <sup>3)</sup> : 2kV
Conducted	IEC 61000-4-6	Level 3 Criteria A <sup>1)</sup> 150kHz-80MHz, 10Vrms
Power Frequency Magnetic Fields	IEC 61000-4-8	Criteria A <sup>1)</sup> 10A/Meter (1A/Meter for DC input)
Voltage Dips	IEC 61000-4-11	100% dip; 1 cycle (20ms); Self Recoverable
Low Energy Pulse Test (Ring Wave)	IEC 61000-4-12	Level 3 Criteria A <sup>1)</sup> Common Mode <sup>2)</sup> : 2kV Differential Mode <sup>3)</sup> : 1kV
Voltage Fluctuation and Flicker		IEC/EN 61000-3-3

1) Criteria A: Normal performance within the specification limits

2) Asymmetrical: Common mode (Line to earth)

3) Symmetrical: Differential mode (Line to line)

# PMC Panel Mount Power Supply

## 12V 60W 1 Phase, NEC Class 2 / PMC-12V060W1NA

### Block Diagram

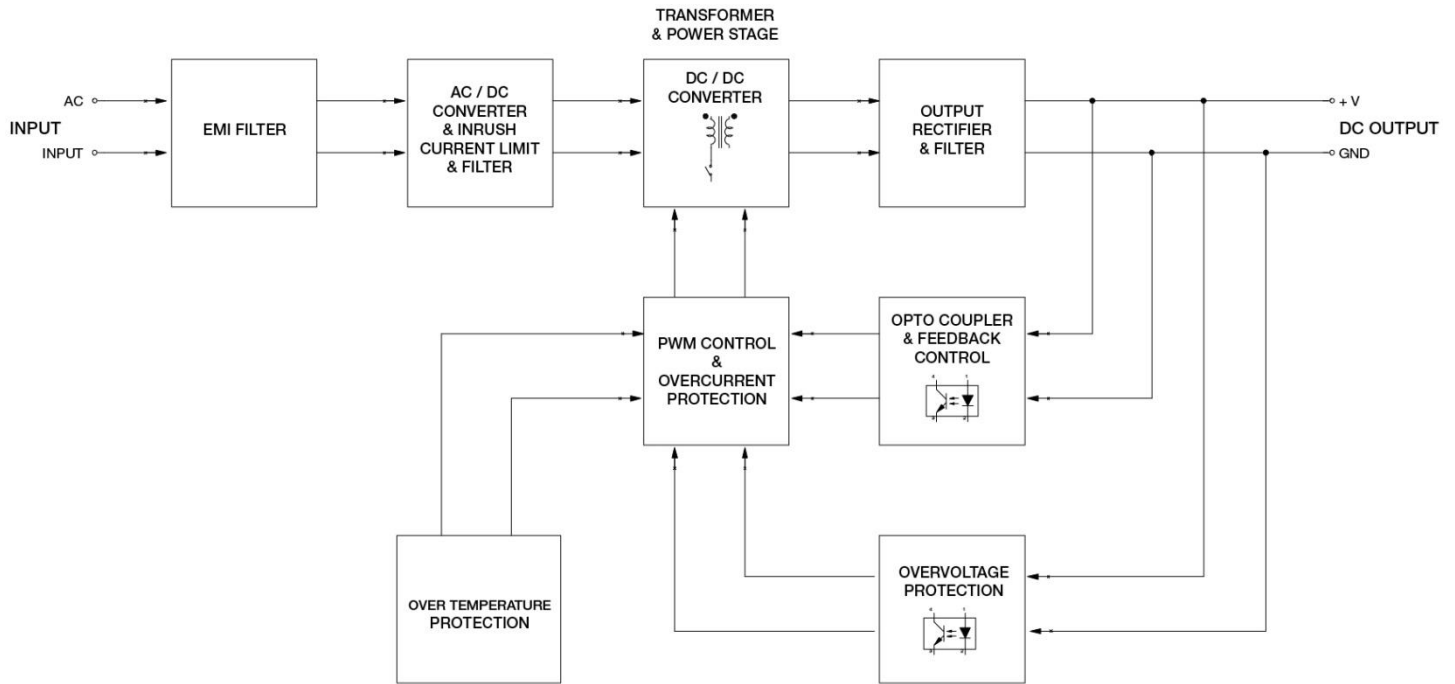

### Device Description

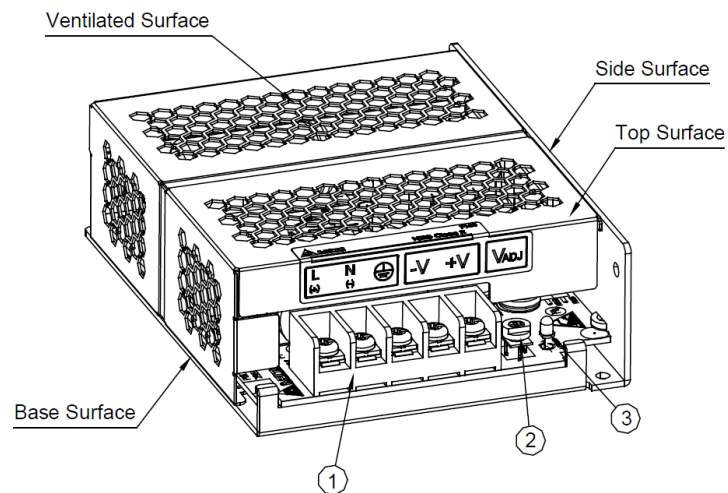

- 1) Input & Output terminal block connector
- 2) DC voltage adjustment potentiometer
- 3) DC OK control LED (Green)

# PMC Panel Mount Power Supply

## 12V 60W 1 Phase, NEC Class 2 / PMC-12V060W1NA

### Dimensions

L x W x D: 128 x 97 x 38 mm

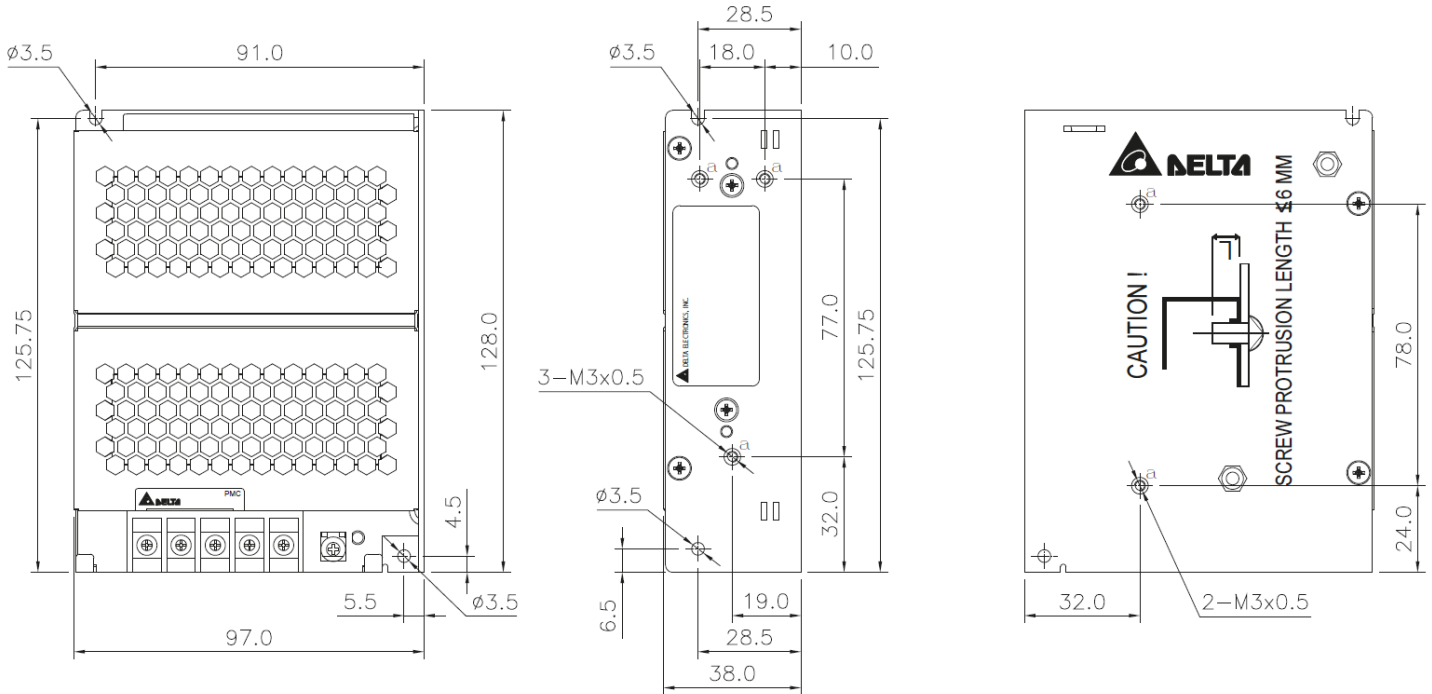

### Engineering Data

#### De-rating

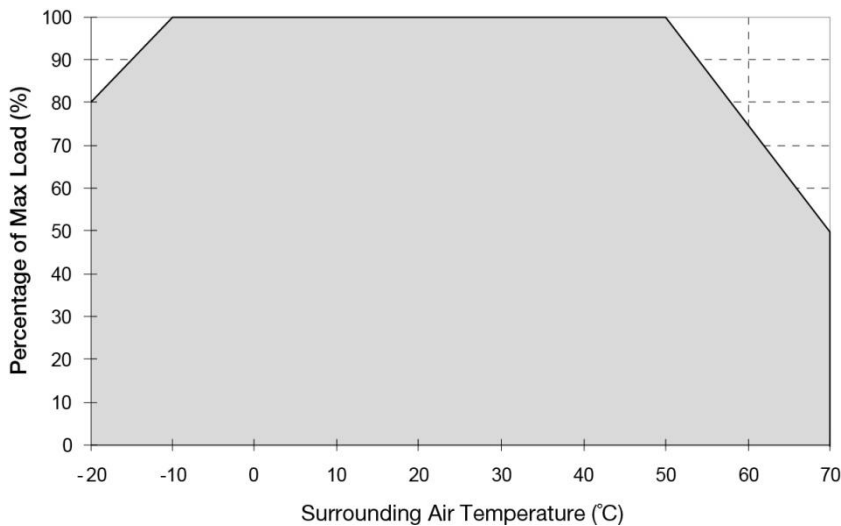

**Fig. 1 De-rating for Vertical and Horizontal Mounting Orientation**

< -10°C de-rate power by 2.0% / °C  
 > 50°C de-rate power by 2.5% / °C

#### Note

1. Power supply components may degrade, or be damaged, when the power supply is continuously used outside the shaded region, refer to the graph shown in Fig. 1.
2. If the output capacity is not reduced when the surrounding air temperature > 50°C, the device may run into Over Temperature Protection. When activated, the output voltage will go into bouncing mode and will recover when the surrounding air temperature is lowered or the load is reduced as far as necessary to keep the device in working condition.
3. In order for the device to function in the manner intended, it is also necessary to keep a safety distance of 20mm with adjacent units while the device is in operation.
4. Depending on the surrounding air temperature and output load delivered by the power supply, the device can be very hot!
5. If the device has to be mounted in any other orientation, please do not hesitate to contact [info@deltapsu.com](mailto:info@deltapsu.com) for more details.

# PMC Panel Mount Power Supply

## 12V 60W 1 Phase, NEC Class 2 / PMC-12V060W1NA

### Output De-rating VS. Input Voltage

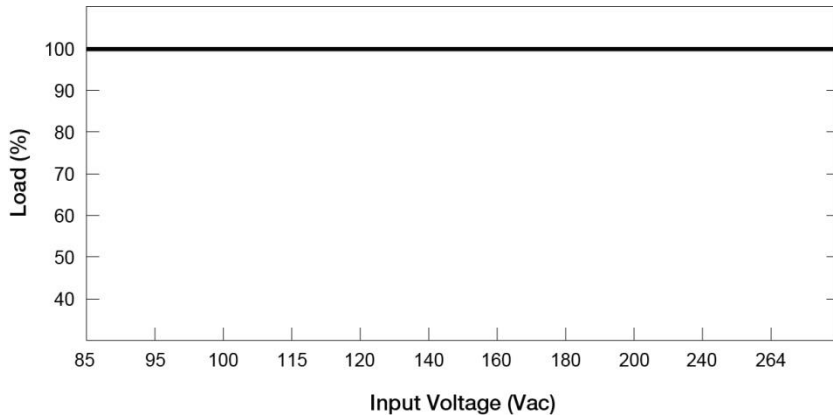

■ No output power de-rating across the entire input voltage range

### Assembly & Installation

- Ⓐ Mounting holes for power supply assembly onto the mounting surface.  
The power supply shall be mounted on minimum 2 mounting holes using M3 screw minimum 5mm length.
- Ⓑ This surface belongs to customer's end system or panel where the power supply is mounted.
- Ⓒ Connector

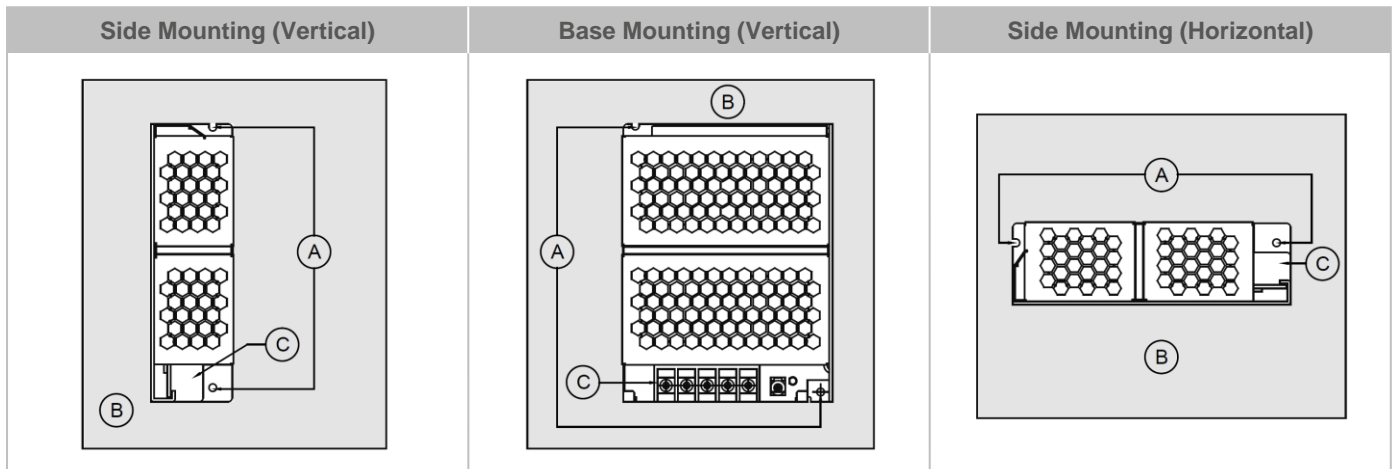

Fig. 2 Mounting Orientation

- Use flexible cable (stranded or solid) of AWG No. 22-14. The torque at the Connector shall not exceed 13Kgf.cm. The insulation stripping length should not exceed 0.275" or 7mm.

# PMC Panel Mount Power Supply

## 12V 60W 1 Phase, NEC Class 2 / PMC-12V060W1NA

### Installation of Mounting Accessories

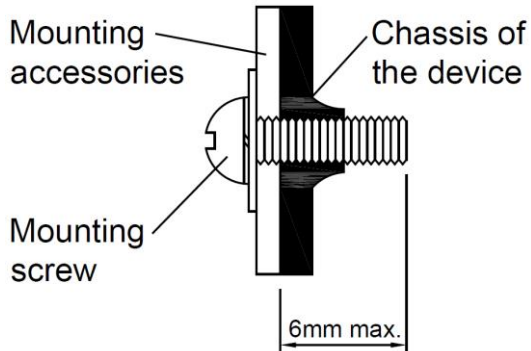

- Only use M3 screw  $\leq 6\text{mm}$  through the base mounting holes. This is to keep a safety distance between the screw and internal components.
- Recommended mounting tightening torque: 4~8Kgf.cm.

### Safety Instructions

- To ensure sufficient convection cooling, always maintain a safety distance of  $\geq 20\text{mm}$  from all ventilated surfaces while the device is in operation.
- The device is not recommended to be placed on low thermal conductive surface, for example, plastics.
- Note that the enclosure of the device can become very hot depending on the ambient temperature and load of the power supply. Do not touch the device while it is in operation or immediately after power is turned OFF. Risk of burning!
- Do not touch the terminals while power is being supplied. Risk of electric shock.
- Prevent any foreign metal, particles or conductors from entering the device through the openings during installation. It may cause: Electric shock; Safety Hazard; Fire; Product failure
- Warning: When connecting the device, secure Earth connection before connecting L and N. When disconnecting the device, remove L and N connections before removing the Earth connection.



# PMC Panel Mount Power Supply

## 12V 60W 1 Phase, NEC Class 2 / PMC-12V060W1NA

### Functions

#### Start-up Time

The time required for the output voltage to reach 90% of its set value, after the input voltage is applied.

#### Rise Time

The time required for the output voltage to change from 10% to 90% of its set value.

#### Hold-up Time

Hold up time is the time when the AC input collapses and output voltage retains regulation for a certain period of time. The time required for the output to reach 95% of its set value, after the input voltage is removed.

#### ■ Graph illustrating the Start-up Time, Rise Time, and Hold-up Time

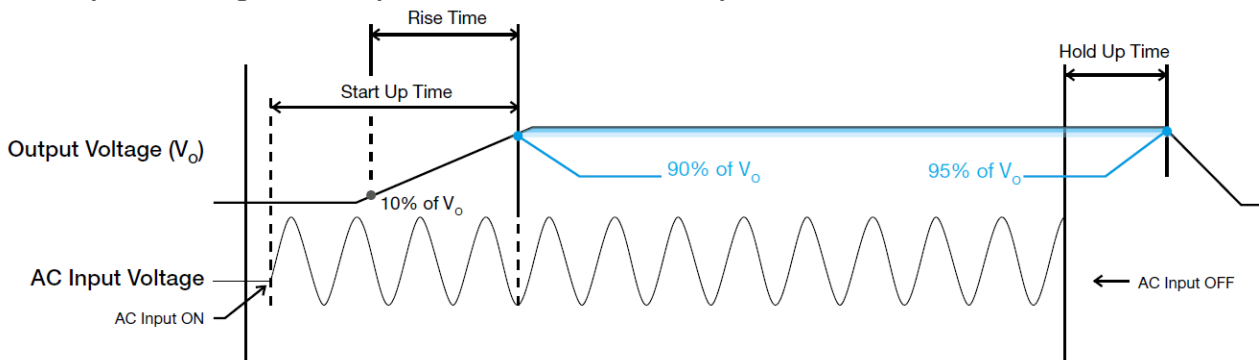

#### Inrush Current

Inrush current is the peak, instantaneous, input current measured and, occurs when the input voltage is first applied. For AC input voltages, the maximum peak value of inrush current will occur during the first half cycle of the applied AC voltage. This peak value decreases exponentially during subsequent cycles of AC voltage.

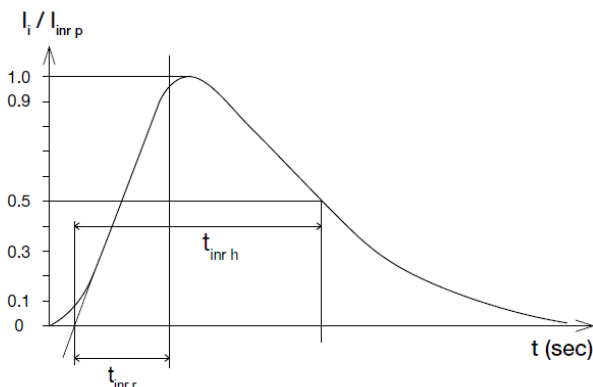

#### Dynamic Response

The power supply output voltage will remain within  $\pm 5\%$  of its steady state value, when subjected to a dynamic load from 0% to 100% of its rated current.

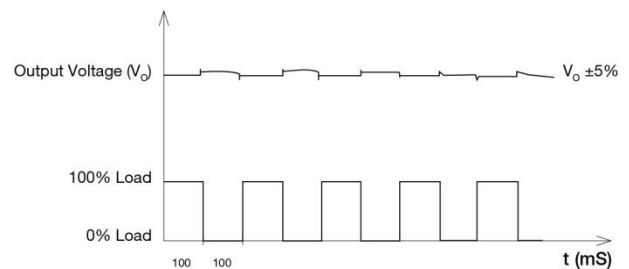

# PMC Panel Mount Power Supply

## 12V 60W 1 Phase, NEC Class 2 / PMC-12V060W1NA

### Overload & Overcurrent Protections

The power supply's Overload (OLP) and Overcurrent (OCP) Protections will be activated when output current exceeds 110-160% of  $I_O$  (Max load). In such occurrence, the  $V_O$  will start to droop and once the power supply has reached its maximum power limit, the protection is activated and the power supply will go into "Hiccup mode" (Auto-Recovery). The power supply will recover once the fault condition of the OLP and OCP is removed and  $I_O$  is back within the specifications.

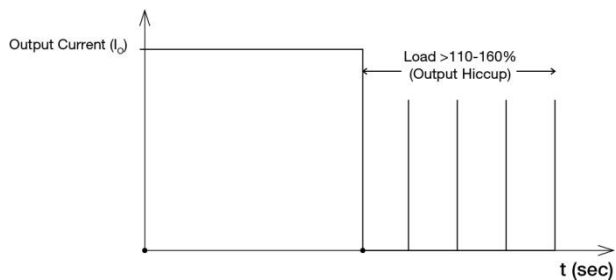

It is not recommended to prolong the duration of  $I_O$  when it is <110-160% but >100%, since it may cause damage to the PSU.

### Short Circuit Protection

The power supply's output OLP/OCP function also provides protection against short circuits. When a short circuit is applied, the output current will operate in "Hiccup mode", as shown in the illustration in the OLP/OCP section on this page. The power supply will return to normal operation after the short circuit is removed.

### Others

#### Delta RoHS Compliant



#### Restriction of the usage of hazardous substances

The European directive 2011/65/EU limits the maximum impurity level of homogeneous materials such as lead, mercury, cadmium, chrome, polybrominated flame retardants PBB and PBDE for the use in electrical and electronic equipment. RoHS is the abbreviation for "Restriction of the use of certain hazardous substances in electrical and electronic equipment".

This product conforms to this standard.

#### Conformal Coating

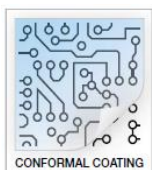

#### The Protective Coating Technology

Delta Electronics Group has designed the perfect dipping technique which penetrates everywhere including under device, and prevents leakage. The conformal coating dipping can be applied to PCBs or circuit board. The coating preserves the performance of precision electronic primarily by preventing ionizable contaminants such as salt from reaching circuit nodes, where the material slumps around sharp edges. This can be a problem especially in highly conversing atmosphere.

### Overvoltage Protection

The power supply's overvoltage circuit will be activated when its internal feedback circuit fails. The output voltage shall not exceed its specifications defined on Page 3 under "Protections".

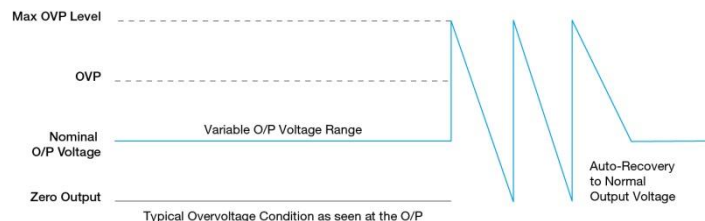

### Over Temperature Protection

As mentioned above, the power supply also has Over Temperature Protection (OTP). In the event of a higher operating temperature at 100% load, the power supply will run into OTP when the operating temperature is beyond what is recommended in the de-rating graph. When activated, the output voltage will go into bouncing mode until the temperature drops to its normal operating temperature as recommended in the de-rating graph.