

Panasonic

Machine Vision System
IMAGECHECKER

PV200 SERIES

CE
Conforming to
EMC Directive

Certified by NRTL
(ANPV0202ADP only)

**High End Performance
in a Compact Body**



COMPACT & HIGH SPEC

ULTRA HIGH SPEED VISION SYSTEM IMAGECHECKER PV200 SERIES

COMPACT & HIGH SPEC

ULTRA HIGH SPEED VISION SYSTEM IMAGECHECKER PV200 SERIES





Improved inspection reliability while reducing engineering time

**Image processing with impressive accuracy and performance can now be achieved
while requiring a surprisingly low implementation and programming time.**

The new ideal machine is a color/grey combination type.

Hardware

Color and grey images can be simultaneously captured for inspection.

In addition, the "3+1" Quad processor provides ultra-high speed parallel processing, significantly reducing the inspection time.

Features are condensed into the ultra-compact body guaranteeing outstanding usability.

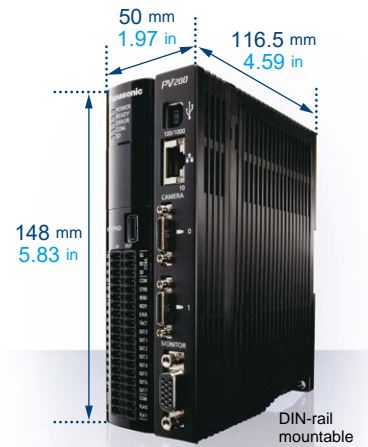

Quad processor, DSP processing & Pipeline processing

"3 + 1" Quad processor for high speed processing

Consists of a processor exclusively for image capture and transfer, a high-speed RISC-CPU, image-processing DSP, and a processor exclusively for display processing

- Pipeline processing by the Quad processor enables concurrent operation of the image capture process and inspection process.
- Ease of operation is increased, because data R (read) / W (write) (see page 10) and display layout switching operations are possible in the RUN mode.
- DSP processing: High-speed DSP is a processor dedicated for realtime image and grey pre-process filtering.
- High reliability, fan-less, standalone hardware

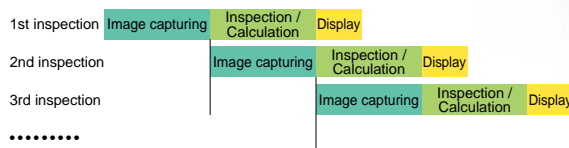
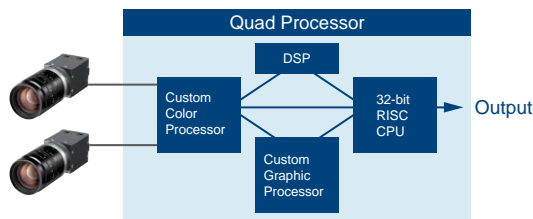

With pipeline (parallel) processing, image capturing and inspection can execute at the same time.

Two cameras, including a combination of color and grey cameras, can be simultaneously connected.

High definition color and grey cameras can be simultaneously connected. Inspections with color and grey images can be conducted concurrently.

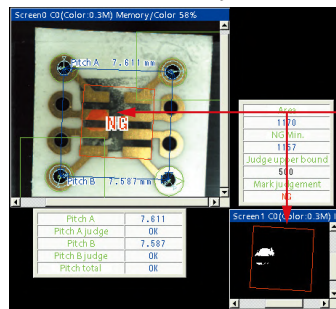

Color images clearly show red bad marks, which are difficult to detect with grey images.

Camera selections



Seven types of cameras, including a 4M grey camera, are available with the system. 0.3M compact camera has been added to the product line-up. The body is approximately 20 mm 0.79 in more compact lengthwise compared to previous 0.3M grey cameras.



*1 The main body firmware Ver.1.50 or later is required. Software can be downloaded from our website.
*2 A dedicated cable is required for connecting.
*3 The 4M camera cannot be used in combination with another type of camera.

Color / Grey combination inspection system

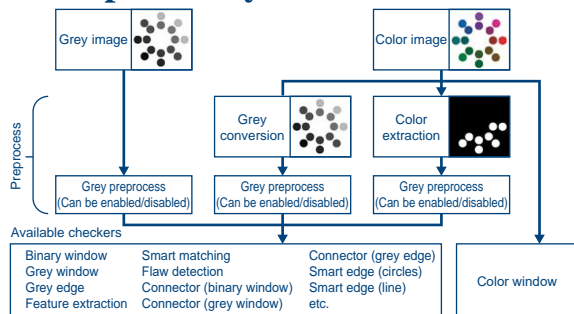

Grey conversion

Highly flexible grey conversion is possible, because each coefficient can be freely specified for each RGB value of a color image.

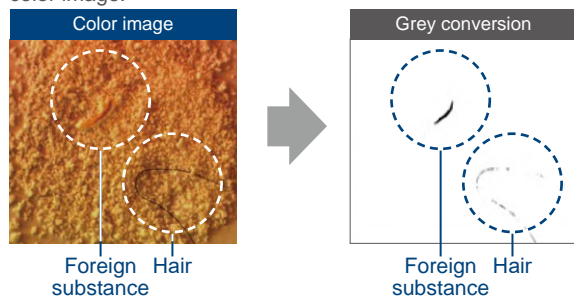

Color window

The maximum, minimum, average, and deviation of RGB values can be obtained. Results can be used for numerical calculations and outputted externally.

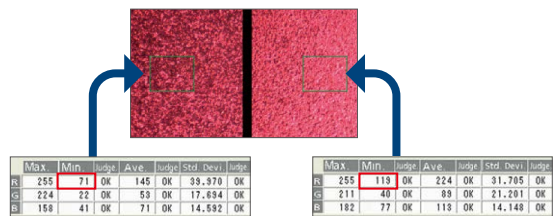

Color extraction

Colors in different color phases can be simultaneously extracted and inspected by using one inspection checker.

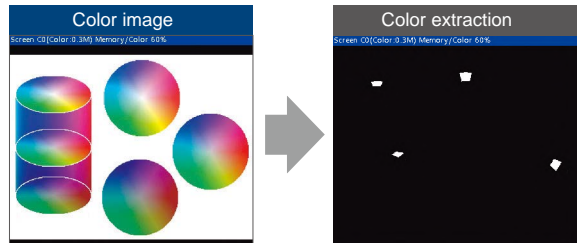

Purple and red orange is extracted.

Branch execution/Designated execution

11-min-hour reduction

The inspections can be quickly changed to meet multiple product types or various conditions.

Branch execution

Up to nine branches can be set to choose an inspection to be executed depending on the test results.

* PV260 cannot do branch execution.

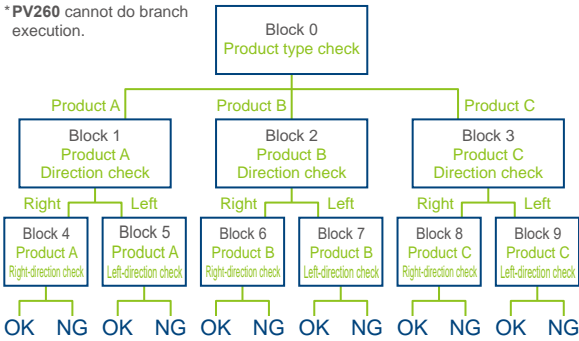

Designated execution

After trigger signal is applied, up to ten different inspections can be executed immediately. This minimizes the time spent on switching product types.

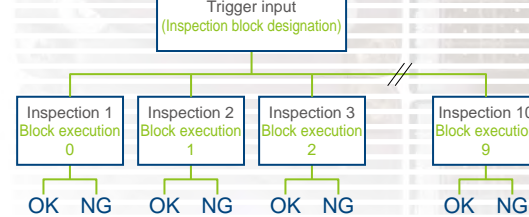

Inspection result of each block is stored until the next execution.

A dedicated application can be created by controlling the block execution timing externally.

Applications

Case 1 One work is moved and inspected numerous times then given a total judgment (inspection of target using split captures in order to obtain necessary resolution).

Total judgment result output with last block

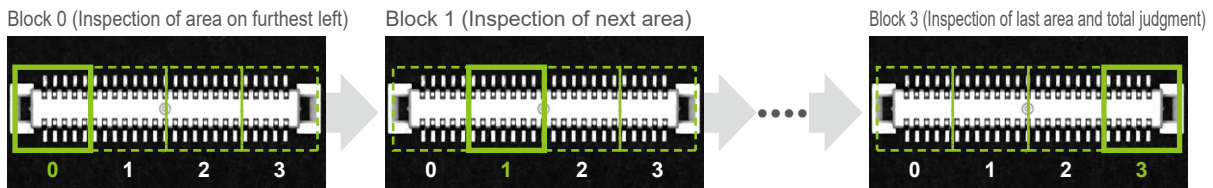

Case 2 Imaging conditions are changed, work is inspected numerous times, and total judgment is made (lighting of light source is controlled by a PLC).

Result of Block 0 is used to inspect at Block 1.

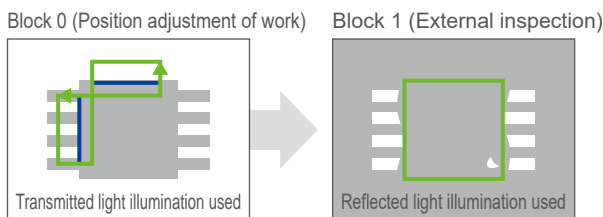

Case 3 Simple alignment

Result of Block 0 is used to inspect at Block 1.

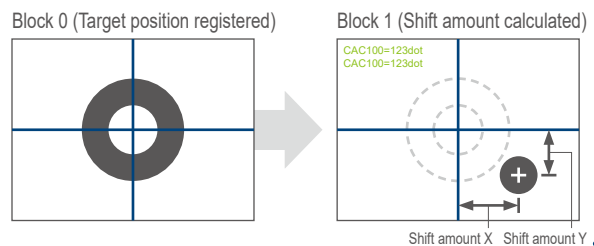

Inspections of a variety of points of a variety of product types

- Data for up to 256 types can be saved in the built-in memory alone, and 25,600 types with an SD memory card inserted.
- Maximum registrable number of checkers: 1,000 checkers / type

Checker types	Line	Binary window	Grey window	Binary edge	Grey edge
	Feature extraction	Smart matching	Contour matching	Flaw detection	Color window
	Three connectors (binary window, grey window, and grey edge)			Smart edge (circles) / (line)	

A total of 15 types

- Maximum registrable number of templates: 2,000 templates
- Maximum available number of numerical calculation formulas: 1,000 formulas / type

A variety of operators for numerical calculation are available: Four fundamental operations (+, -, x, ÷), bracket operation, trigonometric function (14 types), comparison function (6 types), mathematical function (15 types), geometric function (18 types), and statistical function (18 types)

- Execution blocks: 10 blocks / type
- Position adjustment: 1,000 checkers / type, Area adjustment: 1,000 checkers / type

Preprocessing

Grey conversion / Color extraction

- Grey conversion: Max. 16 groups/camera

The conversion coefficients are set for the color image RGB greyscale value and the image is converted to grey. Each RGB coefficient can be set freely (-1,000 to +1,000). This makes it difficult for the inspection to be affected by color changes, such as by the removal of low saturation (low coloration) or non-color parts and by target color enhancement, caused by lighting fluctuations.

- Color extraction: Max. 128 colors/type (one camera, expansion mode)

Utilizing the parameters H (Hue), S (Saturation) and V (Value), which resemble the way humans perceive differences in color, multiple colors (max. 128 colors) can be extracted simultaneously.

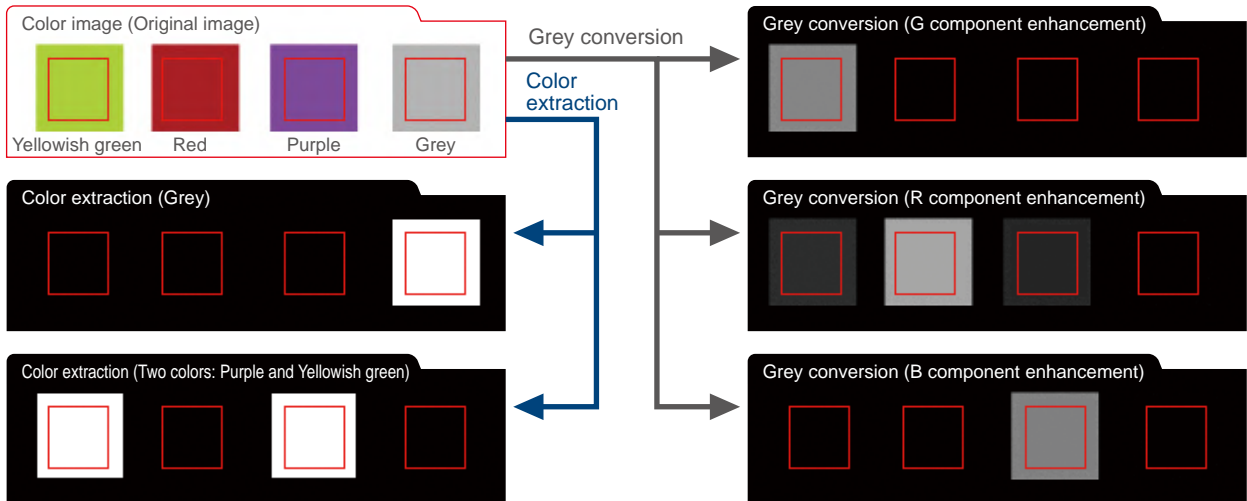

Grey preprocess filters



21 types of grey preprocess filters are available. Reliable inspections are possible even under non-uniform lighting conditions or in the case of images with noise.

- Preprocess filters: 21 types
- Preprocess groups: Max. 16 groups/camera
- Preprocess steps: Max. 10 steps/group

Main purpose	Filter name
Flaw detection	• Tophat • Dynamic • Grey difference
Noise removal	• Dilation • Erosion • Erosion → Dilation • Dilation → Erosion
Image adjustment	• Rotation • Reflect

Main purpose	Filter name
Contour enhancement	• Sobel • Laplacian • Edge extraction Y • Prewitt • Edge extraction X • Sharpen
Blurring	• Median • Smoothing
Contrast enhancement	• Auto correction • Grey cut • Area averaging • Correction settings

Application example	Original image	Processed image
Checking container lids for adhesion of foreign substances Filter used [Tophat]		
Checking films / sheets for scratches / wrinkles Filter used [Grey difference, Area averaging]		
Detecting dirt on transparent sheets Filter used [Dynamic]		

Application example	Original image	Processed image
Extracting printed characters (deleting the background) Filter used [Dynamic]		
Checking the inside of containers for adhesion of foreign substances Filter used [Grey difference, Tophat]		
Checking sintered parts for breaks / cracks Filter used [Grey difference, Tophat]		

Checker Functions

Smart edge (Circle)/(Line)



Complicated inspection processes can be easily performed with highly accurate measurements.

A function for accurate approximation of circles/lines

This function detects a maximum of 3,000 edge points for a line and 3,600 for a circle in one area, dramatically improving the accuracy of the dimension and position measurements.

Operation principle

1. A Grey edge scanning area is created, and edge points in the area are searched to detect the contour of the object.
2. Virtual circles and approximate straight lines can be identified with a high degree of accuracy based on the target edge points.
3. Pass (OK) /fail (NG) evaluations are made based on the measured values (radius, diameter, and width), deviations, circularity, straightness, and the number of edges outside the area.

Smart edge (circle) setting example

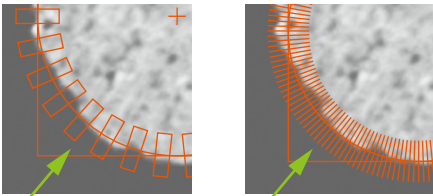

One cell can have a minimum width of one pixel (linear scanning), and a maximum of 3,600 cells can be set per 0.1°.

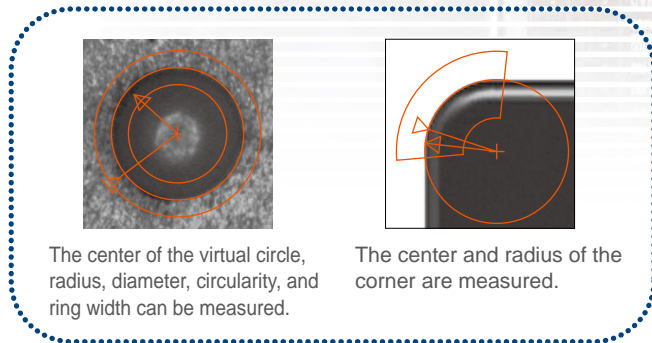

The center of the virtual circle, radius, diameter, circularity, and ring width can be measured.

The center and radius of the corner are measured.

Smart edge (line) setting example

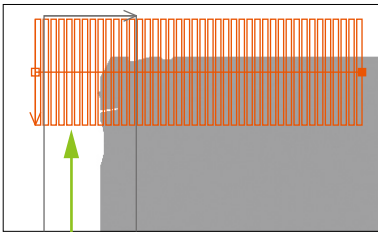

A maximum of 3,000 cells can be set.

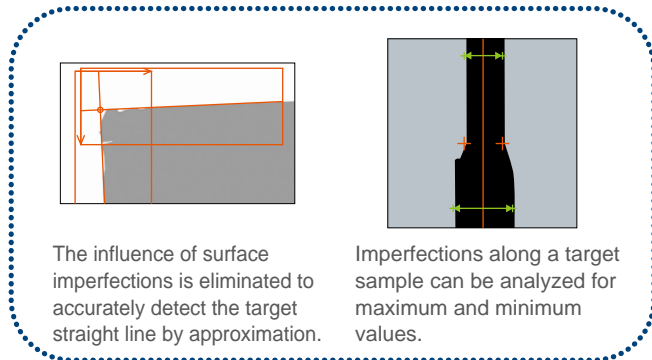

The influence of surface imperfections is eliminated to accurately detect the target straight line by approximation.

Imperfections along a target sample can be analyzed for maximum and minimum values.

Geometry calculation

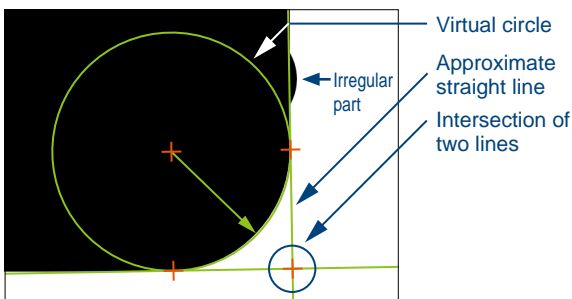

Distances, intersections, and median lines can be detected.

This function detects the distance between two points, the intersection of two lines, the median line of two lines, the perpendicular distance, and an approximate ellipse. In combination with Smart edge (circle) / (line), this function recognizes the object as a geometric figure, allowing the coordinates, distances, dimensions, and angles to be obtained without preparing calculation formulas.

Applications

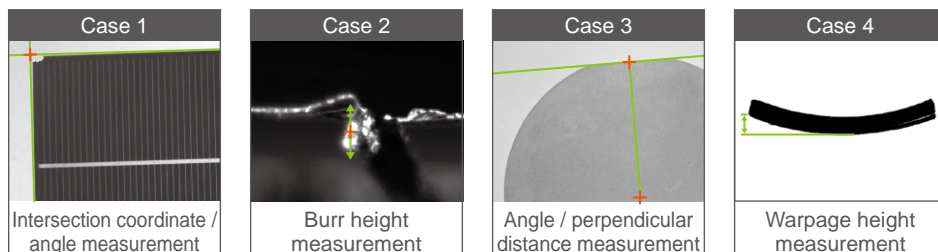

Checker Functions

Matching High accuracy inspection Man-hour reduction

By using the PV200 series matching function, highly accurate detection is possible using two means of matching that take into account the characteristics of the target object and the process environment.

Smart matching

Pattern search



Through means of a unique normalization process, stable detection can be achieved with reduced influence from grey fluctuations.

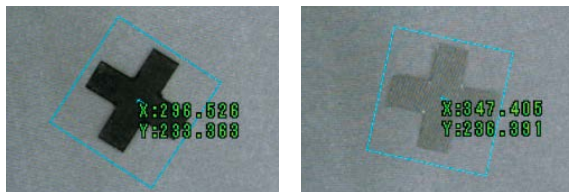

Detects even with low-contrast images

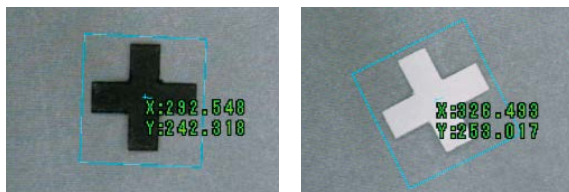

Detects even with negative images

Selection possible among multiple templates

A high-precision inspection is possible by searching a maximum of 64 templates in the same search area to detect a result with the highest correlation.

Template images

Template 0	Template 1	Template 2	Template 3	Template 4	Template 5

Object of search

After searching all templates, Template 3 with the highest correlation is used for detection.

Extraction of deviating portion using pattern difference

Based on the position information obtained by the matching function, the registered object and detected object are overlapped and compared on a pixel-by-pixel basis. Any pixels with a difference in brightness over a certain level are detected. The area value of such pixels can then be used to make pass/fail evaluations.

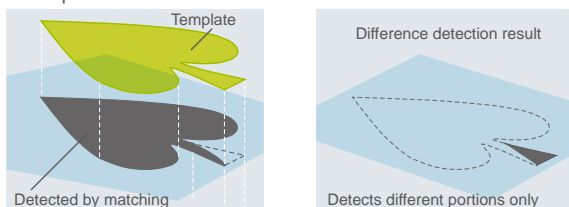

Contour matching

Contour search



A template is created from the contour information (object) obtained from the grey change points (edge points), which means stable detection can be achieved without being influenced by the object shape or changes to the background.

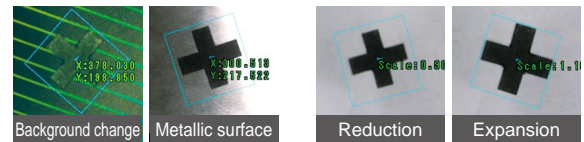

Detects even if background changes.

Even if all of detected target object is registered, detection will be stable regardless of the state of the background.

Detects even if the magnification changes ($\pm 10\%$ max.)

The same template can be used for detection even if in processes where the distance between the work and the camera changes.

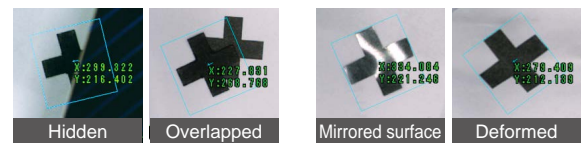

Detects even if target object is hidden

Stable detection is possible even if part of the object being detected is deficient.

Detects even with noise on the target object

Stable detection is possible even if the part of the object being detected changed due to a limitation in the lighting or inspection process.

Common template

Register to smart matching

Register to contour matching

- When a common template is used, the information of all checkers that use the same template will be updated with the switch of one template. Compared to the setting of templates individually, time is saved by reducing repetitious work and operational mistakes are prevented.
- Also, since it is not necessary to register the same template more than once, space for holding templates on the PV200 series can be saved. Images registered as common templates can be used for both smart matching and contour matching.

Flaw detection



This function is ideal for critical appearance inspections, such as scratches, stains, chipped edges, burrs, and other flaws in objects. The inspection is carried out by comparing a target's greyscale image with neighboring parts, which helps in the detection of minor scratches, stains, and chips.

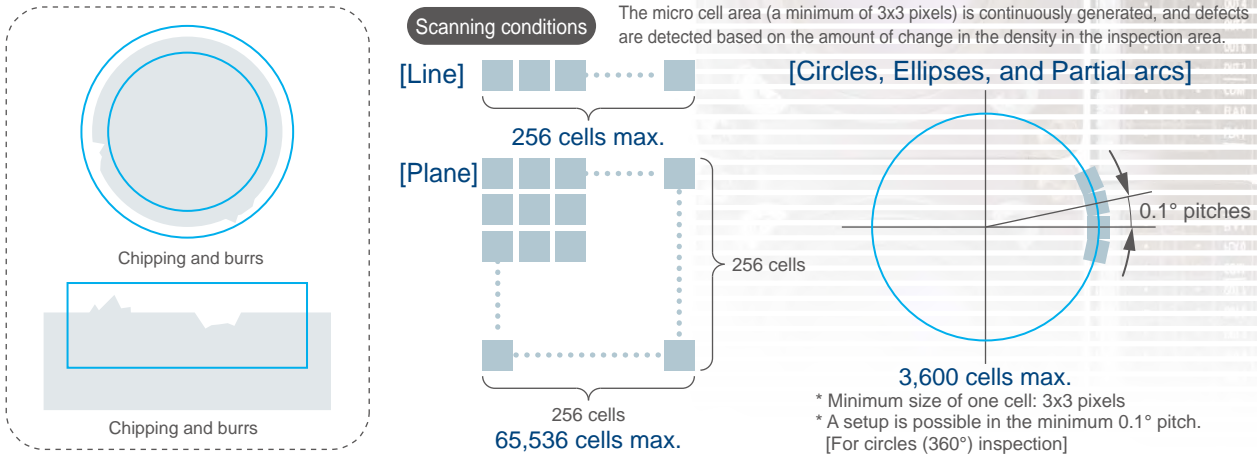

Connector checker



Setup for connector inspection has been burdensome up to now. Now inspection can be accomplished by creating one area. This enables a great man-hour reduction.

Inspection example

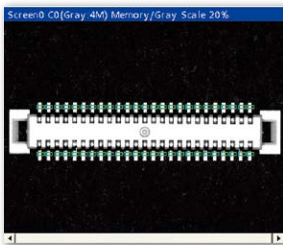

Pin pitch inspection

This function measures the distance between the edges of each pair of adjacent pins and evaluates the results based on the preset upper and lower limits. Data of the "start point", "end point", and "number of pins" should be input.

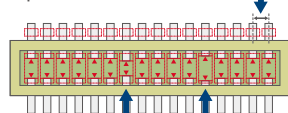

Pin coplanarity inspection

This function detects raised pins. In the same way as the pin pitch inspection, setting simply adjusts the position using one checker and then inputting the number of pins.

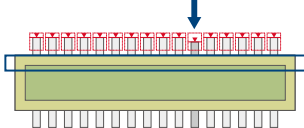

Inside pin gap inspection

This function inspects the gap between facing ends of pins. Simply input the number of pins. The upper and lower limits of the gap can be set.

Coordinate calibration

Setting and calculation is possible, linking the camera image with the actual dimensions.

Link two images

Global coordinates between two cameras are generated and both results are quoted to enable direct calculation.

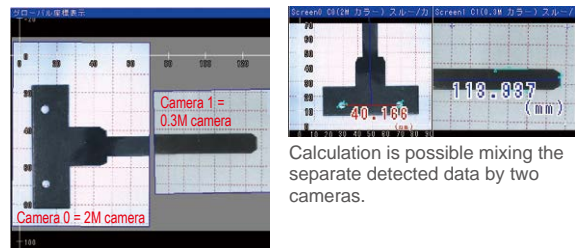

Calculation is possible mixing the separate detected data by two cameras.

Dynamic calibration

Conveyance differences arising during stage and index conveyance are adjusted each time to enable stable measuring of the work dimensions.

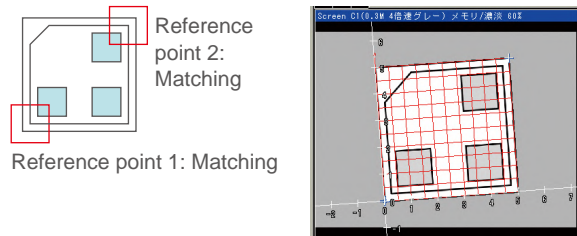

Our unique algorithm for ultra high speed processing

Parallel processing by Quad processor and our unique algorithm ensure outstanding ultra high speed inspections.

[Execution processing speed]	Unit: msec		
Checker functions*1	640 × 480	1,600 × 1,200	2,048 × 2,048
Binary window	0.5	1.7	3.3
Grayscale window	0.4	1.5	2.9
Binary edge	2.1	11.3	23.7
Grayscale edge	8.7	54.0	117.2
Feature extraction	1.1	3.8	6.9
Smart matching*2	5.0	32.3	63.5
Contour matching*3	26.4	111.3	329.4

*1: The processing speed above is a reference value based on default settings. Processing speed vary depending on the image being inspected.

*2: Template: 128 x 128, Without rotation

*3: Template: 128 x 128, Rotation: ±30°, Scale: ±5%

*4: When using a color camera.

[Execution processing speed]	Unit: msec		
Filter functions	640 × 480	1,600 × 1,200	2,048 × 2,048
5 x 5 Dilatation	0.8	3.7	7.6
5 x 5 Erosion	0.8	3.7	7.6
5 x 5 Smoothing	1.2	5.8	13.1
5 x 5 Edge extraction X	0.8	3.3	6.6
5 x 5 Edge extraction Y	0.8	3.3	6.8
5 x 5 Prewitt	1.9	9.9	21.5
5 x 5 Sobel	1.9	10.5	21.7
Image rotation	1.9	11.5	24.8
Grey conversion*4	1.2	5.1	-
Color extraction*4	0.5	2.4	-

Interface

Operation screen Man-hour reduction

The PV200 series has been designed to simplify implementation in both pre-production and post-production.

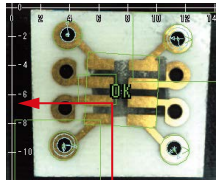

Unit conversion axes

X and Y axes indicate the scale converted into the actual dimensions. (Separately setttable for each camera)

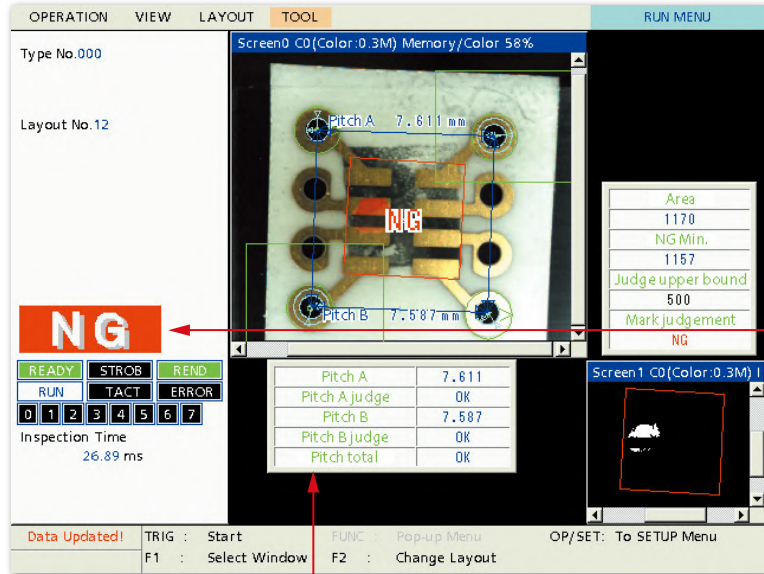

Data R (Read) / W (Write) function

Program modifications can be quickly made in the RUN mode without replacing the program or switching to the setting screen. This is useful in cases where changes to the inspection area and pre-processing parameters must be made after the program has been finalized.

[Modification examples]

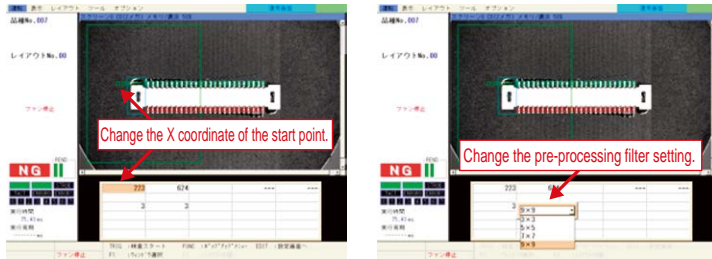

Splash screen

The splash (startup) screen can be changed to an original screen, such as a screen suitable for the user's equipment or a screen including a brand logo. (A bitmap with a maximum size of 640 x 480 pixels)

Operation customization by external signal

The PV200 series is equipped with a total of five points for ASSIGN and EXTRA signals, which allow you to customize the allocations of tasks, such as layout switching, image data output and screenshot printing.

Customizable Display

■ **Character / Figure drawing**
A function for drawing text (multi-lingual), measured values, cross marks, arrow marks (dimension lines), rectangles, and ellipses. This function allows drawn items to be displayed following the calculation results or detected positions. It is also possible to specify the character size, fill regions and switch the drawn item colors or turn on/off the display of the items according to the pass/fail check results.

■ **Marker function**
A straight line, rectangle, circle, ellipse, and cross line can be displayed at any position. The display position can be specified by using external signal.

■ **Layout**
The VGA screen (640 x 480 pixels) can display two images and two pages of the Data R/W screen. Layouts can be customized and up to 16 patterns can be registered. They can be switched in accordance with the situation using either the keypad or external signals.

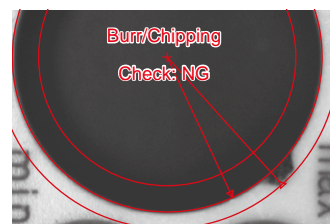
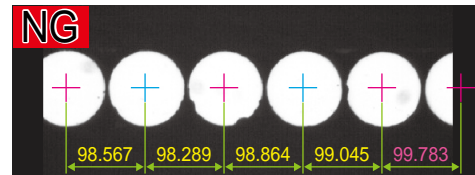

Setup screen Main-hour reduction

Select menu

By registering to the menu list any item you prefer from the items in the setup screen, you become able to perform operations directly, verify settings, and make changes.

- Improve operability by registering to the menu those functions you use a lot.
- Prevent operation mistakes by registering to the menu those functions that are okay to change.

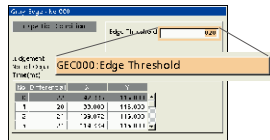
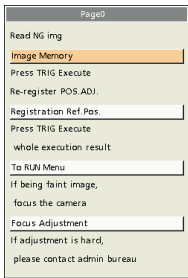

Checker parameter registration
Only the set value and result are displayed when a checker parameter is chosen.
*Parameters other than those items chosen are not displayed.

Number of registrations:
max. 50 pages/product type (16 items/page)

Password protection

Setting a password prevents the careless switching to the setup screen. The password can have a maximum of 15 digits (from 84 alphanumeric and symbol characters). By joint use with the Select Menu, it is possible to distinguish between operator and administrator use.

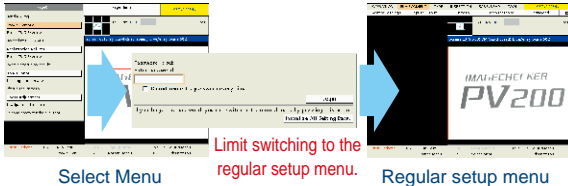

Select Menu

Limit switching to the regular setup menu.

Regular setup menu

Collective moving of inspection areas

This function is essential to simultaneously move multiple inspection areas for the purpose of fine adjustment of the target position. The areas can be chosen by camera, position correction group, or inspection checker type.

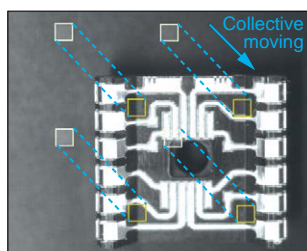

PVWIN200 setup software Main-hour reduction

User-friendly drag-and-drop operations

Drag the target image and drop it onto a PVWIN200 screen to start the operation. The guidance by the navigation view icons will help you set the inspection conditions.

Simulation cycle

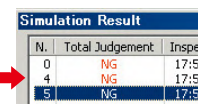
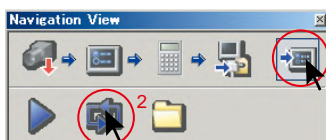

Can be switched to the screen displaying "NG" items only

Download PVWIN for free from our website.

Checker list

The checker list shows the on/off state of each inspection function and the inspection results so that users can check the program outline. It is possible to jump to the setting screen for a selected function and edit the settings.

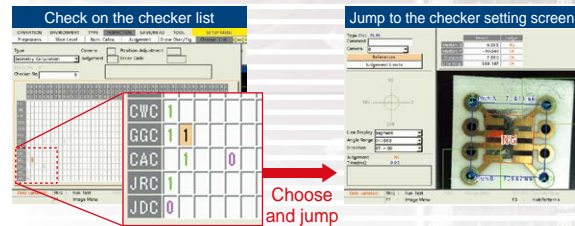

Histogram

In the image preprocessing and the binarization setting screens, both the original image and its histogram are displayed as guidance for processing

Thumbnail of the original image

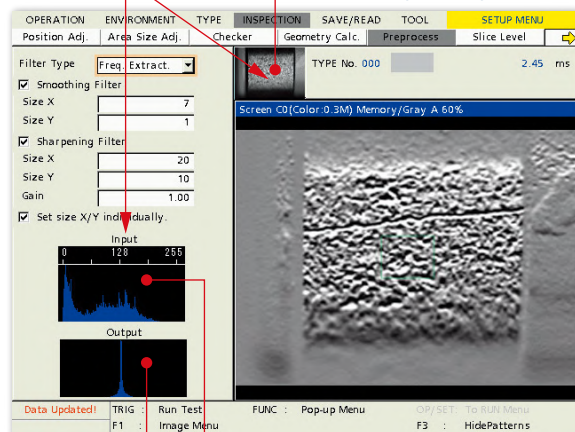

After processing Before processing

Setting help

Various functions are built in that are useful when installing the PV200 series at the worksite.

Setting help function

- Focus adjustment
- Communication test
- Aperture adjustment
- Parallel I/O test
- Grey data analysis
- Image capture delay adjustment

Simulation cycle for debugging

The continuous simulation and data logging functions facilitate setting data corrections and verifications. The export function allows you to manage the setting data change history.

PV200 setup software
IMAGECHECKER

PVWIN200

Interface

Communication Max-hour reduction

PLC communication

By simply setting the register address of the PLC or other equipment you are using with the device, it is possible to receive PV200 series results and perform command operations.

Result output

By using the PLC communications function, the PV200 series results can be written directly to the PLC register without a communications program.

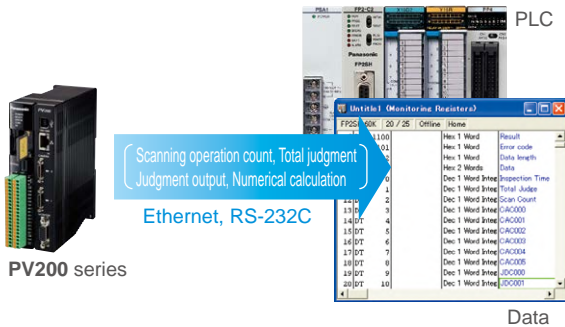

Command processing

PV200 external command control is possible by operating the PLC register values without a communications program.

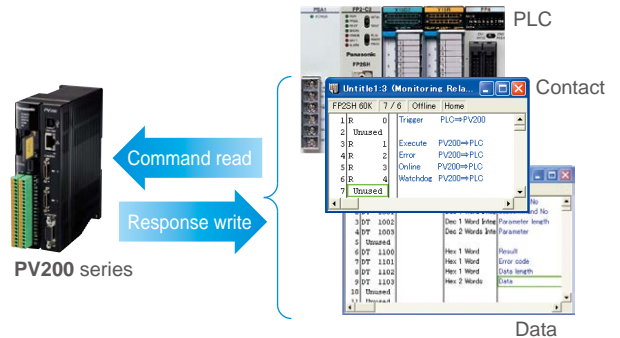

High-speed communications and storage (Built-in memory / Ethernet / SD memory card)

Inspection and judgement result data output

Compatible with parallel I/O, RS-232C (115.2 kbps), Ethernet (Gigabit). The RS-232C PLC communications are now compatible with Modbus RTU.

Image data

- Up to 312 images captured by the 0.3M camera, 39 images captured by the 2M camera and 14 images captured by the 4M camera can be stored in the built-in memory in real time (without increasing the processing time).^{*1}
- A 32 GB SD memory card can store a maximum of about 90,000 images captured by the 0.3M camera, about 16,500 images captured by the 2M camera or about 7,600 images captured by 4M camera.^{*2}
- The Gigabit Ethernet LAN port allows image transfers at three to five times the speed of 100-Megabit Ethernet. Via this port, one image captured by the 0.3M camera can be transferred in 80 msec.^{*3}

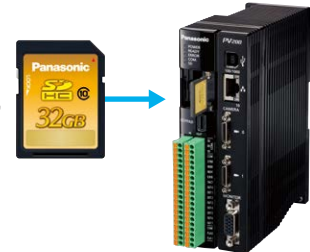

Conventional model (PV310) 100-Megabit Ethernet	Transfer time
PV200 Gigabit Ethernet	Transfer time

^{*1}: When one camera is connected. ^{*2}: Color camera images: Bayer format
^{*3}: Depends on the connected equipment.

Multiple simultaneous output to external devices.

Judgement results and numerical result data can be simultaneously output to RS-232C and Ethernet interfaces, and to SD/SDHC memory cards. For example, the data for traceability and inspection control can be simultaneously output.

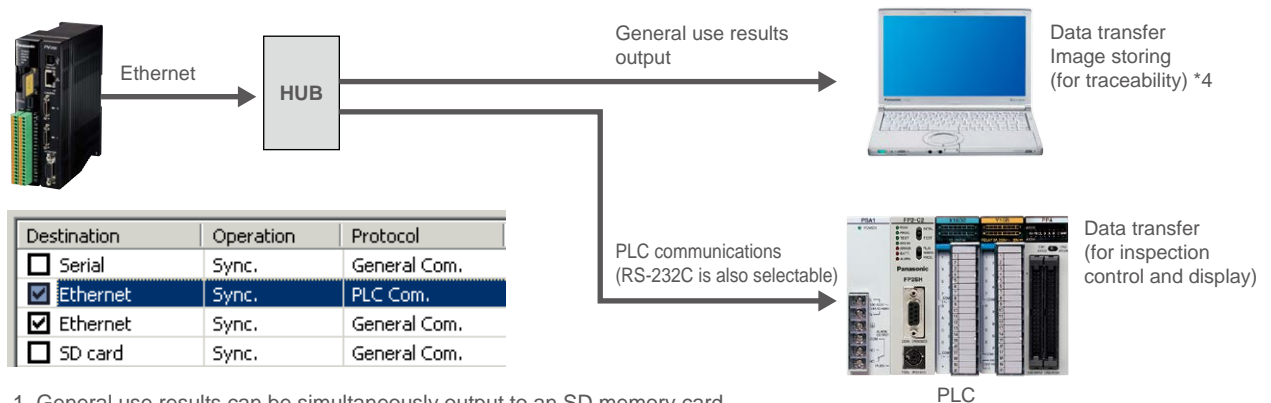

- General use results can be simultaneously output to an SD memory card, RS-232C and Ethernet interfaces.
- Ethernet can be used at the same time for output of general use results and PLC communications.

^{*4}: The free software "Image Receiver for PV" is used.

IMAGECHECKER PV230

Model with code reading and optical character recognition functions built into PV200

Solutions for Optical Character Recognition (OCR) and 1D / 2D Code Reading (CR)

All-in-one model featuring image processing, optical character recognition (OCR) and code reading (CR) functions

- Compatible with a wide variety of cameras ranging from 0.3M to 4M pixels
Reliable character extraction achieved by the color / gray combination function
- The optical character recognition (OCR) can read up to 80 characters. [Capable of case-sensitive (capital letter or small letters) reading]
- The 1D / 2D code reading function is compatible with the following code types and can read up to 80 characters.
1D code: 25 types (Industrial 2 of 5, EAN-13, Code 39, etc. *1)
2D code: 2 types (Data Matrix ECC 200, QR Code)
- Capable of checking the 1D / 2D code reading result with that of reading the character string indicated with the code
- Equipped with a function to check the 2D code print quality (Compliant with ISO / IEC 15415)
- Capable of combination inspections using a variety of checker functions of PV200 (Smart edge, etc.)
- The PLC communications function enables communications with PLC without programming (Ethernet and RS-232C).
- Compatible with setup software (PVWIN230), which enables off-line operation



A wide variety of Preprocessing filters, Color extraction and Gray conversion functions provide reliable reading

Reliably extracting only characters of selected colors even if the contrast with the background is low (Characters of up to 8 colors can be extracted simultaneously.)



Capable of reliably reading deformed, distorted or partly chipped characters
Arc-shaped character strings, italic and dotted characters can be read.

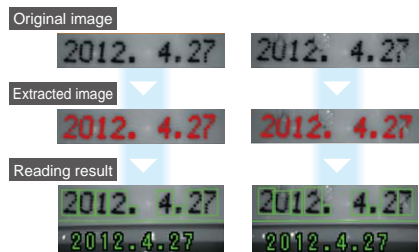

2D code reading: Codes with contrast fluctuations, out-of-focus codes, and codes with hidden or chipped portions can also be read.

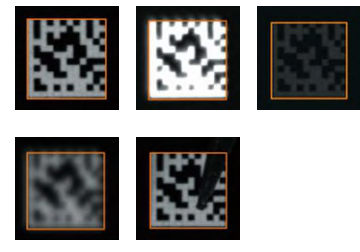

*1: Readable 1D codes (all the 25 types) : Industrial 2 of 5, Interleaved 2 of 5, Codabar, Code39, Code93, Code128, EAN-13, EAN-13 Add-On 2, EAN-13 Add-On 5, EAN-8, EAN-8 Add-On 2, EAN-8 Add-On 5, UPC-A, UPC-A Add-On 2, UPC-A Add-On 5, UPC-E, UPC-E Add-On 2, UPC-E Add-On 5, PharmaCode, RSS-14 (GS1 Databar), RSS-14 Truncated (GS1 Databar Truncated), RSS-14 Stacked (GS1 Databar Stacked), RSS-14 Stacked Omnidirectional (GS1 Databar Stacked Omnidirectional), RSS Limited (GS1 Databar Limited), RSS Expanded (GS1 Databar Expanded)

Application examples of PV230

Optical character recognition and positioning applications

Conventional problem

Work-piece slippage caused printing misalignment, which led to failure to pass the shipping inspection process.

Before



(No image processing)

Benefit by PV230

By performing position adjustment during the printing process, more products can pass which equates to greater yields. Furthermore, optical character recognition can also be performed in the same process.

After

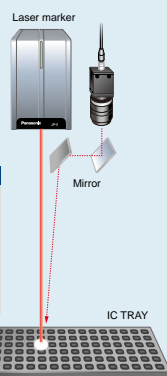
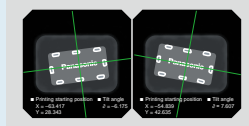

Code reader, optical character recognition, stamp mark presence and external inspection applications

Conventional problem

It was necessary to control a machine vision system and a code reader in multiple steps by workers.

Before



2D code

Benefit by PV230

The traceability can be done in one step, which makes automation possible. Furthermore, external inspection can also be performed in the same step.

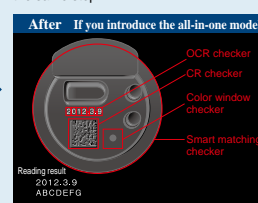

Reading result
2012.3.9
ABCDEFGH

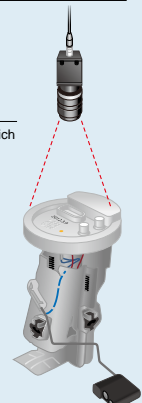

Suggestion of Machine Vision System for Alignment

Suggestion 1 Auto calibration function

Suggestion 2 Calibration graphics

Suggestion 3 Alignment simulation function [setup software]

Suggestion 4 Sample setting data



Supported stages: UWW, XYθ, Xθ, XθY and YθX (also supports Line θ)

Auto calibration function

The alignment mark is captured and the coordinates of the camera and stage are automatically calibrated.

Settings are easy by using the sample setting data!
* Can be downloaded from our website.

[Setting procedure]

1 Calibration setting

- Stage setting • Mark setting

2 Using auto calibration function

- * The coordinates of camera and stage are automatically calibrated.

Calibration complete

- The difference in two camera views and flexible camera attachment (rotation and tilt) also supported.

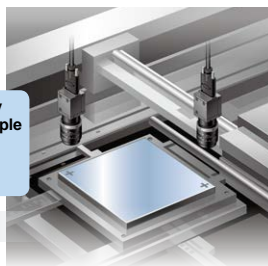

No troublesome settings and calculations!

Calibration graphics

Auto calibration result can be verified visually. Easy to verify whether or not calibration was performed accurately, one of the factors for alignment problems.

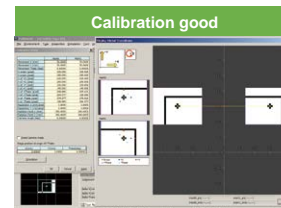
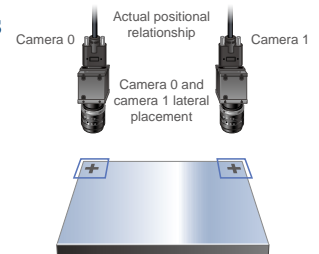

Auto calibration result: Lateral placement same as actual positional relationship

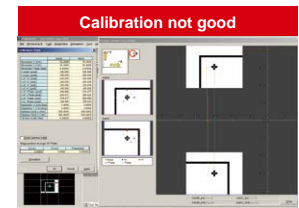

Auto calibration result: Vertical placement different from actual positional relationship

Alignment simulation function [setup software]

* Setup software can be downloaded from our website.

Alignment operation can be replicated on a PC.

The operation can be verified in stages through simulation that splits the alignment operation into 4 steps.

Step 1 Adjustment of rotation direction

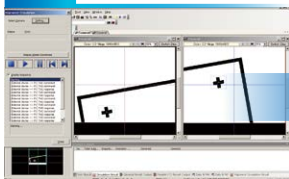

Step 2 Adjustment of X-axis direction

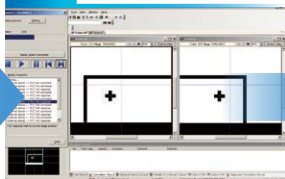

Step 3 Adjustment of Y-axis direction

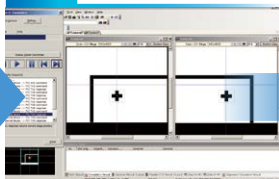

Step 4 Alignment complete

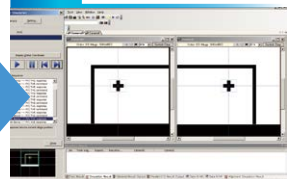

- In the event of a problem, as long as you have an image, you can use the setup software to check the alignment operation at your desk. This is convenient for determining the location of the source of the problem.
- By being able to check the output values, you can tell whether the problem is caused by image processing or whether it originates in the device.

Sample setting data

* Sample setting data can be downloaded from our website.

Sample setting data saved with basic alignment conditions is available. Default settings are easily created by changing conditions such as the marks used by the user.

Application examples of PV240

Applying LCD and film



Crimping LCD and film boards



IC tray positioning



Robot setup made totally simple! Introducing true robot vision

4 functions reduce robot setup time.



1 Auto calibration function

Man-hour reduction

Accuracy improvement

By simply registering 3 or 4 capture coordinates with the PV260, you can easily convert the camera's coordinate system to the robot's coordinate system.

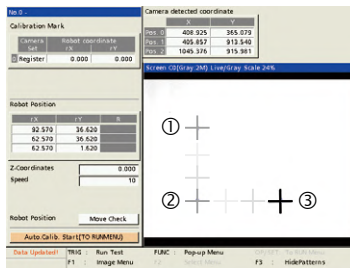

Advantage

- 1 Easier than doing it manually, work time is also reduced.
- 2 Even camera positional deviation can be quickly restored.
- 3 Variance in accuracy due to individual differences is eliminated.

2 Teaching support function

Man-hour reduction

Accuracy improvement

Improving on previous teaching operations that were carried out while manipulating a dedicated robot pendant, robot teaching can now be done on the PV260 setup screen while viewing the captured image. Intuitive teaching can now be achieved using keypad operation.



- Teaching skill not required.
- Convenient in locations where teaching was difficult
- Increased safety
- Burden of repeated teaching reduced.

3 Robot tool offset function

Man-hour reduction

Accuracy improvement

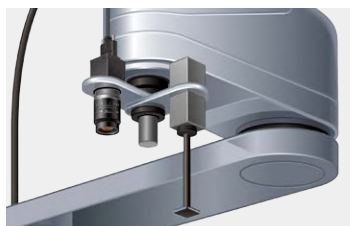

By simply registering two coordinates for the tool installed on the robot, the tool's coordinate system can be automatically calculated and converted to the robot's coordinate system.

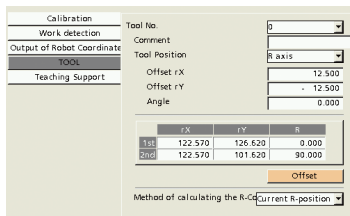

4 Direct communication function

Man-hour reduction

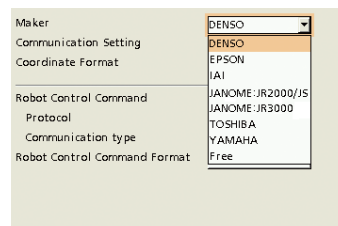

Direct communication is possible with different manufacturer's robot. PLC programming time can be reduced, because communication can be achieved by simply selecting the robot maker and type.

Robot can be operated from keypad.

Robot can be moved using keypad operation. Adjustment of capture position is easy with features such as auto calibration and teaching support.



PVWIN260 setup software

Robot vision inspection result can be replicated on a PC. The continuous simulation and data logging functions facilitate setting data creation, corrections and verifications.



System Configuration

Equipped with a full selection of interfaces essential for image processing devices of the future



SD memory card (SDHC compatible)



Keypad

Serial (RS-232C)

Parallel I/O

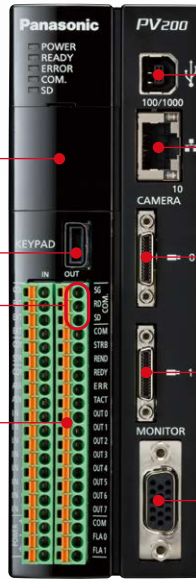

USB2.0

Gigabit Ethernet connector

Cameras (Digital cameras)

Up to two cameras of two different types can be connected.

0.3M color camera
0.3M color compact camera
2M color camera



0.3M grey camera
0.3M grey compact camera
2M grey camera
4M grey camera



*The 4M camera cannot be used in combination with another type of camera.

Analog RGB output



XGA monitor

Product List

Controller unit / Cameras / Keypads / Monitor / Camera attachment bracket

<p>IMAGECHECKER Controller unit</p>  <p>Machine Vision System PV200 ANPV0202ADP PV200 MC ANPV0202MC PV230 ANPV0232ADP Machine Vision System for Alignment PV240 ANPV0242ADP Robot Vision PV260 ANPV0262ADP</p>	<p>Digital cameras for PV200 series</p> <p>0.3M color camera (Quad-speed) ANPVC2040</p> <p>0.3M color compact camera (Triple-speed) ANPVC6030</p> <p>2M color camera ANPVC2260</p> <p>0.3M grey camera (Quad-speed) ANPVC1040</p> <p>0.3M grey compact camera (Triple-speed) ANPVC5030</p> <p>2M grey camera ANPVC1210</p> <p>4M grey camera ANPVC1470</p>	<p>Keypads</p>  <p>3 m 9.8 ft type: ANPVP03</p> <p>10 m 32.8 ft type: ANPVP10</p>	<p>Camera cables for PV200 series</p>  <p>3 m 9.8 ft type: ANPVC8103</p> <p>5 m 16.4 ft type: ANPVC8105 *2</p> <p>10 m 32.8 ft type: ANPVC8110 *2</p>				
<p>Cable for PV200 series compact camera (for ANPVC5030 / ANPVC6030)</p>  <p>3 m 9.8 ft type: ANPVC8203</p> <p>5 m 16.4 ft type: ANPVC8205</p> <p>10 m 32.8 ft type: ANPVC8210</p>	<p>Flexible camera cables</p>  <p>3 m 9.8 ft type: ANPVC8103R</p> <p>5 m 16.4 ft type: ANPVC8105R *2</p> <p>10 m 32.8 ft type: ANPVC8110R *2</p>	<p>0.3M camera lenses</p> <p>f = 6 with lock ANB842NL</p> <p>f = 8.5 with lock ANB843L *1</p> <p>f = 16 with lock ANB845NL</p> <p>f = 16 with lock ANM88161 *1</p> <p>f = 25 with lock ANB846NL</p>					
<p>0.3M camera lenses</p> <p>f = 25 with lock ANM88251 *1</p> <p>f = 50 with lock ANB847L</p> <p>f = 50 with lock ANM88501</p>			<p>2-megapixel camera lenses</p> <p>f = 16 with lock ANPVL162</p> <p>f = 25 with lock ANPVL252</p> <p>f = 50 with lock ANPVL502</p>			<p>Adapter rings (for the 0.3M cameras and 2-megapixel cameras)</p> <p>5 mm 0.20 in x 1 ring ANB84805</p> <p>40, 20, 10, 5, 1, 0.5 mm 1.57, 0.79, 0.39, 0.20, 0.04, 0.02 in x 1 ring ANB848</p>	
<p>XGA monitor</p>  <p>10.4 inches ANPVM11021</p>	<p>Monitor cables</p>  <p>3 m 9.8 ft type: ANMX83313</p> <p>5 m 16.4 ft type: ANMX83315</p>	<p>Camera attachment bracket (For 4M grey camera) ANPVH005</p>	<p>Digital power supply units for LED lighting</p> <p>10 W ANB86001</p> <p>30 W ANB86003</p> 				

*1 It can not be used in combination with the 0.3M compact camera.
*2 It can not be used in combination with the 4M grey camera.

Controller unit / Monitor / Cameras / Keypads

● Controller unit ANPV0202ADP / ANPV0202MC / ANPV0232ADP / ANPV0242ADP / ANPV0262ADP

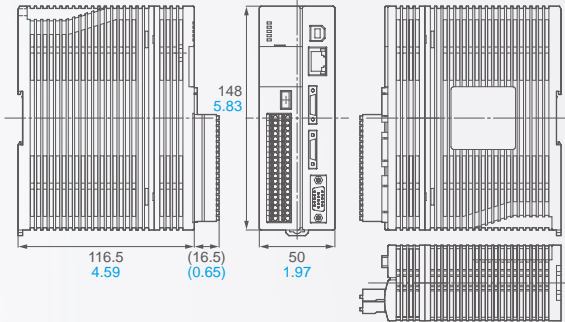

● 0.3M color and grey cameras ANPVC2040 / ANPVC1040 ● 2M color and grey cameras ANPVC2260 / ANPVC1210

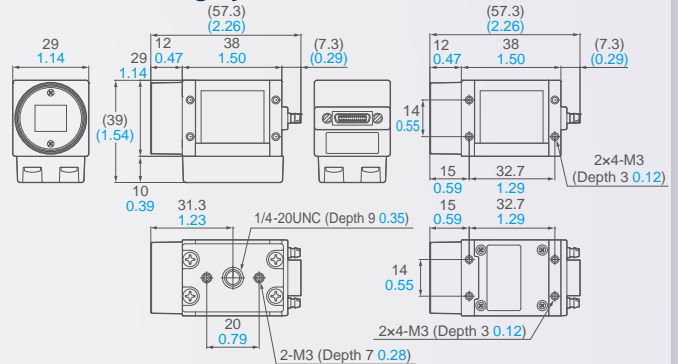

● XGA monitor ANPVM11021

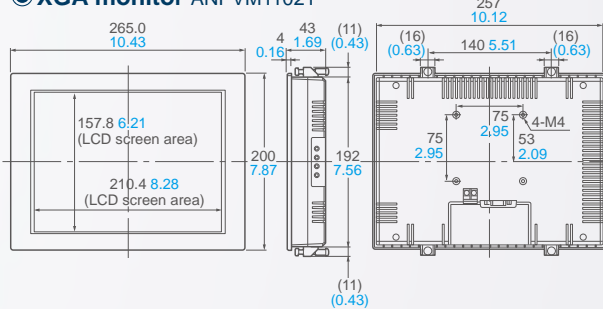

● 0.3M color and grey compact camera ANPVC6030 / ANPVC5030

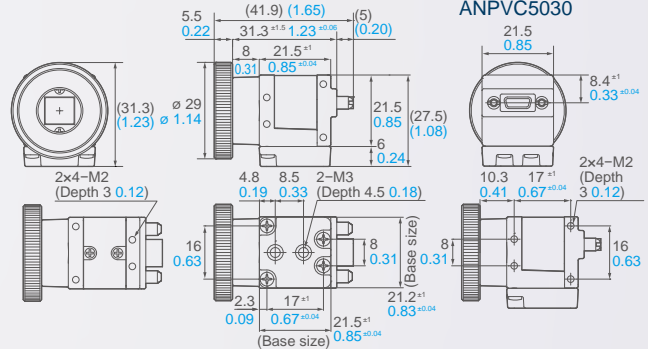

● Operation keypad ANPV□

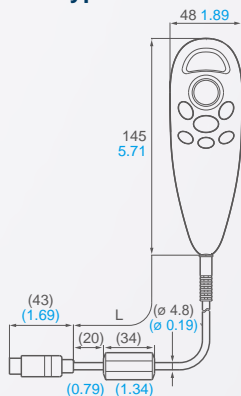

● 4M grey camera ANPVC1470

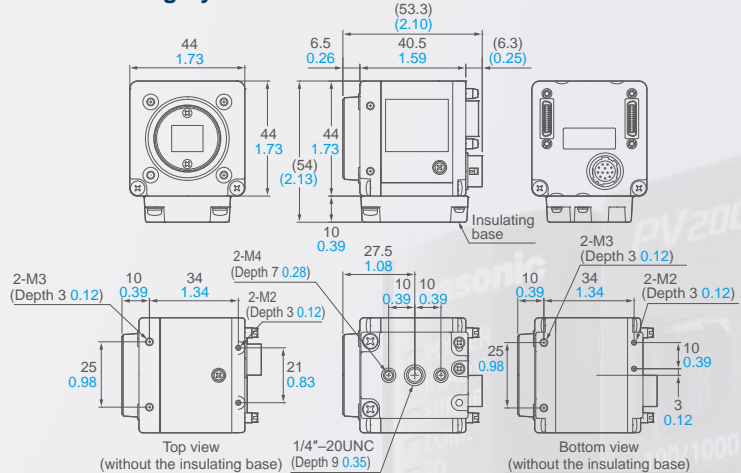

● Lenses for camera (Unit: mm in)

	0.3M camera lenses *2								2-megapixel camera lenses		
	f = 6	f = 8.5	f = 16	f = 25	f = 50	f = 16	f = 25	f = 50	ANPVL162	ANPVL252	ANPVL502
F-number	1.2	1.5	1.4	1.4	1.4	1.6	1.4	2.8	1.4	1.4	2.8
∅ A	42 1.65	42 1.65	31 1.22	30.5 1.20	31 1.22	30.5 1.20	48 1.89	30.5 1.20	34 1.34	34 1.34	34 1.34
L	46 1.81	40 1.58	33 1.30	31.21 1.23	37.3 1.47	31.5 1.24	48 1.89	38.5 1.52	35.9 to 38.0 1.41 to 1.50	47.1 to 52.2 1.85 to 2.06	63.0 to 77.4 2.48 to 3.05
B	- *1	- *1	- *1	21 0.83	- *1	21 0.83	- *1	21 0.83	22.5 0.89	22.5 0.89	22.5 0.89
C	- *1	- *1	- *1	19.8 0.78	- *1	20.05 0.79	- *1	20.6 0.81	22 0.87	22 0.87	22 0.87

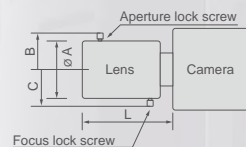

*1: The projection of the lock screw (M1.4 pan-head machine screw) is a maximum of 2 mm 0.08 in.

*2: ANB843L, ANM88161 and ANM88251 can not be used in combination with the 0.3M grey compact camera.

● Camera attachment bracket (For 4M grey camera) ANPVH005



Please refer to our website.

Digital power supply units for LED lighting

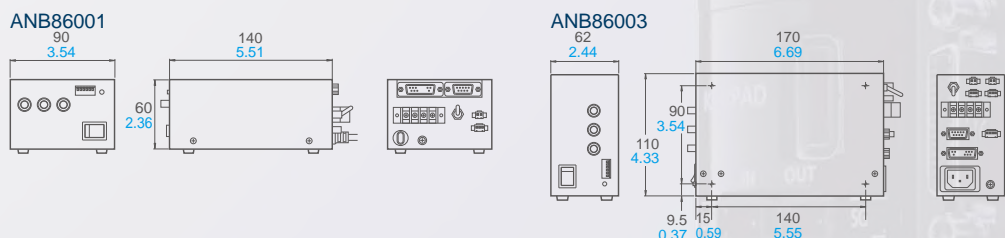

● Digital power supply units for LED lighting



Product Lineup

Function item	PV200	PV200 MC	PV230	
Controller unit	<p>Color and greyscale combination</p>  <p>Image processing with top-level accuracy in its class is available with a surprisingly small number of man-hours required for programming.</p>	<p>High speed processing</p>  <p>0.3M compact limited edition special value camera with all the functions of the PV200.</p>	<p>Code reader and Optical character recognition</p>  <p>All-in-one model featuring image processing, optical character recognition (OCR) and code reading (CR) functions</p>	
Maximum connectable number of cameras	2	2	2	
Camera	Pixel	0.3M compact 0.3M 2M 0.3M compact 0.3M 2M 4M	0.3M compact 0.3M compact 0.3M 0.3M compact 0.3M 2M 0.3M 0.3M 2M 4M	
	Grey/Color	Color Grey	Color Grey	
	Shutter speed	30 μs to 1,000 ms (Set in increments of 10 μs) 100 μs to 500 ms (Set in increments of 10 μs, 0.3M compact type only)	100 μs to 500 ms (Set in increments of 10 μs)	30 μs to 1,000 ms (Set in increments of 10 μs) 100 μs to 500 ms (Set in increments of 10 μs, 0.3M compact type only)
Monitor output	Analog RGB	Analog RGB	Analog RGB	
Processing methods	Color, Greyscale, Binary	Color, Greyscale, Binary	Color, Greyscale, Binary	
Maximum registerable number of product types *1	256 types	256 types	256 types	
Maximum settable number of checkers *1	1,000 checkers/product type max.	1,000 checkers/product type max.	1,000 checkers/product type max.	
Major inspection functions (Checkers)	Position adjustment / Position rotation adjustment	○	○	○
	Area size adjustment	○	○	○
	Binary window / Binary edge	○	○	○
	Feature extraction	○	○	○
	Grey window / Grey edge	○	○	○
	Smart matching	○	○	○
	Contour matching	○	○	○
	Flaw detection	○	○	○
	Connector (binary window, grey window, grey edge)	○	○	○
	Smart edge (circles) / (line)	○	○	○
	Geometry calculation	○	○	○
	Character / Figure drawing	○	○	○
	Dedicated function			Optical Character Recognition (OCR) and 1D / 2D Code Reading (CR)
Numerical calculation / Judgment output	1,000 formula/product type max.	1,000 formulas/product type max.	1,000 formula/product type max.	
Data R/W	160 data	160 data	160 data	
Execution mode	Execution all	Execution of all checkers	Execution of all checkers	
	Branch execution	0 to 9 can be set.	0 to 9 can be set.	
	Designated execution	0 to 9 can be set.	0 to 9 can be set.	
Password protection	○ (Select menu)	○ (Select menu)	○ (Select menu)	
Image preprocess / Image conversion	Preprocessing filters: 21 types, for each product type 16 groups/camera, 10 stages max.	Preprocessing filters: 21 types, for each product type 16 groups/camera, 10 stages max.	Preprocessing filters: 21 types, for each product type 16 groups/camera, 10 stages max.	
Others				
Interface	RS-232C	1 port	1 port	
	Ethernet	○	○	
	SD / SDHC	○	○	
	USB	○	○	
	Parallel input / output	14 inputs, 15 outputs	14 inputs, 15 outputs	14 inputs, 15 outputs
Setup software	PVWIN200	PVWIN200	PVWIN230	
Recommended monitor (cable)	ANPVM11021 (ANMX83313)	ANPVM11021 (ANMX83313)	ANPVM11021 (ANMX83313)	

*1: Depend on the setting data size.

	PV240	PV260	PV500V2	PD60 / PD65
	Alignment	Robot Vision	High speed, high productivity	2D Code Reading Sensor
				
	Alignment functions are built in, such as the "Auto calibration function" and "Alignment simulation function".	4 dedicated robot functions are built in. This not only increases productivity, but achieves a great reduction in the man-hours in robot prepping, maintenance, and product type changeovers.	"4 + 1" Penta processor enables extremely fast parallel processing. Verification of NG (failed) images and program corrections are possible while inspecting all items without stopping the production line.	Compliant with international standards Featuring a "2D code print quality verification function"
	2	2	4	1
	0.3M compact 0.3M 2M 0.3M compact 0.3M 2M 4M	0.3M compact 0.3M 2M 0.3M compact 0.3M 2M 4M	0.3M compact 0.3M 2M	0.1M
	Color Grey	Color Grey	Grey	Grey
	30 μs to 1,000 ms (Set in increments of 10 μs) 100 μs to 500 ms (Set in increments of 10 μs, 0.3M compact type only)	30 μs to 1,000 ms (Set in increments of 10 μs) 100 μs to 500 ms (Set in increments of 10 μs, 0.3M compact type only)	30 μs to 1,000 ms (Set in increments of 10 μs)	30 μs to 50 ms
	Analog RGB	Analog RGB	Analog RGB	—
	Color, Greyscale, Binary	Color, Greyscale, Binary	Greyscale, Binary	Binary
	256 types	256 types	25,600 types	7 types
	1,000 checkers/product type max.	1,000 checkers/product type max.	1,000 checkers/product type max.	1 checker/product type
	○	○	○	—
	○	○	○	—
	○	○	○	—
	○	○	○	—
	○	○	○	—
	○	○	○	—
	○	○	○	—
	○	○	○	—
	○	○	○	—
	○	○	○	—
	Auto calibration, Calibration graphics and Alignment simulation	Auto calibration, Teaching support, Robot tool offset, Direct communication, Optical character recognition and 2D code		2D code reading ● DataMatrix (ECC200) ● QR code ● Micro QR code
	1,000 formula/product type max.	1,000 formula/product type max.	1,000 formula/product type max.	—
	160 data	160 data	320 data	—
	Execution of all checkers	Execution of all checkers	Execution of all checkers	Execution of all checkers
	0 to 9 can be set.	0 to 9 can be set.	0 to 9 can be set.	—
	0 to 9 can be set.	0 to 9 can be set.	0 to 9 can be set.	With retry function
	○ (Select menu)	○ (Select menu)	○	—
	Preprocessing filters: 21 types, for each product type 16 groups/camera, 10 stages max.	Preprocessing filters: 21 types, for each product type 16 groups/camera, 10 stages max.	Preprocessing filters: 21 types, for each product type 5 groups/camera, 10 stages max.	Preprocessing filters: 14 types, 10 stages max.
			Program editing/testing in RUN mode	Integrated lens and lighting unit, Protective construction: IP67G Stationary type: PD60 , Handy type: PD65
	1 port	1 port	1 port	1 port
	○	○	○	—
	○	○	○	—
	○	○	○	○
	14 inputs, 15 outputs	14 inputs, 15 outputs	PHOENIX terminal: 14 inputs, 15 outputs MIL terminal: 32 inputs, 32 outputs	2 inputs, 3 outputs
	PVWIN240	PVWIN260	PVWIN	PDTOOL
	ANPVM11021 (ANMX83313)	ANPVM11021 (ANMX83313)	ANPVM11021 (ANMX83313)	—

Part No. List

Controller units

Product Name	Specification	Part No.
PV200	PhotoMOS relay output, 2-camera type	ANPV0202ADP
PV200 MC	PhotoMOS relay output, 2-camera type	ANPV0202MC
PV230	PhotoMOS relay output, 2-camera type	ANPV0232ADP
PV240	PhotoMOS relay output, 2-camera type	ANPV0242ADP
PV260	PhotoMOS relay output, 2-camera type	ANPV0262ADP
PV500V2	NPN output, 2-camera type	ANPV0502V2ADN
	PhotoMOS relay output, 2-camera type	ANPV0502V2ADP
	NPN output, 4-camera type	ANPV0504V2ADN
	PhotoMOS relay output, 4-camera type	ANPV0504V2ADP
2D Code reading sensor PD60	Field of view: 2 x 1.6 mm 0.08 x 0.06 in, Installation distance: 15±0.5 mm 0.59±0.02 in	ANPD060-02
	Field of view: 4 x 3.2 mm 0.16 x 0.13 in, Installation distance: 50±2.5 mm 1.97±0.10 in	ANPD060-04
	Field of view: 5 x 4 mm 0.20 x 0.16 in, Installation distance: 27±1.0 mm 1.06±0.04 in	ANPD060-05
	Field of view: 6 x 4.8 mm 0.24 x 0.19 in, Installation distance: 30±1.5 mm 1.18±0.06 in	ANPD060-06
	Field of view: 10 x 8 mm 0.39 x 0.32 in, Installation distance: 100±5.0 mm 3.94±0.20 in	ANPD060-10
	Field of view: 10 x 8 mm 0.39 x 0.32 in, Installation distance: 45±2.0 mm 1.77±0.08 in	ANPD060S10
	Field of view: 12 x 10 mm 0.47 x 0.39 in, Installation distance: 110±5.5 mm 4.33±0.22 in	ANPD060-12
	Field of view: 15 x 12 mm 0.59 x 0.47 in, Installation distance: 65±3.0 mm 2.56±0.12 in	ANPD060-15
	Field of view: 20 x 16 mm 0.79 x 0.63 in, Installation distance: 80±4.0 mm 3.15±0.16 in	ANPD060-20
	Field of view: 25 x 20 mm 0.98 x 0.79 in, Installation distance: 200±10 mm 7.78±0.39 in	ANPD060-25
2D Code reading sensor PD65	Field of view: 25 x 20 mm 0.98 x 0.79 in, Installation distance: 105±5 mm 4.13±0.20 in	ANPD060S25
	Field of view: 30 x 25 mm 1.18 x 0.98 in, Installation distance: 55±2.5 mm 2.17±0.10 in	ANPD060-30
	Field of view: 12 x 10 mm 0.47 x 0.39 in, Installation distance: Contact type Field of view: 25 x 20 mm 0.98 x 0.79 in, Installation distance: Contact type	ANPD065-12 ANPD065-25

Cameras and Camera cables ○: Applicable model

Product Name	Specification	Part No.	PV200	PV200 MC	PV230	PV240	PV260	PV500V2	PD60/PD65
0.3M Color camera	0.3M	ANPVC2040	○		○	○	○		
0.3M Color compact camera	0.3M	ANPVC6030	○	○	○	○	○		
2M Color camera	2M	ANPVC2260	○		○	○	○		
0.3M Grey camera	0.3M	ANPVC1040	○		○	○	○	○	
0.3M Grey compact camera	0.3M	ANPVC5030	○	○	○	○	○	○	
2M Grey camera	2M	ANPVC1210	○		○	○	○	○	
4M Grey camera	4M	ANPVC1470	○		○	○	○		
Camera cable	3 m 9.8 ft	ANPVC8103	○		○	○	○	○	
	5 m 16.4 ft *1	ANPVC8105	○		○	○	○	○	
	10 m 32.8 ft *1	ANPVC8110	○		○	○	○	○	
	Flexible 3 m 9.8 ft	ANPVC8103R	○		○	○	○	○	
	Flexible 5 m 16.4 ft *1	ANPVC8105R	○		○	○	○	○	
	Flexible 10 m 32.8 ft *1	ANPVC8110R	○		○	○	○	○	
	For compact camera 3 m 9.8 ft	ANPVC8203	○	○	○	○	○	○	
	For compact camera 5 m 16.4 ft	ANPVC8205	○	○	○	○	○	○	
	For compact camera 10 m 32.8 ft	ANPVC8210	○	○	○	○	○	○	

*1 It can not be used in combination with the 4M grey camera (ANPVC1470).

Keypads ○: Applicable model

Product Name	Specification	Part No.	PV200	PV200 MC	PV230	PV240	PV260	PV500V2	PD60/PD65
Keypad	3 m 9.8 ft, CE product	ANPVP03	○	○	○	○	○	○	
	10 m 32.8 ft, CE product	ANPVP10	○	○	○	○	○	○	

Lens ○: Applicable model

Product Name	Specification	Part No.	PV200	PV200 MC	PV230	PV240	PV260	PV500V2	PD60/PD65
For 0.3M camera	f=6 C mount lens with lock	ANB842NL	○	○	○	○	○	○	
	f=8.5 C mount lens with lock	ANB843L	○ *1		○ *1	○ *1	○ *1	○	
	f=16 C mount compact lens with lock	ANB845NL	○	○	○	○	○	○	
	f=25 C mount compact lens with lock	ANB846NL	○	○	○	○	○	○	
	f=50 C mount lens with lock	ANB847L	○	○	○	○	○	○	
	f=16 C mount ultra compact lens with lock	ANM88161	○ *1		○ *1	○ *1	○ *1	○	
	f=25 C mount ultra compact lens with lock	ANM88251	○ *1		○ *1	○ *1	○ *1	○	
	f=50 C mount compact lens with lock	ANM88501	○	○	○	○	○	○	
For 2-megapixel camera	f=16 C mount lens with lock	ANPVL162	○		○	○	○	○	
	f=25 C mount lens with lock	ANPVL252	○		○	○	○	○	
	f=50 C mount lens with lock	ANPVL502	○		○	○	○	○	

*1 It can not be used in combination with the 0.3M grey compact camera.

Adapter rings ○: Applicable model

Product Name	Specification	Part No.	PV200	PV200 MC	PV230	PV240	PV260	PV500V2	PD60/PD65
C mount	Ring set (40/20/10/5/1/0.5 mm 1.58/0.79/0.39/0.20/0.04/0.02 in, each 1 pc.)	ANB848	○	○	○	○	○	○	
	5 mm 0.20 in adapter ring, 1pc.	ANB84805	○	○	○	○	○	○	

Monitors and Monitor cables ○: Applicable model

Product Name	Specification	Part No.	PV200	PV200 MC	PV230	PV240	PV260	PV500V2	PD60/PD65
XGA monitor	24 V DC, 10.4 inches	ANPVM11021	○	○	○	○	○	○	
For XGA monitor	Monitor cable: 3 m 9.8 ft	ANMX83313	○	○	○	○	○	○	
	Monitor cable: 5 m 16.4 ft	ANMX83315	○	○	○	○	○	○	

Others ○: Applicable model

Product Name	Specification	Part No.	PV200	PV200 MC	PV230	PV240	PV260	PV500V2	PD60/PD65
Attachment bracket	4 attachment bracket for 4M grey camera	ANPVH005	○		○	○	○		
	For mounting PD60	ANE8870							○
Options (repair parts)	Set with PD65 guide pipe, packing, and stop screws	ANPD068-G1							○
	Set with PD65 guide pipe (short pipe type), packing, and stop screws	ANPD068-G2							○
	Power supply I/O cable (2,700 mm 106.30 in) for PD60 / PD65	ANPD068-K1							○
	Set with PD60 front panel, packing, and stop screws	ANPD068-P1							○
	Set with PD60 front panel (narrow view type), packing, and stop screws	ANPD068-P2							○
Extension cables	3 m 9.8 ft for PD60 / PD65	ANPD068-03							○
	5 m 16.4 ft for PD60 / PD65	ANPD068-05							○
	10 m 32.8 ft for PD60 / PD65	ANPD068-10							○
RS-232C communication cable	For PLC (discrete-wire cable) connection, 2 m 6.6 ft	AIP81842						○	
	For PC (D-SUB : 9 pin) connection, 3 m 9.8 ft	AFB85853						○	

General specifications

Item	Specifications
Rated operating voltage	24 V DC
Operating voltage range	21.6 to 26.4 V DC (including ripples)
Rated current consumption	1.2 A max.
Ambient temperature during use	0 to +45 °C 32 to +113 °F (However, no condensation or no freezing)
Storage ambient temperature	-20 to +60 °C -4 to +140 °F (However, no condensation or no freezing)
Ambient humidity during use	35 to 85 % RH (at 25 °C 77 °F, However, no condensation or no freezing)
Storage ambient humidity	35 to 85 % RH (at 25 °C 77 °F, However, no condensation or no freezing)
Noise immunity	1,000 V, Pulse width: 50 ns, 1 μs (using the noise simulator method)
Vibration resistance	10 to 55 Hz, 1 sweep/min, double amplitude of 0.75 mm 0.03 in, 30 minutes each in the X, Y, and Z directions
Shock resistance	196 m/s ² , 5 times each in the X, Y and Z directions
Insulation resistance	100 MΩ or higher (measured by a 500 V DC megger) *1
Input and output terminals (initial value)	Input and output terminals – Power and ground terminals Input and output terminals – Non-energized metal part Power terminal – Non-energized metal part
Breakdown voltage (initial value)	500 V AC for 1 min (600 V AC for 1 sec), Cutoff current: 10 mA *1 Input and output terminals – Power and ground terminals Input and output terminals – Non-energized metal part Power terminal – Non-energized metal part
Battery life	10 years approx. (at 25 °C 77 °F)
Weight	0.5 kg approx. (including terminal blocks)
Pollution degree	2

*1: The evaluation was carried out with the primary side power supply varistor and capacitor removed from the internal circuit of the unit.

Functional specifications

Item	Specifications													
CPU	32-bit, RISC CPU & DSP													
Cameras	Up to two cameras selected from among 0.3M grey/grey compact/color cameras (640 x 480), 0.3M color compact camera (640 x 478) and 2M grey/color cameras (1,600 x 1,200) can be connected. Up to two 4M grey cameras can be connected. *2													
Monitor output	Analog RGB (640 x 480) output													
Memory card	SD/SDHC memory card													
Input/output	PLC communication compatible models (RS-232C)	<table border="1"> <tr> <td>Panasonic Industrial Devices SUNX</td> <td>FP series</td> </tr> <tr> <td>OMRON</td> <td>C, CV, and CS1 series</td> </tr> <tr> <td>Mitsubishi Electric</td> <td>A, Q, FX, and FX2N series</td> </tr> <tr> <td>Fuji Electric</td> <td>MICREX-SX SPH series</td> </tr> <tr> <td>Allen-Bradley</td> <td>SLC500 series</td> </tr> <tr> <td>Modbus RTU compatible (performance confirmed with Siemens S7-1200)</td> <td></td> </tr> </table>	Panasonic Industrial Devices SUNX	FP series	OMRON	C, CV, and CS1 series	Mitsubishi Electric	A, Q, FX, and FX2N series	Fuji Electric	MICREX-SX SPH series	Allen-Bradley	SLC500 series	Modbus RTU compatible (performance confirmed with Siemens S7-1200)	
	Panasonic Industrial Devices SUNX	FP series												
	OMRON	C, CV, and CS1 series												
	Mitsubishi Electric	A, Q, FX, and FX2N series												
	Fuji Electric	MICREX-SX SPH series												
Allen-Bradley	SLC500 series													
Modbus RTU compatible (performance confirmed with Siemens S7-1200)														
PLC communication compatible models (Ethernet)	<table border="1"> <tr> <td>Panasonic Industrial Devices SUNX</td> <td>FP series, ET-LAN unit</td> </tr> <tr> <td>Mitsubishi Electric</td> <td>Q series</td> </tr> <tr> <td>Yokogawa Electric</td> <td>FA-M3 series</td> </tr> </table>	Panasonic Industrial Devices SUNX	FP series, ET-LAN unit	Mitsubishi Electric	Q series	Yokogawa Electric	FA-M3 series							
Panasonic Industrial Devices SUNX	FP series, ET-LAN unit													
Mitsubishi Electric	Q series													
Yokogawa Electric	FA-M3 series													
PLC communication command	Specifiable external command instruction using PLC communication Command input format: polling / parallel input													
Parallel	14 inputs / 15 outputs													
Keypad input	Connector for dedicated keypad (ANPVP**), 1 channel													
USB	USB 2.0, A-B type (Only PVWIN200)													
Menu display	Four languages (five fonts), Switchable (Japanese, English, Korean, Traditional Chinese and Simplified Chinese)													
Monitor display	Split-screen display of up to two camera images, Zoom function (2 to 400%) Image display: Through/Memory/NG object images Display effects: Greyscale/Slice level group/Preprocessing group/Color/Extraction and binary/Grey conversion image, Display area (640 x 480)													
Processing methods	Greyscale processing/Thresholding processin/Color extraction/Grey conversion													
Processing resolution	2M camera (grey/color): 1,600 horizontal x 1,200 vertical pixels													
	0.3M camera (grey/grey compact/color): 640 horizontal x 480 vertical pixels													
	0.3M camera (color compact): 640 horizontal x 478 vertical pixels													
4M camera (grey): 2,048 horizontal x 2,048 vertical pixels														
Trigger input	Select from: All cameras or detection trigger													
Number of connected cameras	Up to two cameras													
Camera connection	Connection by Power Over Camera Link (PoCL)													
Capture method	Frame shooting only. Capable of partial capture of one point													
	In partial capture mode, the minimum capture area to be set for the 0.3M/4M camera is one line, and that for the 2M camera is 100 lines. (The area can be set in increments of one line for the grey camera, and two lines for the color camera.)													
Shutter speed	30 μs to 1,000 ms (Set in increments of 10 μs) However, 0.3M grey compact camera is 100μs to 500 ms (Set in increments of 10μs)													
Gain setting range	1.0 to 5.0													
Number of product types	256 types max. (depends on setting data)													
Password	Switching from the current operating screen to the setup screen can be password controlled (within 15 characters). Administration classification: invalid/valid (limit setting screen transition and limit regular menu switching)													
Inspection functions (Checkers)	1,000 checkers/product type max., including those for geometry calculation and character/figure drawing (depends on setting data)													
	Position adjustment, Position rotation adjustment, Rotation adjustment area size adjustment, Line, Binary window, Grey window, Binary edge, Grey edge, Feature extraction, Smart matching, Contour matching, Flaw detection, Connector (binary window), Connector (grey window), Connector (grey edge), Smart edge (circles), Smart edge (line), Color window													
	* Number of range masks: 16 ranges/checker * Maximum registrable number of smart matching and contour matching templates: 2,000 pcs.													
Geometry calculation	1,000 checkers/product type max., including those for inspection functions and character/figure drawing (depends on setting data) Eight calculation functions (distance between two points, intersection of two lines, median lines of two lines, perpendicular distance, approximate straight line, approximate circle, and approximate ellipse)													
Character/figure drawing	Up to 10,000 characters/graphics (1,000 checkers x 10)/product type can be displayed on the images (depends on setting data).													
Inspection operation mode	Sequential processing: After completing the result output, the next image capture for inspection can be started.													
	Parallel processing: After the capture and the synchronized output of results of the previous inspection are completed, the image capture process for the next inspection is ready to start, and then the capture and inspection results output are processed concurrently.													
Slice level group	16 group/camera, 256-grey scale (0 to 255)													

Functional specifications

Item	Specifications																																																																																																																																																									
Image preprocess	Preprocessing selections: Grey conversion / Color extraction / Grey preprocessing																																																																																																																																																									
	Grey conversion	Available only when a color camera is connected. For each product type, 16 groups/camera Each R/G/B value setting for grey conversion can be changed within the range of -1,000 to 1,000.																																																																																																																																																								
	Color extraction	Available only when a color camera is connected. Color extraction mode: Selectable between high speed and expansion Number of extractable colors: High speed: A total of 16 colors when one camera is connected and eight colors when two cameras are connected. Expansion: A total of 128 colors when one camera is connected and 64 colors when two cameras are connected. Only eight registered colors can be selected from one checker.																																																																																																																																																								
Grey preprocessing	For each product type, 16 groups/camera, 10 stages max. Preprocessing filters: 21 types																																																																																																																																																									
	(Dilation, Erosion, Erosion → Dilation, Dilation → Erosion, Auto correction, Grey cut, Area averaging, Correction settings, Median, Smoothing, Sobel, Prewitt, Laplacian, Edge extraction X, Edge extraction Y, Sharpen, Tophat, Dynamic, Grey difference, Rotation, and Reflect)																																																																																																																																																									
Numerical calculation	1,000 formulas/product type max., including those for judgement output (depends on setting data) Calculations involving output values of inspection functions																																																																																																																																																									
	Operators	Four fundamental operations (+, -, ×, ÷), Bracket operations, Trigonometric functions (14 types), Comparison functions (6 types), Math functions (15 types), Geometry functions (18 types), Coordinate conversion functions (8 types)																																																																																																																																																								
	Statistic data operation items	Scan count/OK count/NG count/Average/Variance/Max./Min./Range/OK average/OK variance/OK judgment max./OK judgment min./OK range/NG average/NG variance/NG judgment max./NG judgment min./NG range User limit: 1,000 items /product type max.																																																																																																																																																								
	Other operation items	Previous data of numerical calculation and judgment results, general-purpose registers																																																																																																																																																								
	Number of reference operators	16 items/formula max.																																																																																																																																																								
Judgement output	1,000 formula/product type max., including those for numerical calculation (depends on setting data) Substitution for and logical calculation of judgement results from checkers and numerical calculations																																																																																																																																																									
	Operators	NOT/AND/OR/XOR/Brackets																																																																																																																																																								
	Number of reference items	16 items/formula max.																																																																																																																																																								
Others	Total judgment conditions, save image conditions, Image output conditions, parallel output setting (8 outputs from OUT0 to OUT7 and 16 outputs from OUT0 to OUT15, or all setting output)																																																																																																																																																									
	Collective movement of set checkers in units of position/rotation adjustment groups Specify the "Move" or "Not move" option for each checker type. However, position and rotation adjustment checkers cannot be moved.																																																																																																																																																									
Marker	8 markers/product type max. for each camera, Graphic display on the operation screen, Selectable from six colors Shapes: Rectangle/Circle, Ellipse/Polygon/Line/Cross																																																																																																																																																									
Data R/W	Two-window display of up to 80 (5x16) cells/product type on screen in table form in RUN mode Substitution of title input, checker conditions/results, numerical calculation results, numerical calculation judgment results, judgment results, statistical results possible. Change of upper/lower limits of numerical computation in the table in RUN mode possible.																																																																																																																																																									
Select menu	Maximum registrable number of arbitrary setup items in setup screen on menu: 16 items x 50 pages/type. Registration information: Button / Text / Page move / Separator Button allocation method: FUNC key for item / Selection from list Others: Page name registration possible																																																																																																																																																									
	Coordinates, coordinate origin, horizontal and vertical coefficients can be set for each camera to obtain actual dimensions for each product type.																																																																																																																																																									
	Processing method: Unit conversion / 1 point coordinate conversion / 2 point coordinate conversion / 3 points coordinate conversion Operation method: Static / Dynamic Standard registration: Arbitrary position / Smart matching / Contour matching / Intersection / Centre of circle / Feature extraction																																																																																																																																																									
Conversion data	Coordinates, coordinate origin, horizontal and vertical coefficients can be set for each camera to obtain actual dimensions. Others: Comment input																																																																																																																																																									
Template re-registration settings	Position: Set position/Adjusted position Display: Yes/No All execution: Execution of all checkers																																																																																																																																																									
Execution mode	Branch execution: Destination blocks (0 to 9) can be set.																																																																																																																																																									
	Designated execution: Blocks to be executed (0 to 9) can be set.																																																																																																																																																									
External input/output functions *3	○: Applicable, ✕: Inapplicable																																																																																																																																																									
	Input	<table border="1"> <thead> <tr> <th></th> <th>Parallel</th> <th>Serial</th> <th>Ethernet</th> <th>SD memory card</th> </tr> </thead> <tbody> <tr> <td>Inspection start instruction</td> <td>○</td> <td>○</td> <td>○</td> <td>—</td> </tr> <tr> <td>Re-inspection start instruction</td> <td>○</td> <td>○</td> <td>○</td> <td>—</td> </tr> <tr> <td>Product type change instruction</td> <td>○</td> <td>○</td> <td>○</td> <td>—</td> </tr> <tr> <td>Template re-registration instruction</td> <td>○</td> <td>○</td> <td>○</td> <td>—</td> </tr> <tr> <td>Display layout switch instruction</td> <td>○</td> <td>○</td> <td>○</td> <td>—</td> </tr> <tr> <td>Operation/stop switch instruction</td> <td>○</td> <td>○</td> <td>○</td> <td>—</td> </tr> <tr> <td>Statistics reset instruction</td> <td>○</td> <td>○</td> <td>○</td> <td>—</td> </tr> <tr> <td>Error reset instruction</td> <td>○</td> <td>○</td> <td>○</td> <td>—</td> </tr> <tr> <td>Instruction to save setting data in the built-in memory</td> <td>○</td> <td>○</td> <td>○</td> <td>—</td> </tr> <tr> <td>Instruction to save setting data in the SD memory card</td> <td>○</td> <td>○</td> <td>○</td> <td>—</td> </tr> <tr> <td>Instruction to read setting data from the built-in memory</td> <td>○</td> <td>○</td> <td>○</td> <td>—</td> </tr> <tr> <td>Instruction to read setting data from the SD memory card</td> <td>○</td> <td>○</td> <td>○</td> <td>—</td> </tr> <tr> <td>Instruction to cancel the saving/reading of setting data</td> <td>○</td> <td>○</td> <td>○</td> <td>—</td> </tr> <tr> <td>Instruction to save the image memory in the SD memory card</td> <td>○</td> <td>○</td> <td>○</td> <td>—</td> </tr> <tr> <td>Instruction to erase the image memory</td> <td>○</td> <td>○</td> <td>○</td> <td>—</td> </tr> <tr> <td>Instruction to print the screenshot</td> <td>○</td> <td>○</td> <td>○</td> <td>—</td> </tr> <tr> <td>Inspection/processing cancellation instruction</td> <td>○</td> <td>○</td> <td>○</td> <td>—</td> </tr> <tr> <td>Instruction to save the latest inspection image</td> <td>○</td> <td>✕</td> <td>✕</td> <td>—</td> </tr> <tr> <td>Instruction to read/change the set value</td> <td>✕</td> <td>○</td> <td>○</td> <td>—</td> </tr> <tr> <td>Instruction to prohibit the keypad screen operation</td> <td>✕</td> <td>○</td> <td>○</td> <td>—</td> </tr> <tr> <td>Keypad emulation instruction</td> <td>✕</td> <td>○</td> <td>○</td> <td>—</td> </tr> <tr> <td>PLC communication command read instruction</td> <td>○</td> <td>✕</td> <td>✕</td> <td>—</td> </tr> <tr> <td>Output</td> <td> <table border="1"> <thead> <tr> <th></th> <th>Parallel</th> <th>Serial</th> <th>Ethernet</th> <th>SD memory card</th> </tr> </thead> <tbody> <tr> <td>Scanning operation count</td> <td>○</td> <td>○</td> <td>○</td> <td>○</td> </tr> <tr> <td>Total judgement output</td> <td>○</td> <td>○</td> <td>○</td> <td>○</td> </tr> <tr> <td>Judgement calculation (JD) result output</td> <td>○</td> <td>○</td> <td>○</td> <td>○</td> </tr> <tr> <td>Numerical calculation result output</td> <td>○</td> <td>○</td> <td>○</td> <td>○</td> </tr> <tr> <td>Image output</td> <td>✕</td> <td>✕</td> <td>○*4</td> <td>○</td> </tr> <tr> <td>Screenshot output</td> <td>✕</td> <td>✕</td> <td>○*4</td> <td>○</td> </tr> </tbody> </table> </td> </tr> </tbody> </table>		Parallel	Serial	Ethernet	SD memory card	Inspection start instruction	○	○	○	—	Re-inspection start instruction	○	○	○	—	Product type change instruction	○	○	○	—	Template re-registration instruction	○	○	○	—	Display layout switch instruction	○	○	○	—	Operation/stop switch instruction	○	○	○	—	Statistics reset instruction	○	○	○	—	Error reset instruction	○	○	○	—	Instruction to save setting data in the built-in memory	○	○	○	—	Instruction to save setting data in the SD memory card	○	○	○	—	Instruction to read setting data from the built-in memory	○	○	○	—	Instruction to read setting data from the SD memory card	○	○	○	—	Instruction to cancel the saving/reading of setting data	○	○	○	—	Instruction to save the image memory in the SD memory card	○	○	○	—	Instruction to erase the image memory	○	○	○	—	Instruction to print the screenshot	○	○	○	—	Inspection/processing cancellation instruction	○	○	○	—	Instruction to save the latest inspection image	○	✕	✕	—	Instruction to read/change the set value	✕	○	○	—	Instruction to prohibit the keypad screen operation	✕	○	○	—	Keypad emulation instruction	✕	○	○	—	PLC communication command read instruction	○	✕	✕	—	Output	<table border="1"> <thead> <tr> <th></th> <th>Parallel</th> <th>Serial</th> <th>Ethernet</th> <th>SD memory card</th> </tr> </thead> <tbody> <tr> <td>Scanning operation count</td> <td>○</td> <td>○</td> <td>○</td> <td>○</td> </tr> <tr> <td>Total judgement output</td> <td>○</td> <td>○</td> <td>○</td> <td>○</td> </tr> <tr> <td>Judgement calculation (JD) result output</td> <td>○</td> <td>○</td> <td>○</td> <td>○</td> </tr> <tr> <td>Numerical calculation result output</td> <td>○</td> <td>○</td> <td>○</td> <td>○</td> </tr> <tr> <td>Image output</td> <td>✕</td> <td>✕</td> <td>○*4</td> <td>○</td> </tr> <tr> <td>Screenshot output</td> <td>✕</td> <td>✕</td> <td>○*4</td> <td>○</td> </tr> </tbody> </table>		Parallel	Serial	Ethernet	SD memory card	Scanning operation count	○	○	○	○	Total judgement output	○	○	○	○	Judgement calculation (JD) result output	○	○	○	○	Numerical calculation result output	○	○	○	○	Image output	✕	✕	○*4	○	Screenshot output	✕	✕	○*4	○
		Parallel	Serial	Ethernet	SD memory card																																																																																																																																																					
	Inspection start instruction	○	○	○	—																																																																																																																																																					
	Re-inspection start instruction	○	○	○	—																																																																																																																																																					
	Product type change instruction	○	○	○	—																																																																																																																																																					
	Template re-registration instruction	○	○	○	—																																																																																																																																																					
	Display layout switch instruction	○	○	○	—																																																																																																																																																					
	Operation/stop switch instruction	○	○	○	—																																																																																																																																																					
	Statistics reset instruction	○	○	○	—																																																																																																																																																					
	Error reset instruction	○	○	○	—																																																																																																																																																					
	Instruction to save setting data in the built-in memory	○	○	○	—																																																																																																																																																					
	Instruction to save setting data in the SD memory card	○	○	○	—																																																																																																																																																					
	Instruction to read setting data from the built-in memory	○	○	○	—																																																																																																																																																					
	Instruction to read setting data from the SD memory card	○	○	○	—																																																																																																																																																					
	Instruction to cancel the saving/reading of setting data	○	○	○	—																																																																																																																																																					
	Instruction to save the image memory in the SD memory card	○	○	○	—																																																																																																																																																					
	Instruction to erase the image memory	○	○	○	—																																																																																																																																																					
	Instruction to print the screenshot	○	○	○	—																																																																																																																																																					
	Inspection/processing cancellation instruction	○	○	○	—																																																																																																																																																					
Instruction to save the latest inspection image	○	✕	✕	—																																																																																																																																																						
Instruction to read/change the set value	✕	○	○	—																																																																																																																																																						
Instruction to prohibit the keypad screen operation	✕	○	○	—																																																																																																																																																						
Keypad emulation instruction	✕	○	○	—																																																																																																																																																						
PLC communication command read instruction	○	✕	✕	—																																																																																																																																																						
Output	<table border="1"> <thead> <tr> <th></th> <th>Parallel</th> <th>Serial</th> <th>Ethernet</th> <th>SD memory card</th> </tr> </thead> <tbody> <tr> <td>Scanning operation count</td> <td>○</td> <td>○</td> <td>○</td> <td>○</td> </tr> <tr> <td>Total judgement output</td> <td>○</td> <td>○</td> <td>○</td> <td>○</td> </tr> <tr> <td>Judgement calculation (JD) result output</td> <td>○</td> <td>○</td> <td>○</td> <td>○</td> </tr> <tr> <td>Numerical calculation result output</td> <td>○</td> <td>○</td> <td>○</td> <td>○</td> </tr> <tr> <td>Image output</td> <td>✕</td> <td>✕</td> <td>○*4</td> <td>○</td> </tr> <tr> <td>Screenshot output</td> <td>✕</td> <td>✕</td> <td>○*4</td> <td>○</td> </tr> </tbody> </table>		Parallel	Serial	Ethernet	SD memory card	Scanning operation count	○	○	○	○	Total judgement output	○	○	○	○	Judgement calculation (JD) result output	○	○	○	○	Numerical calculation result output	○	○	○	○	Image output	✕	✕	○*4	○	Screenshot output	✕	✕	○*4	○																																																																																																																						
	Parallel	Serial	Ethernet	SD memory card																																																																																																																																																						
Scanning operation count	○	○	○	○																																																																																																																																																						
Total judgement output	○	○	○	○																																																																																																																																																						
Judgement calculation (JD) result output	○	○	○	○																																																																																																																																																						
Numerical calculation result output	○	○	○	○																																																																																																																																																						
Image output	✕	✕	○*4	○																																																																																																																																																						
Screenshot output	✕	✕	○*4	○																																																																																																																																																						

Specifications for PV200 firmware Ver. 1.5 or later.

*2: The 4M grey camera cannot be used in combination with another type of camera.

The ANPVC82□ dedicated compact camera cable is required to connect the compact cameras.

*3: USB cannot be used for the external input/output functions.

*4: Image and screenshot output functions via Ethernet are received by dedicated software, Image Receiver for PV.

Specifications

Camera specifications

Item	Specifications							
Type/Part No.	4M grey / ANPVC1470	2M grey / ANPVC1210	0.3M grey / ANPVC1040	0.3M color compact / ANPVC6030	0.3M grey compact / ANPVC5030	2M color/ANPVC2260	0.3M color/ANPVC2040	
Capture element	2/3-inch CCD fixed image element	1/1.8-inch CCD fixed image element	1/3-inch CCD fixed image element	1/3-inch CMOS fixed image element	1/3-inch CMOS fixed image element	1/1.8-inch CCD fixed image element	1/3-inch CCD fixed image element	
Pixels	2,048 horizontal x 2,048 vertical pixels	1,600 horizontal x 1,200 vertical pixels	640 horizontal x 480 vertical pixels	640 horizontal x 478 vertical pixels	640 horizontal x 480 vertical pixels	1,600 horizontal x 1,200 vertical pixels	640 horizontal x 480 vertical pixels	
	Pixel size: 3.45 μm x 3.45 μm (Square pixels)	Pixel size: 4.4 μm x 4.4 μm (Square pixels)	Pixel size: 7.4 μm x 7.4 μm (Square pixels)	Pixel size: 6.0 μm x 6.0 μm (Square pixels)	Pixel size: 6.0 μm x 6.0 μm (Square pixels)	Pixel size: 4.4 μm x 4.4 μm (Square pixels)	Pixel size: 7.4 μm x 7.4 μm (Square pixels)	
Frame rate	16 frames/sec max.	30 frames/sec max.	120 frames/sec max.	90 frames/sec max.	90 frames/sec max.	30 frames/sec max.	120 frames/sec max.	
Lens mount	C mount			NF mount *2		C mount		
Ambient temperature during use *1	0 to +40 °C +32 to +104 °F	0 to +40 °C +32 to +104 °F	0 to +45 °C +32 to +113 °F	0 to +40 °C +32 to +104 °F	0 to +40 °C +32 to +104 °F	0 to +40 °C +32 to +104 °F	0 to +45 °C +32 to +113 °F	
Ambient humidity during use *1	35 to 85% RH (at 25 °C 77 °F)							
Vibration resistance	10 to 55 Hz, 1 sweep/min, double amplitude of 1 mm 0.04 in, 30 minutes each in the X, Y, and Z directions			10 to 200 Hz, 1 sweep/10 min, 30 minutes each in the 3 directions		10 to 55 Hz, 1 sweep/min, double amplitude of 1 mm 0.04 in, 30 minutes each in the X, Y, and Z directions		
Shock resistance	490.3 m/s ² , 1 time each in the X, Y and Z directions		700 m/s ² , 3 times each in the X, Y and Z directions		700 m/s ² , 1 time each in the X, Y and Z directions		700 m/s ² , 3 times each in the X, Y and Z directions	
Weight (Excluding the lens)	125 g approx.	65 g approx.	65 g approx.	30 g approx.	30 g approx.	65 g approx.	65 g approx.	

*1: However, no condensation or no freezing *2: Comes with C mount adapter.

Visual Fields

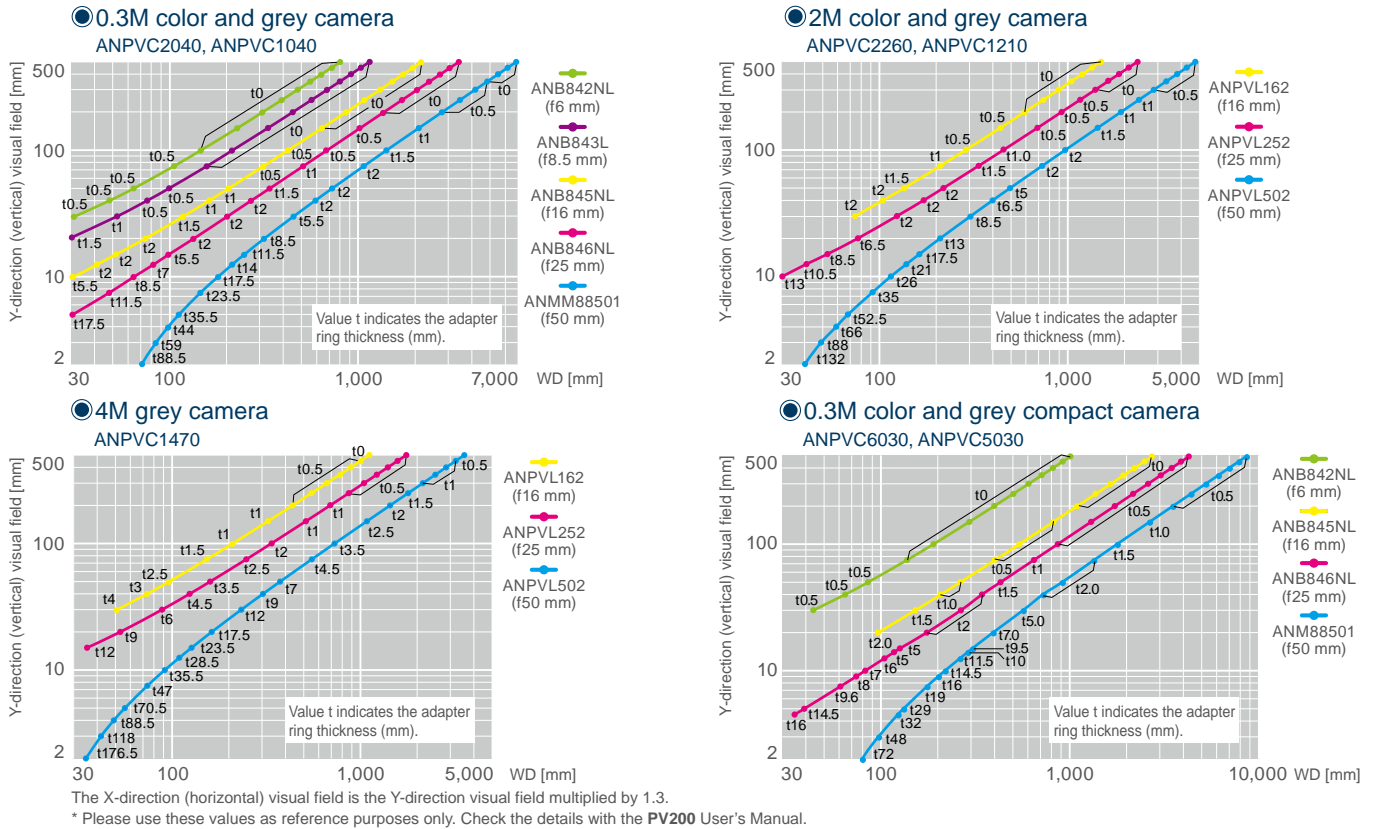

Please contact:

Panasonic Industrial Devices SUNX Co., Ltd.

2431-1 Ushiyama-cho, Kasugai-shi, Aichi, 486-0901, Japan
Global Sales Department

■Telephone: +81-568-33-7861 ■Facsimile: +81-568-33-8591

panasonic.net/id/pidsx/global

The Panasonic logo, consisting of the word "Panasonic" in a bold, blue, sans-serif font, with a registered trademark symbol (®) to the upper right of the "c".

All Rights Reserved ©Panasonic Industrial Devices SUNX Co., Ltd. 2016