

## Safety Light Curtain Type 4 SF4D Series

ME-SF4D No.0077-74V

Thank you very much for purchasing this Panasonic product. Please read this Instruction Manual carefully and thoroughly for the correct and optimum use of this product. Kindly keep this manual in a convenient place for quick reference.

- This document provides brief explanations of mounting and wiring. For detailed handling information, refer "our web site: <https://panasonic.net/id/pidsx/global>".
- Instruction Manuals in the following languages are available on our Website. Japanese, English, Chinese, Korean (excludes the SF4D-□-01), French, German, Spanish (excludes the SF4D-□-01), Polish

### 1 SAFETY CAUTIONS (Always observe)

- This section explains important rules that must be observed to prevent human injury and property damage.
  - The hazards that may occur if the product is used incorrectly are described and classified by level of harm.

**⚠ WARNING** Risk of death or serious injury.  
**⚠ CAUTION** Risk of minor injury or property damage.

- Use this device as per its specifications. Do not modify this device since its functions and capabilities may not be maintained and it may malfunction.
- This device has been developed / produced for industrial use only.
- This device is suitable for indoor use only.
- Use of this device under the following conditions or environments is not presupposed. Please consult us if there is no other choice but to use this device in such an environment.
  - 1) Operating this device under conditions or environments not described in this manual.
  - 2) Using this device in the following fields: nuclear power control, railroad, aircraft, auto mobiles, combustion facilities, medical systems, aerospace development, etc.
- When this device is to be used for enforcing protection of a person from any danger occurring around an operating machine, the user should satisfy the regulations established by national or regional security committees (Occupational Safety and Health Administration: OSHA, the European Standardization Committee, etc.). Contact the relative organization(s) for details.
- In case of installing this device to a particular machine, follow the safety regulations in regard to appropriate usage, mounting (installation), operation and maintenance. The users including the installation operator are responsible for the introduction of this device.
- Note that this device may be damaged if it is subject to a strong shock (if it is dropped onto the floor, for example).
- Use this device by installing suitable protection equipment as a countermeasure for failure, damage, or malfunction of this device.
- Before using this device, check whether the device performs properly with the functions and capabilities as per the design specifications.
- In case of disposal, dispose this device as an industrial waste.

### ⚠ WARNING

- ◆ **Machine designer, installer, employer and operator**
  - The machine designer, installer, employer and operator are solely responsible to ensure that all applicable legal requirements relating to the installation and the use in any application are satisfied and all instructions for installation and maintenance contained in the instruction manual are followed.
  - Whether this device functions as intended to and systems including this device comply with safety regulations depends on the appropriateness of the application, installation, maintenance and operation. The machine designer, installer, employer and operator are solely responsible for these items.

- ◆ **Engineer**
  - The engineer would be a person who is appropriately educated, has widespread knowledge and experience, and can solve various problems which may arise during work, such as a machine designer, installer or employer etc.

- ◆ **Operator**
  - The operator should read this instruction manual thoroughly, understand its contents, and perform operations following the procedures described in this manual for the correct operation of this device.
  - In case this device does not perform properly, the operator should report this to the person in charge and stop the machine operation immediately. The machine must not be operated until correct performance of this device has been confirmed.

- ◆ **Environment**
  - Do not use a mobile phone or a radio phone near this device.
  - If there exists a reflective surface in the place where this device is to be installed, make sure to install this device so that reflected light from the reflective surface does not enter into the receiver, or take countermeasures such as painting, masking, roughening, or changing the material of the reflective surface, etc. Failure to do so may cause the device not to detect, resulting in death or serious injury.
  - Do not install this device in the following places:
    - 1) Areas exposed to intense interference (extraneous) light such as high-frequency fluorescent lamp (inverter type), rapid starter fluorescent lamp, stroboscopic lights or direct sunlight.
    - 2) Areas with high humidity where condensation is likely to occur
    - 3) Areas exposed to corrosive or explosive gases
    - 4) Areas exposed to vibration or shock of levels higher than that specified
    - 5) Areas exposed to contact with water
    - 6) Areas exposed to too much steam or dust

- ◆ **Installation**
  - Always keep the correctly calculated safety distance between this device and the dangerous parts of the machine.
  - Install extra protection structure around the machine so that the operator must pass through the sensing area of this device to reach the dangerous parts of the machine.
  - Install this device such that some part of the operator's body always remains in the sensing area when operator is done with the dangerous parts of the machine.
  - Do not install this device at a location where it can be affected by wall reflection.
  - When installing multiple sets of this device, connect the sets and, if necessary, install some barriers such that mutual interference does not occur. For details, refer to "6 PREVENTING MUTUAL INTERFERENCE BY DEVICE PLACEMENT".
  - Do not use this device in a reflective configuration.

- ◆ **Machine in which this device is installed**
  - When this device is used in "PSDI mode", an appropriate control circuit must be configured between this device and the machine. For details, be sure to refer to the standards and regulations applicable in each region or country.
  - Do not install this device with a machine whose operation cannot be stopped immediately in the middle of an operation cycle by an emergency stop equipment.
  - This device starts the performance after 2 seconds from the power ON. Have the control system started to function with this timing.

- ◆ **Wiring**
  - Be sure to carry out the wiring in the power supply OFF condition.
  - All electrical wiring should conform to the regional electrical regulations and laws. The wiring should be done by engineer(s) having the special electrical knowledge.
  - Do not run the wires together with high-voltage lines or power lines or put them in the same raceway. This can cause malfunction due to induction.
  - In case of extending the cable of the emitter or the receiver, each can be extended up to 70m by using the exclusive cable (Total length 10.5m or less when source/sink current is 350mA.). To use in a series connection, refer to the manual on our website.
  - Do not apply stress such as excessive bending or pulling to a cable or the extracted part of a cable. In particular, the material becomes hard at low temperature and soft at high temperature, and thus caution is required as bending or pulling with excessive force may cause wires to break.
  - Do not control the device only at one control output (OSSD 1 / 2).
  - In order that the output is not turned to ON due to earth fault of the control output (OSSD 1 / 2) wires, be sure to ground to 0V side (PNP output) / +V side (NPN output).
  - When using this device in Korea with KCs-mark, be sure to ground to 0V side (PNP output). (Applicable model: SF4D-□)

- ◆ **Maintenance**
  - When replacement parts are required, always use only genuine supplied replacement parts. If substitute parts from another manufacturer are used, the device may not come to detect, result in death or serious injury.
  - The periodical inspection of this device must be performed by an engineer having the special knowledge.
  - After maintenance or adjustment, and before starting operation, test this device following the procedure specified in "10 MAINTENANCE."
  - Clean this device with a clean cloth. Do not use any volatile chemicals.

- ◆ **Others**
  - Never modify this device. Modification may cause the device not to detect objects, resulting in death or serious injury.
  - Do not use this device to detect objects flying over the detection area.
  - Do not use this device to detect transparent objects, translucent objects or objects smaller than the specified minimum object to be detected.

### 2 APPLICABLE STANDARDS

Standards	Type	SF4D-□	SF4D-□-01
CE		○	○
NRTL (North America)		○	○
GB (Press machine in China)		○	○
Press machine in Japan		×	○
Korea with KCs-mark		○	×

○: Yes, ×: No

#### When using as a safety device for a press machine or paper shearing machine in Japan (Applicable model: SF4D-□-01)

### ⚠ WARNING

In Japan, this device can only be used as a safety device for press machines and paper shearing machines that meet the specifications below.

#### <Press machines>

Item	Specifications
Machine type	Press machine with an emergency stop mechanism and restart prevention mechanism
Pressure capacity	50,000kN or less
Emergency stop time	500ms or less
Stroke length	(Protection height - Die height) or less
Mold size range	Bolster width or less

#### <Shearing machine>

Item	Specifications
Machine type	Shearing machine with an emergency stop mechanism and restart prevention mechanism
Shearing thickness	200mm or less
Shearing width	5,000mm or less
Blade length	5,500mm or less

**When using as a safety device for a press machine or paper shearing machine in Japan (Applicable model: SF4D-□-01)**

<Japanese regulations>  
Standards for safety device mechanisms for press machines and shearing machines. This device has passed, as indicated below, the "Type Examination" based on Article 44, 2 of the Industrial Safety and Health Law of Japan.

**WARNING**

When using as a safety device for a press machine or paper shearing machine in Japan, always attach the protective tube **SFPD-A10** (option) to the cable. The safety device cannot be used for a press machine or shearing machine unless a protective tube is attached to the cable.

**<Type Examination Numbers>**

Model No.		Type Examination Number	
Safety light curtain	Specified control unit	Press machine	Shearing machine
SF4D-F□-01, SF4D-H□-01	-	TA601	TA603
SF4D-A□-01	-	TA600	TA602
SF4D-F□-01, SF4D-H□-01	SF-C11	TA605	-
SF4D-A□-01	SF-C11	TA604	-
SF4D-F□-01, SF4D-H□-01	SF-C13	TA607	-
SF4D-A□-01	SF-C13	TA606	-

- Type Examination Numbers TA601 (press machine) and TA603 (shearing machine) are indicated on SF4D-F□-01 units and SF4D-H□-01 units, and Type Examination Numbers TA600 (press machine) and TA602 (shearing machine) are indicated on SF4D-A□-01 units.
- When only this device is used, or when this device is used in combination with the specified control unit, a different Type Examination Number applies. When used in combination with the specified control unit, the Type Examination Number is indicated on the control unit.
- When used in combination with the specified control unit, this device cannot be used for a shearing machine.

**3 CONFIRMATION OF PACKED OBJECTS**

- Main body: emitter and receiver One for each
- Test Rod 1 piece
- SF4D-F□(-01): SF4B-TR14** (ø14 × 220mm)
- SF4D-H□(-01): SF4B-TR25** (ø25 × 220mm)
- Quick Instruction Manual (Japanese, English, Chinese, Korean) 1 pc. for each language
- General Information for Safety, Compliance, and Instructions (23 languages) 1 pc.

**4 NAMES AND FUNCTIONS OF INDICATORS**

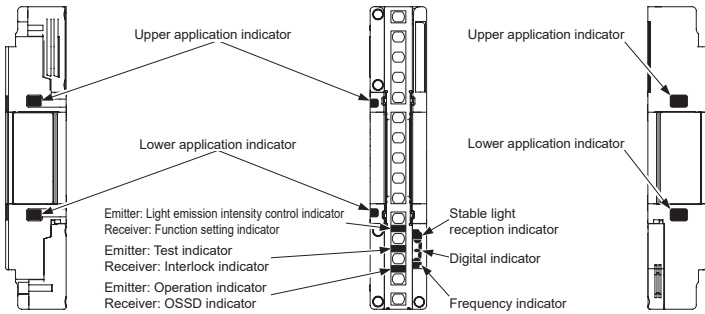

**• Emitter / receiver common**

Name	Function	
	Line synchronization	Optical synchronization
Upper application indicator (Blue / Red / Green / Orange)	<When beam axis alignment mode is set> Control output (OSSD 1 / 2) ON: Lights blue, When top end beam channel receives light: Lights red, When top end beam channel is blocked: Turns OFF	
Lower application indicator (Blue / Red / Green / Orange)	<When beam axis alignment mode is set> Control output (OSSD 1 / 2) ON: Lights blue, When bottom end beam channel receives light: Lights red, When bottom end beam channel is blocked: Turns OFF	
Stable light reception indicator (Green / Orange)	When light reception is stable: Lights green When light reception is unstable: Lights orange When light is blocked: Turns OFF	
Digital indicator (Green / Yellow)	Received light intensity (Green)	Light intensity / Level 3: Lights green "3", Light intensity / Level 2: Lights green "2" Light intensity / Level 1: Lights green "1", When light is blocked: Turns OFF
	Error (Yellow)	Normal operation: Turns OFF, Error: Number blinks or lights yellow "0"
Polarity (Yellow)	When PNP output is set: Lights yellow "P" (only during startup)	
	When NPN output is set: Lights yellow "n" (only during startup)	
Frequency indicator (Orange)	-	When frequency 1 is set: One indicator lights orange When frequency 2 is set: Two indicators light orange

**• Emitter**

Name	Function	
	Line synchronization	Optical synchronization
Light emission intensity control indicator (Orange)	Short mode: Turns OFF, Long mode: Lights orange	
Test indicator (Orange)	During test: Lights orange, Normal operation: Turns OFF	
Operation indicator (Red / Green)	Control output (OSSD 1 / 2) OFF: Lights red Control output (OSSD 1 / 2) ON: Lights green	Normal operation: Lights green Error: Lights red

**• Receiver**

Name	Function	
	Line synchronization	Optical synchronization
Function setting indicator (Orange)	Communication module connected: Blinks orange Blanking function or parallel connection used: Lights orange (Applicable model: SF4D-□) (Note)	
Interlock indicator (Yellow)	Interlock activated: Lights yellow, All other times: Turns OFF	
OSSD indicator (Red / Green)	Control output (OSSD 1 / 2) OFF: Lights red Control output (OSSD 1 / 2) ON: Lights green	

Note: For details on the blanking function and parallel connection, refer to "SF4D Series Instruction Manual".

**5 DIP SWITCH SETTINGS**

For detailed information on the functions of the device, refer "our web site: <https://panasonic.net/id/pidsx/global>".

**• DIP Switch Settings**

**<Changing settings using the DIP switches>**

Item	Description	Settings and ranges, indicator	Factory default setting
DIP switch 1 / 2 (Emitter / Receiver) Synchronization method	Selects the synchronization method. When optical synchronization is selected, you can set a different frequency to reduce mutual interference.	Line synchronization • DIP switch 1: OFF • DIP switch 2: OFF Frequency indicator (orange): Turns OFF  Optical synchronization, Frequency 1 • DIP switch 1: ON • DIP switch 2: OFF Frequency indicator (orange): One indicator lights  Optical synchronization, Frequency 2 • DIP switch 1: OFF • DIP switch 2: ON Frequency indicator (orange): Two indicators light  Line synchronization • DIP switch 1: ON • DIP switch 2: ON Frequency indicator (orange): Turns OFF	Line synchronization
DIP switch 3 (Emitter) Light emission intensity control function	Controls the light from the emitter for the change of sensing range.	Short mode Sensing range SF4D-F□(-01): 0.2 to 7m SF4D-H□(-01), SF4D-A□(-01): 0.2 to 9m  • DIP switch 3: OFF Light emission intensity control indicator (orange): Turns OFF  Long mode Sensing range SF4D-F□(-01): 0.8 to 12m SF4D-H□(-01), SF4D-A□(-01): 0.8 to 15m  • DIP switch 3: ON Light emission intensity control indicator (orange): Lights	Short mode
DIP switch 3 (Receiver) Indicator selector	The upper application indicator and lower application indicator can be used as a beam axis alignment mode or an application mode.	Beam axis alignment mode • DIP switch 3: OFF  Application mode • DIP switch 3: ON	Beam axis alignment mode
DIP switch 4 (Emitter / Receiver) Power save mode	Turns OFF the indicators reduce power consumption.	Normal mode (Allows illumination of some indicators) • DIP switch 4: OFF  Power save mode (Upper application indicator and lower application indicator, digital indicator / received light intensity are always turns OFF) • DIP switch 4: ON	Normal mode

**CAUTION**

Make sure that the power is OFF when setting DIP switch 1 / 2 (emitter / receiver) and DIP switch 3 (emitter). If DIP switch settings are changed while the power is ON, the settings will not be reflected. The settings will be reflected after the power is turned OFF and then turned back ON.

- Remove the indicator cover from the device to access the DIP switches.

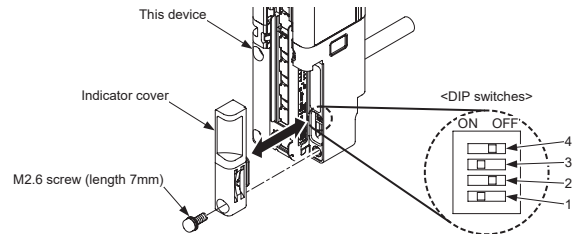

**CAUTION**

- After setting the DIP switches, always reattach the indicator cover on the device. Tighten to a torque of 0.3N·m or less.
- There is packing on the indicator cover. If the packing is not fitted on the cover properly, fit as shown below before attaching to the device.

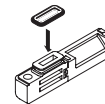

## 6 PREVENTING MUTUAL INTERFERENCE BY DEVICE PLACEMENT

- This section describes methods for placing 2 or more sets of emitters and receivers facing each other, rather than in a series or parallel connection. Consider these when there is a wiring problem or you need to test the system in conjunction with changes such as adding new equipment. Use a test rod to perform an operation test.

### ⚠ WARNING

- Refer to and understand the examples of device placement given below before installing the devices. Risk of death or serious injury if the devices are not placed correctly.
- When using multiple sets of the device, install so as to avoid mutual interference. Risk of death or serious injury if mutual interference occurs.

#### <Examples of device placement>

##### 1) Side-by-side placement

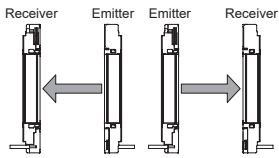

##### 2) Vertical placement

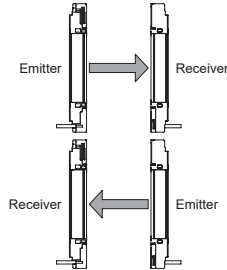

##### 3) Front and back placement

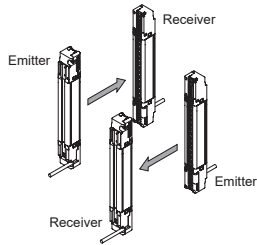

##### 4) With a light-blocking barrier

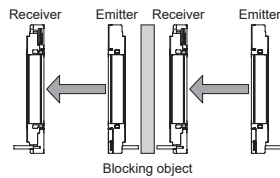

#### <Reference>

If you have questions or problems, please contact our office.

### ⚠ WARNING

The emitter and receiver cables must be oriented in the same direction. Risk of malfunctioning if the cables are not in the same oriented in the same direction.

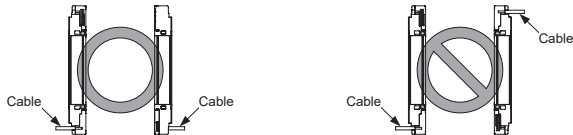

## 7 MOUNTING

### ⚠ CAUTION

- The minimum bending radius of the cables is R6mm. Keep the minimum bending radius of the cables in mind during installation.
- Do not apply stress such as excessive bending or pulling to the extracted part of a cable.
- After installing this device, be sure to adjust the beams so that the device's stable light reception indicator lights green and the number "3" lights green on the digital indicator. To adjust the beams, refer to the manual on our website.

When using as a safety device for a press machine or paper shearing machine in Japan  
(Applicable model: SF4D-□-01)

### ⚠ WARNING

- When using as a safety device for a press machine or paper shearing machine in Japan, always attach the protective tube **SFPD-A10** (option) to the cable.
- The minimum bending radius of the cable with the protective tube **SFPD-A10** attached is 55mm. Take into consideration the minimum bending radius of the cable with the protective tube **SFPD-A10** attached.

#### <Reference>

Mount the emitter and the receiver at the same level and parallel to each other. The effective aperture angle of the device is  $\pm 2.5^\circ$  or less for a sensing range of 3m.

#### <Using beam adjustment mounting bracket MS-SFD-1-5 (Option)>

- Insert the mounting plate of the base bracket into the base bracket mounting rail on the back of the device.

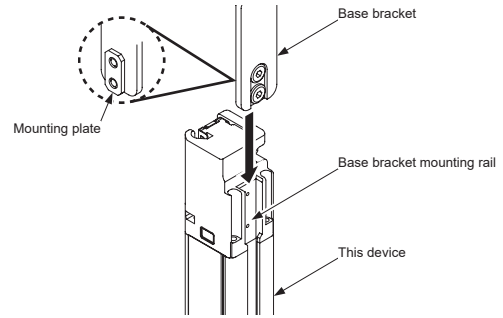

- With the base bracket in firm contact with the device, tighten the two ultra low-head hex socket bolts [M5 (length 5mm), opposing faces 3mm] that fasten the base bracket. Tighten to a torque of 3N·m or less.

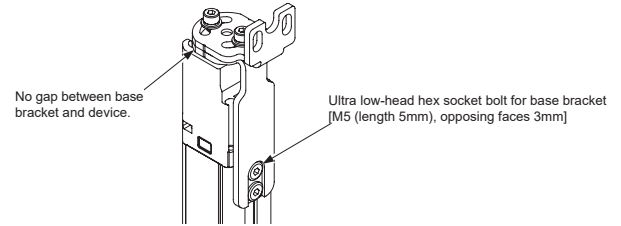

#### <Side mounting>

Loosen the two hexagon-socket head bolts with washers [M4 (length 8mm), opposing faces 3mm] and remove the bracket. Change the orientation of the mounting bracket, and tighten the two hexagon-socket head bolts with washers [M4 (length 8mm), opposing faces 3mm]. Tighten to a torque of 1.5N·m or less.

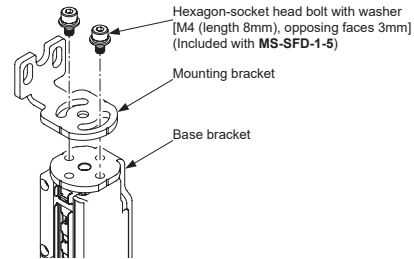

- Install the beam adjustment mounting bracket on the mounting surface with a hexagon-socket head bolt (purchase separately).

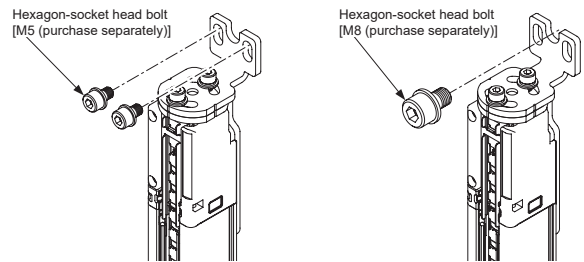

#### <Using intermediate supporting bracket MS-SFB-2 (Option)>

- Loosen the hexagon-socket head bolt [M4 (length 12mm), opposing faces 3mm] on the intermediate supporting bracket.

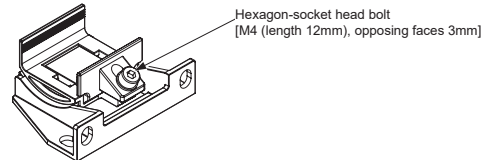

- Fit the intermediate supporting bracket onto the side of the device, and fasten with the hexagon-socket head bolt [M4 (length 12mm), opposing faces 3mm]. Tighten to a torque of 1.2N·m or less.

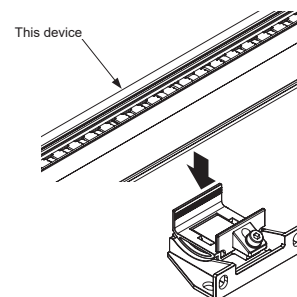

### <Side mounting>

Slide and remove the fixing fitting of the intermediate supporting bracket from the base bracket. Change the direction of the fixing fitting, and engage the notches on the fixing fitting with the rails on the base bracket.

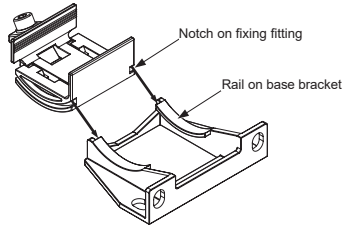

3. Install the intermediate supporting bracket on the mounting surface with two hexagon-socket head bolts [M5 (purchase separately)].

### <Rear mounting>

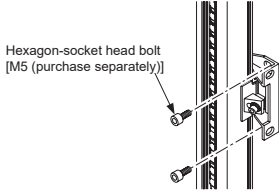

### <Side mounting>

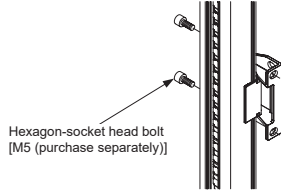

Note: When the number of beam axes is SF4D-F□: 111 or more beam axes, SF4D-H□: 56 or more beam axes, SF4D-A□: 28 or more beam axes, one set is required.

### ⚠ CAUTION

The intermediate supporting bracket MS-SFB-2 is not intended to secure the device.

### <Installing the bottom cap cables (Option)>

### ⚠ CAUTION

- Take care not to misplace any screws while you are working.
- The bottom cap cables are distinguished by round connector color. Gray is for the emitter, and black is for the receiver. Make sure that the correct cable is connected to the emitter and to the receiver.
- There is packing on the connector of the bottom cap cable. If the packing is not fitted on the connector properly, fit as shown below before connecting to the device.

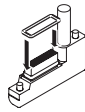

1. Insert the connector of the bottom cap cable (option) into the connector on the device. When inserting the connector, fit the cable into the groove on the device.

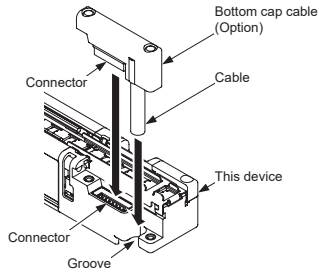

2. Tighten the two M2.6 screws. Tighten to a torque of 0.3N·m or less.

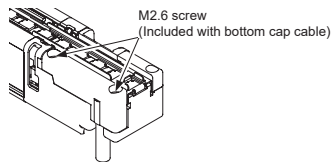

## 8 WIRING

### ⚠ WARNING

- Ground the machine or support on which the device is installed to frame ground (F.G.). If not grounded properly, there is a risk of death or serious injury from malfunctioning caused by noise. Enclose the wiring in a metal wiring box connected to frame ground (F.G.).
- Design the system that uses the device so that dangerous operation will not be caused by a grounding failure. Risk of death or serious injury if the system cannot be stopped.
- If you are extending the synchronization + wire (orange) and synchronization - wire (orange / black) using a cable other than the special-use cable, use 0.2mm<sup>2</sup> or more twisted-pair cable, and extend 0V as well. For other than synchronization + wire (orange) and synchronization - wire (orange / black), use 0.3mm<sup>2</sup> or more cable.
- In the case of line synchronization, emitter and receiver 0V should be common.
- Always verify that nobody is in the danger zone before using the interlock function. Risk of death or serious injury.
- Install the reset switch in a location that allows operation from outside the danger zone and which provides a clear view of the entire danger zone.
- Do not use the test input function and auxiliary output to stop a machine that is connected to this device. Risk of death or serious injury.
- Always operate the device that starts the override function manually. Install the device for override function startup in a location that allows operation from outside the danger zone and which provides a clear view of the entire danger zone.
- Always verify that no one is in the danger zone before using the override function. Risk of death or serious injury.

### ⚠ CAUTION

Always insulate the ends of lead wires that are not used.

### • Power supply unit

### ⚠ CAUTION

Use a power supply unit that conforms to the laws and regulations (code) of the region where the device is to be used, and connect correctly. Risk of device damage and malfunctioning if a non-compliant unit is used or the wiring is incorrect.

### <Reference>

Wiring must only be done by a qualified electrician or technician.

The power supply unit must satisfy the following requirements:

- The power unit must be certified for use in your region.
- The power supply unit must be a SELV (safety extra low voltage) / PELV (protected extra low voltage) unit that conforms to the EMC Directive and Low-voltage Directive. (When CE marking is required.)
- When using a commercial switching regulator, the frame ground (F.G.) terminal must be connected to ground.
- The power supply unit must have an output holding time of 20ms or more.
- If surges occur, take countermeasures such as connecting a surge absorber to the source of the surges.
- The power unit must be a CLASS 2 compliant unit. (When cTUVus mark compliance is required.)

### Using optical synchronization setting and 5-core cable

### ⚠ CAUTION

When using the 5-core cable, set the synchronization method to optical synchronization. For the setting of optical synchronization, refer to "5 DIP SWITCH SETTINGS."

### <Using PNP output>

### • I/O circuit diagrams

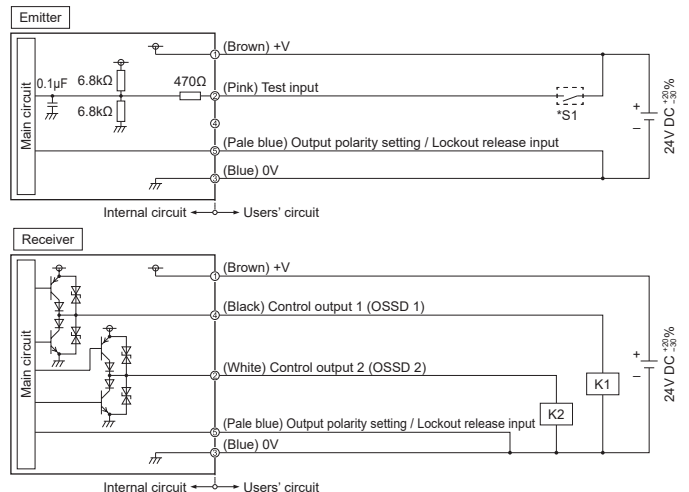

• Basic wiring

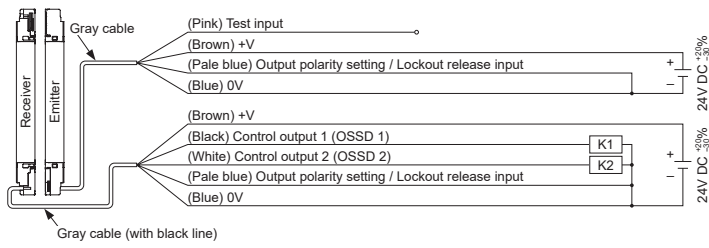

\*S1  
Switch S1  
• Test input  
Vs to Vs - 2.5V (sink current 5mA or less): Emission halt, Open: Emission (Note)

Note: Vs is the supply voltage.

<Reference>

K1, K2: Safety relay unit, etc.

<Using NPN output>

• I/O circuit diagrams

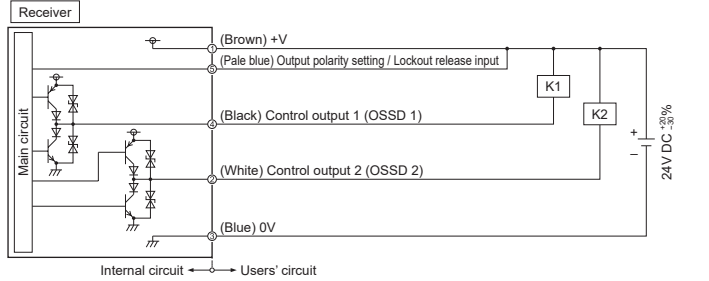
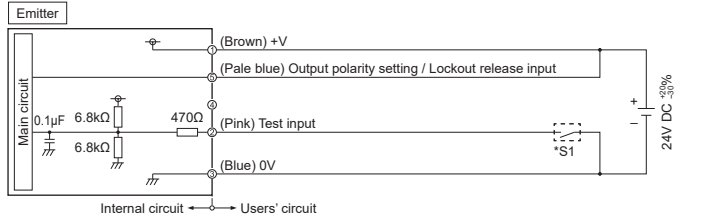

• Basic wiring

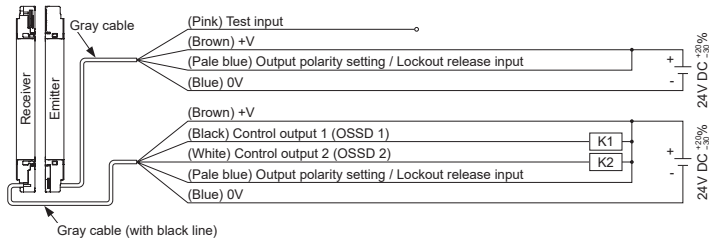

\*S1  
Switch S1  
• Test input  
0 to +2.5V (source current 5mA or less): Emission halt, Open: Emission

<Reference>

K1, K2: Safety relay unit, etc.

Using line synchronization setting and 8-core cable

<Using PNP output>

• I/O circuit diagrams

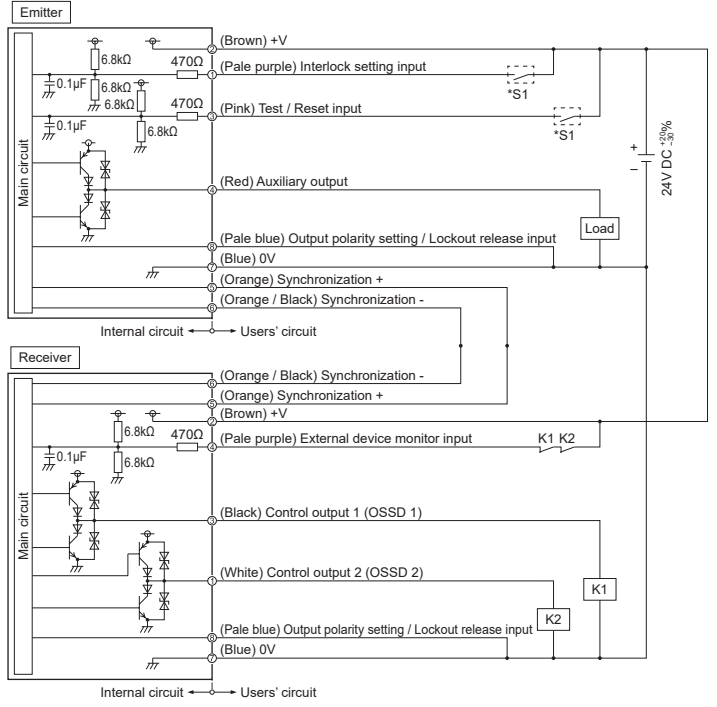

<Reference>

K1, K2: External device (forcible guide relay or magnetic contactor)

• Basic wiring

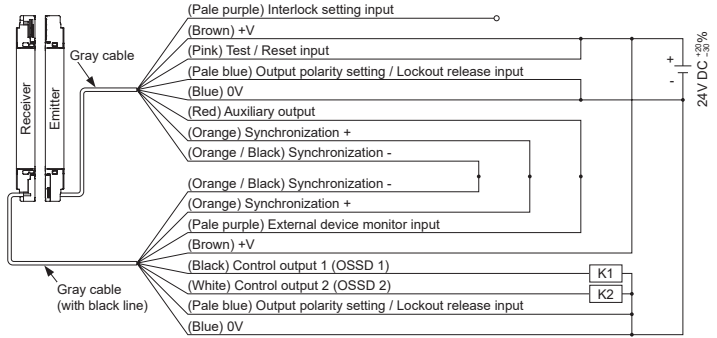

Interlock function	Invalid (auto reset)
External device monitor function	Invalid
Auxiliary output	Cannot be used

<Reference>

K1, K2: Safety relay unit, etc.

\*S1

Switch S1  
• Test / Reset input  
Manual reset ...Vs to Vs - 2.5V (sink current 5mA or less): Emission halt (Note), Open: Emission  
Auto reset ...Vs to Vs - 2.5V (sink current 5mA or less): Emission (Note), Open: Emission halt  
• Interlock setting input, External device monitor input  
Vs to Vs - 2.5V (sink current 5mA or less): Valid (Note), Open: Invalid

Note: Vs is the supply voltage.



<Using NPN output>

• I/O circuit diagrams

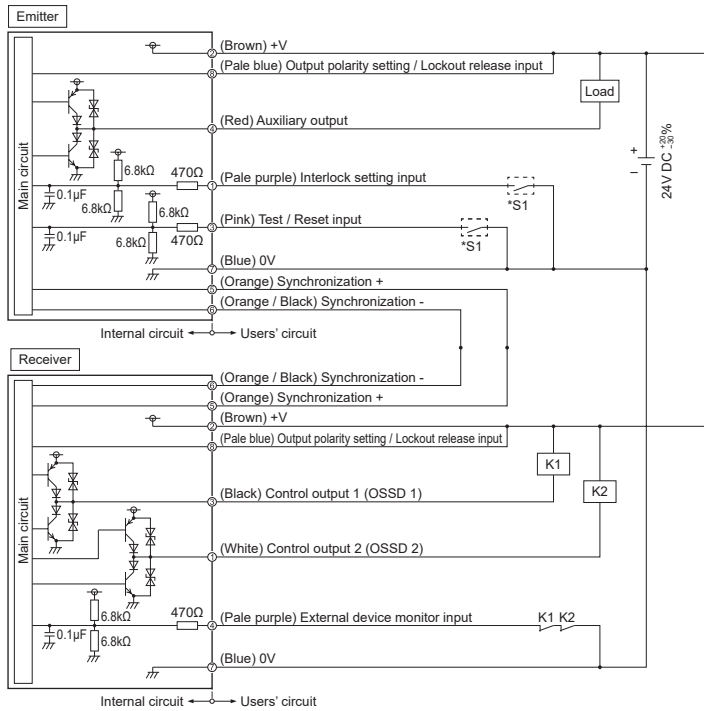

<Reference>

K1, K2: External device (forcible guide relay or magnetic contactor)

• Basic wiring

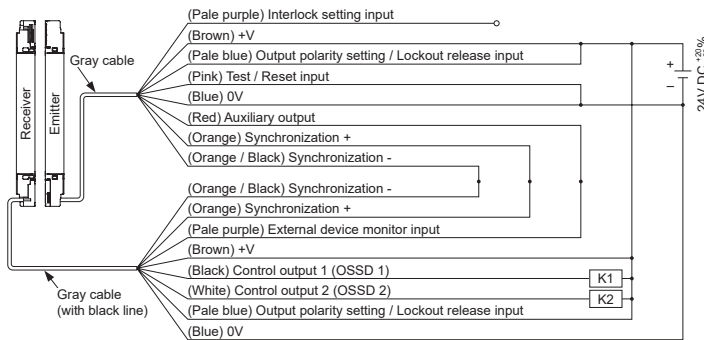

Interlock function	Invalid (auto reset)
External device monitor function	Invalid
Auxiliary output	Cannot be used

<Reference>

K1, K2: Safety relay unit, etc.

\*S1

Switch S1

- Test / Reset input
- Manual reset ...0 to +2.5V (source current 5mA or less): Emission halt, Open: Emission
- Auto reset ...0 to +2.5V (source current 5mA or less): Emission, Open: Emission halt
- Interlock setting input, External device monitor input
- 0 to +2.5V (source current 5mA or less): Valid, Open: Invalid

Using line synchronization setting and 12-core cable

• Refer to the manual on "our web site: <https://panasonic.net/id/pidsx/global>".

9 INDICATOR OPERATION

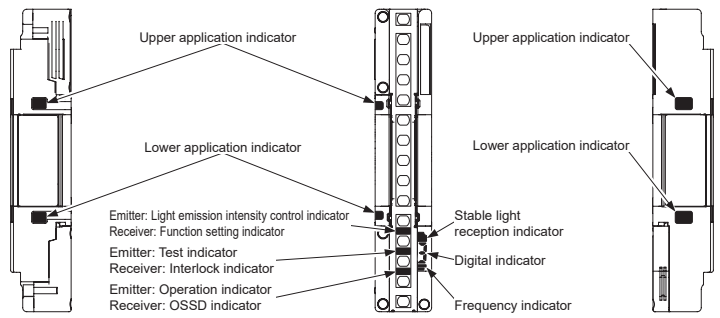

<Conditions: Line synchronization, Test input function invalid, Interlock function invalid>

• Emitter indicator operation

	Light blocked state				Light received state (all beam channels)			
	Top end beam channel	Light blocked		Light received	Unstable light reception state	Stable light reception state		
	Light blocked	Light received	Light blocked	Light received	Received light intensity			
	Light blocked	Light blocked	Light received	Light received				
	Bottom end beam channel				Received light intensity			
	Light blocked	Light blocked	Light received	Light received				
	Other beam channels				Received light intensity			
	Light received / Light blocked	Light received / Light blocked	Light received / Light blocked	Light blocked	Level 1	Level 1	Level 2	Level 3
Control output (OSSD 1 / 2)	OFF	OFF	OFF	OFF	ON	ON	ON	ON
Upper application indicator	Turns OFF	Lights red	Turns OFF	Lights red	Lights blue	Lights blue	Lights blue	Lights blue
Lower application indicator	Turns OFF	Turns OFF	Lights red	Lights red	Lights blue	Lights blue	Lights blue	Lights blue
Stable light reception indicator	Turns OFF	Turns OFF	Turns OFF	Turns OFF	Lights orange	Lights green	Lights green	Lights green
Digital indicator	Turns OFF	Turns OFF	Turns OFF	Turns OFF	Green 1 lights	Green 1 lights	Green 2 lights	Green 3 lights
Frequency indicator	Turns OFF	Turns OFF	Turns OFF	Turns OFF	Turns OFF	Turns OFF	Turns OFF	Turns OFF
Light emission intensity control indicator	When short mode is selected by DIP switch: Lights orange							
Test indicator	Turns OFF	Turns OFF	Turns OFF	Turns OFF	Turns OFF	Turns OFF	Turns OFF	Turns OFF
Operation indicator	Lights red	Lights red	Lights red	Lights red	Lights green	Lights green	Lights green	Lights green

• Receiver indicator operation

	Light blocked state				Light received state (all beam channels)			
	Top end beam channel	Light blocked		Light received	Unstable light reception state	Stable light reception state		
	Light blocked	Light received	Light blocked	Light received	Received light intensity			
	Light blocked	Light blocked	Light received	Light received				
	Bottom end beam channel				Received light intensity			
	Light blocked	Light blocked	Light received	Light received				
	Other beam channels				Received light intensity			
	Light received / Light blocked	Light received / Light blocked	Light received / Light blocked	Light blocked	Level 1	Level 1	Level 2	Level 3
Control output (OSSD 1 / 2)	OFF	OFF	OFF	OFF	ON	ON	ON	ON
Upper application indicator	Turns OFF	Lights red	Turns OFF	Lights red	Lights blue	Lights blue	Lights blue	Lights blue
Lower application indicator	Turns OFF	Turns OFF	Lights red	Lights red	Lights blue	Lights blue	Lights blue	Lights blue
Stable light reception indicator	Turns OFF	Turns OFF	Turns OFF	Turns OFF	Lights orange	Lights green	Lights green	Lights green
Digital indicator	Turns OFF	Turns OFF	Turns OFF	Turns OFF	Green 1 lights	Green 1 lights	Green 2 lights	Green 3 lights
Frequency indicator	Turns OFF	Turns OFF	Turns OFF	Turns OFF	Turns OFF	Turns OFF	Turns OFF	Turns OFF
Function setting indicator	When the blanking function or parallel connection is used: Lights yellow (Applicable model: SF4D-□) When the communication module SF4D-TM1 (option) is connected: Blinks orange							
Interlock indicator	Turns OFF	Turns OFF	Turns OFF	Turns OFF	Turns OFF	Turns OFF	Turns OFF	Turns OFF
OSSD indicator	Lights red	Lights red	Lights red	Lights red	Lights green	Lights green	Lights green	Lights green

<Conditions: Optical synchronization (frequency 1), Test input function invalid, Interlock function invalid>

• Emitter indicator operation

	Light blocked state				Light received state (all beam channels)			
	Top end beam channel	Light blocked		Light received	Unstable light reception state	Stable light reception state		
	Light blocked	Light received	Light blocked	Light received	Received light intensity			
	Light blocked	Light blocked	Light received	Light received				
	Bottom end beam channel				Received light intensity			
	Light blocked	Light blocked	Light received	Light received				
	Other beam channels				Received light intensity			
	Light received / Light blocked	Light received / Light blocked	Light received / Light blocked	Light blocked	Level 1	Level 1	Level 2	Level 3
Control output (OSSD 1 / 2)	OFF	OFF	OFF	OFF	ON	ON	ON	ON
Upper application indicator	Turns OFF	Turns OFF	Turns OFF	Turns OFF	Turns OFF	Turns OFF	Turns OFF	Turns OFF
Lower application indicator	Turns OFF	Turns OFF	Turns OFF	Turns OFF	Turns OFF	Turns OFF	Turns OFF	Turns OFF
Stable light reception indicator	Turns OFF	Turns OFF	Turns OFF	Turns OFF	Turns OFF	Turns OFF	Turns OFF	Turns OFF
Digital indicator	Turns OFF	Turns OFF	Turns OFF	Turns OFF	Turns OFF	Turns OFF	Turns OFF	Turns OFF
Frequency indicator	Lights orange	Lights orange	Lights orange	Lights orange	Lights orange	Lights orange	Lights orange	Lights orange
Light emission intensity control indicator	When short mode is selected by DIP switch: Lights orange							
Test indicator	Turns OFF	Turns OFF	Turns OFF	Turns OFF	Turns OFF	Turns OFF	Turns OFF	Turns OFF
OSSD indicator	Lights green	Lights green	Lights green	Lights green	Lights green	Lights green	Lights green	Lights green

• Receiver indicator operation

	Light blocked state				Light received state (all beam channels)			
	Top end beam channel	Light blocked		Light received	Unstable light reception state	Stable light reception state		
	Light blocked	Light received	Light blocked	Light received	Received light intensity			
	Light blocked	Light blocked	Light received	Light received				
	Bottom end beam channel				Received light intensity			
	Light blocked	Light blocked	Light received	Light received				
	Other beam channels				Received light intensity			
	Light received / Light blocked	Light received / Light blocked	Light received / Light blocked	Light blocked	Level 1	Level 1	Level 2	Level 3
Control output (OSSD 1 / 2)	OFF	OFF	OFF	OFF	ON	ON	ON	ON
Upper application indicator	Turns OFF	Lights red	Turns OFF	Lights red	Lights blue	Lights blue	Lights blue	Lights blue
Lower application indicator	Turns OFF	Turns OFF	Lights red	Lights red	Lights blue	Lights blue	Lights blue	Lights blue
Stable light reception indicator	Turns OFF	Turns OFF	Turns OFF	Turns OFF	Lights orange	Lights green	Lights green	Lights green
Digital indicator	Turns OFF	Turns OFF	Turns OFF	Turns OFF	Green 1 lights	Green 1 lights	Green 2 lights	Green 3 lights
Frequency indicator	Lights orange	Lights orange	Lights orange	Lights orange	Lights orange	Lights orange	Lights orange	Lights orange
Function setting indicator	When the blanking function or parallel connection is used: Lights yellow (Applicable model: SF4D-□) When the communication module SF4D-TM1 (option) is connected: Blinks orange							
Interlock indicator	Turns OFF	Turns OFF	Turns OFF	Turns OFF	Turns OFF	Turns OFF	Turns OFF	Turns OFF
OSSD indicator	Lights red	Lights red	Lights red	Lights red	Lights green	Lights green	Lights green	Lights green

<Conditions: Line synchronization, Test input function invalid, Interlock function invalid>

• Emitter indicator operation when error occurs

	Light blocked state				Light received state (all beam channels)
	Top end beam channel				
	Light blocked	Light received	Light blocked	Light received	
	Bottom end beam channel				
	Light blocked	Light blocked	Light received	Light received	
	Other beam channels				
	Light received / Light blocked	Light received / Light blocked	Light received / Light blocked	Light blocked	
Control output (OSSD 1 / 2)	OFF	OFF	OFF	OFF	OFF
Upper application indicator	Turns OFF	Turns OFF	Turns OFF	Turns OFF	Turns OFF
Lower application indicator	Turns OFF	Turns OFF	Turns OFF	Turns OFF	Turns OFF
Stable light reception indicator	Turns OFF	Turns OFF	Turns OFF	Turns OFF	Turns OFF
Digital indicator	Blinking or lights yellow number	Blinking or lights yellow number	Blinking or lights yellow number	Blinking or lights yellow number	Blinking or lights yellow number
Frequency indicator	Turns OFF	Turns OFF	Turns OFF	Turns OFF	Turns OFF
Light emission intensity control indicator	When short mode is selected by DIP switch: Lights orange				
Test indicator	Turns OFF	Turns OFF	Turns OFF	Turns OFF	Turns OFF
Operation indicator	Lights red	Lights red	Lights red	Lights red	Lights red

• Receiver indicator operation when error occurs

	Light blocked state				Light received state (all beam channels)
	Top end beam channel				
	Light blocked	Light received	Light blocked	Light received	
	Bottom end beam channel				
	Light blocked	Light blocked	Light received	Light received	
	Other beam channels				
	Light received / Light blocked	Light received / Light blocked	Light received / Light blocked	Light blocked	
Control output (OSSD 1 / 2)	OFF	OFF	OFF	OFF	OFF
Upper application indicator	Turns OFF	Turns OFF	Turns OFF	Turns OFF	Turns OFF
Lower application indicator	Turns OFF	Turns OFF	Turns OFF	Turns OFF	Turns OFF
Stable light reception indicator	Turns OFF	Turns OFF	Turns OFF	Turns OFF	Turns OFF
Digital indicator	Blinking or lights yellow number	Blinking or lights yellow number	Blinking or lights yellow number	Blinking or lights yellow number	Blinking or lights yellow number
Frequency indicator	Turns OFF	Turns OFF	Turns OFF	Turns OFF	Turns OFF
Function setting indicator	When the blanking function or parallel connection is used: Lights yellow (Applicable model: SF4D-□) When the communication module SF4D-TM1 (option) is connected: Blinks orange				
Interlock indicator	Turns OFF	Turns OFF	Turns OFF	Turns OFF	Turns OFF
OSSD indicator	Lights red	Lights red	Lights red	Lights red	Lights red

10 MAINTENANCE

<Reference>

If you notice an abnormal condition, refer "our web site: <https://panasonic.net/id/pidsx/global>". If you are unsure what action to take, contact our office. Make a copy of the checklist, enter a checkmark after checking each item, and retain the list.

• Daily inspection



**WARNING**

Before starting work, inspect the items below and verify that there are no abnormalities. Risk of death or serious injury if inspection is neglected or the device is operated with an abnormal condition.

Check column	Inspection item
<input type="checkbox"/>	Dangerous parts of the machine cannot be reached without passing through the sensing area of the device.
<input type="checkbox"/>	Some part of the operator's body remains in the sensing area when working with dangerous parts of the machine.
<input type="checkbox"/>	The device is installed at a distance that is equal to or greater than the calculated safety distance.
<input type="checkbox"/>	No safety guard or protective structure damage.
<input type="checkbox"/>	No damaged, defective, or bent wires.
<input type="checkbox"/>	All connectors are firmly connected.
<input type="checkbox"/>	No dirt or scratches on the light emitting surface.
<input type="checkbox"/>	Test rods are not deformed or defective.
<input type="checkbox"/>	When no objects are present in the sensing area, the operation indicator (green) of the emitter and the OSSD indicator (green) of the receiver are lit. The control output (OSSD 1 / 2) is ON. You can check for effects of external noise in this state. If external noise affects operation, remove the cause and reinspect.
<input type="checkbox"/>	When moved at a speed of 1,600mm/sec or less, it should be possible to detect the test rod [ø14mm for SF4D-F□(-01), ø25mm for SF4D-H□(-01), ø45mm for SF4D-A□(-01)] directly in front of the emitter, midway between the emitter and the receiver, and directly in front of the receiver (3 positions).
<input type="checkbox"/>	When the test rod is in the sensing area, the OSSD indicator (red) of the receiver and the operation indicator (red) of the emitter remain lit.
<input type="checkbox"/>	When the machine is in the operating state, dangerous parts operate normally (do not stop) when no objects are present in the sensing area.
<input type="checkbox"/>	When the machine is in the operating state, dangerous parts stop immediately when the test rod is inserted directly in front of the emitter, midway between the emitter and the receiver, and directly in front of the receiver (3 positions).
<input type="checkbox"/>	Dangerous parts remain stopped as long as the test rod is present in the sensing area.
<input type="checkbox"/>	Dangerous parts stop immediately when the power of the device is turned OFF.
<input type="checkbox"/>	Be sure to test operation before using the muting function. Check the condition of the muting indicator (dirt, brightness, etc.).

• Periodic inspection (every six months)



**WARNING**

Be sure to inspect the following items every six months and verify that there are no abnormalities. Risk of death or serious injury if inspection is neglected or the device is operated with an abnormal condition.

Check column	Inspection item
<input type="checkbox"/>	The structure of the machine does not obstruct any safety mechanisms for stopping operation.
<input type="checkbox"/>	No modification has been made in the machine control system that obstructs the safety mechanisms.
<input type="checkbox"/>	Output from the device is correctly detected.
<input type="checkbox"/>	Wiring from the device is correct.
<input type="checkbox"/>	The response time of the overall system is equal to or less than the calculated value.
<input type="checkbox"/>	The current number of operation cycles (time) of parts with a limited service life is less than the number of service life cycles (time).
<input type="checkbox"/>	No screws or connectors related to the device are loose.
<input type="checkbox"/>	No objects that scatter or reflect light have been added near the device.

• Inspection after maintenance

1. When any parts of the device are replaced.
2. When an abnormal condition is noticed during operation.
3. After aligning the beam axes of the emitter and receiver.
4. When the installation site or environment of the device is changed.
5. When the wiring method or wiring layout is changed.
6. When a safety relay unit or external device (forcible guide relay or magnetic contactor) part has been replaced.
7. When safety controller or safety PLC settings are changed.

When using as a safety device for a press machine in Japan (Applicable model: SF4D-□(-01))

When using as a safety device for a press machine in Japan, press machine work supervisors and personnel in charge of the matters described in No. 1, No. 2, and No. 4 of Article 134 of the Occupational Safety and Health Act are required to perform inspection prior to the start of work and perform periodic inspection. Press machine work supervisors, etc. must inspect the items below prior to the start of work and record/retain the results.

Device emitter

- Firmness of installation
- Suitability of installation position (safe distance and vertical position)
- Existence of damage
- Existence of external wire abnormalities
- Existence of dirt on emitter
- Certainty of detection states

Device receiver

- Firmness of installation
- Suitability of installation position (safe distance and vertical position)
- Existence of damage
- Existence of external wire abnormalities
- Existence of dirt on emitter
- Certainty of detection states

Specified control unit SF-C11, SF-C13

- External wiring
- Indicator
- Abnormal operation of switches, etc.
- Firmness of installation

For details, refer to "Press Machine Safety Device Control Policy" of the Ministry of Health, Labour and Welfare.

11 SPECIFICATIONS

Type	10mm pitch type	20mm pitch type	40mm pitch type
Model No.	SF4D-F□(-01)	SF4D-H□(-01)	SF4D-A□(-01)
Number of beam channels	15/23/31/39/47/55/63/71/79/95/111/127	8/12/16/20/24/28/32/36/40/48/56/64/72/80/88/96	4/6/8/10/12/14/16/18/20/24/28/32/36/40/44/48
Detection width (protection height)	150 (15 beam channels) to 1,270mm (127 beam channels)	150 (8 beam channels) to 1,910mm (96 beam channels)	150 (4 beam channels) to 1,910mm (48 beam channels)
When using as safety equipment for press machines in Japan and China	140 (15 beam channels) to 1,260mm (127 beam channels)	140 (8 beam channels) to 1,900mm (96 beam channels)	120 (4 beam channels) to 1,880mm (48 beam channels)
Sensing range (effective)	Short mode: 0.2 to 7m Long mode: 0.8 to 12m (selectable by DIP switch)	Short mode: 0.2 to 9m, Long mode: 0.8 to 15m (selectable by DIP switch)	
Minimum sensing object	ø14mm opaque object	ø25mm opaque object	ø45mm opaque object
Supply voltage	24V DC <sup>±5%</sup> (excluding voltage drop due to cable)		
Control output (OSSD 1 / 2)	Maximum source (PNP) / sink (NPN) current: 350mA, Residual voltage: 2V or less Leakage current: 0.2mA or less, Maximum load capacity: 2.2µF Load wiring resistance: 3Ω or less		
Response time	OFF response: 10ms or less (not connected in serial / parallel) 18ms or less (connected in serial / parallel) (Refer to <Response time by number of beam channels (OFF response)>) ON response: 50ms or less (Note 1, 2)		
Auxiliary output (AUX)	Maximum source (PNP) / sink (NPN) current: 60mA, residual voltage: 2V or less		
Response time	OFF response: 60ms or less, ON response: 60ms or less		
Ambient temperature	-10 to +55°C, Storage: -25 to +60°C		
Ambient humidity	30 to 85% RH, storage: 30 to 95% RH		

- Notes: 1) Because the control output (OSSD 1 / 2) must be OFF for at least 80ms, the ON response will be delayed more than 50ms when the light blocked time is less than 30ms.  
2) When optical synchronization is selected, if the beam axes of both the top end and bottom end are blocked, the ON response speed decreases by as much as 1 sec.

<Response time by number of beam channels (OFF response)>

Control output (OSSD 1 / 2)

Number of units in series connection	Main sensor		Sub sensor			
	1 unit	2 units	1 unit	2 units	3 units	4 units
4 to 48 beam channels	6ms	10ms	10ms	12ms	12ms	12ms
49 to 96 beam channels	8ms	10ms	10ms	12ms	12ms	12ms
97 to 127 beam channels	10ms	12ms	12ms	14ms	14ms	14ms
128 to 144 beam channels	—	12ms	12ms	14ms	14ms	14ms
145 to 192 beam channels	—	14ms	14ms	16ms	16ms	16ms
193 to 256 beam channels	—	16ms	16ms	18ms	18ms	18ms

12 CE MARKING DECLARATION OF CONFORMITY

**Itemized Essentials of EU Declaration of Conformity**

Manufacturer's Name: Panasonic Industrial Devices SUNX Co., Ltd

Manufacturer's Address: 2431-1, Ushiyama-cho, Kasugai, Aichi 486-0901, Japan

EU Representative's Name: Panasonic Marketing Europe GmbH Panasonic Testing Center

EU Representative's Address: Winsbergring 15, 22525 Hamburg, Germany

Product: Active Opto-electronic Protective Device (Light Curtain)

Model Name: SF4D Series

Trade Name: Panasonic

Application of Council Directive:

- 2006/42/EC Machinery Directive
- 2014/30/EU EMC Directive
- 2011/65/EU RoHS Directive

Applicable Standard(s):

- EN ISO 13849-1:2015 - IEC 61496-1
- EN 55011 - IEC 61496-2
- EN 61000-6-2 - IEC 61508-1
- EN IEC 63000 - IEC 61508-2
- IEC 61508-3
- IEC 61508-4

Type Examination: Certified by TÜV SÜD Product Service GmbH Ridlerstrasse 65 80339 München Germany

Panasonic Corporation

Panasonic Industrial Devices SUNX Co., Ltd.

<https://panasonic.net/id/pidsx/global>

Please visit our website for inquiries and about our sales network.

PRINTED IN JAPAN

© Panasonic Industrial Devices SUNX Co., Ltd. 2021