

Safety Light Curtain Type 4

SF4D-□-01

Instruction Manual



Ministry of Health, Labour and Welfare approved device

Press machines: Model examination No. TA601 (**SF4D-F,-H**), TA600 (**SF4D-A**)

Shearing machines: Model examination No. TA603 (**SF4D-F,-H**), TA602 (**SF4D-A**)

(MEMO)

Thank you very much for purchasing Panasonic Industrial Devices SUNX's Safety Light Curtain, **SF4D-□-01**.

Please read this Instruction Manual carefully and thoroughly for the correct and optimum use of this product.

Kindly keep this manual in a convenient place for quick reference.

This device is an optoelectronic safety sensor that protects persons from injury or accident which can be caused by dangerous parts of a machine.

This manual is for the following persons who have received appropriate training and have knowledge of optoelectronic safety sensor and safety.

- Those who are in charge of installation of this device.
- Those who incorporate this device into systems or design them.
- Those who install and/or connect this device
- Those who manage or perform operations at sites where this device is used.

Notes

- 1) No part of this description should be copied or reprinted in any form or by any means without prior permission in writing from the publisher.
- 2) The contents of this description are subject to change without notice for future improvement.
- 3) Every effort is made to produce this description. If you find any question, error, incorrect collating and/or missing page, please do not hesitate to contact our nearest local office to you: Panasonic Industrial Devices SUNX.
- 4) The original version of this description is written in Japanese and English.

Contents

Chapter 1 Introduction	7
1-1 Safety Cautions	8
1-2 Applicable Standards / Regulations	12
1-3 Confirmation of Packed Objects	14
Chapter 2 Before Using The Device	15
2-1 Features	16
2-2 Parts of the Device	16
2-3 Protection Area	20
2-3-1 Sensing Area	20
2-3-2 Safety Distance	21
2-3-3 Effects of Reflective Surfaces	29
2-3-4 Preventing Mutual Interference	30
2-3-4-1 Interference Prevention Function	30
2-3-4-2 Series Connection	30
2-3-4-3 Preventing Mutual Interference by Device Placement	31
2-4 Mounting	33
2-4-1 Installing the Mounting Brackets	33
2-4-1-1 Using Beam Adjustment Mounting Bracket MS-SFD-1-□ (Option) ..	34
2-4-1-2 Using Intermediate Supporting Bracket MS-SFB-2 (Option) ..	36
2-4-1-3 Using No Dead-Space Beam Adjustment Mounting Bracket MS-SFD-3-6 (Option)	38
2-4-1-4 Using SF4B-G Compatible Mounting Bracket MS-SFD-4BG (Option)	41
2-4-2 Installing the Bottom Cap Cables (Option)	43
2-4-3 Adding and Removing Sensors (Series Connection)	45
2-4-4 Attaching the protective tube	48
2-4-5 Mounting and Removing the Front Protective Cover	49
2-5 Wiring	51
2-5-1 Power Supply Unit	51
2-5-2 Input / Output Circuit Diagrams and Output Waveforms	52
2-5-3 Cable Wiring / Connections / Extension and Connector Pinouts	61
2-5-4 Basic Wiring	64
2-5-5 Wiring for Manual Reset (Interlock is Valid)	67
2-5-6 Wiring for Series Connection	69
2-5-7 Wiring Configuration for Valid External Device Monitor Function	71
2-5-8 Wiring Configuration for Valid Muting Function	73
2-6 Adjustment	75
2-6-1 Beam Adjustment	75
2-6-2 Operation Test	79
2-6-3 Indicator Operation	81

Chapter 3 Functions	99
3-1 Self-Diagnosis Function	100
3-2 Interlock Function	100
3-3 Lockout Release Function	102
3-4 Test Input Function	103
3-5 Auxiliary Output (Non-Safety Output)	104
3-6 External Device Monitor Function	105
3-7 Muting Function	107
3-8 Override Function	113
3-9 DIP Switch Settings	115
3-10 Application indicator function	117
 Chapter 4 Maintenance	 121
4-1 Daily Inspection	122
4-2 Periodic Inspection (Every Six Months)	123
4-3 Inspection after Maintenance	124
 Chapter 5 Troubleshooting	 125
5-1 Emitter Troubleshooting	126
5-2 Receiver Troubleshooting	129
 Chapter 6 Specifications and Dimensions	 135
6-1 Specifications	136
6-2 Options	142
6-3 Dimensions	148
6-3-1 Rear Mounting with MS-SFD-1-5 and MS-SFB-2	148
6-3-2 Side Mounting with MS-SFD-1-5 and MS-SFB-2	149
6-3-3 Rear Mounting with MS-SFD-1-6 and MS-SFB-2	150
6-3-4 Side Mounting with MS-SFD-1-6 and MS-SFB-2	151
6-3-5 Rear Mounting with MS-SFD-1-8 and MS-SFB-2	152
6-3-6 Side Mounting with MS-SFD-1-8 and MS-SFB-2	153
6-3-7 Mounting with MS-SFD-3-6	154
6-3-8 Rear Mounting with MS-SFD-4BG and MS-SFB-2	155
6-3-9 Side Mounting with MS-SFD-4BG and MS-SFB-2	156
6-3-10 Mounting Brackets	157
6-3-10-1 Beam Adjustment Mounting Bracket MS-SFD-1-5	157
6-3-10-2 Beam Adjustment Mounting Bracket MS-SFD-1-6	158
6-3-10-3 Beam Adjustment Mounting Bracket MS-SFD-1-8	159
6-3-10-4 Intermediate Support Bracket MS-SFB-2	160
6-3-10-5 No Dead-Space Beam Adjustment Mounting Bracket MS-SFD-3-6	161
6-3-10-6 SF4B-G Compatible Mounting Bracket MS-SFD-4BG	162
 Chapter 7 Other Information	 163
7-1 Glossary	164
7-2 CE Marking Declaration of Conformity	166

(MEMO)

Chapter 1 Introduction



1-1 Safety Cautions	8
1-2 Applicable Standards / Regulations	12
1-3 Confirmation of Packed Objects	14

Introduction

1-1 Safety Cautions Always observe

This section explains important rules that must be observed to prevent human injury and property damage.

- The hazards that may occur if the product is used incorrectly are described and classified by level of harm.

 WARNING Risk of death or serious injury.
 CAUTION Risk of minor injury or property damage.
<Reference> It gives useful information for better use of this device.

- Use this device as per its specifications. Do not modify this device since its functions and capabilities may not be maintained and it may malfunction.
- This device has been developed / produced for industrial use only.
- This device is suitable for indoor use only.
- Use of this device under the following conditions or environments is not presupposed. Please consult us if there is no other choice but to use this device in such an environment.
 - 1) Operating this device under conditions or environments not described in this manual.
 - 2) Using this device in the following fields: nuclear power control, railroad, aircraft, auto mobiles, combustion facilities, medical systems, aerospace development, etc.
- When this device is to be used for enforcing protection of a person from any danger occurring around an operating machine, the user should satisfy the regulations established by national or regional security committees (Occupational Safety and Health Administration: OSHA, the European Standardization Committee, etc.). Contact the relative organization(s) for details.
- In case of installing this device to a particular machine, follow the safety regulations in regard to appropriate usage, mounting (installation), operation and maintenance. The users including the installation operator are responsible for the introduction of this device.
- Note that this device may be damaged if it is subject to a strong shock (if it is dropped onto the floor, for example).
- Use this device by installing suitable protection equipment as a countermeasure for failure, damage, or malfunction of this device.
- Before using this device, check whether the device performs properly with the functions and capabilities as per the design specifications.
- In case of disposal, dispose this device as an industrial waste.

When using as a safety device for a press machine or paper shearing machine in Japan

When using as a safety device for a press machine or paper shearing machine in Japan, always attach the protective tube **SFPD-A10** (option) to the cable.

⚠ WARNING**◆ Machine designer, installer, employer and operator**

- The machine designer, installer, employer and operator are solely responsible to ensure that all applicable legal requirements relating to the installation and the use in any application are satisfied and all instructions for installation and maintenance contained in the instruction manual are followed.
- Whether this device functions as intended to and systems including this device comply with safety regulations depends on the appropriateness of the application, installation, maintenance and operation. The machine designer, installer, employer and operator are solely responsible for these items.

◆ Engineer

- The engineer would be a person who is appropriately educated, has widespread knowledge and experience, and can solve various problems which may arise during work, such as a machine designer, installer or employer etc.

◆ Operator

- The operator should read this instruction manual thoroughly, understand its contents, and perform operations following the procedures described in this manual for the correct operation of this device.
- In case this device does not perform properly, the operator should report this to the person in charge and stop the machine operation immediately. The machine must not be operated until correct performance of this device has been confirmed.

◆ Environment

- Do not use a mobile phone or a radio phone near this device.
- If there exists a reflective surface in the place where this device is to be installed, make sure to install this device so that reflected light from the reflective surface does not enter into the receiver, or take countermeasures such as painting, masking, roughening, or changing the material of the reflective surface, etc. Failure to do so may cause the device not to detect, resulting in death or serious injury.
- Do not install this device in the following places:
 - 1) Areas exposed to intense interference (extraneous) light such as high-frequency fluorescent lamp (inverter type), rapid starter fluorescent lamp, stroboscopic lights or direct sunlight.
 - 2) Areas with high humidity where condensation is likely to occur
 - 3) Areas exposed to corrosive or explosive gases
 - 4) Areas exposed to vibration or shock of levels higher than that specified
 - 5) Areas exposed to contact with water
 - 6) Areas exposed to too much steam or dust

◆ Installation

- Always keep the correctly calculated safety distance between this device and the dangerous parts of the machine.
- Install extra protection structure around the machine so that the operator must pass through the sensing area of this device to reach the dangerous parts of the machine.
- Install this device such that some part of the operator's body always remains in the sensing area when operator is done with the dangerous parts of the machine.
- Do not install this device at a location where it can be affected by wall reflection.
- When installing multiple sets of this device, connect the sets and, if necessary, install some barriers such that mutual interference does not occur. For details, refer to "**2-3-4 Preventing Mutual Interference**".
- Do not use this device in a reflective configuration.
- The corresponding emitter and receiver must have the same serial No. and be correctly oriented.

WARNING

◆ **Machine in which this device is installed**

- When this device is used in “PSDI mode”, an appropriate control circuit must be configured between this device and the machine. For details, be sure to refer to the standards and regulations applicable in each region or country.
- Do not use this device as a safety device for a press machine in China or Korea.
- Do not install this device with a machine whose operation cannot be stopped immediately in the middle of an operation cycle by an emergency stop equipment.
- This device starts the performance after 2 seconds from the power ON. Have the control system started to function with this timing.

◆ **Wiring**

- Be sure to carry out the wiring in the power supply OFF condition.
- All electrical wiring should conform to the regional electrical regulations and laws. The wiring should be done by engineer(s) having the special electrical knowledge.
- Do not run the wires together with high-voltage lines or power lines or put them in the same raceway. This can cause malfunction due to induction.
- In case of extending the cable of the emitter or the receiver, each can be extended up to 70m by using the exclusive cable. Taking cable voltage drop into account, the cable length differs according to the source current / sink current of the control output (OSSD1 / 2). For details, refer to “**6-1 Specifications**”. Using a cable length outside the specifications may cause the device to malfunction, possibly resulting in death or serious injury.
- Do not apply stress such as excessive bending or pulling to a cable or the extracted part of a cable. In particular, when the temperature is low, cable materials harden, and when the temperature is high, the materials soften, and so take care that cables may break if they are subject to stress such as bending or pulling when the temperature is low or high.
- Do not control the device only at one control output (OSSD 1 / 2).
- In order that the output is not turned to ON due to earth fault of the control output (OSSD 1 / 2) wires, be sure to ground to 0V side (PNP output) / +V side (NPN output).

◆ **Maintenance**

- When replacement parts are required, always use only genuine supplied replacement parts. If substitute parts from another manufacturer are used, the device may not come to detect, result in death or serious injury.
- The periodical inspection of this device must be performed by an engineer having the special knowledge.
- After maintenance or adjustment, and before starting operation, test this device following the procedure specified in “**Chapter 4 Maintenance**”.
- Clean this device with a clean cloth. Do not use any volatile chemicals.

◆ **Others**

- Never modify this device. Modification may cause the device not to detect objects, resulting in death or serious injury.
- Do not use this device to detect objects flying over the detection area.
- Do not use this device to detect transparent objects, translucent objects or objects smaller than the specified minimum object to be detected.

When using as a safety device for a press machine or paper shearing machine in Japan** WARNING**

In Japan, this device can only be used as a safety device for press machines and paper shearing machines that meet the specifications below.

<Press machines>

Item	Specification
Machine type	Press machine with an emergency stop mechanism and restart prevention mechanism
Pressure capacity	50,000kN or less
Emergency stop time	500ms or less
Stroke length	(Protection height - Die height) or less
Mold size range	Bolster width or less

<Shearing machine>

Item	Specification
Machine type	Shearing machine with an emergency stop mechanism and restart prevention mechanism
Shearing thickness	200mm or less
Shearing width	5,000mm or less
Blade length	5,500mm or less

Introduction

1-2 Applicable Standards / Regulations

This device complies with the following standards and regulations.

<EU Directives>

EU Machinery Directive 2006/42/EC
EMC Directive 2014/30/EU
RoHS Directive 2011/65/EU

<European Standards>

EN 55011, EN 61000-6-2, EN IEC 63000, EN ISO 13849-1: 2015 (Category 4, PL_e)

<International Standards>

IEC 61496-1/2 (Type 4), ISO 13849-1: 2015 (Category 4, PL_e), IEC 61508-1 to 7 (SIL3)

<Japanese Industrial Standards (JIS)>

JIS B 9704-1/2 (Type 4), JIS B 9705-1 (Category 4), JIS C 0508-1 to 7 (SIL3)

<Standards in US / Canada>

ANSI/UL 61496-1/2 (Type 4)
CAN/CSA C22.2 No.14, CAN/CSA E61496-1/2

<Regulations in US>

OSHA 1910.212, OSHA 1910.217 (C), ANSI B11.1 to B11.19, ANSI/RIA 15.06

For Machinery Directive, type certification a Notified Body TÜV SÜD has been acquired.
For the standards in US / Canada, cTÜVus mark by a Notified Body TÜV SÜD has been acquired.

<Standards in China>

GB 4584

<Reference>

The conformance of this device to JIS, OSHA and ANSI is based on our self-evaluation.
The cTÜVus mark  indicates that this device conforms to the NRTL certification (such as UL) in the US and CSA certification in Canada.

When using as a safety device for a press machine or paper shearing machine in Japan

<Japanese regulations>

Standards for safety device mechanisms for press machines and shearing machines (including Sept. 21, 1978; Ministry of Labor Notification No. 102, Jan. 12, 2011; Ministry of Health, Labour and Welfare Notification No. 5)

This device has passed, as indicated below, the "Model Examination" based on Article 44, 2 of the Ministry of Health, Labour and Welfare of Japan.

WARNING

When using as a safety device for a press machine or paper shearing machine in Japan, always attach the protective tube **SFPD-A10** (option) to the cable.

The safety device cannot be used for a press machine or shearing machine unless a protective tube is attached to the cable.

<Model examination No.>

Model No.		Model Examination Number	
Light curtain	Specified control unit	Press machine	Shearing machine
SF4D-F□-01 SF4D-H□-01	—	TA601	TA603
SF4D-A□-01	—	TA600	TA602
SF4D-F□-01 SF4D-H□-01	SF-C11	TA605	—
SF4D-A□-01	SF-C11	TA604	—
SF4D-F□-01 SF4D-H□-01	SF-C13	TA607	—
SF4D-A□-01	SF-C13	TA606	—

- The model examination No. TA601 (press machine) and TA603 (shearing machine) are indicated on **SF4D-F□-01** units and **SF4D-H□-01** units, and the model examination No. TA600 (press machine) and TA602 (shearing machine) are indicated on **SF4D-A□-01** units.
- When only this device is used, or when this device is used in combination with the specified control unit, a different the model examination No. applies. When used in combination with the specified control unit, the model examination No. is indicated on the control unit.
- When used in combination with the specified control unit, this device cannot be used for a shearing machine.

Introduction

When using this device, configure a control system satisfying the following requirements to establish a system-wide safety.

To use in Category 4 or 3

- **To prevent the loss of the safety function due to a single fault.**
Be sure to use control output (OSSD 1 / 2) of two systems.
- **To prevent the loss of the safety function due to accumulation of faults.**
Configure a control system that can monitor the control output (OSSD 1 / 2) and stop the device if discrepancy is detected.
<Example of inconsistency detection method>
(Example 1) Use of relay unit and controller for light curtain
(Example 2) Monitoring of control outputs (OSSD 1 / 2) with the safety PLC.
(Example 3) Monitoring of contact welding when safety relay is used

To use in Category 2

When using the control output (OSSD) of only one system, connect auxiliary output to PLC, etc., to monitor the operation of this device. In this case, configure a control system that stops the device when discrepancy between control output (OSSD) and auxiliary output is detected. In place of the auxiliary output, control output (OSSD) of one more system is available.

1-3 Confirmation of Packed Objects

- Main body: emitter and receiver One for each
- Test Rod 1 piece
- **SF4D-F□-01: SF4B-TR14** (ø14 × 220mm), **SF4D-H□-01: SF4B-TR25** (ø25 × 220mm)
- Quick Instruction Manual (Japanese, English, Chinese) 1 pc. for each language
- General Information for Safety, Compliance, and Instructions (23 languages) 1 pc.

Chapter 2 Before Using The Device

2-1	Features	16
2-2	Parts of the Device	16
2-3	Protection Area	20
2-3-1	Sensing Area	20
2-3-2	Safety Distance	21
2-3-3	Effects of Reflective Surfaces	29
2-3-4	Preventing Mutual Interference	30
2-3-4-1	Interference Prevention Function	30
2-3-4-2	Series Connection	30
2-3-4-3	Preventing Mutual Interference by Device Placement	31
2-4	Mounting	33
2-4-1	Installing the Mounting Brackets	33
2-4-1-1	Using Beam Adjustment Mounting Bracket MS-SFD-1-□ (Option)	34
2-4-1-2	Using Intermediate Supporting Bracket MS-SFB-2 (Option)	36
2-4-1-3	Using No Dead-Space Beam Adjustment Mounting Bracket MS-SFD-3-6 (Option)	38
2-4-1-4	Using SF4B-G Compatible Mounting Bracket MS-SFD-4BG (Option)	41
2-4-2	Installing the Bottom Cap Cables (Option)	43
2-4-3	Adding and Removing Sensors (Series Connection)	45
2-4-4	Attaching the protective tube	48
2-4-5	Mounting and Removing the Front Protective Cover	49
2-5	Wiring	51
2-5-1	Power Supply Unit	51
2-5-2	Input / Output Circuit Diagrams and Output Waveforms	52
2-5-3	Cable Wiring / Connections / Extension and Connector Pinouts	61
2-5-4	Basic Wiring	64
2-5-5	Wiring for Manual Reset (Interlock is Valid)	67
2-5-6	Wiring for Series Connection	69
2-5-7	Wiring Configuration for Valid External Device Monitor Function	71
2-5-8	Wiring Configuration for Valid Muting Function	73
2-6	Adjustment	75
2-6-1	Beam Adjustment	75
2-6-2	Operation Test	79
2-6-3	Indicator Operation	81

Before Using This Device

2-1 Features

This device is a light curtain with the following features:

- A special controller is not required.
- PNP or NPN can be selected for the control output (OSSD 1 / 2).
- Upper application indicator and lower application indicator make beam alignment easy.
- For details on options, refer to “6-2 Options”.

2-2 Parts of the Device

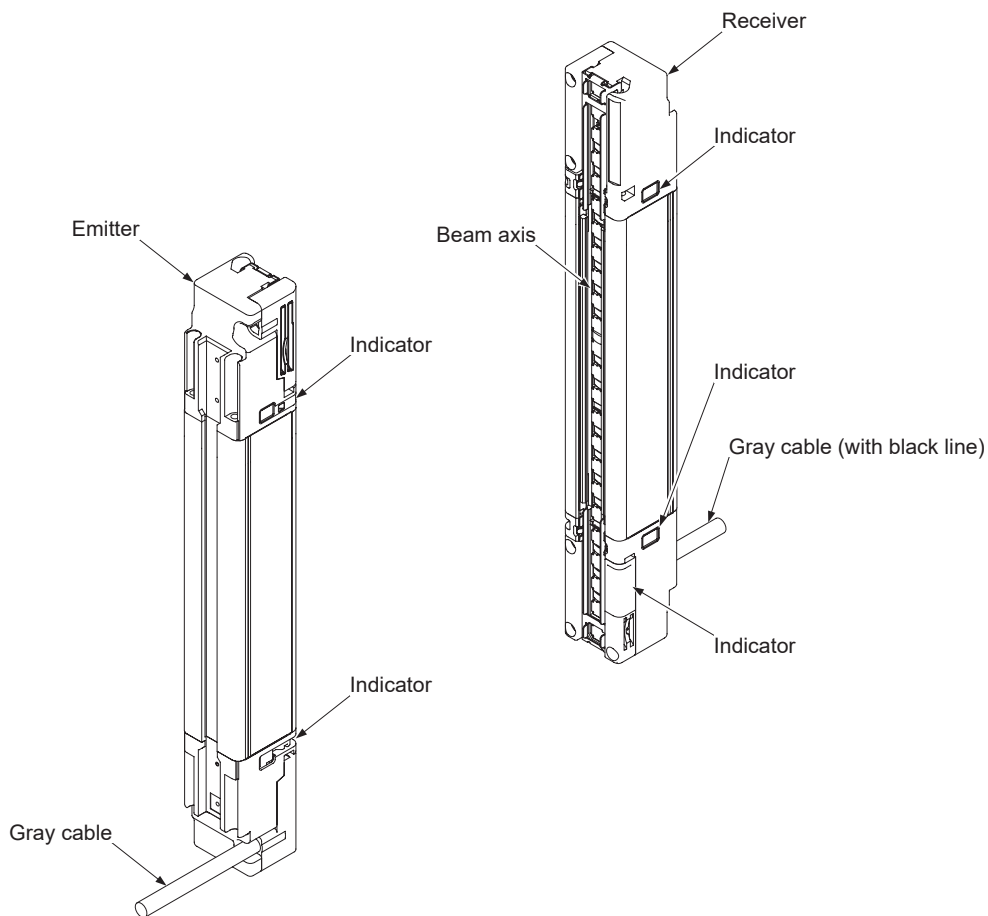

<Emitter>

Emits light toward the facing receiver. The status of the emitter is indicated by the indicators.

<Receiver>

Receives light from the facing emitter. The control output (OSSD 1 / 2) turns ON when light from the emitter is received on all beam channels, and turns OFF when light is blocked on one or more beam channels.

The status of the receiver is indicated by the indicators.

When using as a safety device for a press machine or paper shearing machine in Japan

When using as a safety device for a press machine or paper shearing machine in Japan, always attach the protective tube **SFPD-A10** (option) to the cable.

<Beam channels>





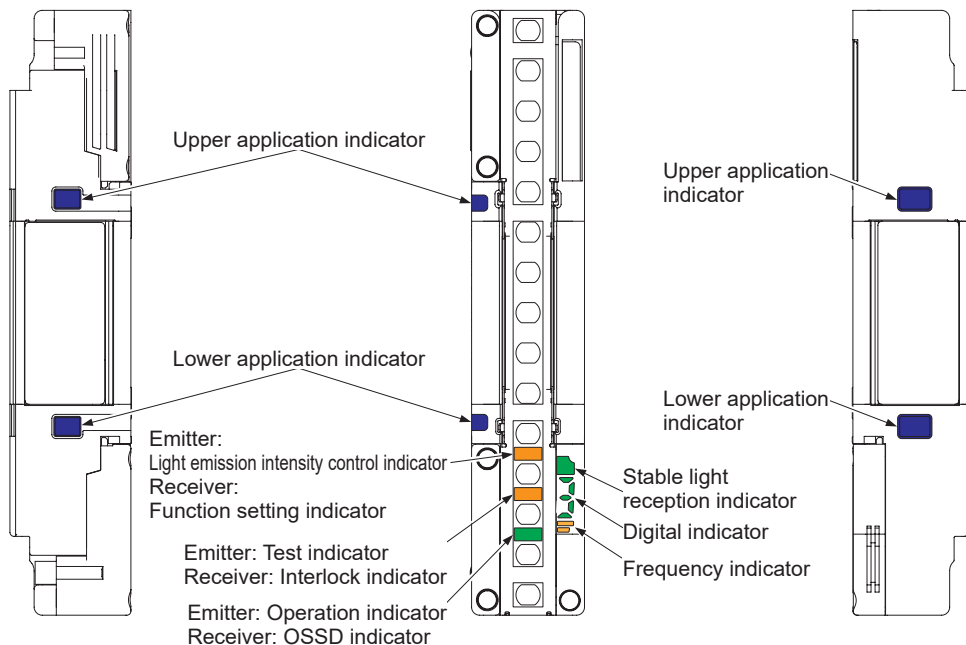















Light emitting elements are arranged in the emitter and light receiving elements are arranged in the receiver at intervals of 10mm (**SF4D-F□-01**), 20mm (**SF4D-H□-01**), or 40mm (**SF4D-A□-01**).

<Indicators>









Part Description





● Emitter/receiver common

Name		Function	
		Line synchronization	Optical synchronization
Upper application indicator (Blue / Red / Green / Orange) (Note 1)		<When beam axis alignment mode is set> Control output (OSSD 1 / 2) ON: Lights blue “  ” When top end beam channel receives light: Lights red “  ” When top end beam channel is blocked: Turns OFF <When application mode is set> When application indicator input 1 is ON: Lights green “  ” When application indicator input 2 is ON: Lights red “  ” When application indicator input 1 / 2 are ON: Lights orange “  ” When application indicator input 1 / 2 are OFF: Turns OFF	
Lower application indicator (Blue / Red / Green / Orange) (Note 1)		<When beam axis alignment mode is set> Control output (OSSD 1 / 2) ON: Lights blue “  ” When bottom end beam channel receives light: Lights red “  ” When bottom end beam channel is blocked: Turns OFF <When application mode is set> When application indicator input 1 is ON: Lights green “  ” When application indicator input 2 is ON: Lights red “  ” When application indicator input 1 / 2 are ON: Lights orange “  ” When application indicator input 1 / 2 are OFF: Turns OFF	
Stable light reception indicator (Green / Orange)		When light reception is stable: Lights green “  ” When light reception is unstable: Lights orange “  ” When light is blocked: Turns OFF	
Digital indicator (Green / Yellow)	Received light intensity (Green)	Light intensity / Level 3: Lights green “  ” Light intensity / Level 2: Lights green “  ” Light intensity / Level 1: Lights green “  ” When light is blocked: Turns OFF	
	Error (Yellow)	Normal operation: Turns OFF, Error: Yellow number blinks or lights “  ”	
	Polarity (Yellow)	When PNP output is set: Lights yellow “  ” (only during startup) When NPN output is set: Lights yellow “  ” (only during startup)	
Frequency indicator (Orange)		–	When frequency 1 is set: Lights orange “  ” When frequency 2 is set: Lights orange “  ”

● Emitter

Name		Function	
		Line synchronization	Optical synchronization
Light emission intensity control indicator (Orange) [CTRL]		Short mode: Turns OFF, Long mode: Lights orange “  ”	
Test indicator (Orange) [TEST]		During test: Lights orange “  ”, Normal operation: Turns OFF	
Operation indicator (Red / Green) [OP]		Control output (OSSD 1 / 2) OFF: Lights red “  ” Control output (OSSD 1 / 2) ON: Lights green “  ”	Normal operation: Lights green “  ” Error: Lights red “  ”

● Receiver

Name		Function	
		Line synchronization	Optical synchronization
Function setting indicator (Orange) [FUNC]		Communication module connected: Blinks orange “  ”	
Interlock indicator (Yellow) [LOCK]		Interlock activated: Lights yellow “  ”, All other times: Turns OFF	
OSSD indicator (Red / Green) [OSSD]		Control output (OSSD 1 / 2) OFF: Lights red “  ” Control output (OSSD 1 / 2) ON: Lights green “  ”	

Notes: 1) In the case of optical synchronization, the upper application indicator and lower application indicator on the emitter remain OFF.

2) Names in brackets [] are names that are indicated on the device.

● How to check product information

Product information is shown on the plate on the side of the product.

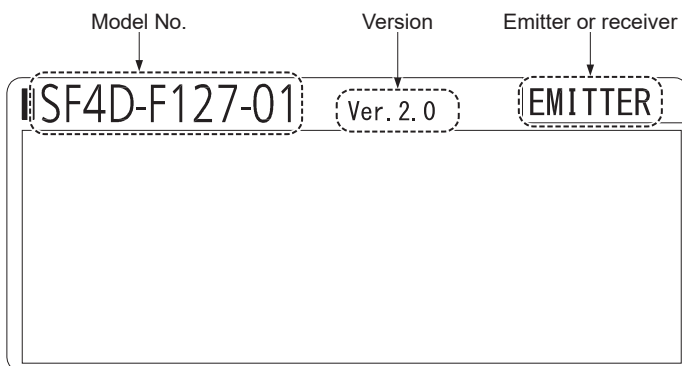

		Version		
		Ver. 1.11	Ver. 2.0	Ver. 3.0
Configurator Light Curtain software	Checking basic information	○	○	○
	Monitoring operations	○	○	○
+ Communication module SF4D-TM1 (option)	Checking histories such as errors	-	○	○
	Collating settings	-	-	-
	Reading and writing settings	-	-	-
Communication module SF4D-TM1 (option)	Copy function	-	-	-
	Saved data initialization function	-	-	-

○: Available, -: Unavailable

● About Product Version 3.0

If the Ver. 3.0 product is connected in series with the Ver. 2.0 product, all products will operate as Ver. 2.0 products.

If the communication module **SF4D-TM1** and the Configurator Light Curtain software are used together with this product, version restrictions of each product will apply. When using the Ver. 3.0 product, use the communication module **SF4D-TM1** Ver.2.0 or later and the Configurator Light Curtain software Ver. 1.4.0 or later.

Configuration software		Communication module		Light curtain SF4D (Product version)	
				Ver.2.0	Ver.3.0
Configurator Light Curtain	Ver.1.3.0	SF4D-TM1	Ver.1.0	○	-
	Ver.1.4.0 or later		Ver.2.0 or later	○	○

Note: You can download the Configurator Light Curtain software from our website (<https://panasonic.net/id/pidsx/global>).

If the communication unit **SFD-WL3** is used with this product, version restrictions of each product will apply. When using the Ver. 3.0 product, use the communication unit **SFD-WL3** Ver.2.0 or later (F/W version).

IO-Link communication unit for the SF4D series		Light curtain SF4D (Product version)	
		Ver.2.0	Ver.3.0
SFD-WL3 (optional)	Ver.1.0	○	-
	Ver.2.0 or later	○	○

Protection Area

2-3 Protection Area

2-3-1 Sensing Area

⚠ WARNING

- Be sure to install a protection structure around the machine so that the operator must pass through the sensing area of the device to reach dangerous parts of the machine. Ensure that part or all of the operator's body remains in the sensing area when the operator works with dangerous parts of the machine. Risk of death or serious injury if the operator's body is not detected.
- Do not use in a reflective type or recursive reflective type setup.
- Multiple receivers (emitters) cannot be connected for use with a single emitter (receiver).

The sensing area is the zone formed by the sensing height of the device and the sensing range between the emitter and the receiver.

The sensing height of the device is determined by the number of beam channels.

The sensing range of the **SF4D-F□-01** is 0.2 to 7m (0.8 to 12m in long mode). The sensing range of the **SF4D-H□-01** and **SF4D-A□-01** is 0.2 to 9m (0.8 to 15m in long mode).

If used at less than 0.2m (less than 0.8m in long mode), optical system effects may cause malfunctioning.

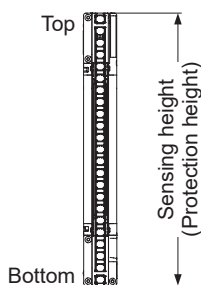

[The sensing height (protection height) is the length from the top to the bottom of the device.]

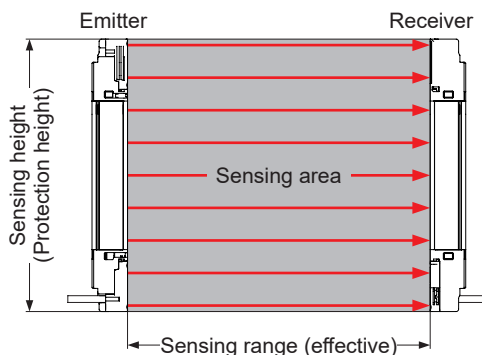

<Example of correct sensing area setup>

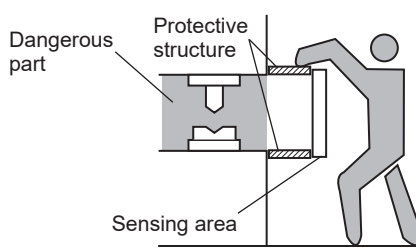
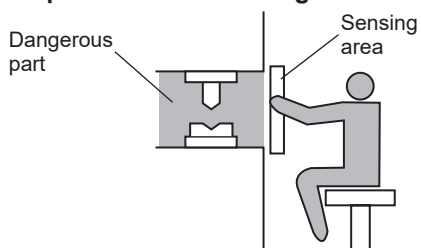

<Example of incorrect sensing area setup>

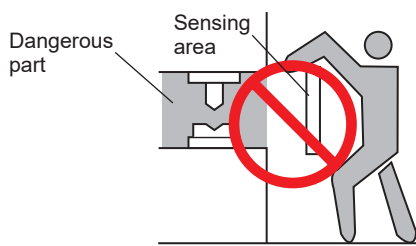
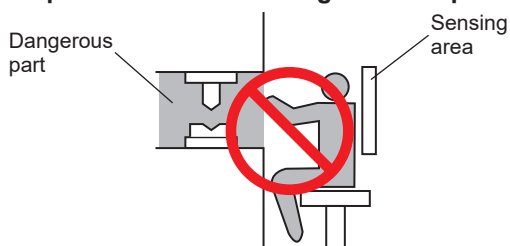

2-3-2 Safety Distance

⚠ WARNING

- Calculate the safety distance correctly, and install so that the distance between the sensing area of the device and dangerous parts of the machine is equal to or greater than the safety distance. If the safety distance is miscalculated or a sufficient distance is not established, the machine will not be able to stop before a human body or object arrives at a dangerous part, creating a risk of death or serious injury.
- Before designing and installing the system, refer to the applicable standards of the region where the device is to be used.
The equations on the following pages are to be used only when the direction of intrusion is perpendicular to the sensing area. If the direction of intrusion is not perpendicular to the sensing area, be sure to check all applicable standards (regional standards, specifications of the machine, etc.) for calculation details.
- The maximum response time of the machine is from the point that the machine receives the halt signal from the device to the point that the dangerous parts of the machine stop. The maximum response time of the machine should be measured using the actual machine to be used.

The safety distance is the minimum distance that must be maintained between the device and the dangerous parts of the machine so that the machine can be stopped before a human body or object reaches a dangerous part.

The safety distance is calculated using the equations given on the following pages when a person moves perpendicularly (normal intrusion) into the sensing area of the device.

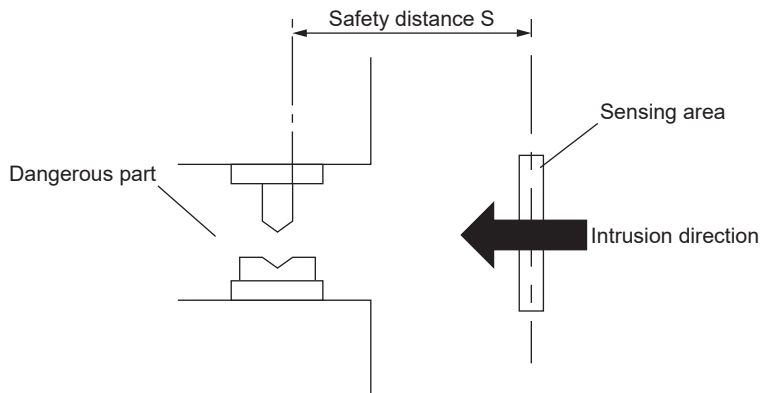

Protection Area

[For use in Europe (EU) (based on EN ISO 13855)] (Also applies to JIS B 9705)
(For intrusion perpendicular to the sensing area)

<When the minimum sensing object is $\varnothing 40\text{mm}$ or less>

• Equation 1 $S = K \times T + C$

- S: Safety distance (mm)
Minimum required distance between the sensing area plane and the dangerous part of the machine
- K: Intrusion speed of person or object (mm/sec.)
Normally 2,000 (mm/sec.) is used.
- T: Response time of overall system
 $T = T_m + T_{SF4D}$
 T_m : Maximum response time of machine (sec.)
 T_{SF4D} : Response time of device (sec.)
- C: Additional distance calculated from the minimum sensing object of the device (mm)
The value of C cannot be less than 0.
 $C = 8 \times (d - 14)$
d: Diameter of minimum sensing object (mm)

<Reference>

- When calculating the safety distance S, the following five cases must be considered.
First calculate using $K = 2,000$ (mm/sec.) in the above equation. Consider these three cases for the result: 1) $S < 100$, 2) $100 \leq S \leq 500$, and 3) $S > 500$. If the result of the calculation is 3) $S > 500$, calculate again using $K = 1,600$ (mm/sec.). Consider these two cases for the result: 4) $S \leq 500$ and 5) $S > 500$.
For details, refer to “**Calculation example 1: For use in Europe**”.
- When the device is used in “PSDI Mode”, an appropriate safety distance S must be calculated.
For details, refer to the standards and regulations that apply in your region or country.

<When the minimum sensing object is greater than $\varnothing 40\text{mm}$ >

• Equation 1 $S = K \times T + C$

- S: Safety distance (mm)
Minimum required distance between the sensing area plane and the nearest dangerous part of the machine
- K: Intrusion speed of person or object (mm/sec.)
Normally 1,600 (mm/sec.) is used.
- T: Overall response time of system
 $T = T_m + T_{SF4D}$
 T_m : Maximum response time of machine (sec.)
 T_{SF4D} : Response time of device (sec.)
- C: Additional distance calculated from the minimum sensing object of the device (mm)
 $C = 850$ (mm)

<Calculation examples>

- **Calculation example 1: For use in Europe**

(OFF response time: 6ms or less, diameter of minimum sensing object: 25mm)

First, calculate with $K = 2,000$.

$$\begin{aligned}
 S &= K \times T + C \\
 &= K \times (T_m + T_{SF4D}) + 8 \times (d - 14) \\
 &= 2,000 \times (T_m + 0.006) + 8 \times (25 - 14) \\
 &= 2,000 \times T_m + 2,000 \times 0.006 + 8 \times 11 \\
 &= 2,000 \times T_m + 12 + 88 \\
 &= 2,000 \times T_m + 100
 \end{aligned}$$

If the result is:

- 1) $S < 100$ (mm)
Take 100 (mm) as the safety distance S .
- 2) $100 \leq S \leq 500$ (mm)
Take $2,000 \times T_m + 116$ (mm) as the safety distance S .
- 3) $S > 500$ (mm)

$$\begin{aligned}
 S &= K' \times (T_m + T_{SF4D}) + 8 \times (d - 14) \\
 &= 1,600 \times (T_m + 0.006) + 8 \times (25 - 14) \\
 &= 1,600 \times T_m + 1,600 \times 0.006 + 8 \times 11 \\
 &= 1,600 \times T_m + 9.6 + 88 \\
 &= 1,600 \times T_m + 97.6
 \end{aligned}$$

Calculate again using the above.

If the result is:

- 4) $S \leq 500$ (mm)
Use 500 (mm) as the safety distance S .
- 5) $S > 500$ (mm)
Use $1,600 \times T_m + 97.6$ (mm) as the safety distance S .

If the device is installed in a system with a maximum machine halting time of 0.1 (sec.)

$$\begin{aligned}
 S &= 2,000 \times T_m + 100 \\
 &= 2,000 \times 0.1 + 100 \\
 &= 300
 \end{aligned}$$

This meets condition 2) above, and thus the safety distance is 300 (mm).

If the device is installed in a system with a maximum machine halting time of 0.4 (sec.)

$$\begin{aligned}
 S &= 2,000 \times T_m + 100 \\
 &= 2,000 \times 0.4 + 100 \\
 &= 900
 \end{aligned}$$

This meets condition 3) above, and thus

$$\begin{aligned}
 S &= 1,600 \times T_m + 97.6 \\
 &= 1,600 \times 0.4 + 97.6 \\
 &= 737.6
 \end{aligned}$$

This meets condition 5) above, and thus the safety distance is 737.6 (mm).

Protection Area

[For use in the USA (per ANSI/RIA 15.06)]

• **Equation 2** $D_s = K \times T + D_{pf}$

D_s : Safety distance (mm)

Minimum required distance between the sensing area plane and the nearest dangerous part of the machine

K : Intrusion speed {OSHA-recommended value is 63 (inch/sec.) [\approx 1,600 (mm/sec.)]}

When determining K , consider all possible factors including the physical ability of operators.

T : Maximum response time (sec.) for dangerous operation of the machine to halt or for dangerous operation in a machine cycle to be completed.

When determining T , consider all possible factors.

For details, refer to "ANSI B11.19".

D_{pf} : Additional distance calculated from the minimum sensing object of the device (mm)

SF4D-F□-01 : $D_{pf} = 23.8\text{mm}$

SF4D-H□-01 : $D_{pf} = 61.2\text{mm}$

SF4D-A□-01 : $D_{pf} = 129.2\text{mm}$

$D_{pf} = 3.4 \times (d - 0.275)$ (inches)
 $\approx 3.4 \times (d - 7)$ (mm)

d : Diameter of minimum sensing object 0.552 (inches) \approx 14 (mm) **SF4D-F□-01**

Diameter of minimum sensing object 0.985 (inches) \approx 25 (mm) **SF4D-H□-01**

Diameter of minimum sensing object 1.772 (inches) \approx 45 (mm) **SF4D-A□-01**

<Reference>

- When the floating blanking function is used, the minimum sensing object becomes larger. According to ANSI B11.19, $D_{pf} = 900\text{mm}$ (3ft) when $d > 63.5\text{mm}$ (2.5 inches).
- Calculated using 1 (inch) = 25.4 (mm).

When using as a safety device for a press machine in Japan

[Japan: Power Press Machine Structural Standards]

<Safety distance (reference)>

The safe distance formula given in "Power Press Machine Structural Standards" (including Dec. 26, 1977; Ministry of Labor Notification No. 102, Jan. 12, 2011; Ministry of Health, Labour and Welfare Notification No. 4) based on the rules of Article 44 is indicated below. The example below provides values for reference.

For actual installation of a light beam press machine safety device on a press machine, install in accordance with "Power Press Machine Structural Standards".

Formula (from Article 43 of Power Press Machine Structural Standards)

$$D = 1.6 \times (T_L + T_S) + C$$

D, T_L , and T_S in the above equation indicate the following values.

D : Distance between beam axis of light beam press machine safety device and danger limit (danger source) (mm)

T_L : Time from blocking of beam until activation of emergency mechanism of press machine
[Activation delay time of this device (6 to 18msec)]

T_S : Time from activation of emergency mechanism of press machine until slide stops (ms)

C : Additional distance (mm)

When continuous blocking width is 30mm or less: C = 0 (**SF4D-F□-01**, **SF4D-H□-01**)

When continuous blocking width is 35 to 45mm: C = 300 (**SF4D-A□-01**)

The safe distance (D) is calculated from the formula and the installation distance (A) is thereby determined; however, if the horizontal distance between the light beam and the front line of the bolster exceeds 400mm, or if the distance does not exceed 400mm but there is a possibility that a worker will enter the area between the light beam and the bolster, an auxiliary beam channel or additional guard must be installed.

<Calculation example>

When the **SF4D-H16-01** is used and the maximum stopping time of the press machine is 200ms.

Response time of **SF4D-H16-01**: 6ms

$$\begin{aligned} D &= 1.6 \times (200 + 6) + 0 \\ &= 329.6 \text{ (mm)} \end{aligned}$$

The safe distance in this case is D = 329.6 (mm).

<Auxiliary beam channel installation method>

We recommend that you connect the devices used for the primary beam channel (main sensor) and auxiliary beam channel (sub sensor) in series. A series connection enables prevention of mutual interference.

1. If there is sufficient space for a worker to enter the area between the primary beam axis (main sensor) of the light beam press machine safety device (installed so as to maintain the safe distance) and the front line of the bolster, install auxiliary beam channels (sub sensors) so that the horizontal distance between the primary beam channel (main sensor) and auxiliary beam channels (sub sensors) is 75mm or less, and the horizontal distance between the bolster and the auxiliary beam channel (sub sensors) closest to the bolster is 75mm or less.
2. Install the auxiliary beam channels (sub sensors) so that they are horizontal with respect to the front line of the bolster, and in a position that is about the height of the worker's waist.

Protection Area

When using as a safety device for a press machine in Japan

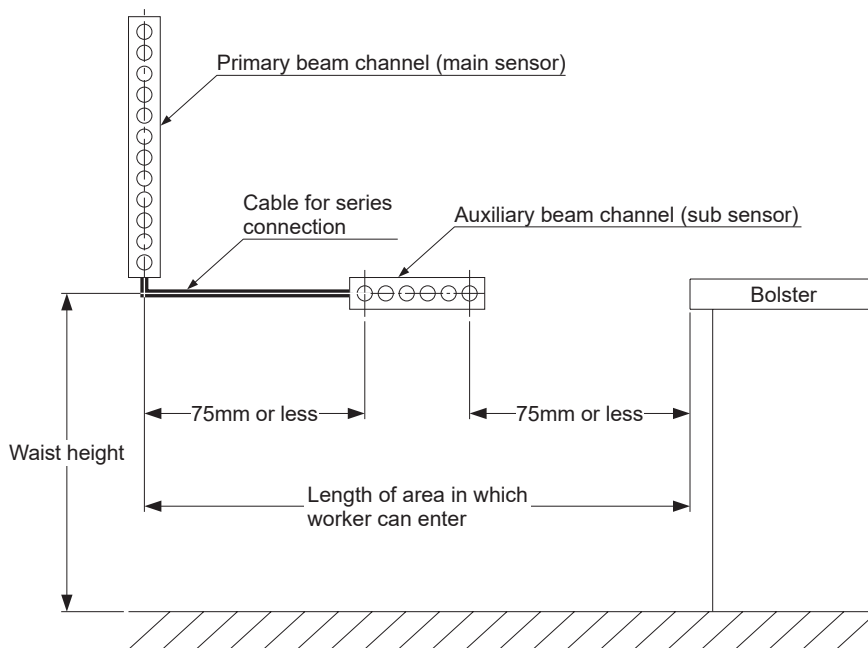

A paired light emitter and receiver that are installed to directly protect the span equal to the sum of the press machine stroke length and die height are referred to as the "primary beam channel (main sensor)", and a paired light emitter and receiver that are installed for any other purpose are referred to as an "auxiliary beam channel (sub sensor)". When the device is installed as the primary beam channel (main sensor), a beam channel with a protection height greater than the sum of the press machine stroke length and the die height must be selected. If the distance between the center of the beam of the primary beam channel (main sensor) and the front line of the bolster is 75mm or more, an auxiliary beam channel (sub sensor) must be installed between the primary beam channel (main sensor) and bolster to prevent worker entry.

For details, refer to "About the Revision of the Safety Device Management Guidelines for Press Machines" (Ministry of Health, Labour and Welfare Publication 930 No. 11, September 30, 2015).

⚠ WARNING

When using auxiliary beam channels (sub sensors), install the auxiliary beam channels (sub sensors) to prevent machine users from standing between the machine and the device, and to prevent accidental entry into the danger zone of the machine if a user goes around the area protected by the device. Risk of death or serious injury if auxiliary beam channels (sub sensors) are not installed.

When using as a safety device for a paper shearing machine in Japan

When using as a safety device for a paper shearing machine in Japan, always observe the points below in accordance with the standards for safety device mechanisms for press machines and shearing machines (including Sept. 21, 1978; Ministry of Labor Notification No. 102, Jan. 12, 2011; Ministry of Health, Labour and Welfare Notification No. 5).

- Establish a safe distance of at least [(Device activation delay time + Shearing machine emergency stop time) × 1.6 + Additional distance]. If the safe distance exceeds 270mm, install an auxiliary beam channel (sub sensor) between the primary beam channel (main sensor) and the blade.
- The height of the beam channel from the table surface should be no more than (safe distance × 0.67mm), and no more than 180mm.

WARNING

When using auxiliary beam channels (sub sensors), install the auxiliary beam channels (sub sensors) to prevent machine users from standing between the machine and this device, and to prevent accidental entry into the danger zone of the machine if a user goes around the area protected by the device. Risk of death or serious injury if auxiliary beam channels (sub sensors) are not installed.

Protection Area

[For use in China (GB 4584)]

For a press machine with a slide that can be stopped at any position, calculate the safety distance S using Equation 1.

• Equation example 1 $S = K \times T + C$

- S: Safety distance (mm)
Minimum required distance between the sensing area plane and the nearest dangerous part of the machine
- K: Intrusion speed of person or object (mm/sec.)
For intrusion horizontal to the sensing area, calculate using 1,600mm/sec.
For intrusion vertical to the sensing area, if the safety distance is $S \leq 500$ mm, calculate using 2,000mm/sec. If the safety distance is $S > 500$ mm, calculate using 1,600mm/sec.
- T: Overall response time of system (sec.)
 $T = T_m + T_{SF4D}$
 T_m : Maximum response time of machine (sec.)
 T_{SF4D} : Response time of device (sec.)
- C: Distance from intrusion of hand into sensing area until detection by this product (mm).
On a press machine, if the interlock (start-restart interlock) function of the device or a safety controller is not used, calculate using the table below.

Minimum sensing object	Additional distance C	Stroke start by the device or a safety controller
≤ 14 mm	0mm	Possible
> 14 to 20mm	80mm	
> 20 to 30mm	130mm	
> 30 to 40mm	240mm	Not possible
> 40mm	850mm	

On a press machine, if the interlock (start-restart interlock) function of the device or a safety controller is used, calculate with $C = 0$.

For a press machine with a slide that cannot be stopped at any position, calculate the safety distance S using Equation 2.

• Equation example 2 $S = K \times T_s + C$

- S: Safety distance (mm)
Minimum required distance between the sensing area plane and the nearest dangerous part of the machine
- K: Intrusion speed of person or object (mm/sec.)
For intrusion horizontal to the sensing area, calculate using 1,600mm/sec.
For intrusion vertical to the sensing area, if the safety distance is $S \leq 500$ mm, calculate using 2,000mm/sec. If the safety distance is $S > 500$ mm, calculate using 1,600mm/sec.
- T_s : Time from insertion of hand into this product until the slide reaches the low dead point (sec)
 $T_s = [(1 / 2) + (1 / N)] \times T_n$
N: Number of clutch grooves
 T_n : Time required for one revolution of crankshaft (sec.)
- C: Distance from intrusion of hand into sensing area until detection by this product (mm).
On a press machine, if the interlock (start-restart interlock) function of the device or a safety controller is not used, calculate using the table below.

Minimum sensing object	Additional distance C	Stroke start by the device or a safety controller
≤ 14 mm	0mm	Possible
> 14 to 20mm	80mm	
> 20 to 30mm	130mm	
> 30 to 40mm	240mm	Not possible
> 40mm	850mm	

On a press machine, if the interlock (start-restart interlock) function of the device or a safety controller is used, calculate with $C = 0$.

2-3-3 Effects of Reflective Surfaces

⚠ WARNING

If there are reflective surfaces where the device is to be installed, install so that light reflected from the reflective surfaces does not enter the receiver. Or prevent reflection from the surface by coating or masking the surface, roughening the surface, changing materials, or otherwise. Risk of death or serious injury if the device becomes incapable of detection because measures are not taken to prevent reflection.

Install the device at a distance greater than or equal to the distance A (m) indicated below from a metal wall, floor, ceiling, or sensing object, or a cover, panel, or glass with a reflective surface (surface with high reflectivity).

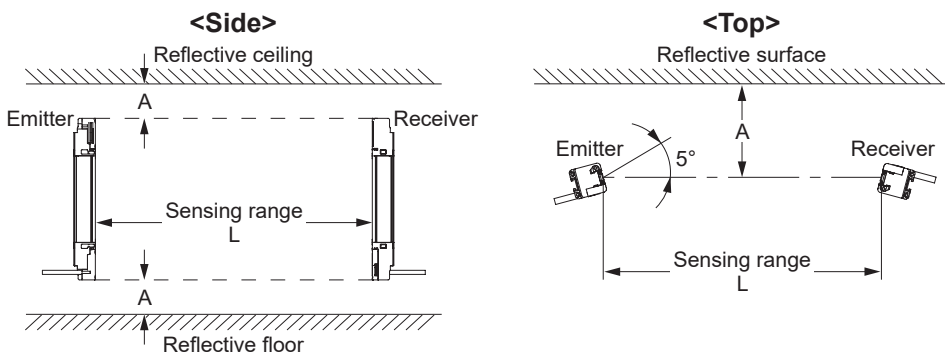

Distance (sensing range L) between emitter and receiver	Permissible installation distance A
When 0.2 to 3m	0.131m
When 3 to 15m	$L / 2 \times \tan 5 \approx L \times 0.0437$ (m)

Permissible device installation distance from reflective surface

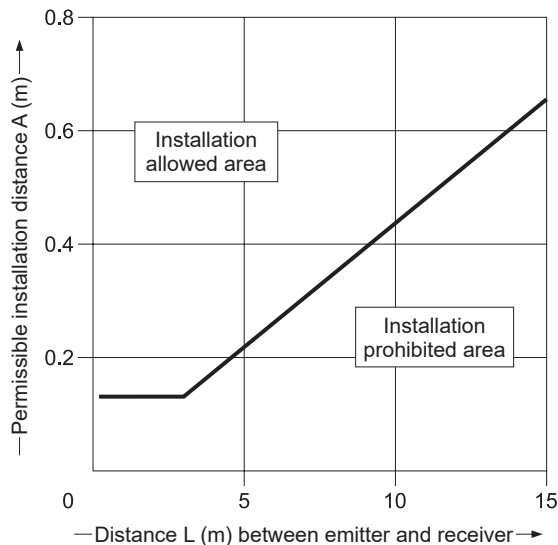

Protection Area

2-3-4 Preventing Mutual Interference

When multiple sets of the device are used, mutual interference may occur and cause malfunctioning. Use the most suitable means to prevent mutual interference.

WARNING

When using multiple sets of the device, install so as to avoid mutual interference.
Risk of death or serious injury if mutual interference occurs.

2-3-4-1 Interference Prevention Function

<Line synchronization>

Automatically reduces interference for up to two sets of the device.

<Optical synchronization>

Reduces interference for up to two sets of the device by frequency switching. To change frequencies, refer to “3-9 DIP Switch Settings”.

2-3-4-2 Series Connection

When the devices are connected in series, mutual interference does not occur.

A maximum of 5 sets can be connected in series (maximum total of 256 beam channels)]

When the devices are connected in series, the control outputs (OSSD1 / 2) can be aggregated into one set. The control output (OSSD 1 / 2) turns OFF when light is blocked, regardless of which set is in the light blocked state.

<Reference>

- To change the synchronization method of devices connected in series, set all DIP switches 1 / 2 to the same state. If DIP switches 1 / 2 are not set to the same state on devices connected in series, the device will change to the lockout state.
- When connecting devices in series, connect emitters to emitters and receivers to receivers. If an emitter is connected to a receiver, the device will change to the lockout state.

2-3-4-3 Preventing Mutual Interference by Device Placement

This section describes methods for placing 2 or more sets of emitters and receivers facing each other, rather than in a series connection. Consider these when there is a wiring problem or you need to test the system in conjunction with adding new equipment or otherwise. Use a test rod to perform an operation test as explained in “2-6-2 Operation Test”.

⚠ WARNING

Refer to and understand the examples of device placement given below before installing the devices. Risk of death or serious injury if the devices are not placed correctly.

<Examples of device placement>

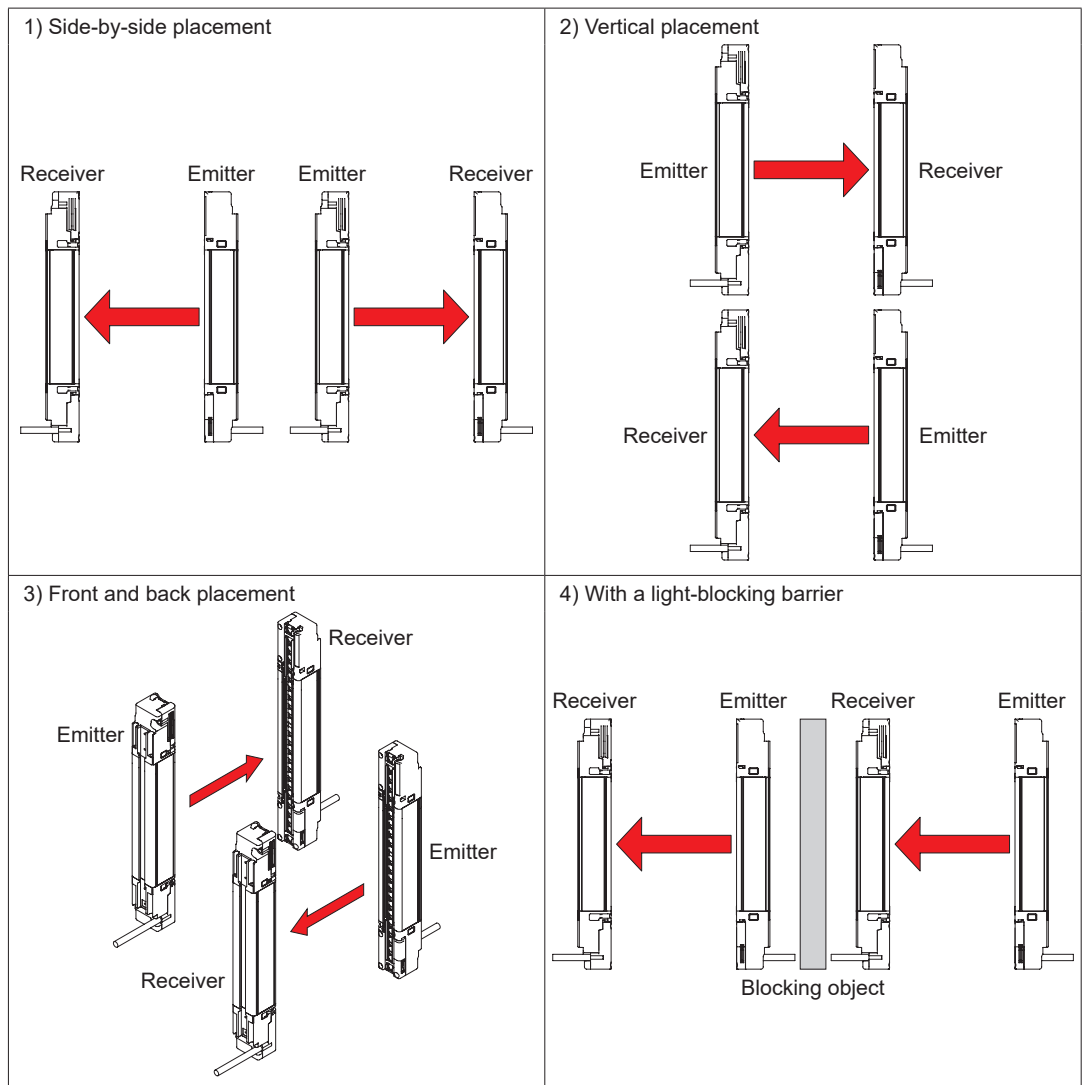

Protection Area

<Reference>

The above placement methods are examples. If you have questions or problems, please contact our office.

WARNING

The emitter and receiver cables must be oriented in the same direction. Risk of malfunctioning if the cables are not in the same oriented in the same direction.

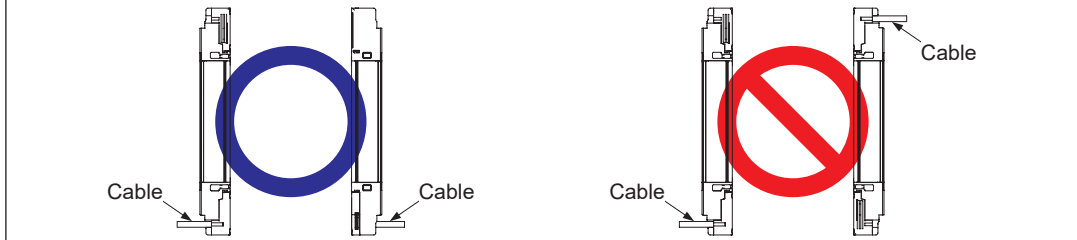

2-4 Mounting

2-4-1 Installing the Mounting Brackets

⚠ CAUTION

- To allow selection of mounting brackets that are appropriate for the installation environment, mounting brackets are not provided with the device. Please purchase the separately available mounting brackets that match your environment.
- Do not forcibly bend or otherwise apply a load to the cables of the device. Risk of wire breakage.
- The minimum bending radius of the cables is R6mm. Keep the minimum bending radius of the cables in mind during installation.
- Make sure that stress by forcible bend or pulling is not applied to the sensor cable joint.
- If you install mounting brackets after connecting the bottom-cap cable and series connection cable to the device, move the cables to the other side of the mounting socket when tightening the hex head cap bolt to prevent tangling of the cables.



When using as a safety device for a press machine or paper shearing machine in Japan

⚠ WARNING

The minimum bending radius of the cable with the protective tube **SFPD-A10** attached is 55mm. Take into consideration the minimum bending radius of the cable with the protective tube **SFPD-A10** attached.

<Reference>

- Mount the emitter and the receiver at the same level and parallel to each other. The effective aperture angle of the device is $\pm 2.5^\circ$ or less for a sensing range of 3m.
- Unless otherwise indicated, the mounting procedures that follow are for both the emitter and receiver. Prior to mounting, prepare mounting holes in the mounting surface as described in “**6-3 Dimensions**”.

Mounting

2-4-1-1 Using Beam Adjustment Mounting Bracket MS-SFD-1-□ (Option)

Step 1 Insert the mounting plate of the base bracket into the base bracket mounting rail on the back of the device.

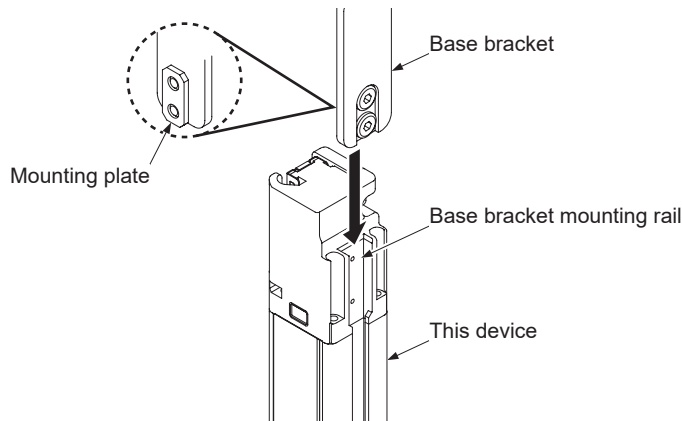

Step 2 With the base bracket in firm contact with the device, tighten the two ultra low-head hex socket bolts [M5 (length 5mm), opposing faces 3mm] that fasten the base bracket. Tighten to a torque of 3N·m or less.

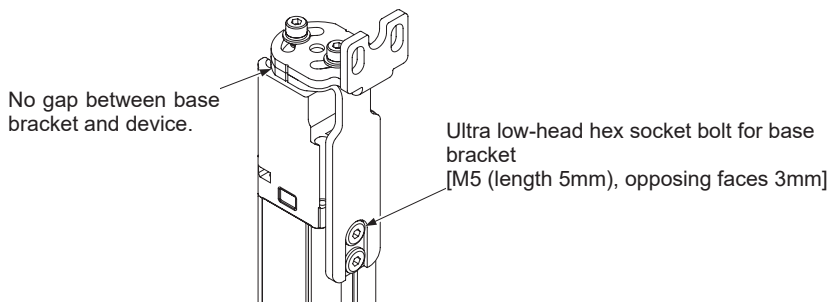

<Side mounting>

Loosen the two hexagon-socket head bolts with washers [M4 (length 8mm), opposing faces 3mm] and remove the bracket.

Change the orientation of the mounting bracket, and tighten the two hexagon-socket head bolts with washers [M4 (length 8mm), opposing faces 3mm]. Tighten to a torque of 1.5N·m or less.

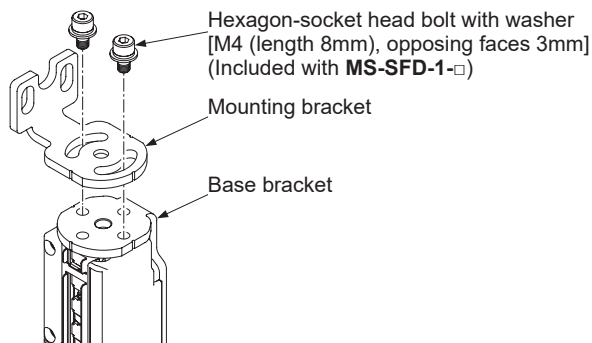

Step 3 Install the beam adjustment mounting bracket on the mounting surface with a hexagon-socket head bolt (purchase separately).

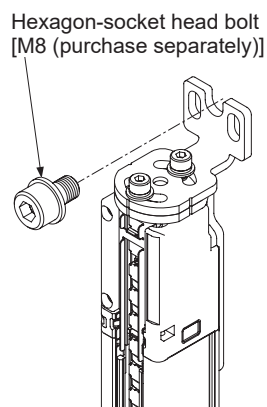
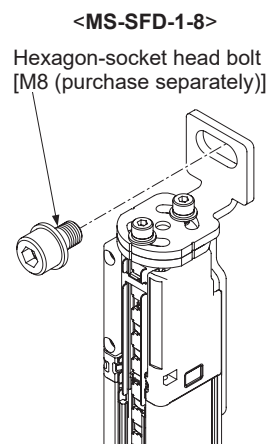
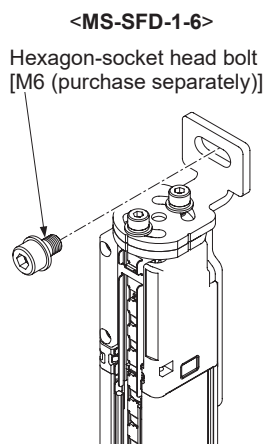
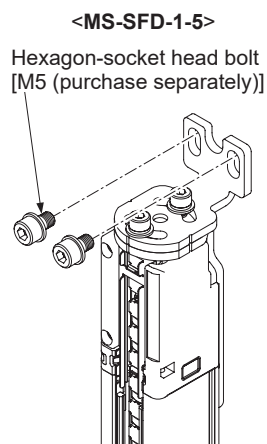

Mounting

2-4-1-2 Using Intermediate Supporting Bracket MS-SFB-2 (Option)

Step 1 Loosen the hexagon-socket head bolt [M4 (length 12mm), opposing faces 3mm] on the intermediate supporting bracket.

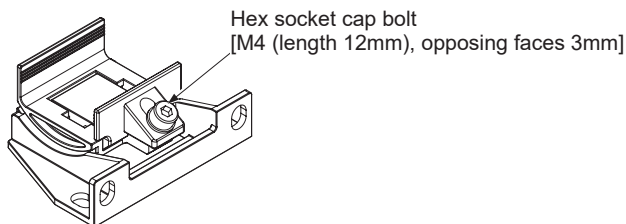

Step 2 Fit the intermediate supporting bracket onto the side of the device, and fasten with the hexagon-socket head bolt [M4 (length 12mm), opposing faces 3mm]. Tighten to a torque of 1.2N·m or less. For the mounting position of the intermediate supporting bracket, refer to “6-3 Dimensions”.

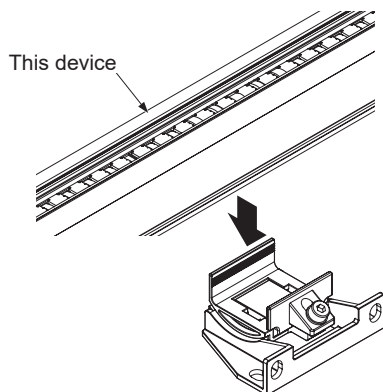

<Side mounting>

Slide and remove the fixing fitting of the intermediate supporting bracket from the base bracket. Change the direction of the fixing fitting, and engage the notches on the fixing fitting with the rails on the base bracket.

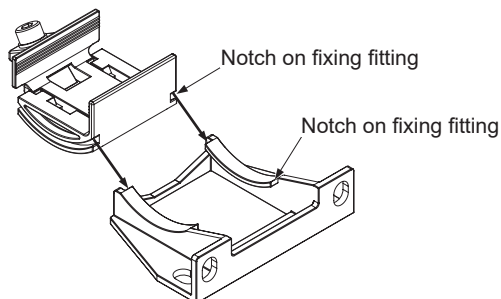

Step 3 Install the intermediate supporting bracket on the mounting surface with two hexagon-socket head bolts [M5 (purchase separately)].

<Rear mounting>

Hexagon-socket head bolt
[M5 (purchase separately)]

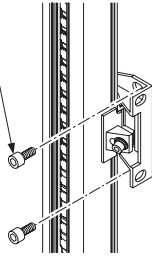

<Side mounting>

Hexagon-socket head bolt
[M5 (purchase separately)]

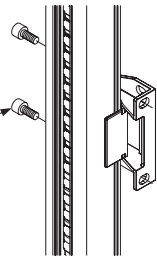

Note: When the number of beam axes is **SF4D-F□-01**: 111 or more beam axes, **SF4D-H□-01**: 56 or more beam axes, **SF4D-A□-01**: 28 or more beam axes, one set is required.

CAUTION

The intermediate supporting bracket **MS-SFB-2** is not intended to secure the device.

Mounting

2-4-1-3 Using No Dead-Space Beam Adjustment Mounting Bracket MS-SFD-3-6 (Option)

Step 1 Mount on the mounting surface with two hexagon-socket head bolt [M5 (purchase separately)] or two hex bolts [M6 (purchase separately)]. Tighten sufficiently to prevent the product from falling (do not overtighten). Tighten sufficiently to prevent the product from falling (do not overtighten).

<Rear mounting>

Hexagon-socket head bolt
[M5 (purchase separately)]

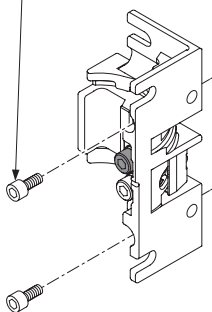

<Side mounting>

Hexagon-socket head bolt
[M5 (purchase separately)]

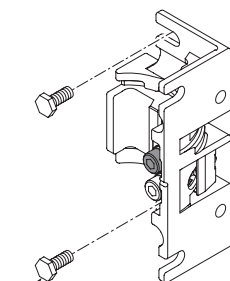

Hex bolt
[M6 (purchase separately)]

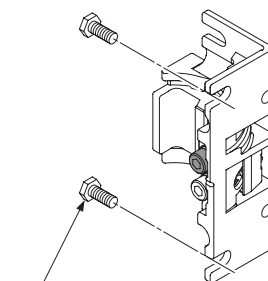
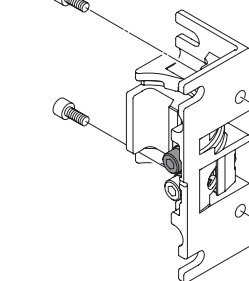

Hex bolt
[M6 (purchase separately)]

<Reference>

- Open mounting holes in the no dead-space beam adjustment mounting bracket in a straight line as indicated in “6-3-7 Mounting with MS-SFD-3-6”.
- If mounting the no dead-space beam adjustment mounting bracket on a commercially available aluminum frame, using non-slip nuts (purchase separately) will facilitate mounting.

Step 2 Partially loosen the hexagon-socket head bolt (M5, black) for light curtain fastening.

Hexagon-socket head bolt
for light curtain fastening
(M5, black)

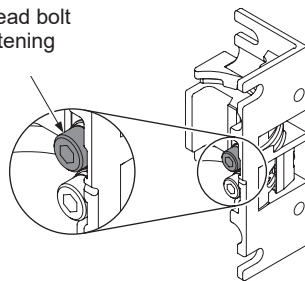

⚠ CAUTION

Do not remove the hexagon-socket head bolt (M5, black) that fastens the light curtain from this product.

Step 3 While pushing the product against the hexagon-socket head bolt side, mount the no dead-space beam adjustment mounting bracket. Make sure the slot in the product is locked onto the tab on the no dead-space beam adjustment mounting bracket.

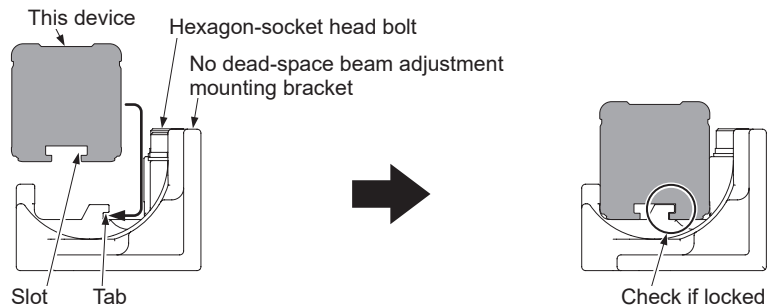

⚠ CAUTION

- Do not mount the no dead-space beam adjustment mounting bracket on the cap (black part) of the product.
- In step 3, the product is not yet fastened. If you do not maintain a firm grip on the product, it may fall and cause injury or product damage.

Step 4 Fasten with the hexagon-socket head bolt (M5, black) for light curtain fastening. Tighten to a torque of 2N·m or less.

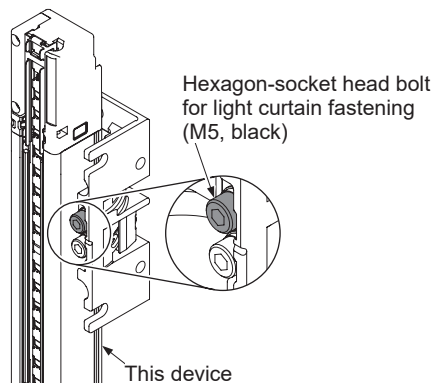

⚠ CAUTION

Firmly fasten the product to the no dead-space beam adjustment mounting bracket. Risk of product falling and causing injury or product damage.

Mounting

Step 5 Tighten the hexagon-socket head bolt (M5, silver) for beam adjustment.
Tighten to a torque of 2N·m or less.

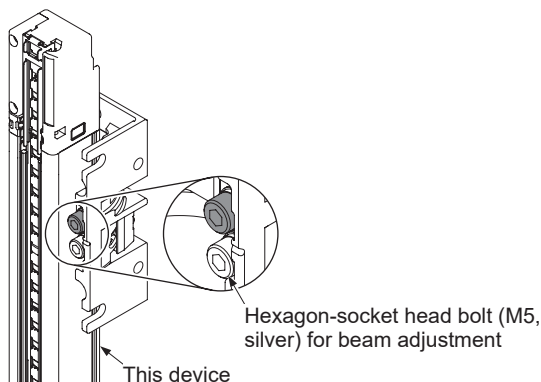

Step 6 Fully tighten the two hexagon-socket head bolts [M5] or the two hex bolts [M6] you partially tightened in step 1.

<Removing the product>

Step 1 While holding the product, partially loosen the hex-socket head bolt (M5, black) for light curtain fastening.

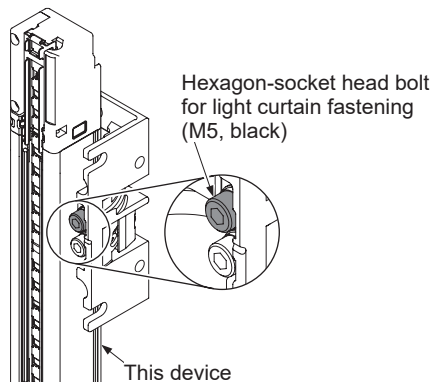

CAUTION

If you loosen the hex-socket head bolt (M5, black) for light curtain fastening without holding the product, there is a risk that the product will fall and cause injury or product damage.

Step 2 While pushing the product against the hexagon-socket head bolt side, remove the no dead-space beam adjustment mounting bracket.

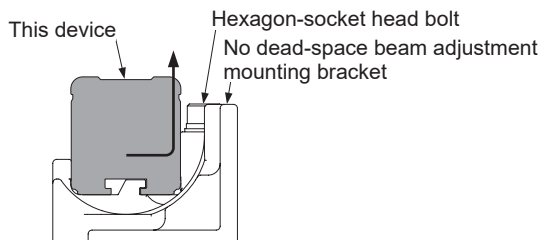

2-4-1-4 Using SF4B-G Compatible Mounting Bracket MS-SFD-4BG (Option)

Step 1 Insert the mounting plate of the base bracket into the base bracket mounting rail of the back of the device.

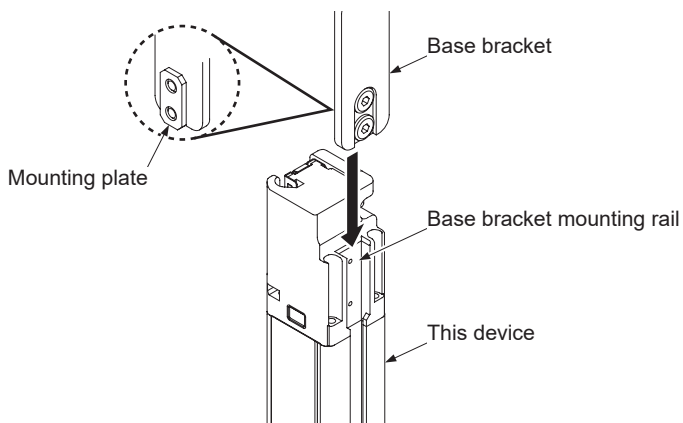

Step 2 With the base bracket in firm contact with the device, tighten the two ultra low-head hex socket bolts [M5 (length 5mm), opposing faces 3mm] that fasten the base bracket. Tighten to a torque of 3N·m or less.

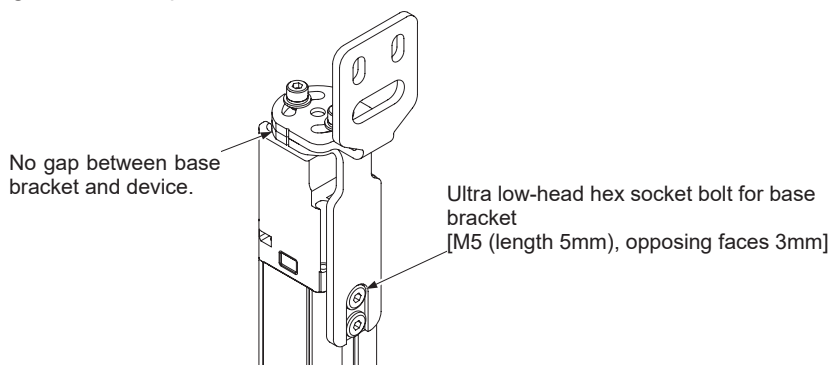

<Side mounting>

Loosen the two hexagon-socket head bolts with washers [M4 (length 8mm), opposing faces 3mm] and remove the bracket.

Change the orientation of the mounting bracket, and tighten the two hexagon-socket head bolts with washers [M4 (length 8mm), opposing faces 3mm]. Tighten to a torque of 1.5N·m or less.

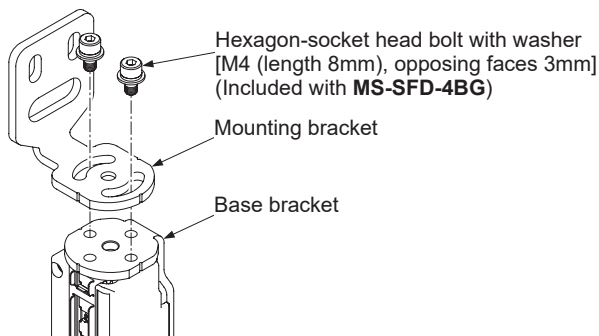

Mounting

Step 3 Install the beam adjustment mounting bracket on the mounting surface with a hexagon-socket head bolts (purchase separately).

Hexagon-socket head bolt
[M5 (purchase separately)]

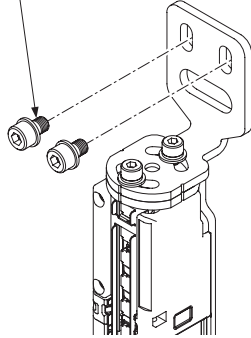

Hexagon-socket head bolt
[M8 (purchase separately)]

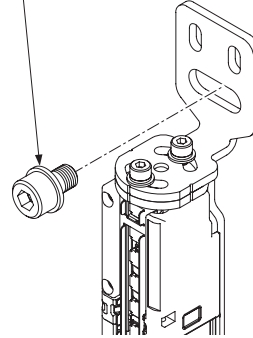

2-4-2 Installing the Bottom Cap Cables (Option)

Cables are not provided with the device.
To install the bottom cap cables (option), follow the steps below.

⚠ CAUTION

- Take care not to misplace any screws while you are working.
- The bottom cap cables are distinguished by round connector color. Gray is for the emitter, and black is for the receiver. Make sure that the correct cable is connected to the emitter and to the receiver.
- There is packing on the connector of the bottom cap cable. If the packing is not fitted on the connector properly, fit as shown below before connecting to the device.

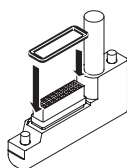

When using as a safety device for a press machine or paper shearing machine in Japan

When using as a safety device for a press machine or paper shearing machine in Japan, always attach the protective tube **SFPD-A10** (option) to the cable.

<Reference>

Bottom cap cables are available in three types: 5-core, 8-core, and 12-core. Discrete wire and connector types are also available. Select the appropriate type for the application.
The length of the bottom cap cable varies by model No.

Type		Model No.	Length
5-core	Discrete wire type	SFD-CCB5-S	5m
		SFD-CCB10-S	10m
	Connector type	SFD-CB05-S	0.5m
8-core	Discrete wire type	SFD-CCB3	3m
		SFD-CCB7	7m
		SFD-CCB10	10m
		SFD-CCB15	15m
	Connector type	SFD-CB05	0.5m
		SFD-CB5	5m
	SFD-CB10	10m	
12-core	Discrete wire type	SFD-CCB3-MU	3m
		SFD-CCB7-MU	7m
		SFD-CCB10-MU	10m
	Connector type	SFD-CB05-MU	0.5m

Mounting

<Connection method>

Step 1 Insert the connector of the bottom cap cable (option) into the connector on the device.
When inserting the connector, fit the cable into the groove on the device.

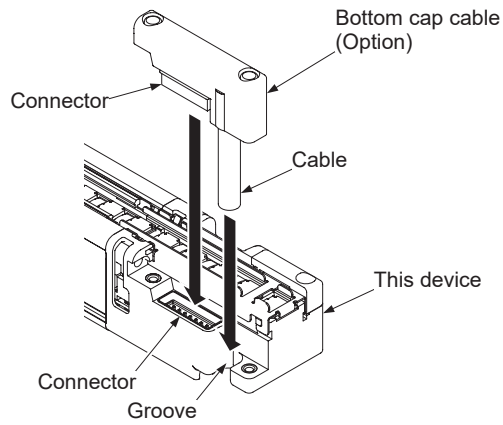

Step 2 Tighten the two M2.6 screws. Tighten to a torque of 0.3N·m or less.

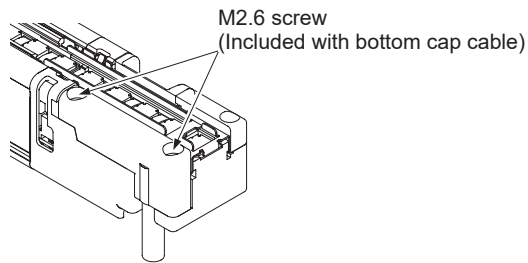

2-4-3 Adding and Removing Sensors (Series Connection)

This section explains how to create a series connection using options. To create a series connection, the following tasks must be performed.

⚠ CAUTION

- Take care not to misplace any screws while you are working.
- Keep the removed end cap in a safe place.
- Do not mix emitters and receiver in the series connection.
- There is packing on the connector of the bottom cap cable. If the packing is not fitted on the connector properly, fit as shown below before connecting to the device.

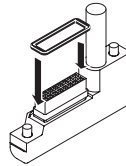

- The shape of the connector on the **SFD-CSL**□ series connection cable (option) is different from the bottom connector and end cap connector. Take care not to mix up the cables when installing.
- The series connection cable cannot be extended.
- When inserting the series connection cable into the main sensor, pay attention to the following points. Risk of bending of connector pins if inserted carelessly.

1. Do not run the cable before you have fastened the connector with the M2.6 screws.



2. Make sure the connector is completely inserted before fastening with the M2.6 screws.

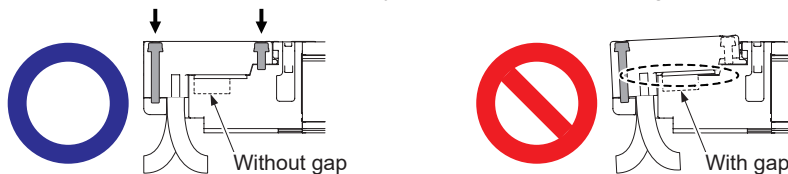

Mounting

<Reference>

The series connection cable is used in common for both the emitter and receiver.

The length of the series connection cable varies by model No.

If this device is to be installed in an L-shaped layout configuration, we recommend that an at least 0.1m long series connection cable be used.

Model No.	Length	Model No.	Length
SFD-CSL005	0.05m	SFD-CSL1	1m
SFD-CSL01	0.1m	SFD-CSL5	5m
SFD-CSL05	0.5m	SFD-CSL10	10m

<Connecting the series connection cable>

Step 1 Loosen the two M2.6 screws on the end cap of the main sensor (emitter / receiver connected by synchronization wire), and remove the end cap.

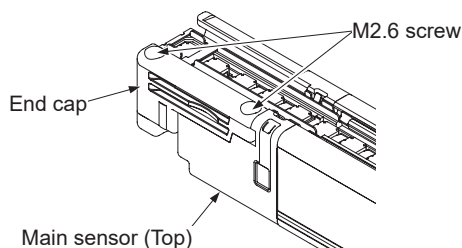

Step 2 Insert the connector of the series connection cable (option) into the connector on the device. When inserting the connector, fit the cable into the groove on the device.

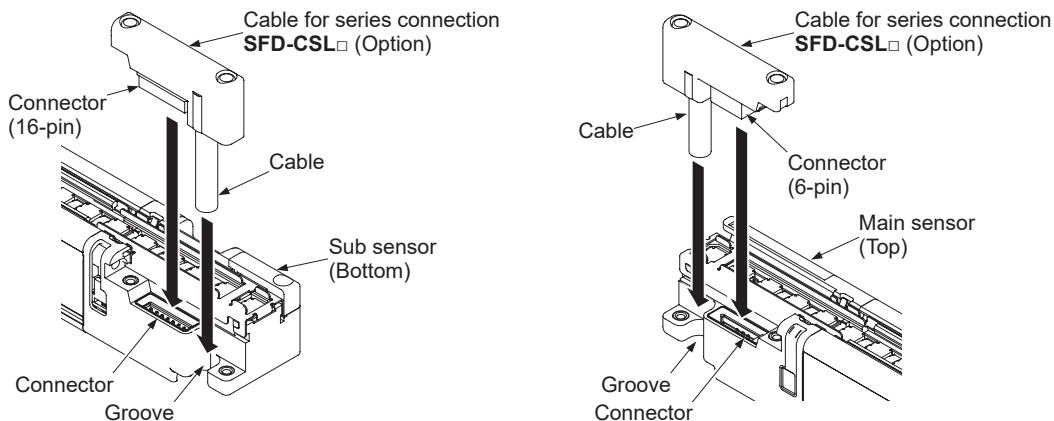

Step 3 Tighten the two M2.6 screws. Tighten to a torque of 0.3N·m or less.

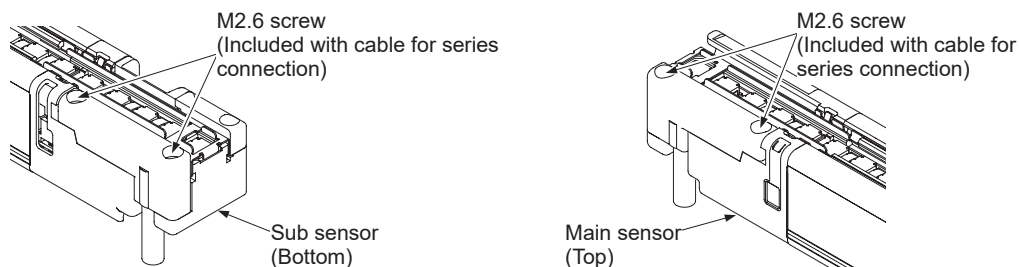

When using as a safety device for a press machine or paper shearing machine in Japan

When using as a safety device for a press machine or paper shearing machine in Japan, always attach the protective tube **SFPD-A10** (option) to the cable.

<Removing the series connection cable>

Step 1 To disconnect the series connection cable, reverse the procedure for <Connecting the series connection cable>.

Mounting

When using as a safety device for a press machine or paper shearing machine in Japan

2-4-4 Attaching the protective tube

When using as a safety device for a press machine or paper shearing machine in Japan, always attach the protective tube **SFPD-A10** (option) to the cable.

Step 1 Cut a length of the protective tube equal to the length of the cable to be used.

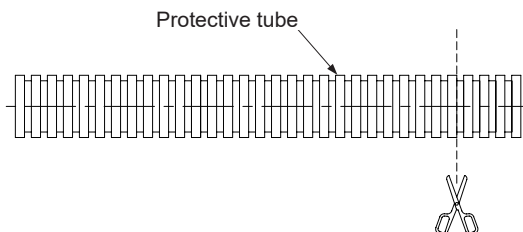

Note: Cut a length of the protective tube that is sufficient to cover the entire cable (excluding the connectors). A protective tube is not needed for the bottom cap cable **SFD-CCB**□ or **SFD-CB**□, nor for the direct connection cable **SFD-CSL**□, nor for the section of the cable (about 33mm) that overlaps with the device when connected to the device.

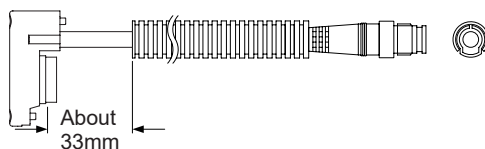

Step 2 Separate the protective tube as shown below.

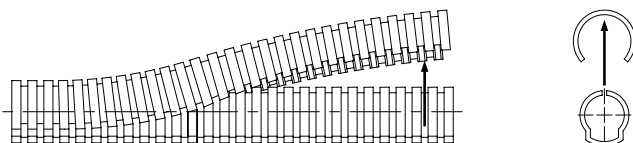

Step 3 Insert the cable.

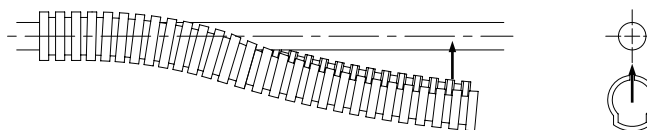

Step 4 Reinsert the protective tube to restore to its original state.

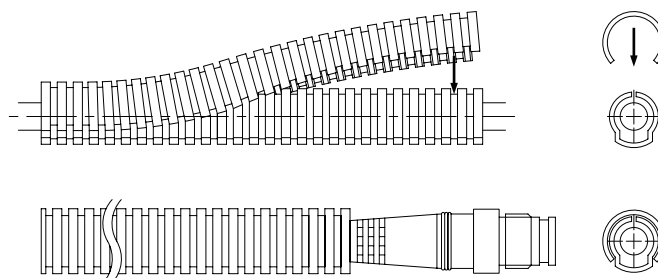

2-4-5 Mounting and Removing the Front Protective Cover

Use the following method when mounting a front protective cover (option) on the device.

⚠ CAUTION

Take care not to apply excessive force to the front protective cover, as it may break.

<Mounting wide type FC-SFDH□>

Press the front protective cover from the front side of the device and hook the nails on the cover into the grooves on the side of the device.

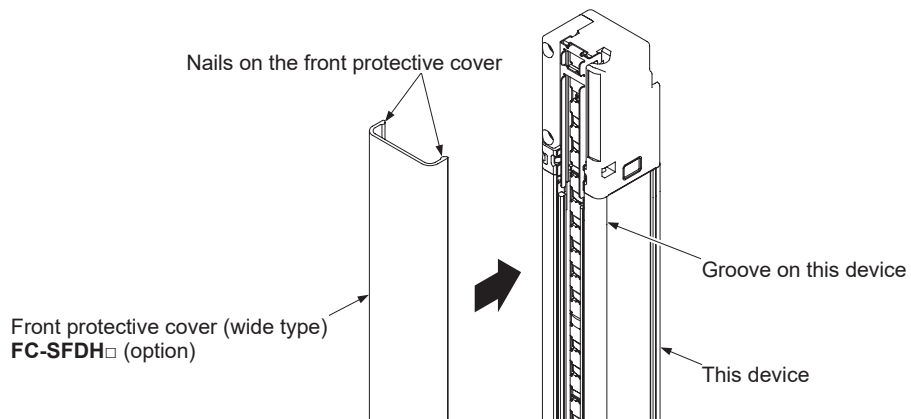

<Removing wide type FC-SFDH□>

Expand both sides of the front protective cover to the right and left and then remove the cover from the device.

Mounting

<Mounting slim type FC-SFDH□-S>

Step 1 Press the front protective cover into the groove on the cap (black part) on the device.

Step 2 Press the front protective cover into all the grooves on the device.

Step 3 Use a soft cloth to gently wipe off any dirt (such as fingerprints) that adheres to the front protective cover.

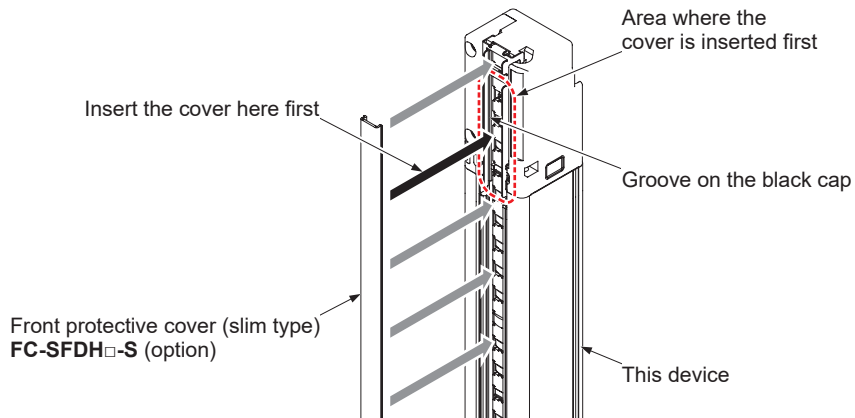

<Removing slim type FC-SFDH□-S>

Insert your fingers into the gaps on the top and bottom of the front protective cover and slowly remove the cover from the device.

CAUTION

Do not apply excessive force when removing the front protective cover from the device. Doing so may break the cover.

2-5 Wiring

WARNING

- Ground the machine or support on which the device is installed to frame ground (F.G.). If not grounded properly, there is a risk of death or serious injury from malfunctioning caused by noise. Enclose the wiring in a metal wiring box connected to frame ground (F.G.).
- Design the system that uses the device so that dangerous operation will not be caused by a grounding failure. Risk of death or serious injury if the system cannot be stopped.
- To prevent the output from turning ON if the control output (OSSD 1 / 2) wire shorts to ground (ground fault), always ground to 0V for PNP output, or +V for NPN output.

CAUTION

Always insulate the ends of lead wires that are not used.

2-5-1 Power Supply Unit

CAUTION

Use a power supply unit that conforms to the laws and regulations (code) of the region where the device is to be used, and connect correctly.
Risk of device damage and malfunctioning if a non-compliant unit is used or the wiring is incorrect.

<Reference>

Wiring work must only be done by a qualified electrician or technician.

The power supply unit must satisfy the following requirements:

- 1) The power unit must be certified for use in your region.
- 2) The power supply unit must be a SELV (safety extra low voltage) / PELV (protected extra low voltage) unit that conforms to the EMC Directive and Low-voltage Directive. (When CE marking is required.)
- 3) When using a commercial switching regulator, the frame ground (F.G.) terminal must be connected to ground.
- 4) The power supply unit must have an output holding time of 20ms or more.
- 5) If surges occur, take countermeasures such as connecting a surge absorber to the source of the surges.
- 6) The power unit must be a CLASS 2 compliant unit. (When cTÜVus mark compliance is required.)

Wiring

2-5-2 Input / Output Circuit Diagrams and Output Waveforms

- Using optical synchronization setting and 5-core cable

⚠ CAUTION

When using the 5-core cable, set the synchronization method to optical synchronization.
For the setting of optical synchronization, refer to “3-9 DIP Switch Settings”

<Using PNP output>

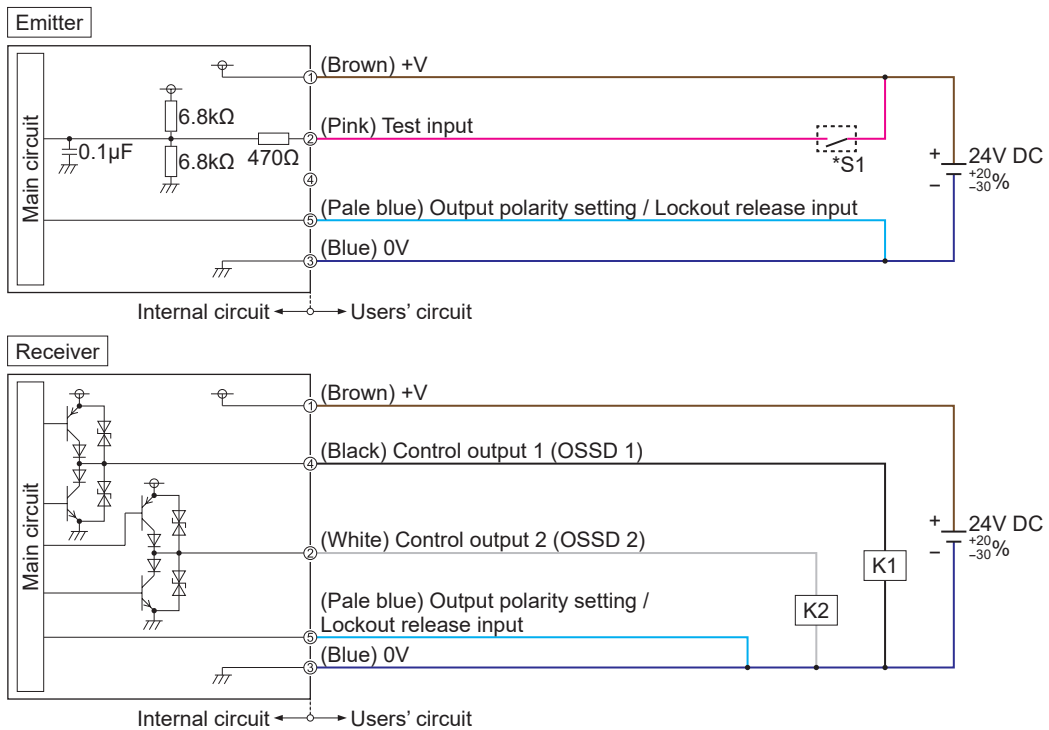

***S1**

Switch S1

- Test input

V_s to $V_s - 2.5V$ (sink current 5mA or less): Emission halt, Open: Emission (Note)

Note: V_s is the supply voltage.

<Reference>

K1, K2: Safety relay unit, etc.

<Using NPN output>

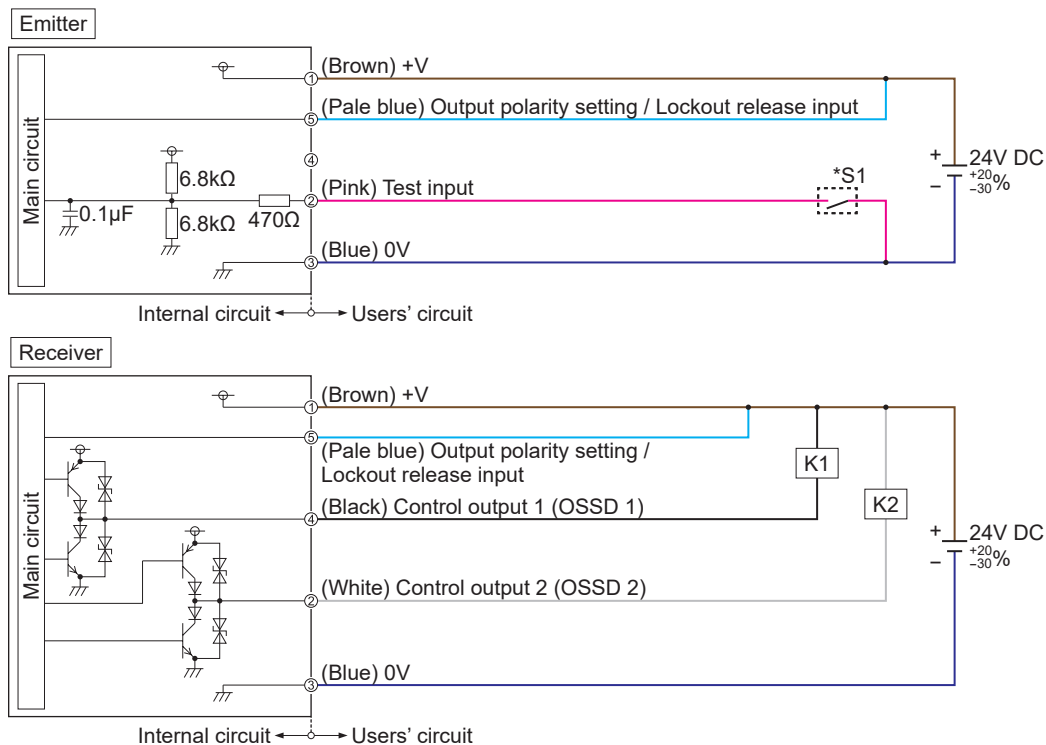

*S1

Switch S1

- Test input
0 to +2.5V (source current 5mA or less): Emission halt, Open: Emission

<Reference>

K1, K2: Safety relay unit, etc.

Wiring

• Using line synchronization setting and 8-core cable

<Using PNP output>

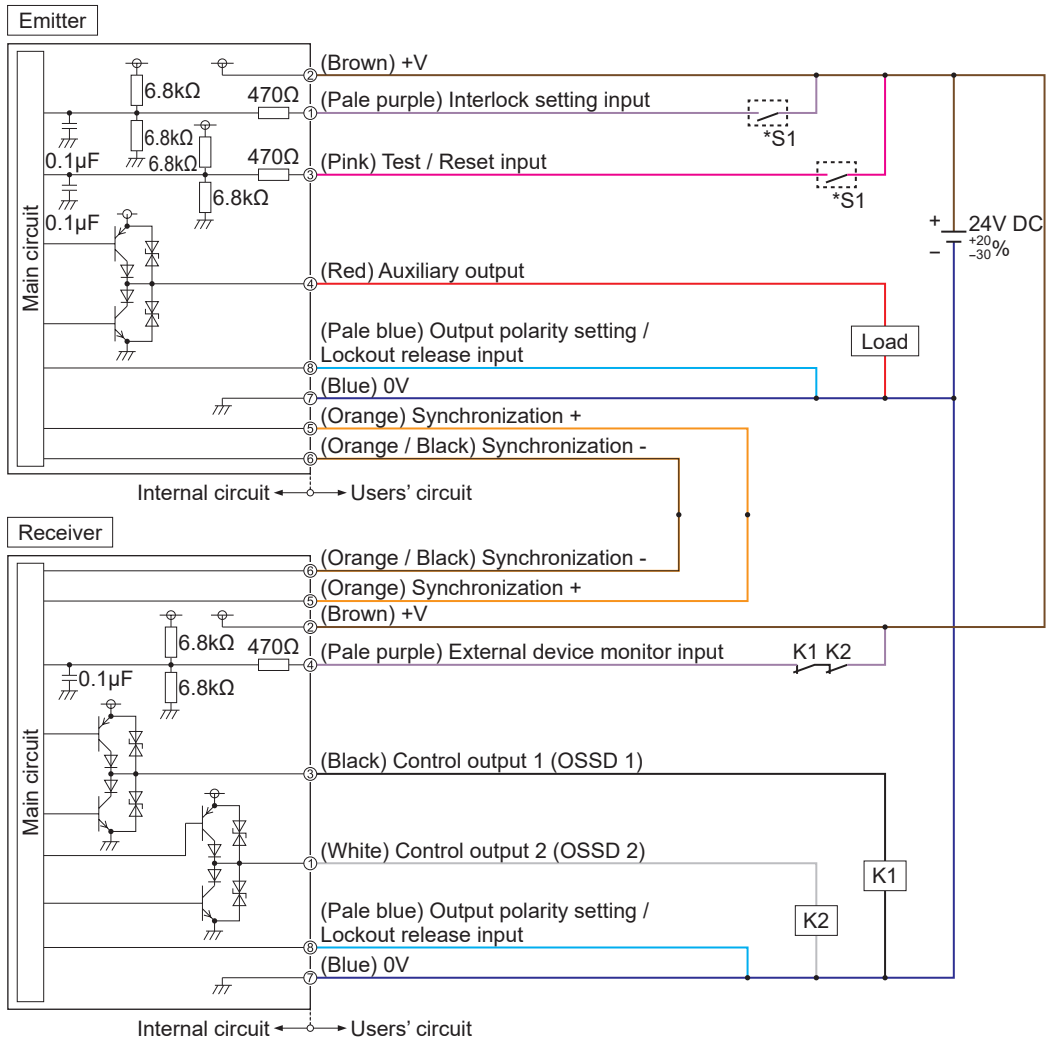

*S1

Switch S1

- Test / Reset input
Manual reset ...Vs to Vs - 2.5V (sink current 5mA or less): Emission halt (Note), Open: Emission
Auto reset ...Vs to Vs - 2.5V (sink current 5mA or less): Emission (Note), Open: Emission halt
- Interlock setting input, External device monitor input
Vs to Vs - 2.5V (sink current 5mA or less): Valid (Note), Open: Invalid

Note: Vs is the supply voltage.

<Reference>

K1, K2: External device (forcible guide relay or magnetic contactor)

<Using NPN output>

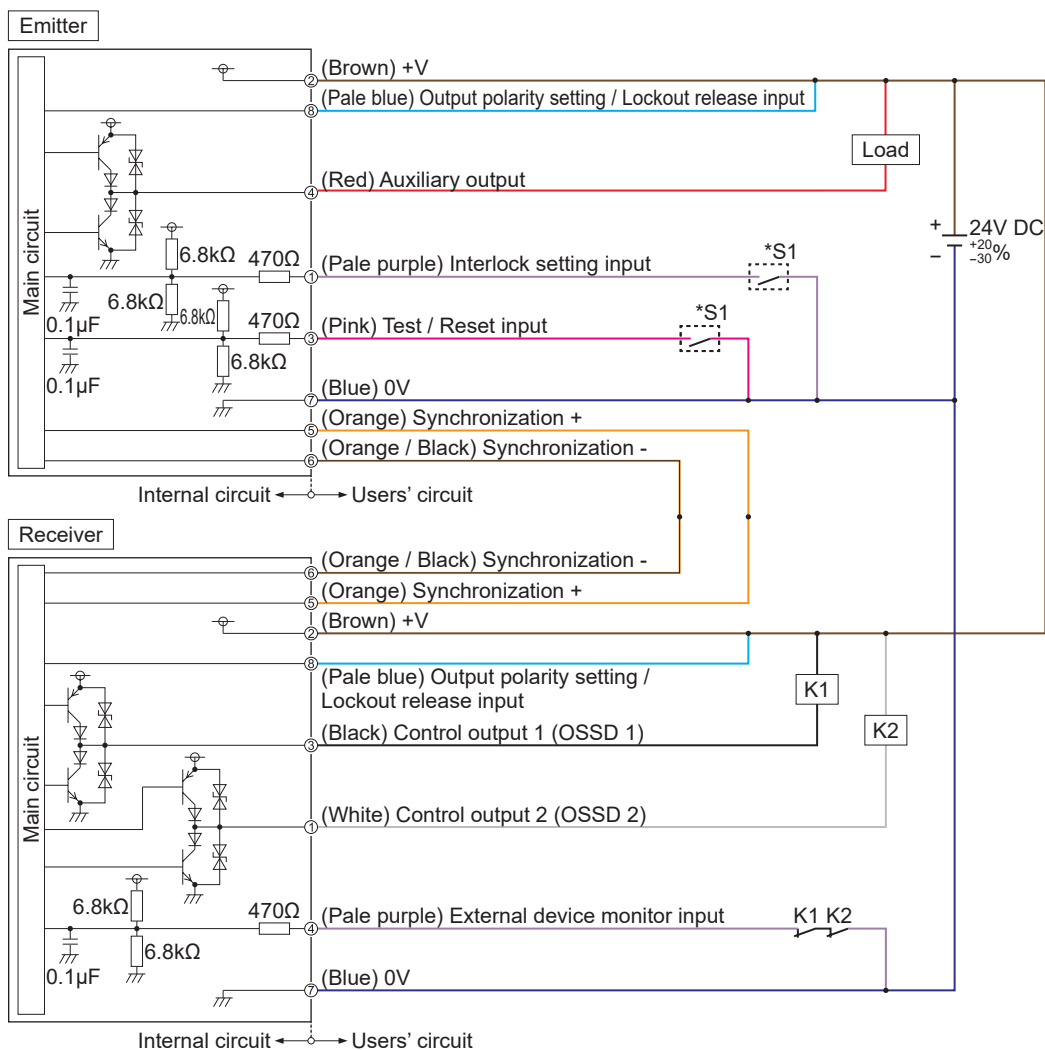

*S1

Switch S1

- Test / Reset input
Manual reset ...0 to +2.5V (source current 5mA or less): Emission halt, Open: Emission
Auto reset ...0 to +2.5V (source current 5mA or less): Emission, Open: Emission halt
- Interlock setting input, External device monitor input
0 to +2.5V (source current 5mA or less): Valid, Open: Invalid

<Reference>

K1, K2: External device (forcible guide relay or magnetic contactor)

Wiring

- Using line synchronization setting and 12-core cable

<Using PNP output>

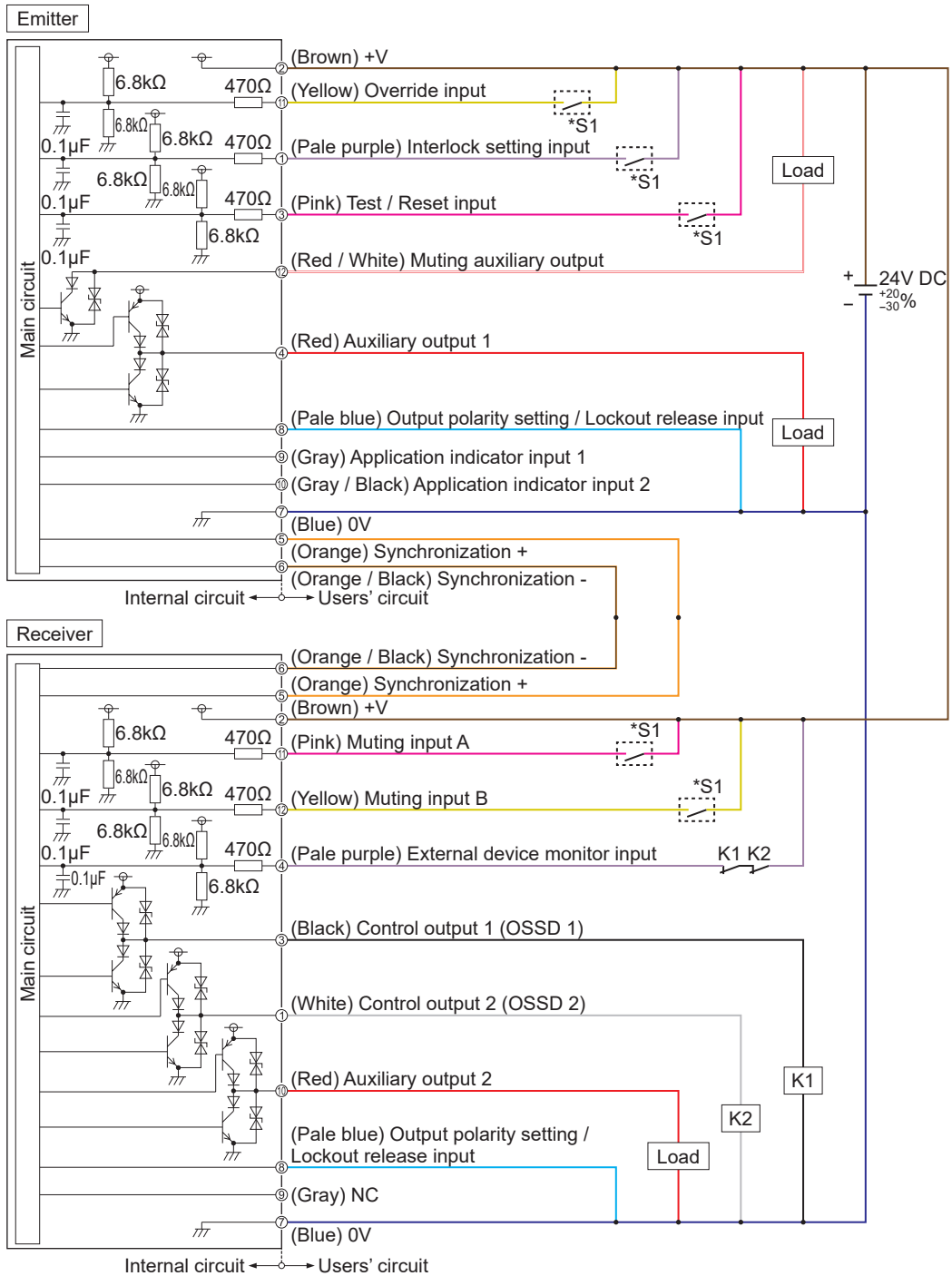

*S1

Switch S1

- Test / Reset input

Manual reset ...Vs to Vs - 2.5V (sink current 5mA or less): Emission halt (Note), Open: Emission

Auto reset ...Vs to Vs - 2.5V (sink current 5mA or less): Emission (Note), Open: Emission halt

- Interlock setting input, Override input, Muting input A / B, External device monitor input

Vs to Vs - 2.5V (sink current 5mA or less): Valid (Note), Open: Invalid

Note: Vs is the supply voltage.

<Reference>

K1, K2: External device (forcible guide relay or magnetic contactor)

Wiring

<Using NPN output>

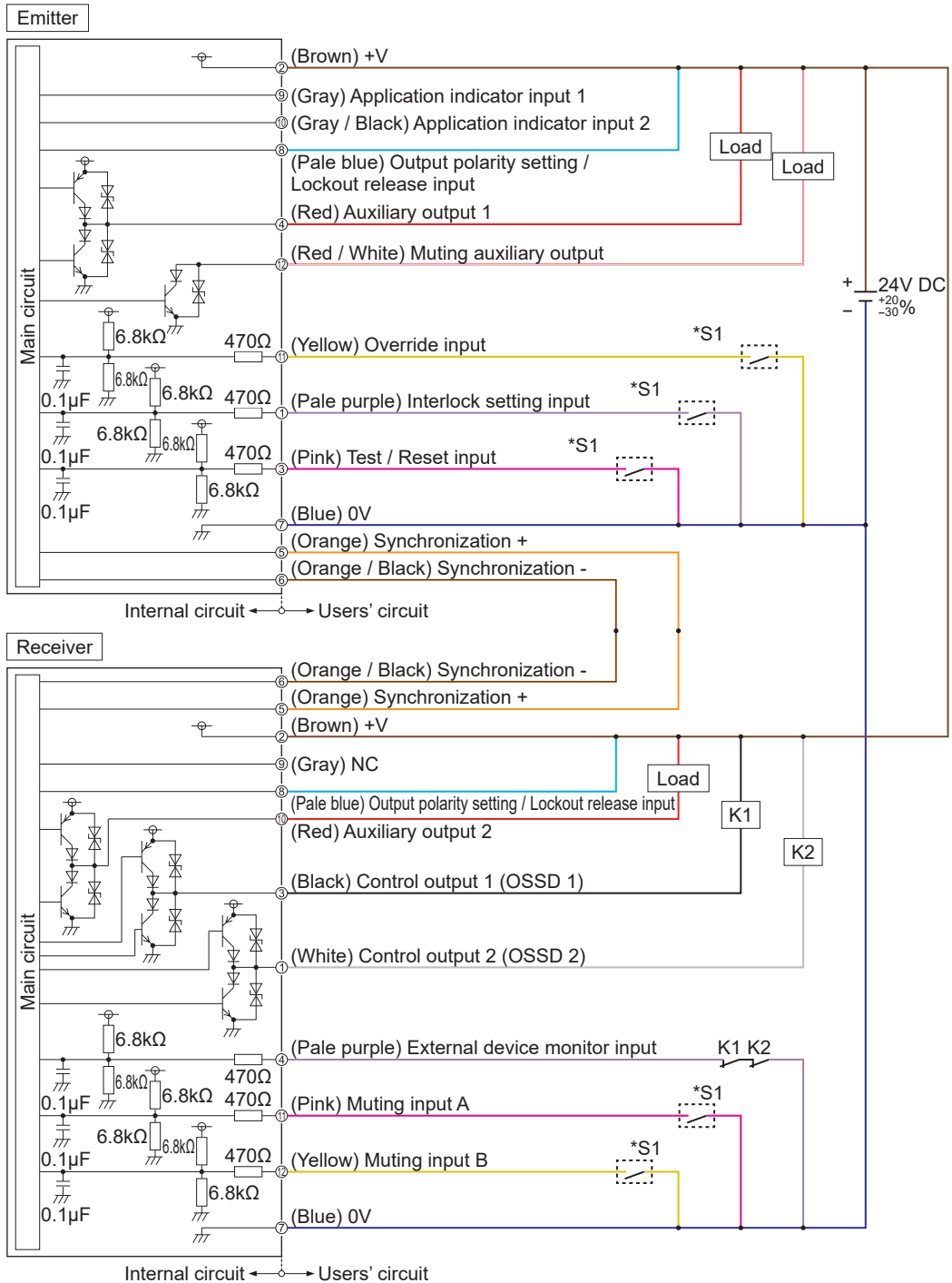

*S1

Switch S1

- Test / Reset input
 - Manual reset ...0 to 2.5V (source current 5mA or less): Emission halt, Open: Emission
 - Auto reset ...0 to 2.5V (source current 5mA or less): Emission, Open: Emission halt
- Interlock setting input, Override input, Muting input A / B, External device monitor input
 - 0 to +2.5V (source current 5mA or less): Valid, Open: Invalid

<Reference>

- K1, K2: External device (forcible guide relay or magnetic contactor)
- For wiring, refer to 2-5-4 and following sections.

Wiring

<Output waveform [control output (OSSD 1 / 2) ON]>

The receiver executes self-diagnosis of the output circuit when the device is in the light receiving state (ON state), and thus the output transistor turns OFF periodically. (Refer to the chart below.)

When an OFF signal is fed back, the receiver determines that the output circuit is normal. If an OFF signal is not fed back, the receiver determines that there is an output circuit or wiring error, and the control output (OSSD 1 / 2) holds the OFF state.

CAUTION

Because the OFF signal of the device may cause the machine to malfunction, pay attention to the input response time of the machine when connecting the machine to the device.

<Timing chart>

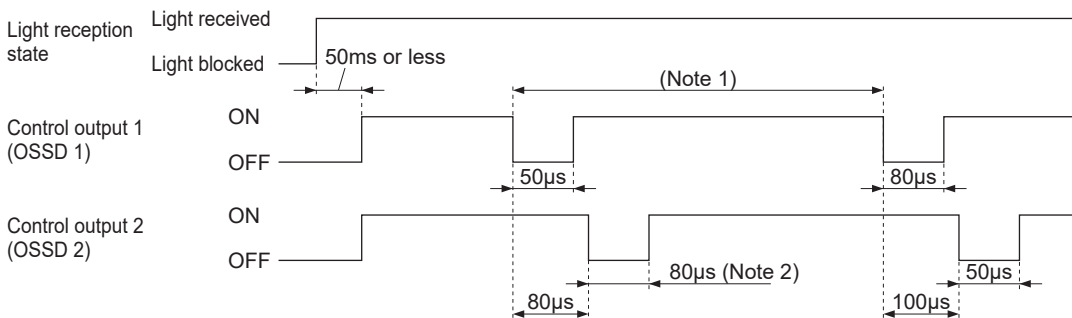

Notes: 1) Depends on main cycle: 2.6 to 8.9ms

2) Extended up to a maximum of 300μs when the load is a capacitance load.

2-5-3 Cable Wiring / Connections / Extension and Connector Pinouts

Connect the connector of the connection cable (connector on one end, connector on both ends) to the connector of the bottom cap cable connected to the device (emitter, receiver).

Connect the wires on the other end of the connection cable as required for the application, referring to the connector pinouts below.

⚠ WARNING

- If you need to extend the cable, use the special-use cable. Extension is possible to a maximum total length of 70m each for the emitter and the receiver. If the total length is greater than 70m, the device may malfunction, creating a risk of death or serious injury.
- When connecting in a series connection, do not exceed a total length of 70m each for the emitter and the receiver, including the cable for series connection. If the total length is greater than the specification, the device may malfunction, creating a risk of death or serious injury.
- If you are extending the synchronization + wire (orange) and synchronization - wire (orange / black) using a cable other than the special-use cable, use 0.2mm² or more twisted-pair cable, and extend 0V as well. For other than synchronization + wire (orange) and synchronization - wire (orange / black), use 0.3mm² or more cable.
- In the case of line synchronization, emitter and receiver 0V should be common.

When using as a safety device for a press machine or paper shearing machine in Japan

⚠ WARNING

When using as a safety device for a press machine or paper shearing machine in Japan, always attach the protective tube **SFPD-A10** (option) to the cable. To attach the protective tube, refer to **“2-4-4 Attaching the protective tube”**.

Bottom cap cable - discrete wire

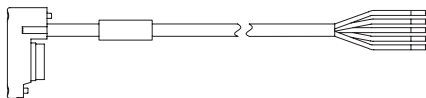

Bottom cap cable - connector

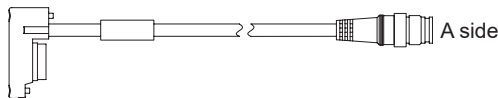

Cable with connector on one end

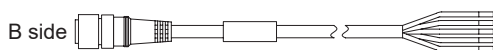

Cable with connector on both ends

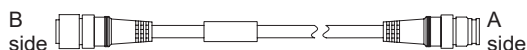

Side A connector (emitter/receiver common)

<5-core>

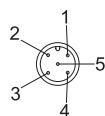

<8-core>

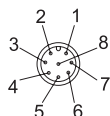

<12-core>

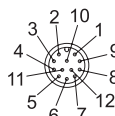

Side B connector (emitter/receiver common)

<5-core>

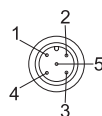

<8-core>



<12-core>

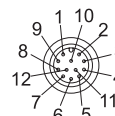

Wiring

<5-core cable (SFD-CCB□-S, SFD-CB□-S, SFD-CC□-S, SFD-CCJ□-S)>

	Cable color / Connector color	Pin No.	Lead wire color	Name
Emitter	Gray / Gray	1	Brown	24V DC
		2	Pink	Test input
		3	Blue	0V
		4	–	–
		5	Pale blue	Output polarity setting / Lockout release input
Receiver	Gray (with Black line) / Black	1	Brown	24V DC
		2	White	Control output 2 (OSSD 2)
		3	Blue	0V
		4	Black	Control output 1 (OSSD 1)
		5	Pale blue	Output polarity setting / Lockout release input

<8-core cable (SFD-CCB□, SFD-CB□, SFD-CC□, SFB-CCJ□)>

	Cable color / Connector color	Pin No.	Lead wire color	Name
Emitter	Gray / Gray	1	Pale purple	Interlock setting input
		2	Brown	24V DC
		3	Pink	Test / Reset input
		4	Red	Auxiliary output
		5	Orange	Synchronization +
		6	Orange / Black	Synchronization -
		7	Blue	0V
		8	Pale blue	Output polarity setting / Lockout release input
Receiver	Gray (with black line) / Black	1	White	Control output 2 (OSSD 2)
		2	Brown	24V DC
		3	Black	Control output 1 (OSSD 1)
		4	Pale purple	External device monitor input
		5	Orange	Synchronization +
		6	Orange / Black	Synchronization -
		7	Blue	0V
		8	Pale blue	Output polarity setting / Lockout release input

<12-core cable (SFD-CCB□-MU, SFD-CB□-MU, SFD-CC□-MU)>

	Cable color / Connector color	Pin No.	Lead wire color	Name
Emitter	Gray / Gray	1	Pale purple	Interlock setting input
		2	Brown	24V DC
		3	Pink	Test / Reset input
		4	Red	Auxiliary output 1
		5	Orange	Synchronization +
		6	Orange / Black	Synchronization -
		7	Blue	0V
		8	Pale blue	Output polarity setting / Lockout release input
		9	Gray	Application indicator input 1
		10	Gray / Black	Application indicator input 2
		11	Yellow	Override input
		12	Red / White	Muting auxiliary output
Receiver	Gray (with black line) / Black	1	White	Control output 2 (OSSD 2)
		2	Brown	24V DC
		3	Black	Control output 1 (OSSD 1)
		4	Pale purple	External device monitor input
		5	Orange	Synchronization +
		6	Orange / Black	Synchronization -
		7	Blue	0V
		8	Pale blue	Output polarity setting / Lockout release input
		9	Gray	NC
		10	Red	Auxiliary output 2
		11	Pink	Muting input A
		12	Yellow	Muting input B

<Reference>

- Connectors for the emitter are gray, and connectors for the receiver are black.
- For details on cables with a connector on one end and cables with a connector on both ends, refer to “6-2 Options”.

Wiring

2-5-4 Basic Wiring

This is a common connection method whereby one emitter and one receiver face each other. The control output (OSSD 1 / 2) turns OFF when light is blocked, and automatically turns ON when light is received.

The output setting of the device is set by the connection of the output polarity setting / lockout release input wire (pale blue).
If the wiring is not correct, the lockout state will activate.

- Using optical synchronization setting and 5-core cable

⚠ CAUTION

When using the 5-core cable, set the synchronization method to optical synchronization.
For the setting of optical synchronization, refer to “3-9 DIP Switch Settings”

<Using PNP output>

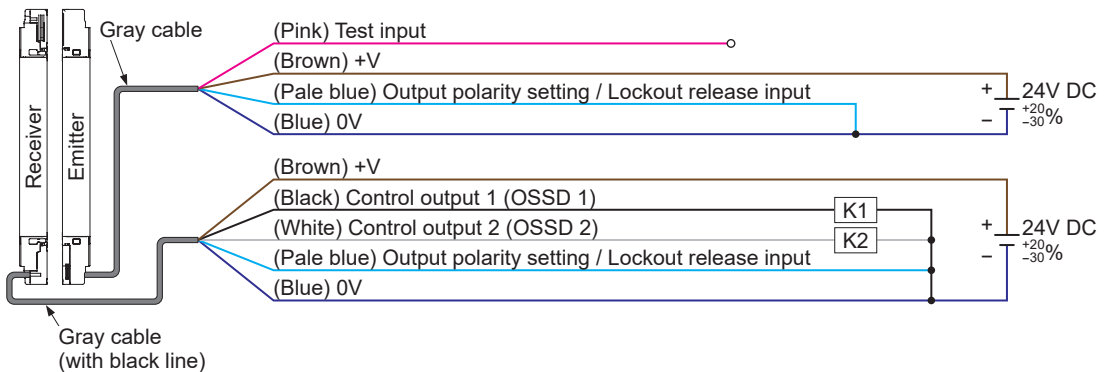

*Symbols

K1, K2: Safety relay unit, etc.

<Using NPN output>

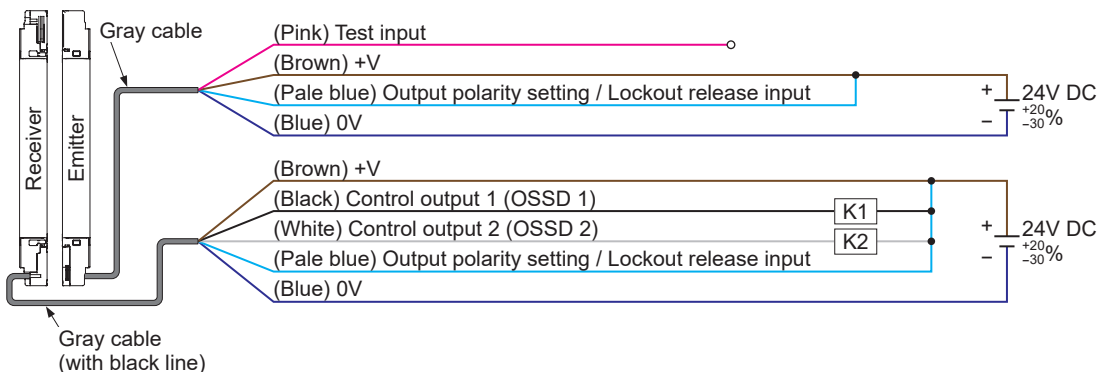

*Symbols

K1, K2: Safety relay unit, etc.

The auxiliary output is used to invalidate the external device monitor function. The auxiliary output should be set to “control output negative logic” (factory setting). External devices cannot be connected to the auxiliary output.

- Using line synchronization setting and 8-core cable

<Using PNP output>

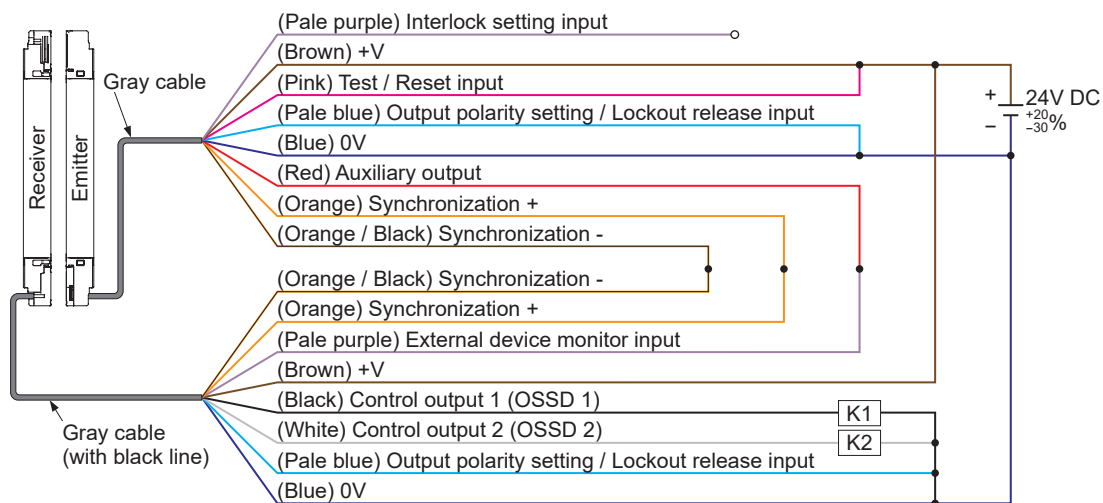

Interlock function	Invalid (auto reset)
External device monitor function	Invalid
Auxiliary output	Cannot be used

***Symbols**

K1, K2: Safety relay unit, etc.

Wiring

<Using NPN output>

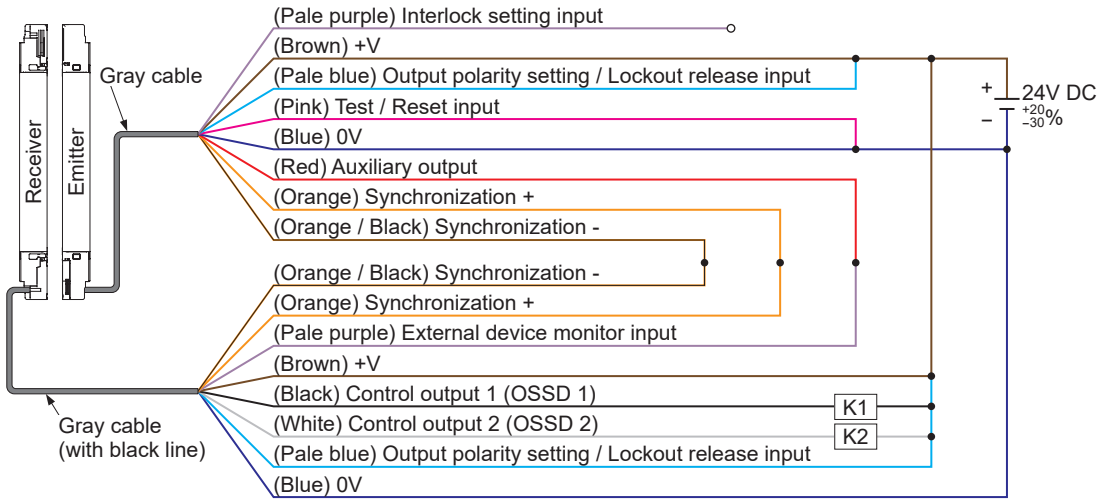

Interlock function	Invalid (auto reset)
External device monitor function	Invalid
Auxiliary output	Cannot be used

*Symbols

K1, K2: Safety relay unit, etc.

2-5-5 Wiring for Manual Reset (Interlock is Valid) (Example of Control Category 4 Wiring)

This is a common connection method whereby one emitter and one receiver face each other. The control output (OSSD 1 / 2) turns OFF when light is blocked.

- Using line synchronization setting and 8-core cable

<Using PNP output>

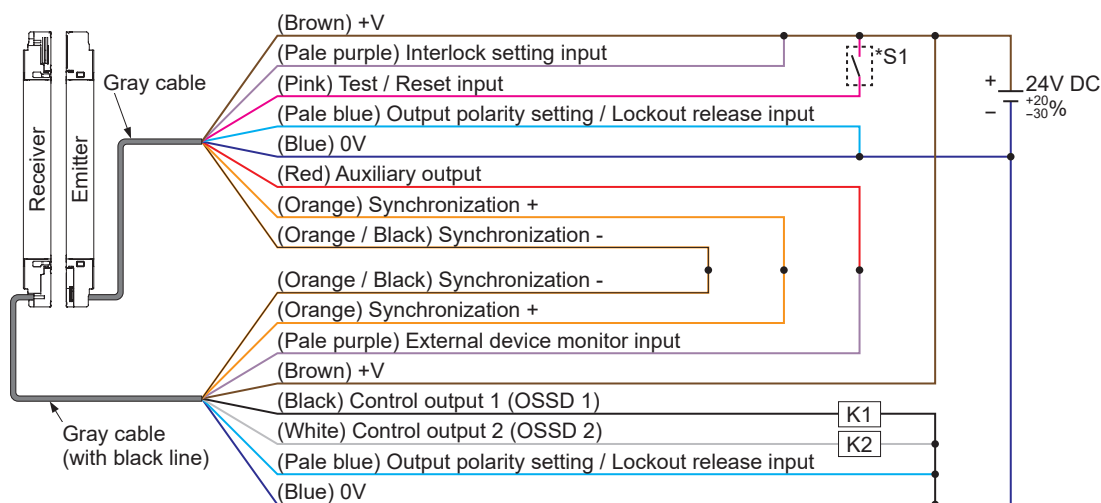

Interlock function	Valid (manual reset)
External device monitor function	Invalid
Auxiliary output	Not possible

*Symbols

Switch S1
 V_s to $V_s - 2.5V$ (sink current 5mA or less): Emission halt (Note 1), Open: Emission
 K1, K2: Safety relay unit, etc.

Notes: 1) V_s is the supply voltage.

2) For information on reset, refer to "3-2 Interlock Function (8-core cable, 12-core cable)".

Wiring

<Using NPN output>

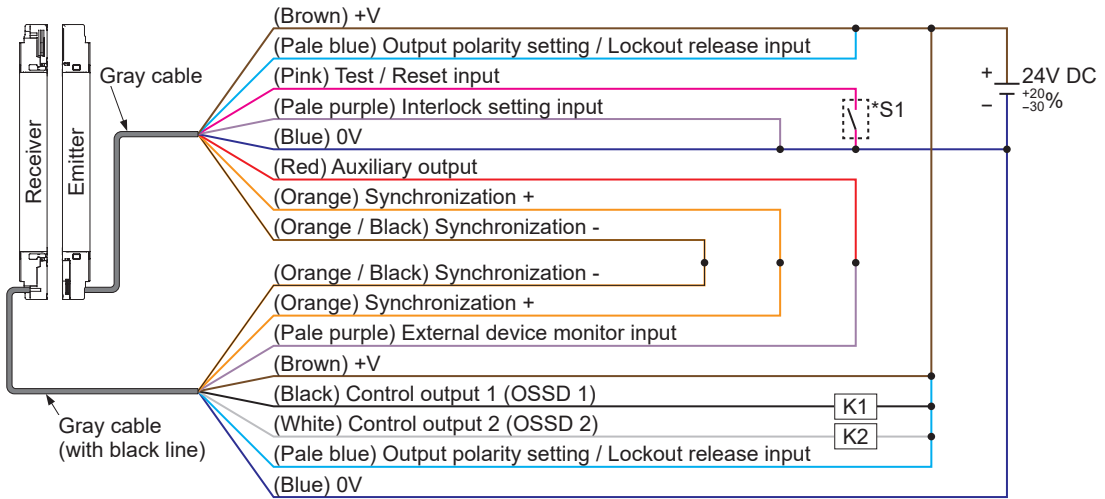

Interlock function	Valid (manual reset)
External device monitor function	Invalid
Auxiliary output	Not possible

*Symbols

Switch S1
0 to +2.5V (source current 5mA or less): Emission halt, Open: Emission
K1, K2: Safety relay unit, etc.

Note: For information on reset, refer to “3-2 Interlock Function (8-core cable, 12-core cable)”.

2-5-6 Wiring for Series Connection (Example of Control Category 4 Wiring)

[Maximum of 5 sets can be connected (maximum total of 256 beam channels)]

This method is used to connect multiple emitters and receivers facing each other in series. This connection method is used when there are two or more paths to the dangerous part of the machine. The control output (OSSD 1 / 2) turns OFF when light is blocked, regardless of which set is in the light blocked state.

⚠ WARNING

To use a series connection, you must use the special-use **SFD-CSL** series connection cables to connect emitters to emitters and receivers to receivers. Risk of death or serious injury if a non-sensing area is created due incorrect connection.

- Using line synchronization setting and 8-core cable
- <Using PNP output>

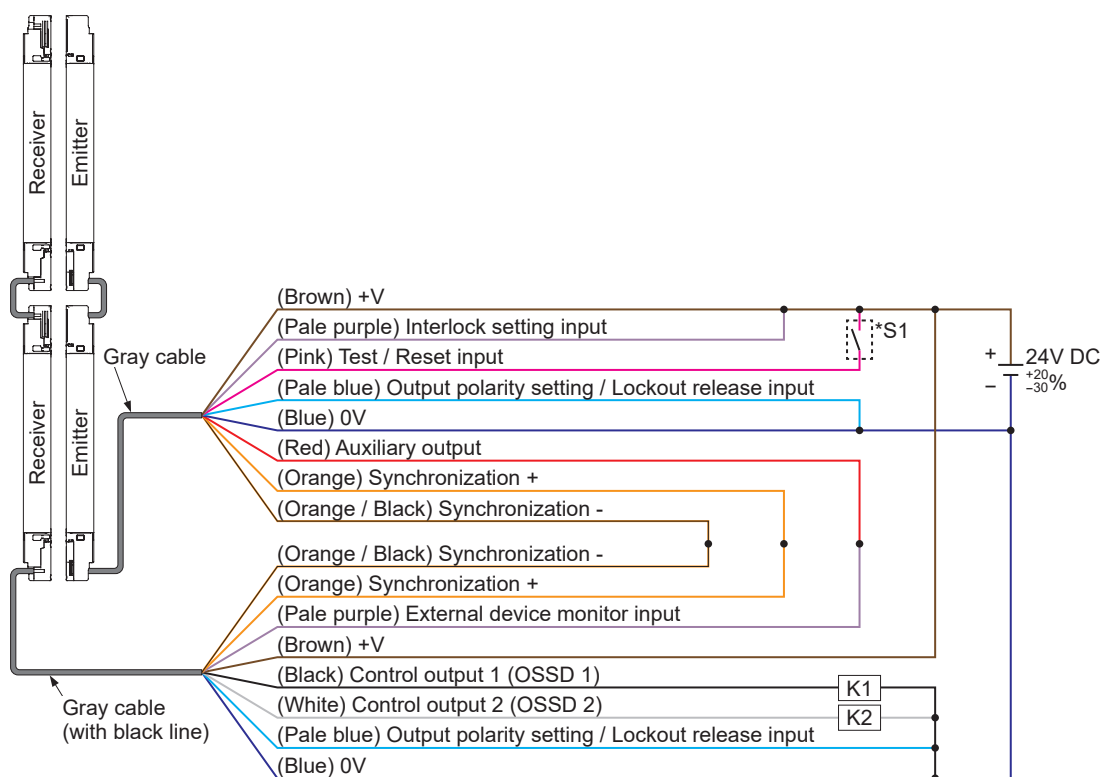

Interlock function	Valid (manual reset)
External device monitor function	Invalid
Auxiliary output	Not possible

*Symbols

Switch S1
 Vs to Vs - 2.5V (sink current 5mA or less): Emission halt (Note 1), Open: Emission
 K1, K2: Safety relay unit, etc.

Notes: 1) Vs is the supply voltage.

2) For information on reset, refer to “3-2 Interlock Function (8-core cable, 12-core cable)”.

Wiring

<Using NPN output>

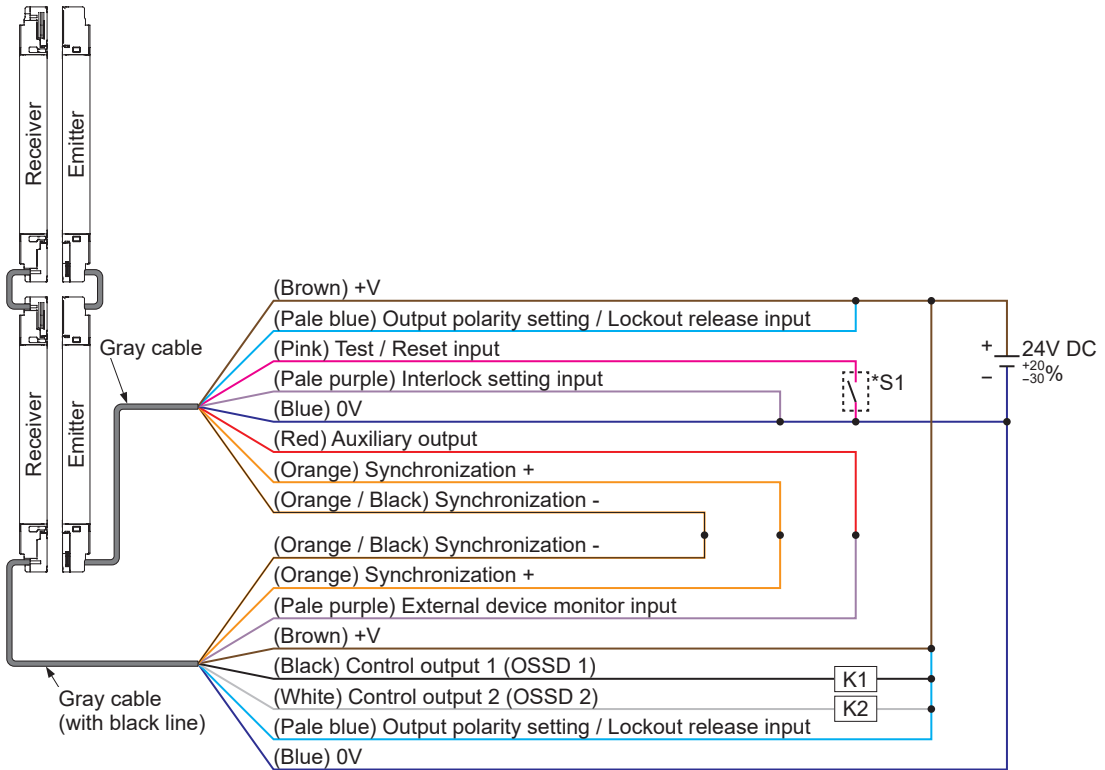

Interlock function	Valid (manual reset)
External device monitor function	Invalid
Auxiliary output	Not possible

*Symbols

Switch S1
 0 to +2.5V (source current 5mA or less): Emission halt, Open: Emission
 K1, K2: Safety relay unit, etc.

Note: For information on reset, refer to “3-2 Interlock Function (8-core cable, 12-core cable)”.

2-5-7 Wiring Configuration for Valid External Device Monitor Function (Example of Control Category 4 Wiring)

Connect contact b of K1 and K2 to the external device monitor inputs as shown.

- Using line synchronization setting and 8-core cable
<Using PNP output>

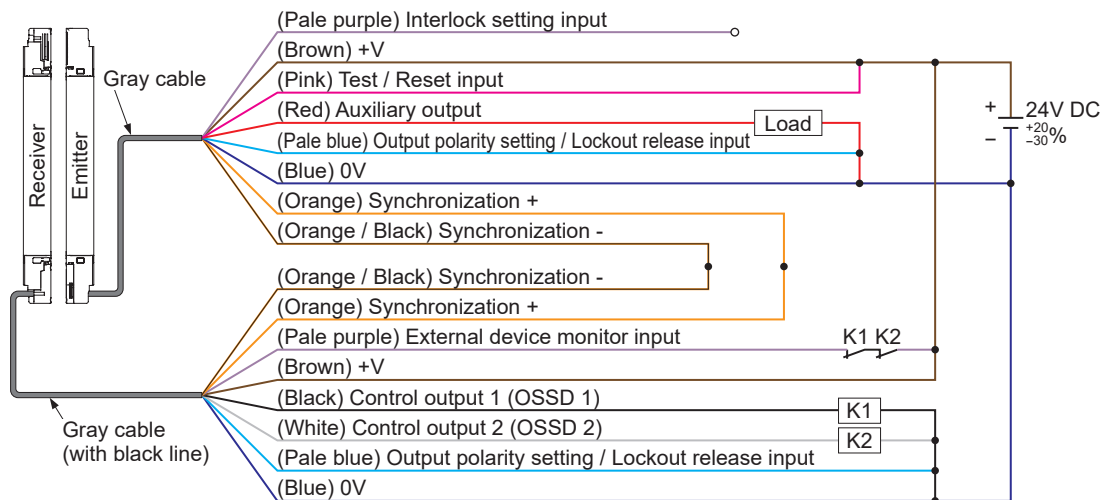

Interlock function	Invalid (auto reset)
External device monitor function	Valid
Auxiliary output	Can be used

*Symbols

K1, K2: External device (forcible guide relay or magnetic contactor)

Wiring

<Using NPN output>

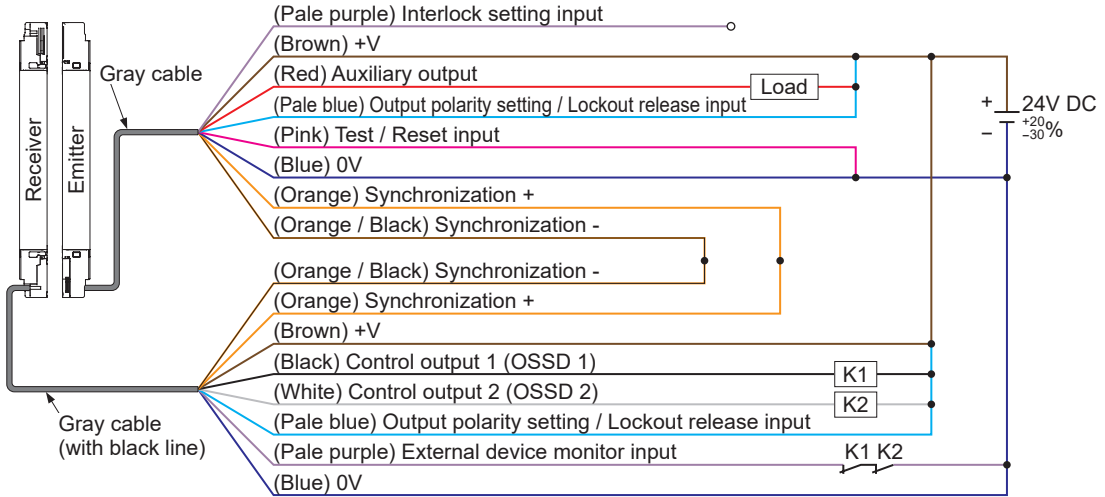

Interlock function	Invalid (auto reset)
External device monitor function	Valid
Auxiliary output	Can be used

*Symbols

K1, K2: External device (forcible guide relay or magnetic contactor)

2-5-8 Wiring Configuration for Valid Muting Function (Example of Control Category 4 Wiring)

- Using line synchronization setting and 12-core cable
<Using PNP output>

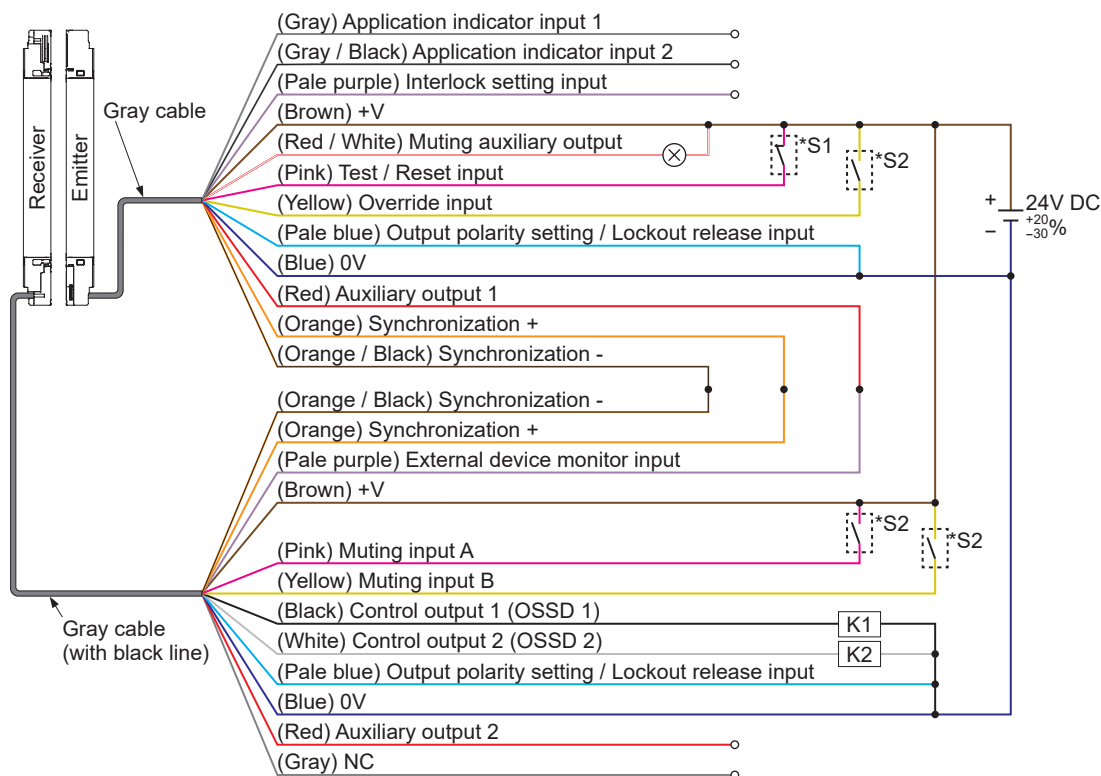

Interlock function	Invalid (auto reset)
External device monitor function	Invalid
Auxiliary output 1	Not possible

*Symbols

- Switch S1
- Test / Reset input
Vs to Vs - 2.5V (sink current 5mA or less): Emission (Note), Open: Emission halt
- Switch S2
- Muting input A / B, Override input
Vs to Vs - 2.5V (sink current 5mA or less): Valid (Note), Open: Invalid
- K1, K2: Safety relay unit, etc.

Note: Vs is the supply voltage.

Wiring

<Using NPN output>

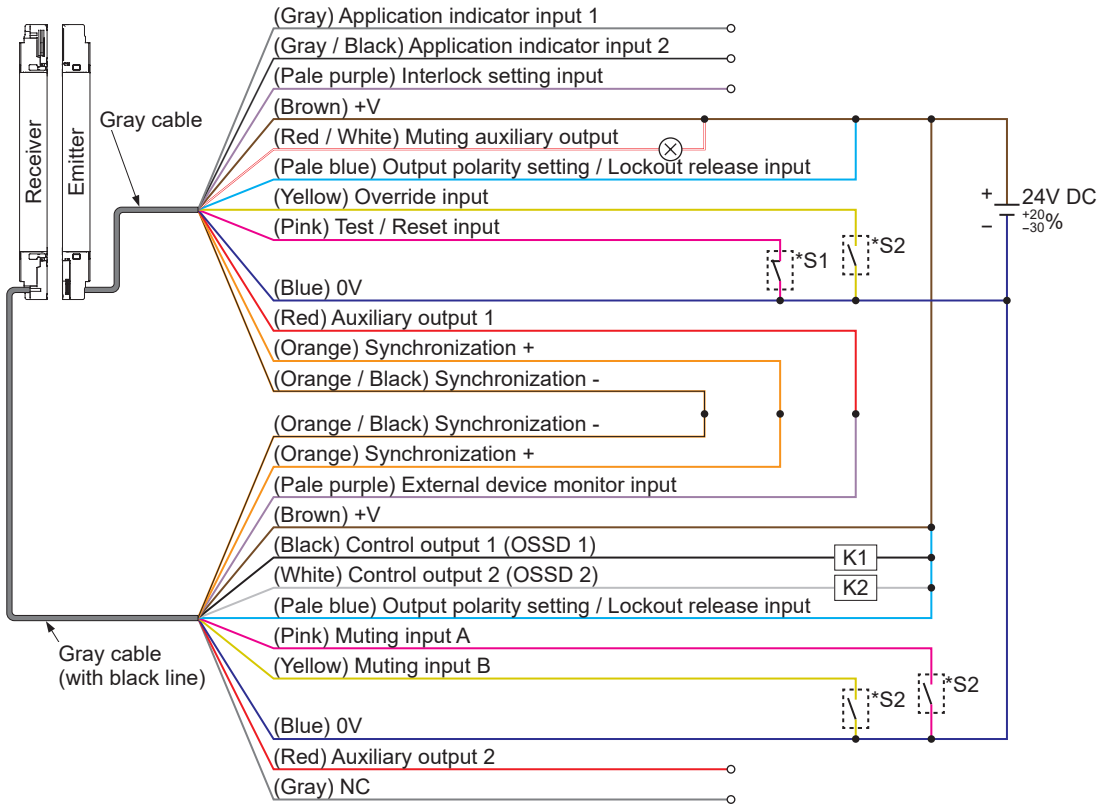

Interlock function	Invalid (auto reset)
External device monitor function	Invalid
Auxiliary output 1	Not possible



*Symbols

- Switch S1
- Test / Reset input
0 to +2.5V (source current 5mA or less): Emission, Open: Emission halt
- Switch S2
- Muting input A / B, Override input
0 to +2.5V (source current 5mA or less): Valid, Open: Invalid
- K1, K2: Safety relay unit, etc.

2-6 Adjustment

2-6-1 Beam Adjustment

Step 1 Supply power to the device.

Step 2 When the device starts, “” (when PNP output is set) or “” (when NPN output is set) lights yellow on the digital indicator.

Step 3 Make sure that the digital indicators on the emitter and receiver are OFF.
If a yellow number blinks or lights in the digital indicator, refer to “**Chapter 5 Troubleshooting**” and inform your technician.

Normal state

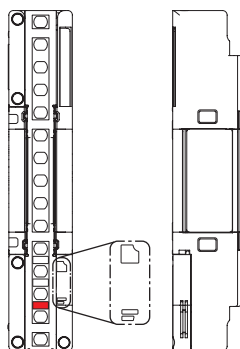

Error state

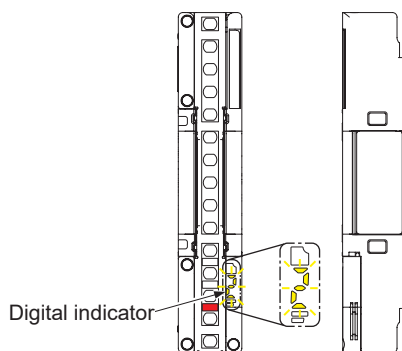

Step 4 Check the upper application indicator and lower application indicator on the emitter, the operation indicator, the upper application indicator and lower application indicator on the receiver, and the OSSD indicator.

If the upper application indicator and lower application indicator light red or are OFF, or the operation indicator and OSSD indicator light red, the beam axes are out of alignment.

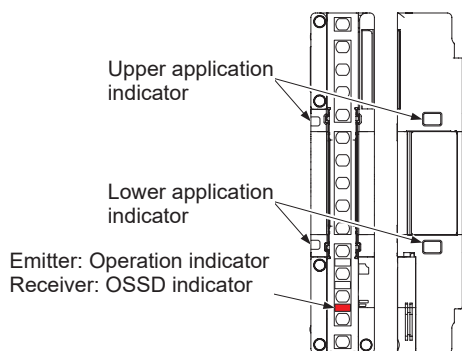

All beams blocked state

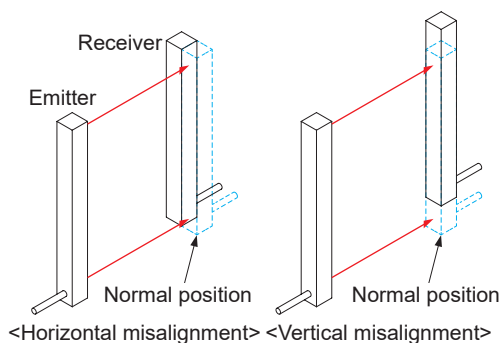

Adjustment

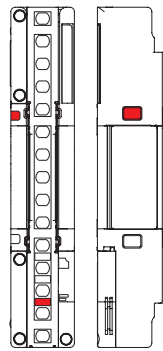

Light only received at top end

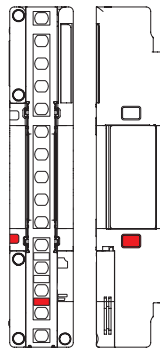
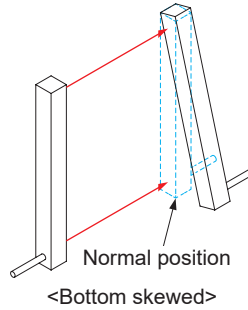

Light only received at bottom end

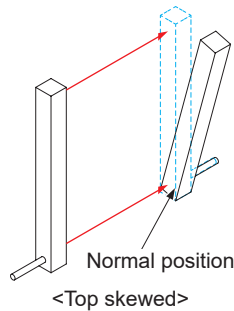

Note: When optical synchronization is selected, the operation indicator of the emitter lights green, and the upper application indicator and lower application indicator are turns OFF.

Step 5 Adjust the emitter or receiver (horizontally / vertically, angle) so that the upper application indicator and lower application indicator light blue, operation indicator and OSSD indicator light green.

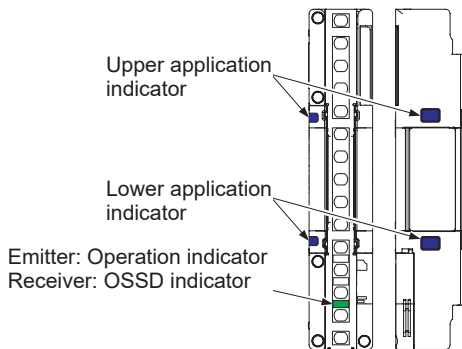

Angle adjustment

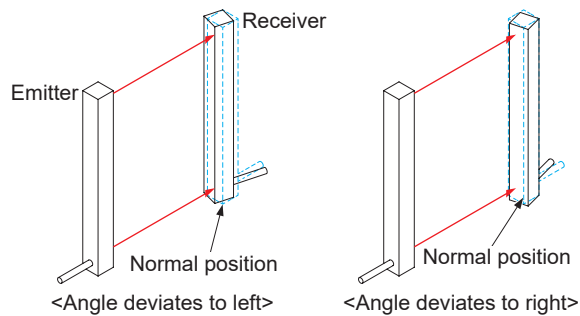

<Reference>

For series connection, when all the devices connected in series receive light, the upper and lower application indicators light blue and the operation indicator and OSSD indicator light green.

<When mounting bracket is installed>

- **Beam adjustment mounting bracket, Compatible bracket**

Loosen the four hexagon socket head bolts with washers [M4 (length: 8mm), width across flats: 3mm] that hold the mounting bracket in place, and rotate the emitter and receiver to adjust the angle.

The angle of the emitter and receiver can be finely adjusted within the range of $\pm 45^\circ$.

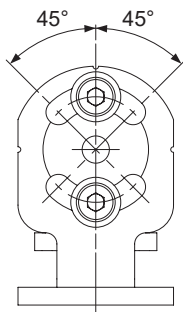

- **No dead-space beam adjustment mounting bracket**

Loosen the hexagon-socket head bolt (M5, silver) for beam adjustment on the mounting bracket, and rotate the emitter and receiver to adjust the angle.

The angle of the emitter and receiver can be finely adjusted within the range of $\pm 7.5^\circ$.

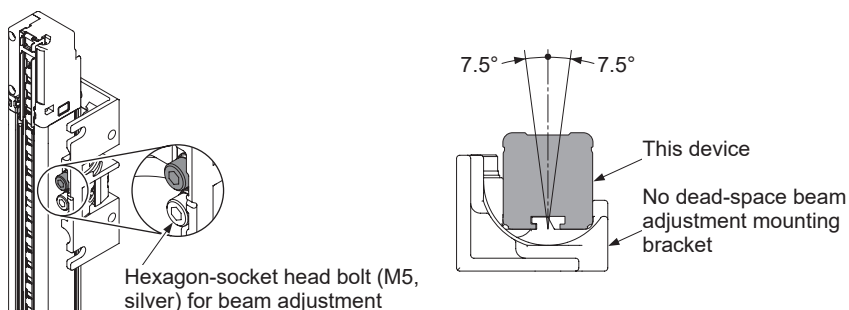

⚠ CAUTION

- Do not remove the hexagon-socket head bolt (M5, silver) for beam adjustment from this product.
- If it is still difficult to rotate the emitter or receiver even after the hexagon-socket head bolt (M5, silver) for beam adjustment is loosened, loosen the hexagon-socket head bolt [M5] or hex bolt [M6] securing the no dead-space beam adjustment mounting bracket on the mounting surface.

Adjustment

Step 6 Check the stable light reception indicator and digital indicator on the emitter and receiver. If the stable light reception indicator lights orange the device is in the unstable light reception state.

Unstable light reception: Light intensity / Level 1

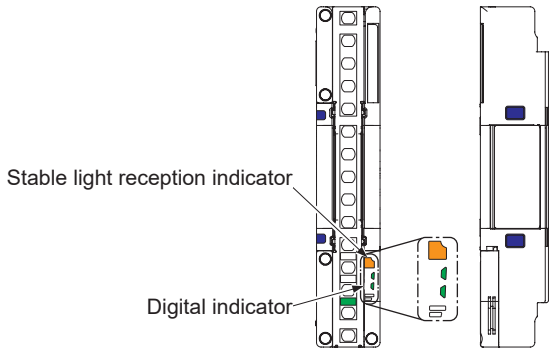

Step 7 If the stable light reception indicator lights green the device is in the stable light reception state.

Stable light reception state: Light intensity / Level 1

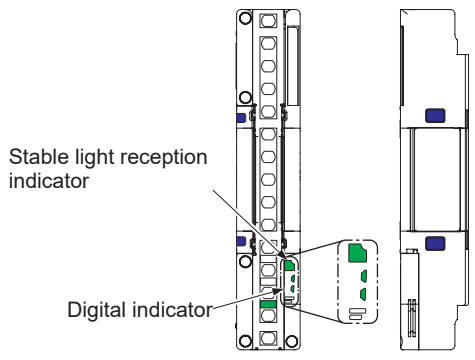

Stable light reception state: Light intensity / Level 2

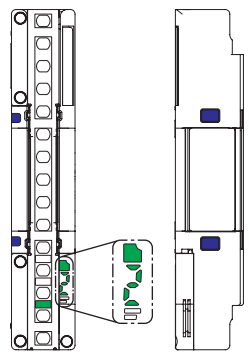

Stable light reception state: Light intensity / Level 3

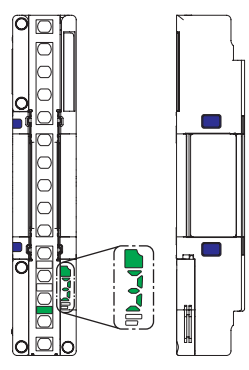

2-6-2 Operation Test

- Step 1 Supply power to the device.
- Step 2 When the device starts, “ \bar{P} ” (when PNP output is set) or “ \bar{N} ” (when NPN output is set) lights up in yellow on the digital indicator.
- Step 3 Make sure that the digital indicators on the emitter and receiver are OFF.
If a yellow number blinks or lights in the digital indicator, refer to “**Chapter 5 Troubleshooting**” and inform your technician.
- Step 4 Move the test rod ($\varnothing 14\text{mm}$ for **SF4D-F□-01**, $\varnothing 25\text{mm}$ for **SF4D-H□-01**, $\varnothing 45\text{mm}$ for **SF4D-A□-01**) up and down directly in front of the emitter (A), midway between the emitter and the receiver (B), and directly in front of the receiver (C) (3 positions) at a speed of 1,600mm/sec. or less.

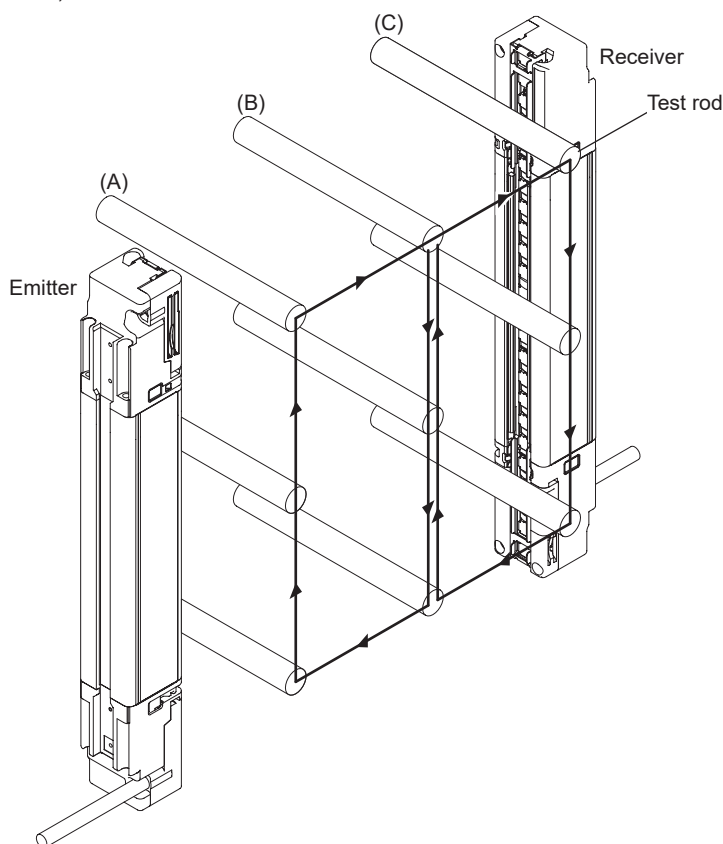

- Step 5 While moving the test rod in Step 4, verify that the control output (OSSD 1 / 2) is OFF while the test rod is in the sensing area. In addition, verify that the OSSD indicator of the receiver and the operation indicator of the emitter both light red.
If the operation of the control output (OSSD 1 / 2) and the indicators of the emitter and receiver do not match the movement of the test rod, refer to “**Chapter 5 Troubleshooting**” and inform your technician.

<Reference>

If an indicator indicates the light-received state when the test rod blocks light, make sure there are no reflective objects or scattered light in the vicinity.

Adjustment

When using as a safety device for a press machine in Japan

When using as a safety device for a press machine in Japan, strictly observe the points below and use correctly.

- Establish the safe distance based on the maximum stop time of the press machine.
- Start the press machine and verify that the slide stops when the light beam is blocked.
- Do not expose the receiver to direct sunlight.
- If you are using a rise invalidate circuit (muting function) with a function that invalidates slide emergency stop when the light beam is blocked while the slide rises, verify that the safety device activates when the slide descends and is only invalidated when the slide rises.
- Adjust the emitter and receiver to ensure that no parts of the body enter the danger zone from above the highest beam channel or from under the lowest beam channel due to the nature of the work or the body position during work.

For details, refer to “About the Revision of the Safety Device Management Guidelines for Press Machines” (Ministry of Health, Labour and Welfare Publication 930 No. 11, September 30, 2015).

2-6-3 Indicator Operation

- Emitter indicator operation 1

<Conditions: Line synchronization, Test input function invalid, Interlock function invalid>

Emitter	Light blocked state				Light received state (all beam channels)			
	Top end beam channel				Unstable light reception state	Stable light reception state		
	Light blocked	Light received	Light blocked	Light received				
	Bottom end beam				Received light intensity			
	Light blocked	Light blocked	Light received	Light received				
Other beam channels				Level 1	Level 1	Level 2	Level 3	
Light received / Light blocked	Light received / Light blocked	Light received / Light blocked	Light blocked	Level 1	Level 1	Level 2	Level 3	
Control output (OSSD 1 / 2)	OFF	OFF	OFF	OFF	ON	ON	ON	ON
Upper application indicator (Note 1)	Turns OFF	Lights red	Turns OFF	Lights red	Lights blue	Lights blue	Lights blue	Lights blue
Lower application indicator (Note 1)	Turns OFF	Turns OFF	Lights red	Lights red	Lights blue	Lights blue	Lights blue	Lights blue
Stable light reception indicator	Turns OFF	Turns OFF	Turns OFF	Turns OFF	Lights orange	Lights green	Lights green	Lights green
Digital indicator	Turns OFF	Turns OFF	Turns OFF	Turns OFF	Green 1 lights	Green 1 lights	Green 2 lights	Green 3 lights
Frequency indicator	Turns OFF	Turns OFF	Turns OFF	Turns OFF	Turns OFF	Turns OFF	Turns OFF	Turns OFF
Light emission intensity control indicator (Note 2)	Turns OFF	Turns OFF	Turns OFF	Turns OFF	Turns OFF	Turns OFF	Turns OFF	Turns OFF
Test indicator	Turns OFF	Turns OFF	Turns OFF	Turns OFF	Turns OFF	Turns OFF	Turns OFF	Turns OFF
Operation indicator	Lights red	Lights red	Lights red	Lights red	Lights green	Lights green	Lights green	Lights green

Notes: 1) The states of the upper application indicator and lower application indicator can also be checked from the side of the device.

2) The light emission intensity control indicator (orange) lights orange when long mode is selected with the DIP switches.

Adjustment

• Receiver indicator operation 1

<Conditions: Line synchronization, Test input function invalid, Interlock function invalid>

Receiver	Light blocked state				Light received state (all beam channels)			
	Top end beam channel				Unstable light reception state	Stable light reception state		
	Light blocked	Light received	Light blocked	Light received				
	Bottom end beam				Received light intensity			
	Light blocked	Light blocked	Light received	Light received				
Other beam channels				Level 1	Level 1	Level 2	Level 3	
Light received / Light blocked	Light received / Light blocked	Light received / Light blocked	Light blocked	Level 1	Level 1	Level 2	Level 3	
Control output (OSSD 1 / 2)	OFF	OFF	OFF	OFF	ON	ON	ON	ON
Upper application indicator (Note)	Turns OFF	Lights red	Turns OFF	Lights red	Lights blue	Lights blue	Lights blue	Lights blue
Lower application indicator (Note)	Turns OFF	Turns OFF	Lights red	Lights red	Lights blue	Lights blue	Lights blue	Lights blue
Stable light reception indicator	Turns OFF	Turns OFF	Turns OFF	Turns OFF	Lights orange	Lights green	Lights green	Lights green
Digital indicator	Turns OFF	Turns OFF	Turns OFF	Turns OFF	Green 1 lights	Green 1 lights	Green 2 lights	Green 3 lights
Frequency indicator	Turns OFF	Turns OFF	Turns OFF	Turns OFF	Turns OFF	Turns OFF	Turns OFF	Turns OFF
Function setting indicator	Turns OFF	Turns OFF	Turns OFF	Turns OFF	Turns OFF	Turns OFF	Turns OFF	Turns OFF
Interlock indicator	Turns OFF	Turns OFF	Turns OFF	Turns OFF	Turns OFF	Turns OFF	Turns OFF	Turns OFF
OSSD indicator	Lights red	Lights red	Lights red	Lights red	Lights green	Lights green	Lights green	Lights green

Note: The states of the upper application indicator and lower application indicator can also be checked from the side of the device.

• Emitter indicator operation 2

<Conditions: Line synchronization, Test input function valid, Interlock function invalid>

Emitter	Light blocked state				Light received state (all beam channels)			
	Top end beam channel				Unstable light reception state	Stable light reception state		
	Light blocked	Light received	Light blocked	Light received				
	Bottom end beam				Received light intensity			
	Light blocked	Light blocked	Light received	Light received				
	Other beam channels				Level 1	Level 1	Level 2	Level 3
Light received / Light blocked	Light received / Light blocked	Light received / Light blocked	Light blocked					
Control output (OSSD 1 / 2)	OFF	OFF	OFF	OFF	OFF	OFF	OFF	OFF
Upper application indicator (Note 1)	Turns OFF	Lights red	Turns OFF	Lights red	Lights red	Lights red	Lights red	Lights red
Lower application indicator (Note 1)	Turns OFF	Turns OFF	Lights red	Lights red	Lights red	Lights red	Lights red	Lights red
Stable light reception indicator	Turns OFF	Turns OFF	Turns OFF	Turns OFF	Turns OFF	Turns OFF	Turns OFF	Turns OFF
Digital indicator	Turns OFF	Turns OFF	Turns OFF	Turns OFF	Turns OFF	Turns OFF	Turns OFF	Turns OFF
Frequency indicator	Turns OFF	Turns OFF	Turns OFF	Turns OFF	Turns OFF	Turns OFF	Turns OFF	Turns OFF
Light emission intensity control indicator (Note 2)	Turns OFF	Turns OFF	Turns OFF	Turns OFF	Turns OFF	Turns OFF	Turns OFF	Turns OFF
Test indicator	Lights orange	Lights orange	Lights orange	Lights orange	Lights orange	Lights orange	Lights orange	Lights orange
Operation indicator	Lights red	Lights red	Lights red	Lights red	Lights red	Lights red	Lights red	Lights red

Notes: 1) The states of the upper application indicator and lower application indicator can also be checked from the side of the device.

2) The light emission intensity control indicator (orange) lights orange when long mode is selected with the DIP switches.

Adjustment

● Receiver indicator operation 2

<Conditions: Line synchronization, Test input function valid, Interlock function invalid>

Receiver	Light blocked state				Light received state (all beam channels)			
	Top end beam channel				Unstable light reception state	Stable light reception state		
	Light blocked	Light received	Light blocked	Light received				
	Bottom end beam				Received light intensity			
	Light blocked	Light blocked	Light received	Light received				
Other beam channels				Level 1	Level 1	Level 2	Level 3	
Light received / Light blocked	Light received / Light blocked	Light received / Light blocked	Light blocked	Level 1	Level 1	Level 2	Level 3	
Control output (OSSD 1 / 2)	OFF	OFF	OFF	OFF	OFF	OFF	OFF	OFF
Upper application indicator (Note)	Turns OFF	Lights red	Turns OFF	Lights red	Lights red	Lights red	Lights red	Lights red
Lower application indicator (Note)	Turns OFF	Turns OFF	Lights red	Lights red	Lights red	Lights red	Lights red	Lights red
Stable light reception indicator	Turns OFF	Turns OFF	Turns OFF	Turns OFF	Turns OFF	Turns OFF	Turns OFF	Turns OFF
Digital indicator	Turns OFF	Turns OFF	Turns OFF	Turns OFF	Turns OFF	Turns OFF	Turns OFF	Turns OFF
Frequency indicator	Turns OFF	Turns OFF	Turns OFF	Turns OFF	Turns OFF	Turns OFF	Turns OFF	Turns OFF
Function setting indicator	Turns OFF	Turns OFF	Turns OFF	Turns OFF	Turns OFF	Turns OFF	Turns OFF	Turns OFF
Interlock indicator	Turns OFF	Turns OFF	Turns OFF	Turns OFF	Turns OFF	Turns OFF	Turns OFF	Turns OFF
OSSD indicator	Lights red	Lights red	Lights red	Lights red	Lights red	Lights red	Lights red	Lights red

Note: The states of the upper application indicator and lower application indicator can also be checked from the side of the device.

• Emitter indicator operation 3

<Conditions: Line synchronization, Test input function invalid, Interlock function valid>

Emitter	Light blocked state				Light received state (all beam channels)				
	Top end beam channel				Interlock state	Unstable light reception state	Stable light reception state		
	Light blocked	Light received	Light blocked	Light received					
	Bottom end beam				Received light intensity				
	Light blocked	Light blocked	Light received	Light received					
	Other beam channels				Level 3	Level 1	Level 1	Level 2	Level 3
Light received / Light blocked	Light received / Light blocked	Light received / Light blocked	Light blocked						
Interlock state					Interlock released state				
Control output (OSSD 1 / 2)	OFF	OFF	OFF	OFF	OFF	ON	ON	ON	ON
Upper application indicator (Note 1)	Turns OFF	Lights red	Turns OFF	Lights red	Lights red	Lights blue	Lights blue	Lights blue	Lights blue
Lower application indicator (Note 1)	Turns OFF	Turns OFF	Lights red	Lights red	Lights red	Lights blue	Lights blue	Lights blue	Lights blue
Stable light reception indicator	Turns OFF	Turns OFF	Turns OFF	Turns OFF	Lights green	Lights orange	Lights green	Lights green	Lights green
Digital indicator	Turns OFF	Turns OFF	Turns OFF	Turns OFF	Green 3 lights	Green 1 lights	Green 1 lights	Green 2 lights	Green 3 lights
Frequency indicator	Turns OFF	Turns OFF	Turns OFF	Turns OFF	Turns OFF	Turns OFF	Turns OFF	Turns OFF	Turns OFF
Light emission intensity control indicator (Note 2)	Turns OFF	Turns OFF	Turns OFF	Turns OFF	Turns OFF	Turns OFF	Turns OFF	Turns OFF	Turns OFF
Test indicator	Turns OFF	Turns OFF	Turns OFF	Turns OFF	Turns OFF	Turns OFF	Turns OFF	Turns OFF	Turns OFF
Operation indicator	Lights red	Lights red	Lights red	Lights red	Lights red	Lights green	Lights green	Lights green	Lights green

Notes: 1) The states of the upper application indicator and lower application indicator can also be checked from the side of the device.

2) The light emission intensity control indicator (orange) lights orange when long mode is selected with the DIP switches.

Adjustment

• Receiver indicator operation 3

<Conditions: Line synchronization, Test input function invalid, Interlock function valid>

Receiver	Light blocked state				Light received state (all beam channels)					
	Top end beam channel				Interlock state	Unstable light reception state	Stable light reception state			
	Light blocked	Light received	Light blocked	Light received						
	Bottom end beam				Received light intensity					
	Light blocked	Light blocked	Light received	Light received						
	Other beam channels				Level 3	Level 1	Level 1	Level 2	Level 3	
Light received / Light blocked	Light received / Light blocked	Light received / Light blocked	Light blocked							
Interlock state					Interlock released state					
Control output (OSSD 1 / 2)	OFF	OFF	OFF	OFF	OFF	ON	ON	ON	ON	
Upper application indicator (Note)	Turns OFF	Lights red	Turns OFF	Lights red	Lights red	Lights blue	Lights blue	Lights blue	Lights blue	
Lower application indicator (Note)	Turns OFF	Turns OFF	Lights red	Lights red	Lights red	Lights blue	Lights blue	Lights blue	Lights blue	
Stable light reception indicator	Turns OFF	Turns OFF	Turns OFF	Turns OFF	Lights green	Lights orange	Lights green	Lights green	Lights green	
Digital indicator	Turns OFF	Turns OFF	Turns OFF	Turns OFF	Green 3 lights	Green 1 lights	Green 1 lights	Green 2 lights	Green 3 lights	
Frequency indicator	Turns OFF	Turns OFF	Turns OFF	Turns OFF	Turns OFF	Turns OFF	Turns OFF	Turns OFF	Turns OFF	
Function setting indicator	Turns OFF	Turns OFF	Turns OFF	Turns OFF	Turns OFF	Turns OFF	Turns OFF	Turns OFF	Turns OFF	
Interlock indicator	Lights yellow	Lights yellow	Lights yellow	Lights yellow	Lights yellow	Turns OFF	Turns OFF	Turns OFF	Turns OFF	
OSSD indicator	Lights red	Lights red	Lights red	Lights red	Lights red	Lights green	Lights green	Lights green	Lights green	

Note: The states of the upper application indicator and lower application indicator can also be checked from the side of the device.

• Emitter indicator operation 4

<Conditions: Optical synchronization (frequency 1), Test input function invalid, Interlock function invalid>

Emitter	Light blocked state				Light received state (all beam channels)			
	Top end beam channel				Unstable light reception state	Stable light reception state		
	Light blocked	Light received	Light blocked	Light received				
	Bottom end beam				Received light intensity			
	Light blocked	Light blocked	Light received	Light received				
Other beam channels				Level 1	Level 1	Level 2	Level 3	
Light received / Light blocked	Light received / Light blocked	Light received / Light blocked	Light blocked					
Control output (OSSD 1 / 2)	OFF	OFF	OFF	OFF	ON	ON	ON	ON
Upper application indicator	Turns OFF	Turns OFF	Turns OFF	Turns OFF	Turns OFF	Turns OFF	Turns OFF	Turns OFF
Lower application indicator	Turns OFF	Turns OFF	Turns OFF	Turns OFF	Turns OFF	Turns OFF	Turns OFF	Turns OFF
Stable light reception indicator	Turns OFF	Turns OFF	Turns OFF	Turns OFF	Turns OFF	Turns OFF	Turns OFF	Turns OFF
Digital indicator	Turns OFF	Turns OFF	Turns OFF	Turns OFF	Turns OFF	Turns OFF	Turns OFF	Turns OFF
Frequency indicator	Lights orange	Lights orange	Lights orange	Lights orange	Lights orange	Lights orange	Lights orange	Lights orange
Light emission intensity control indicator (Note)	Turns OFF	Turns OFF	Turns OFF	Turns OFF	Turns OFF	Turns OFF	Turns OFF	Turns OFF
Test indicator	Turns OFF	Turns OFF	Turns OFF	Turns OFF	Turns OFF	Turns OFF	Turns OFF	Turns OFF
Operation indicator	Lights green	Lights green	Lights green	Lights green	Lights green	Lights green	Lights green	Lights green

Note: The light emission intensity control indicator (orange) lights orange when long mode is selected with the DIP switches.

Adjustment

● Receiver indicator operation 4

<Conditions: Optical synchronization (frequency 1), Test input function invalid, Interlock function invalid>

Receiver	Light blocked state				Light received state (all beam channels)			
	Top end beam channel				Unstable light reception state	Stable light reception state		
	Light blocked	Light received	Light blocked	Light received				
	Bottom end beam				Received light intensity			
	Light blocked	Light blocked	Light received	Light received				
Other beam channels				Level 1	Level 1	Level 2	Level 3	
Light received / Light blocked	Light received / Light blocked	Light received / Light blocked	Light blocked	Level 1	Level 1	Level 2	Level 3	
Control output (OSSD 1 / 2)	OFF	OFF	OFF	OFF	ON	ON	ON	ON
Upper application indicator (Note)	Turns OFF	Lights red	Turns OFF	Lights red	Lights blue	Lights blue	Lights blue	Lights blue
Lower application indicator (Note)	Turns OFF	Turns OFF	Lights red	Lights red	Lights blue	Lights blue	Lights blue	Lights blue
Stable light reception indicator	Turns OFF	Turns OFF	Turns OFF	Turns OFF	Lights orange	Lights green	Lights green	Lights green
Digital indicator	Yellow c lights	Turns OFF	Turns OFF	Turns OFF	Green 1 lights	Green 1 lights	Green 2 lights	Green 3 lights
Frequency indicator	Lights orange	Lights orange	Lights orange	Lights orange	Lights orange	Lights orange	Lights orange	Lights orange
Function setting indicator	Turns OFF	Turns OFF	Turns OFF	Turns OFF	Turns OFF	Turns OFF	Turns OFF	Turns OFF
Interlock indicator	Turns OFF	Turns OFF	Turns OFF	Turns OFF	Turns OFF	Turns OFF	Turns OFF	Turns OFF
OSSD indicator	Lights red	Lights red	Lights red	Lights red	Lights green	Lights green	Lights green	Lights green

Note: The states of the upper application indicator and lower application indicator can also be checked from the side of the device.

• Emitter indicator operation 5

<Conditions: Optical synchronization (frequency 1), Test input function valid, Interlock function invalid>

Emitter	Light blocked state				Light received state (all beam channels)			
	Top end beam channel				Unstable light reception state	Stable light reception state		
	Light blocked	Light received	Light blocked	Light received				
	Bottom end beam				Received light intensity			
	Light blocked	Light blocked	Light received	Light received				
Other beam channels				Level 1	Level 1	Level 2	Level 3	
Light received / Light blocked	Light received / Light blocked	Light received / Light blocked	Light blocked					
Control output (OSSD 1 / 2)	OFF	OFF	OFF	OFF	OFF	OFF	OFF	OFF
Upper application indicator	Turns OFF	Turns OFF	Turns OFF	Turns OFF	Turns OFF	Turns OFF	Turns OFF	Turns OFF
Lower application indicator	Turns OFF	Turns OFF	Turns OFF	Turns OFF	Turns OFF	Turns OFF	Turns OFF	Turns OFF
Stable light reception indicator	Turns OFF	Turns OFF	Turns OFF	Turns OFF	Turns OFF	Turns OFF	Turns OFF	Turns OFF
Digital indicator	Turns OFF	Turns OFF	Turns OFF	Turns OFF	Turns OFF	Turns OFF	Turns OFF	Turns OFF
Frequency indicator	Lights orange	Lights orange	Lights orange	Lights orange	Lights orange	Lights orange	Lights orange	Lights orange
Light emission intensity control indicator (Note)	Turns OFF	Turns OFF	Turns OFF	Turns OFF	Turns OFF	Turns OFF	Turns OFF	Turns OFF
Test indicator	Lights orange	Lights orange	Lights orange	Lights orange	Lights orange	Lights orange	Lights orange	Lights orange
Operation indicator	Lights green	Lights green	Lights green	Lights green	Lights green	Lights green	Lights green	Lights green

Note: The light emission intensity control indicator (orange) lights orange when long mode is selected with the DIP switches.

Adjustment

• Receiver indicator operation 5

<Conditions: Optical synchronization (frequency 1), Test input function valid, Interlock function invalid>

Receiver	Light blocked state				Light received state (all beam channels)			
	Top end beam channel				Unstable light reception state	Stable light reception state		
	Light blocked	Light received	Light blocked	Light received				
	Bottom end beam				Received light intensity			
	Light blocked	Light blocked	Light received	Light received				
Other beam channels				Level 1	Level 1	Level 2	Level 3	
Light received / Light blocked	Light received / Light blocked	Light received / Light blocked	Light blocked	Level 1	Level 1	Level 2	Level 3	
Control output (OSSD 1 / 2)	OFF	OFF	OFF	OFF	OFF	OFF	OFF	OFF
Upper application indicator (Note)	Turns OFF	Turns OFF	Turns OFF	Turns OFF	Turns OFF	Turns OFF	Turns OFF	Turns OFF
Lower application indicator (Note)	Turns OFF	Turns OFF	Turns OFF	Turns OFF	Turns OFF	Turns OFF	Turns OFF	Turns OFF
Stable light reception indicator	Turns OFF	Turns OFF	Turns OFF	Turns OFF	Turns OFF	Turns OFF	Turns OFF	Turns OFF
Digital indicator	Yellow c lights	Yellow c lights	Yellow c lights	Yellow c lights	Yellow c lights	Yellow c lights	Yellow c lights	Yellow c lights
Frequency indicator	Lights orange	Lights orange	Lights orange	Lights orange	Lights orange	Lights orange	Lights orange	Lights orange
Function setting indicator	Turns OFF	Turns OFF	Turns OFF	Turns OFF	Turns OFF	Turns OFF	Turns OFF	Turns OFF
Interlock indicator	Turns OFF	Turns OFF	Turns OFF	Turns OFF	Turns OFF	Turns OFF	Turns OFF	Turns OFF
OSSD indicator	Lights red	Lights red	Lights red	Lights red	Lights red	Lights red	Lights red	Lights red

Note: The states of the upper application indicator and lower application indicator can also be checked from the side of the device.

● Series connection, emitter indicator operation 1

<Conditions: Line synchronization, Test input function invalid, Interlock function invalid>

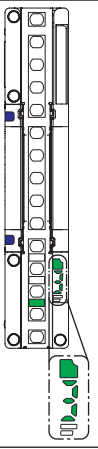
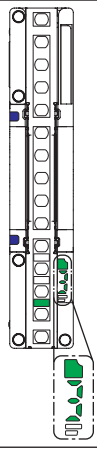
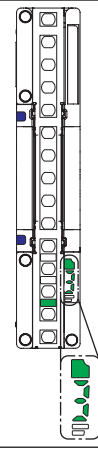
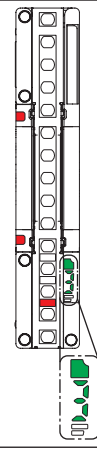
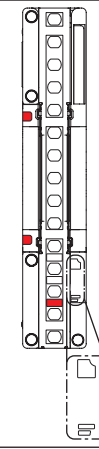
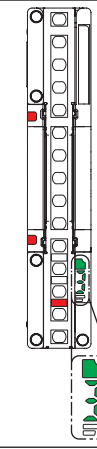
	Light received state (all beam channels)			Light received state (all beam channels)	Light blocked state	Light received state (all beam channels)
	Main sensor	Sub sensor 1	Sub sensor 2			
Emitter	Stable light reception state • Received light intensity Level 3	Stable light reception state • Received light intensity Level 3e	Stable light reception state • Received light intensity Level 3	Stable light reception state • Received light intensity Level 3	Top end beam channel: Light received Bottom end beam channel: Light received Other beam channels: Light blocked	Stable light reception state • Received light intensity Level 3
						
Control output (OSSD 1 / 2)	ON	ON	ON	OFF	OFF	OFF
Upper application indicator (Note 1)	Lights blue	Lights blue	Lights blue	Lights red	Lights red	Lights red
Lower application indicator (Note 1)	Lights blue	Lights blue	Lights blue	Lights red	Lights red	Lights red
Stable light reception indicator	Lights green	Lights green	Lights green	Lights green	Turns OFF	Lights green
Digital indicator	Green 3 lights	Green 3 lights	Green 3 lights	Green 3 lights	Turns OFF	Green 3 lights
Frequency indicator	Turns OFF	Turns OFF	Turns OFF	Turns OFF	Turns OFF	Turns OFF
Light emission intensity control indicator (Note 2)	Turns OFF	Turns OFF	Turns OFF	Turns OFF	Turns OFF	Turns OFF
Test indicator	Turns OFF	Turns OFF	Turns OFF	Turns OFF	Turns OFF	Turns OFF
Operation indicator	Lights green	Lights green	Lights green	Lights red	Lights red	Lights red

Notes: 1) The states of the upper application indicator and lower application indicator can also be checked from the side of the device.

2) The light emission intensity control indicator (orange) lights orange when long mode is selected with the DIP switches.

Adjustment

• Series connection, receiver indicator operation 1

<Conditions: Line synchronization, Test input function invalid, Interlock function invalid>

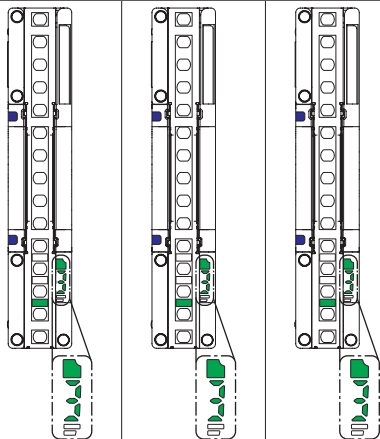
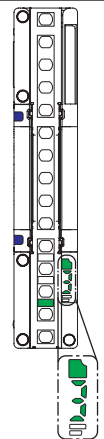
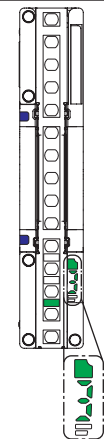
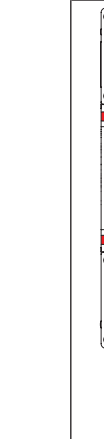
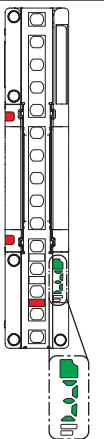
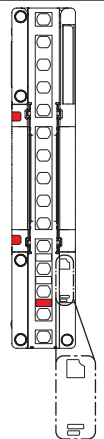
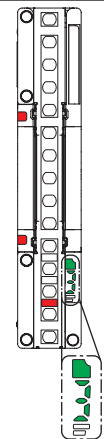
Receiver	Light received state (all beam channels)			Light received state (all beam channels)	Light blocked state	Light received state (all beam channels)
	Main sensor	Sub sensor 1	Sub sensor 2	Main sensor	Sub sensor 1	Sub sensor 2
	Stable light reception state • Received light intensity Level 3	Stable light reception state • Received light intensity Level 3	Stable light reception state • Received light intensity Level 3	Stable light reception state • Received light intensity Level 3	Stable light reception state • Received light intensity Level 3	Top end beam channel: Light received Bottom end beam channel: Light received Other beam channels: Light blocked
						
Control output (OSSD 1 / 2)	ON	ON	ON	OFF	OFF	OFF
Upper application indicator (Note)	Lights blue	Lights blue	Lights blue	Lights red	Lights red	Lights red
Lower application indicator (Note)	Lights blue	Lights blue	Lights blue	Lights red	Lights red	Lights red
Stable light reception indicator	Lights green	Lights green	Lights green	Lights green	Turns OFF	Lights green
Digital indicator	Green 3 lights	Green 3 lights	Green 3 lights	Green 3 lights	Turns OFF	Green 3 lights
Frequency indicator	Turns OFF	Turns OFF	Turns OFF	Turns OFF	Turns OFF	Turns OFF
Function setting indicator	Turns OFF	Turns OFF	Turns OFF	Turns OFF	Turns OFF	Turns OFF
Interlock indicator	Turns OFF	Turns OFF	Turns OFF	Turns OFF	Turns OFF	Turns OFF
OSSD indicator	Lights green	Lights green	Lights green	Lights red	Lights red	Lights red

Note: The states of the upper application indicator and lower application indicator can also be checked from the side of the device.

● Series connection, emitter indicator operation 2

<Conditions: Optical synchronization (frequency 1), Test input function invalid, Interlock function invalid>

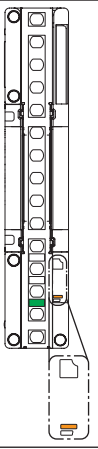
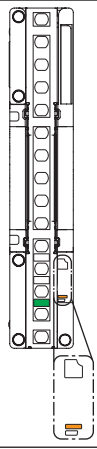
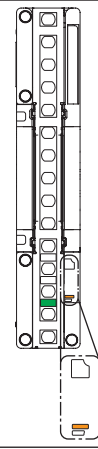
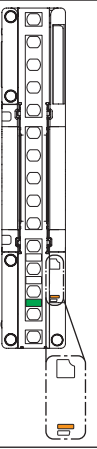
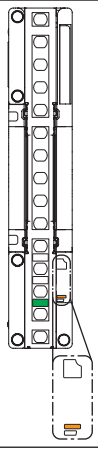
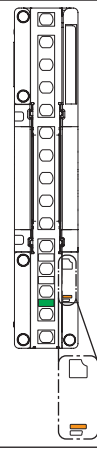
	Light received state (all beam channels)			Light received state (all beam channels)	Light blocked state	Light received state (all beam channels)
	Main sensor	Sub sensor 1	Sub sensor 2			
Emitter	Stable light reception state • Received light intensity Level 3	Stable light reception state • Received light intensity Level 3	Stable light reception state • Received light intensity Level 3	Stable light reception state • Received light intensity Level 3	Top end beam channel: Light received Bottom end beam channel: Light received Other beam channels: Light blocked	Stable light reception state • Received light intensity Level 3
						
Control output (OSSD 1 / 2)	ON	ON	ON	OFF	OFF	OFF
Upper application indicator	Turns OFF	Turns OFF	Turns OFF	Turns OFF	Turns OFF	Turns OFF
Lower application indicator	Turns OFF	Turns OFF	Turns OFF	Turns OFF	Turns OFF	Turns OFF
Stable light reception indicator	Turns OFF	Turns OFF	Turns OFF	Turns OFF	Turns OFF	Turns OFF
Digital indicator	Turns OFF	Turns OFF	Turns OFF	Turns OFF	Turns OFF	Turns OFF
Frequency indicator	Lights orange	Lights orange	Lights orange	Lights orange	Lights orange	Lights orange
Light emission intensity control indicator (Note)	Turns OFF	Turns OFF	Turns OFF	Turns OFF	Turns OFF	Turns OFF
Test indicator	Turns OFF	Turns OFF	Turns OFF	Turns OFF	Turns OFF	Turns OFF
Operation indicator	Lights green	Lights green	Lights green	Lights green	Lights green	Lights green

Note: The light emission intensity control indicator (orange) lights orange when long mode is selected with the DIP switches.

Adjustment

• Series connection, receiver indicator operation 2

<Conditions: Optical synchronization (frequency 1), Test input function invalid, Interlock function invalid>

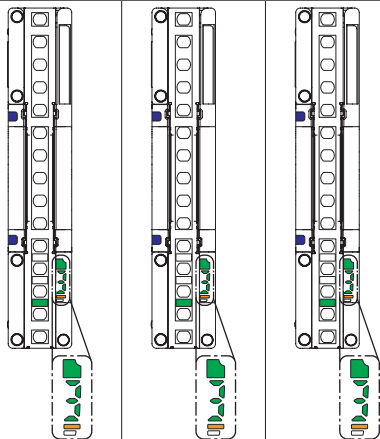
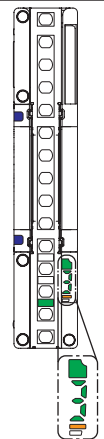
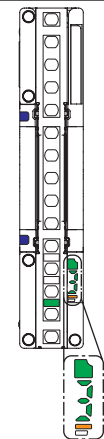
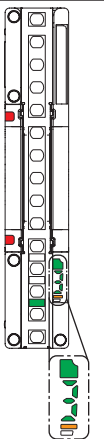
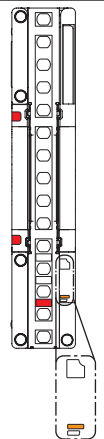
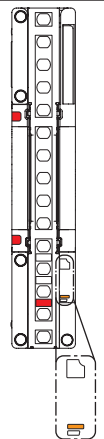
Receiver	Light received state (all beam channels)			Light received state (all beam channels)	Light blocked state	Light received state (all beam channels)
	Main sensor	Sub sensor 1	Sub sensor 2	Main sensor	Sub sensor 1	Sub sensor 2
	Stable light reception state • Received light intensity Level 3 	Stable light reception state • Received light intensity Level 3 	Stable light reception state • Received light intensity Level 3 	Stable light reception state • Received light intensity Level 3 	Stable light reception state • Received light intensity Level 3 	Top end beam channel: Light received Bottom end beam channel: Light received Other beam channels: Light blocked 
Control output (OSSD 1 / 2)	ON	ON	ON	OFF	OFF	OFF
Upper application indicator (Note)	Lights blue	Lights blue	Lights blue	Lights red	Lights red	Lights red
Lower application indicator (Note)	Lights blue	Lights blue	Lights blue	Lights red	Lights red	Lights red
Stable light reception indicator	Lights green	Lights green	Lights green	Lights green	Turns OFF	Lights green
Digital indicator	Green 3 lights	Green 3 lights	Green 3 lights	Green 3 lights	Turns OFF	Green 3 lights
Frequency indicator	Lights orange	Lights orange	Lights orange	Lights orange	Lights orange	Lights orange
Function setting indicator	Turns OFF	Turns OFF	Turns OFF	Turns OFF	Turns OFF	Turns OFF
Interlock indicator	Turns OFF	Turns OFF	Turns OFF	Turns OFF	Turns OFF	Turns OFF
OSSD indicator	Lights green	Lights green	Lights green	Lights red	Lights red	Lights red

Note: The states of the upper application indicator and lower application indicator can also be checked from the side of the device.

● Emitter indicator operation 1 when error occurs

When the device detects an error, the control output (OSSD 1 / 2) turns OFF and a number blinks or lights yellow in the digital indicator.

- When an error is detected in the emitter, the emitter enters the lockout state. Light emission stops, and thus the control output (OSSD 1 / 2) turns OFF.
- When an error is detected in the receiver, the receiver enters the lockout state and the control output (OSSD 1 / 2) turns OFF.

**<Conditions: Line synchronization, Test input function invalid, Interlock function invalid>
Example: Series connection error ("2" blinks yellow)**

	Light blocked state				Light received state (all beam channels)
	Top end beam channel				
	Light blocked	Light received	Light blocked	Light received	
	Bottom end beam				
	Light blocked	Light blocked	Light received	Light received	
Other beam channels					
Emitter	Light received / Light blocked	Light blocked	Light blocked	Light blocked	
Control output (OSSD 1 / 2)	OFF	OFF	OFF	OFF	OFF
Upper application indicator (Note 1)	Turns OFF	Turns OFF	Turns OFF	Turns OFF	Turns OFF
Lower application indicator (Note 1)	Turns OFF	Turns OFF	Turns OFF	Turns OFF	Turns OFF
Stable light reception indicator (Note 2)	Turns OFF	Turns OFF	Turns OFF	Turns OFF	Turns OFF
Digital indicator	Yellow number blinks or lights	Yellow number blinks or lights	Yellow number blinks or lights	Yellow number blinks or lights	Yellow number blinks or lights
Frequency indicator	Turns OFF	Turns OFF	Turns OFF	Turns OFF	Turns OFF
Light emission intensity control indicator (Note 3)	Turns OFF	Turns OFF	Turns OFF	Turns OFF	Turns OFF
Test indicator	Turns OFF	Turns OFF	Turns OFF	Turns OFF	Turns OFF
Operation indicator	Lights red	Lights red	Lights red	Lights red	Lights red

Notes: 1) The states of the upper application indicator and lower application indicator can also be checked from the side of the device.

2) The stable light reception indicator (green) does not light in the lockout state.

3) The light emission intensity control indicator (orange) lights orange when long mode is selected with the DIP switches.

4) For details on yellow blinking or lit numbers in the digital indicator, refer to "**Chapter 5 Troubleshooting**".

Adjustment

- Receiver indicator operation 1 when error occurs

<Conditions: Line synchronization, Test input function invalid, Interlock function invalid>

Example: Series connection error ("2" blinks yellow)

Receiver	Light blocked state				Light received state (all beam channels)
	Top end beam channel				
	Light blocked	Light received	Light blocked	Light received	
	Bottom end beam channel				
	Light blocked	Light blocked	Light received	Light received	
	Other beam channels				
Light received / Light blocked	Light blocked	Light blocked	Light blocked		
Control output (OSSD 1 / 2)	OFF	OFF	OFF	OFF	OFF
Upper application indicator (Note 1)	Turns OFF	Turns OFF	Turns OFF	Turns OFF	Turns OFF
Lower application indicator (Note 1)	Turns OFF	Turns OFF	Turns OFF	Turns OFF	Turns OFF
Stable light reception indicator (Note 2)	Turns OFF	Turns OFF	Turns OFF	Turns OFF	Turns OFF
Digital indicator	Yellow number blinks or lights	Yellow number blinks or lights	Yellow number blinks or lights	Yellow number blinks or lights	Yellow number blinks or lights
Frequency indicator	Turns OFF	Turns OFF	Turns OFF	Turns OFF	Turns OFF
Function setting indicator	Turns OFF	Turns OFF	Turns OFF	Turns OFF	Turns OFF
Interlock indicator	Turns OFF	Turns OFF	Turns OFF	Turns OFF	Turns OFF
OSSD indicator	Lights red	Lights red	Lights red	Lights red	Lights red

Notes: 1) The states of the upper application indicator and lower application indicator can also be checked from the side of the device.

2) The stable light reception indicator (green) does not light in the lockout state.

3) For details on yellow blinking or lit numbers in the digital indicator, refer to "Chapter 5 Troubleshooting".

After removing the cause of the error, you must turn the power OFF and then ON (the device will not recover automatically).

Cause of error: Control output (OSSD) short, scattered light detected, sensor failure, etc.

Refer to "Chapter 5 Troubleshooting" to remove the cause of the problem.

• Emitter indicator operation 2 when error occurs

When the device detects an error, the control output (OSSD 1 / 2) turns OFF and a number blinks or lights yellow in the digital indicator.

- When an error is detected in the emitter, the emitter enters the lockout state. Light emission stops, and thus the control output (OSSD 1 / 2) turns OFF.
- When an error is detected in the receiver, the receiver enters the lockout state and the control output (OSSD 1 / 2) turns OFF.

<Conditions: Optical synchronization (frequency 1), Test input function invalid, Interlock function invalid>

Example: Series connection error (“2” blinks yellow)

Emitter	Light blocked state				Light received state (all beam channels)	Error detected in receiver
	Top end beam channel					
	Light blocked	Light received	Light blocked	Light received		
	Bottom end beam					
	Light blocked	Light blocked	Light received	Light received		
Other beam channels						
Light received / Light blocked	Light received / Light blocked	Light received / Light blocked	Light blocked			
Control output (OSSD 1 / 2)	OFF	OFF	OFF	OFF	OFF	OFF
Upper application indicator	Turns OFF	Turns OFF	Turns OFF	Turns OFF	Turns OFF	Turns OFF
Lower application indicator	Turns OFF	Turns OFF	Turns OFF	Turns OFF	Turns OFF	Turns OFF
Stable light reception indicator (Note 1)	Turns OFF	Turns OFF	Turns OFF	Turns OFF	Turns OFF	Turns OFF
Digital indicator	Yellow number blinks or lights	Yellow number blinks or lights	Yellow number blinks or lights	Yellow number blinks or lights	Yellow number blinks or lights	Turns OFF
Frequency indicator	Lights orange	Lights orange	Lights orange	Lights orange	Lights orange	Lights orange
Light emission intensity control indicator (Note 2)	Turns OFF	Turns OFF	Turns OFF	Turns OFF	Turns OFF	Turns OFF
Test indicator	Turns OFF	Turns OFF	Turns OFF	Turns OFF	Turns OFF	Turns OFF
Operation indicator	Lights red	Lights red	Lights red	Lights red	Lights red	Lights green

Notes: 1) The stable light reception indicator (green) does not light in the lockout state.

2) The light emission intensity control indicator (orange) lights orange when long mode is selected with the DIP switches.

3) For details on yellow blinking or lit numbers in the digital indicator, refer to “Chapter 5 Troubleshooting”.

Adjustment

- Receiver indicator operation 2 when error occurs

<Conditions: Optical synchronization (frequency 1), Test input function invalid, Interlock function invalid>

Example: Series connection error (“2” blinks yellow)

Receiver	Light blocked state				Light received state (all beam channels)	Error detected in emitter
	Top end beam channel					
	Light blocked	Light received	Light blocked	Light received		
	Bottom end beam					
	Light blocked	Light blocked	Light received	Light received		
	Other beam channels					
Light received / Light blocked	Light received / Light blocked	Light received / Light blocked	Light blocked			
Control output (OSSD 1 / 2)	OFF	OFF	OFF	OFF	OFF	OFF
Upper application indicator (Note 1)	Turns OFF	Turns OFF	Turns OFF	Turns OFF	Turns OFF	Turns OFF
Lower application indicator (Note 1)	Turns OFF	Turns OFF	Turns OFF	Turns OFF	Turns OFF	Turns OFF
Stable light reception indi- cator (Note 2)	Turns OFF	Turns OFF	Turns OFF	Turns OFF	Turns OFF	Turns OFF
Digital indicator	Yellow number blinks or lights	Yellow number blinks or lights	Yellow number blinks or lights	Yellow number blinks or lights	Yellow number blinks or lights	Yellow c lights
Frequency indicator	Lights orange	Lights orange	Lights orange	Lights orange	Lights orange	Lights orange
Function setting indicator	Turns OFF	Turns OFF	Turns OFF	Turns OFF	Turns OFF	Turns OFF
Interlock indicator	Turns OFF	Turns OFF	Turns OFF	Turns OFF	Turns OFF	Turns OFF
OSSD indicator	Lights red	Lights red	Lights red	Lights red	Lights red	Lights red

Notes: 1) The states of the upper application indicator and lower application indicator can also be checked from the side of the device.

2) The stable light reception indicator (green) does not light in the lockout state.

3) For details on yellow blinking or lit numbers in the digital indicator, refer to “**Chapter 5 Troubleshooting**”.

After removing the cause of the error, you must turn the power OFF and then ON (the device will not recover automatically).

Cause of error: Control output (OSSD) short, scattered light detected, sensor failure, etc.

Refer to “**Chapter 5 Troubleshooting**” to remove the cause of the problem.

Chapter 3 Functions

3-1 Self-Diagnosis Function (Common for all cables)	100
3-2 Interlock Function (8-core cable, 12-core cable)	100
3-3 Lockout Release Function (Common for all cables)	102
3-4 Test Input Function (Common for all cables)	103
3-5 Auxiliary Output (Non-Safety Output) (8-core cable, 12-core cable)	104
3-6 External Device Monitor Function (8-core cable, 12-core cable)	105
3-7 Muting Function (12-core cable)	107
3-8 Override Function (12-core cable)	113
3-9 DIP Switch Settings	115
3-10 Application indicator function (12-core cable)	117

Functions

3-1 Self-Diagnosis Function (Common for all cables)

The device includes a self-diagnosis function.

Self-diagnosis is executed when the power is turned ON and periodically during operation.

If an abnormality is detected, the device is immediately put in the lockout state and the control output (OSSD 1 / 2) is fixed in the OFF state.

Refer to “**Chapter 5 Troubleshooting**” to remove the cause of the problem.

3-2 Interlock Function (8-core cable, 12-core cable)

The interlock function prevents the control output (OSSD 1 / 2) from automatically turning ON when the device is in the light-receiving state.

With manual reset selected and the control output (OSSD 1 / 2) in the OFF state (interlock state), execute a reset in the light-receiving state to turn ON the control output (OSSD 1 / 2).

Manual reset / automatic reset can be selected by means of the connection of the interlock setting input wire (pale purple) when the power is turned ON.

Interlock setting input wire (Pale purple)	Interlock function
When using PNP output: Connect to +V When using NPN output: Connect to 0V	Manual reset
Open	Auto reset

WARNING

- Always verify that nobody is in the danger zone before using the interlock function.
Risk of death or serious injury.
- Install the reset switch in a location that allows operation from outside the danger zone and which provides a clear view of the entire danger zone.
- When using the device with auto-reset, use a safety relay unit or other device to prevent automatic restart of the system after safety output shutoff. (EN 60204-1)

Manual reset: The control output (OSSD 1 / 2) does not automatically turn ON when the device is in the light-receiving state. The control output (OSSD 1 / 2) turns ON when the device is reset {test / reset input: (open) → [short (+V when using PNP output or 0V when using NPN output)] → (open)} in the light-receiving state.

<Timing chart>

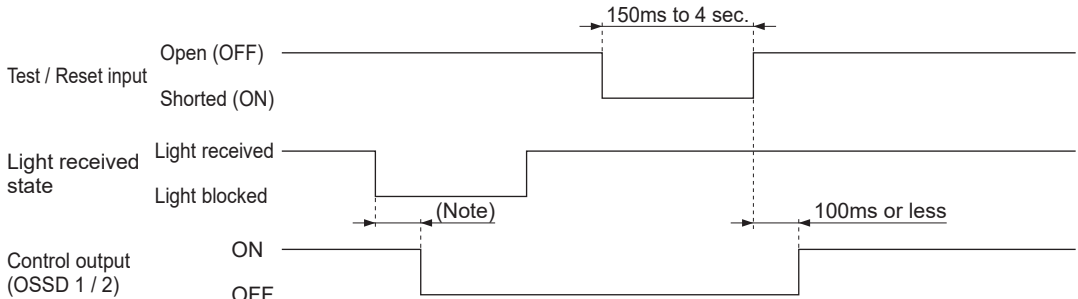

Note: The response time depends on the number of beam channels.

		Response time (OFF response)				
		Main sensor	Sub sensor			
Number of units in series connection		1 unit	1 unit	2 units	3 units	4 units
Number of beam channels	4 to 48	6ms	10ms	10ms	12ms	12ms
	49 to 96	8ms	10ms	10ms	12ms	12ms
	97 to 127	10ms	12ms	12ms	14ms	14ms
	128 to 144	—	12ms	12ms	14ms	14ms
	145 to 192	—	14ms	14ms	16ms	16ms
	193 to 256	—	16ms	16ms	18ms	18ms

Auto reset: The control output (OSSD 1 / 2) automatically turns ON when the device is in the light-receiving state.

<Timing chart>

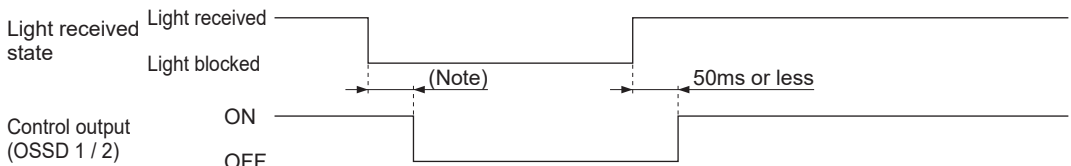

Note: The response time depends on the number of beam channels.

		Response time (OFF response)				
		Main sensor	Sub sensor			
Number of units in series connection		1 unit	1 unit	2 units	3 units	4 units
Number of beam channels	4 to 48	6ms	10ms	10ms	12ms	12ms
	49 to 96	8ms	10ms	10ms	12ms	12ms
	97 to 127	10ms	12ms	12ms	14ms	14ms
	128 to 144	—	12ms	12ms	14ms	14ms
	145 to 192	—	14ms	14ms	16ms	16ms
	193 to 256	—	16ms	16ms	18ms	18ms

Functions

3-3 Lockout Release Function (Common for all cables)

This function releases the device from the lockout state and returns it to normal operation. When in the lockout state, the device is returned to normal operation by removing the cause of the lockout, performing lockout release: [open the output polarity setting / lockout release input wire (pale blue) that was short-circuited, and then short-circuit within approx. 150ms to 4 sec.].

<Reference>

The device can also be released from the lockout state by turning the power OFF then ON.

<Timing chart>

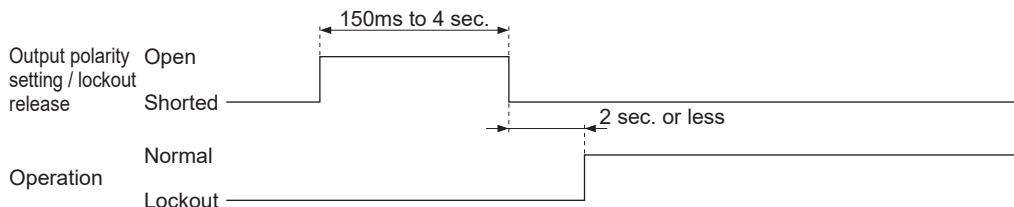

<Using PNP output>

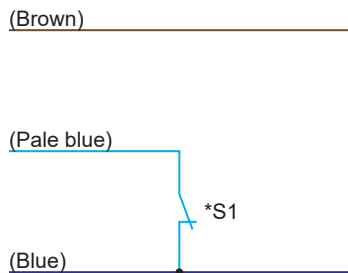

***Switch S1**

- Output polarity setting / Lockout release input 0 to +2.5V (source current 5mA or less): Short circuit

<Using NPN output>

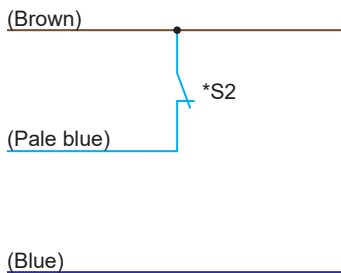

***Switch S2**

- Output polarity setting / Lockout release input V_s to $V_s - 2.5V$ (sink current 5mA or less): Short circuit (Note)

Note: V_s is the supply voltage.

3-4 Test Input Function (Common for all cables)

The test input function is used to check the operation of the control output (OSSD 1 / 2). This function forcibly turn OFF the control output (OSSD 1 / 2) when the device is in the light receiving state. ON or OFF can be selected for the test input function using the test / reset input wire (pink).

• **Line synchronization**

Light received / Light blocked	Interlock function	Test / Reset input wire (Pink)	Test input	Control output (OSSD 1 / 2) state
Light received state	Manual reset	Open	Invalid	ON
		When using PNP output: Connect to +V When using NPN output: Connect to 0V	Valid	OFF
	Auto reset	Open	Valid	OFF
		When using PNP output: Connect to +V When using NPN output: Connect to 0V	Invalid	ON
Light blocked state	-	-	-	OFF

<Timing chart>

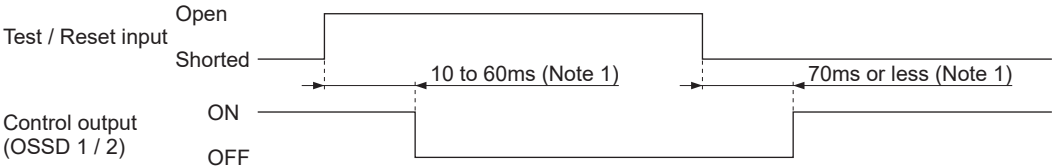

Notes: 1) The range depends on the number of beam channels and number of series connections.
2) Operation in auto reset mode is indicated. In manual reset mode, light is emitted when open and stopped when short-circuited.

• **Optical synchronization**

Light received / Light blocked	Test / Reset input wire (Pink)	Test input	Control output (OSSD 1 / 2) state
Light received state	Open	Invalid	ON
	When using PNP output: Connect to +V When using NPN output: Connect to 0V	Valid	OFF
Light blocked state	-	-	OFF

<Timing chart>

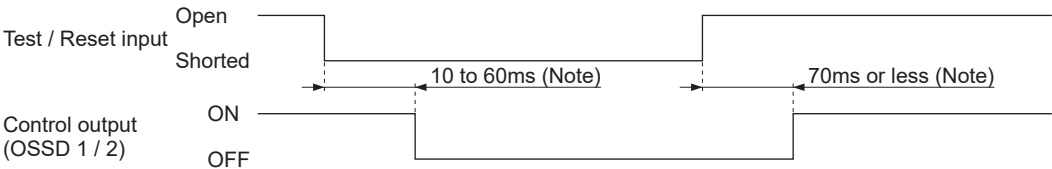

Note: The range depends on the number of beam channels and number of series connections.

⚠ WARNING
Do not use the test input function for the purpose of stopping the machine for which the device is installed. Risk of death or serious injury.

Functions

3-5 Auxiliary Output (Non-Safety Output) (8-core cable, 12-core cable)

The device is equipped with an auxiliary output for non-safety applications. The auxiliary output can be used to monitor specific states of the device.

Auxiliary output	Normal operation			Lockout
	Test input state			
	Valid	Invalid		
		Control output (OSSD 1 / 2) state		
	ON	OFF		
Control output (OSSD 1 / 2) negative logic	ON	OFF	ON	ON

<Timing chart>

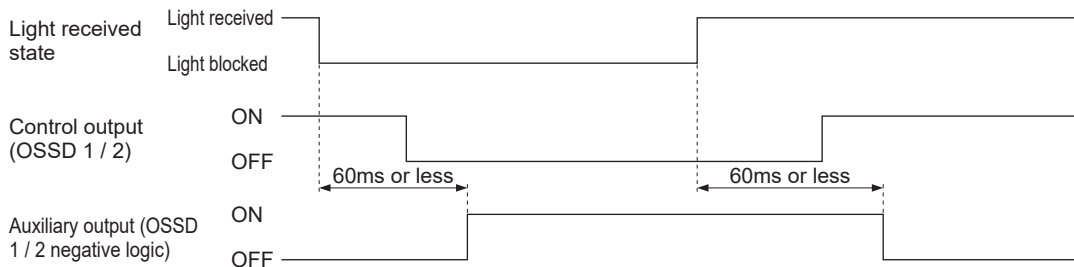

⚠ WARNING

Do not use the auxiliary output for the purpose of stopping the machine for which the device is installed. Risk of death or serious injury.

3-6 External Device Monitor Function (8-core cable, 12-core cable)

The external device monitor function is used to check if an external device (safety relay, contactor) connected to the control output (OSSD 1 / 2) operates normally in accordance with the control output (OSSD 1 / 2).

Contact "b" of the external device is monitored, and if an error is detected such as malfunctioning due to contact welding, the device is put in the lockout state and the control output (OSSD 1 / 2) turns OFF.

The monitor time of contact "b" is 300ms. If 300ms is exceeded, the lockout state activates.

- **Enabling the external device monitor function**

Connect the external device monitor input wire (pale purple) to the external safety relay that is connected to the control output 1 (OSSD 1) wire (black) and the control output 2 (OSSD 2) wire (white).

- **Disabling the external device monitor function**

Connect the external device monitor input wire (pale purple) to the auxiliary output wire (red). Set the auxiliary output to [negative logic of control output (OSSD 1 / 2)].

When the external device monitor function is invalid, external devices cannot be connected to the auxiliary output.

Functions

<Timing chart (Normal)>

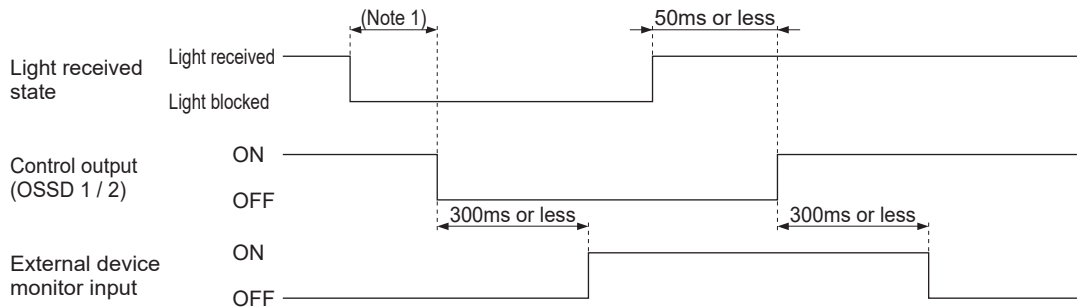

<Timing chart (Error 1)>

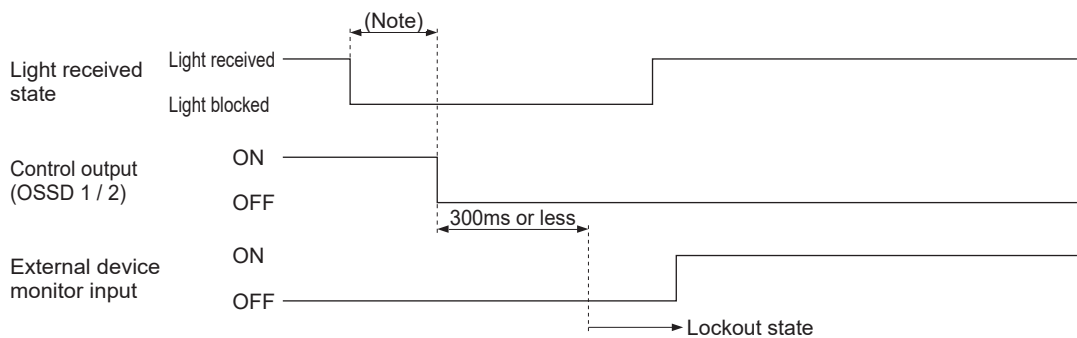

<Timing chart (Error 2)>

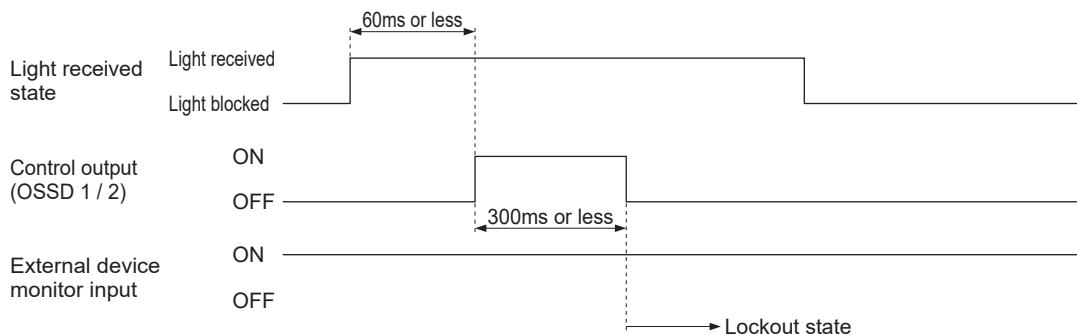

Note: The response time depends on the number of beam channels.

		Response time (OFF response)				
		Main sensor	Sub sensor			
Number of units in series connection		1 unit	1 unit	2 units	3 units	4 units
Number of beam channels	4 to 48	6ms	10ms	10ms	12ms	12ms
	49 to 96	8ms	10ms	10ms	12ms	12ms
	97 to 127	10ms	12ms	12ms	14ms	14ms
	128 to 144	—	12ms	12ms	14ms	14ms
	145 to 192	—	14ms	14ms	16ms	16ms
	193 to 256	—	16ms	16ms	18ms	18ms

3-7 Muting Function (12-core cable)

 WARNING
<ul style="list-style-type: none"> ● Risk of an accident if muting control is used incorrectly. Fully understand the muting function before use. Requirements for muting control are given by the international standards below. ISO 13849-1: 2015 (EN ISO 13849-1: 2015, JIS B 9705-1): “Safety of machinery - Safety-related parts of control systems - Part 1: General principles for design, Article 5.2.5 Muting” IEC 61496-1 (ANSI/UL 61496, JIS B 9704-1): “Safety of machinery - Electro sensitive protective equipment - Part 1: General requirements and tests, Annex A, A.7 Muting” IEC 60204-1 (JIS B 9960-1): “Safety of machinery - Electrical equipment of machines - Part 1: General requirements, 9.2.4 Suspension of safeguards” EN 415-4: “Safety of packaging machines - Part 4: Palletizers and depalletizers, Annex A, A2.2 Muting” ANSI/RIA R15.06-2012: “U.S. A. Standards for Industrial Robots and Robot Systems - Safety Requirements, 5.10.10 Muting” ● Use muting control when the machine cycle is not dangerous. Maintain safety by other methods while muting control is activated. ● In an application where muting control is activated when a workpiece passes through, place the muting sensor so that the conditions for muting control are not satisfied when a person intrudes, regardless of whether or not a workpiece is passing through. ● Conduct a risk assessment, and if a muting indicator is required, check the standards and regulations in the country or region where the device is to be used and install the indicator accordingly. ● Be sure to test operation before using the muting function.

The muting function temporarily invalid the safety functions of the device. When the control output (OSSD 1 / 2) is ON, use the muting function when you want to allow a workpiece to pass through the sensing area of the device without stopping the machinery.

The muting function is valid when the following conditions are all satisfied.

- The control output (OSSD 1 / 2) is ON.
- Muting inputs A and B change from OFF (open) to ON. The time difference between muting input A changing to ON and muting input B changing to ON is from 0.03 to under 3 sec.

Note: When optical synchronization is selected, do not block the beam axis of the top end or the beam axis of the bottom end. Doing so cancels the muting function.

A photoelectric sensor with semiconductor output, proximity sensor, or position switch with a NO (Normally Open) contact can be used for the muting sensor.

<Output operation of muting sensors>

	Operation when ON	Operation when OFF
NO (Normally Open) type ON when light not received (photoelectric sensor, etc.) ON when object approaches (proximity sensor, etc.) ON when contact occurs (position switch, etc.)	0V or +V	Open

 WARNING
<p>Use only a muting sensor that is capable of the above <Output operation of muting sensors>. If a muting sensor other than the above is used, the muting function may activate at a time not intended by the machine designer and create a risk of death or serious injury.</p>

Functions

<Start conditions for muting>

The muting state activates when the following conditions are all satisfied.

- The device is not in the lockout state.
- The device is in the light receiving state and the control output (OSSD 1 / 2) is ON.
- The time difference when muting inputs A and B change to ON is from 0.03 to under 3 sec.

<Release conditions for muting>

The muting state deactivates when any one of the following conditions is satisfied.

- The device enters the lockout state.
- Muting input A or B turned OFF for at least 20ms.
- The muting time exceeded two hours.

<Example of muting sensor installation conditions>

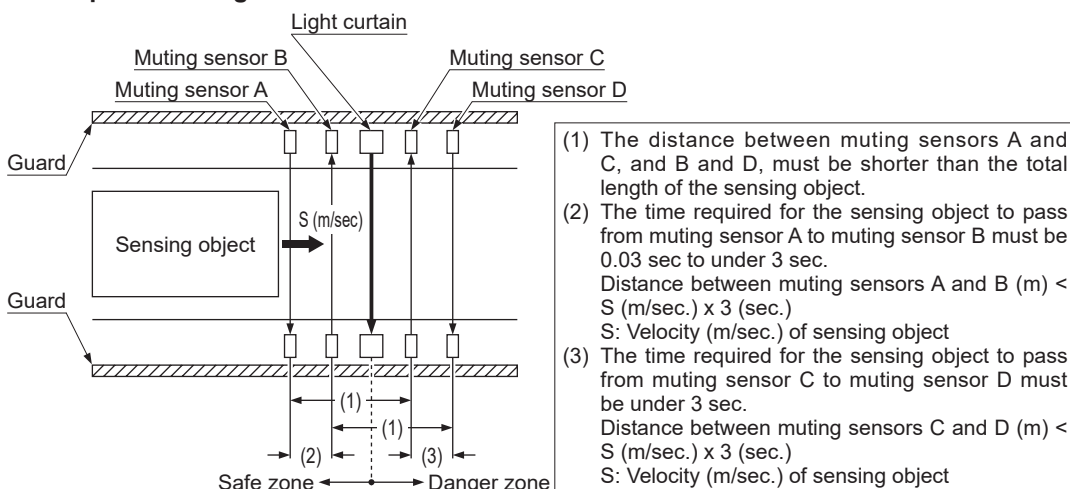

<PNP output type>

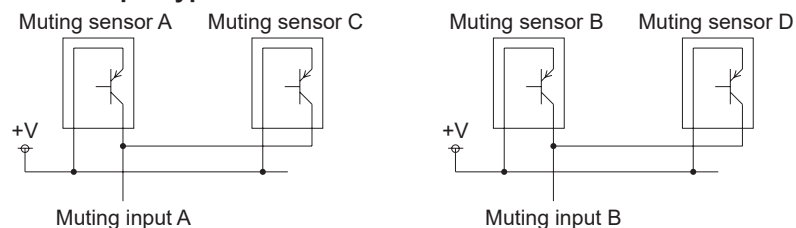

<NPN output type>

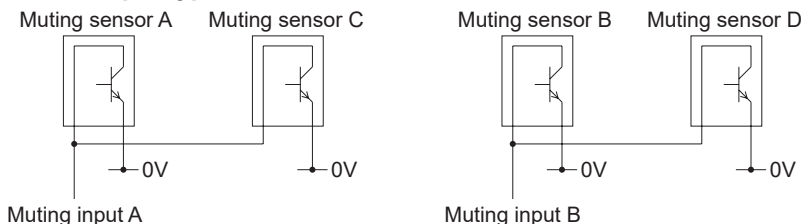

< Preventing light interference of muting sensor >

When a photoelectric sensor (such as **CX-410** series) is used as a muting sensor, light interference may occur and disable the light curtain's muting function to operate according to the setting. The following shows causes of light interference and countermeasures. Please take an appropriate countermeasure to prevent light interference.

Cause

- (1) Light interference between muting sensors
- (2) Light interference from light curtain to muting sensor
- (3) Light interference from muting sensor to light curtain

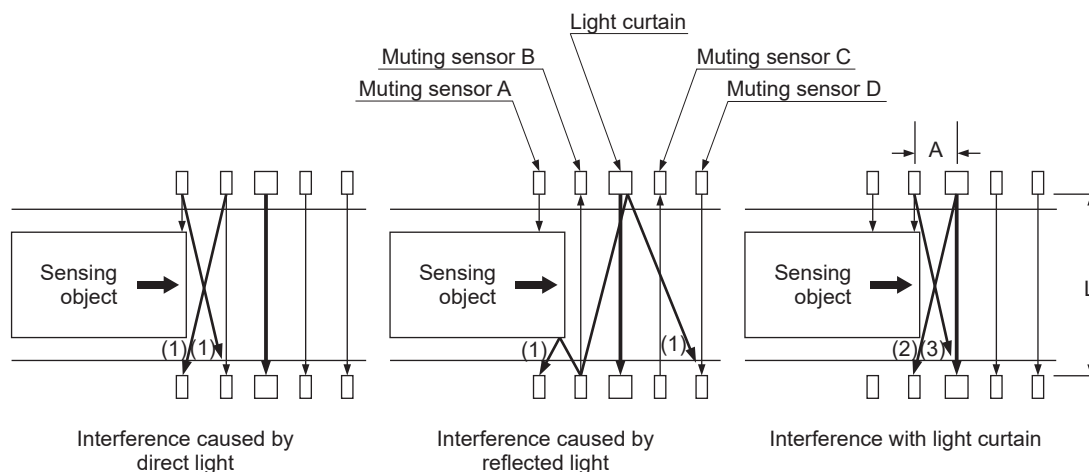

Countermeasure

- (1) Light interference between muting sensors
 - Increase the distance from the sensor that causes interference.
 - If light reflected by the sensing object causes interference, decrease the distance between the object and muting sensor.
 - Displace the beam axis from each other to prevent interference. (Example: Change the installation height or place them at an oblique angle.)
 - Install a light shielding plate.
 - Attach an interference prevention filter. (Example: **PF-CX4**)
 - Attach a slit to reduce the light intensity. (Example: **OS-CX** series)
 - Lower the sensitivity.
- (2) Light interference from light curtain to muting sensor
 - Increase the distance A between the muting sensor and the light curtain that causes interference.
 - Displace the beam axis from each other to prevent interference. (Example: Change the installation height or place them at an oblique angle.)
 - Install a light shielding plate.
 - Set the muting sensor and the light curtain that causes interference in a staggered arrangement.
 - Lower the sensitivity of the light sensor affected by interference.

Functions

(3) Light interference from muting sensor to light curtain

- Use a red LED type sensor. (Example: **CX-411**)
- Increase the distance A between the light curtain and the muting sensor that causes interference.
- Displace the beam axis from each other to prevent interference. (Example: Change the installation height or place them at an oblique angle.)
- Install a light shielding plate.
- Set the light curtain and the muting sensor that causes interference in a staggered arrangement.
- Attach a slit to reduce the light intensity. (Example: **OS-CX** series)

If light interference occurs between the muting sensor and light curtain as described in (2) or (3) it can be prevented by providing the distance A (m) that satisfies the formula below:

Distance (L) between the emitter and receiver of the light curtain	Distance (A) between the muting sensor and light curtain
When L is between 0.2 and 3m	0.262m or more
When L is between 3 and 15m	$L \times \tan 5^\circ = L \times 0.0874\text{m}$ or more

Note that nearby photoelectric sensors can cause light interference in some cases. Please check the surrounding area to see if there are sources of light interference.

When using as a safety device for a press machine in Japan

<Example of muting sensor installation>

When using as a safety device for a press machine in Japan, use in the installation conditions described below.

The muting function can only operate when the slide rises. For details, refer to "Power Press Machine Structural Standards and Press Machine and Shearing Machine Safety Device Structural Standards".

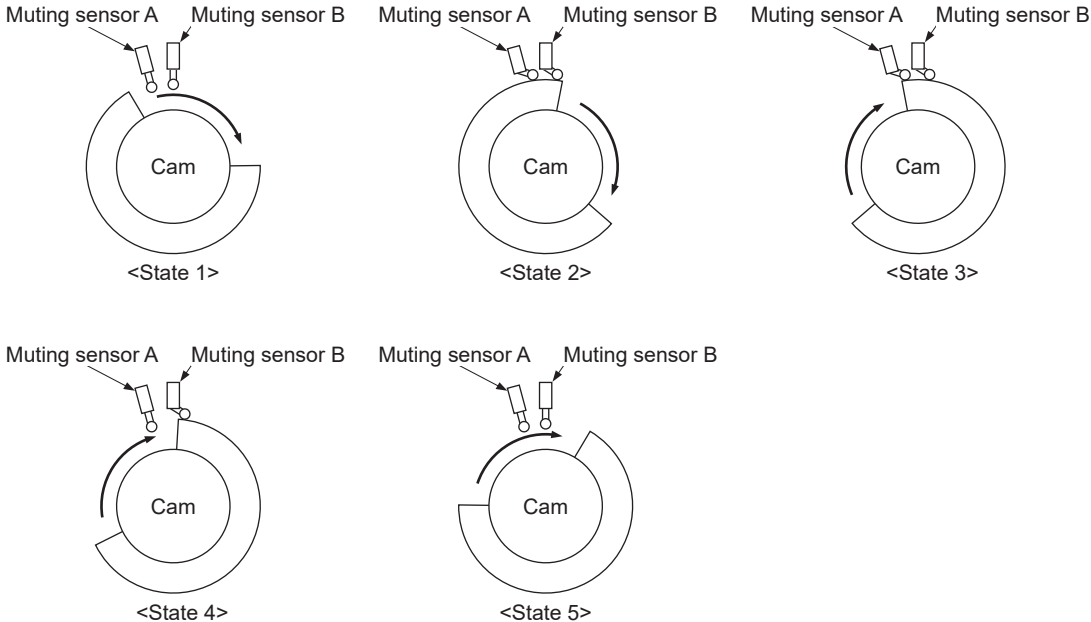

State	1	2	3	4	5
Muting sensor A	OFF	ON	ON	OFF	OFF
Muting sensor B	OFF	ON	ON	ON	OFF
Machine state	Bottom dead point	Rise operation	Top dead point	Start of descent	Descent operation
Device state	Safety function valid (normal operation)	Safety function invalid (muting function valid)		Safety function valid (normal operation)	

Functions

<Timing chart>

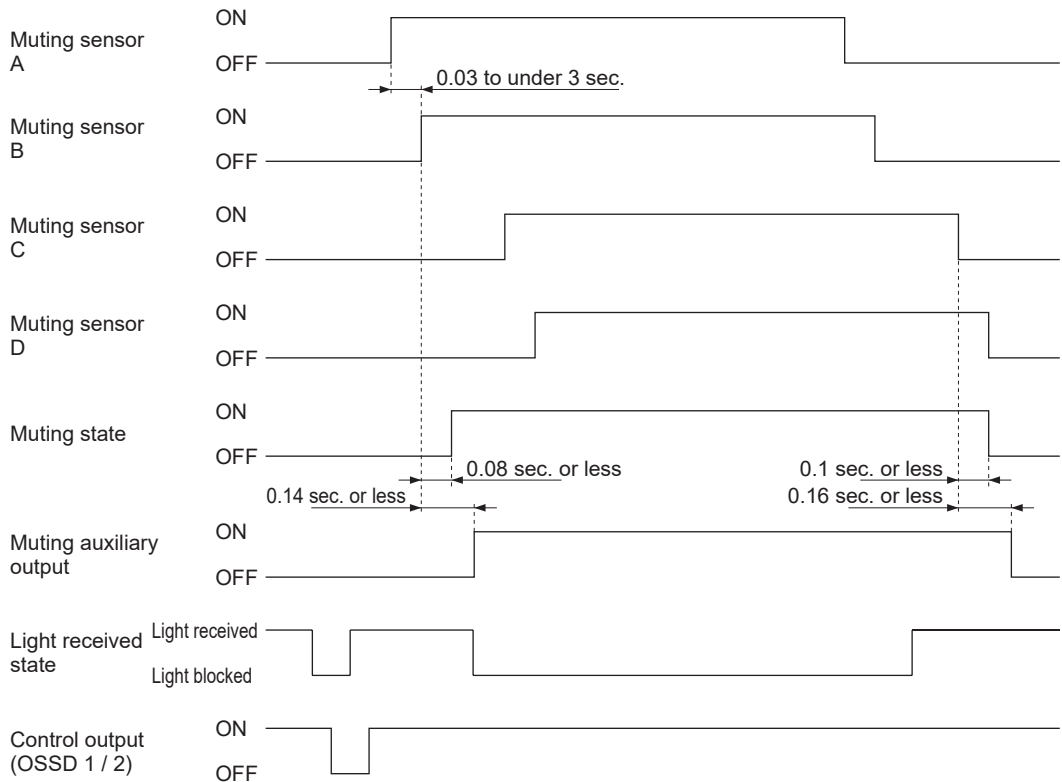

<Reference>

About Muting Auxiliary Output

When the muting function is enabled, signals interlocked with the muting output are output.

<Ratings>

NPN open-collector transistor

Maximum sink current: Equivalent to 6-W incandescent lamp (approx. 250mA)

Applied voltage: Same as supply voltage

Residual voltage: 2V or less

Leakage current: 0.2mA or less

Protective circuit (short circuit protection): Incorporated (1A min.)

3-8 Override Function (12-core cable)

WARNING

- Risk of an accident if muting control is used incorrectly. Fully understand the muting function before use. Requirements for muting control are given by the international standards below.
ISO 13849-1: 2015 (EN ISO 13849-1: 2015, JIS B 9705-1):
“Safety of machinery - Safety-related parts of control systems - Part 1: General principles for design, Article 5.2.5 Muting”
IEC 61496-1 (ANSI/UL 61496, JIS B 9704-1):
“Safety of machinery - Electro sensitive protective equipment - Part 1: General requirements and tests, Annex A, A.7 Muting”
IEC 60204-1 (JIS B 9960-1):
“Safety of machinery - Electrical equipment of machines - Part 1: General requirements, 9.2.4 Overriding safeguards”
EN 415-4:
“Safety of packaging machines - Part 4: Palletizers and depalletizers, Annex A, A2.2 Muting”
ANSI/RIA R15.06-2012:
“U.S. A. Standards for Industrial Robots and Robot Systems - Safety Requirements, 5.10.10 Muting”
- Use muting control when the machine cycle is not dangerous. Maintain safety by other methods while muting control is activated.
- In an application where muting control is activated when a workpiece passes through, place the muting sensor so that the conditions for muting control are not satisfied when a person intrudes, regardless of whether or not a workpiece is passing through.
- Conduct a risk assessment, and if a muting indicator is required, check the standards and regulations in the country or region where the device is to be used and install the indicator accordingly.
- Be sure to test operation before using the muting function.
- Always operate the device that starts the override function manually. Install the device for override function startup in a location that allows operation from outside the danger zone and which provides a clear view of the entire danger zone.
- Always verify that no one is in the danger zone before using the override function. Risk of death or serious injury.

The override function forcibly invalid the safety functions of the device. Use the override function when you want to start the machine when the control output (OSSD 1 / 2) is OFF while the muting function is being used, or when the muting sensor is ON while the line is starting.

The override function is valid when the following conditions are all satisfied.

- A signal is input to one or both of muting inputs A and B.
- The override input is shorted to 0V or +V, and the test / reset input is open.
(Continuously for 3 seconds)

The override function is invalid if at least one of the two conditions is not satisfied, or if 60 sec. elapses.

Note: The override function only operates when auto reset is selected (interlock invalid).

Functions

<Timing chart>

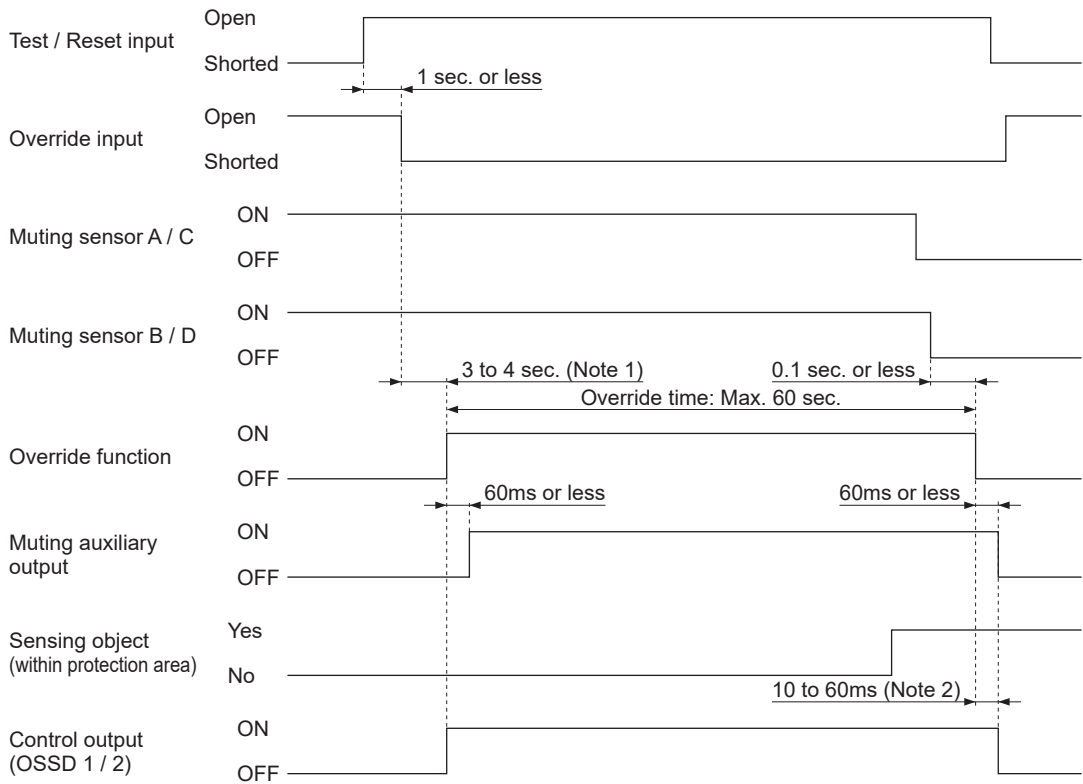





- Notes: 1) If the muting indicator does not turn ON after 1 sec. when the muting indicator diagnosis function is valid, the override function is invalid. When the muting indicator diagnosis function is invalid, the muting function is valid 3 sec. after the input conditions of muting sensors A (C) and B (D) are satisfied.
- 2) The range depends on the number of beam channels and number of series connections.

3-9 DIP Switch Settings

Some of the device settings can be changed using DIP switches. The settings that can be changed using the DIP switches are indicated below.

<Changing settings using the DIP switches>

Item	Description	Settings and ranges, indicator	Factory default setting
DIP switch 1 / 2 (Emitter / Receiver) Synchronization method	Selects the synchronization method. When optical synchronization is selected, you can set a different frequency to reduce mutual interference.	Line synchronization • DIP switch 1: OFF • DIP switch 2: OFF Frequency indicator (orange): "  " turns OFF Optical synchronization, Frequency 1 • DIP switch 1: ON • DIP switch 2: OFF Frequency indicator (orange): "  " lights Optical synchronization, Frequency 2 • DIP switch 1: OFF • DIP switch 2: ON Frequency indicator (orange): "  " lights	Line synchronization
DIP switch 3 (Emitter) Light emission intensity control function	Controls the light from the emitter for the change of sensing range.	Short mode Sensing range SF4D-F□-01: 0.2 to 7m SF4D-H□-01, SF4D-A□-01: 0.2 to 9m • DIP switch 3: OFF Light emission intensity control indicator (orange): "  " turns OFF Long mode Sensing range SF4D-F□-01: 0.8 to 12m SF4D-H□-01, SF4D-A□-01: 0.8 to 15m • DIP switch 3: ON Light emission intensity control indicator (orange): "  " lights	Short mode
DIP switch 3 (Receiver) Indicator selector	The upper application indicator and lower application indicator can be used as an beam axis alignment mode or an application mode.	Beam axis alignment mode • DIP switch 3: OFF Application mode • DIP switch 3: ON	Beam axis alignment mode
DIP switch 4 (Emitter / Receiver) Power save mode	Turns OFF the indicators reduce power consumption.	Normal mode (Allows illumination of some indicators) • DIP switch 4: OFF Power save mode (Upper application indicator and lower application indicator, Digital indicator / received light intensity are always OFF) • DIP switch 4: ON	Normal mode

CAUTION

Make sure that the power is OFF when setting DIP switch 1 / 2 (emitter / receiver) and DIP switch 3 (emitter). If DIP switch settings are changed while the power is ON, the settings will not be reflected. The settings will be reflected after the power is turned OFF and then turned back ON.

Functions

Remove the indicator cover from the device to access the DIP switches.

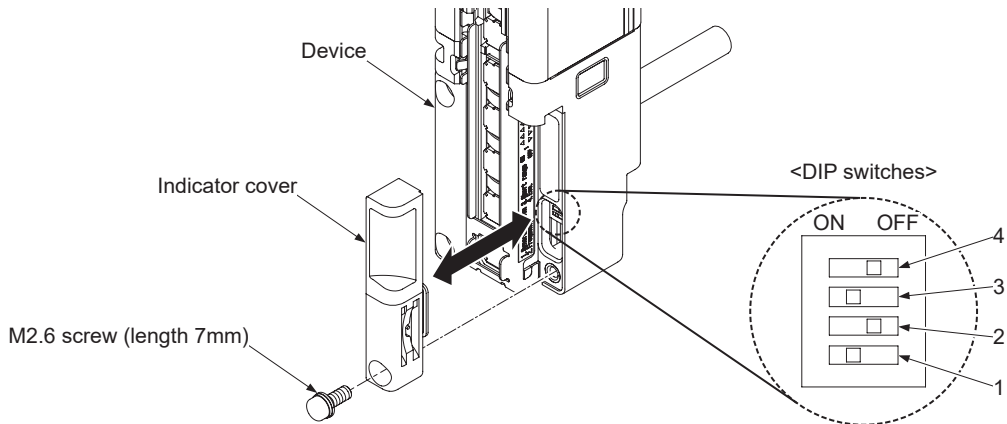

CAUTION

- After setting the DIP switches, always reattach the indicator cover on the device. Tighten to a torque of 0.3N·m or less.
- There is packing on the indicator cover. If the packing is not fitted on the cover properly, fit as shown below before attaching to the device.

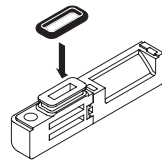

Indicators on emitter side

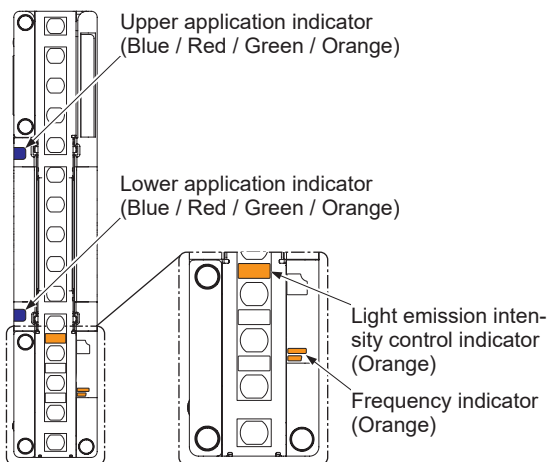

Indicators on receiver side

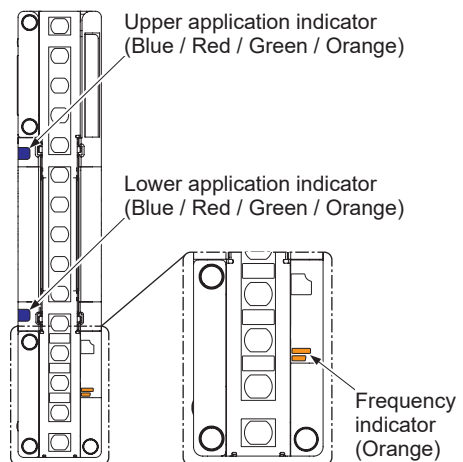

3-10 Application indicator function (12-core cable)

This function allows the upper application indicator and lower application indicator to be used as an application indicator.

Use a 12-core cable, and set DIP switch 3 to ON.

You can select application indicator lights / turns OFF with the application indicator input 1 wire (gray) or application indicator input 2 wire (gray / black).

DIP switches of receiver

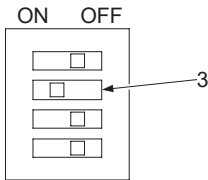

Application indicator	Application indicator input 1 (Gray)	Application indicator input 2 (Gray / Black)
Lights green	Short circuit	Open
Lights red	Open	Short circuit
Lights orange	Short circuit	Short circuit
Turns OFF	Open	Open

Short circuit: When using PNP output: Connect to +V
When using NPN output: Connect to 0V

CAUTION

The following diagrams show the connection of wires for when using the application indicator function. Wiring methods other than those shown below vary depending on the functions used in combination. For the detail of wiring for the use of different functions, refer to "2-5 Wiring"

Wiring diagram

<Using PNP output>

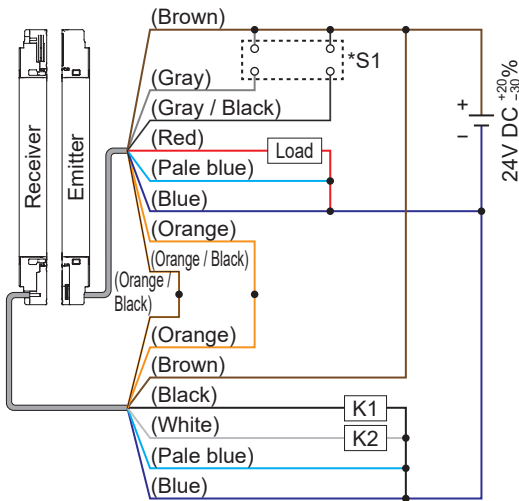

*Switch S1

- Application indicator input 1 / 2
Vs to Vs - 2.5V (sink current 5mA or less):
Short circuit (Note)

Note: Vs is the supply voltage.

<Using NPN output>

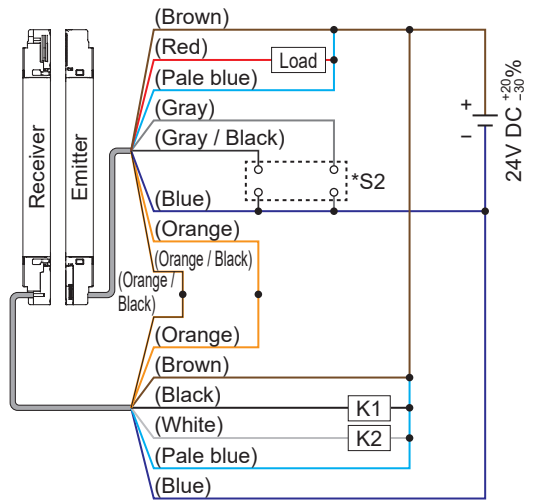

*Switch S2

- Application indicator input 1 / 2
0 to +2.5V (source current 5mA or less):
Short circuit

Functions

Emitter		Receiver	
Lead wire color	Name	Lead wire color	Name
Brown	+V	Orange / Black	Synchronization -
Gray	Application indicator input 1	Orange	Synchronization +
Gray / Black	Application indicator input 2	Brown	+V
Red	Auxiliary output 1	Black	Control output 1 (OSSD 1)
Pale blue	Output polarity setting / Lockout release input	White	Control output 2 (OSSD 2)
Blue	0V	Pale blue	Output polarity setting / Lockout release input
Orange	Synchronization +	Blue	0V
Orange / Black	Synchronization -		

Application indicator / Lights green

<Using PNP output>

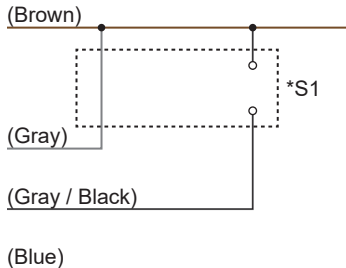

<Using NPN output>

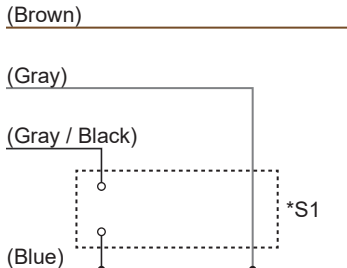

<Application indicator>

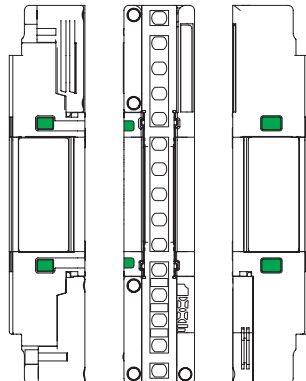

Application indicator / Lights red

<Using PNP output>

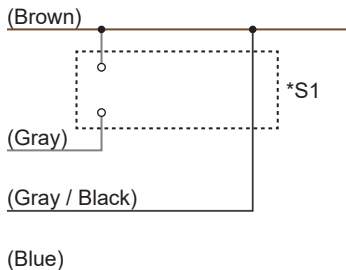

<Using NPN output>

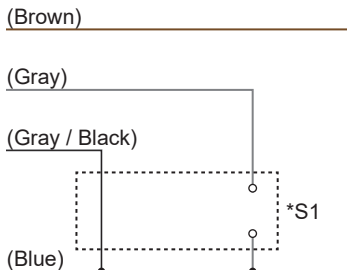

<Application indicator>

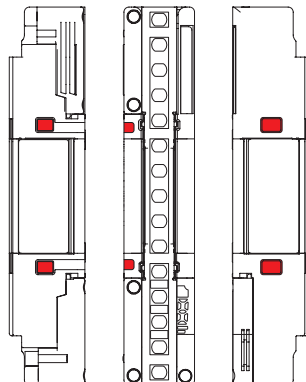

Application indicator / Lights orange

<Using PNP output>

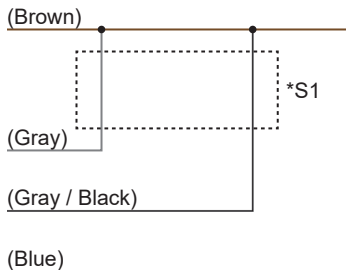

<Using NPN output>

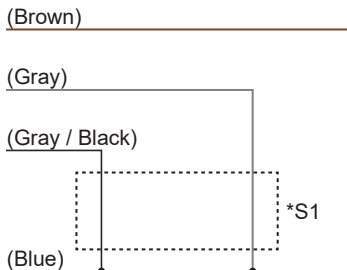

<Application indicator>

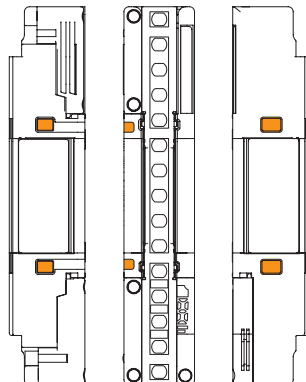

Functions

(MEMO)

Chapter 4 Maintenance

4-1 Daily Inspection	122
4-2 Periodic Inspection (Every Six Months)	123
4-3 Inspection after Maintenance	124

Maintenance

<Reference>

If you discover an abnormal condition, refer to “**Receiver**” and inform your technician.
 If you are unsure what action to take, contact our office.
 Make a copy of the checklist, enter a checkmark after checking each item, and retain the list.

4-1 Daily Inspection

⚠ WARNING

Before starting work, inspect the items below and verify that there are no abnormalities. Risk of death or serious injury if inspection is neglected or the device is operated with an abnormal condition.

Checklist (daily inspection)

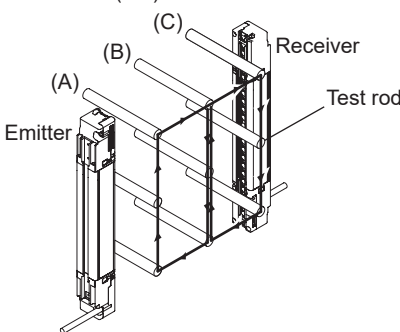
Check column	Inspection item
<input type="checkbox"/>	Dangerous parts of the machine cannot be reached without passing through the sensing area of the device.
<input type="checkbox"/>	Some part of the operator's body remains in the sensing area when working with dangerous parts of the machine.
<input type="checkbox"/>	The device is installed at a distance that is equal to or greater than the calculated safety distance.
<input type="checkbox"/>	No safety guard or protective structure damage.
<input type="checkbox"/>	No damaged, defective, or bent wires.
<input type="checkbox"/>	All connectors are firmly connected.
<input type="checkbox"/>	No dirt or scratches on the light emitting surface.
<input type="checkbox"/>	Test rods are not deformed or defective.
<input type="checkbox"/>	When no objects are present in the sensing area, the operation indicator (green) of the emitter and the OSSD indicator (green) of the receiver are lit. The control output (OSSD 1 / 2) is ON. You can check for effects of external noise in this state. If external noise affects operation, remove the cause and reinspect.
<input type="checkbox"/>	<p>When moved at a speed of 1,600mm/sec. or less, it should be possible to detect the test rod (ø14mm for SF4D-F□-01, ø25mm for SF4D-H□-01, ø45mm for SF4D-A□-01) directly in front of the emitter (A), midway between the emitter and the receiver (B), and directly in front of the receiver (C) (3 positions). When the test rod is in the sensing area (A) to (C), the OSSD indicator (red) of the receiver and the operation indicator (red) of the emitter remain lit.</p>  <p>The diagram illustrates the sensing area of the device. It shows an emitter (A) on the left and a receiver (C) on the right. A test rod (B) is shown in three positions: (A) directly in front of the emitter, (B) midway between the emitter and the receiver, and (C) directly in front of the receiver. Labels include 'Emitter', 'Receiver', and 'Test rod'.</p>
<input type="checkbox"/>	When the machine is in the operating state, dangerous parts operate normally (do not stop) when no objects are present in the sensing area.
<input type="checkbox"/>	When the machine is in the operating state, dangerous parts stop immediately when the test rod is inserted directly in front of the emitter (A), midway between the emitter and the receiver (B), and directly in front of the receiver (C) (3 positions).
<input type="checkbox"/>	Dangerous parts remain stopped as long as the test rod is present in the sensing area.
<input type="checkbox"/>	Dangerous parts stop immediately when the power of the device is turned OFF.
<input type="checkbox"/>	Be sure to test operation before using the muting function. Check the condition of the muting indicator (dirt, brightness, etc.).

When using as a safety device for a press machine in Japan

When using as a safety device for a press machine in Japan, press machine work supervisors and personnel in charge of the matters described in No. 1, No. 2, and No. 4 of Article 134 of the Occupational Safety and Health Act are required to perform inspection prior to the start of work and perform periodic inspection. Press machine work supervisors, etc. must inspect the items below prior to the start of work and record/retain the results.

Device emitter

- Firmness of installation
- Suitability of installation position (safe distance and vertical position)
- Existence of damage
- Existence of external wire abnormalities
- Existence of dirt on emitter
- Certainty of detection states

Device receiver

- Firmness of installation
- Suitability of installation position (safe distance and vertical position)
- Existence of damage
- Existence of external wire abnormalities
- Existence of dirt on emitter
- Certainty of detection states

Specified control unit SF-C11, SF-C13

- External wiring
- Indicators
- Abnormal operation of switches, etc.
- Firmness of installation

For details, refer to “About the Revision of the Safety Device Management Guidelines for Press Machines” (Ministry of Health, Labour and Welfare Publication 930 No. 11, September 30, 2015).

4-2 Periodic Inspection (Every Six Months)

WARNING

Be sure to inspect the following items every six months and verify that there are no abnormalities. Risk of death or serious injury if inspection is neglected or the device is operated with an abnormal condition.

Checklist (periodic inspection)

Check column	Inspection item
<input type="checkbox"/>	The structure of the machine does not obstruct any safety mechanisms for stopping operation.
<input type="checkbox"/>	No modification has been made in the machine control system that obstructs the safety mechanisms.
<input type="checkbox"/>	Output from the device is correctly detected.
<input type="checkbox"/>	Wiring from the device is correct.
<input type="checkbox"/>	The response time of the overall system is equal to or less than the calculated value.
<input type="checkbox"/>	The current number of operation cycles (time) of parts with a limited service life is less than the number of service life cycles (time).
<input type="checkbox"/>	No screws or connectors related to the device are loose.
<input type="checkbox"/>	No objects that scatter or reflect light have been added near the device.

Maintenance

4-3 Inspection after Maintenance

In the situations below, inspect all items listed in “4-1 Daily Inspection” and “4-2 Periodic Inspection (Every Six Months)”.

- 1) When any parts of the device are replaced.
- 2) When an abnormal condition is noticed during operation.
- 3) After aligning the beam axes of the emitter and receiver.
- 4) When the installation site or environment of the device is changed.
- 5) When the wiring method or wiring layout is changed.
- 6) When a safety relay unit or external device (forcible guide relay or magnetic contactor) part has been replaced.
- 7) When safety controller or safety PLC settings are changed.

Chapter 5 Troubleshooting

5-1 Emitter Troubleshooting	126
5-2 Receiver Troubleshooting	129

Troubleshooting

<Reference>

- Check the wiring.
- Check the power voltage and power supply capacity.

5-1 Emitter Troubleshooting

<Indicators on emitter>

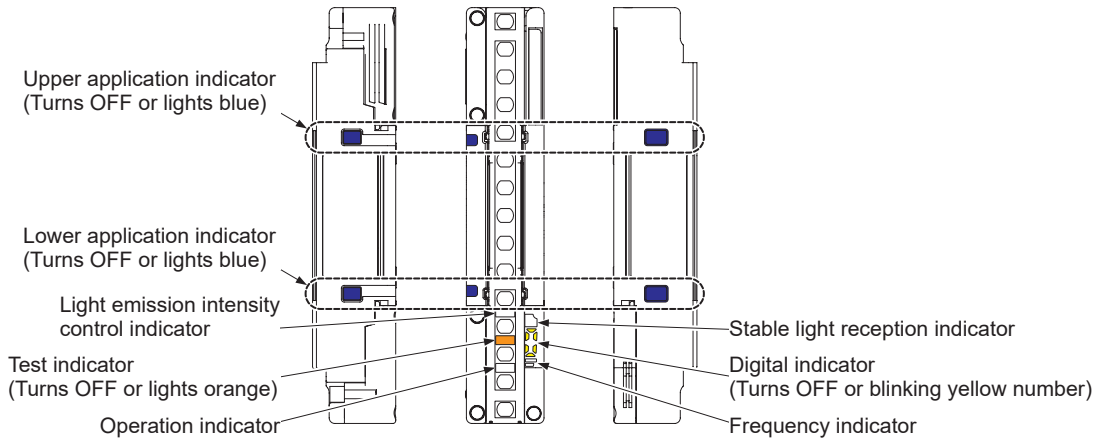





<All indicators are turns OFF>

Cause	Remedy
Power is not supplied.	Make sure the power supply capacity is sufficient. Connect the power supply correctly.
Supply voltage is outside the specified range.	Set the supply voltage correctly.
Connector not connected securely.	Connect the connector firmly.

<Digital indicator shows a blinking or steadily lit yellow number>

	Cause	Remedy
[“ 0 ” lights] Error in device settings.	Internal failure	Contact our office.
[“ 1 ” blinks] Error in the number of beam channels	The device is affected by noise or the power supply. An internal circuit has failed.	<ul style="list-style-type: none"> • Check the noise environment of the device. • Check the connections, supply voltage, and power supply capacity. • Replace the device.
[“ 2 ” blinks] Series connection error, error in total number of beam channels	The number of sensors in series connection exceeds the specified limit.	Limit the number of sensors in series connection to 5 or less.
	The total number of beam channels of the sensors in series connection exceeds the specified limit.	Limit the total number of beam channels to 256 or less.
	Incorrect emitter and receiver connection when connected in a series connection.	Connect emitters to emitters and receivers to receivers using a series connection cable.
	In a series connection, the DIP switches 1 / 2 (synchronization method) are not all set to the same state.	Set all DIP switches 1 / 2 (synchronization method) to the same state.
	End cap is not attached.	Make sure the end cap is installed correctly.
	Cable for series connection is disconnected.	<ul style="list-style-type: none"> • Make sure the cable for series connection is connected correctly. • Replace the cable for series connection.
	Another error has generated.	Check the operation of other sensors in series connection.
[“ 3 ” blinks] Emitter and receiver system mismatch.	The emitter system and receiver system do not match.	<p>Make sure the beam pitch, number of sensors and number of beam channels of the emitter and receiver match.</p> <p>Connect the output polarity setting / lockout release input wires (pale blue) of the emitter and receiver in the same way.</p> <ul style="list-style-type: none"> • Using PNP output: Connect to 0V (blue) • Using NPN output: Connect to + V (brown)
[“ 4 ” blinks] Error in wiring of output polarity setting / lockout release input wire (pale blue).	Output polarity setting / lockout release input wire (pale blue) is broken or shorted to another input / output wire. Incorrect connection of output polarity setting / lockout release input wire (pale blue) on receiver side of emitter / receiver.	<p><Using PNP output> Connect the output polarity setting / lockout release input wire (pale blue) to 0V (blue).</p> <p><Using NPN output> Connect the output polarity setting / lockout release input wire (pale blue) to + V (brown).</p>
[“ 5 ” blinks] Power supply voltage error	The voltage of the power supplied to the device exceeds the specified range.	Make sure the power supply voltage conforms to the specification.
[“ 6 ” blinks] Muting auxiliary output error	Output is shorted to another input / output wire.	Use the muting auxiliary output at a current from 250mA or less.
	Excessive rush current in the muting auxiliary output.	
	Output circuit error.	Output circuit damage. Replace the device.

Troubleshooting

Cause		Remedy	
 Synchronization error	Mismatch between synchronization method and wiring.	The wiring and synchronization method (line synchronization, optical synchronization) must be made to match. To change the synchronization method, refer to “ 3-9 DIP Switch Settings ”. For wiring, refer to “ 2-5 Wiring ”.	
	Line synchronization	Synchronization + wire (orange) or synchronization - wire (orange / black) is shorted or broken.	Make sure that the synchronization + wire (orange) and synchronization - wire (orange / black) are connected correctly.
		The receiver has generated an error.	Check the operation of the receiver.
	Optical synchronization	Significant noise outside the specified range is being received.	Check the noise environment of the device.
Cable for series connection has failed.		Replace the cable for series connection.	
 Emitter error	The other emitter connected in series is locked out.	Check the digital indicator (yellow) of the other emitter connected in series.	
 Effects of noise or power supply, or internal circuit failure.	The device is affected by noise or the power supply. An internal circuit has failed.	Check the noise environment of the device. Check the connections, supply voltage, and power supply capacity. If you are extending the synchronization + wire (orange) and synchronization - wire (orange / black) using a cable other than the special-use cable, use a 0.2mm ² or more twisted pair cable. If the problem persists, check the number that is blinking in the digital indicator (yellow) and the number of times it blinks, and contact our office.	
 Synchronization error	Receiver is in lockout state.	Check an digital indicator (yellow) of receiver.	

<Test indicator (orange) lights up>

Cause		Remedy
Test state activated. (Error state or interlock setting error.)	Digital indicator (yellow) is blinking.	Check the number shown in the digital indicator.
	Auto reset was selected with the test / reset input wire (pink) open.	<Using PNP output> Connect the test / reset input wire (pink) to + V (brown). <Using NPN output> Connect the test / reset input wire (pink) to 0V (blue).
	Manual reset was selected with the test / reset input wire (pink) connected to 0V or +V.	Open the test / reset input wire (pink).

Take action as indicated in the troubleshooting for the emitter and receiver. If the problem persists, contact our office.

5-2 Receiver Troubleshooting

<Indicators on emitter>

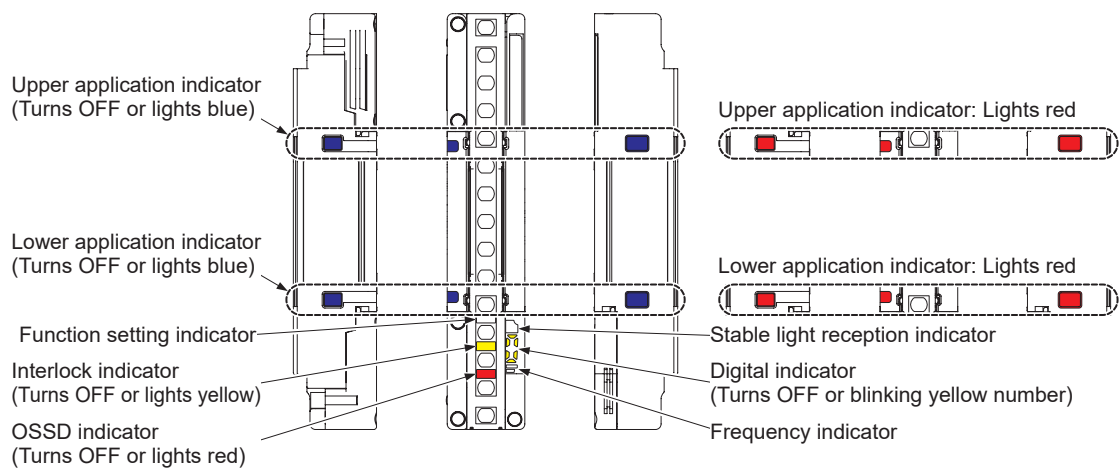









<All indicators are turns OFF>

Cause	Remedy
Power is not supplied.	Make sure the power supply capacity is sufficient. Connect the power supply correctly.
Supply voltage is outside the specified range.	Set the supply voltage correctly.
Connector not firmly connected.	Connect the connector firmly.





Troubleshooting

<Digital indicator shows a blinking or steadily lit yellow number>

	Cause		Remedy
 lights] Error in device settings.	Internal error		Contact our office.
 blinks] Error in the number of beam channels	Line synchronization	The device is affected by noise or the power supply. An internal circuit has failed.	<ul style="list-style-type: none"> • Check the noise environment of the device. • Check the connections, supply voltage, and power supply capacity. • Replace the device.
	Optical synchronization	Scattered light is received, or light emitted from a different model is received.	<ul style="list-style-type: none"> • Make sure that the receiver will not receive scattered light at the time of power ON. • Light from a different model set to the same frequency may be received. Change the setting of the DIP switches 1/2 to a different frequency. • Follow the instructions in “2-3-4-3 Preventing Mutual Interference by Device Placement”
 blinks] Series connection error, error in total number of beam channels	The number of sensors in series connection exceeds the specified limit.		Limit the number of sensors in series connection to 5 or less.
	The total number of beam channels of the sensors in series connection exceeds the specified limit.		Limit the total number of beam channels to 256 or less.
	Incorrect emitter and receiver connection when connected in a series connection.		Connect emitters to emitters and receivers to receivers using a series connection cable.
	In a series connection, the DIP switches 1 / 2 (synchronization method) are not all set to the same state.		Set all DIP switches 1 / 2 (synchronization method) to the same state.
	End cap is not attached.		Make sure the end cap is installed correctly.
	Cable for series connection is disconnected.		<ul style="list-style-type: none"> • Make sure the cable for series connection is connected correctly. • Replace the cable for series connection.
	Another error has generated.		Check the operation of other sensors in series connection.
 blinks] Emitter and receiver system mismatch.	The emitter system and receiver system do not match.		Make sure the beam pitch, number of sensors and number of beam channels of the emitter and receiver match. Wire the output polarity setting / lockout release input wire (pale blue) of the emitter and the receiver in the same way. <ul style="list-style-type: none"> • Using PNP output: Connect to 0V (blue) • Using NPN output: Connect to + V (brown)
 blinks] Scattered light error.	Scattered light is received, or light emitted from a different model No. is received.		After turning on the power, make sure that the receiver does not receive scattered light. If light emitted from a different model No. is received, follow the instructions in “ 2-3-4-3 Preventing Mutual Interference by Device Placement ”.

		Cause	Remedy
 ["5", "4" blinks] Control output (OSSD 1 / 2) error.		The control output 1 (OSSD 1) wire (black) or the control output 2 (OSSD 2) wire (white) is shorted to 0V or +V.	Connect the control output 1 (OSSD 1) wire (black) and the control output 2 (OSSD 2) wire (white) to the safety relay unit, external device (forcible guide relay or magnetic contactor), safety controller, or safety PLC. The current values of the control output 1 (OSSD 1) wire (black) and the control output 2 (OSSD 2) wire (white) must be within the specified range.
		The control output 1 (OSSD 1) wire (black) and control output 2 (OSSD 2) wire (white) are shorted to each other, or to another input / output wire.	
		Excessive current is flowing in the control output 1 (OSSD 1) wire (black) or control output 2 (OSSD 2) wire (white).	
		The output polarity setting / lockout release input wire (pale blue), and the control output 1 (OSSD 1) wire (black) and control output 2 (OSSD 2) wire (white) are not connected correctly.	
	Output circuit error.	Output circuit damage. Replace the device.	
 ["5" blinks] Error in wiring of output polarity setting / lockout release input wire (pale blue).		Output polarity setting / lockout release input wire (pale blue) is broken or shorted to another input / output wire. Incorrect connection of output polarity setting / lockout release input wire (pale blue) of receiver side of emitter / receiver.	<Using PNP output> Connect the output polarity setting / lockout release input wire (pale blue) to 0V (blue). <Using NPN output> Connect the output polarity setting / lockout release input wire (pale blue) to + V (brown).
 ["4" blinks] External device error.	When a safety relay is used	The safety relay contact has welded.	Replace the safety relay.
		The response time of the safety relay is slow.	Replace with a safety relay with a suitable response time. Refer to "3-6 External Device Monitor Function (8-core cable, 12-core cable)" .
		Safety relay contact "b" is not connected.	Correctly connect the safety relay. Refer to "2-5-7 Wiring Configuration for Valid External Device Monitor Function (Example of Control Category 4 Wiring)" .
	When the external device monitor function is invalid.	The auxiliary output wire (red) and external device monitor input wire (pale purple) are not connected.	Connect the auxiliary output wire (red) and external device monitor input wire (pale purple).
		Auxiliary output does not operate correctly.	Check if the auxiliary output wire (red) is broken or has shorted.

Troubleshooting

	Cause	Remedy	
["  "] blinks] Power supply voltage error	The voltage of the power supplied to the device exceeds the specified range.	Make sure the power supply voltage conforms to the specification.	
["  "] lights] Synchronization error	Mismatch between synchronization method and wiring.	The wiring and synchronization method (line synchronization, optical synchronization) must be made to match. To change the synchronization method, refer to " 3-9 DIP Switch Settings ". For wiring, refer to " 2-5 Wiring ".	
	Line synchronization	Synchronization + wire (orange) or synchronization - wire (orange / black) is shorted or broken.	Make sure that the synchronization + wire (orange) and synchronization - wire (orange / black) are connected correctly.
		The emitter has generated an error.	Check the operation of the emitter.
	Optical synchronization	The beam axes of the top and bottom ends are not received.	Make sure the beam axis of either the top end or bottom end is received.
		Significant noise outside the specified range is being received.	Check the noise environment of the device.
		Cable for series connection has failed.	Replace the cable for series connection.
["  "] blinks] Emitter error	Emitter is in lockout state.	Check a digital indicator (yellow) of emitter.	
["  "] blinks] Effects of noise or power supply, or internal circuit failure.	The device is affected by noise or the power supply. An internal circuit has failed.	Check the noise environment of the device. Check the connections, supply voltage, and power supply capacity, and check for scattered light. If you are extending the synchronization + wire (orange) and synchronization - wire (orange / black) using a cable other than the special-use cable, use a 0.2mm ² or more twisted pair cable. If the problem persists, check the number that is blinking in the digital indicator (yellow) and the number of times it blinks, and contact our office.	
["  "] blinks] Synchronization error	The other receiver connected in series is locked out.	Check the digital indicator (yellow) of the other receiver connected in series.	

<Interlock indicator lights yellow>

Cause	Remedy
The control output (OSSD 1 / 2) has been turned OFF by interlock.	Perform a reset [Open test / reset input wire (pink) → Short to 0V or +V → Open].
	If the interlock function is not needed (When auto reset is used), open the interlock setting input wire (pale purple), and isolate.

<Upper application indicator and lower application indicator light red or are OFF>

Cause	Remedy
Beam axes not aligned.	Perform beam axis adjustment. Refer to “ 2-6 Adjustment ”. Align the upper and lower directions between the emitter and receiver.
Synchronization + wire (orange) or synchronization - wire (orange / black) error. Synchronization + wire (orange) or synchronization - wire (orange / black) has shorted or is broken.	Correctly connect the synchronization + wire (orange) and synchronization - wire (orange / black).

Take action as indicated in the troubleshooting for the emitter and receiver. If the problem persists, contact our office.

Troubleshooting

(MEMO)

Chapter 6 Specifications and Dimensions

6-1 Specifications	136
6-2 Options	142
6-3 Dimensions	148
6-3-1 Rear Mounting with MS-SFD-1-5 and MS-SFB-2	148
6-3-2 Side Mounting with MS-SFD-1-5 and MS-SFB-2	149
6-3-3 Rear Mounting with MS-SFD-1-6 and MS-SFB-2	150
6-3-4 Side Mounting with MS-SFD-1-6 and MS-SFB-2	151
6-3-5 Rear Mounting with MS-SFD-1-8 and MS-SFB-2	152
6-3-6 Side Mounting with MS-SFD-1-8 and MS-SFB-2	153
6-3-7 Mounting with MS-SFD-3-6	154
6-3-8 Rear Mounting with MS-SFD-4BG and MS-SFB-2	155
6-3-9 Side Mounting with MS-SFD-4BG and MS-SFB-2	156
6-3-10 Mounting Brackets	157
6-3-10-1 Beam Adjustment Mounting Bracket MS-SFD-1-5	157
6-3-10-2 Beam Adjustment Mounting Bracket MS-SFD-1-6	158
6-3-10-3 Beam Adjustment Mounting Bracket MS-SFD-1-8	159
6-3-10-4 Intermediate Support Bracket MS-SFB-2	160
6-3-10-5 No Dead-Space Beam Adjustment Mounting Bracket MS-SFD-3-6	161
6-3-10-6 SF4B-G Compatible Mounting Bracket MS-SFD-4BG	162

Specifications

6-1 Specifications

Model No.

SF4D - □ □ -01

<Number of beam channels>

<Beam pitch>

F: 10mm, H: 20mm, A: 40mm

Example: SF4D-H32-01

Number of beam channels: 32 channels

Beam pitch: 20mm

Specifications by model No.

<10mm pitch type>

Type	10mm pitch type			
Model No.	SF4D-F15-01	SF4D-F23-01	SF4D-F31-01	SF4D-F39-01
Number of beam channels	15	23	31	39
Protection height	150mm	230mm	310mm	390mm
When using as safety equipment for press machines in Japan and China	140mm	220mm	300mm	380mm
Current consumption	Emitter: 110mA or less Receiver: 130mA or less		Emitter: 120mA or less Receiver: 130mA or less	Emitter: 120mA or less Receiver: 140mA or less
PFHd	1.21×10^{-9}	1.48×10^{-9}	1.80×10^{-9}	2.07×10^{-9}
MTTFd	1,031 years	833 years	672 years	582 years
Weight (emitter / receiver total)	Approx. 270g	Approx. 470g	Approx. 680g	Approx. 890g

Type	10mm pitch type			
Model No.	SF4D-F47-01	SF4D-F55-01	SF4D-F63-01	SF4D-F71-01
Number of beam channels	47	55	63	71
Protection height	470mm	550mm	630mm	710mm
When using as safety equipment for press machines in Japan and China	460mm	540mm	620mm	700mm
Current consumption	Emitter: 120mA or less Receiver: 140mA or less		Emitter: 120mA or less Receiver: 150mA or less	
PFHd	2.40×10^{-9}	2.66×10^{-9}	2.99×10^{-9}	3.25×10^{-9}
MTTFd	498 years	447 years	396 years	363 years
Weight (emitter / receiver total)	Approx. 1,100g	Approx. 1,300g	Approx. 1,500g	Approx. 1,700g

Type	10mm pitch type			
Model No.	SF4D-F79-01	SF4D-F95-01	SF4D-F111-01	SF4D-F127-01
Number of beam channels	79	95	111	127
Protection height	790mm	950mm	1,110mm	1,270mm
When using as safety equipment for press machines in Japan and China	780mm	940mm	1,100mm	1,260mm
Current consumption	Emitter: 120mA or less Receiver: 150mA or less	Emitter: 120mA or less Receiver: 160mA or less	Emitter: 120mA or less Receiver: 170mA or less	Emitter: 120mA or less Receiver: 180mA or less
PFHd	3.58×10^{-9}	4.17×10^{-9}	4.76×10^{-9}	5.36×10^{-9}
MTTFd	328 years	281 years	245 years	217 years
Weight (emitter / receiver total)	Approx. 1,900g	Approx. 2,300g	Approx. 2,800g	Approx. 3,200g

PFHd: Probability of dangerous failure per hour, MTTFd: Mean time to dangerous failure (in years).

<20mm pitch type>

Type	20mm pitch type			
Model No.	SF4D-H8-01	SF4D-H12-01	SF4D-H16-01	SF4D-H20-01
Number of beam channels	8	12	16	20
Protection height	150mm	230mm	310mm	390mm
When using as safety equipment for press machines in Japan and China	140mm	220mm	300mm	380mm
Current consumption	Emitter: 100mA or less, Receiver: 120mA or less			
PFHd	9.57×10^{-10}	1.12×10^{-9}	1.26×10^{-9}	1.40×10^{-9}
MTTFd	1,340 years	1,119 years	988 years	881 years
Weight (emitter / receiver total)	Approx. 270g	Approx. 470g	Approx. 680g	Approx. 890g

Type	20mm pitch type			
Model No.	SF4D-H24-01	SF4D-H28-01	SF4D-H32-01	SF4D-H36-01
Number of beam channels	24	28	32	36
Protection height	470mm	550mm	630mm	710mm
When using as safety equipment for press machines in Japan and China	460mm	540mm	620mm	700mm
Current consumption	Emitter: 100mA or less Receiver: 130mA or less	Emitter: 110mA or less Receiver: 130mA or less	Emitter: 120mA or less Receiver: 130mA or less	Emitter: 120mA or less Receiver: 130mA or less
PFHd	1.56×10^{-9}	1.73×10^{-9}	1.87×10^{-9}	2.04×10^{-9}
MTTFd	782 years	701 years	647 years	591 years
Weight (emitter / receiver total)	Approx. 1,100g	Approx. 1,300g	Approx. 1,500g	Approx. 1,700g

Type	20mm pitch type			
Model No.	SF4D-H40-01	SF4D-H48-01	SF4D-H56-01	SF4D-H64-01
Number of beam channels	40	48	56	64
Protection height	790mm	950mm	1,110mm	1,270mm
When using as safety equipment for press machines in Japan and China	780mm	940mm	1,100mm	1,260mm
Current consumption	Emitter: 120mA or less, Receiver: 140mA or less			Emitter: 120mA or less Receiver: 150mA or less
PFHd	2.17×10^{-9}	2.48×10^{-9}	2.78×10^{-9}	3.09×10^{-9}
MTTFd	552 years	481 years	426 years	383 years
Weight (emitter / receiver total)	Approx. 1,900g	Approx. 2,300g	Approx. 2,800g	Approx. 3,200g

Type	20mm pitch type			
Model No.	SF4D-H72-01	SF4D-H80-01	SF4D-H88-01	SF4D-H96-01
Number of beam channels	72	80	88	96
Protection height	1,430mm	1,590mm	1,750mm	1,910mm
When using as safety equipment for press machines in Japan and China	1,420mm	1,580mm	1,740mm	1,900mm
Current consumption	Emitter: 120mA or less Receiver: 150mA or less		Emitter: 120mA or less Receiver: 160mA or less	
PFHd	3.39×10^{-9}	3.69×10^{-9}	4.00×10^{-9}	4.30×10^{-9}
MTTFd	347 years	318 years	293 years	272 years
Weight (emitter / receiver total)	Approx. 3,600g	Approx. 4,000g	Approx. 4,400g	Approx. 4,800g

PFHd: Probability of dangerous failure per hour, MTTFd: Mean time to dangerous failure (in years).

Specifications

<40mm pitch type>

Type	40mm pitch type			
Model No.	SF4D-A4-01	SF4D-A6-01	SF4D-A8-01	SF4D-A10-01
Number of beam channels	4	6	8	10
Protection height	150mm	230mm	310mm	390mm
When using as safety equipment for press machines in Japan and China	120mm	200mm	280mm	360mm
Current consumption	Emitter: 100mA or less, Receiver: 120mA or less			
PFHd	8.29×10^{-10}	9.34×10^{-10}	1.01×10^{-9}	1.11×10^{-9}
MTTFd	1,577 years	1,378 years	1,267 years	1,136 years
Weight (emitter / receiver total)	Approx. 270g	Approx. 470g	Approx. 680g	Approx. 890g

Type	40mm pitch type			
Model No.	SF4D-A12-01	SF4D-A14-01	SF4D-A16-01	SF4D-A18-01
Number of beam channels	12	14	16	18
Protection height	470mm	550mm	630mm	710mm
When using as safety equipment for press machines in Japan and China	440mm	520mm	600mm	680mm
Current consumption	Emitter: 100mA or less, Receiver: 130mA or less			
PFHd	1.18×10^{-9}	1.29×10^{-9}	1.36×10^{-9}	1.46×10^{-9}
MTTFd	1,060 years	966 years	910 years	840 years
Weight (emitter / receiver total)	Approx. 1,100g	Approx. 1,300g	Approx. 1,500g	Approx. 1,700g

Type	40mm pitch type			
Model No.	SF4D-A20-01	SF4D-A24-01	SF4D-A28-01	SF4D-A32-01
Number of beam channels	20	24	28	32
Protection height	790mm	950mm	1,110mm	1,270mm
When using as safety equipment for press machines in Japan and China	760mm	920mm	1,080mm	1,240mm
Current consumption	Emitter: 100mA or less Receiver: 130mA or less	Emitter: 100mA or less Receiver: 140mA or less		Emitter: 110mA or less Receiver: 140mA or less
PFHd	1.54×10^{-9}	1.71×10^{-9}	1.89×10^{-9}	2.07×10^{-9}
MTTFd	798 years	710 years	640 years	582 years
Weight (emitter / receiver total)	Approx. 1,900g	Approx. 2,300g	Approx. 2,800g	Approx. 3,200g

Type	40mm pitch type			
Model No.	SF4D-A36-01	SF4D-A40-01	SF4D-A44-01	SF4D-A48-01
Number of beam channels	36	40	44	48
Protection height	1,430mm	1,590mm	1,750mm	1,910mm
When using as safety equipment for press machines in Japan and China	1,400mm	1,560mm	1,720mm	1,880mm
Current consumption	Emitter: 110mA or less, Receiver: 150mA or less			Emitter: 110mA or less Receiver: 160mA or less
PFHd	2.24×10^{-9}	2.42×10^{-9}	2.60×10^{-9}	2.77×10^{-9}
MTTFd	534 years	493 years	458 years	428 years
Weight (emitter / receiver total)	Approx. 3,600g	Approx. 4,000g	Approx. 4,400g	Approx. 4,800g

PFHd: Probability of dangerous failure per hour, MTTFd: Mean time to dangerous failure (in years).

Common specifications

Type	10mm pitch type	20mm pitch type	40mm pitch type
Model No.	SF4D-F□-01	SF4D-H□-01	SF4D-A□-01
Sensing range (effective)	Short mode: 0.2 to 7m Long mode: 0.8 to 12m (selectable by DIP switch)	Short mode: 0.2 to 9m, Long mode: 0.8 to 15m (selectable by DIP switch)	
Minimum sensing object	ø14mm opaque object	ø25mm opaque object	ø45mm opaque object
Effective aperture angle	±2.5° or less at a sensing range of 3m or longer (based on IEC 61496-2)		
Supply voltage	24V DC $^{+20}_{-30}$ % Ripple P-P 10% or less (excluding voltage drop due to cable)		
Control output (OSSD 1 / 2)	PNP open-collector transistor / NPN open collector transistor (selectable)		
	<PNP output selected>		<NPN output selected>
	<ul style="list-style-type: none"> • Maximum source current: 350mA • Applied voltage: Same as supply voltage (between control output and +V) • Residual voltage: 2V or less (source current 350mA) (excluding voltage drop due to cable) • Leakage current 0.2mA or less (including power OFF state) • Maximum load capacity: 2.2μF (from no load to maximum output current) • Load wiring resistance: 3Ω or less 		<ul style="list-style-type: none"> • Maximum sink current: 350mA • Applied voltage: Same as supply voltage (between control output and 0V) • Residual voltage: 2V or less (sink current 350mA) (excluding voltage drop due to cable) • Leakage current 0.2mA or less (including power OFF state) • Maximum load capacity: 2.2μF (from no load to maximum output current) • Load wiring resistance: 3Ω or less
	Operation mode (Output operation)		
ON when all beams are received, OFF when one or more beams are blocked (Also OFF when internal sensor error or synchronization signal error occurs)			
Protective circuit (short circuit protection)			
Incorporated			
Response time			
OFF response: 10ms or less (not connected in serial), 18ms or less (connected in serial) (Refer to <Response time by number of beam channels>) ON response: 50ms or less (Note 1, 2)			
Auxiliary output (AUX) (Non-safety output)	PNP open-collector transistor / NPN open collector transistor (selectable)		
	<PNP output selected>		<NPN output selected>
	<ul style="list-style-type: none"> • Maximum source current: 60mA • Applied voltage: Same as supply voltage (between auxiliary output and +V) • Residual voltage: 2V or less (source current 60mA) (excluding voltage drop due to cable) • Leakage current 0.2mA or less (including power OFF state) 		<ul style="list-style-type: none"> • Maximum sink current: 60mA • Applied voltage: Same as supply voltage (between auxiliary output and 0 V) • Residual voltage: 2V or less (sink current 60mA) (excluding voltage drop due to cable) • Leakage current 0.2mA or less (including power OFF state)
	Operation mode (Output operation)		
OSSD ON: OFF, OSSD OFF: ON			
Protective circuit (short circuit protection)			
Incorporated			
Response time			
OFF response: 60ms or less, ON response: 60ms or less			
Synchronization method	Line synchronization / optical synchronization (selectable by DIP switch)		
Interference prevention function	Line synchronization: Two units or less (auto) Optical synchronization: Two units or less (selectable by DIP switch) • Series connection: 5 units or less (total number of beam channels 256 or less)		
Protective structure	IP67, IP65 (IEC), NEMA Type 13 (NEMA 250)		
Ambient temperature	-10 to +55°C (No condensation or icing), Storage: -25 to +60°C		
Ambient humidity	30 to 85% RH, storage: 30 to 95% RH		
Ambient illumination	Incandescent light: 5,000lx or less at the light-receiving surface		
Degree of pollution	3		
Operating altitude	2,000m or less (Note 3)		
Withstand voltage	AC 1,000V for one minute (between all supply terminals connected together and enclosure)		
Insulation resistance	20MΩ or higher using DC 500V megger (between all supply terminals connected together and enclosure)		
Vibration resistance	10 to 55Hz, 0.75mm double amplitude for two hours each in X, Y, and Z directions Malfunction resistance 10 to 55Hz, 0.75mm double amplitude 20 times each in X, Y, and Z directions		

Specifications

Type	10mm pitch type	20mm pitch type	40mm pitch type
Model No.	SF4D-F□-01	SF4D-H□-01	SF4D-A□-01
Shock resistance	300m/s ² (approx. 30G) 3 times each in X, Y, and Z directions Malfunction resistance 100m/s ² (approx. 10G) 1,000 times each in X, Y, and Z directions		
SFF (Safe Failure Fraction)	99%		
HFT (Hardware Fault Tolerance)	1		
Subsystem type	Type B (IEC 61508-2)		
T1 (proof test interval)	20 years		
Failure response time	Within response time (OFF response)		
Safety state	Control output (OSSD 1 / 2) OFF state		
Emitter element	Infrared LED (peak emission wavelength: 850nm)		
Connection method	By connector		
Cable extension	Total length of emitter / receiver can be extended up to 70m each using optional connection cable (Note 4)		
Material	Enclosure: Aluminum, Detection surface: Polycarbonate / resin and SS304 Upper cap / lower cap: Nylon		
Accessories	SF4B-TR14 (test rod): 1 pc.	SF4B-TR25 (test rod): 1 pc.	-
Applicable standards	IEC 61496-1/2 (Type 4), ISO 13849-1: 2015 (Category 4, PLe), IEC 61508-1 to 7 (SIL3) EN ISO 13849-1: 2015 (Category 4, PLe), EN 55011, EN 61000-6-2, EN IEC 63000 JIS B 9704-1/2 (Type 4), JIS B 9705-1 (Category 4), JIS C 0508-1 to 7 (SIL3) ANSI/UL 61496-1/2 (Type 4), CAN/CSA C22.2 No.14, CAN/CSA E61496-1/2		

- Notes: 1) Because the control output (OSSD 1 / 2) must be OFF for at least 80ms, the ON response will be delayed more than 50ms when the light blocked time is less than 30ms.
2) When optical synchronization is selected, if the beam axes of both the top end and bottom end are blocked, the ON response speed decreases by as much as 1 sec.
3) Do not use or store in an environment pressurized to atmospheric pressure or higher at an altitude of 0m.
4) Taking cable voltage drop and other factors into account, use a cable length as indicated below for the source / sink current of the control output (OSSD 1 / 2).

Number of sub-sensors	Control output (OSSD 1 / 2) source / sink current	Length of power cable + length of series connection cable (total cable length)	Cable	
			Length of power cable	Length of series connection cable
0 (no series connection)	100mA	70m or less	-	-
	200mA	70m or less	-	-
	350mA	10.5m or less	-	-
1	100mA	50m or less	-	Total cable length minus the power cable length
	200mA	50m or less	-	
	350mA	50m or less	10.5m or less	
2	100mA	50m or less	-	
	200mA	50m or less	-	
	350mA	50m or less	10.5m or less	
3	100mA	50m or less	-	
	200mA	50m or less	40.5m or less	
	350mA	50m or less	10.5m or less	
4	100mA	25.5m or less	-	
	200mA	25.5m or less	20.5m or less	
	350mA	25.5m or less	10.5m or less	

Power cable: A bottom cap cable (option) combined with an extension cable (option)

<Response time by number of beam channels>

Control output (OSSD 1 / 2)

		Response time (OFF response)				
		Main sensor	Sub sensor			
Number of units in series connection		1 unit	1 unit	2 units	3 units	4 units
Number of beam channels	4 to 48	6ms	10ms	10ms	12ms	12ms
	49 to 96	8ms	10ms	10ms	12ms	12ms
	97 to 127	10ms	12ms	12ms	14ms	14ms
	128 to 144	—	12ms	12ms	14ms	14ms
	145 to 192	—	14ms	14ms	16ms	16ms
	193 to 256	—	16ms	16ms	18ms	18ms

CAUTION

Both emitter and receiver are adjusted before shipment, please apply both emitter and receiver with the same serial No. The serial No. is indicated on the plates of both emitter and receiver. (Under the model represents the serial No.)

Options

6-2 Options

When using as a safety device for a press machine or paper shearing machine in Japan

When using as a safety device for a press machine or paper shearing machine in Japan, always attach the protective tube **SFPD-A10** (option) to the cable.

• Bottom cap cable: 2pcs./set

<Discrete wire>

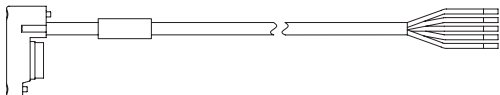

<Connector>

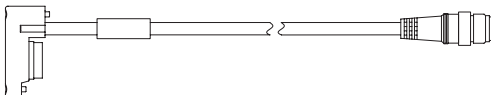

Type	Model No.	Length	Remarks	
5-core	Discrete wire	SFD-CCB5-S	5m	For emitter: Gray connector For receiver: Black connector
	Discrete wire	SFD-CCB10-S	10m	
	Connector	SFD-CB05-S	0.5m	
8-core	Discrete wire	SFD-CCB3	3m	For emitter: Gray connector For receiver: Black connector
		SFD-CCB7	7m	
		SFD-CCB10	10m	
		SFD-CCB15	15m	
	Connector	SFD-CB05	0.5m	
		SFD-CB10	10m	
12-core	Discrete wire	SFD-CCB3-MU	3m	For emitter: Gray connector For receiver: Black connector
		SFD-CCB7-MU	7m	
		SFD-CCB10-MU	10m	
	Connector	SFD-CB05-MU	0.5m	

• Extension cable with connector on one end: 2 pcs./set

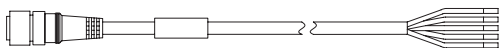

Type	Model No.	Length	Remarks
5-core	SFD-CC3-S	3m	Use to extend a 5-core cable. For emitter: Gray connector For receiver: Black connector
	SFD-CC10-S	10m	
8-core	SFD-CC3	3m	Use to extend a 8-core cable. For emitter: Gray connector For receiver: Black connector
	SFD-CC10	10m	
12-core	SFD-CC3-MU	3m	Use to extend a 12-core cable. For emitter: Gray connector For receiver: Black connector
	SFD-CC7-MU	7m	
	SFD-CC10-MU	10m	

- Extension cable with connectors on both ends: 1 pc.

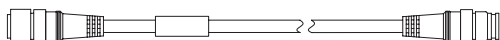

Type	Model No.	Length	Remarks	
5-core	For emitter	SFD-CCJ10E-S	10m	Use to extend a 5-core cable. Both ends of the cable are connectors. For emitter: Gray connector For receiver: Black connector
	For receiver	SFD-CCJ10D-S	10m	
8-core	For emitter	SFB-CCJ3E	3m	Use to extend an 8-core cable. Both ends of the cable are connectors. For emitter: Gray connector, Shielded cable For receiver: Black connector, Shielded cable
		SFB-CCJ10E	10m	
	For receiver	SFB-CCJ3D	3m	
		SFB-CCJ10D	10m	
12-core	For emitter	SFB-CCJ3E-MU	3m	Use to extend a 12-core cable. Both ends of the cable are connectors. For emitter: Gray connector, Shielded cable For receiver: Black connector, Shielded cable
		SFB-CCJ10E-MU	10m	
	For receiver	SFB-CCJ3D-MU	3m	
		SFB-CCJ10D-MU	10m	

- Cable for series connection: 2pcs./set

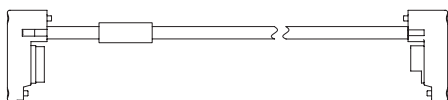

Model No.	Length	Remarks
SFD-CSL005	0.05m	Use to connect the device in series. If this device is to be installed in an L-shaped layout configuration, we recommend that an at least 0.1m long series connection cable be used. Common for emitter / receiver
SFD-CSL01	0.1m	
SFD-CSL05	0.5m	
SFD-CSL1	1m	
SFD-CSL5	5m	
SFD-CSL10	10m	

When using as a safety device for a press machine or paper shearing machine in Japan

- Protective tube: Refer to the table below

⚠ WARNING

When using as a safety device for a press machine or paper shearing machine in Japan, always attach the protective tube **SFPD-A10** (option) to the cable.

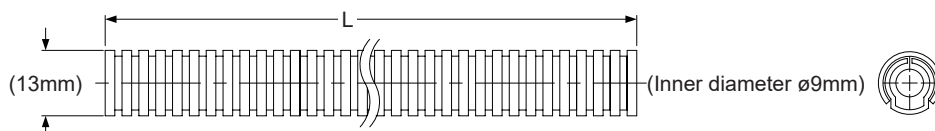

Options

- **Beam Adjustment Mounting Bracket: 4 pcs./set**

<MS-SFD-1-5> <MS-SFD-1-6> <MS-SFD-1-8>

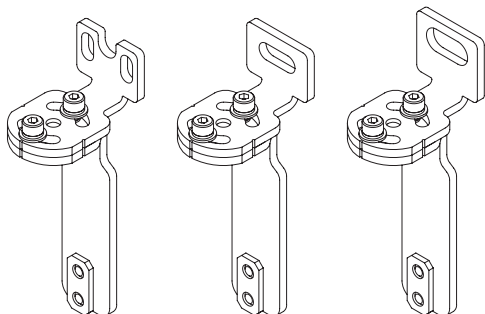

Model No.	Remarks	
MS-SFD-1-5	M5 hexagon-socket head bolt: 2 used or M8 hexagon-socket head bolt: 1 used	Can be mounted on rear or side of device. Material: SPCC
MS-SFD-1-6	M6 hexagon-socket head bolt: 1 used	
MS-SFD-1-8	M8 hexagon-socket head bolt: 1 used	

- **Intermediate supporting bracket: 2 pcs./set**

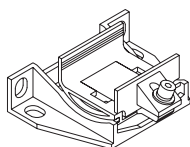

Model No.	Remarks
MS-SFB-2	Bracket for support of the middle of the device. Use when installing the device in a location subject to vibration. M5 hexagon-socket head bolt: 2 used Material: Die-cast zinc alloy

Note: When the number of beam axes is **SF4D-F□-01**: 111 or more beam axes, **SF4D-H□-01**: 56 or more beam axes, **SF4D-A□-01**: 28 or more beam axes, one set is required.

- **No dead-space beam adjustment mounting bracket: 4 pcs./set**

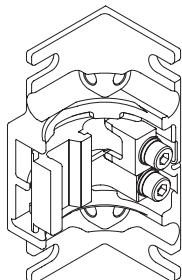

Model No.	Remarks
MS-SFD-3-6	This is the mounting bracket for reducing the dead space. Can be mounted on rear or side of device. M5 hexagon-socket head bolt: 2 used M6 Hex bolt: 2 used Material: Die-cast zinc alloy

- **SF4B-G compatible bracket: 4 pcs./set**

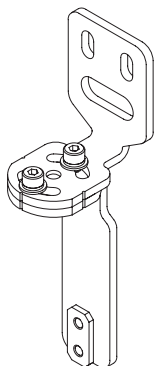

Model No.	Remarks
MS-SFD-4BG	Mounting brackets for replacement of a previous SF4B-G<V2> series model with this model. No need to change the mounting hole pitch. Use when installing the device in a location subject to vibration. M5 hexagon-socket head bolt: 2 used M8 hexagon-socket head bolt: 1 used Material: SPCC

- Front protective cover (wide type): 1 pc.

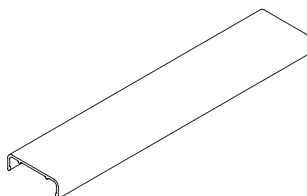

Model No.	Applicable models			Remarks			
FC-SFDH-8	SF4D-F15-01	SF4D-H8-01	SF4D-A4-01	Protects the detection surface of the device from dirt. Mounting the front protective cover shortens the sensing range as shown in the following table.			
FC-SFDH-12	SF4D-F23-01	SF4D-H12-01	SF4D-A6-01				
FC-SFDH-16	SF4D-F31-01	SF4D-H16-01	SF4D-A8-01				
FC-SFDH-20	SF4D-F39-01	SF4D-H20-01	SF4D-A10-01				
FC-SFDH-24	SF4D-F47-01	SF4D-H24-01	SF4D-A12-01				
FC-SFDH-28	SF4D-F55-01	SF4D-H28-01	SF4D-A14-01				
FC-SFDH-32	SF4D-F63-01	SF4D-H32-01	SF4D-A16-01				
FC-SFDH-36	SF4D-F71-01	SF4D-H36-01	SF4D-A18-01				
FC-SFDH-40	SF4D-F79-01	SF4D-H40-01	SF4D-A20-01				
FC-SFDH-48	SF4D-F95-01	SF4D-H48-01	SF4D-A24-01				
FC-SFDH-56	SF4D-F111-01	SF4D-H56-01	SF4D-A28-01				
FC-SFDH-64	SF4D-F127-01	SF4D-H64-01	SF4D-A32-01				
FC-SFDH-72	–	SF4D-H72-01	SF4D-A36-01				
FC-SFDH-80	–	SF4D-H80-01	SF4D-A40-01				
FC-SFDH-88	–	SF4D-H88-01	SF4D-A44-01				
FC-SFDH-96	–	SF4D-H96-01	SF4D-A48-01				
				Model No.	Front protective cover	Sensing range	
						Short mode	Long mode
				SF4D-F□-01	Only emitter	0.2 to 6m	0.8 to 9.5m
					Only receiver	0.2 to 6m	0.8 to 9.5m
					Both	0.2 to 5.5m	0.8 to 9m
				SF4D-H□-01 SF4D-A□-01	Only emitter	0.2 to 7.5m	0.8 to 12m
					Only receiver	0.2 to 7.5m	0.8 to 12m
					Both	0.2 to 7m	0.8 to 11m
				Material: Polycarbonate			

- Front protective cover (slim type): 1 pc.

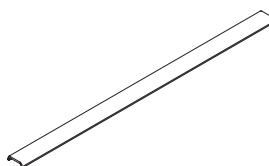

Model No.	Applicable models			Remarks			
FC-SFDH-8	SF4D-F15-01	SF4D-H8-01	SF4D-A4-01	Protects the detection surface of the device from dirt. Mounting the front protective cover shortens the sensing range as shown in the following table.			
FC-SFDH-12	SF4D-F23-01	SF4D-H12-01	SF4D-A6-01				
FC-SFDH-16	SF4D-F31-01	SF4D-H16-01	SF4D-A8-01				
FC-SFDH-20	SF4D-F39-01	SF4D-H20-01	SF4D-A10-01				
FC-SFDH-24	SF4D-F47-01	SF4D-H24-01	SF4D-A12-01				
FC-SFDH-28	SF4D-F55-01	SF4D-H28-01	SF4D-A14-01				
FC-SFDH-32	SF4D-F63-01	SF4D-H32-01	SF4D-A16-01				
FC-SFDH-36	SF4D-F71-01	SF4D-H36-01	SF4D-A18-01				
FC-SFDH-40	SF4D-F79-01	SF4D-H40-01	SF4D-A20-01				
FC-SFDH-48	SF4D-F95-01	SF4D-H48-01	SF4D-A24-01				
FC-SFDH-56	SF4D-F111-01	SF4D-H56-01	SF4D-A28-01				
FC-SFDH-64	SF4D-F127-01	SF4D-H64-01	SF4D-A32-01				
FC-SFDH-72	–	SF4D-H72-01	SF4D-A36-01				
FC-SFDH-80	–	SF4D-H80-01	SF4D-A40-01				
FC-SFDH-88	–	SF4D-H88-01	SF4D-A44-01				
FC-SFDH-96	–	SF4D-H96-01	SF4D-A48-01				
				Model No.	Front protective cover	Sensing range	
						Short mode	Long mode
				SF4D-F□-01	Only emitter	0.2 to 6m	0.8 to 9.5m
					Only receiver	0.2 to 6m	0.8 to 9.5m
					Both	0.2 to 5.5m	0.8 to 9m
				SF4D-H□-01 SF4D-A□-01	Only emitter	0.2 to 7.5m	0.8 to 12m
					Only receiver	0.2 to 7.5m	0.8 to 12m
					Both	0.2 to 7m	0.8 to 11m
				Material: Polycarbonate			

Note: Avoid using this cover in a place where severe vibration occurs.

Options

- Connector-type control unit: 1 pc.

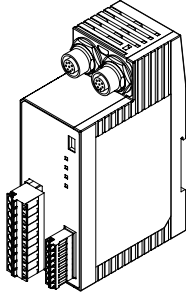

Model No.	Remarks
SF-C11	Control unit that complies with European and North American safety standards. Compatible with cables having an 8-core connector

- Thin-type control unit: 1 pc.

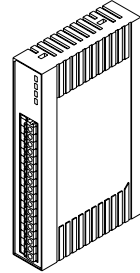

Model No.	Remarks
SF-C13	Control unit that complies with European and North American safety standards.

- Safety control unit: 1 pc.

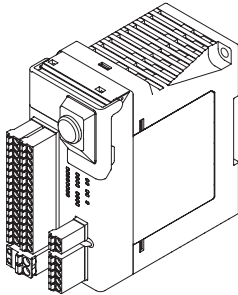

Model No.	Remarks
SF-C21	Equipped with a preset logic certified for the international safety standards and a customized logic. Various types of safety circuit can be configured by selecting a logic and connecting a safety device.

- Beam axis adjuster: 1 pc.

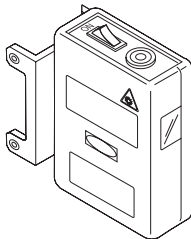

Model No.	Remarks
SF-LAT-2N	Convenient for beam adjustment.

- Test rod: 1 pc.

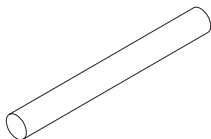

Model No.	Remarks
SF4B-TR45	For SF4D-A□-01 . ø45mm. Can also be used for SF4D-H□-01 single beam axis floating.

- Communication module: 1 pc.

Model No.	Remarks
SF4D-TM1	Conversion module that lets you connect a PC to the device to change function settings and monitor the device status. The Configurator Light Curtain software is required to use the SF4D-TM1 . The Configurator Light Curtain software can be downloaded free-of-charge from our website (panasonic.net/id/pidsx/global).

- IO-Link communication unit: 1 pc.

Model	Remarks
SFD-WL3	When the SFD-WL3 is connected to the IO-Link master, it is possible to monitor operating conditions (light received / light blocked, lockout, etc.) of this product.

Dimensions

6-3 Dimensions

6-3-1 Rear Mounting with MS-SFD-1-5 and MS-SFB-2

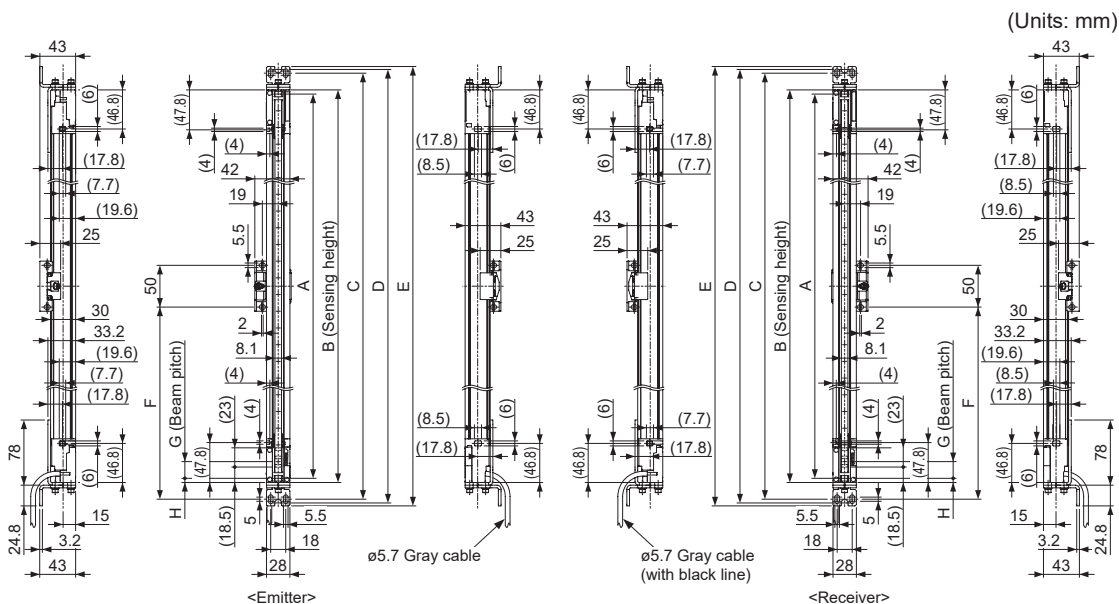

Model No.			A		B	C	D	E	F
			SF4D-F□-01 SF4D-H□-01	SF4D-A□-01					
SF4D-F15-01	SF4D-H8-01	SF4D-A4-01	140	120	150	190	199	206	-
SF4D-F23-01	SF4D-H12-01	SF4D-A6-01	220	200	230	270	279	286	-
SF4D-F31-01	SF4D-H16-01	SF4D-A8-01	300	280	310	350	359	366	-
SF4D-F39-01	SF4D-H20-01	SF4D-A10-01	380	360	390	430	439	446	-
SF4D-F47-01	SF4D-H24-01	SF4D-A12-01	460	440	470	510	519	526	-
SF4D-F55-01	SF4D-H28-01	SF4D-A14-01	540	520	550	590	599	606	-
SF4D-F63-01	SF4D-H32-01	SF4D-A16-01	620	600	630	670	679	686	-
SF4D-F71-01	SF4D-H36-01	SF4D-A18-01	700	680	710	750	759	766	-
SF4D-F79-01	SF4D-H40-01	SF4D-A20-01	780	760	790	830	839	846	-
SF4D-F95-01	SF4D-H48-01	SF4D-A24-01	940	920	950	990	999	1,006	-
SF4D-F111-01	SF4D-H56-01	SF4D-A28-01	1,100	1,080	1,110	1,150	1,159	1,166	550
SF4D-F127-01	SF4D-H64-01	SF4D-A32-01	1,260	1,240	1,270	1,310	1,319	1,326	630
-	SF4D-H72-01	SF4D-A36-01	1,420	1,400	1,430	1,470	1,479	1,486	710
-	SF4D-H80-01	SF4D-A40-01	1,580	1,560	1,590	1,630	1,639	1,646	790
-	SF4D-H88-01	SF4D-A44-01	1,740	1,720	1,750	1,790	1,799	1,806	870
-	SF4D-H96-01	SF4D-A48-01	1,900	1,880	1,910	1,950	1,959	1,966	950

Type	G	H
SF4D-F□-01	10	5
SF4D-H□-01	20	5
SF4D-A□-01	40	15

6-3-2 Side Mounting with MS-SFD-1-5 and MS-SFB-2

(Units: mm)

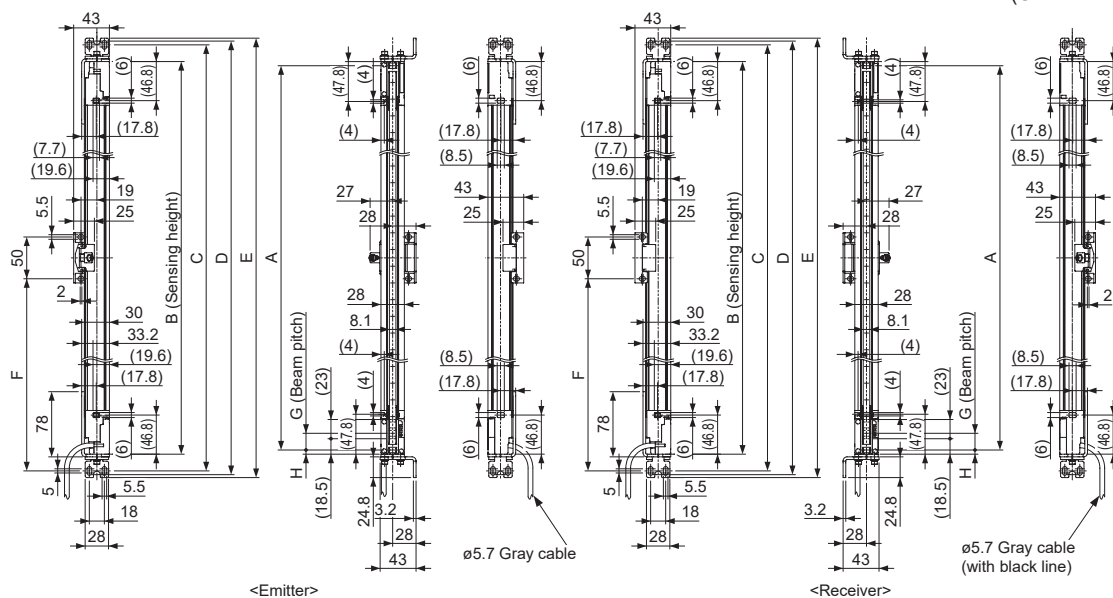

Model No.			A		B	C	D	E	F
			SF4D-F□-01 SF4D-H□-01	SF4D-A□-01					
SF4D-F15-01	SF4D-H8-01	SF4D-A4-01	140	120	150	190	199	206	-
SF4D-F23-01	SF4D-H12-01	SF4D-A6-01	220	200	230	270	279	286	-
SF4D-F31-01	SF4D-H16-01	SF4D-A8-01	300	280	310	350	359	366	-
SF4D-F39-01	SF4D-H20-01	SF4D-A10-01	380	360	390	430	439	446	-
SF4D-F47-01	SF4D-H24-01	SF4D-A12-01	460	440	470	510	519	526	-
SF4D-F55-01	SF4D-H28-01	SF4D-A14-01	540	520	550	590	599	606	-
SF4D-F63-01	SF4D-H32-01	SF4D-A16-01	620	600	630	670	679	686	-
SF4D-F71-01	SF4D-H36-01	SF4D-A18-01	700	680	710	750	759	766	-
SF4D-F79-01	SF4D-H40-01	SF4D-A20-01	780	760	790	830	839	846	-
SF4D-F95-01	SF4D-H48-01	SF4D-A24-01	940	920	950	990	999	1,006	-
SF4D-F111-01	SF4D-H56-01	SF4D-A28-01	1,100	1,080	1,110	1,150	1,159	1,166	550
SF4D-F127-01	SF4D-H64-01	SF4D-A32-01	1,260	1,240	1,270	1,310	1,319	1,326	630
-	SF4D-H72-01	SF4D-A36-01	1,420	1,400	1,430	1,470	1,479	1,486	710
-	SF4D-H80-01	SF4D-A40-01	1,580	1,560	1,590	1,630	1,639	1,646	790
-	SF4D-H88-01	SF4D-A44-01	1,740	1,720	1,750	1,790	1,799	1,806	870
-	SF4D-H96-01	SF4D-A48-01	1,900	1,880	1,910	1,950	1,959	1,966	950

Type	G	H
SF4D-F□-01	10	5
SF4D-H□-01	20	5
SF4D-A□-01	40	15

Dimensions

6-3-3 Rear Mounting with MS-SFD-1-6 and MS-SFB-2

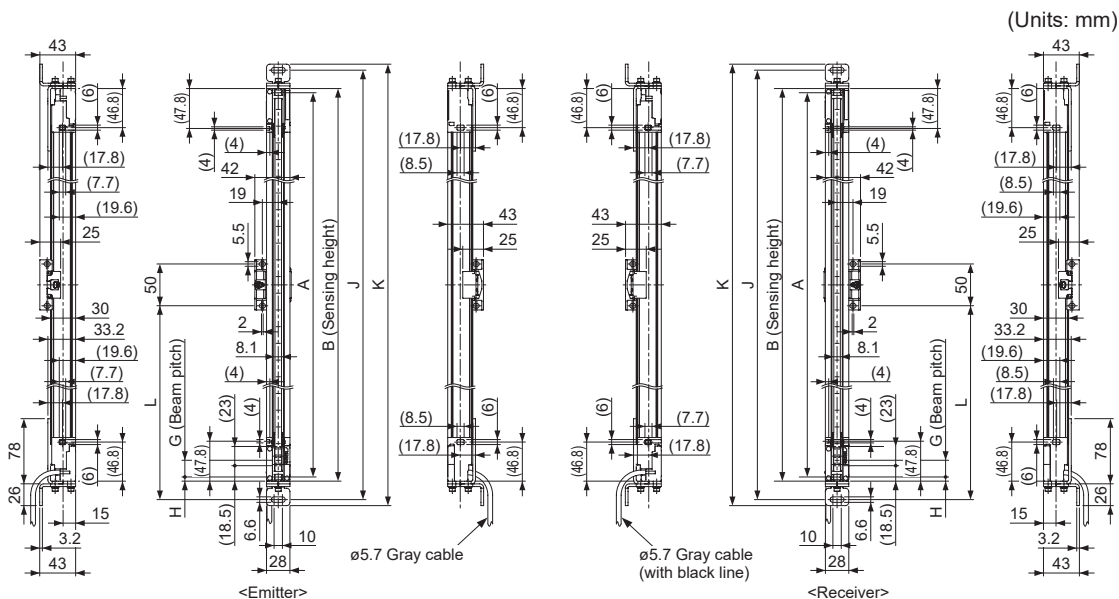

Model No.			A		B	J	K	L
			SF4D-F□-01 SF4D-H□-01	SF4D-A□-01				
SF4D-F15-01	SF4D-H8-01	SF4D-A4-01	140	120	150	194	208	-
SF4D-F23-01	SF4D-H12-01	SF4D-A6-01	220	200	230	274	288	-
SF4D-F31-01	SF4D-H16-01	SF4D-A8-01	300	280	310	354	368	-
SF4D-F39-01	SF4D-H20-01	SF4D-A10-01	380	360	390	434	448	-
SF4D-F47-01	SF4D-H24-01	SF4D-A12-01	460	440	470	514	528	-
SF4D-F55-01	SF4D-H28-01	SF4D-A14-01	540	520	550	594	608	-
SF4D-F63-01	SF4D-H32-01	SF4D-A16-01	620	600	630	674	688	-
SF4D-F71-01	SF4D-H36-01	SF4D-A18-01	700	680	710	754	768	-
SF4D-F79-01	SF4D-H40-01	SF4D-A20-01	780	760	790	834	848	-
SF4D-F95-01	SF4D-H48-01	SF4D-A24-01	940	920	950	994	1,008	-
SF4D-F111-01	SF4D-H56-01	SF4D-A28-01	1,100	1,080	1,110	1,154	1,168	552
SF4D-F127-01	SF4D-H64-01	SF4D-A32-01	1,260	1,240	1,270	1,314	1,328	632
-	SF4D-H72-01	SF4D-A36-01	1,420	1,400	1,430	1,474	1,488	712
-	SF4D-H80-01	SF4D-A40-01	1,580	1,560	1,590	1,634	1,648	792
-	SF4D-H88-01	SF4D-A44-01	1,740	1,720	1,750	1,794	1,808	872
-	SF4D-H96-01	SF4D-A48-01	1,900	1,880	1,910	1,954	1,968	952

Type	G	H
SF4D-F□-01	10	5
SF4D-H□-01	20	5
SF4D-A□-01	40	15

6-3-4 Side Mounting with MS-SFD-1-6 and MS-SFB-2

(Units: mm)

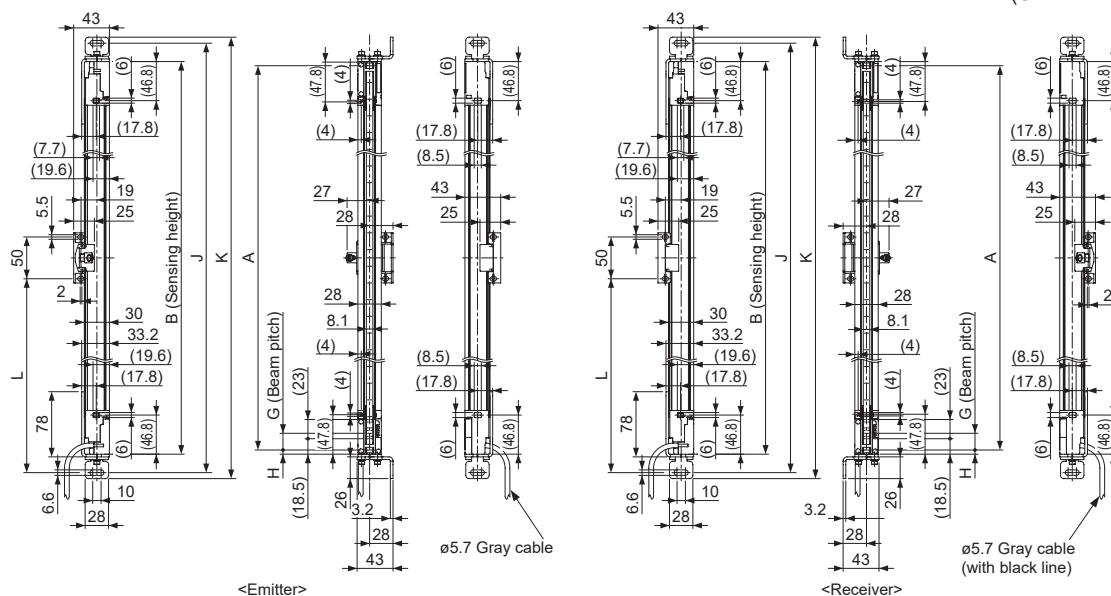

Model No.			A		B	J	K	L
			SF4D-F□-01 SF4D-H□-01	SF4D-A□-01				
SF4D-F15-01	SF4D-H8-01	SF4D-A4-01	140	120	150	194	208	-
SF4D-F23-01	SF4D-H12-01	SF4D-A6-01	220	200	230	274	288	-
SF4D-F31-01	SF4D-H16-01	SF4D-A8-01	300	280	310	354	368	-
SF4D-F39-01	SF4D-H20-01	SF4D-A10-01	380	360	390	434	448	-
SF4D-F47-01	SF4D-H24-01	SF4D-A12-01	460	440	470	514	528	-
SF4D-F55-01	SF4D-H28-01	SF4D-A14-01	540	520	550	594	608	-
SF4D-F63-01	SF4D-H32-01	SF4D-A16-01	620	600	630	674	688	-
SF4D-F71-01	SF4D-H36-01	SF4D-A18-01	700	680	710	754	768	-
SF4D-F79-01	SF4D-H40-01	SF4D-A20-01	780	760	790	834	848	-
SF4D-F95-01	SF4D-H48-01	SF4D-A24-01	940	920	950	994	1,008	-
SF4D-F111-01	SF4D-H56-01	SF4D-A28-01	1,100	1,080	1,110	1,154	1,168	552
SF4D-F127-01	SF4D-H64-01	SF4D-A32-01	1,260	1,240	1,270	1,314	1,328	632
-	SF4D-H72-01	SF4D-A36-01	1,420	1,400	1,430	1,474	1,488	712
-	SF4D-H80-01	SF4D-A40-01	1,580	1,560	1,590	1,634	1,648	792
-	SF4D-H88-01	SF4D-A44-01	1,740	1,720	1,750	1,794	1,808	872
-	SF4D-H96-01	SF4D-A48-01	1,900	1,880	1,910	1,954	1,968	952

Type	G	H
SF4D-F□-01	10	5
SF4D-H□-01	20	5
SF4D-A□-01	40	15

Dimensions

6-3-5 Rear Mounting with MS-SFD-1-8 and MS-SFB-2

(Units: mm)

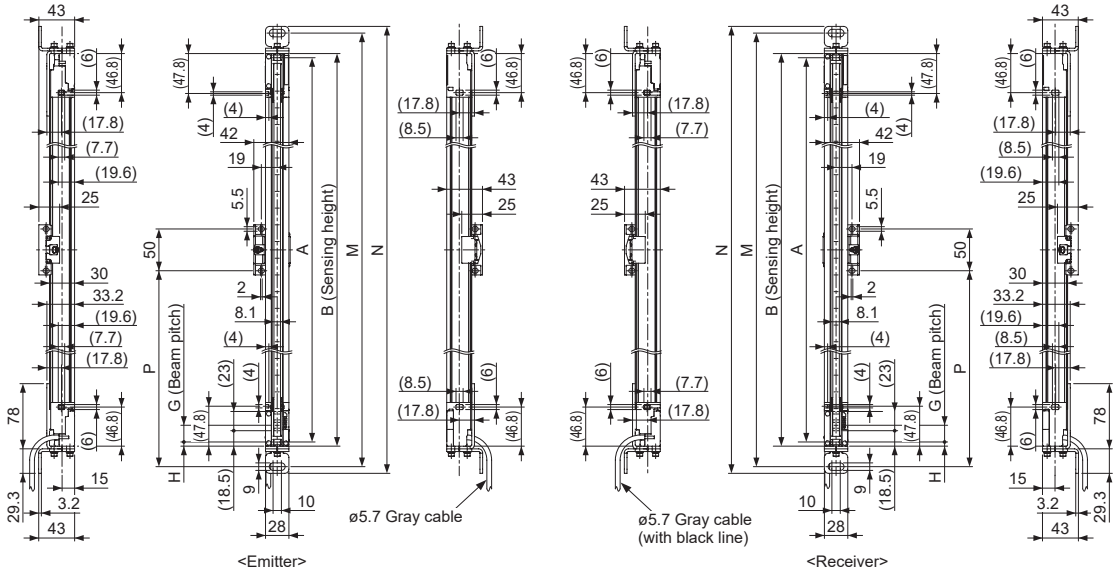

Model No.			A		B	M	N	P
			SF4D-F□-01 SF4D-H□-01	SF4D-A□-01				
SF4D-F15-01	SF4D-H8-01	SF4D-A4-01	140	120	150	199	215	-
SF4D-F23-01	SF4D-H12-01	SF4D-A6-01	220	200	230	279	295	-
SF4D-F31-01	SF4D-H16-01	SF4D-A8-01	300	280	310	359	375	-
SF4D-F39-01	SF4D-H20-01	SF4D-A10-01	380	360	390	439	455	-
SF4D-F47-01	SF4D-H24-01	SF4D-A12-01	460	440	470	519	535	-
SF4D-F55-01	SF4D-H28-01	SF4D-A14-01	540	520	550	599	615	-
SF4D-F63-01	SF4D-H32-01	SF4D-A16-01	620	600	630	679	695	-
SF4D-F71-01	SF4D-H36-01	SF4D-A18-01	700	680	710	759	775	-
SF4D-F79-01	SF4D-H40-01	SF4D-A20-01	780	760	790	839	855	-
SF4D-F95-01	SF4D-H48-01	SF4D-A24-01	940	920	950	999	1,015	-
SF4D-F111-01	SF4D-H56-01	SF4D-A28-01	1,100	1,080	1,110	1,159	1,175	555
SF4D-F127-01	SF4D-H64-01	SF4D-A32-01	1,260	1,240	1,270	1,319	1,335	635
-	SF4D-H72-01	SF4D-A36-01	1,420	1,400	1,430	1,479	1,495	715
-	SF4D-H80-01	SF4D-A40-01	1,580	1,560	1,590	1,639	1,655	795
-	SF4D-H88-01	SF4D-A44-01	1,740	1,720	1,750	1,799	1,815	875
-	SF4D-H96-01	SF4D-A48-01	1,900	1,880	1,910	1,959	1,975	955

Type	G	H
SF4D-F□-01	10	5
SF4D-H□-01	20	5
SF4D-A□-01	40	15

6-3-6 Side Mounting with MS-SFD-1-8 and MS-SFB-2

(Units: mm)

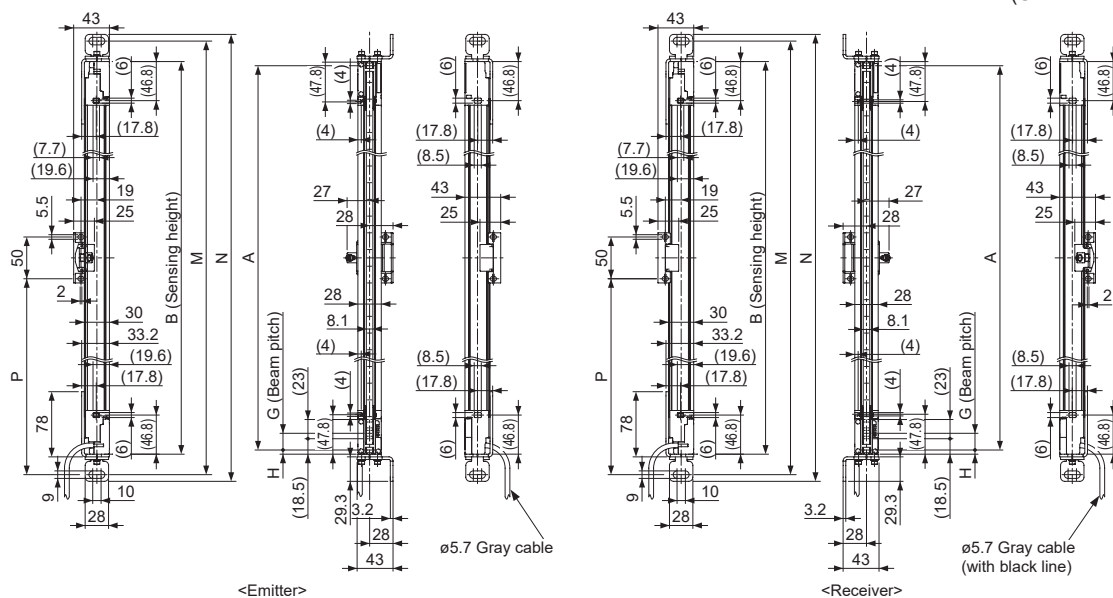

Model No.			A		B	M	N	P
			SF4D-F□-01 SF4D-H□-01	SF4D-A□-01				
SF4D-F15-01	SF4D-H8-01	SF4D-A4-01	140	120	150	199	215	-
SF4D-F23-01	SF4D-H12-01	SF4D-A6-01	220	200	230	279	295	-
SF4D-F31-01	SF4D-H16-01	SF4D-A8-01	300	280	310	359	375	-
SF4D-F39-01	SF4D-H20-01	SF4D-A10-01	380	360	390	439	455	-
SF4D-F47-01	SF4D-H24-01	SF4D-A12-01	460	440	470	519	535	-
SF4D-F55-01	SF4D-H28-01	SF4D-A14-01	540	520	550	599	615	-
SF4D-F63-01	SF4D-H32-01	SF4D-A16-01	620	600	630	679	695	-
SF4D-F71-01	SF4D-H36-01	SF4D-A18-01	700	680	710	759	775	-
SF4D-F79-01	SF4D-H40-01	SF4D-A20-01	780	760	790	839	855	-
SF4D-F95-01	SF4D-H48-01	SF4D-A24-01	940	920	950	999	1,015	-
SF4D-F111-01	SF4D-H56-01	SF4D-A28-01	1,100	1,080	1,110	1,159	1,175	555
SF4D-F127-01	SF4D-H64-01	SF4D-A32-01	1,260	1,240	1,270	1,319	1,335	635
-	SF4D-H72-01	SF4D-A36-01	1,420	1,400	1,430	1,479	1,495	715
-	SF4D-H80-01	SF4D-A40-01	1,580	1,560	1,590	1,639	1,655	795
-	SF4D-H88-01	SF4D-A44-01	1,740	1,720	1,750	1,799	1,815	875
-	SF4D-H96-01	SF4D-A48-01	1,900	1,880	1,910	1,959	1,975	955

Type	G	H
SF4D-F□-01	10	5
SF4D-H□-01	20	5
SF4D-A□-01	40	15

Dimensions

6-3-7 Mounting with MS-SFD-3-6

(Units: mm)

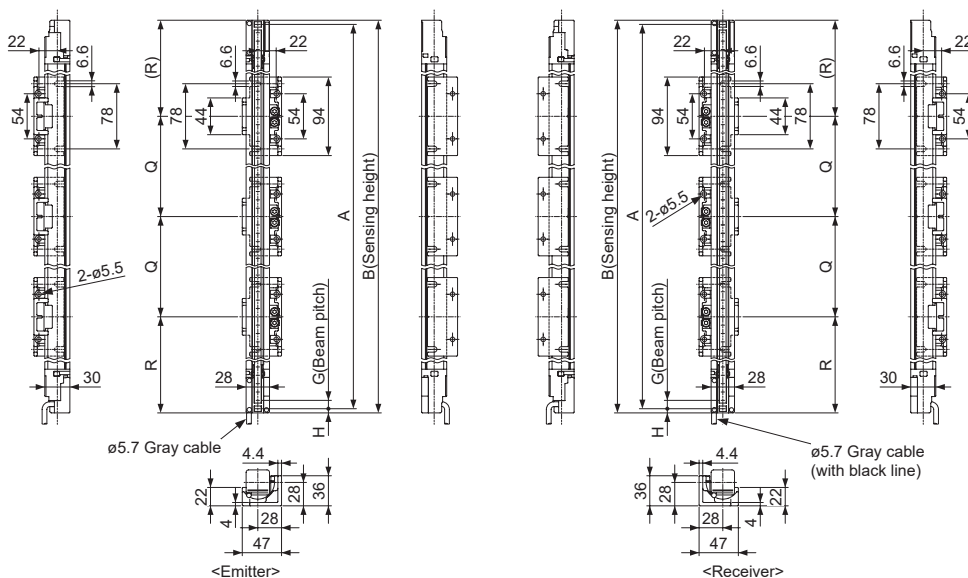

Model No.			A		B	Q	R	Count
			SF4D-F□-01 SF4D-H□-01	SF4D-A□-01				
SF4D-F15-01	SF4D-H8-01	SF4D-A4-01	140	120	150	0	75	1
SF4D-F23-01	SF4D-H12-01	SF4D-A6-01	220	200	230	94	68	2
SF4D-F31-01	SF4D-H16-01	SF4D-A8-01	300	280	310	110	100	
SF4D-F39-01	SF4D-H20-01	SF4D-A10-01	380	360	390	160	115	
SF4D-F47-01	SF4D-H24-01	SF4D-A12-01	460	440	470	200	135	
SF4D-F55-01	SF4D-H28-01	SF4D-A14-01	540	520	550	250	150	
SF4D-F63-01	SF4D-H32-01	SF4D-A16-01	620	600	630	290	170	
SF4D-F71-01	SF4D-H36-01	SF4D-A18-01	700	680	710	340	185	
SF4D-F79-01	SF4D-H40-01	SF4D-A20-01	780	760	790	380	205	
SF4D-F95-01	SF4D-H48-01	SF4D-A24-01	940	920	950	470	240	
SF4D-F111-01	SF4D-H56-01	SF4D-A28-01	1,100	1,080	1,110	560	275	
SF4D-F127-01	SF4D-H64-01	SF4D-A32-01	1,260	1,240	1,270	650	310	3
-	SF4D-H72-01	SF4D-A36-01	1,420	1,400	1,430	730	350	
-	SF4D-H80-01	SF4D-A40-01	1,580	1,560	1,590	530	265	
-	SF4D-H88-01	SF4D-A44-01	1,740	1,720	1,750	590	285	
-	SF4D-H96-01	SF4D-A48-01	1,900	1,880	1,910	650	305	

Type	G	H
SF4D-F□-01	10	5
SF4D-H□-01	20	5
SF4D-A□-01	40	15

6-3-8 Rear Mounting with MS-SFD-4BG and MS-SFB-2

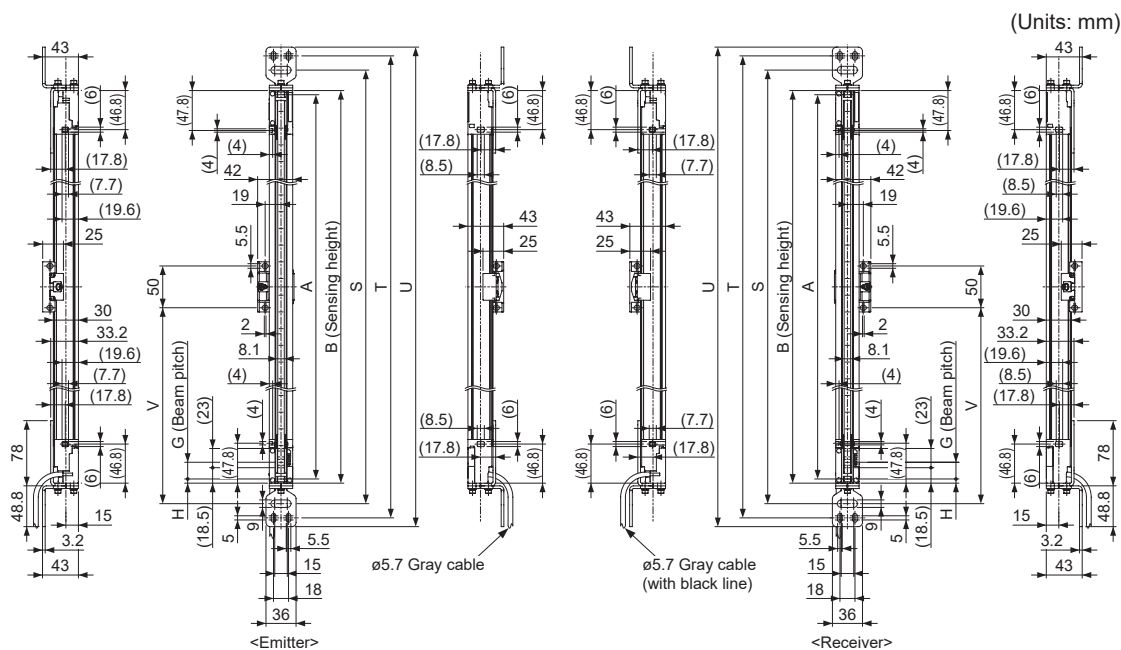

Model No.			A		B	S	T	U	V
			SF4D-F□-01 SF4D-H□-01	SF4D-A□-01					
SF4D-F15-01	SF4D-H8-01	SF4D-A4-01	140	120	150	199	233	254	-
SF4D-F23-01	SF4D-H12-01	SF4D-A6-01	220	200	230	279	313	334	-
SF4D-F31-01	SF4D-H16-01	SF4D-A8-01	300	280	310	359	393	414	-
SF4D-F39-01	SF4D-H20-01	SF4D-A10-01	380	360	390	439	473	494	-
SF4D-F47-01	SF4D-H24-01	SF4D-A12-01	460	440	470	519	553	574	-
SF4D-F55-01	SF4D-H28-01	SF4D-A14-01	540	520	550	599	633	654	-
SF4D-F63-01	SF4D-H32-01	SF4D-A16-01	620	600	630	679	713	734	-
SF4D-F71-01	SF4D-H36-01	SF4D-A18-01	700	680	710	759	793	814	-
SF4D-F79-01	SF4D-H40-01	SF4D-A20-01	780	760	790	839	873	894	-
SF4D-F95-01	SF4D-H48-01	SF4D-A24-01	940	920	950	999	1,033	1,054	-
SF4D-F111-01	SF4D-H56-01	SF4D-A28-01	1,100	1,080	1,110	1,159	1,193	1,214	555
SF4D-F127-01	SF4D-H64-01	SF4D-A32-01	1,260	1,240	1,270	1,319	1,353	1,374	635
-	SF4D-H72-01	SF4D-A36-01	1,420	1,400	1,430	1,479	1,513	1,534	715
-	SF4D-H80-01	SF4D-A40-01	1,580	1,560	1,590	1,639	1,673	1,694	795
-	SF4D-H88-01	SF4D-A44-01	1,740	1,720	1,750	1,799	1,833	1,854	875
-	SF4D-H96-01	SF4D-A48-01	1,900	1,880	1,910	1,959	1,993	2,014	955

Type	G	H
SF4D-F□-01	10	5
SF4D-H□-01	20	5
SF4D-A□-01	40	15

Dimensions

6-3-9 Side Mounting with MS-SFD-4BG and MS-SFB-2

(Units: mm)

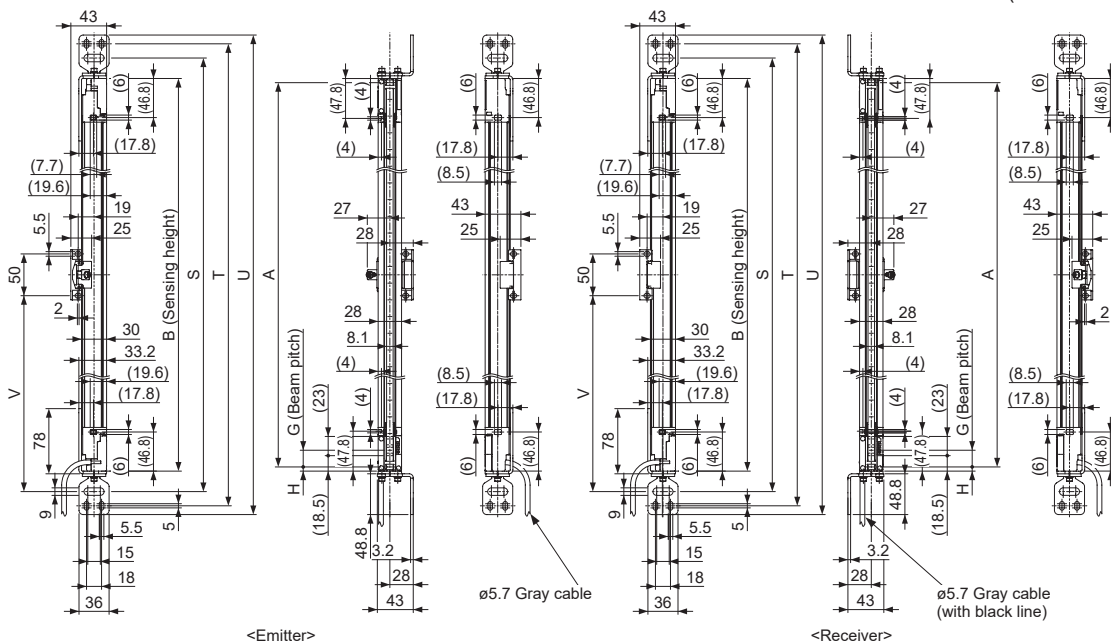

Model No.			A		B	S	T	U	V
			SF4D-F□-01 SF4D-H□-01	SF4D-A□-01					
SF4D-F15-01	SF4D-H8-01	SF4D-A4-01	140	120	150	199	233	254	-
SF4D-F23-01	SF4D-H12-01	SF4D-A6-01	220	200	230	279	313	334	-
SF4D-F31-01	SF4D-H16-01	SF4D-A8-01	300	280	310	359	393	414	-
SF4D-F39-01	SF4D-H20-01	SF4D-A10-01	380	360	390	439	473	494	-
SF4D-F47-01	SF4D-H24-01	SF4D-A12-01	460	440	470	519	553	574	-
SF4D-F55-01	SF4D-H28-01	SF4D-A14-01	540	520	550	599	633	654	-
SF4D-F63-01	SF4D-H32-01	SF4D-A16-01	620	600	630	679	713	734	-
SF4D-F71-01	SF4D-H36-01	SF4D-A18-01	700	680	710	759	793	814	-
SF4D-F79-01	SF4D-H40-01	SF4D-A20-01	780	760	790	839	873	894	-
SF4D-F95-01	SF4D-H48-01	SF4D-A24-01	940	920	950	999	1,033	1,054	-
SF4D-F111-01	SF4D-H56-01	SF4D-A28-01	1,100	1,080	1,110	1,159	1,193	1,214	555
SF4D-F127-01	SF4D-H64-01	SF4D-A32-01	1,260	1,240	1,270	1,319	1,353	1,374	635
-	SF4D-H72-01	SF4D-A36-01	1,420	1,400	1,430	1,479	1,513	1,534	715
-	SF4D-H80-01	SF4D-A40-01	1,580	1,560	1,590	1,639	1,673	1,694	795
-	SF4D-H88-01	SF4D-A44-01	1,740	1,720	1,750	1,799	1,833	1,854	875
-	SF4D-H96-01	SF4D-A48-01	1,900	1,880	1,910	1,959	1,993	2,014	955

Type	G	H
SF4D-F□-01	10	5
SF4D-H□-01	20	5
SF4D-A□-01	40	15

6-3-10 Mounting Brackets

6-3-10-1 Beam Adjustment Mounting Bracket MS-SFD-1-5

(Units: mm)

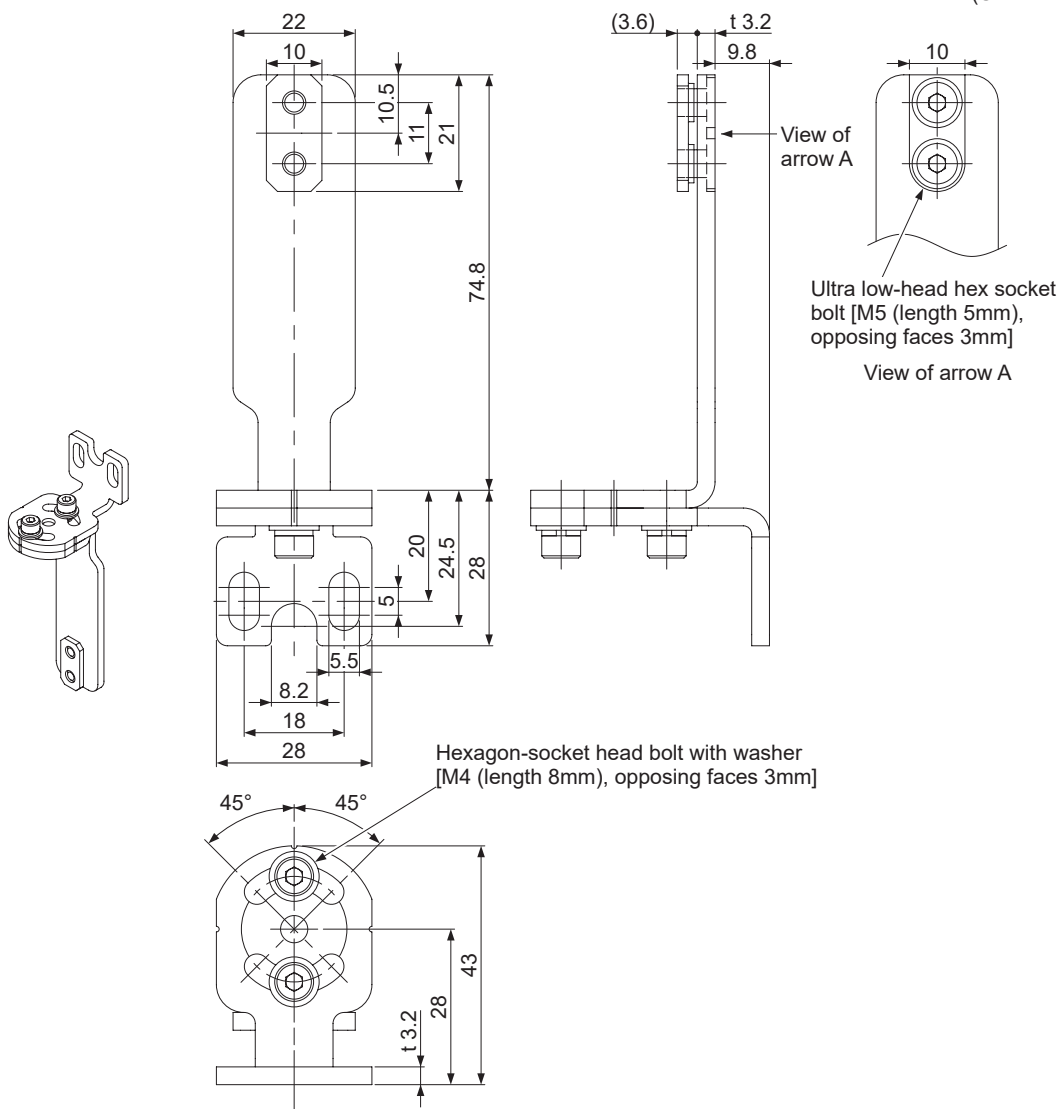

Material: SPCC

Dimensions

6-3-10-2 Beam Adjustment Mounting Bracket MS-SFD-1-6

(Units: mm)

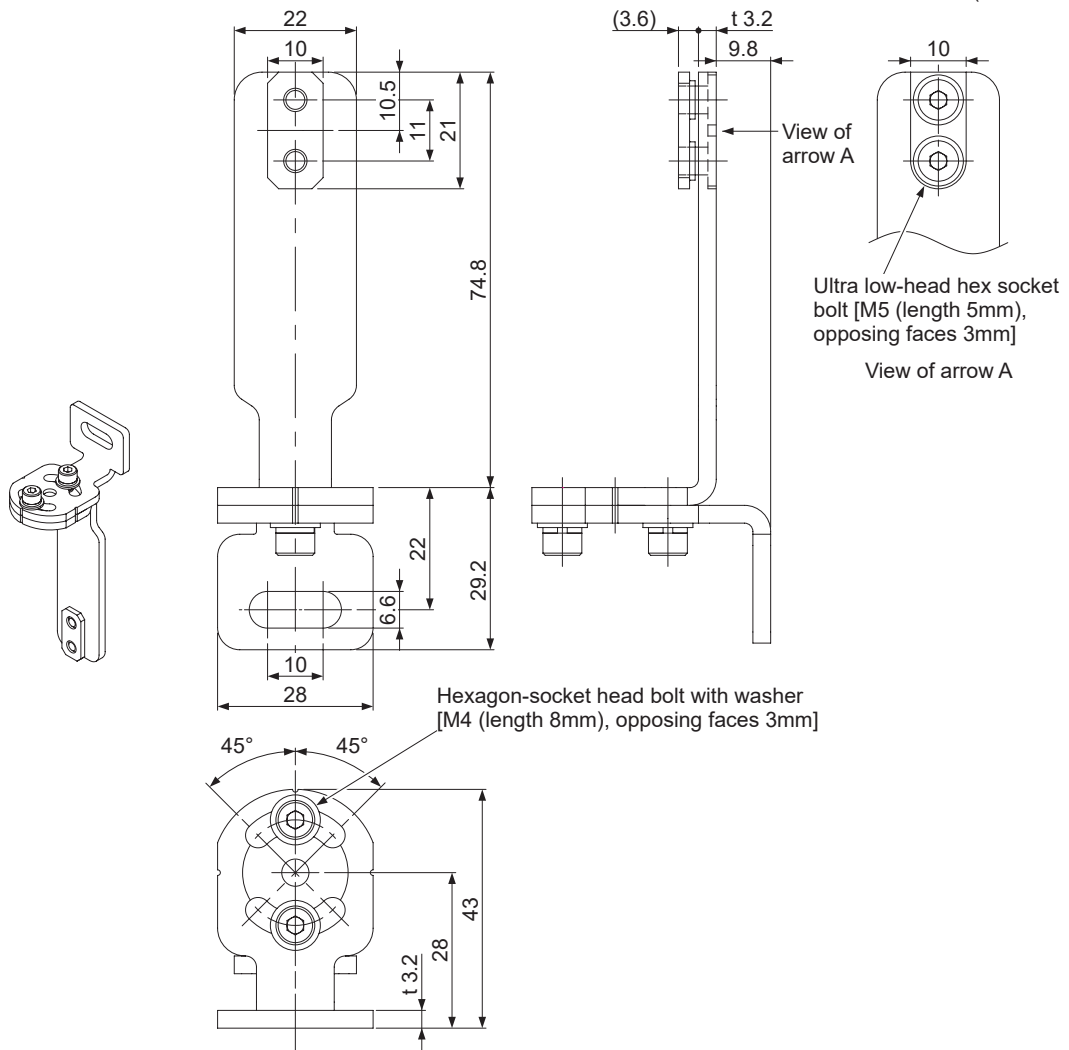

Material: SPCC

6-3-10-3 Beam Adjustment Mounting Bracket MS-SFD-1-8

(Units: mm)

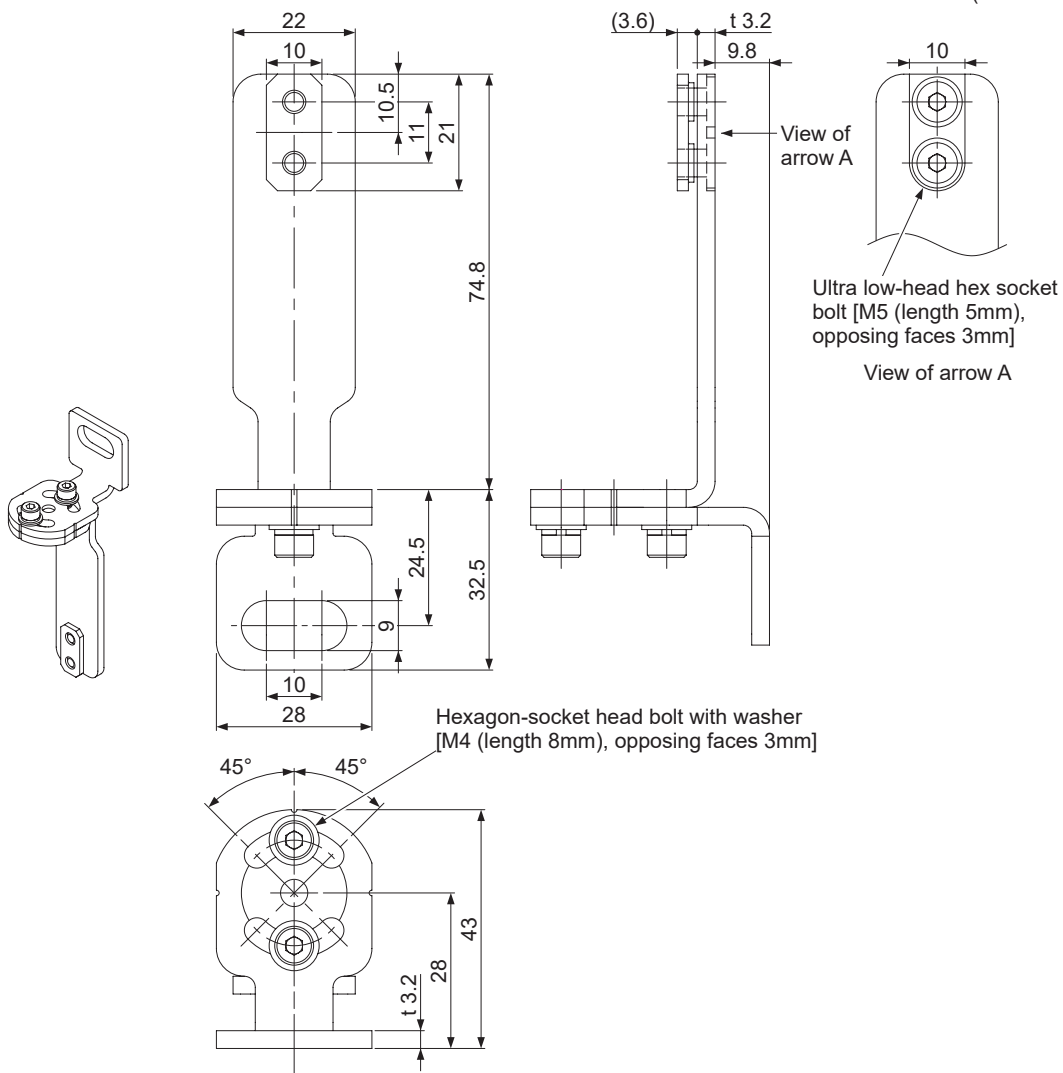

Material: SPCC

Dimensions

6-3-10-4 Intermediate Support Bracket MS-SFB-2

(Units: mm)

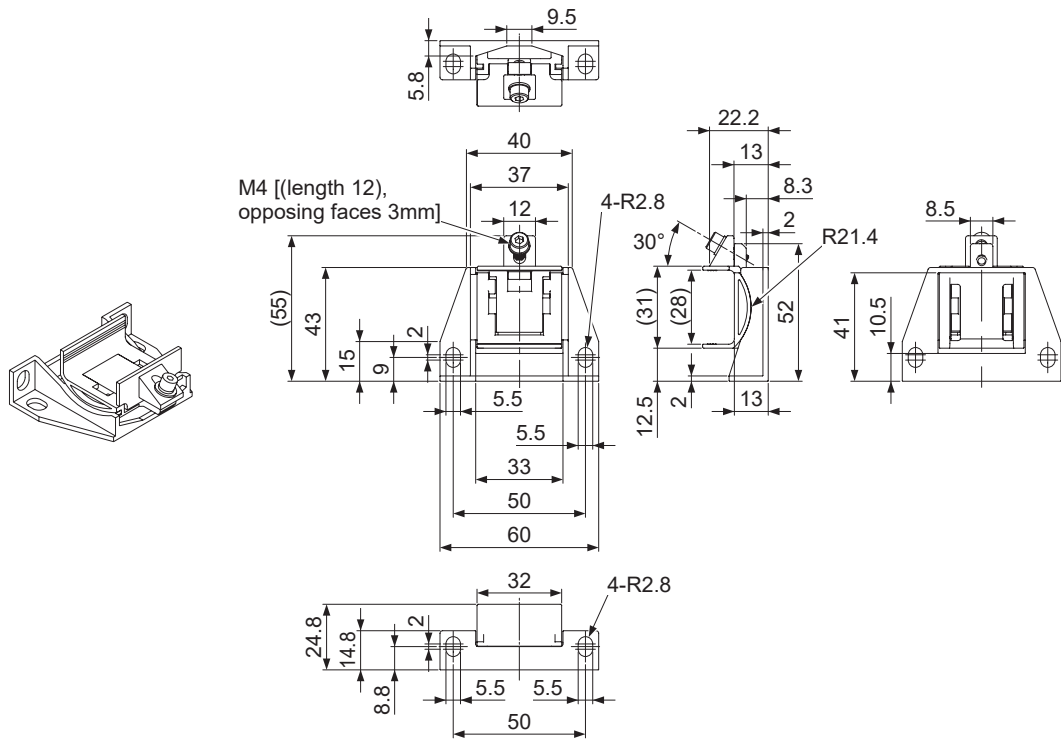

Material: Die-cast zinc alloy

6-3-10-5 No Dead-Space Beam Adjustment Mounting Bracket MS-SFD-3-6

(Units: mm)

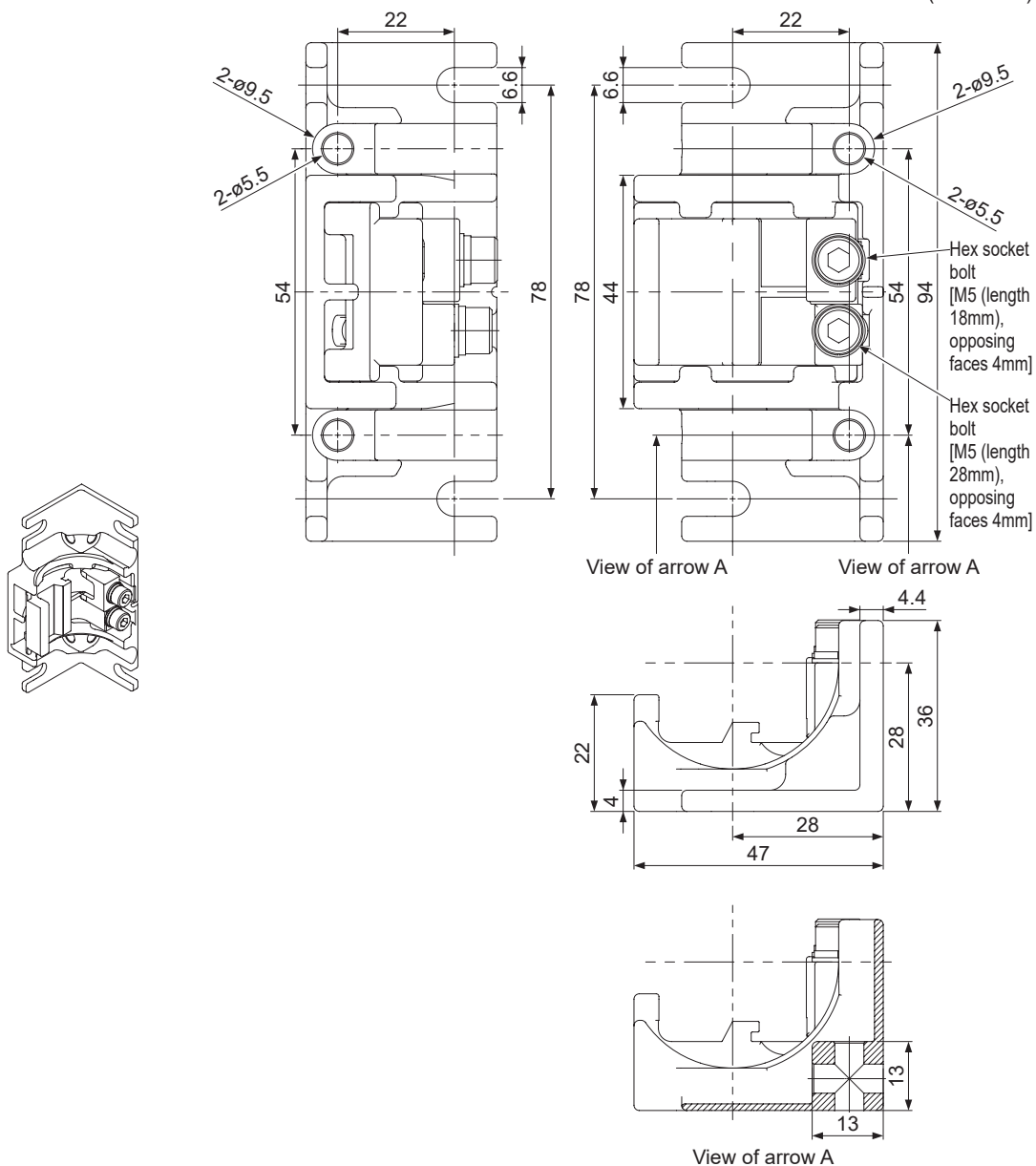

Material: Die-cast zinc alloy

Dimensions

6-3-10-6 SF4B-G Compatible Mounting Bracket MS-SFD-4BG

(Units: mm)

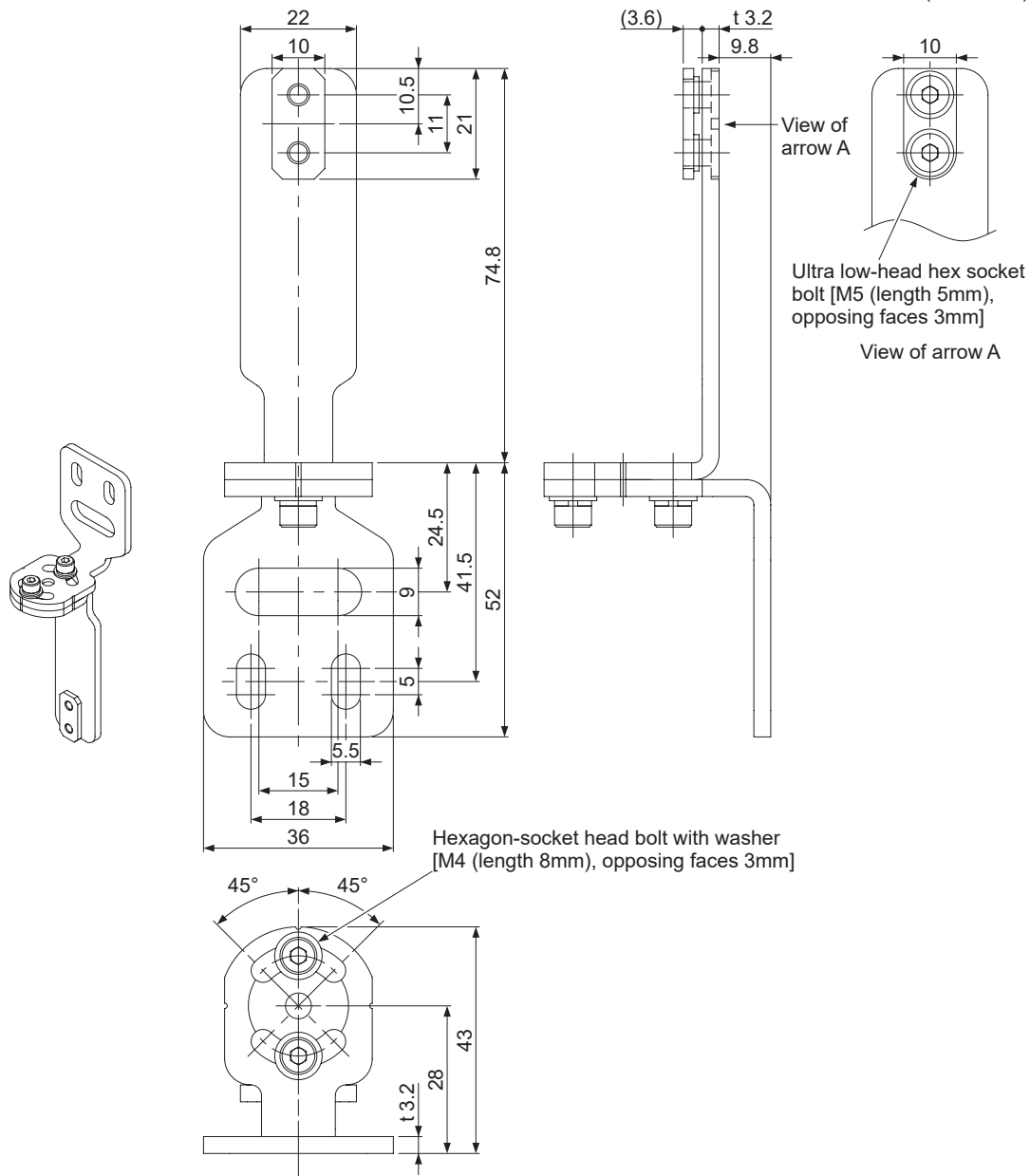

Material: SPCC

Chapter 7 Other Information

7-1 Glossary.....	164
7-2 CE Marking Declaration of Conformity	166

Glossary

7-1 Glossary

Machinery Directive	This directive applies to assemblies of linked parts or components powered by electricity, compressed air, oil pressure, or other means, consisting of at least one component which moves and a component which fulfills a safety function, and which is sold in the market as a single unit.
EMC Directive	This directives applies to electric or electronic devices which may create electromagnetic interference, or whose performance may be affected by electromagnetic interference.
IEC 61496-1/2 ANSI/UL 61496-1/2 JIS B 9704-1/2	Standards that pertain to machine safety, especially electrosensitive protective equipment (ESPE). IEC 61496-1, ANSI/UL 61496-1 and JIS B 9704-1 give general rules for failure mode and effect analysis, EMC requirements, and other matters. IEC 61496-2, ANSI/UL 61496-2 and JIS B 9704-2 specify effective aperture angles and protection against extraneous light sources for Active Opto-electronic Protective Devices (AOP-Ds).
IEC 61508-1 to 7 JIS C 0508-1 to 7	Standards that pertain to general functional safety for electrical, electronic, and programmable electronic devices. These standards prescribe methods, safety integrity levels (SIL), and other specifications that reduce risk to a tolerable level of probability.
EN 55011	Specifies the allowable levels and measurement methods for radio interference characteristics of industrial, scientific and medical (ISM) radio-frequency equipment.
EN ISO 13849-1: 2015 EN 13849-1: 2015 JIS B 9705-1	Standards for safety-related matters of machine safety / control systems. These standards specify levels (categories) of structure and fault detection reliability, and levels of safety function performance capability (PL: Performance Level).
ESPE	Abbreviation for Electro-Sensitive Protective Equipment.
Control output (OSSD)	Abbreviation for Output Signal Switching Device. A component of the light curtain that turns OFF when light of the light curtain is blocked.
FSD	Abbreviation for Final Switching Device. This is a component of the machine's control system that breaks the MPCE circuit when the OSSD outputs an OFF signal due to the light from the light curtain being blocked.
Test rod	Rod for checking the detection capability of the device. The size of the rod is equivalent to the minimum sensing object.
Lockout	One of the safety states of the device. Operation stops when the self-diagnosis function determines that an irrecoverable failure (OSSDs not operating normally, etc.) has occurred. When the emitter is in the lockout state, the OSSD and SSD of the receiver turn OFF. When the receiver is in the lockout state, the OSSD and SSD turn OFF.

Safety distance	The minimum distance that must be maintained between the light curtain and the dangerous part of the machine so that the machine can be stopped before a human body or object reaches the dangerous part.
Sensing height (protection height)	The height of the beam-axis direction wherein the minimum sensing object can be detected. Length from the center of the 1st beam axis of the device to the center of the last beam axis + 20 mm (top end + 10 mm, bottom end + 10 mm)
Sensing range (effective)	Distance between the emitter and receiver.
Sensing area	Area over which intrusion by people or objects can be detected by the device. The area is given by the sensing height multiplied by the sensing range.
Test input state	Function that checks operation by forcibly turning the control output (OSSD) of the receiver ON and OFF while light from the emitter is being received
PSDI	Abbreviation for Presence Sensing Device Initiation. This is a safety device that restarts the device automatically without operator intervention after the device has detected danger and temporarily halted.

CE Marking Declaration of Conformity

7-2 CE Marking Declaration of Conformity

Itemized Essentials of EC Declaration of Conformity

Manufacturer's Name: Panasonic Industrial Devices SUNX Co., Ltd

Manufacturer's Address:

2431-1, Ushiyama-cho, Kasugai, Aichi 486-0901, Japan

EC Representative's Name:

Panasonic Marketing Europe GmbH Panasonic Testing Center

EC Representative's Address: Winsbergring 15, 22525 Hamburg, Germany

Product: Active Opto-electronic Protective Device (Light Curtain)

Model Name: SF4D Series

Trade Name: Panasonic

Application of Council Directive:

- 2006/42/EC Machinery Directive
- 2014/30/EU EMC Directive
- 2011/65/EU RoHS Directive

Applicable standard(s):

- EN ISO 13849-1: 2015
- EN 55011
- EN 61000-6-2
- EN IEC 63000
- IEC 61496-1
- IEC 61496-2
- IEC 61508-1
- IEC 61508-2
- IEC 61508-3
- IEC 61508-4

Type Examination: Certified by TÜV SÜD Product Service GmbH Ridlerstrasse
65 80339 München Germany

Revision history

First edition	November 30, 2016
Second edition	March 31, 2017
Third edition	June 30, 2017
Fourth edition	January 20, 2020
Fifth edition	March 27, 2020
Sixth edition	December 11, 2020
Seventh edition	November 15, 2021

(MEMO)

1. WARRANTIES:

- (1) Subject to the exclusions stated in 2 (EXCLUSIONS) herein below, Panasonic Industrial Devices SUNX warrants the Products to be free of defects in material and workmanship for a period of one (1) year from the date of shipment under normal usage in environments commonly found in manufacturing industry.
- (2) Any Products found to be defective must be shipped to Panasonic Industrial Devices SUNX with all shipping costs paid by Purchaser or offered to Panasonic Industrial Devices SUNX for inspection and examination. Upon examination by Panasonic Industrial Devices SUNX, Panasonic Industrial Devices SUNX will, at its sole discretion, repair or replace at no charge, or refund the purchase price of, any Products found to be defective.

2. EXCLUSIONS:

- (1) This warranty does not apply to defects resulting from any cause:
 - (i) which was due to abuse, misuse, mishandling, improper installation, improper interfacing, or improper repair by Purchaser;
 - (ii) which was due to unauthorized modification by Purchaser, in part or in whole, whether in structure, performance or specification;
 - (iii) which was not discoverable by a person with the state-of-the-art scientific and technical knowledge at the time of manufacture;
 - (iv) which was due to an operation or use by Purchaser outside of the limits of operation or environment specified by Panasonic Industrial Devices SUNX;
 - (v) which was due to normal wear and tear;
 - (vi) which was due to Force Majeure; and
 - (vii) which was due to any use or application expressly discouraged by Panasonic Industrial Devices SUNX in 4 (CAUTIONS FOR SAFE USE) hereunder.
- (2) This warranty extends only to the first purchaser for application, and is not transferable to any person or entity which purchased from such purchaser for application.

3. DISCLAIMERS

- (1) Panasonic Industrial Devices SUNX's sole obligation and liability under this warranty is limited to the repair or replacement, or refund of the purchase price, of a defective Product, at Panasonic Industrial Devices SUNX's option.
- (2) THE REPAIR, REPLACEMENT, OR REFUND IS THE EXCLUSIVE REMEDY OF THE PURCHASER, AND ALL OTHER WARRANTIES, EXPRESS OR IMPLIED, INCLUDING, WITHOUT LIMITATION, THE WARRANTIES OF MERCHANTABILITY, FITNESS FOR A PARTICULAR PURPOSE, AND NON-INFRINGEMENT OF PROPRIETARY RIGHTS, ARE HEREBY EXPRESSLY DISCLAIMED. IN NO EVENT SHALL PANASONIC INDUSTRIAL DEVICES SUNX AND ITS AFFILIATED ENTITIES BE LIABLE FOR DAMAGES IN EXCESS OF THE PURCHASE PRICE OF THE PRODUCTS, OR FOR ANY INDIRECT, INCIDENTAL, SPECIAL OR CONSEQUENTIAL DAMAGES OF ANY KIND, GENERAL TERMS AND CONDITIONS 4 OR ANY DAMAGES RESULTING FROM LOSS OF USE, BUSINESS INTERRUPTION, LOSS OF INFORMATION, LOSS OR INACCURACY OF DATA, LOSS OF PROFITS, LOSS OF SAVINGS, THE COST OF PROCUREMENT OF SUBSTITUTED GOODS, SERVICES OR TECHNOLOGIES, OR FOR ANY MATTER ARISING OUT OF OR IN CONNECTION WITH THE USE OR INABILITY TO USE THE PRODUCTS.

4. CAUTIONS FOR SAFE USE

- (1) The applications shown in the catalogue are only suggestions, and it is Purchaser's sole responsibility to ascertain the fitness and suitability of the Products for any particular application, as well as to abide by Purchaser's applicable local laws and regulations, if any.
- (2) Never use the Products NOT rated or designated as "SAFETY SENSOR" in any application involving risk to life or property. When such a use is made by Purchaser, such Purchaser shall indemnify and hold harmless Panasonic Industrial Devices SUNX from any liability or damage whatsoever arising out of or in relation to such use.
- (3) In incorporating the Products to any equipment, facilities or systems, it is highly recommended to employ fail-safe designs, including but not limited to a redundant +++design, flame propagation prevention design, and malfunction prevention design so as not to cause any risk of bodily injury, fire accident, or social damage due to any failure of such equipment, facilities or systems.
- (4) The Products are each intended for use only in environments commonly found in manufacturing industry, and, unless expressly allowed in the catalogue, specification or otherwise, shall not be used in, or incorporated into, any equipment, facilities or systems, such as those:
 - (a) which are used for the protection of human life or body parts;
 - (b) which are used outdoors or in environments subject to any likelihood of chemical contamination or electromagnetic influence;
 - (c) which are likely to be used beyond the limits of operations or environments specified by Panasonic Industrial Devices SUNX in the catalogue or otherwise;
 - (d) which may cause risk to life or property, such as nuclear energy control equipment, transportation equipment (whether on rail or land, or in air or at sea), and medical equipment;
 - (e) which are operated continuously each day for 24 hours; and
 - (f) which otherwise require a high level of safety performance similar to that required in those equipment, facilities or systems as listed in (a) through (e) above.

5. EXPORT CONTROL LAWS

In some jurisdictions, the Products may be subject to local export laws and regulations. If any diversion or re-export is to be made, Purchaser is advised to abide by such local export laws and regulations, if any, at its own responsibility.

Please contact

Panasonic Corporation

Panasonic Industrial Devices SUNX Co., Ltd.
<https://panasonic.net/id/pidsx/global>

Please visit our website for inquiries and about our sales network.

© Panasonic Industrial Devices SUNX Co., Ltd. 2021
November, 2021 WUME-SF4D01-7