

Controller for Safety Liquid Leak Sensor
SQ4-A Series

SQ4-C11

Instruction Manual

(MEMO)

Thank you for purchasing Panasonic Industrial Devices SUNX's controller **SQ4-C11** for safety liquid leak sensor **SQ4-A** series.
Read this instruction manual carefully and thoroughly for the correct and optimum use of this device.
Kindly keep this manual in a convenient place for quick reference.

This device is a special controller of safety liquid leak sensor **SQ4-A** series.

This manual has been written for the following personnel who have undergone suitable training and have knowledge of safety liquid leak sensors, as well as, safety systems and standards.

- who are responsible for the introduction of this device
- who design the system using this device
- who install and connect this device
- who manage and operate a plant using this device

Notes



- 1) All the contents of this instruction manual are the copyright of the publishers, and may not be reproduced (even extracts) in any form by any electronic or mechanical means (including photocopying, recording, or information storage and retrieval) without permission in writing from the publisher.
- 2) The contents of this instruction manual may be changed without prior notice for further improvement of the device.
- 3) Though we have carefully drawn up the contents of this instruction manual, if there are any aspects that are not clear, or any error that you may notice, please contact our local Panasonic Industrial Devices SUNX office of the nearest distributor.
- 4) English and Japanese are original instructions.

Contents

Chapter 1 Introduction	5
1-1 Attention Marks	5
1-2 Safety Precautions	5
1-3 Applicable Standards / Regulations	8
1-4 Confirmation of Packed Contents	8
Chapter 2 Before using this device	9
2-1 Features	9
2-2 Names and Functions of Parts	9
2-3 Mounting / Removal	12
2-3-1 Mounting / Removal of Controller	12
2-4 Wiring	14
2-4-1 Power Supply Unit	14
2-4-2 I/O Circuit Diagrams	15
2-4-3 Connecting to the Terminal Block of the Controller	17
2-4-4 Connection / Removal of Controller and Safety Liquid Leak Sensor SQ4-A Series	18
Chapter 3 Functions	21
3-1 Self-diagnosis Function	21
3-2 Interlock Function	21
3-2-1 Manual Reset	21
3-2-2 Auto reset	22
3-3 Test Input Function	23
3-6 Lockout Cancel Function	27
Chapter 4 Maintenance	28
4-1 Daily Inspection	28
4-2 Periodic Inspection (Every Six Months)	28
4-3 Inspection after Maintenance	28
Chapter 5 Troubleshooting	29
Chapter 6 Specifications / Dimensions	31
6-1 Specifications	31
6-2 Option	33
6-3 Dimensions	34
Chapter 7 Others	35
7-1 Glossary	35
7-2 CE Marking Declaration of Conformity	36

Chapter 1 Introduction

1-1 Attention Marks

This instruction manual employs the following attentions marks , , depending on the degree of the danger to call operator's attention to each particular action. Read the following explanation of these marks thoroughly and observe these notices without fail.



If you ignore the advice with this mark, death or serious injury could result.



If you ignore the advice with this mark, injury or material damage could result.

<Reference> It gives useful information for better use of this device.

1-2 Safety Precautions

- Use this device as per its specifications. Do not modify this device since its functions and capabilities may not be maintained and it may malfunction.
- This device has been developed / produced for industrial use only.
- This device is suitable for indoor use only.
- Use of this device under the following conditions or environments is not presupposed. Consult us if there is no other choice but to use this device in such an environment.
 - 1) Operating this device under conditions or environments not described in this manual.
 - 2) Using this device in the following fields: nuclear power control, railroad, aircraft, automobiles, combustion facilities, medical systems, aerospace development, etc.
- When this device is to be used for enforcing protection of a person from any danger occurring around an operating machine, the user should satisfy the regulations established by national or regional security committees (Occupational Safety and Health Administration: OSHA, the European Standardization Committee, etc.). Contact the relative organization(s) for details.
- In case of installing this device to particular machine, follow the safety regulations in regard to appropriate usage, mounting (installation), operation and maintenance. The users including the installation operator are responsible for the introduction of this device.
- Note that this device may be broken with strong impact including drop.
- Use this device by installing suitable protection equipment as a countermeasure for failure, damage, or malfunction of this device.
- Before using this device, check whether the device performs properly with the functions and capabilities as per the design specifications.
- In case of disposal, dispose this device as industrial waste.

WARNING

◆ **Machine designer, installer, employer and operator**

- The machine designer, installer, employer and operator are solely responsible to ensure that all applicable legal requirements relating to the installation and the use in any application are satisfied and all instructions for installation and maintenance contained in the instruction manual are followed.
- Whether this device functions as intended to and systems including this device comply with safety regulations depends on the appropriateness of the application, installation, maintenance and operation. The machine designer, installer, employer and operator are solely responsible for these items.

◆ **Engineer**

- The engineer would be a person who is appropriately educated, has widespread knowledge and experience, and can solve various problems which may arise during work, such as a machine designer, or a person in charge of installation or operation etc.

◆ **Operator**

- The operator should read this instruction manual thoroughly, understand its contents, and perform operations following the procedures described in this manual for the correct operation of this device.
- In case this device does not perform properly, the operator should report this to the person in charge and stop the machine operation immediately. The machine must not be operated until correct performance of this device has been confirmed.

◆ **Environment**

- Since this product is not an explosion-proof type, it cannot be used in an explosive atmosphere.
- Do not use a mobile phone or a radio phone near this device.
- Do not install this device in the following environments.
 - 1) Areas with high humidity where condensation is likely to occur
 - 2) Areas exposed to corrosive or explosive gases
 - 3) Areas exposed to vibration or shock of levels higher than that specified
 - 4) Areas exposed to contact with water
 - 5) Areas exposed to too much steam or dust

◆ **Installation**

- Install this device in the control panel. In installation, provide clearance between the upper / lower parts of this device and the structure or parts to have good ventilation and to ease maintenance.
- Be careful not to have wire offal or cutting chips in this device. Otherwise, fire, failure or malfunction may occur.
- Do not disassemble or modify this device. Otherwise, failure, malfunction, injury or fire may occur. If repair or modification is performed not by Panasonic Electric Works SUNX, the warranty is not applied.
- Do not touch a conductive part of this device. Otherwise, malfunction or failure may occur.
- Since the case of this device is plastic, do not give strong impact including drop. Otherwise, it may be broken.

◆ **Machine for installation**

- This product start the operation after 2 seconds from turning ON the power. Thus, set the control system properly works with the timing.

WARNING

◆ **Wiring**

- Be sure to carry out the wiring in the power supply OFF condition.
- All electrical wiring should conform to the regional electrical regulations and laws. The wiring should be done by engineer(s) having the special electrical knowledge.
- Do not run the sensor wires together with high-voltage lines or power lines or put them together in the same raceway. This can cause malfunction due to induction.
- In case of extending the cable of sensor safety liquid sensor **SQ4-A** series, use the cable of 0.3mm² or more of conductor area and the total length should be 30m or less.
- Do not control the device only at one control output 1 / 2 (OSSD 1 / 2).
- In order that the output is not turned ON due to earth fault of the control output 1 / 2 (OSSD 1 / 2) terminal, be sure to ground to 0V side (PNP output) / +24V side (NPN output).

◆ **Maintenance**

- When replacement parts are required, always use only genuine supplied replacement parts. If substitute parts from another manufacturer are used, the device may not come to detect, resulting in death or serious injury.
- The periodical inspection of this device must be performed by an engineer having the special knowledge.
- After maintenance or adjustment, and before starting operation, test this device following the procedure specified in "**Chapter 4 Maintenance**."
- Clean this device with a clean cloth. Do not use any volatile chemicals.

Introduction

1-3 Applicable Standards / Regulations

This device complies with the following standards / regulations.

<EU Directives>

EU Machinery Directive 2006/42/EC
EMC Directive 2014/30/EU
RoHS Directive 2011/65/EU

<European Standards>

EN 55011 Class A, EN 61000-6-2, EN IEC 63000
EN ISO 13849-1: 2015 (Category 4, PLe), EN 61508-1 to 7 (SIL3)

<International Standards>

ISO 13849-1: 2015 (Category 4, PLe), IEC 61508-1 to 7 (SIL3)

<Japanese Industrial Standards (JIS)>

JIS B 9705-1 (Category 4), JIS C 0508-1 to 7 (SIL3)

<Standards in U.S. / Canada>

ANSI/UL 508, CAN/CSA C22.2 No.14

<Regulations in Korea>

S1-G-1-2009, S2-W-5-2009

This product is pursuant to following standard.



<SEMI Standard>

SEMI-S2-0310a

Regarding EU Machinery Directive, a Notified Body, TÜV SÜD, has certified with the type examination certificate.

With regard to the standards in US / Canada, a TÜV SÜD has certified for cTÜVus Mark.

The pursuant to SEMI for this device has been evaluated by TÜV SÜD JAPAN.

<Reference> to JIS for this device has been evaluated by ourselves.
The cTÜVus Mark  indicates compliance with both CSA of Canada and US requirements.
This device conforms to the EMC Directive and the Machinery directive. The  mark on the product indicates that this device conforms to the EMC Directive.
 mark marked on this device shows that this device has certified with the type examination certificate.



WARNING

When this device is used in a place other than the places shown above, be sure to confirm the standards or regulations applicable in each region or country before use.

1-4 Confirmation of Packed Contents

- | | |
|---|--------|
| <input type="checkbox"/> Main device | 1 unit |
| <input type="checkbox"/> Instruction manual (this document) | 1 pc. |
| <input type="checkbox"/> Terminal blocks (6 poles) | 2 pcs. |
| <input type="checkbox"/> Terminal blocks (14 poles) | 1 pc. |

Chapter 2 Before using this device

2-1 Features

This device is the controller for safety liquid leak sensor with the following features:

- This device and safety liquid leak sensor **SQ4-A** series are combined for operation.
- Maximum of 4 safety liquid leak sensors can be connected to this device.
- With the output polarity selection switch of the controller, the control output 1 / 2 (OSSD 1 / 2) can be switched to the PNP / NPN output. **SQ4-A□-P** PNP output type and **SQ4-A□-N** NPN output type cannot be used together.
- Replacement of the relay is not required with the semi-conductor output.

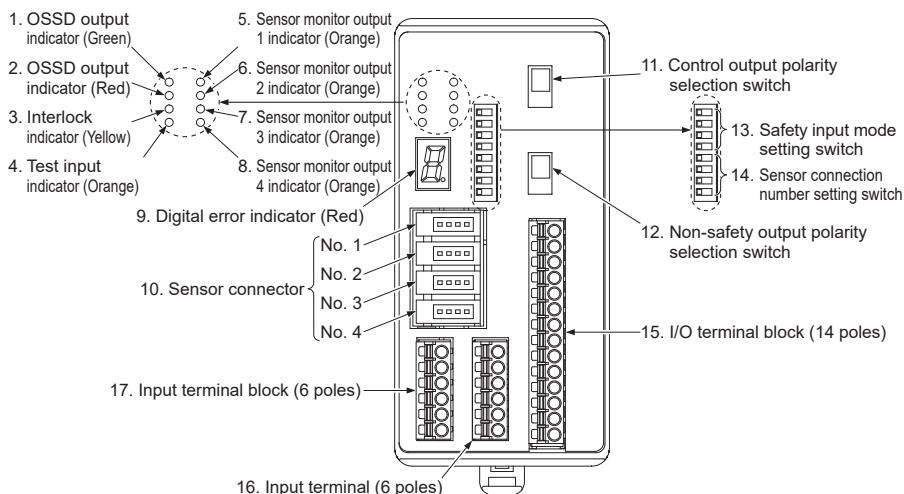

2-2 Names and Functions of Parts

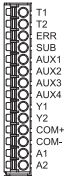

	Names	Functions
1	OSSD output indicator (Green) [OSSD ON]	Lights when control output 1/2 (OSSD 1 / 2) is ON.
2	OSSD output indicator (Red) [OSSD OFF]	Lights when control output (OSSD 1 / 2) is OFF.
3	Interlock indicator (Yellow) [INLK]	Lights for interlock goes OFF for an error or when control output 1 / 2 (OSSD 1 / 2) is ON.
4	Test input indicator (Orange) [TEST]	Lights when test input terminal is open (effective).

Parts Description

	Names	Functions																													
5	Sensor monitor output 1 indicator (Orange) [AUX1]	Light up when auxiliary detection output of each sensor is ON. Blink when sensor error is occurred. For details, refer to "Chapter 5 Troubleshooting."																													
6	Sensor monitor output 2 indicator (Orange) [AUX2]																														
7	Sensor monitor output 3 indicator (Orange) [AUX3]																														
8	Sensor monitor output 4 indicator (Orange) [AUX4]																														
9	Digital error indicator (Red)	It lights in 7 segments for an error. For details, refer to "Chapter 5 Troubleshooting."																													
10	Sensor connector	Connect safety liquid leak sensor SQ4-A series. (Maximum 4) To connect multiple sensors, use the connector from No. 1. PNP output type and NPN output type cannot be used together.																													
11	Control output polarity selection switch	The polarities of control output 1 / 2 (OSSD 1 / 2) are set to the PNP output or the NPN output mode. The polarities of safety input 1 / 2 are set to the PNP input or the NPN input mode.																													
12	Non-safety output polarity selection switch	Polarities of non-safety output ERR, SUB, AUX1 to 4 are set to the PNP output or the NPN output.																													
13	Safety input mode setting switch (Switch No. 1 to No. 4)	<table border="1"> <thead> <tr> <th colspan="4">Switch No.</th> <th rowspan="2">Safety input 1 / 2</th> </tr> <tr> <th>1</th> <th>2</th> <th>3</th> <th>4</th> </tr> </thead> <tbody> <tr> <td>ON</td> <td>OFF</td> <td>ON</td> <td>OFF</td> <td>Invalid</td> </tr> <tr> <td>OFF</td> <td>ON</td> <td>OFF</td> <td>ON</td> <td>Valid: Semiconductor input mode</td> </tr> <tr> <td>OFF</td> <td>OFF</td> <td>OFF</td> <td>OFF</td> <td>Valid: Contact input mode</td> </tr> </tbody> </table> <p>Settings other than above become lockout status.</p>	Switch No.				Safety input 1 / 2	1	2	3	4	ON	OFF	ON	OFF	Invalid	OFF	ON	OFF	ON	Valid: Semiconductor input mode	OFF	OFF	OFF	OFF	Valid: Contact input mode					
Switch No.				Safety input 1 / 2																											
1	2	3	4																												
ON	OFF	ON	OFF	Invalid																											
OFF	ON	OFF	ON	Valid: Semiconductor input mode																											
OFF	OFF	OFF	OFF	Valid: Contact input mode																											
14	Sensor connection number setting switch (Switch No. 5 to No. 8)	<table border="1"> <thead> <tr> <th colspan="4">Switch No.</th> <th rowspan="2">No. of connecting sensors</th> </tr> <tr> <th>5</th> <th>6</th> <th>7</th> <th>8</th> </tr> </thead> <tbody> <tr> <td>ON</td> <td>ON</td> <td>ON</td> <td>ON</td> <td>1 unit</td> </tr> <tr> <td>ON</td> <td>OFF</td> <td>ON</td> <td>OFF</td> <td>2 units</td> </tr> <tr> <td>OFF</td> <td>ON</td> <td>OFF</td> <td>ON</td> <td>3 units</td> </tr> <tr> <td>OFF</td> <td>OFF</td> <td>OFF</td> <td>OFF</td> <td>4 units</td> </tr> </tbody> </table>	Switch No.				No. of connecting sensors	5	6	7	8	ON	ON	ON	ON	1 unit	ON	OFF	ON	OFF	2 units	OFF	ON	OFF	ON	3 units	OFF	OFF	OFF	OFF	4 units
Switch No.				No. of connecting sensors																											
5	6	7	8																												
ON	ON	ON	ON	1 unit																											
ON	OFF	ON	OFF	2 units																											
OFF	ON	OFF	ON	3 units																											
OFF	OFF	OFF	OFF	4 units																											
15	I/O terminal block (14 poles)	<table border="1"> <thead> <tr> <th>Terminal names</th> <th>Description</th> </tr> </thead> <tbody> <tr> <td>T1</td> <td>Test input terminal (for contact only)</td> </tr> <tr> <td>T2</td> <td>Open: Test input valid [Control output 1 / 2 (OSSD 1 / 2) OFF] Short circuit: Test input invalid</td> </tr> <tr> <td>ERR</td> <td>Lockout output</td> </tr> <tr> <td>SUB</td> <td>Output for negative logic output of control output 1 / 2 (OSSD 1 / 2)</td> </tr> <tr> <td>AUX1</td> <td rowspan="4">Sensor monitor output 1 to 4 Monitor output corresponding to the detection auxiliary output of sensors No. 1 to 4</td> </tr> <tr> <td>AUX2</td> </tr> <tr> <td>AUX3</td> </tr> <tr> <td>AUX4</td> </tr> <tr> <td>Y1</td> <td>Control output 1 (OSSD 1)</td> </tr> <tr> <td>Y2</td> <td>Control output 2 (OSSD 2)</td> </tr> <tr> <td>COM+</td> <td>Common terminal for control output 1 / 2 (OSSD 1 / 2) return in NPN output</td> </tr> <tr> <td>COM-</td> <td>Common terminal for control output 1/2 (OSSD 1 / 2) return in PNP output</td> </tr> <tr> <td>A1</td> <td>+24V</td> </tr> <tr> <td>A2</td> <td>0V</td> </tr> </tbody> </table> 	Terminal names	Description	T1	Test input terminal (for contact only)	T2	Open: Test input valid [Control output 1 / 2 (OSSD 1 / 2) OFF] Short circuit: Test input invalid	ERR	Lockout output	SUB	Output for negative logic output of control output 1 / 2 (OSSD 1 / 2)	AUX1	Sensor monitor output 1 to 4 Monitor output corresponding to the detection auxiliary output of sensors No. 1 to 4	AUX2	AUX3	AUX4	Y1	Control output 1 (OSSD 1)	Y2	Control output 2 (OSSD 2)	COM+	Common terminal for control output 1 / 2 (OSSD 1 / 2) return in NPN output	COM-	Common terminal for control output 1/2 (OSSD 1 / 2) return in PNP output	A1	+24V	A2	0V		
Terminal names	Description																														
T1	Test input terminal (for contact only)																														
T2	Open: Test input valid [Control output 1 / 2 (OSSD 1 / 2) OFF] Short circuit: Test input invalid																														
ERR	Lockout output																														
SUB	Output for negative logic output of control output 1 / 2 (OSSD 1 / 2)																														
AUX1	Sensor monitor output 1 to 4 Monitor output corresponding to the detection auxiliary output of sensors No. 1 to 4																														
AUX2																															
AUX3																															
AUX4																															
Y1	Control output 1 (OSSD 1)																														
Y2	Control output 2 (OSSD 2)																														
COM+	Common terminal for control output 1 / 2 (OSSD 1 / 2) return in NPN output																														
COM-	Common terminal for control output 1/2 (OSSD 1 / 2) return in PNP output																														
A1	+24V																														
A2	0V																														

	Names		Functions														
16	Input terminal block (6 poles)		<table border="1" style="width: 100%; border-collapse: collapse;"> <thead> <tr> <th style="width: 20%;">Terminal names</th> <th>Description</th> </tr> </thead> <tbody> <tr> <td>X1</td> <td>Reset input terminal</td> </tr> <tr> <td>X2</td> <td>X1 - X2 connection: Manual reset</td> </tr> <tr> <td>X3</td> <td>X1 - X3 connection: Auto reset</td> </tr> <tr> <td>NC</td> <td>Not used</td> </tr> <tr> <td>SO+</td> <td>When the safety input 1 / 2 is in contact mode, it is connected to the SI+ terminal for power supply. When safety input mode is invalid and it is in semiconductor input mode, not used.</td> </tr> <tr> <td>SO-</td> <td>When the safety input 1 / 2 is in contact mode, it is connected to the SI- terminal for power supply. When safety input mode is invalid and it is in semiconductor input mode, not used.</td> </tr> </tbody> </table>	Terminal names	Description	X1	Reset input terminal	X2	X1 - X2 connection: Manual reset	X3	X1 - X3 connection: Auto reset	NC	Not used	SO+	When the safety input 1 / 2 is in contact mode, it is connected to the SI+ terminal for power supply. When safety input mode is invalid and it is in semiconductor input mode, not used.	SO-	When the safety input 1 / 2 is in contact mode, it is connected to the SI- terminal for power supply. When safety input mode is invalid and it is in semiconductor input mode, not used.
Terminal names	Description																
X1	Reset input terminal																
X2	X1 - X2 connection: Manual reset																
X3	X1 - X3 connection: Auto reset																
NC	Not used																
SO+	When the safety input 1 / 2 is in contact mode, it is connected to the SI+ terminal for power supply. When safety input mode is invalid and it is in semiconductor input mode, not used.																
SO-	When the safety input 1 / 2 is in contact mode, it is connected to the SI- terminal for power supply. When safety input mode is invalid and it is in semiconductor input mode, not used.																
17	Input terminal block (6 poles)		<table border="1" style="width: 100%; border-collapse: collapse;"> <thead> <tr> <th style="width: 20%;">Terminal names</th> <th>Description</th> </tr> </thead> <tbody> <tr> <td>SIN+</td> <td>Common terminal when the safety input 1 / 2 is the semiconductor input mode and in the NPN output.</td> </tr> <tr> <td>SIN1</td> <td>Safety input 1</td> </tr> <tr> <td>SIN2</td> <td>Safety input 2</td> </tr> <tr> <td>SIN-</td> <td>Common terminal when the safety input 1 / 2 is the semiconductor input mode and in the PNP output.</td> </tr> <tr> <td>SI+</td> <td>It is connected to the SO+ terminal when the safety input 1 / 2 is in the contact mode.</td> </tr> <tr> <td>SI-</td> <td>It is connected to the SO- terminal when the safety input 1 / 2 is in the contact mode.</td> </tr> </tbody> </table>	Terminal names	Description	SIN+	Common terminal when the safety input 1 / 2 is the semiconductor input mode and in the NPN output.	SIN1	Safety input 1	SIN2	Safety input 2	SIN-	Common terminal when the safety input 1 / 2 is the semiconductor input mode and in the PNP output.	SI+	It is connected to the SO+ terminal when the safety input 1 / 2 is in the contact mode.	SI-	It is connected to the SO- terminal when the safety input 1 / 2 is in the contact mode.
Terminal names	Description																
SIN+	Common terminal when the safety input 1 / 2 is the semiconductor input mode and in the NPN output.																
SIN1	Safety input 1																
SIN2	Safety input 2																
SIN-	Common terminal when the safety input 1 / 2 is the semiconductor input mode and in the PNP output.																
SI+	It is connected to the SO+ terminal when the safety input 1 / 2 is in the contact mode.																
SI-	It is connected to the SO- terminal when the safety input 1 / 2 is in the contact mode.																

2-3 Mounting / Removal

2-3-1 Mounting / Removal of Controller

The controller can be mounted on the 35mm width DIN rail.

<Mounting method>

Step 1 Fit the tab on the opposite side of the DIN rail stopper into the 35mm width DIN rail.

Step 2 Press down the tab on the other side against the 35mm width DIN rail to fit it.

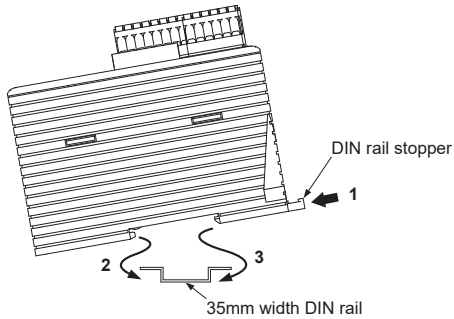

<Removing method>

Step 1 Insert a flathead screwdriver into the groove on the DIN rail stopper and pull out the stopper.

Step 2 Push the controller to the other side of the DIN rail stopper.

Step 3 While maintaining the condition in the procedure 2, lift up the controller to remove it.

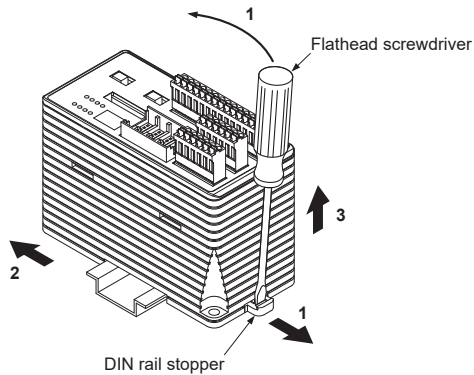

CAUTION

Take care that if the controller is lifted with the stopper remained inside, the tabs crack

Also the controller can be mounted with M4 pan head screw (length: 12mm or more) (purchase separately). The tightening torque should be 1.2N·m or less.

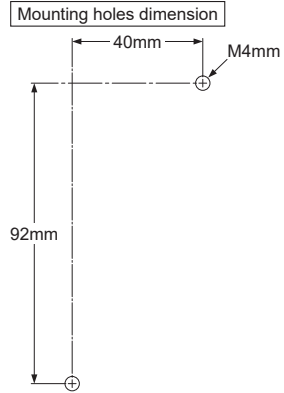
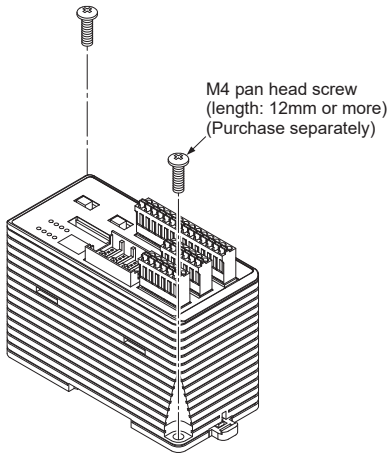

Wiring

2-4 Wiring

WARNING

- Take countermeasure against the system to be applied for this device so as not to carry out the dangerous performance caused by the earth failure. Failure to do so could cause invalid for the system stop, resulting in death or serious injury.
- In order that the output is not turned ON due to earth fault of control output 1 / 2 (OSSD 1 / 2) wires, be sure to ground to 0V side (PNP output) / +24V side (NPN output).

<Reference>

Use a safety relay unit or an equivalent control circuit in safety for FSD.

2-4-1 Power Supply Unit

WARNING

Wire correctly using a power supply unit which conforms to the laws and standards of the region where this device is to be used. If the power supply unit is non-conforming or the wiring is improper, it can cause damage or malfunction of this device.

<Reference>

A specialist who has the required electrical knowledge should perform the wiring.

The power supply unit must satisfy the conditions given below.

- 1) Power supply unit authorized in the region where this device is to be used.
- 2) Power supply unit SELV (safety extra low voltage) / PELV (protected extra low voltage) conforming to EMC Directive and Low-voltage Directive (only for requiring CE marking conformation).
- 3) Power supply unit conforming to the Low-voltage Directive and with an output of 100VA or less.
- 4) The frame ground (F.G.) terminal must be connected to ground when using a commercially available switching regulator.
- 5) Power supply unit with an output holding time of 20ms or more.
- 6) In case a surge is generated, take countermeasures such as connecting a surge absorber to the origin of the surge.
- 7) Power supply unit corresponding to CLASS 2 (only for requiring cTÜVus Mark conformation).

2-4-2 I/O Circuit Diagrams

<Reference>

Manual / Auto reset can be selected by the wiring of the reset input terminals (X1, X2, and X3).

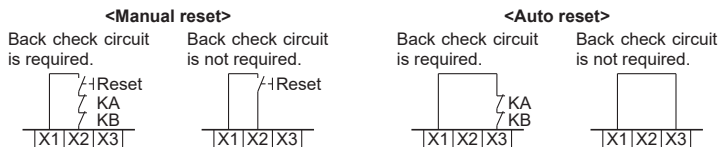

• For operation with PNP output

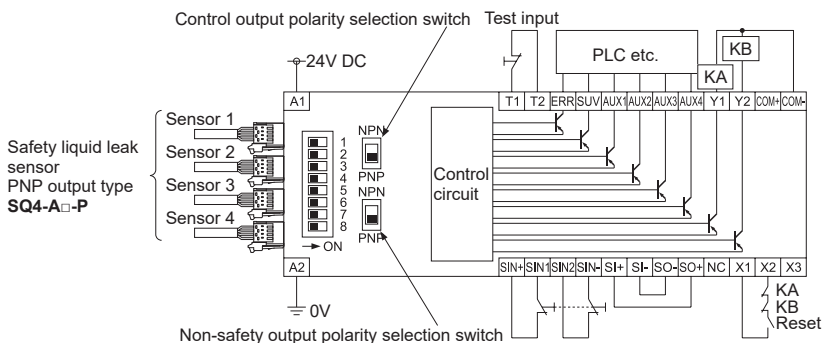

• For operation with NPN output

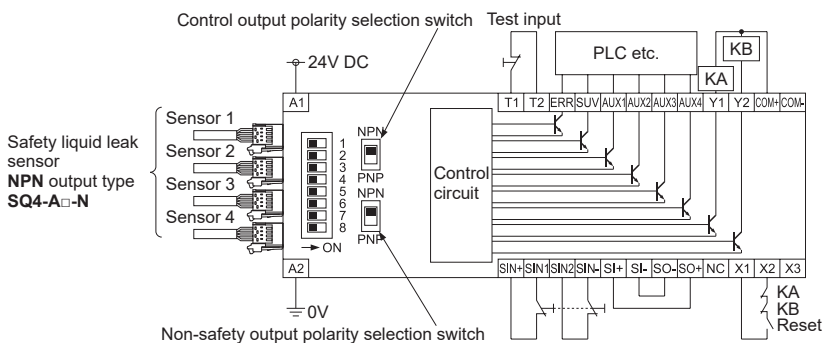

<Reference>

KA and KB are external devices (forced guide relay, magnet contactor or monitored valve).

Wiring

<Output waveform [Control outputs 1 / 2 (OSSD 1 / 2) are ON]>

When the sensor is ON, the controller self-diagnoses the output circuit.

The output transistor is cyclically OFF. (Refer to the figure below.)

When feedback of the OFF signal is given, the controller evaluates that the output circuit is normal. If feedback of the OFF signal is not given, the controller evaluates that the output circuit or wiring has an error and the control outputs 1 / 2 (OSSD 1 / 2) maintains OFF status.

CAUTION

Perform connection paying attention to the input response time of the unit connected to this device. The unit may malfunction due to OFF signal of this device.

<Time chart>

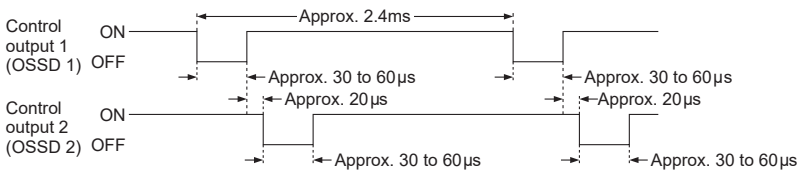

2-4-3 Connecting to the Terminal Block of the Controller

- In connection to the terminal block of the controller, mount a single wire or stranded wire (lead wire) with a ferrule (sleeve) terminal (prepared separately) as shown in the figure below, and insert it to the back of the hole.
- When it is correctly inserted, it is locked and not removed by pulling. If it is pulled with strong force, it may be disconnected.
- To connect a stranded wire (lead wire) without using a ferrule (sleeve) terminal, mount it while holding the release button.
- To disconnect a single wire or stranded wire (lead wire), pull out the single wire or stranded wire (lead wire) while pressing the release button.
- 0.2 to 1.5mm² (AWG 24 to 16) is recommend for single wire or stranded wire (lead wire).

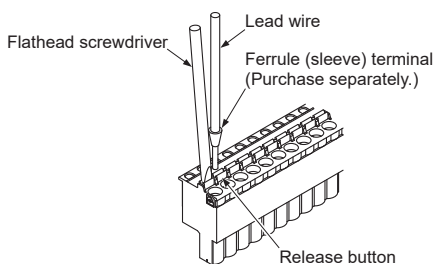

2-4-4 Connection / Removal of Controller and Safety Liquid Leak Sensor SQ4-A Series

When wiring safety liquid leak sensor to this device, mount easy insulation displacement connector **CN-EP** (optional) to safety liquid leak sensor.

Used easy insulation displacement displacement connector depends on type of safety liquid leak sensor, so refer table below. Also, In case the cable of the safety liquid leak sensor is extended, use different type of displacement connector. Choosing easy insulation displacement connector depends on the wire cover diameter.

Type	Model No.	Crimp color	Proper sensor	Cable type	Wire cover diameter.
Displacement connector	CN-EP2	Yellow	SQ4-A21 -□	PVC cable	ø1.0 to ø1.15mm
	CN-EP3	Orange	SQ4-A22 -□	PFA cable	ø0.6 to ø0.9mm

<Name of parts of easy insulation displacement connector (Optional)>

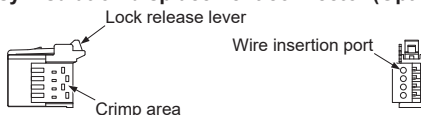

<Description of terminal of easy insulation displacement connector (Optional)>



Terminal No.	Color code	Terminal name
1	Brown	+V
2	White	Detection auxiliary output
3	Blue	0V
4	Black	Detection output

<Connecting method>

Step 1 Process the cable as shown in the figure below.

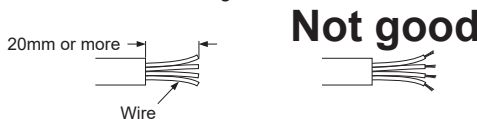

Step 2 Insert the wire into the wire inlet of easy insulation displacement connector until its end comes in contact with the back.

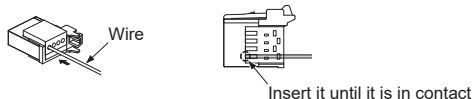

Step 3 Crimp the easy insulation displacement connector with pliers.

- Place pliers parallel to the easy insulation displacement connector and crimp the connector as shown in the figure below.
- Be careful not to damage the wire with pliers.
- Crimp the connector carefully so that the wire may not be disconnected.

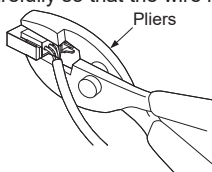

Step 4 Pull the wire gently to confirm that the wire may not be disconnected.

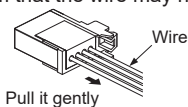

CAUTION

A easy insulation displacement connector that has been crimped once cannot be reused.

Use optional easy insulation displacement connector **CN-EP2** (for PVC cable, 5 pcs. / set) and **CN-EP3** (for PFA cable, 5 pcs. / set) or recommended parts.

<Recommended easy insulation displacement connector>

e-CON: [By Tyco Electronics Japan G.K.]

- For PVC cable: 1473562-4
- For PFA cable: 3-1473562-4

Step 5 Insert the easy displacement connector into sensor connector No. 1 of this device. Maximum 4 safety liquid leak sensor can be connected.

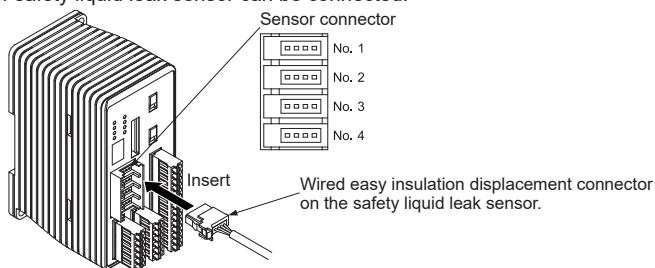

CAUTION

- When connecting to the sensor connector, be sure connect the safety liquid leak sensors from No. 1 in order. If you connect in disorder, the controller becomes lockout status and does not work.

- In case connecting PNP output type of safety liquid leak sensor, set to PNP side the control output polarity selection switch of this device. Also, in case connecting NPN output type set to PNP side the control output polarity selection switch of this device.

Step 6 Depending on No. of the safety liquid leak sensor connecting, set the sensor connection number setting switches as table below.

Sensor connection number setting switches



Switch No.				No. of the sensor connecting
5	6	7	8	
ON	ON	ON	ON	1 unit
ON	OFF	ON	OFF	2 units
OFF	ON	OFF	ON	3 units
OFF	OFF	OFF	OFF	4 units

Wiring

<Removing method>

Step 1 Pull it out from this device while holding the lock release lever of easy insulation displacement connector.

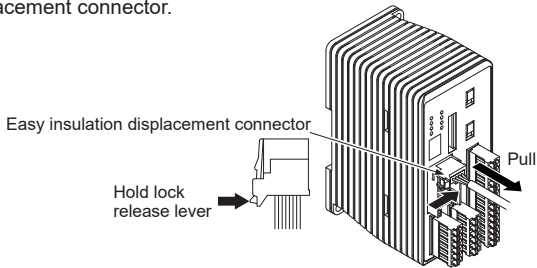

CAUTION

When pulling out the easy insulation displacement connector, be sure to hold the lock release lever. In case pulling out without holding the lock release lever, the connector or the cable may break.

Chapter 3 Functions

3-1 Self-diagnosis Function

This device is equipped with a self-diagnosis function.

The device performs self-diagnosis when the power is supplied and during operation.

If an error is found, lockout occurs at the time and the control outputs 1 / 2 (OSSD 1 / 2) are fixed to OFF. Refer to “**Chapter 5 Troubleshooting**” to eliminate the cause of the error.

3-2 Interlock Function

For control output 1 / 2 (OSSD 1 / 2), manual / auto reset in interlock can be selected.

Manual / Auto reset can be selected by the wiring of the reset input terminals (X1, X2, and X3).

Terminal	Operation
X1 - X2 connection	Manual reset
X1 - X3 connection	Auto reset



WARNING

In using the interlock function, make sure that there is no operator in the dangerous zone. Otherwise, death or injury may occur.

3-2-1 Manual Reset

Even if detecting output of sensor is ON (without liquid leak), control outputs 1 / 2 (OSSD 1 / 2) cannot be automatically ON.

A reset button and a back check circuit (KA, KB) should be prepared between X1 and X2 to monitor an external device. If a back check circuit (KA, KB) is not required, only the reset button should be prepared.

When the sensor is ON, it can be recovered with start-up of the external reset button.

<When back check circuit is required>



<When back check circuit is not required>

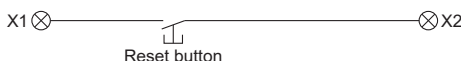

Note: The reset will be canceled in case cleaning of sub detection part is not enough or detecting auxiliary output (white) of safety leak sensor is broken.



WARNING

Mount the reset button a place where the entire dangerous zone can always be known and the button can be operated outside the dangerous zone.

Functions

<Time chart>

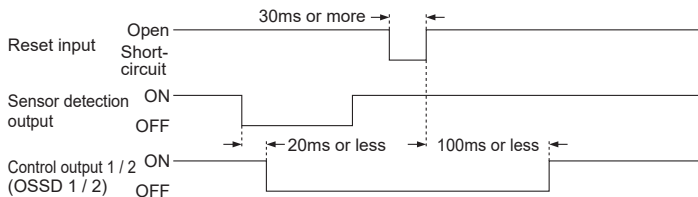

3-2-2 Auto reset

When the detecting output of sensor is ON (without liquid leak), control outputs 1 / 2 (OSSD 1 / 2) can be automatically ON.

To monitor an external device, a back check circuit (KA, KB) should be prepared between X1 and X3. If a back check circuit (KA, KB) is not required, the circuit between X1 and X3 should be shorted.

<When back check circuit is required>



<When back check circuit is not required>



Note: The reset will be canceled in case cleaning of sub detection part is not enough or detecting auxiliary output (white) of safety leak sensor is broken.



WARNING

When this device is operated in auto reset, auto recovery of the system after control output shutoff should be prevented with a safety relay unit.
(From EN 60204-1)

<Time chart>

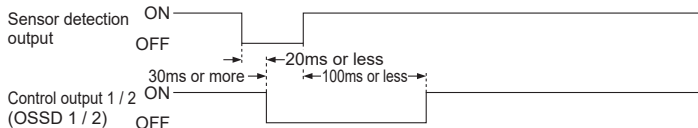

3-3 Test Input Function

It is the function to check normal operation by turning ON / OFF control outputs 1 / 2 (OSSD 1 / 2) of the controller without generating a liquid leak condition at the sensor. When the test input terminal between T1 and T2 is open, valid operation can be selected, and when it is shorted, invalid operation (normal operation) can be selected. Use a conductor (contact, copper wire, etc.) for short-circuit. A semiconductor (transistor) etc. may not ensure normal operation.

<Time chart for manual reset selection>

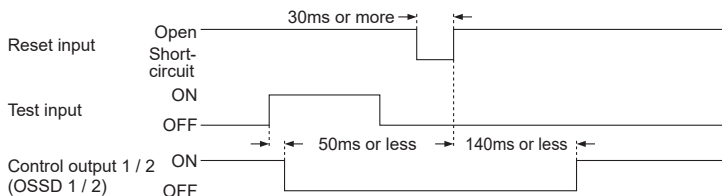

<Time chart for auto reset selection>

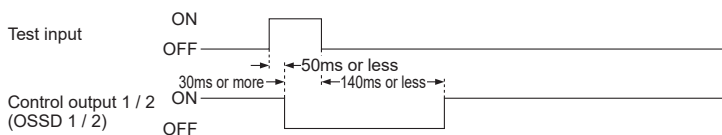

WARNING

Do not use the test input function for the purpose of stopping the machine in which this device is mounted. Otherwise, death or injury may occur.

3-4 Safety Input Function

It is the function to control outputs 1 / 2 (OSSD 1 / 2) of this device with the safety contact connected to safety input terminals SIN1 and SIN2 or the detection signal of the safety sensor. When safety inputs 1 / 2 are OFF, control outputs 1 / 2 (OSSD 1 / 2) are forcibly OFF. The time difference for operation of safety inputs 1 / 2 from OFF to ON or ON to OFF should be 1 second or less. In case the time exceed more than one second, This device become lockout status and control output 1 / 2 (OSSD 1 / 2) becomes OFF status.

In shipment, safety input mode setting switch of this device is set to contact input mode (switch No. 1 to 4: OFF). For connection of the safety contact, short circuit between SI+ and SO+, and between SI- and SO-.

[Contact input mode]

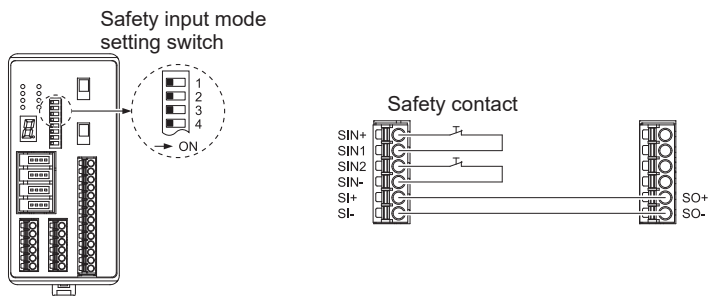

To connect the safety sensors, set the semiconductor input mode (switch No. 1 and 3 to OFF and switch No. 2 and 4 to ON) and open the circuits between SI+ and SO+, and between SI- and SO-. Safety sensors can be connected to this device.

[Semiconductor input mode]

<PNP output>

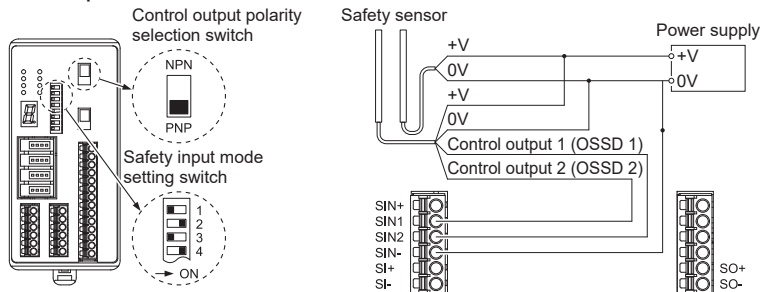

<NPN output>

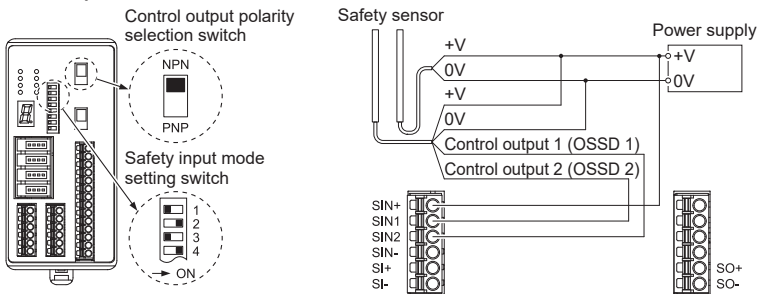

WARNING

This device can connect one st of safety sensor. However, response time of the connected safety sensor are added

Response time of safety sensor

<Example>

In case using SF4C-H□ as safety sensor

Response time of safety sensor + response of this device + response time of sensor head
 = 7ms + 20ms + 10ms
 =37ms

When connecting control output terminal Y1 of other **SQ4-C11** and safety input terminal SIN1, and connecting control output terminal Y2 of other **SQ4-C11** and safety input terminal SIN2, it can also be used as serial connection.

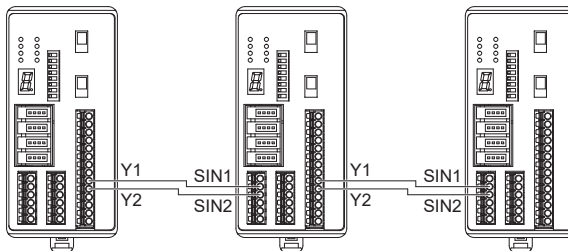

Functions

When safety inputs 1 / 2 are not used, set the No. 1 and 3 of “safety input mode switches” to ON and No. 2 and 4 to OFF, and open the safety input terminals of SIN1 / SIN2, SIN+ / SIN-, SI+ / SI- and SO+ / SO-.

[Invalid]

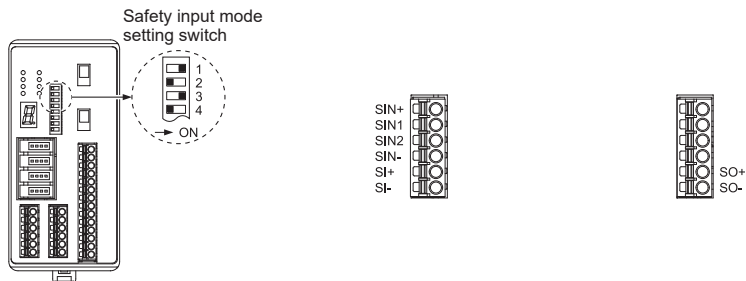

	NC (normal close) type	Operation for ON	Operation for OFF
Contact input mode (Safety contact)	“Closed” for safe condition (emergency stop switch, etc.)	SIN1 and SIN+ are “Close”. SIN2 and SIN- are “Close”.	SIN1 and SIN+ are “Open”. SIN2 and SIN- are “Open”.
Semiconductor input mode (Safety sensor)	ON for light interruption (light curtain, scanner, etc.) ON for approach (safety switch, etc.)	Safety sensor is ON.	Safety sensor is OFF.

⚠ WARNING

When control outputs 1 / 2 (OSSD1 / 2) of other device are connected to the safety input 1 / 2 of this device, mount in the same control panel.

⚠ CAUTION

- When this device is used with PNP output (or NPN output), use the PNP output type (or NPN output type) for the safety sensor. If a different output type is used, control outputs 1 / 2 (OSSD 1 / 2) are OFF.
- Use the sensor with the cross-wire monitoring function for control output 1 / 2 (OSSD 1 / 2). Connect wires to both safety inputs 1 and 2. Note that only one side connection does not lead to normal operation. Use the safety contact with two NC (normal close) contacts and connect wires to both safety inputs 1 / 2. Note that only one side connection does not lead to normal operation.

3-5 Auxiliary Output Function (Non-safety Output)

This device is equipped with auxiliary output as non-safety application.

Terminal No.	Names	Description
ERR	Lockout output	OFF for lockout
SUB	Auxiliary output	Negative logic output of control output 1 / 2 (OSSD 1 / 2)
AUX1	Sensor monitoring output 1	Monitor output corresponding to detection auxiliary output of sensor No. 1
AUX2	Sensor monitoring output 2	Monitor output corresponding to detection auxiliary output of sensor No. 2
AUX3	Sensor monitoring output 3	Monitor output corresponding to detection auxiliary output of sensor No. 3
AUX4	Sensor monitoring output 4	Monitor output corresponding to detection auxiliary output of sensor No. 4

<Time chart of lockout output>

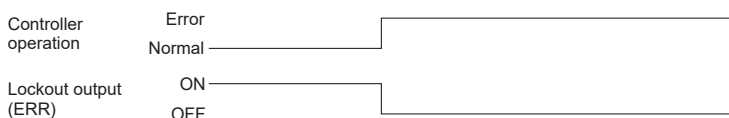

<Time chart of auxiliary output>

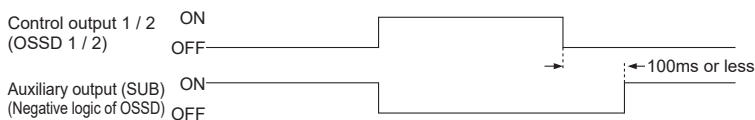

<Time chart of sensor monitor outputs 1 to 4>

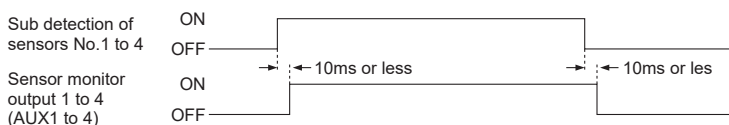

WARNING

Do not use the auxiliary output for the purpose of stopping the machine in which this device is mounted. Otherwise, death or injury may occur.

3-6 Lockout Cancel Function

After removing cause of the error, The lockout can be canceled by method listed below.

- 1) Turns ON power supply again.
- 2) Reset operation from reset input terminal.

<Manual reset>

After short circuit between X1 and X2 30ms or more, open again.

<Auto reset>

After open between X1 and X3 30ms or more, short circuit again.

Chapter 4 Maintenance

<Reference>

If an error is found, refer to “**Chapter 5 Troubleshooting**” and contact a professional engineer for the details. Contact us if you are not sure about the corrective action. Copy inspection sheets, fill the check columns and file them.

4-1 Daily Inspection



WARNING

Check the following items before start-up and confirm that there is no error. If this device is operated in a failed condition without inspection, there may be a risk of death or severe injury.

Inspection items (Daily inspection)

Check column	Inspection items
<input type="checkbox"/>	There shall be no scratch, bend or breaking of wires.
<input type="checkbox"/>	Connectors shall be securely connected.
<input type="checkbox"/>	When the test input terminal T1-T2 is open, make sure that control outputs 1 / 2 (OSSD 1 / 2) are OFF. At this time, effect of external noise can be inspected. If there is effect of external noise, eliminate the cause and perform re-inspection.

4-2 Periodic Inspection (Every Six Months)



WARNING

Check the following items every 6 months and confirm that there is no error. If this device is operated in a failed condition without inspection, there may be a risk of death or severe injury.

Periodic Inspection (Every Six Months)

Check column	Inspection items
<input type="checkbox"/>	The machine shall be designed not to prevent safety mechanism such as stop or emergency stop.
<input type="checkbox"/>	Modification or change of the machine control system that disturbs the safety mechanism shall not be performed.
<input type="checkbox"/>	Output from this device shall be correctly detected.
<input type="checkbox"/>	Wiring from this device shall be correctly performed.
<input type="checkbox"/>	The number of operation cycle (time) for a part that has a service life (relay, etc) shall be less than the rated operation cycles (time).
<input type="checkbox"/>	Screws and connectors related to this device shall not be loose.
<input type="checkbox"/>	There shall be no additional object that generates disturbing light or reflecting light near the sensor.

4-3 Inspection after Maintenance

For the following cases, perform inspection for all items of “**4-1 Daily Inspection**” and “**4-2 Periodic Inspection (Every Six Months)**.”

- 1) When this device or sensor part is replaced
- 2) When an error is felt on operating condition of this device or sensor
- 3) When the location or installation environment of this device is changed
- 4) When wires or routing method of wires are changed
- 5) When FSD (Final Switching Device) parts are changed
- 6) When FSD (Final Switching Device) settings are change

Chapter 5 Troubleshooting

Symptom	Cause		Remedy
All indicators are OFF	Power is not supplied.		Connect the power supply correctly. Check if the power capacity is sufficient.
	The power voltage is out of the specification value.		Set the power voltage correctly.
	Connectors are not securely connected.		Connect connectors securely.
Test input indicator (orange) lights.	Test input is opened		Short-circuit the test input terminals between T1 and T2.
Interlock indicator (yellow) lights.	Resetting is not cancelled.	Wiring to reset is not performed.	Wire the reset input terminal (manual reset: between X1 and X2 or auto reset: between X1 and X3) correctly. To ensure the system safety, use the NC contact of the forced guide relay.
		Relay is fused.	Replace the relay.
		Relay response time is long.	Replace the relay with the one of appropriate response time.
		The start-up reset signal is not input. (Manual)	Use the momentary switch. Replace the switch.

<Digital error indicator (red)>

Display	Symptom	Cause	Remedy
1	Incorrect number of sensors	The number of sensors connected does not conform to the value of the sensor number setting switch. Or the number is not matched due to failure of sensors.	Match the setting of this device with the number of sensors connected. Set the sensor connection number setting switch correctly. Replace the failed sensors.
2	Sensor error	The sensors connected do not operate correctly.	Be sure sensor is ON Turn ON power supply again and the status is not changed. Replace the sensor (Sensor monitoring output indicator connected to broken sensor and indicator of the failed sensor blink.)
4	Safety input 1 / 2 circuit error	Safety input terminals SIN1 and SIN2 are shorted.	Check wires of safety input terminals SIN1 and SIN2. Check if safety contacts or safety sensors are broken, and replace them as necessary.
5, 6	Control outputs 1 / 2 (OSSD 1 / 2) output circuit error	Control output terminal Y1 or Y2 is shorted with 0V or +V.	Wire control output terminals Y1 and Y2 correctly. Refer to "2-4 Wiring." Use the current value within the specification range of control output terminals Y1 and Y2. Refer to "6-1 Specifications."
		Shorting between control output terminals Y1 and Y2 or with other input / output lines is found.	
		Overcurrent runs in control output terminal Y1 or Y2.	Set the control output polarity selection switch correctly. Refer to "2-2 Names and Functions of Parts." Wire control output terminals Y1 and Y2 correctly. Refer to "2-4 Wiring."
		The settings of the control output polarity selection switch do not conform to combinations of control output terminals Y1 and Y2 wires.	
	Output circuit error	Output circuit is damaged. Replace this device.	

Troubleshooting

Display	Symptom	Cause	Remedy	
⊞	Setting error of safety input mode setting switch Setting error of sensor connection number setting switch Setting error of output polarity selection switch	The safety input mode setting switch and the sensor connection number setting switch are set to the combination not allowed.	Set the safety input mode setting switch and the sensor connection number setting switch correctly.	
		Broken the output polarity selection switch (PNP / NPN setting)	Replace this device.	
		Safety input mode / sensor connection number setting switch	Switch is operated during operation. Switch failure	Turn the power OFF, restore the switch settings and restart this device. Replace this device.
⊟	Reset circuit error	Wiring to reset input terminals X1, X2 and X3 are different from the initial status due to disconnection or shorting.	Check wiring of reset input terminals X1, X2 and X3.	
⊠	Power voltage error	Specified voltage is not supplied.	Check wiring, power voltage and power capacity.	
⊡	The safety input 1 / 2 mode error	Wired safety sensor (Light curtain, scanner etc) is OFF.	Be sure the safety sensor is ON	
		Wired safety contact (emergency etc.) is "Open".	Use 2NC (Normal Close) contacts Be sure 2NC (Normal Close) contacts are "Close"	
		No wiring of the safety input terminals SIN+, SIN1, SIN2, SIN-, SI+, SO+, SO-, SI-. Or the wiring is not perfectly completed..	Check wiring of safety input terminals SIN+, SIN1, SIN2, SIN-, SI+, SO+, SO- and SI- and perform correct wiring.	
⊢	Effect due to noise or failure of internal circuit	Influenced from noise etc. Internal circuit is failed.	Check noise environment around this device. If correct performance cannot be obtained, contact us.	

<OSSD output indicator dose not blink>

Cause	Remedy
Wired sensor is OFF	Be sure detecting output indicators (green) of sensor connected are all light up. Clean up liquid on sensor.
Setting of control output polarity selection switch and output polarity of sensor are not matched	Match the control output 1 / 2 (OSSD 1 / 2) and output polarity of sensor
Connected sensor is broken	Replace the sensor.

Chapter 6 Specifications / Dimensions

6-1 Specifications

Type	Controller for safety liquid leak sensor SQ4-A series			
Model No.	SQ4-C11			
Power voltage	24V DC \pm 15%, Ripple P-P10% or less			
Consumption current	200mA or less			
Number of connecting sensor	4 units (with easy insulation displacement connector) PNP output type / NPN output type can be connected. (Mixture is not allowed.)			
Control output (OSSD 1 / 2)	PNP / NPN open collector transistor (switch type)			
	<table border="0"> <tr> <td><Selecting PNP output></td> <td><Selecting NPN output></td> </tr> <tr> <td> <ul style="list-style-type: none"> • Maximum source current: 200mA • Applied voltage: Same as power voltage (between control output to +V) • Residual voltage: 2.5V or less (at 200mA source current) • Leak current: 200μA or less (including power OFF) • Maximum load capacity: 1.0μF (from no load to maximum output current) • Load wiring resistance: 3Ω or less </td> <td> <ul style="list-style-type: none"> • Maximum sink current: 200mA • Applied voltage: Same as power voltage (between control output to 0V) • Residual voltage: 2.0V or less (at 200mA sink current) • Leak current: 200μA or less (including power OFF) • Maximum load capacity: 1.0μF (from no load to maximum output current) • Load wiring resistance: 3Ω or less </td> </tr> </table>	<Selecting PNP output>	<Selecting NPN output>	<ul style="list-style-type: none"> • Maximum source current: 200mA • Applied voltage: Same as power voltage (between control output to +V) • Residual voltage: 2.5V or less (at 200mA source current) • Leak current: 200μA or less (including power OFF) • Maximum load capacity: 1.0μF (from no load to maximum output current) • Load wiring resistance: 3Ω or less
<Selecting PNP output>	<Selecting NPN output>			
<ul style="list-style-type: none"> • Maximum source current: 200mA • Applied voltage: Same as power voltage (between control output to +V) • Residual voltage: 2.5V or less (at 200mA source current) • Leak current: 200μA or less (including power OFF) • Maximum load capacity: 1.0μF (from no load to maximum output current) • Load wiring resistance: 3Ω or less 	<ul style="list-style-type: none"> • Maximum sink current: 200mA • Applied voltage: Same as power voltage (between control output to 0V) • Residual voltage: 2.0V or less (at 200mA sink current) • Leak current: 200μA or less (including power OFF) • Maximum load capacity: 1.0μF (from no load to maximum output current) • Load wiring resistance: 3Ω or less 			
Response time	20ms or less (excluding the response time of the sensor)			
Operation mode (Output operation)	Normal or sub detection: ON Main detection or installation error: OFF			
Protection circuit (Short circuit protection)	Incorporated			
Categories used	DC-12, DC-13			
Sensor monitor output 1 to 4 (Non-safety output)	PNP / NPN open collector transistor (switch type)			
	<table border="0"> <tr> <td><Selecting PNP output></td> <td><Selecting NPN output></td> </tr> <tr> <td> <ul style="list-style-type: none"> • Maximum source current: 60mA • Applied voltage: Same as power voltage (between sensor monitor output to 0V) • Residual voltage: 2.5V or less (at 60mA source current) </td> <td> <ul style="list-style-type: none"> • Maximum sink current: 60mA • Applied voltage: Same as power voltage (between sensor monitor output to +V) • Residual voltage: 2.0V or less (at 60mA sink current) </td> </tr> </table>	<Selecting PNP output>	<Selecting NPN output>	<ul style="list-style-type: none"> • Maximum source current: 60mA • Applied voltage: Same as power voltage (between sensor monitor output to 0V) • Residual voltage: 2.5V or less (at 60mA source current)
<Selecting PNP output>	<Selecting NPN output>			
<ul style="list-style-type: none"> • Maximum source current: 60mA • Applied voltage: Same as power voltage (between sensor monitor output to 0V) • Residual voltage: 2.5V or less (at 60mA source current) 	<ul style="list-style-type: none"> • Maximum sink current: 60mA • Applied voltage: Same as power voltage (between sensor monitor output to +V) • Residual voltage: 2.0V or less (at 60mA sink current) 			
Response time	100ms or less (excluding the response time of the sensor)			
Operation mode (Output operation)	Normal operation: ON (output for each sensor) Sub detection and main detection: OFF (output for each sensor) *When the connecting sensor is 1 stage detection type, the operation mode is the same as that of the OSSD output.			
Protection circuit (Short circuit protection)	Incorporated			
Categories used	DC-12, DC-13			
Lockout output	OFF for lockout (Rating: Same as sensor monitor output)			
Auxiliary output	Negative logic output of control output 1 / 2 (OSSD 1 / 2) (Rating: Same as sensor monitor output) [Auxiliary output ON when control output 1 / 2 (OSSD1/2) is OFF]			
Interlock function / lockout cancel function	Incorporated			
Test input function	Incorporated			
External device monitor function	Incorporated			
Safety input function	Incorporated			
Control output polarity selection function	Incorporated			
Non-safety output polarity selection function	Incorporated			

Specification

Type	Controller for safety liquid leak sensor SQ4-A series
Model No.	SQ4-C11
Sensor connection number setting function	Incorporated
Overvoltage category	II
Protection structure	IP20 (IEC) (However, it should be in IP54 protection structure of control panel)
Degree of pollution	2
Ambient temperature	-10 to +55°C (No dew condensation or icing allowed.) Storage: -20 to +70°C
Ambient humidity	35 to 85% RH, Storage: 35 to 85%RH
Altitude for use	2,000m or less above sea level (Note 5)
Withstand voltage	AC1,000V for 1 minute (between total charge area and case)
Insulation resistance	20MΩ or more at DC 500V megger (between total charge area and case)
Vibration resistance	Malfunction: 10 to 55 Hz multiple amplitude 0.75mm 30 minutes for each X, Y and Z directions (in power supply)
Impact resistance	Malfunction: Peak acceleration 294m/s ² , Pulse continuation time 11ms times for each X, Y and Z direction, 3 times for 6 directions of 3 orthogonal axes each other (in power supply)
PFHd (Note 1)	Selecting PNP output: 1.89×10^{-9} (when connecting 4 safety liquid connecting sensors) Selecting NPN output: 1.80×10^{-9} (when connecting 4 safety liquid connecting sensors)
MTTFd (Note 2)	100 years or more
SFF (Note 3)	99%
HFT (Note 4)	1
Sub-system time	Type B (IEC 61508-2)
Mission time	20 years
Detectable failure mode	Output short, broken internal circuit and etc.
Connecting method	Sensor connection: Easy insulation displacement connector Power supply and input / output: Cage clamp type removable connector terminal
Material	Main unit case: PC / ABS (alloy)
Mass	Approx. 300g
Applicable standard	EN 55011 ClassA, EN 61000-6-2, EN IEC 63000 EN ISO 13849-1: 2015 (Category 4, PL), EN 61508-1 to 7 (SIL3) ISO 13849-1: 2015 (Category 4, PL), IEC 61508-1 to 7 (SIL3) JIS B 9705-1 (Category 4), JIS C 0508-1 to 7 (SIL3)

- Notes: 1) PFHd: Probability of dangerous failure per hour
 2) MTTFd: Mean time to dangerous failure
 3) Safe failure fraction
 4) Hardware failure tolerance
 5) Do not use or storage in environment of more than atmospheric pressure at sea level.

6-2 Option

- Easy insulation displacement connector: 5 pieces / set

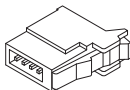

Model No.	Applicable sensor	Description
CN-EP2	SQ4-A21 -□	For PVC cable
CN-EP3	SQ4-A22 -□	For PFA cable

Dimensions

6-3 Dimensions

(Unit: mm)

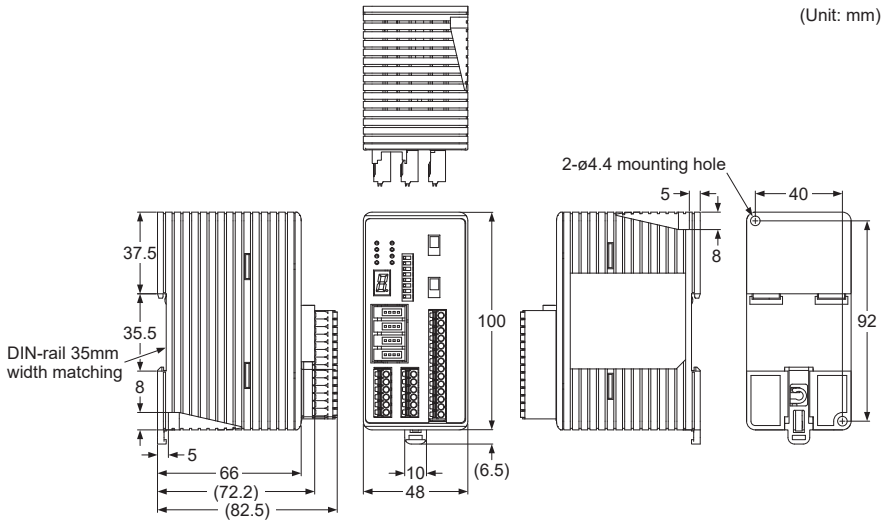

Chapter 7 Others

7-1 Glossary

Machinery Directive	This directive is for an assembly of linked parts or components, energized by an electricity, compressed air or oil pressure, etc. and at least one of which moves, and a component which fulfills a safety function and is released into the market by itself.
EMC Directive	The directives is to any electric or electronic devices which will create more than a limited amount of RF interference, or will withstand a certain amount of Electro Magnetic fields while operating as intended within specifications.
EN 55011	Specifies the limits and methods of measurement of radio disturbance characteristics of industrial, scientific and medical (ISM) radio-frequency equipment.
EN ISO 13849-1: 2015 ISO 13849-1: 2015 JIS B 9705-1	The standard that specifies the safety-related matters of machine safety / control system. They give roles for level (category) of structure and fault detection reliability and for level of safety future performance capability (PL: Performance Level).
UL 1998	UL standard for safety-related software in programmable components.
ESPE	Abbreviation of Electro-Sensitive Protective Equipment
Control output (OSSD)	Abbreviation of Output Signal Switching Device A component of a part of ESPE that turns OFF when detecting device worked in normal operation.
FSD	Abbreviation of Final Switching Device The component of the machine's safety related control system that open-circuits the MPCE circuit when the OSSD operates due to the light from the light curtain being blocked.
Lockout	It is one of the safe status of this device. Operation is stopped if the self-diagnosis function determines that an irrecoverable failure (OSSDs do not operate normally, etc.) has occurred.

CE Marking Declaration of Conformity

7-2 CE Marking Declaration of Conformity

Itemized Essentials of EU Declaration of Conformity

Manufacturer's Name: Panasonic Industrial Devices SUNX Co., Ltd.

Manufacturer's Address: 2431-1, Ushiyama-cho, Kasugai, Aichi 486-0901, Japan

EU Representative's Name:

Panasonic Marketing Europe GmbH Panasonic Testing Center

EU Representative's Address: Winsbergring 15, 22525 Hamburg, Germany

Product: Safety Liquid Leakage Sensor

Model Name: SQ4 Series

Trade Name: Panasonic

Application of Council Directive:

- 2006/42/EC Machinery Directive
- 2014/30/EU EMC Directive
- 2011/65/EU RoHS Directive

Applicable Standard(s):

- | | |
|------------------------|---------------|
| - EN ISO 13849-1: 2015 | - IEC 61508-1 |
| - EN 55011 | - IEC 61508-2 |
| - EN 61000-6-2 | - IEC 61508-3 |
| - EN IEC 63000 | - IEC 61508-4 |

Type Examination: Certified by TÜV SÜD Product Service GmbH Ridlerstrasse
65 80339 München Germany

Revision History

First edition: October 1, 2010
Second edition: November 10, 2010
Third edition: January 5, 2011
Forth edition: June 1, 2011
Fifth edition: January 20, 2013
Sixth edition: January 15, 2016
Seventh edition: September 30, 2021

(MEMO)

1. WARRANTIES:

- (1) Subject to the exclusions stated in 2 (EXCLUSIONS) herein below, Panasonic Electric Works SUNX warrants the Products to be free of defects in material and workmanship for a period of one (1) year from the date of shipment under normal usage in environments commonly found in manufacturing industry.
- (2) Any Products found to be defective must be shipped to Panasonic Electric Works SUNX with all shipping costs paid by Purchaser or offered to Panasonic Electric Works SUNX for inspection and examination. Upon examination by Panasonic Electric Works SUNX, Panasonic Electric Works SUNX will, at its sole discretion, repair or replace at no charge, or refund the purchase price of, any Products found to be defective.

2. EXCLUSIONS:

- (1) This warranty does not apply to defects resulting from any cause:
 - (i) which was due to abuse, misuse, mishandling, improper installation, improper interfacing, or improper repair by Purchaser,
 - (ii) which was due to unauthorized modification by Purchaser, in part or in whole, whether in structure, performance or specification,
 - (iii) which was not discoverable by a person with the state-of-the-art scientific and technical knowledge at the time of manufacture,
 - (iv) which was due to an operation or use by Purchaser outside of the limits of operation or environment specified by Panasonic Electric Works SUNX;
 - (v) which was due to normal wear and tear;
 - (vi) which was due to Force Majeure; and
 - (vii) which was due to any use or application expressly discouraged by Panasonic Electric Works SUNX in 4 (CAUTIONS FOR SAFE USE) hereunder.
- (2) This warranty extends only to the first purchaser for application, and is not transferable to any person or entity which purchased from such purchaser for application.

3. DISCLAIMERS

- (1) Panasonic Electric Works SUNX's sole obligation and liability under this warranty is limited to the repair or replacement, or refund of the purchase price, of a defective Product, at Panasonic Electric Works SUNX's option.
- (2) THE REPAIR, REPLACEMENT, OR REFUND IS THE EXCLUSIVE REMEDY OF THE PURCHASER, AND ALL OTHER WARRANTIES, EXPRESS OR IMPLIED, INCLUDING, WITHOUT LIMITATION, THE WARRANTIES OF MERCHANTABILITY, FITNESS FOR A PARTICULAR PURPOSE, AND NON-INFRINGEMENT OF PROPRIETARY RIGHTS, ARE HEREBY EXPRESSLY DISCLAIMED. IN NO EVENT SHALL PANASONIC ELECTRIC WORKS SUNX AND ITS AFFILIATED ENTITIES BE LIABLE FOR DAMAGES IN EXCESS OF THE PURCHASE PRICE OF THE PRODUCTS, OR FOR ANY INDIRECT, INCIDENTAL, SPECIAL OR CONSEQUENTIAL DAMAGES OF ANY KIND, GENERAL TERMS AND CONDITIONS 4 OR ANY DAMAGES RESULTING FROM LOSS OF USE, BUSINESS INTERRUPTION, LOSS OF INFORMATION, LOSS OR INACCURACY OF DATA, LOSS OF PROFITS, LOSS OF SAVINGS, THE COST OF PROCUREMENT OF SUBSTITUTED GOODS, SERVICES OR TECHNOLOGIES, OR FOR ANY MATTER ARISING OUT OF OR IN CONNECTION WITH THE USE OR INABILITY TO USE THE PRODUCTS.

4. CAUTIONS FOR SAFE USE

- (1) The applications shown in the catalogue are only suggestions, and it is Purchaser's sole responsibility to ascertain the fitness and suitability of the Products for any particular application, as well as to abide by Purchaser's applicable local laws and regulations, if any.
- (2) Never use the Products NOT rated or designated as "SAFETY SENSOR" in any application involving risk to life or property. When such a use is made by Purchaser, such Purchaser shall indemnify and hold harmless Panasonic Electric Works SUNX from any liability or damage whatsoever arising out of or in relation to such use.
- (3) In incorporating the Products to any equipment, facilities or systems, it is highly recommended to employ fail-safe designs, including but not limited to a redundant +++design, flame propagation prevention design, and malfunction prevention design so as not to cause any risk of bodily injury, fire accident, or social damage due to any failure of such equipment, facilities or systems.
- (4) The Products are each intended for use only in environments commonly found in manufacturing industry, and, unless expressly allowed in the catalogue, specification or otherwise, shall not be used in, or incorporated into, any equipment, facilities or systems, such as those:
 - (a) which are used for the protection of human life or body parts;
 - (b) which are used outdoors or in environments subject to any likelihood of chemical contamination or electromagnetic influence;
 - (c) which are likely to be used beyond the limits of operations or environments specified by Panasonic Electric Works SUNX in the catalogue or otherwise;
 - (d) which may cause risk to life or property, such as nuclear energy control equipment, transportation equipment (whether on rail or land, or in air or at sea), and medical equipment;
 - (e) which are operated continuously each day for 24 hours; and
 - (f) which otherwise require a high level of safety performance similar to that required in those equipment, facilities or systems as listed in (a) through (e) above.

5. EXPORT CONTROL LAWS

In some jurisdictions, the Products may be subject to local export laws and regulations. If any diversion or re-export is to be made, Purchaser is advised to abide by such local export laws and regulations, if any, at its own responsibility.

Please contact

Panasonic Corporation

Panasonic Industrial Devices SUNX Co., Ltd.
<https://panasonic.net/id/pidsx/global>

Please visit our website for inquiries and about our sales network.

© Panasonic Industrial Devices SUNX Co., Ltd. 2021
September, 2021 PRINTED IN JAPAN MJE-SQ4C11 No.0077-99V