



**Machine Automation Controller  
NJ/NX-series**

---



**Sysmac Library User's Manual  
for Adept Robot Control Library**

## NOTE

All rights reserved. No part of this publication may be reproduced, stored in a retrieval system, or transmitted, in any form, or by any means, mechanical, electronic, photocopying, recording, or otherwise, without the prior written permission of OMRON.

No patent liability is assumed with respect to the use of the information contained herein. Moreover, because OMRON is constantly striving to improve its high-quality products, the information contained in this manual is subject to change without notice. Every precaution has been taken in the preparation of this manual. Nevertheless, OMRON assumes no responsibility for errors or omissions. Neither is any liability assumed for damages resulting from the use of the information contained in this publication.

## Trademarks

- Sysmac and SYSMAC are trademarks or registered trademarks of OMRON Corporation in Japan and other countries for OMRON factory automation products.
- Microsoft, Windows, Windows Vista, Excel, and Visual Basic are either registered trademarks or trademarks of Microsoft Corporation in the USA and other countries.
- EtherCAT® is registered trademark and patented technology, licensed by Beckhoff Automation GmbH, Germany.
- ODVA, CIP, CompoNet, DeviceNet, and EtherNet/IP are trademarks of ODVA.
- The SD and SDHC logos are trademarks of SD-3C, LLC.  

Other company names and product names in this document are the trademarks or registered trademarks of their respective companies.

## Copyrights

Microsoft product screen shots reprinted with permission from Microsoft Corporation.

# Introduction

Thank you for purchasing an NJ/NX-series CPU Unit and NY-series Industrial PC.

This manual provides information required to use the function blocks in the Adept Robot Control Library. ("Function block" is sometimes abbreviated as "FB".) Please read this manual and make sure you understand the functionality and performance of the NJ/NX-series CPU Unit before you attempt to use it in a control system.

This manual contains the specifications of the Function Block. It does not include restrictions on use of the Controller, Units, or components, or restrictions due to combinations. Make sure to read the user's manual for each product before use.

Keep this manual in a safe place where it will be available for reference during operation.

## Features of the Library

The Adept Robot Control Libraries are used to directly control Adept Robots from the NJ/NX-series CPU Unit and NY-series Industrial PC Controller.

You can use this library to control any types of robots like parallel, SCARA and articulated from PLC with common instructions and a common programming method.

## Intended Audience

This manual is intended for the following personnel, who must also have knowledge of electrical systems (an electrical engineer or the equivalent).

- Personnel in charge of introducing FA systems.
- Personnel in charge of designing FA systems.
- Personnel in charge of installing and maintaining FA systems.
- Personnel in charge of managing FA systems and facilities.
- Personnel with knowledge of control logic.

For programming, this manual is intended for personnel who understand the programming language specifications in international standard IEC 61131-3 or Japanese standard JIS B 3503.

## Applicable Products

This manual covers the following products.

| Item                | Product name                  | Model numbers                 | Version  |
|---------------------|-------------------------------|-------------------------------|--|
| Sysmac Library      | Adept robot control libraries | SYSMAC-XR009                  | Version 1.0.0 or higher                        |
| Automation software | Sysmac Studio                 | SYSMAC-SE□□□□                 | Version 1.15 or higher                         |
| Device              | CPU Unit                      | NX701-□□□□                    | Version 1.10 or later                          |
|                     |                               | NJ101-□□□□                    |  |
|                     |                               | NJ501-□□□□                    | Version 1.01 or later                          |
|                     |                               | NJ301-□□□□                    |  |
|                     | Industrial PC                 | NX1P2-□□□□□□(1)<br>NY5□□-1□□□ | Version.1.13 or later<br>Version 1.12 or later |

Part of the specifications and restrictions for the CPU Units are given in other manuals. Refer to *Related Manuals* on page 12.

# Manual Structure

---

## Special Information

Special information in this manual is classified as follows:



### **Precautions for Safe Use**

---

Precautions on what to do and what not to do to ensure safe usage of the product.



### **Precautions for Correct Use**

---

Precautions on what to do and what not to do to ensure proper operation and performance.



### **Additional Information**

---

Additional information to read as required.

This information is provided to increase understanding or make operation easier.



### **Version Information**

---

Information on differences in specifications and functionality for CPU Units with different unit versions and for different versions of the Sysmac Studio are given.

Note References are provided to more detailed or related information.

# CONTENTS

---

|  |           |
|--|-----------|
| <b>Introduction</b> .....  | <b>1</b>  |
| Features of the Library .....  | 1         |
| Intended Audience .....  | 1         |
| Applicable Products.....   | 1         |
| <b>Manual Structure</b> .....  | <b>2</b>  |
| Special Information.....   | 2         |
| <b>CONTENTS</b> .....  | <b>3</b>  |
| <b>Terms and Conditions Agreement</b> .....                          | <b>6</b>  |
| Warranty, Limitations of Liability .....                             | 6         |
| Application Considerations.....                                      | 7         |
| Disclaimers.....   | 7         |
| <b>Safety Precautions</b> .....                                      | <b>8</b>  |
| Warning .....  | 9         |
| Cautions .....   | 9         |
| <b>Precautions for Safe Use</b> .....                                | <b>10</b> |
| <b>Precautions for Correct Use</b> .....                             | <b>11</b> |
| <b>Related Manuals</b> .....   | <b>12</b> |
| <b>Terminology</b> .....   | <b>14</b> |
| <b>Revision History</b> .....  | <b>15</b> |
| <b>Procedure to Use Sysmac Libraries</b> .....                       | <b>17</b> |
| Procedure to Use Sysmac Libraries Installed Using the Installer..... | 18        |
| How to use Sysmac Library in the CPU Unit or Industrial PC.....      | 22        |
| <b>Common Specifications of Function Blocks</b> .....                | <b>25</b> |
| Common Variables .....   | 26        |
| Precautions .....  | 32        |
| <b>Individual Specifications of Function Blocks</b> .....            | <b>33</b> |
| Common data types .....  | 34        |
| ARB_SetToolTransform.....  | 38        |
| ARB_ResetToolTransform.....  | 44        |
| ARB_DefineLocation.....  | 50        |
| ARB_DefinePallet.....  | 57        |
| ARB_ResetRobotError.....   | 65        |
| ARB_RobotControl.....  | 71        |
| ARB_TeachPosition.....   | 83        |
| ARB_InputOutputSignals .....   | 91        |
| ARB_TeachPendantControl .....  | 100       |
| ARB_ReadLatch.....   | 108       |
| ARB_MoveCommand.....   | 115       |
| ARB_PickAndPlaceCommand .....  | 123       |
| ARB_Jog .....  | 130       |
| ARB_AlignToolCommand.....  | 138       |
| ARB_MoveArcCommand .....   | 144       |
| ARB_MoveCircularCommand .....  | 152       |
| ARB_DefineBelt .....   | 159       |
| ARB_BeltReadLatch .....  | 164       |
| ARB_TrackBelt .....  | 169       |
| Execution Conditions Table .....                                     | 174       |
| Multi-execution of Function Blocks.....                              | 176       |

|   |            |
|---|------------|
| Re-execution of Function Blocks .....                       | 177        |
| Errors from Controller .....                                | 178        |
| <b>Appendix .....</b>                                       | <b>179</b> |
| Referring to Library Information .....                      | 180        |
| Referring to Function Block and Function Source Codes ..... | 183        |



# Terms and Conditions Agreement

---

## Warranty, Limitations of Liability

### Warranties

---

#### ● Exclusive Warranty

Omron's exclusive warranty is that the Products will be free from defects in materials and workmanship for a period of twelve months from the date of sale by Omron (or such other period expressed in writing by Omron). Omron disclaims all other warranties, express or implied.

#### ● Limitations

OMRON MAKES NO WARRANTY OR REPRESENTATION, EXPRESS OR IMPLIED, ABOUT NON-INFRINGEMENT, MERCHANTABILITY OR FITNESS FOR A PARTICULAR PURPOSE OF THE PRODUCTS. BUYER ACKNOWLEDGES THAT IT ALONE HAS DETERMINED THAT THE PRODUCTS WILL SUITABLY MEET THE REQUIREMENTS OF THEIR INTENDED USE.

Omron further disclaims all warranties and responsibility of any type for claims or expenses based on infringement by the Products or otherwise of any intellectual property right.

#### ● Buyer Remedy

Omron's sole obligation hereunder shall be, at Omron's election, to (i) replace (in the form originally shipped with Buyer responsible for labor charges for removal or replacement thereof) the non-complying Product, (ii) repair the non-complying Product, or (iii) repay or credit Buyer an amount equal to the purchase price of the non-complying Product; provided that in no event shall Omron be responsible for warranty, repair, indemnity or any other claims or expenses regarding the Products unless Omron's analysis confirms that the Products were properly handled, stored, installed and maintained and not subject to contamination, abuse, misuse or inappropriate modification. Return of any Products by Buyer must be approved in writing by Omron before shipment. Omron Companies shall not be liable for the suitability or unsuitability or the results from the use of Products in combination with any electrical or electronic components, circuits, system assemblies or any other materials or substances or environments. Any advice, recommendations or information given orally or in writing, are not to be construed as an amendment or addition to the above warranty.

See <http://www.omron.com/global/> or contact your Omron representative for published information.

### Limitation on Liability; Etc

---

OMRON COMPANIES SHALL NOT BE LIABLE FOR SPECIAL, INDIRECT, INCIDENTAL, OR CONSEQUENTIAL DAMAGES, LOSS OF PROFITS OR PRODUCTION OR COMMERCIAL LOSS IN ANY WAY CONNECTED WITH THE PRODUCTS, WHETHER SUCH CLAIM IS BASED IN CONTRACT, WARRANTY, NEGLIGENCE OR STRICT LIABILITY.

Further, in no event shall liability of Omron Companies exceed the individual price of the Product on which liability is asserted.



## Application Considerations

### Suitability of Use

---

Omron Companies shall not be responsible for conformity with any standards, codes or regulations which apply to the combination of the Product in the Buyer's application or use of the Product. At Buyer's request, Omron will provide applicable third party certification documents identifying ratings and limitations of use which apply to the Product. This information by itself is not sufficient for a complete determination of the suitability of the Product in combination with the end product, machine, system, or other application or use. Buyer shall be solely responsible for determining appropriateness of the particular Product with respect to Buyer's application, product or system. Buyer shall take application responsibility in all cases.

NEVER USE THE PRODUCT FOR AN APPLICATION INVOLVING SERIOUS RISK TO LIFE OR PROPERTY WITHOUT ENSURING THAT THE SYSTEM AS A WHOLE HAS BEEN DESIGNED TO ADDRESS THE RISKS, AND THAT THE OMRON PRODUCT(S) IS PROPERLY RATED AND INSTALLED FOR THE INTENDED USE WITHIN THE OVERALL EQUIPMENT OR SYSTEM.

### Programmable Products

---

Omron Companies shall not be responsible for the user's programming of a programmable Product, or any consequence thereof.

## Disclaimers

### Performance Data

---

Data presented in Omron Company websites, catalogs and other materials is provided as a guide for the user in determining suitability and does not constitute a warranty. It may represent the result of Omron's test conditions, and the user must correlate it to actual application requirements. Actual performance is subject to the Omron's Warranty and Limitations of Liability.

### Change in Specifications

---

Product specifications and accessories may be changed at any time based on improvements and other reasons. It is our practice to change part numbers when published ratings or features are changed, or when significant construction changes are made. However, some specifications of the Product may be changed without any notice. When in doubt, special part numbers may be assigned to fix or establish key specifications for your application. Please consult with your Omron's representative at any time to confirm actual specifications of purchased Product.

### Errors and Omissions

---

Information presented by Omron Companies has been checked and is believed to be accurate; however, no responsibility is assumed for clerical, typographical or proofreading errors or omissions.



# Safety Precautions

## Definition of Precautionary Information





The following notation is used in this user’s manual to provide precautions required to ensure safe usage of an NJ/NX-series Controller and NY-series Industrial PC Controller.

The safety precautions that are provided are extremely important to safety. Always read and heed the information provided in all safety precautions.

The following notation is used.

|  |  |
|--|--|
|  <b>WARNING</b> | Indicates a potentially hazardous situation which, if not avoided, could result in death or serious injury. Additionally, there may be severe property damage. |
|  <b>Caution</b> | Indicates a potentially hazardous situation which, if not avoided, may result in minor or moderate injury, or property damage.                                 |

## Symbols

|   |  |
|---|--|
|  | The circle and slash symbol indicates operations that you must not do. The specific operation is shown in the circle and explained in text. This example indicates prohibiting disassembly.                  |
|  | The triangle symbol indicates precautions (including warnings). The specific operation is shown in the triangle and explained in text. This example indicates a precaution for electric shock.               |
|  | The triangle symbol indicates precautions (including warnings). The specific operation is shown in the triangle and explained in text. This example indicates a general precaution.                          |
|  | The filled circle symbol indicates operations that you must do. The specific operation is shown in the circle and explained in text. This example shows a general precaution for something that you must do. |

## Warning

### Warning

If you wish to control robots using the libraries in this guide, make sure to install the robot and perform the test run according to the *Robot Safety Guide* (Cat. No. I590).



Check the user program, data, and parameter settings for proper execution before you use them for actual operation.



## Cautions

### Caution

Read all related manuals carefully before you use this library. Especially read the *Robot Safety Guide* (Cat. No. I590) prior to above.



Implement safety measures given in the manuals for the robots used before you use this library.



Emergency stop circuits, interlock circuits, limit circuits, and similar safety measures must be provided in external control circuits.



The Sysmac Library and manuals are assumed to be used by personnel that is given in Intended Audience in this manual. Otherwise, do not use them.



You must confirm that the user program and parameter values are appropriate to the specifications and operation methods of the devices.



The sample programming shows only the portion of a program that uses the function or function block from the library.



Understand the contents of sample programming before you use the sample programming and create the user program.



# Precautions for Safe Use

---

## Using the Library

---

- The robot might stop at a point different from expected trajectory, when an error occurs during movement.  
Confirm that the robot avoids obstacles when returning to the waiting position.

# Precautions for Correct Use

---

## Using the Library

---

- When you use the library, functions or function blocks that are not described in the library manual may be displayed on the Sysmac Studio. Do not use functions or function blocks that are not described in the manual.
- You cannot change the source code of the functions or function blocks that are provided in the Sysmac Library.

## Using Sample Programming

---

- Create a user program that will produce the intended device operation.
- Check the user program for proper execution before you use it for actual operation.

## Operation

---

- Specify the input parameter values within the valid range.
- In the function or function block with an Enabled output variable, if the value of Enabled is FALSE, do not use the processing result of the function or function block as a command value to the control target.

# Related Manuals

The following are the manuals related to this manual. Use these manuals for reference.

| Manual name   | Cat. No. | Model numbers                          | Application  | Description  |
|---|----------|--|--|--|
| NX-series CPU Unit Hardware User's Manual                                   | W535     | NX701-□□□□                             | Learning the basic specifications of the NX-series CPU Units, including introductory information, designing, installation, and maintenance. Mainly hardware information is provided.                       | <p>An introduction to the entire NX-series system is provided along with the following information on the CPU Unit.</p> <ul style="list-style-type: none"> <li>• Features and system configuration</li> <li>• Introduction</li> <li>• Part names and functions</li> <li>• General specifications</li> <li>• Installation and wiring</li> <li>• Maintenance and inspection</li> </ul> <p>Use this manual together with the <i>NJ/NX-series CPU Unit Software User's Manual</i> (Cat. No. W501).</p> |
| NX-series NX1P2 CPU Unit Hardware User's Manual                             | W578     | NX1P2-□□□□                             | Learning the basic specifications of the NX1P2 CPU Unit, including introductory information, design, installation, and maintenance. Mainly hardware information is provided.                               | <p>An introduction to the overall NX1P2 system is provided, along with the following information on the CPU Unit.</p> <ul style="list-style-type: none"> <li>• Features and system configuration</li> <li>• Overview</li> <li>• Part names and functions</li> <li>• General specifications</li> <li>• Installation and wiring</li> <li>• Maintenance and inspection</li> </ul>   |
| NJ-series CPU Unit Hardware User's Manual                                   | W500     | NJ501-□□□□<br>NJ301-□□□□<br>NJ101-□□□□ | Learning the basic specifications of the NJ-series CPU Units, including introductory information, designing, installation, and maintenance. Mainly hardware information is provided.                       | <p>An introduction to the entire NJ-series system is provided along with the following information on the CPU Unit.</p> <ul style="list-style-type: none"> <li>• Features and system configuration</li> <li>• Introduction</li> <li>• Part names and functions</li> <li>• General specifications</li> <li>• Installation and wiring</li> <li>• Maintenance and inspection</li> </ul> <p>Use this manual together with the <i>NJ/NX-series CPU Unit Software User's Manual</i> (Cat. No. W501).</p> |
| NY-series IPC Machine Controller Industrial Panel PC Hardware User's Manual | W557     | NY532-□□□□                             | Learning basic information about the IPC Machine Controller Industrial Panel PC. Includes basic information on installation, procedures for use, and maintenance. Mainly hardware information is provided. | <p>An introduction to the overall IPC Machine Controller Industrial Panel PC system is provided, along with the following information.</p> <ul style="list-style-type: none"> <li>• Overview</li> <li>• System configuration</li> <li>• Specifications</li> <li>• Installation</li> <li>• Procedures for use</li> <li>• Maintenance</li> </ul>   |
| NY-series IPC Machine Controller Industrial Box PC Hardware User's Manual   | W556     | NY512-1□□□□                            | Learning basic information about the IPC Machine Controller Industrial Box PC. Includes basic information on installation, procedures for use, and maintenance. Mainly hardware information is provided.   | <p>An introduction to the overall IPC Machine Controller Industrial Box PC system is provided, along with the following information.</p> <ul style="list-style-type: none"> <li>• Overview</li> <li>• System configuration</li> <li>• Specifications</li> <li>• Installation</li> <li>• Procedures for use</li> <li>• Maintenance</li> </ul>   |

| Manual name   | Cat. No. | Model numbers  | Application  | Description  |
|---|----------|--|--|--|
| NJ/NX-series CPU Unit Software User's Manual  | W501     | NX701-□□□□<br>NJ501-□□□□<br>NJ301-□□□□<br>NJ101-□□□□<br>NX1P2-□□□□ | Learning how to program and set up an NJ/NX-series CPU Unit. Mainly software information is provided.                  | The following information is provided on a Controller built with an NJ/NX-series CPU Unit. <ul style="list-style-type: none"> <li>• CPU Unit operation</li> <li>• CPU Unit features</li> <li>• Initial settings</li> <li>• Programming based on IEC 61131-3 language specifications</li> </ul> Use this manual together with the <i>NX-series CPU Unit Hardware User's Manual</i> (Cat. No. W535) or <i>NJ-series CPU Unit Hardware User's Manual</i> (Cat. No. W500). |
| NY-series IPC Machine Controller Industrial Panel PC / Industrial Box PC Hardware User's Manual | W558     | NY532-□□□□<br>NY512-1□□□□  | Learning how to set up the system and program the Machine Controller functions of an NY-series IPC Machine Controller. | The following information is provided on the Machine Controller. <ul style="list-style-type: none"> <li>• Controller operation</li> <li>• Controller functions</li> <li>• Controller settings</li> <li>• Language specifications and programming based on IEC 61131-3</li> </ul>   |
| NJ/NX-series Instructions Reference Manual  | W502     | NX701-□□□□<br>NJ501-□□□□<br>NJ301-□□□□<br>NJ101-□□□□<br>NX1P2-□□□□ | Learning detailed specifications on the basic instructions of an NJ/NX-series CPU Unit.                                | The instructions in the instruction set (IEC 61131-3 specifications) are described. When programming, use this manual together with the <i>NX-series CPU Unit Hardware User's Manual</i> (Cat. No. W535) or <i>NJ-series CPU Unit Hardware User's Manual</i> (Cat. No. W500) and with the <i>NJ/NX-series CPU Unit Software User's Manual</i> (Cat. No. W501).   |
| NY-series Instructions Reference Manual   | W560     | NY532-□□□□<br>NY512-1□□□□  | Learning the detailed specifications of the basic instructions of an NY-series IPC Machine Controller.                 | Describes the instructions in the instruction set (IEC 61131-3 specifications).  |
| NJ/NX-series CPU Unit Built-in EtherNet/IP Port User's Manual                                   | W506     | NJ501-□□□□<br>NJ301-□□□□<br>NJ101-□□□□                             | Using the built-in EtherNet/IP port on an NJ-series CPU Unit.  | Information on the built-in EtherNet/IP port is provided. Information is provided on the basic setup, tag data links, and other features. Use this manual together with the <i>NJ-series CPU Unit Hardware User's Manual</i> (Cat. No. W500) and <i>NJ-series CPU Unit Software User's Manual</i> (Cat. No. W501).   |
| Robot Safety Guide  | I590     | -  | Using any of the Adept robots.   | Safety information on the robots are provided.   |
| NJ-series EtherNet/IP Connection Guide OMRON Corporation Adept Robot of ePLC                    | P649     | -  | Using any of the Adept robots.   | Information on wiring and operation settings for the robot controllers, and settings for an NJ-series CPU Unit.  |
| NJ-series Startup Guide OMRON Corporation Adept Robot Control Library                           | P103     | -  | Using Adept robot control libraries.   | Information on how to start up function blocks for controlling an OMRON robot controller from an NJ-series CPU Unit, when the robot controller and the NJ-series CPU Unit are used in combination.   |
| Cobra 350 Robot User's Guide  | I591     | Cobra350   | Using any of the robots shown on the left.   | Describes the functionality of the robots.   |
| eCobra 600, 800, and 800 Inverted Robots User's Guide   | I593     | eCobra 600/800/800 Inverted  |  |  |
| Hornet 565 Robot User's Guide   | I596     | Hornet 565   |  |  |
| Quattro 650H/650HS/800H/800HS User's Guide  | I597     | Quattro 650H/650HS/800H/800HS                                      |  |  |
| Viper 650/850 Robot with eMB-60R User's Guide   | I599     | Viper 650/850 eMB-60R  |  |  |
| T20 User's Guide  | I601     | T20  | Using an Adept T20 pendant.  | Describes the functionality of the pendant.  |
| SmartController EX User's Guide   | I602     | SmartController EX   | Using SmartController EX.  | Information on installation and operation for the SmartController EX and sDIO products (sold separately).  |
| ACE User's Guide  | I603     | -  | Using Automation Control Environment (ACE).  | Information for configuration of the robots.   |

# Terminology

---

| Term              | Cat. No.  |
|-------------------|---|
| Joint coordinates | Coordinate system whose elements are positions of each joint of the robot.<br>To see which joint corresponds to which element actually, please refer the user's manual of the robot which you will use. |
| Location          | A functionality which defines a position in Cartesian coordinates or in Joint coordinates into the robot, and uses it.  |
| Location number   | A number which specifies a location to be defined in the robot or to be used.   |
| Yaw               | Yaw is a rotation about the local reference frame Z axis.   |
| Pitch             | Pitch is defined as a rotation about the Y axis, after yaw has been applied.  |
| Roll              | Roll is defined as a rotation about the Z axis after yaw and pitch have been applied.   |



# Revision History

---

A manual revision code appears as a suffix to the catalog number on the front and back covers of the manual.

**Cat. No. W575-E1-03**

↑  
Revision code

| Revision code | Date       | Revised content  |
|---------------|------------|--|
| 01            | April 2016 | Original production  |
| 02            | July 2016  | Added five Function Blocks for version 2.0<br>ARB_MoveArcCommand, ARB_MoveCircularCommand, ARB_DefineBelt,<br>ARB_BeltReadLatch, ARB_TrackBelt |
| 03            | March 2017 | Added compatible models  |



# Procedure to Use Sysmac Libraries

# Procedure to Use Sysmac Libraries Installed Using the Installer

This section describes the procedure to use Sysmac Libraries that you installed using the installer.

There are two ways to use libraries.

- Using newly installed Sysmac Libraries
- Using upgraded Sysmac Libraries



## Version Information

To use Sysmac Libraries, you need the Sysmac Studio version 1.14 or higher.

## Using Newly Installed Libraries

- 1 Start the Sysmac Studio and open or create a new project in which you want to use Sysmac Libraries.

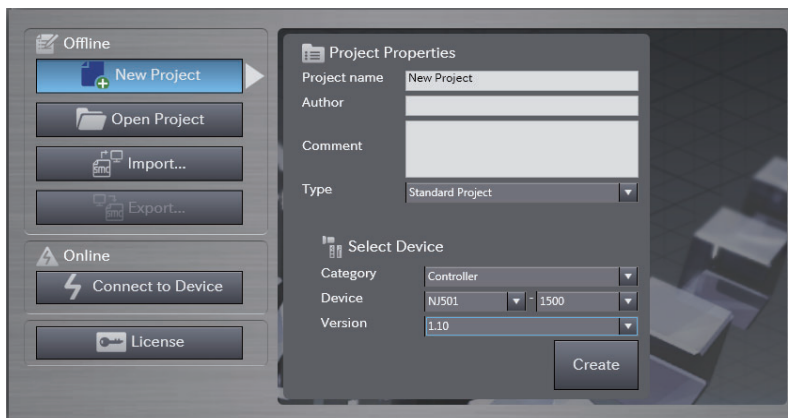

## Precautions for Correct Use

If you create a new project, be sure to configure the settings as follows to enable the use of Sysmac Libraries. If you do not configure the following settings, you cannot proceed to the step 2 and later steps.

- Set the project type to Standard Project or Library Project.
- Set the device category to Controller.
- Set the device version to 1.01 or later.

**2** Select **Project – Library – Show References**.

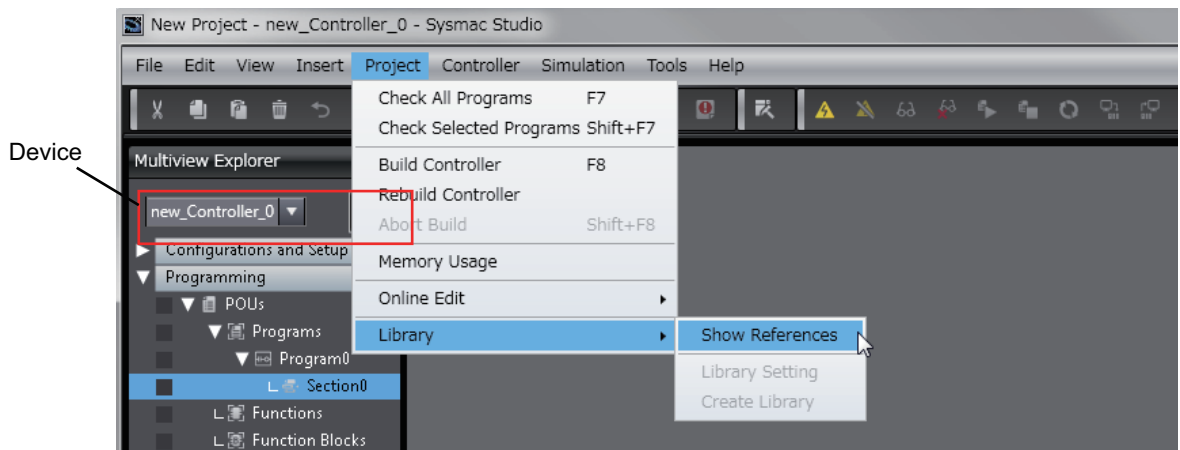

**Precautions for Correct Use**

If you have multiple devices registered in the project, make sure that the currently selected device is the NJ/NX-series CPU Unit or NY-series Industrial PC. If the NJ/NX-series CPU Unit or NY-series Industrial PC is not selected, the menu for browsing the library will not appear. When the selected device is the NJ/NX-series CPU Unit or NY-series Industrial PC, the device icon displayed in Multiview Explorer changes to .

**3** Add the desired Sysmac Library to the list and click the **OK** Button.



The Sysmac Library file is read into the project.

Now, when you select the Ladder Editor or ST Editor, the function blocks and functions included in a Sysmac Library appear in the Toolbox.

For the procedure for adding and setting libraries in the above screen, refer to the *Sysmac Studio Version 1 Operation Manual (Cat. No. W504)*.

**4** Insert the Sysmac Library's function blocks and functions into the circuit using one of the following two methods.

- Select the desired function block or function in the Toolbox and drag and drop it onto the programming editor.

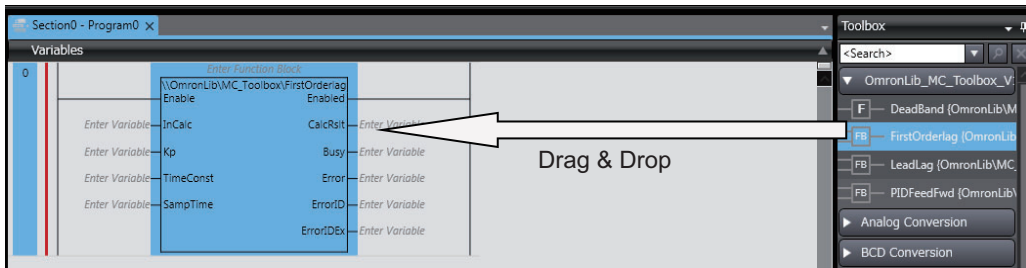

- Right-click the programming editor, select **Insert Function Block** in the menu, and enter the fully qualified name (\\name of namespace\\name of function block).

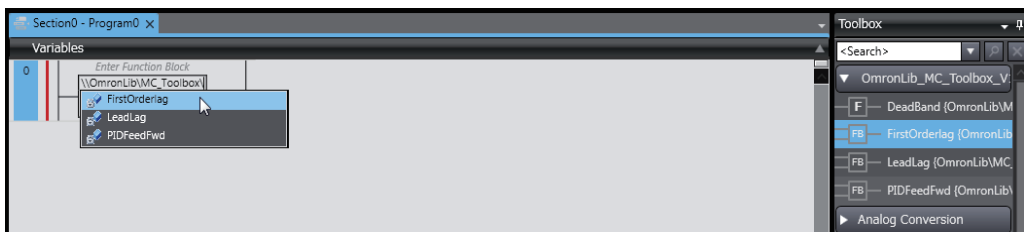

**Precautions for Correct Use**

After you upgrade the Sysmac Studio, check all programs and make sure that there is no error of the program check results on the Build Tab Page.

Select **Project – Check All Programs** from the Main Menu.

## Using Upgraded Libraries

- 1 Start the Sysmac Studio and open a project in which any old-version Sysmac Library is included.
- 2 Select **Project – Library – Show References**.

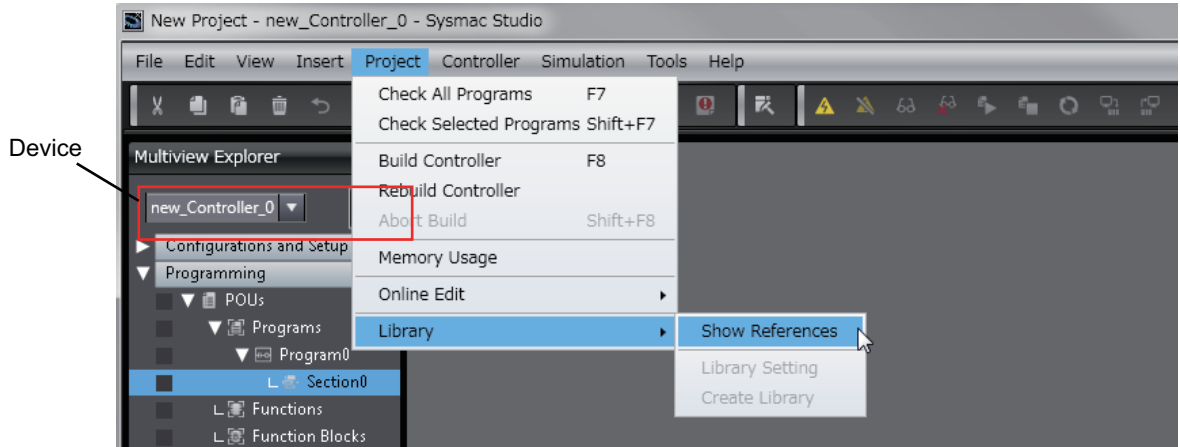

### Precautions for Correct Use

If you have multiple devices registered in the project, make sure that the currently selected device is the NJ/NX-series CPU Unit or NY-series Industrial PC. If the NJ/NX-series CPU Unit or NY-series Industrial PC is not selected, the menu for browsing the library will not appear. When the selected device is the NJ/NX-series CPU Unit or NY-series Industrial PC, the device icon displayed in Multiview Explorer changes to .

- 3 Select an old-version Sysmac Library and click the **Delete Reference Button**.

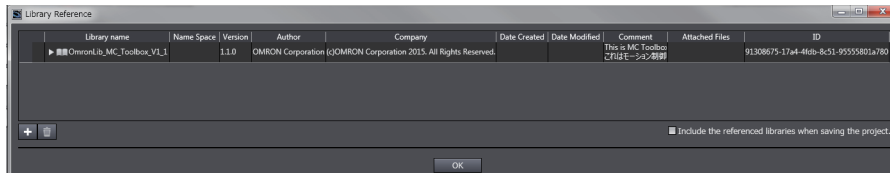

- 4 Add the desired Sysmac Library to the list and click the **OK Button**.

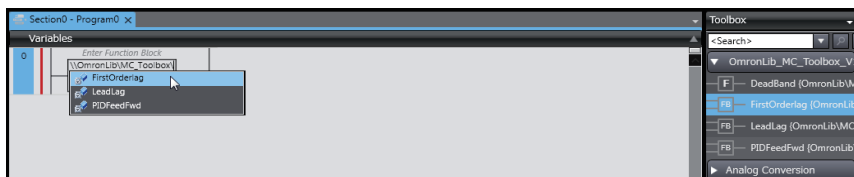

# How to use Sysmac Library in the CPU Unit or Industrial PC

Even when Sysmac Library is not installed on your computer, you can use Sysmac Library by uploading it from the CPU Unit or Industrial PC to your computer.

The procedure to use uploaded Sysmac Libraries from a CPU Unit is as follows.

## ✓ Version Information

To use Sysmac Libraries, you need the Sysmac Studio version 1.14 or higher.

- 1 Start the Sysmac Studio and create a new project in which you want to use Sysmac Libraries.

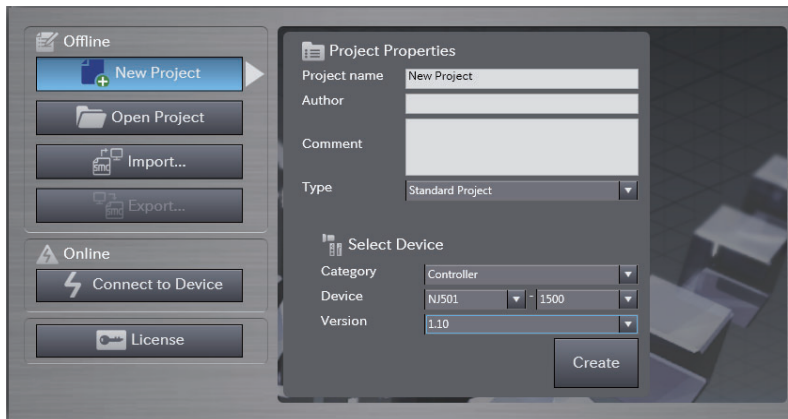

- 2 Connect the computer to the CPU Unit and place it online.
- 3 Upload POU in which any Sysmac Library is used to the computer.

Now, when you select the Ladder Editor or ST Editor, the function blocks and functions included in the Sysmac Library used in the uploaded POU appear in the Toolbox.



**4** Insert the Sysmac Library's function blocks and functions into the circuit using one of the following two methods.

- Select the desired function block or function in the Toolbox and drag and drop it onto the Ladder Editor.

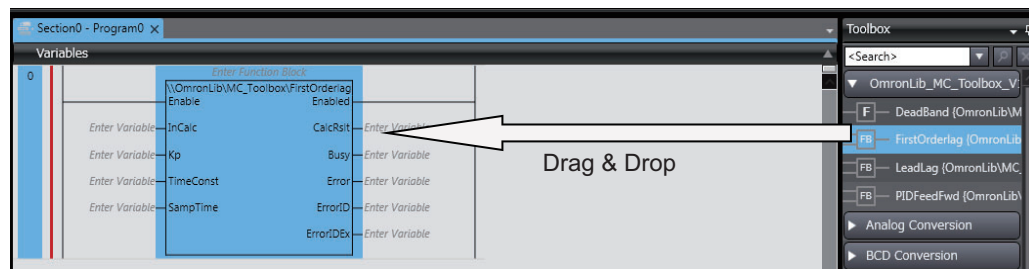

- Right-click the programming editor, select **Insert Function Block** in the menu, and enter the fully qualified name (\\name of namespace\name of function block).

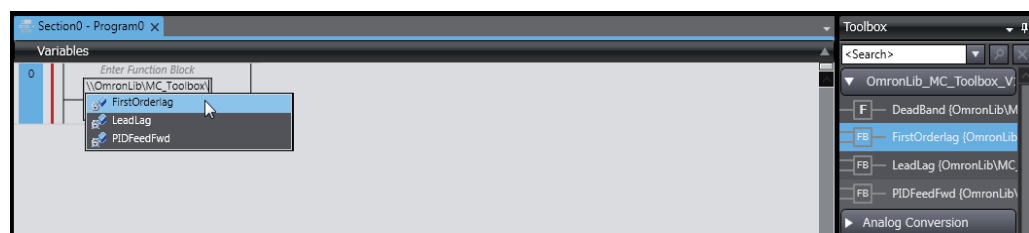

**Precautions for Correct Use**

- The Sysmac Studio installs library files of the uploaded Sysmac Studio to the specified folder on the computer if they are not present. However, the Sysmac Studio does not install library files to the specified folder on the computer if they are present.  
The specified folder here means the folder in which library files are installed by the installer.
- Note that uploading Sysmac Library from a CPU Unit or Industrial PC does not install the manual and help files for the libraries, unlike installation using the installer.



# Common Specifications of Function Blocks

# Common Variables

This section describes the specifications of variables (*EN, Execute, Enable, Abort, ENO, Done, Cal-crslt, Enabled, Busy, CommandAborted, Error, ErrorID, and ErrorIDEx*) that are used for more than one function or function block. The specifications are described separately for functions, for execute-type function blocks, and for enable-type function blocks.

## Definition of Input Variables and Output Variables

Common input variables and output variables used in functions and function blocks are as follows.

| Variable        | I/O    | Data type | Function/function block type to use |             |          | Meaning              | Definition   |
|-----------------|--------|-----------|-------------------------------------|-------------|----------|----------------------|--|
|                 |        |           | Function block                      |             | Function |                      |  |
|                 |        |           | Execute-type                        | Enable-type |          |                      |  |
| EN              | Input  | BOOL      |                                     |             | OK       | Execute              | The processing is executed while the variable is TRUE.   |
| Execute         |        |           | OK                                  |             |          | Execute              | The processing is executed when the variable changes to TRUE.  |
| Enable          |        |           |                                     | OK          |          | Run                  | The processing is executed while the variable is TRUE.   |
| Abort           |        | BOOL      | OK                                  |             |          | Abort                | The processing is aborted.<br>You can select the aborting method.  |
| ENO             | Output | BOOL      |                                     |             | OK       | Done                 | The variable changes to TRUE when the processing ends normally.<br>It is FALSE when the processing ends in an error, the processing is in progress, or the execution condition is not met. |
| Done            |        | BOOL      | OK                                  |             |          | Done                 | The variable changes to TRUE when the processing ends normally.<br>It is FALSE when the processing ends in an error, the processing is in progress, or the execution condition is not met. |
| Busy            |        | BOOL      | OK                                  | OK          |          | Executing            | The variable is TRUE when the processing is in progress.<br>It is FALSE when the processing is not in progress.  |
| Enabled         |        | BOOL      |                                     | OK          |          | Enabled              | The variable is TRUE when the output is enabled. It is used to calculate the control amount for motion control, temperature control, etc.  |
| Command Aborted |        | BOOL      | OK                                  |             |          | Command Aborted      | The variable changes to TRUE when the processing is aborted.<br>It changes to FALSE when the processing is re-executed the next time.  |
| Error           |        | BOOL      | OK                                  | OK          |          | Error                | This variable is TRUE while there is an error.<br>It is FALSE when the processing ends normally, the processing is in progress, or the execution condition is not met.                     |
| ErrorID         |        | WORD      | OK                                  | OK          |          | Error Code           | An error code is output.   |
| ErrorIDEx       |        | DWORD     | OK                                  | OK          |          | Expansion Error Code | An expansion error code is output.   |

## Execute-type Function Blocks

- Processing starts when *Execute* changes to TRUE.
- When *Execute* changes to TRUE, *Busy* also changes to TRUE. When processing is completed normally, *Busy* changes to FALSE and *Done* changes to TRUE.
- When continuously executes the function blocks of the same instance, change the next *Execute* to TRUE for at least one task period after *Done* changes to FALSE in the previous execution.
- If the function block has a *CommandAborted* (Instruction Aborted) output variable and processing is aborted, *CommandAborted* changes to TRUE and *Busy* changes to FALSE.
- If an error occurs in the function block, *Error* changes to TRUE and *Busy* changes to FALSE.
- For function blocks that output the result of calculation for motion control and temperature control, you can use the BOOL input variable *Abort* to abort the processing of a function block. When *Abort* changes to TRUE, *CommandAborted* changes to TRUE and the execution of the function block is aborted.

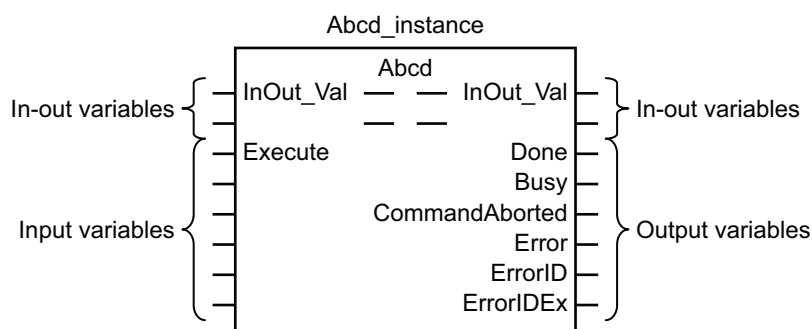

- If *Execute* is TRUE and *Done*, *CommandAborted*, or *Error* changes to TRUE, *Done*, *CommandAborted*, and *Error* changes to FALSE when *Execute* is changed to FALSE.
- If *Execute* is FALSE and *Done*, *CommandAborted*, or *Error* changes to TRUE, *Done*, *CommandAborted*, and *Error* changes to TRUE for only one task period.
- If an error occurs, the relevant error code and expansion error code are set in *ErrorID* (Error Code) and *ErrorIDEx* (Expansion Error Code). The error codes are retained even after *Error* changes to FALSE, but *ErrorID* is set to 16#0000 and *ErrorIDEx* is set to 16#0000 0000 when *Execute* changes to TRUE.

## Timing Charts

This section provides timing charts for a normal end, aborted execution, and errors.

### ● Normal End

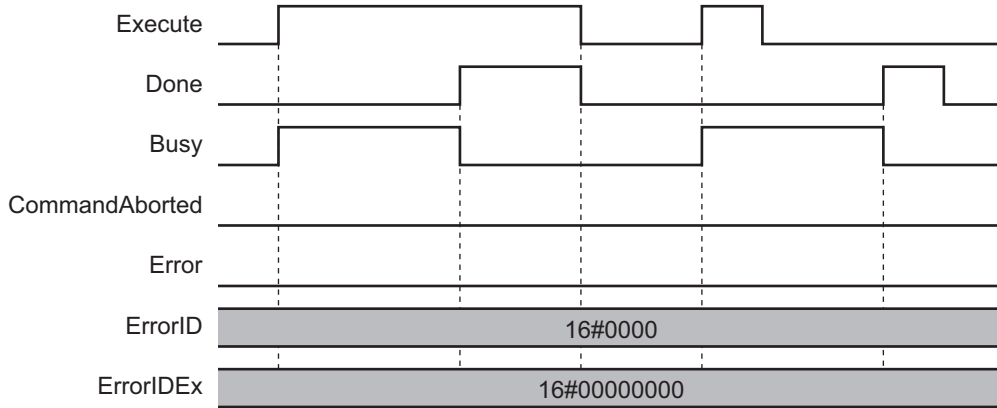

### ● Canceled Execution

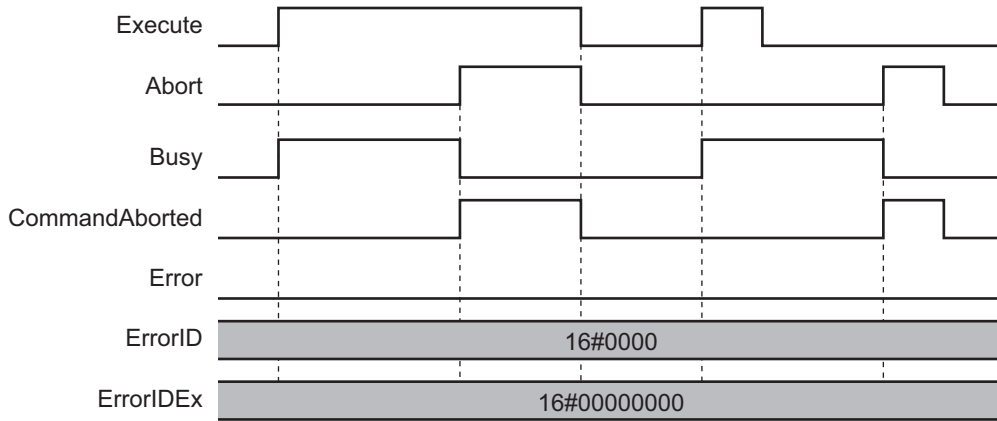

### ● Aborted Execution

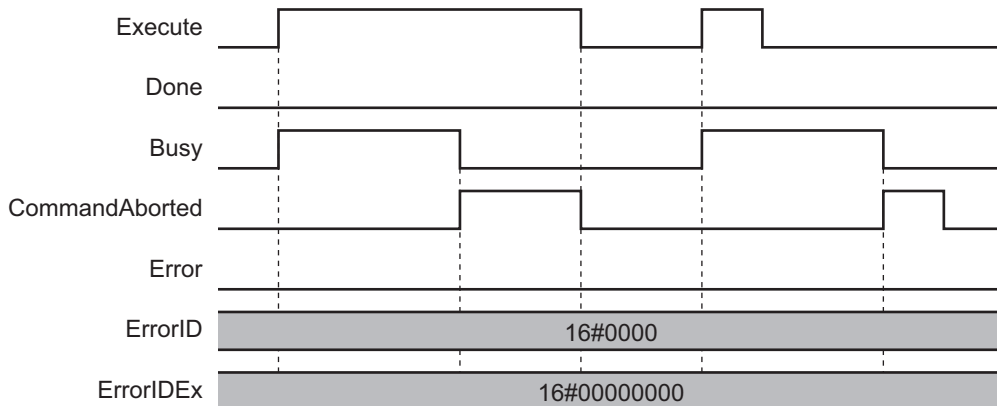

● Errors

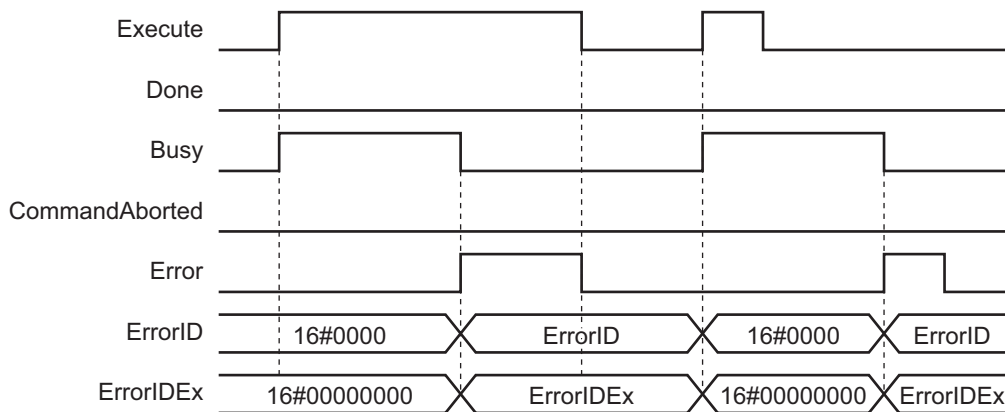

## Enable-type Function Blocks

- Processing is executed while *Enable* is TRUE.
- When *Enable* changes to TRUE, *Busy* also changes to TRUE. *Enabled* is TRUE during calculation of the output value.
- If an error occurs in the function block, *Error* changes to TRUE and *Busy* and *Enabled* change to FALSE. When *Enable* changes to FALSE, *Enabled*, *Busy*, and *Error* change to FALSE.

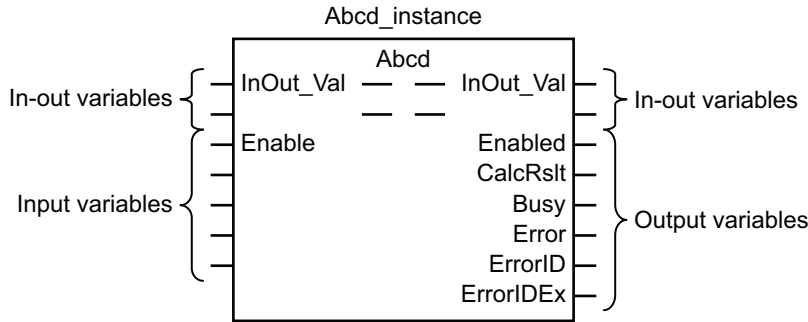

- If an error occurs, the relevant error code and expansion error code are set in *ErrorID* (Error Code) and *ErrorIDEx* (Expansion Error Code). The error codes are retained even after *Error* changes to FALSE, but *ErrorID* is set to 16#0000 and *ErrorIDEx* is set to 16#0000 0000 when *Enable* changes to TRUE.
- For function blocks that calculate the control amount for motion control, temperature control, etc., *Enabled* is FALSE when the value of *CalcRslt* (Calculation Result) is incorrect. In such a case, do not use *CalcRslt*. In addition, after the function block ends normally or after an error occurs, the value of *CalcRslt* is retained until *Enable* changes to TRUE. The control amount will be calculated based on the retained *CalcRslt* value, if it is the same instance of the function block that changed *Enable* to TRUE. If it is a different instance of the function block, the control amount will be calculated based on the initial value.



## Timing Charts

This section provides timing charts for a normal end and errors.

### ● Normal End

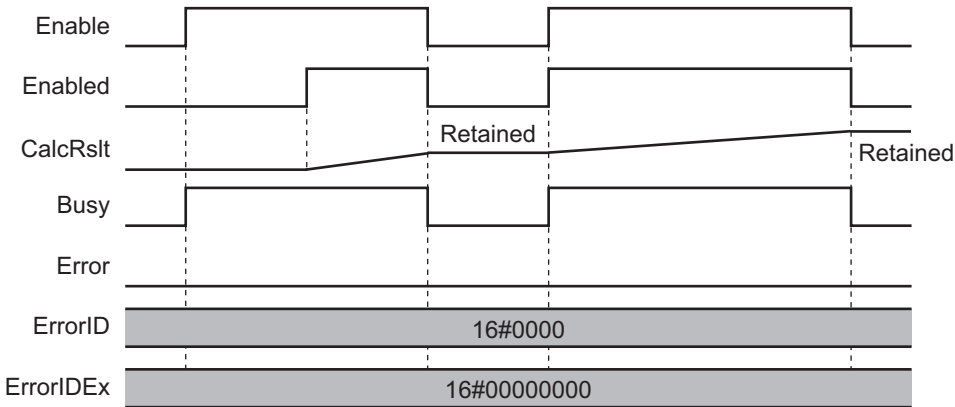

### ● Errors

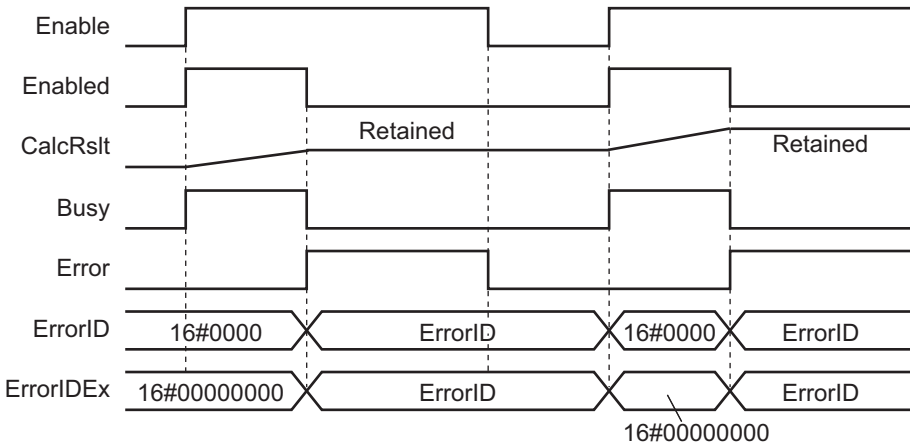

# Precautions

---

This section provides precautions for the use of this function block.

## Nesting

You can nest calls to this function block for up to four levels.

For details on nesting, refer to the *NJ/NX-series CPU Unit Software User's Manual* (Cat. No. W501).

## Instruction Options

You cannot use the upward differentiation option for this function block.

## Re-execution of Function Blocks

Execute-type function blocks cannot be re-executed by the same instance.

If you do so, the output value will be the initial value.

For details on re-execution, refer to the *NJ/NX-series CPU Unit Motion Control User's Manual* (Cat. No. W507).

## Precautions for Safe Use

The robot might stop at a point different from expected trajectory, when an error occurs during movement.

Confirm that the robot avoids obstacles when returning to the waiting position.

# Individual Specifications of Function Blocks

| Instruction                           | Name                  | Page   |
|---------------------------------------|-----------------------|--------|
| ARB_SetToolTransform                  | Set Tool Transform    | P. 38  |
| ARB_ResetToolTransform                | Reset Tool Transform  | P. 44  |
| ARB_DefineLocation                    | Define Location       | P. 50  |
| ARB_DefinePallet                      | Define Pallet         | P. 57  |
| ARB_ResetRobotError                   | Reset Error           | P. 65  |
| ARB_RobotControl                      | Robot Control         | P. 71  |
| ARB_TeachPosition                     | Teach Position        | P. 83  |
| ARB_InputOutputSignals                | Input Output Signals  | P. 91  |
| ARB_TeachPendantControl               | Teach Pendant Control | P. 100 |
| ARB_ReadLatch                         | Read Latch            | P. 108 |
| ARB_MoveCommand                       | MoveCommand           | P. 115 |
| ARB_PickAndPlaceCommand               | PickAndPlaceCommand   | P. 123 |
| ARB_Jog                               | Jog                   | P. 130 |
| ARB_AlignToolCommand                  | AlignToolCommand      | P. 138 |
| ARB_MoveArcCommand* <sup>1</sup>      | Move Arc Command      | P. 144 |
| ARB_MoveCircularCommand* <sup>1</sup> | Move Circular Command | P. 152 |
| ARB_DefineBelt* <sup>1</sup>          | Define Belt           | P. 159 |
| ARB_BeltReadLatch* <sup>1</sup>       | Belt Read Latch       | P. 164 |
| ARB_TrackBelt* <sup>1</sup>           | Track Belt            | P. 169 |

\*1. The library version 2.0 or higher is required to use this FB.

# Common data types

This section describes the instructions (Function blocks) and data types that are in the library.

## sARB\_ROBOT\_DATA\_REF

| Member Variable  | Meaning           | Data type                    | Valid range   | Function  |
|------------------|-------------------|------------------------------|---------------|---|
| ConnectionStatus | Connection Status | BOOL                         | TRUE or FALSE | Specify the network connection status for the corresponding EIP slave number. |
| CommandData      | Command Data      | ARRAY<br>[0..213] OF<br>BYTE | ---           | Specify the memory used to share command data with the Robot Controller.      |
| StatusData       | Status Data       | ARRAY<br>[0..283] OF<br>BYTE | ---           | Specify the memory used to share status data with the Robot Controller.       |

## sARB\_MOVE\_POSITION\_REF

| Member Variable | Meaning           | Data type            | Valid range                            | Default       | Function   |
|-----------------|-------------------|----------------------|--|---------------|--|
| JointCoord      | Joint coordinates | BOOL                 | TRUE or FALSE                          | FALSE         | Specifies how the robot controller will process the positions.<br>If TRUE position is in Joint coordinates, otherwise is in Cartesian coordinates.   |
| LocationNumber  | Location number   | INT                  | 0 and [2...999]                        | 0             | Identifies a position stored in the robot controller.<br>When 0, it means that Location Number is not used and Position or PalletNumber have to be used instead.   |
| PalletNumber    | Pallet number     | INT                  | 0 to 100                               | 0             | Identifies the pallet definition stored in the robot controller to be used.<br>When 0, it means that Pallet-Number is not used and Position or Location Number has to be used instead.   |
| PalletIndex     | Pallet index      | INT                  | Non-negative number <sup>*1</sup>      | 0             | Identifies the destination location within the pallet.   |
| Position        | Target position   | ARRAY [0..5] OF REAL | Positive number, Negative number, or 0 | [0,0,0,0,0,0] | Target position:<br>Position[0]: X axis coordinate or Joint_1<br>Position[1]: Y axis coordinate or Joint_2<br>Position[2]: Z axis coordinate or Joint_3<br>Position[3]: Yaw angle coordinate or Joint_4<br>Position[4]: Pitch angle coordinate or Joint_5<br>Position[5]: Roll angle coordinate or Joint_6 |

Note Position, location number and pallet data cannot be used at the same time, the order of preference is like the one displayed in the structure.

\*1. When PalletNumber is not 0, PalletIndex has to be set to from one to the number of points in the pallet. The number is determined from the parameters of ARB\_DefinePallet for the definition of the pallet. Otherwise an error will occur in the robot controller, and RobotState.ErrorState output variable in the ARB\_RobotControl will be TRUE.

When PalletNumber is set to 0, PalletIndex allows also negative value and it is ignored.

**sARB\_MOVE\_CONFIG\_REF**

| Member Variable  | Meaning                   | Data type | Valid range                            | Default | Function  |
|------------------|---------------------------|-----------|--|---------|---|
| Relative         | Relative Move             | BOOL      | TRUE or FALSE                          | FALSE   | Determines if the movement is relative to the robot's current position or to absolute coordinates. When TRUE the movement is relative otherwise Absolute is set.  |
| CoarseNulling    | Coarse nulling tolerances | BOOL      | TRUE or FALSE                          | FALSE   | Determines the nulling tolerances that will apply at the end of the motion. When it is TRUE, the tolerance is coarse and the duration time of the robot motion will be shorter. In detail, refer to the <i>ACE User's Guide</i> (Cat. No. I603).  |
| SingleTurn       | Single turn               | BOOL      | TRUE or FALSE                          | FALSE   | Allows full rotations of the robot wrist joints, enabling this bit limits rotations to the range +/- 180 degrees.   |
| AbsoluteApproach | Absolute Approach         | BOOL      | TRUE or FALSE                          | FALSE   | Determines the effect of the defined approach height value. When it is TRUE the robot moves to the specified location using the ApproachHeight value as absolute Z. Otherwise ApproachHeight is used as the Z offset from the specified location. |
| ApproachHeight   | Approach height value     | REAL      | Positive number, Negative number, or 0 | 0       | Value that defines the approach height.   |
| Righty           | Righty arm configuration  | BOOL      | TRUE or FALSE                          | FALSE   | When TRUE righty configuration is applied otherwise is lefty. Note that this is only effective for Cartesian coordinates.   |
| Below            | Below arm configuration   | BOOL      | TRUE or FALSE                          | FALSE   | When TRUE below configuration is applied otherwise is above. Note that this is only effective for Cartesian coordinates.  |
| Flip             | Flip arm configuration    | BOOL      | TRUE or FALSE                          | FALSE   | When TRUE flip configuration is applied otherwise is no flip. Note that this is only effective for Cartesian coordinates.   |

**sARB\_MOTION\_PARAMS\_REF**

| Member Variable     | Meaning             | Data type | Valid range   | Function  |
|---------------------|---------------------|-----------|---------------|---|
| Speed               | Target speed        | INT       | 1 to 120      | Set target speed (percentage of robot maximum speed configured in the controller)   |
| Acceleration        | Target acceleration | INT       | 0 to 1000     | Set target acceleration (percentage of robot maximum acceleration configured in the controller)                             |
| Deceleration        | Target deceleration | INT       | 0 to 1000     | Set target deceleration (percentage of robot maximum deceleration configured in the controller)                             |
| AccelerationProfile | Acceleration Type   | INT       | 0, 1, 2, 3, 4 | Specify the acceleration and deceleration profile.<br>0 = Trapezoidal movement profile<br>1,2,3,4 = S-shaped moving profile |
| SpeedLimit          | Speed limit         | INT       | 0 to 100      | Maximum joint speed (percentage of joint maximum speed configured in the controller)  |

**sARB\_JOG\_PARAMS\_REF**

| Member variable | Meaning      | Data type | Valid range | Default | Function   |
|-----------------|--------------|-----------|-------------|---------|--|
| Speed           | Target speed | INT       | 0 to 100    | 0       | Set target speed (percentage of robot maximum speed configured in the controller)    |
| SpeedLimit      | Speed limit  | INT       | 0 to 100    | 0       | Maximum joint speed (percentage of joint maximum speed configured in the controller) |

**sARB\_ALIGN\_CONFIG\_REF**

| Member variable | Meaning                   | Data type | Valid range   | Function   |
|-----------------|---------------------------|-----------|---------------|--|
| CoarseNulling   | Coarse nulling tolerances | BOOL      | TRUE or FALSE | Determines the nulling tolerances that will apply at the end of the motion. When it is TRUE, the tolerance is coarse and the duration time of the robot motion will be shorter. In detail, refer to the <i>ACE User's Guide</i> (Cat. No. I603). |
| SingleTurn      | Single turn               | BOOL      | TRUE or FALSE | Allows full rotations of the robot wrist joints, enabling this bit limits rotations to the range +/- 180 degrees.  |

# ARB\_SetToolTransform

The ARB\_SetToolTransform instruction defines and sets a robot tool by setting a tool system transformation to the robot.

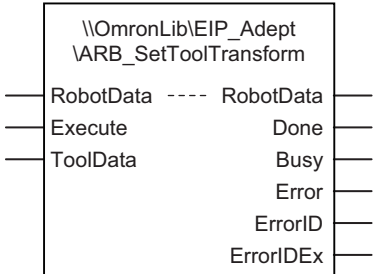
| Instruction               | Name               | FB/<br>FUN | Graphic expression   | ST expression   |
|---------------------------|--------------------|------------|--|---|
| ARB_SetTool-<br>Transform | Set Tool Transform | FB         |  | ARB_SetToolTransform_instance(<br>RobotData:=parameter,<br>Execute:=parameter,<br>ToolData:=parameter,<br>Done =>parameter,<br>Busy =>parameter,<br>Error =>parameter,<br>ErrorID=>parameter,<br>ErrorIDEx=>parameter<br>); |

## Variables

### Input Variables

| Name     | Meaning         | Data type              | Valid range   | Default | Description   |
|----------|-----------------|------------------------|---------------|---------|---|
| Execute  | Execute         | BOOL                   | TRUE or FALSE | FALSE   | The instruction is executed when Execute changes to TRUE. |
| ToolData | Tool definition | sARB_TOOL-<br>DATA_REF | ---           | ---     | Tool definition.  |

### ● sARB\_TOOLDATA\_REF

| Name                | Meaning  | Data type            | Valid range                            | Default       | Description   |
|---------------------|--|----------------------|--|---------------|---|
| LocationNum-<br>ber | Location number                                  | INT                  | 0 and [2...999]                        | 0             | Identifies a location stored in the robot controller used to define the robot tool.<br><br>When 0, it means that LocationNumber is not used and ToolTransform has to be used instead. |
| ToolTransform       | Tool Coordinate System Transformation definition | ARRAY [0..5] OF REAL | Positive number, Negative number, or 0 | [0.0,...,0.0] | X, Y, Z, Yaw, Pitch, Roll defined respect to the robot tool flange.   |



## Output Variables

| Name      | Meaning           | Data type | Valid range   | Description  |
|-----------|-------------------|-----------|---------------|--|
| Done      | Done              | BOOL      | TRUE or FALSE | TRUE when the execution is completed. Tool is set. |
| Busy      | Executing         | BOOL      | TRUE or FALSE | TRUE when the instruction is acknowledged.         |
| Error     | Error             | BOOL      | TRUE or FALSE | TRUE while there is an error.                      |
| ErrorID   | Error code        | WORD      | *1            | Specify error number.                              |
| ErrorIDEx | Extended error ID | DWORD     | *1            | Specify extended error number.                     |

\*1. Refer to *Troubleshooting* on page 43 for details.

### ● Output Variable Update Timing

| Name  | Timing for changing to TRUE   | Timing for changing to FALSE  |
|-------|---|---|
| Done  | <ul style="list-style-type: none"> <li>When execution is completed.</li> </ul>  | <ul style="list-style-type: none"> <li>When <i>Execute</i> is TRUE and changes to FALSE.</li> <li>After one control period when <i>Execute</i> is FALSE.</li> </ul> |
| Busy  | <ul style="list-style-type: none"> <li>When <i>Execute</i> changes to TRUE.</li> </ul>  | <ul style="list-style-type: none"> <li>When <i>Done</i> changes to TRUE.</li> <li>When <i>Error</i> changes to TRUE</li> </ul>                                      |
| Error | <ul style="list-style-type: none"> <li>When there is an error in the execution conditions or input parameters for the instruction.</li> </ul> | <ul style="list-style-type: none"> <li>When <i>Execute</i> changes to FALSE.</li> </ul>   |

## In-Out Variables

| Name      | Meaning               | Data type             | Valid range | Description                                   |
|-----------|-----------------------|-----------------------|-------------|---|
| RobotData | Robot controller data | sARB_RO-BOT_-DATA_REF | ---         | Specify data needed for the robot controller. |

## Function

- This instruction is used to set a tool coordinate system for the robot.
- Only one tool can be defined and activated for each robot.
- When the tool coordinate system is successfully registered, it is used by movement commands.
- The setting tool will be retained till it is reset.

## Timing charts

### ● Normal execution

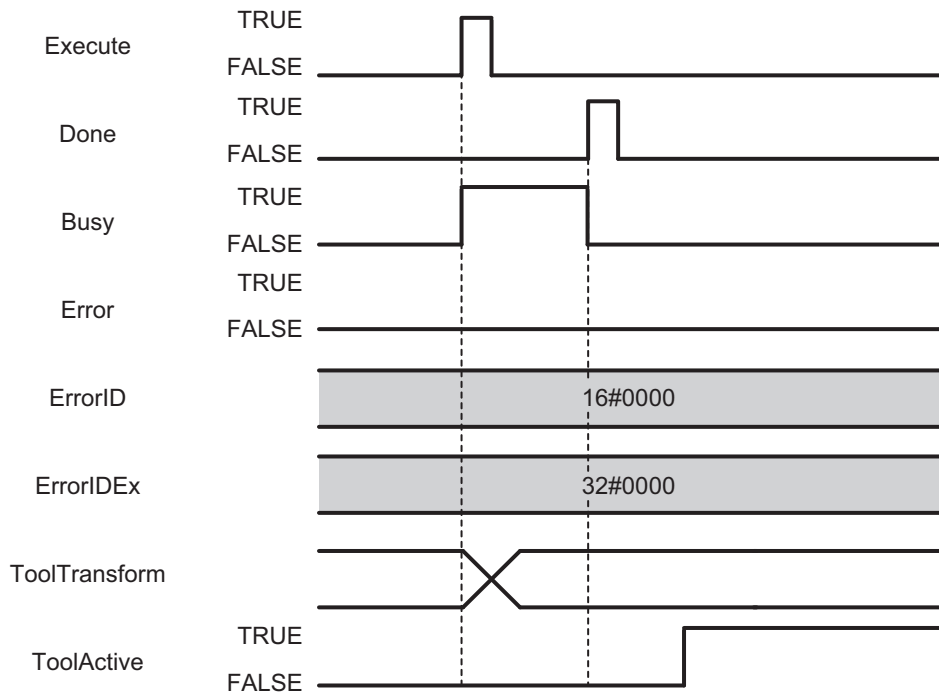

● Error execution

If an error occurs during instruction execution, *Error* will change to TRUE. You can find out the cause of the error by referring to the value output by *ErrorID* and *ErrorIDEx*.

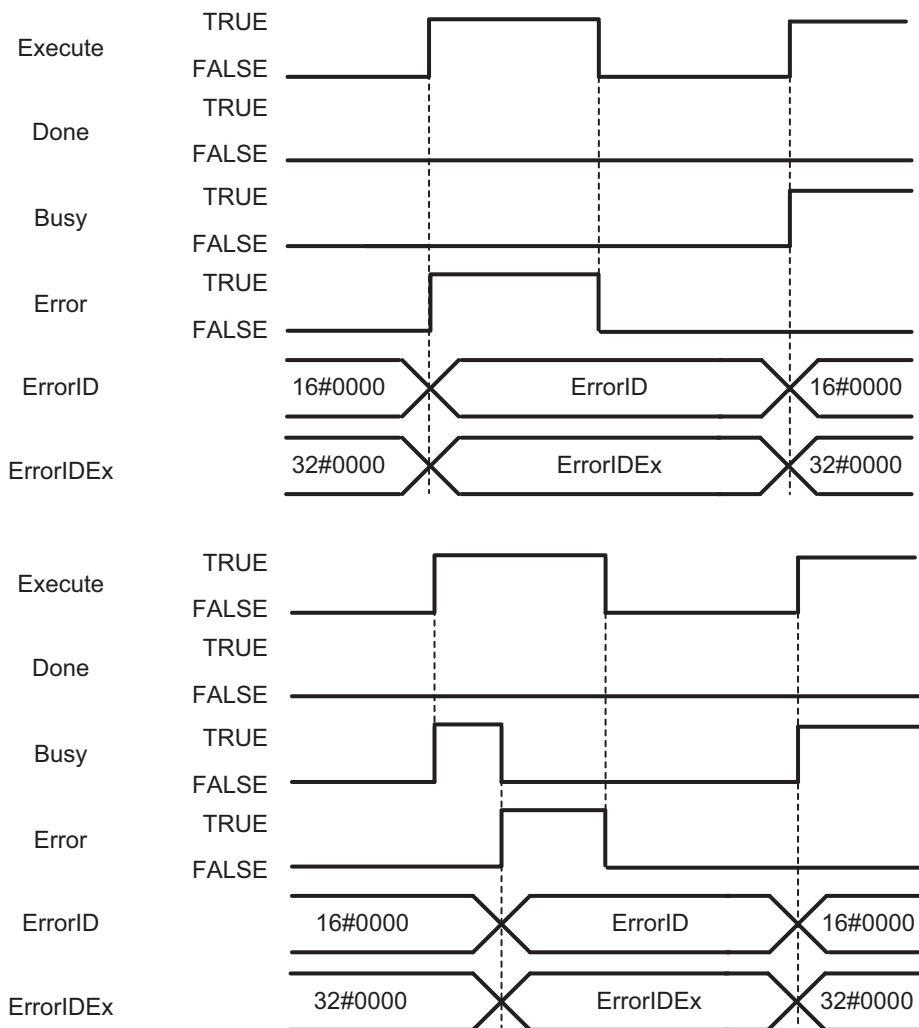

## Troubleshooting

| Error code | Extended error ID | Status                       | Meaning   | Correction   |
|------------|-------------------|------------------------------|---|--|
| 16#0000    | 16#00000000       | Normal End                   | ---   | ---  |
| 16#3C32    | 16#00000001       | Robot controller error       | Error occurs in the robot controller.   | Check the RobotError variable output in ARB_RobotControl and perform corrections for the error.                                |
|            | 16#00000002       | Communication error          | Ethernet/IP communication error.  | Execute the instruction after the successful EtherNet/IP communication recovery.   |
|            | 16#00000003       | Invalid operation            | The instruction could not be executed in this controller state.<br><i>See Execution Conditions Table on page 174.</i> | Execute the instruction after the function block is ready for execution.   |
|            | 16#00000004       | Re-execution disabled        | Instruction cannot be re-executed   | Wait for the Done variable output changes to TRUE and then execute the function block again.                                   |
|            | 16#00000005       | Multi-execution disabled     | Multiple instructions that cannot be executed simultaneously were executed for the same target.                       | Wait for the Done variable output in the previously executed instructions changes to TRUE and then execute the function block. |
|            | 16#00000006       | Location Number Out of Range | The value specified for the parameter LocationNumber in the input variable ToolData is out of range.                  | Set the LocationNumber within range.   |

# ARB\_ResetToolTransform

The ARB\_ResetToolTransform instruction resets the active robot tool which is set to the robot.

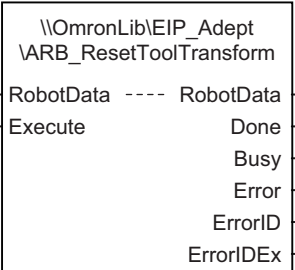
| Instruction                 | Name                      | FB/<br>FUN | Graphic expression   | ST expression   |
|-----------------------------|---------------------------|------------|--|---|
| ARB_Reset-<br>ToolTransform | Reset Tool Trans-<br>form | FB         | <p>ARB_ResetToolTransform_instance</p>  | <pre>ARB_ResetToolTransform_in- stance( RobotData:=parameter, Execute:=parameter, Done =&gt;parameter, Busy =&gt;parameter, Error =&gt;parameter, ErrorID=&gt;parameter, ErrorIDEx=&gt;parameter );</pre> |

## Variables

### Input Variables

| Name    | Meaning | Data type | Valid range   | Default | Description  |
|---------|---------|-----------|---------------|---------|--|
| Execute | Execute | BOOL      | TRUE or FALSE | FALSE   | The instruction is executed when <i>Execute</i> changes to TRUE. |

### Output Variables

| Name      | Meaning           | Data type | Valid range   | Description   |
|-----------|-------------------|-----------|---------------|---|
| Done      | Done              | BOOL      | TRUE or FALSE | TRUE when the execution is completed. Tool is reset |
| Busy      | Executing         | BOOL      | TRUE or FALSE | TRUE when the instruction is acknowledged.          |
| Error     | Error             | BOOL      | TRUE or FALSE | TRUE while there is an error.                       |
| ErrorID   | Error ID          | WORD      | *1            | Specify error number.                               |
| ErrorIDEx | Extended error ID | DWORD     | *1            | Specify extended error number.                      |

\*1. Refer to *Troubleshooting* on page 49 for details.

### ● Output Variable Update Timing

| Name  | Timing for changing to TRUE   | Timing for changing to FALSE  |
|-------|---|---|
| Done  | <ul style="list-style-type: none"> <li>When execution is completed.</li> </ul>  | <ul style="list-style-type: none"> <li>When <i>Execute</i> is TRUE and changes to FALSE.</li> <li>After one control period when <i>Execute</i> is FALSE.</li> </ul> |
| Busy  | <ul style="list-style-type: none"> <li>When <i>Execute</i> changes to TRUE.</li> </ul>  | <ul style="list-style-type: none"> <li>When <i>Done</i> changes to TRUE.</li> <li>When <i>Error</i> changes to TRUE</li> </ul>                                      |
| Error | <ul style="list-style-type: none"> <li>When there is an error in the execution conditions or input parameters for the instruction.</li> </ul> | <ul style="list-style-type: none"> <li>When <i>Execute</i> changes to FALSE.</li> </ul>   |

### In-Out Variables

| Name      | Meaning               | Data type           | Valid range | Description                                   |
|-----------|-----------------------|---------------------|-------------|---|
| RobotData | Robot controller data | sARB_ROBOT_DATA_REF | ---         | Specify data needed for the robot controller. |

## Function

This instruction is used to reset the active tool coordinate system for the robot.  
If there is no active tool, this instruction has no effect.



## Timing charts

● Normal execution

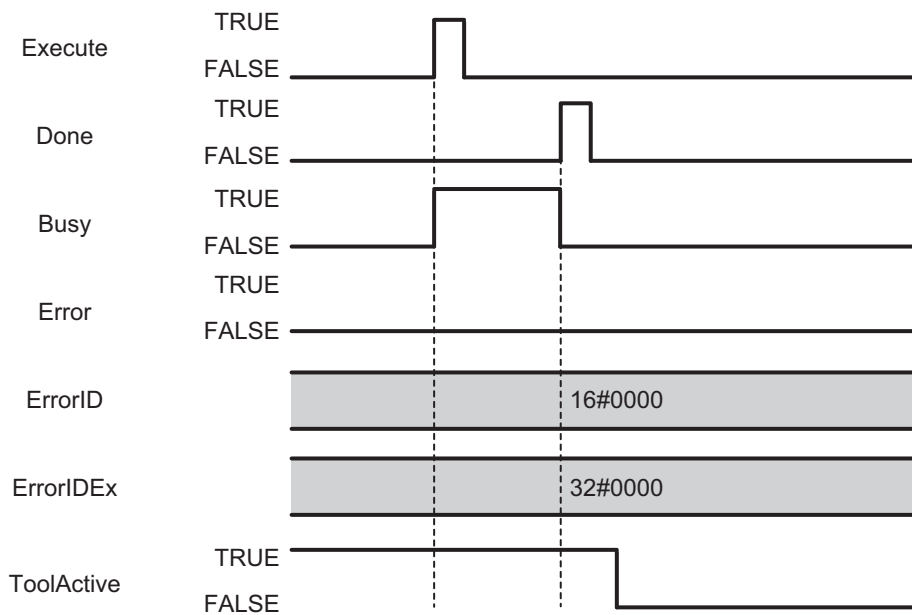

● **Error execution**

If an error occurs during instruction execution, *Error* will change to TRUE. You can find out the cause of the error by referring to the value output by *ErrorID* and *ErrorIDEx*.

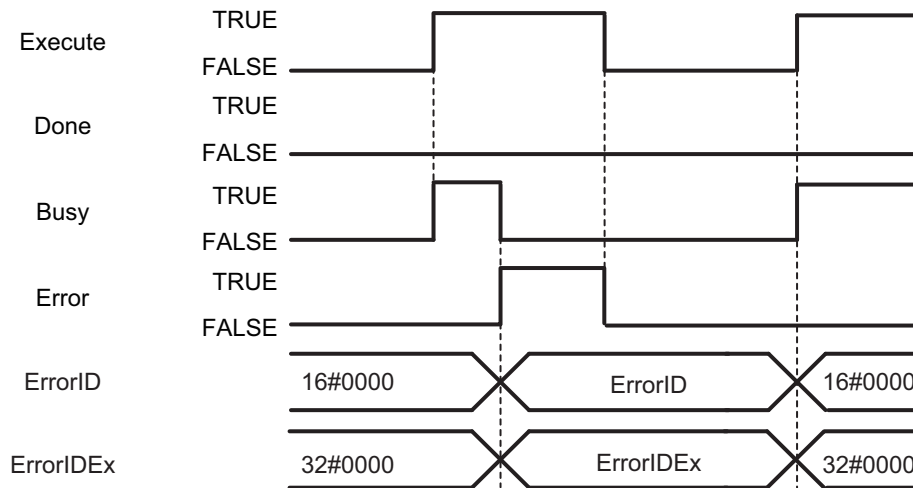
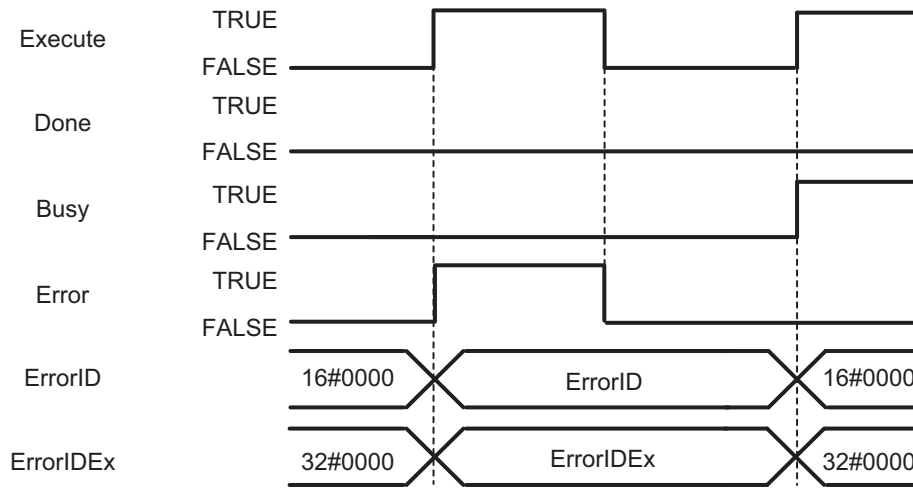

## Troubleshooting

| Error code | Extended error ID | Status                      | Meaning   | Correction   |
|------------|-------------------|-----------------------------|---|--|
| 16#0000    | 16#00000000       | The service ended normally. | ---   | ---  |
| 16#3C33    | 16#00000001       | Robot controller error      | Error occurs in the robot controller.   | Check the RobotError variable output in ARB_RobotControl and perform corrections for the error.                                |
|            | 16#00000002       | Communication error         | Ethernet/IP communication error.  | Execute the instruction after the successful EtherNet/IP communication recovery.   |
|            | 16#00000003       | Invalid operation           | The instruction could not be executed in this controller state.<br><i>See Execution Conditions Table on page 174.</i> | Execute the instruction after the function block is ready for execution.   |
|            | 16#00000004       | Re-execution disabled       | Instruction cannot be re-executed   | Wait for the Done variable output changes to TRUE and then execute the function block again.                                   |
|            | 16#00000005       | Multi-execution disabled    | Multiple instructions that cannot be executed simultaneously were executed for the same target.                       | Wait for the Done variable output in the previously executed instructions changes to TRUE and then execute the function block. |

# ARB\_DefineLocation

The ARB\_DefinePosition instruction defines a position in the robot controller.

| Instruction             | Name            | FB/<br>FUN | Graphic expression   | ST expression  |
|-------------------------|-----------------|------------|--|--|
| ARB_De-<br>fineLocation | Define Location | FB         | <p style="text-align: center;">ARB_DefineLocation_instance</p> <div style="border: 1px solid black; padding: 5px; margin: 10px auto; width: fit-content;"> <p style="margin: 0;">\\OmronLib\EIP_Adept<br/>ARB_DefineLocation</p> <p style="margin: 5px 0 0 20px;">— RobotData    ---- RobotData    —</p> <p style="margin: 5px 0 0 20px;">— Execute                            Done    —</p> <p style="margin: 5px 0 0 20px;">— PositionData                        Busy    —</p> <p style="margin: 5px 0 0 20px;">    Error    —</p> <p style="margin: 5px 0 0 20px;">    ErrorID —</p> <p style="margin: 5px 0 0 20px;">    ErrorIDEx —</p> </div> | <pre>ARB_DefineLocation_instance( RobotData:=parameter, Execute:=parameter, PositionData:=parameter, Done =&gt;parameter, Busy =&gt;parameter, Error =&gt;parameter, ErrorID=&gt;parameter, ErrorIDEx=&gt;parameter );</pre> |

## Variables

### Input Variables

| Name         | Meaning             | Data type              | Valid range   | Default | Description  |
|--------------|---------------------|------------------------|---------------|---------|--|
| Execute      | Execute             | BOOL                   | TRUE or FALSE | FALSE   | The instruction is executed when <i>Execute</i> changes to TRUE. |
| PositionData | Position definition | sARB_POSITION-DATA_REF | ---           | ---     | Position definition.   |

#### ● sARB\_POSITIONDATA\_REF

| Member Variable | Meaning         | Data type            | Valid range                            | Description   |
|-----------------|-----------------|----------------------|--|---|
| LocationNumber  | Location number | INT                  | 2 to 999                               | Specify the number of a location where the position is stored.  |
| Position        | Position        | ARRAY [0..5] OF REAL | Positive number, Negative number, or 0 | Specify the position:<br>Position[0]: X axis coordinate or Joint_1<br>Position[1]: Y axis coordinate or Joint_2<br>Position[2]: Z axis coordinate or Joint_3<br>Position[3]: Yaw angle coordinate or Joint_4<br>Position[4]: Pitch angle coordinate or Joint_5<br>Position[5]: Roll angle coordinate or Joint_6 |

## Output Variables

| Name      | Meaning           | Data type | Valid range   | Description                                |
|-----------|-------------------|-----------|---------------|--|
| Done      | Done              | BOOL      | TRUE or FALSE | TRUE when the execution is completed.      |
| Busy      | Executing         | BOOL      | TRUE or FALSE | TRUE when the instruction is acknowledged. |
| Error     | Error             | BOOL      | TRUE or FALSE | TRUE while there is an error.              |
| ErrorID   | Error ID          | WORD      | *1            | Specify error number.                      |
| ErrorIDEx | Extended error ID | DWORD     | *1            | Specify extended error number.             |

\*1. Refer to *Troubleshooting* on page 56 for details.

### ● Output Variable Update Timing

| Name  | Timing for changing to TRUE   | Timing for changing to FALSE  |
|-------|---|---|
| Done  | <ul style="list-style-type: none"> <li>TRUE when the execution is completed.</li> </ul>   | <ul style="list-style-type: none"> <li>When <i>Execute</i> is TRUE and changes to FALSE.</li> <li>After one control period when <i>Execute</i> is FALSE.</li> </ul> |
| Busy  | <ul style="list-style-type: none"> <li>When <i>Execute</i> changes to TRUE.</li> </ul>  | <ul style="list-style-type: none"> <li>When <i>Done</i> changes to TRUE.</li> <li>When <i>Error</i> changes to TRUE</li> </ul>                                      |
| Error | <ul style="list-style-type: none"> <li>When there is an error in the execution conditions or input parameters for the instruction.</li> </ul> | <ul style="list-style-type: none"> <li>When <i>Execute</i> changes to FALSE.</li> </ul>   |

## In-Out Variables

| Name      | Meaning               | Data type           | Valid range | Description                                   |
|-----------|-----------------------|---------------------|-------------|---|
| RobotData | Robot controller data | sARB_ROBOT_DATA_REF | ---         | Specify data needed for the robot controller. |

## Function

- This instruction is used to download a position into the robot controller.
- It's possible to define a position in both, Cartesian and Joint space.
- Positions must be downloaded to Locations each time the Adept controller is restarted.

## Timing charts

### ● Normal execution

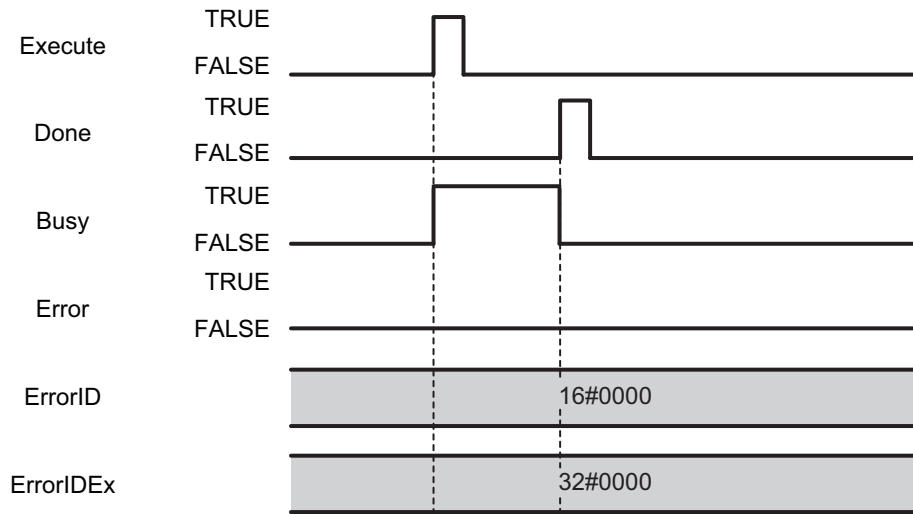



● **Error execution**

If an error occurs during instruction execution, *Error* will change to TRUE. You can find out the cause of the error by referring to the value output by *ErrorID* and *ErrorIDEx*.

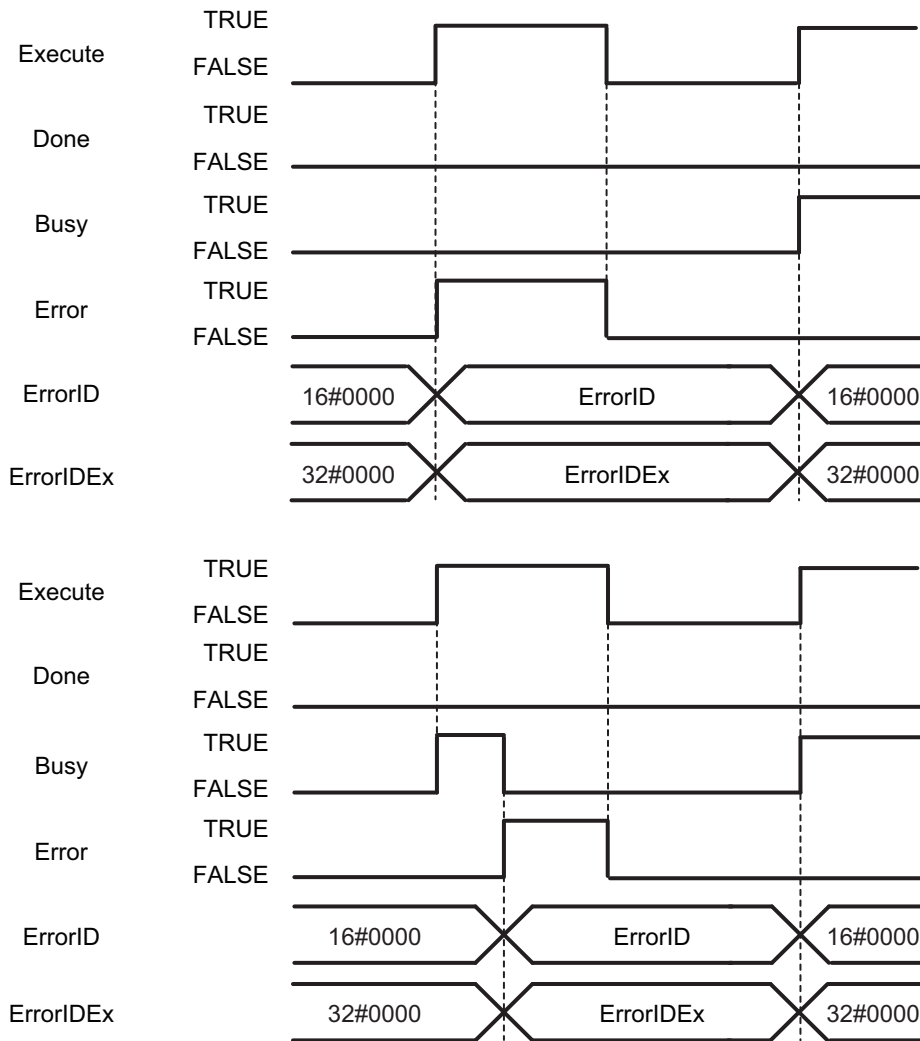

## Troubleshooting

| Error code | Extended error ID | Status                       | Meaning   | Correction   |
|------------|-------------------|------------------------------|---|--|
| 16#0000    | 16#00000000       | The service ended normally.  | ---   | ---  |
| 16#3C34    | 16#00000001       | Robot controller error       | Error occurs in the robot controller.   | Check the RobotError variable output in ARB_RobotControl and perform corrections for the error.                                |
|            | 16#00000002       | Communication error          | Ethernet/IP communication error   | Execute the instruction after the successful EtherNet/IP communication recovery.   |
|            | 16#00000003       | Invalid operation            | The instruction could not be executed in this controller state.<br><i>See Execution Conditions Table on page 174.</i> | Execute the instruction after the function block is ready for execution.   |
|            | 16#00000004       | Re-execution disabled        | Instruction cannot be re-executed   | Wait for the Done variable output changes to TRUE and then execute the function block again.                                   |
|            | 16#00000005       | Multi-execution disabled     | Multiple instructions that cannot be executed simultaneously were executed for the same target.                       | Wait for the Done variable output in the previously executed instructions changes to TRUE and then execute the function block. |
|            | 16#00000006       | Location Number Out of Range | The value specified for the parameter LocationNumber in the input variable Position-Data is out of range.             | Set the LocationNumber within range.   |

# ARB\_DefinePallet

The ARB\_DefinePallet instruction defines all pallet information in the robot controller.

| Instruction           | Name          | FB/<br>FUN | Graphic expression   | ST expression  |
|-----------------------|---------------|------------|--|--|
| ARB_De-<br>finePallet | Define Pallet | FB         | <p style="text-align: center;">ARB_DefinePallet_instance</p> | <pre>ARB_DefinePallet_instance( RobotData:=parameter, Execute:=parameter, PalletData:=parameter, Done =&gt;parameter, Busy =&gt;parameter, Error =&gt;parameter, ErrorID=&gt;parameter, ErrorIDEx=&gt;parameter );</pre> |

## Variables

### Input Variables

| Name       | Meaning           | Data type            | Valid range   | Default | Description  |
|------------|-------------------|----------------------|---------------|---------|--|
| Execute    | Execute           | BOOL                 | TRUE or FALSE | FALSE   | The instruction is executed when <i>Execute</i> changes to TRUE. |
| PalletData | Pallet definition | sARB_PALLET-DATA_REF | ---           | ---     | Pallet definition data.  |

#### ● sARB\_PALLETDATA\_REF

| Member Variable         | Meaning                             | Data type | Valid range                            | Description  |
|-------------------------|-------------------------------------|-----------|--|--|
| PalletNumber            | Pallet number                       | INT       | 1...100                                | Specify the number of the pallet.  |
| StartingLocation-Number | Starting location number            | INT       | 2...999                                | Specify the number of a location where the position is stored.   |
| FirstRowLocation-Number | First row location number           | INT       | 2...999                                | Specify the number of a location where the position is stored.   |
| LastRowLocation-Number  | Last row position number            | INT       | 2...999                                | Specify the number of a location where the position is stored.   |
| NumberPosition-FirstRow | Number of position in the first row | INT       | Positive number, Negative number, or 0 | Number of location in the first row  |
| NumberRows              | Number of rows                      | INT       | Positive number, Negative number, or 0 | Number of rows   |
| PalletConfig            | Configuration                       | INT       | [0, 1, 2, 3, 4]                        | Pallet configuration type.<br>Refer to <i>Possible pallet configuration codes</i> in the following section <i>Function</i> on page 60 for the meaning of each of the configuration codes 0 to 4. |
| TravDirection           | Traverse direction                  | INT       | [0, 1]                                 | Traverse direction.<br>Refer to the following section <i>Function</i> on page 60 for the meaning of each of the traverse direction setting values 0 and 1.                                       |

## Output Variables

| Name      | Meaning           | Data type | Valid range   | Description                                |
|-----------|-------------------|-----------|---------------|--|
| Done      | Done              | BOOL      | TRUE or FALSE | TRUE when the execution is completed.      |
| Busy      | Executing         | BOOL      | TRUE or FALSE | TRUE when the instruction is acknowledged. |
| Error     | Error             | BOOL      | TRUE or FALSE | TRUE while there is an error.              |
| ErrorID   | Error ID          | WORD      | *1            | Specify error number.                      |
| ErrorIDEx | Extended error ID | DWORD     | *1            | Specify extended error number.             |

\*1. Refer to *Troubleshooting* on page 64 for details.

### ● Output Variable Update Timing

| Name  | Timing for changing to TRUE   | Timing for changing to FALSE  |
|-------|---|---|
| Done  | <ul style="list-style-type: none"> <li>When execution is completed.</li> </ul>  | <ul style="list-style-type: none"> <li>When <i>Execute</i> is TRUE and changes to FALSE.</li> <li>After one control period when <i>Execute</i> is FALSE.</li> </ul> |
| Busy  | <ul style="list-style-type: none"> <li>When <i>Execute</i> changes to TRUE.</li> </ul>  | <ul style="list-style-type: none"> <li>When <i>Done</i> changes to TRUE.</li> <li>When <i>Error</i> changes to TRUE</li> </ul>                                      |
| Error | <ul style="list-style-type: none"> <li>When there is an error in the execution conditions or input parameters for the instruction.</li> </ul> | <ul style="list-style-type: none"> <li>When <i>Execute</i> changes to FALSE.</li> </ul>   |

## In-Out Variables

| Name      | Meaning               | Data type             | Valid range | Description                                   |
|-----------|-----------------------|-----------------------|-------------|---|
| RobotData | Robot controller data | sARB_RO-BOT_-DATA_REF | ---         | Specify data needed for the robot controller. |

## Function

- This instruction is used to define all information related to the pallet.
- It uses three locations that have to be already defined: StartingLocation (A), FirstRowLocation (B) and LastRowLocation (C).
- The origin is the first position in the pallet which corresponds to 1 (not 0).
- The spacing between rows is constant for all rows.
- The even-numbered rows, if offset, are always offset by half the distance between positions in a row.
- When defining the pallet, if location C is on the same line (row) as A and B, an error will be reported.
- In the case of a single-row pallet, location C must be the same as location B.

Image below represents an overview of the pallet layout definition elements:

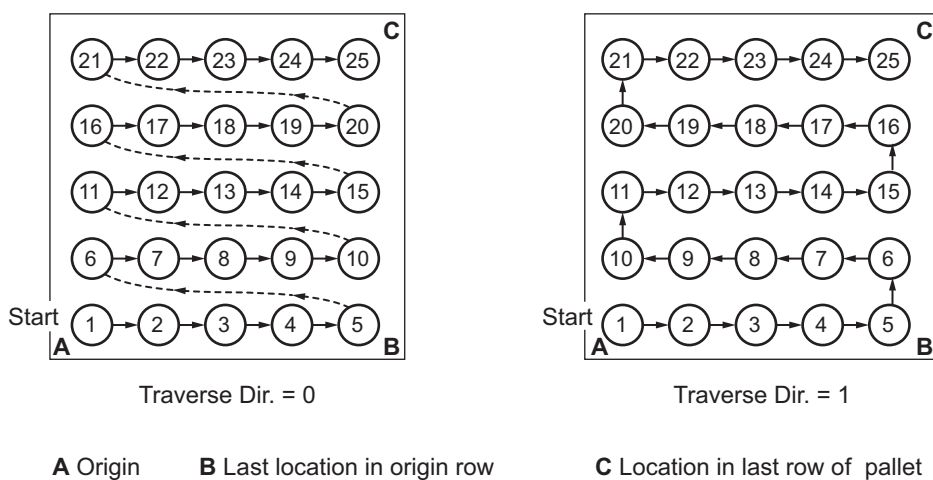

● Possible pallet configuration codes:

A Origin

B Last location in origin row

C Location in last row of pallet

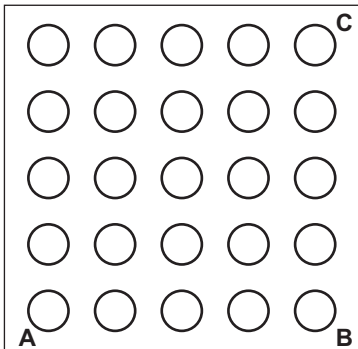

Config. Code = 0

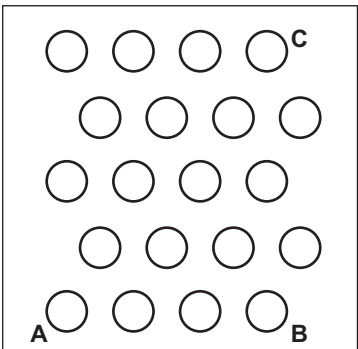

Config. Code = 1

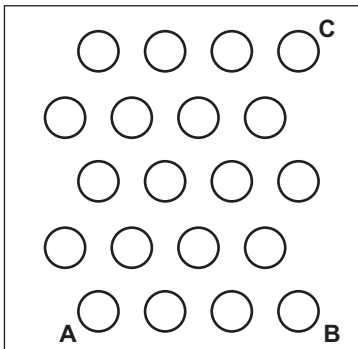

Config. Code = 2

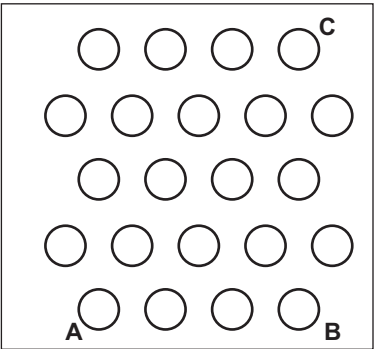

Config. Code = 3

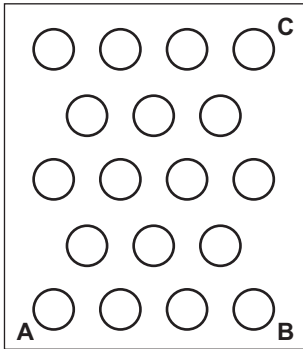

Config. Code = 4

## Timing charts

### ● Normal execution

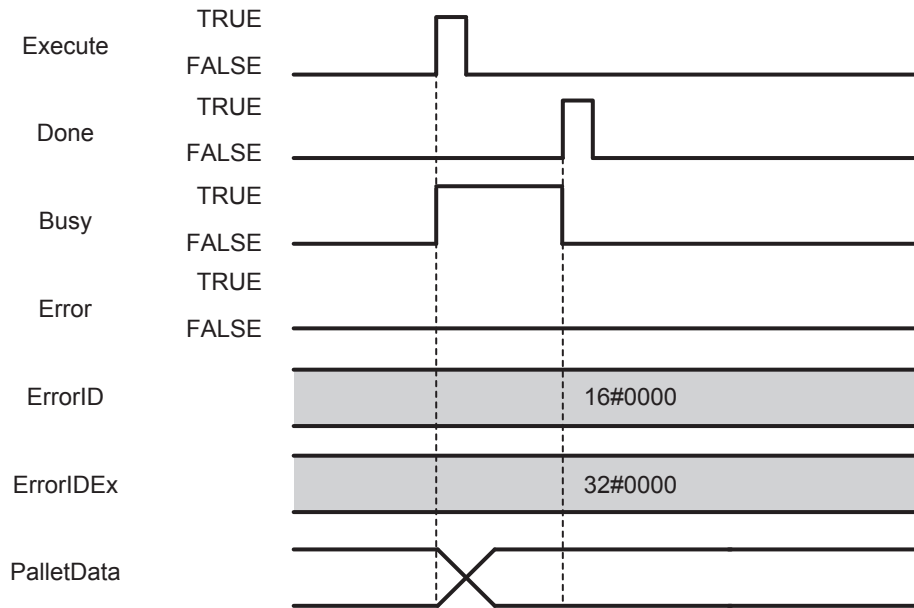



● Error execution

If an error occurs during instruction execution, *Error* will change to TRUE. You can find out the cause of the error by referring to the value output by *ErrorID* and *ErrorIDEx*.

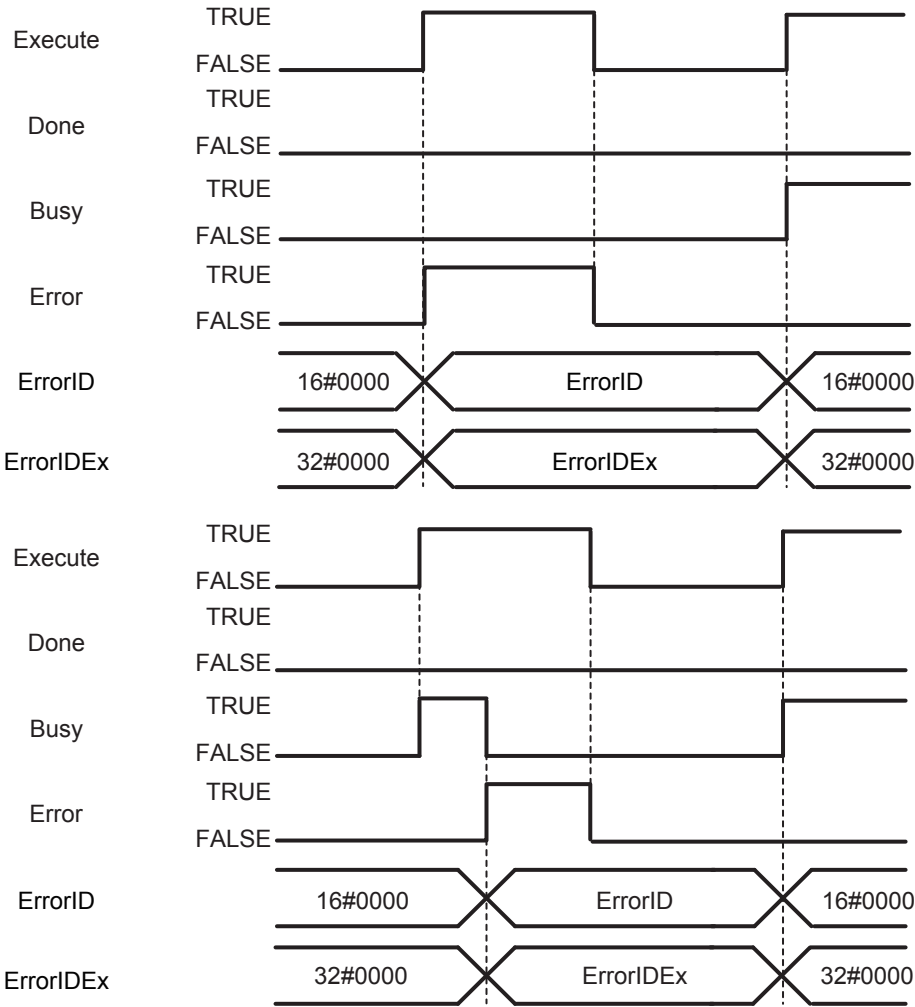

## Troubleshooting

| Error code | Extended error ID | Status                                      | Meaning   | Correction   |
|------------|-------------------|---|---|--|
| 16#0000    | 16#00000000       | The service ended normally.                 | ---   | ---  |
| 16#3C35    | 16#00000001       | Robot controller error                      | Error occurs in the robot controller.   | Check the RobotError variable output in ARB_RobotControl and perform corrections for the error.                                |
|            | 16#00000002       | Communication error                         | Ethernet/IP communication error   | Execute the instruction after the successful EtherNet/IP communication recovery.   |
|            | 16#00000003       | Invalid operation                           | The instruction could not be executed in this controller state.<br><i>See Execution Conditions Table on page 174.</i> | Execute the instruction after the function block is ready for execution.   |
|            | 16#00000004       | Re-execution disabled                       | Instruction cannot be re-executed   | Wait for the Done variable output changes to TRUE and then execute the function block again.                                   |
|            | 16#00000005       | Multi-execution disabled                    | Multiple instructions that cannot be executed simultaneously were executed for the same target.                       | Wait for the Done variable output in the previously executed instructions changes to TRUE and then execute the function block. |
|            | 16#00000006       | Location Number Out of Range                | The value specified any of the parameters in the input variable PalletData is out of range.                           | Set the parameter value within range.  |
|            | 16#00000007       | Pallet Number Out of Range                  | The value specified for the parameter PalletNumber in the input variable PalletData is out of range.                  | Set the PalletNumber within range.   |
|            | 16#00000008       | Pallet Configuration Selection Out of Range | The value specified for the parameter PalletConfig in the input variable PalletData is out of range.                  | Set the PalletConfig within range.   |
|            | 16#00000009       | Traverse Direction Out of Range             | The value specified for the parameter TravDirection in the input variable PalletData is out of range.                 | Set the TravDirection within range.  |

# ARB\_ResetRobotError

The ARB\_ResetRobotError instruction resets any existing error in the robot.

| Instruction         | Name        | FB/<br>FUN | Graphic expression                  | ST expression  |
|---------------------|-------------|------------|-------------------------------------|--|
| ARB_ResetRobotError | Reset Error | FB         | <p>ARB_ResetRobotError_instance</p> | <pre>ARB_ResetRobotError_instance( RobotData:=parameter, Execute:=parameter, Done =&gt;parameter, Busy =&gt;parameter, Error =&gt;parameter, ErrorID=&gt;parameter, ErrorIDEx=&gt;parameter );</pre> |

## Variables

### Input Variables

| Name    | Meaning | Data type | Valid range   | Default | Description   |
|---------|---------|-----------|---------------|---------|---|
| Execute | Execute | BOOL      | TRUE or FALSE | FALSE   | The instruction is executed when Execute changes to TRUE. |

### Output Variables

| Name      | Meaning           | Data type | Valid range   | Description                                |
|-----------|-------------------|-----------|---------------|--|
| Done      | Done              | BOOL      | TRUE or FALSE | TRUE when the execution is completed.      |
| Busy      | Executing         | BOOL      | TRUE or FALSE | TRUE when the instruction is acknowledged. |
| Error     | Error             | BOOL      | TRUE or FALSE | TRUE while there is an error.              |
| ErrorID   | Error ID          | WORD      | *1            | Specify error number.                      |
| ErrorIDEx | Extended error ID | DWORD     | *1            | Specify extended error number.             |

\*1. Refer to *Troubleshooting* on page 70 for details.

### ● Output Variable Update Timing

| Name  | Timing for changing to TRUE   | Timing for changing to FALSE  |
|-------|---|---|
| Done  | <ul style="list-style-type: none"> <li>TRUE when the execution is completed.</li> </ul>   | <ul style="list-style-type: none"> <li>When Execute is TRUE and changes to FALSE.</li> <li>After one control period when Execute is FALSE.</li> </ul> |
| Busy  | <ul style="list-style-type: none"> <li>When Execute changes to TRUE.</li> </ul>   | <ul style="list-style-type: none"> <li>When Done changes to TRUE.</li> <li>When Error changes to TRUE</li> </ul>                                      |
| Error | <ul style="list-style-type: none"> <li>When there is an error in the execution conditions or input parameters for the instruction.</li> </ul> | <ul style="list-style-type: none"> <li>When Execute changes to FALSE.</li> </ul>  |

### In-out variables

| Name      | Meaning               | Data type           | Valid range | Description                                   |
|-----------|-----------------------|---------------------|-------------|---|
| RobotData | Robot controller data | sARB_ROBOT_DATA_REF | ---         | Specify data needed for the robot controller. |

## Function

- Resets the robot controller if it is in a fault state. The current error message and error number tags are cleared by the reset command.
- When an error occurs, the robot goes to fault state. The reset command will release the robot from the fault state.
- In order to complete the reset correctly there cannot be any other command in execution.
- If reset is executed when the robot controller is not in fault state, then the reset operation is not send to the controller.

## Timing charts

### ● Normal execution

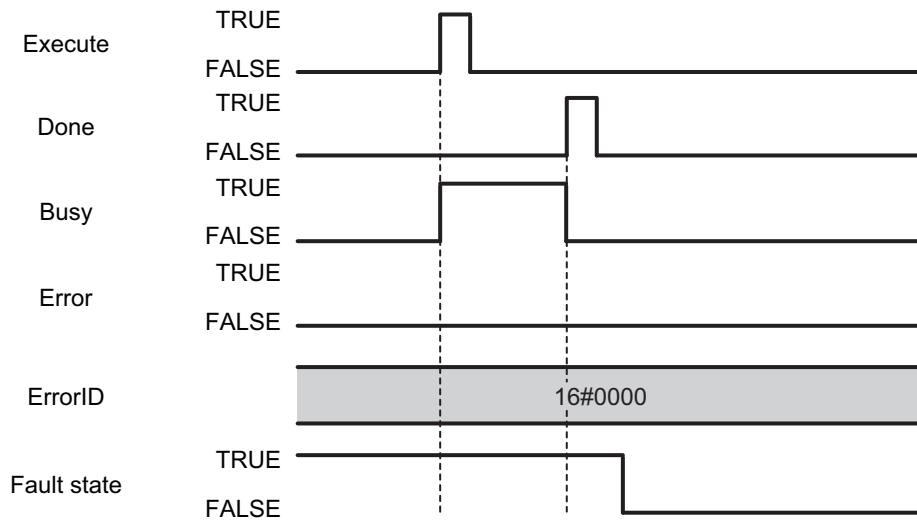

● **Error execution**

If an error occurs during instruction execution, *Error* will change to TRUE. You can find out the cause of the error by referring to the value output by *ErrorID* and *ErrorIDEx*.

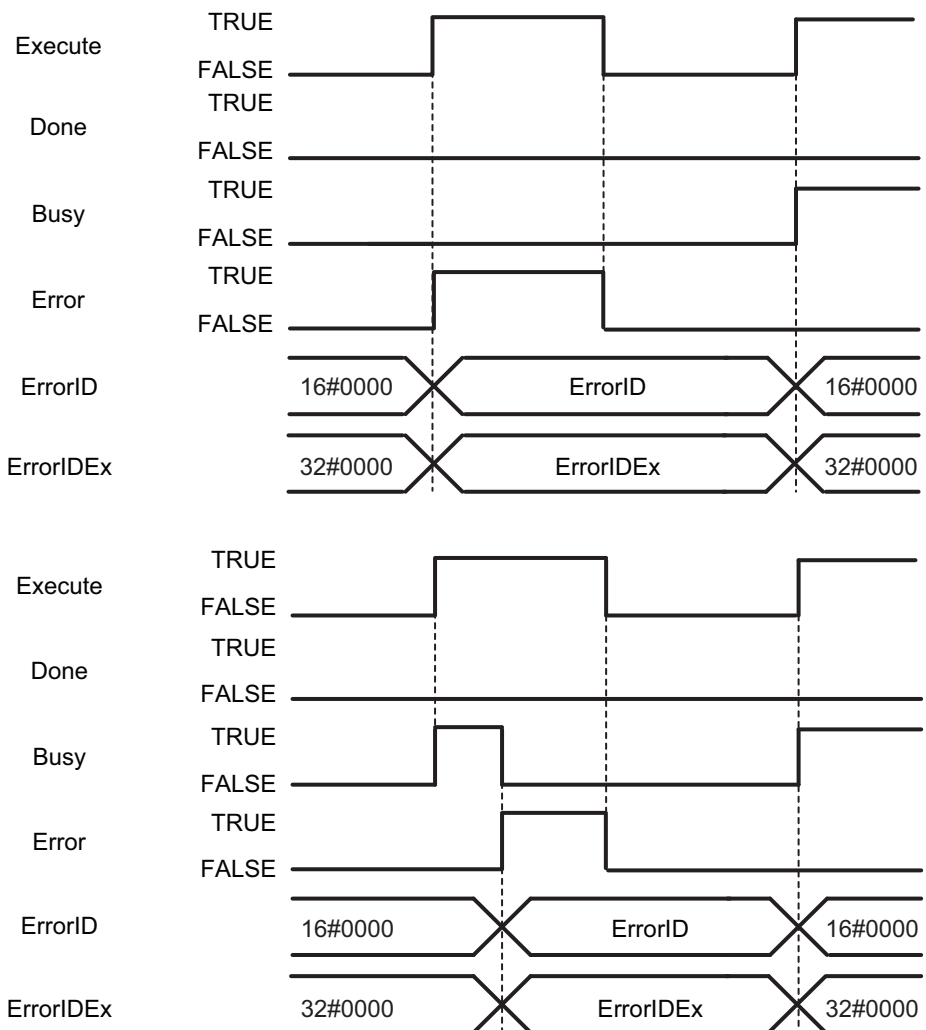

## Troubleshooting

| Error code | Extended error ID | Status                      | Meaning                               | Correction  |
|------------|-------------------|-----------------------------|---------------------------------------|---|
| 16#0000    | 16#00000000       | The service ended normally. | ---                                   | ---   |
| 16#3C36    | 16#00000001       | Robot controller error      | Error occurs in the robot controller. | Check the RobotError variable output in ARB_RobotControl and perform corrections for the error. |
|            | 16#00000002       | Communication error         | Ethernet/IP communication error       | Execute the instruction after the successful EtherNet/IP communication recovery.                |
|            | 16#00000004       | Re-execution disabled       | Instruction cannot be re-executed     | Wait for the Done variable output changes to TRUE and then execute the function block again.    |



# ARB\_RobotControl

The ARB\_RobotControl instruction controls the main robot settings and operations and monitors the robot states, positions, configuration and errors.

| Instruction           | Name         | FB/<br>FUN | Graphic expression               | ST expression   |
|-----------------------|--------------|------------|----------------------------------|---|
| ARB_Robot-<br>Control | Stop Control | FB         | <p>ARB_RobotControl_instance</p> | <pre>ARB_RobotControl_instance( RobotData:=parameter, Enable:=parameter, Power:=parameter, Calibrate:=parameter, CancelMotion:=parameter, StopOnInput:=parameter, Enabled =&gt;parameter, Busy =&gt;parameter, Connected =&gt;parameter, RobotState=&gt;parameter, RobotMotion=&gt;parameter, RobotPosition=&gt;parameter, RobotConfig=&gt;parameter, RobotError=&gt;parameter );</pre> |

## Variables

### Input Variables

| Name         | Meaning               | Data type | Valid range   | Default | Description   |
|--------------|-----------------------|-----------|---------------|---------|---|
| Enable       | Enable                | BOOL      | TRUE or FALSE | FALSE   | The instruction is executed while Enable is to TRUE.            |
| Power        | Enable Power          | BOOL      | TRUE or FALSE | FALSE   | Enable Power of the robot when input is TRUE                    |
| Calibrate    | Calibrate Robot       | BOOL      | TRUE or FALSE | FALSE   | Robot calibration starts when the input is set to TRUE          |
| CancelMotion | Cancel Robot Movement | BOOL      | TRUE or FALSE | FALSE   | The brake instruction is executed when the input is set to TRUE |
| StopOnInput  | Stop on latch input   | BOOL      | TRUE or FALSE | FALSE   | The option to stop on input is enabled while the input is TRUE  |

### Output Variables

| Name          | Meaning             | Data type             | Valid range   | Description   |
|---------------|---------------------|-----------------------|---------------|---|
| Enabled       | Done                | BOOL                  | TRUE or FALSE | TRUE while the instruction is being executed without error.     |
| Busy          | Executing           | BOOL                  | TRUE or FALSE | TRUE when the instruction is acknowledged.                      |
| Connected     | Connected           | BOOL                  | TRUE or FALSE | TRUE when the connection with the controller is working.        |
| RobotState    | Robot State         | sARB_ROBOT_STATE_REF  | ---           | Robot State   |
| RobotMotion   | Robot Motion        | sARB_ROBOT_MOTION_REF | ---           | Robot motion data.  |
| RobotPosition | Robot Position      | sARB_ROBOT_POS_REF    | ---           | Robot Actual Position in Cartesian and Joint Coordinate Systems |
| RobotConfig   | Robot Configuration | sARB_ROBOT_CONFIG_REF | ---           | Robot configuration status                                      |
| RobotError    | Robot Error         | sARB_ROBOT_ERROR_REF  | ---           | Robot controller error state and message                        |

### ● sARB\_ROBOT\_STATE\_REF

| Name            | Meaning                  | Data type | Valid range   | Default | Description  |
|-----------------|--------------------------|-----------|---------------|---------|--|
| SysInitState    | System Initialized State | BOOL      | TRUE or FALSE | FALSE   | Status of the initialization of the system.<br>TRUE: System is initialized<br>FALSE: System is not initialized |
| PowerState      | Robot Power state        | BOOL      | TRUE or FALSE | FALSE   | Status of the robot power.<br>TRUE: Robot power is turned ON<br>FALSE: Robot power is turned OFF               |
| CalibratedState | Robot Calibrated state   | BOOL      | TRUE or FALSE | FALSE   | Status of the robot calibration.<br>TRUE: Robot is calibrated<br>FALSE: Robot is not calibrated                |
| ErrorState      | Robot Error State        | BOOL      | TRUE or FALSE | FALSE   | Status of the system<br>TRUE: System is in error<br>FALSE: System is not in error                              |
| EStopState      | Emergency Stop State     | BOOL      | TRUE or FALSE | FALSE   | Status of Emergency Stop input<br>TRUE: E-stop circuit is open<br>FALSE: E-stop circuit is closed              |

### ● sARB\_ROBOT\_MOTION\_REF

| Name            | Meaning                        | Data type | Valid range                            | Default | Description  |
|-----------------|--------------------------------|-----------|--|---------|--|
| InMotionState   | In Motion State                | BOOL      | TRUE or FALSE                          | FALSE   | Status of the robot motion:<br>TRUE: Robot is moving<br>FALSE: Robot is not moving   |
| InPositionState | In Position State              | BOOL      | TRUE or FALSE                          | FALSE   | 0=Not in position;<br>1=In position  |
| MotionCompleted | Percentage of motion completed | INT       | 0 to 100                               | 0       | Returns the percentage of the current motion that has completed. The value 100 indicates that no motion is in progress.<br>For continuous-path motions, the value of Motion Completed increases during each motion until the transition to the next motion, and then the value suddenly changes to close to 0 to reflect the start of the next motion. That is, Motion Completed does not reach 100 before it is reset to reflect the next motion. |
| MotionCounter   | Motion Counter                 | INT       | Positive number, Negative number, or 0 | 0       | The Current Motion Counter is incremented each time a motion begins.<br>It can be used to determine that the previous commanded motion has started.  |

### ● sARB\_ROBOT\_POS\_REF

| Name              | Meaning            | Data type            | Valid range                            | Default       | Description                                    |
|-------------------|--------------------|----------------------|--|---------------|--|
| CartesianPosition | Cartesian Position | ARRAY [0..5] OF REAL | Positive number, Negative number, or 0 | [0.0 ... 0.0] | Actual Robot Position in Cartesian Coordinates |
| JointPosition     | Joint Position     | ARRAY [0..5] OF REAL | Positive number, Negative number, or 0 | [0.0 ... 0.0] | Actual Robot Position in Joint Coordinates     |

### ● sARB\_ROBOT\_CONFIG\_REF

| Name         | Meaning              | Data type | Valid range   | Default | Description   |
|--------------|----------------------|-----------|---------------|---------|---|
| ToolActive   | Tool is set          | BOOL      | TRUE or FALSE | FALSE   | State of the tool activation of the robot:<br>TRUE: Tool is active<br>FALSE: Tool is not active (null tool)                           |
| RightyConfig | Righty configuration | BOOL      | TRUE or FALSE | FALSE   | State of the Righty/Lefty configuration of the robot.<br>TRUE: Robot has RIGHTY configuration<br>FALSE: Robot has LEFTY configuration |
| BelowConfig  | Below Configuration  | BOOL      | TRUE or FALSE | FALSE   | State of the Below/Above configuration of the robot.<br>TRUE: Robot has BELOW configuration<br>FALSE: Robot has ABOVE configuration   |
| FlipConfig   | Flip Configuration   | BOOL      | TRUE or FALSE | FALSE   | State of the flip/NoFlip configuration of the robot.<br>TRUE: Robot has FLIP configuration<br>FALSE: Robot has NOFLIP configuration   |

### ● sARB\_ROBOT\_ERROR\_REF

| Name         | Meaning       | Data type  | Valid range                            | Default | Description   |
|--------------|---------------|------------|--|---------|---|
| ErrorNumber  | Error Number  | DINT       | Positive number, Negative number, or 0 | 0       | Contains the current robot controller error number. Refer to <i>Errors from Controller</i> on page 178 for details. |
| ErrorMessage | Error Message | STRING[82] | ---                                    | ---     | Contains the current robot controller message string  |

**● Output Variable Update Timing**

| Name    | Timing for changing to TRUE   | Timing for changing to FALSE   |
|---------|---|--|
| Enabled | • When <i>Enable</i> changes to TRUE.   | • When <i>Enable</i> changes to FALSE.   |
| Busy    | • When <i>Enable</i> changes to TRUE.   | • When <i>Enable</i> changes to FALSE.<br>• When <i>Error</i> changes to TRUE. |
| Error   | • When there is an error in the execution conditions or input parameters for the instruction. | • When <i>Enable</i> is FALSE  |

## In-Out Variables

---

| Name      | Meaning               | Data type           | Valid range | Description                                   |
|-----------|-----------------------|---------------------|-------------|---|
| RobotData | Robot controller data | sARB_ROBOT_DATA_REF | ---         | Specify data needed for the robot controller. |

## Function

The instruction enables the use of the main robot control settings and operations and the monitoring of robot states, positions, configuration and errors.

In order to execute any operation from the function block or to monitor updated outputs the Enable input must be set and the function block must be in Enabled state.

## Operations and Settings of the robot

### ● Power

Power function allows switching the power at the robot on and off to enable the movement of the robot.

The input bit should remain true to keep the power on state.

In order to execute any robot movement or definition (location, pallet, etc.) the robot must be in power on state, otherwise an error occurs.

### ● Calibrate

Initialize the robot positioning system with the robot's current position. When the operation is triggered, the controller executes the main calibration program which causes the robot-specific calibration routines to be loaded and robot calibrated.

The calibration status is output through the field Calibrated in the RobotState structure.

Calibrate operation may operate differently for each type of robot.

If the robot is already calibrated (RobotState.Calibrated=TRUE) no calibration occurs when rising up the calibration input.

In order to execute any robot movement or definition the robot must be calibrated, otherwise an error occurs.

### ● Cancel Motion

Cancels the current motion and decelerates the robot to a stop. Motion can be cancelled if it has been already commanded and not while movement command is being sent. It only affects motion of ARB\_MoveComamnd, ARB\_AlignToolCommand, ARB\_PickAndPlaceCommand, ARB\_MoveArcCommand and ARB\_MoveCircularCommand.

### ● Stop on input

Immediate stop when digital input is latched. A "stop-on-digital-signal" functionality is available. Motion can be stopped if it has been already commanded and not while movement command is being sent. It only affects motion of ARB\_MoveComamnd, ARB\_AlignToolCommand, ARB\_PickAndPlaceCommand, ARB\_MoveArcCommand and ARB\_MoveCircularCommand. With this feature, any Adept robot system can be programmed to stop rapidly on a digital-input latch event. Requires the Enhanced Trajectory Generator license and several configuration changes in eV+.

## Status and Monitor

### ● Robot State

Provides information about the state of the robot and the robot controller. See detailed description of the states in the structure sARB\_ROBOT\_STATE\_REF.

### ● Robot Position

Provides current position of the robot in Cartesian coordinates and Joint coordinates.

Positions are a 6-elements array of REAL:

| Name                  | Data type | Meaning                      | Valid range                            | Default | Units |
|-----------------------|-----------|------------------------------|--|---------|-------|
| CartesianPosition [0] | REAL      | Coordinate X Position        | Positive number, Negative number, or 0 | 0.0     | mm    |
| CartesianPosition [1] | REAL      | Coordinate Y Position        | Positive number, Negative number, or 0 | 0.0     | mm    |
| CartesianPosition [2] | REAL      | Coordinate Z Position        | Positive number, Negative number, or 0 | 0.0     | mm    |
| CartesianPosition [3] | REAL      | Rotation around coordinate X | Positive number, Negative number, or 0 | 0.0     | °     |
| CartesianPosition [4] | REAL      | Rotation around coordinate Y | Positive number, Negative number, or 0 | 0.0     | °     |
| CartesianPosition [5] | REAL      | Rotation around coordinate Z | Positive number, Negative number, or 0 | 0.0     | °     |

| Name              | Data type | Meaning          | Valid range                            | Default | Units |
|-------------------|-----------|------------------|--|---------|-------|
| JointPosition [0] | REAL      | Joint-1 Position | Positive number, Negative number, or 0 | 0.0     | °     |
| JointPosition [1] | REAL      | Joint-2 Position | Positive number, Negative number, or 0 | 0.0     | °     |
| JointPosition [2] | REAL      | Joint-3 Position | Positive number, Negative number, or 0 | 0.0     | °     |
| JointPosition [3] | REAL      | Joint-4 Position | Positive number, Negative number, or 0 | 0.0     | °     |
| JointPosition [4] | REAL      | Joint-5 Position | Positive number, Negative number, or 0 | 0.0     | °     |
| JointPosition [5] | REAL      | Joint-6 Position | Positive number, Negative number, or 0 | 0.0     | °     |

### ● Robot Configuration

Provides information about the current configuration of the robot. See detailed description of the states in the structure sARB\_ROBOT\_CONFIG\_REF.

### ● Robot Error

Provides information about the errors of the robot and the robot controller. See detailed description of the states in the structure sARB\_ROBOT\_ERROR\_REF.

See detailed description of the error codes and messages in the *Troubleshooting*.



# Timing charts

## ● Power and Calibration

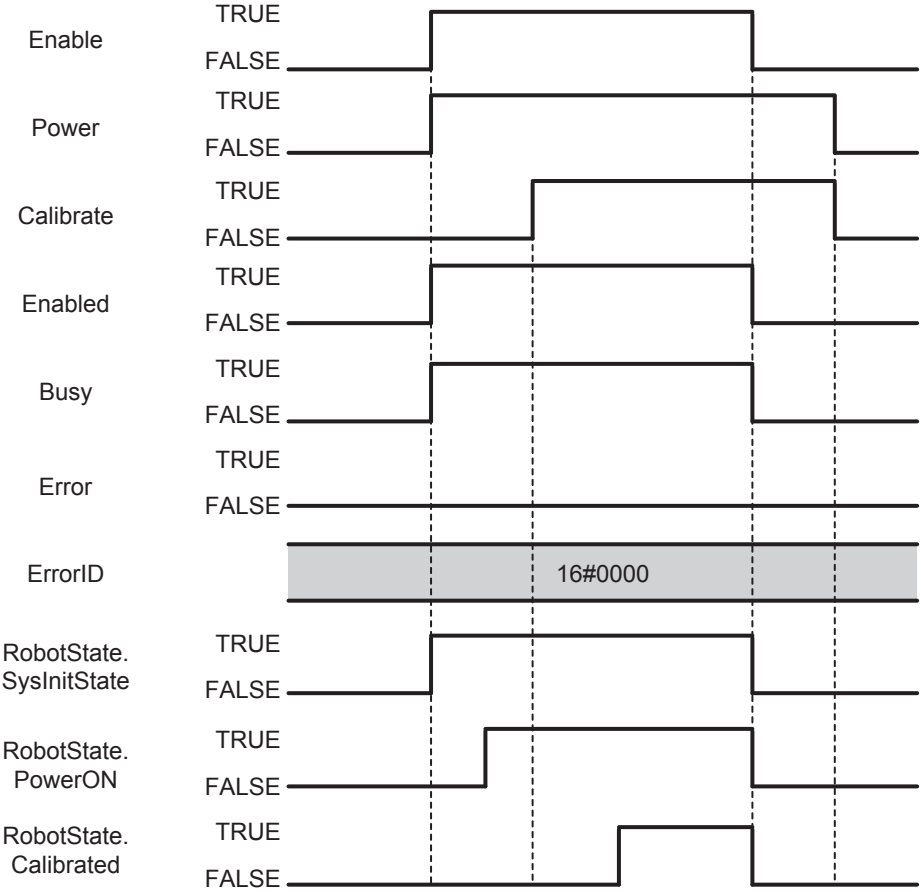

● **Cancel Movement**

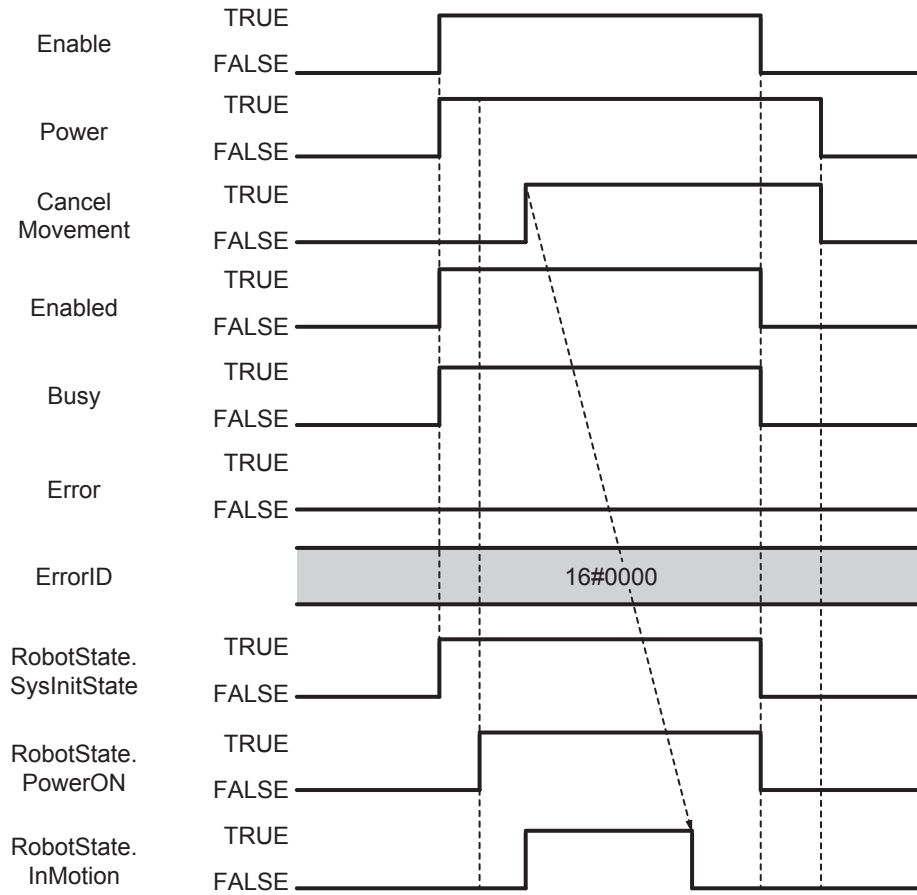

● **Current Position**

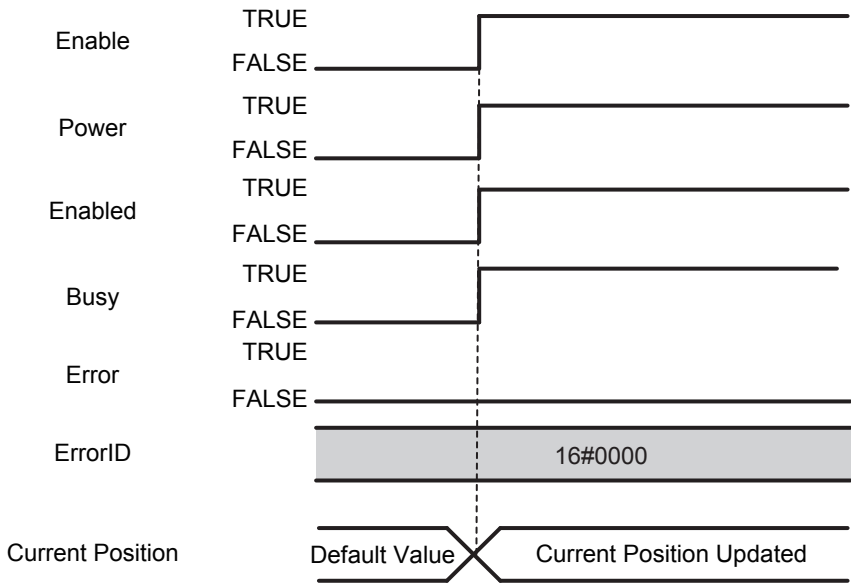

● **Error State and Messages**

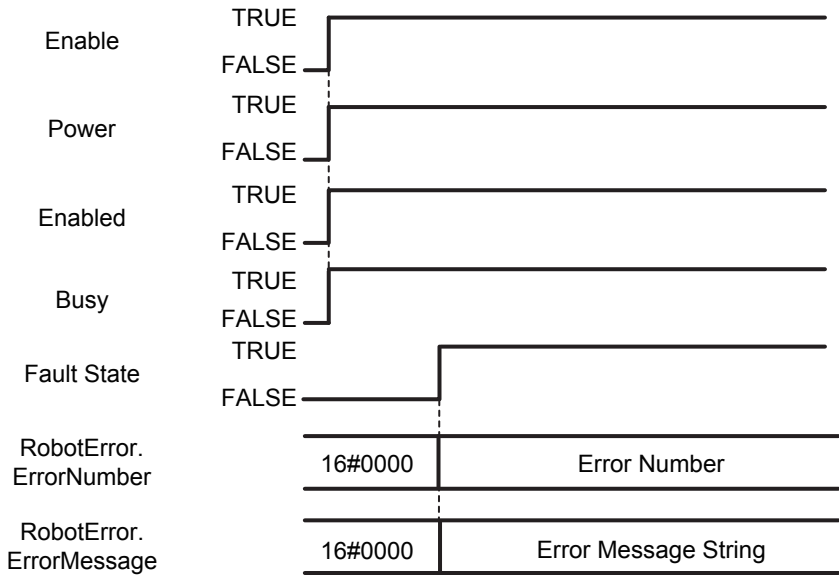

## Errors

There is no error state on this function block because as long as it is enabled it provides control of the robot to the user and it is monitoring status and errors of the robot and the robot controller.

In case of connection problem, instruction can be enabled, but 'Connected' output will be FALSE.

# ARB\_TeachPosition

The ARB\_TeachPosition instruction teaches the current robot position and configuration.

| Instruction            | Name           | FB/<br>FUN | Graphic expression  | ST expression  |
|------------------------|----------------|------------|---|--|
| ARB_Teach-<br>Position | Teach Position | FB         | <p style="text-align: center;">ARB_TeachPosition_instance</p> <div style="border: 1px solid black; padding: 5px; margin: 10px auto; width: fit-content;"> <p style="margin: 0;">\\OmronLib\EIP_Adept<br/>ARB_TeachPosition</p> </div> | <pre>ARB_TeachPosition_instance( RobotData:=parameter, Execute:=parameter, LocationNumber:= parameter, JointCoord:= parameter, Done =&gt;parameter, Busy =&gt;parameter, Error =&gt;parameter, ErrorID=&gt;parameter, ErrorIDEx=&gt;parameter, MotionRecord=&gt;parameter );</pre> |

## Variables

### Input Variables

| Name           | Meaning          | Data type | Valid range   | Default | Description  |
|----------------|------------------|-----------|---------------|---------|--|
| Execute        | Execute          | BOOL      | TRUE or FALSE | FALSE   | The instruction is executed when Execute changes to TRUE.  |
| LocationNumber | Location number  | INT       | 2 to 999      | 0       | Number of a location in the robot controller where the location is stored                                    |
| JointCoord     | Joint Coordinate | BOOL      | TRUE or FALSE | 0       | Position taught in joint or Cartesian coordinates<br>TRUE: joint coordinates<br>FALSE: Cartesian coordinates |

### Output Variables

| Name         | Meaning              | Data type             | Valid range   | Description                                   |
|--------------|----------------------|-----------------------|---------------|---|
| Done         | Done                 | BOOL                  | TRUE or FALSE | TRUE when the Teaching is completed.          |
| Busy         | Executing            | BOOL                  | TRUE or FALSE | TRUE when the instruction is acknowledged.    |
| Error        | Error                | BOOL                  | TRUE or FALSE | TRUE while there is an error.                 |
| ErrorID      | Error Code           | WORD                  | *1            | Contains the error code when an error occurs. |
| ErrorIDEx    | Extended error ID    | DWORD                 | *1            | Specify extended error number.                |
| MotionRecord | Motion Recorded Data | sARB_MOTIONRECORD_REF | ---           | Contains the information of the taught data   |

\*1. Refer to *Troubleshooting* on page 90 for details.

## ● sARB\_MOTIONRECORD\_REF

| Name         | Meaning              | Data type            | Valid range                            | Default       | Description  |
|--------------|----------------------|----------------------|--|---------------|--|
| Position     | Position taught      | ARRAY [0..5] OF REAL | Positive number, Negative number, or 0 | [0.0 ... 0.0] | Position taught in joint coordinates or Cartesian coordinates depending on the JointCoord input.<br>Position[0]: X axis coordinate or Joint_1<br>Position[1]: Y axis coordinate or Joint_2<br>Position[2]: Z axis coordinate or Joint_3<br>Position[3]: Yaw angle coordinate or Joint_4<br>Position[4]: Pitch angle coordinate or Joint_5<br>Position[5]: Roll angle coordinate or Joint_6 |
| JointCoord   | Joint Coordinates    | BOOL                 | TRUE or FALSE                          | FALSE         | Position taught in Joint or Cartesian coordinates.<br>TRUE: joint coordinates<br>FALSE: Cartesian coordinates  |
| RightyConfig | Righty configuration | BOOL                 | TRUE or FALSE                          | FALSE         | Righty/Lefty configuration of the robot when teaching is done.<br>TRUE: Robot has RIGHTY configuration<br>FALSE: Robot has LEFTY configuration   |
| BelowConfig  | Below Configuration  | BOOL                 | TRUE or FALSE                          | FALSE         | Below/Aboveconfiguration of the robot when teaching is done.<br>TRUE: Robot has BELOW configuration<br>FALSE: Robot has ABOVE configuration  |
| FlipConfig   | Flip Configuration   | BOOL                 | TRUE or FALSE                          | FALSE         | Flip/NoFlip configuration of the robot when teaching is done.<br>TRUE: Robot has FLIP configuration<br>FALSE: Robot has NOFLIP configuration   |

## ● Output Variable Update Timing

| Name  | Timing for changing to TRUE   | Timing for changing to FALSE  |
|-------|---|---|
| Done  | <ul style="list-style-type: none"> <li>When an execution is completed.</li> </ul>   | <ul style="list-style-type: none"> <li>When <i>Execute</i> is TRUE and changes to FALSE.</li> <li>After one control period when <i>Execute</i> is FALSE.</li> </ul> |
| Busy  | <ul style="list-style-type: none"> <li>When <i>Execute</i> changes to TRUE.</li> </ul>  | <ul style="list-style-type: none"> <li>When <i>Done</i> changes to TRUE.</li> <li>When <i>Error</i> changes to TRUE</li> </ul>                                      |
| Error | <ul style="list-style-type: none"> <li>When there is an error in the execution conditions or input parameters for the instruction.</li> </ul> | <ul style="list-style-type: none"> <li>When <i>Execute</i> input is FALSE</li> </ul>  |

## In-Out Variables

---

| Name      | Meaning               | Data type           | Valid range | Description                                   |
|-----------|-----------------------|---------------------|-------------|---|
| RobotData | Robot controller data | sARB_ROBOT_DATA_REF | ---         | Specify data needed for the robot controller. |



## Function

This instruction is used to teach current position into the robot controller. It means that current position is defined with the input location number.

It is possible to teach position in Cartesian or Joint space depending on the Joint Coordinate Input.

When the teaching is done the current robot position and configuration is also recorded in the output structure called Motion Record.

Taught positions must be downloaded each time the Adept controller is restarted.

MotionRecord output is set to its default value when instruction is executed and it is updated with the recorded values when the instruction is completed.

## Timing charts

### ● Normal execution

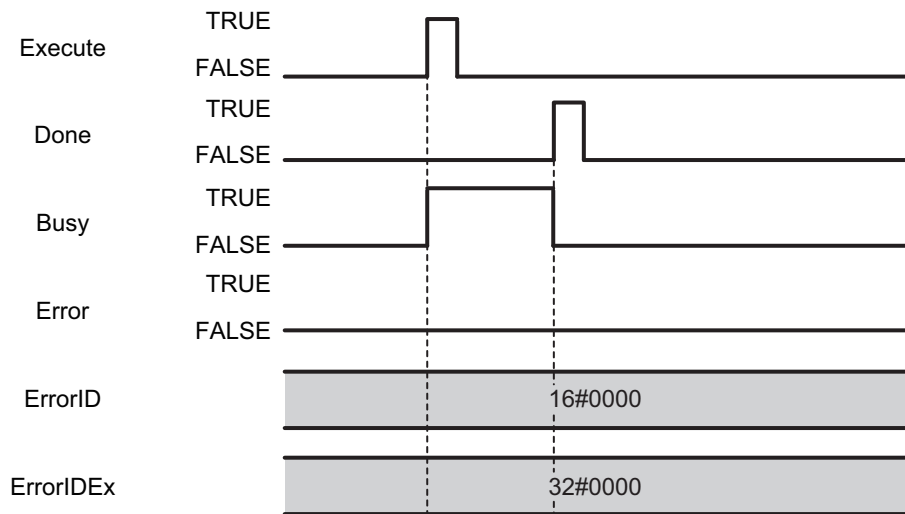

● **Error execution**

If an error occurs during instruction execution, *Error* will change to TRUE. You can find out the cause of the error by referring to the value output by *ErrorID* and *ErrorIDEx*.

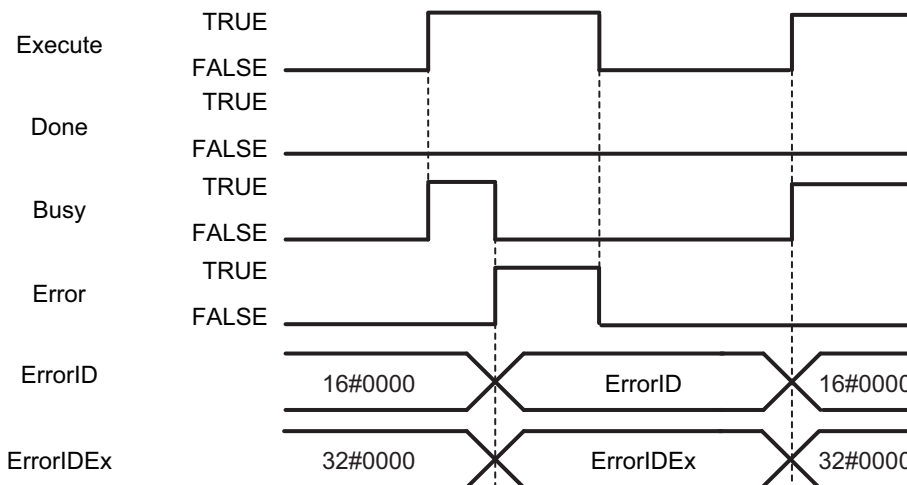
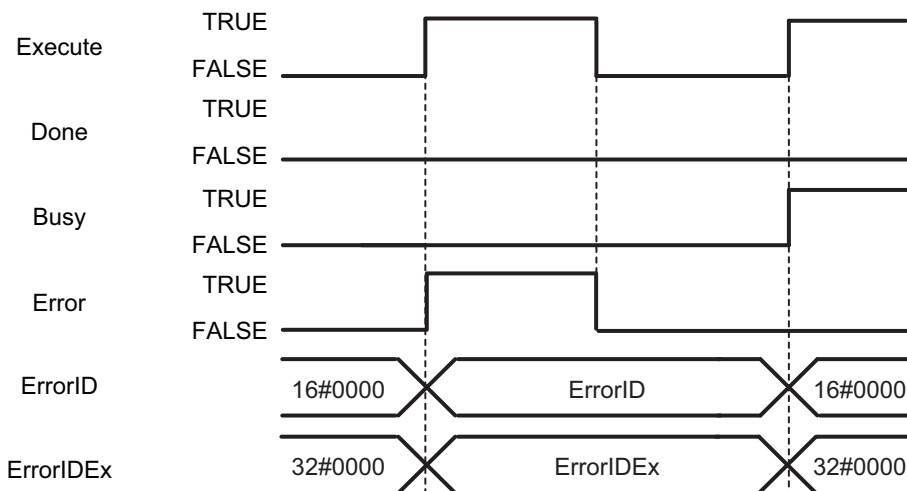

## Troubleshooting

| Error code | Extended error ID | Status                       | Meaning   | Correction   |
|------------|-------------------|------------------------------|---|--|
| 16#0000    | 16#00000000       | The service ended normally.  | ---   | ---  |
| 16#3C38    | 16#00000001       | Robot controller error       | Error occurs in the robot controller.   | Check the RobotError variable output in ARB_RobotControl and perform corrections for the error.                                |
|            | 16#00000002       | Communication error          | Ethernet/IP communication error   | Execute the instruction after the successful EtherNet/IP communication recovery.   |
|            | 16#00000003       | Invalid operation            | The instruction could not be executed in this controller state.<br><i>See Execution Conditions Table on page 174.</i> | Execute the instruction after the function block is ready for execution.   |
|            | 16#00000004       | Re-execution disabled        | Instruction cannot be re-executed   | Wait for the Done variable output changes to TRUE and then execute the function block again.                                   |
|            | 16#00000005       | Multi-execution disabled     | Multiple instructions that cannot be executed simultaneously were executed for the same target.                       | Wait for the Done variable output in the previously executed instructions changes to TRUE and then execute the function block. |
|            | 16#00000006       | Location Number Out of Range | The value specified the input variable LocationNumber is out of range.  | Set the LocationNumber within range.   |

# ARB\_InputOutputSignals

The scope of the ARB\_InputOutputSignals instruction is to communicate with the robot controller through its digital input and outputs.

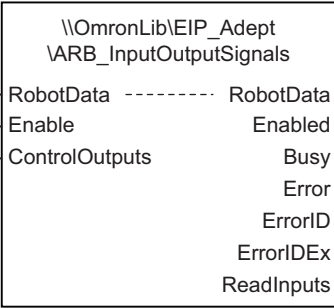
| Instruction                 | Name                      | FB/<br>FUN | Graphic expression  | ST expression  |
|-----------------------------|---------------------------|------------|---|--|
| ARB_Input-<br>OutputSignals | Input Output Sig-<br>nals | FB         | <p>ARB_InputOutputSignals_instance</p>  | <pre>ARB_InputOutputSignals_in- stance( RobotData:=parameter, Enable:=parameter, ControlOutputs:=parameter, Enabled =&gt;parameter, Busy =&gt;parameter, Error =&gt;parameter, ErrorID=&gt;parameter, ErrorIDEx=&gt;parameter, ReadInputs=&gt;parameter );</pre> |

## Variables

### Input Variables

| Name           | Meaning   | Data type              | Valid range   | Default   | Description  |
|----------------|---|------------------------|---------------|-----------|--|
| Enable         | Enable  | BOOL                   | TRUE or FALSE | FALSE     | The instruction is activated when Enable is TRUE.<br>In this moment it reads/writes the inputs/outputs from/to the controller. |
| ControlOutputs | Signals written to the outputs of the robot controller. | sARB_OUTPUTSIGNALS_REF | ---           | All FALSE | A structure that represents all the digital outputs.   |

#### ● sARB\_OUTPUTSIGNALS\_REF

| Member Variable | Meaning            | Data type | Valid range   | Description                |
|-----------------|--------------------|-----------|---------------|----------------------------|
| Output1         | Output Signal 1    | BOOL      | TRUE or FALSE | Digital Output Signal 1    |
| Output2         | Output Signal 2    | BOOL      | TRUE or FALSE | Digital Output Signal 2    |
| Output3         | Output Signal 3    | BOOL      | TRUE or FALSE | Digital Output Signal 3    |
| Output4         | Output Signal 4    | BOOL      | TRUE or FALSE | Digital Output Signal 4    |
| Output5         | Output Signal 5    | BOOL      | TRUE or FALSE | Digital Output Signal 5    |
| Output6         | Output Signal 6    | BOOL      | TRUE or FALSE | Digital Output Signal 6    |
| Output7         | Output Signal 7    | BOOL      | TRUE or FALSE | Digital Output Signal 7    |
| Output8         | Output Signal 8    | BOOL      | TRUE or FALSE | Digital Output Signal 8    |
| Output3001      | Output Signal 3001 | BOOL      | TRUE or FALSE | Digital Output Signal 3001 |
| Output3002      | Output Signal 3002 | BOOL      | TRUE or FALSE | Digital Output Signal 3002 |
| Output3003      | Output Signal 3003 | BOOL      | TRUE or FALSE | Digital Output Signal 3003 |
| Output3004      | Output Signal 3004 | BOOL      | TRUE or FALSE | Digital Output Signal 3004 |
| OutReserved1    | Reserved bit 1     | BOOL      | TRUE or FALSE | ---                        |
| OutReserved2    | Reserved bit 2     | BOOL      | TRUE or FALSE | ---                        |
| OutReserved3    | Reserved bit 3     | BOOL      | TRUE or FALSE | ---                        |
| OutReserved4    | Reserved bit 4     | BOOL      | TRUE or FALSE | ---                        |

## Output Variables

| Name       | Meaning   | Data type             | Valid range   | Description  |
|------------|---|-----------------------|---------------|--|
| Enabled    | Done  | BOOL                  | TRUE or FALSE | TRUE when the instruction is started.                        |
| Busy       | Executing   | BOOL                  | TRUE or FALSE | TRUE when the instruction is acknowledged.                   |
| Error      | Error   | BOOL                  | TRUE or FALSE | TRUE while there is an error.                                |
| ErrorID    | Error ID  | WORD                  | *1            | Contains the error code when an error occurs.                |
| ErrorIDEx  | Extended error ID                                     | DWORD                 | *1            | Specify extended error number.                               |
| ReadInputs | Signals read from the inputs of the robot controller. | sARB_INPUTSIGNALS_REF | ---           | A structure that represent all hardware and software inputs. |

\*1. Refer to *Troubleshooting* on page 99 for details.

### ● sARB\_INPUTSIGNALS\_REF

| Member Variable | Meaning           | Data type | Valid range   | Description               |
|-----------------|-------------------|-----------|---------------|---------------------------|
| Input1001       | Input Signal 1001 | BOOL      | TRUE or FALSE | Digital Input Signal 1001 |
| Input1002       | Input Signal 1002 | BOOL      | TRUE or FALSE | Digital Input Signal 1002 |
| Input1003       | Input Signal 1003 | BOOL      | TRUE or FALSE | Digital Input Signal 1003 |
| Input1004       | Input Signal 1004 | BOOL      | TRUE or FALSE | Digital Input Signal 1004 |
| Input1005       | Input Signal 1005 | BOOL      | TRUE or FALSE | Digital Input Signal 1005 |
| Input1006       | Input Signal 1006 | BOOL      | TRUE or FALSE | Digital Input Signal 1006 |
| Input1007       | Input Signal 1007 | BOOL      | TRUE or FALSE | Digital Input Signal 1007 |
| Input1008       | Input Signal 1008 | BOOL      | TRUE or FALSE | Digital Input Signal 1008 |
| Input1009       | Input Signal 1009 | BOOL      | TRUE or FALSE | Digital Input Signal 1009 |
| Input1010       | Input Signal 1010 | BOOL      | TRUE or FALSE | Digital Input Signal 1010 |
| Input1011       | Input Signal 1011 | BOOL      | TRUE or FALSE | Digital Input Signal 1011 |
| Input1012       | Input Signal 1012 | BOOL      | TRUE or FALSE | Digital Input Signal 1012 |
| Input2001       | Input Signal 2001 | BOOL      | TRUE or FALSE | Digital Input Signal 2001 |
| Input2002       | Input Signal 2002 | BOOL      | TRUE or FALSE | Digital Input Signal 2002 |
| Input2003       | Input Signal 2003 | BOOL      | TRUE or FALSE | Digital Input Signal 2003 |
| Input2004       | Input Signal 2004 | BOOL      | TRUE or FALSE | Digital Input Signal 2004 |

**● Output Variable Update Timing**

| Name    | Timing for changing to TRUE   | Timing for changing to FALSE   |
|---------|---|--|
| Enabled | • When <i>Enable</i> changes to TRUE.   | • When <i>Enable</i> changes to FALSE.   |
| Busy    | • When <i>Enable</i> changes to TRUE.   | • When <i>Enable</i> changes to FALSE.<br>• When <i>Error</i> changes to TRUE. |
| Error   | • When there is an error in the execution conditions or input parameters for the instruction. | • When <i>Enable</i> is FALSE  |



## In-out variables

---

| Name      | Meaning               | Data type           | Valid range | Description                                   |
|-----------|-----------------------|---------------------|-------------|---|
| RobotData | Robot controller data | sARB_ROBOT_DATA_REF | ---         | Specify data needed for the robot controller. |

## Function

This instruction writes the value of its *ControlOutputs* variable to the robot controller outputs and it reads the robot controller inputs in its *ReadInputs* variable.

Note When the function block is disabled the signals outputs in the robot controller keep the latest state.

## Timing charts

● Normal execution

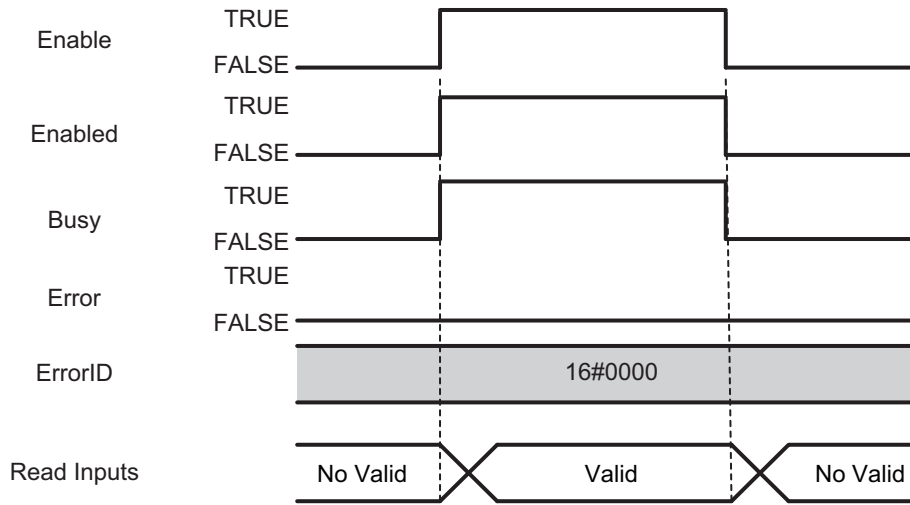

● **Error execution**

If an error occurs during instruction execution, *Error* will change to TRUE. You can find out the cause of the error by referring to the value output by *ErrorID*.

This function block is only affected by the connection error. All other errors will not stop the execution of this FB.

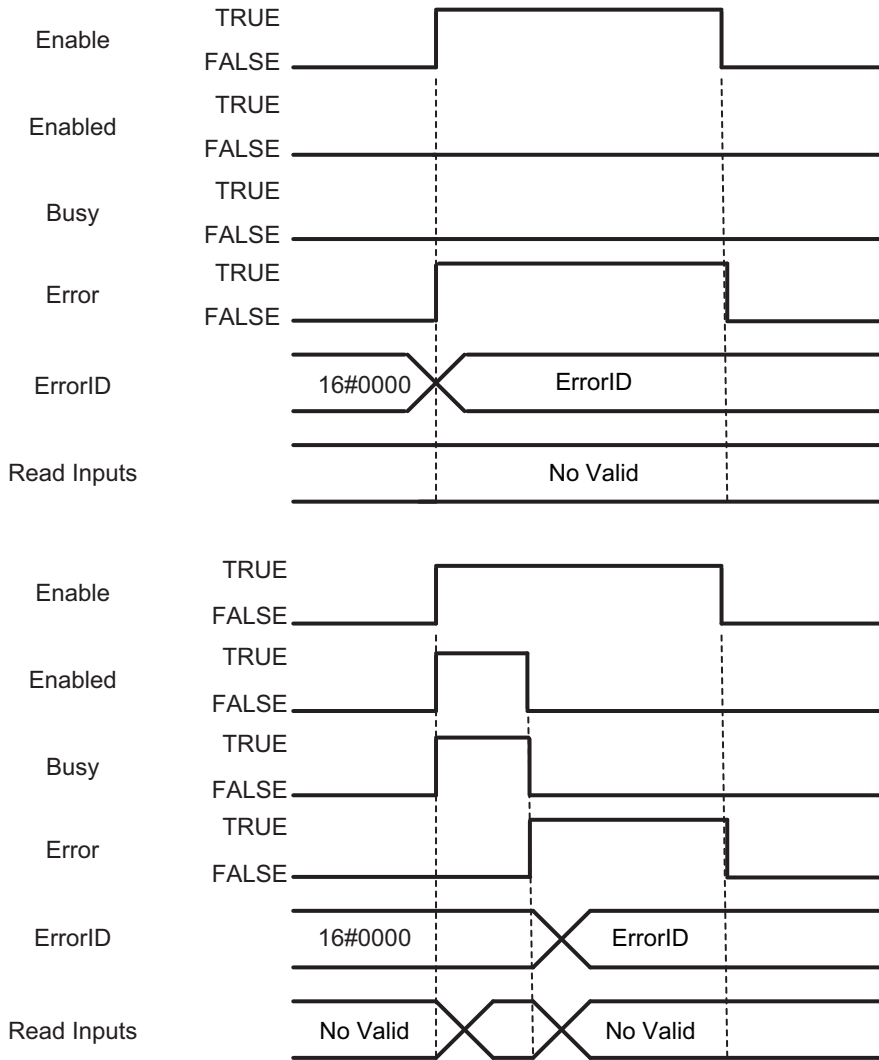

## Troubleshooting

| Error code | Extended error ID | Status                      | Meaning                               | Correction  |
|------------|-------------------|-----------------------------|---------------------------------------|---|
| 16#0000    | 16#00000000       | The service ended normally. | ---                                   | ---   |
| 16#3C39    | 16#00000001       | Robot controller error      | Error occurs in the robot controller. | Check the RobotError variable output in ARB_RobotControl and perform corrections for the error. |
|            | 16#00000002       | Communication error         | Ethernet/IP communication error       | Execute the instruction after the successful EtherNet/IP communication recovery.                |

# ARB\_TeachPendantControl

The ARB\_TeachPendantControl instruction is used to send and receive information from the manual control pendant attached to the robot controller.

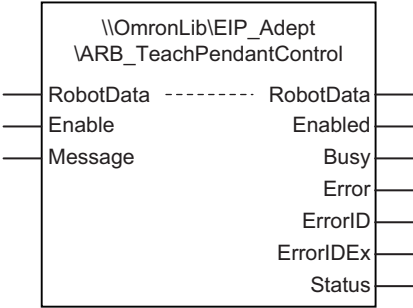
| Instruction             | Name                  | FB/<br>FUN | Graphic expression   | ST expression  |
|-------------------------|-----------------------|------------|--|--|
| ARB_TeachPendantControl | Teach Pendant Control | FB         |  | <pre>ARB_TeachPendantControl_in- stance(   RobotData:=parameter,   Enable:=parameter,   Message:=parameter,   Enabled =&gt;parameter,   Busy =&gt;parameter,   Error =&gt;parameter,   ErrorID=&gt;parameter,   ErrorIDEx=&gt;parameter,   Status=&gt;parameter );</pre> |

## Variables

### Input Variables

| Name    | Meaning | Data type  | Valid range   | Default | Description   |
|---------|---------|------------|---------------|---------|---|
| Enable  | Enable  | BOOL       | TRUE or FALSE | FALSE   | The instruction is executed while <i>Enable</i> is TRUE.<br>In this moment it reads/writes the inputs/outputs from/to the controller. |
| Message | Message | STRING[82] | ---           |         | Text to be written in the screen of the teach pendant.  |

### Output Variables

| Name      | Meaning           | Data type                    | Valid range   | Description  |
|-----------|-------------------|------------------------------|---------------|--|
| Enabled   | Done              | BOOL                         | TRUE or FALSE | TRUE when the instruction is started and teach pendant is connected. |
| Busy      | Executing         | BOOL                         | TRUE or FALSE | TRUE when the instruction is acknowledged.                           |
| Error     | Error             | BOOL                         | TRUE or FALSE | TRUE while there is an error.  |
| ErrorID   | Error Code        | WORD                         | *1            | Contains the error code when an error occurs.                        |
| ErrorIDEx | Extended error ID | DWORD                        | *1            | Specify extended error number.                                       |
| Status    |                   | sARB_TEACHPENDANT_STATUS_REF | ---           |  |

\*1. Refer to *Troubleshooting* on page 107 for details.

● **sARB\_TEACHPENDANT\_STATUS\_REF**

| Member Variable   | Meaning                  | Data type | Valid range                            | Description                                      |
|-------------------|--------------------------|-----------|--|--|
| Speed             | Speed Status             | INT       | Positive number, Negative number, or 0 | Status of Teach Pendant Speed potentiometer      |
| ButtonF1          | Button F1 Status         | BOOL      | TRUE or FALSE                          | Status of Teach Pendant Button F1                |
| ButtonF2          | Button F2 Status         | BOOL      | TRUE or FALSE                          | Status of Teach Pendant Button F2                |
| ButtonF3          | Button F3 Status         | BOOL      | TRUE or FALSE                          | Status of Teach Pendant Button F3                |
| ButtonF4          | Button F4 Status         | BOOL      | TRUE or FALSE                          | Status of Teach Pendant Button F4                |
| ButtonMenu        | Button Menu              | BOOL      | TRUE or FALSE                          | Status of Teach Pendant Button Menu              |
| ButtonOk          | Button Ok                | BOOL      | TRUE or FALSE                          | Status of Teach Pendant Button Ok                |
| ButtonCancel      | Button Cancel            | BOOL      | TRUE or FALSE                          | Status of Teach Pendant Button Cancel            |
| ButtonUp          | Button Up                | BOOL      | TRUE or FALSE                          | Status of Teach Pendant Button Up                |
| ButtonDown        | Button Down              | BOOL      | TRUE or FALSE                          | Status of Teach Pendant Button Down              |
| ButtonLeft        | Button Left              | BOOL      | TRUE or FALSE                          | Status of Teach Pendant Button Left              |
| ButtonRight       | Button Right             | BOOL      | TRUE or FALSE                          | Status of Teach Pendant Button Right             |
| ButtonSelectRobot | Button Select Robot      | BOOL      | TRUE or FALSE                          | Status of Teach Pendant Button Select Robot      |
| ButtonJogMode     | Button JogMode           | BOOL      | TRUE or FALSE                          | Status of Teach Pendant Button JogMode           |
| ButtonSlow        | Button Slow              | BOOL      | TRUE or FALSE                          | Status of Teach Pendant Button Slow              |
| ButtonSpeedMinus  | Button Speed Minus       | BOOL      | TRUE or FALSE                          | Status of Teach Pendant Button Speed Minus       |
| ButtonSpeedPlus   | Button Speed Plus        | BOOL      | TRUE or FALSE                          | Status of Teach Pendant Button Speed Plus        |
| ButtonPosXOrJ1    | Button Positive J1 Or X  | BOOL      | TRUE or FALSE                          | Status of Teach Pendant Button Positive J1 Or X  |
| ButtonNegXOrJ1    | Button Negative J1 Or X  | BOOL      | TRUE or FALSE                          | Status of Teach Pendant Button Negative J1 Or X  |
| ButtonPosYOrJ2    | Button Positive J2 Or Y  | BOOL      | TRUE or FALSE                          | Status of Teach Pendant Button Positive J2 Or Y  |
| ButtonNegYOrJ2    | Button Negative J2 Or Y  | BOOL      | TRUE or FALSE                          | Status of Teach Pendant Button Negative J2 Or Y  |
| ButtonPosZOrJ3    | Button Positive J3 Or Z  | BOOL      | TRUE or FALSE                          | Status of Teach Pendant Button Positive J3 Or Z  |
| ButtonNegZOrJ3    | Button Negative J3 Or Z  | BOOL      | TRUE or FALSE                          | Status of Teach Pendant Button Negative J3 Or Z  |
| ButtonPosRxOrJ4   | Button Positive J4 Or Rx | BOOL      | TRUE or FALSE                          | Status of Teach Pendant Button Positive J4 Or Rx |
| ButtonNegRxOrJ4   | Button Negative J4 Or Rx | BOOL      | TRUE or FALSE                          | Status of Teach Pendant Button Negative J4 Or Rx |
| ButtonPosRyOrJ5   | Button Positive J5 Or Ry | BOOL      | TRUE or FALSE                          | Status of Teach Pendant Button Positive J5 Or Ry |

| Member Variable | Meaning                  | Data type | Valid range   | Description                                      |
|-----------------|--------------------------|-----------|---------------|--|
| ButtonNegRyOrJ5 | Button Negative J5 Or Ry | BOOL      | TRUE or FALSE | Status of Teach Pendant Button Negative J5 Or Ry |
| ButtonPosRzOrJ6 | Button Positive J6 Or Rz | BOOL      | TRUE or FALSE | Status of Teach Pendant Button Positive J6 Or Rz |
| ButtonNegRzOrJ6 | Button Negative J6 Or Rz | BOOL      | TRUE or FALSE | Status of Teach Pendant Button Negative J6 Or Rz |

### ● Output Variable Update Timing

| Name    | Timing for changing to TRUE  | Timing for changing to FALSE  |
|---------|--|---|
| Enabled | <ul style="list-style-type: none"> <li>When <i>Enable</i> changes to TRUE and the manual control pendant is attached to the robot controller.</li> </ul> | <ul style="list-style-type: none"> <li>When instruction is active and <i>Enable</i> changes to FALSE.</li> <li>When an mcp connection error occurs</li> </ul> |
| Busy    | <ul style="list-style-type: none"> <li>When <i>Enable</i> changes to TRUE.</li> </ul>  | <ul style="list-style-type: none"> <li>When <i>Enable</i> changes to FALSE.</li> <li>When <i>Error</i> changes to TRUE</li> </ul>                             |
| Error   | <ul style="list-style-type: none"> <li>When there is an error in the execution conditions or input parameters for the instruction.</li> </ul>            | <ul style="list-style-type: none"> <li>When <i>Enable</i> is FALSE</li> </ul>   |



## In-out variables

---

| Name      | Meaning               | Data type           | Valid range | Description                                   |
|-----------|-----------------------|---------------------|-------------|---|
| RobotData | Robot controller data | sARB_ROBOT_DATA_REF | ---         | Specify data needed for the robot controller. |

## Function

- This instruction is used to switch on/off leads in the manual control pendant, send a text message and receive if any button is pressed. Therefore, it only works when there is a manual control pendant attached to the robot controller.
- It applies to the Adept T20 pendant which is used with the Adept SmartController EX. It does not apply to the T1 or T2 pendants (SmartController CX).

## Timing charts

### ● Normal execution

- The manual control pendant (MCP) is attached to the robot controller.

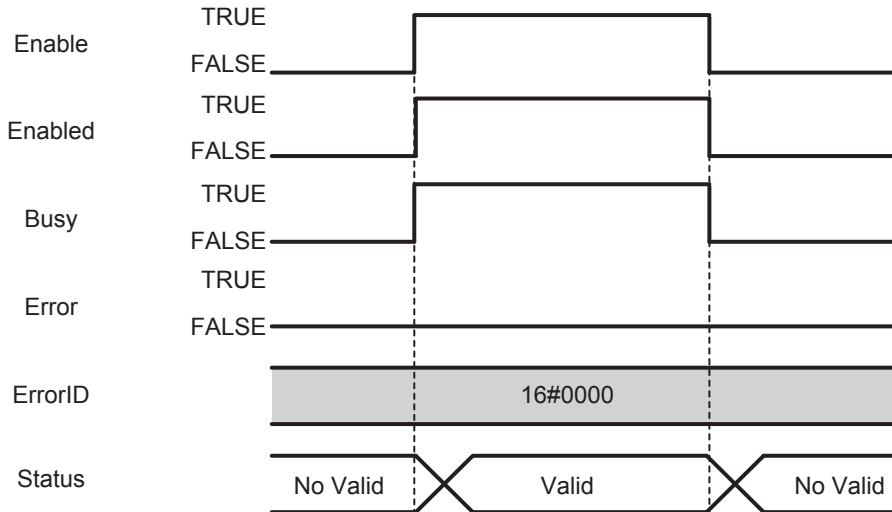

- The manual control pendant (MCP) is not attached to the robot controller.

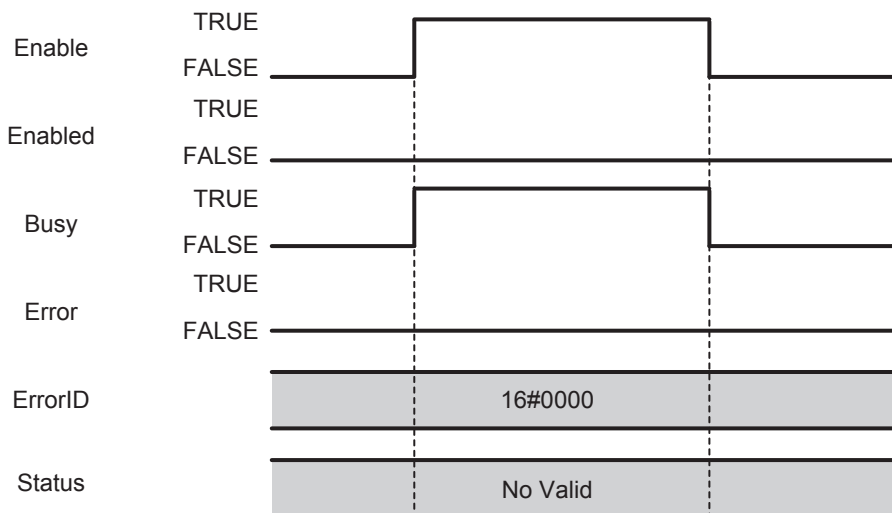

● **Error execution**

If an error occurs during instruction execution, Error will change to TRUE. You can find out the cause of the error by referring to the value output by ErrorID.

This function block is only affected by the connection error. All other errors will not stop the execution of this FB.

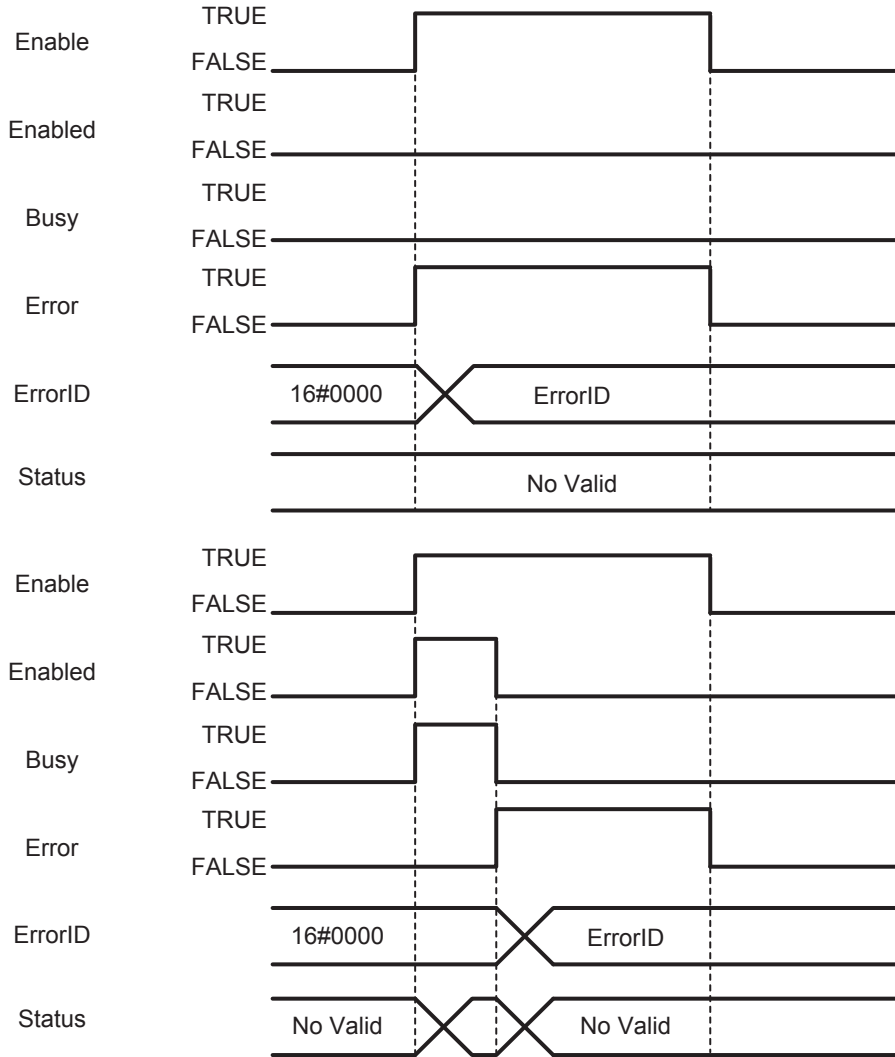

## Troubleshooting

| Error code | Extended error ID | Status                      | Meaning                               | Correction  |
|------------|-------------------|-----------------------------|---------------------------------------|---|
| 16#0000    | 16#00000000       | The service ended normally. | ---                                   | ---   |
| 16#3C3A    | 16#00000001       | Robot controller error      | Error occurs in the robot controller. | Check the RobotError variable output in ARB_RobotControl and perform corrections for the error. |
|            | 16#00000002       | Communication error         | Ethernet/IP communication error       | Execute the instruction after the successful EtherNet/IP communication recovery.                |

# ARB\_ReadLatch

The ARB\_ReadLatch instruction is used to get robot the Cartesian position of the robot when an external trigger is raised.

| Instruction    | Name       | FB/<br>FUN | Graphic expression   | ST expression   |
|----------------|------------|------------|--|---|
| ARB_Read-Latch | Read Latch | FB         | <p style="text-align: center;">ARB_ReadLatch_instance</p> <div style="border: 1px solid black; padding: 5px; margin: 10px auto; width: fit-content;"> <p style="text-align: center;">\\OmronLib\EIP_Adept<br/>ARB_ReadLatch</p> <p>— RobotData ----- RobotData —</p> <p>— Enable Enabled —</p> <p>— ReadLatch Busy —</p> <p style="padding-left: 100px;">Error —</p> <p style="padding-left: 100px;">ErrorID —</p> <p style="padding-left: 100px;">ErrorIDEx —</p> <p style="padding-left: 100px;">IsLatched —</p> <p style="padding-left: 100px;">Position —</p> </div> | <pre>ARB_ReadLatch_instance( RobotData:=parameter, Enable:=parameter, ReadLatch:=parameter, Enabled =&gt;parameter, Busy =&gt;parameter, Error =&gt;parameter, ErrorID=&gt;parameter, ErrorIDEx=&gt;parameter, IsLatched=&gt;parameter, Position=&gt;parameter );</pre> |

## Variables

### Input Variables

| Name      | Meaning            | Data type | Valid range   | Default | Description  |
|-----------|--------------------|-----------|---------------|---------|--|
| Enable    | Enable             | BOOL      | TRUE or FALSE | FALSE   | The instruction is executed while Enable is to TRUE. |
| ReadLatch | Read latch command | BOOL      | TRUE or FALSE | FALSE   | Activate the read latch command                      |

### Output Variables

| Name      | Meaning           | Data type            | Valid range   | Description   |
|-----------|-------------------|----------------------|---------------|---|
| Enabled   | Done              | BOOL                 | TRUE or FALSE | TRUE when the instruction is started.   |
| Busy      | Executing         | BOOL                 | TRUE or FALSE | TRUE when the instruction is active.  |
| Error     | Error             | BOOL                 | TRUE or FALSE | TRUE while there is an error.   |
| ErrorID   | Error Code        | WORD                 | *1            | Contains the error code when an error occurs.   |
| ErrorIDEx | Extended error ID | DWORD                | *1            | Specify extended error number.  |
| IsLatched | Latched           | BOOL                 | TRUE or FALSE | TRUE in case that latch signal was raised in the robot controller, otherwise it is FALSE. otherwise it is FALSE.  |
| Position  | Latched Position  | ARRAY [0..5] OF REAL | ---           | Position of the robot when the latched signal is rised:<br>Position[0]: X axis coordinate<br>Position[1]: Y axis coordinate<br>Position[2]: Z axis coordinate<br>Position[3]: Yaw angle coordinate<br>Position[4]: Pitch angle coordinate<br>Position[5]: Roll angle coordinate |

\*1. Refer to *Troubleshooting* on page 114 for details.

### ● Output Variable Update Timing

| Name    | Timing for changing to TRUE   | Timing for changing to FALSE   |
|---------|---|--|
| Enabled | • When <i>Enable</i> changes to TRUE.   | • When <i>Enable</i> changes to FALSE.   |
| Busy    | • When <i>Enable</i> changes to TRUE.   | • When <i>Enable</i> changes to FALSE.<br>• When <i>Error</i> changes to TRUE. |
| Error   | • When there is an error in the execution conditions or input parameters for the instruction. | • When <i>Enable</i> is FALSE  |

## In-out variables

---

| Name      | Meaning               | Data type           | Valid range | Description                                   |
|-----------|-----------------------|---------------------|-------------|---|
| RobotData | Robot controller data | sARB_ROBOT_DATA_REF | ---         | Specify data needed for the robot controller. |



## Function

- This function returns the Cartesian position of the robot when an external latch signal is raised; this signal is configured in the robot controller.
- When the input ReadLatch is TRUE and an external latch signal is raised the IsLatched output is set to TRUE and the Position output could be read. IsLatched stays TRUE while input ReadLatch is TRUE. Meanwhile all latch signals are detected and the output LatchPosition is updated with the robot position related to the last latch signal.
- When enabling the FB (Enable set to TRUE), the previous latches stored in the Robot controller pile will be cleared automatically. When the Enabled output is TRUE the latch clearing will be completed and then latch inputs using the FB is possible. Clearing the latches can take several RPI. Once the clearing process has been completed, the first latch received (IsLatched=TRUE) is the last latch signal received in the Robot controller.
- Latch Position output is only updated when the IsLatched signal is received (value equal to TRUE)

## Additional Information

Due to the clearing process, user can use only one instance of the FB with the same robot. If 2 or more instances are used, the FBs might hang in the cleaning process forever.

## Timing charts

### ● Normal execution

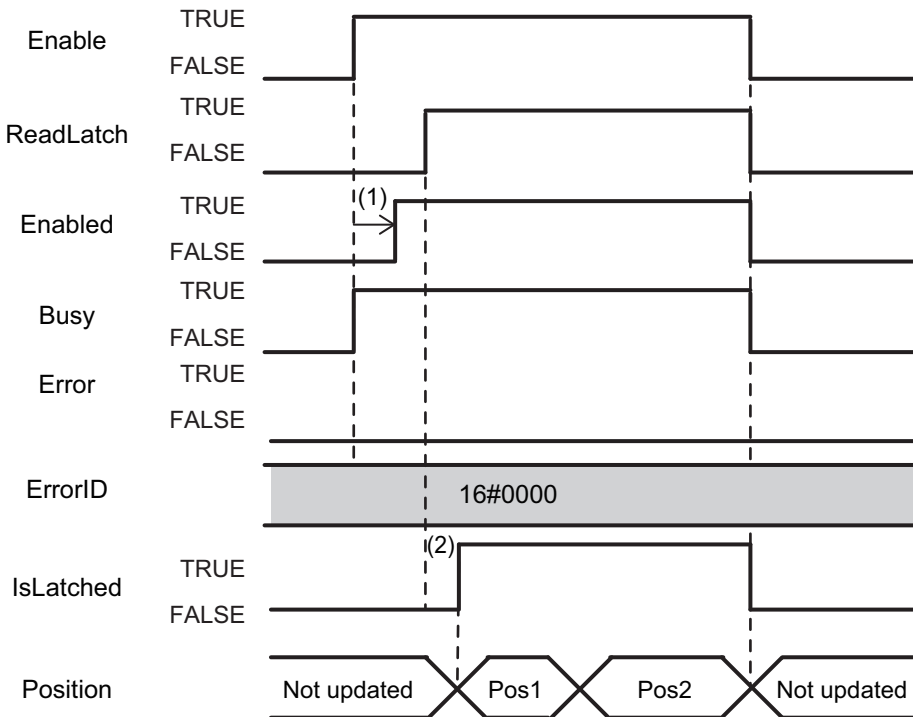
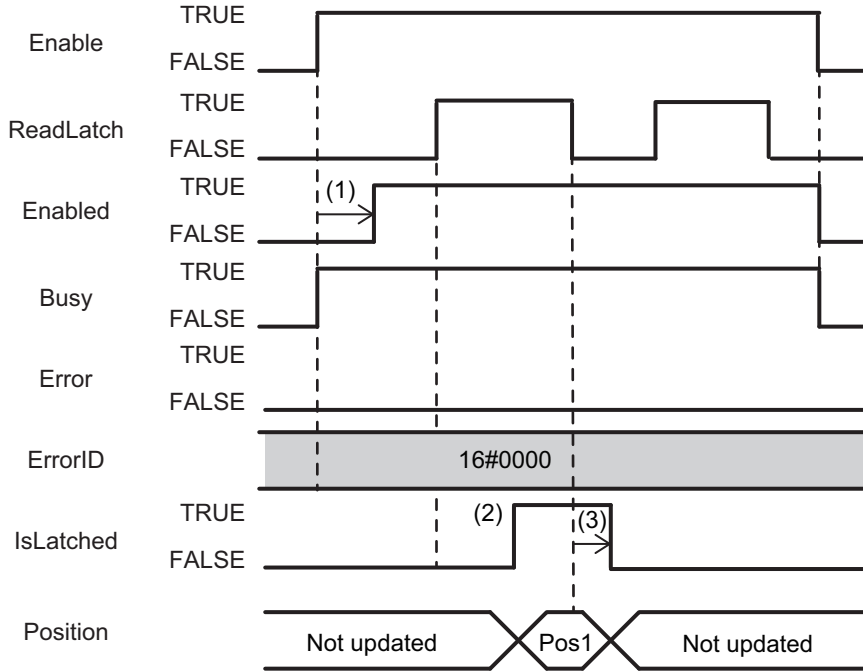

- (1): Time to clear the previous latches
- (2): Latch signal is received
- (3): 1 RPI between ReadLatch input is reset and IsLatched output is reset

● **Error execution**

If an error occurs during instruction execution, *Error* will change to TRUE. You can find out the cause of the error by referring to the value output by *ErrorID*.

This function block is only affected by the connection error. All other errors will not stop the execution of this FB.

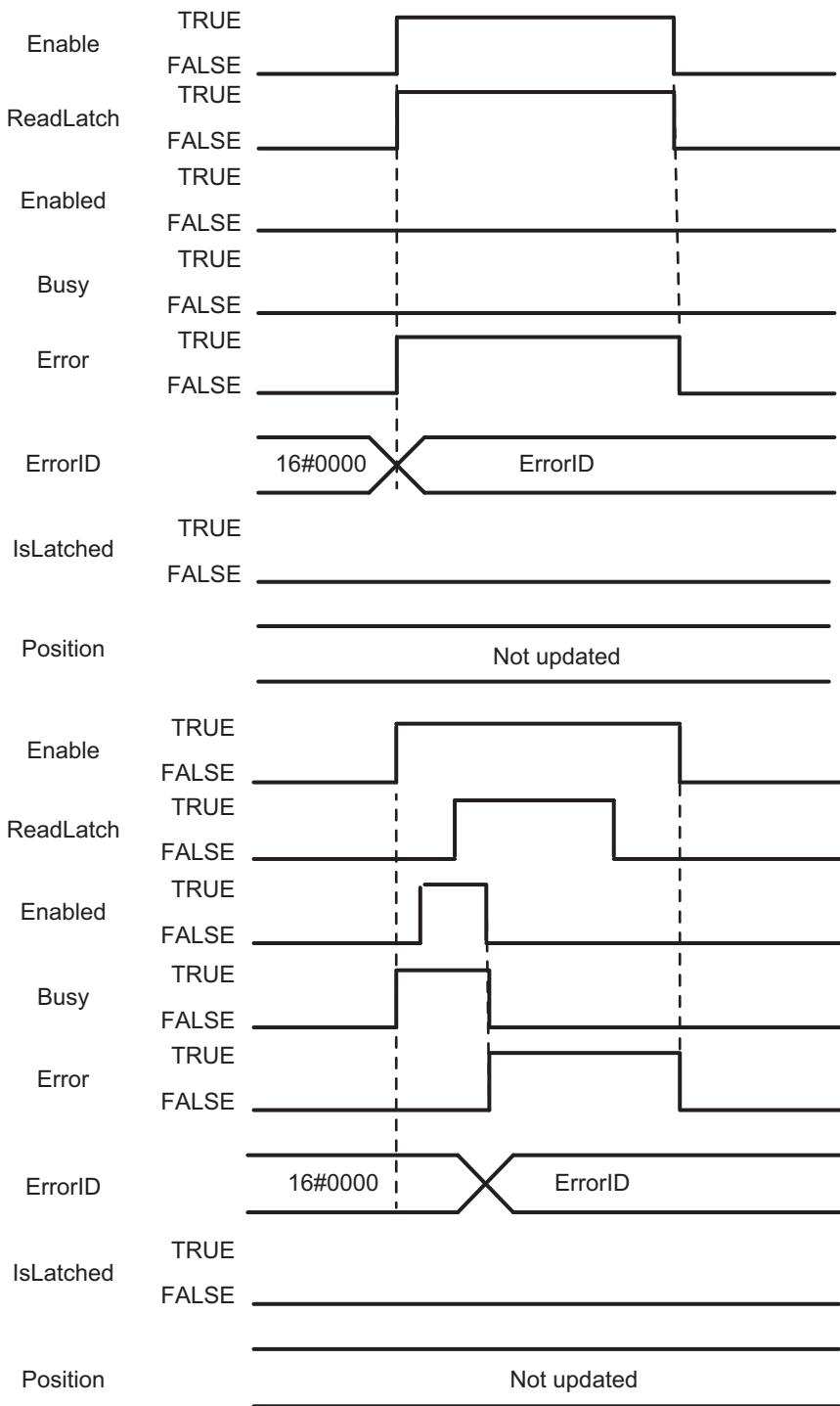

## Troubleshooting

| Error code | Extended error ID | Status                      | Meaning   | Correction  |
|------------|-------------------|-----------------------------|---|---|
| 16#0000    | 16#00000000       | The service ended normally. | ---   | ---   |
| 16#3C3B    | 16#00000001       | Robot controller error      | Error occurs in the robot controller.   | Check the RobotError variable output in ARB_RobotControl and perform corrections for the error. |
|            | 16#00000002       | Communication error         | Ethernet/IP communication error   | Execute the instruction after the successful EtherNet/IP communication recovery.                |
|            | 16#00000003       | Invalid operation           | The instruction could not be executed in this controller state.<br><i>See Execution Conditions Table on page 174.</i> | Execute the instruction after the function block is ready for execution.                        |

# ARB\_MoveCommand

The ARB\_MoveCommand instruction moves the robot to a target position using a linear movement or a point to point operation depending on the user selection.

| Instruction          | Name        | FB/<br>FUN | Graphic expression | ST expression   |
|----------------------|-------------|------------|--------------------|---|
| ARB_Move-<br>Command | MoveCommand | FB         |                    | <pre>ARB_MoveCommand_instance( RobotData:=parameter, Execute:=parameter, Position:=parameter, StraightLineMove:=parameter, Blending:=parameter, MotionParams:=parameter, MoveConfig:=parameter, Done =&gt;parameter, Busy =&gt;parameter, Error =&gt;parameter, ErrorId=&gt;parameter, ErrorIdEx=&gt;parameter );</pre> |

## Variables

### Input Variables

| Name             | Meaning                | Data type              | Valid range   | Default | Description  |
|------------------|------------------------|------------------------|---------------|---------|--|
| Execute          | Execute                | BOOL                   | TRUE or FALSE | FALSE   | The instruction is executed when <i>Execute</i> changes to TRUE.   |
| Position         | Position               | sARB_MOVE_POSITION_REF | ---*1         |         | Sets the parameters used to define the robot target position for the move command.   |
| StraightLineMove | Straight Line movement | BOOL                   | TRUE or FALSE | FALSE   | Defines if the movement will be executed as a linear trajectory in Cartesian space, otherwise as a PTP trajectory.<br>TRUE: Linear Movement<br>FALSE: PTP Movement |
| Blending         | Blending               | BOOL                   | TRUE or FALSE | FALSE   | Enables blending between the executed movement and the next movement executed.<br>TRUE: Blending enabled (Continuous Path)<br>FALSE: No blending enabled           |
| MotionParams     | Motion parameters      | sARB_MOTION_PARAMS_REF | ---*1         | ---     | Set the motion parameters.   |
| MoveConfig       | Motion Configuration   | sARB_MOVE_CONFIG_REF   | ---*1         | ---     | Sets the motion configuration settings.  |

\*1. See structure definition

## Output Variables

| Name      | Meaning           | Data type | Valid range   | Description  |
|-----------|-------------------|-----------|---------------|--|
| Done      | Done              | BOOL      | TRUE or FALSE | TRUE when the instruction is acknowledged by the robot controller. |
| Busy      | Executing         | BOOL      | TRUE or FALSE | TRUE when the instruction is being executed.                       |
| Error     | Error             | BOOL      | TRUE or FALSE | TRUE while there is an error.                                      |
| ErrorID   | Error ID          | WORD      | *1            | Contains the error code when an error occurs.                      |
| ErrorIDEx | Extended error ID | DWORD     | *1            | Specify extended error number.                                     |

\*1. Refer to *Troubleshooting* on page 121 for details.

### ● Output Variable Update Timing

| Name  | Timing for changing to TRUE   | Timing for changing to FALSE   |
|-------|---|--|
| Done  | <ul style="list-style-type: none"> <li>When instruction is acknowledge by the robot controller.</li> </ul>                                    | <ul style="list-style-type: none"> <li>When <i>Execute</i> changes to FALSE.</li> <li>After one control period when <i>Execute</i> is FALSE.</li> <li>When <i>Error</i> changes to TRUE</li> </ul> |
| Busy  | <ul style="list-style-type: none"> <li>When <i>Execute</i> changes to TRUE.</li> </ul>  | <ul style="list-style-type: none"> <li>When <i>Done</i> changes to TRUE.</li> <li>When <i>Error</i> changes to TRUE</li> </ul>   |
| Error | <ul style="list-style-type: none"> <li>When there is an error in the execution conditions or input parameters for the instruction.</li> </ul> | <ul style="list-style-type: none"> <li>When <i>Execute</i> changes to FALSE.</li> </ul>  |

## In-Out Variables

| Name      | Meaning               | Data type           | Valid range | Description                                   |
|-----------|-----------------------|---------------------|-------------|---|
| RobotData | Robot controller data | sARB_ROBOT_DATA_REF | ---         | Specify data needed for the robot controller. |

## Function

- This instruction moves the robot from the current position to the target position specified in the position input variable.
- If the StraightLineMov input variable is TRUE then the movement will be done using a linear movement, otherwise it will execute a point to point operation.
- Changing the arm configuration (Righty, Flip and Below configurations) is only effective in the robot when working in Cartesian coordinates and the linear movement has not been selected (PTP movement).
- When AbsoluteApproach input variable is set to TRUE, ApproachHeight input variable is used as absolute target position of Z coordinate.  
The TRUE of AbsoluteApproach is preceded to the TRUE of Relative input variable.
- The configuration in the CoarseNulling input variable is only effective when Blending input variable is set to FALSE.
- Target position is provided by the Position input:
  - In case LocationNumber is higher than zero, this pre-defined position will be used.
  - In case LocationNumber is zero and PalletNumber is different than zero, the movement will be relative to the pallet. PalletNumber, PalletIndex and Position array will be used.
  - In the case that LocationNumber and PalletNumber are both equal to zero. Position array will be used as target position.
- Once the command has been completed (Done output is TRUE) another command can be executed. If the Blending input of the first one is TRUE, the second command will be blended before the first one achieves its target position. If not, the first command will achieve its target position and later the second command will start.
- Cancel Motion input can stop the movement once it has been commanded (Done output is TRUE).



## Timing charts

### ● Normal execution

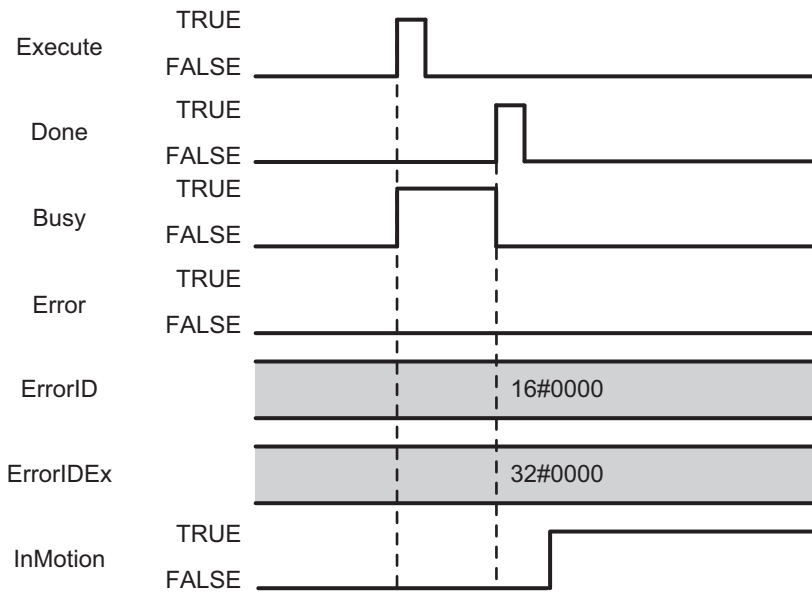

● Error execution

If an error occurs during instruction execution, *Error* will change to TRUE. You can find out the cause of the error by referring to the value output by *ErrorID* and *ErrorIDEx*.

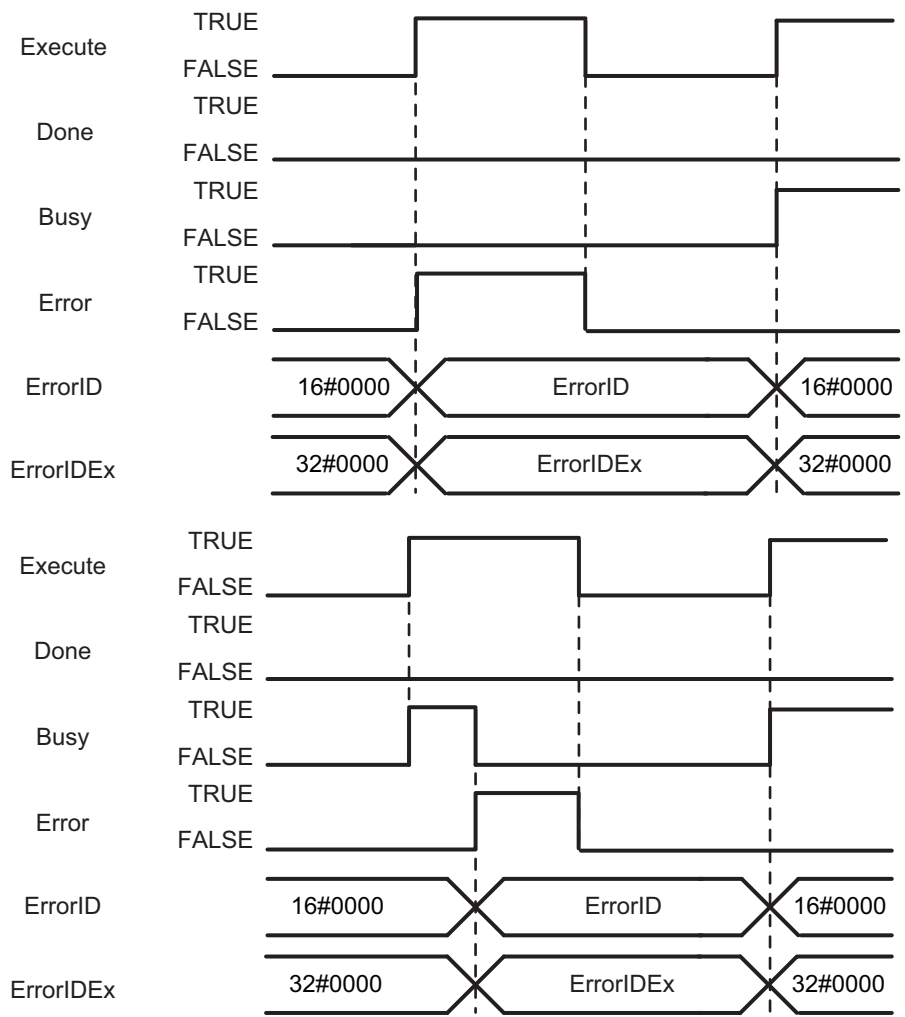

## Troubleshooting

| Error code  | Extended error ID        | Status   | Meaning   | Correction   |
|-------------|--------------------------|--|---|--|
| 16#0000     | 16#00000000              | The service ended normally.  | ---   | ---  |
| 16#3C3C     | 16#00000001              | Robot controller error   | Error occurs in the robot controller.   | Check the RobotError variable output in ARB_RobotControl and perform corrections for the error.                                |
|             | 16#00000002              | Communication error  | Ethernet/IP communication error   | Execute the instruction after the successful EtherNet/IP communication recovery.   |
|             | 16#00000003              | Invalid operation  | The instruction could not be executed in this controller state.<br><i>See Execution Conditions Table on page 174.</i> | Execute the instruction after the function block is ready for execution.   |
|             | 16#00000004              | Re-execution disabled  | Instruction cannot be re-executed   | Wait for the Done variable output changes to TRUE and then execute the function block again.                                   |
|             | 16#00000005              | Multi-execution disabled   | Multiple instructions that cannot be executed simultaneously were executed for the same target.                       | Wait for the Done variable output in the previously executed instructions changes to TRUE and then execute the function block. |
|             | 16#00000006              | Location Number Out of Range   | The value specified for the parameter LocationNumber in the input variable Position is out of range.                  | Set the LocationNumber within range.   |
|             | 16#00000007              | Pallet Number Out of Range   | The value specified for the parameter PalletNumber in the input variable Position is out of range.                    | Set the PalletNumber within range.   |
|             | 16#0000000B              | Speed Out of Range   | The value specified for the parameter Speed in the input variable MotionParams is out of range.                       | Set the Speed within range.  |
|             | 16#0000000C              | Acceleration Out of Range  | The value specified for the parameter Acceleration in the input variable MotionParams is out of range.                | Set the Acceleration within range.   |
|             | 16#0000000D              | Deceleration Out of Range  | The value specified for the parameter Deceleration in the input variable MotionParams is out of range.                | Set the Deceleration within range.   |
|             | 16#0000000E              | Acceleration Type Selection Out of Range   | The value specified for the parameter AccelerationProfile in the input variable MotionParams is out of range.         | Set the AccelerationProfile within range.  |
| 16#0000000F | Speed Limit Out of Range | The value specified for the parameter SpeedLimit in the input variable MotionParams is out of range. | Set the SpeedLimit within range.  |  |

| Error code | Extended error ID | Status                      | Meaning   | Correction  |
|------------|-------------------|-----------------------------|---|---|
| 16#3C3C    | 16#0000012        | Illegal Motion Stop request | Cancel Motion or Stop on Input executed during execution of MoveCommand. Current Movement not started yet, so it cannot be stopped. | Wait for completion of the Current Movement and then execute the instruction again. |
|            | 16#0000013        | Emergency Stop state        | Emergency Stop input has been set during the execution of the instruction   | Reset the Emergency Stop input.   |

# ARB\_PickAndPlaceCommand

The ARB\_PickAndPlaceCommand instruction performs a movement composed by depart, move and approach to a target position.

| Instruction             | Name                | FB/<br>FUN | Graphic expression | ST expression  |
|-------------------------|---------------------|------------|--------------------|--|
| ARB_PickAndPlaceCommand | PickAndPlaceCommand | FB         |                    | <pre>ARB_PickAndPlaceCommand_in- stance( RobotData:=parameter, Execute:=parameter, Position:=parameter, Blending:=parameter, MotionParams:=parameter, MoveConfig:=parameter, Done =&gt;parameter, Busy =&gt;parameter, Error =&gt;parameter, ErrorId=&gt;parameter, ErrorIdEx=&gt;parameter );</pre> |

## Variables

### Input Variables

| Name         | Meaning              | Data type              | Valid range   | Default | Description  |
|--------------|----------------------|------------------------|---------------|---------|--|
| Execute      | Execute              | BOOL                   | TRUE or FALSE | FALSE   | The instruction is executed when <i>Execute</i> changes to TRUE.   |
| Position     | Target position      | sARB_MOVE_POSITION_REF | ---*1         |         | Sets the parameters used to define the robot target position for the movement command.   |
| Blending     | Blending             | BOOL                   | TRUE or FALSE | FALSE   | Enables blending between the executed movement and the next movement executed.<br><br>TRUE: Blending enabled (Continuous Path)<br>FALSE: No blending enabled |
| MotionParams | Motion parameters    | sARB_MOTION_PARAMS_REF | ---*1         |         | Set the motion parameters.   |
| MoveConfig   | Motion Configuration | sARB_MOVE_CONFIG_REF   | ---*1         |         | Sets the motion configuration settings.  |

\*1. See structure definition

## Output Variables

| Name      | Meaning           | Data type | Valid range   | Description  |
|-----------|-------------------|-----------|---------------|--|
| Done      | Done              | BOOL      | TRUE or FALSE | TRUE when the instruction is acknowledged by the robot controller. |
| Busy      | Executing         | BOOL      | TRUE or FALSE | TRUE when the instruction is being executed.                       |
| Error     | Error             | BOOL      | TRUE or FALSE | TRUE while there is an error.                                      |
| ErrorID   | Error ID          | WORD      | *1            | Specify error number.  |
| ErrorIDEx | Extended error ID | DWORD     | *1            | Specify extended error number.                                     |

\*1. Refer to *Troubleshooting* on page 128 for details.

### ● Output Variable Update Timing

| Name  | Timing for changing to TRUE   | Timing for changing to FALSE   |
|-------|---|--|
| Done  | <ul style="list-style-type: none"> <li>When instruction is acknowledged by the robot controller.</li> </ul>                                   | <ul style="list-style-type: none"> <li>When <i>Execute</i> changes to FALSE.</li> <li>After one control period when <i>Execute</i> is FALSE.</li> <li>When <i>Error</i> changes to TRUE</li> </ul> |
| Busy  | <ul style="list-style-type: none"> <li>When <i>Execute</i> changes to TRUE.</li> </ul>  | <ul style="list-style-type: none"> <li>When <i>Done</i> changes to TRUE.</li> <li>When <i>Error</i> changes to TRUE</li> </ul>   |
| Error | <ul style="list-style-type: none"> <li>When there is an error in the execution conditions or input parameters for the instruction.</li> </ul> | <ul style="list-style-type: none"> <li>When <i>Execute</i> changes to FALSE.</li> </ul>  |

## In-out variables

| Name      | Meaning               | Data type           | Valid range | Description                                   |
|-----------|-----------------------|---------------------|-------------|---|
| RobotData | Robot controller data | sARB_ROBOT_DATA_REF | ---         | Specify data needed for the robot controller. |

## Function

- This instruction moves the robot from the current position to the target position specified in the position input variable executing a three-motion pick-and-place operation as detailed in image below:

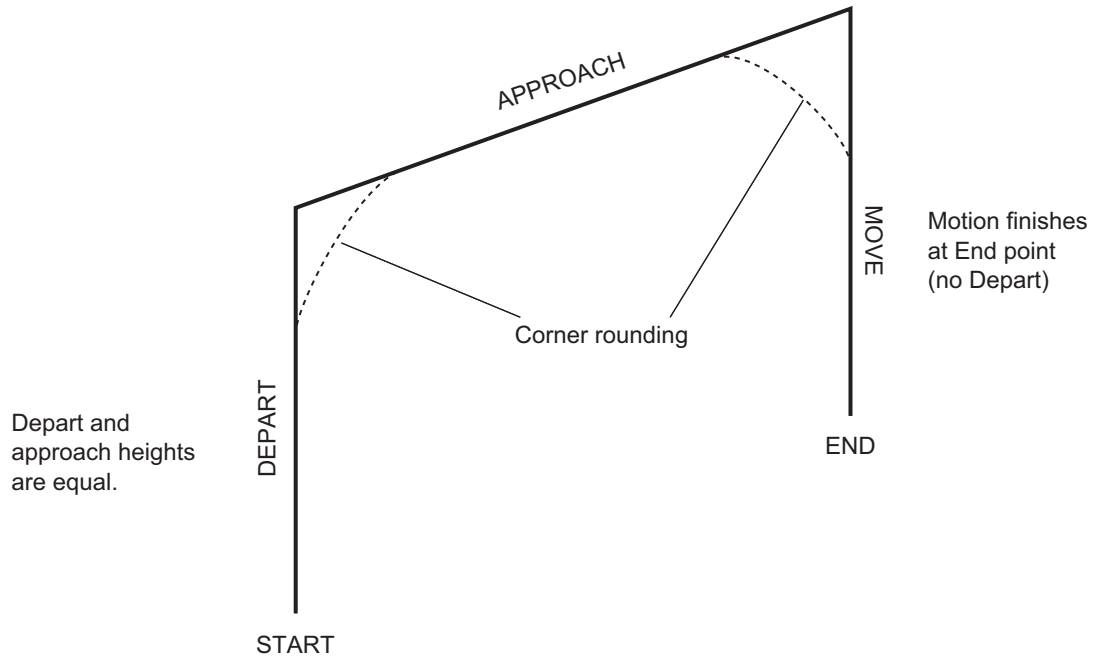

- Pick and Place is composed by 3 linear movements. A Depart from start position along Z axis and Approach to target position along X-Y coordinates and a Move down to end position along Z axis.
- If the Blending input is TRUE the corners will be rounded as shown in the picture above. The distance of the rounding can not be specified.
- Changing the arm configuration is not possible since Pick and Place is always a linear movement.
- When AbsoluteApproach input variable is set to TRUE, ApproachHeight input variable is used as absolute target position of Z coordinate. The TRUE of AbsoluteApproach is preceded to the TRUE of Relative input variable.
- The motion to the final position is always nulled following the precision specified in the CoarseNulling input variable inside the MotionConfig structure.
- Target position is provided by the Position input:
  - In case LocationNumber is higher than zero, this pre-defined position will be used.
  - In case LocationNumber is zero and PalletNumber is different than zero, the movement will be relative to the pallet. PalletNumber, PalletIndex and Position array will be used.
  - In the case that LocationNumber and PalletNumber are both equal to zero. Position array will be used as target position.
- Once the command has been completed (Done output is TRUE) another command can be executed. If the Blending input of the first one is TRUE, the second command will be blended.
- Pick and Place command always achieves its target position, even if the blending input is set to TRUE.
- Cancel Motion input can stop the movement once it has been commanded (Done output is TRUE).

## Timing charts

### ● Normal execution

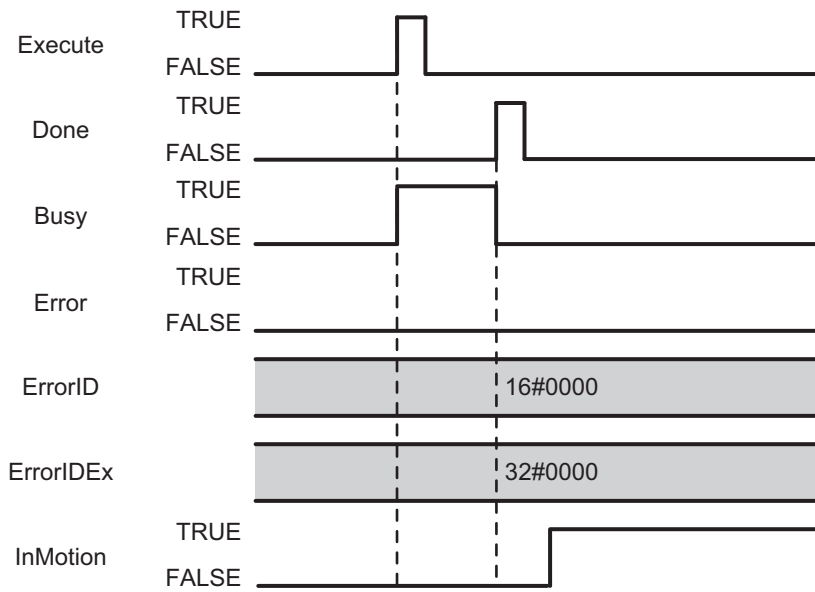



● Error execution

If an error occurs during instruction execution, Error will change to TRUE. You can find out the cause of the error by referring to the value output by ErrorID and ErrorIDEx.

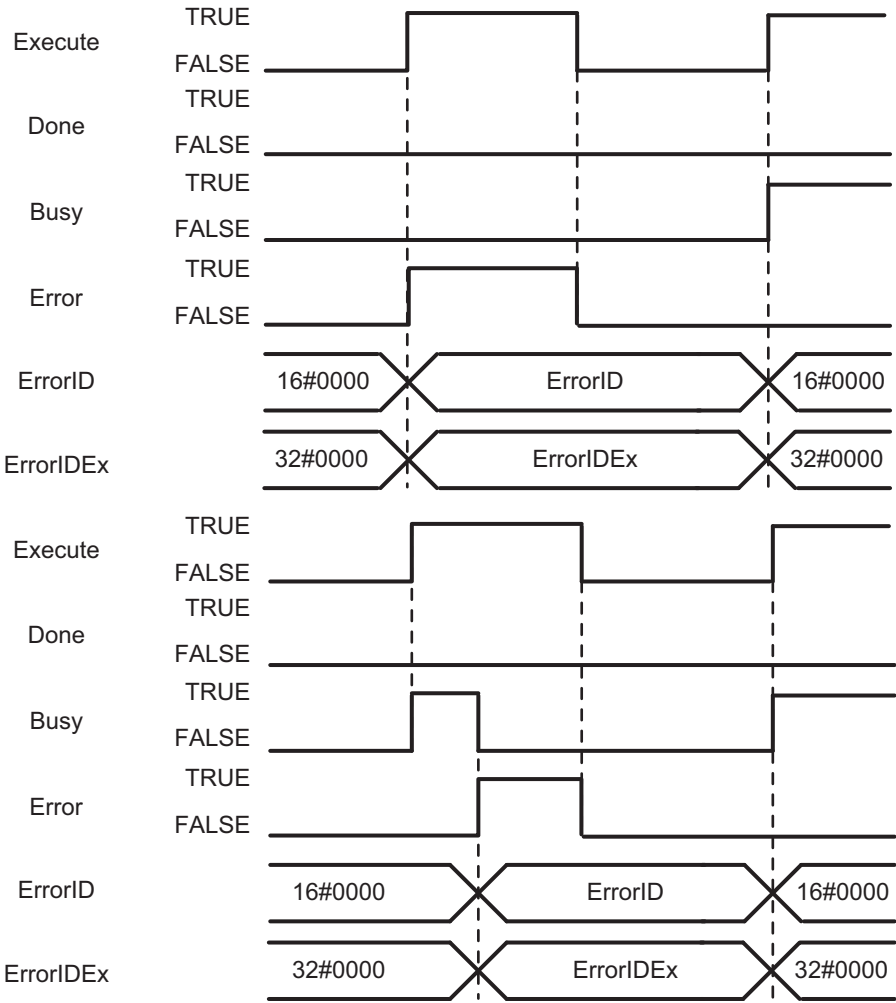

## Troubleshooting

| Error code  | Extended error ID        | Status   | Meaning   | Correction   |
|-------------|--------------------------|--|---|--|
| 16#0000     | 16#00000000              | The service ended normally.  | ---   | ---  |
| 16#3C3F     | 16#00000001              | Robot controller error   | Error occurs in the robot controller.   | Check the RobotError variable output in ARB_RobotControl and perform corrections for the error.                                |
|             | 16#00000002              | Communication error  | Ethernet/IP communication error   | Execute the instruction after the successful EtherNet/IP communication recovery.   |
|             | 16#00000003              | Invalid operation  | The instruction could not be executed in this controller state.<br><i>See Execution Conditions Table on page 174.</i> | Execute the instruction after the function block is ready for execution.   |
|             | 16#00000004              | Re-execution disabled  | Instruction cannot be re-executed   | Wait for the Done variable output changes to TRUE and then execute the function block again.                                   |
|             | 16#00000005              | Multi-execution disabled   | Multiple instructions that cannot be executed simultaneously were executed for the same target.                       | Wait for the Done variable output in the previously executed instructions changes to TRUE and then execute the function block. |
|             | 16#00000006              | Location Number Out of Range   | The value specified for the parameter LocationNumber in the input variable Position is out of range.                  | Set the LocationNumber within range.   |
|             | 16#00000007              | Pallet Number Out of Range   | The value specified for the parameter PalletNumber in the input variable Position is out of range.                    | Set the PalletNumber within range.   |
|             | 16#0000000B              | Speed Out of Range   | The value specified for the parameter Speed in the input variable MotionParams is out of range.                       | Set the Speed within range.  |
|             | 16#0000000C              | Acceleration Out of Range  | The value specified for the parameter Acceleration in the input variable MotionParams is out of range.                | Set the Acceleration within range.   |
|             | 16#0000000D              | Deceleration Out of Range  | The value specified for the parameter Deceleration in the input variable MotionParams is out of range.                | Set the Deceleration within range.   |
|             | 16#0000000E              | Acceleration Type Selection Out of Range   | The value specified for the parameter AccelerationProfile in the input variable MotionParams is out of range.         | Set the AccelerationProfile within range.  |
| 16#0000000F | Speed Limit Out of Range | The value specified for the parameter SpeedLimit in the input variable MotionParams is out of range. | Set the SpeedLimit within range.  |  |

| Error code | Extended error ID | Status                      | Meaning   | Correction  |
|------------|-------------------|-----------------------------|---|---|
| 16#3C3F    | 16#00000012       | Illegal Motion Stop request | Cancel Motion or Stop on Input executed during execution of MoveCommand. Current Movement not started yet, so it cannot be stopped. | Wait for completion of the Current Movement and then execute the instruction again. |
|            | 16#00000013       | Emergency Stop state        | Emergency Stop input has been set during the execution of the instruction   | Reset the Emergency Stop input.   |

# ARB\_Jog

The ARB\_Jog instruction moves the specified joint or axis of the robot.

| Instruction    | Name      | FB/<br>FUN | Graphic expression   | ST expression |           |        |         |         |      |               |       |               |         |               |           |               |         |               |  |               |  |                |  |                |  |                |  |                |  |                |  |                |  |              |  |  |
|----------------|-----------|------------|--|---------------|-----------|--------|---------|---------|------|---------------|-------|---------------|---------|---------------|-----------|---------------|---------|---------------|--|---------------|--|----------------|--|----------------|--|----------------|--|----------------|--|----------------|--|----------------|--|--------------|--|--|
| ARB_Jog        | Jog       | FB         | <div style="border: 1px solid black; padding: 5px; margin: 5px auto; width: fit-content;"> <p style="text-align: center;">ARB_Jog_instance</p> <p style="text-align: center;">\\OmronLib\EIP_Adept<br/>ARB_Jog</p> <table style="width: 100%; border-collapse: collapse;"> <tr> <td style="width: 50%; border-right: 1px solid black; padding: 2px;">RobotData</td> <td style="width: 50%; padding: 2px;">RobotData</td> </tr> <tr> <td style="border-right: 1px solid black; padding: 2px;">Enable</td> <td style="padding: 2px;">Enabled</td> </tr> <tr> <td style="border-right: 1px solid black; padding: 2px;">JogMode</td> <td style="padding: 2px;">Busy</td> </tr> <tr> <td style="border-right: 1px solid black; padding: 2px;">PositiveXOrJ1</td> <td style="padding: 2px;">Error</td> </tr> <tr> <td style="border-right: 1px solid black; padding: 2px;">NegativeXOrJ1</td> <td style="padding: 2px;">ErrorID</td> </tr> <tr> <td style="border-right: 1px solid black; padding: 2px;">PositiveYOrJ2</td> <td style="padding: 2px;">ErrorIDEx</td> </tr> <tr> <td style="border-right: 1px solid black; padding: 2px;">NegativeYOrJ2</td> <td style="padding: 2px;">Jogging</td> </tr> <tr> <td style="border-right: 1px solid black; padding: 2px;">PositiveZOrJ3</td> <td></td> </tr> <tr> <td style="border-right: 1px solid black; padding: 2px;">NegativeZOrJ3</td> <td></td> </tr> <tr> <td style="border-right: 1px solid black; padding: 2px;">PositiveRxOrJ4</td> <td></td> </tr> <tr> <td style="border-right: 1px solid black; padding: 2px;">NegativeRxOrJ4</td> <td></td> </tr> <tr> <td style="border-right: 1px solid black; padding: 2px;">PositiveRyOrJ5</td> <td></td> </tr> <tr> <td style="border-right: 1px solid black; padding: 2px;">NegativeRyOrJ5</td> <td></td> </tr> <tr> <td style="border-right: 1px solid black; padding: 2px;">PositiveRzOrJ6</td> <td></td> </tr> <tr> <td style="border-right: 1px solid black; padding: 2px;">NegativeRzOrJ6</td> <td></td> </tr> <tr> <td style="border-right: 1px solid black; padding: 2px;">MotionParams</td> <td></td> </tr> </table> </div> | RobotData     | RobotData | Enable | Enabled | JogMode | Busy | PositiveXOrJ1 | Error | NegativeXOrJ1 | ErrorID | PositiveYOrJ2 | ErrorIDEx | NegativeYOrJ2 | Jogging | PositiveZOrJ3 |  | NegativeZOrJ3 |  | PositiveRxOrJ4 |  | NegativeRxOrJ4 |  | PositiveRyOrJ5 |  | NegativeRyOrJ5 |  | PositiveRzOrJ6 |  | NegativeRzOrJ6 |  | MotionParams |  | <pre>ARB_Jog_instance( Invalid parameter Enable:=parameter, JogMode:=parameter, PositiveXOrJ1:=parameter, NegativeXOrJ1:=parameter, PositiveYOrJ2:=parameter, NegativeYOrJ2:=parameter, PositiveZOrJ3:=parameter, NegativeZOrJ3:=parameter, PositiveRxOrJ4:=parameter, NegativeRxOrJ4:=parameter, PositiveRyOrJ5:=parameter, NegativeRyOrJ5:=parameter, PositiveRzOrJ6:=parameter, NegativeRzOrJ6:=parameter, MotionParams:=parameter, Enabled =&gt;parameter, Busy =&gt;parameter, Error =&gt;parameter, ErrorID=&gt;parameter, ErrorIDEx=&gt;parameter, Jogging=&gt;parameter );</pre> |
| RobotData      | RobotData |            |  |               |           |        |         |         |      |               |       |               |         |               |           |               |         |               |  |               |  |                |  |                |  |                |  |                |  |                |  |                |  |              |  |  |
| Enable         | Enabled   |            |  |               |           |        |         |         |      |               |       |               |         |               |           |               |         |               |  |               |  |                |  |                |  |                |  |                |  |                |  |                |  |              |  |  |
| JogMode        | Busy      |            |  |               |           |        |         |         |      |               |       |               |         |               |           |               |         |               |  |               |  |                |  |                |  |                |  |                |  |                |  |                |  |              |  |  |
| PositiveXOrJ1  | Error     |            |  |               |           |        |         |         |      |               |       |               |         |               |           |               |         |               |  |               |  |                |  |                |  |                |  |                |  |                |  |                |  |              |  |  |
| NegativeXOrJ1  | ErrorID   |            |  |               |           |        |         |         |      |               |       |               |         |               |           |               |         |               |  |               |  |                |  |                |  |                |  |                |  |                |  |                |  |              |  |  |
| PositiveYOrJ2  | ErrorIDEx |            |  |               |           |        |         |         |      |               |       |               |         |               |           |               |         |               |  |               |  |                |  |                |  |                |  |                |  |                |  |                |  |              |  |  |
| NegativeYOrJ2  | Jogging   |            |  |               |           |        |         |         |      |               |       |               |         |               |           |               |         |               |  |               |  |                |  |                |  |                |  |                |  |                |  |                |  |              |  |  |
| PositiveZOrJ3  |           |            |  |               |           |        |         |         |      |               |       |               |         |               |           |               |         |               |  |               |  |                |  |                |  |                |  |                |  |                |  |                |  |              |  |  |
| NegativeZOrJ3  |           |            |  |               |           |        |         |         |      |               |       |               |         |               |           |               |         |               |  |               |  |                |  |                |  |                |  |                |  |                |  |                |  |              |  |  |
| PositiveRxOrJ4 |           |            |  |               |           |        |         |         |      |               |       |               |         |               |           |               |         |               |  |               |  |                |  |                |  |                |  |                |  |                |  |                |  |              |  |  |
| NegativeRxOrJ4 |           |            |  |               |           |        |         |         |      |               |       |               |         |               |           |               |         |               |  |               |  |                |  |                |  |                |  |                |  |                |  |                |  |              |  |  |
| PositiveRyOrJ5 |           |            |  |               |           |        |         |         |      |               |       |               |         |               |           |               |         |               |  |               |  |                |  |                |  |                |  |                |  |                |  |                |  |              |  |  |
| NegativeRyOrJ5 |           |            |  |               |           |        |         |         |      |               |       |               |         |               |           |               |         |               |  |               |  |                |  |                |  |                |  |                |  |                |  |                |  |              |  |  |
| PositiveRzOrJ6 |           |            |  |               |           |        |         |         |      |               |       |               |         |               |           |               |         |               |  |               |  |                |  |                |  |                |  |                |  |                |  |                |  |              |  |  |
| NegativeRzOrJ6 |           |            |  |               |           |        |         |         |      |               |       |               |         |               |           |               |         |               |  |               |  |                |  |                |  |                |  |                |  |                |  |                |  |              |  |  |
| MotionParams   |           |            |  |               |           |        |         |         |      |               |       |               |         |               |           |               |         |               |  |               |  |                |  |                |  |                |  |                |  |                |  |                |  |              |  |  |

## Variables

### Input Variables

| Name           | Meaning            | Data type | Valid range   | Default | Description  |
|----------------|--------------------|-----------|---------------|---------|--|
| Enable         | Enable             | BOOL      | TRUE or FALSE | FALSE   | The instruction is executed when Enable changes to TRUE.   |
| JogMode        | Jog Mode           | INT       | 0 to 2        | 0       | Specify the Jog Mode.<br>0 = World Mode<br>1 = Tool Mode<br>2 = Joint Mode   |
| PositiveXOrJ1  | Positive Jog X/J1  | BOOL      | TRUE or FALSE | FALSE   | When this variable changes to TRUE, the robot starts moving in the positive direction of X or Joint 1.<br>When it changes to FALSE, the robot stops in the positive direction of X or Joint 1.   |
| NegativeXOrJ1  | Negative Jog X/J1  | BOOL      | TRUE or FALSE | FALSE   | When this variable changes to TRUE, the robot starts moving in the negative direction of X or Joint 1.<br>When it changes to FALSE, the robot stops in the negative direction of X or Joint 1.   |
| PositiveYOrJ2  | Positive Jog Y/J2  | BOOL      | TRUE or FALSE | FALSE   | When this variable changes to TRUE, the robot starts moving in the positive direction of Y or Joint 2.<br>When it changes to FALSE, the robot stops in the positive direction of Y or Joint 2.   |
| NegativeYOrJ2  | Negative Jog Y/J2  | BOOL      | TRUE or FALSE | FALSE   | When this variable changes to TRUE, the robot starts moving in the negative direction of Y or Joint 2.<br>When it changes to FALSE, the robot stops in the negative direction of Y or Joint 2.   |
| PositiveZOrJ3  | Positive Jog Z/J3  | BOOL      | TRUE or FALSE | FALSE   | When this variable changes to TRUE, the robot starts moving in the positive direction of Z or Joint 3.<br>When it changes to FALSE, the robot stops in the positive direction of Z or Joint 3.   |
| NegativeZOrJ3  | Negative Jog Z/J3  | BOOL      | TRUE or FALSE | FALSE   | When this variable changes to TRUE, the robot starts moving in the negative direction of Z or Joint 3.<br>When it changes to FALSE, the robot stops in the negative direction of Z or Joint 3.   |
| PositiveRxOrJ4 | Positive Jog Rx/J4 | BOOL      | TRUE or FALSE | FALSE   | When this variable changes to TRUE, the robot starts moving in the positive direction of Rx or Joint 4.<br>When it changes to FALSE, the robot stops in the positive direction of Rx or Joint 4. |

| Name            | Meaning            | Data type                 | Valid range   | Default | Description  |
|-----------------|--------------------|---------------------------|---------------|---------|--|
| NegativeRx-OrJ4 | Negative Jog Rx/J4 | BOOL                      | TRUE or FALSE | FALSE   | When this variable changes to TRUE, the robot starts moving in the negative direction of Rx or Joint 4.<br>When it changes to FALSE, the robot stops in the negative direction of Rx or Joint 4. |
| PositiveRyOrJ5  | Positive Jog Ry/J5 | BOOL                      | TRUE or FALSE | FALSE   | When this variable changes to TRUE, the robot starts moving in the positive direction of Ry or Joint 5.<br>When it changes to FALSE, the robot stops in the positive direction of Ry or Joint 5. |
| NegativeRy-OrJ5 | Negative Jog Ry/J5 | BOOL                      | TRUE or FALSE | FALSE   | When this variable changes to TRUE, the robot starts moving in the negative direction of Ry or Joint 5.<br>When it changes to FALSE, the robot stops in the negative direction of Ry or Joint 5. |
| PositiveRzOrJ6  | Positive Jog Rz/J6 | BOOL                      | TRUE or FALSE | FALSE   | When this variable changes to TRUE, the robot starts moving in the positive direction of Rz or Joint 6.<br>When it changes to FALSE, the robot stops in the positive direction of Rz or Joint 6. |
| NegativeRz-OrJ6 | Negative Jog Rz/J6 | BOOL                      | TRUE or FALSE | FALSE   | When this variable changes to TRUE, the robot starts moving in the negative direction of Rz or Joint 6.<br>When it changes to FALSE, the robot stops in the negative direction of Rz or Joint 6. |
| MotionParams    | Motion Parameters  | sARB - JOG_PAR<br>AMS_REF | ---           | ---     | Set the motion parameters of jog function  |

## Output Variables

| Name      | Meaning           | Data type | Valid range   | Description  |
|-----------|-------------------|-----------|---------------|--|
| Enabled   | Enabled           | BOOL      | TRUE or FALSE | TRUE when the instruction is acknowledged by the robot controller. |
| Busy      | Executing         | BOOL      | TRUE or FALSE | TRUE when the function is being executed.                          |
| Error     | Error             | BOOL      | TRUE or FALSE | TRUE while there is an error.                                      |
| ErrorID   | Error ID          | WORD      | *1            | Specify error number.  |
| ErrorIDex | Extended error ID | DWORD     | *1            | Specify extended error number.                                     |
| Jogging   | Jogging           | BOOL      | TRUE or FALSE | TRUE when the robot is jogging                                     |

\*1. Refer to *Troubleshooting* on page 137 for details.

### ● Output Variable Update Timing

| Name    | Timing for changing to TRUE   | Timing for changing to FALSE  |
|---------|---|---|
| Enabled | <ul style="list-style-type: none"> <li>When instruction is acknowledged by the robot controller.</li> </ul>                                   | <ul style="list-style-type: none"> <li>When <i>Enable</i> changes to FALSE.</li> <li>When <i>Error</i> changes to TRUE</li> </ul> |
| Busy    | <ul style="list-style-type: none"> <li>When <i>Enable</i> is TRUE.</li> </ul>   | <ul style="list-style-type: none"> <li>When <i>Enable</i> changes to FALSE.</li> <li>When <i>Error</i> changes to TRUE</li> </ul> |
| Error   | <ul style="list-style-type: none"> <li>When there is an error in the execution conditions or input parameters for the instruction.</li> </ul> | <ul style="list-style-type: none"> <li>When <i>Enable</i> changes to FALSE.</li> </ul>  |
| Jogging | <ul style="list-style-type: none"> <li>When robot is in jog mode state</li> </ul>   | <ul style="list-style-type: none"> <li>When robot is not in jog mode state.</li> <li>When <i>Error</i> changes to TRUE</li> </ul> |

## In-out variables

| Name      | Meaning               | Data type           | Valid range | Description                                   |
|-----------|-----------------------|---------------------|-------------|---|
| RobotData | Robot controller data | sARB_ROBOT_DATA_REF | ---         | Specify data needed for the robot controller. |

## Function

- The Jog function moves the individual robot axes in jog mode.
- When enable input changes to true the selected jog mode is set (World Mode, Tool Mode or Joint Mode). The point of the robot to be commanded and the coordinate system to base the movement is defined by the Jog Mode.
- If the Jog Mode is set to Joint the jog movement is linked to each robot joint J1 to J6. While, if Jog Mode is set to World or Tool the jog movement is linked to Cartesian coordinates (X, Y, Z) and rotations around them (Rx, Ry, Rz).
- When enable input changes to true and jogging starts to be done in some direction, the movement will continue until enable input changes to false. At that moment, the robot would start to decelerate until it stops.
- Jogging can be only done in one direction at a time. An error is raised in case that more than one direction is selected.
- Jog command cannot be blended with any other motion.
- Jog command cannot be stopped by the CancelMotion option (see ARB\_RobotControl).



## Timing charts

### ● Normal execution

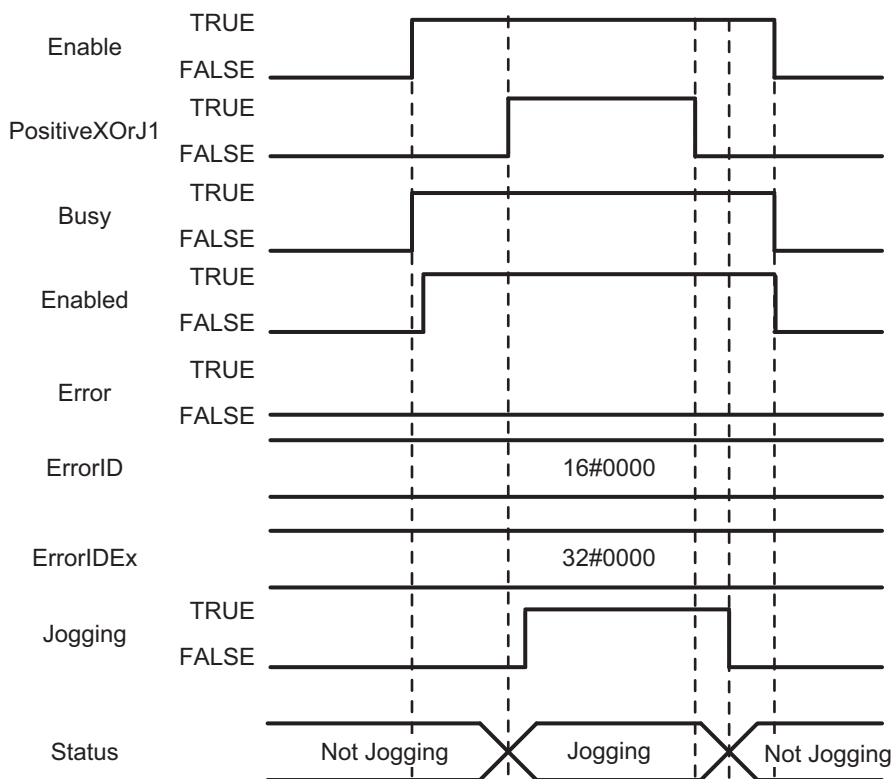

● Error execution

If an error occurs during instruction execution, Error will change to TRUE. You can find out the cause of the error by referring to the value output by ErrorID.

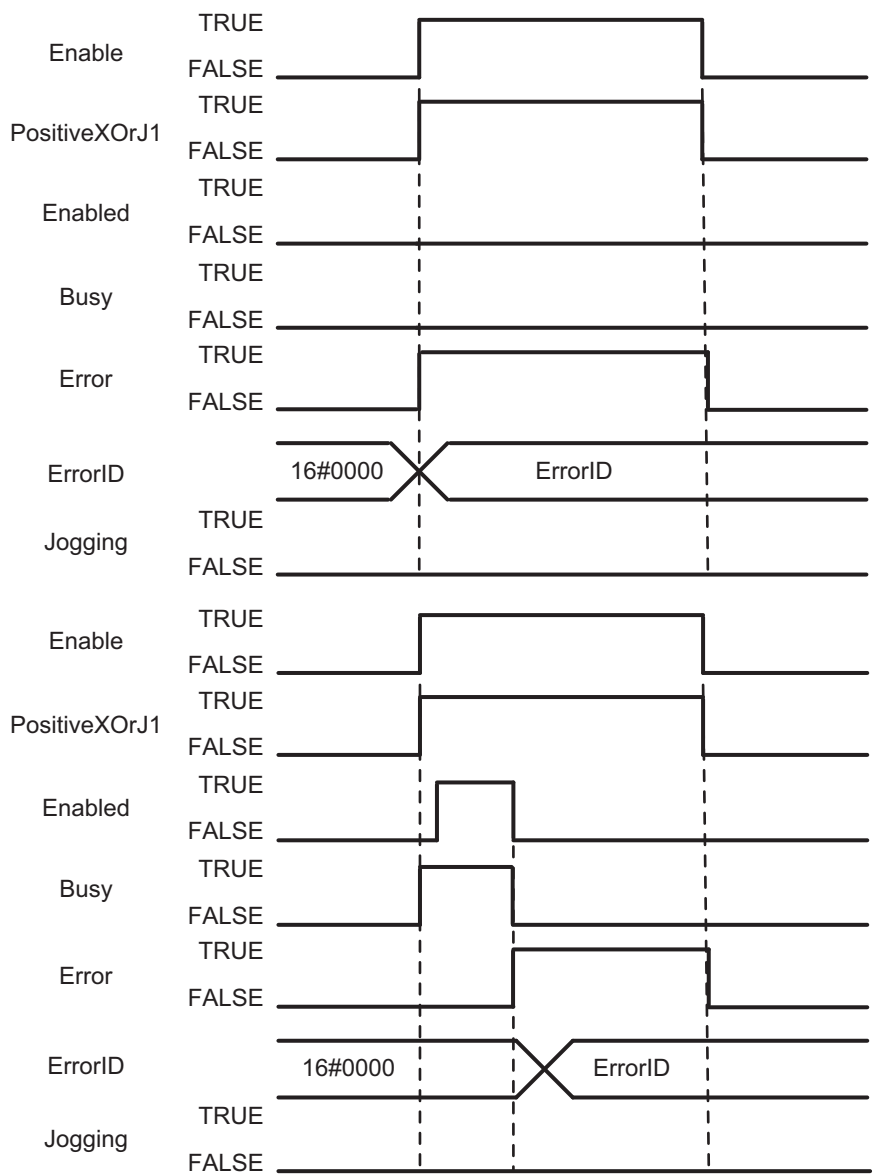

## Troubleshooting

| Error code  | Extended error ID    | Status  | Meaning   | Correction  |
|-------------|----------------------|---|---|---|
| 16#0000     | 16#00000000          | The service ended normally.   | ---   | ---   |
| 16#3C40     | 16#00000001          | Robot controller error  | Error occurs in the robot controller.   | Check the RobotError variable output in ARB_RobotControl and perform corrections for the error. |
|             | 16#00000002          | Communication error   | Ethernet/IP communication error   | Execute the instruction after the successful EtherNet/IP communication recovery.                |
|             | 16#00000003          | Invalid operation   | The instruction could not be executed in this controller state.<br><i>See Execution Conditions Table on page 174.</i> | Execute the instruction after the function block is ready for execution.                        |
|             | 16#00000004          | Re-execution disabled   | Instruction cannot be re-executed   | Wait for the Done variable output changes to TRUE and then execute the function block again.    |
|             | 16#0000000A          | Jog Mode Selection Out of Range   | The value specified for the input variable JogMode is out of range.   | Set the JogMode within range.   |
|             | 16#0000000B          | Speed Out of Range  | The value specified for the parameter Speed in the input variable MotionParams is out of range.                       | Set the Speed within range.   |
|             | 16#0000000C          | Acceleration Out of Range   | The value specified for the parameter Acceleration in the input variable MotionParams is out of range.                | Set the Acceleration within range.  |
|             | 16#0000000D          | Deceleration Out of Range   | The value specified for the parameter Deceleration in the input variable MotionParams is out of range.                | Set the Deceleration within range.  |
|             | 16#0000000E          | Acceleration Type Selection Out of Range                                  | The value specified for the parameter AccelerationProfile in the input variable MotionParams is out of range.         | Set the AccelerationProfile within range.   |
|             | 16#0000000F          | Speed Limit Out of Range  | The value specified for the parameter SpeedLimit in the input variable MotionParams is out of range.                  | Set the SpeedLimit within range.  |
|             | 16#00000011          | More than one direction selected  | More than one direction input is true at the same time.   | Input only one jog signal at a time.  |
| 16#00000013 | Emergency Stop state | Emergency Stop input has been set during the execution of the instruction | Reset the Emergency Stop input.   |   |

# ARB\_AlignToolCommand

The ARB\_AlignTool instruction rotates the tool to be aligned with World Coordinate System of the robot.

| Instruction                    | Name                  | FB/<br>FUN | Graphic expression                   | ST expression  |
|--------------------------------|-----------------------|------------|--------------------------------------|--|
| ARB_Align-<br>ToolCom-<br>mand | AlignToolCom-<br>mand | FB         | <p>ARB_AlignToolCommand_instance</p> | <pre>ARB_AlignToolCommand_in- stance( RobotData :=parameter, Execute :=parameter, Blending :=parameter, MotionParams :=parameter, AlignConfig :=parameter, Done =&gt;parameter, Busy =&gt;parameter, Error =&gt;parameter, ErrorID=&gt;parameter, ErrorIDEx=&gt;parameter );</pre> |

## Variables

### Input Variables

| Name         | Meaning             | Data type                  | Valid range   | Default | Description  |
|--------------|---------------------|----------------------------|---------------|---------|--|
| Execute      | Execute             | BOOL                       | TRUE or FALSE | FALSE   | The instruction is executed when <i>Enable</i> changes to TRUE.  |
| Blending     | Blending            | BOOL                       | TRUE or FALSE | FALSE   | Enables blending between the executed movement and the next movement executed.<br><br>TRUE: Blending enabled (Continuous Path)<br>FALSE: No blending enabled |
| MotionParams | Motion parameters   | sARB_MOTION_PARAMETERS_REF | ---*1         | 0       | Set the motion parameters.   |
| AlignConfig  | Align configuration | sARB_ALIGN_CONFIG_REF      | ---*1         | 0       | Set the align configuration related with the robot movement operation.   |

\*1. See structure definition

## Output Variables

| Name      | Meaning           | Data type | Valid range   | Description   |
|-----------|-------------------|-----------|---------------|---|
| Done      | Done              | BOOL      | TRUE or FALSE | TRUE when the instruction is acknowledge by the robot controller. |
| Busy      | Executing         | BOOL      | TRUE or FALSE | TRUE when the instruction is being executed.                      |
| Error     | Error             | BOOL      | TRUE or FALSE | TRUE while there is an error.                                     |
| ErrorID   | Error ID          | WORD      | *1            | Specify error number.   |
| ErrorIDEx | Extended error ID | DWORD     | *1            | Specify extended error number.                                    |

\*1. Refer to *Troubleshooting* on page 143 for details.

### ● Output Variable Update Timing

| Name  | Timing for changing to TRUE   | Timing for changing to FALSE   |
|-------|---|--|
| Done  | <ul style="list-style-type: none"> <li>When instruction is acknowledge by the robot controller.</li> </ul>                                    | <ul style="list-style-type: none"> <li>When <i>Execute</i> is TRUE and changes to FALSE.</li> <li>After one control period when <i>Execute</i> is FALSE.</li> <li>When <i>Error</i> changes to TRUE</li> </ul> |
| Busy  | <ul style="list-style-type: none"> <li>When <i>Execute</i> changes to TRUE.</li> </ul>  | <ul style="list-style-type: none"> <li>When <i>Done</i> changes to TRUE.</li> <li>When <i>Error</i> changes to TRUE.</li> </ul>  |
| Error | <ul style="list-style-type: none"> <li>When there is an error in the execution conditions or input parameters for the instruction.</li> </ul> | <ul style="list-style-type: none"> <li>When <i>Execute</i> changes to FALSE.</li> </ul>  |

## In-Out Variables

| Name      | Meaning               | Data type           | Valid range | Description                                   |
|-----------|-----------------------|---------------------|-------------|---|
| RobotData | Robot controller data | sARB_ROBOT_DATA_REF | ---         | Specify data needed for the robot controller. |

## Function

- This instruction moves the robot to align robot tool Z-axis with the nearest world axis. All joints of the robot could be moved when alignment movement is executed.
- This function only affects 6-axis robots (Viper)
- Align movement is always a linear movement.
- Once the command has been completed (Done output is TRUE) another command can be executed. If the Blending input of the first one is TRUE, the second command will be blended.
- Align command always achieves its target position, even if the blending input is set to TRUE.
- Cancel Motion input can stop the movement once it has been commanded (Done output is TRUE).

## Timing charts

● Normal execution

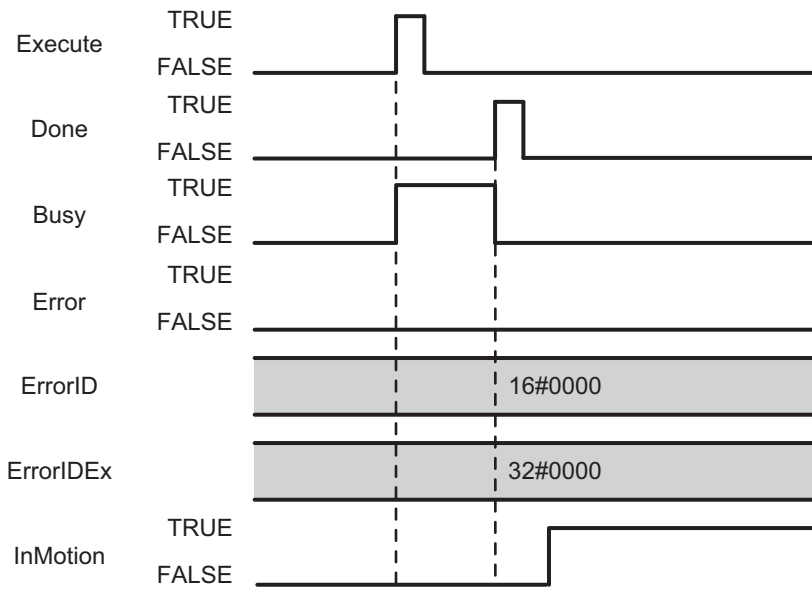

● **Error execution**

If an error occurs during instruction execution, Error will change to TRUE. You can find out the cause of the error by referring to the value output by ErrorID and ErrorIDEx.

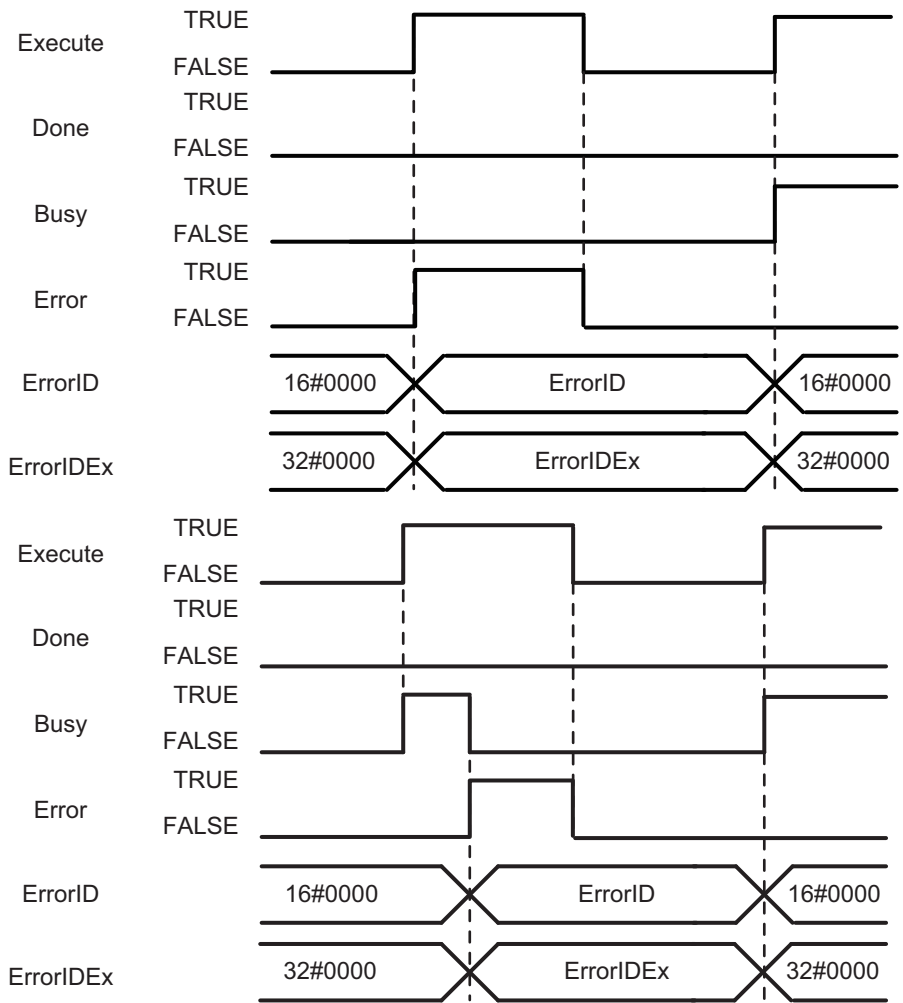



## Troubleshooting

| Error code  | Extended error ID    | Status  | Meaning   | Correction   |
|-------------|----------------------|---|---|--|
| 16#0000     | 16#00000000          | The service ended normally.   | ---   | ---  |
| 16#3C41     | 16#00000001          | Robot controller error  | Error occurs in the robot controller.   | Check the RobotError variable output in ARB_RobotControl and perform corrections for the error.                                |
|             | 16#00000002          | Communication error   | Ethernet/IP communication error   | Execute the instruction after the successful EtherNet/IP communication recovery.   |
|             | 16#00000003          | Invalid operation   | The instruction could not be executed in this controller state.<br>* See <i>Execution Conditions Table</i> on page 174.             | Execute the instruction after the function block is ready for execution.   |
|             | 16#00000004          | Re-execution disabled   | Instruction cannot be re-executed   | Wait for the Done variable output changes to TRUE and then execute the function block again.                                   |
|             | 16#00000005          | Multi-execution disabled  | Multiple instructions that cannot be executed simultaneously were executed for the same target.                                     | Wait for the Done variable output in the previously executed instructions changes to TRUE and then execute the function block. |
|             | 16#0000000B          | Speed Out of Range  | The value specified for the parameter Speed in the input variable MotionParams is out of range.                                     | Set the Speed within range.  |
|             | 16#0000000C          | Acceleration Out of Range   | The value specified for the parameter Acceleration in the input variable MotionParams is out of range.                              | Set the Acceleration within range.   |
|             | 16#0000000D          | Deceleration Out of Range   | The value specified for the parameter Deceleration in the input variable MotionParams is out of range.                              | Set the Deceleration within range.   |
|             | 16#0000000E          | Acceleration Type Selection Out of Range                                  | The value specified for the parameter AccelerationProfile in the input variable MotionParams is out of range.                       | Set the AccelerationProfile within range.  |
|             | 16#0000000F          | Speed Limit Out of Range  | The value specified for the parameter SpeedLimit in the input variable MotionParams is out of range.                                | Set the SpeedLimit within range.   |
|             | 16#00000012          | Illegal Motion Stop request   | Cancel Motion or Stop on Input executed during execution of MoveCommand. Current Movement not started yet, so it cannot be stopped. | Wait for completion of the Current Movement and then execute the instruction again.  |
| 16#00000013 | Emergency Stop state | Emergency Stop input has been set during the execution of the instruction | Reset the Emergency Stop input.   |  |

# ARB\_MoveArcCommand

It moves the robot to the specified target position along arc trajectory.

| Instruction        | Name             | FB/<br>FUN | Graphic expression | ST expression  |
|--------------------|------------------|------------|--------------------|--|
| ARB_MoveArcCommand | Move Arc Command | FB         |                    | <pre>ARB_MoveArcCommand_instance( RobotData:=parameter, Execute:=parameter, Position:= parameter, Blending:=parameter, MotionParams:=parameter, MoveConfig:=parameter, Done =&gt;parameter, Busy =&gt;parameter, Error =&gt;parameter, ErrorID=&gt;parameter, ErrorIDEx=&gt;parameter );</pre> |

## Variables

### Input Variables

| Name         | Meaning              | Data type                  | Valid range   | Default | Description  |
|--------------|----------------------|----------------------------|---------------|---------|--|
| Execute      | Execute              | BOOL                       | TRUE or FALSE | FALSE   | The instruction is executed when Execute changes to TRUE.  |
| Position     | Position             | sARB_MOVEARC_POSITION_REF  | ---           |         | Sets the parameters used to define the robot target position for the movement command.   |
| Blending     | Blending             | BOOL                       | TRUE or FALSE | FALSE   | Enables blending between the executed movement and the next movement executed.<br><br>TRUE: Blending enabled (Continuous Path)<br>FALSE: No blending enabled |
| MotionParams | Motion parameters    | sARB_MOTION_PARAMETERS_REF | ---           |         | Set the motion parameters.   |
| MoveConfig   | Motion configuration | sARB_MOVEARC_CONFIG_REF    | ---           |         | Sets the motion configuration settings.  |

● sARB\_MOVEARC\_POSITION\_REF

| Name                 | Meaning               | Data type            | Valid range                            | Function  |
|----------------------|-----------------------|----------------------|--|---|
| JointCoord           | Joint coordinates     | BOOL                 | TRUE or FALSE                          | Specifies how the robot controller will process the positions.<br>If TRUE position is in Joint coordinates, otherwise is in Cartesian coordinates.  |
| LocationNumber       | Location number       | INT                  | 0 and [2...998]                        | Identifies two positions stored in the robot controller. LocationNumber and LocationNumber+1 are used.<br>When 0, it means that Location Number is not used and IntermediatePosition and EndPosition have to be used instead.   |
| PalletNumber         | Pallet number         | INT                  | 0 to 100                               | Identifies the pallet definition stored in the robot controller to be used.<br>When 0, it means that PalletNumber is not used and IntermediatePosition and EndPosition or Location Number has to be used instead.   |
| PalletIndex          | Pallet index          | INT                  | Non-negative number*1                  | Identifies the destination location within the pallet.  |
| IntermediatePosition | Intermediate position | ARRAY [0..5] OF REAL | Positive number, Negative number, or 0 | Intermediate position of the arc.<br>Position[0]: X axis coordinate or Joint_1<br>Position[1]: Y axis coordinate or Joint_2<br>Position[2]: Z axis coordinate or Joint_3<br>Position[3]: Yaw angle coordinate or Joint_4<br>Position[4]: Pitch angle coordinate or Joint_5<br>Position[5]: Roll angle coordinate or Joint_6 |
| EndPosition          | Final position        | ARRAY [0..5] OF REAL | Positive number, Negative number, or 0 | Final position of the arc.<br>Refer to IntermediatePosition in detail.  |

\*1. When PalletNumber is not 0, PalletIndex has to be set to from one to the number of points in the pallet. The number is determined from the parameters of ARB\_DefinePallet for the definition of the pallet. Otherwise an error will occur in the robot controller, and RobotState.ErrorState output variable in the ARB\_RobotControl will be TRUE.

When PalletNumber is set to 0, PalletIndex allows also negative value and it is ignored.

## ● sARB\_MOVEARC\_CONFIG\_REF

| Name             | Meaning                   | Data type | Valid range                            | Function   |
|------------------|---------------------------|-----------|--|--|
| Relative         | Relative Move             | BOOL      | TRUE or FALSE                          | Determines if the movement is relative to the robot's current position or to absolute coordinates. When TRUE the movement is relative otherwise Absolute is set.   |
| CoarseNulling    | Coarse nulling tolerances | BOOL      | TRUE or FALSE                          | Determines the nulling tolerances that will apply at the end of the motion. When it is TRUE, the tolerance is coarse and the duration time of the robot motion will be shorter. In detail, refer to the <i>ACE User's Guide</i> (Cat. No. I603).         |
| SingleTurn       | Single turn               | BOOL      | TRUE or FALSE                          | Allows full rotations of the robot wrist joints, enabling this bit limits rotations to the range +/- 180 degrees.  |
| AbsoluteApproach | Absolute Approach         | BOOL      | TRUE or FALSE                          | Determines the effect of the defined approach height value.<br>When it is TRUE the robot moves to the specified location using the Approach-Height value as absolute Z.<br>Otherwise ApproachHeight is used as the Z offset from the specified location. |
| Approach-Height  | Approach height value     | REAL      | Positive number, Negative number, or 0 | Value that defines the approach height.  |

## Output Variables

| Name      | Meaning           | Data type | Valid range   | Default | Description  |
|-----------|-------------------|-----------|---------------|---------|--|
| Done      | Done              | BOOL      | TRUE or FALSE | FALSE   | TRUE when the instruction is acknowledged by the robot controller. |
| Busy      | Executing         | BOOL      | TRUE or FALSE | FALSE   | TRUE when the instruction is being executed.                       |
| Error     | Error             | BOOL      | TRUE or FALSE | FALSE   | TRUE while there is an error.                                      |
| ErrorID   | Error code        | WORD      | *1            | 0       | Contains the error code when an error occurs.                      |
| ErrorIDEx | Extended error ID | DWORD     | *1            | 0       | Specify extended error number.                                     |

\*1. Refer to *Troubleshooting* on page 150 for details.

## ● Output Variable Update Timing

| Name  | Timing for changing to TRUE   | Timing for changing to FALSE  |
|-------|---|---|
| Done  | <ul style="list-style-type: none"> <li>When instruction is acknowledge by the robot controller.</li> </ul>                                    | <ul style="list-style-type: none"> <li>When Execute changes to FALSE.</li> <li>After one control period when Execute is FALSE.</li> <li>When Error changes to TRUE</li> </ul> |
| Busy  | <ul style="list-style-type: none"> <li>When Execute changes to TRUE.</li> </ul>   | <ul style="list-style-type: none"> <li>When Done changes to TRUE.</li> <li>When Error changes to TRUE.</li> </ul>   |
| Error | <ul style="list-style-type: none"> <li>When there is an error in the execution conditions or input parameters for the instruction.</li> </ul> | <ul style="list-style-type: none"> <li>When Execute changes to FALSE.</li> </ul>  |

## In-Out Variables

| Name      | Meaning               | Data type           | Valid range | Description                                   |
|-----------|-----------------------|---------------------|-------------|---|
| RobotData | Robot controller data | sARB_ROBOT_DATA_REF | ---         | Specify data needed for the robot controller. |

## Function

- This instruction moves the robot from the current position to the target position passing intermediate position which are specified in the Position input variable, along arc trajectory.

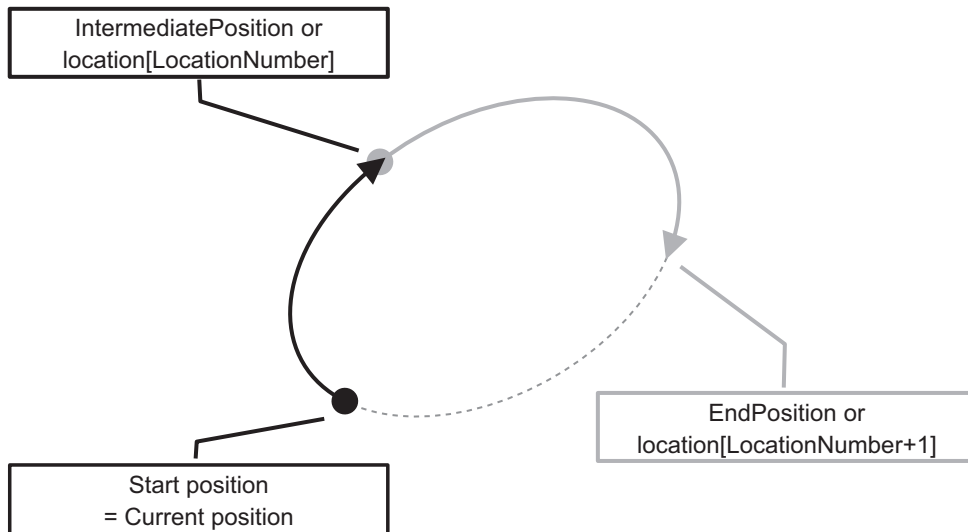

- When AbsoluteApproach input variable is set to TRUE, ApproachHeight input variable is used as absolute target position of Z coordinate. The TRUE of AbsoluteApproach is preceded to the TRUE of Relative input variable.
- The configuration in the CoarseNulling input variable is only effective when Blending input variable is set to false.
- Target position and intermediate position are provided by the Position input:
  - In case LocationNumber is higher than zero, the pre-defined location with LocationNumber is used as the intermediate position, and the location with LocationNumber+1 is used as the target position.
  - In case LocationNumber is zero and PalletNumber is different than zero, the movement will be relative to the pallet. PalletNumber, PalletIndex, IntermediatePosition and EndPosition arrays will be used.
  - In the case that LocationNumber and PalletNumber are both equal to zero. IntermediatePosition and EndPosition arrays will be used as intermediate position and target position.
- Once the command has been completed (Done output is TRUE) another command can be executed. If the Blending input of the first one is TRUE, the second command will be blended before the first one achieves its target position. If not, the first command will achieve its target position and later the second command will start.
- Cancel Motion input can stop the movement once it has been commanded (Done output is TRUE).

## Timing charts

### ● Normal execution

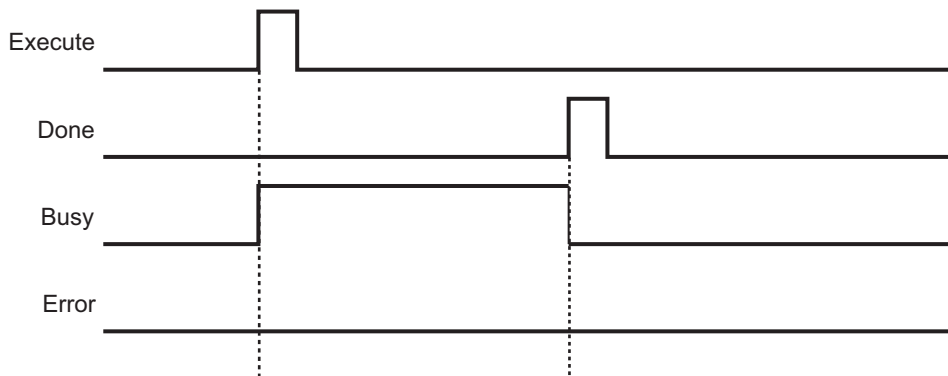

### ● Error execution

If an error occurs during instruction execution, *Error* will change to TRUE. You can find out the cause of the error by referring to the value output by *ErrorID* and *ErrorIDEx*.

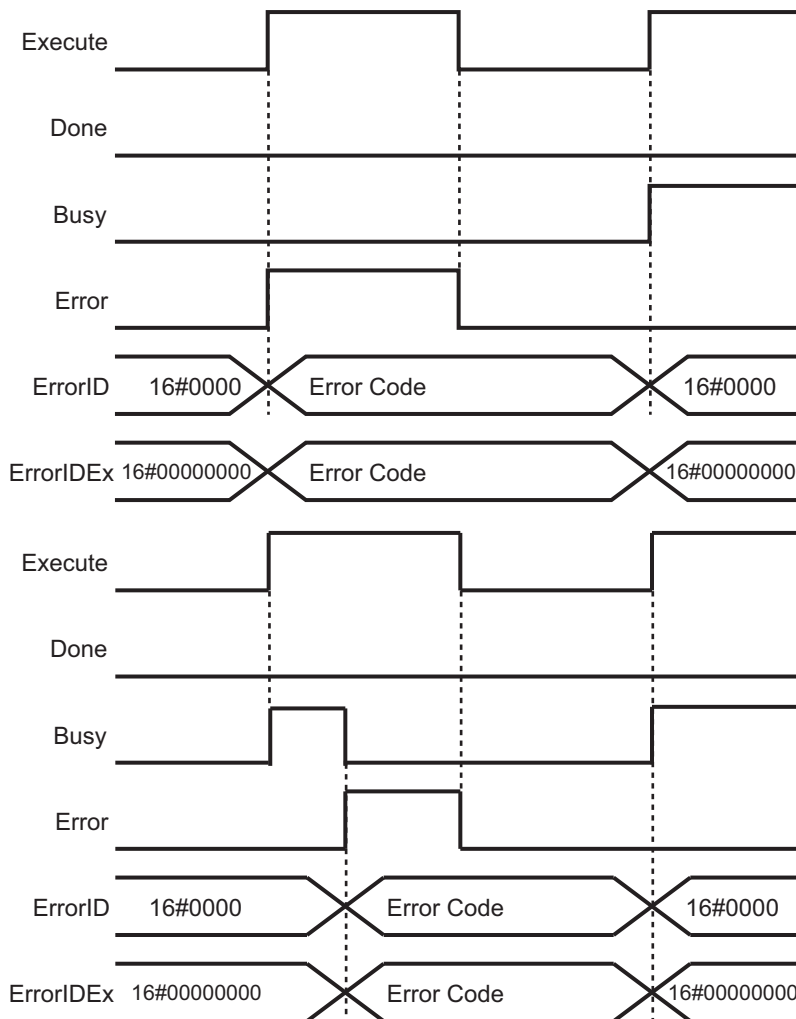

## Troubleshooting

| Error code  | Extended error ID        | Status   | Meaning   | Correction   |
|-------------|--------------------------|--|---|--|
| 16#0000     | 16#00000000              | The service ended normally.  | ---   | ---  |
| 16#3C3D     | 16#00000001              | Robot controller error   | Error occurs in the robot controller.   | Check the RobotError variable output in ARB_RobotControl and perform corrections for the error.                                |
|             | 16#00000002              | Communication error  | Ethernet/IP communication error   | Execute the instruction after the successful EtherNet/IP communication recovery.   |
|             | 16#00000003              | Invalid operation  | The instruction could not be executed in this controller state.<br><i>See Execution Conditions Table on page 174.</i> | Execute the instruction after the function block is ready for execution.   |
|             | 16#00000004              | Re-execution disabled  | Instruction cannot be re-executed   | Wait for the Done variable output changes to TRUE and then execute the function block again.                                   |
|             | 16#00000005              | Multi-execution disabled   | Multiple instructions that cannot be executed simultaneously were executed for the same target.                       | Wait for the Done variable output in the previously executed instructions changes to TRUE and then execute the function block. |
|             | 16#00000006              | Location Number Out of Range   | The value specified for the parameter LocationNumber in the input variable Position is out of range.                  | Set the LocationNumber within range.   |
|             | 16#00000007              | Pallet Number Out of Range   | The value specified for the parameter PalletNumber in the input variable Position is out of range.                    | Set the PalletNumber within range.   |
|             | 16#0000000B              | Speed Out of Range   | The value specified for the parameter Speed in the input variable MotionParams is out of range.                       | Set the Speed within range.  |
|             | 16#0000000C              | Acceleration Out of Range  | The value specified for the parameter Acceleration in the input variable MotionParams is out of range.                | Set the Acceleration within range.   |
|             | 16#0000000D              | Deceleration Out of Range  | The value specified for the parameter Deceleration in the input variable MotionParams is out of range.                | Set the Deceleration within range.   |
|             | 16#0000000E              | Acceleration Type Selection Out of Range   | The value specified for the parameter AccelerationType in the input variable MotionParams is out of range.            | Set the AccelerationType within range.   |
| 16#0000000F | Speed Limit Out of Range | The value specified for the parameter SpeedLimit in the input variable MotionParams is out of range. | Set the SpeedLimit within range.  |  |



| <b>Error code</b> | <b>Extended error ID</b> | <b>Status</b>               | <b>Meaning</b>  | <b>Correction</b>   |
|-------------------|--------------------------|-----------------------------|---|---|
| 16#3C3D           | 16#0000012               | Illegal Motion Stop request | Cancel Motion or Stop on Input executed during execution of MoveCommand. Current Movement not started yet, so it cannot be stopped. | Wait for completion of the Current Movement and then execute the instruction again. |
|                   | 16#0000013               | Emergency Stop state        | Emergency Stop input has been set during the execution of the instruction   | Reset the Emergency Stop input.   |

# ARB\_MoveCircularCommand

It moves the robot along a circular trajectory, passing specified two positions.

| Instruction             | Name                  | FB/<br>FUN | Graphic expression | ST expression   |
|-------------------------|-----------------------|------------|--------------------|---|
| ARB_MoveCircularCommand | Move Circular Command | FB         |                    | <pre>ARB_MoveCircularCommand_instance( RobotData:=parameter, Execute:=parameter, Position:= parameter, Blending:=parameter, MotionParams:=parameter, MoveConfig:=parameter, Done =&gt;parameter, Busy =&gt;parameter, Error =&gt;parameter, ErrorID=&gt;parameter, ErrorIDEx=&gt;parameter );</pre> |

## Variables

### Input Variables

| Name         | Meaning              | Data type                       | Valid range   | Default | Description  |
|--------------|----------------------|---------------------------------|---------------|---------|--|
| Execute      | Execute              | BOOL                            | TRUE or FALSE | FALSE   | The instruction is executed when Execute changes to TRUE.  |
| Position     | Position             | sARB_MOVE-CIRCULAR_POSITION_REF | ---           |         | Sets the parameters used to define the robot target position for the movement command.   |
| Blending     | Blending             | BOOL                            | TRUE or FALSE | FALSE   | Enables blending between the executed movement and the next movement executed.<br><br>TRUE: Blending enabled (Continuous Path)<br>FALSE: No blending enabled |
| MotionParams | Motion parameters    | sARB_MOTION_PARAMETERS_REF      | ---           |         | Set the motion parameters.   |
| MoveConfig   | Motion configuration | sARB_MOVE-CIRCULAR_CONFIG_REF   | ---           |         | Sets the motion configuration settings.  |

### ● sARB\_MOVECIRCULAR\_POSITION\_REF

| Name                   | Meaning                 | Data type            | Valid range                            | Function   |
|------------------------|-------------------------|----------------------|--|--|
| LocationNumber         | Location number         | INT                  | 0 and [2...998]                        | Identifies two positions stored in the robot controller: LocationNumber and LocationNumber+1.<br><br>When 0, it means that Location Number is not used and IntermediatePosition1 and IntermediatePosition2 have to be used instead.  |
| PalletNumber           | Pallet number           | INT                  | 0 to 100                               | Identifies the pallet definition stored in the robot controller to be used.<br><br>When 0, it means that PalletNumber is not used and Position or Location Number has to be used instead.  |
| PalletIndex            | Pallet index            | INT                  | Non-negative number*1                  | Identifies the destination location within the pallet.   |
| Intermediate-Position1 | Intermediate position 1 | ARRAY [0..5] OF REAL | Positive number, Negative number, or 0 | First intermediate position of the circle.<br>Position[0]: X axis coordinate or Joint_1<br>Position[1]: Y axis coordinate or Joint_2<br>Position[2]: Z axis coordinate or Joint_3<br>Position[3]: Yaw angle coordinate or Joint_4<br>Position[4]: Pitch angle coordinate or Joint_5<br>Position[5]: Roll angle coordinate or Joint_6 |
| Intermediate-Position2 | Intermediate position 2 | ARRAY [0..5] OF REAL | Positive number, Negative number, or 0 | Second intermediate position of the circle.<br>Refer to IntermediatePosition1 in detail.   |

\*1. When PalletNumber is not 0, PalletIndex has to be set to from one to the number of points in the pallet. The number is determined from the parameters of ARB\_DefinePallet for the definition of the pallet. Otherwise an error will occur in the robot controller, and RobotState.ErrorState output variable in the ARB\_RobotControl will be TRUE.

When PalletNumber is set to 0, PalletIndex allows also negative value and it is ignored.

### ● sARB\_MOVECIRCULAR\_CONFIG\_REF

| Name          | Meaning                   | Data type | Valid range   | Function   |
|---------------|---------------------------|-----------|---------------|--|
| Relative      | Relative Move             | BOOL      | TRUE or FALSE | Determines if the movement is relative to the robot's current position or to absolute coordinates. When TRUE the movement is relative otherwise Absolute is set.   |
| CoarseNulling | Coarse nulling tolerances | BOOL      | TRUE or FALSE | Determines the nulling tolerances that will apply at the end of the motion. When it is TRUE, the tolerance is coarse and the duration time of the robot motion will be shorter. In detail, refer to the <i>ACE User's Guide</i> (Cat. No. I603). |
| SingleTurn    | Single turn               | BOOL      | TRUE or FALSE | Allows full rotations of the robot wrist joints, enabling this bit limits rotations to the range +/- 180 degrees.  |

## Output Variables

| Name      | Meaning           | Data type | Valid range   | Default | Description  |
|-----------|-------------------|-----------|---------------|---------|--|
| Done      | Done              | BOOL      | TRUE or FALSE | FALSE   | TRUE when the instruction is acknowledged by the robot controller. |
| Busy      | Executing         | BOOL      | TRUE or FALSE | FALSE   | TRUE when the instruction is being executed.                       |
| Error     | Error             | BOOL      | TRUE or FALSE | FALSE   | TRUE while there is an error.                                      |
| ErrorID   | Error code        | WORD      | *1            | 0       | Contains the error code when an error occurs.                      |
| ErrorIDEx | Extended error ID | DWORD     | *1            | 0       | Specify extended error number.                                     |

\*1. Refer to *Troubleshooting* on page 157 for details.

### ● Output Variable Update Timing

| Name  | Timing for changing to TRUE   | Timing for changing to FALSE  |
|-------|---|---|
| Done  | <ul style="list-style-type: none"> <li>When instruction is acknowledge by the robot controller.</li> </ul>                                    | <ul style="list-style-type: none"> <li>When Execute changes to FALSE.</li> <li>After one control period when Execute is FALSE.</li> <li>When Error changes to TRUE</li> </ul> |
| Busy  | <ul style="list-style-type: none"> <li>When Execute changes to TRUE.</li> </ul>   | <ul style="list-style-type: none"> <li>When Done changes to TRUE.</li> <li>When Error changes to TRUE.</li> </ul>   |
| Error | <ul style="list-style-type: none"> <li>When there is an error in the execution conditions or input parameters for the instruction.</li> </ul> | <ul style="list-style-type: none"> <li>When Execute changes to FALSE.</li> </ul>  |

## In-Out Variables

| Name      | Meaning               | Data type           | Valid range | Description                                   |
|-----------|-----------------------|---------------------|-------------|---|
| RobotData | Robot controller data | sARB_ROBOT_DATA_REF | ---         | Specify data needed for the robot controller. |

## Function

- This instruction moves the robot from the current position to the current position passing two intermediate positions which are specified in the Position input variable along a circular trajectory.

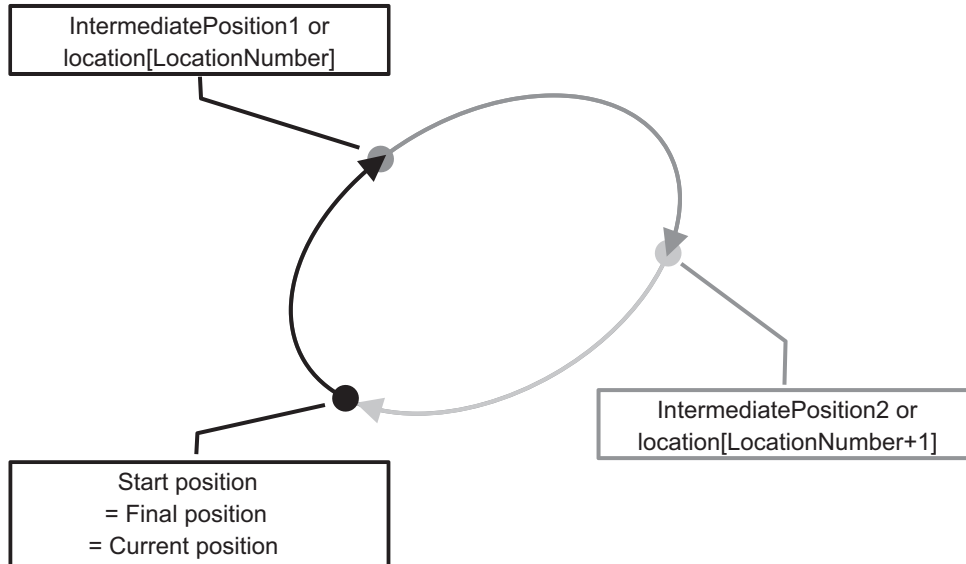

- The configuration in the CoarseNulling input variable is only effective when Blending input variable is set to false.
- Target position and intermediate position are provided by the Position input:
  - In case LocationNumber is higher than zero, the pre-defined location with LocationNumber is used as the first intermediate position, and the location with LocationNumber+1 is used as the second intermediate position.
  - In case LocationNumber is zero and PalletNumber is different than zero, the movement will be relative to the pallet. PalletNumber, PalletIndex, IntermediatePosition1 and IntermediatePosition2 arrays will be used.
  - In the case that LocationNumber and PalletNumber are both equal to zero. IntermediatePosition1 and IntermediatePosition2 arrays will be used as the first and the second intermediate position.
- Once the command has been completed (Done output is TRUE) another command can be executed. If the Blending input of the first one is TRUE, the second command will be blended before the first one achieves its target position. If not, the first command will achieve its target position and later the second command will start.
- Cancel Motion input can stop the movement once it has been commanded (Done output is TRUE).

## Timing charts

### ● Normal execution

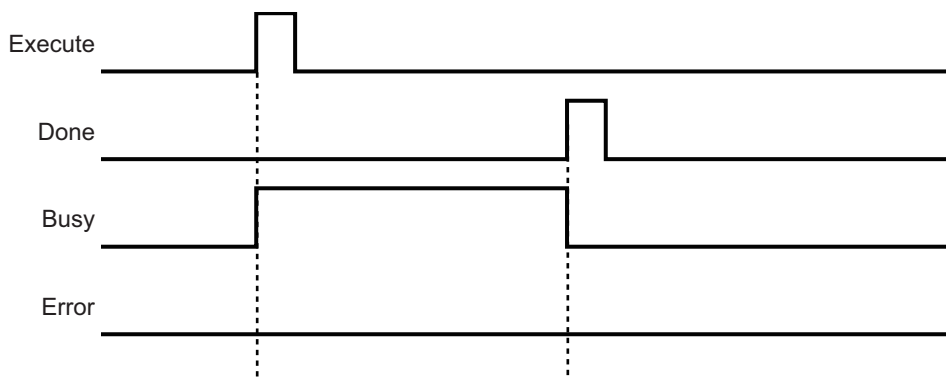

### ● Error execution

If an error occurs during instruction execution, *Error* will change to TRUE. You can find out the cause of the error by referring to the value output by *ErrorID* and *ErrorIDEx*.

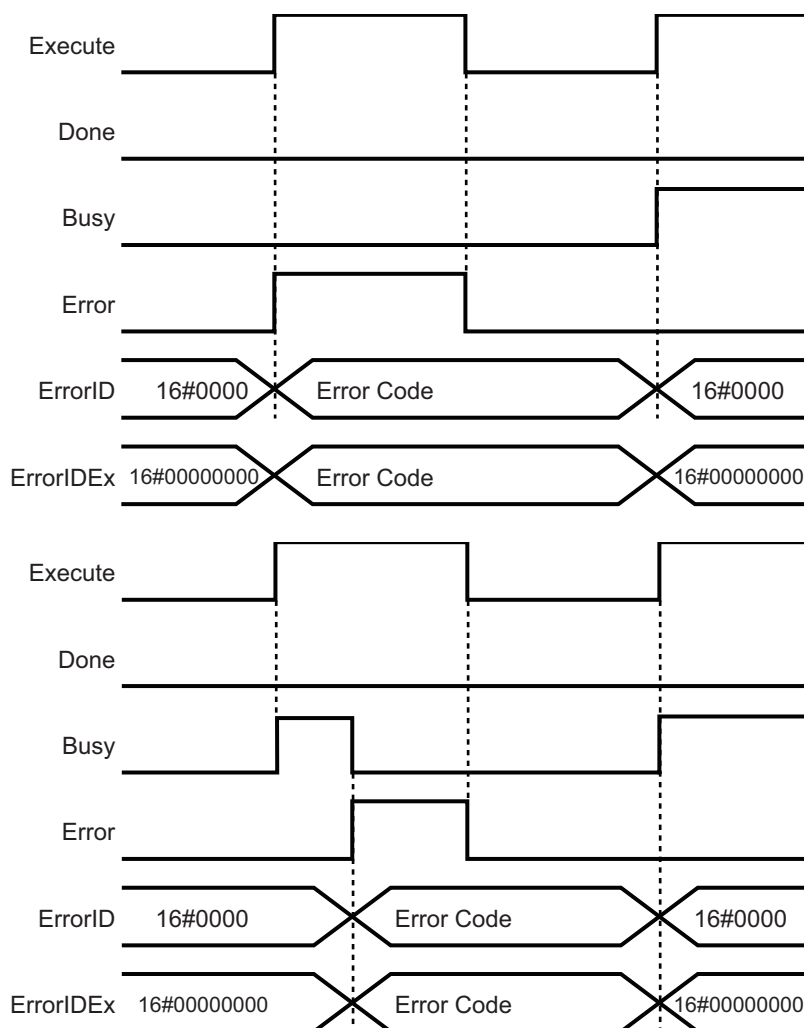

## Troubleshooting

| Error code  | Extended error ID        | Status   | Meaning   | Correction   |
|-------------|--------------------------|--|---|--|
| 16#0000     | 16#00000000              | The service ended normally.  | ---   | ---  |
| 16#3C3E     | 16#00000001              | Robot controller error   | Error occurs in the robot controller.   | Check the RobotError variable output in ARB_RobotControl and perform corrections for the error.                                |
|             | 16#00000002              | Communication error  | Ethernet/IP communication error   | Execute the instruction after the successful EtherNet/IP communication recovery.   |
|             | 16#00000003              | Invalid operation  | The instruction could not be executed in this controller state.<br><i>See Execution Conditions Table on page 174.</i> | Execute the instruction after the function block is ready for execution.   |
|             | 16#00000004              | Re-execution disabled  | Instruction cannot be re-executed   | Wait for the Done variable output changes to TRUE and then execute the function block again.                                   |
|             | 16#00000005              | Multi-execution disabled   | Multiple instructions that cannot be executed simultaneously were executed for the same target.                       | Wait for the Done variable output in the previously executed instructions changes to TRUE and then execute the function block. |
|             | 16#00000006              | Location Number Out of Range   | The value specified for the parameter LocationNumber in the input variable Position is out of range.                  | Set the LocationNumber within range.   |
|             | 16#00000007              | Pallet Number Out of Range   | The value specified for the parameter PalletNumber in the input variable Position is out of range.                    | Set the PalletNumber within range.   |
|             | 16#0000000B              | Speed Out of Range   | The value specified for the parameter Speed in the input variable MotionParams is out of range.                       | Set the Speed within range.  |
|             | 16#0000000C              | Acceleration Out of Range  | The value specified for the parameter Acceleration in the input variable MotionParams is out of range.                | Set the Acceleration within range.   |
|             | 16#0000000D              | Deceleration Out of Range  | The value specified for the parameter Deceleration in the input variable MotionParams is out of range.                | Set the Deceleration within range.   |
|             | 16#0000000E              | Acceleration Type Selection Out of Range   | The value specified for the parameter AccelerationType in the input variable MotionParams is out of range.            | Set the AccelerationType within range.   |
| 16#0000000F | Speed Limit Out of Range | The value specified for the parameter SpeedLimit in the input variable MotionParams is out of range. | Set the SpeedLimit within range.  |  |

| Error code | Extended error ID | Status                      | Meaning   | Correction  |
|------------|-------------------|-----------------------------|---|---|
| 16#3C3E    | 16#00000012       | Illegal Motion Stop request | Cancel Motion or Stop on Input executed during execution of MoveCommand. Current Movement not started yet, so it cannot be stopped. | Wait for completion of the Current Movement and then execute the instruction again. |
|            | 16#00000013       | Emergency Stop state        | Emergency Stop input has been set during the execution of the instruction   | Reset the Emergency Stop input.   |



# ARB\_DefineBelt

It defines a conveyor belt.

| Instruction    | Name        | FB/<br>FUN | Graphic expression | ST expression   |
|----------------|-------------|------------|--------------------|---|
| ARB_DefineBelt | Define Belt | FB         |                    | <pre>ARB_DefineBelt_instance( RobotData:=parameter, Execute:=parameter, BeltData:= parameter, Done =&gt;parameter, Busy =&gt;parameter, Error =&gt;parameter, ErrorID=&gt;parameter, ErrorIDEx=&gt;parameter );</pre> |

## Variables

### Input Variables

| Name     | Meaning         | Data type          | Valid range   | Default | Description   |
|----------|-----------------|--------------------|---------------|---------|---|
| Execute  | Execute         | BOOL               | TRUE or FALSE | FALSE   | The instruction is executed when Execute changes to TRUE. |
| BeltData | Belt definition | sARB_BELT-DATA_REF | ---           | ---     | Belt definition.  |

### ● sARB\_BELTDATA\_REF

| Name              | Meaning            | Data type | Valid range                        | Function   |
|-------------------|--------------------|-----------|------------------------------------|--|
| BeltNumber        | Belt number        | INT       | [1..100]                           | Specify an unique identifier of the belt.  |
| BeltTransform     | Belt transform     | INT       | [2..999]                           | Specify the location number of the belt transformation.  |
| BeltDown-stream   | Belt down-stream   | INT       | [2..999]                           | Specify the location number of the down-stream boundary.   |
| SensorPosition    | Sensor position    | INT       | [2..999]                           | Specify the location number of the origin of the sensor view.  |
| EncoderNumber     | Encoder number     | INT       | [1..4]                             | Specify an unique identifier of the belt encoder.  |
| ScaleFactor       | Scale factor       | REAL      | Positive number, Negative number,0 | Specify a scale factor from belt encoder count to Cartesian coordinates (Unit: mm/encoder count)   |
| ViolationStrategy | Violation strategy | INT       | 0 or 1                             | What to do when the robot reaches the downstream boundary of the belt:<br>0 = continue to track and return an error<br>1 = retract Z and return an error |

## Output Variables

| Name      | Meaning           | Data type | Valid range   | Default | Description  |
|-----------|-------------------|-----------|---------------|---------|--|
| Done      | Done              | BOOL      | TRUE or FALSE | FALSE   | TRUE when the instruction is acknowledged by the robot controller. |
| Busy      | Executing         | BOOL      | TRUE or FALSE | FALSE   | TRUE when the instruction is being executed.                       |
| Error     | Error             | BOOL      | TRUE or FALSE | FALSE   | TRUE while there is an error.                                      |
| ErrorID   | Error code        | WORD      | *1            | 0       | Contains the error code when an error occurs.                      |
| ErrorIDEx | Extended error ID | DWORD     | *1            | 0       | Specify extended error number.                                     |

\*1. Refer to *Troubleshooting* on page 163 for details.

### ● Output Variable Update Timing

| Name  | Timing for changing to TRUE   | Timing for changing to FALSE  |
|-------|---|---|
| Done  | <ul style="list-style-type: none"> <li>When instruction is acknowledge by the robot controller.</li> </ul>                                    | <ul style="list-style-type: none"> <li>When Execute changes to FALSE.</li> <li>After one control period when Execute is FALSE.</li> <li>When Error changes to TRUE</li> </ul> |
| Busy  | <ul style="list-style-type: none"> <li>When Execute changes to TRUE.</li> </ul>   | <ul style="list-style-type: none"> <li>When Done changes to TRUE.</li> <li>When Error changes to TRUE.</li> </ul>   |
| Error | <ul style="list-style-type: none"> <li>When there is an error in the execution conditions or input parameters for the instruction.</li> </ul> | <ul style="list-style-type: none"> <li>When Execute changes to FALSE.</li> </ul>  |

## In-Out Variables

| Name      | Meaning               | Data type            | Valid range | Description                                   |
|-----------|-----------------------|----------------------|-------------|---|
| RobotData | Robot controller data | sARB_ROBOT_-DATA_REF | ---         | Specify data needed for the robot controller. |

## Function

- This instruction is used to define a belt conveyor with its orientation, direction, window, belt encoder and vision sensor. Refer to the *ACE User's Guide* (Cat. No. I603) for details of conveyor belt managed by Adept robot controller.
- The origin of the belt coordinate in the world coordinate system and belt plane are specified by BeltTransform. The belt plane is its X-Y plane, and the direction of the belt conveyor is its X axis.
- The boundary of the operating window of conveyor tracking in the world coordinate system is specified by BeltDownstream. The location must be downstream position from the origin in the belt coordinate.
- The origin in the world coordinate system and orientation of the sight of the vision sensor is specified by SensorPosition.

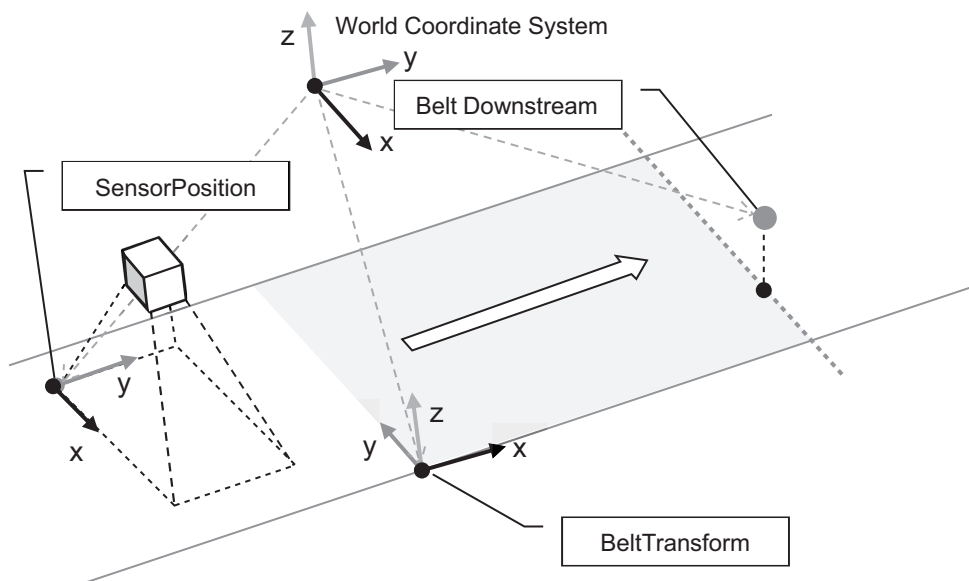

- The conversion ratio from belt encoder value to the belt coordinate is specified by ScaleFactor. Its unit is (mm/encoder count).
- The behavior when the workpiece which is tracked by the robot reaches the downstream boundary is specified by ViolationStrategy. When 0, the robot will detect an error and continue to track the workpiece. Stop the tracking by setting CancelMotion in ARB\_RobotControl to TRUE. When 1, the robot will retract in Z coordinate and detect an error. The distance of retraction in Z is determined in the robot controller as 50 mm.

## Timing charts

### ● Normal execution

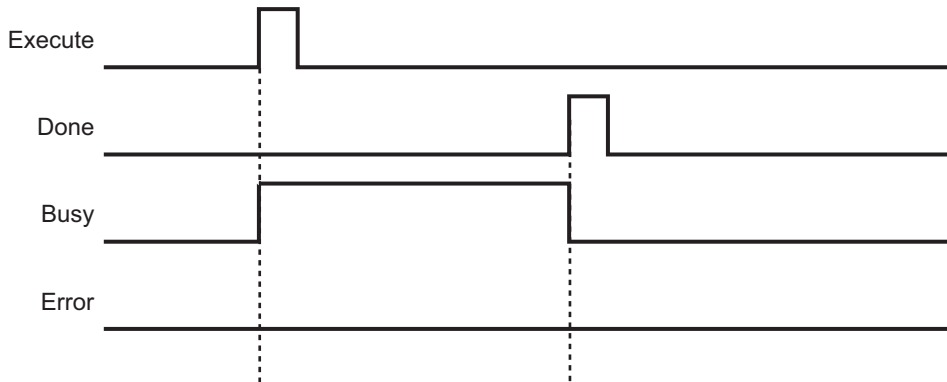

### ● Error execution

If an error occurs during instruction execution, *Error* will change to TRUE. You can find out the cause of the error by referring to the value output by *ErrorID* and *ErrorIDEx*.

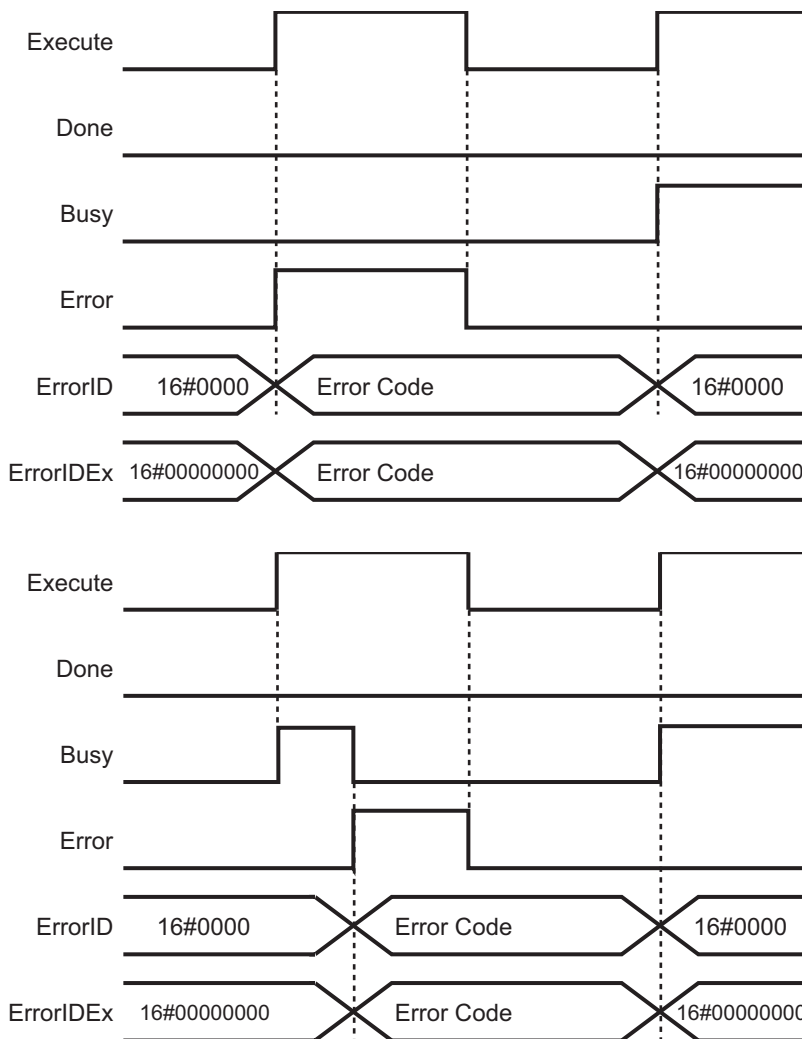

## Troubleshooting

| Error code  | Extended error ID              | Status  | Meaning   | Correction   |
|-------------|--------------------------------|---|---|--|
| 16#0000     | 16#00000000                    | The service ended normally.   | ---   | ---  |
| 16#3CCD     | 16#00000001                    | Robot controller error  | Error occurs in the robot controller.   | Check the RobotError variable output in ARB_RobotControl and perform corrections for the error.                                |
|             | 16#00000002                    | Communication error   | Ethernet/IP communication error   | Execute the instruction after the successful EtherNet/IP communication recovery.   |
|             | 16#00000003                    | Invalid operation   | The instruction could not be executed in this controller state.<br><i>See Execution Conditions Table on page 174.</i> | Execute the instruction after the function block is ready for execution.   |
|             | 16#00000004                    | Re-execution disabled   | Instruction cannot be re-executed   | Wait for the Done variable output changes to TRUE and then execute the function block again.                                   |
|             | 16#00000005                    | Multi-execution disabled  | Multiple instructions that cannot be executed simultaneously were executed for the same target.                       | Wait for the Done variable output in the previously executed instructions changes to TRUE and then execute the function block. |
|             | 16#00000014                    | Belt Number Out of Range  | The value specified for the parameter BeltNumber in the input variable BeltData is out of range.                      | Set the BeltNumber within range.   |
|             | 16#00000015                    | Belt Transform Out of Range   | The value specified for the parameter BeltTransform in the input variable BeltData is out of range.                   | Set the BeltTransform within range.  |
|             | 16#00000016                    | Belt Downstream Out of Range  | The value specified for the parameter BeltDownstream in the input variable BeltData is out of range.                  | Set the BeltDownstream within range.   |
|             | 16#00000017                    | SensorPosition Out of Range   | The value specified for the parameter SensorPosition in the input variable BeltData is out of range.                  | Set the SensorPosition within range.   |
|             | 16#00000018                    | EncoderNumber Out of Range  | The value specified for the parameter EncoderNumber in the input variable BeltData is out of range.                   | Set the EncoderNumber within range.  |
|             | 16#00000019                    | ScaleFactor Out of Range  | The value specified for the parameter ScaleFactor in the input variable BeltData is not valid.                        | Set the ScaleFactor to a valid value.  |
| 16#0000001A | ViolationStrategy Out of Range | The value specified for the parameter ViolationStrategy in the input variable BeltData is out of range. | Set the ViolationStrategy within range.   |  |

# ARB\_BeltReadLatch

Outputs the belt encoder value of the conveyor when an external trigger is input.

| Instruction       | Name            | FB/<br>FUN | Graphic expression | ST expression  |
|-------------------|-----------------|------------|--------------------|--|
| ARB_BeltReadLatch | Belt Read Latch | FB         |                    | <pre>ARB_BeltReadLatch_instance(   RobotData:=parameter,   Enable:=parameter,   ReadLatch:=parameter,   EncoderNumber:=parameter,   ClearLatch:=parameter,   Enabled=&gt;parameter,   Busy=&gt;parameter,   Error=&gt;parameter,   ErrorID=&gt;parameter,   ErrorIDEx=&gt;parameter,   IsLatched=&gt;parameter,   LatchedInput=&gt;parameter,   LatchedValue=&gt;parameter,   EncoderValue=&gt;parameter,   EncoderSpeed=&gt;parameter,   Cleared=&gt;parameter );</pre> |

## Variables

### Input Variables

| Name          | Meaning            | Data type | Valid range | Default | Description  |
|---------------|--------------------|-----------|-------------|---------|--|
| Enable        | Enable             | BOOL      | TRUE, FALSE | FALSE   | The instruction is executed while Enable is to TRUE.   |
| ReadLatch     | Read latch command | BOOL      | TRUE, FALSE | FALSE   | Activate the read latch command.   |
| EncoderNumber | Encoder number     | INT       | [1..4]      | 0       | Specify a unique identifier of the belt encoder, which was used in ARB_DefineBelt                  |
| ClearLatch    | Clear latch        | BOOL      | TRUE, FALSE | FALSE   | Clear latch values which are stored in the robot controller when it is changed from FALSE to TRUE. |

## Output Variables

| Name         | Meaning           | Data type | Valid range                        | Default | Description   |
|--------------|-------------------|-----------|------------------------------------|---------|---|
| Enabled      | Done              | BOOL      | TRUE, FALSE                        | FALSE   | TRUE: Enable is TRUE and clearing latch is finished<br>FALSE: Enable is FALSE or Error raised |
| Busy         | Executing         | BOOL      | TRUE, FALSE                        | FALSE   | TRUE when the instruction is being executed.  |
| Error        | Error             | BOOL      | TRUE, FALSE                        | FALSE   | TRUE while there is an error.   |
| ErrorID      | Error code        | INT       | *1                                 | 0       | Contains the error code when an error occurs.   |
| ErrorIDEx    | Extended error ID | DINT      | *1                                 | 0       | Specify extended error number.  |
| IsLatched    | Is latched        | BOOL      | TRUE, FALSE                        | FALSE   | TRUE in case that latch signal was raised in the robot controller, otherwise it is FALSE.     |
| LatchedInput | Latched input     | INT       | Positive number, Negative number,0 | 0       | The digital input signal number that generated the latch.                                     |
| LatchedValue | Latched value     | DINT      | Positive number, Negative number,0 | 0       | The belt encoder position when the latch signal was received.                                 |
| EncoderValue | Encoder value     | DINT      | Positive number, Negative number,0 | 0       | Current position from the belt encoder during Enabled.  |
| EncoderSpeed | Encoder speed     | INT       | Positive number, Negative number,0 | 0       | Current speed from the belt encoder during Enabled.   |
| Cleared      | Cleared           | BOOL      | TRUE, FALSE                        | FALSE   | TRUE when clearing latch is finished.   |

\*1. Refer to *Troubleshooting* on page 168 for details.

### ● Output Variable Update Timing

| Name    | Timing for changing to TRUE   | Timing for changing to FALSE                                     |
|---------|---|--|
| Enabled | • When Enable changes to TRUE.  | • When Enable changes to FALSE.                                  |
| Busy    | • When Enable changes to TRUE.  | • When Enable changes to FALSE.<br>• When Error changes to TRUE. |
| Error   | • When there is an error in the execution conditions or input parameters for the instruction. | • When Enable is FALSE.  |

## In-Out Variables

| Name      | Meaning               | Data type           | Valid range | Description                                   |
|-----------|-----------------------|---------------------|-------------|---|
| RobotData | Robot controller data | sARB_ROBOT_DATA_REF | ---         | Specify data needed for the robot controller. |

## Function

- This function returns the encoder count of the specified belt encoder by EncoderNumber and an input signal number that generated the latch when an external latch signal is raised.
- When enabling the FB (Enable set to TRUE), specified belt encoder number is set to the robot controller. When the Enabled output is TRUE the setting is completed and FB can be used.
- During the output Enabled is TRUE, EncoderValue output is set to the current value of the belt encoder, and EncoderSpeed output is set to the current speed of the belt encoder.
- When the output Enabled is TRUE, the input ReadLatch is TRUE and an external latch signal is raised, the IsLatched output is set to TRUE, the LatchedInput and LatchedValue output are set to the result.
- When the output IsLatched is TRUE and an external latch signal is raised again, the outputs LatchedInput and LatchedValue will not be updated, but the value is stored in the robot controller. When ReadLatch is once set to FALSE and set to TRUE again, the oldest stored value will be set to the result.
- When the output Enabled is TRUE and ClearLatch input is changed from FALSE to TRUE, all latched values which are cleared. When Cleared output is TRUE the latch clearing will be completed. At that time, the outputs IsLatched, LatchedInput and LatchedValue are not cleared.
- This FB doesn't check the simultaneous starting or interference of ReadLatch and ClearLatch input variables.

## Timing charts

### ● Normal execution

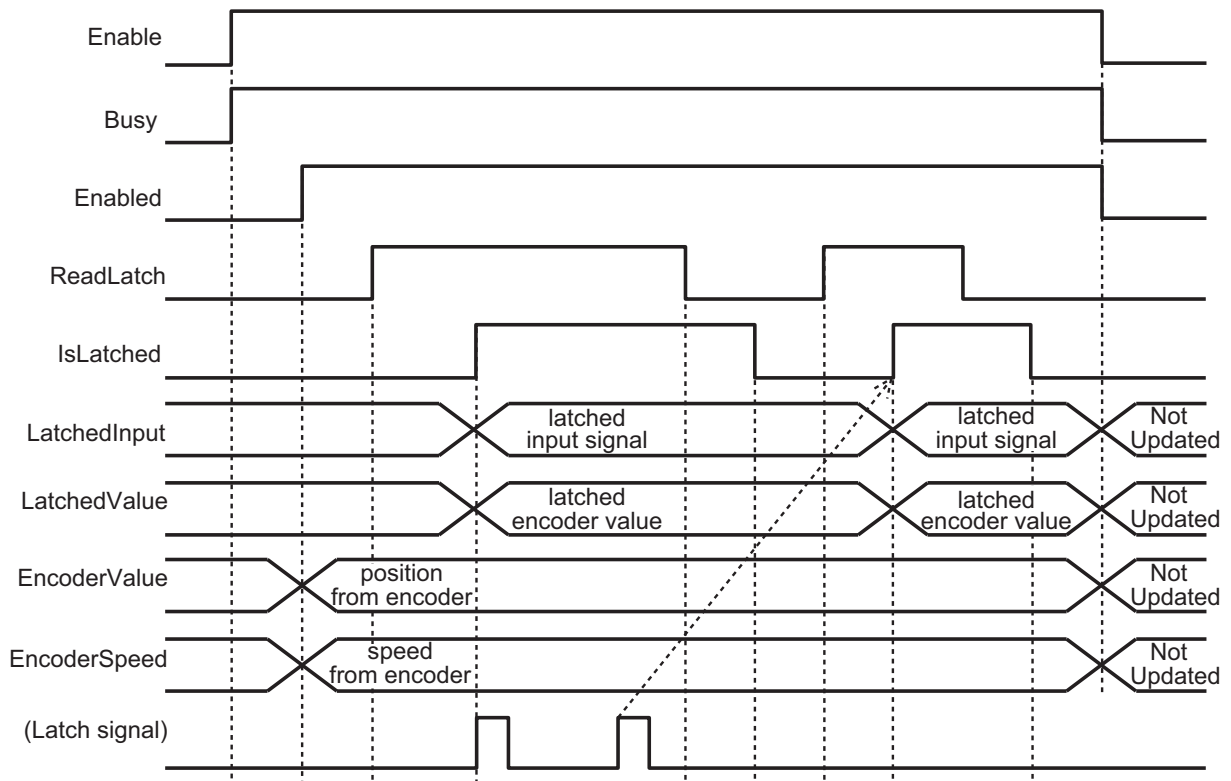



● **Clear Latch**

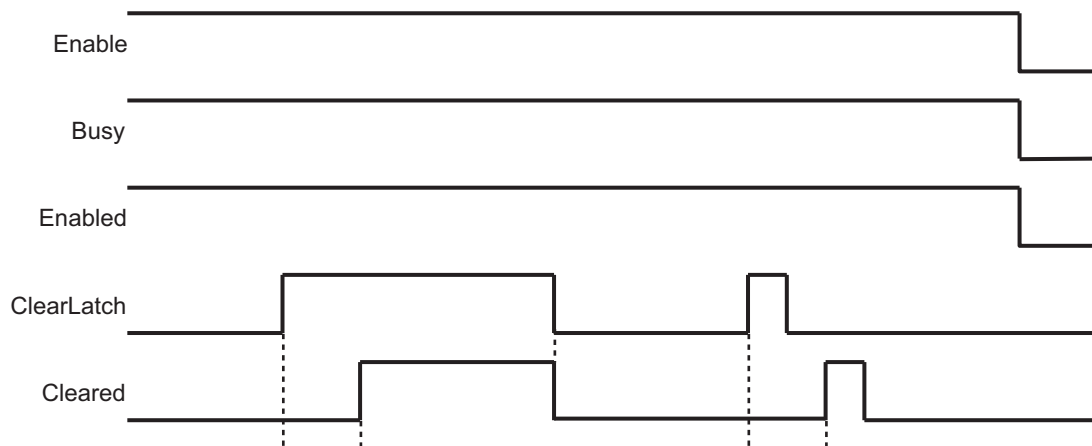

● **Error execution**

If an error occurs during instruction execution, *Error* will change to TRUE. You can find out the cause of the error by referring to the value output by *ErrorID* and *ErrorIDEx*.

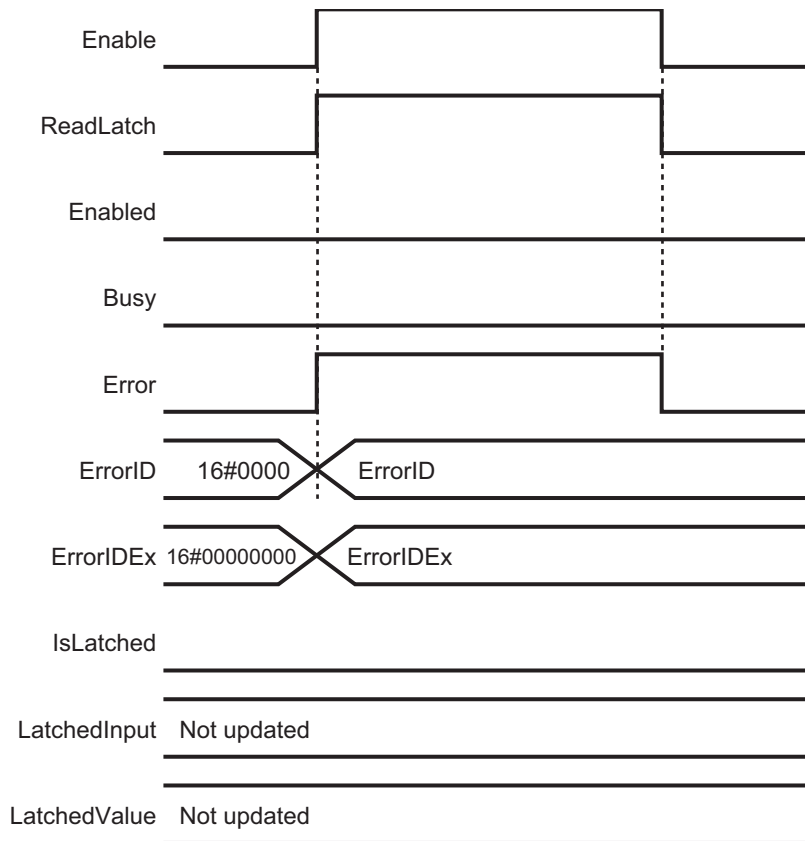

## Troubleshooting

| Error code | Extended error ID | Status                      | Meaning   | Correction   |
|------------|-------------------|-----------------------------|---|--|
| 16#0000    | 16#00000000       | The service ended normally. | ---   | ---  |
| 16#3CCE    | 16#00000002       | Communication error         | Ethernet/IP communication error   | Execute the instruction after the successful EtherNet/IP communication recovery. |
|            | 16#00000003       | Invalid operation           | The instruction could not be executed in this controller state.<br>See <i>Execution Conditions Table</i> on page 174. | Execute the instruction after the function block is ready for execution.         |
|            | 16#00000018       | EncoderNumber Out of Range  | The value specified for the parameter EncoderNumber in the input variable BeltData is out of range.                   | Set the EncoderNumber within range.  |

# ARB\_TrackBelt

Enables tracking a workpiece.

| Instruction   | Name       | FB/<br>FUN | Graphic expression | ST expression  |
|---------------|------------|------------|--------------------|--|
| ARB_TrackBelt | Track Belt | FB         |                    | <pre>ARB_TrackBelt_instance( RobotData:=parameter, Enable:=parameter, BeltNumber:=parameter, LatchedValue:=parameter, BeltRelativeMotion:=parameter, Enabled=&gt;parameter, Busy=&gt;parameter, Error=&gt;parameter, ErrorID=&gt;parameter, ErrorIDEx=&gt;parameter, DistFromUpstream=&gt;parameter, DistFromDownstream=&gt;parameter );</pre> |

## Variables

### Input Variables

| Name               | Meaning              | Data type | Valid range                         | Default | Description   |
|--------------------|----------------------|-----------|-------------------------------------|---------|---|
| Enable             | Enable               | BOOL      | TRUE, FALSE                         | FALSE   | The instruction is executed while Enable is to TRUE.                        |
| BeltNumber         | Belt Number          | INT       | [1..100]                            | 0       | Specify an unique identifier of the belt, which was used in ARB_DefineBelt. |
| LatchedValue       | Latched value        | DINT      | Positive number, Negative number, 0 | 0       | Specify the belt encoder position which was get by ARB_BeltReadLatch.       |
| BeltRelativeMotion | Belt relative motion | BOOL      | TRUE, FALSE                         | FALSE   | Enable motion commands to track a workpiece.                                |

## Output Variables

| Name               | Meaning                  | Data type | Valid range                            | Default | Description   |
|--------------------|--------------------------|-----------|--|---------|---|
| Enabled            | Done                     | BOOL      | TRUE, FALSE                            | FALSE   | TRUE: Enable is TRUE and clearing latch is finished<br>FALSE: Enable is FALSE or Error raised |
| Busy               | Executing                | BOOL      | TRUE, FALSE                            | FALSE   | TRUE when the instruction is being executed.  |
| Error              | Error                    | BOOL      | TRUE, FALSE                            | FALSE   | TRUE while there is an error.   |
| ErrorID            | Error code               | INT       | *1                                     | 0       | Contains the error code when an error occurs.   |
| ErrorIDEx          | Extended error ID        | DINT      | *1                                     | 0       | Specify extended error number.  |
| DistFromUpstream   | Distance from upstream   | REAL      | Positive number, Negative number, or 0 | 0       | Distance from upstream limit to the workpiece. (Unit: mm)                                     |
| DistFromDownstream | Distance from downstream | REAL      | Positive number, Negative number, or 0 | 0       | Distance from downstream limit to the workpiece. (Unit: mm)                                   |

\*1. Refer to *Troubleshooting* on page 173 for details.

### ● Output Variable Update Timing

| Name    | Timing for changing to TRUE   | Timing for changing to FALSE                                     |
|---------|---|--|
| Enabled | • When Enable changes to TRUE.  | • When Enable changes to FALSE.                                  |
| Busy    | • When Enable changes to TRUE.  | • When Enable changes to FALSE.<br>• When Error changes to TRUE. |
| Error   | • When there is an error in the execution conditions or input parameters for the instruction. | • When Enable is FALSE.  |

## In-Out Variables

| Name      | Meaning               | Data type           | Valid range | Description                                   |
|-----------|-----------------------|---------------------|-------------|---|
| RobotData | Robot controller data | sARB_ROBOT_DATA_REF | ---         | Specify data needed for the robot controller. |

## Function

- This instruction sets the belt number of the target of tracking and the belt encoder value when latched, and enables conveyor tracking.
- When enabling the FB (Enable set to TRUE), it sequently sets the belt number and the encoder value to the robot controller. When the Enabled output is TRUE the tracking is enabled.
- During the output Enabled is TRUE, the distance from the origin of the belt coordinate to the work-piece is set to DistFromUpstream, and the distance from downstream limit to the workpiece is set to DistFromDownstream.
- When the output Enabled is TRUE and the input BeltRelativeMotion is TRUE, the next motion of the robot is configured as a relative motion to the belt. (The robot doesn't start to track the workpiece by only setting the input BeltRelativeMotion to TRUE.)  
In this situation, when setting the target position as the position of the workpiece when latched and starting ARB\_MoveCommand or ARB\_PickAndPlaceCommand, the robot moves with tracking the workpiece on the belt.
- When tracking a workpiece with ARB\_MoveCommand, set StraightLineMove input variable of ARB\_MoveCommand to TRUE. If setting it to FALSE and executing the FB, the robot controller will detect an error.
- After ARB\_MoveCommand or ARB\_PickAndPlaceCommand with workpiece tracking reached its target position, the robot will continue to track the workpiece. To stop that tracking, set CancelMotion in ARB\_RobotControl to TRUE.

## Timing charts

### ● Normal execution

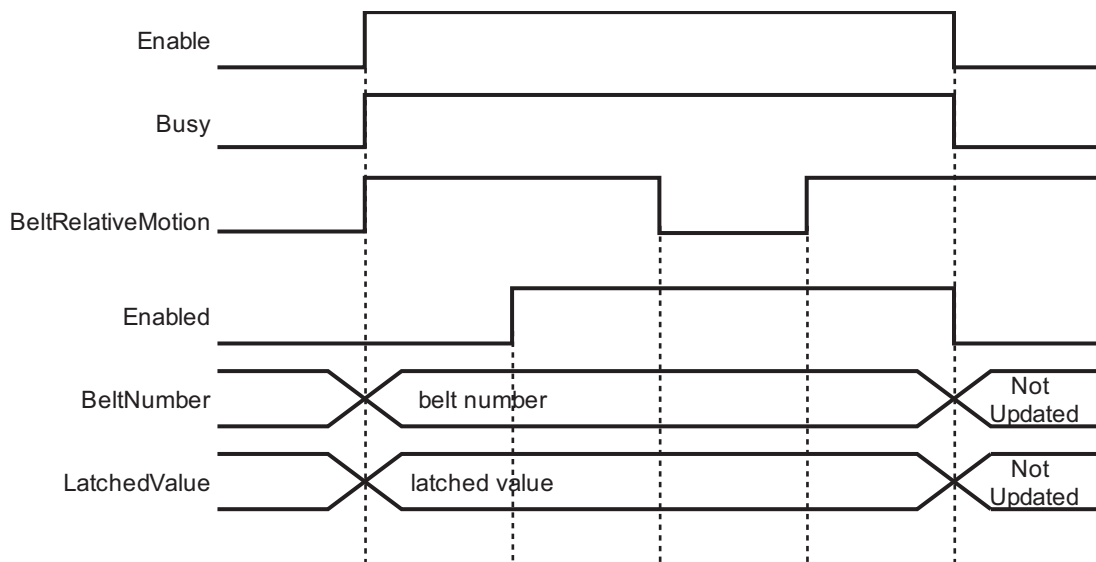

● **Error execution**

If an error occurs during instruction execution, *Error* will change to TRUE. You can find out the cause of the error by referring to the value output by *ErrorID* and *ErrorIDEx*.

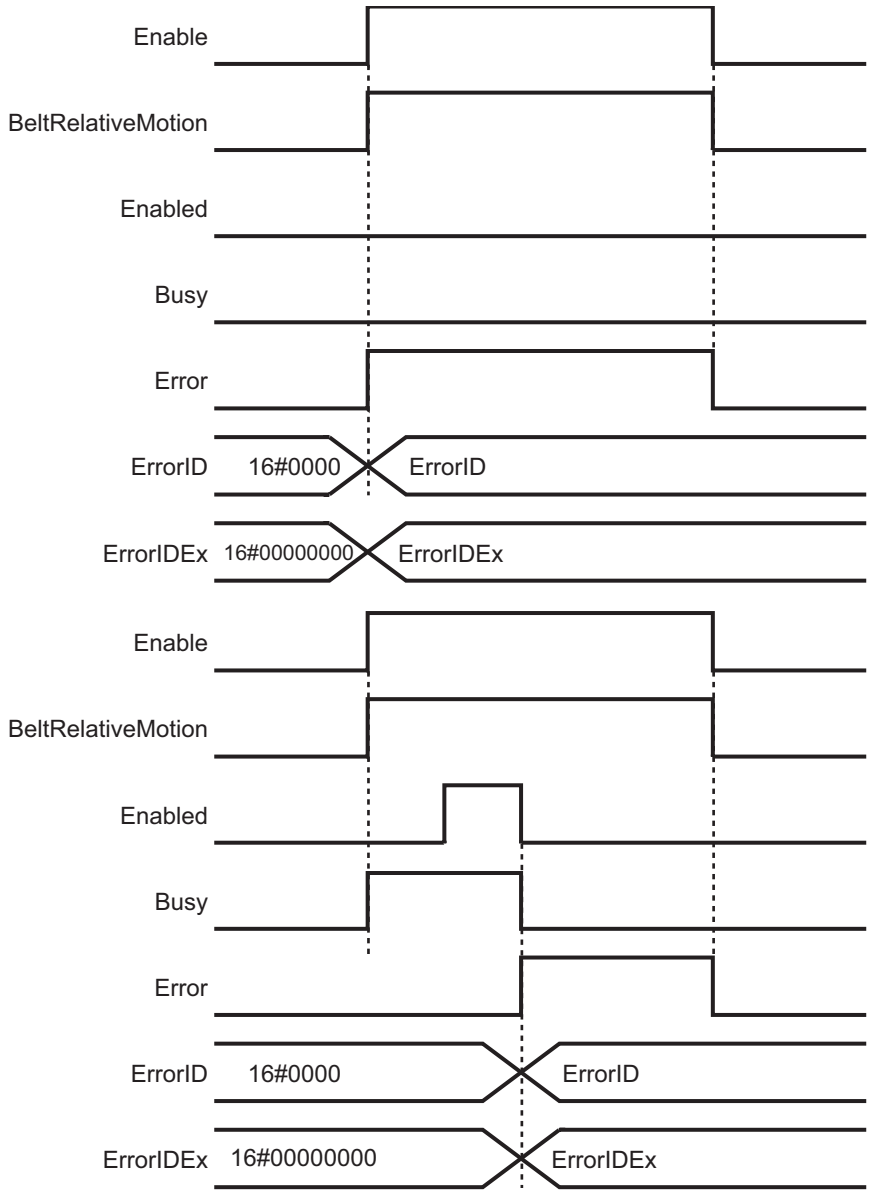

## Troubleshooting

| Error code | Extended error ID | Status                      | Meaning   | Correction   |
|------------|-------------------|-----------------------------|---|--|
| 16#0000    | 16#00000000       | The service ended normally. | ---   | ---  |
| 16#3CCF    | 16#00000002       | Communication error         | Ethernet/IP communication error   | Execute the instruction after the successful EtherNet/IP communication recovery. |
|            | 16#00000003       | Invalid operation           | The instruction could not be executed in this controller state.<br>See <i>Execution Conditions Table</i> on page 174. | Execute the instruction after the function block is ready for execution.         |
|            | 16#00000014       | Belt Number Out of Range    | The value specified for the parameter BeltNumber is out of range.   | Set the BeltNumber within range.   |

# Execution Conditions Table

Before and during execution of each command following conditions will be checked. In case one of the conditions is not fulfilled an error will occur.

|                         | Connected <sup>*1</sup> | Cancel Motion <sup>*2</sup> | Stop On Input <sup>*3</sup> | Power State <sup>*4</sup> | Calibrated State <sup>*5</sup> | Error State <sup>*6</sup> | Estop State <sup>*7</sup> |
|-------------------------|-------------------------|-----------------------------|-----------------------------|---------------------------|--------------------------------|---------------------------|---------------------------|
| ARB_SetToolTransform    | TRUE                    | ---                         | ---                         | ---                       | ---                            | FALSE                     | ---                       |
| ARB_ResetToolTransform  | TRUE                    | ---                         | ---                         | ---                       | ---                            | FALSE                     | ---                       |
| ARB_DefinePosition      | TRUE                    | ---                         | ---                         | ---                       | ---                            | FALSE                     | ---                       |
| ARB_DefinePallet        | TRUE                    | ---                         | ---                         | ---                       | ---                            | FALSE                     | ---                       |
| ARB_ResetRobotError     | TRUE                    | ---                         | ---                         | ---                       | ---                            | ---                       | ---                       |
| ARB_RobotControl        | ---                     | ---                         | ---                         | ---                       | ---                            | ---                       | ---                       |
| ARB_TeachPosition       | TRUE                    | ---                         | ---                         | ---                       | ---                            | FALSE                     | ---                       |
| ARB_InputOutputSignals  | TRUE                    | ---                         | ---                         | ---                       | ---                            | ---                       | ---                       |
| ARB_TeachPendantControl | TRUE                    | ---                         | ---                         | ---                       | ---                            | ---                       | ---                       |
| ARB_ReadLatch           | TRUE                    | ---                         | ---                         | ---                       | ---                            | ---                       | ---                       |
| ARB_MoveCommand         | TRUE                    | FALSE                       | FALSE                       | TRUE                      | TRUE                           | FALSE                     | FALSE                     |
| ARB_PickAndPlaceCommand | TRUE                    | FALSE                       | FALSE                       | TRUE                      | TRUE                           | FALSE                     | FALSE                     |
| ARB_Jog                 | TRUE                    | ---                         | ---                         | TRUE                      | TRUE                           | FALSE                     | FALSE                     |
| ARB_AlignToolCommand    | TRUE                    | FALSE                       | FALSE                       | TRUE                      | TRUE                           | FALSE                     | FALSE                     |
| ARB_MoveArcCommand      | TRUE                    | FALSE                       | FALSE                       | TRUE                      | TRUE                           | FALSE                     | FALSE                     |
| ARB_MoveCircularCommand | TRUE                    | FALSE                       | FALSE                       | TRUE                      | TRUE                           | FALSE                     | FALSE                     |
| ARB_DefineBelt          | TRUE                    | ---                         | ---                         | ---                       | ---                            | FALSE                     | ---                       |
| ARB_BeltReadLatch       | TRUE                    | ---                         | ---                         | ---                       | ---                            | ---                       | ---                       |
| ARB_TrackBelt           | TRUE                    | ---                         | ---                         | ---                       | ---                            | ---                       | ---                       |

\*1. The RobotControl output variable in the ARB\_RobotControl function block

\*2. The CancelMotion input variable in the ARB\_RobotControl function block

\*3. The StopOnInput input variable in the ARB\_RobotControl function block

\*4. The RobotState.PowerState output variable in the ARB\_RobotControl function block

\*5. The RobotState.CalibratedState output variable in the ARB\_RobotControl function block

\*6. The RobotState.ErrorState output variable in the ARB\_RobotControl function block

\*7. The RobotState.EStopState output variable in the ARB\_RobotControl function block



- **For the condition of Connected:**

In case of NOT connected state the error will be always “16#00000002: Communication error”

- **For the other conditions of the table:**

In case conditions are not fulfilled in the instruction execution error will be “16#00000003: Invalid operation”

In case conditions are not fulfilled during execution errors will be different depending on the error cause:

- Power State, Calibrated State, and Error State:  
“16#00000001: OAT controller error”
- Cancel Motion and Stop on Input:  
“16#00000012: Illegal Motion Request”
- E-Stop State:  
“16#00000013: Emergency Stop State”

# Multi-execution of Function Blocks

---

Multi-execution is possible for the following instructions: They can be executed while other instructions are executed.

- ARB\_TeachPendantControl
- ARB\_InputOutputSignals

Multi-execution is disabled for the following instructions: Error will happen in case two or more instructions of this group are executed at same time.

- ARB\_Jog
- ARB\_MoveCommand
- ARB\_PickAndPlaceCommand
- ARB\_DefineLocation
- ARB\_DefinePallet
- ARB\_SetToolTransform
- ARB\_ResetToolTransform
- ARB\_ResetRobotError
- ARB\_TeachPosition
- ARB\_AlignToolCommand
- ARB\_MoveArcCommand
- ARB\_MoveCircularCommand

The instruction ARB\_RobotControl control several robot actions. Some of the actions can be executed while other instructions are being executed:

- Power
- CancelMotion
- StopOnInput

About these FBs, when executing multiple instances of a same FB at the same time, they cannot work correctly.

- ARB\_ReadLatch
- ARB\_BeltReadLatch
- ARB\_TrackBelt

# Re-execution of Function Blocks

---

An error occurs when re-executing the same instance of any function block before it has been completed successfully ('Done' output is raised) or by error ('Error output is raised). This is only applicable for the 'Execute' type function blocks.

# Errors from Controller

The specific errors of the robot controller are listed in the following table:

| Error | Description   |
|-------|---|
| -3001 | *E-stop due to lost communications with PLC*  |
| -3007 | *Invalid command: More than one command bit enabled*  |
| -3008 | *Only one axis bit can be set while jogging*  |
| -3009 | *Cannot mix joint-coordinate location and pallet*   |
| -3010 | *Cannot move relative to a pallet*  |
| -3011 | *Invalid location number* Location n  |
| -3012 | *Invalid pallet number* Pallet n  |
| -3013 | *Invalid speed parameter* Speed n   |
| -3014 | *Invalid acceleration/deceleration parameter* Value n   |
| -3015 | *Undefined location* Location n   |
| -3016 | *Undefined pallet* Pallet n   |
| -3019 | *ePLC Connect start-up error* Code n<br>Here are the possible causes: invalid eV+ software version, invalid eV+ software license, or invalid ePLC connection application license. |
| -3020 | *Invalid approach parameter for this robot*   |
| -3021 | *Pallet locations are linear*   |
| -3022 | *Invalid pallet index* Position n   |
| -3024 | *Adept ACE Control mode enabled*  |

# Appendix

# Referring to Library Information

When you make an inquiry to OMRON about the library, you can refer to the library information to identify the library to ask about.

The library information is useful in identifying the target library among the libraries provided by OMRON or created by the user.

The library information consists of the attributes of the library and the attributes of function blocks and functions contained in the library.

- Attributes of libraries  
Information for identifying the library itself
- Attributes of function blocks and functions  
Information for identifying the function block and function contained in the library

Use the Sysmac Studio to access the library information.

## Attributes of Libraries, Function Blocks and Functions

The following attributes of libraries, function blocks and functions are provided as the library information.

### ● Attributes of Libraries

| No.*1 | Attribute         | Description                        |
|-------|-------------------|------------------------------------|
| (1)   | Library file name | The name of the library file       |
| (2)   | Library version   | The version of the library         |
| (3)   | Author            | The name of creator of the library |
| (4)   | Comment           | The description of the library*2   |

\*1. These numbers correspond to the numbers shown on the screen images in the next section, *Referring to Attributes of Libraries, Function Blocks and Functions* on page 181.

\*2. It is provided in English and Japanese.

### ● Attributes of Function Blocks and Functions

| No.*1 | Attribute      | Description   |
|-------|----------------|---|
| (5)   | FB/FUN name    | The name of the function block or function                |
| (6)   | Name space     | The name of name space for the function block or function |
| (7)   | FB/FUN version | The version of the function block or function             |
| (8)   | Author         | The name of creator of the function block or function     |
| (9)   | FB/FUN number  | The function block number or function number              |
| (10)  | Comment        | The description of the function block or function*2       |

\*1. These numbers correspond to the numbers shown on the screen images in the next section, *Referring to Attributes of Libraries, Function Blocks and Functions* on page 181.

\*2. It is provided in English and Japanese.

## Referring to Attributes of Libraries, Function Blocks and Functions

You can refer to the attributes of libraries, function blocks and functions of the library information at the following locations on the Sysmac Studio.

- Library Reference Dialog Box
- Toolbox Pane
- Ladder Editor

### (a) Library Reference Dialog Box

When you refer to the libraries, the library information is displayed at the locations shown below.

(1)Library file name      (2)Library version      (3)Library author      (4)Library comment

| Library name                        | Name Space         | Version | Author            | Company   | Date Creat | Date Modif | Comment   |
|-------------------------------------|--------------------|---------|-------------------|---|------------|------------|---|
| OmronLib_MC_Toolbox_V1_1            |                    | 1.1.0   | OMRON Corporation | (c)OMRON Corporation 2015. All Rights Reserved. |            |            | This is MC Toolbox library.<br>これはモーション制御ツールボックスライ                    |
| POU                                 |                    |         |                   |   |            |            |   |
| Programs                            |                    |         |                   |   |            |            |   |
| Functions                           |                    |         |                   |   |            |            |   |
| DeadBand (OmronLib_MC_Toolbox)      | OmronLib_MC_Toolbo | 1.1.0   | OMRON Corporation |   | 03/16/2015 | 08/10/201  | No.00006<br>The DeadBand function block cont<br>処理結果にオフセットを発生させないデ    |
| Function Blocks                     |                    |         |                   |   |            |            |   |
| FirstOrderLag (OmronLib_MC_Toolbox) | OmronLib_MC_Toolbo | 1.1.0   | OMRON Corporation |   | 04/01/2015 | 08/10/201  | No.00004<br>The FirstOrderLag function block p<br>設定されたパラメータテーブルに従って、 |
| LeadLag (OmronLib_MC_Toolbox)       | OmronLib_MC_Toolbo | 1.1.0   | OMRON Corporation |   | 04/01/2015 | 08/10/201  | No.00005<br>The LeadLag function block perfor<br>設定されたパラメータテーブルに従って、  |
| PIDFeedFwd (OmronLib_MC_Toolbox)    | OmronLib_MC_Toolbo | 1.1.0   | OMRON Corporation |   | 04/01/2015 | 08/10/201  | No.00003<br>The PIDFeedFwd function block pe<br>設定されたパラメータテーブルに従って、   |

(5)FB/FUN name      (6)Name space      (7)FB/FUN version      (8)FB/FUN author      (10)FB/FUN comment

Namespace - Using

| In/Out    | Name      | In/Out | Data Type | Edge    | Initial Value | Retain                   | Constant                 | Comment |
|-----------|-----------|--------|-----------|---------|---------------|--------------------------|--------------------------|---------|
| Externals | Enable    | Input  | BOOL      | No Edge | False         | <input type="checkbox"/> | <input type="checkbox"/> |         |
|           | InCalc    | Input  | LREAL     | No Edge | 0.0           | <input type="checkbox"/> | <input type="checkbox"/> |         |
|           | Kp        | Input  | LREAL     | No Edge | 1.0           | <input type="checkbox"/> | <input type="checkbox"/> |         |
|           | TimeConst | Input  | LREAL     | No Edge | 1.0           | <input type="checkbox"/> | <input type="checkbox"/> |         |
|           | SampTime  | Input  | LREAL     | No Edge | 1.0           | <input type="checkbox"/> | <input type="checkbox"/> |         |
|           | Enabled   | Output | BOOL      | No Edge |               | <input type="checkbox"/> | <input type="checkbox"/> |         |

OK

(b) Toolbox Pane

Select a function block and function to display its library information at the bottom of the Toolbox Pane.

The text “by OMRON” which is shown on the right of the library name (1) indicates that this library was provided by OMRON.

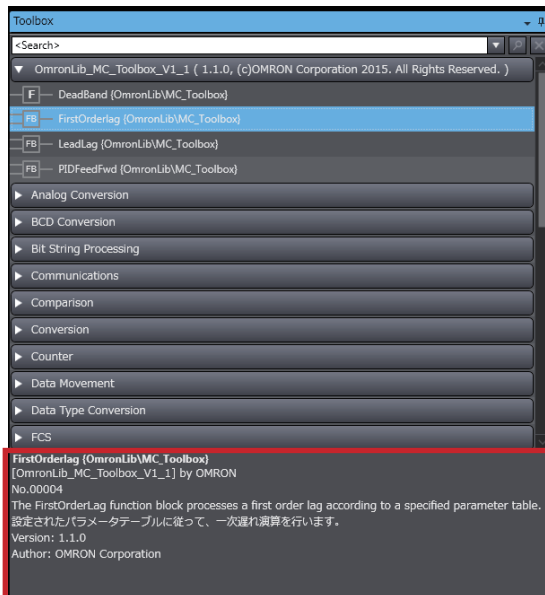

- (5)FB/FUN name
- (6)Name space
- (1)Library file name
- (9)FB/FUN number
- (10)FB/FUN comment
- (7)FB/FUN version
- (8)FB/FUN author

(c) Ladder Editor

Place the mouse on a function block and function to display the library information in a tooltip.

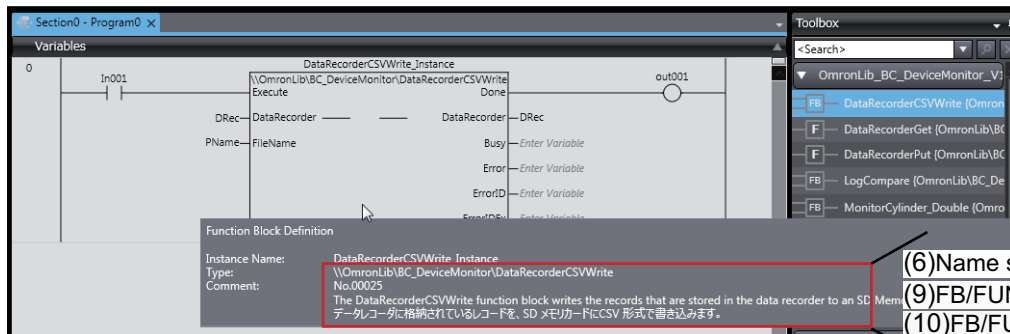

- (6)Name space
- (5)FB/FUN name
- (9)FB/FUN number
- (10)FB/FUN comment



# Referring to Function Block and Function Source Codes

You can refer to the source codes of function blocks and functions provided by OMRON to customize them to suit the user's environment.

User function blocks and user functions can be created based on the copies of these source codes.

The following are the examples of items that you may need to customize.

- Customizing the size of arrays to suit the memory capacity of the user's Controller
- Customizing the data types to suit the user-defined data types

Note that you can access only function blocks and functions whose Source code published/not published is set to Published in the library information shown in their individual specifications.

Use the following procedure to refer to the source codes of function blocks and functions.

- 1 Select a function block or function in the program.

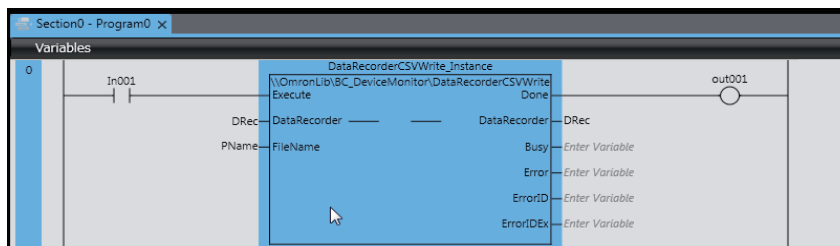

- 2 Double-click or right-click and select **To Lower Layer** from the menu.

The source code is displayed.

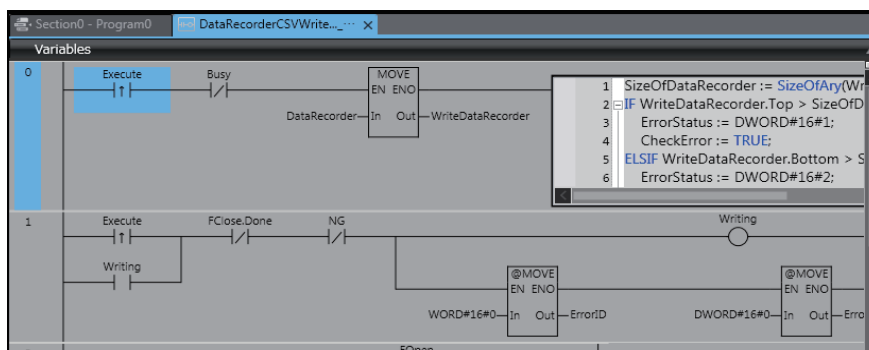

## Precautions for Correct Use

For function blocks and functions whose source codes are not published, the following dialog box is displayed in the above step 2. Click the **Cancel** button.

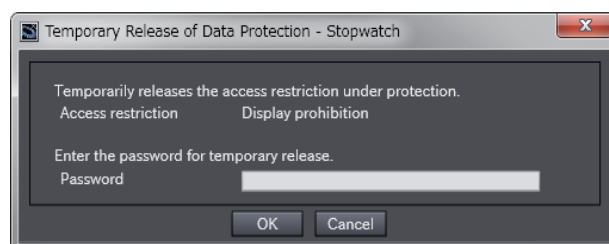





**OMRON Corporation** Industrial Automation Company  
Kyoto, JAPAN

Contact: [www.ia.omron.com](http://www.ia.omron.com)

**Regional Headquarters**

**OMRON EUROPE B.V.**

Wegalaan 67-69, 2132 JD Hoofddorp  
The Netherlands  
Tel: (31)2356-81-300/Fax: (31)2356-81-388

**OMRON ELECTRONICS LLC**

2895 Greenspoint Parkway, Suite 200  
Hoffman Estates, IL 60169 U.S.A.  
Tel: (1) 847-843-7900/Fax: (1) 847-843-7787

**OMRON ASIA PACIFIC PTE. LTD.**

No. 438A Alexandra Road # 05-05/08 (Lobby 2),  
Alexandra Technopark,  
Singapore 119967  
Tel: (65) 6835-3011/Fax: (65) 6835-2711

**OMRON (CHINA) CO., LTD.**

Room 2211, Bank of China Tower,  
200 Yin Cheng Zhong Road,  
PuDong New Area, Shanghai, 200120, China  
Tel: (86) 21-5037-2222/Fax: (86) 21-5037-2200

**Authorized Distributor:**

© OMRON Corporation 2016-2017 All Rights Reserved.  
In the interest of product improvement,  
specifications are subject to change without notice.

**Cat. No. W575-E1-03**

0317