

### Proposal of suitable static control device for your application.

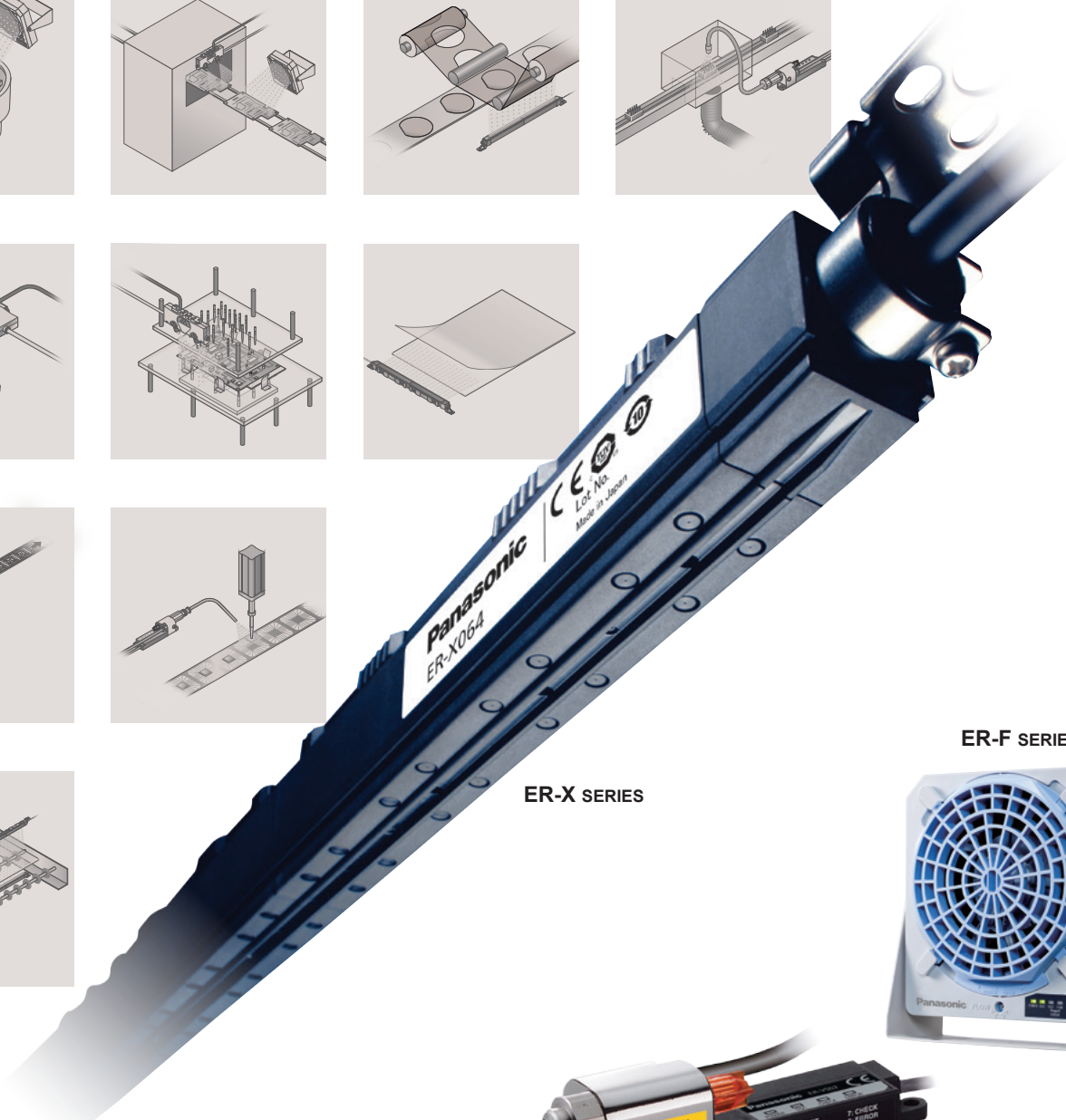

ER-X SERIES

ER-F SERIES

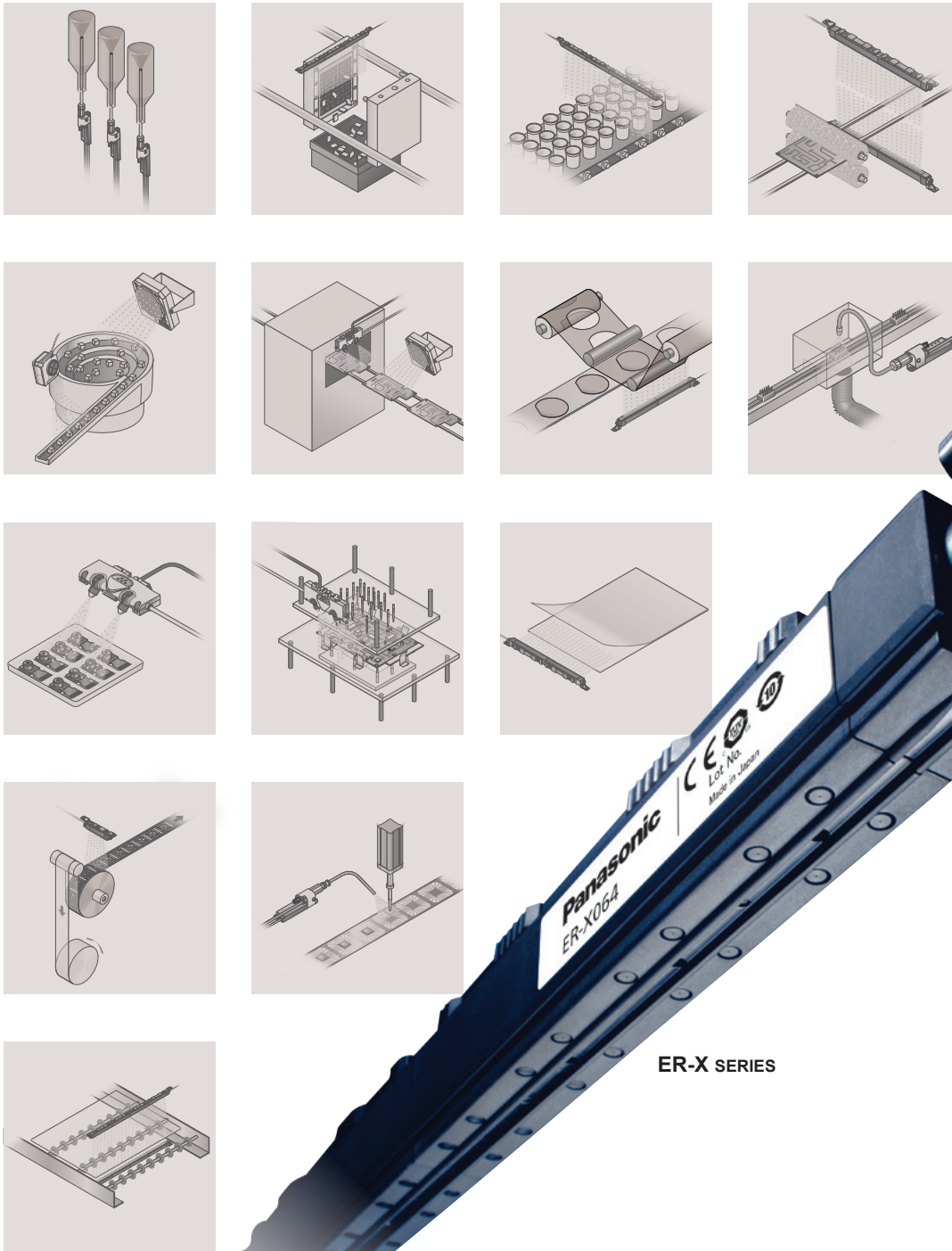

ER-VS02

# Solve your problems caused by static electricity.

Static electricity causes a variety of problems at production sites. Although invisible to the human eye, it is continuously generated and may impact production efficiency and even quality before you have a chance to realize it.

## Are these problems occurring at your production site?

### Adhesion of contamination and dust

Static electricity causes contamination and dust to adhere to workpieces. Need to be aware when manipulating delicate workpieces which requires a high degree of cleanliness.

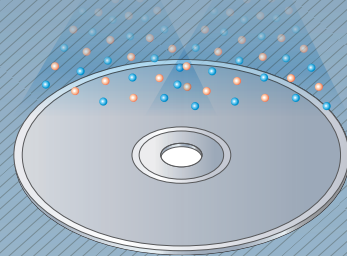

### Adhesion of workpieces to each other and jamming or clogging

Workpieces with a static charge sometimes adhere to each other and clog machinery, preventing materials from moving normally on manufacturing lines and lowering production efficiency.

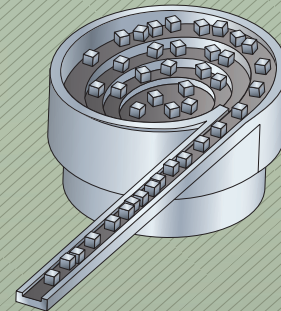

### Damage to electronic components and circuits

As ICs use increasingly miniaturized and high-density designs, damage to components and circuits due to their lower withstanding voltages has become an issue. Even a small amount of static electricity can cause reduced yields.

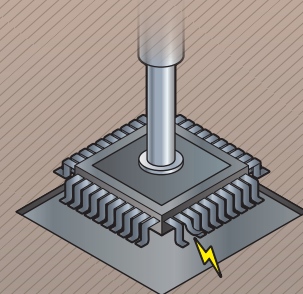

These problems can be solved by eliminating static charges from workpieces and manufacturing processes.

**Static control devices from Panasonic are highly effective at eliminating static electricity at production sites.**

# Workpieces

Static electricity countermeasures sounds simple enough, but the potential problems and necessary measures vary depending on the type of workpiece. The following pages explain how to choose the best static remover that will increase charge removal performance for various types of workpieces.

## Which type of workpiece is giving you trouble?

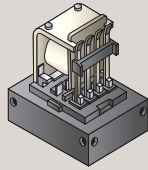

### Electrical / electronic components

Connectors, capacitors, switches, etc.

➔ P.06

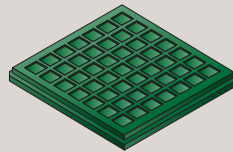

### Semiconductors

Bare chips, IC pallets, wafers, etc.

➔ P.07

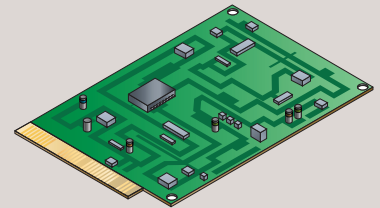

### Circuit boards

Electronic circuit boards

➔ P.08

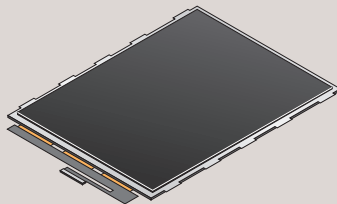

### Glass

LCD screens, etc.

➔ P.09

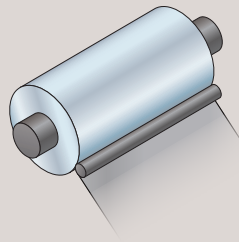

### Films

Medicine and food packaging materials, protective sheets, etc.

➔ P.10

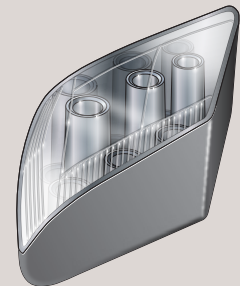

### Resins

Plastic parts, etc.

➔ P.11

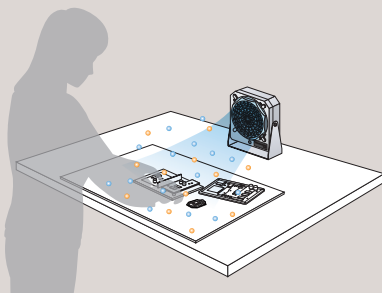

### Workbench

Workpieces handled on cell production bench

➔ P.12

## Types of problems

|                      | Electrical / electronic components | Semiconductors        | Circuit boards        | Glass                 | Films                 | Resins                | Workbench             |
|----------------------|------------------------------------|-----------------------|-----------------------|-----------------------|-----------------------|-----------------------|-----------------------|
| Contamination / dust | <input type="radio"/>              | <input type="radio"/> | <input type="radio"/> | <input type="radio"/> | <input type="radio"/> | <input type="radio"/> | <input type="radio"/> |
| Adhesion / clogging  | <input type="radio"/>              | <input type="radio"/> | <input type="radio"/> | <input type="radio"/> | <input type="radio"/> | <input type="radio"/> | <input type="radio"/> |
| Electrostatic damage | <input type="radio"/>              | <input type="radio"/> | <input type="radio"/> | <input type="radio"/> | <input type="radio"/> | <input type="radio"/> | <input type="radio"/> |

Note: For more information, please refer to individual product pages.



# Charge removal strategies

## Charge removal method

Consider which of these two methods of charge removal performance to prioritize depending on the purpose for which you need to eliminate / remove static electricity and the conditions.

### Prioritizing ion balance

Ion balance refers to the balance of positive and negative ions that are supplied from discharge needle of the static remover. High-performance units will be able to keep the ion balance extremely close to 0 V and to maintain the balance close to 0 V for extended periods of time. The effects of poor ion balance include an inability to precisely eliminate static electricity and accumulation of the opposite charge.

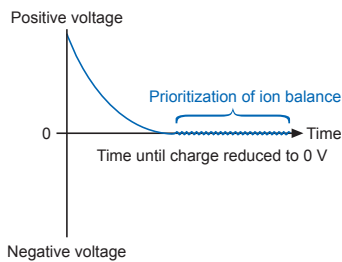

**The high-frequency AC method is advantageous** when prioritizing ion balance.

In the high-frequency AC method, a high-frequency, high-voltage signal is applied to a single discharge needle.

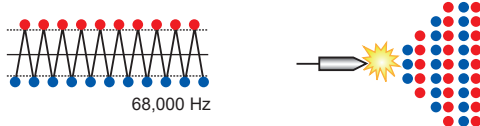

#### Advantages

- Best ion balance
- Ability to transport ions with a nozzle
- Ability to use even at close distances

#### Disadvantages

- Slower removal speed
- Need for air-based ion transport

Recommended workpieces ⇒ **Semiconductors, electric / electronic components, etc.**

Recommended products ⇒ **ER-VS02, ER-VW, etc.**



### Prioritizing charge removal speed

Charge removal speed refers to the time it takes to eliminate the charge on a positively or negatively charged workpiece. Generally, this time is expressed as the time in seconds that it takes to reduce a 1,000 V charge to 100 V, with faster times indicating a higher level of performance. Slower charge removal speeds may have effects such as incomplete charge removal, more man-hours, and longer takt times.

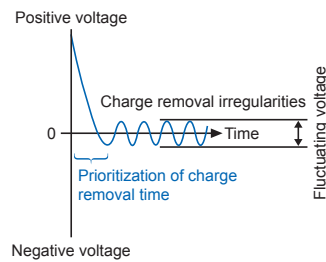

**The pulse AC method is advantageous** when prioritizing charge removal speed.

In the pulse AC method, a DC high-voltage signal is alternately applied to a single discharge needle.

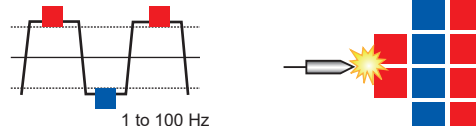

#### Advantages

- Fast charge removal
- Airless charge removal

#### Disadvantages

- Charge removal irregularities due to fluctuating voltage
- Inferior ion balance compared to the high-frequency AC method

Recommended workpieces ⇒ **Resin parts, film material, etc.**

Recommended products ⇒ **ER-X**





### Using this catalog

Charge removal strategies are indicated using icons in the Product Guide (starting on page 14). Use this information to choose the product that best suits your charge removal strategy.

1 Check the icons.



2 Search for an appropriate product.

Designed for optimal ion balance

Small-area

Medium-area

Wide-area

Designed for best charge removal speed

Compressed air type

Fan type

Airless type

## Charge removal area

It is necessary to choose a static remover capable of providing coverage for the target workpiece or area.

### Small-area

Charge removal width (guideline): Up to 200 mm  
7.874 in

Efficient charge removal is possible by concentrating ions in a small area.



### Medium-area

Charge removal width (guideline): 200 to 600 mm  
7.874 to 23.622 in

This is the standard charge removal area. Most static electricity removal devices operate within this area.

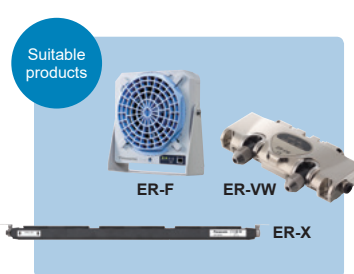

### Wide-area

Charge removal width (guideline): 600 mm  
23.622 in or more

This area is appropriate for use with wide workpieces such as films or FPD substrates or when eliminating static electricity from a space.

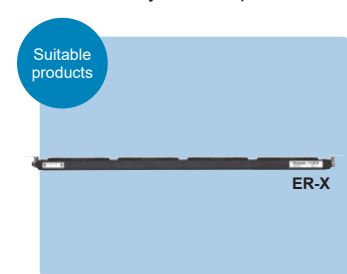

## Air method

Ions generated by the device can be transported by these three methods.

### Compressed air type

Ions are transported by applying compressed air from an external source.

#### Advantages

- Allows charge removal over short to long distances.
- Since a large number of ions can be transported in a short period of time, charge removal times are shortened.
- Ions can be transported over greater distances.
- Charge removal capacity can be varied comparatively easily by changing the air pressure.
- This approach has a high level of cleanliness.

#### Disadvantages

- Requires equipment such as tubing and a compressor.
- Imposes running costs.

### Fan type

Ions are transported by a small, built-in fan.

#### Advantages

- This approach is well suited to charge removal at medium distances.
- Installation is simple, allowing this type of system to be used immediately as a static electricity countermeasure.
- Does not require equipment such as tubing.

#### Disadvantages

- Nearby dust may be ingested into the fan.

### Airless type

Ions are transported by Coulomb's force without using air movement.

#### Advantages

- This approach is well suited to charge removal at close distances.
- Charges can be removed without the effects of air movement, for example scattering of minuscule parts and film flutter.
- Does not require equipment or impose associated costs.
- Operates quietly without any wind or motor noise.

#### Disadvantages

- It is difficult to use this approach to remove charges at a distance.

# Electrical and electronic components

## Contamination / dust

### Removing dust from connectors and switches

Dust removal using ionized air is ideal for use in assembly processes of components with contacts, for example connectors and switches. The **ER-VS02** strips away foreign matter with a powerful stream of ionized air and prevents it from re-adhering.

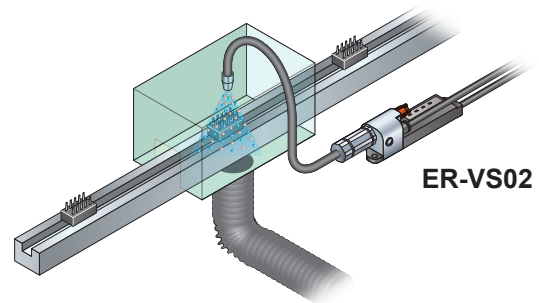

**ER-VS02** ➔ P.14

## Adhesion / clogging

### Preventing jamming in part feeders

By combining the **ER-F**, which can eliminate static electricity over a large area thanks to its wide-angle louvers, and the **ER-Q**, which incorporates a super-compact fan for local charge removal, you can reduce the incidence of jamming throughout feeder processes without needing to use compressed air.

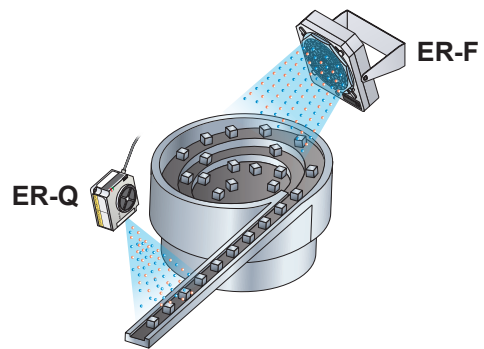

**ER-F** ➔ P.20

**ER-Q** ➔ P.17

## Electrostatic damage

### Preventing electrostatic damage to camera module elements

Reducing the charge to near zero with the high-frequency AC type **ER-VW** provides an ideal means of preventing damage to camera modules, which have a low withstand voltage.

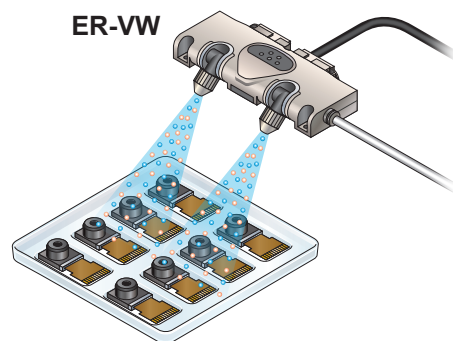

**ER-VW** ➔ P.16

## Contamination / dust

### Removing dust while separating TAB protective film

An extremely large amount of static electricity is generated when separating film, attracting contamination and dust. It is recommended to use the **ER-X**, which delivers high-speed charge removal performance with either airless or low-airflow operation, to prevent adhesion of contamination, which can keep film from adhering properly to ICs.

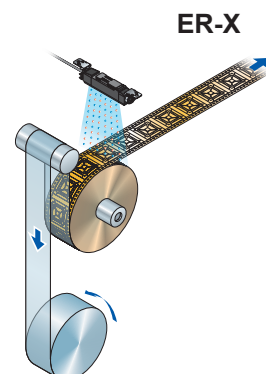

**ER-X** ➔ P.18

# Semiconductors

## Electrostatic damage

### Removing static electricity during loader / unloader operation

By installing static remover on loaders and unloaders used in manufacturing equipment, you can prevent problems caused by static electricity inside those systems while keeping charged workpieces from being passed on to the next process. Static removers with compact heads such as the **ER-X** and **ER-VW** can be embedded in equipment to provide effective charge removal performance.

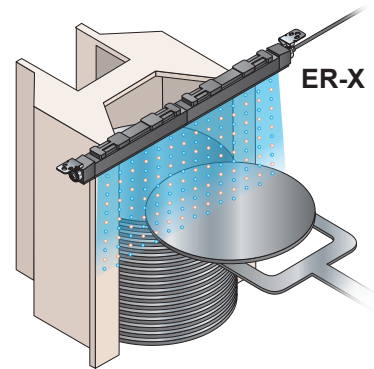

**ER-X**

➔ **P.18**

**ER-VW**

➔ **P.16**

## Electrostatic damage

### Removing static electricity during BG sheet separation

A large amount of static electricity is generated when separating, cleaning, and drying wafer sheets. It is recommended to use the **ER-VW** or **ER-X**, which can accommodate wafers of up to 300 mm **11.811 in** in diameter, to eliminate static electricity before wafers are passed to the next process.

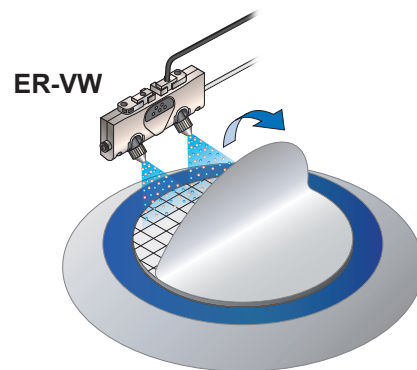

**ER-VW**

➔ **P.16**

**ER-X**

➔ **P.18**

## Electrostatic damage

### Preventing electrostatic damage during bonding

Bare chips that have been cut from wafer during the dicing process are among the devices that are most susceptible to electrostatic damage. During bonding, it is recommended to reduce the charge to  $\pm 10$  V or less through charge removal of small area with the **ER-VS02**.

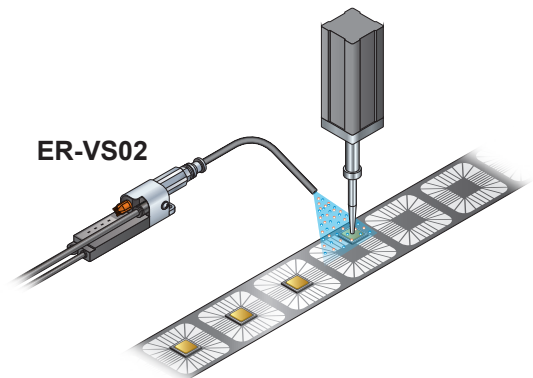

**ER-VS02** ➔ **P.14**

## Electrostatic damage

### Eliminating static electricity during IC tray stacking

The **ER-VW**, which offers excellent ion balance and multiple units connection that can accommodate a variety of IC tray layouts, is ideal for stopping electrostatic damage of ICs before and after the final inspection process.

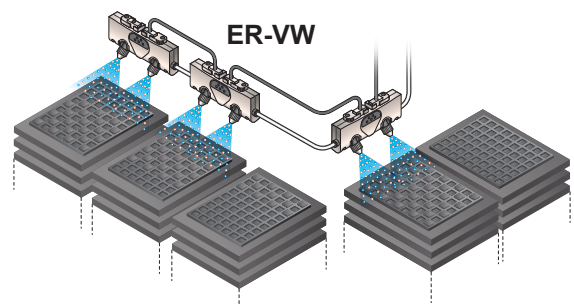

**ER-VW** ➔ **P.16**



# Circuit boards

## Contamination / dust

### Eliminating static electricity after circuit board cleaning

During cleaning, circuit boards pick up a large electrostatic charge due to friction as they are transported. To keep contamination from re-adhering to the boards, it is recommended to use the **ER-X**, which can eliminate large amounts of static electricity at high speeds.

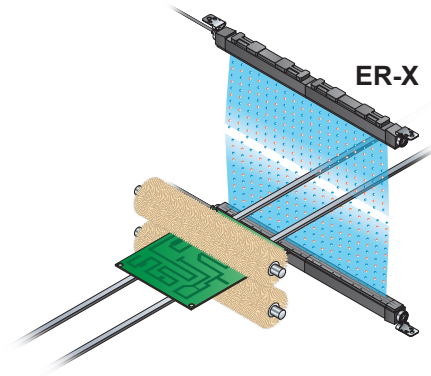

**ER-X** ➔ P.18

## Electrostatic damage

### Eliminating static electricity when transporting circuit boards

Electrostatic damage sustained while mounting components on circuit boards is rapidly becoming a serious problem due to the miniaturization of components and patterns. The **ER-VW** and **ER-F**, which can eliminate static electricity over the entire surface of a circuit board, can be used effectively to ensure quality before and after mounting of components on precision circuit boards.

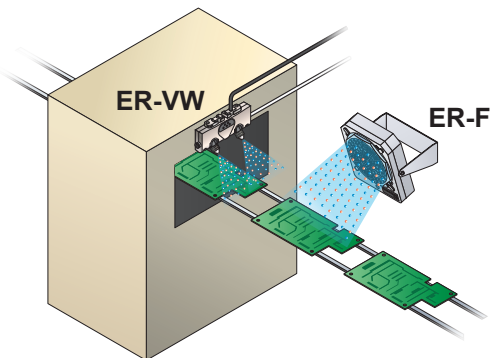

**ER-VW** ➔ P.16    **ER-F** ➔ P.20

## Electrostatic damage

### Eliminating static electricity during loading of circuit boards into in-circuit testers

When test pins are brought into contact with a circuit board carrying an electrostatic charge, component or testing system can cause damage. Such problems can be prevented with the **ER-VW** or **ER-VS02**, which offer excellent ion balance.

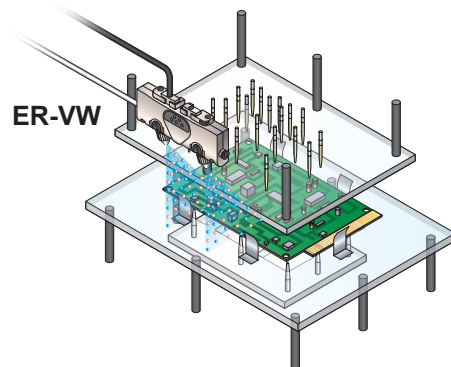

**ER-VW** ➔ P.16    **ER-VS02** ➔ P.14

## Electrostatic damage

### Managing circuit board charges

Even if the workpiece and system are the same, the amount of charge carried by individual workpieces varies with slight environmental changes such as movements of nearby people, temperature, and humidity. By installing an inline **EF-S1**, a compact, low-cost electrostatic sensor, you can continuously monitor variations in charge so that you can implement simple, visible electrostatic countermeasures.

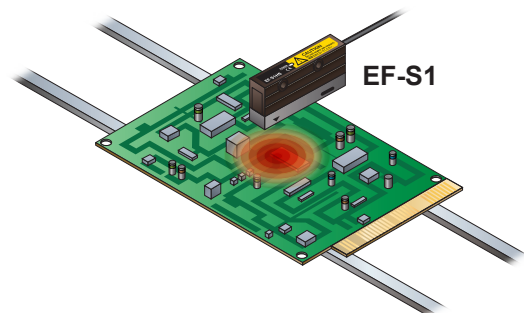

**EF-S1** ➔ P.23

# Glass

## Contamination / dust

### Dealing with foreign matter when applying films

Adhesion of contamination during touch panel or glass circuit board application processes can cause contact and appearance defects. Because the **ER-X** can perform airless or low-airflow charge removal without stirring up dust, it is ideal for preventing adhesion of contamination.

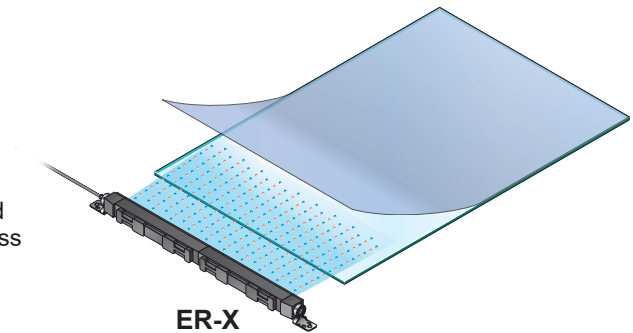

ER-X → P.18

## Electrostatic damage

### Eliminating static electricity when transporting glass circuit boards

Separating glass circuit boards from the surface with which they are in contact when transporting them generates a large amount of static electricity, causing a variety of problems including workpiece damage and contamination adhesion. Optimal charge removal in such applications can be implemented by using the **ER-X**, which can drive two heads with a single controller, to eliminate static electricity from both sides of the glass.

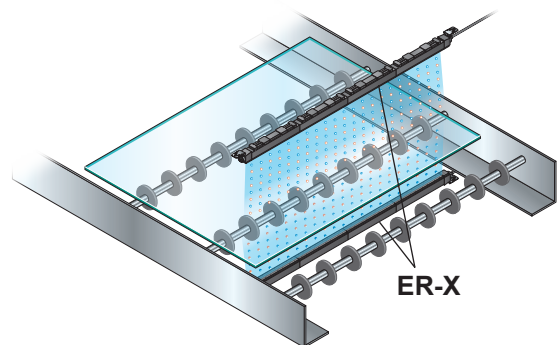

ER-X → P.18

## Adhesion / clogging

### Eliminating static electricity when lifting glass sheets

Lifting glass sheets off a metal stage generates a large amount of static electricity and may cause the glass to crack under certain conditions. The **ER-X**, a compact device that delivers high-speed charge removal performance, is ideal for use in addressing this issue.

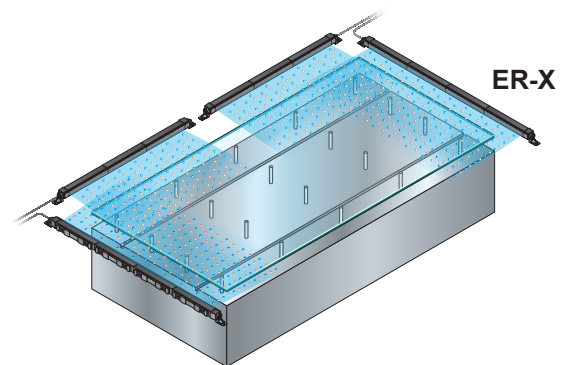

ER-X → P.18

## Contamination / dust

### Cleaning bottles

Contamination inside bottles that will be used to hold medicines or cosmetics can have a significant negative effect on the quality of the product. The **ER-VS02** can be used to eliminate static electricity inside the bottle by means of nozzle transport and prevent re-adhesion of the contamination.

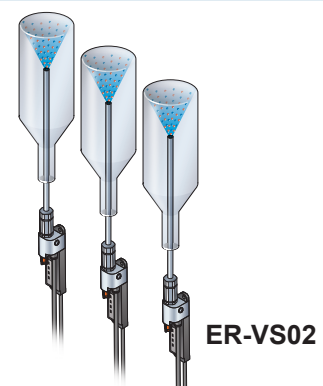

ER-VS02 → P.14

# Films

## Contamination / dust

### Preventing jamming of packaging material

It is recommended to prevent adhesion of contamination and dust, which can cause process defects, with the **ER-X**, which provides airless, high-speed charge removal capability.

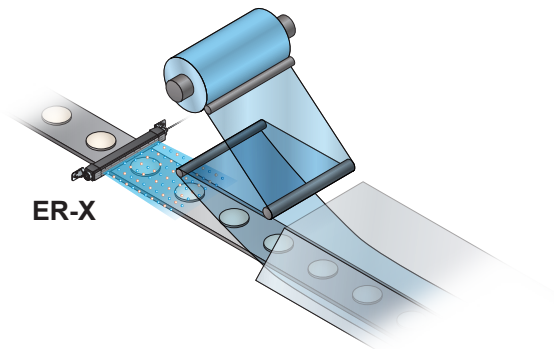

ER-X → P.18

## Adhesion / clogging

### Keeping knockout material from sticking to punches

By adding ionized air from the **ER-VS02**, which can perform small area charge removal between processing machines and film, you can prevent process defects in the form of film jamming and sticking.

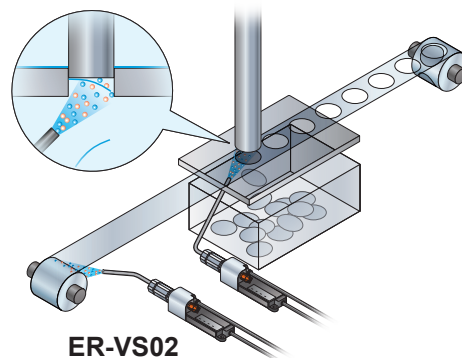

ER-VS02 → P.14

## Adhesion / clogging

### Eliminating static electricity when separating protective tape

A large amount of static electricity is generated when separating protective tape. The **ER-X**, which can perform high-speed charge removal, is ideal for use in preventing jamming of separated tape and inclusion of dust.

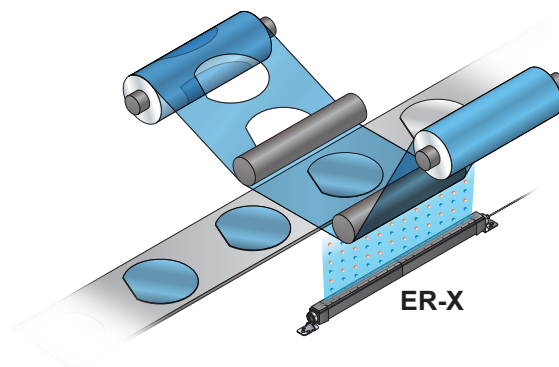

ER-X → P.18

## Contamination / dust

### Eliminating static electricity before and after screen printing

Printing irregularities and contamination adhesion caused by static electricity can occur during a variety of printing-related processes, including the transport of printing film and application of ink. The incidence of printing defects can be reduced by using the **ER-X**, which can perform charge removal with two heads driven by a single controller, to reduce the amount of charge in each process.

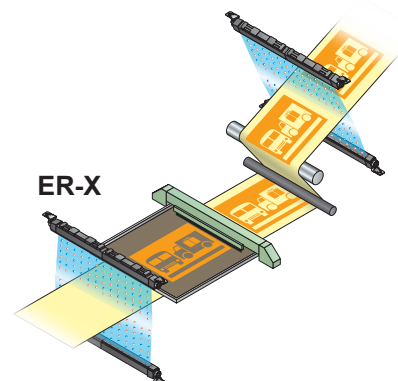

ER-X → P.18



# Resins

## Adhesion / clogging

### Preventing adhesion of molded parts to molds

Highly charged molded parts can cause mold damage, incomplete ejection, and dust ingestion. High-speed charge removal for molded parts can be performed by fine-tuning frequency and the amount of positive and negative ions with the **ER-X**.

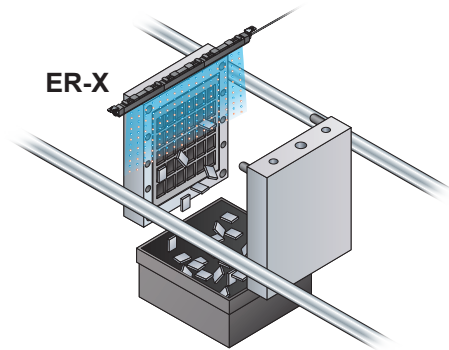

ER-X → P.18

## Contamination / dust

### Removing dust during instrument panel assembly

If dust adheres to an automobile instrument panel, it may cause a quality defect. The **ER-X**, which can perform high-speed charge removal without stirring up dust, is ideal for use in preventing contamination and dust adhesion.

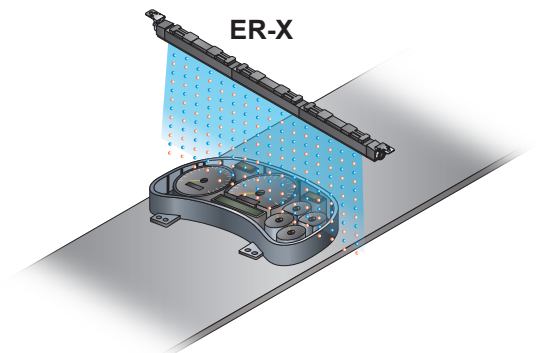

ER-X → P.18

## Contamination / dust

### Removing dust during lens assembly

The **ER-VS02**, which can supply large volumes of ionized air, can reduce the incidence of optical defects by removing dust and contamination of small area that would otherwise adhere to the lens.

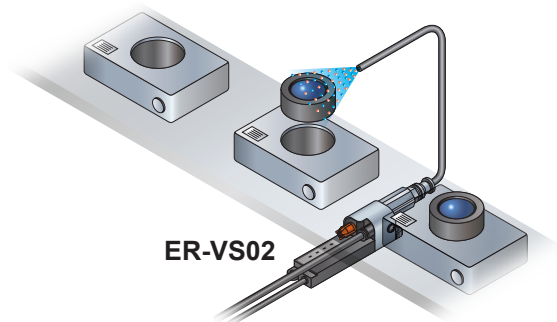

ER-VS02 → P.14

## Contamination / dust

### Removing dust during food product cup transport

Static electricity generated during the transport of food product cups can attract dust and hair, causing the container to be contaminated with foreign matter. The **ER-X** can perform charge and dust removal across a wide area for rows of numerous food product cups.

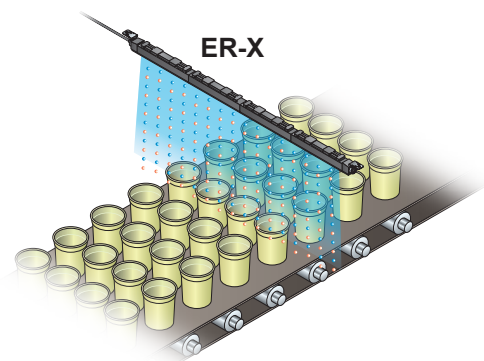

ER-X → P.18

# Workbench

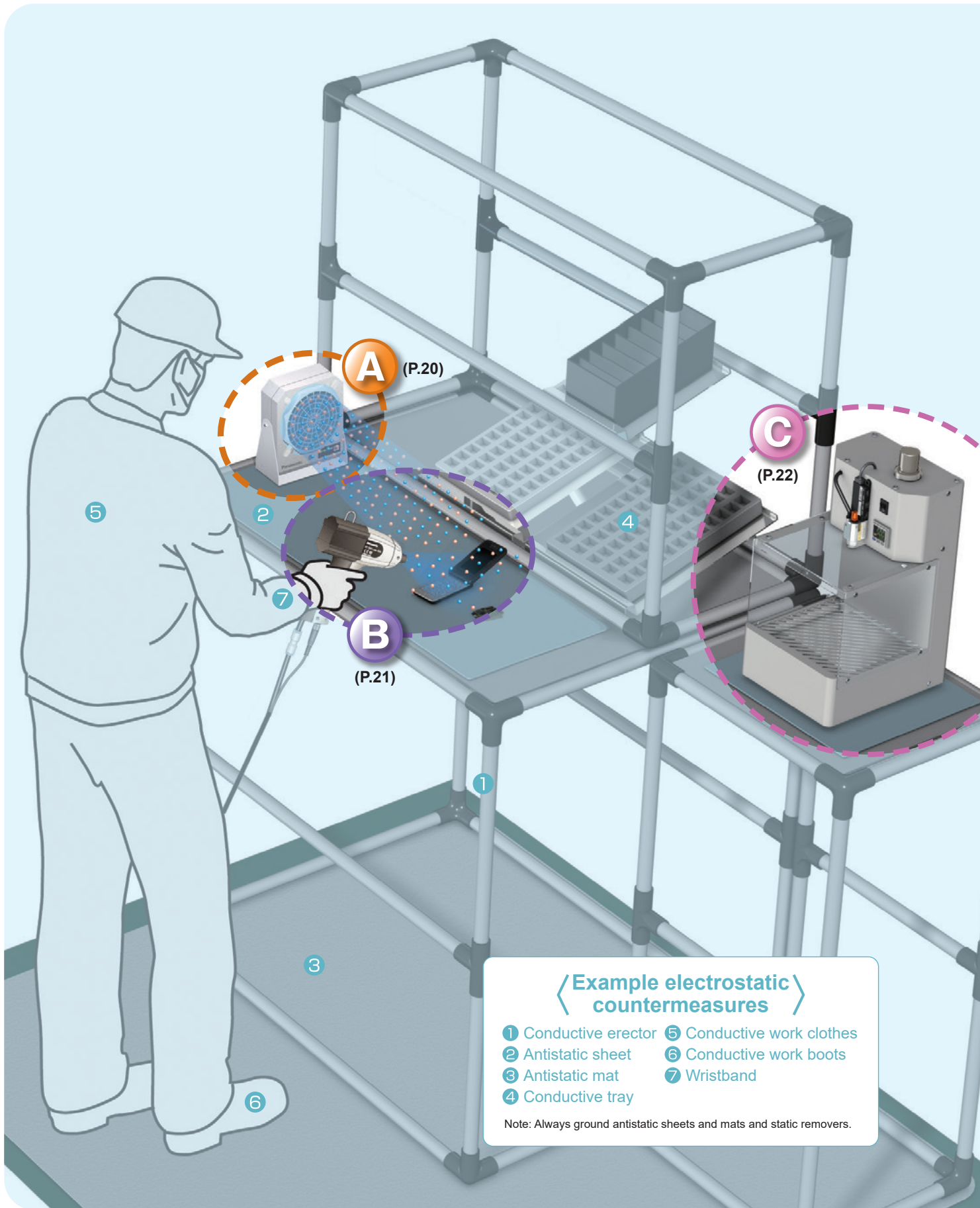

## Example electrostatic countermeasures

- 1 Conductive erector
- 2 Antistatic sheet
- 3 Antistatic mat
- 4 Conductive tray
- 5 Conductive work clothes
- 6 Conductive work boots
- 7 Wristband

Note: Always ground antistatic sheets and mats and static removers.

Contamination / dust

### Preventing charging in the immediate work area

The compact **ER-F** can be placed wherever there is space on a workbench to quickly remove static electricity in front of workers.

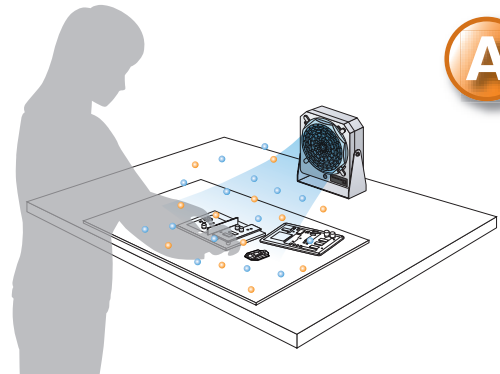

**ER-F** ➔ P.20

Contamination / dust

### Removing dust during film separation

The **EC-G02** quickly removes dust that has adhered to film due to static charges generated as it separates with pulse ionized air.

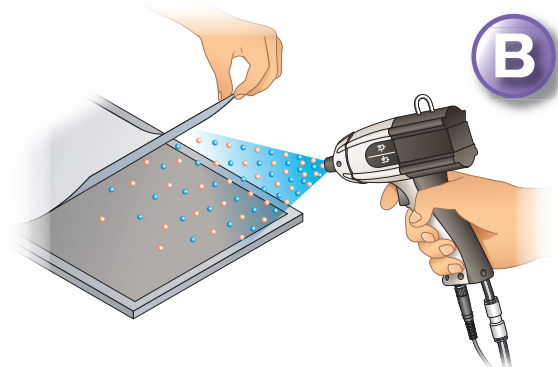

**EC-G02** ➔ P.21

Contamination / dust

### Removing dust during electronic circuit board assembly

Dust removal starts when you place the workpiece inside the **EC-B**. Dust is exhausted from the device so that it does not re-adhere to the workpiece.

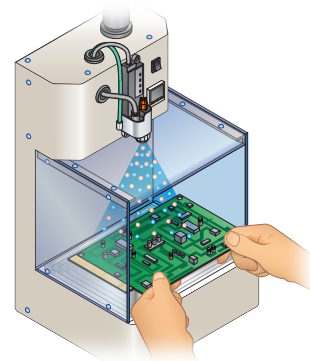

**EC-B** ➔ P.22



## Usable in various applications thanks to outstanding ion balance, powerful dust removal capability, and a variety of nozzles

Can be installed in confined locations. Reliably removes dust from vicinity of workpieces.

- Designed for optimal ion balance
- Small-area
- Medium-area
- Wide-area
- Designed for best charge removal speed
- Compressed air type
- Fan type
- Airless type

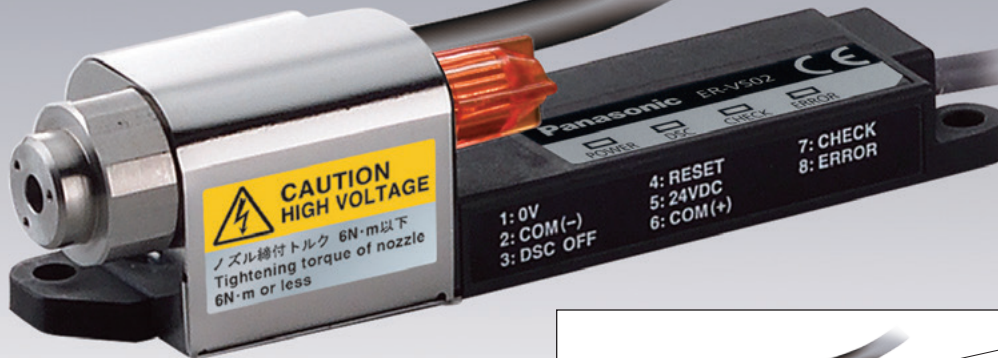

High-frequency AC method  
Ultra-compact Ionizer  
**ER-VS02**

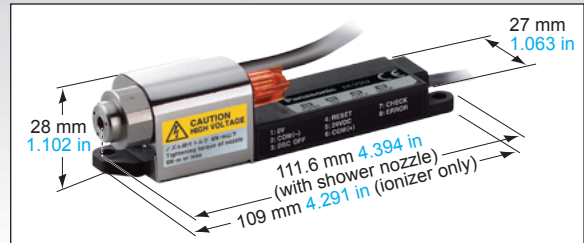

### Produces excellent ion balance

Charge removal time (typical)

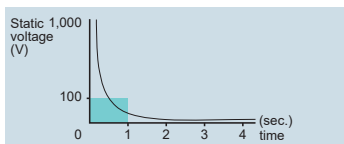

Ion balance comparison (typical)

• Spot type

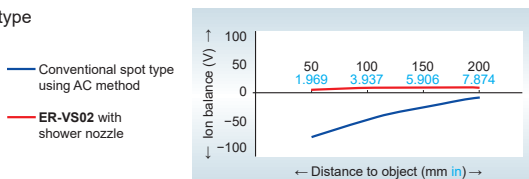

\* Comparison test carried out by our company

• Bar type

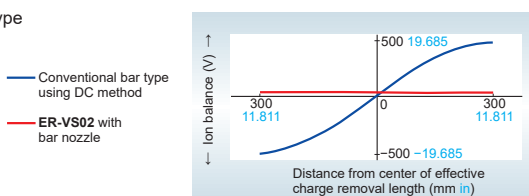

\* Comparison test carried out by our company

The adoption of high-frequency AC method allows extremely stable ion balance to be achieved. Because the ion balance is not affected by the pressure of air supplied or by the setup distance, no troublesome adjustments are required after setup.

### Ultra-compact design

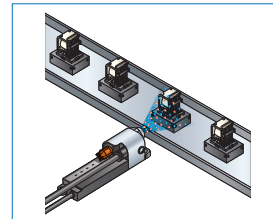

The main unit is merely 109 × 27 × 28 mm 4.291 × 1.063 × 1.102 in, so it can easily be combined with other devices and also be installed as an add-on. Furthermore, the high-voltage power supply is built-in, so no extra space is required except for the ionizer itself.

### High performance with no controller needed

A full range of functions have been provided with full consideration given to ease of use in the workplace. No separate controller is needed.

### Specifications

| Item                                    | Designation                   | Spot type      |
|---|-------------------------------|----------------|
|   | Model No.                     | <b>ER-VS02</b> |
| Supply voltage / current consumption    | 24 V DC ±10 % / 70 mA or less |                |
| Charge removal time (±1,000 V → ±100 V) | 1 sec. or less                |                |
| Ion balance                             | ±10 V or less                 |                |
| Supplied air flow                       | 500 ℓ/min. (ANR) or less      |                |
| Air pressure range                      | 0.05 to 0.7 MPa               |                |
| Discharge method                        | High-frequency AC method      |                |
| Weight                                  | 120 g approx.                 |                |

Note: Please refer to product catalog and specifications for more details.

# ER-V series Nozzle variations

## Shower nozzles

### Dispersion type

Disperses air.

#### ER-VAS

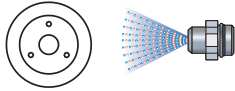

## Bar nozzles

### Straight type

Ensures a wide effective charge removal area with a straight bar nozzle.

#### ER-VAB□



| Model No. | Effective charge removal length |
|-----------|---------------------------------|
| ER-VAB020 | 200 mm 7.874 in                 |
| ER-VAB032 | 320 mm 12.598 in                |
| ER-VAB065 | 650 mm 25.591 in                |

#### ER-VAB□N

Made to order with an effective charge removal length from 100 to 640 mm 3.937 to 25.197 in, specified in 10 mm 0.394 in units. (For an effective charge removal length of 180 mm 7.087 in, refer to ER-VAB018N.)

### Bar & flexible type

Included a conductive tube that can be bent or cut as desired and a joint nozzle.

#### ER-VAB-AT

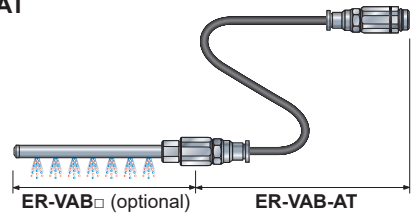

#### ER-VAB-ATL

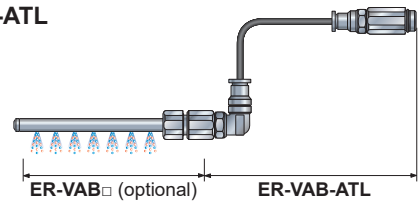

Tube length: 500 mm 19.685 in  
 Tube diameter: ø8 mm ø0.315 in  
 Minimum bending radius: R25 mm R0.984 in  
 Compatible nozzles: straight nozzles  
 (Effective charge removal length 320 mm 12.598 in or less)

## Tube nozzles

### Shape-preserving type

Bends easily and maintains its shape, so there's no need to secure the tube in place.



| Model No. | Tube length      |
|-----------|------------------|
| ER-VAK10  | 112 mm 4.409 in  |
| ER-VAK30  | 312 mm 12.283 in |
| ER-VAK50  | 512 mm 20.157 in |

Tube diameter: ø10 mm ø0.394 in  
 Minimum bending radius: R40 mm R1.575 in

### Flexible type

This conductive tube can be bent as desired. Since it can be cut freely, it can accommodate a variety of applications.



Tube length: 500 mm 19.685 in  
 Tube diameter: ø6 mm ø0.236 in  
 Minimum bending radius: R15 mm R0.591 in

## Featuring two powerful nozzles in a thin-profile form

You'll find the **ER-VW** hard at work in a variety of environments thanks to the ease with which it accommodates different layouts.

|  |                     |             |              |
|--|---------------------|-------------|--------------|
| Designed for optimal ion balance       | Small-area          | Medium-area | Wide-area    |
| Designed for best charge removal speed | Compressed air type | Fan type    | Airless type |



High-frequency AC method

Thin type ionizer  
**ER-VW**

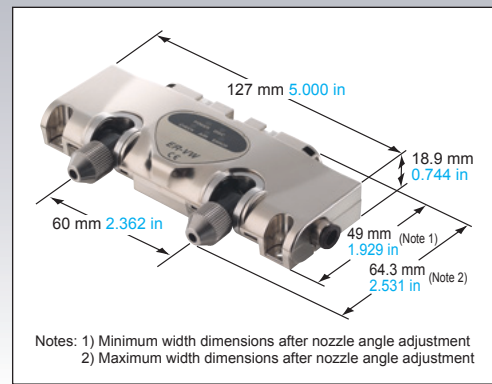

### Compact and thin design

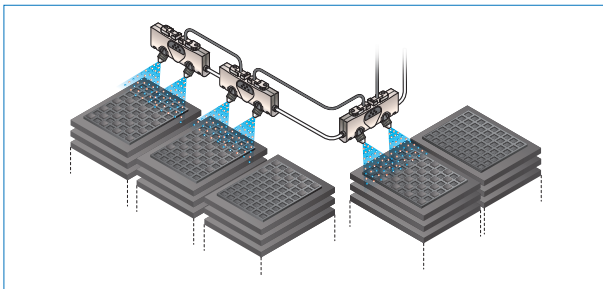

The thickness of the unit is 18.9 mm **0.744 in**. Even so, the nozzle angles can be adjusted, so that they can still be installed in places where there are space restrictions, such as inside other equipment or along several adjacent production lines.

### Nozzle angle adjustment mechanism

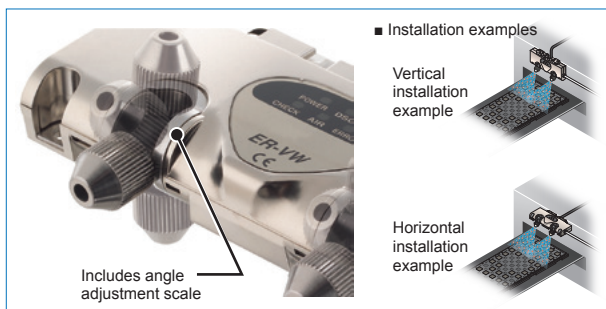

The angles of the two nozzles can be adjusted within a range of approximately 190° by screwing down the ends of the nozzles. After adjusting the angle, turn the ends of the nozzles to tighten them and secure them at that angle. This allows the nozzle angles of the **ER-VW** to be adjusted easily after installation.

### Easy connection possible

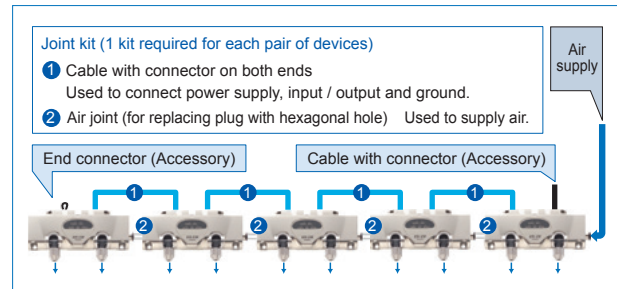

The joint kit (optional) can be used to connect up to a maximum of 5 **ER-VW** units. The air supply part is connected via quick connection joints, and the power supply and input / output signals can also be connected easily using connection cables with connectors at both ends.

### Specifications

| Designation   | Spot type                           |
|---|-------------------------------------|
| Item Model No.  | <b>ER-VW</b>                        |
| Supply voltage / current consumption                                      | 24 V DC $\pm 10\%$ / 120 mA or less |
| Charge removal time ( $\pm 1,000\text{ V} \rightarrow \pm 100\text{ V}$ ) | 1 sec. or less                      |
| Ion balance   | $\pm 10\text{ V}$ or less           |
| Supplied air flow   | 60 $\ell/\text{min.}$ (ANR) or less |
| Air pressure range  | 0.05 to 0.5 MPa                     |
| Discharge method  | High-frequency AC method            |
| Weight  | 110 g approx.                       |

Note: Please refer to product catalog and specifications for more details.



# No need for compressed air! Introducing exceptional freedom of installation in a super-compact size

The ER-Q supplies clean air from its built-in fan in an energy-efficient manner.

|  |                     |             |              |
|--|---------------------|-------------|--------------|
| Designed for optimal ion balance       | Small-area          | Medium-area | Wide-area    |
| Designed for best charge removal speed | Compressed air type | Fan type    | Airless type |

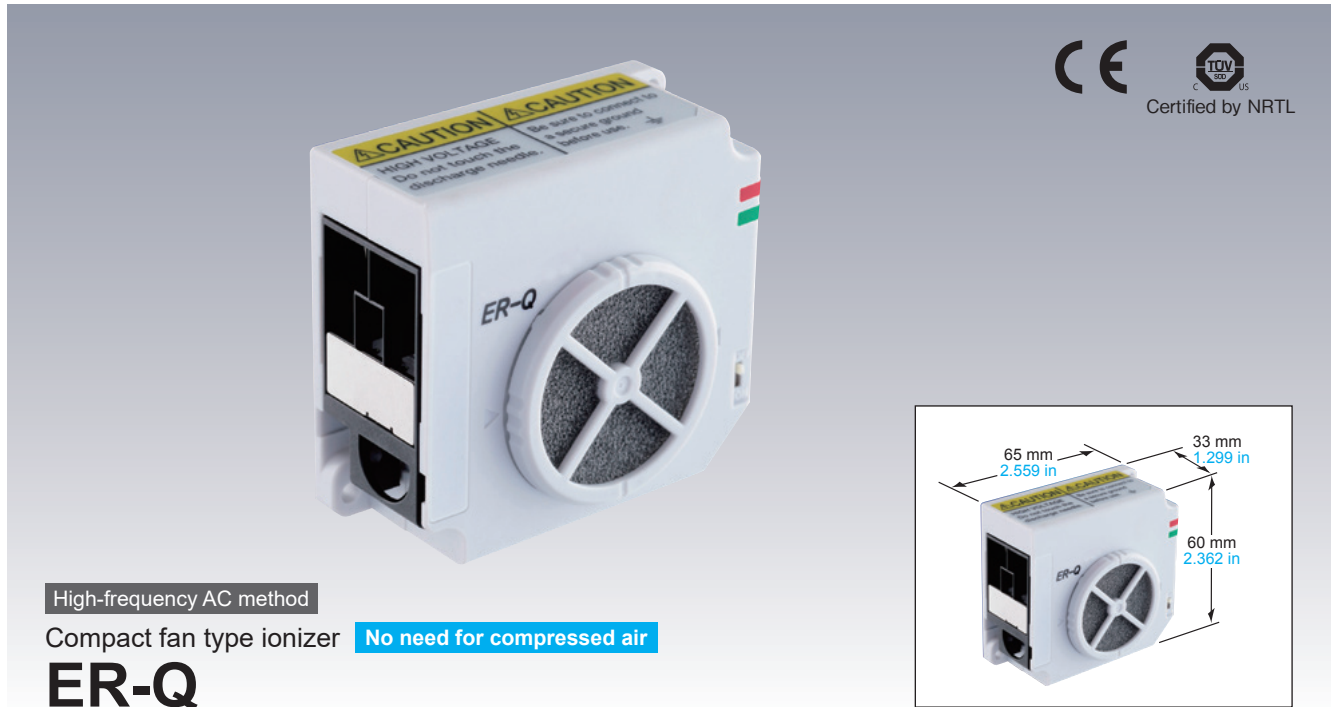

## Compact body with outstanding installation freedom

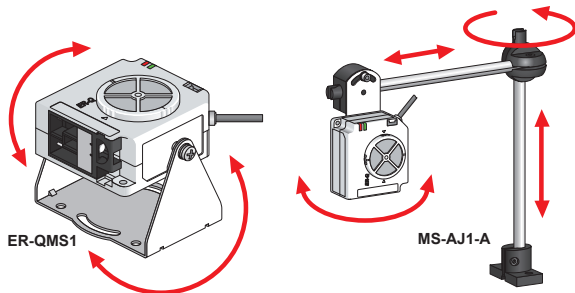

With a super-compact body that measures just W33 × H60 × D65 mm (W1.299 × H2.362 × D2.559 in), the ER-Q can be installed as if it were a sensor. A knob lets you adjust airflow to suit your application.

## Outstanding charge removal performance

A proprietary, high-frequency AC design and sirocco fan deliver outstanding charge removal performance with exceptional ion balance, even at low airflow settings. The ER-Q is particularly well suited for use in spot charge removal applications with semiconductor post-processes and electronic component fabrication equipment.

## Designed for maintainability and peace of mind



You can easily check if the unit needs maintenance or has a fan malfunction by means of its LED indicator or output. One-touch removal and reattachment of the discharge needle unit and filter allows the number of man-hours required for replacement and cleaning to be reduced.

## Specifications

| Designation                             | Compact fan type               |
|---|--------------------------------|
| Item                                    | Model No.                      |
| Supply voltage / current consumption    | 24 V DC ±10 % / 200 mA or less |
| Charge removal time (±1,000 V → ±100 V) | 1.5 sec. approx.               |
| Ion balance                             | ±10 V or less                  |
| Discharge method                        | High-frequency AC method       |
| Weight                                  | 110 g approx.                  |

Note: Please refer to product catalog and specifications for more details.

# Helping save time with high-speed charge removal made possible by high ion volume

Multifunctional type can be used for both airless and low-airflow charge removal.

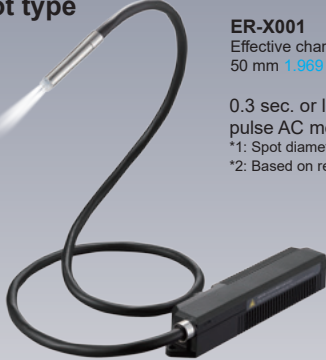

|  |                     |             |              |
|--|---------------------|-------------|--------------|
| Designed for optimal ion balance       | Small-area          | Medium-area | Wide-area    |
| Designed for best charge removal speed | Compressed air type | Fan type    | Airless type |

### Spot type



**ER-X001**  
Effective charge removal width: 50 mm 1.969 in approx.  
0.3 sec. or less\*1 fastest charge removal achieved with pulse AC method spot type ionizer\*2.  
\*1: Spot diameter of ø15 mm ø0.591 in or less  
\*2: Based on research conducted by our company as of March 2016.

### Bar type

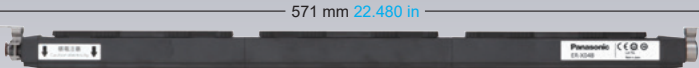
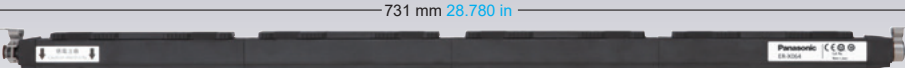
|                  |   |  |
|------------------|---|--|
| 163 mm 6.417 in  |  | <b>ER-X008</b><br>Effective charge removal width: 80 mm 3.150 in approx.   |
| 251 mm 9.882 in  |   | <b>ER-X016</b><br>Effective charge removal width: 160 mm 6.299 in approx.  |
| 411 mm 16.181 in |   | <b>ER-X032</b><br>Effective charge removal width: 320 mm 12.598 in approx. |
| 571 mm 22.480 in |   | <b>ER-X048</b><br>Effective charge removal width: 480 mm 18.898 in approx. |
| 731 mm 28.780 in |   | <b>ER-X064</b><br>Effective charge removal width: 640 mm 25.197 in approx. |

Pulse AC method  
Area Ionizer  
**ER-X SERIES**

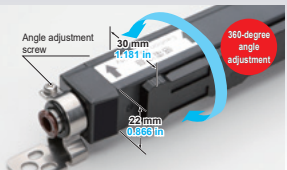

Angle adjustment screw  
30 mm 1.181 in  
360-degree angle adjustment  
22 mm 0.866 in

CE  
TUV  
Certified by NRTL

## Pulse AC method for high-speed charge removal

■ Charge removal time characteristics (typical)  
Measured at a charge removal distance of 100 mm 3.937 in, □150 mm □5.906 in CPM (at center of CPM).

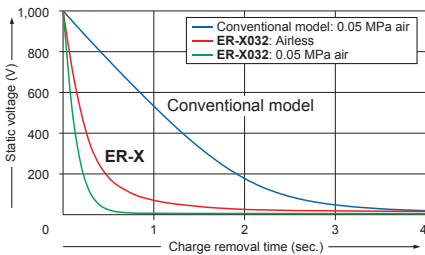

The ER-X series uses the pulse AC method to alternately apply positive and negative voltages to a single discharge needle. Since this approach yields high ion generation volume and releases a large volume of ions, it can remove charges in a short amount of time.

## Automatic ion balance control function

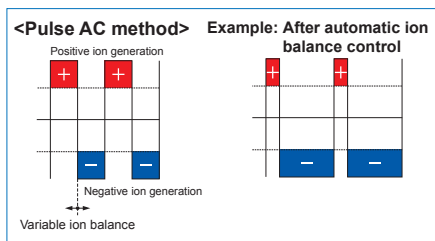

The ER-X series automatically maintains the set ion balance by sensing the ion generation volume, which fluctuates with variations in the environment, and using changes as feedback to control its own operation.

## Compatibility with airless and low-airflow charge removal



Since there is almost no dispersion of dust from air from the unit and no need to worry about work fluttering or moving due to airflow, the ER-X series is ideal for charge removal applications involving laminate film, minuscule components, and FPDs (mobile panels) requiring a high level of cleanliness.

## Dual head connections to increase charge removal area and layout expandability

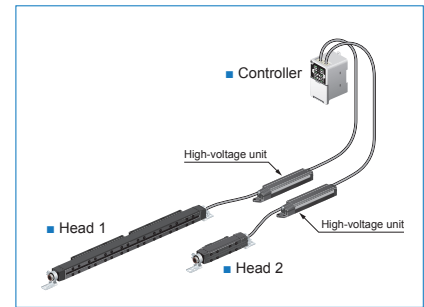

- Different heads can be combined.
- Charge removal is possible with a layout that places heads on either side of the workpiece.
- The charge removal efficiency can be increased by synchronizing the two heads.

## High and low temperature resistant type also available



Bar type head compatible with ambient temperatures of -60 to +200 °C  
-76 to +392 °F is available.

## Flat discharge surface for easy cleaning

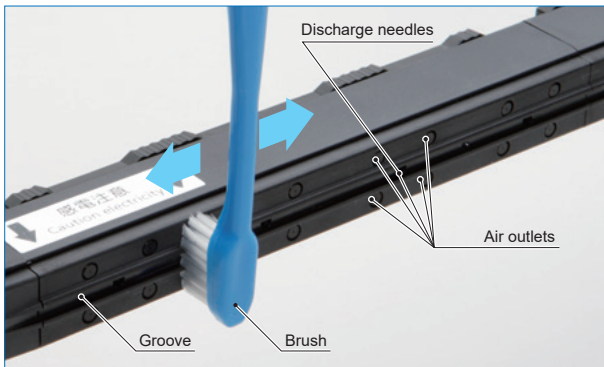

The **ER-X** series heads have a flat discharge face, allowing effortless cleaning of the discharge needles and air outlets by simply brushing along the groove provided.

## Discharge needle unit for simple needle replacement

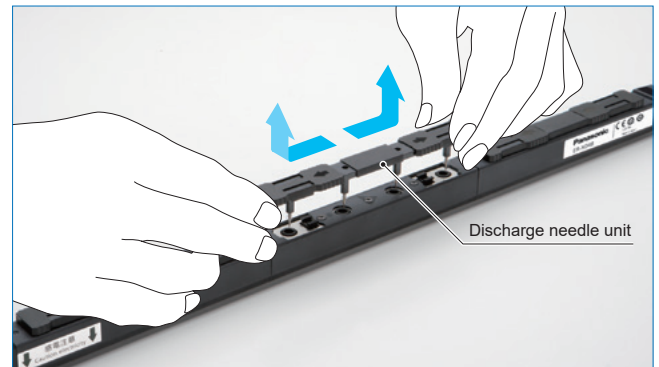

The removable discharge needle unit (including a set of four needles) substantially simplifies maintenance. To remove the unit, just slide it toward both ends as indicated by the arrows.

## Specifications

### Heads

| Item                                     | Type      | Spot type   | Bar type                |                |                |                |                |
|--|-----------|---|-------------------------|----------------|----------------|----------------|----------------|
|  | Model No. | <b>ER-X001</b>  | <b>ER-X008</b>          | <b>ER-X016</b> | <b>ER-X032</b> | <b>ER-X048</b> | <b>ER-X064</b> |
| Charge removal time<br>(±1,000 V→±100 V) |           | 0.3 sec. or less (Note 1),<br>0.5 sec. or less (Note 2) | 1 sec. or less (Note 2) |                |                |                |                |
| Ion balance                              |           | ±30 V or less (Note 2, 3)                               |                         |                |                |                |                |
| Discharge method                         |           | Pulse AC method   |                         |                |                |                |                |
| Maximum air pressure                     |           | 0.5 MPa   |                         |                |                |                |                |
| Net weight                               |           | 370 g approx.   | 330 g approx.           | 410 g approx.  | 530 g approx.  | 650 g approx.  | 780 g approx.  |

| Item                                     | Type      | High and low temperature resistant type |                  |                  |                  |                  |
|--|-----------|---|------------------|------------------|------------------|------------------|
|  | Model No. | <b>ER-X008HC</b>                        | <b>ER-X016HC</b> | <b>ER-X032HC</b> | <b>ER-X048HC</b> | <b>ER-X064HC</b> |
| Charge removal time<br>(±1,000 V→±100 V) |           | 1 sec. or less (Note 2)                 |                  |                  |                  |                  |
| Ion balance                              |           | ±30 V or less (Note 2, 3)               |                  |                  |                  |                  |
| Discharge method                         |           | Pulse AC method                         |                  |                  |                  |                  |
| Maximum air pressure                     |           | 0.1 MPa                                 |                  |                  |                  |                  |
| Net weight                               |           | 420 g approx.                           | 490 g approx.    | 620 g approx.    | 760 g approx.    | 900 g approx.    |

### Controller

| Item                | Type      | Controller   |
|---------------------|-----------|--|
|                     | Model No. | <b>ER-XC02</b>   |
| Supply voltage      |           | 24 V DC ±10 %  |
| Current consumption |           | 450 mA or less when connecting 1 heads, 800 mA or less when connecting 2 heads |
| Net weight          |           | 130 g approx.  |

Notes: 1) Typical value in condition of discharge distance 50 mm **1.969 in**

2) Typical value in condition of discharge distance 100 mm **3.937 in**

3) The **ER-X□HC** high / low temperature resistant type head can be used under temperatures from -60 to +200 °C **-76 to +392 °F** (Bar type only)

\* For more details, please refer to product catalog and specifications.

## A compact shape for reducing workbench clutter

One of the industry's smallest 120 mm 4.724 in (fan diameter) class units at just W150 × H166 × D62 mm W5.906 × H6.535 × D2.441 in

|  |                     |             |              |
|--|---------------------|-------------|--------------|
| Designed for optimal ion balance       | Small-area          | Medium-area | Wide-area    |
| Designed for best charge removal speed | Compressed air type | Fan type    | Airless type |



High-frequency AC method

Fan type ionizer **No need for compressed air**

## ER-F SERIES

### Low-airflow models available

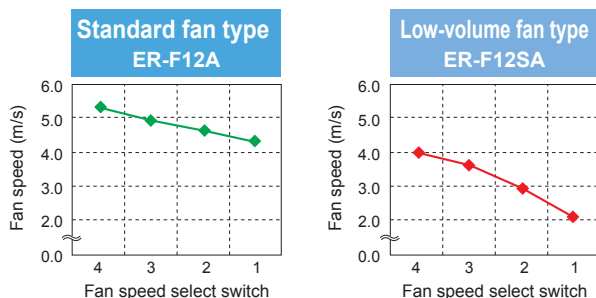

Low-volume fan type with a suppressed fan speed of approx. half is available for charge removal in processes which involve handling of small parts or thin films.

Note: Graphs represent typical values at 300 mm 11.811 in from directly in front of air outlet, straight louver, with no filter installed.

### Two exchangeable louvers to suit your needs

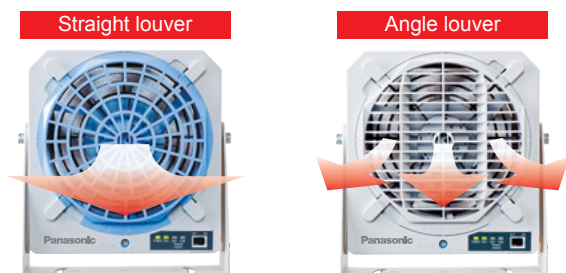

Removes charges quickly at long distance

Removes charges completely in wide area

Just simply replace the louver to change configuration between long distance and wide area ionization.

### Equipped with discharge needle fouling detection function



Additionally equipped with discharge needle fouling detection function. When discharge becomes weak due to needle fouling, the DSC indicator will flash for notification.

### Specifications

| Item                                    | Designation | Standard fan type              | Low-volume fan type            |
|---|-------------|--------------------------------|--------------------------------|
|   | Model No.   | ER-F12A                        | ER-F12SA                       |
| Supply voltage / current consumption    |             | 24 V DC ±10 % / 700 mA or less | 24 V DC ±10 % / 400 mA or less |
| Charge removal time (±1,000 V → ±100 V) |             | 1 sec. approx.                 | 1.5 sec. approx.               |
| Ion balance                             |             | ±10 V or less                  |                                |
| Discharge method                        |             | High-frequency AC method       |                                |
| Weight                                  |             | 790g approx.                   |                                |

Note: Please refer to product catalog and specifications for more details.



# Air-gun type ionizer that can remove dust in a single burst using pulsed air

A new approach to dust removal that lets you aim ions directly where they are needed

Designed for optimal ion balance

Small-area

Medium-area

Wide-area

Designed for best charge removal speed

Compressed air type

Fan type

Airless type



High-frequency AC method

Pulse air-gun ionizer

## EC-G02

### Three discharge modes



The EC-G02 features two pulse air modes in addition to the standard continuous mode.

### White LED illumination



The EC-G02 features a high-brightness white LED above the ionized air outlet, allowing you to target and spray dust revealed by the light with a stream of ionized air.

### Compact, highly usable design

A high-voltage power supply circuit and solenoid valve are built into the air gun, providing a high level of usability and eliminating the need to install an external controller or route thick, high-voltage cables.

Additionally, since the lightweight unit weighs just 270 g, it reduces stress on the operator, even when used for extended periods of time.

### External input

External input allows the unit to be used in combination with a foot switch or other device.

### No-oil compliance

All parts along the air path (air nozzle, solenoid valve, joints, etc.) are no-oil compliant.

**Features**

**Improved dust removal effectiveness thanks to pulse (intermittent) air**

Since pulse air causes dust to oscillate and lifts it up, even difficult-to-dislodge dust inside concave pockets can be easily removed. The EC-G02 can deliver greater dust removal effectiveness than continuous airflow models.

### Specifications

| Item  | Model No. | EC-G02  |
|---|-----------|---|
| Supply voltage / power consumption (Accessory AC adapter)                 |           | 100 to 240 V AC $\pm 10\%$ 50/60 Hz / 30 VA or less |
| Charge removal time ( $\pm 1,000\text{ V} \rightarrow \pm 100\text{ V}$ ) |           | Approx. 0.5 sec. or less                            |
| Supplied air flow   |           | 300 l/min. (ANR) or less                            |
| Air pressure range  |           | 0.05 to 0.50 MPa                                    |
| Discharge method  |           | High-frequency AC method                            |
| Weight  |           | 270 g approx.                                       |

Note: Please refer to product catalog and specifications for more details.

# Compact dust collection and removal features

Solve dust-related issues caused by static charges in cell production.

|  |                     |             |              |
|--|---------------------|-------------|--------------|
| Designed for optimal ion balance       | Small-area          | Medium-area | Wide-area    |
| Designed for best charge removal speed | Compressed air type | Fan type    | Airless type |



**EC-B02**  
W406 × H492 × D367 mm  
W15.984 × H19.370 × D14.449 in

**EC-B01**  
W206 × H401 × D283 mm  
W8.110 × H15.787 × D11.142 in

High-frequency AC method

Bench Top Ionizer Cleaning Box

## EC-B SERIES

### Three discharge modes

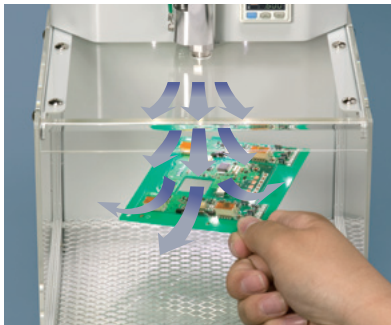

The EC-B features two pulse air modes in addition to the standard continuous mode.

### White LED illumination

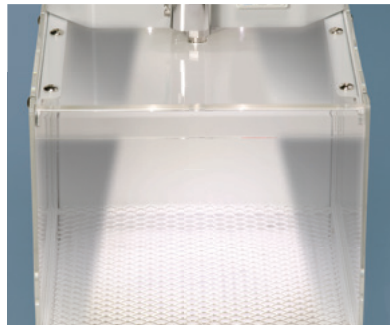

Three white LEDs illuminate the work area, increasing visibility and helping ensure you don't overlook any dust that has adhered to workpieces.

### Dust collecting fan

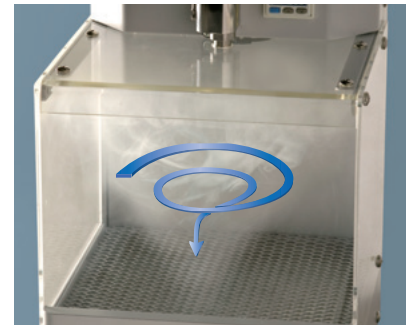

A powerful dust collecting fan exhausts dust quickly, preventing re-adhesion of dust.

### Features

#### Economic and ecological benefits of pulse (intermittent) air

##### Electrical charge comparison

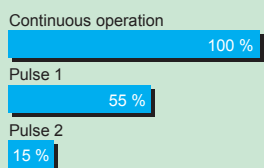

##### CO<sub>2</sub> emissions comparison (per month)

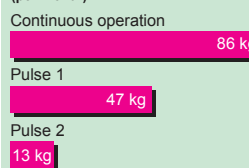

Note: Calculated using operating conditions at Panasonic Industrial Devices SUNX's Head Office Plant, 8 hours per day × 20 days.

### Specifications

| Item                                    | Model No. | EC-B01                                      | EC-B02                   |
|---|-----------|---|--------------------------|
| Supply voltage (Accessory AC adapter)   |           | 100 to 240 V AC ±10 % 50/60 Hz              |                          |
| Power consumption                       |           | 80 VA or less                               | 90 VA or less            |
| Charge removal time (±1,000 V → ±100 V) |           | Approx. 0.5 sec. or less                    |                          |
| Ion balance                             |           | ±10 V or less                               |                          |
| Supplied air flow                       |           | 300 l/min. (ANR) or less                    | 500 l/min. (ANR) or less |
| Air pressure range                      |           | 0.05 to 0.5 MPa                             |                          |
| Discharge method                        |           | High-frequency AC method (includes ER-VS02) |                          |
| Weight                                  |           | 6.5 kg approx.                              | 13 kg approx.            |

Note: Please refer to product catalog and specifications for more details.

## Continuously check invisible static electricity with an inline sensor.

The **EF-S1** series continuously monitors equipment status while the line is operating so you can take immediate action in the event of a malfunction.

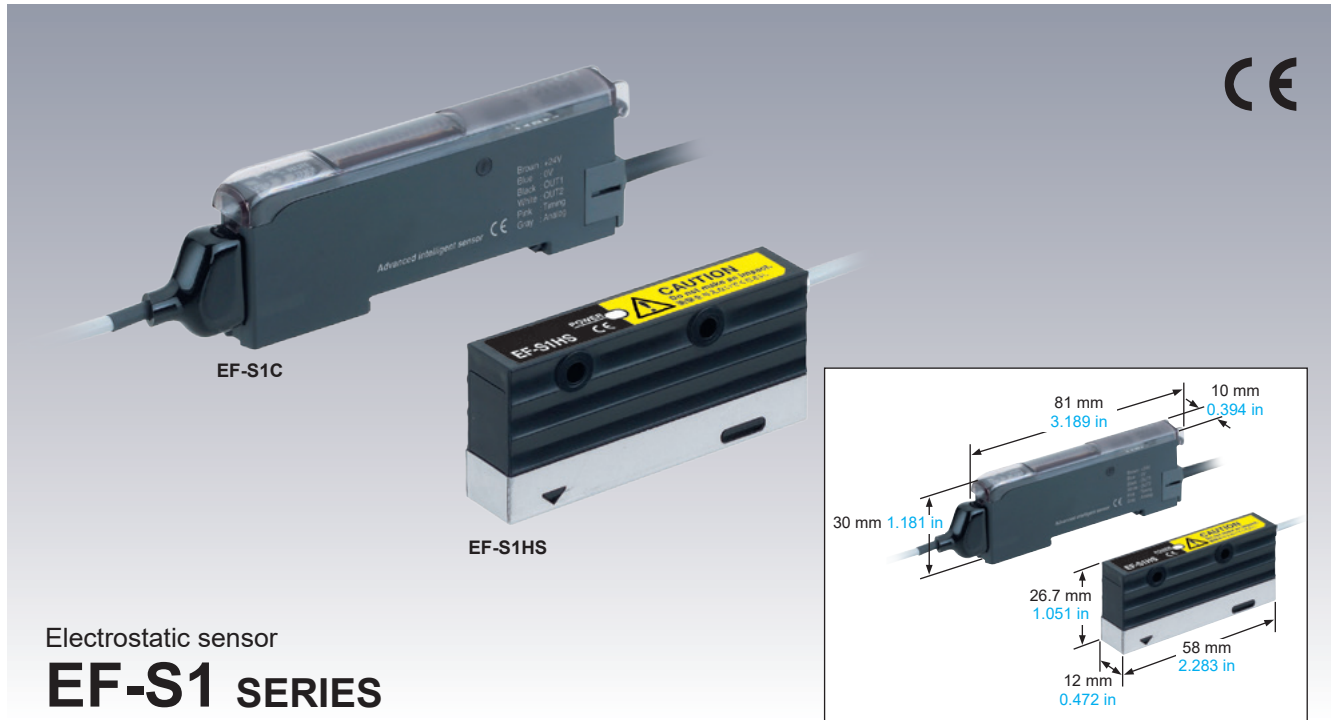

### Electrostatic sensor **EF-S1** SERIES

#### A new approach to electrostatic measures

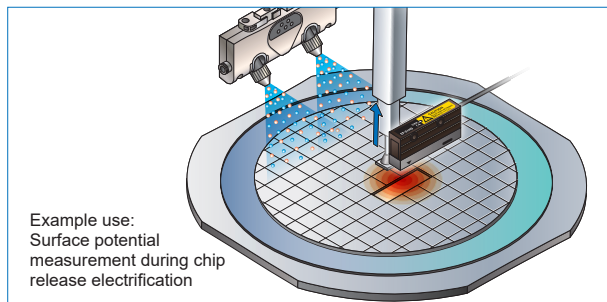

Unlike handheld measuring instruments, the **EF-S1** series is mounted on the line so that it can make measurements continuously while the line is operating. This approach has the additional benefit of reducing the level of variation in measurements made by different workers in different positions and at different distances.

#### Easy data management using analog output

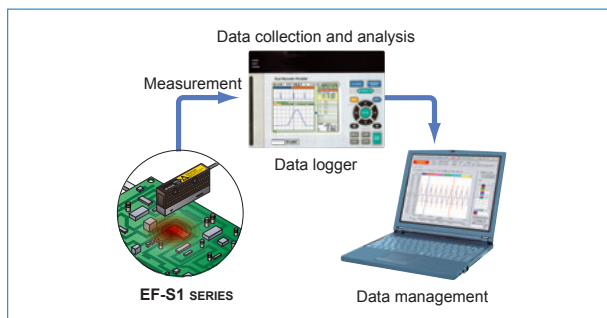

A device such as a data logger can be used to collect and analyze data, which is useful when carrying out inspections of factors such as ionizer setup angle and the number of devices installed.

#### Easy-to-read 2-color dual display

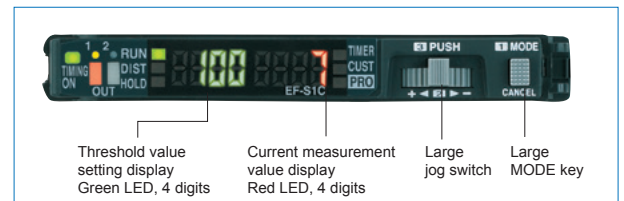

The controller is equipped with a red and a green display. Current values and threshold values can be viewed at a glance.

#### Specifications

| Designation                          | Sensor head | Controller   |
|--------------------------------------|-------------|--|
| Item                                 | Model No.   | EF-S1HS  |
| Supply voltage / current consumption |             | 24 V DC $\pm 10\%$ / 50 mA or less   |
| Measurement range (Range mode)       |             | 8.0 to 20.5 mm 0.315 to 0.807 in ( $\pm 1$ kV range mode)<br>21.0 to 100 mm 0.827 to 3.937 in ( $\pm 2$ kV range mode) |
| Display range (Measurement range)    |             | -1,000 to 1,000 V ( $\pm 1$ kV range mode)<br>-1,999 to 1,999 V ( $\pm 2$ kV range mode)                               |
| Repeatability                        |             | $\pm 0.3\%$ F.S.   |
| Analog output                        |             | Output voltage: 1 to 5 V   |
| Weight                               |             | 90 g approx.      65 g approx.   |

Notes: 1) Please refer to product catalog and specifications for more details.  
2) Also available with a measurement range of 150 mm 5.906 in and a display range of  $\pm 10$  kV.

---

Please contact .....

**Panasonic Corporation**

Industrial Device Business Division

■ 1006, Oaza Kadoma, Kadoma-shi, Osaka 571-8506, Japan  
[industrial.panasonic.com/ac/e/](http://industrial.panasonic.com/ac/e/)

**Panasonic**<sup>®</sup>

©Panasonic Corporation 2020