



# VFD-B

## User Manual

High Performance/User-Friendly Powerful AC Motor Drives



230V Series		460V Series	
0.75	37KW	0.75	75KW
1.0	50HP	1.0	100HP





**DELTA ELECTRONICS, INC.**

[www.delta.com.tw/acdrives](http://www.delta.com.tw/acdrives)

**ASIA**  
**DELTA ELECTRONICS, INC.**  
**Taoyuan Plant**  
31-1, SHIEN PAN ROAD,  
KUEI SAN INDUSTRIAL ZONE,  
TAOYUAN SHIEN, TAIWAN  
TEL: 886-3-362-6301  
FAX: 886-3-362-7267

**EUROPE**  
**DELTRONICS (NETHERLANDS) B.V.**  
INDUSTRIEGEBIED VENLO NR. 9031  
COLUMBUSWEG 20  
NL-5928 LC VENLO  
THE NETHERLANDS  
TEL: 31-77-324-1930  
FAX: 31-77-324-1931

**NORTH/SOUTH AMERICA**  
**DELTA PRODUCTS CORPORATION**  
**Sales Office**  
P.O. BOX 12173  
5101 DAVIS DRIVE  
RESEARCH TRIANGLE PARK,  
NC 27709, U.S.A.  
TEL: 1-919-767-3813  
FAX: 1-919-767-3969

5011025710  
200407-05



BE12



**VFD-B**

***User Manual***

High Performance/User-Friendly Powerful AC Motor Drives

## Preface

Thank you for choosing DELTA's high-performance VFD-B Series. VFD-B Series are manufactured by adopting high-quality components, material and incorporating the latest microprocessor technology available.

### Getting Started

This manual will be helpful in the installation, parameter setting, troubleshooting, and daily maintenance of the AC motor drives. To guarantee safe operation of the equipment, read the following safety guidelines before connecting power to the AC drives. Keep this operating manual handy and distribute to all users for reference.



## WARNING



Always read this manual thoroughly before using VFD-B series AC Motor Drives.



**DANGER! AC input power must be disconnected before any maintenance. Do not connect or disconnect wires and connectors while power is applied to the circuit. Maintenance must be performed by qualified technicians.**



**CAUTION!** There are highly sensitive MOS components on the printed circuit boards. These components are especially sensitive to static electricity. To avoid damage to these components, do not touch these components or the circuit boards with metal objects or your bare hands.



**DANGER!** A charge may still remain in the DC-link capacitor with hazardous voltages even if the power has been turned off. To avoid personal injury, please ensure that power has turned off before operating AC drive and wait ten minutes for capacitors to discharge to safe voltage levels.



**CAUTION!** Ground the VFD-B using the ground terminal. The grounding method must comply with the laws of the country where the AC drive is to be installed. Refer to Basic Wiring Diagram.



**DANGER!** The AC drive may be destroyed beyond repair if incorrect cables are connected to the input/output terminals. Never connect the AC drive output terminals U/T1, V/T2, and W/T3 directly to the AC main circuit power supply.



**CAUTION!** The final enclosures of the AC drive must comply with EN50178. (Live parts shall be arranged in enclosures or located behind barriers that meet at least the requirements of the Protective Type IP20. The top surface of the enclosures or barrier that is easily accessible shall meet at least the requirements of the Protective Type IP40). (VFD-B series corresponds with this regulation.)



**CAUTION!** Heat sink may heat up over 70°C (158°F), during the operation. Do not touch the heat sink.



# TABLE OF CONTENTS

## CHAPTER 1 RECEIVING AND INSPECTIONS

1.1 Nameplate Information .....	1 - 1
1.2 Model Explanation .....	1 - 1
1.3 Serial Number Explanation .....	1 - 2

## CHAPTER 2 STORAGE AND INSTALLATION

2.1 Storage .....	2 - 1
2.2 Installation .....	2 - 2

## CHAPTER 3 WIRING

3.1 Basic Wiring Diagram .....	3 - 2
3.2 External Wiring .....	3 - 6
3.3 Terminal Explanation .....	3 - 7
3.4 Control Terminal Explanation .....	3 - 7
3.5 Main Circuit Wiring .....	3 - 9
3.6 Wiring Notes .....	3-16
3.7 Motor Operation Precautions .....	3-17

## CHAPTER 4 DIGITAL KEYPAD OPERATION

4.1 Description of the Digital Keypad VFD-PU01 .....	4 - 2
4.2 Operation steps of the Digital Keypad VFD-PU01 .....	4 - 4

---

## **CHAPTER 5 DESCRIPTION OF PARAMETER SETTINGS**

Group 0: User Parameters .....	5 - 1
Group 1: Basic Parameters .....	5 - 5
Group 2: Operating Method Parameters .....	5-11
Group 3: Output Function Parameters .....	5-17
Group 4: Input Function Parameters .....	5-22
Group 5: Multi-step Speed and PLC (Process Logic Control) Parameter .	5-32
Group 6: Protection Parameters.....	5-38
Group 7: Motor Parameters.....	5-44
Group 8: Special Parameters .....	5-47
Group 9: Communication Parameters.....	5-54
Group 10: PID Control Parameters .....	5-69
Group 11: Fan and Pump Control Parameters .....	5-74

## **CHAPTER 6 MAINTENANCE AND INSPECTIONS**

6.1 Periodic Inspection .....	6 - 1
6.2 Periodic Maintenance .....	6 - 1

## **CHAPTER 7 TROUBLESHOOTING AND FAULT INFORMATION..... 7 - 1**

## **CHAPTER 8 SUMMARY OF PARAMETER SETTINGS..... 8 - 1**

## **APPENDIX A SPECIFICATIONS..... A - 1**

**APPENDIX B ACCESSORIES**

B.1 Non-fused Circuit Breaker and Fuse Specification Chart..... B - 1

B.2 Braking Resistors & Braking Units ..... B - 3

B.3 AMD-EMI Filter Cross Reference ..... B - 7

B.4 PG Cards ..... B-16

B.5 Remote Controller RC-01..... B-22

B.6 Remote Panel Adapter ..... B-23

B.7 Zero Phase Reactor ..... B-24

**APPENDIX C DIMENSIONS..... C - 1**

**APPENDIX D EC DECELERATION OF CONFORMITY..... D - 1**





# CHAPTER 1 RECEIVING AND INSPECTION

This VFD-B AC drive has gone through rigorous quality control tests at the factory before shipment. After receiving the AC drive, please check for the following:

## Receiving

- ✓ Check to make sure that the package includes an AC drive, the User Manual, dust covers and rubber bushings.
- ✓ Inspect the unit to insure it was not damaged during shipment.
- ✓ Make sure that the part number indicated on the nameplate corresponds with the part number of your order.

### 1.1 Nameplate Information: Example for 1HP/0.75kW 3-phase 230V AC drive

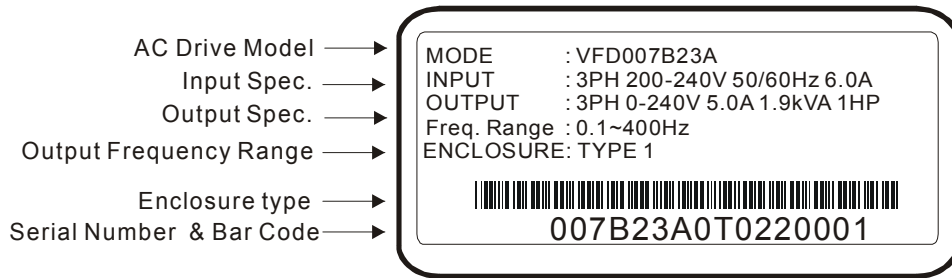

### 1.2 Model Explanation:

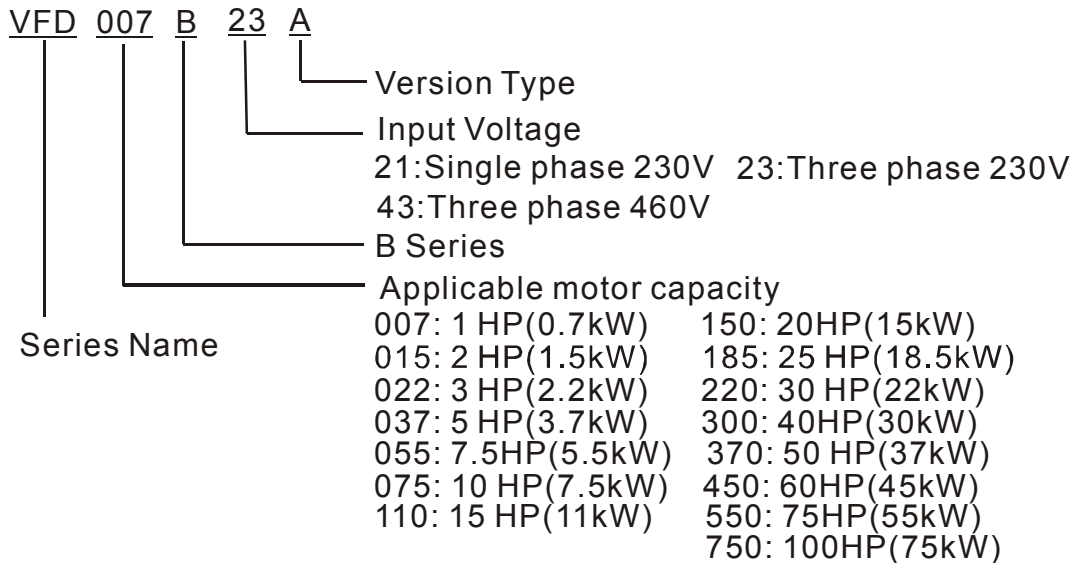

### 1.3 Series Number Explanation:

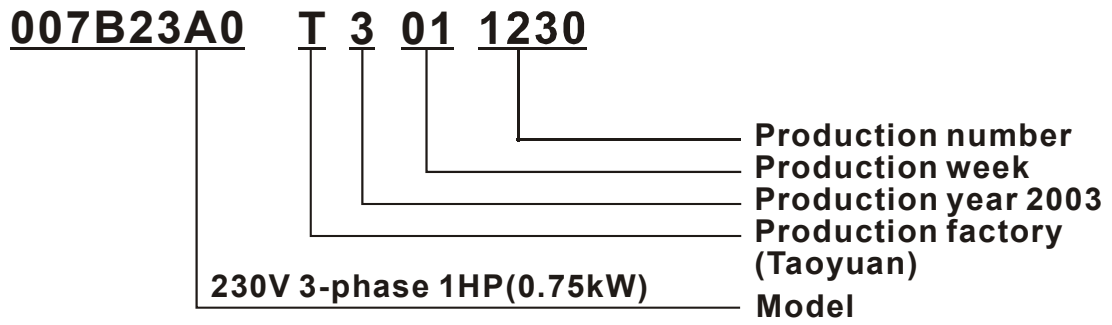

If there is any nameplate information not corresponding to your purchase order or any problem, please contact your distributor.

## CHAPTER 2 STORAGE AND INSTALLATION

### 2.1 Storage

The AC drive should be kept in the shipping carton before installation. In order to retain the warranty coverage, the AC drive should be stored properly when it is not to be used for an extended period of time.

#### Ambient Conditions:

Operation	Air Temperature: -10°C to +40°C (14°F to 104°F) (UL & cUL); +50°C (122°F) without dust cover. Atmosphere pressure: 86 to 106 kPa Installation Site Altitude: below 1000m Vibration: Maximum 9.80 m/s <sup>2</sup> (1G) at less than 20Hz Maximum 5.88 m/s <sup>2</sup> (0.6G) at 20Hz to 50Hz
Storage	Temperature: -20°C to +60°C (-4°F to 140°F) Relative Humidity: Less than 90%, no condensation allowed Atmosphere pressure: 86 to 106 kPa
Transportation	Temperature: -20°C to +60°C (-4°F to 140°F) Relative Humidity: Less than 90%, no condensation allowed Atmosphere pressure: 86 to 106 kPa Vibration: Maximum 9.80 m/s <sup>2</sup> (1G) at less than 20Hz, Maximum 5.88 m/s <sup>2</sup> (0.6G) at 20Hz to 50Hz
Pollution Degree	2: good for a factory type environment.

## 2.2 Installation



### CAUTION

The control, power supply and motor leads must be laid separately. They must not be fed through the same cable conduit / trunking.

High voltage insulation test equipment must not be used on cables connected to the drive.

Improper installation of the AC drive will greatly reduce its life. Be sure to observe the following precautions when selecting a mounting location.

***Failure to observe these precautions may void the warranty!***

- ◆ Do not mount the AC drive near heat-radiating elements or in direct sunlight.
- ◆ Do not install the AC drive in a place subjected to high temperature, high humidity, excessive vibration, corrosive gases or liquids, or airborne dust or metallic particles.
- ◆ Mount the AC drive vertically and do not restrict the air flow to the heat sink fins.
- ◆ The AC drive generates heat. Allow sufficient space around the unit for heat dissipation.

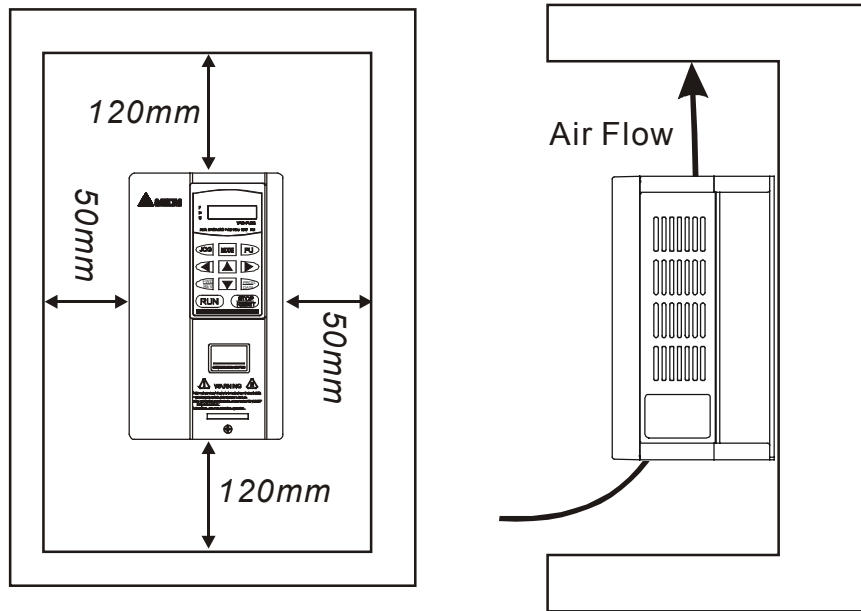

## CHAPTER 3 WIRING



### DANGER

#### Hazardous Voltage

Before accessing the AC drive:

- ◆ Disconnect all power to the AC drive.
- ◆ Wait five minutes for DC bus capacitors discharge.

3

***Any electrical or mechanical modification to this equipment without prior written consent of Delta Electronics, Inc. will void all warranties and may result in a safety hazard in addition to voiding the UL listing.***

#### Short Circuit Withstand:

The rated voltage must be equal to or less than 240V (460V model is 480Volts) and the current must be equal to or less than 5000A RMS. (the model of 40HP or above is 10000A RMS)

#### General Wiring Information

##### Applicable Codes

All VFD-B AC drives except 015B21A, 015B23A and 075B23B are Underwriters Laboratories, Inc. (UL) and Canadian Underwriters Laboratories (cUL) listed, and therefore comply with the requirements of the National Electrical Code (NEC) and the Canadian Electrical Code (CEC).

Installation intended to meet the UL and cUL requirements must follow the instructions provided in "Wiring Notes" as a minimum standard. Follow all local codes that exceed UL and cUL requirements. Refer to the technical data label affixed to the AC drive and the motor nameplate for electrical data.

The "Line Fuse Specification" in Appendix B, lists the recommended fuse part number for each B-Series part number. These fuses (or equivalent) must be used on all installations where compliance with U.L. standards is a required.

### 3.1 Basic Wiring Diagram

Users must connect wires according to the following circuit diagram shown below. Do not plug a Modem or telephone line to the RS-485 communication port, permanent damage may result. Terminals 1 & 2 are the power sources only for the optional copy keypad and should not be used while using RS-485 communication.

**Figure 1 for models of VFD-B Series  
VFD007B21A/23A/43A, VFD015B21A/21B/23A/23B/43A  
VFD022B23B/43B**

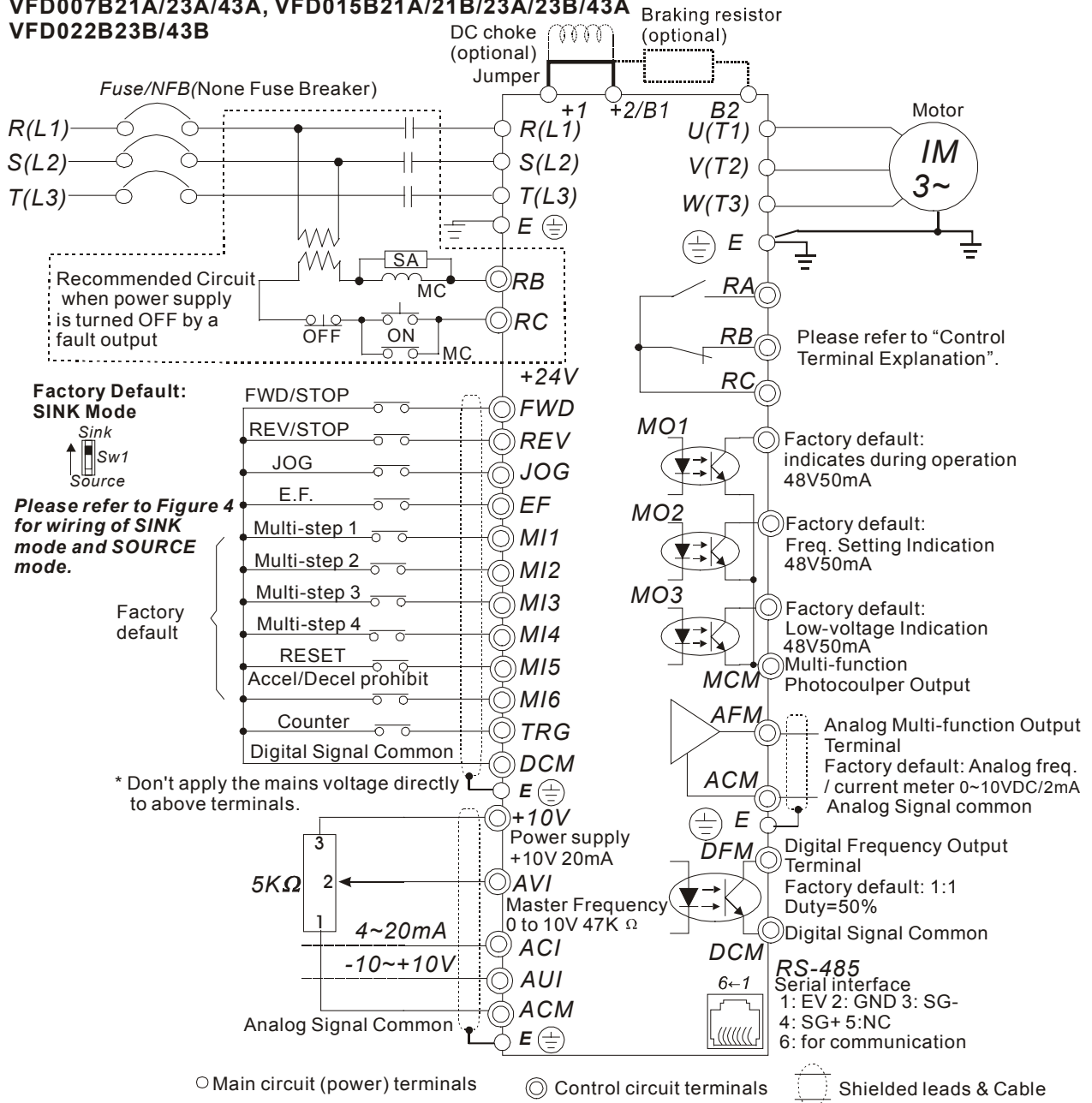

**Figure 2 for models of VFD-B Series 3-15 HP**

VFD022B21A, VFD037B23A/43A, VFD055B23A/43A, VFD075B23A/43A, VFD110B23A/43A

- \* Three phase input power may apply to single phase drives.
- \* For the single phase application, the AC input line can be connected to any two of the three input terminals R,S,T

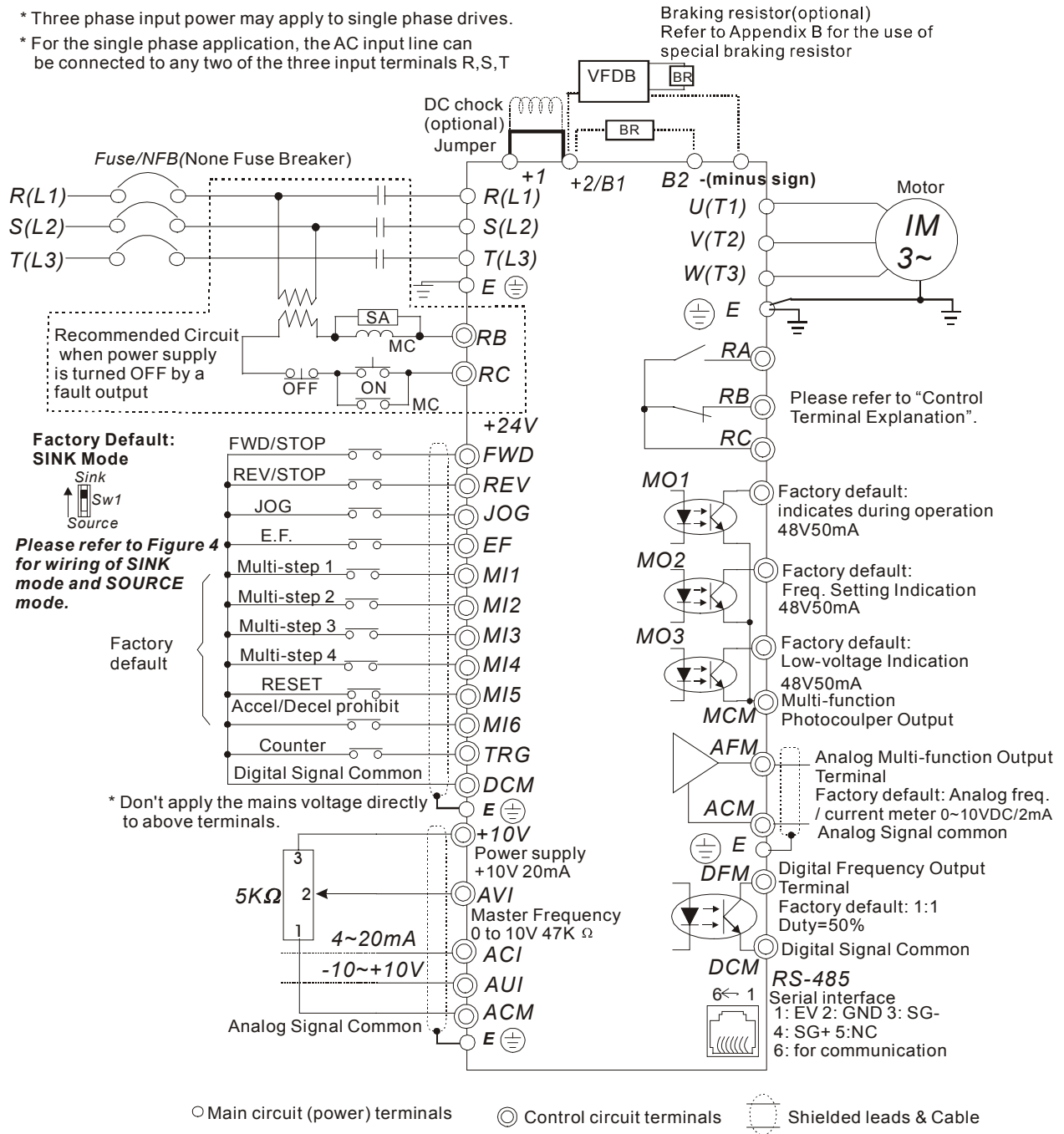



**Figure 3 for models of VFD-B Series 20 HP and above**  
 VFD150B23A/43A, VFD185B23A/43A, VFD220B23A/43A, VFD300B23A/43A,  
 VFD370B23A/43A, VFD450B43A, VFD550B43A, VFD750B43A

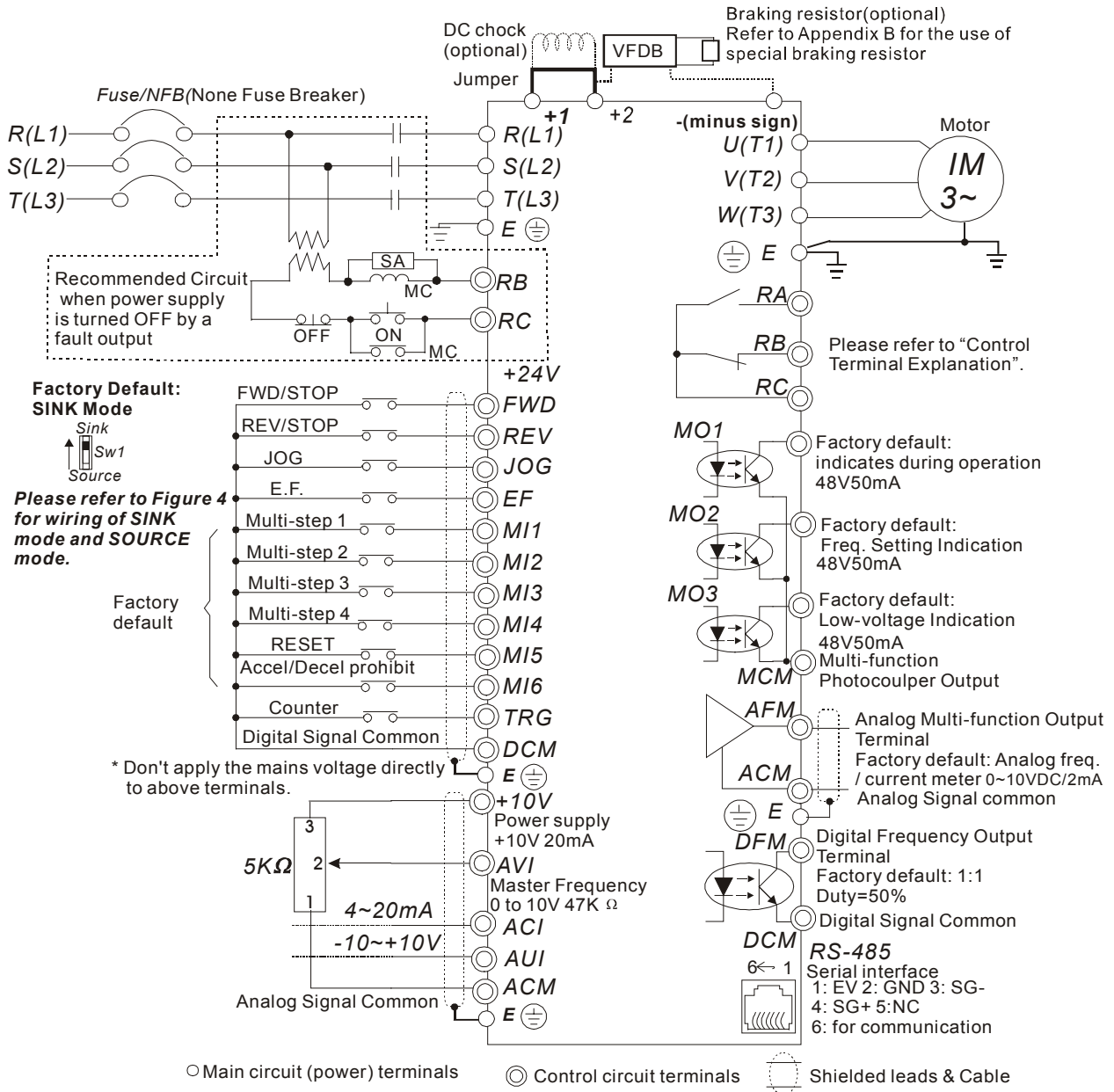
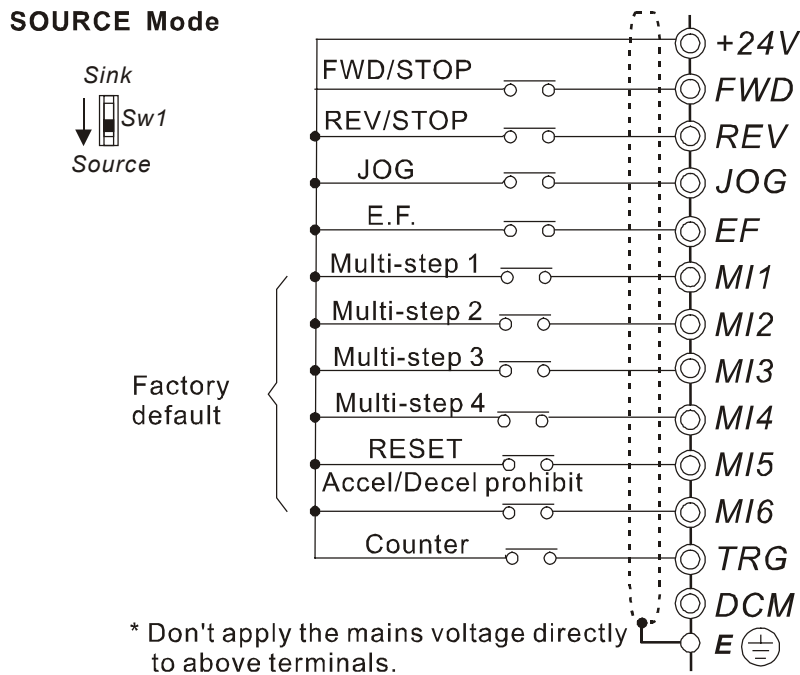
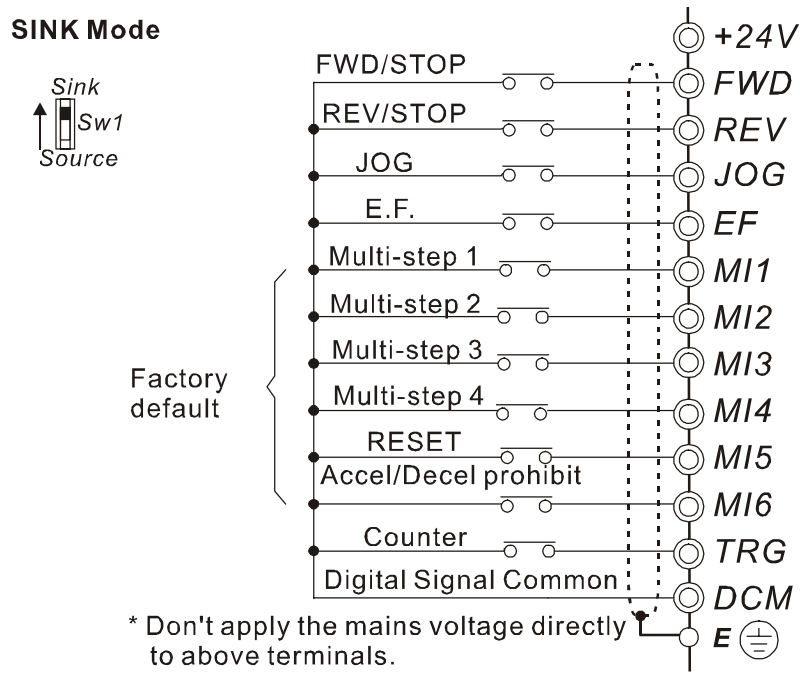
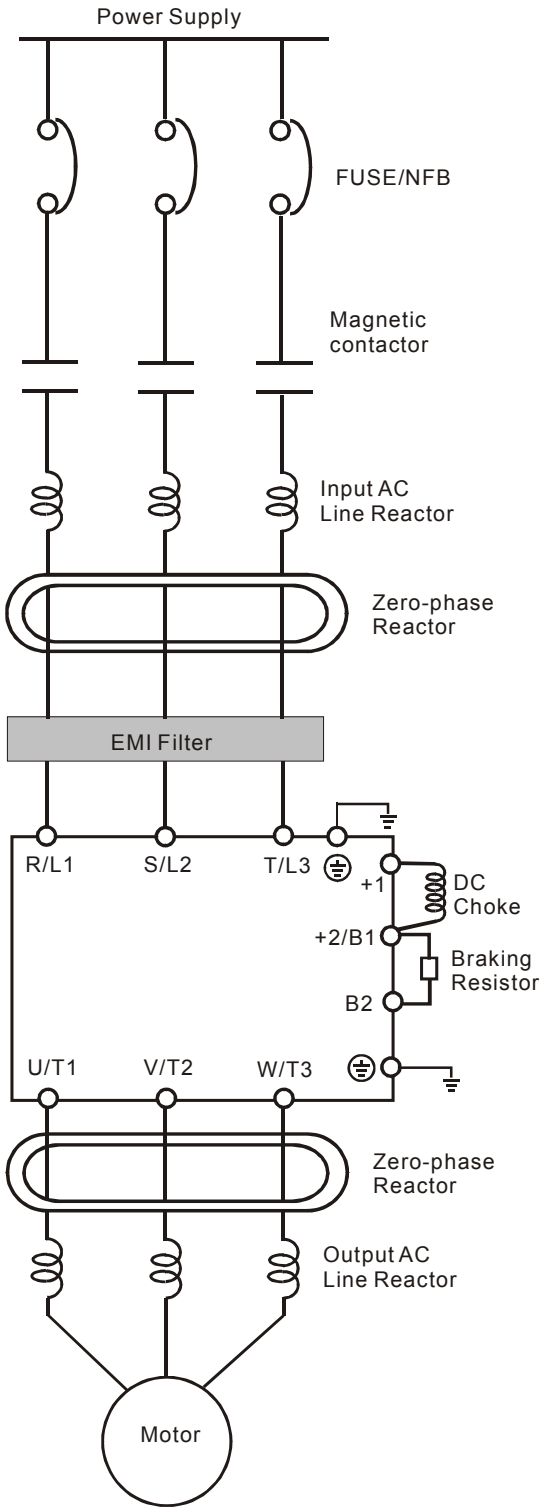

Figure 4 Wiring for SINK mode and SOURCE mode



3

### 3.2 External Wiring



Items	Explanations
Power supply	Please follow the specific power supply requirement shown in APPENDIX-A.
Fuse/NFB (Optional)	There may be inrush current during power up. Please check the chart of APPENDIX B and select the correct fuse with rated current. NFB is optional.
Magnetic contactor (Optional)	Please do not use a Magnetic contactor as the I/O switch of the AC drive, this will reduce the operating life cycle of the AC drive.
Input AC Line Reactor (Optional)	In order to improve the input power factor, reduces harmonics and protection from AC line disturbances. (Surge, switching spike, power flick, etc.) AC line reactor should be installed when the power supply capacity is 500kVA or more and exceeds 6 times of the inverter capacity, or the wiring distance within 10m.
Zero-phase Reactor (Ferrite Core Common Choke) (Optional)	Zero phase reactors are used to reduce radio noise specify when the audio equipments installed near the inverter. Good effective for noise reduction on both the input and output sides. Attenuation quality is good in a wide range from AM band to 10Mhz. Appendix B for specifies zero phase reactors. (RF220X00A)
EMI filter (Optional)	To reduce the electromagnetic interference. Please refer to Appendix B for detail.
Braking Resistor (Optional)	Used to reduce stopping time of the motor. Please refer to the chart on Appendix B for specific Braking Resistors.
Output AC Line Reactor (Optional)	Motor surge voltage amplitudes depending on the motor cable length. For long motor cable application, it is necessary installed on the inverter output side.

### 3.3 Terminal Explanations

Terminal Symbol	Explanation of Terminal Function
R/L1, S/L2, T/L3	AC line input terminals
U/T1, V/T2, W/T3	AC drive output terminals motor connections
+1,+2	Connections for DC Link Reactor (optional)
+2/B1~B2	Connections for Braking Resistor (optional)
+2 ~ -(minus sign) +2/B1~ -(minus sign)	Connections for External Braking Unit (VFDB series)
	Earth Ground

3

### 3.4 Control Terminals Explanations

Terminal Symbols	Terminal Functions	Factory Settings
FWD	Forward-Stop command	
REV	Reverse-Stop command	
JOG	Jog command	
EF	External fault	
TRG	External counter input	
MI1	Multi-function Input 1	Refer to Pr.04-04 to Pr.04-09 Multi-function Input Terminals
MI2	Multi-function Input 2	
MI3	Multi-function Input 3	
MI4	Multi-function Input 4	
MI5	Multi-function Input 5	
MI6	Multi-function Input 6	
DFM	Digital Frequency Meter (Open Collector Output)	Factory setting 1:1 (Maximum 48VDC, 50mA)
+24V	DC Voltage Source	(+24V, 20mA), used for source mode.
DCM	Digital Signal Common	Used as common for digital inputs and used for sink mode.

Terminal Symbols	Terminal Functions	Factory Settings
RA	Multi-function Relay output (N.O.) a	Resistor Load 5A(N.O.)/3A(N.C.) 240VAC 5A(N.O.)/3A(N.C.) 24VDC Inductive Load 1.5A(N.O.)/0.5A(N.C.) 240VAC 1.5A(N.O.)/0.5A(N.C.) 24VDC Refer to Pr.03-01 to Pr.03-03
RB	Multi-function Relay output (N.C.) b	
RC	Multi-function Relay common	
MO1	Multi-function output 1 (Photocoupler)	Maximum 48VDC, 50mA Refer to Pr.03-01 to Pr.03-03
MO2	Multi-function output 2 (Photocoupler)	
MO3	Multi-function output 3 (Photocoupler)	
MCM	Multi-function output common	Maximum 48VDC, 50mA
+10V	Potentiometer output power source	+10V 20mA
AVI	Analog voltage Input	0 to +10V
ACI	Analog current Input	4 to 20mA
AUI	Auxiliary analog voltage input	-10 to +10V
AFM	Analog output meter	0 to 10V, 2mA
ACM	Analog control signal (common)	

\* Control signal wiring size: 18 AWG (0.75 mm<sup>2</sup>).

### 3.5 Main Circuit Wiring

**1HP to 3HP (VFD007B23A, VFD007B43A, VFD007B21A, VFD015B21A, VFD015B23A, VFD015B43A, VFD015B21B, VFD015B23B, VFD022B23B, VFD022B43B)**

**3**

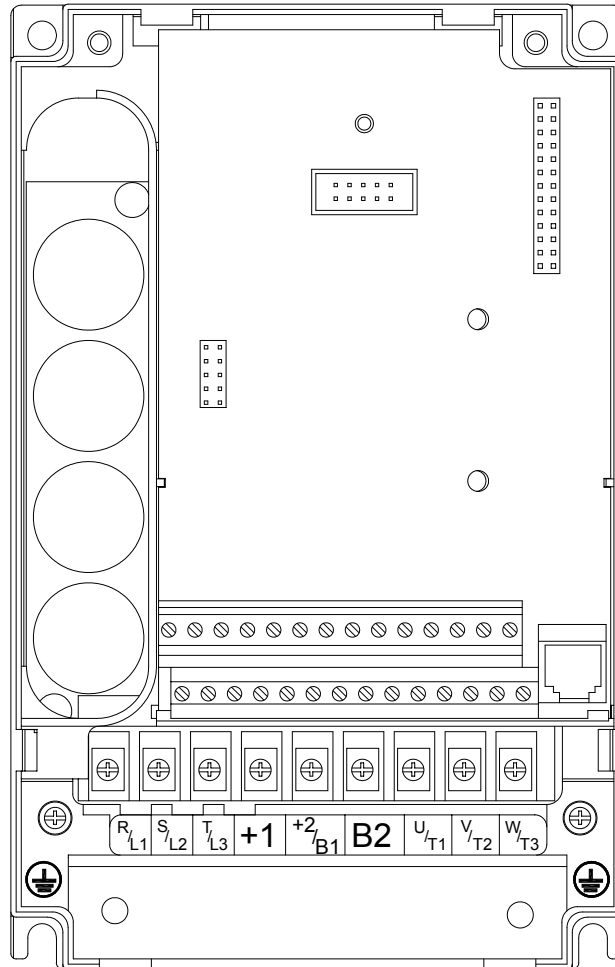

Control Terminal

Torque: 4Kgf-cm (3 in-lbf)

Wire: 12-24 AWG

Power Terminal

Torque: 18 kgf-cm (15.6 in-lbf)

Wire Gauge: 10-18 AWG stranded wire, 12-18 AWG solid wire

Wire Type: Copper only, 75°C

**3HP to 5HP (VFD022B21A, VFD037B23A, VFD037B43A)**

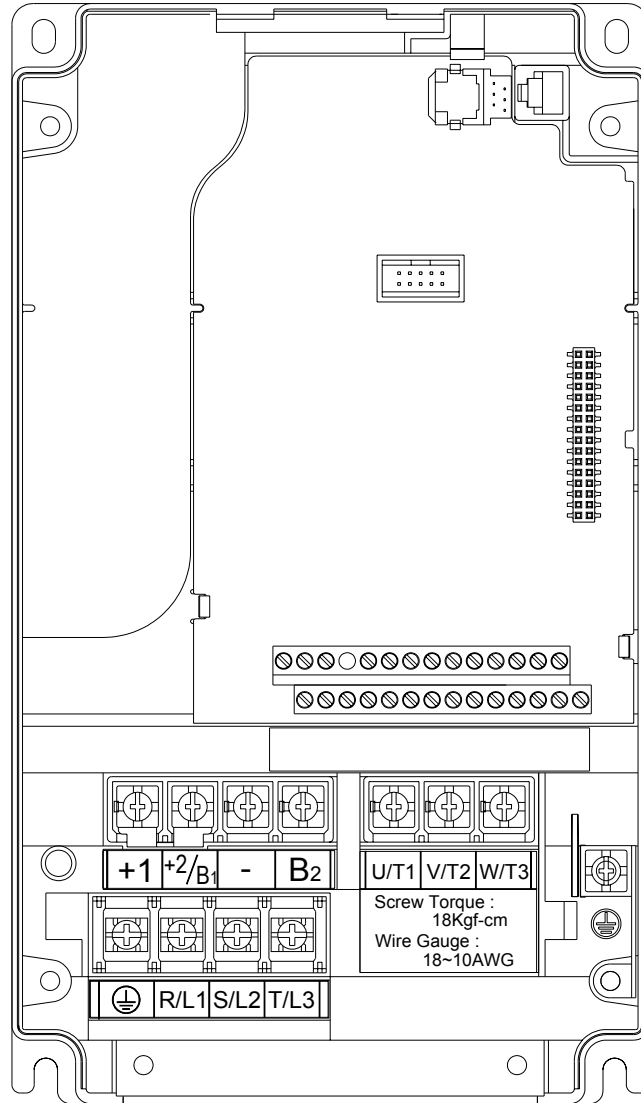

**Control Terminal**

Torque: 4Kgf-cm (3 in-lbf)

Wire: 12-24 AWG

**Power Terminal**

Torque: 18 kgf-cm (15.6 in-lbf)

Wire Gauge: 10-18 AWG

Wire Type: Stranded copper only, 75°C

**7.5 HP to 15 HP (VFD055B23A, VFD055B43A, VFD075B23A, VFD075B43A, VFD110B23A, VFD110B43A)**

**3**

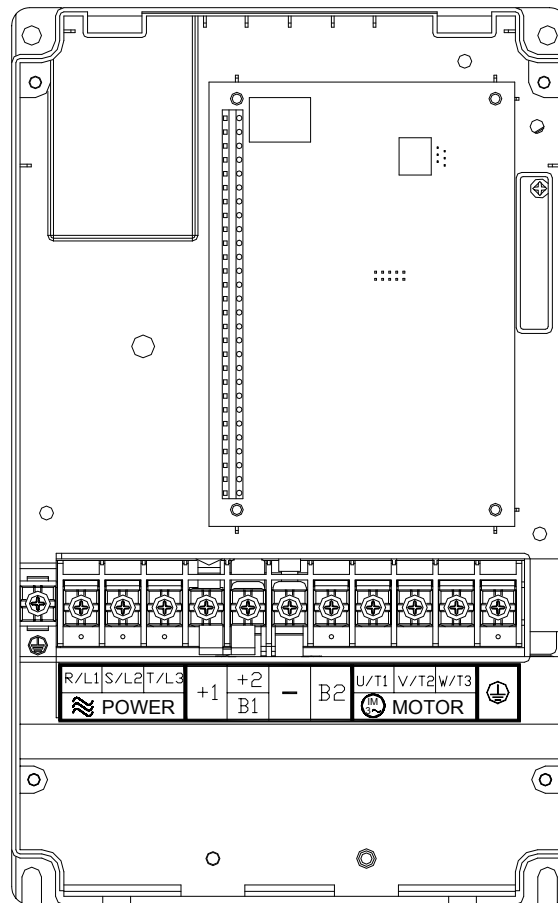

**Control Terminal**

Torque: 4Kgf-cm (3 in-lbf)

Wire: 12-24 AWG

**Power Terminal**

Torque: 30Kgf-cm (26 in-lbf)

Wire: 8-12 AWG

Wire Type: Stranded Copper only, 75°C

NOTE: If wiring of the terminal utilizes the wire with a 6AWG-diameter, it is thus necessary to use the Recognized Ring Terminal to conduct a proper wiring.



**20 HP to 30 HP (VFD150B23A, VFD150B43A, VFD185B23A, VFD185B43A,  
VFD220B23A, VFD220B43A)**

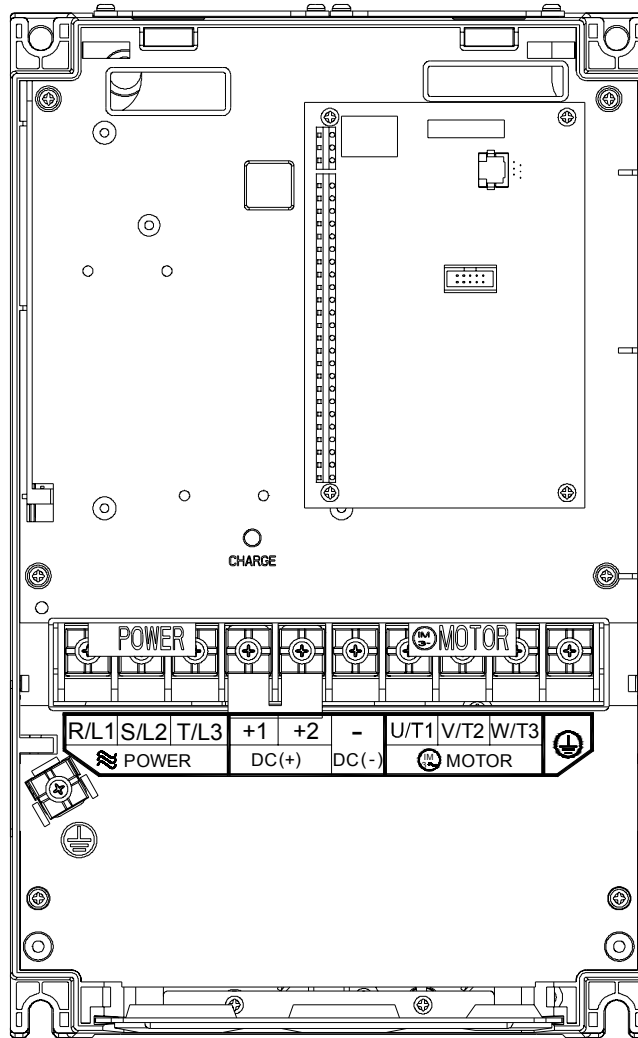

Control Terminal

Torque: 4Kgf-cm (3 in-lbf)

Wire: 12-24 AWG

Power Terminal

Torque: 30Kgf-cm (26 in-lbf)

Wire: 2-8 AWG

Wire Type: Stranded Copper only, 75°C

NOTE: If wiring of the terminal utilizes the wire with a 1AWG-diameter, it is thus necessary to use the Recognized Ring Terminal to conduct a proper wiring.

**40 HP to 50 HP 230V (VFD300B23A, VFD370B23A)**

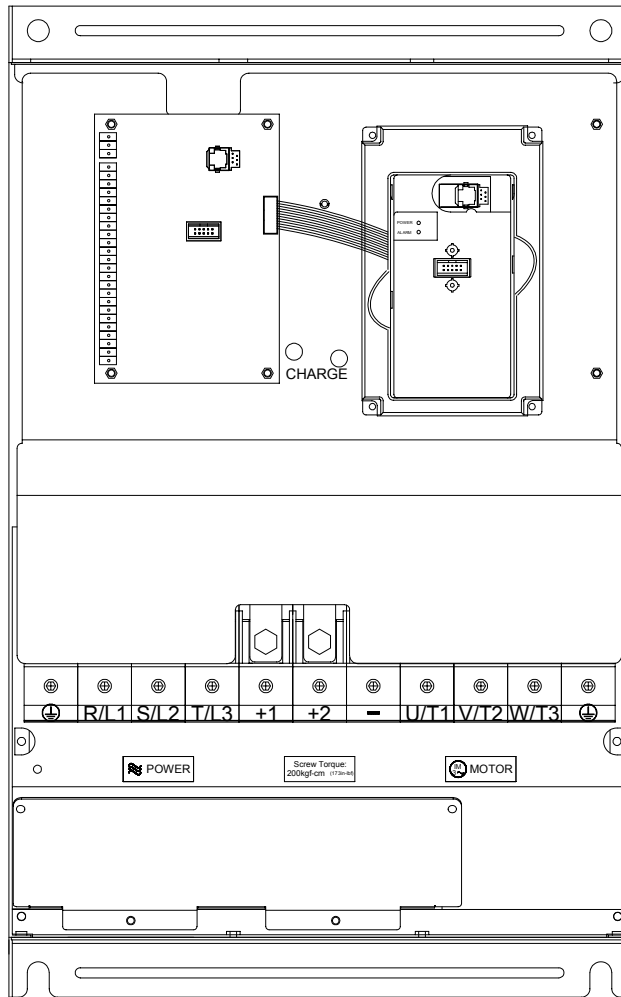

**3**

**Control Terminal**

Torque: 4Kgf-cm (3 in-lbf)

Wire: 12-24 AWG

**Power Terminal**

Torque: 200kgf-cm (173 in-lbf)

Wire Gauge: 2/0 - 3/0 AWG

Wire Type: Stranded copper only, 75°C

**40 HP to 60 HP 460V (VFD300B43A, VFD370B43A, VFD450B43A)**

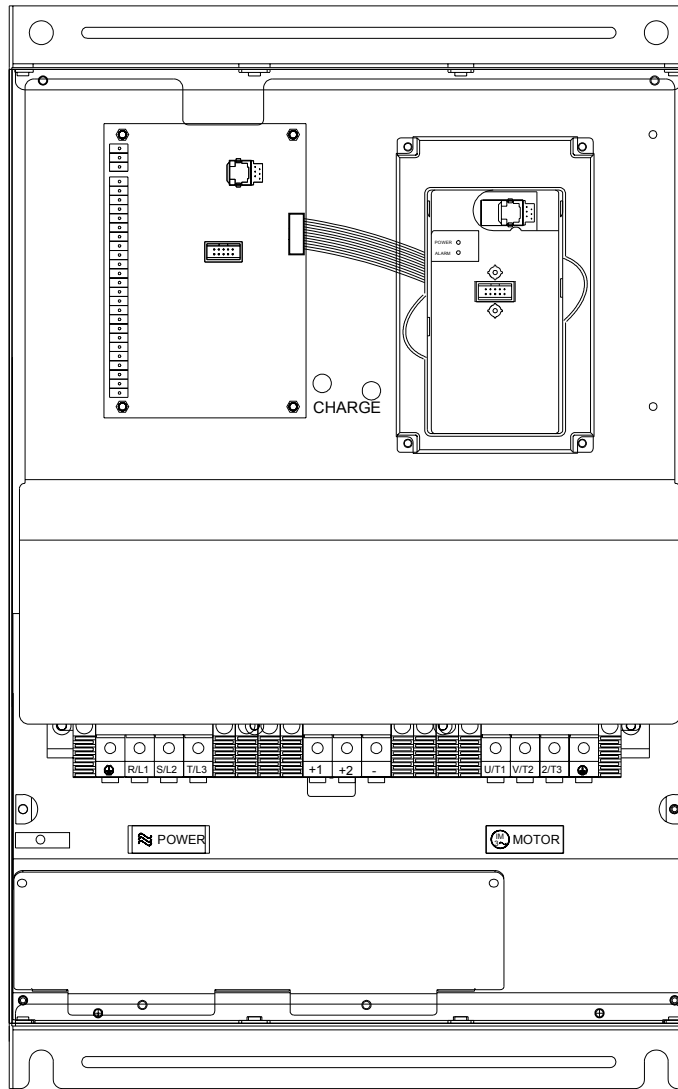

**Control Terminal**

Torque: 4Kgf-cm (3 in-lbf)

Wire: 12-24 AWG

**Power Terminal**

Torque: 58.7kgf-cm (50.9 in-lbf) max.

Wire Gauge: 2-4AWG

Wire Type: Stranded copper only, 75°C

**75-100 HP 460V (VFD550B43A, VFD750B43A)**

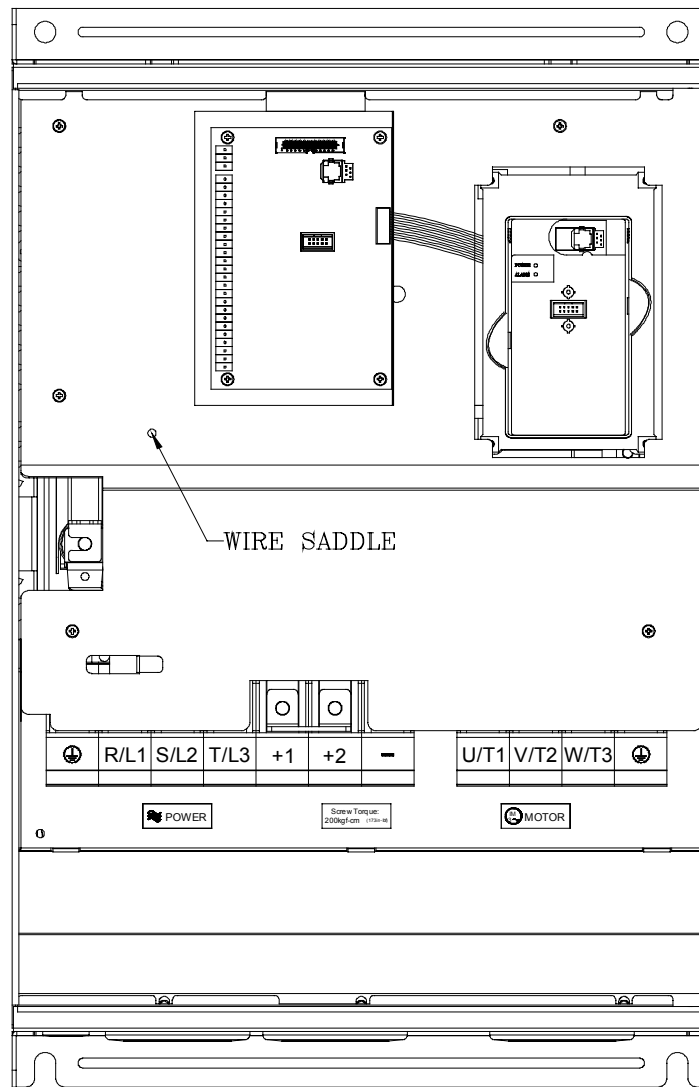

3

**Control Terminal**

Torque: 4Kgf-cm (3 in-lbf)

Wire: 12-24 AWG



**Power Terminal**

Torque: 200 kgf-cm (173 in-lbf)

Wire Gauge: 2/0-3/0 AWG

Wire Type: Stranded copper only, 75°C

### 3.6 Wiring Notes: PLEASE READ PRIOR TO INSTALLATION.

1. There are corresponding ring terminals which will be included with each unit (20-30HP), and please use the proper crimping tool by KST INC. P/N: KST-HDC38A for securing the conductor.
2.  **CAUTION:** Do not connect the AC power to the U/T1, V/T2, W/T3 terminals, as it will damage the AC drive.
3.  **WARNING:** Ensure all screws are tightened to the proper torque rating.
4. During installation, follow all local electrical, construction, and safety codes for the country the drive is to be installed in.
5. Ensure that the appropriate protective devices (circuit breaker or fuses) are connected between the power supply and AC drive.
6. Make sure that the leads are connected correctly and the AC drive is properly grounded.  
(Ground resistance should not exceed 0.1Ω .)
7. Use ground leads that comply with AWG/MCM standards and keep them as short as possible.
8. Multiple VFD-B units can be installed in one location. All the units should be grounded directly to a common ground terminal. The VFD-B ground terminals may also be connected in parallel, as shown in the figure below. **Ensure there are no ground loops.**

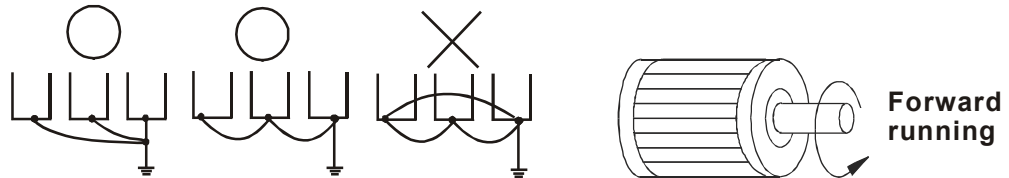

9. When the AC drive output terminals U/T1, V/T2, and W/T3 are connected to the motor terminals U/T1, V/T2, and W/T3, respectively, the motor will rotate counterclockwise (as viewed from the shaft ends of the motor) when a forward operation command is received. To reverse the direction of motor rotation, switch over any of the two motor leads.

10. Make sure that the power source is capable of supplying the correct voltage and required current to the AC drive.
11. Do not attach or remove wiring when power is applied to the AC drive.
12. Do not monitor the signals on the circuit board while the AC drive is in operation.
13. For the single-phase rated AC drives, the AC power can be connected to any two of the three input terminals R/L1, S/L2, T/L3. **Note: This drive is not intended for the use with single-phase motors.**
14. Route the power and control wires separately, or at 90° angle to each other.
15. If a filter is required for reducing EMI (Electro Magnetic Interference), install it as close as possible to AC drive. EMI can also be reduced by lowering the Carrier Frequency.
16. If the AC drive is installed in the place where a load reactor is needed, install the filter close to U/T1, V/T2, W/T3, side of AC drive. Do not use a Capacitor or L-C Filter (Inductance-Capacitance) or R-C Filter (Resistance-Capacitance), unless approved by Delta.
17. When using a GFCI (Ground Fault Circuit Interrupt), select current sensor with sensitivity of 200mA, and not less than 0.1-second detection to avoid nuisance tripping.

### 3.7 Motor Operation Precautions

1. When using the AC drive to operate a standard 3-phase induction motor, notice that the energy loss is greater than for an inverter duty motor.
2. Avoid running a standard induction motor at low speed. Under these conditions, the motor temperature may rise above the motor rating due to limited airflow produced by the motor's fan.
3. When the standard motor operates at low speed, the output load must be decreased.
4. If 100% output torque is desired at low speed, it may be necessary to use a special "inverter-duty" rated motor.



# CHAPTER 4 DIGITAL KEYPAD OPERATION

This chapter describes the various controls and indicators found on the digital keypad/display PU01. The information in this chapter should be read and understood before performing the start-up procedures described in the chapter of parameter settings.

- ↳ Description of the Keypad
- ↳ Description of Display
- ↳ Keypad Operation Modes & Programming Steps

## VFD-PU01 Dimensions: mm (inch)

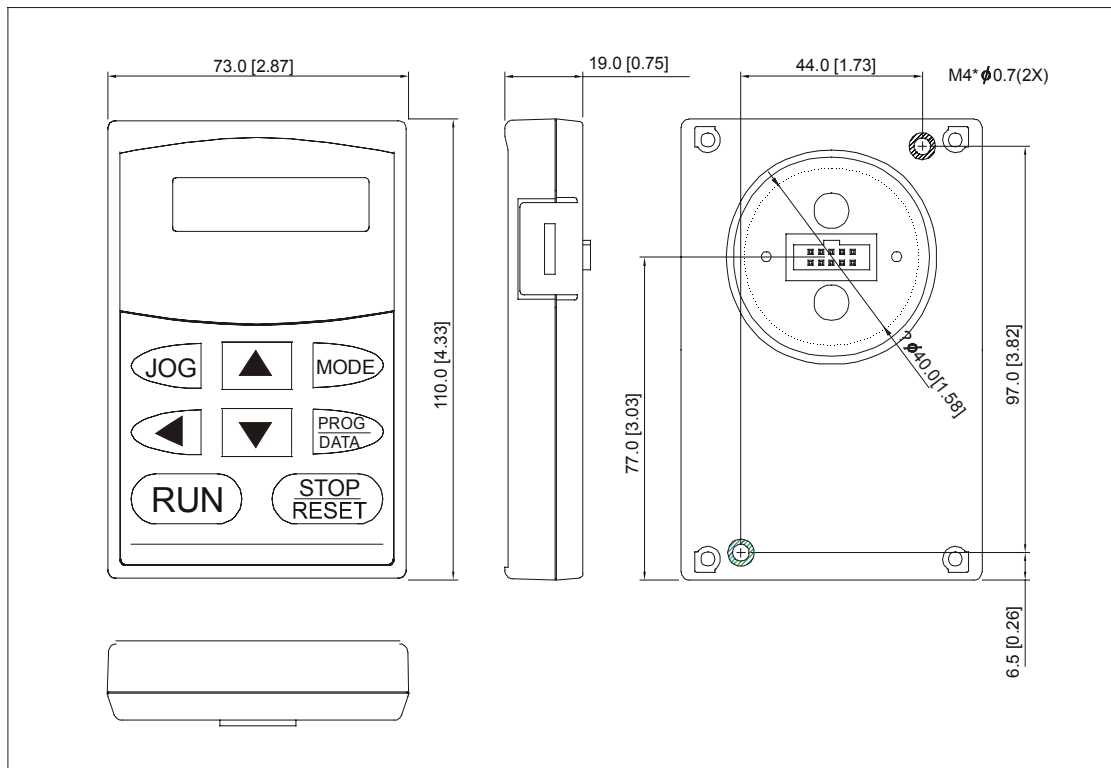





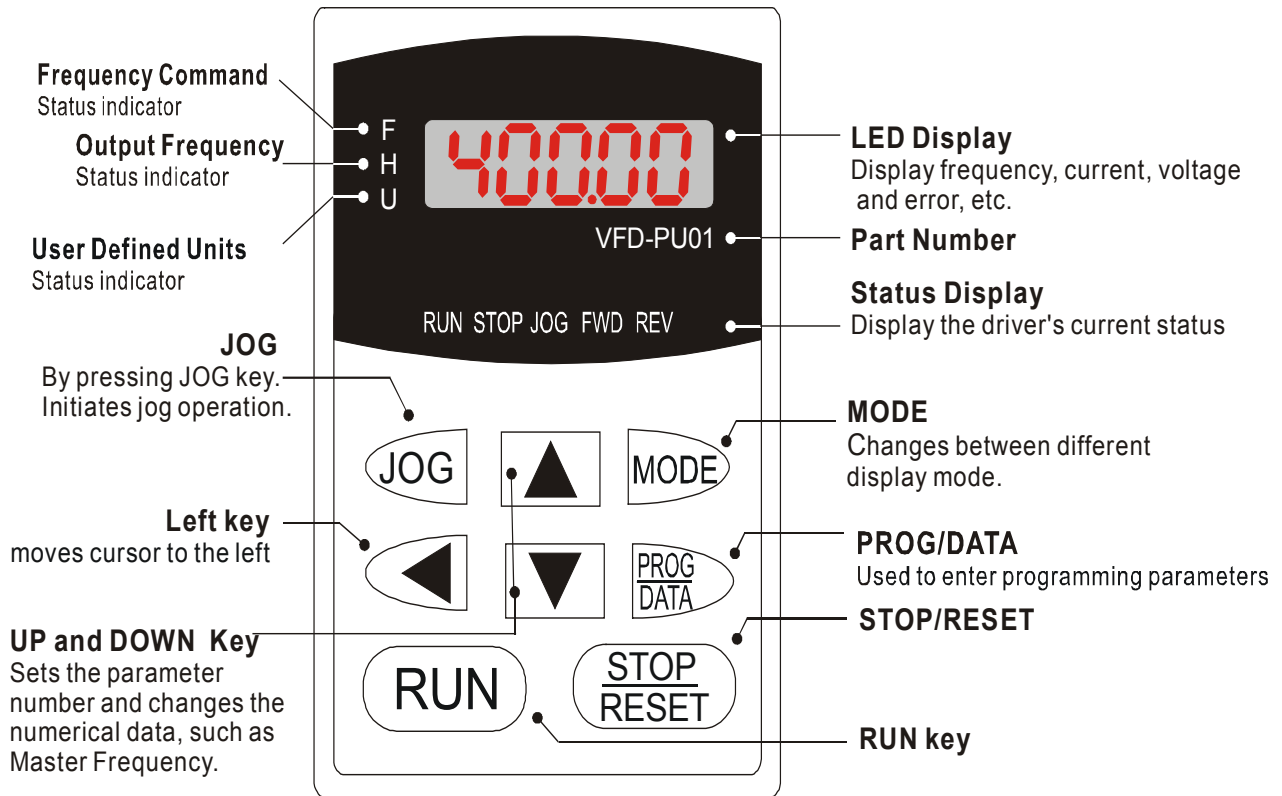







### 4.1 Description of the Digital Keypad VFD-PU01



Display Message	Descriptions
	Display the AC drive Master Frequency.
	Display the actual operation frequency present at terminals U/T1, V/T2, and W/T3.
	User defined unit, where $(U = F \times Pr.00-05)$

Display Message	Descriptions
	Display the output current present at terminals U/T1, V/T2, and W/T3.
	Display the AC drive forward run status.
	The AC drive reverse run status.
	The counter value (C).
	Display the specified parameter setting.
	Display the actual value stored within the specified parameter.
	External Fault.
	Display “End” for approximately 1 second if input has been accepted. After a parameter value has been set, the new value is automatically stored in memory. To modify an entry, use the  or  keys.
	Display “Err”, if the input is invalid.

## 4.2 Operation steps of the Digital Keypad VFD-PU01

### Selecting mode

#### START

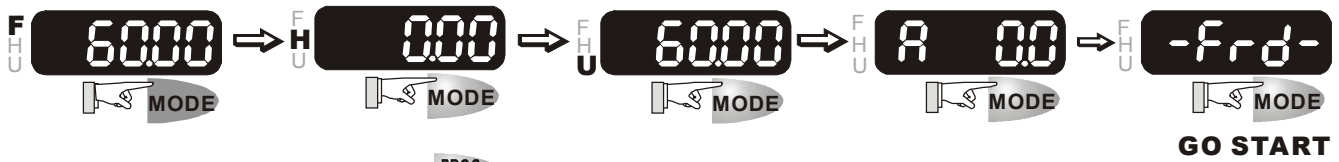

Note : In the selection mode, press **PROG DATA** to set the parameters.

### Setting parameters

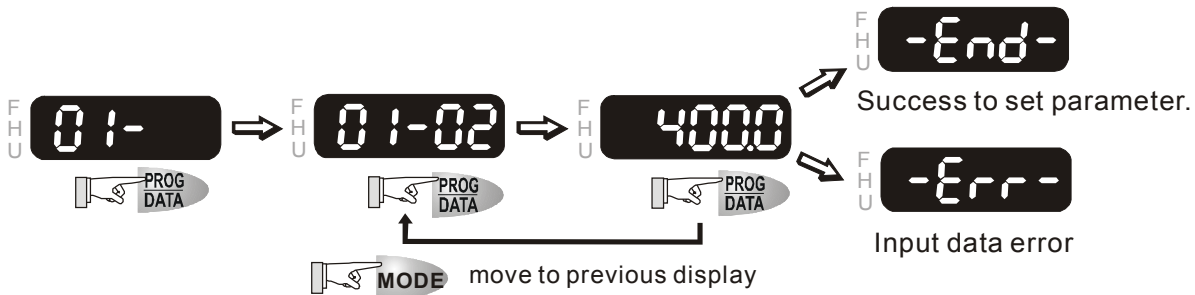

NOTE :In the parameter setting mode, you can press **MODE** to return the selecting mode.

### To shift data

#### START



### To modify data

#### START



### Setting direction

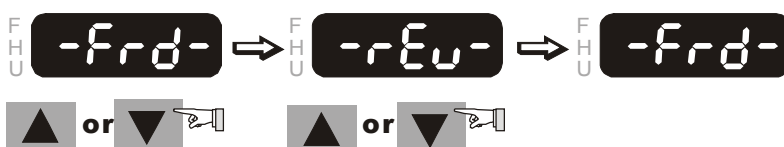

# CHAPTER 5 DESCRIPTION OF PARAMETER SETTINGS

## Group 0: User Parameters

✎: This parameter can be set during operation.

<b>00 - 00</b>	Identity Code of AC Drive	Factory setting: ##
	Factory Setting	

<b>00 - 01</b>	Rated Current Display of the AC drive	Factory setting: ##
	Settings      None	Unit: 0.1 A

 This parameter displays the rated current of the AC drive. It is based on Pr.00-00, and is read-only.

 Users can use the following table to check if the rated current of the AC drive is corresponds to the identity code.

### 230V Series

KW	0.75	1.5	2.2	3.7	5.5	7.5	11	15	18.5	22	30	37
HP	1.0	2.0	3.0	5.0	7.5	10	15	20	25	30	40	50
Pr.00-00	04	06	08	10	12	14	16	18	20	22	24	26
Rated current (A)	5.0	7.0	11	17	25	33	49	65	75	90	120	146
Max. Carried Freq.	15KHz				15 KHz				9 KHz			

### 460V Series

KW	0.75	1.5	2.2	3.7	5.5	7.5	11	15	18.5	22	30	37	45	55	75
HP	1.0	2.0	3.0	5.0	7.5	10	15	20	25	30	40	50	60	75	100
Pr.00-00	05	07	09	11	13	15	17	19	21	23	25	27	29	31	33
Rated Current (A)	2.7	4.2	5.5	8.5	13	18	24	32	38	45	60	73	91	110	150
Max. Carried Freq.	15 KHz				15 KHz				9 KHz				6 KHz		

<b>00 - 02</b>	Parameter Reset	Factory Setting: 00
----------------	-----------------	---------------------

Settings      08    Keypad Lock  
                   10    All parameters are reset to factory settings

 This setting allows the user to return all parameters to the factory default settings except the fault records (Pr.06-08 ~ Pr06-11).

 If this parameter is set to 08, the operation function of VFD-PU01 keypad is disabled. At this time, you should set Pr.00-02 to 00 to disable parameter lock function.

<b>00 - 03</b>	<b>Start-up Display Page Selection</b>		Factory Setting: 00
Settings	00	Display the Master Frequency (F)	
	01	Display the actual operation frequency (H)	
	02	Display the content of user-defined unit (U)	
	03	Multifunction display, [default setting: output current (A)]	
	04	FWD/REV command	

 This setting determines the display mode after power is applied to the drive.

<b>00 - 04</b>	<b>Content of Multi Function Display</b>		Factory Setting: 00
Settings	00	Display the output current (A)	
	01	Display the counter value (C)	
	02	Display the content of PLC time (1.tt)	
	03	Display the DC BUS voltage (U)	
	04	Display the output voltage (E)	
	05	Display the power factor angle (n.)	
	06	Display the output power (P), unit: kW	
	07	Display actual motor speed (enable during vector control or Pulse Generator feedback control) (HU)	
	08	Display the estimative value of the ration of torque (t)	
	09	Display PG numbers/10ms (G)	
	10	Display analog feedback signal value (b) (%)	
	11	Display AVI (U1.) (%)	
	12	Display ACI (U2.) (%)	
	13	Display AUI (U3.) (%)	

 This parameter determines the content for Multi function Display. User also can view other information by pressing the “LEFT” key on the VFD-PU01 when the display page is at Multi function Display.

 The 100% of settings 11-13 is +10V or 20mA.

<b>00 - 05</b>	<b>User Defined Coefficient K</b>		Factory Setting: 1.00
Settings	0.01 to d 160.00		Unit: 0.01

 The coefficient K determines the multiplying factor for the user-defined unit.

The display value is calculated as follows:

$$U \text{ (user-defined unit)} = \text{Frequency Command} \times K \text{ (Pr.00-05)}$$

$$H \text{ (actual output)} = \text{(actual output frequency)} \times K \text{ (Pr.00-05)}$$

The display window is only capable of showing five digits, yet you could use Pr.00-05 to create larger numbers. The display windows use decimal points to signify numbers up to seven digits as illustrated below:

Display	Number Represented
99999	The absence of a decimal point indicates a five-digit integer.
9999.9	A signal decimal point between the middle and the right-most numbers is a true decimal point. For example, the number 1234.5 would be displayed as “1234.5”.
99999.	A single decimal point after the right-most number is not a true decimal point; instead it indicates that a zero follows the right-most number. For example, the number 123450~123459 would be displayed as “12345.”
9999.9.	Two decimal points (one between the middle and the right-most numbers, and one after the right-most number) are not true decimal points; instead they indicate that two zeros follow the right-most number. For example, the number 3456700~3456799 would be displayed as “3456.7.”

5

**00 - 06** Software Version Factory Setting: ###

Settings      None

The software version is read-only.

**00 - 07** Password Decode Factory Setting: 00

Display      00-02 (times of wrong password)

Settings      1 to 65535 Unit: 1

Function of this parameter is to decode the password that is to be input into Pr.00-08. Input the correct password here so as to revise the parameters; the trials are limit to 3 times only. If the entered passwords are wrong consecutively, a blinking “codE” will show up to caution the users to restart the AC drive in order to key in the correct password again.

**00 - 08** Password Input Factory Setting: 00

Settings      1 to 65535 Unit: 1

To cancel the parameter lock, setting the parameter as 0. To lock all parameters, setting a value other than 0 in the parameter as a password. To change the one of the parameter settings of this AC drive, one must enter the correct password in Pr.00-07 to activate this function. Be sure to keep the password in mind for later use.

Display states:

00: no password

01: password has been set  
**Password Decode Flow Chart**

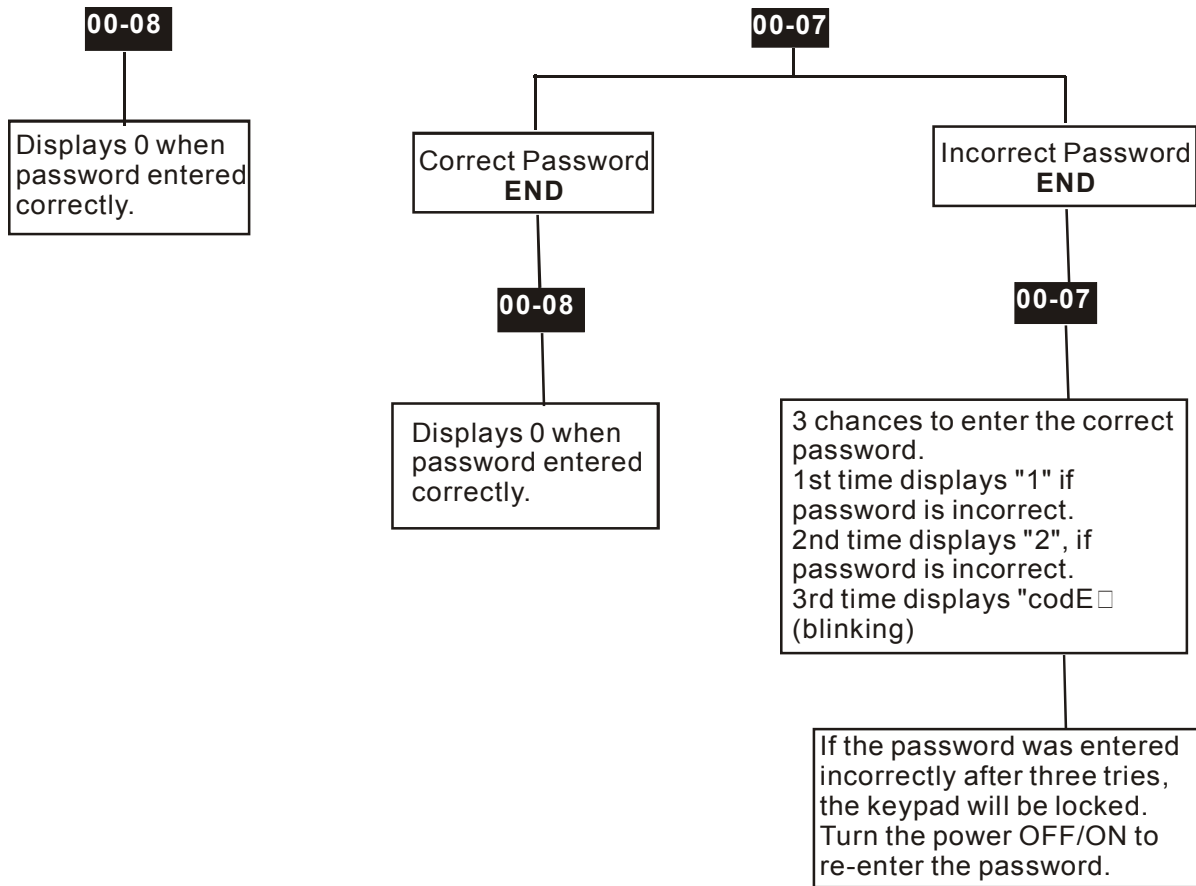

**00 - 09** Control methods

Factory Setting: 00

- |          |    |                     |
|----------|----|---------------------|
| Settings | 00 | V/F control         |
|          | 01 | V/F + PG Control    |
|          | 02 | Vector Control      |
|          | 03 | Vector + PG Control |

This parameter determines the control methods of the AC drive.

**00 - 10** Reserved

## Group 1: Basic Parameters

---

**01 - 00** Maximum Output Frequency (Fmax) Factory Setting: 60.00

Settings 50.00 to 400.00 Hz Unit: 0.01Hz

 This parameter determines the AC drive's Maximum Output Frequency. All the AC drive analog inputs (0 to +10V, 4 to 20mA, -10V to +10V) are scaled to correspond to the output frequency range.

---

**01 - 01** Maximum Voltage Frequency (Fbase) Factory Setting: 60.00

Settings 0.10 to 400.00Hz Unit: 0.01Hz

 This value should be set according to rated frequency of the motor as indicated on the motor nameplate. Maximum Voltage Frequency determines the volts per hertz ratio. For example, if the drive is rated for 460 VAC output and the Maximum Voltage Frequency is set to 60Hz, the drive will maintain a constant ratio of 7.66 V/Hz (460V/60Hz=7.66V/Hz). This parameter value must be equal to or greater than the Mid-Point Frequency (Pr.01-03).

---

**01 - 02** Maximum Output Voltage (Vmax) Unit: 0.1

Settings 230V series 0.1 to 255.0V Factory Setting: 220.0  
 460V series 0.1 to 510.0V Factory Setting: 440.0

 This parameter determines the Maximum Output Voltage of the AC drive. The Maximum Output Voltage setting must be smaller than or equal to the rated voltage of the motor as indicated on the motor nameplate. This parameter value must be equal to or greater than the Mid-Point Voltage (Pr.01-04).

---

**01 - 03** Mid-Point Frequency (Fmid) Factory Setting: 0.50

Settings 0.10 to 400.00Hz Unit: 0.01Hz

 This parameter sets the Mid-Point Frequency of the V/F curve. With this setting, the V/F ratio between Minimum Frequency and Mid-Point frequency can be determined. This parameter must be equal to or greater than Minimum Output Frequency (Pr.01-05) and equal to or less than Maximum Voltage Frequency (Pr.01-01).

---

**01 - 04** Mid-Point Voltage (Vmid) Unit: 0.1

Settings 230V series 0.1 to 255.0V Factory setting: 1.7V  
 460V series 0.1 to 510.0V Factory setting: 3.4V



 This parameter sets the Mid-Point Voltage of any V/F curve. With this setting, the V/F ratio between Minimum Frequency and Mid-Point Frequency can be determined. This parameter must be equal to or greater than Minimum Output Voltage (Pr.01-06) and equal to or less than Maximum Output Voltage (Pr.01-02). However, this parameter is ineffective when Pr.11-00 is set to 1 to 4.

<b>01 - 05</b>	<b>Minimum Output Frequency (Fmin)</b>	Factory Setting: 0.50
Settings	0.10 to 400.00Hz	Unit: 0.01Hz

 This parameter sets the Minimum Output Frequency of the AC drive. This parameter must be equal to or less than Mid-Point Frequency (Pr.01-03).

 The settings of 01-03, 01-04, 01-06 are invalid in Vector Control mode.

<b>01 - 06</b>	<b>Minimum Output Voltage (Vmin)</b>	Unit: 0.1
Settings	230V series 0.1 to 255.0V 460V series 0.1 to 510.0V	Factory setting: 1. 7V Factory setting: 3.4V

 This parameter sets the Minimum Output Voltage of the AC drive. This parameter must be equal to or less than Mid-Point Voltage (Pr.01-04).

 The settings of Pr.01-01 to Pr.01-06 have to meet the agreement that  $Pr.01-02 \geq Pr.01-04 \geq Pr.01-06$  and  $Pr.01-01 \geq Pr.01-03 \geq Pr.01-05$ .

<b>01 - 07</b>	<b>Upper Bound of Output Frequency</b>	Factory Setting: 100
Settings	1 to 120%	Unit: 1%

 This parameter must be equal to or greater than the Lower Bound of Output Frequency (Pr.01-08). The Maximum Output Frequency (Pr.01-00) is regarded as 100%.



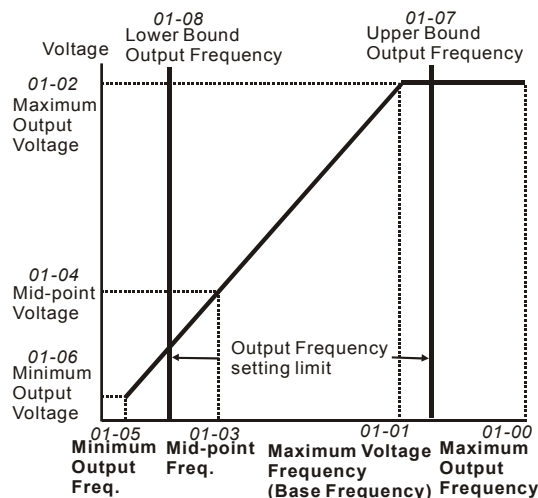

 Upper Bound of Output Frequency value =  $(Pr.01-00 \times Pr.01-07)/100$



**V/F Curve**





**01 - 08** Lower Bound of Output Frequency Factory Setting: 00

Settings      00 to 100% Unit: 1%

-  The Upper/Lower Bound is to prevent operation error and machine damage.
-  If the Upper Bound of Output Frequency is 50Hz and the Maximum Output Frequency is 60Hz, the Maximum Output Frequency will be limited to 50Hz.
-  If the Lower Bound of Output Frequency is 10Hz, and the Minimum Output Frequency (Pr.01-05) is set at 1.0Hz, then any Command Frequency between 1.0-10Hz will generate a 10Hz output from the drive.
-  This parameter must be equal to or less than the Upper Bound of Output Frequency (Pr.01-07).
-  The Lower Bound of Output Frequency value =  $(Pr.01-00 \times Pr.01-08) / 100$

<b>01 - 09</b>	Acceleration Time 1 (Taccel 1)	↗	Factory Setting: 10.0
<b>01 - 10</b>	Deceleration Time 1 (Tdecel 1)	↗	Factory Setting: 10.0
<b>01 - 11</b>	Acceleration Time 2 (Taccel 2)	↗	Factory Setting: 10.0
<b>01 - 12</b>	Deceleration Time 2 (Tdecel 2)	↗	Factory Setting: 10.0
<b>01 - 18</b>	Acceleration Time 3 (Taccel 3)	↗	Factory Setting: 10.0
<b>01 - 19</b>	Deceleration Time 3 (Tdecel 3)	↗	Factory Setting: 10.0
<b>01 - 20</b>	Acceleration Time 4 (Taccel 4)	↗	Factory Setting: 10.0
<b>01 - 21</b>	Deceleration Time 4 (Tdecel 4)	↗	Factory Setting: 10.0

Settings      0.01 to 3600.0 sec Unit: 0.1/0.01sec

- ◆ Factory setting 60sec is for the models of 30 HP and above.
-  Unit can be set by Pr.01-23.
-  The Acceleration Time is used to determine the time required for the AC drive to ramp from 0 Hz to its Maximum Output Frequency (Pr.01-00). The rate is linear unless S-Curve is “Enabled.”
-  The Deceleration Time is used to determine the time required for the AC drive to decelerate from the Maximum Output Frequency (Pr.01-00) down to 0 Hz. The rate is linear unless S-Curve is “Enabled.”
-  The Acceleration/Deceleration Time 1, 2, 3, 4 is switched according to the Multi-Function Input Terminals Setting. See Pr.04-04 to Pr.04-09 for more details.

In the diagram shown below, the Acceleration/Deceleration Time of the AC drive is time between 0 Hz to Maximum Output Frequency (Pr.01-00). Suppose the Maximum Output Frequency is 60 Hz, Minimum Output Frequency (Pr.01-05) is 1.0 Hz, and Acceleration/Deceleration Time is 10 seconds. The actual time for the AC drive to accelerate from start-up to 60 Hz is 9.83 seconds and the deceleration time is also 9.83 seconds.  $((60-1) \times 10/60=9.83\text{secs})$ .

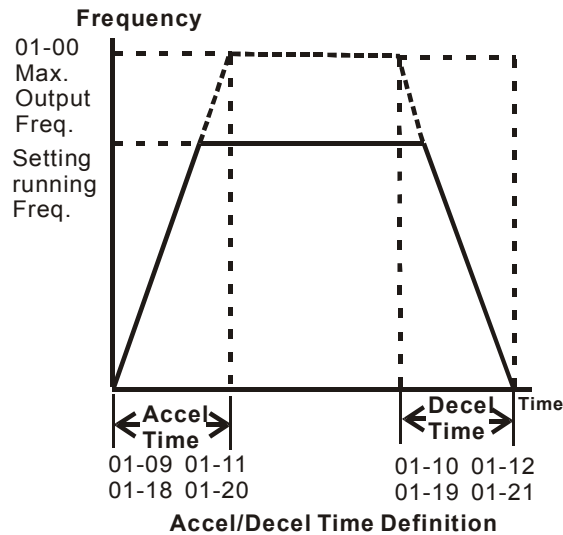

<b>01 - 13</b>	Jog Acceleration Time	↗	Factory Setting: 1.0
	Settings     0.1 to 3600.0 sec		Unit: 0.1sec
<b>01 - 22</b>	Jog Deceleration Time	↘	Factory Setting: 1.0
	Settings     0.1 to 3600.0 sec		Unit: 0.1sec
<b>01 - 14</b>	Jog Frequency	↗	Factory Setting: 6.00
	Settings     0.10 to 400.00Hz		Unit: 0.01Hz

When the Jog command is “ON”, the AC drive will accelerate from Minimum Output Frequency (Pr.01-05) to Jog Frequency (Pr.01-14). When the Jog command is “OFF”, the AC drive will decelerate from Jog Frequency to zero. The Accel/Decel time is decided by the Jog Accel/Decel time (Pr.01-13, Pr01-22).

During operation, the AC drive cannot perform Jog command. And during Jog operation, other operation commands cannot be accepted, except command of FORWARD, REVERSE and STOP keys on the digital keypad.

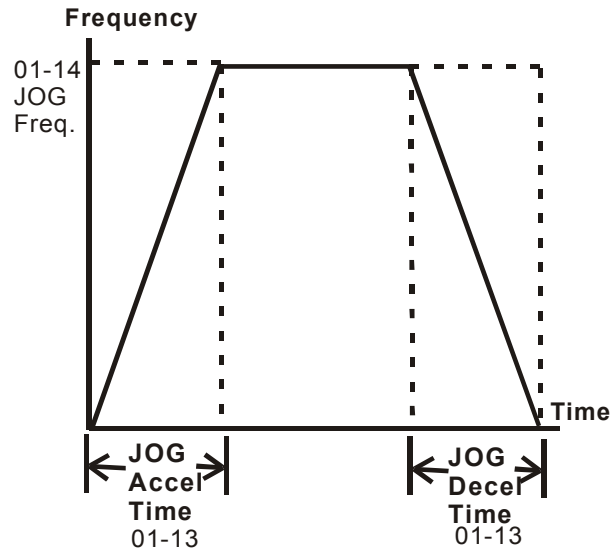

<b>01 - 15</b>	Auto-Acceleration / Deceleration	↗	Factory Setting: 00
----------------	----------------------------------	---	---------------------

- |          |    |  |
|----------|----|--|
| Settings | 00 | Linear acceleration / deceleration                                   |
|          | 01 | Auto acceleration, linear Deceleration.                              |
|          | 02 | Linear acceleration, auto Deceleration.                              |
|          | 03 | Auto acceleration / deceleration                                     |
|          | 04 | Auto acceleration / deceleration (refer to Accel/Decel Time setting) |

- 📖 If this parameter is set to 03, the AC drive will accel/decel in the fastest and smoothest means possible by automatically adjusting the time of accel/decel.
- 📖 If this parameter is set to 04, the real accel/decel time will be equal to or more than parameter Pr.01-09 ~Pr.01-12 and Pr.01-18 to Pr.01-21.

<b>01 - 16</b>	Acceleration S-Curve	Factory Setting: 00
----------------	----------------------	---------------------

<b>01 - 17</b>	Deceleration S-Curve	Factory Setting: 00
----------------	----------------------	---------------------

Settings    00 to 07

- 📖 This parameter is used to ensure a smooth acceleration and deceleration. The S-curve is enabled when sets at 01-07. Setting 1 offers the quickest S-curve and 07 offers the longest and smoothest S-curve. The AC drive will not follow Accel/Decel Time in Pr.01-09 to Pr.01-12. To Disable the S-curve, set Pr.01-16 and Pr.01-17 to 00.

NOTE: From the diagram shown below, the original setting Accel/Decel Time will be for reference when the function of the S-curve is enabled. The actual Accel/Decel Time will be determined based on the S-curve selected (01 to 07).

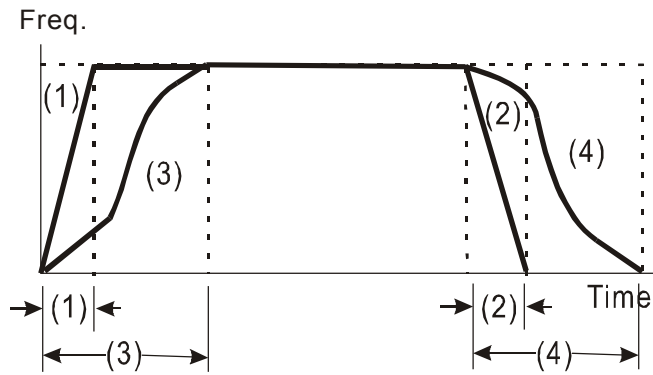

Accel/Decel characteristics  
 (1), (2) Disabling S curve  
 (3), (4) Enabling S curve

<b>01 - 23</b>	<b>Unit for Accel/Decel Time</b>	↗	Factory Setting: 00
Settings	00	Unit: 1 sec	
	01	Unit: 0.1 sec	
	02	Unit: 0.01 sec	

This parameter can be used to set the unit of Accel/Decel Time and the setting range of Accel/Decel Time is also changed at the same time.

## Group 2: Operation Method Parameters

<b>02 - 00</b>		Source of First Frequency Command	↗	Factory Setting: 00
Settings	00	Master Frequency determined by the digital keypad or external UP/DOWN keys of the Multi Function Inputs.		
	01	Master Frequency determined by analog signal DC 0V to +10V (external terminal AVI)		
	02	Master Frequency determined by analog signal DC 4mA to 20mA (external terminal ACI).		
	03	Master Frequency determined by analog signal DC -10V to +10V (external terminal AUI).		
	04	Master Frequency determined by RS-485 serial communication. (RJ-11).		
	05	Master Frequency determined by RS-485 serial communication. (RJ-11). It won't memorize the frequency.		
	06	Combined usage of the master and auxiliary frequency command Pr. 02-10, 02-11,02-12		

<b>02 - 13</b>		Source of Second Frequency Command	↗	Factory Setting: 00
Settings	00	Master Frequency determined by the digital keypad or external UP/DOWN keys of the Multi Function Inputs.		
	01	Master Frequency determined by analog signal DC 0V to +10V (external terminal AVI)		
	02	Master Frequency determined by analog signal DC 4mA to 20mA (external terminal ACI).		
	03	Master Frequency determined by analog signal DC -10V to +10V (external terminal AUI).		
	04	Master Frequency determined by RS-485 serial communication. (RJ-11).		
	05	Master Frequency determined by RS-485 serial communication. (RJ-11). It won't memorize the frequency.		
	06	Combined usage of the master and auxiliary frequency command Pr. 02-10, 02-11,02-12		

 These parameters set the Frequency Command Source of the AC drive.

02 - 01	Source of First Operation Command		Factory Setting: 00
Settings	00	Controlled by the digital keypad	
	01	Controlled by the external terminals, keypad STOP enabled.	
	02	Controlled by the external terminals, keypad STOP disabled.	
	03	Controlled by the RS-485 communication interface, keypad STOP enabled.	
	04	Controlled by the RS-485 communication interface, keypad STOP disabled.	

02 - 14	Source of Second Operation Command		Factory Setting: 00
Settings	00	Controlled by the digital keypad	
	01	Controlled by the external terminals, keypad STOP enabled.	
	02	Controlled by the external terminals, keypad STOP disabled.	
	03	Controlled by the RS-485 communication interface, keypad STOP enabled.	
	04	Controlled by the RS-485 communication interface, keypad STOP disabled.	

 When the AC drive is controlled by external terminal, please refer to Pr.02-05 for detailed explanations.

 The first /second frequency/operation command is enable/disable by Multi Function Input Terminals. Please refer to the setting of Pr.04-04 ~ 04-09.

02 - 02	Stop Method		Factory Setting: 00
Settings	00	STOP: ramp to stop; E.F. (External Fault) : coast to stop	
	01	STOP: coast to stop; E.F. : coast to stop	
	02	STOP: ramp to stop; E.F. : ramp to stop	
	03	STOP: coast to stop; E.F. : ramp to stop	

 The parameter determines how the motor is stopped when the AC drive receives a valid stop command or External Fault.

1. Ramp: the AC drive decelerates to Minimum Output Frequency (Pr.01-05) according to the deceleration time and then stops.
2. Coast: the AC drive stops output instantly upon command, and the motor free runs until it comes to a complete stop.
3. The motor stop method is usually determined by the characteristics of the motor load and the frequency of stop

(1) It is recommended to use “ramp to stop” for the personnel’s safety or to prevent the materials from being wasted applications that the motor has to stop after the drive is stopped. As for the deceleration time, it has to be set according to the field tuning.

(2) If the motor free run is okay or the loading inertia is great, it is recommended to set it as “coast to stop”.

For example: blowers, punching machines, and pumps.

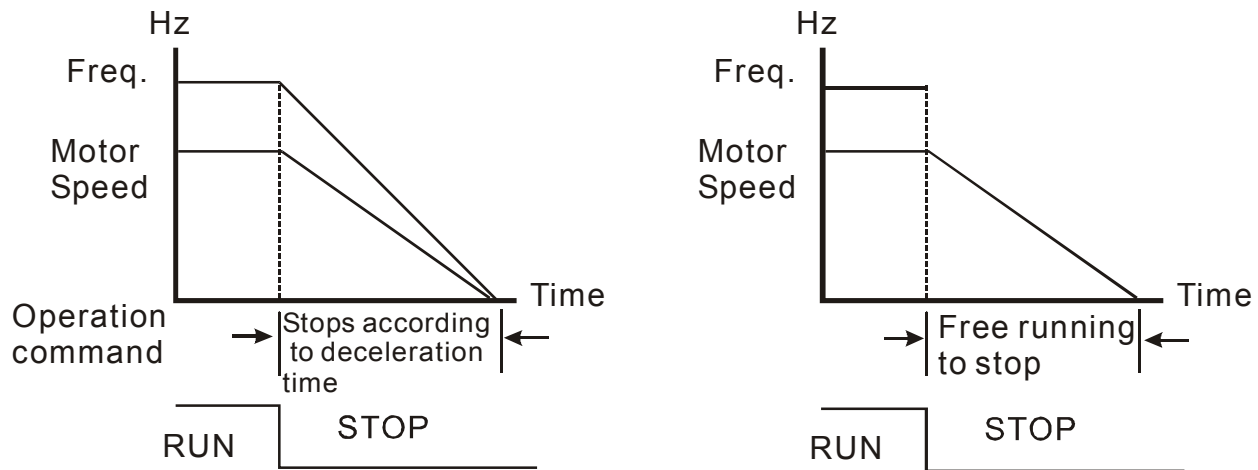

02 - 03 PWM Carrier Frequency Selections		Unit: 1
HP	Setting range	Factory setting
1-5HP	01-15KHz	15
7.5-25HP	01-15KHz	09
30-60HP	01-09KHz	06
75-100HP	01-06KHz	06

This parameter determines the PWM carrier frequency of AC drive.

Carrier Frequency	Acoustic Noise	Electromagnetic Noise, Leakage Current	Heat Dissipation
1kHz	Significant	Minimal	Minimal
↑ ↓	↑ ↓	↑ ↓	↑ ↓
15KHz	Minimal	Significant	Significant

From the table, we see that the PWM carrier frequency has a significant influence on the electromagnetic noise, heat dissipation of the AC drive, and the acoustic noise to the motor.



**02 - 04** Motor Direction Control

Factory Setting: 00

- Settings 00 Enable Forward/Reverse operation
- 01 Disable Reverse operation
- 02 Disabled Forward operation

 The parameter determines the direction that AC drive can operate.

**02 - 05** 2-wire/ 3-wire Operation Control Modes

Factory Setting: 00

- Settings 00 FWD/STOP, REV/STOP
- 01 FWD/REV, RUN/STOP
- 02 3-wire Operation

 There are three different types of control modes:

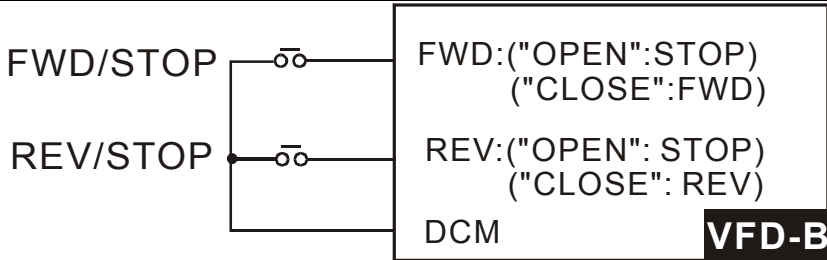
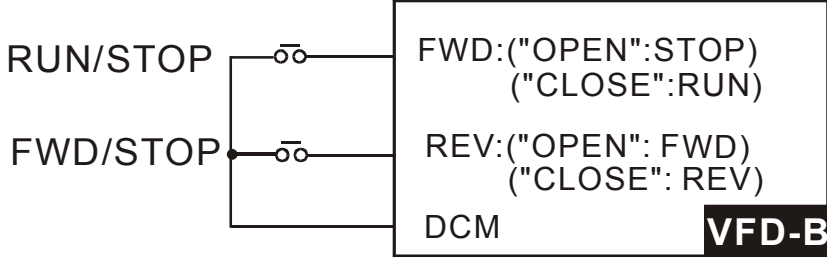
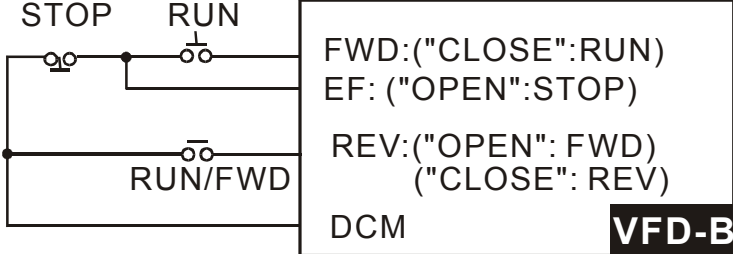
02-05		External Terminal	
00 2-wire	FWD /STOP REV / STOP		<b>VFD-B</b>
01 2-wire	FWD/ REV RUN / STOP		<b>VFD-B</b>
02 3-wire			<b>VFD-B</b>

**02- 06** Line Start Lockout

Factory Setting: 00

- Settings 00 Disable
- 01 Enable

 When enabled, the AC drive will not start when powered up with run commands applied. To start in Line Start Lockout mode, the AC drive must see the run command go from stop to run after power up. When Line Start Lockout is disable (also known as Auto-Start), the drive will start when powered-up with run commands applied.

 The Line Start Lockout feature does not guarantee the motor will never start under this condition. It is possible the motor may be set in motion by a malfunctioning switch.

<b>02-07</b>	<b>Loss of ACI Signal (4-20mA)</b>	Factory Setting: 00
Settings	00 Decelerate to 0Hz.	
	01 Stop immediately and display “EF”.	
	02 Continue operation by the last frequency command.	

 This parameter determines the process when ACI is lost.

<b>02-08</b>	<b>Up/Down Key Mode</b>		Factory Setting: 00
Settings	00 Based on Accel/Decel Time		
	01 Constant speed		

<b>02-09</b>	<b>The Acce/Decel Speed of the UP/DOWN Key with Constant Speed</b>		Factory Setting: 0.01
Settings	0.01~1.00 Hz/msec		

 These parameters determine increase/decrease method of frequency command when the Multi-Function Input parameters Pr.04-04~Pr.04-09 are set to 11 (Up command) or 12 (Down command).

Pr.02-08=0: It will increase/decrease frequency command by the setting of accel/decel speed.

Pr.02-08=1: It will accel/decel frequency command by Pr.02-09.

<b>02-10</b>	<b>Source of the Master Frequency Command (FCHA)</b>		Factory Setting: 00
Settings	00 Digital keypad		
	01 0 to +10V from AVI		
	02 4 to 20mA from ACI		
	03 -10 to +10Vdc from AUI		
	04 RS-485 communication interface		

<b>02 - 11</b>	<b>Source of the Auxiliary Frequency Command (FCHB)</b>	↗	Factory Setting: 00
Settings	00	Digital keypad	
	01	0 to +10V from AVI	
	02	4 to 20mA from ACI	
	03	-10 to +10Vdc from AUI	
	04	RS-485 communication interface	

<b>02 - 12</b>	<b>Combination of the Master and Auxiliary Frequency Command</b>	↗	Factory Setting: 00
Settings	00	Master frequency + Auxiliary frequency	
	01	Master frequency - Auxiliary frequency	

 These three parameters (Pr.02-10~02-12) are enabled when Pr.02-00 or Pr.02-13 is set to 06. If they are enabled, the frequency command will be determined by these parameters.

<b>02 - 15</b>	<b>Keyboard Frequency Command</b>	↗	Factory Setting: 60.00
Settings	0.00 ~ 400.00Hz		Unit: 0.01

 This parameter can be used to set frequency command or read keypad frequency command.

### Group 3: Output Function Parameters

<b>03 - 00</b>	Multi-function Output Terminal (Relay contact point RA, RB, RC)	Factory Setting: 08
<b>03 - 01</b>	Multi-function Output Terminal MO1	Factory Setting: 01
<b>03 - 02</b>	Multi-function Output Terminal MO2	Factory Setting: 02
<b>03 - 03</b>	Multi-function Output Terminal MO3	Factory Setting: 20

Settings      00 to 28

#### Function Table List:

Setting	Functions	Descriptions
00	No function	
01	AC Drive Operational	The terminal will be activated when there is an output from the drive or RUN command is "ON".
02	Master Frequency Attained	The output will be activated when the AC drive attains the Output Frequency Setting.
03	Zero speed	The output will be activated when Command Frequency is lower than the Minimum Output Frequency.
04	Over-Torque detection	The output will be activated as long as over-torque is detected. (Refer to Pr.06-03 ~ Pr.06-05)
05	Baseblock (B.B.) Indication	The output will be activated when the output of the AC drive is shut off by external baseblock.
06	Low-Voltage Indication	The output will be activated when low voltage is detected.
07	Operation Mode Indication	The output will be activated when operation command is controlled by external terminal.
08	Fault Indication	The output will be activated when faults occur (oc, ov, oH, oL, oL1, EF, cF3, HPF, ocA, ocd, ocn, GFF).
09	Desired Frequency Attained 1	The output will be activated when the desired frequency (Pr.03-04) is attained.
10	PLC Program Running	The Output will be activated when PLC Program is running.
11	PLC Program Step Completed	The Output will be activated for 0.5 sec when each multi-step speed is attained.
12	PLC Program Completed	The output will be activated for 0.5 sec when the PLC program cycle has completed

Setting	Functions	Descriptions
13	PLC Operation Paused	The output will be activated when PLC operation is paused.
14	Terminal Count Value Attained	The output will be activated when the counter reaches Terminal Count Value.
15	Preliminary Count Value Attained	The output will be activated when the counter reaches Preliminary Count Value.
16 17 18	Auxiliary Motor 1, 2 and 3	For the fan & pump control applications, one can use the Multi-function Output Terminals to define the auxiliary motor 1-3. Refer to CH 5-11 (PID Controls) and CH 5-12 (Fan and Pump Control).
19	Heatsink overheat warning (OH1)	When heatsink overheats, it will signal to prevent OH turn off the drive. > 85°C (185°F) ON, < 85°C (185°F) OFF.
20	AC drive ready	The output will be activated when the drive is on and no abnormality detected.
21	Emergency Stop Indication	The contact will be activated once the drive's emergency stop function is activated.
22	Desired Frequency Attained 2	The output will be activated when the desired frequency (Pr.03-10) is attained.
23	Soft Braking Signal	This function is used in conjunction with a VFDB Braking Unit. The output will be activated when the drive needs help braking the load. A smooth deceleration is achieved using this function.
24	Zero Speed Output Signal	The output is always active unless there is an output frequency present at terminals U/T1, V/T2, and W/T3.
25	Low-current Detection	The output will be activated once the drive's current is too low. (Refer to Pr.06-12, 06-13)
26	Operation Indication (H>=Fmin)	The output will be activated when there is output voltage from U, V, W.
27	Feedback Signal Error	The output will be activated once the feedback signal is abnormal. (Refer to Pr.10-08, Pr.10-16)
28	User-defined low-voltage Detection	The output will be activated once the DC Bus voltage is too low. (Refer to Pr.06-16, Pr.06-17)

**03 - 04** Desired Frequency Attained 1

Factory Setting: 0.00

Settings 0.00 to 400.00 Hz

Unit: 0.01Hz

**03 - 10** Desired Frequency Attained 2 Factory Setting: 0.00  
 Settings 0.00 to 400.00 Hz Unit: 0.01

If a Multi-function output terminal is set to function as Desired Frequency Attained 1 (Pr.03-00 to Pr.03-03 = 09), then the output will be activated when the programmed frequency is attained.

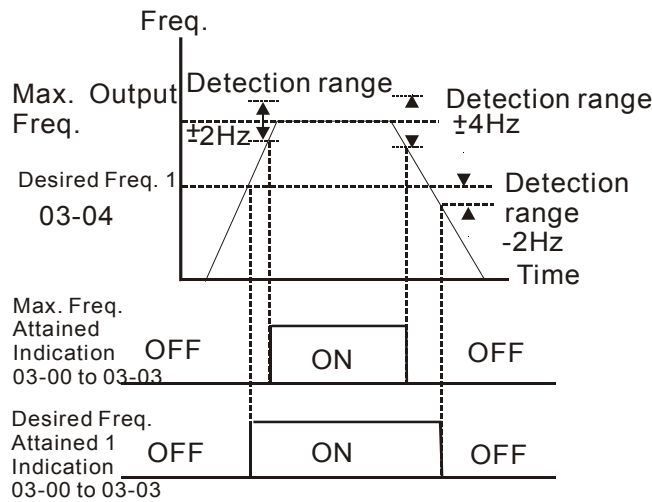

Desired Freq. Attained 1 & Max. Freq. Attained

5

**03 - 05** Analog Output Signal (AFM) Factory Setting: 00

- Settings 00 Analog Frequency Meter (from 0 to the Maximum Output Frequency)
- 01 Analog Current Meter (from 0 to 250% of the rated AC drive current)
- 02 Output voltage (from 0 to Pr.01-02)
- 03 Output frequency command (from 0 to the Maximum Frequency)
- 04 Output motor speed (from 0 to the Maximum Frequency)
- 05 Load power factor ( $\cos\theta = 90^\circ$  to  $\cos\theta = 0^\circ$ )

This parameter determines the meaning of the 0~+10VDC output from AFM and ACM.

**03 - 06** Analog Output Gain Factory Setting: 100

Settings 01 to 200% Unit: 1%

This parameter sets the voltage range of the analog output signal.

When Pr.03-05 is set to 0, the analog output voltage is directly proportional to the output frequency of the AC drive. With Pr.03-06 set to 100%, the Maximum Output Frequency (Pr.01-00) of the AC drive corresponds to +10VDC on the AFM output.

Similarly, if Pr.03-05 is set to 1, the analog output voltage is directly proportional to the output current of the AC drive. With Pr.03-06 set to 100%, then 2.5 times the rated current corresponds to +10VDC on the AFM output.

Note: Any type of voltmeter can be used. If the meter reads full scale at a voltage less than 10 volts, the parameter 03-06 should be set using the following formula:

$$\text{Pr. 03-06} = ((\text{meter full scale voltage})/10) \times 100\%$$

For Example: When using the meter with full scale of 5 volts, adjust Pr.03-06 to 50%. If Pr.03-05 is set to 0, then 5Vdc will correspond to Maximum Output Frequency.

<b>03 - 07</b>	<b>Digital Output Multiplying Factor</b>	↗	Factory Setting: 01
	Settings      01 to 20 times		Unit: 1

This parameter determines the multiplying factor for the AC drives digital output frequency at the digital output terminals (DFM-DCM). The number of output pulses per second is equal to the AC drive output frequency multiplied by Pr.03-07. (Pulse per second = actual output frequency x Pr.03-07)

<b>03 - 08</b>	<b>Terminal Count Value</b>	↗	Factory Setting: 00
	Settings      00 to 65500		Unit: 1

The parameter determines the value of the internal counter. The internal counter can be triggered by the external terminal TRG. Upon completion of counting, the specified output terminal will be activated. (Pr.03-00, to Pr.03-03 set to 14).

When the display shows c5555, the drive has counted 5,555 times. If display shows c5555., it means that real counter value is between 55,550 to 55,559.

<b>03 - 09</b>	<b>Preliminary Count Value</b>	↗	Factory Setting: 00
	Settings      00 to 65500		Unit: 1

When the counter value is counted up from “1” to the set value of this parameter, the corresponding multi-function output terminal will be activated, when set to 15 (Preliminary Count Value Setting). The corresponding multi-function output terminal will be deactivated upon completion of Terminal Count Value Attained.

The timing diagram:

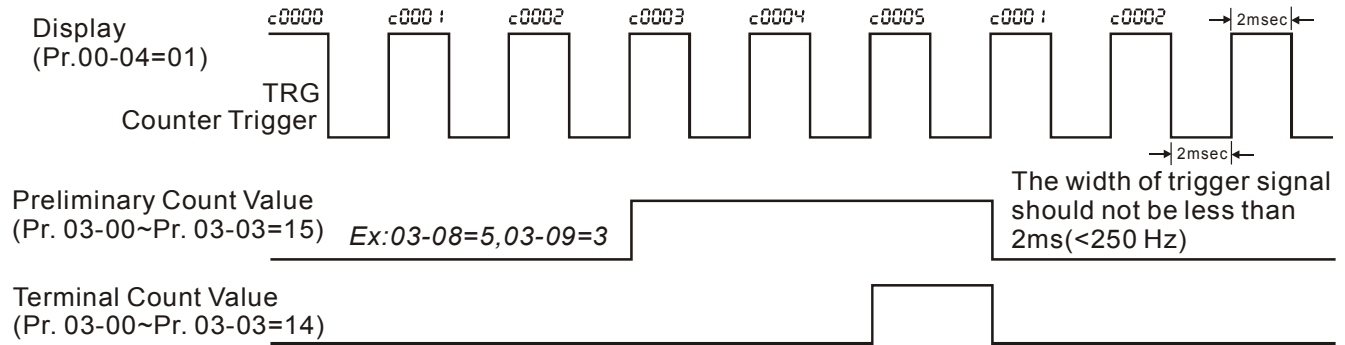

**03 - 11** EF Active when Preliminary Count Value Attained Factory Setting: 00

- Settings    00    No function.
- 01    Preliminary count value attained, EF active.

If this parameter is set to 01, When the desired value of counter is attained, the AC drive treat it as a fault, the drive will stop and show the “cEF” message on the display.

**03 - 12** Fan Control Factory Setting: 00

- Settings    00    Always fan on
- 01    Power off 1 minute later, fan off
- 02    Run and fan on, stop and fan off
- 03    Preliminary temperature attained, Fan start to run

This parameter determines the operation mode of cooling fan.



## Group 4: Input Function Parameters

<b>04 - 00</b>	AVI Analog Input Bias	↗	Factory Setting: 0.00
	Settings	0.00 to 200.00%	Unit: 0.01%
<b>04 - 01</b>	AVI Bias Polarity		Factory Setting: 00
	Settings	00 Positive Bias 01 Negative Bias	
<b>04 - 02</b>	AVI Input Gain	↗	Factory Setting: 100
	Settings	1 to 200%	Unit: 1%
<b>04 - 03</b>	AVI Negative Bias, Reverse Motion Enabled		Factory Setting: 00
	Settings	00 Forward motion only 01 Forward and reverse motion enabled. Forward motion with positive bias. Reverse motion with negative bias. 02 Forward and reverse motion enabled. Forward and Reverse motion with positive or negative bias. Select direction via the keypad or external terminals.	
<b>04 - 11</b>	ACI Analog Input Bias	↗	Factory Setting: 0.00
	Settings	0.00 to 200.00%	Unit: 0.01%
<b>04 - 12</b>	ACI Bias Polarity		Factory Setting: 00
	Settings	00 Positive Bias 01 Negative Bias	
<b>04 - 13</b>	ACI Input Gain	↗	Factory Setting: 100
	Settings	01 to 200%	Unit: 1%
<b>04 - 14</b>	ACI Negative Bias, Reverse Motion Enable		Factory Setting: 00
	Settings	00 No ACI Negative bias command 01 Negative bias, REV motion enabled 02 Negative bias, REV motion disabled	
<b>04 - 15</b>	AUI Analog Input Bias	↗	Factory Setting: 0.00
	Settings	0.00 to 200.00%	Unit: 0.01%
<b>04 - 16</b>	AUI Bias Polarity		Factory Setting: 00
	Settings	00 Positive Bias 01 Negative Bias	

<b>04 - 17</b>	<b>AUI Input Gain</b>	↗	Factory Setting: 100
Settings	01 to 200%		Unit: 1%
<b>04 - 18</b>	<b>No AUI Negative bias command</b>		Factory Setting: 00
Settings	00 No ACI Negative bias command		
	01 Negative bias, REV motion enabled		
	02 Negative bias, REV motion disabled		

Pr.04-00 ~ 04-03, Pr.04-11 ~ 04-18 are used when the source of frequency command is the analog signal. Refer to the following examples.

**Example 1:**

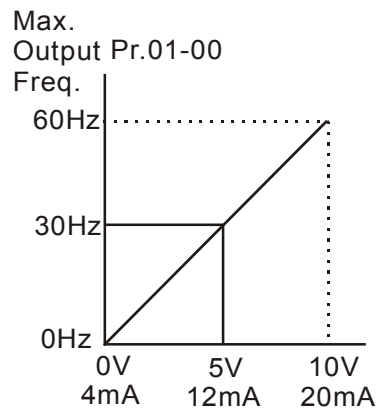

**Factory Settings**  
 Pr.01-00=60Hz--Max. output Freq.  
 Pr.04-11=0%--bias adjustment  
 Pr.04-12=0-- bias polarity  
 Pr.04-13=100% -- pot. freq. gain  
 Pr.04-14=0 -- REV disable in negative bias

**Example 2:**

In this example with the potentiometer set to 0V the Output Frequency is 10 Hz. The mid-point of the potentiometer becomes 40 Hz. Once the Maximum Output Frequency is reached any further increase of the potentiometer will not increase output frequency. (If you want to use the range of 60Hz, please refer to the example 3.) The value of external input voltage/current 0-8.33V (4-13.33mA) corresponds to the setting frequency 0-60Hz.

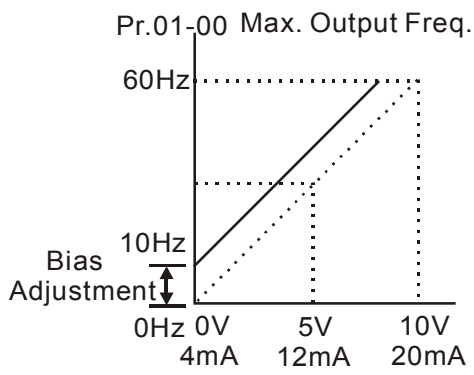

**Factory Settings**  
 Pr.01-00=60Hz--Max. output Freq.  
 Pr.04-11=16.7%-- bias adjustment  
 Pr.04-12=0 -- bias polarity  
 Pr.04-13=100% -- pot. freq. gain  
 Pr.04-14=0 -- REV motion disable in negative bias

**Example 3:**

The example also shows the popular method. The whole scale of the potentiometer can be used as desired. In addition to signals of 0 to 10V and 4 to 20mA, the popular voltage signals also include signals of 0 to 5V, 20 to 4mA or that under 10V. Regarding the setting, please refer to the following examples.

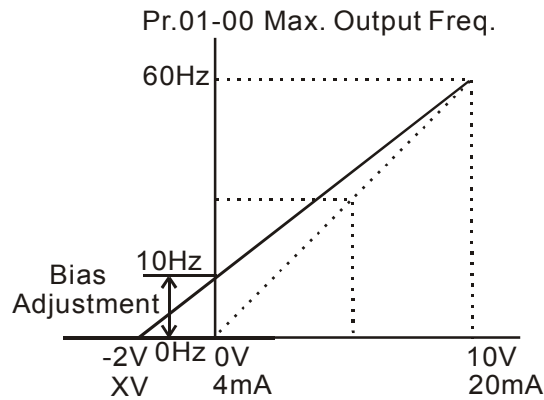

**Factory Settings**

- Pr. 01-00 = 60Hz--Max. output Freq.
- Pr. 04-11 = 20.0%-- bias adjustment
- Pr. 04-12 = 0-- bias polarity
- Pr. 04-13 = 83.3%-- pot. Freq. gain
- Pr. 04-14 = 0-- REV motion disable in negative bias

$$\text{Pr. 04-13} = \frac{10\text{V}}{12\text{V}} \times 100\% = 83.3\%$$

**Negative bias:**

$$\frac{60-10\text{Hz}}{10\text{V}} = \frac{10-0\text{Hz}}{\text{XV}}$$

$$\text{XV} = \frac{100}{50} = 2\text{V} \quad \therefore \text{Pr.04-11} = \frac{2}{10} \times 100\%$$

**Example 4:**

This example shows a potentiometer range of 0 to 5 Volts. In addition to adjust gain, you also can set Pr. 01-00 to 120Hz.

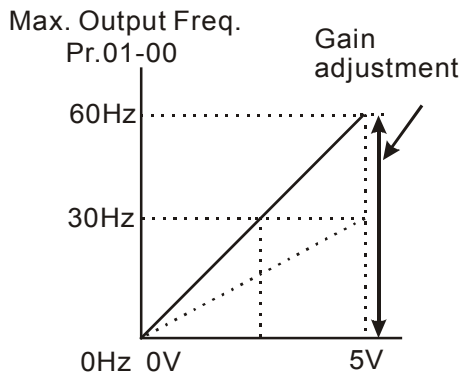

**Factory Settings**

- Pr.01-00=60Hz--Max. output Freq.
- Pr.04-11=0.0% bias adjustment
- Pr.04-12=0 -- bias polarity
- Pr.04-13=200% -- pot. freq. gain
- Pr.04-14=0 -- REV motion disable in negative bias

**Calculation of gain**

$$\text{Pr.04-13} = \left( \frac{10\text{V}}{5\text{V}} \right) \times 100\% = 200\%$$

**Example 5:**

In this example a 1-volt negative bias is used. In a noisy environment, it is advantageous to use negative bias to provide a noise margin (1V in this example).

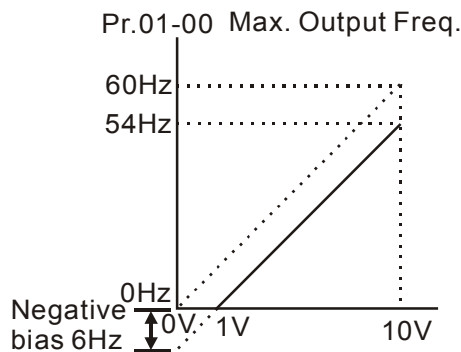

**Factory Settings**

- Pr.01-00=60Hz--Max. output Freq.
- Pr.04-11=10.0% -- bias adjustment
- Pr.04-12=1 -- bias polarity
- Pr.04-13=100% -- pot. freq. gain
- Pr.04-14=0 -- Rev. motion disable in negative bias

**Example 6:**

In this example, a negative bias is used to provide a noise margin. Also a potentiometer frequency gain is used to allow the Maximum Output Frequency to be reached.

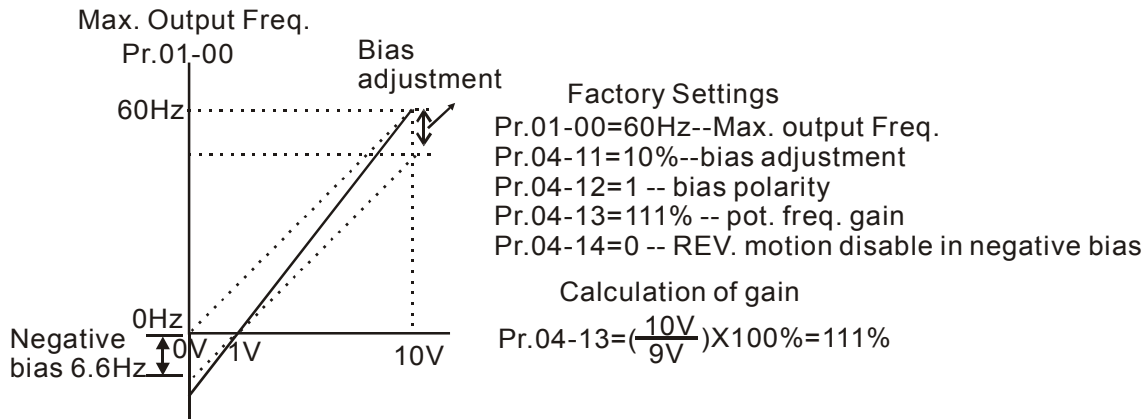

5

**Example 7:**

In this example, the potentiometer is programmed to run a motor in both forward and reverse direction. A motor will be idle when the potentiometer position is at mid-point of its scale. Using this example will disable the external FWD and REV controls.

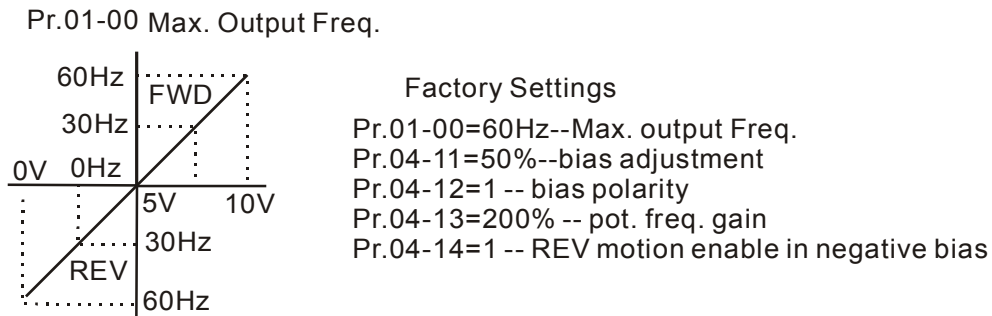

**Example 8:**

In this example, the option of anti-slope is shown. Anti-slope is used in an application where control of pressure, temperature, or flow is needed. Under a high pressure or flow situation, a sensor will generate a large signal such as 20 mA or 10V. With anti-slope enable, the large signal will slow or stop the AC drive. The limit in this application is can't change the direction of run. For AC drive, it just can run in reverse direction.

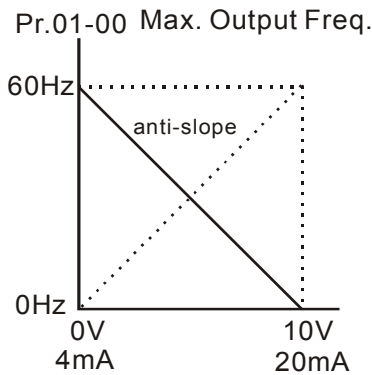

**Factory Settings**  
 Pr.01-00=60Hz--Max. output Freq.  
 Pr.04-11=100%--bias adjustment  
 Pr.04-12=1 -- bias polarity  
 Pr.04-13=100% -- pot. freq. gain  
 Pr.04-14=1 -- REV. motion enable in negative bias

<b>04 - 04</b>	Multi-function Input Terminal (MI1)	Factory Setting: 01
<b>04 - 05</b>	Multi-function Input Terminal (MI2)	Factory Setting: 02
<b>04 - 06</b>	Multi-function Input Terminal (MI3)	Factory Setting: 03
<b>04 - 07</b>	Multi-function Input Terminal (MI4)	Factory Setting: 04
<b>04 - 08</b>	Multi-function Input Terminal (MI5)	Factory Setting: 05
<b>04 - 09</b>	Multi-function Input Terminal (MI6)	Factory Setting: 06

Settings 00 to 36

Settings

Parameters & Functions Table:

Value	Functions	Descriptions
00	No Function	The purpose of this setting is to provide isolation for unused Multi-Function Input Terminals. Any unused terminals should be programmed to 0 to insure they have no effect on drive operation.
01	Multi-Step Speed Command 1	Parameter values 1, 2, 3, 4 program any four of the following Multi-Function Input Terminals for multi-step speed command function. These four inputs select the multi-step speeds defined by Pr.05-00 to Pr.05-14 as shown in the following diagram. Note: Pr.05-00 to Pr.05-14 can also control output speed by programming the AC drive's internal PLC function. There are 17 step speed frequencies (including Master Frequency and Jog Frequency) to select for application.
02	Multi-Step Speed Command 2	
03	Multi-Step Speed Command 3	
04	Multi-Step Speed Command 4	
05	External Reset (NO)**	Parameter value 5 programs a Multi-Function Input Terminal to be an External Reset. Note: the External Reset has the same function as the Reset key on the Digital keypad. After fault such as O.H., O.C. and O.V. are clear, this input can be used to reset the drive.

Value	Functions	Descriptions
06	Accel/Decel Inhibit	Parameter value 6 programs Multi-Function Input Terminal: for Accel/Decel Inhibit. When the command is active, acceleration and deceleration is stopped and the AC drive maintains a constant speed.
07	Accel/Decel Time Selection Command 1	Parameter value 7, 8 programs any two of Multi-Function Input Terminals to select the one of four Accel/Decel Time. (Pr.01-09 to Pr.01-12, Pr.01-18 to Pr.01-21)
08	Accel/Decel Time Selection Command 2	
09	External Base Block (NO)**	Parameter values 9, 10 program Multi-Function Input Terminals for external Base Block control. Value 9 is for normally open (N.O.) input, and value d10 is for a normally close (N.C.) input. <b>Note:</b>
10	External Base Block (NC)***	When a Base-Block signal is received, the AC drive will stop all output and the motor will free run. When base block control is deactivated, the AC drive will start its speed search function and synchronize with the motor speed, and then accelerate to Master Frequency.
11	Increase Master Frequency	Parameter values 11, 12 program the Multi-Function Input Terminals to incrementally increase/ decrease the Master Frequency each time an input is received. Please refer to Pr.02-08, 02-09.
12	Decrease Master Frequency	
13	Counter Reset	Parameter value 13 programs Multi Function Input Terminal to reset the counter.
14	Run PLC Program	Parameter value 14 programs Multi-Function Input Terminal to enable the AC drive internal PLC program. Parameter value d15 programs an input terminal to pause the PLC program. Note: Pr.05-00 to Pr.05-16 defines the PLC program.
15	Pause PLC Program	
16	Auxiliary Motor No.1 output failure	Parameter value 16 to 18 program Multi-Function Input Terminal to disable the corresponding relay of the AC drive multi-function output terminals, Pr.03-00 to 3-03 (MO1 to MO3).
17	Auxiliary Motor No.2 output failure	
18	Auxiliary Motor No.3 output failure	
19	Emergency Stop (NO)**	Parameter value 19 to 20 program Multi-Function Input Terminal to the AC drive to receive the signals of malfunction and emergency stop. Please press "RESET" after fault has been cleared.
20	Emergency Stop (NC)***	

Value	Functions	Descriptions
*21	Master Frequency Selection AVI /ACI	Pr.02-00 will automatically be disabled once this parameter value 21 is enabled; the situation will be determined by the terminals. If the terminal is open, it is AVI; if closed, it is ACI otherwise.
*22	Master Frequency Selection AVI/AUI	Pr.02-00 will automatically be disabled once this parameter value 22 is enabled; the situation will be determined by the terminals. If the terminal is open, it is AVI; if closed, it is AUI otherwise.
23	Operation Command Selection keypad/external	Pr.02-01 will automatically be disabled once this parameter value 21 is enabled; the situation will be determined by the terminals. If the terminal is open, it is via keypad; if closed, it is via the external terminals otherwise.
24	Auto accel/decel mode disable	If enables, the auto accel/decel mode set by Pr.01-15 will be disabled
25	Forced Stop (NC)***	These two parameters function is the same as the "STOP" command. It won't display any error message. Once parameter value 25 or 26 occurs, you need to press "RUN" to run AC drive.
26	Forced Stop (NO)**	
27	Parameter lock enable	When this setting is enabled, all parameters will be locked, Read/write parameters is disabled.
28	PID function disabled	When this setting is enabled, PID function will be disabled.
29	Jog Fwd/Rev command	It will be effective only when external terminal JOG is active.
30	External Reset (NC)***	The function is the same as setting 05 but it uses in normal close.
31	Source of second frequency command enabled	These two functions are used to select the first/second frequency/operation command source.
32	Source of second operation command enabled	
33	One shot PLC	The function is the same as setting 14 but the trigger signal is a one shot pulse, for example: a push button input. It can be cancel by "STOP" command.
34	Proximity sensor input for simple Index function	This function should be used with Pr.04-23 ~ Pr.04-25.

Value	Functions	Descriptions
35	Output Shutoff Stop (NO)**	AC drive will stop output and the motor free run if one of these settings is enabled. If the state of terminal is changed, AC drive will restart from 0Hz.
36	Output Shutoff Stop (NC)***	

\* Setting 21, 22: you just can set one of them at one time.

\*\* NO: Normal Open input.

\*\*\* NC: Normal Close input.

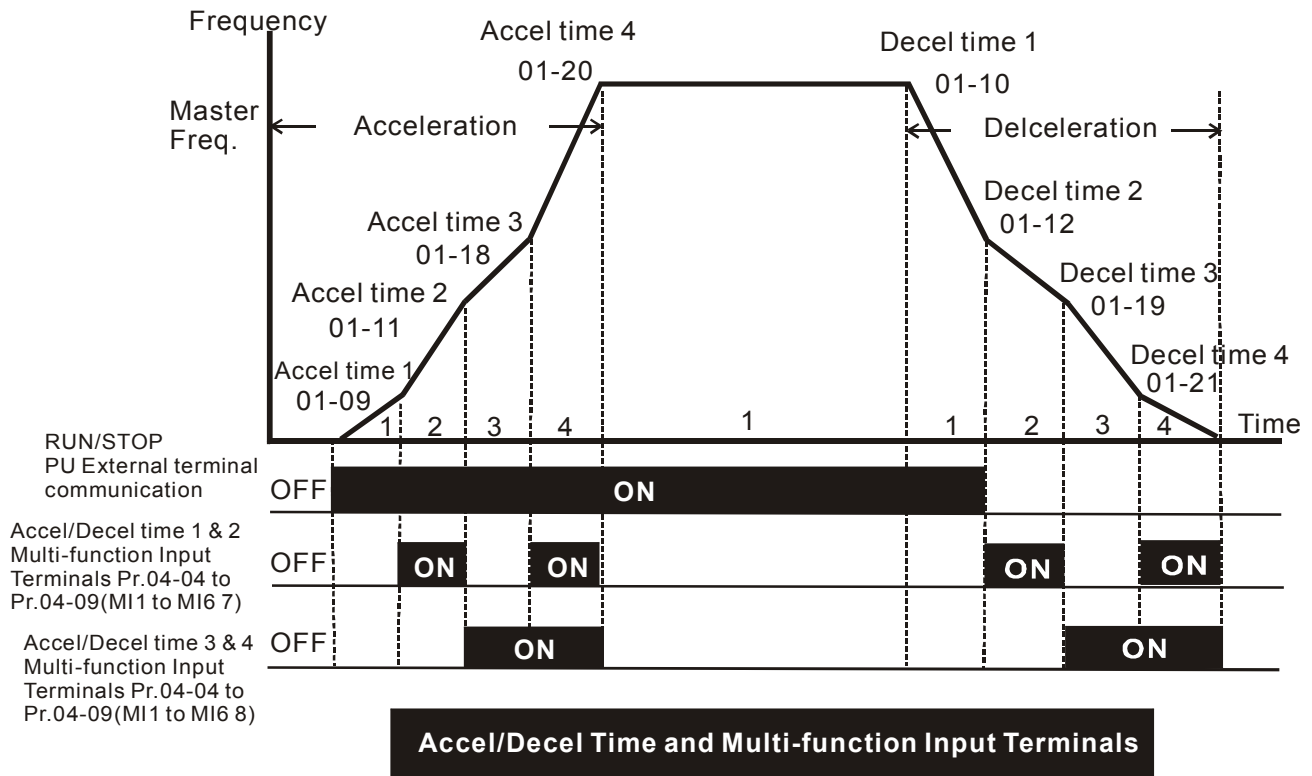



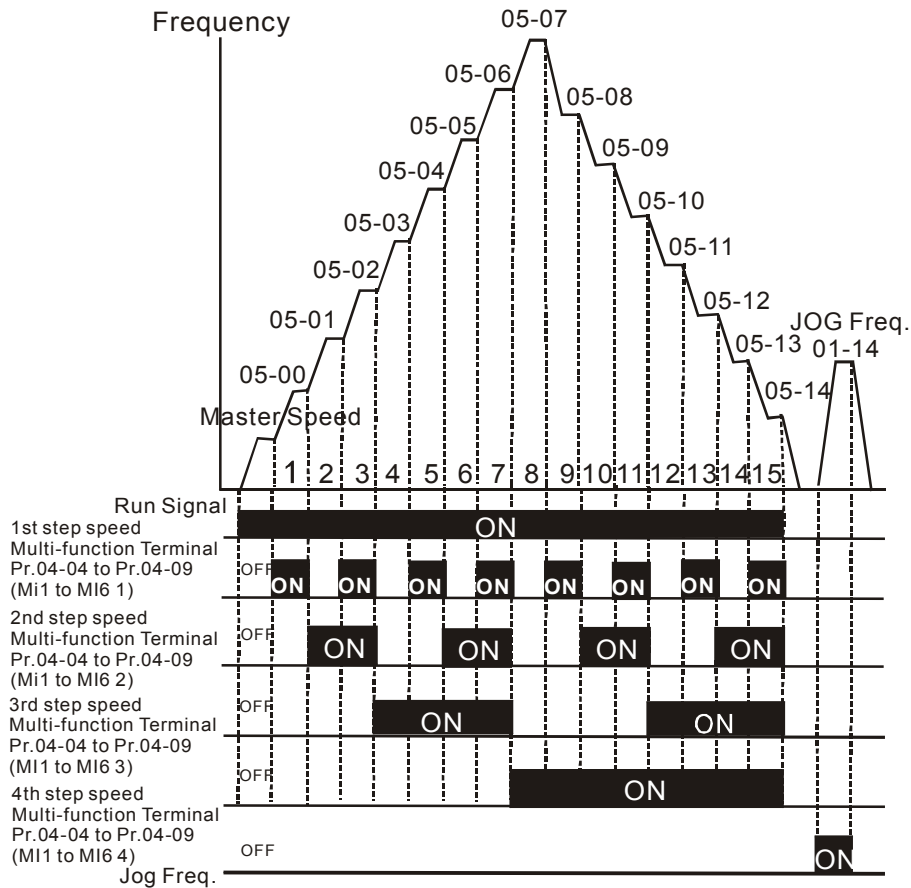

**Multi-Step Speed via External Terminals**

**04 - 10** Digital Terminal Input Debouncing Time Factory Setting: 1

Settings 1 to 20m sec Unit: 1

This parameter is to delay and to check the signals from digital input terminals. 1 unit is 2 msec, 2 units are 4 msec, etc. The delay time is to check if there is any noise that causes the digital terminal malfunction.

**04 - 19** AVI Analog Input Delay Factory Setting: 0.05

Settings 0.00 to 10.00 Sec Unit: 0.01

**04 - 20** ACI Analog Input Delay Factory Setting: 0.05

Settings 0.00 to 10.00 Sec Unit: 0.01

**04 - 21** AUI Analog Input Delay Factory Setting: 0.05

Settings 0.00 to 10.00 Sec Unit: 0.01

**04 - 22** Analog Input Frequency Resolution Factory Setting: 01

Settings 00 0.01Hz  
01 0.1Hz

<b>04 - 23</b>	Gear Ratio for Simple Index Function	Factory Setting: 200
	Settings 4 ~ 1000	Unit: 1
<b>04 - 24</b>	Index Angle for Simple Index Function	Factory Setting: 180.0
	Settings 0.0 ~360.0°	Unit: 0.1
<b>04 - 25</b>	Deceleration Time for Simple Index Function	Factory Setting: 0.00
	Settings 0.00 ~100.00 sec	Unit: 0.01

 The simple index function is to position the machine at the same position when it stops. The function should be used with the function 34 of Multi-Function Input Terminals.

 The system diagram is shown below. The machine is driven by the gear motor or other reduction gear. The trigger position of sensor is used as the original point of index angle. When the stop command is accepted, the AC drive will not decelerate until the sensor is triggered, then the AC drive begin to decelerate and stop according to the Pr.04-24 and Pr.04-25.

5

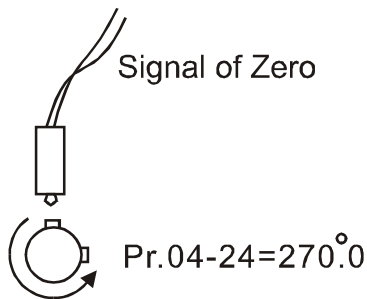
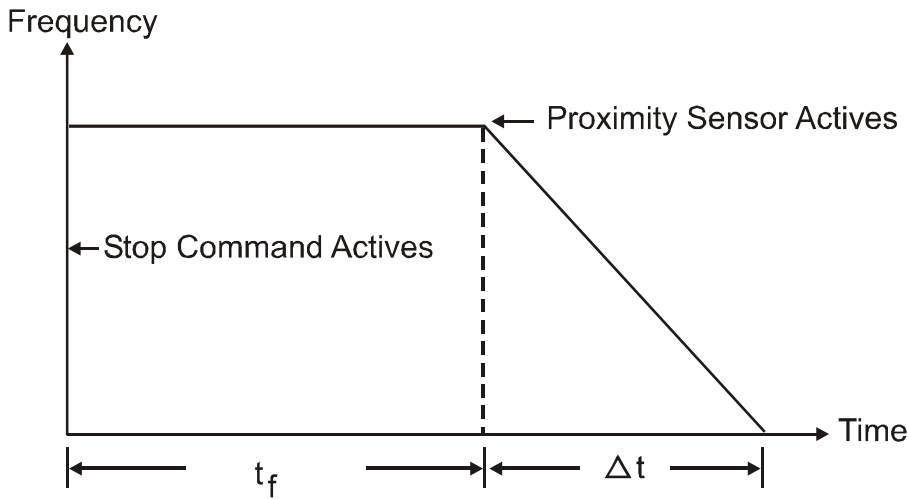

$t_f$  is uncertainty, it is the time from the stop command ON to the proximity sensor triggered.  
 $\Delta t = \text{Pr. 04-25}$

## Group 5: Multi-step Speed and PLC (Process Logic Control) Parameters

<b>05 - 00</b>	1st Step Speed Frequency	↗	Factory Setting: 0.00
<b>05 - 01</b>	2nd Step Speed Frequency	↗	Factory Setting: 0.00
<b>05 - 02</b>	3rd Step Speed Frequency	↗	Factory Setting: 0.00
<b>05 - 03</b>	4th Step Speed Frequency	↗	Factory Setting: 0.00
<b>05 - 04</b>	5th Step Speed Frequency	↗	Factory Setting: 0.00
<b>05 - 05</b>	6th Step Speed Frequency	↗	Factory Setting: 0.00
<b>05 - 06</b>	7th Step Speed Frequency	↗	Factory Setting: 0.00
<b>05 - 07</b>	8th Step Speed Frequency	↗	Factory Setting: 0.00
<b>05 - 08</b>	9th Step Speed Frequency	↗	Factory Setting: 0.00
<b>05 - 09</b>	10th Step Speed Frequency	↗	Factory Setting: 0.00
<b>05 - 10</b>	11th Step Speed Frequency	↗	Factory Setting: 0.00
<b>05 - 11</b>	12th Step Speed Frequency	↗	Factory Setting: 0.00
<b>05 - 12</b>	13th Step Speed Frequency	↗	Factory Setting: 0.00
<b>05 - 13</b>	14th Step Speed Frequency	↗	Factory Setting: 0.00
<b>05 - 14</b>	15th Step Speed Frequency	↗	Factory Setting: 0.00

Settings 0.00 to 400.00 Hz

Unit: 0.01Hz

 The Multi-Function Input Terminals (refer to Pr.04-04 to 04-09) are used to select one of the AC drive Multi-Step speeds. The speeds (frequencies) are determined by Pr.05-00 to 05-14 shown above. Also can be accompanied with Pr.05-15 to 05-31 for PLC programs.

<b>05 - 15</b>	PLC Mode	Factory Setting: 00
----------------	----------	---------------------

- Settings
- 00 Disable PLC operation
  - 01 Execute one program cycle
  - 02 Continuously execute program cycles
  - 03 Execute one program cycle step by step
  - 04 Continuously execute program cycles step by step

 This parameter selects the mode of PLC operation for the AC drive. The AC drive will change speeds and directions according to the user's desired programming.

**Example 1 (Pr.05-15 = 1):** Execute one cycle of the PLC program. Its relative parameter settings are:

- Pr.05-00 to 05-14: 1<sup>st</sup> to 15<sup>th</sup> step speed (sets the frequency of each step speed)
- Pr.04-04 to 04-09: Multi-Function Input Terminals (set one multi-function terminal as 14 - PLC auto-operation).
- Pr.03-00 to 03-03: Multi-Function Output Terminals (set a Multi-Function Terminal as 10-PLC running indication, 11-PLC step completed or 12-PLC program completed).
- Pr.05-16: Direction of operation for the 1<sup>st</sup> to 15<sup>th</sup> step speed.
- Pr.05-17 to 05-31: Operation time setting of the 1<sup>st</sup> to 15<sup>th</sup> step speed.

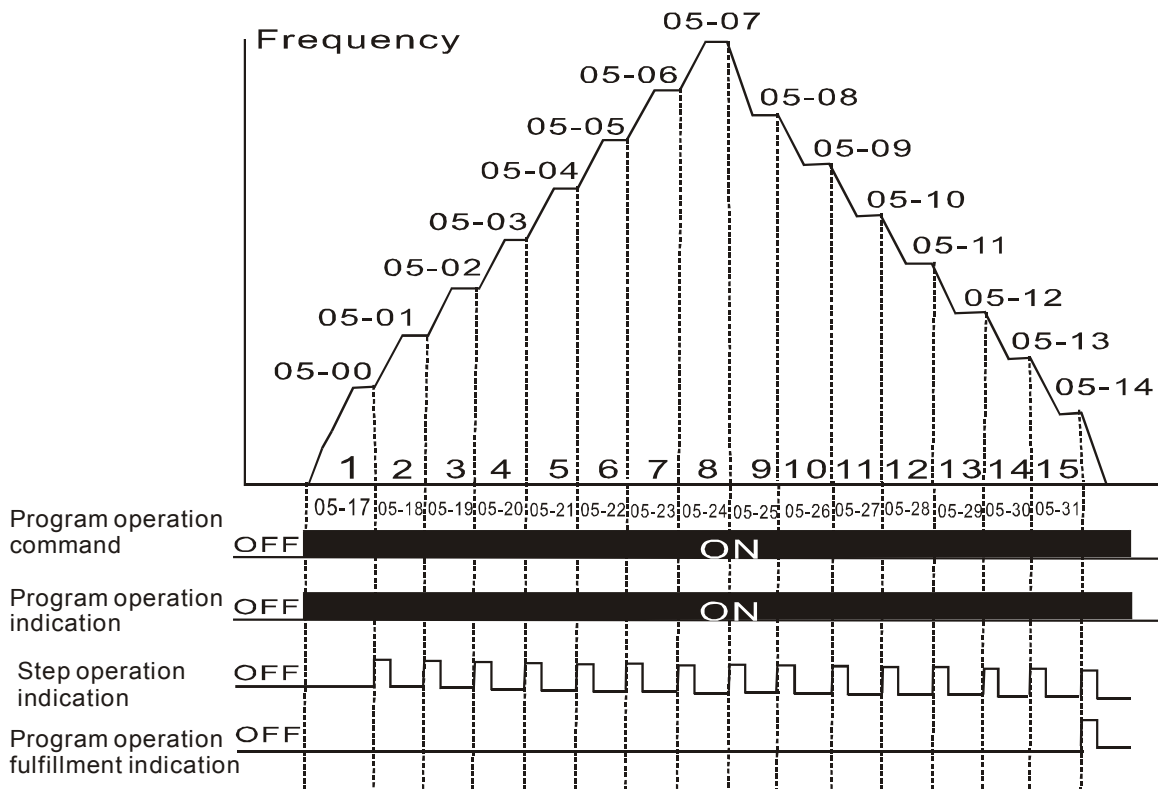

Note: The above diagram shows one complete PLC cycle. To restart the cycle, turn the PLC program off and on again.

**Example 2 (Pr.05-15 = 2): Continuously executes program cycles:**

The diagram above shows the PLC program stepping through each speed. Set Pr.05-15 to 2 continuously executes the program. To stop the PLC program, one must either pause the program or turn it off. (Refer to Pr.04-04 to 04-09 values 14 and 15).

**Example 3 (Pr.05-15 = 3) Execute one cycle step by step:**

The example below shows how the PLC can perform one cycle at a time, within in a complete cycle. Each step will use the accel/decel times in Pr.01-09 to Pr.01-12. It should be noticed that the time each step spends at its intended frequency is diminished, due to the time spent during accel/decel.

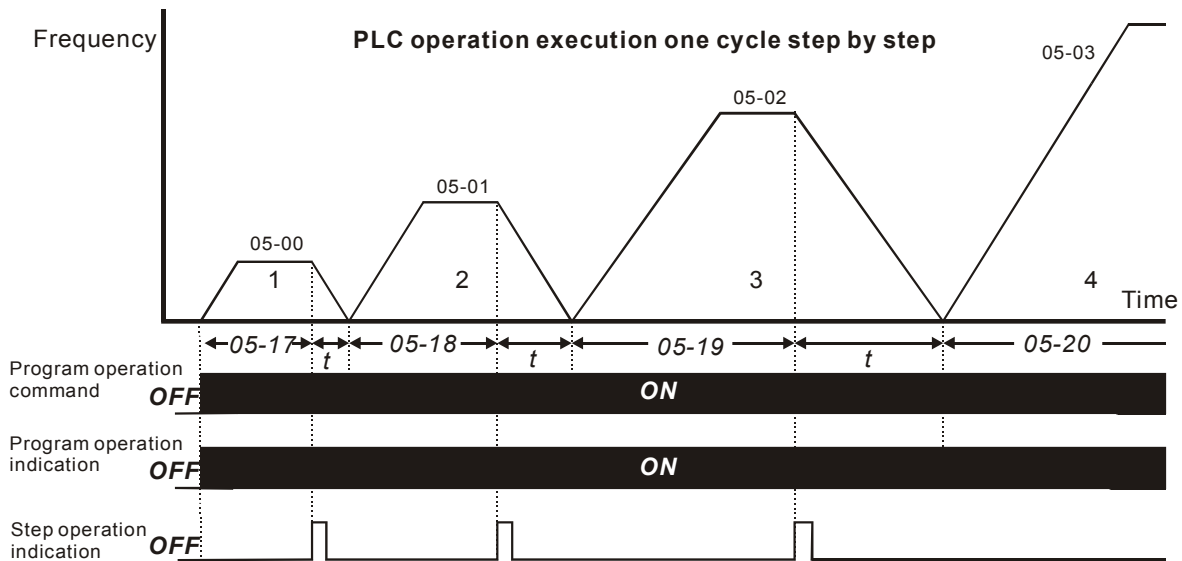

**05 - 16** PLC Forward/Reverse Motion

Factory Setting: 00

Settings 00 to 32767

This parameter controls the direction of motion for the Multi-Step Speeds Pr.05-00 to Pr.05-14 during PLC mode. All other direction commands are invalid during the PLC mode.

Note:

The equivalent 15-bit number is used to program the forward/reverse motion for each of the 15 speed steps. The binary notation for the 15-bit number must be translated into decimal notation and then entered.

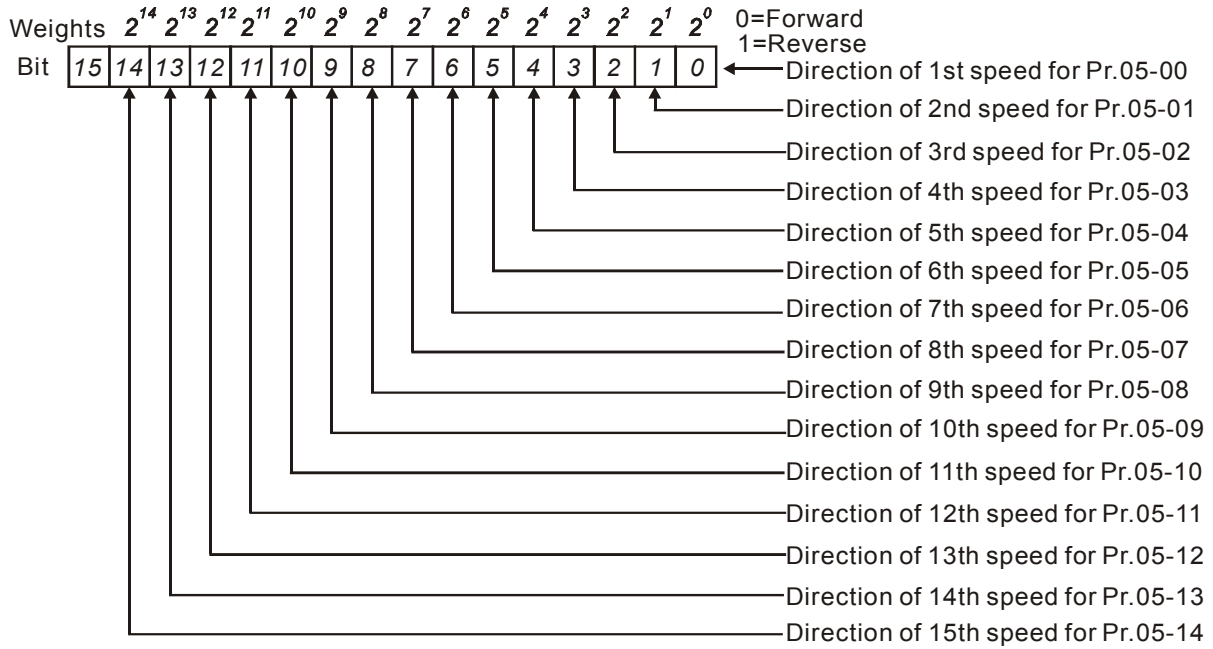

5

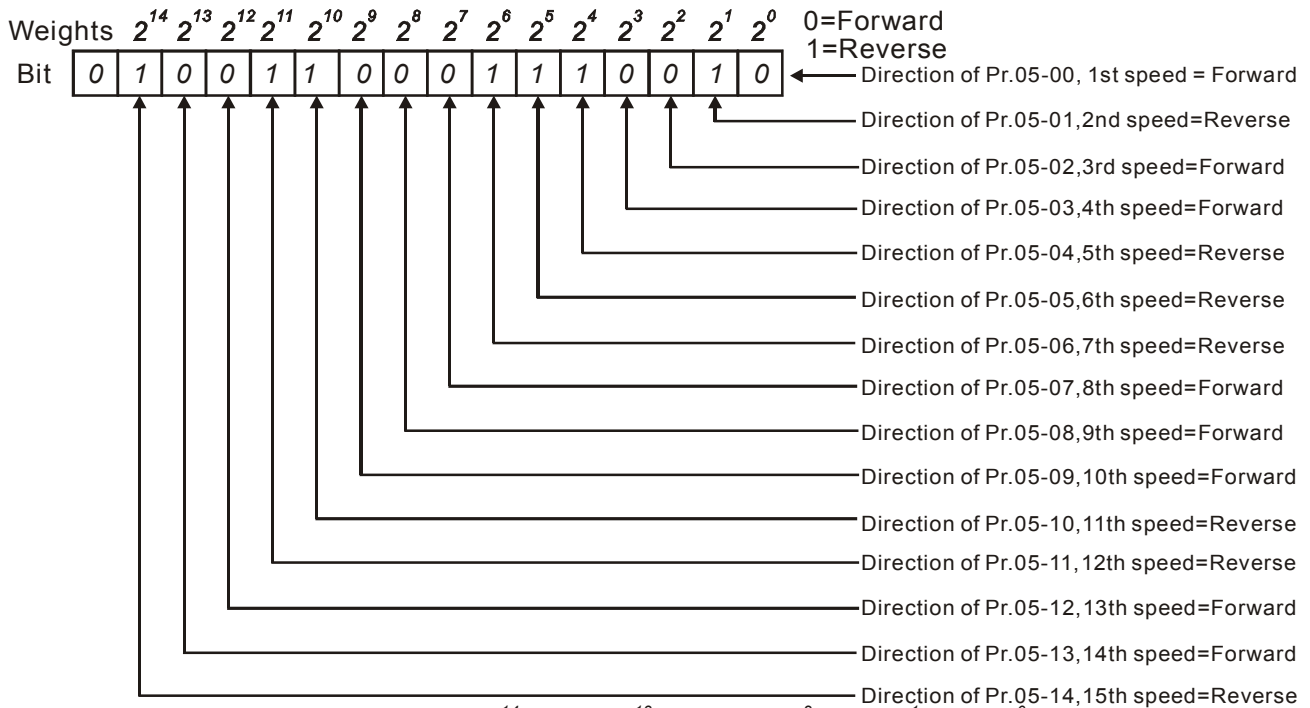

The setting value =  $bit_{14} \times 2^{14} + bit_{13} \times 2^{13} + \dots + bit_2 \times 2^2 + bit_1 \times 2^1 + bit_0 \times 2^0$   
 $= 1 \times 2^{14} + 1 \times 2^{11} + 1 \times 2^{10} + 1 \times 2^6 + 1 \times 2^5 + 1 \times 2^4 + 1 \times 2^1$   
 $= 16384 + 2048 + 1024 + 64 + 32 + 16 + 2$   
 $= 19570$   
 Setting 05-16 = 19570

NOTE:				
$2^{14} = 16384$	$2^{13} = 8192$	$2^{12} = 4096$	$2^{11} = 2048$	$2^{10} = 1024$
$2^9 = 512$	$2^8 = 256$	$2^7 = 128$	$2^6 = 64$	$2^5 = 32$
$2^4 = 16$	$2^3 = 8$	$2^2 = 4$	$2^1 = 2$	$2^0 = 1$

<b>05 - 17</b>	Time Duration of 1st Step Speed	Factory Setting: 0.0
<b>05 - 18</b>	Time Duration of 2nd Step Speed	Factory Setting: 0.0
<b>05 - 19</b>	Time Duration of 3rd Step Speed	Factory Setting: 0.0
<b>05 - 10</b>	Time Duration of 4th Step Speed	Factory Setting: 0.0
<b>05 - 21</b>	Time Duration of 5th Step Speed	Factory Setting: 0.0
<b>05 - 22</b>	Time Duration of 6th Step Speed	Factory Setting: 0.0
<b>05 - 23</b>	Time Duration of 7th Step Speed	Factory Setting: 0.0
<b>05 - 24</b>	Time Duration of 8th Step Speed	Factory Setting: 0.0
<b>05 - 25</b>	Time Duration of 9th Step Speed	Factory Setting: 0.0
<b>05 - 26</b>	Time Duration of 10th Step Speed	Factory Setting: 0.0
<b>05 - 27</b>	Time Duration of 11th Step Speed	Factory Setting: 0.0
<b>05 - 28</b>	Time Duration of 12th Step Speed	Factory Setting: 0.0
<b>05 - 29</b>	Time Duration of 13th Step Speed	Factory Setting: 0.0
<b>05 - 30</b>	Time Duration of 14th Step Speed	Factory Setting: 0.0
<b>05 - 31</b>	Time Duration of 15th Step Speed	Factory Setting: 0.0

Settings      0.0 to 65500      Unit: 1 /0.1sec

 Pr.05-17 to Pr.05-31 correspond to operation time of each step speed defined by Pr.05-00 to Pr.05-14. The maximum setting 65500 seconds will be displayed as t6550. If it is displayed t6550. that means 6550 seconds.

Note: If a parameter is set to “00” (0 sec), the corresponding step will be skipped. This is commonly used to reduce the number of program steps

<b>05 - 32</b>	Time Unit Settings	Factory Setting: 00
	Settings      00    1 Sec	
	01    0.1 Sec	

 This parameter determines the time unit for Pr.05-17~Pr.05-31.

<b>05 - 33</b>	Skip Frequency Width	Factory Setting: 0.00
	Settings      0.00~400.00 Hz	

<b>05 - 34</b>	Bias Frequency Width	Factory Setting: 0.00
	Settings      0.00~400.00 Hz	

 Frequency of  $\Delta$  top point  $F_{up}$  = master frequency  $F$  + Pr.05-33 + Pr.05-34.

 Frequency of  $\Delta$  down point  $F_{down}$  = master frequency  $F$  – Pr.05-33 – Pr.05-34.

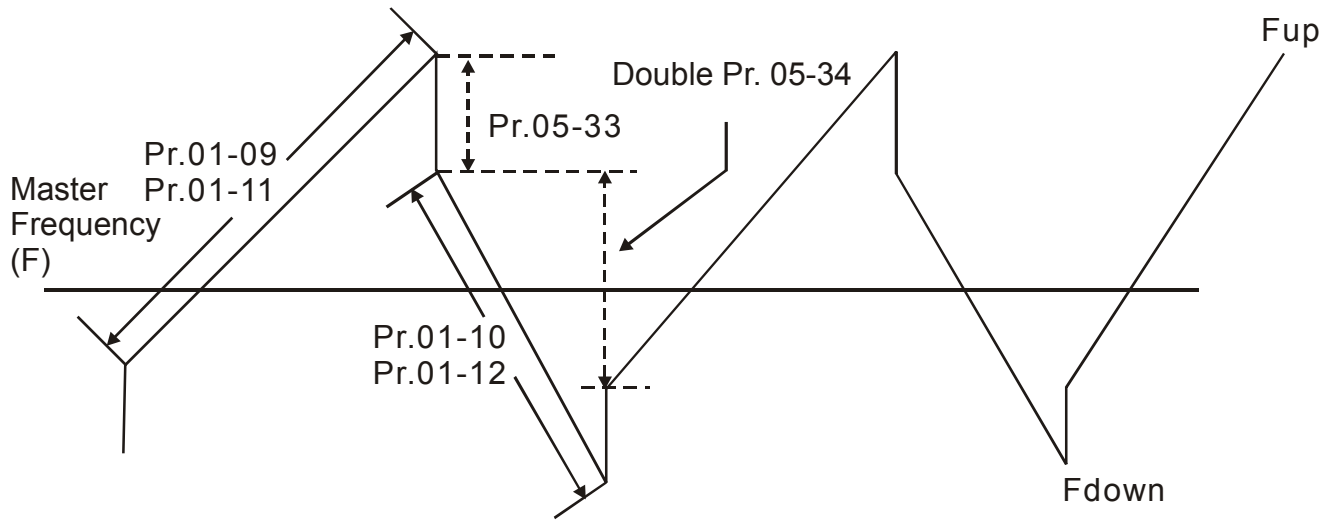



**Group 6: Protection Parameters**

**06 - 00** Over-Voltage Stall Prevention

Factory Setting: 390V

Settings 00 Disable Over-Voltage Stall Prevention  
 230V series: 330 ~ 410V  
 460V series: 660 ~ 820V

During deceleration, the DC bus voltage may exceed its Maximum Allowable Value due to motor regeneration. When this function is enabled, the AC drive will not decelerate and keep the output frequency until the voltage drops below the preset value.

Note:

With moderate inertial load, the over-voltage stall prevention will not occur and the real deceleration time should be equal to the setting of deceleration time. The AC drive will automatically extend the deceleration time with high inertial loads. If deceleration time is critical for the application, then dynamic braking resistor should be used.

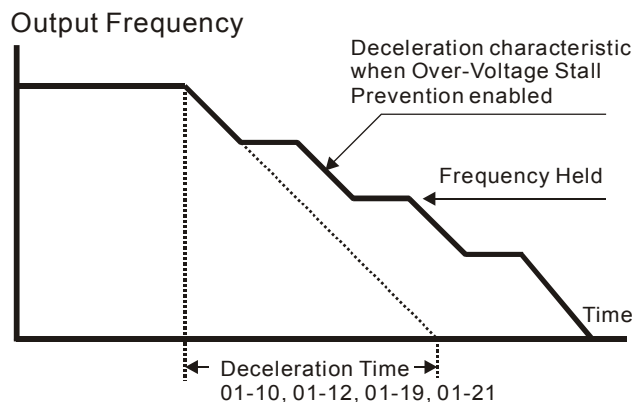

**06 - 01** Over-Current Stall Prevention during Acceleration

Factory Setting: 170

Settings 20 to 250%

Unit: 1%

A setting of 100% is equal to the Rated Output Current of the drive.

During acceleration, the AC drive output current may increase abruptly and exceed the value specified by Pr.06-01 due to rapid acceleration or excessive load on the motor. When this function is enabled, the AC drive will stop accelerating and keep the output frequency until the current drops below the maximum value.

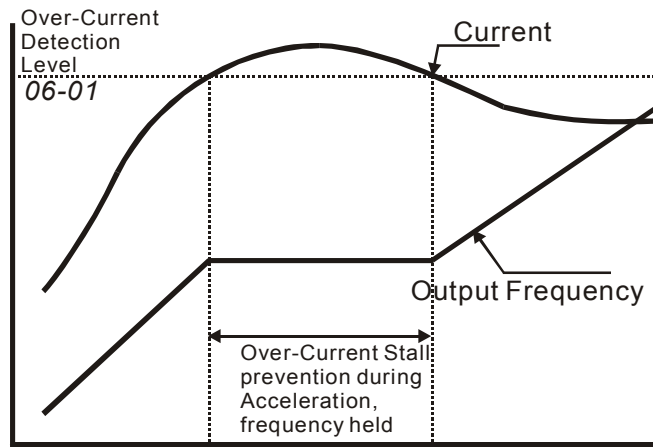

**Over-Current Stall Prevention during Acceleration**

5

**06 - 02** Over-current Stall Prevention during Operation Factory Setting: 170

Settings 20 to 250% Unit: 1%

If the output current exceeds the setting specified in Pr.06-02 (the over-current stall prevention current level during operation) when the drive is operating, the drive will decrease its output frequency to prevent the motor stall. If the output current is lower than the setting specified in Pr.06-02, the drive will then accelerate to catch up with the frequency specified.

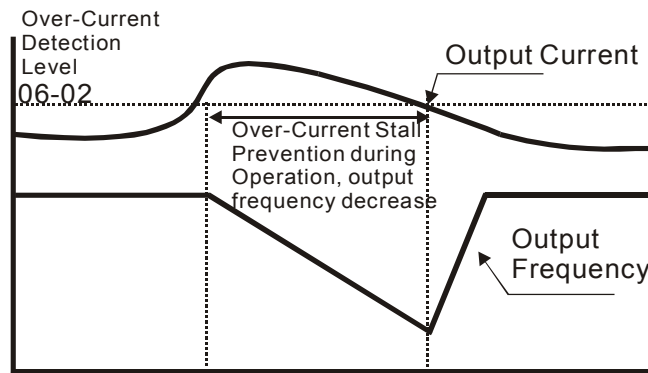

**Over-Current Stall Prevention during Operation**

<b>06 - 03</b>	<b>Over-Torque Detection Mode (OL2)</b>	Factory Setting: 00
----------------	---	---------------------

- |          |    |  |
|----------|----|--|
| Settings | 00 | Over-Torque detection disabled.  |
|          | 01 | Over-Torque detection enabled during constant speed operation, and keep operation after the over-torque is detected. |
|          | 02 | Over-Torque detection enabled during constant speed operation, and operation halted after over-torque detection.     |
|          | 03 | Over-Torque detection enabled during acceleration, and keep operation after the over-torque is detected.             |
|          | 04 | Over-Torque detection enabled during acceleration, and operation halted after over-torque detection                  |

 This parameter determines the operation mode of the drive after the over-torque is detected with the following method: if the output current exceeds the over-torque detection level (Pr.06-04) and which also exceeds the setting of Pr.06-05 Over-Torque Detection Time, with the [Multi-Functional Output Terminal] specified as an indication for the over-torque detection, the contact will then be “closed”. Please refer to Pr.03-00~03-03 for detail.

<b>06 - 04</b>	<b>Over-Torque Detection Level</b>	Factory Setting: 150
----------------	------------------------------------	----------------------

Settings	10 to 200%	Unit: 1%
----------	------------	----------

 This setting is proportional to the Rated Output Current of the drive.

<b>06 - 05</b>	<b>Over-Torque Detection Time</b>	Factory Setting: 0.1
----------------	-----------------------------------	----------------------

Settings	0.1 to 60.0Sec	Unit: 0.1sec
----------	----------------	--------------

 This parameter determines the time for over-torque detection.

<b>06 - 06</b>	<b>Electronic Thermal Overload Relay Selection</b>	Factory Setting: 00
----------------	--	---------------------

- |          |    |   |
|----------|----|---|
| Settings | 00 | Operate with a Standard Motor (coaxial heat dissipation)    |
|          | 01 | Operate with a Special Motor (independent heat dissipation) |
|          | 02 | Operation disabled  |

 This function is used to protect the motor from overload or overheat.

<b>06 - 07</b>	<b>Electronic Thermal Characteristic</b>		Factory Setting: 60
----------------	--	---	---------------------

Settings	30 to d 600 Sec	Unit: 1 Sec
----------	-----------------	-------------

 The parameter determines the time required activating the I<sup>2</sup>t electronic thermal protection function. The graph below shows I<sup>2</sup>t curves for 150% output power for 1 minute.

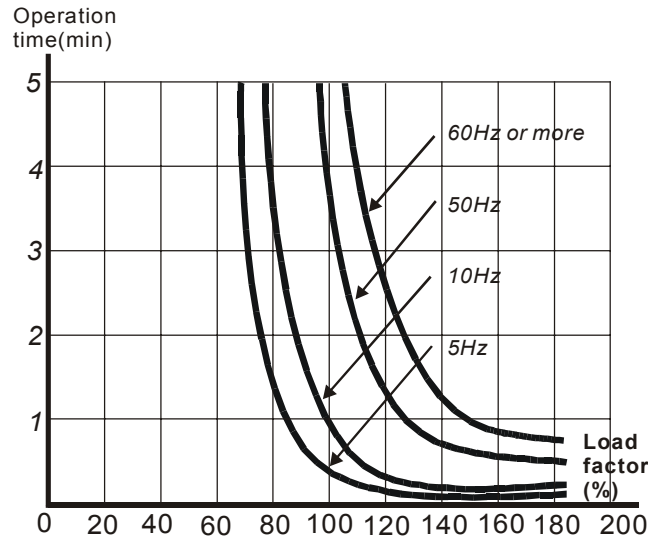

<b>06 - 08</b>	Present Fault Record	Factory Setting: 00
<b>06 - 09</b>	Second Most Recent Fault Record	Factory Setting: 00
<b>06 - 10</b>	Third Most Recent Fault Record	Factory Setting: 00
<b>06 - 11</b>	Fourth Recent Fault Record	Factory Setting: 00

- |          |    |   |
|----------|----|---|
| Settings | 00 | No fault occurred   |
|          | 01 | Over-current (oc)   |
|          | 02 | Over-voltage (ov)   |
|          | 03 | Overheat (oH)   |
|          | 04 | Overload (oL)   |
|          | 05 | Overload1 (oL1)   |
|          | 06 | External fault (EF)   |
|          | 07 | IGBT protection (occ)   |
|          | 08 | CPU failure (CF3)   |
|          | 09 | Hardware protection failure (HPF)   |
|          | 10 | Current exceeds 2 times rated current during accel.(ocA)                  |
|          | 11 | Current exceeds 2 times rated current during decel.(ocd)                  |
|          | 12 | Current exceeds 2 times rated current during steady state operation (ocn) |
|          | 13 | Ground fault (GFF)  |
|          | 14 | Low voltage (Lv)  |
|          | 15 | CPU READ failure (CF1)  |
|          | 16 | CPU WRITE failure (CF2)   |

- 17 External Base block stop (bb)
- 18 Motor over load (oL2)
- 19 Auto accel/decel failure (CFA)
- 20 Software/password protection (code)
- 21 Emergency stop (EF1)
- 22 PHL (Phase-Loss)
- 23 cEF (Preliminary count value attained, EF active)
- 24 Lc (Low-current)
- 25 AnLEr (Analog feedback signal error)
- 26 PGEr (PG feedback signal error)

 Pr.06-08 to Pr.06-11 store records of the four most recent faults that had occurred. Use the reset key to reset the drive when the fault no longer exists.

---

**06 - 12** Low-Current Detection Level Factory Setting: 00

---

Settings    00    Disabled  
                   00 ~ 100%

---

**06 - 13** Low-Current Detection Time Factory Setting: 10.0

---

Settings    0.1~ 3600.0 Sec Unit: 0.1sec

---

**06 - 14** Low-Current Treatment Factory Setting: 00

---

Settings    00    Warn and keep operating  
                   01    Warn and ramp to stop  
                   02    Warn and coast to stop  
                   03    Warn, after coast to stop, restart (delay 06-15 setting time)

---

**06 - 15** Low-Current Detection Restart Delay Time Factory Setting: 10.0

---

Settings    1~600.0 Min. Unit: 1min

 If output current is lower than Pr.06-12 and exceed the time that Pr.06-13 sets during running, AC drive will warn as Pr.06-14 sets. If Pr.06-14 is set to 03, AC drive will restart after the delay time set by Pr.06-15 is up.

---

<b>06 - 16</b>	<b>User-Defined Low-Voltage Detection Level</b>	Factory Setting: 00
Settings	00 Disabled	
	230V series: 220 ~ 300VDC	
	460V series: 440 ~ 600VDC	

---

<b>06 - 17</b>	<b>User-Defined Low-Voltage Detection Time</b>	Factory Setting: 0.5
Settings	0.1~ 3600.0 Sec	Unit: 0.1sec

---







 When the voltage of DC BUS is lower than Pr.06-16 and the time exceeds the setting of Pr.06-17, AC drive will output a signal by the setting 28 of Pr.03-00 ~ Pr.03-03.

---

**06 - 18** Reserved

---

## Group 7: Motor Parameters

<b>07 - 00</b>	<b>Motor Rated Current</b>	↗	Factory Setting: 100
	Settings     30 to 120%		Unit: 1%
	Use the following method to calculate the percentage entered in this parameter. (Motor Rated Current (Ampere)/ AC Drive Rated output current (Pr00-01)) x 100%		
	Pr.07-00 and Pr.07-01 must be set if the drive is programmed to operate in Vector Control mode (Pr.0-09 = 2, 3). It also must be set if the "Electronic Thermal Overload Relay" (Pr.06-06) or "Slip Compensation" functions is selected.		
<b>07 - 01</b>	<b>Motor No-load Current</b>	↗	Factory Setting: 40
	Settings     01 to 90%		Unit: 1%
	The rated current of the AC drive is regarded as 100%. The setting of the Motor no-load current will effect the slip compensation.		
	The setting value must be less than the Pr.07-00 (Motor Rated Current).		
<b>07 - 02</b>	<b>Torque Compensation</b>	↗	Factory Setting: 0.0
	Settings     0.0 to 10.0		Unit: 0.1
	This parameter may be set so that the AC drive will increase its voltage output to obtain a higher torque. Only for V/F control mode.		
<b>07 - 03</b>	<b>Slip Compensation (Used without PG)</b>	↗	Factory Setting: 0.00
	Settings     0.00 to 3.00		Unit: 0.1
	While driving an asynchronous motor, increasing load on the AC drive will cause an increase in slip. This parameter may be used to compensate the slip by increasing the output frequency. When the output current of the AC drive is greater than the motor no-load current (Pr.07-01), the AC drive will adjust its output frequency according to this parameter.		
<b>07 - 04</b>	<b>Number of Motor Poles</b>		Factory Setting: 04
	Settings     02 to 10		Unit: 2
	This parameter sets the number of motor poles (must be an even number).		
<b>07 - 05</b>	<b>Motor Parameters Auto Tuning</b>		Factory Setting: 00
	Settings     00    Disable		Unit: 1
	01    Auto Tuning R1		
	02    Auto Tuning R1 + No-load Test		

 It will auto detect by pressing RUN key after this parameter is set to 01 or 02. When setting to 01, it just auto detect R1 value, and the Pr.07-01 needed to input by manual. When setting to 02, AC drive should be no-load and the value of Pr.07-01 and Pr.07-06 will be filled automatically.

 The steps to AUTO-Tuning are:

1. Make sure that all the parameters are set to factory settings and the wiring connected to motor is correctly.
2. Make sure that motor is no-load before auto-tuning and the axis doesn't connect to any belt or gear motor.
3. Fill in Pr.01-02, Pr.01-01, Pr.07-00, Pr.07-04 and Pr.07-08 with correct value.
4. After Pr.07-05 is set to 1 or 2, the AC drive will execute auto-tuning immediately as soon as it receives the "RUN" command The execution time will be 15 seconds + Pr.01-09 + Pr.01-10. (The more horsepower needs the more Accel/decel time)
5. After executing, please check if there are values filled in Pr.07-01 and Pr.07-06. If not, please press RUN key after setting Pr.07-05.
6. Then, you can set Pr.00-09 to 02/03 and set other parameters according to your requirement.

Note 1: It is not suitable for many motors run with parallel in vector control mode.

Note 2: It is not suitable for using in vector control mode if | horsepower of motor | - | horsepower of AC drive | doesn't exceed the useful range.

<b>07 - 06</b>	<b>Motor Line-to-line Resistance R1</b>	Factory Setting: 00
	Settings      00 to 65535 mΩ	Unit: 01

 The motor auto detection will set this parameter. The user may also set this parameter without using Pr.07-05.

<b>07 - 07</b>	Reserved
----------------	----------



<b>07 - 08</b>	<b>Motor Rated Slip</b>	Factory Setting: 3.00
	Settings      0.00 to 20.00Hz	Unit: 0.01

 Refer to the rated rpm on the nameplate of the motor and use the following equation to determine the rated slip.

$$\text{Rated Slip} = F (\text{Pr.01-01 base frequency}) - (\text{rated rpm} \times \text{motor pole}/120)$$



---

<b>07 - 09</b>	<b>Slip Compensation Limit</b>	Factory Setting: 200
	Settings 00 to 250%	Unit: 1
	This parameter can set the upper limit of the compensation frequency (the percentage of Pr.07-08).	
<b>07 - 10</b>	Reserved	
<b>07 - 11</b>	Reserved	
<b>07 - 12</b>	<b>Torque Compensation Time Constant</b>	Factory Setting: 0.05
	Settings 0.01 ~10.00 Sec	Unit: 0.01
<b>07 - 13</b>	<b>Slip Compensation Time Constant</b>	Factory Setting: 0.10
	Settings 0.05 ~10.00 Sec	Unit: 0.01
	Setting the Pr.07-12 and Pr.07-13 can change the response time for the compensation.	
<b>07 - 14</b>	<b>Accumulative Motor Operation Time (Min.)</b>	Factory Setting: 00
	Settings 00 ~1439	Unit: 01
<b>07 - 15</b>	<b>Accumulative Motor Operation Day</b>	Factory Setting: 00
	Settings 00 ~65535	Unit: 01
	Pr.07-14 and Pr.07-15 are used to record the motor operation time. They can be cleared by setting to 00 and won't record if the time is less than 60 seconds.	

---

## Group 8: Special Parameters

**08 - 00** DC Braking Current Level Factory Setting: 0

Settings 0 to 100% Unit: 1%

This parameter determines the level of DC Braking Current output to the motor during start-up and stopping. When setting DC Braking Current, the Rated Current (Pr.00-01) is regarded as 100%. It is recommended to start with a low DC Braking Current Level and then increase until proper holding torque has been attained.

**08 - 01** DC Braking Time during Start-up Factory Setting: 0.0

Settings 0.0 to 60.0 sec Unit: 0.1sec

This parameter determines the duration that the DC Braking current will be applied to the motor during the AC drive start-up. When the time is up, the AC drive will start acceleration from the Minimum Frequency (Pr.01-05).

**08 - 02** DC Braking Time during Stopping Factory Setting: d 0.0

Settings 0.0 to 60.0 sec Unit: 0.1sec

This parameter determines the duration that the DC Braking current will be applied to the motor during stopping. If stopping with DC Braking is desired, the Pr.02-02 must be set to RAMP stop.

**08 - 03** Start-Point for DC Braking Factory Setting: 0.00

Settings 0.00 to 400.00Hz Unit: 0.01Hz

This parameter determines the frequency that the DC Braking will begin while the output Frequency reached during deceleration.

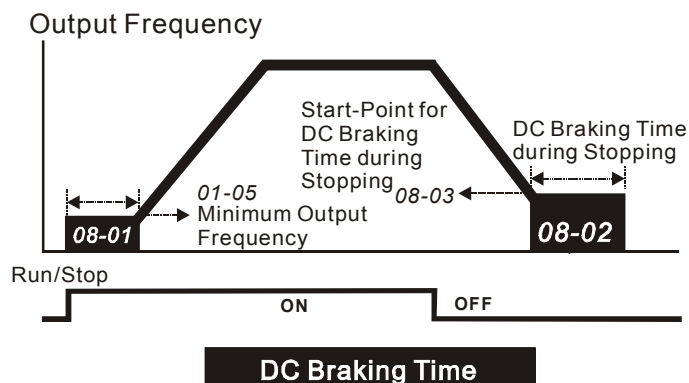

NOTE: 1. DC Braking during Start-up is used for loads that may move before the AC drive starts, such as fans and pumps. Under such circumstances, DC Braking can be executed to hold the load in position before applying a forward motion.

2. DC Braking during stopping is used to shorten stopping time and also to hold a stopped load in position. For high inertial loads, a dynamic braking resistor may also be needed for quick decelerations.

---

**08 - 04** Momentary Power Loss Operation Selection Factory Setting: 00

---

- |          |    |  |
|----------|----|--|
| Settings | 00 | Operation stops after momentary power loss.  |
|          | 01 | Operation continues after momentary power loss, speed search starts with the Master Frequency reference value. |
|          | 02 | Operation continues after momentary power loss, speed search starts with the minimum frequency.                |

 This parameter determines the operation mode when the AC drive restart from a momentary power loss.

---

**08 - 05** Maximum Allowable Power Loss Time Factory Setting: 2.0

---

- |          |                |              |
|----------|----------------|--------------|
| Settings | 0.1 to 5.0 sec | Unit: 0.1sec |
|----------|----------------|--------------|

 If the power loss time is less than this parameter setting, the AC drive will resume operation, or if exceed the Maximum Allowable Power Loss Time, the AC drive output is then turned off.

---

**08 - 06** Baseblock Time for Speed Search (BB) Factory Setting: 0.5

---

- |          |                |              |
|----------|----------------|--------------|
| Settings | 0.1 to 5.0 sec | Unit: 0.1sec |
|----------|----------------|--------------|

 When momentary power loss is detected, the AC drive will stop its output, and then wait for a specified period of time (determined by Pr.08-06, called Base-Block) before resuming the operation. Setting of this parameter should be the residual voltage with a close-to-0V value on the output end before the drive is activated again.

 This parameter could also determine the searching time when performing External Baseblock and Auto Restart after Fault (Pr.08-14).

---

**08 - 07** Current Limit for Speed Search Factory Setting: 150

---

- |          |            |          |
|----------|------------|----------|
| Settings | 30 to 200% | Unit: 1% |
|----------|------------|----------|

 This parameter limit the current output when the Drive operates in speed search mode.

 When executing speed search, V/F curve will base on the setting of Group 01.

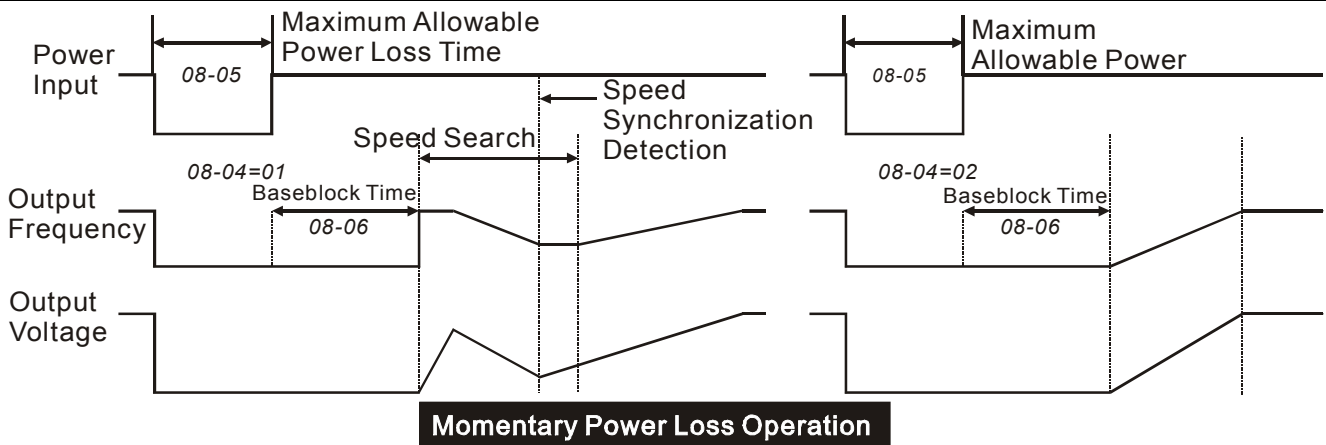

**Momentary Power Loss Operation**

<b>08 - 08</b>	Skip Frequency 1 Upper Bound	Factory Setting: 0.00
<b>08 - 09</b>	Skip Frequency 1 Lower Bound	Factory Setting: 0.00
<b>08 - 10</b>	Skip Frequency 2 Upper Bound	Factory Setting: 0.00
<b>08 - 11</b>	Skip Frequency 2 Lower Bound	Factory Setting: 0.00
<b>08 - 12</b>	Skip Frequency 3 Upper Bound	Factory Setting: 0.00
<b>08 - 13</b>	Skip Frequency 3 Lower Bound	Factory Setting: 0.00

Settings 0.00 to 400.00Hz Unit: 0.01Hz

These parameters select the Skip Frequency. It will cause the AC drive to skip operation at these frequency ranges with continuous frequency output.

Pr.08-09, Pr.08-11, Pr.08-13 are for Lower Bound setting, and the settings should follow as  $Pr.08-09 \geq Pr.08-11 \geq Pr.08-13$ .

<b>08 - 14</b>	Auto Restart After Fault	Factory Setting: 00
----------------	--------------------------	---------------------

Settings 00 to 10 Unit: 1

After fault occurs (allowable faults: over-current OC, over-voltage OV), the AC drive can be reset/restarted automatically up to 10 times. Setting this parameter to 0 will disable the reset/restart operation after any fault has occurred. When enabled, the AC drive will restart with speed search, which starts at the Frequency before fault.

<b>08 - 15</b>	Automatic energy-saving	Factory Setting: 00
----------------	-------------------------	---------------------

Settings 00 Energy-saving operation disabled  
01 Energy-saving operation enabled

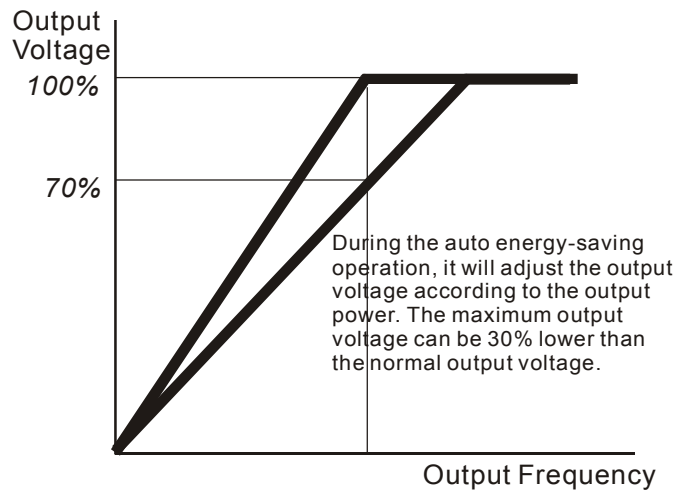

**08 - 16** Automatic Voltage Regulation (AVR)

Factory Setting: 00

- Settings 00 AVR function enabled
- 01 AVR function disabled
- 02 AVR function disabled for deceleration

The rated voltage of motor is usually AC220V/200V, 60Hz/50Hz and the input voltage of AC drive is AC 180V ~ 264V, 50Hz/60Hz. When AC drive runs without AVR function, if input power is AC 250V and the output voltage to motor will also be AC 250V. The voltage exceeds 12% ~ 20% of the rated voltage. When motor runs in the higher voltage, the temperature of motor will be risen, the insulation will be destroyed and the output of torque will be unsteadily. The motor will be short life if using in these situation for a long time.

This function will make the output power stay on the rated voltage of motor when input power exceeds the rated voltage of motor. For example, V/F curve is set to AC 200V/50Hz, input power is AC 200 ~ 264V, the voltage that output to motor will be AC 200V/50Hz and not exceed the setting voltage. If the input power vary between AC 180 ~ 200V, the voltage that output to motor will be the same ratio with input power.

Selecting program value 2 enables the AVR function and will disables the AVR function during deceleration. This offers a quicker deceleration.

**08 - 17** Software Setting of the Braking Level  
(the Action Level of the Braking Resistor)

Unit: 1

- Settings 230V series: 370 to 430V Factory Setting: 380
- 460V series: 740 to 860V Factory Setting: 760

This parameter is the software setting utilized in controlling the braking Resistor; please refer to the DC voltage value on the DC-BUS for reference.

**08 - 18** Base block Speed Search Factory Setting: 00

- Settings 00 Speed search starts with last frequency command
- 01 Starts with minimum output frequency (Pr.01-05)

This parameter determines the AC drive restart method after base block is enabled.

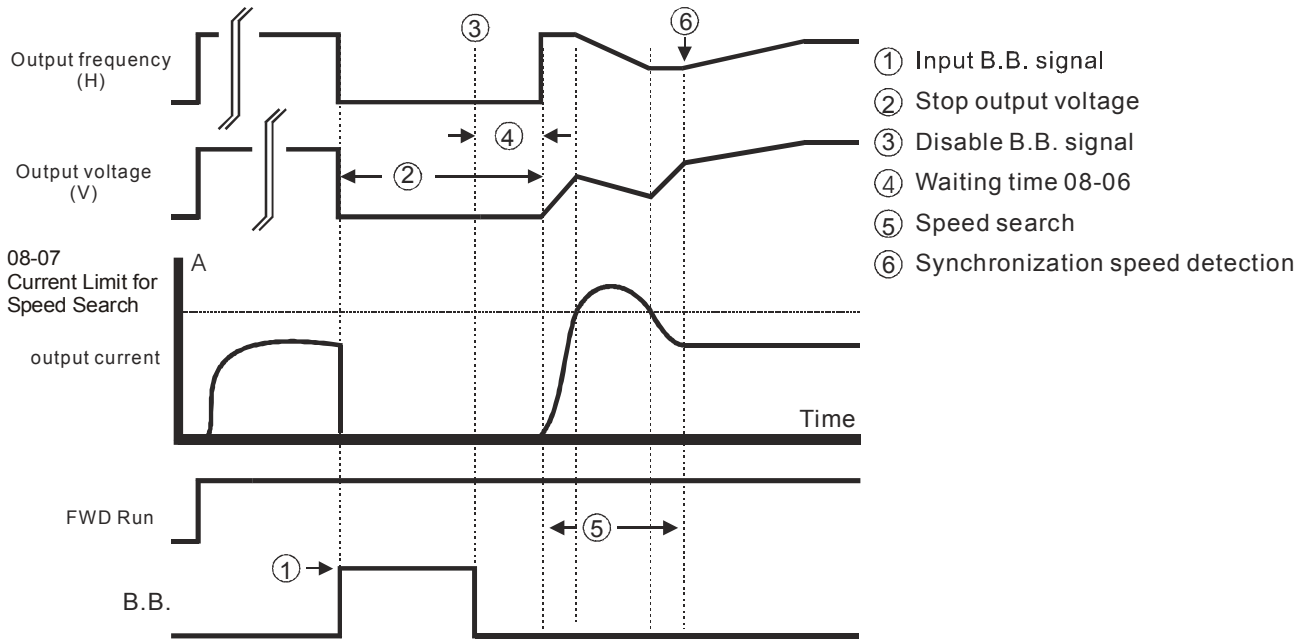

Fig 1: B.B. Speed Search with Last Output Frequency Downward Timing Chart (Speed Search Current Attains Speed Search Level)

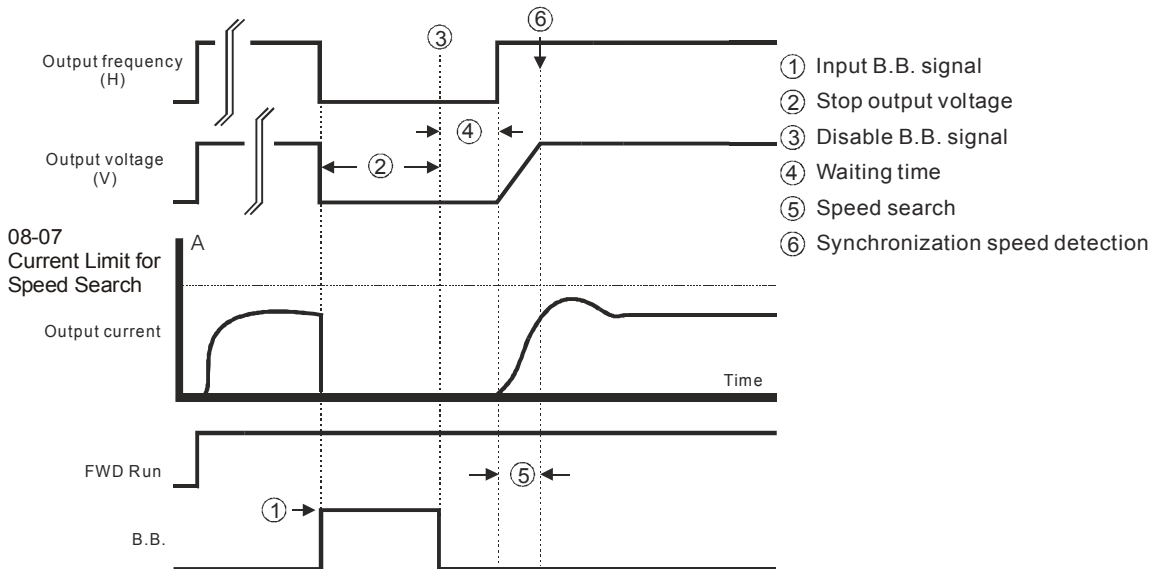

Fig 2: B.B. Speed Search with Last Output Frequency Downward Timing Chart (Speed Search Current doesn't Attain Speed Search Level)

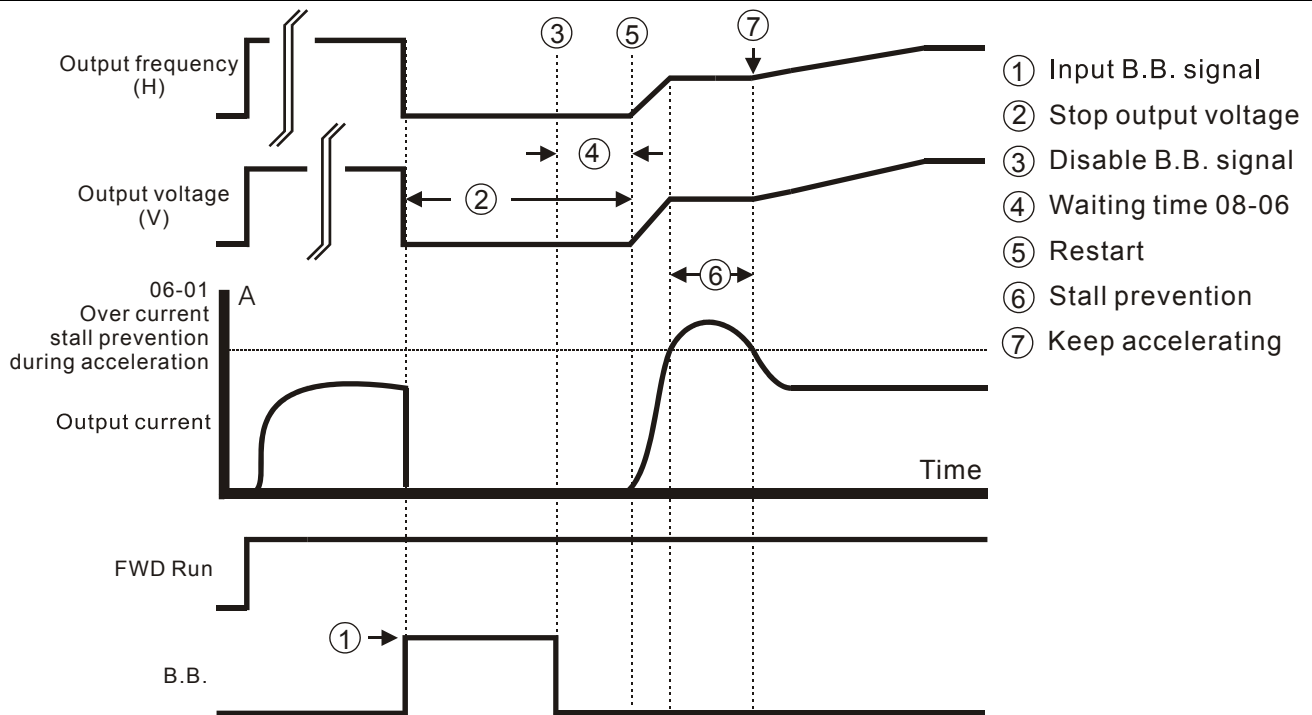

Fig 3: B.B. Speed Search with Minimum Output Frequency Upward Timing Chart (Start-up Current Attains Stall Current Level)

**08 - 19** Speed Search during Start-up

Factory Setting: 00

- Settings 00 Speed search disable
- 01 Speed search enable

This parameter is used for starting and stopping a motor with high inertia. A motor with high inertia will take a long time to stop completely. By setting this parameter, the user does not need to wait for the motor to come to a complete stop before restarting the AC drive. If a PG card and encoder is being used on the drive and motor, then the speed search will start from the speed that is detected and accelerate quickly to the commanded frequency. Pr.08-04 and Pr.08-06 will be disabled when using this parameter with PG feedback control.

Note: Please make sure Pr.07-04, Pr.10-10, and Pr.10-11 are set correctly. An incorrect setting may cause the motor to exceed its speed limit and permanent damage to the motor and machine can occur.

**08 - 20** Speed Search Frequency during Start-up



Factory Setting: 00

- Settings 00 Setting Frequency
- 01 Maximum Operation Frequency (01-00)

This parameter determines the start frequency of speed search frequency.

<b>08 - 21</b>	<b>Auto Reset Time at Restart after Fault</b>	Factory Setting: 600
----------------	---	----------------------

	Settings    00 to 60000 sec	Unit: 1
--	-----------------------------	---------

 This parameter should be used with Pr.08-14. For example: Pr.08-14 is set to 10 and Pr.08-21 is set to 600s (10 min), if there is no fault over 600 seconds from the restart for the previous fault, the auto reset times for restart after fault will be reset to 10.

<b>08 - 22</b>	<b>Compensation Coefficient for Motor Instability</b>	↗	Factory Setting: 00
----------------	---	---	---------------------

	Settings    00~1000	Unit: 1
--	---------------------	---------

 This parameter can improve the motor instability situation.



## Group 9: Communication Parameters

<b>09 - 00</b>	Communication Address	↗	Factory Setting: 01
----------------	-----------------------	---	---------------------

Settings 01 to 254

 If the AC drive is controlled by RS-485 serial communication, the communication address for this drive must be set via this parameter.

<b>09 - 01</b>	Transmission Speed	↗	Factory Setting: 01
----------------	--------------------	---	---------------------

Settings 00 Baud rate 4800 (data transmission speed: bits / second)  
 01 Baud rate 9600 (data transmission speed: bits / second)  
 02 Baud rate 19200 (data transmission speed: bits / second)  
 03 Baud rate 38400 (data transmission speed: bits / second)

 Users can set parameters and control the operation of the AC drive via the RS-485 serial interface of a personal computer. This parameter is used to set the transmission speed between the computer and AC drive.

<b>09 - 02</b>	Transmission Fault Treatment	↗	Factory Setting: 03
----------------	------------------------------	---	---------------------

Settings 00 Warn and keep operating  
 01 Warn and RAMP to stop  
 02 Warn and COAST to stop  
 03 No warning and keep operating

 This parameter is set to detect if an error occurs and take actions.

<b>09 - 03</b>	Time Out Detection	↗	Factory Setting: 0.0
----------------	--------------------	---	----------------------

Settings 0.0 Disable  
 0.0 ~ 60.0 sec Unit: 1

 If Pr09-03 is not equal to zero, Pr09-02=0~2, and there are not any communication on the bus during setting time period (set by Pr. 09-03), "cE10" will be shown on the keypad.

<b>09 - 04</b>	Communication Protocol	↗	Factory Setting: 00
----------------	------------------------	---	---------------------

Settings 00 Modbus ASCII mode, protocol <7,N,2>  
 01 Modbus ASCII mode, protocol <7,E,1>  
 02 Modbus ASCII mode, protocol <7,O,1>  
 03 Modbus RTU mode, protocol <8,N,2>  
 04 Modbus RTU mode, protocol <8,E,1>  
 05 Modbus RTU mode, protocol <8,O,1>

1. Computer Control

★There is a built-in RS-485 serial interface, marked (RJ-11 Jack) on the control terminal block. The pins are defined below:

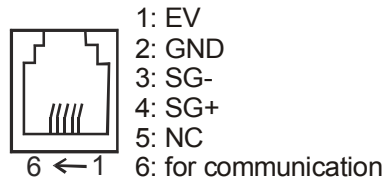

Each VFD-B AC drive has a pre-assigned communication address specified by Pr.09-00. The computer then controls each AC drive according to its communication address.

★A VFD-B can be setup to communicate on Modbus networks using one of the following modes: ASCII (American Standard Code for Information Interchange) or RTU (Remote Terminal Unit). Users can select the desired mode along with the serial port communication protocol in Pr.9-04.

★Code Description:

**ASCII mode:**

Each 8-bit data is the combination of two ASCII characters. For example, a 1-byte data: 64 Hex, shown as '64' in ASCII, consists of '6' (36Hex) and '4' (34Hex).

Character	'0'	'1'	'2'	'3'	'4'	'5'	'6'	'7'
ASCII code	30H	31H	32H	33H	34H	35H	36H	37H

Character	'8'	'9'	'A'	'B'	'C'	'D'	'E'	'F'
ASCII code	38H	39H	41H	42H	43H	44H	45H	46H

**RTU mode:**

Each 8-bit data is the combination of two 4-bit hexadecimal characters. For example, 64 Hex.

2. Data Format

10-bit character frame (For ASCII):

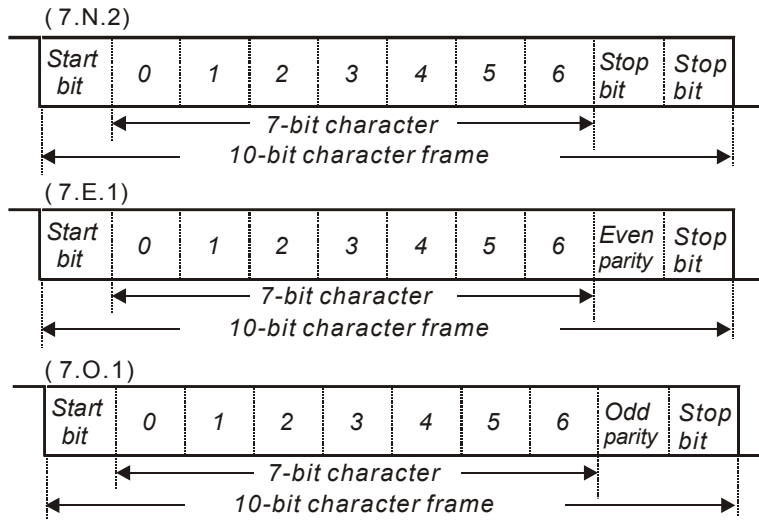

11-bit character frame (For RTU):

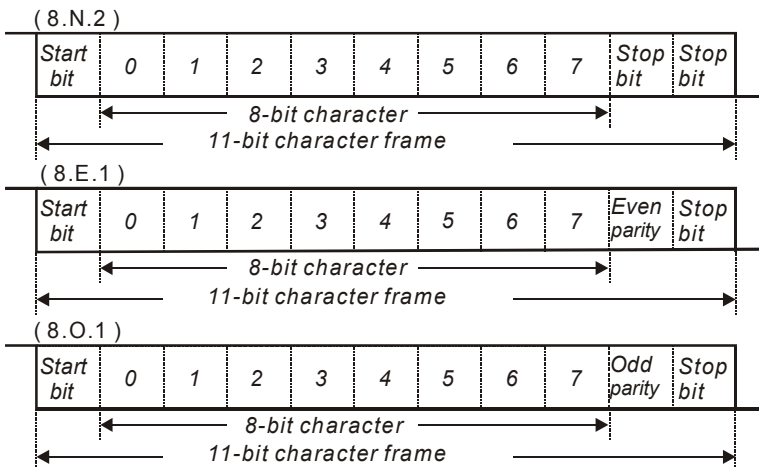

3. Communication Protocol

3.1 Communication Data Frame:

**ASCII mode:**

STX	Start character ':' (3AH)
ADR 1	Communication address:
ADR 0	8-bit address consists of 2 ASCII codes
CMD 1	Command code:
CMD 0	8-bit command consists of 2 ASCII codes
DATA (n-1) to DATA 0	Contents of data: n×8-bit data consist of 2n ASCII codes. n≤25, maximum of 50 ASCII codes
LRC CHK 1	LRC check sum:
LRC CHK 0	8-bit check sum consists of 2 ASCII codes
END 1	End characters:
END 0	END1= CR (0DH), END0= LF(0AH)

**RTU mode:**

START	A silent interval of more than 10 ms
ADR	Communication address: 8-bit address
CMD	Command code: 8-bit command
DATA (n-1) to DATA 0	Contents of data: n×8-bit data, n≤16
CRC CHK Low	CRC check sum: 16-bit check sum consists of 2 8-bit characters
CRC CHK High	
END	A silent interval of more than 10 ms

### 3.2 ADR (Communication Address)

Valid communication addresses are in the range of 0 to 254. A communication address equal to 0, means broadcast to all AC drives (AMD). In this case, the AMD will not reply any message to the master device.

For example, communication to AMD with address 16 decimal:

ASCII mode: (ADR 1, ADR 0)='1','0' => '1'=31H, '0'=30H

RTU mode: (ADR)=10H

### 3.3 CMD (Command code) and DATA (data characters)

The format of data characters depends on the command code. The available command codes and examples for VFD-B are described as followed:

(1) 03H: multi read, read data from registers.

Example: reading continuous 2 data from register address 2102H, AMD address is 01H.

#### ASCII mode:

Command message:

STX	':'
ADR 1	'0'
ADR 0	'1'
CMD 1	'0'
CMD 0	'3'
Starting data address	'2'
	'1'
	'0'
	'2'
Number of data (count by word)	'0'
	'0'
	'0'
	'2'
LRC CHK 1	'D'

Response message:

STX	':'
ADR 1	'0'
ADR 0	'1'
CMD 1	'0'
CMD 0	'3'
Number of data (Count by byte)	'0'
	'4'
Content of register 2102H	'1'
	'7'
	'7'
	'0'
Content of register 2103H	'0'
	'0'
	'0'

LRC CHK 0	'7'
END 1	CR
END 0	LF

	'0'
LRC CHK 1	'7'
LRC CHK 0	'1'
END 1	CR
END 0	LF

**RTU mode:**

Command message:

ADR	01H
CMD	03H
Starting data address	21H 02H
Number of data (count by word)	00H 02H
CRC CHK Low	6FH
CRC CHK High	F7H

Response message:

ADR	01H
CMD	03H
Number of data (count by byte)	04H
Content of register 2102H	17H 70H
Content of register 2103H	00H 00H
CRC CHK Low	FEH
CRC CHK High	5CH

(2) 06H: single write, write single data to register.

Example: writing data 6000(1770H) to register 0100H. AMD address is 01H.

**ASCII mode:**

Command message:

STX	':'
ADR 1	'0'
ADR 0	'1'
CMD 1	'0'
CMD 0	'6'
Register address	'0'
	'1'
	'0'
	'0'
Data content	'1'
	'7'
	'7'
	'0'
LRC CHK 1	'7'
LRC CHK 0	'1'
END 1	CR
END 0	LF

Response message:

STX	':'
ADR 1	'0'
ADR 0	'1'
CMD 1	'0'
CMD 0	'6'
Register address	'0'
	'1'
	'0'
	'0'
Data content	'1'
	'7'
	'7'
	'0'
LRC CHK 1	'7'
LRC CHK 0	'1'
END 1	CR
END 0	LF

**RTU mode:**

Command message:

ADR	01H
CMD	06H
Register address	00H
	00H
Data content	12H
	ABH
CRC CHK Low	ADH
CRC CHK High	14H

Response message:

ADR	01H
CMD	06H
Register address	00H
	00H
Data content	17H
	70H
CRC CHK Low	ADH
CRC CHK High	14H

(3) 08H: loop detection, this command is used to test if the communication between master equipment (PC or PLC) and AC drive is normal or not. AC drive will send the data received from master equipment back to master equipment.

Example: AMD address is 01H.

**ASCII mode:**

Command message:

STX	‘.’
ADR 1	‘0’
ADR 0	‘1’
CMD 1	‘0’
CMD 0	‘8’
Data address	‘0’
	‘0’
	‘0’
	‘0’
Data content	‘1’
	‘7’
	‘7’
	‘0’
LRC Check	‘7’
	‘0’
END	CR
	LF

Response message:

STX	‘.’
ADR 1	‘0’
ADR 0	‘1’
CMD 1	‘0’
CMD 0	‘8’
Data address	‘0’
	‘0’
	‘0’
	‘0’
Data content	‘1’
	‘7’
	‘7’
	‘0’
LRC Check	‘7’
	‘0’
END	CR
	LF

**RTU mode:**

Command message:

ADR	01H
CMD	08H
Data address	00H
	00H
Data content	17H
	70H
CRC CHK Low	8EH
CRC CHK High	0EH

Response message:

ADR	01H
CMD 1	08H
Data address	00H
	00H
Data content	17H
	70H
CRC CHK Low	8EH
CRC CHK High	0EH

(4) 10H: multi write, write multi data to registers.

Example: Set the multi-step speed,  
 Pr.05-00=50.00 (1388H),  
 Pr.05-01=40.00 (0FA0H). AC drive address is 01H.

**ASCII Mode:**

Command message:

STX	‘:’
ADR 1	‘0’
ADR 0	‘1’
CMD 1	‘1’
CMD 0	‘0’
Starting register address	‘0’
	‘5’
	‘0’
	‘0’
Number of data (count by word)	‘0’
	‘0’
	‘2’
Number of data (count by byte)	‘0’
	‘4’
The first data content	‘1’
	‘3’
	‘8’
	‘8’
The second data content	‘0’
	‘F’
	‘A’
LRC Check	‘0’
	‘A’
END	CR
	LF

Response message:

STX	‘:’
ADR 1	‘0’
ADR 0	‘1’
CMD 1	‘1’
CMD 0	‘0’
Starting register address	‘0’
	‘5’
	‘0’
	‘0’
Number of data (count by word)	‘0’
	‘0’
	‘2’
LRC Check	‘E’
	‘8’
END	CR
	LF

**RTU mode:**

Command message:

ADR	01H
CMD	10H
Starting register address	05H
	00H
Number of data (count by word)	00H
	02H
Number of data (count by byte)	04
The first data content	13H
	88H
The second data	0FH

Response message:

ADR	01H
CMD 1	10H
Starting register address	05H
	00H
Number of data (count by word)	00H
	02H
CRC Check Low	41H
CRC Check High	04H

content	A0H
CRC Check Low	'9'
CRC Check High	'A'

### 3.4 CHK (check sum)

#### ASCII mode:

LRC (Longitudinal Redundancy Check) is calculated by summing up, module 256, the values of the bytes from ADR1 to last data character then calculating the hexadecimal representation of the 2's-complement negation of the sum.

For example, reading 1 word from address 0401H of the AC drive with address 01H

STX	':'
ADR 1	'0'
ADR 0	'1'
CMD 1	'0'
CMD 0	'3'
Starting register address	'0'
	'4'
	'0'
	'1'
Number of data	'0'
	'0'
	'0'
	'1'
LRC CHK 1	'F'
LRC CHK 0	'6'
END 1	CR
END 0	LF

01H+03H+04H+01H+00H+01H=0AH,  
the 2's-complement negation of 0AH is **F6H**.

#### RTU mode:

ADR	01H
CMD	03H
Starting register address	21H
	02H
Number of data (count by word)	00H
	02H
CRC CHK Low	6FH
CRC CHK High	F7H

CRC (Cyclical Redundancy Check) is calculated by the following steps:

Step 1: Load a 16-bit register (called CRC register) with FFFFH.

Step 2: Exclusive OR the first 8-bit byte of the command message with the low order byte of the 16-bit CRC register, putting the result in the CRC register.



Step 3: Examine the LSB of CRC register.

Step 4: If the LSB of CRC register is 0, shift the CRC register one bit to the right with MSB zerofilling, then repeat step 3. If the LSB of CRC register is 1, shift the CRC register one bit to the right with MSB zerofilling, Exclusive OR the CRC register with the polynomial value A001H, then repeat step 3.

Step 5: Repeat step 3 and 4 until eight shifts have been performed. When this is done, a complete 8-bit byte will have been processed.

Step 6: Repeat step 2 to 5 for the next 8-bit byte of the command message. Continue doing this until all bytes have been processed. The final contents of the CRC register are the CRC value. **When transmitting the CRC value in the message, the upper and lower bytes of the CRC value must be swapped, i.e. the lower order byte will be transmitted first.**

The following is an example of CRC generation using C language. The function takes two arguments:

Unsigned char\* data ← a pointer to the message buffer

Unsigned char length ← the quantity of bytes in the message buffer

The function returns the CRC value as a type of unsigned integer.

```
Unsigned int crc_chk(unsigned char* data, unsigned char length){
    int j;
    unsigned int reg_crc=0xFFFF;
    while(length--){
        reg_crc ^= *data++;
        for(j=0;j<8;j++){
            if(reg_crc & 0x01){ /* LSB(b0)=1 */
                reg_crc=(reg_crc>>1) ^ 0xA001;
            }else{
                reg_crc=reg_crc >>1;
            }
        }
    }
    return reg_crc;
}
```

### 3.5 Address list:

The contents of available addresses are shown as below:

Content	Address	Function	
AC drive Parameters	GGnnH	GG means parameter group, nn means parameter number, for example, the address of Pr 4-01 is 0401H. Referencing to chapter 5 for the function of each parameter. When reading parameter by command code 03H, only one parameter can be read at one time.	
Command Write only	2000H	Bit 0-1	00B: No function 01B: Stop 10B: Run 11B: Jog + Run
		Bit 2-3	Reserved
		Bit 4-5	00B: No function 01B: FWD 10B: REV 11B: Change direction
		Bit 6-7	00B: Comm. forced 1st accel/decel 01B: Comm. forced 2nd accel/decel 10B: Comm. forced 3rd accel/decel 11B: Comm. forced 4th accel/decel
		Bit 8-11	Represented 16 step speeds.
		Bit 12	0: No comm. multi step speed or accel/decel time 1: Comm. multi step speed or accel/decel time
		Bit 13-15	Reserved
Command Write only	2001H	Freq. command	
	2002H	Bit 0	1: EF (external fault) on
		Bit 1	1: Reset
Status monitor Read only	2100H	Error code:	
		00: No error occurred	
		01: Over-current (oc)	
		02: Over-voltage (ov)	
		03: Overheat (oH)	
		04: Overload (oL)	
		05: Overload1 (oL1)	
		06: External fault (EF)	
		07: IGBT short circuit protection (occ)	
		08: CPU failure (cF3)	
		09: Hardware protection failure (HPF)	
		10: Current exceeds 2 times rated current during accel (ocA)	
11: Current exceeds 2 times rated current during decel (ocd)			
Status monitor Read only	2100H	12: Current exceeds 2 times rated current during steady state operation (ocn)	
		13: Ground Fault (GFF)	

Content	Address	Function	
		14: Low voltage (Lv)	
		15: CPU failure 1 (cF1)	
		16: CPU failure 2 (cF2)	
		17: Base Block	
		18: Overload (oL2)	
		19: Auto accel/decel failure (cFA)	
		20: Software protection enabled (codE)	
		21: EF1 Emergency stop	
		22:PHL (Phase-Loss)	
		23:cEF (Preliminary count value attained, EF active)	
		24:Lc (Low-current)	
		25:AnLEr (Analog feedback signal error)	
		26:PGErr (PG feedback signal error)	
		Status of AC drive	
	2101H	LED: 0: light off, 1: light up	
		00: RUN LED	
		01: STOP LED	
		02: JOG LED	
		03: FWD LED	
		04: REV LED	
		Bit 0-4	
		Bit 5	0: F light off, 1: F light on
		Bit 6	0: H light off, 1: H light on
		Bit 7	0: "u" light off, 1: "u" light on
		Bit 8	1: Main freq. Controlled by communication interface
		Bit 9	1: Main freq. controlled by analog signal
		Bit 10	1: Operation command controlled by communication interface
		Bit 11	1: Parameters have been locked
	Bit 12	0: AC drive stops, 1: AC drive operates	
	Bit 13	1: Jog command	
	Bit 14-15	Reserved	
	2102H	Frequency command (F)	
	2103H	Output frequency (H)	
	2104H	Output current (AXXX.X)	
	2105H	DC-BUS Voltage U (XXX.X)	
	2106H	Output voltage E (XXX.X)	
	2107H	Step number of Multi-Step Speed Operation	
	2108H	Step number of PLC operation	
	2109H	Content of external TRIGGER	
	210AH	Power factor angle	
	210BH	Estimated torque ratio	
	210CH	Motor speed (Hz)	

Content	Address	Function
	210DH	PG pulse (low byte) /unit time (Pr.10-15)
	210EH	PG pulse (high byte) /unit time (Pr.10-15)
	210FH	Output power (KW)
	2110H	Reserved
	2200H	Feedback Signal (XXX.XX %)
	2201H	User-defined (Low word)
	2202H	User-defined (High word)
	2203H	AVI analog input (XXX.XX %)
	2204H	ACI analog input (XXX.XX %)
	2205H	AUI analog input (XXX.XX %)

### 3.6 Exception response:

The AC drive is expected to return a normal response after receiving command messages from the master device. The following depicts the conditions that no normal response is replied to the master device.

The AC drive does not receive the messages due to a communication error; thus, the AC drive has no response. The master device will eventually process a timeout condition.

The AC drive receives the messages without a communication error, but cannot handle it, an exception response will return to the master device and an error message “CExx” will display on the keypad of AC drive. The xx of “CExx” is a decimal code equal to the exception code that will describe below.

In the exception response, the most significant bit of the original command code is set to 1, and an exception code explains the condition that caused the exception is returned. An example of exception response of command code 06H and exception code 02H:

#### ASCII mode:

STX	‘:’
ADR 1	‘0’
ADR 0	‘1’
CMD 1	‘8’
CMD 0	‘6’
Error code	‘0’
	‘2’
LRC CHK 1	‘7’
LRC CHK 0	‘7’
END 1	CR
END 0	LF

#### RTU mode:

ADR	01H
CMD	86H
Exception code	02H
CRC CHK Low	C3H
CRC CHK High	A1H

The explanation of error codes:

Error codes	Explanation
01	Illegal command code: The command code received in the command message is not available for the AC drive.
02	Illegal data address: The data address received in the command message is not available for the AC drive.
03	Illegal data value: The data value received in the command message is not available for the AC drive.
04	Slave device failure: The AC drive is unable to perform the requested action.
10	Time out: If Pr09-03 is not equal to zero, Pr09-02=0~2, and there are not any communication on the bus during setting time period (set by Pr. 09-03), "cE10" will be shown on the keypad.

### 3.7 Communication program of PC:

The following is a simple example of how to write a communication program for Modbus ASCII mode on a PC by C language.

```
#include<stdio.h>
#include<dos.h>
#include<conio.h>
#include<process.h>
#define PORT 0x03F8 /* the address of COM1 */
/* the address offset value relative to COM1 */
#define THR 0x0000
#define RDR 0x0000
#define BRDL 0x0000
#define IER 0x0001
#define BRDH 0x0001
#define LCR 0x0003
#define MCR 0x0004
#define LSR 0x0005
#define MSR 0x0006
unsigned char rdat[60];
/* read 2 data from address 2102H of AC drive with address 1 */
unsigned char tdat[60]={':', '0', '1', '0', '3', '2', '1', '0', '2',
                      '0', '0', '0', '2', 'D', '7', '\r', '\n'};

void main(){
    int i;
    outportb(PORT+MCR,0x08); /* interrupt enable */
```

```

outportb(PORT+IER,0x01);          /* interrupt as data in */
outportb(PORT+LCR,(inportb(PORT+LCR) | 0x80));
    /* the BRDL/BRDH can be access as LCR.b7==1 */
outportb(PORT+BRDL,12);          /* set baudrate=9600,
12=115200/9600*/
outportb(PORT+BRDH,0x00);
outportb(PORT+LCR,0x06);          /* set protocol, <7,N,2>=06H
                                   <7,E,1>=1AH, <7,O,1>=0AH
                                   <8,N,2>=07H, <8,E,1>=1BH
                                   <8,O,1>=0BH */

for(i=0;i<=16;i++){
    while(!(inportb(PORT+LSR) & 0x20)); /* wait until THR empty */
    outportb(PORT+THR,tdat[i]);      /* send data to THR */
}

i=0;
while(!kbhit()){
    if(inportb(PORT+LSR) & 0x01){ /* b0==1, read data ready */
        rdat[i++]=inportb(PORT+RDR); /* read data form RDR */
    }
}
}

```

<b>09 - 05</b>	HMI Register 1	↗	Factory Setting: 00
Settings    00~65535			

<b>09 - 06</b>	HMI Register 2	↗	Factory Setting: 00
Settings    00~65535			

 These two parameters provide two registers for HMI or PLC.

<b>09 - 07</b>	Response Delay Time	↗	Factory Setting: 00
Settings    00 ~ 200			Unit: 0.5msec

 This parameter is the response delay time after AC drive receives communication command as shown in the following.

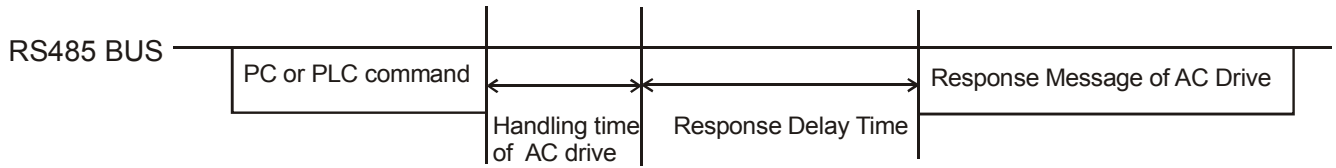

\* This parameter is only for version 4.01 and higher.

## Group 10: PID Controls

### 10 - 00 Input Terminal for PID Feedback Factory Setting: 00

Settings	00	Inhibit PID operation; external terminals AVI, ACI might be used for V/F control if required (Pr.02-00).
	01	Input negative PID feedback from external terminal AVI (0 to +10V).
	02	Input negative PID feedback from external terminal ACI (4 to 20mA).
	03	Input positive PID feedback from external terminal AVI (0 to +10V).
	04	Input positive PID feedback from external terminal ACI (4 to 20mA).

 Note that the measured variable (feedback) is the output frequency (Hz). Select input terminal accordingly. Make sure this parameter setting does not conflict with the setting for Pr.02-00 (Master Frequency)

The negative feedback is (+target value – feedback).

The positive feedback is (-target value + feedback).

### 10 - 01 Gain Over the PID Detection Value Factory Setting: 1.00

Settings	0.00 to 10.00	Unit: 0.01
----------	---------------	------------

 This is the gain adjustment over the feedback detection value, which is utilized in adjusting the inaccuracy between the target value and the measured value.

### 10 - 02 Proportional Gain (P) Factory Setting: 1.0

Settings	0.0 to 10.0
----------	-------------

 This parameter specifies proportional control and associated gain (P). If the other two gains (I and D) are set to zero, proportional control is the one effective. With 10% deviation (error) and P=1, the output will be  $1/6 \times P \times 10\% \times \text{Master Frequency}$ .

Note: The parameter can be set during operation.

### 10 - 03 Integral Gain ( I ) Factory Setting: 1.00

Settings	0.00 to 100.00 sec
	0.00 disable

 This parameter specifies integral control (continual sum of the deviation) and associated gain (I). When the integral gain is set to 1 and the deviation is fixed, the output is equal to the input (deviation) once the integral time setting is attained.



Note: The parameter can be set during operation.

<b>10 - 04</b>	<b>Derivative Control (D)</b>	Factory Setting: 0.00
	Settings 0.00 to 1.00 sec	

 This parameter specifies derivative control (rate of change of the input) and associated gain (D). With this parameter set to 1, the PID output is equal to differential time X (present deviation – previous deviation). It increases the response speed but it may cause over-compensation.

Note: The parameter can be set during operation.

<b>10 - 05</b>	<b>Upper Bound for Integral Control</b>	Factory Setting: 100
	Settings 00 to 100 %	Unit: 1 %

 This parameter defines an upper bound or limit for the integral gain (I) and therefore limits the Master Frequency.

The formula is: Integral upper bound = Maximum Output Frequency (Pr.01-00) x (Pr.10-05). This parameter can limit the Maximum Output Frequency

<b>10 - 06</b>	<b>Primary Delay Filter Time</b>	Factory Setting: 0.0
	Settings 0.0 to 2.5 sec	Unit: 0.1 sec

-  (1) To avoid amplification of measurement noise in the controller output, a derivative digital filter is inserted. This filter helps in smoothing oscillations.
- (2) When Pr.02-01 is set to 01 or 02, the set point (Master Frequency) for PID control is obtained from the AVI external terminal (0 to +10V) or from multi-step speed. When Pr.02-01 is set to 00, the set point is obtained from the keypad.

The complete PID diagram is the following:

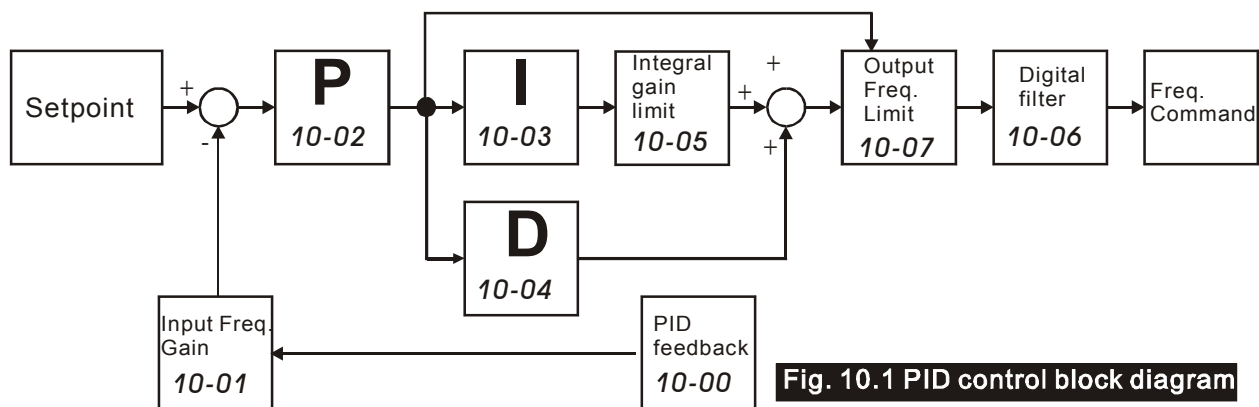

**Fig. 10.1 PID control block diagram**

<b>10 - 07</b>	<b>PID Output Frequency Limit</b>	Factory Setting: 100
	Settings 00 to 110 %	Unit: 1 %

 This parameter defines the percentage of output frequency limit during the PID control. The formula is Output Frequency Limit = Maximum Output Frequency (Pr.01-00) X Pr.10-07 %. This parameter will limit the Maximum Output Frequency.

<b>10 - 08</b>	Feedback Signal Detection Time	Factory Setting: 60.0
	Settings 0.0 to d 3600.0 sec	Unit: 0.1

<b>10 - 16</b>	Deviation Range of PID Feedback Signal Error	Factory Setting: 100.00
	Settings 0.00~100.00%	

 The base is Pr.01-00. When PID feedback control, if | Source of PID reference target – feedback | > Pr.10-16 and exceed Pr.10-08 for period time, AC drive will operate according to the Pr.10-09.

 This parameter defines the detecting time when feedback signal detects any abnormality in the system during the PID control. It also can be modified according to the system feedback signal time.

 When this parameter is set to 00 mean the system would not detect any abnormality signal.

<b>10 - 09</b>	Treatment of the Erroneous Feedback Signals	 Factory Setting: 00
	Settings 00 Warning and keep operating	
	01 Warning and RAMP to stop	
	02 Warning and COAST to stop	

 Treatment of the drive towards the feedback signals, such as the analog signals or the PG pulse signals, when they are performing abnormally.

<b>10 - 10</b>	PG Pulse Range	Factory Setting: 600
	Settings 1 to 40000 (Max=20000 for 2-pole motor)	Unit: 1

 A Pulse Generator (PG) is used as a transducer that translate into feedback the motor speed, and this parameter defines the number of pulses for each cycle of the PG control.

<b>10 - 11</b>	PG Input	Factory Setting: 00
	Settings 00 Disable PG	
	01 Single phase	
	02 Forward / Counterclockwise rotation	
	03 Reverse / Clockwise rotation	

 The relationship between the motor rotation and PG input as below:

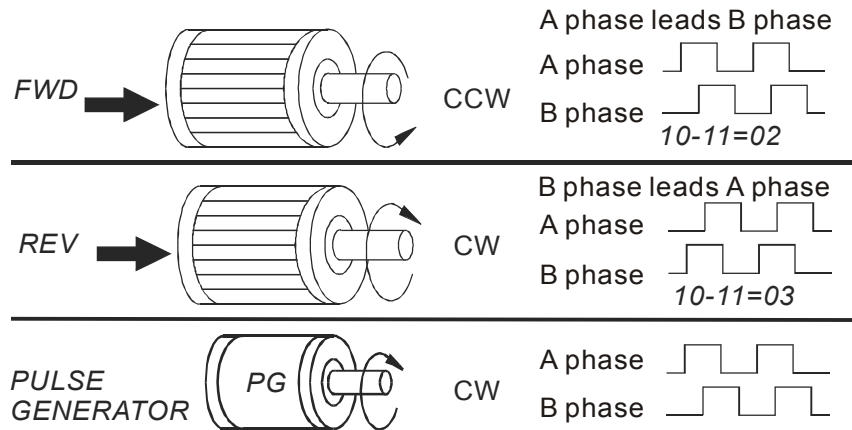

**10 - 12** Proportional Speed Control (P)



Factory Setting: 1.0

Settings 0.0 to 10.0

Unit: 0.1

This parameter specifies Proportional control and associated gain (P), used for vector control with PG feedback.

Note: The parameter can be set during operation.

**10 - 13** Integral Speed Control (I)



Factory Setting: 1.00

Settings 0.00 to 100.00  
0.00 disable

Unit: 0.01

This parameter specifies Integral control and associated gain (I), used for vector control with PG feedback.

Note: The parameter can be set during operation.

**10 - 14** Speed Control Output Frequency Limit

Factory Setting: 10.00

Settings 0.00 to 10.00

Unit: 0.01Hz

This parameter limits the amount of correction by the PI control on the output frequency when controlling speed. It can limit the maximum output frequency.

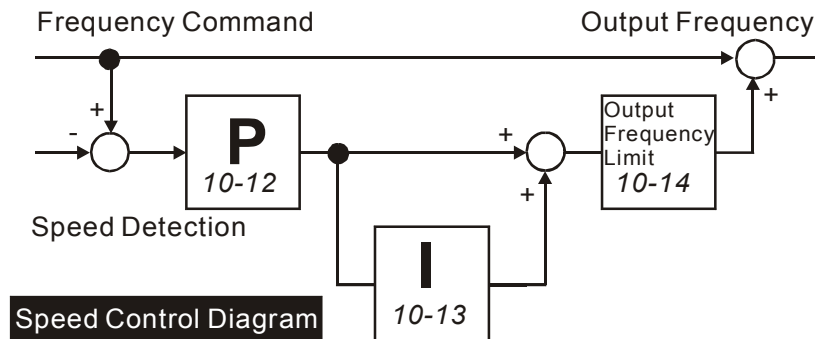

**10 - 15**

Sample time for refreshing the content of 210DH and 210EH

Factory Setting: 0.10

Settings 0.01~1.00 seconds

When the signal source of feedback control is PG and it needs to read the pulse numbers from communication, this parameter can be used to set the refresh time of two communication addresses (210D and 210E).

**PID Control Block Diagram**

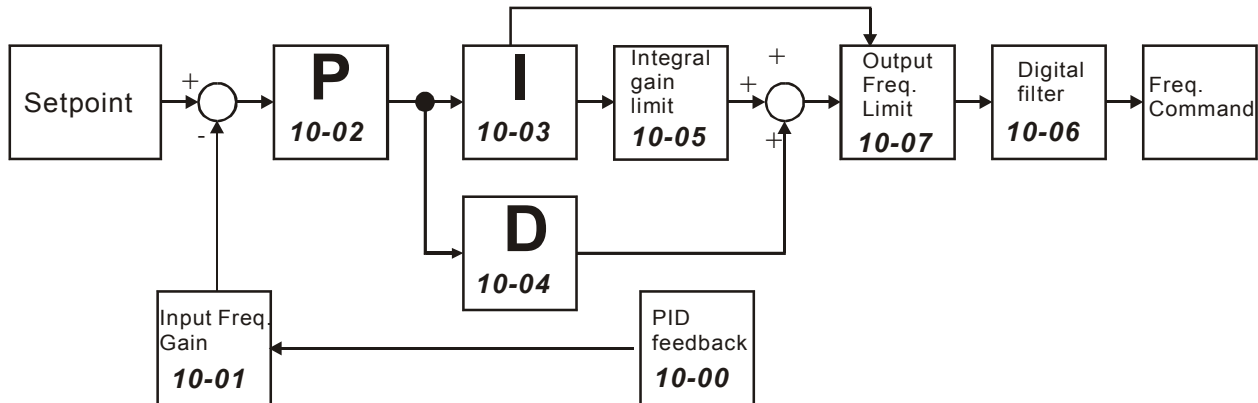

**Speed Control Diagram**

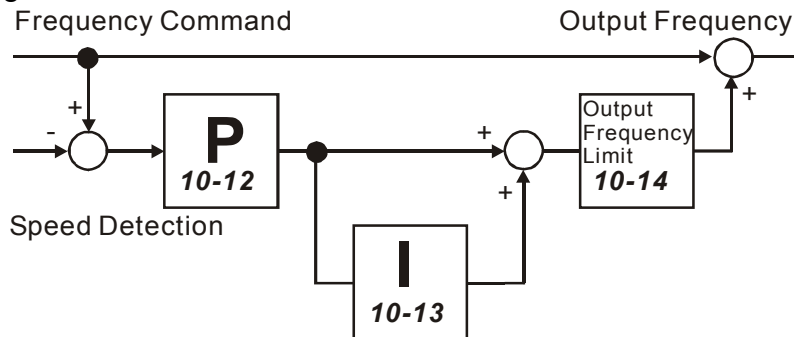

**Group 11: Fan and Pump Control Parameters**

**11 - 00 V / F Curve Selection** Factory Setting: 00

- Settings    00    V/F curve determined by Pr.01-00 to Pr.01-06.
- 01    1.5 power curve
- 02    1.7 power curve
- 03    square curve
- 04    Cube curve

☞ Confirm the curve of load and select the proper V/F curve before use.

☞ V/F curve is shown as below:

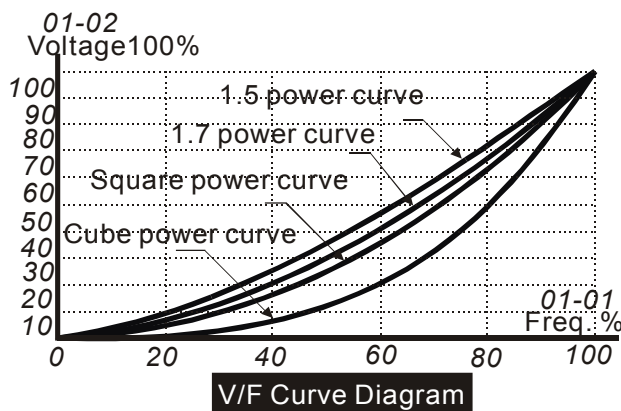

**11 - 01 Start-up Frequency of the Auxiliary Motor** Factory Setting: 0.00

Settings    0.00 to 120.00 Hz Unit: 0.01

☞ This parameter serves as a reference for the startup value of the auxiliary motor; if the setting is 0, the auxiliary motor cannot be activated.

**11 - 02 Stop Frequency of the Auxiliary Motor** Factory Setting: 0.00

Settings    0.00 to 120.00 Hz Unit: 0.01

☞ When Output Frequency reaches this parameter value, the auxiliary motor would come to a stop. There is a minimum of a 5 Hz segment between the start frequency and stop frequency of auxiliary motor. (Pr.11-01-Pr.11-02) > 5 Hz.

**11 - 03 Time Delay before Starting the Auxiliary Motor** Factory Setting: 0.0

Settings    0.0 to 3600.0 sec Unit: 0.1

**11 - 04 Time Delay before Stopping the Auxiliary Motor** Factory Setting: 0.0

Settings    0.0 to 3600.0 sec Unit: 0.1

- 📖 The terminals of Multi-function Output decides the number of auxiliary motors, the maximum is three.
- 📖 The start/stop frequency of the auxiliary motor must have a minimum of 5Hz bandwidth.
- 📖 The start/stop delay time can prevent the AC drive from overloaded during starting/stopping.
- 📖 These parameters determine the starting sequence of auxiliary motors.

The auxiliary motor started first will be stopped first.

Example: Start sequence: motor 1 -> motor 2 -> motor 3

Stop sequence: motor 1 -> motor 2 -> motor 3

- 📖 The flowchart of auxiliary motor start/stop sequence:

Pr.11-01 Start-up frequency = 50 Hz

Pr.11-02 Stop frequency = 20 Hz

Pr.11-03 Time delay before start up = 10 sec.

Pr.11-04 Time delay before stopping = 5 sec.

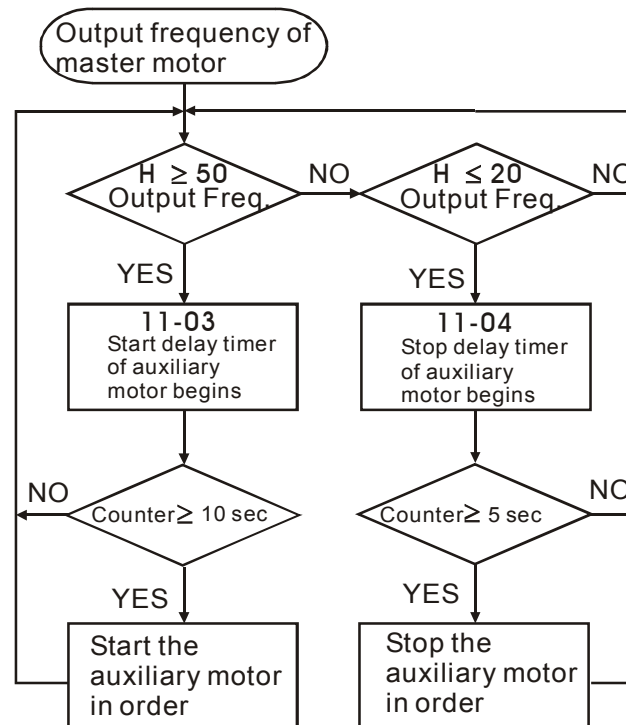

<b>11 - 05</b>	Sleep/Wake Up Detection Time	Factory Setting: 0.0
	Settings 0.0 to 6550.0 sec	Unit: 0.1
<b>11 - 06</b>	Sleep Frequency	Factory Setting: 0.00
	Settings 0.00 to Fmax	Unit: 0.01Hz



---

**11 - 07** Wakeup Frequency

Factory Setting: 0.00

Settings 0.00 to Fmax

Unit: 0.01Hz

-  When actual output frequency  $H < \text{Pr.11-06}$  and time exceeds the setting of Pr.11-05, AC drive will be in sleep mode.
  
-  When actual frequency command  $> \text{Pr.11-07}$  and time exceeds the setting of Pr.11-05, Ac drive will restart.

## CHAPTER 6 MAINTENANCE AND INSPECTIONS

Modern AC drives are based on solid state electronics technology, preventive maintenance is required to operate this AC drive in its optimal condition, and to ensure a long life. It is recommended to perform a monthly check up of the AC drive by a qualified technician. Before the check up, always turn off the AC Input Power to the unit. ***Wait at least 2 minutes after all display lamps have gone out, and then confirm that the capacitors have fully discharged by measuring the voltage between B1 and Ground using a multimeter set to measure DC.***

### 6.1 Periodic Inspection:

Basic check up items to detect if there were any abnormality during the operation:

1. Whether the motors are operating as expected.
2. Whether the installation environment is abnormal.
3. Whether the cooling system is operating as expected.
4. Whether any irregular vibration or sound occurred during the operation.
5. Whether the motors are overheated during the operation.
6. Always check the input voltage of the AC drive with Voltmeter.

### 6.2 Periodic Maintenance

 **WARNING!** Disconnecting AC power before processing!

1. Tighten and reinforce the screws of the AC drive if necessary, cause it may loose due to the vibration or changing of temperatures.
2. Whether the conductors or insulators were corroded and damaged.
3. Check the resistance of the insulation with Mega-ohmmeter.
4. Often check and change the capacitors and relays.
5. If use of the AC drive is discontinued for a long period of time, turn the power on at least once every two years and confirm that it still functions properly. To confirm functionality, disconnect the motor and energize the AC drive for 5 hours or more before attempting to run a motor with it.
6. Clean off any dust and dirt with a vacuum cleaner. Place special emphasis on cleaning the ventilation ports and PCBs. Always keep these areas clean, as accumulation of dust and dirt can cause unforeseen failures.





## CHAPTER 7 Troubleshooting and Fault Information

The AC drive has a comprehensive fault diagnostic system that includes several different alarms and fault messages. Once a fault is detected, the corresponding protective functions will be activated. The following faults are displayed as shown on the AC drive digital keypad display. The four most recent faults can be read on the digital keypad display.

NOTE: Faults can be cleared by a reset from the keypad or Input Terminal.

### Common Problems and Solutions:

Fault Name	Fault Descriptions	Corrective Actions
<b>OC</b>	The AC drive detects an abnormal increase in current.	<ol style="list-style-type: none"> <li>1. Check whether the motors horsepower corresponds to the AC drive output power.</li> <li>2. Check the wiring connections between the AC drive and motor for possible short circuits.</li> <li>3. Increase the Acceleration time.</li> </ol>
<b>OCC</b>	IGBT protection	<ol style="list-style-type: none"> <li>4. Check for possible excessive loading conditions at the motor.</li> <li>5. If there are any abnormal conditions when operating the AC drive after short-circuit being removed, it should be sent back to manufacturer.</li> </ol>
<b>OU</b>	The AC drive detects that the DC bus voltage has exceeded its maximum allowable value.	<ol style="list-style-type: none"> <li>1. Check whether the input voltage falls within the rated AC drive input voltage.</li> <li>2. Check for possible voltage transients.</li> <li>3. Bus over-voltage may also be caused by motor regeneration. Either increase the decel time or add an optional braking resistor.</li> <li>4. Check whether the required braking power is within the specified limits.</li> </ol>

Fault Name	Fault Descriptions	Corrective Actions
OH	The AC drive temperature sensor detects excessive heat.	<ol style="list-style-type: none"> <li>1. Ensure that the ambient temperature falls within the specified temperature range.</li> <li>2. Make sure that the ventilation holes are not obstructed.</li> <li>3. Remove any foreign objects on the heatsinks and check for possible dirty heat sink fins.</li> <li>4. Provide enough spacing for adequate ventilation.</li> </ol>
LU	The AC drive detects that the DC bus voltage has fallen below its minimum value.	Check whether the input voltage falls within the rated AC drive's input voltage.
OL	The AC drive detects excessive drive output current. Note: The AC drive can withstand up to 150% of the rated current for a maximum of 60 seconds.	<ol style="list-style-type: none"> <li>1. Check whether the motor is overloaded.</li> <li>2. Reduce torque compensation setting as set in Pr.7-02.</li> <li>3. Increase the AC drive's output capacity.</li> </ol>
OL1	Internal electronic overload trip	<ol style="list-style-type: none"> <li>1. Check for possible motor overload.</li> <li>2. Check electronic thermal overload setting.</li> <li>3. Increase motor capacity.</li> <li>4. Reduce the current level so that the drive output current does not exceed the value set by the Motor Rated Current Pr.7-00.</li> </ol>
OL2	Motor overload. Check the parameter settings (Pr.6-03 to Pr.6-05)	<ol style="list-style-type: none"> <li>1. Reduce the motor load.</li> <li>2. Adjust the over-torque detection setting to an appropriate setting (Pr.06-03 to Pr.06-05).</li> </ol>
CE-	Communication Error	<ol style="list-style-type: none"> <li>1. Check the connection between the AC drive and computer for loose wires.</li> <li>2. Check if the communication protocol is properly set.</li> </ol>

Fault Name	Fault Descriptions	Corrective Actions
ocA	Over-current during acceleration: 1. Short-circuit at motor output. 2. Torque boost too high. 3. Acceleration time too short. 4. AC drive output capacity is too small.	1. Check for possible poor insulation at the output line. 2. Decrease the torque boost setting in Pr.7-02. 3. Increase the acceleration time. 4. Replace the AC drive with one that has a higher output capacity (next HP size).
ocd	Over-current during deceleration: 1. Short-circuit at motor output. 2. Deceleration time too short. 3. AC drive output capacity is too small.	1. Check for possible poor insulation at the output line. 2. Increase the deceleration time. 3. Replace with the AC drive with one that has a higher output capacity (next HP size).
ocn	Over-current during steady state operation: 1. Short-circuit at motor output. 2. Sudden increase in motor loading. 3. AC drive output capacity is too small.	1. Check for possible poor insulation at the output line. 2. Check for possible motor stall. 3. Replace the AC drive with one that has a higher output capacity (next HP size).
EF	The external terminal EF-GND goes from OFF to ON.	1. When external terminal EF-GND is closed, the output will be turned off. (Under N.O. E.F.) 2. Press RESET after fault has been cleared.

Fault Name	Fault Descriptions	Corrective Actions
EF1	Emergency stop. When the multi-function input terminals (MI1 to MI6) are set to emergency stop, AC drive stops any output.	Press RESET after fault has been cleared.
cF1	Internal memory IC can not be programmed.	<ol style="list-style-type: none"> <li>1. Return to the factory.</li> <li>2. Check the EEPROM on the control board.</li> </ol>
cF2	Internal memory IC can not be read.	<ol style="list-style-type: none"> <li>1. Return to the factory.</li> <li>2. Reset drive to factory defaults.</li> </ol>
cF3	Drive's internal circuitry abnormal.	Return to the factory.
HPF	Hardware protection failure	Return to the factory.
code	Software protection failure	Return to the factory.
cFA	Auto accel/decel failure	Don't use the function of auto acceleration /deceleration.
GFF	Ground fault : The AC drive output is abnormal. When the output terminal is grounded (short circuit current is 50% more than the AC drive rated current), the AC drive power module may be damaged. The short circuit protection is provided for AC drive protection, not user protection.	Ground fault : <ol style="list-style-type: none"> <li>1. Check whether the IGBT power module is damaged.</li> <li>2. Check for possible poor insulation at the output line.</li> </ol>

Fault Name	Fault Descriptions	Corrective Actions
<b>bb</b>	External Base Block. AC drive output is turned off.	<ol style="list-style-type: none"> <li>1. When the external input terminal (B.B) is active, the AC drive output will be turned off.</li> <li>2. Disable this connection and the AC drive will begin to work again.</li> </ol>
<b>AnLEr</b> <b>PGErr</b>	AnLEr: analog feedback error or ACI open circuit PGErr: PG feedback signal error	<ol style="list-style-type: none"> <li>1. Check both parameter settings and wiring of Analog/PG (Pr.10-00).</li> <li>2. Check for possible fault between system reaction time and the feedback signal detection time (Pr.10-08).</li> </ol>
<b>AUE</b>	Auto Tuning Error	<ol style="list-style-type: none"> <li>1. Check cabling between drive and motor</li> <li>2. Retry again</li> </ol>
<b>cef</b>	EF when preliminary count value attained	<ol style="list-style-type: none"> <li>1. Check counter trigger signal</li> <li>2. Check Pr.03-09, Pr.03-11 setting</li> </ol>
<b>Lc</b>	Low Current	<ol style="list-style-type: none"> <li>1. Check Load current</li> <li>2. Check Pr.06-12 to Pr.06-15 setting</li> </ol>
<b>PHL</b>	Phase Loss	Check Power Source Input



## CHAPTER 8 SUMMARY OF PARAMETER SETTINGS

◇: The parameter can be set during operation. \*: Twice the value for 460V class

### Group 0: User Parameters

Parameter	Explanation	Settings	Factory Setting
00-00	Identity Code of AC Drive	Read-only	##
00-01	Rated Current Display	Read-only	##.#
00-02	Parameter Reset	08: Keypad lock 10: Reset parameter to factory setting	00
00-03	Start-up Display Page Selection ◇	00: F (setting frequency) 01: H (actual frequency) 02: U (user-defined unit) 03: Multi Function Display 04: FWD/REV	00
00-04	Content of Multi Function Display	00: Display output current (A) 01: Display counter value (C) 02: Display process operation (1. tt) 03: Display DC-BUS voltage (U) 04: Display output voltage (E) 05: Output power factor angle (n.) 06: Display output power (kW) 07: Display actual motor speed (HU) 08: Display the estimative value of the ration of torque (t) 09: Display PG numbers/10ms (G) 10: Display analog feedback signal value (b) (%) 11: Display AVI (U1.) (%) 12: Display ACI (U2.) (%) 13: Display AUI (U3.) (%)	00





Parameter	Explanation	Settings	Factory Setting
00-05	User-Defined Coefficient K $\diamond$	0.01 to 160.00	1.00
00-06	Software Version	Read-only	#.##
00-07	Password Decode	1 to 65535	00
00-08	Password Input	0 to 65535	00
00-09	Control Methods	00: V/F Control 01: V/F + PG Control 02: Vector Control 03: Vector + PG Control	00
00-10	Reserved		







### Group 1 Basic Parameters

Parameters	Explanation	Settings	Factory Setting
01-00	Maximum Output Freq. (Fmax)	50.00 to 400.00 Hz	60.00
01-01	Maximum Voltage Frequency (Fbase)	0.10 to 400.00 Hz	60.00
01-02	Maximum Output Voltage (Vmax)	230V series: 0.1V to 255.0V 460V series: 0.1V to 510.0V	220.0 440.0
01-03	Mid-Point Frequency (Fmid)	0.10 to 400.00 Hz	0.50
01-04	Mid-Point Voltage (Vmid)	230V: 0.1V to 255V 460V: 0.1V to 510V	1.7 3.4
01-05	Minimum Output Frequency (Fmin)	0.10 to 400.00 Hz	0.50
01-06	Minimum Output Voltage (Vmin)	230V series: 0.1V to 255.0V 460V series: 0.1V to 510.0V	1.7 3.4
01-07	Upper bound of freq.	1 to 120%	100
01-08	Lower bound of freq.	00 to 100 %	00
01-09	Accel Time 1	◇ 0.01 to 3600.0 sec	10.0
01-10	Decel Time 1	◇ 0.01 to 3600.0 sec	10.0
01-11	Accel Time 2	◇ 0.01 to 3600.0 sec	10.0
01-12	Decel Time 2	◇ 0.01 to 3600.0 sec	10.0
01-09 ~ 01-12: Factory setting is 60.0 for 30HP and above model.			
01-13	Jog Acceleration Time	◇ 0.01 to 3600.0 sec	1.0
01-14	Jog Frequency	◇ 0.10 Hz to 400.00 Hz	6.00
01-15	Auto acceleration / deceleration (refer to Accel/Decel Time setting)	◇ 00: Linear Accel/Decel 01: Auto Accel, Linear Decel 02: Linear Accel, Auto Decel 03: Auto Accel/Decel 04: Auto Accel/Decel (Please refer to P01-09~12 and P01-18~21)	00
01-16	S-Curve in Accel	00 to 07	00
01-17	S-Curve in Decel	00 to 07	00
01-18	Accel Time 3	◇ 0.01 to 3600.0 sec	10.0
01-19	Decel Time 3	◇ 0.01 to 3600.0 sec	10.0
01-20	Accel Time 4	◇ 0.01 to 3600.0 sec	10.0
01-21	Decel Time 4	◇ 0.01 to 3600.0 sec	10.0
01-18 ~ 01-21: Factory setting is 60.0 for 30HP and above model.			
01-22	Jog Deceleration Time	◇ 0.01 to 3600.0 sec	1.0

Parameters	Explanation	Settings	Factory Setting
01-23	Unit for Accel/Decel Time	00: Unit: 1 sec 01: Unit: 0.1 sec 02: Unit: 0.01 sec	01

### Group 2 Operation Method Parameters

Parameters	Explanation	Settings	Factory Setting
02-00	Source of First Frequency Command 	00: Master Frequency determined by the digital keypad or external UP/DOWN keys of the Multi Function Inputs. 01: 0 to +10V from AVI 02: 4 to 20mA from ACI 03: Potentiometer control (-10 to +10Vdc) 04: RS-485 communication interface 05: RS-485 communication interface. It won't memorize the frequency. 06: Combined usage of the master and auxiliary frequency command Pr. 02-10, 02-11, 02-12	00
02-01	Source of First Operation Command 	00: Determined by digital keypad 01: Master frequency determined by external terminal, STOP key enabled. 02: Master Frequency determined by external terminal, STOP key disabled. 03: Master Frequency determined by RS-485 communication interface, STOP key enabled. 04: Master Frequency determined by RS-485 communication interface, STOP key disabled.	00
02-02	Stop Method	00: Ramp Stop; E.F. coast stop 01: Coast Stop; E.F. coast stop 02: Ramp Stop; E.F. ramp stop 03: Coast Stop; E.F. ramp stop	00
02-03	PWM Carrier Frequency	1-5HP: 01-15KHz	15
		7.5HP: 01-15KHz	09
		30-60HP: 01-09KHz	06
		75-100HP: 01-09KHz	06

Parameters	Explanation	Settings	Factory Setting
02-04	Motor Direction Control	00: Enable Forward/Reverse operation 01: Disable Reverse operation 02: Disabled Forward operation	00
02-05	2-wire/3-wire Operation Control Modes	00: FWD/STOP, REV/STOP 01: FWD/REV, RUN/STOP 02: 3-wire Operation	00
02-06	Line Start Lockout	00: Disable 01: Enable	00
02-07	Loss of ACI Signal	00: Decelerate to 0 Hz 01: Stop immediately and display “EF” 02: Continue operation by last frequency command	00
02-08	Up/Down Key Mode 	00: Based on Accel/Decel Time 01: Constant speed	00
02-09	The Acce/Decel Speed of the UP/DOWN Key with Constant Speed 	0.01~1.00 Hz/msec	0.01
02-10	Source of the Master Frequency Command (FCHA) 	00: Digital keypad 01: 0 to +10V from AVI 02: 4 to 20mA from ACI 03: -10 to +10Vdc from AUI 04: RS-485 communication interface	00
02-11	Source of the Auxiliary Frequency Command (FCHB) 	00: Digital keypad 01: 0 to +10V from AVI 02: 4 to 20mA from ACI 03: -10 to +10Vdc from AUI 04: RS-485 communication interface	00
02-12	Combination of the Master and Auxiliary Frequency Command 	00: Master frequency + Auxiliary frequency 01: Master frequency - Auxiliary frequency	00
02-13	Source of Second Frequency Command 	00: Master Frequency determined by the digital keypad or external UP/DOWN keys of the Multi Function Inputs. 01: 0 to +10V from AVI 02: 4 to 20mA from ACI 03: -10 to +10Vdc from AUI 04: RS-485 communication interface 05: RS-485 communication interface. It won't memorize the frequency.	00



Parameters	Explanation	Settings	Factory Setting
02-13	Source of Second Frequency Command ◆	06: Combined usage of the master and auxiliary frequency command Pr. 02-10, 02-11,02-12	00
02-14	Source of Second Operation Command ◆	00: Controlled by the digital keypad 01: Controlled by the external terminals, keypad STOP enabled. 02: Controlled by the external terminals, keypad STOP disabled. 03: Controlled by the RS-485 communication interface, keypad STOP enabled. 04: Controlled by the RS-485 communication interface, keypad STOP disabled.	00
02-15	Keyboard Frequency Command ◆	0.00 ~ 400.00Hz	60.00

### Group 3 Output Function Parameters





Parameters	Explanation	Settings	Factory Setting
03-00	Multi-Function Output Terminal (Relay Output)	00: Not Used 01: AC Drive Operational 02: Master Freq. Attained 03: Zero Speed	08
03-01	Multi-Function Output Terminal MO1	04: Over Torque Detection 05: Base-Block (B.B.) Indication 06: Low-Voltage Indication 07: AC Drive Operation Mode	01
03-02	Multi-Function Output Terminal MO2	08: Fault Indication 09: Desired Freq. Attained 1 10: PLC Program Running 11: PLC Program Step Completed	02
03-03	Multi-Function Output Terminal MO3	12: PLC Program Completed 13: PLC Program Operation Paused 14: Terminal Count Value Attained 15: Preliminary Count Value Attained 16: Auxiliary Motor No.1 17: Auxiliary Motor No.2 18: Auxiliary Motor No.3 19: Heat Sink Overheat Warning 20: AC Drive Ready 21: Emergency Stop Indication 22: Desired Frequency Attained 2 23: Soft Braking Signal 24: Zero Speed Output Signal 25: Low-current Detection 26: Operation indication (H>=Fmin) 27: Feedback signal error 28: User-defined low-voltage Detection	20
03-04	Desired Freq. Attained 1	00: No functions	0.00
03-05	Desired Freq. Attained 1	0.00 to 400.00 Hz	0.00
03-05	Analog Output Signal	00: Output frequency 01: Output current 02: Output voltage 03: Output frequency command 04: Output motor speed 05: Load power factor	00
03-06	Analog Output Gain 	01 to 200%	100

Parameters	Explanation	Settings	Factory Setting
03-07	Digital Output Multiplying Factor 	01 to 20	01
03-08	Terminal Count Value	00 to 65500	00
03-09	Preliminary Count Value	00 to 65500	00
03-10	Desired Freq. attained 2	0.00 to 400.00 Hz	0.00
03-11	EF Active when Preliminary Count Value Attained	00: No function. 01: Preliminary count value attained, EF active.	00
03-12	Fan Control	00: Always fan on 01: Power off 1 minute later, fan off 02: Run and fan on, stop and fan off 03: Preliminary temperature attained, Fan start to run	00















## Group 4 Input Function Parameters

Parameters	Explanation	Settings	Factory Setting
04-00	AVI Analog Input Bias 	0.00 ~ 200.00 %	0.00
04-01	AVI Bias Polarity	00: Positive bias 01: Negative bias	00
04-02	AVI Input Gain 	1 to 200 %	100
04-03	AVI Negative Bias, Reverse Motion Enabled	00: no AVI Negative bias command 01: Negative bias, REV motion enabled 02: Negative bias, REV motion disabled	00
04-04	Multi-Function Input Terminal 1 (MI0, MI1)	00: Parameter Disable 01: Multi-Step Speed Command 1 02: Multi-Step Speed Command 2 03: Multi-Step Speed Command 3	01
04-05	Multi-Function Input Terminal 2 (MI2)	04: Multi-Step Speed Command 4 05: External Reset 06: Accel/Decel Speed Inhibit 07: Accel/Decel Time Selection Command 1	02
04-06	Multi-Function Input Terminal 3 (MI3)	08: Accel/Decel Time Selection Command 2 09: External Base Block (NO) 10: External Base Block (NC) 11: Increase Master Frequency	03
04-07	Multi-Function Input Terminal 4 (MI4)	12: Decrease Master Frequency 13: Counter Reset 14: Run PLC Program 15: Pause PLC Program	04
04-08	Multi-Function Input Terminal 5 (MI5)	16: Auxiliary Motor No.1 output failure 17: Auxiliary Motor No.2 Output Failure 18: Auxiliary Motor No.3 Output Failure 19: Emergency Stop (NO)	05
04-09	Multi-Function Input Terminal 6 (MI6)	20: Emergency Stop (NC) 21: Master Frequency Selection AVI /ACI 22: Master Frequency Selection AVI/AUI 23: Operation Command Selection keypad/external 24: Auto accel/decel mode disable 25: Forced Stop (N.C.) 26: Forced Stop (N.O.) 27: Parameter lock enable 28: PID function disabled	06



Parameters	Explanation	Settings	Factory Setting
		29: Jog Fwd/Rev command 30: External Reset (NC) 31: Source of second frequency command enabled 32: Source of second operation command enabled 33: One shot PLC 34: Proximity sensor input for simple Index function 35: Output Shutoff Stop (NO) 36: Output Shutoff Stop (NC) 00: No functions	
04-10	Digital Terminal Input Debouncing Time	1 to 20m sec (*2ms)	01
04-11	ACI Analog Input Bias 	0.00 ~ 200.00 %	0.00
04-12	ACI Bias Polarity	00: Positive bias 01: Negative bias	00
04-13	ACI Input Gain 	1 to 200 %	100
04-14	ACI Negative Bias, Reverse Motion Enable	00: No ACI Negative bias command 01: Negative bias, REV motion enabled 02: Negative bias, REV motion disabled	00
04-15	AUI Analog Input Bias 	0.00 ~ 200.00 %	0.00
04-16	AUI Bias Polarity	00: Positive bias 01: Negative bias	00
04-17	AUI Input Gain 	1 to 200 %	100
04-18	AUI Negative Bias Reverse Motion Enabled	00: No AUI Negative bias command 01: Negative bias, REV motion enabled 02: Negative bias, REV motion disabled	00
04-19	AVI Analog Input Delay	0.00 to 10.00 Sec	0.05
04-20	ACI Analog Input Delay	0.00 to 10.00 Sec	0.05
04-21	AUI Analog Input Delay	0.00 to 10.00 Sec	0.05
04-22	Analog Input Frequency Resolution	00: 0.01Hz 01: 0.1Hz	01
04-23	Gear Ratio for Simple Index Function	4 ~ 1000	200
04-24	Index Angle for Simple Index Function	0.0 ~360.0	180.0
04-25	Deceleration Time for Simple Index Function 	0.00 ~100.00	0.00

## Group 5 Multi-Step Speed and PLC Parameters

Parameters	Explanation	Settings	Factory Setting
05-00	1 <sup>st</sup> Step Speed Freq. 	0.00 to 400.00 Hz	0.00
05-01	2 <sup>nd</sup> Step Speed Freq. 	0.00 to 400.00 Hz	0.00
05-02	3 <sup>rd</sup> Step Speed Freq. 	0.00 to 400.00 Hz	0.00
05-03	4 <sup>th</sup> Step Speed Freq. 	0.00 to 400.00 Hz	0.00
05-04	5 <sup>th</sup> Step Speed Freq. 	0.00 to 400.00 Hz	0.00
05-05	6 <sup>th</sup> Step Speed Freq. 	0.00 to 400.00 Hz	0.00
05-06	7 <sup>th</sup> Step Speed Freq. 	0.00 to 400.00 Hz	0.00
05-07	8 <sup>th</sup> Step Speed Freq. 	0.00 to 400.00 Hz	0.00
05-08	9 <sup>th</sup> Step Speed Freq. 	0.00 to 400.00 Hz	0.00
05-09	10 <sup>th</sup> Step Speed Freq. 	0.00 to 400.00 Hz	0.00
05-10	11 <sup>th</sup> Step Speed Freq. 	0.00 to 400.00 Hz	0.00
05-11	12 <sup>th</sup> Step Speed Freq. 	0.00 to 400.00 Hz	0.00
05-12	13 <sup>th</sup> Step Speed Freq. 	0.00 to 400.00 Hz	0.00
05-13	14 <sup>th</sup> Step Speed Freq. 	0.00 to 400.00 Hz	0.00
05-14	15 <sup>th</sup> Step Speed Freq. 	0.00 to 400.00 Hz	0.00
05-15	PLC Mode	00: Disable PLC Operation 01: Execute one program cycle 02: Continuously execute program cycles 03: Execute one program cycle step by step 04: Continuously execute program cycles step by step	00
05-16	PLC Forward/ Reverse Motion	00 to 32767 (00: FWD 01: REV)	00
05-17	Time Duration Step 1	0.0 to 65500 sec	0.0
05-18	Time Duration Step 2	0.0 to 65500 sec	0.0
05-19	Time Duration Step 3	0.0 to 65500 sec	0.0
05-20	Time Duration Step 4	0.0 to 65500 sec	0.0
05-21	Time Duration Step 5	0.0 to 65500 sec	0.0
05-22	Time Duration Step 6	0.0 to 65500 sec	0.0
05-23	Time Duration Step 7	0.0 to 65500 sec	0.0
05-24	Time Duration Step 8	0.0 to 65500 Sec	0.0
05-25	Time Duration Step 9	0.0 to 65500 Sec	0.0
05-26	Time Duration Step 10	0.0 to 65500 Sec	0.0
05-27	Time Duration Step 11	0.0 to 65500 Sec	0.0
05-28	Time Duration Step 12	0.0 to 65500 Sec	0.0
05-29	Time Duration Step 13	0.0 to 65500 Sec	0.0
05-30	Time Duration Step 14	0.0 to 65500 Sec	0.0
05-31	Time Duration Step 15	0.0 to 65500 Sec	0.0

<b>Parameters</b>	<b>Explanation</b>	<b>Settings</b>	<b>Factory Setting</b>
05-32	Time Unit Settings	00: 1 Sec 01: 0.1 Sec	00
05-33	Skip Frequency Width	0.00 ~ 400.00 Hz	0.00
05-34	Bias Frequency Width	0.00 ~ 400.00 Hz	0.00

## Group 6 Protection Parameters

Parameters	Explanation	Settings	Factory Setting
06-00	Over-Voltage Stall Prevention	330V ~ 410V* 0: Disable	390*
06-01	Over-Current Stall Prevention during Accel	20 to 250%	170
06-02	Over-Current Stall Prevention during Operation	20 to 250%	170
06-03	Over-Torque Detection Mode	00: Disabled 01: Enabled during constant speed operation and continues until OL1 or OL is reached. 02: Enabled during Constant Speed Operation and halted after Detection 03: Enabled during Accel and continues until OL1 or OL is reached 04: Enabled during Accel and halted after Over-Torque Detection	00
06-04	Over-Torque Detection Level	10 to 200%	150
06-05	Over-Torque Detection Time	0.1 to 60.0 Sec	0.1
06-06	Electronic Thermal Overload Relay Selection	00: Standard Motor 01: Special Motor 02: Disabled	02
06-07	Electronic Thermal Characteristic	30 to 600 Sec	60
06-08	Present Fault Record	00: No Fault occurred 01: Over Current (oc) 02: Over Voltage (ov) 03: Over Heat (oH) 04: Over Load (oL)	00
06-09	Second Most Recent Fault Record	05: Over Load (oL1) 06: External Fault (EF) 07: IGBT Protection (occ) 08: CPU failure (cF3) 09: Hardware Protection Failure (HPF)	
06-10	Third Most Recent Fault Record	10: Current exceed during Acceleration (ocA) 11: Current exceed during Deceleration (ocd) 12: Current exceed during Steady State (ocn) 13: Ground Fault (GFF) 14: Lv 15: CF1	

Parameters	Explanation	Settings	Factory Setting
06-11	Fourth Most Recent Fault Record	16: CF2 17: Base Block (b.b) 18: oL2 19: CFA 20: code 21: EF1 (External Emergency Stop) 22: PHL (Phase-Loss) 23: cEF (Preliminary count value attained, EF active) 24:Lc (Low-current) 25:AnLEr (Analog feedback signal error) 26:PGErr (PG feedback signal error)	
06-12	Low-Current Detection Level	00 ~ 100% (00: Disabled)	00
06-13	Low-Current Detection Time	0.1~ 3600.0 Sec	10.0
06-14	Low-Current Treatment	00: Warn and keep operating 01: Warn and ramp to stop 02: Warn and coast to stop 03: Warn, after coast to stop, restart (delay 06-15 setting time)	00
06-15	Low-Current Detection Restart Delay Time	1~600 Min.	10
06-16	User-Defined Low-Voltage Detection Level	220VDC ~ 300VDC* 0: Disabled	00
06-17	User-Defined Low-Voltage Detection Time	0.1~ 3600.0 Sec	0.5
06-18	Reserved		

### Group 7 Motor Parameters

Parameters	Explanation	Settings	Factory Setting
07-00	Motor Rated Current	◇ 30 to 120%	100
07-01	Motor No-Load Current	◇ 01 to 90%	40
07-02	Torque Compensation	◇ 0.0 to 10.0	0.0
07-03	Slip Compensation	◇ 0.0 to 3.0	0.0
07-04	Number of Motor Poles	02 to 10	04
07-05	Motor Parameters Auto Tuning	00: Disable 01: Auto Tuning R1 02: Auto Tuning R1 + No-load Test	00
07-06	Motor Line-to-line Resistance R1	00 ~ 65535 mΩ	00
07-07	Reserved		
07-08	Motor Rated Slip	0.00 to 20.00 Hz	3.00
07-09	Slip Compensation Limit	0 to 250%	200
07-10	Reserved		
07-11	Reserved		
07-12	Torque Compensation Time Constant	0.01 ~10.00 Sec	0.05
07-13	Slip Compensation Time Constant	0.05 ~10.00 Sec	0.10
07-14	Accumulative Motor Operation Time (Min.)	00 to 1439 Min.	00
07-15	Accumulative Motor Operation Day	00 to 65535 Day	00

### Group 8 Special Parameters

Parameters	Explanation	Settings	Factory Setting
08-00	DC Braking Current Level	00 to 100%	00
08-01	DC Braking Time during Start-Up	0.0 to 60.0 Sec	0.0
08-02	DC Braking Time during Stopping	0.0 to 60.0 Sec	0.0
08-03	Start-Point for DC Braking	0.00 to 400.00 Hz	0.00
08-04	Momentary Power Loss Operation Selection	00: Operation stops after Momentary Power Loss 01: Operation continues after Momentary Power Loss, speed search starts with Master Frequency 02: Operation continues after Momentary Power Loss, speed search starts with Minimum Output Frequency	00
08-05	Maximum Allowable Power Loss Time	0.1 to 5.0 sec	2.0
08-06	B.B. Time for Speed Search	0.1 to 5.0 sec	0.5
08-07	Current Limit for Speed Search	30 to 200%	150
08-08	Skip Frequency 1 Upper Bound	0.00 to 400.00 Hz	0.00
08-09	Skip Frequency 1 Lower Bound	0.00 to 400.00 Hz	0.00
08-10	Skip Frequency 2 Upper Bound	0.00 to 400.00 Hz	0.00
08-11	Skip Frequency 2 Lower bound	0.00 to 400.00 Hz	0.00
08-12	Skip Frequency 3 Upper bound	0.00 to 400.00 Hz	0.00
08-13	Skip Frequency 3 Lower Bound	0.00 to 400.00 Hz	0.00
08-14	Auto Restart After Fault	00 to 10	00
08-15	Auto Energy Saving	00: Disable 01: Enable	00
08-16	AVR Function	00: AVR Function Enable 01: AVR Function Disable 02: AVR Function Disable for Decel	00
08-17	Software Setting of the Braking Level	230V: 370 to 430V 460V: 740 to 860V	380 760
08-18	Base-block Speed Trace	00: Speed Search Starts with Last Frequency Command 01: Starts with Minimum Output Frequency	00
08-19	Speed Search during Start-up	00: Speed Search Disable 01: Speed Search Enable	00
08-20	Speed Search Frequency during Start-up	00: Setting Frequency 01: Maximum Operation Frequency (01-00)	00

Parameters	Explanation	Settings	Factory Setting
08-21	Auto Reset Time at Restart after Fault	00 to 60000 sec	600
08-22	Compensation Coefficient for Motor Instability 	00~1000	00



### Group 9 Communication Parameters

Parameters	Explanation	Settings	Factory Setting
09-00	Communication Address ◇	01 to 254	01
09-01	Transmission Speed ◇	00: Baud Rate 4800bps 01: Baud Rate 9600bps 02: Baud Rate 19200bps 03: Baud Rate 38400bps	01
09-02	Transmission Fault Treatment ◇	00: Warn and keep Operating 01: Warn and Ramp to Stop 02: Warn and Coast to Stop 03: No warning and keep Operating	03
09-03	Overtime Detection ◇	0.0 ~ 60.0 second 0.0: Disable	0.0
09-04	Communication Protocol ◇	00: 7,N,2 (Modbus, ASCII) 01: 7,E,1 (Modbus, ASCII) 02: 7,O,1 (Modbus, ASCII) 03: 8,N,2 (Modbus, RTU) 04: 8,E,1 (Modbus, RTU) 05: 8,O,1 (Modbus, RTU)	00
09-05	HMI Register 1 ◇	00 ~ 65535	00
09-06	HMI Register 2 ◇	00 ~ 65535	00
09-07	Response Delay Time	00 ~ 200	00

### Group 10 PID Control Parameters

Parameters	Explanation	Settings	Factory Setting
10-00	Input terminal for PID Feedback	00: Inhibit PID operation 01: Input negative PID feedback from external terminal (AVI) 0 to +10V 02: Input negative PID feedback from external terminal (ACI) 4 to 20mA 03: Input positive PID feedback from external terminal (AVI) 0 to +10V 04: Input positive PID feedback from external terminal (ACI) 4 to 20mA	00
10-01	Gain over PID Detection value	0.00 to 10.00	1.00
10-02	Proportional Gain (P) ◆	0.0 to 10.0	1.0
10-03	Integral Gain (I) ◆	0.00 to 100.00 sec (0.00 disable)	1.00
10-04	Derivative Control (D) ◆	0.00 to 1.00 sec	0.00
10-05	Upper Bound for Integral Control	00 to 100%	100
10-06	Primary Delay Filter time	0.0 to 2.5 sec	0.0
10-07	PID Output Freq Limit	0 to 110%	100
10-08	Feedback Signal Detection time	0.0 to 3600.0 sec	60.0
10-09	Treatment of the Erroneous Feedback Signals	00: Warn and keep operation 01: Warn and RAMP to stop 02: Warn and COAST to stop	00
10-10	PG Pulse Range	01 to 40000	600
10-11	PG Input	00: Disable PG 01: Single phase 02: Forward / Counterclockwise rotation 03: Reverse / Clockwise rotation	00
10-12	Proportional Speed control (P) ◆	0.0 to 10.0	1.0
10-13	Integral Speed Control (I) ◆	0.00 to 100.00 (0.00 disable)	1.00
10-14	Speed Control Output Frequency Limit	0.00 to 10.00 Hz	10.00
10-15	Sample time for refreshing the content of 210DH and 210EH	0.01~1.00 seconds	0.10
10-16	Deviation Range of PID Feedback Signal Error	0.00~100.00%	100.00

## Group 11 Fan & Pump Control Parameters

Parameters	Explanation	Settings	Factory Setting
11-00	V/F Curve Selection	00: V/F Curve determined by Pr.01-00 to Pr.01-06 01: 1.5 Power Curve 02: 1.7 Power Curve 03: Square Curve 04: Cube Curve	00
11-01	Start-Up Frequency of the Auxiliary Motor	0.00 to 120.00 Hz	0.00
11-02	Stop Frequency of Auxiliary Motor	0.00 to 120.00 Hz	0.00
11-03	Time Delay before Starting the Auxiliary Motor	0.0 to 3600.0 sec	0.0
11-04	Time Delay before Stopping the Auxiliary Motor	0.0 to 3600.0 sec	0.0
11-05	Sleep/Wake Up Detection Time	0.0 ~6550.0 sec	0.0
11-06	Sleep Frequency	0.00~Fmax	0.00
11-07	Wakeup Frequency	0.00~Fmax	0.00

# SPECIFICATIONS

Voltage Class		230V Class											
Model Number VFD- B		007	015	022	037	055	075	110	150	185	220	300	370
Max. Applicable Motor Output (kW)		0.75	1.5	2.2	3.7	5.5	7.5	11	15	18.5	22	30	37
Max. Applicable Motor Output (HP)		1.0	2.0	3.0	5.0	7.5	10	15	20	25	30	40	50
Output Rating	Rated Output Capacity (KVA)	1.9	2.5	4.2	6.5	9.5	12.5	18.3	24.7	28.6	34.3	45.7	55.0
	Rated Output Current (A)	5.0	7.0	11	17	25	33	49	65	75	90	120	145
Maximum Output Voltage (V)		Proportional to Input Voltage											
Rated Frequency (Hz)		60.0/50.0 Hz											
Input Rating	Rated Input Current (A)	11.9/ 5.7	15.3/ 7.6	22/ 15.5	20.6	26	34	50	60	75	90	110	142
	Single (3-phase Input Current)	7.0	9.4	14.0									
	Rated Voltage	Single/3-phase 180-264 V				3-phase 180-264 V							
	Frequency Tolerance	47 – 63 Hz											
Control Characteristics	Control System	SPWM (Sinusoidal Pulse Width Modulation, carrier frequency 1-15kHz)											
	Output Frequency Resolution	0.01Hz											
	Torque Characteristics	Including the auto-torque, auto-slip compensation; starting torque can be 150% at 1.0Hz											
	Overload Endurance	150% of rated current for 1 minute											
	Accel/Decel Time	0.1to 3600 seconds (2 Independent settings for Accel/Decel Time)											
	V/F Pattern	Adjustable V/F pattern											
	Stall Prevention Level	20 to 250%, Setting of Rated Current											
Operating Characteristics	Frequency Setting	Keypad	Setting by ▲ ▼										
		External Signal	Potentiometer-5KΩ/0.5W, DC 0 to +10V or 0 to +5V (Input impedance 47KΩ), RS-485 interface, 4 to 20mA (Input impedance 250Ω), Multi-Function Inputs 1 to 6 (7 steps, Jog, up/down)										
	Operation Setting Signal	Keypad	Set by RUN, STOP and JOG										
		External Signal	M0 to M5 can be combined to offer various modes of operation, RS-485 serial interface (MODBUS).										
	Multi-Function Input Signal	Multi-step selection 0 to 15, Jog, accel/decel inhibit, first to forth accel/decel switches, counter, PLC operation, external Base Block (NC, NO), auxiliary motor control is invalid, ACI/AVI selections, driver reset, UP/DOWN key settings, sink/source selection											
	Multi-Function Output Indication	AC Drive Operating, Frequency Attained, Non-zero, Base Block, Fault Indication, Local/Remote indication, PLC Operation indication, Auxiliary Motor Output, Driver is Ready, Overheat Alarm, Emergency Stop											
	Analog Output Signal	Analog frequency/current signal output											
Other Functions		AVR, S-Curve, Over-Voltage, Over-Current Stall Prevention, Fault Records, Adjustable Carrier Frequency, DC Braking, Momentary Power Loss restart, Auto Tuning, Frequency Limits, Parameter Lock/Reset, Vector Control, Counter, PID Control, Fan & Pump Control, PLC, MODBUS Communication, Reverse Inhibition, PG feedback control, abnormal reset, abnormal re-start, digital frequency output, sleep/revival function, master/auxiliary frequency, 1st/2nd frequency source selections											
Protection		Self-testing, Over Voltage, Over Current, Under Voltage, Overload, Overheating, External Fault, Electronic thermal, Ground Fault											
Cooling Methods		Convection cooled	Fan-cooled										
Environmental Conditions	Installation Location	Altitude 1,000 m or lower, keep from corrosive gasses, liquid and dust											
	Pollution Degree	2											
	Ambient Temperature	-10°C to 40°C (-10°C to 50°C without blind plate) Non-Condensing and not frozen											
	Storage/ Transportation Temperature	-20°C to 60°C											
	Ambient Humidity	Below 90% RH (non-condensing)											
	Vibration	9.80665m/s <sup>2</sup> (1G) less than 20Hz, 5.88m/s <sup>2</sup> (0.6G) at 20 to 50Hz											



Voltage Class		460V Class														
Model Number VFD- B		007	015	022	037	055	075	110	150	185	220	300	370	450	550	750
Max. Applicable Motor Output (kW)		0.75	1.5	2.2	3.7	5.5	7.5	11	15	18.5	22	30	37	45	55	75
Max. Applicable Motor Output (HP)		1.0	2.0	3.0	5.0	7.5	10	15	20	25	30	40	50	60	75	100
Output Rating	Rated Output Capacity (KVA)	2.3	3.2	4.2	6.5	9.9	13.7	18.3	24.4	28.9	34.3	45.7	55.6	69.3	84	114
	Rated Output Current (A)	2.7	4.2	5.5	8.5	13	18	24	32	38	45	60	73	91	110	150
	Maximum Output Voltage (V)	Proportional to Input Voltage														
Input Rating	Rated Input Current (A)	3.2	4.3	5.9	11.2	14	19	25	32	39	49	60	63	90	130	160
	Rated Voltage	3-phase 342 to 528 V														
	Frequency Tolerance	47-63 Hz														
Control Characteristics	Control System	SPWM (Sinusoidal Pulse Width Modulation, carrier frequency 1-15kHz)														
	Output Frequency Resolution	0.01Hz														
	Torque Characteristics	Including the auto-torque, auto-slip compensation; starting torque can be 150% at 1.0Hz														
	Overload Endurance	150% of rated current for 1 minute														
	Accel/Decel Time	0.1 to 3600 seconds (2 Independent settings for Accel/Decel Time)														
	V/F Pattern	Adjustable V/F pattern														
	Stall Prevention Level Frequency Setting	20 to 250%, Setting of Rated Current														
Operating Characteristics	Frequency Setting	Keypad	Setting by ▲ ▼													
		External Signal	Potentiometer-5K $\Omega$ /0.5W, DC 0 to +10V or 0 to +5V (Input impedance 47K $\Omega$ ); RS-485 interface; 4 to 20mA (Input impedance 250 $\Omega$ ); Multi-Function Inputs 1 to 6 (7 steps, Jog, up/down)													
	Operation Setting	Keypad	Set by RUN, STOP and JOG													
		External Signal	M0 to M5 can be combined to offer various modes of operation, RS-485 serial interface (MODBUS).													
	Multi-Function Input Signal	Multi-step selection 0 to 15, Jog, accel/decel inhibit, first to forth accel/decel switches, counter, PLC operation, external Base Block (NC, NO), auxiliary motor control is invalid, ACI/AVI selections, driver reset, UP/DOWN key settings, sink/source selection														
	Multi-Function Output Indication	AC Drive Operating, Frequency Attained, Non-zero, Base Block, Fault Indication, Local/Remote indication, PLC Operation indication, Auxiliary Motor Output, Driver is Ready, Overheat Alarm, Emergency Stop														
Analog Output Signal	Analog frequency/current signal output.															
Other Functions		AVR, S-Curve, Over-Voltage, Over-Current Stall Prevention, Fault Records, Adjustable Carrier Frequency, DC Braking, Momentary Power Loss restart, Auto Tuning, Frequency Limits, Parameter Lock/Reset, Vector Control, Counter, PID Control, Fan & Pump Control, PLC, MODBUS Communication, Reverse Inhibition, PG feedback control, abnormal reset, abnormal re-start, digital frequency output, sleep/revival function, master/auxiliary frequency, 1st/2nd frequency source selections														
Protection		Self-testing, Over Voltage, Over Current, Under Voltage, Overload, Overheating, External Fault, Electronic thermal, Ground Fault.														
Cooling Methods		Convection cooled					Fan-cooled									
Environmental Conditions	Installation Location	Altitude 1,000 m or lower, keep from corrosive gasses, liquid and dust														
	Pollution Degree	2														
	Ambient Temperature	-10°C to 40°C (-10°C to 50°C without blind plate) Non-Condensing and not frozen														
	Storage/Transportation Temperature	-20°C to 60°C														
	Ambient Humidity	Below 90% RH (non-condensing)														
	Vibration	9.80665m/s <sup>2</sup> (1G) less than 20Hz, 5.88m/s <sup>2</sup> (0.6G) at 20 to 50Hz														

## Electrical Characteristics

MODEL NO.	Input Voltage (V)	Phase	3 Phase Motor Rating (KW)(HP)	Output Power (KVA)	Input Current (A)	Output Current (A)
VFD007B21A	200-240	1 Phase	0.75 (1)	1.9	11.9	5
	200-240	3 Phase	0.75 (1)	1.9	7.0	5
VFD007B23A	200-240	3 Phase	0.75 (1)	1.9	5.7	5
VFD007B43A	380-480	3 Phase	0.75 (1)	2.3	3.2	2.7
VFD015B21A	200-240	1 Phase	1.5 (2)	2.5	15.3	7
	200-240	3 Phase	1.5 (2)	2.5	9.4	7
VFD015B23A	200-240	3 Phase	1.5 (2)	2.5	7.6	7
VFD015B43A	380-480	3 Phase	1.5 (2)	3.2	4.3	4.2
VFD022B21A	200-240	1 Phase	2.2 (3)	4.2	22	11
	200-240	3 Phase	2.2 (3)	4.2	14	11
VFD022B23B	200-240	3 Phase	2.2 (3)	4.2	15.5	11
VFD022B43B	380-480	3 Phase	2.2 (3)	4.2	5.9	5.5
VFD037B23A	200-240	3 Phase	3.7 (5)	6.5	20.6	17
VFD037B43A	380-480	3 Phase	3.7 (5)	6.5	11.2	8.5
VFD055B23A	200-240	3 Phase	5.5 (7.5)	9.5	26	25
VFD055B43A	380-480	3 Phase	5.5 (7.5)	9.9	14	13
VFD075B23A	200-240	3 Phase	7.5 (10)	12.5	34	33
VFD075B43A	380-480	3 Phase	7.5 (10)	13.7	19	18
VFD110B23A	200-240	3 Phase	11 (15)	18.3	50	49
VFD110B43A	380-480	3 Phase	11 (15)	18.3	25	24
VFD150B23A	200-240	3 Phase	15 (20)	24.7	60	65
VFD150B43A	380-480	3 Phase	15 (20)	24.4	32	32
VFD185B23A	200-240	3 Phase	18.5 (25)	28.6	75	75
VFD185B43A	380-480	3 Phase	18.5 (25)	28.9	39	38
VFD220B23A	200-240	3 Phase	22 (30)	34.3	90	90
VFD220B43A	380-480	3 Phase	22 (30)	34.3	49	45
VFD300B23A	200-240	3 Phase	30 (40)	45.7	110	120
VFD300B43A	380-480	3 Phase	30 (40)	45.7	60	60
VFD370B23A	200-240	3 Phase	37 (50)	55.0	142	145
VFD370B43A	380-480	3 Phase	37 (50)	55.6	63	73
VFD450B43A	380-480	3 Phase	45 (60)	69.3	90	91
VFD550B43A	380-480	3 Phase	55 (75)	84	130	110
VFD750B43A	380-480	3 Phase	75 (100)	114	160	150

Input Frequency: 47-63 Hz  
 Output Voltage: Proportional to input voltage  
 Output Frequency: 0.1 to 400Hz  
 Max. Ambient Temp: 40 degree C (\*)  
 Enclosure: ENCLOSED Type 1

\*: Max. Ambient Temp is 50 degree C for 7.5-15hp.



## ACCESSORIES

### B.1 Non-fuse Circuit Breaker Chart

Per UL 508C, paragraph 45.8.4, part a,

1. For 1-phase drives, the current rating of the breaker shall be 4 times maximum of input current rating.
2. For 3-phase drives, the current rating of the breaker shall be 4 times maximum of output current rating.

**(Note: According to our experience, we suggest to use 1.5 – 2 times maximum of input/output current rating.)**

1-phase		3-phase	
Model	Input Current (A)	Model	Output Current (A)
VFD007B21A	11.9	VFD007B23A	5.0
VFD015B21A/B	15.3	VFD007B43A	2.7
VFD022B21A	22.0	VFD015B23A/B	7.0
		VFD015B43A	4.2
		VFD022B23A	11
		VFD022B43B	5.5
		VFD037B23A	17
		VFD037B43A	8.5
		VFD055B23A	25
		VFD055B43A	13
		VFD075B23A	33
		VFD075B43A	18
		VFD110B23A	49
		VFD110B43A	24
		VFD150B23A	65
		VFD150B43A	32
		VFD185B23A	75
		VFD185B43A	38
		VFD220B23A	90
		VFD220B43A	45
		VFD300B23A	123
		VFD300B43A	60
		VFD370B23A	142
		VFD370B43A	63
		VFD450B43A	90
		VFD550B43A	110
		VFD750B43A	150



## Fuse Specification Chart

Smaller fuses than those shown in the table are permitted.

Model	I (A) (Input)	I (A) (Output)	Line Fuse	
			I (A)	Bussmann P/N
VFD007B21A	11.9	5.0	30	JJN-30
VFD007B23A	5.7	5.0	20	JJN-20
VFD007B43A	3.2	2.7	10	JJS-10
VFD015B21A/B	15.3	7.0	40	JJN-40
VFD015B23A/B	7.6	7.0	25	JJN-25
VFD015B43A	4.3	4.2	15	JJS-15
VFD022B21A	22.0	11	60	JJN-60
VFD022B23A	15.5	11	40	JJN-40
VFD022B43B	5.9	5.5	20	JJS-20
VFD037B23A	20.6	17	60	JJN-60
VFD037B43A	11.2	8.5	30	JJS-30
VFD055B23A	26	25	100	JJN-100
VFD055B43A	14	13	50	JJS-50
VFD075B23A	34	33	125	JJN-125
VFD075B43A	19	18	70	JJS-70
VFD110B23A	50	49	175	JJN-175
VFD110B43A	25	24	90	JJS-90
VFD150B23A	60	65	250	JJN-250
VFD150B43A	32	32	125	JJS-125
VFD185B23A	75	75	300	JJN-300
VFD185B43A	39	38	150	JJS-150
VFD220B23A	90	90	350	JJN-350
VFD220B43A	49	45	175	JJS-175
VFD300B23A	110	120	450	JJN-450
VFD300B43A	60	60	225	JJS-225
VFD370B23A	142	145	500	JJN-500
VFD370B43A	63	73	250	JJS-250
VFD450B43A	90	91	350	JJS-350
VFD550B43A	130	110	400	JJS-400
VFD750B43A	160	150	600	JJS-600

## B.2 All Braking Resistors & Braking Units Use in AC Drives

Note: Please only use DELTA resistors and recommended values. Other resistors and values will void Delta's warranty. Please contact your nearest Delta representative for use of special resistors. For instance, in 460 V series, 100 HP, AC drive has 2 braking units with total of 16 braking resistors, so each braking unit uses 8 braking resistors. There should be at least 10 cm away from AC drive to avoid possible noise. Refer to the "Braking Unit Module User Manual" for further detail.

Voltage	Applicable Motor		Full Load Torque KG-M	Equivalent Resistors Specification for Each AC Drive	Braking Unit Model VFDB No. of Unit Used		Braking Resistors		Braking Torque 10%ED	Equivalent Minimum Resistor Value for Each AC Drive
	HP	kW					Model	No. of Units Used		
230V Series	1	0.75	0.427	80W 200Ω			BR080W200	1	125	80Ω
	2	1.5	0.849	300W 100Ω			BR300W100	1	125	55Ω
	3	2.2	1.262	300W 70Ω			BR300W070	1	125	35Ω
	5	3.7	2.080	400W 40Ω			BR400W040	1	125	25Ω
	7.5	5.5	3.111	500W 30Ω			BR500W030	1	125	16Ω
	10	7.5	4.148	1000W 20Ω			BR1K0W020	1	125	12Ω
	15	11	6.186	2400W 13.6Ω	2015	1	BR1K2W6P8	2	125	13.6Ω
	20	15	8.248	3000W 10Ω	2015	1	BR1K5W005	2	125	10Ω
	25	18.5	10.281	4800W 8Ω	2022	1	BR1K2W008	4	125	8Ω
	30	22	12.338	4800W 6.8Ω	2022	1	BR1K2W6P8	4	125	6.8Ω
	40	30	16.497	6000W 5Ω	2015	2	BR1K5W005	4	125	5Ω
50	37	20.6	9600W 4Ω	2015	2	BR1K2W008	8	125	4Ω	
460V Series	1	0.75	0.427	80W 750Ω			BR080W750	1	125	260Ω
	2	1.5	0.849	300W 400Ω			BR300W400	1	125	190Ω
	3	2.2	1.262	300W 250Ω			BR300W250	1	125	145Ω
	5	3.7	2.080	400W 150Ω			BR400W150	1	125	95Ω
	7.5	5.5	3.111	500W 100Ω			BR500W100	1	125	60Ω
	10	7.5	4.148	1000W 75Ω			BR1K0W075	1	125	45Ω
	15	11	6.186	1000W 50Ω	4030	1	BR1K0W050	1	50Ω	50Ω
	20	15	8.248	1500W 40Ω	4030	1	BR1K5W040	1	40Ω	40Ω
	25	18.5	10.281	4800W 32Ω	4030	1	BR1K2W008	4	32Ω	32Ω
	30	22	12.338	4800W 27.2Ω	4030	1	BR1K2W6P8	4	27.2Ω	27.2Ω
	40	30	16.497	6000W 20Ω	4030	1	BR1K5W005	4	20Ω	20Ω
	50	37	20.6	9600W 16Ω	4045	1	BR1K2W008	8	16Ω	16Ω
	60	45	24.745	9600W 13.6Ω	4045	1	BR1K2W6P8	8	13.6Ω	13.6Ω
75	55	31.11	12000W 10Ω	4030	2	BR1K5W005	8	10Ω	10Ω	
100	75	42.7	19200W 6.8Ω	4045	2	BR1K2W6P8	16	6.8Ω	6.8Ω	

Note:

1. Please select the factory default resistance value (Watt) and the frequency value (ED%)
2. If damage resulted in the drive or other equipments due to the fact that the braking resistors and the braking modules in use are not provided by Delta, the warranty will be void.
3. Take into consideration the safety of the environment when installing the braking resistors.
4. If the minimum resistance value is to be utilized, consult local dealers for the calculation of the Watt figures.
5. Please select thermal relay trip contact to prevent resistor over load.
6. When using more than 2 braking units, equivalent resistor value of parallel braking unit can't be less than the value in the column "Equivalent Minimum Resistor Value for Each AC Drive" (the right-most column in the table).



## Braking Resistors & Braking Units

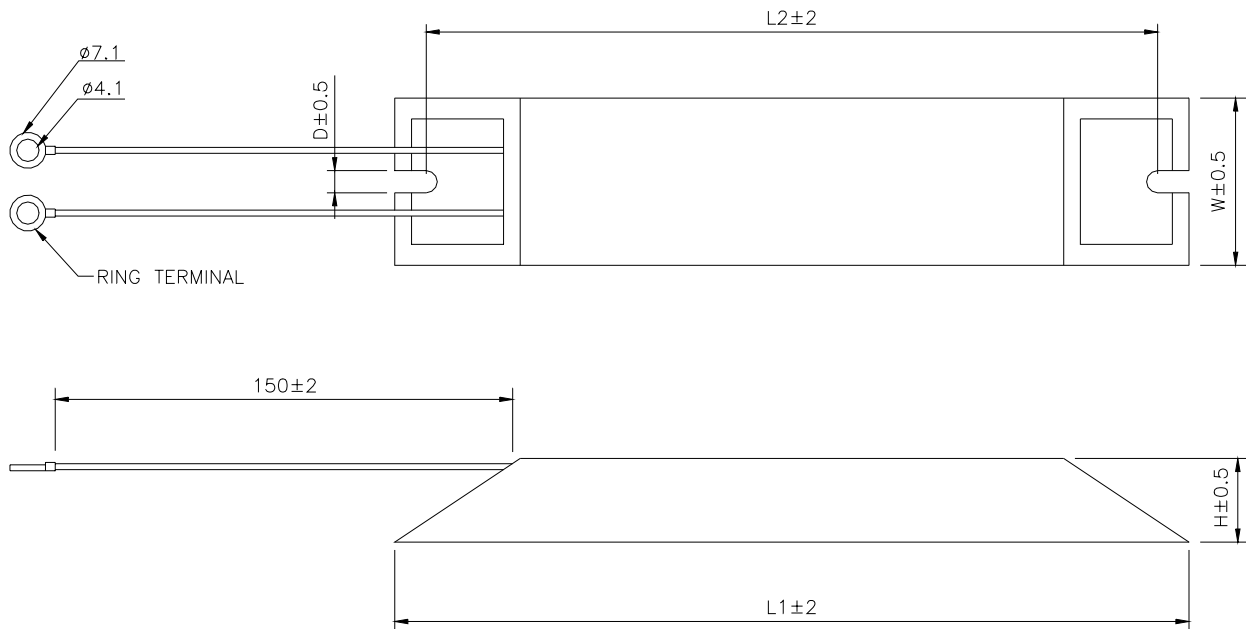

TYPE	L1	L2	H	D	W	MAX. WEIGHT (g)
MHR200W120	165	150	20	5.3	40	240
MHR400W120	165	150	20	5.3	40	240
BR080W200	140	125	20	5.3	60	160
BR080W750	140	125	20	5.3	60	160
BR300W070	215	200	30	5.3	60	750
BR300W100	215	200	30	5.3	60	750
BR300W250	215	200	30	5.3	60	750
BR300W400	215	200	30	5.3	60	750
BR400W150	265	250	30	5.3	60	930
BR400W040	265	250	30	5.3	60	930

## Braking Resistors & Braking Units

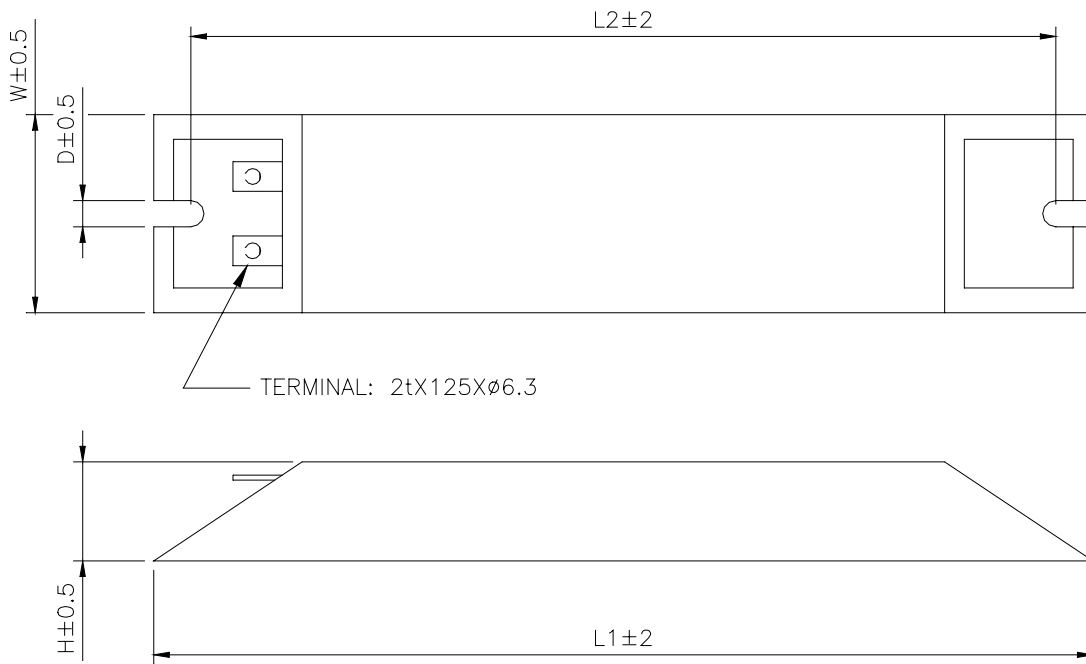

TYPE	L1	L2	H	D	W	MAX. WEIGHT (g)
MHR025W500	335	320	30	5.3	60	1100
MHR050W500	335	320	30	5.3	60	1100
MHR100W500	335	320	30	5.3	60	1100
BR500W030	335	320	30	5.3	60	1100
BR500W100	335	320	30	5.3	60	1100
BR1K0W020	400	385	50	5.3	100	2800
BR1K0W075	400	385	50	5.3	100	2800

**B**

## Braking Resistors & Braking Units

Braking resistors model no.: **BR1K0W050, BR1K2W008, BR1K2W6P8, BR1K5W005, BR1K5W040**

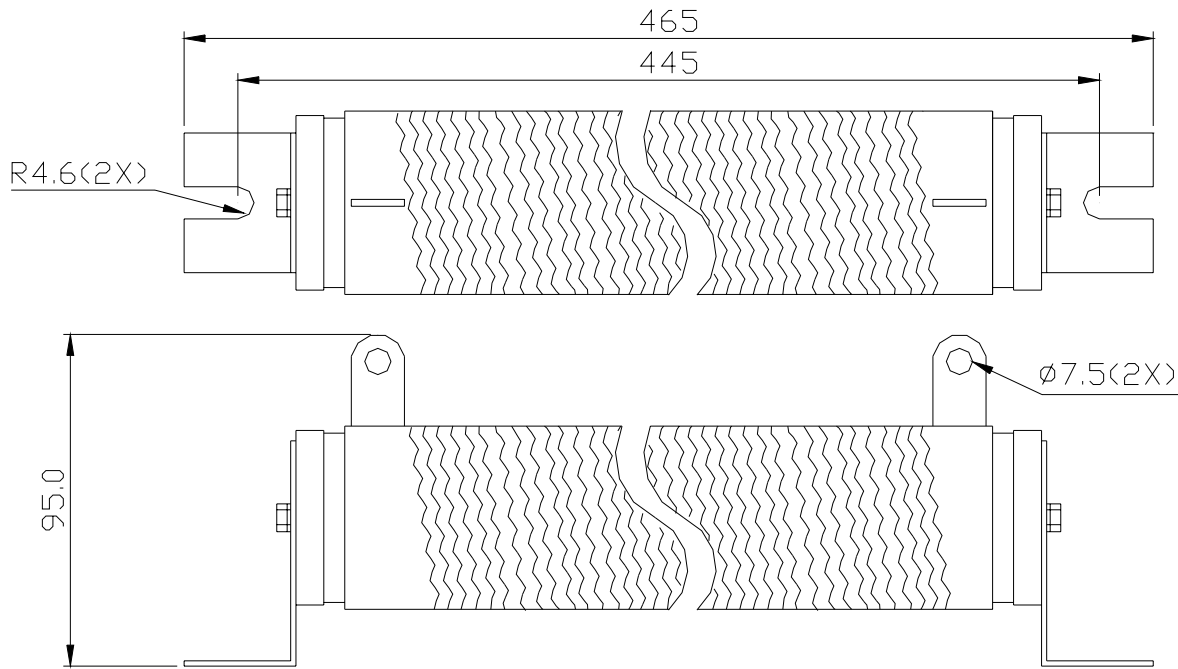

### B.3 AMD - EMI FILTER CORSS REFERENCE

AC Drives	Model Number	FootPrint
VFD007B21A, VFD015B21A	RF015B21AA	Y
VFD022B21A	RF022B21BA	Y
VFD007B43A, VFD015B43A, VFD022B43B	RF022B43AA	Y
VFD037B43A	RF037B43BA	Y
VFD055B43A, VFD075B43A, VFD110B43A	RF110B43CA	Y
VFD007B23A, VFD015B23A	10TDT1W4C	N
VFD022B23A, VFD037B23A	26TDT1W4C	N
VFD055B23A, VFD075B23A, VFD150B43A, VFD185B43A	50TDS4W4C	N
VFD110B23A, VFD150B23A, VFD220B43A, VFD300B43A, VFD370B43A	100TDS84C	N
VFD550B43A, VFD750B43A	200TDDS84C	N
VFD185B23A, VFD220B23A, VFD300B23A, VFD450B43A	150TDS84C	N
VFD370B23A	180TDS84C	N
VFD022B23B	20TDT1W4D	N
VFD022B21B	35DRT1W3C	N
VFD037B43B, VFD037B23B	26TDT1W4B4	N

**B**

Order P/N: RF015B21AA / RF022B43AA

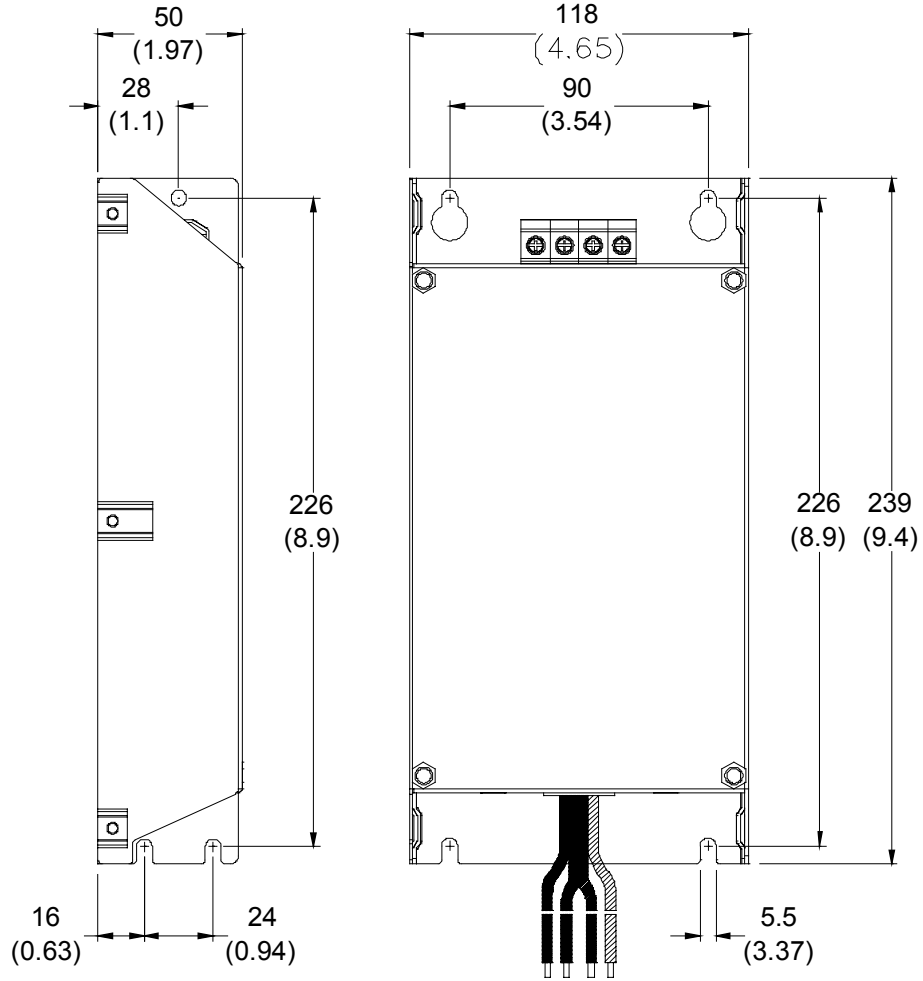
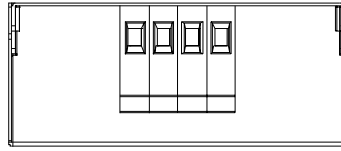

Order P/N: RF022B21BA / RF037B43BA

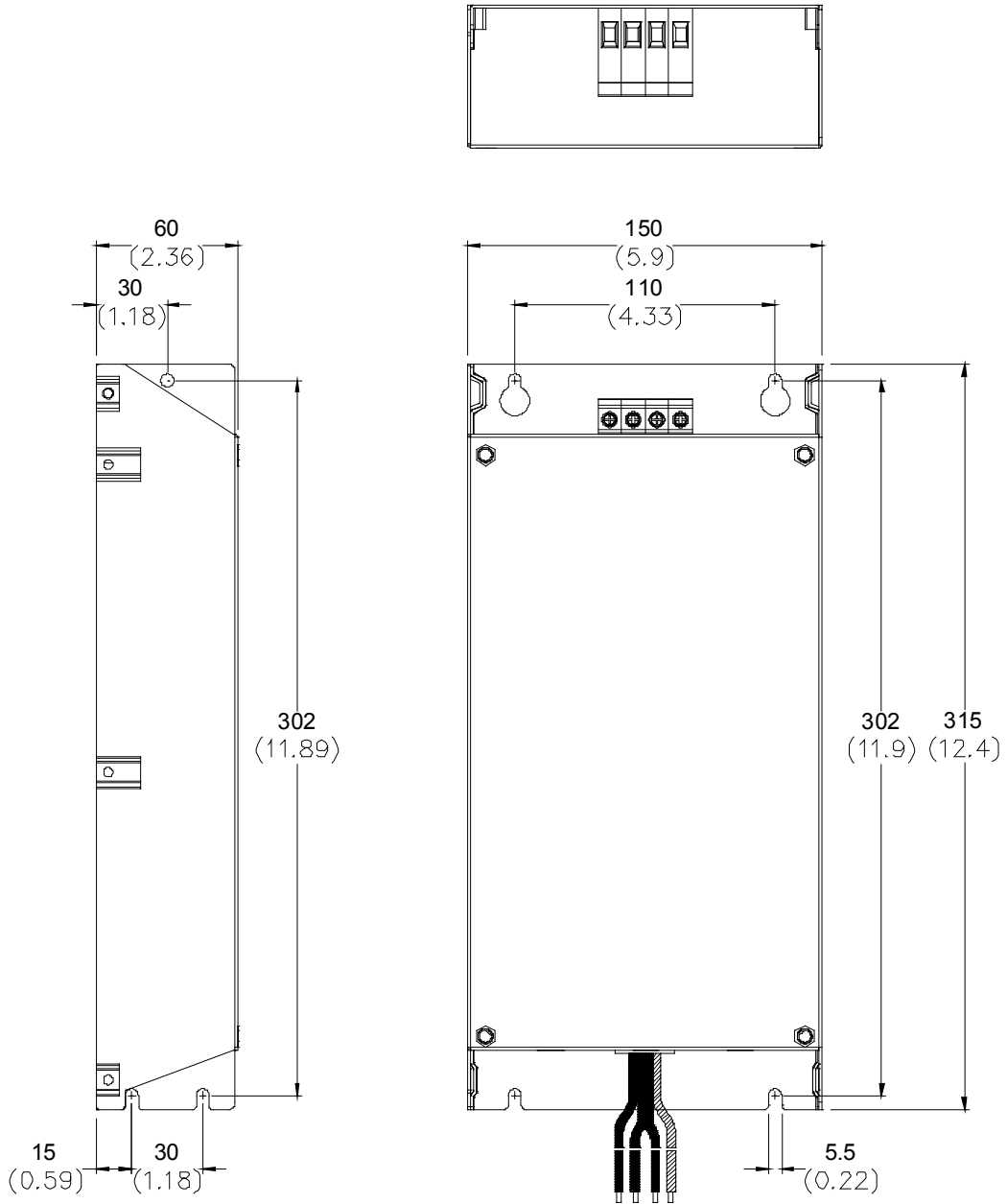

**B**



**Order P/N: RF110B43CA**

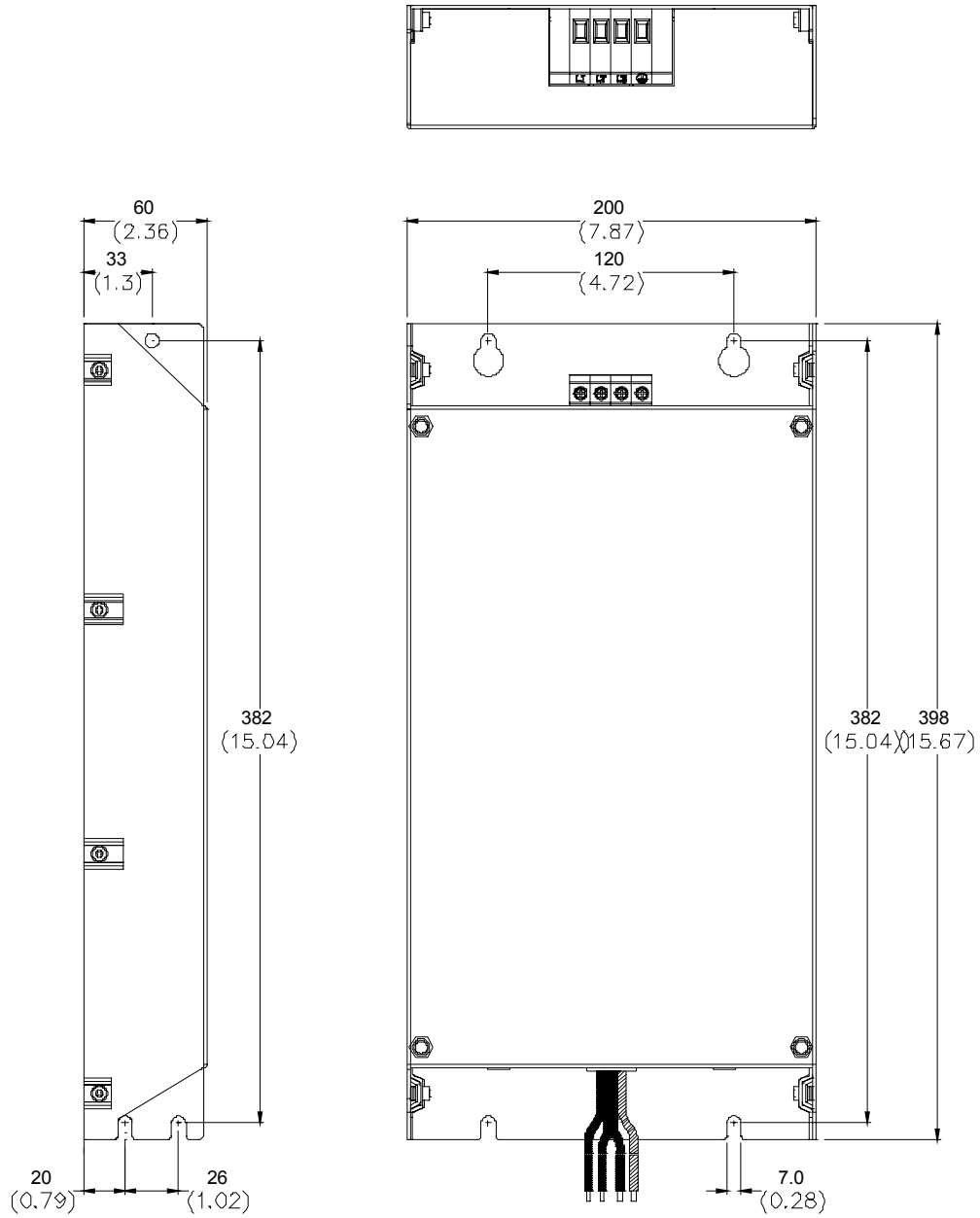

**Order P/N: 10TDT1W4C**

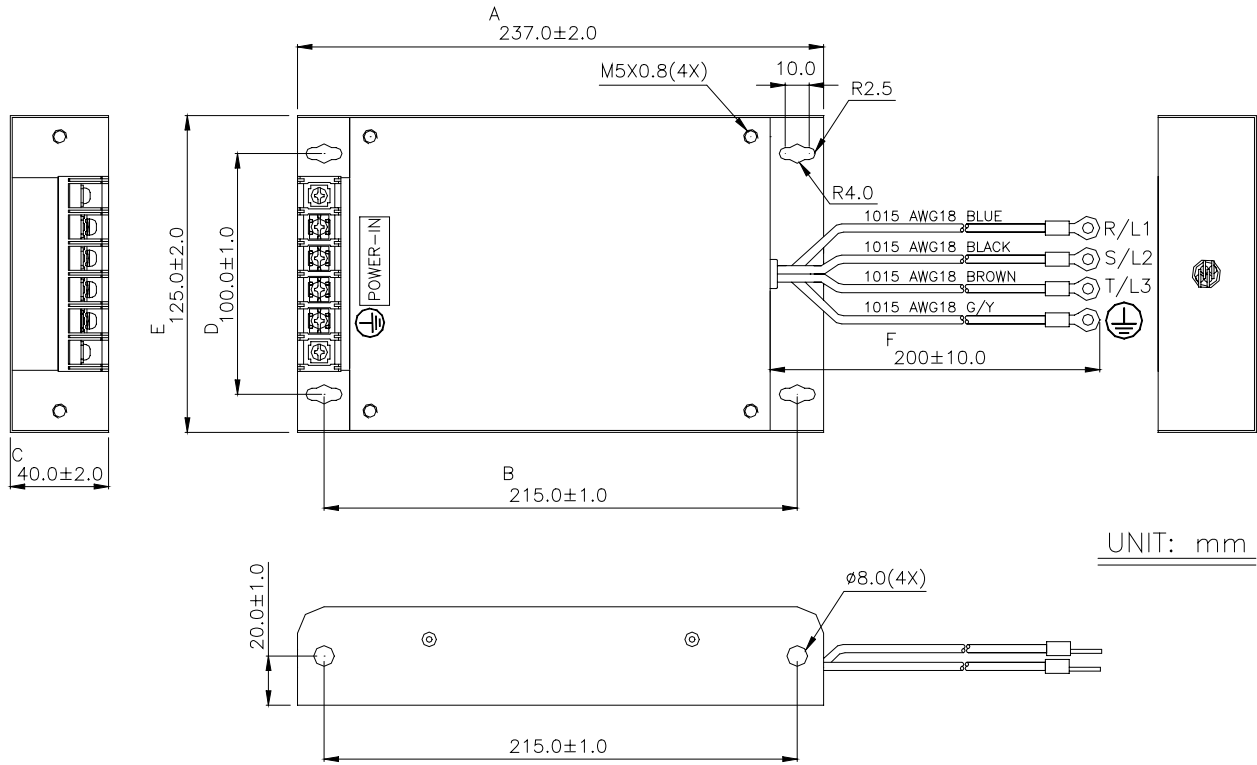

**Order P/N: 26TDT1W4C**

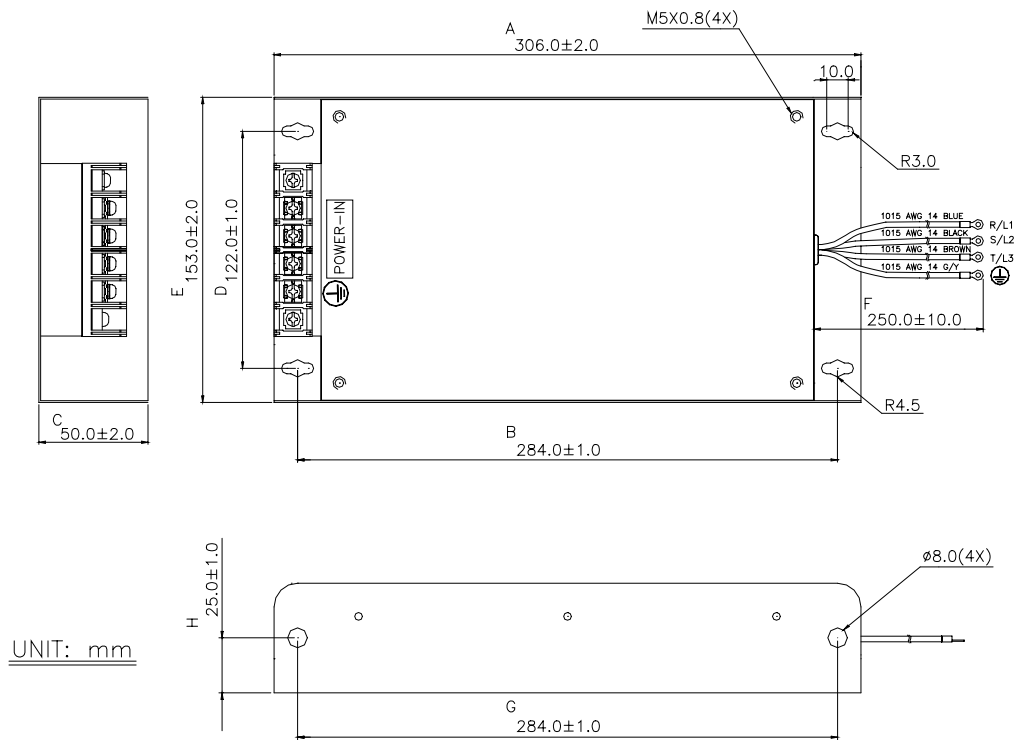

**Order P/N: 50TDS4W4C**

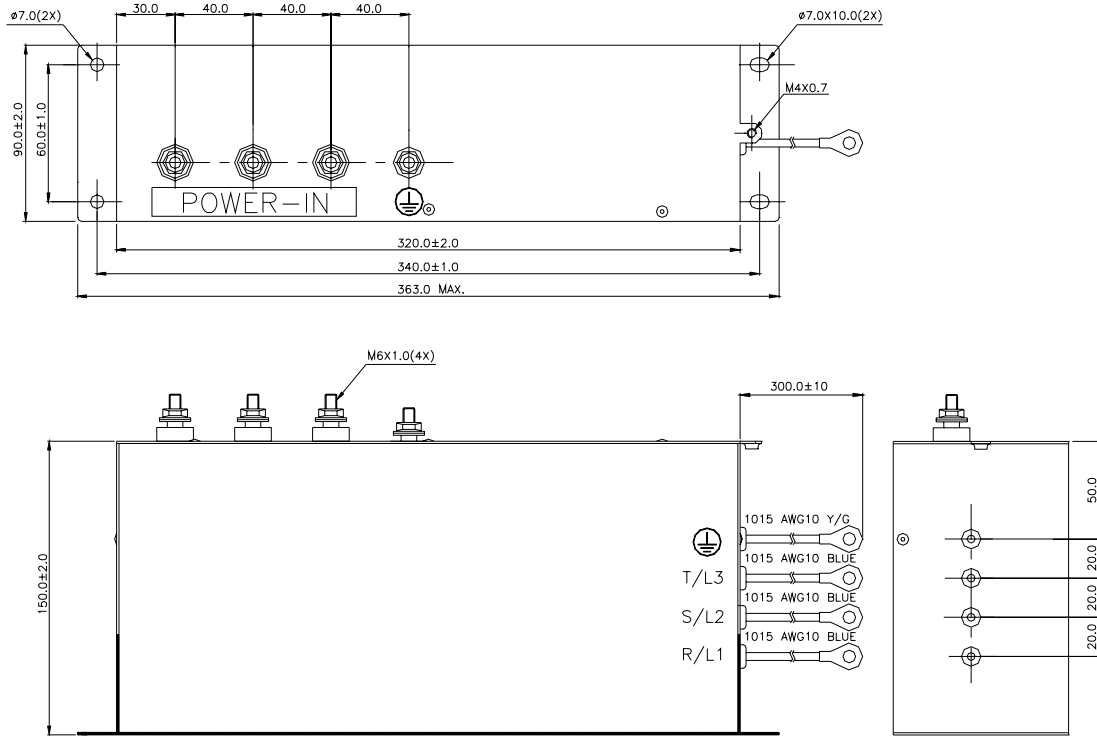

**Order P/N: 100TDS84C**

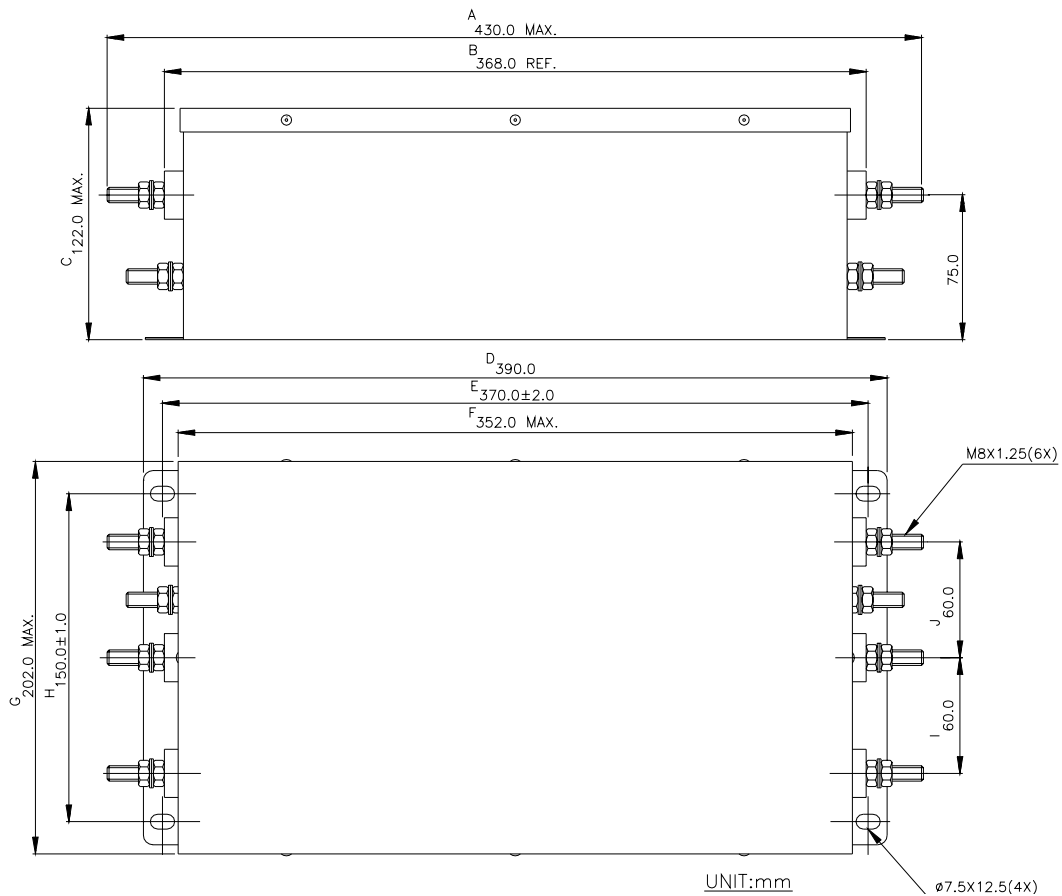

UNIT:mm

**Order P/N: 200TDDS84C**

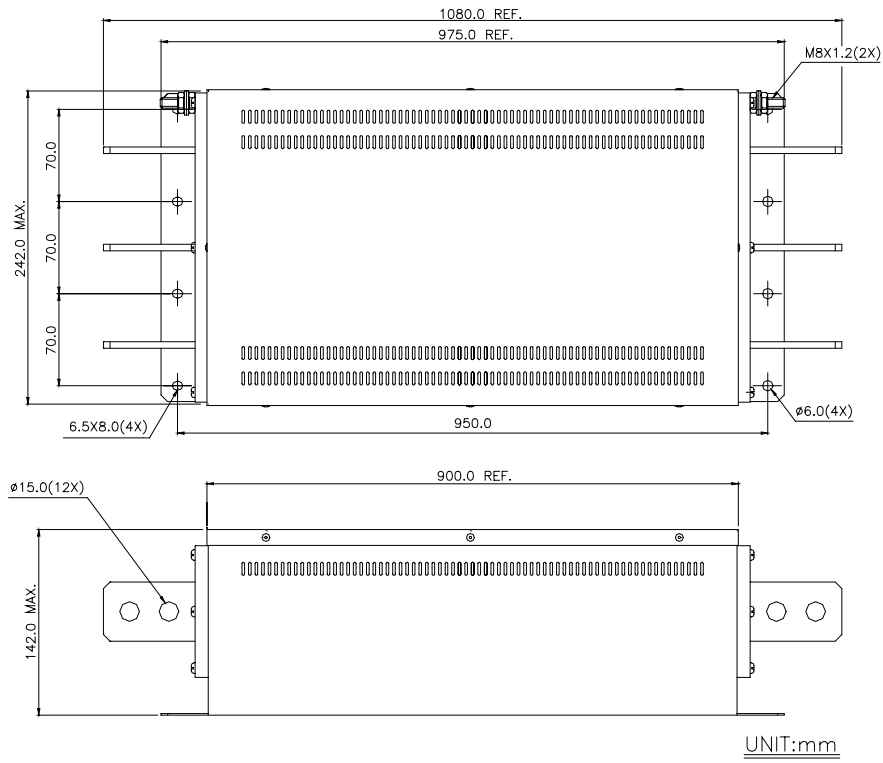

**Order P/N: 150TDS84C**

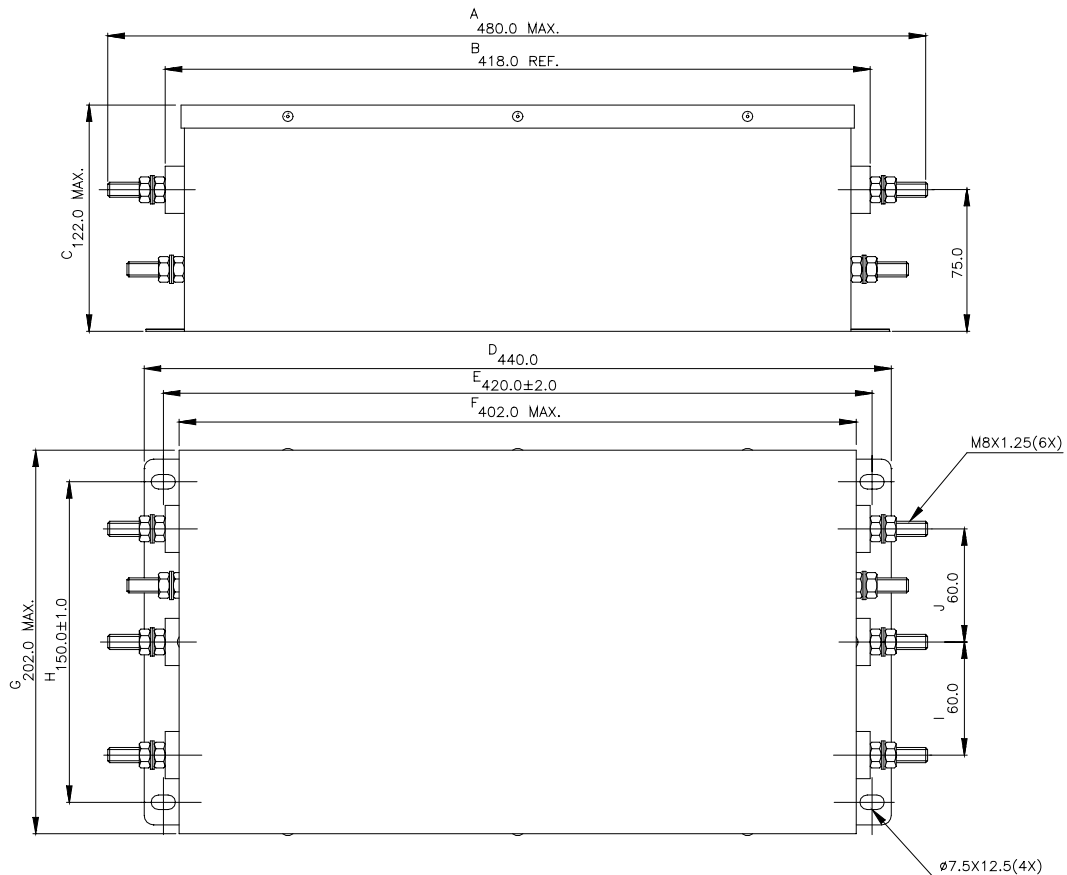

**Order P/N: 180TDS84C**

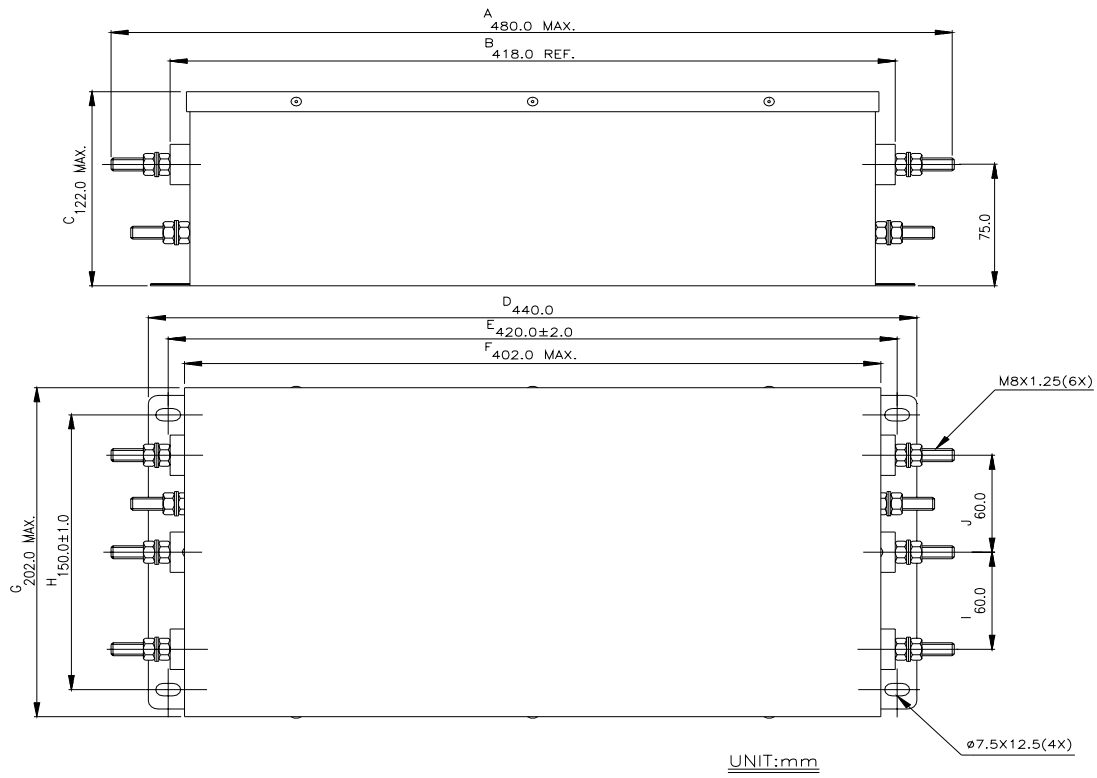

**Order P/N: 20TDT1W4D**

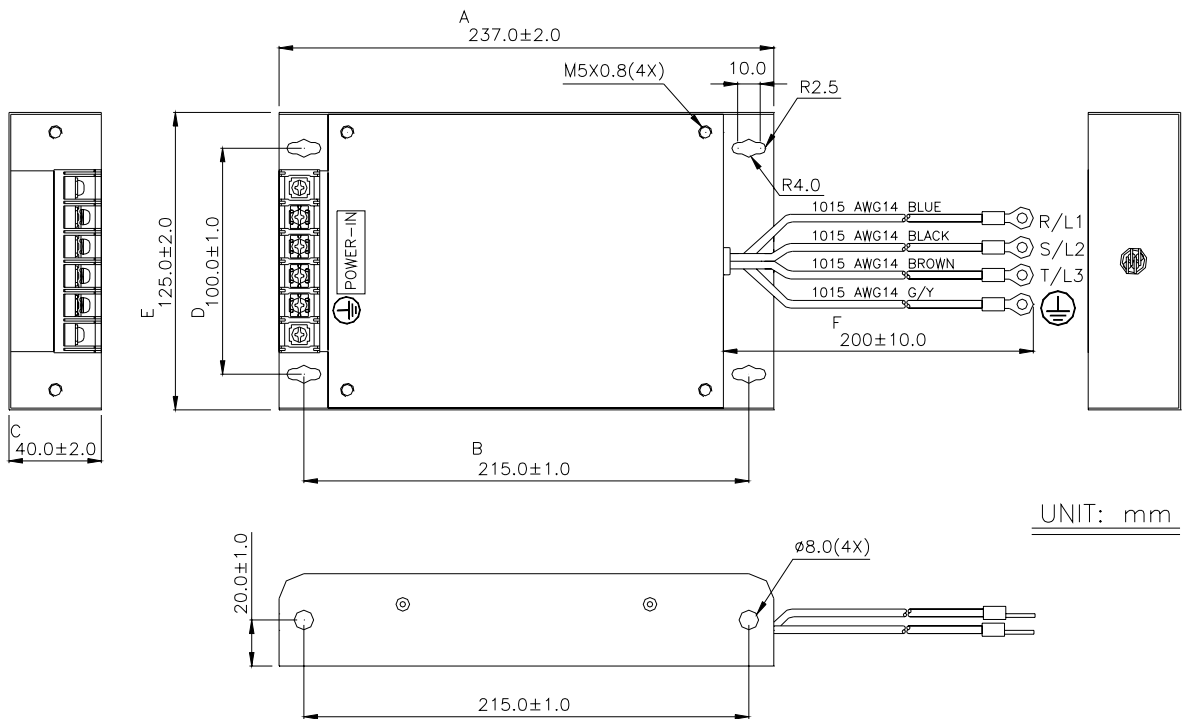

Order P/N: 26TDT1W4B4

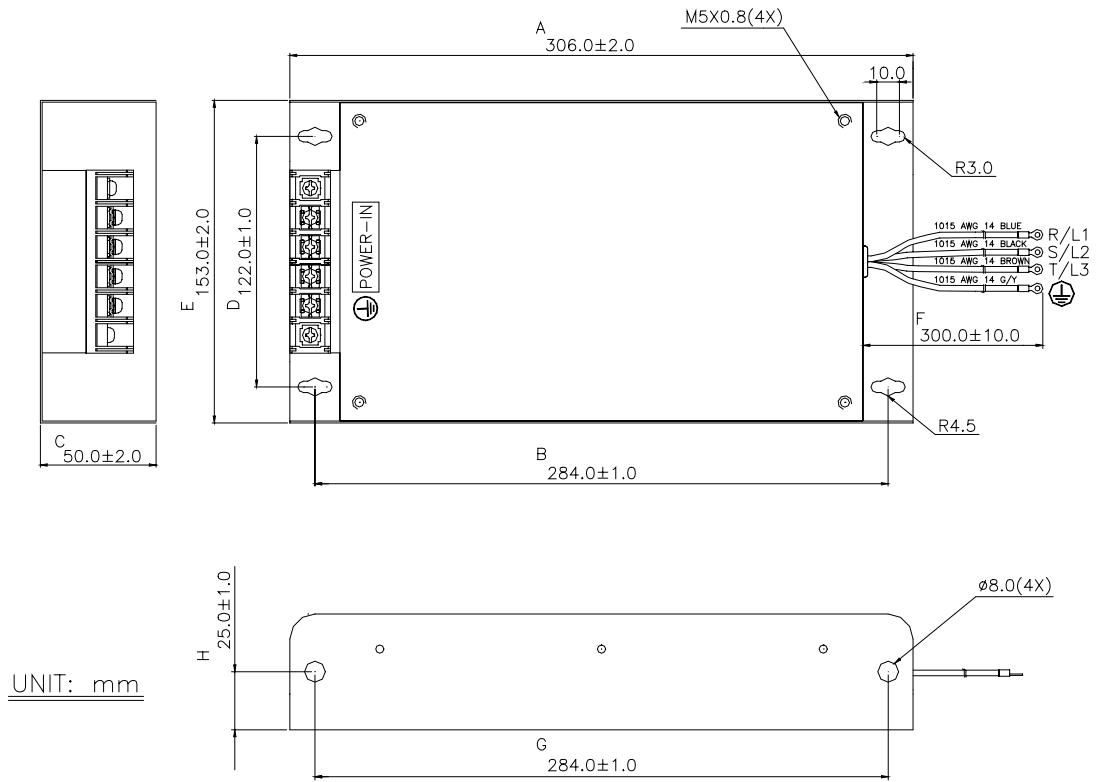

**B**

## B.4 PG Card (Refer to Pr.10-10 to 10-15 of related parameter settings)

### Section 1 Installation

#### 1.1) 1 to 2HP (0.75kW to 1.5kW)

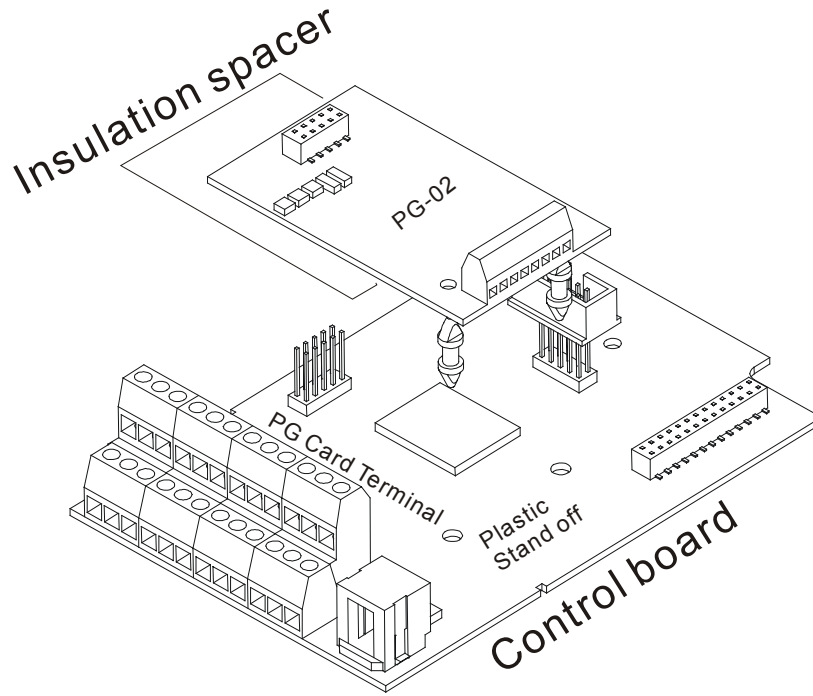

#### 1.2) 3 to 5HP (2.2kW to 3.7kW)

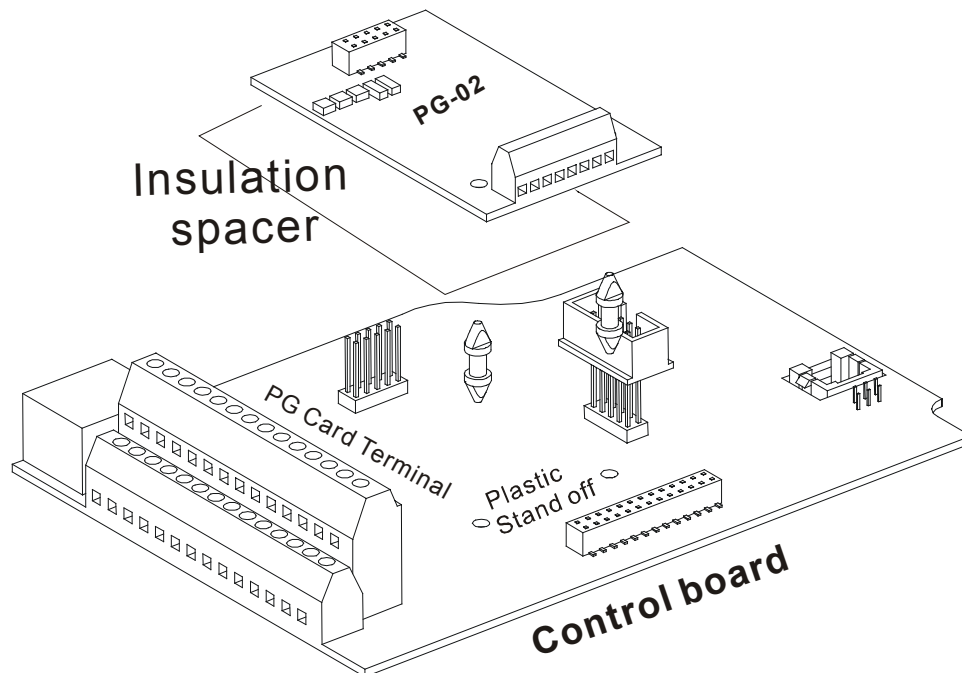

1.3) 7.5HP (5.5kW) and above

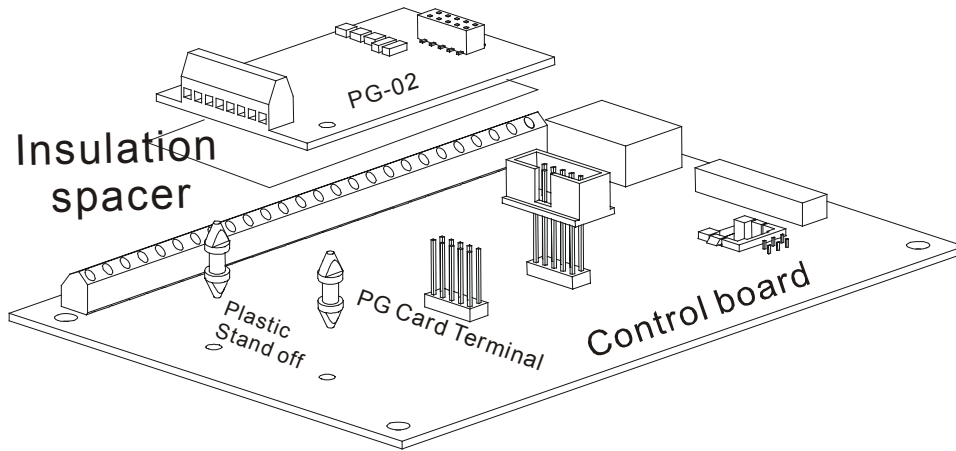

Section 2 PG Card and Pulse Generator

2.1) Basic Wiring Diagram

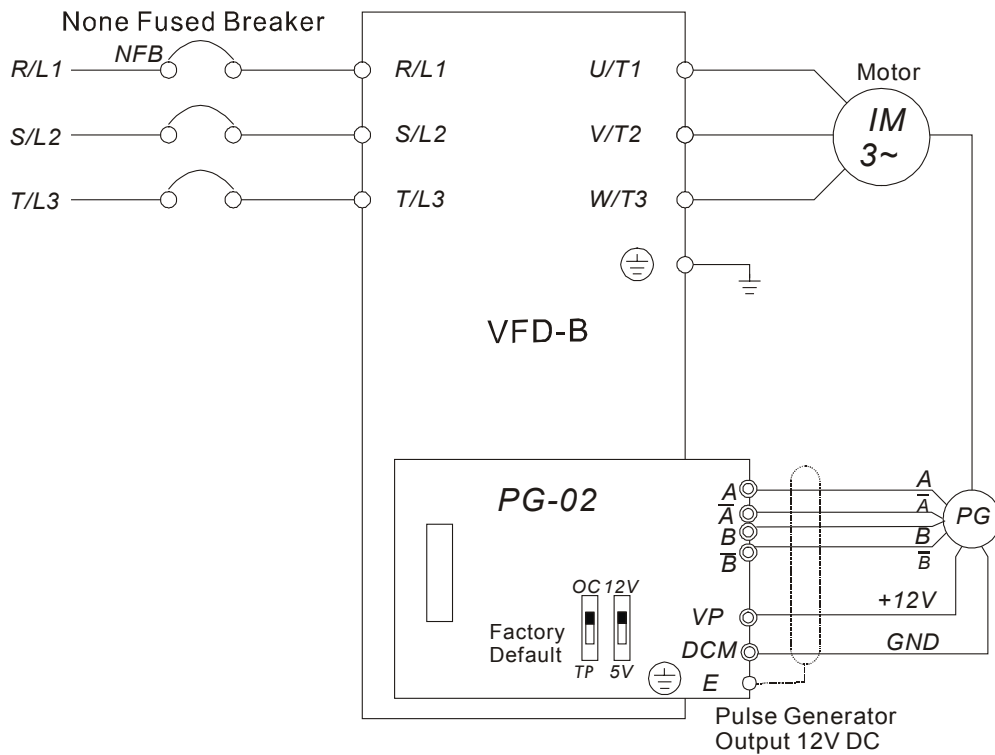

PG-02 and Pulse Generator Connections





2.2) Basic Wiring Diagram with RPM Meter Attached.

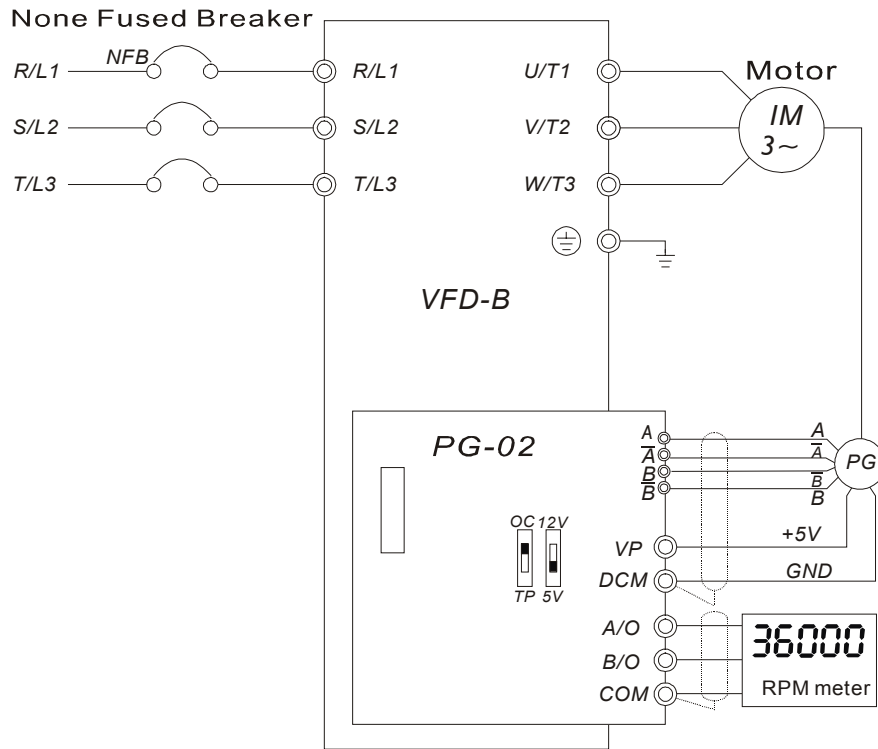

PG-02 and Pulse Generator Connections

2.3) When Pulse Generators is Open Collector type, please refer to following wiring.

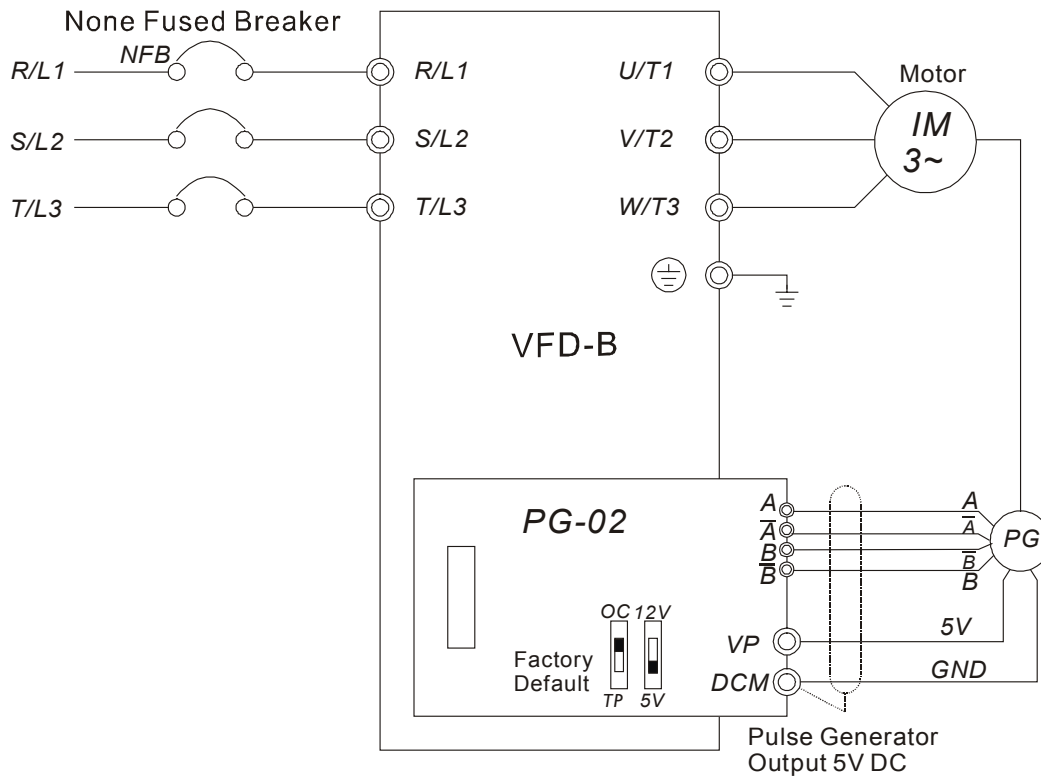

## Section 3 PG-02 Terminal Descriptions

### 3.1) Terminals

Terminal Symbols	Descriptions
VP	Power source of PG-02 (FSW1 can be switched to 12V or 5V) Output Voltage: (+12VDC $\pm 5\%$ 200mA) or (+5VDC $\pm 2\%$ 400mA)
DCM	Power source (VP) and input signal (A, B) common
A, $\bar{A}$ , B, $\bar{B}$	Input signal from Pulse Generator. Input type is selected by FSW2. Please See section 3.4. Maximum 500KP/Sec
A/O, B/O	PG-02 output signal for use with RPM Meter. (Open Collector) Maximum DC24V 100mA
COM	PG-02 output signal (A/O, B/O) common.

### 3.2) Wiring Notes

**The control, power supply and motor leads must be laid separately. They must not be fed through the same cable conduit / trunking.**

1. Please use a shield cable to prevent interference. Do not run control wire parallel to any high voltage AC power line (220 V and up).
2. Connect shielded wire to  $\oplus$  E only.
3. Recommended wire size 0.21 to 0.81mm<sup>2</sup> (AWG24 to AWG18).
4. Wire length:

Types of Pulse Generators	Maximum Wire Length	Wire Gauge
Output Voltage	50m	1.25mm <sup>2</sup> (AWG16) or above
Open Collector	50m	
Line Driver	300m	
Complementary	70m	

**B**

### 3.3) Control Terminals Block Designations.

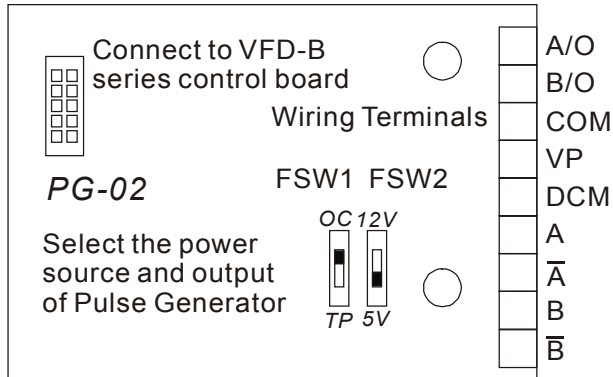

### 3.4) Types of Pulse Generators

Types of Pulse Generators		FSW1 and FSW2 switches	
		5V	12V
Output Voltage			
Open collector			
Line driver			
Complimentary			

## B.5 Remote Controller RC-01

Unit: mm (inches)

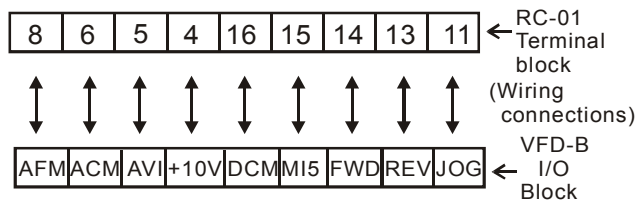
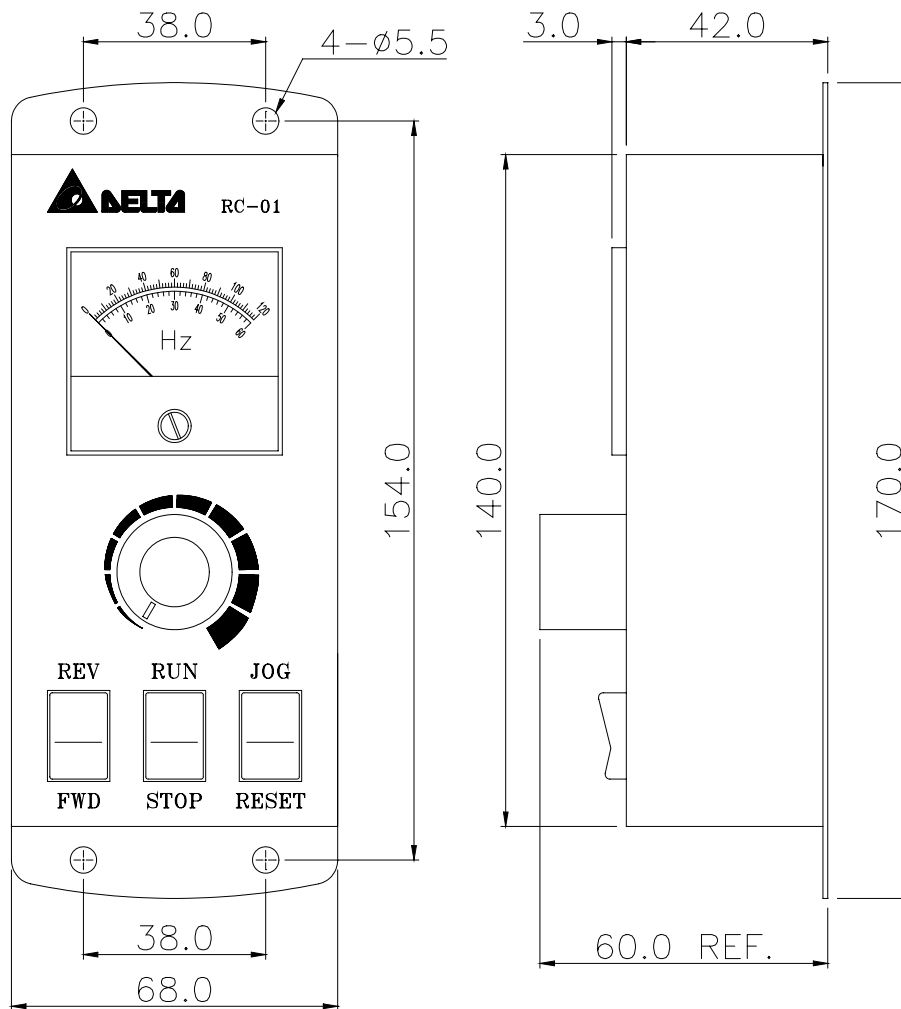

B

### VFD-B Programming:

Pr.02-00 set to 1

Pr.02-01 set to 1 (external controls)

Pr.02-05 set to 1 (setting Run/Stop and Fwd/Rev controls)

Pr.04-08 (MI5) set to 8 (External reset)

## B.6 Remote Panel Adapter (RPA 01)

Remote panel adapter for VFDPU01

VFD-PU01 Assembly figure is as following:

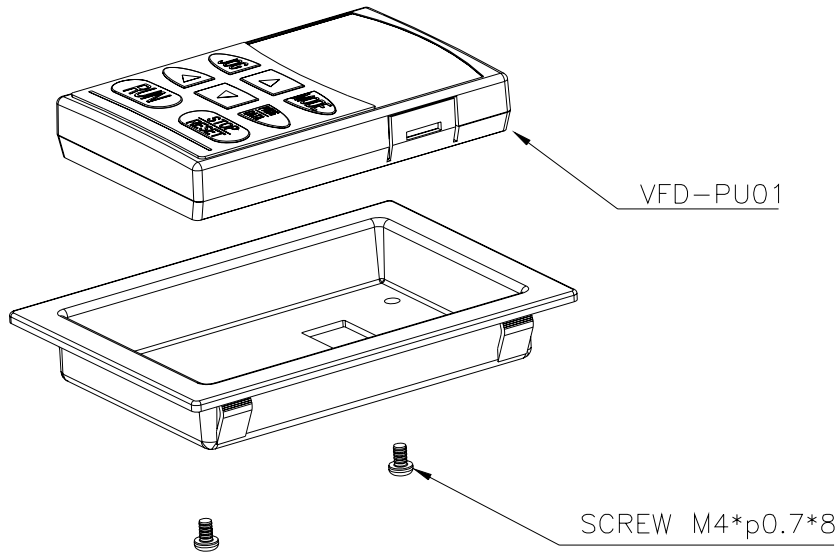

Please refer to the following screw hole dimension according to panel thickness:

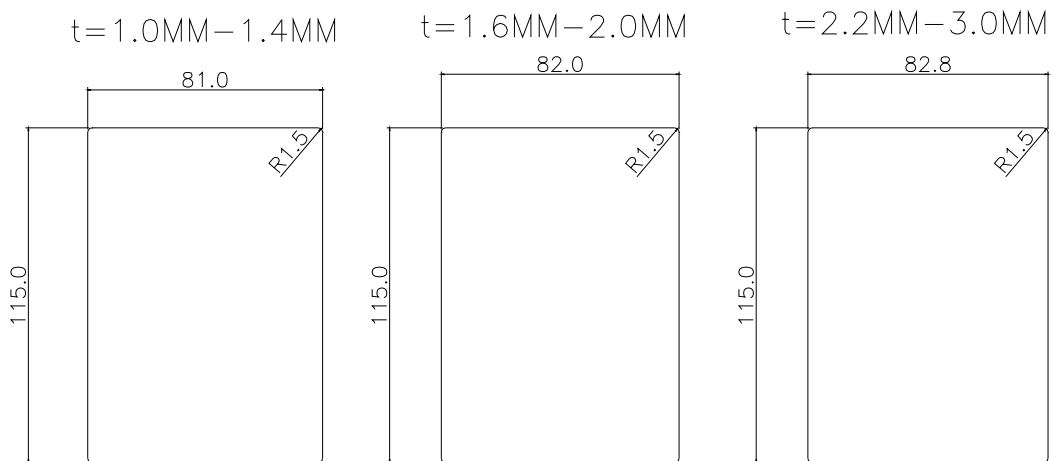

## B.7 Zero Phase Reactor (RF220X00A)

### 1. Dimension

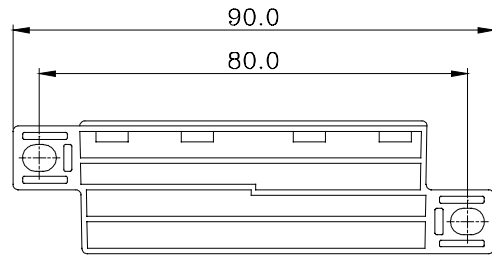
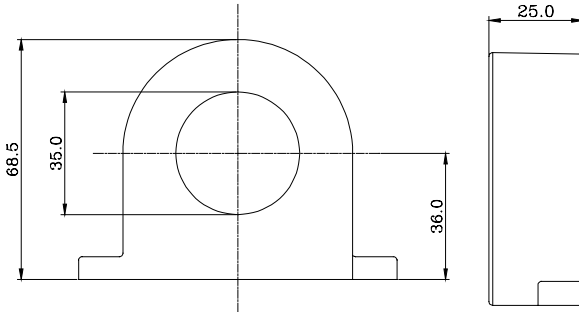

	Motor		Qty.	Recommended Wire Size (mm <sup>2</sup> )	Wiring Method			
	HP	kW						
230 V Series	1/4	0.2	1	0.5 - 5.5	Diagram A			
	1/2	0.5						
	1	0.75						
	2	1.5		3.5 - 5.5				
	3	2.2						
	5	3.7						
	7.5	5.5	4	8	Diagram B			
	10	7.5						
	15	11						
	20	15						
	25	18.5						
	30	22						
40	30	38	38 - 100					
50	37							
460 V Series	1/4				0.2	1	0.5 - 5.5	Diagram A
	1/2				0.5			
	1	0.75						
	2	1.5	3.5 - 5.5					
	3	2.2						
	5	3.7						
	7.5	5.5	4	8 - 14	Diagram B			
	10	7.5						
	15	11						
	20	15						
	25	18.5						
	30	22						
40	30	22	30					
50	37							
60	45							
75	55							
100	75	38 - 100						

#### Diagram A

Please wind each wire **4 times** around the core. The reactor must be put at inverter side as close as possible.

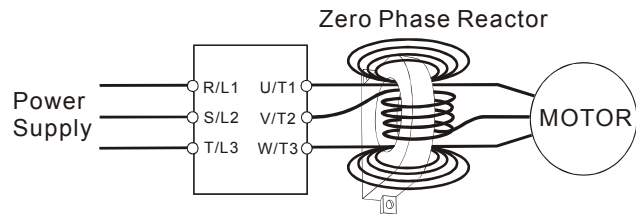

#### Diagram B

Please put all wires through 4 cores in series without winding.

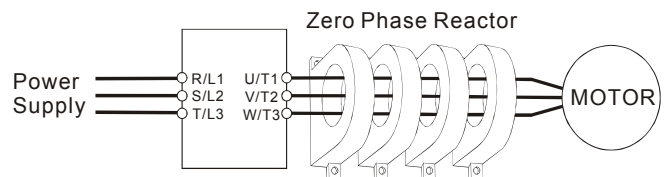

**B**



# DIMENSIONS

VFD007B23A 0.75 kW (1HP) 230V / 3-phase

VFD007B43A 0.75 kW (1HP) 460V / 3-phase

Unit: mm (inches)

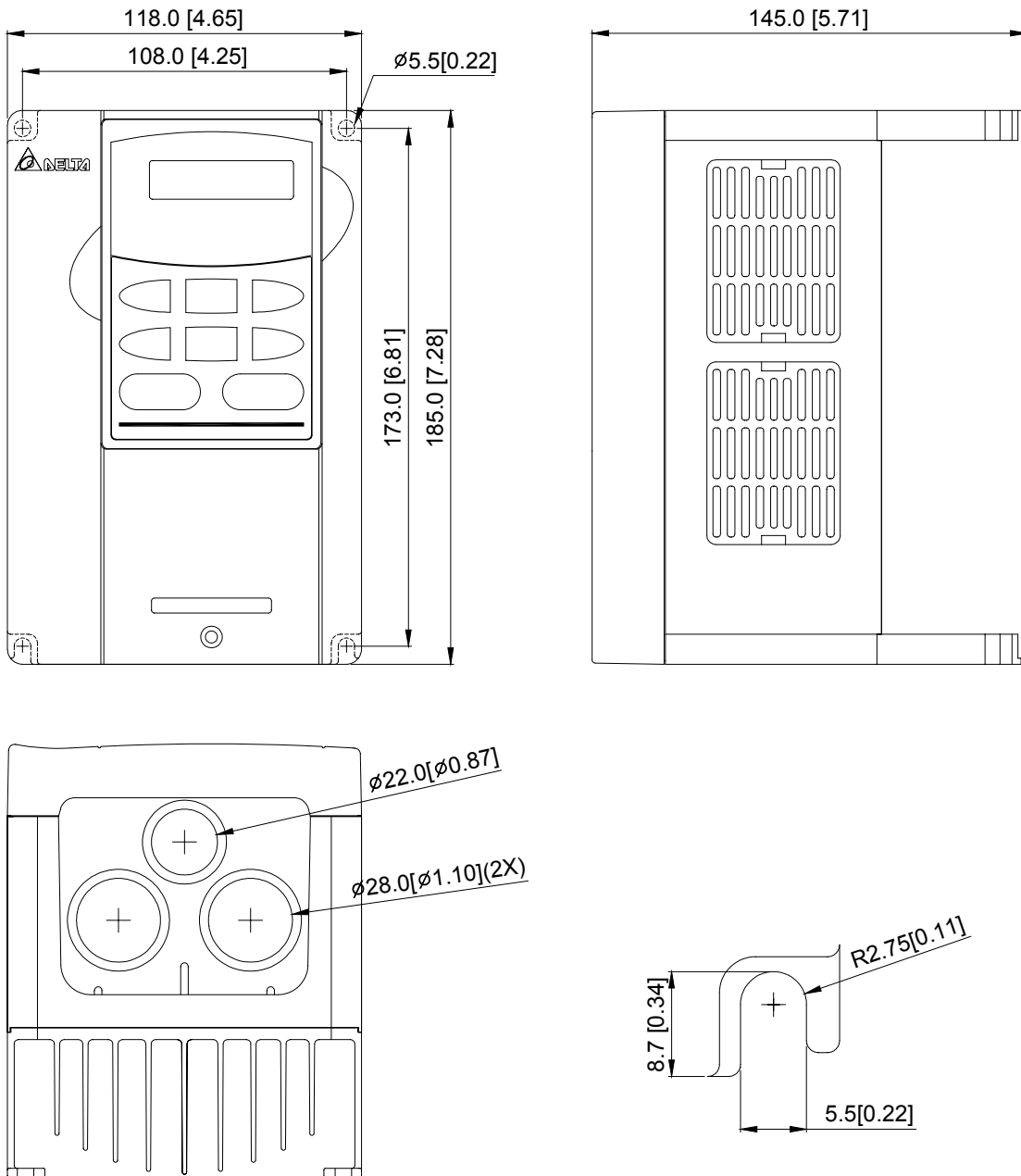



- VFD007B21A 0.75 kW (1HP) 230V / 1-phase**
- VFD015B21A 1.50 kW (2HP) 230V / 1-phase**
- VFD015B23A 1.50 kW (2HP) 230V / 3-phase**
- VFD015B43A 1.50 kW (2HP) 460V / 3-phase**

**Unit: mm (inches)**

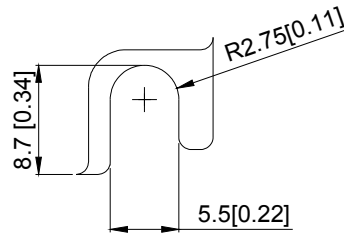
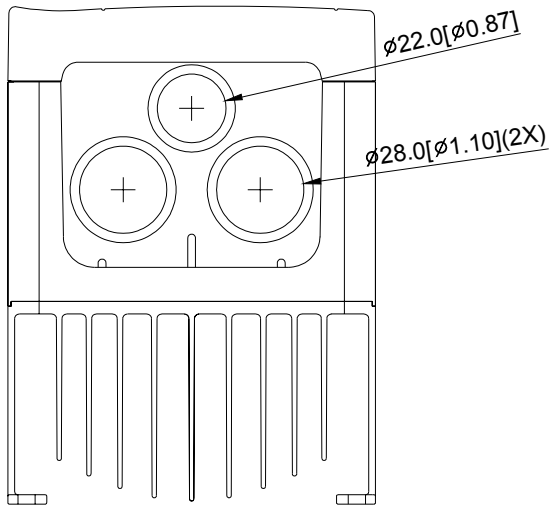
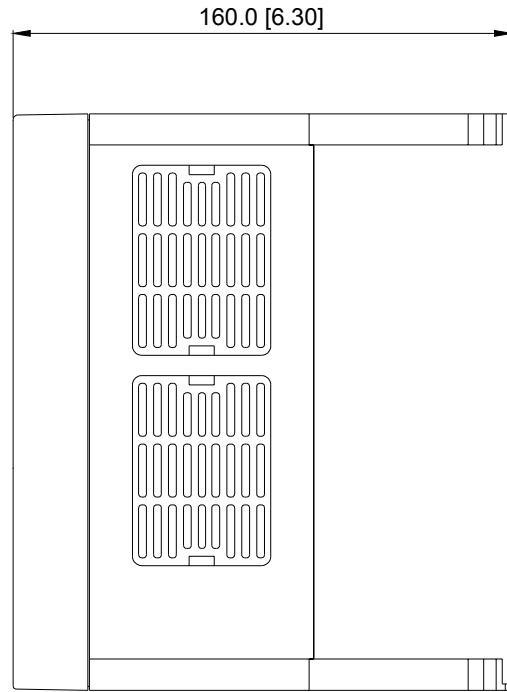
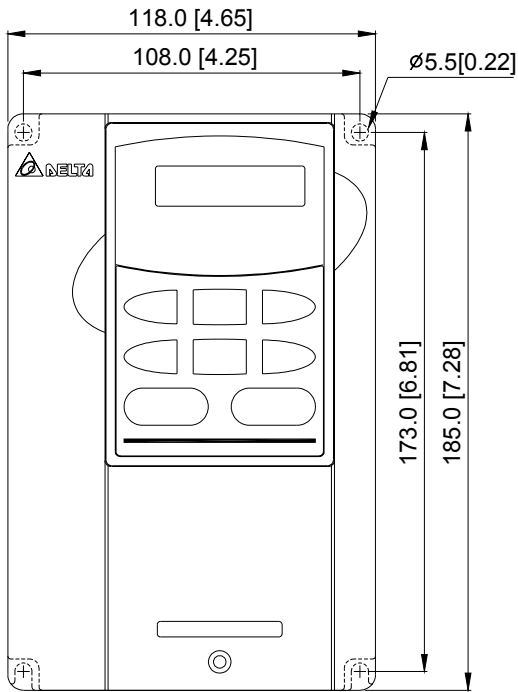

- VFD015B21B 1.50 kW (2HP) 230V / 1-phase**
- VFD015B23B 1.50 kW (2HP) 230V / 3-phase**
- VFD022B23B 2.20 kW (3HP) 230V / 3-phase**
- VFD022B43B 2.20 kW (3HP) 460V / 3-phase**

**Unit: mm (inches)**

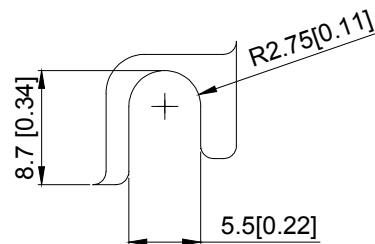
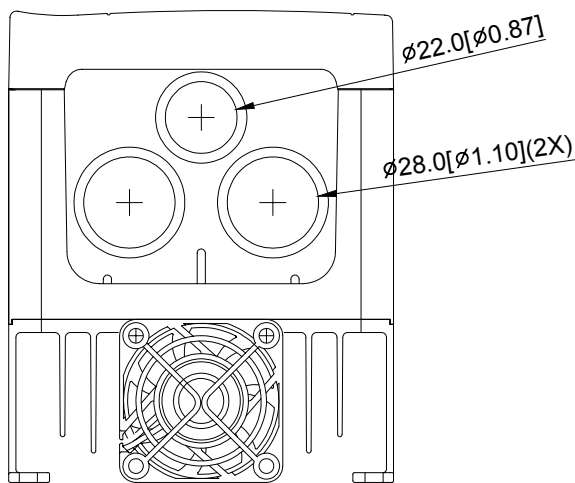
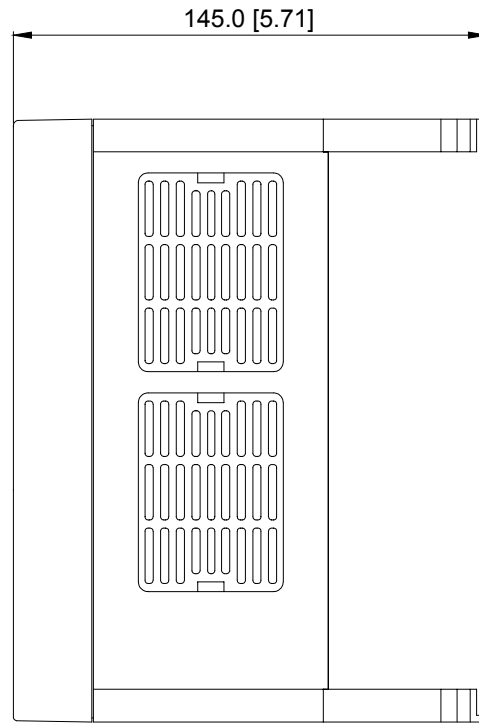
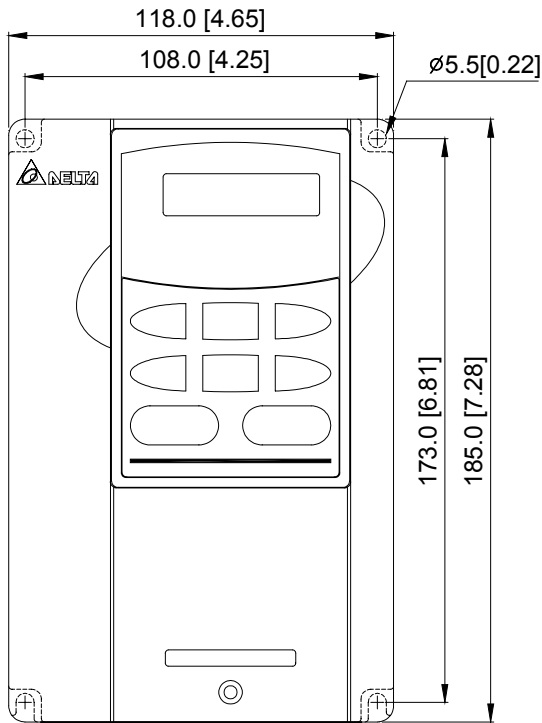

- VFD022B21A    2.20 kW (3HP) 230V / 1-phase**
- VFD037B23A    3.70 kW (5HP) 230V / 3-phase**
- VFD037B43A    3.70 kW (5HP) 460V / 3-phase**

**Unit: mm (inches)**

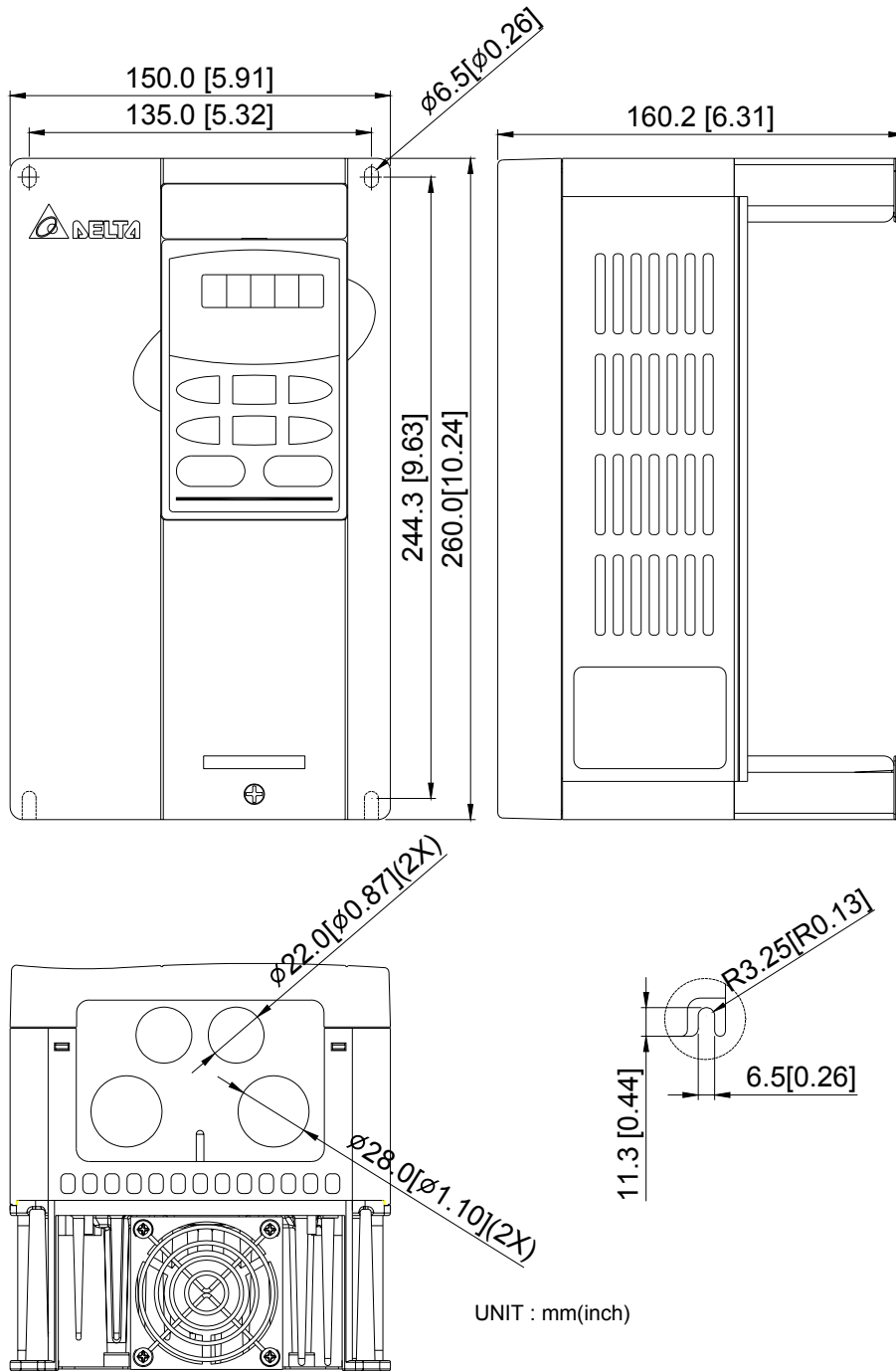

- VFD055B23A 5.50 kW (7.50HP) 230V / 3-phase**
- VFD055B43A 5.50 kW (7.50HP) 460V / 3-phase**
- VFD075B23A 7.50 kW (10.0HP) 230V / 3-phase**
- VFD075B43A 7.50 kW (10.0HP) 460V / 3-phase**
- VFD110B23A 11.0 kW (15.0HP) 230V / 3-phase**
- VFD110B43A 11.0 kW (15.0HP) 460V / 3-phase**

**Unit: mm (inches)**

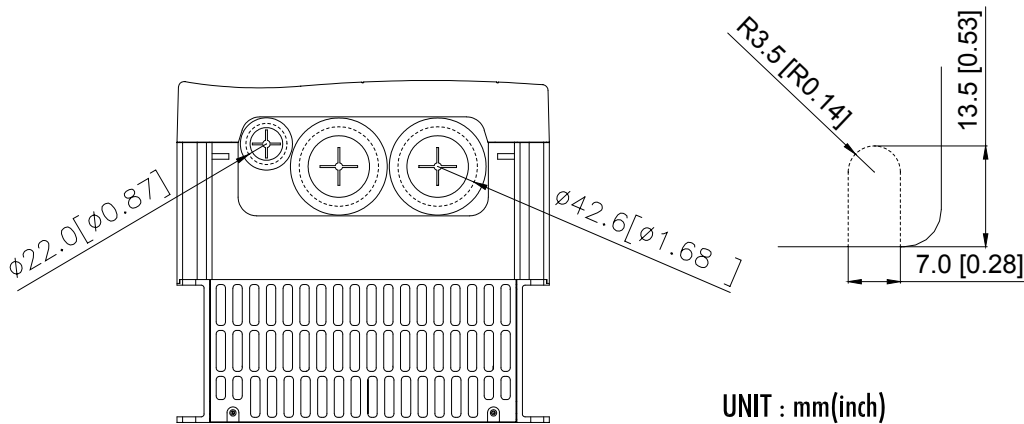
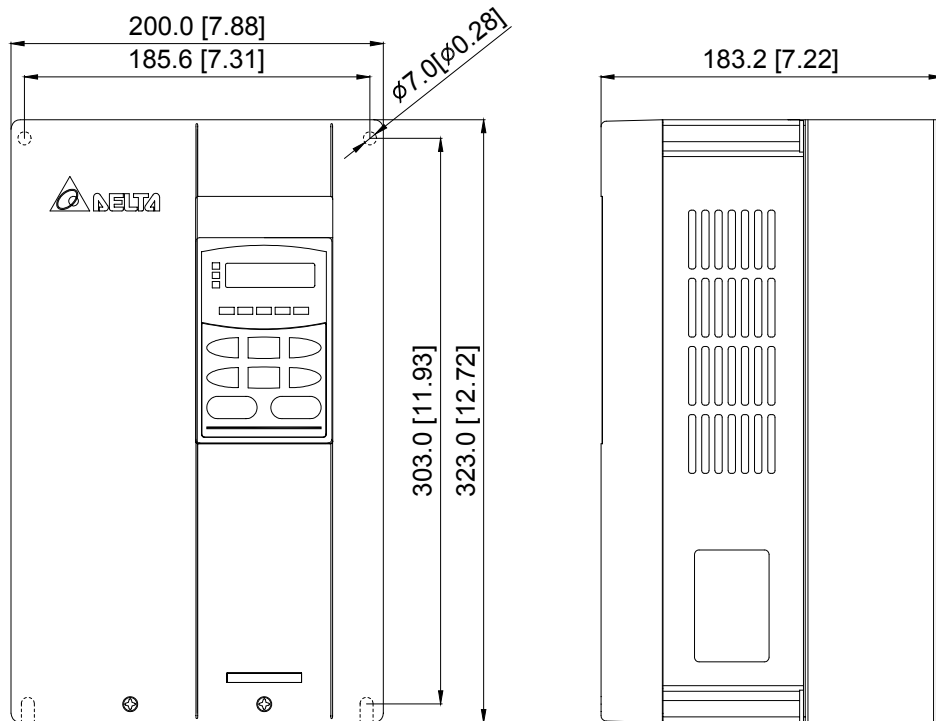

UNIT : mm(inch)



- VFD150B23A 15.0 kW (20.0HP) 230V / 3-phase**
- VFD150B43A 15.0 kW (20.0HP) 460V / 3-phase**
- VFD185B23A 18.5 kW (25.0HP) 230V / 3-phase**
- VFD185B43A 18.5 kW (25.0HP) 460V / 3-phase**
- VFD220B23A 22.0 kW (30.0HP) 230V / 3-phase**
- VFD220B43A 22.0 kW (30.0HP) 460V / 3-phase**

**Unit: mm (inches)**

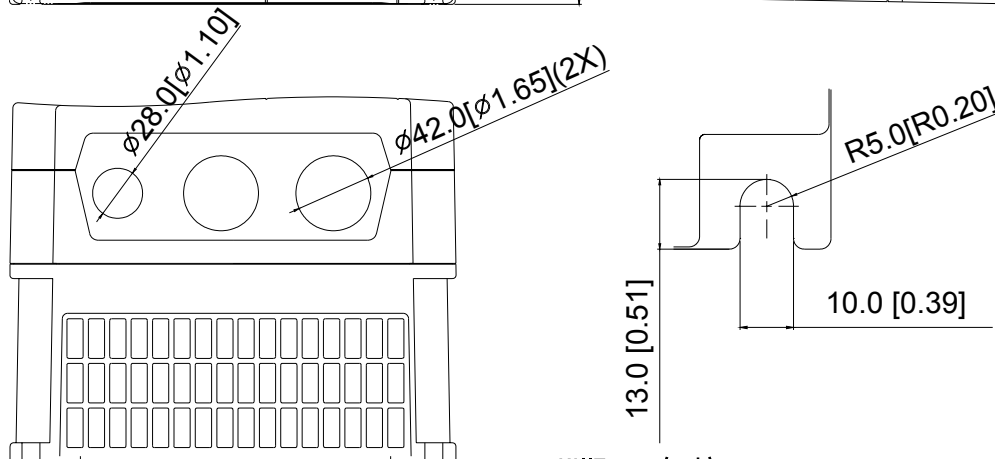
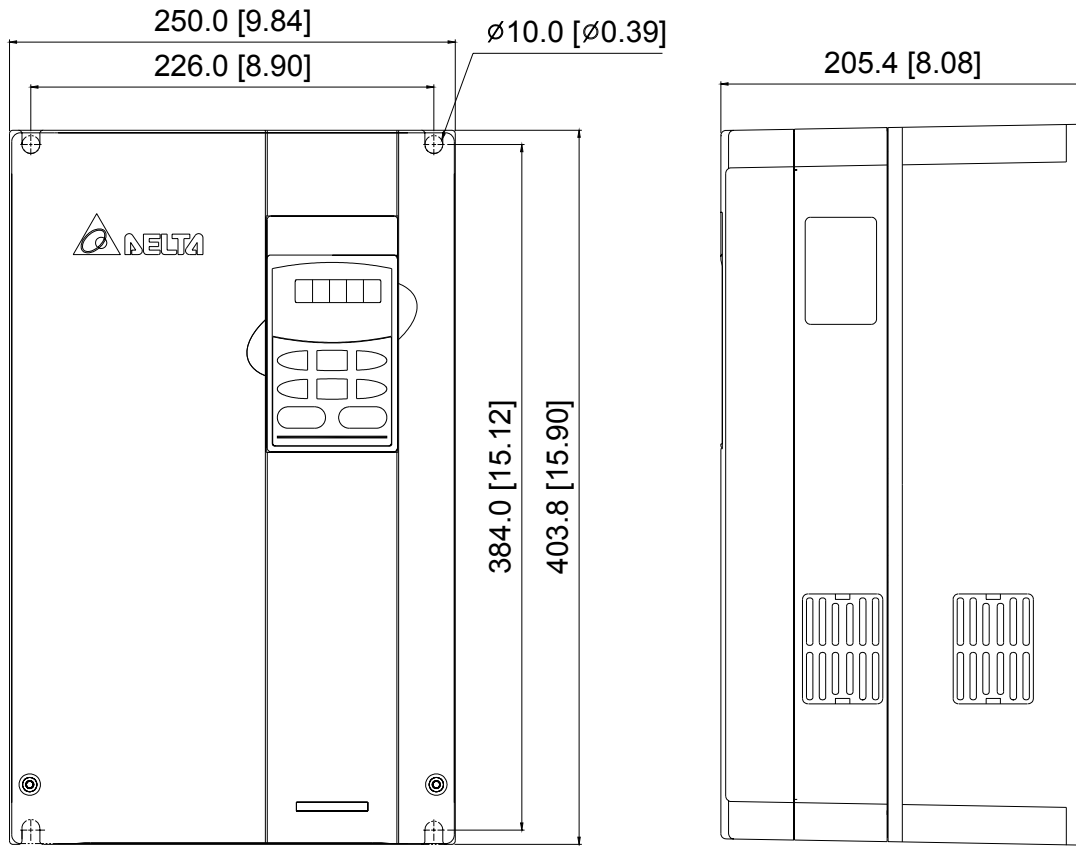

**UNIT : mm(inch)**

VFD300B23A 30.0 kW (40HP) 230V / 3-phase

VFD370B23A 37.0 kW (50HP) 230V / 3-phase

Unit: mm (inches)

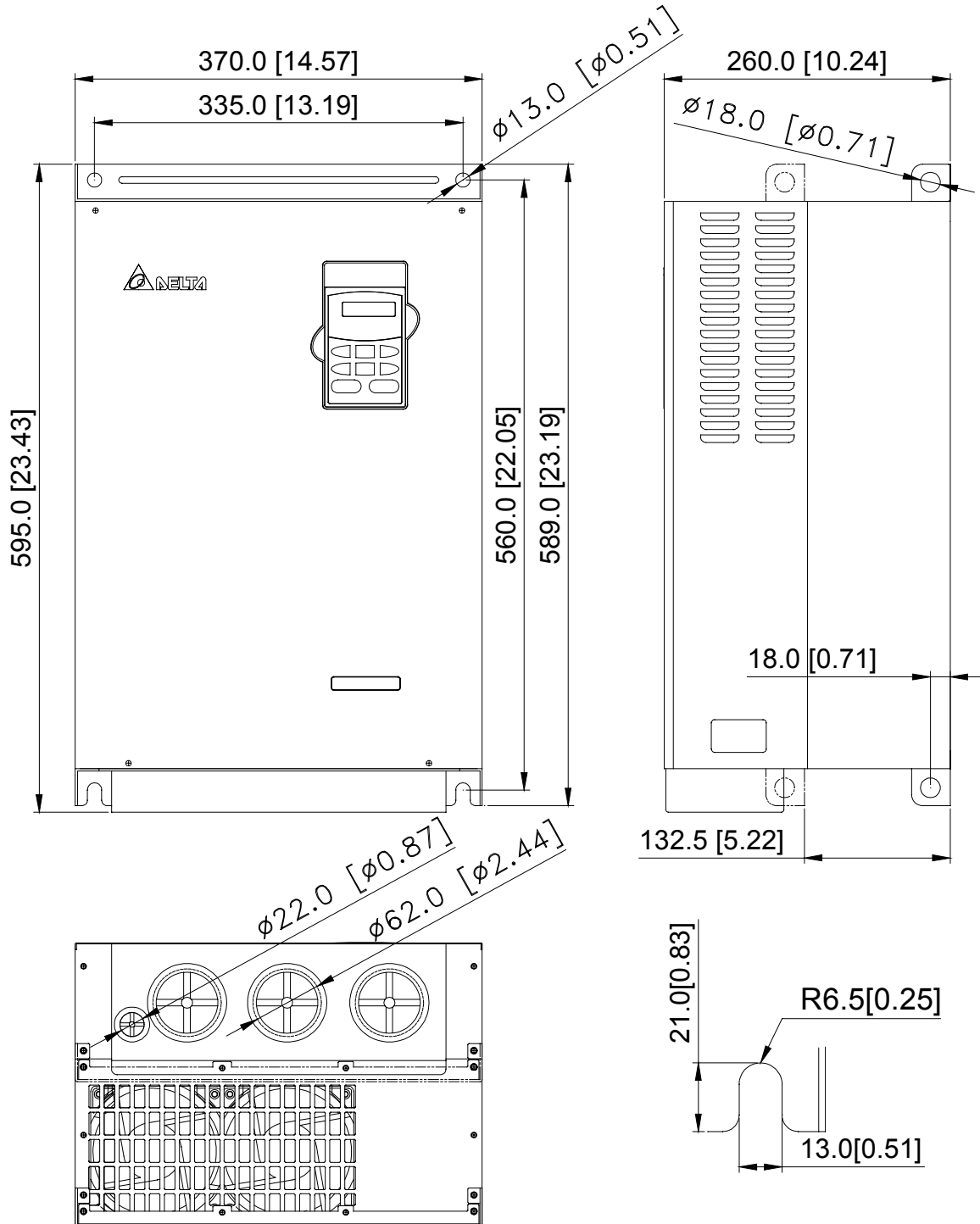

**VFD300B43A 30.0 kW (40HP) 460V / 3-phase**

**VFD370B43A 37.0 kW (50HP) 460V / 3-phase**

**VFD450B43A 45.0 kW (60HP) 460V / 3-phase**

**Unit: mm (inches)**

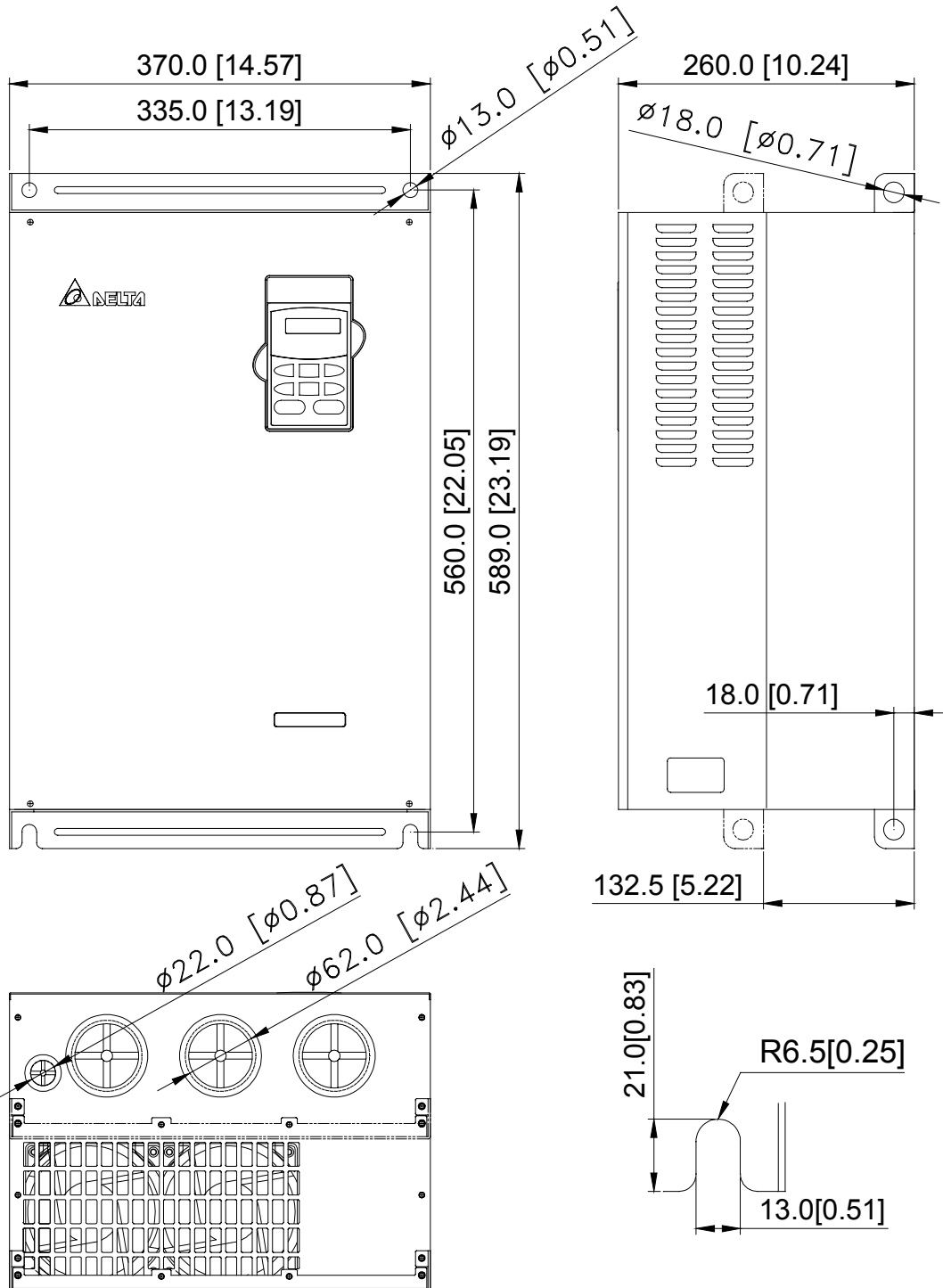

VFD550B43A 55.0 kW (75HP) 460V / 3-phase

VFD750B43A 75.0 kW (100HP) 460V / 3-phase

Unit: mm (inches)

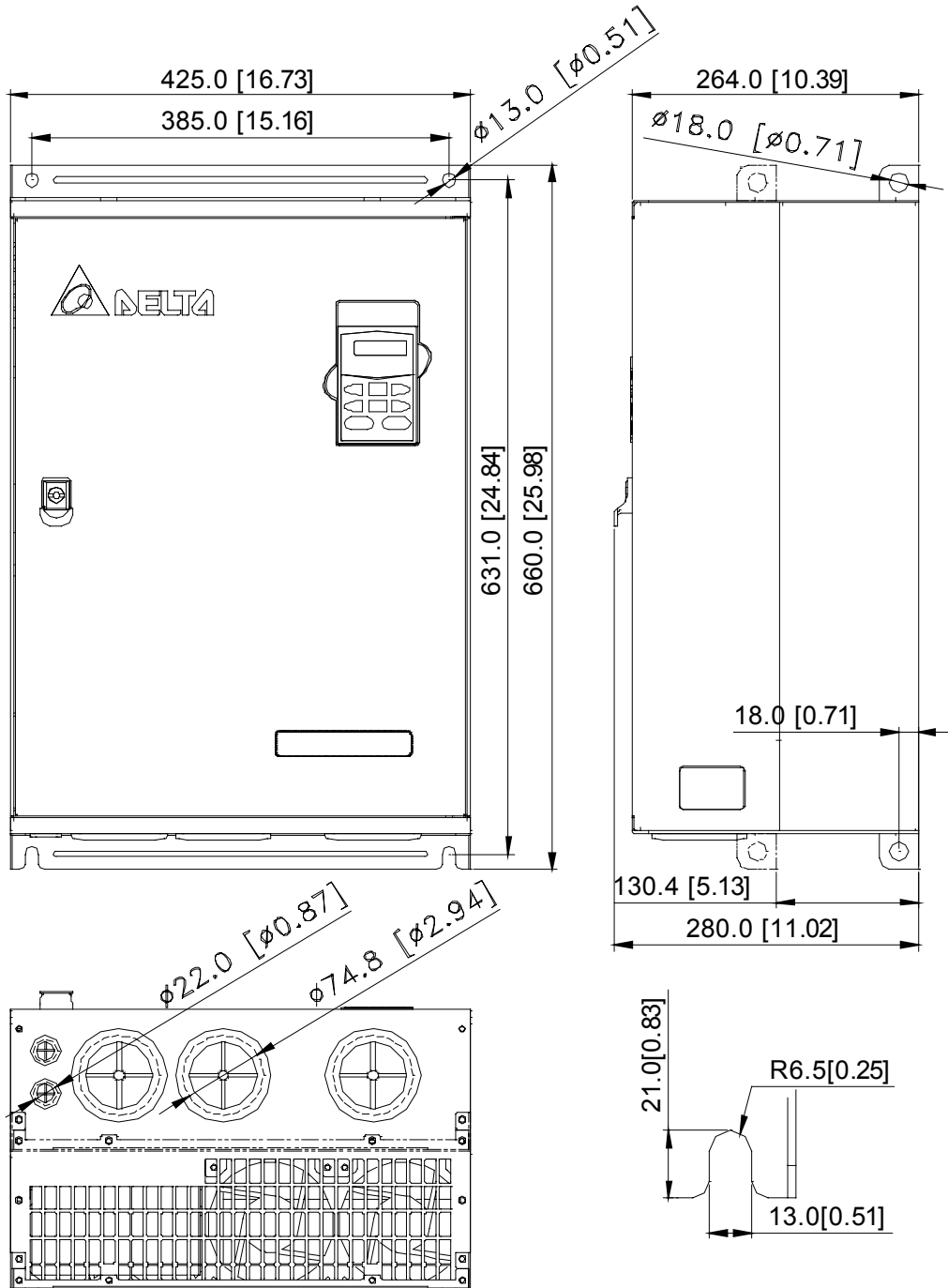

**C**







DELTA ELECTRONICS, INC.

**EC Declaration of Conformity  
According to the Low Voltage Directive 73/23/EEC and the  
Amendment Directive 93/68/EEC**

For the following equipment:

AC Motor Drive

(Product Name)

VFD007B21A, VFD007A23A, VFD007B43A, VFD015B21A, VFD015B21B,  
VFD015B23A, VFD015B23B, VFD015B43A, VFD022B21A, VFD022B23A,  
VFD022B43A, VFD037B23A, VFD037B43A, VFD055B23A, VFD055B43A,  
VFD075B23A, VFD075B43A, VFD110B23A, VFD110B43A, VFD150B23A/43A,  
VFD185B23A/43A, VFD220B23A/43A, VFD300B23A/43A, VFD370B23A/43A,  
VFD450B43A

(Model Name)

is herewith confirmed to comply with the requirements set out in the Council Directive 73/23/EEC for electrical equipment used within certain voltage limits and the Amendment Directive 93/68/EEC. For the evaluation of the compliance with this Directive, the following standard was applied:

EN 50178

The following manufacturer/importer is responsible for this declaration:

Delta Electronics, Inc.

(Company Name)

D



**EC Declaration of Conformity**  
**According to the Electromagnetic Compatibility 89/336/EEC and**  
**the Amendment Directive 93/68/EEC**

For the following equipment:

AC Motor Drive  
(Product Name)

---

VFD007B21A, VFD007A23A, VFD007B43A, VFD015B21A, VFD015B21B,  
VFD015B23A, VFD015B23B, VFD015B43A, VFD022B21A, VFD022B23A,  
VFD022B43A, VFD037B23A, VFD037B43A, VFD055B23A, VFD055B43A,  
VFD075B23A, VFD075B43A, VFD110B23A, VFD110B43A, VFD150B23A/43A,  
VFD185B23A/43A, VFD220B23A/43A, VFD300B23A/43A, VFD370B23A/43A,  
VFD450B43A

---

(Model Name)

is herewith confirmed to comply with the requirements set out in the Council Directive 89/336/EEC for electromagnetic compatibility and the Amendment Directive 93/68/EEC. For the evaluation of the compliance with this Directive, the following standard was applied:

EN61800-3, EN55011, EN61000-4-2, EN61000-4-3, EN61000-4-4, EN61000-4-5,  
EN61000-4-6, EN61000-4-8

---

The following manufacturer/importer is responsible for this declaration:

Delta Electronics, Inc.  
(Company Name)

---