

Vision Sensor

NEW

■ Features

- Light integrated vision sensor
- Minimized image distortion with global shutter method
- Proprietary technology to block optical interference to improve optical performance (patent)
- Stronger in environment of vibration or impact with lens cover detachment prevention technology
- Various inspection function
 - : Alignment, brightness, contrast, area, edge, shape comparison, length, angle, diameter, object counting, color identification, area of color, object of color counting
- Inspection test with simulator
- Flexible response to changing work environment by setting 32 work groups (64 inspection items for each work group)
- Saving data to FTP server
- Free vision sensor program (Vision Master)
 - : Inspection simulator, managing parameter and work group, monitoring inspection result, inspection result FTP transmission, multilingual support, Etc.
- Protection structure IP67 (IEC standard)



⚠ Please read "Safety Considerations" in instruction manual before using.



■ Manual

For the detail information and instructions, please refer to user manual, and be sure to follow cautions written in the technical description (catalog, homepage).
Visit our homepage (www.autonics.com) to download manuals.

■ Ordering Information

V	G	-	M	04	W	-	8	E
Item	Type	Image element	Resolution (pixel)	Light ^{※1}	Effective focal length	Communication	E Ethernet communication (TCP/IP)	
							8 8mm	
							16 16mm	
							25 25mm	
							W White	
							R Red	
							G Green	
							B Blue	
							04 752×480	
M Mono CMOS								
C Color CMOS								
G General inspection								
V Vision sensor								

※1: Light can be purchased separately.

Overall Configuration Diagram

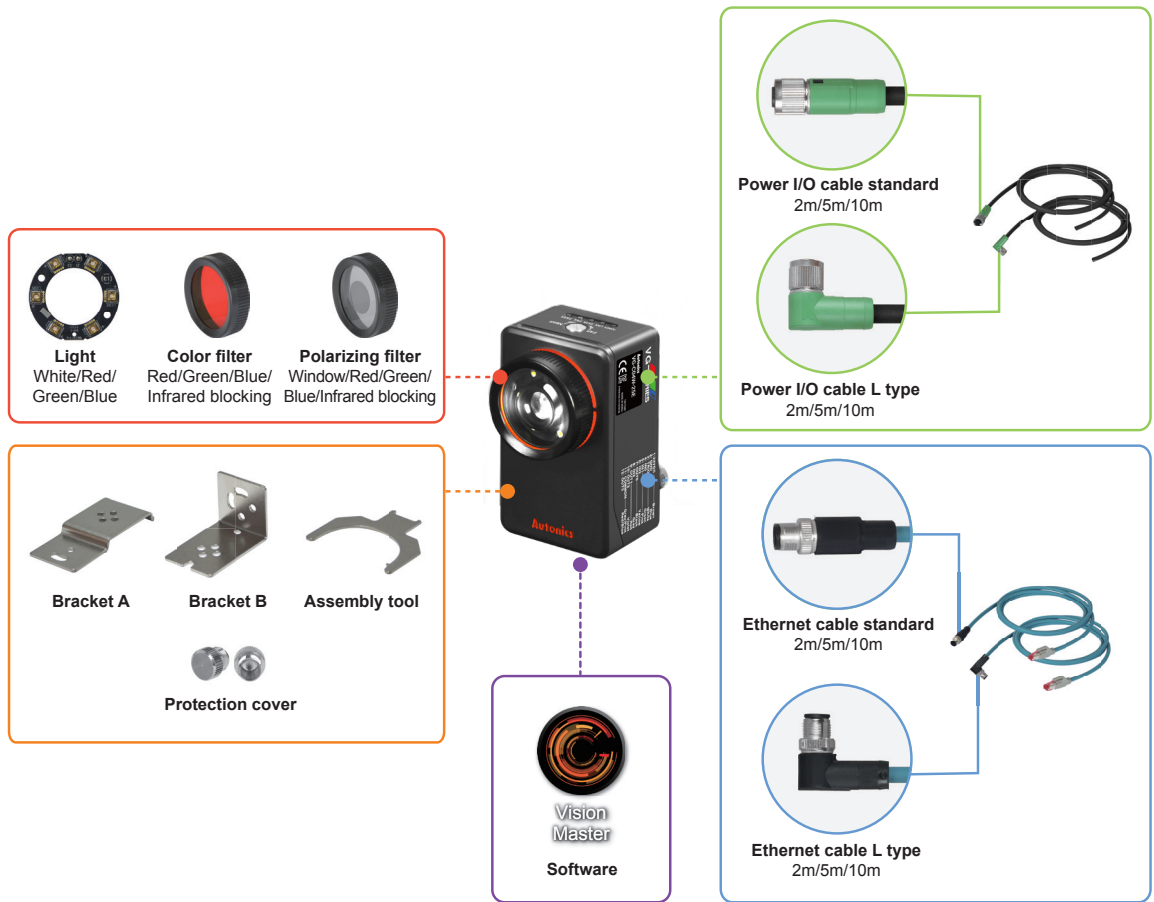

(A) Photoelectric Sensors

(B) Fiber Optic Sensors

(C) Door/Area Sensors

(D) Vision Sensor

(E) Proximity Sensors

(F) Pressure Sensors

(G) Rotary Encoders

(H) Connectors/
Connector Cables/
Sensor Distribution
Boxes/Sockets

(I) Temperature Controllers

(J) SSRs / Power Controllers

(K) Counters

(L) Timers

(M) Panel Meters

(N) Tacho /
Speed / Pulse
Meters

(O) Display Units

(P) Sensor Controllers

(Q) Switching
Mode Power
Supplies

(R) Stepper Motors
& Drivers
& Controllers

(S) Graphic/
Logic
Panels

(T) Field
Network
Devices

(U) Software

VG Series

■ Accessories

- Assembly tool
- ASST-VG



- Bracket A
- BK-VG-A



■ Sold Separately

- Light
- LR-W-06-VG (white)
- LR-R-06-VG (red)
- LR-G-06-VG (green)
- LR-B-06-VG (blue)

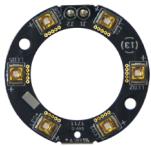

- Bracket B
- BK-VG-B



- Protection cover
- P96-M12-1



※Protection cover protects the unused connector from foreign object. When installing, hand tighten.

- Color filter
- FL-R-VG (red)
- FL-G-VG (green)
- FL-B-VG (blue)
- FL-IC-VG (infrared blocking)



- Polarizing filter
- FL-P-VG (window)
- FL-RP-VG (red)
- FL-GP-VG (green)
- FL-BP-VG (blue)
- FL-ICP-VG (infrared blocking)



- Power I/O cable
- Standard
 - CID-2-VG (2m)
 - CID-5-VG (5m)
 - CID-10-VG (10m)
- L type
 - CLD-2-VG (2m)
 - CLD-5-VG (5m)
 - CLD-10-VG (10m)
- Ethernet cable
- Standard
 - CIR-2-VG (2m)
 - CIR-5-VG (5m)
 - CIR-10-VG (10m)
- L type
 - CLR-2-VG (2m)
 - CLR-5-VG (5m)
 - CLR-10-VG (10m)



Specifications

Model	VG-M04□-8E	VG-M04□-16E	VG-M04□-25E	VG-C04□-8E	VG-C04□-16E	VG-C04□-25E	
Effective focal length	8mm	16mm	25mm	8mm	16mm	25mm	
Min. working distance	50mm	100mm	200mm	50mm	100mm	200mm	
Power supply	24VDC \pm (±10%)						
Current consumption	1A						
Inspection	Inspection item	Alignment, brightness, contrast, area, edge, shape comparison, length, angle, diameter, object counting		Alignment, brightness ^{※2} , contrast ^{※2} , area ^{※2} , edge, shape comparison ^{※2} , length, angle, diameter, object counting ^{※2} , color identification, area of color, object of color counting			
	Work group	32					
	Simultaneous inspection	64					
Image snap	Camera frame per second ^{※1}	Max. 60fps					
	Image filter	Preprocessing, external filter (color filter, polarizing filter)					
	Image element	1/3 inch mono CMOS			1/3 inch color CMOS		
	Resolution	752×480 pixel					
	Camera frame per second ^{※1}	Max. 60fps					
	Shutter	Global shutter					
Light	Exposure time	20 to 10,000μs					
	ON/OFF method	Pulse					
Trigger mode	Color	White, red, green, blue					
	External trigger, internal trigger, free-run trigger						
Input	Signal	Rated input 24VDC \pm (±10%)					
	Type	External trigger (TRIG), work group change (IN0 to IN3), alarm cleared (IN0 to IN3), encoder (IN2, IN3)					
Output	Signal	NPN or PNP open collector output Max. 24VDC \pm 50mA, residual voltage: max. 1.2VDC \pm					
	Type	Control output (OUT0 to OUT3) : inspection completion, inspection result, external light trigger, alarm, camera busy, changing work group completed					
	FTP transmission	Possible					
Communication	Ethernet (TCP/IP), 100BASE-TX/10BASE-T						
Protection circuit	Output short over current protection circuit						
Indicator	<ul style="list-style-type: none"> Power indicator (POWER), Ethernet connection indicator (LINK), pass indicator (PASS): green LED Data transmission indicator (DATA): orange LED Failure indicator (FAIL): red LED 						
Insulation resistance	Over 20MΩ (at 500VDC megger)						
Dielectric strength	500VAC 50/60Hz for 1 min						
Vibration	1.5mm amplitude at frequency of 10 to 55Hz (for 1 min) in each X, Y, Z direction for 2 hours						
Shock	300m/s ² (approx. 30G) in each X, Y, Z direction for 3 times						
Environment	Ambient temp.	0 to 45°C, storage: -20 to 70°C					
	Ambient humi.	35 to 85%RH, storage: 35 to 85%RH					
Protection structure	IP67 (IEC standard)						
Material	Case: aluminum, lens cover/focus adjuster: polycarbonate, cable: polyurethane						
Accessories	Assembly tool, bracket A, mounting screw: 2						
Sold separately	Light, color filter, polarizing filter, power I/O cable, Ethernet cable, bracket B, protection cover						
Approval	CE 						
Weight ^{※3}	Approx. 415g (approx. 273g)	Approx. 416g (approx. 274g)	Approx. 416g (approx. 274g)	Approx. 415g (approx. 273g)	Approx. 416g (approx. 274g)	Approx. 416g (approx. 274g)	

※1: The number of camera frames per second can be different by image setting or inspection item.

※2: These inspection items convert a color image to a mono color image to inspect data.

※3: The weight includes packaging. The weight in parenthesis is for unit only.

※Environment resistance is rated at no freezing or condensation.

(A) Photoelectric Sensors

(B) Fiber Optic Sensors

(C) Door/Area Sensors

(D) Vision Sensor

(E) Proximity Sensors

(F) Pressure Sensors

(G) Rotary Encoders

(H) Connectors/ Connector Cables/ Sensor Distribution Boxes/Sockets

(I) Temperature Controllers

(J) SSRs / Power Controllers

(K) Counters

(L) Timers

(M) Panel Meters

(N) Tacho / Speed / Pulse Meters

(O) Display Units

(P) Sensor Controllers

(Q) Switching Mode Power Supplies

(R) Stepper Motors & Drivers & Controllers

(S) Graphic/ Logic Panels

(T) Field Network Devices

(U) Software

VG Series

■ Connections

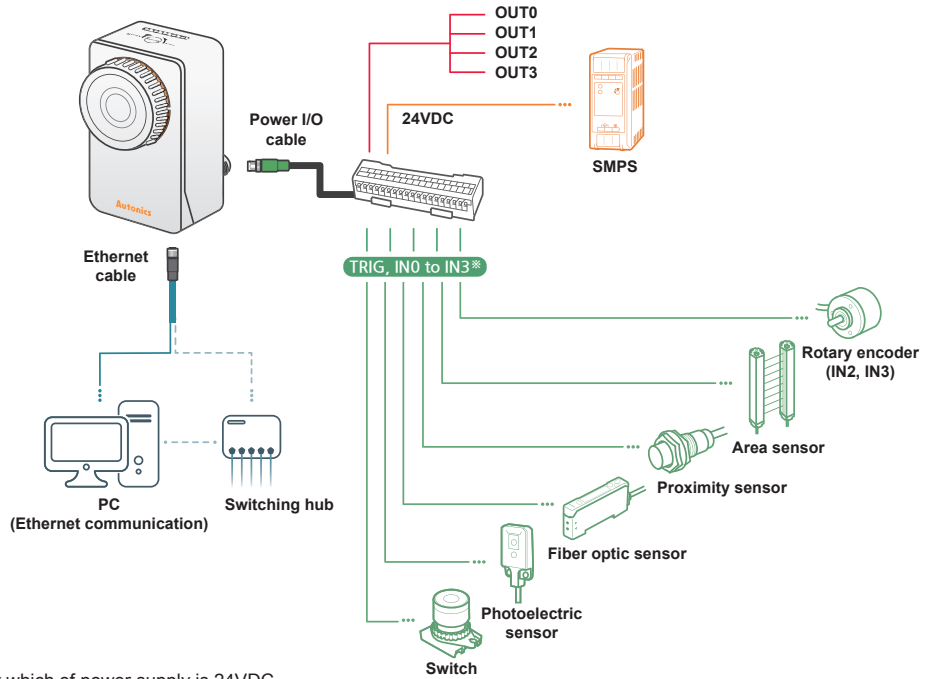

※Use the product which of power supply is 24VDC.
When selecting a product, please refer to Autonics selection guide.

○ Power I/O cable (M12 12-pin connector)

Pin arrangement	Pin No.	Cable color	Signal	Function		
	1	Brown	24VDC	24VDC		
	2	Blue	GND	GND		
	3	White	TRIG	Trigger input		
	4	Green	IN0	Work group change Bit 0	Work group change Clock	
	5	Pink	IN1	Work group change Bit 1	Work group change Data	
	6	Yellow	IN2	Work group change Bit 2	Encoder - Up counter - Quadrature A	Alarm cleared
	8	Gray	IN3	Work group change Bit 3	Encoder - Down counter - Quadrature B	
	11	Gray/Pink	COMMON	COMMON		
	7	Black	OUT0	Inspection completion, inspection result, external light trigger, alarm, camera busy, changing work group completed		
	9	Red	OUT1			
	10	Purple	OUT2			
	12	Red/Blue	OUT3			

○ Ethernet cable (M12 8-pin/RJ45 connector)

Pin arrangement	M12 8-pin		Cable color	RJ45	
	Pin No.	Signal		Pin No.	Signal
	6	RX+	White/Orange	1	TX+
	4	RX-	Orange	2	TX-
	5	TX+	White/Green	3	RX+
	8	TX-	Green	6	RX-
	1	—	White/Blue	5	—
	7	—	Blue	4	—
	2	—	White/Brown	7	—
	3	—	Brown	8	—

Input Circuit Diagram

- External trigger input (TRIG)
Work group change input (IN0 to IN3)
Alarm cleared input (IN0 to IN3)

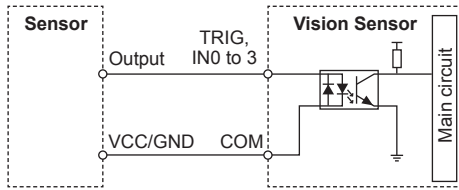

- Encoder input (IN2, IN3)

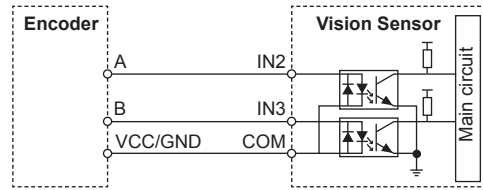

Control Output Circuit Diagram

- NPN open collector output

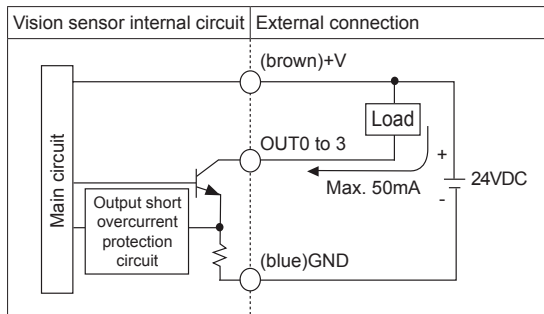

- PNP open collector output

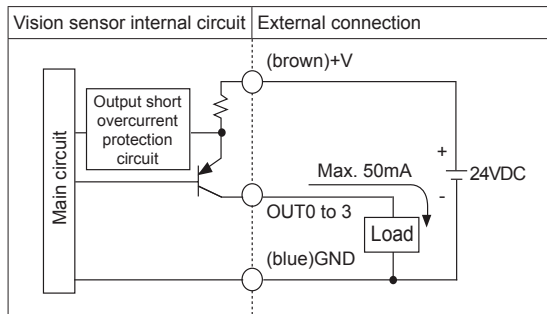

Unit Description

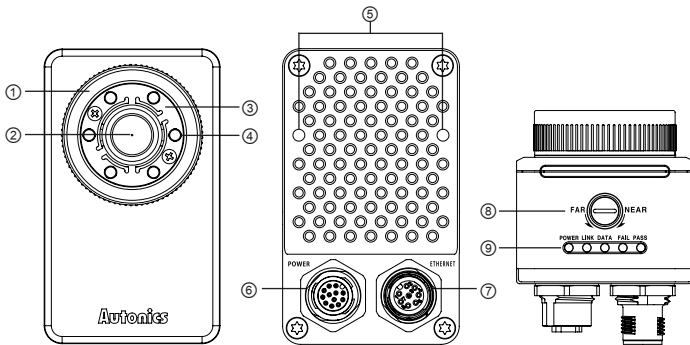

- ① Lens cover: Front cover of lens
※In case using a filter (color filter/polarizing filter), separate the lens cover with the assembly tool before insert the filter.
- ② Lens: There are 8mm, 16mm, 25mm models by effective focal length.
- ③ Light cover: Light cover fixes inner LED lights.
- ④ Light: Inner LED lights
※In order to change the light, separate lens cover and light cover.
- ⑤ Bracket mounting hole on back side: Install the vision master from the back side using bracket B.
- ⑥ Power I/O connector: Connect the power I/O cable.
- ⑦ Ethernet connector: Connect the Ethernet cable. It is for TCP/IP communication.
- ⑧ Focus adjuster: After fixing vision sensor, adjust focus by the rotating focus adjuster.
- ⑨ Indicators

Indicators	Color	Descriptions
POWER Power indicator	Green LED	Turns ON when power is supplied.
LINK Ethernet connection indicator	Green LED	Turns ON when vision sensor is connected with PC (Ethernet communication).
DATA Data transmission indicator	Orange LED	Flashes when data is transmitted from vision sensor to PC.
FAIL Failure indicator	Red LED	Flashes when detects failure during work group inspection.
PASS Pass indicator	Green LED	Flashes when passed inspection during work group inspection.

(A) Photoelectric Sensors

(B) Fiber Optic Sensors

(C) Door/Area Sensors

(D) Vision Sensor

(E) Proximity Sensors

(F) Pressure Sensors

(G) Rotary Encoders

(H) Connectors/ Connector Cables/ Sensor Distribution Boxes/Sockets

(I) Temperature Controllers

(J) SSRs / Power Controllers

(K) Counters

(L) Timers

(M) Panel Meters

(N) Tacho / Speed / Pulse Meters

(O) Display Units

(P) Sensor Controllers

(Q) Switching Mode Power Supplies

(R) Stepper Motors & Drivers & Controllers

(S) Graphic/ Logic Panels

(T) Field Network Devices

(U) Software

VG Series

Dimensions

(unit: mm)

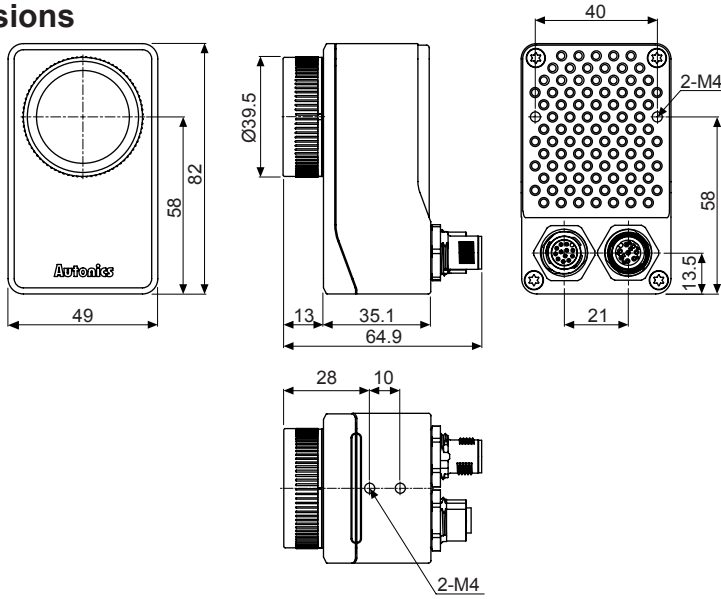

Accessory

● Bracket A (BK-VG-A)

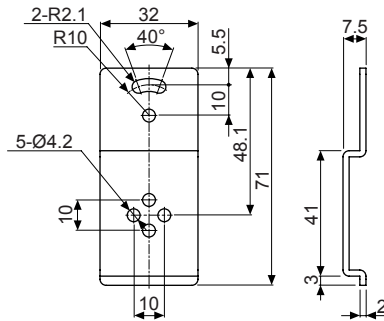

Sold separately

● Bracket B (BK-VG-B)

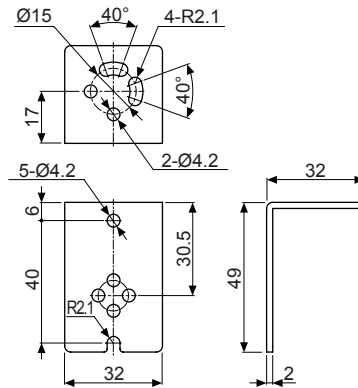

● Power I/O cable (M12 12-pin connector)

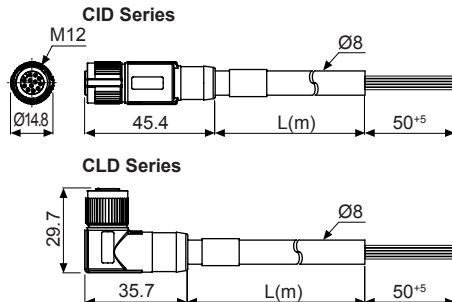

Type	Model	L
Standard	CID-2-VG	2m
	CID-5-VG	5m
	CID-10-VG	10m
L type	CLD-2-VG	2m
	CLD-5-VG	5m
	CLD-10-VG	10m

● Ethernet cable (M12 8-pin/RJ45 connector)

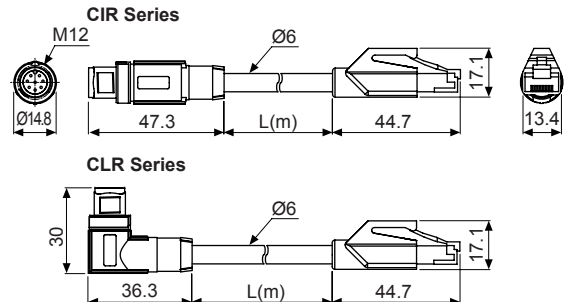

Type	Model	L
Standard	CIR-2-VG	2m
	CIR-5-VG	5m
	CIR-10-VG	10m
L type	CLR-2-VG	2m
	CLR-5-VG	5m
	CLR-10-VG	10m

■ Installation

Installing vision sensor

- Checking working distance and FOV by effective focal length
- Bracket installation (fixing vision sensor)



Installing software

- Installing the vision sensor program, Vision Master, to PC



Connecting vision sensor and PC

- Setting network from Vision Master



Adjusting vision sensor focus

- Running Vision Master and activating the 'Focusing Guide' function in the camera setting menu
- Adjusting focus with focus adjuster

○ Bracket installation

- Install horizontally from the bottom - bracket A (accessory)

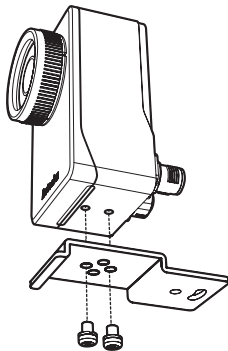

- Install vertically from the bottom - bracket B (sold separately)

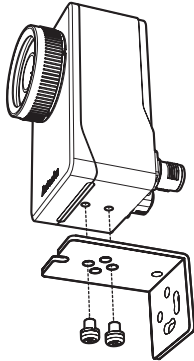

- Install vertically from the back side - bracket B (sold separately)

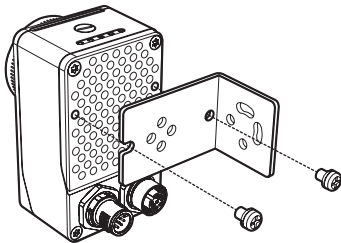

○ Installation position

Place the sensing target at the center of the vision sensor lens.

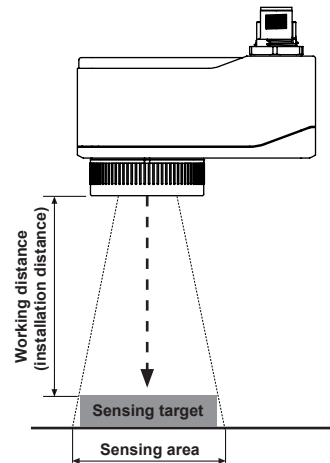

○ Focus adjustment

After installing and running Vision Master, use the focusing guide function to adjust the focus. Using (-) screwdriver, turn focus adjuster to right and left to adjust the focus.

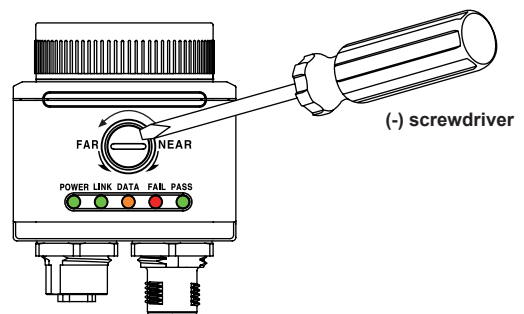

(A) Photoelectric Sensors

(B) Fiber Optic Sensors

(C) Door/Area Sensors

(D) Vision Sensor

(E) Proximity Sensors

(F) Pressure Sensors

(G) Rotary Encoders

(H) Connectors/ Connector Cables/ Sensor Distribution Boxes/Sockets

(I) Temperature Controllers

(J) SSRs / Power Controllers

(K) Counters

(L) Timers

(M) Panel Meters

(N) Tacho / Speed / Pulse Meters

(O) Display Units

(P) Sensor Controllers

(Q) Switching Mode Power Supplies

(R) Stepper Motors & Drivers & Controllers

(S) Graphic/ Logic Panels

(T) Field Network Devices

(U) Software

VG Series

Working Distance and FOV by Effective Focal Length

Working distance

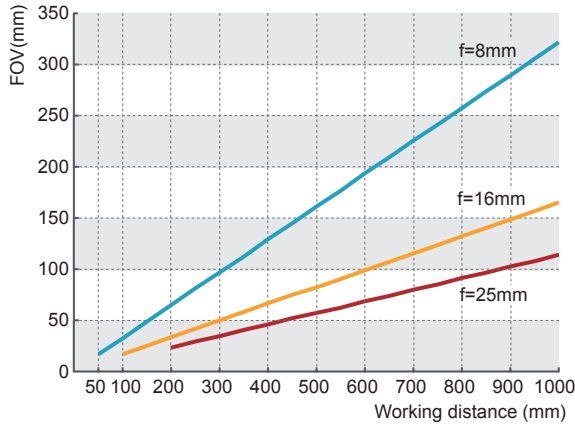

Effective focal length (f)	8mm	16mm	25mm
Min. working distance	50mm	100mm	200mm
Brightness	F2.0	F2.5	F2.5

FOV (Field of view)

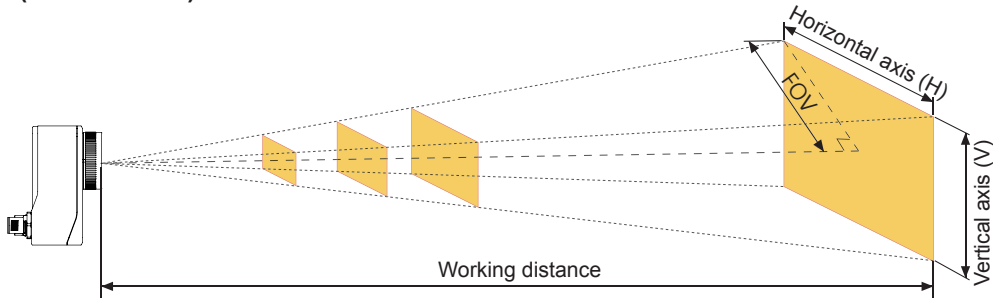

Sensing range by effective focal length (unit: mm)

Effective focal length	Working distance	50	100	200	300	400	500	600	700	800	900	1,000
8mm	FOV	16	32	64	96	129	161	193	255	257	289	322
	Horizontal axis (H)	27	54	108	163	217	271	325	380	434	488	542
	Vertical axis (V)	17	35	69	104	138	173	208	242	277	311	346
16mm	FOV	—	16	33	49	66	82	99	155	132	148	165
	Horizontal axis (H)	—	28	56	83	111	139	167	195	222	250	278
	Vertical axis (V)	—	18	35	53	71	89	106	124	142	160	177
25mm	FOV	—	—	23	34	46	57	68	80	91	103	114
	Horizontal axis (H)	—	—	38	58	77	96	115	134	154	173	192
	Vertical axis (V)	—	—	25	37	49	61	74	86	98	110	123

■ Vision Sensor Program [Vision Master]

Vision Master is the vision sensor program that allows setting of vision sensor parameters and management of monitoring data such as inspection status and status information.

<Computer specification for using software>

Item	Minimum specifications
System	32bit (x86) or 64bit (x64) processor over 1GHz
Operations	Microsoft Windows 7/8/10
Memory	1GB+
Hard disk	400MB+ of available hard disk space
VGA	Resolution: 1024×768 or higher
Others	RJ45 Ethernet port

<Vision Master execution screen>

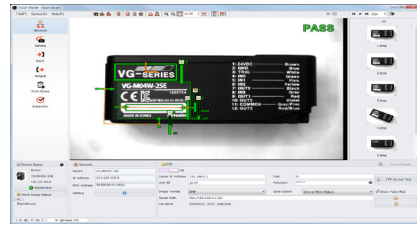

※Vision sensor is connected with Vision Master in Ethernet (TCP/IP) communication.

※For initial IP address of vision sensor, refer to the following table. Configure the network settings of vision sensor via Vision Master.

IP address	192.168.0.2
Subnet mask	255.255.255.0
Gateway	192.168.0.1

<Inspection setting screen>

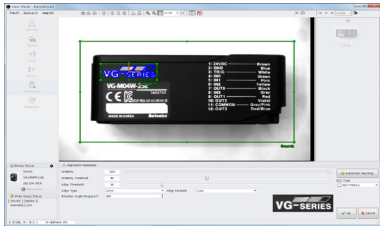

<Inspection executing screen>

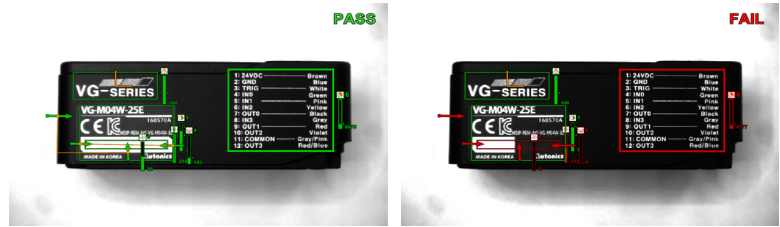

<FTP transmission setting screen>

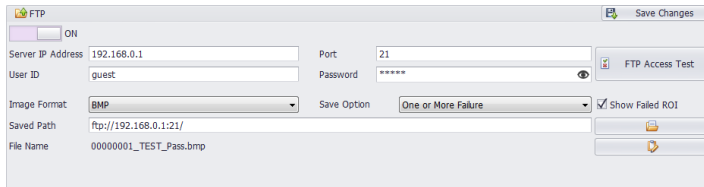

<Registered inspections in work group>

Number	Work	Result
1	Alignment 1	Pass
2	Brightness 1	Pass
3	Contrast 1	Pass
4	Area 1	Pass
5	Edge 1	Pass
6	Length 1	Pass
7	Angle 1	Pass
8	Diameter 1	Pass
9	Object Counting 1	Pass

<Inspection status monitoring screen>

Number	Work Name	Result Value	Result	Pass/Fail	Operating Time(ms)
1	Alignment 1	82 [X:377 Y:250 R:0.2]	Pass	103/0(100.0%)	562.72
2	Brightness 1	153	Pass	78/25(75.7%)	0.19
3	Contrast 1	69	Pass	87/16(84.4%)	1.02
4	Area 1	5179	Pass	87/16(84.4%)	0.37
5	Edge 1	0 [Distance:8]	Pass	94/9(91.2%)	9.63
6	Length 1	0	Pass	89/14(86.4%)	0.82
7	Angle 1	100	Pass	100/3(97.0%)	23.00
8	Diameter 1	68 [Round:88]	Pass	100/3(97.0%)	86.24
				817/110(88.1%)	694.26

Input Trigger	Value
Pass	103
Fail	4352
- Work	46.6%
All Pass	48
One or More Failure	55
The Number of Works	9
Overall Inspection Time(ms)	728

(A) Photoelectric Sensors

(B) Fiber Optic Sensors

(C) Door/Area Sensors

(D) Vision Sensor

(E) Proximity Sensors

(F) Pressure Sensors

(G) Rotary Encoders

(H) Connectors/ Connector Cables/ Sensor Distribution Boxes/Sockets

(I) Temperature Controllers

(J) SSRs / Power Controllers

(K) Counters

(L) Timers

(M) Panel Meters

(N) Tacho / Speed / Pulse Meters

(O) Display Units

(P) Sensor Controllers

(Q) Switching Mode Power Supplies

(R) Stepper Motors & Drivers & Controllers

(S) Graphic/ Logic Panels

(T) Field Network Devices

(U) Software

○ Vision Master Work Flow

● Setting mode

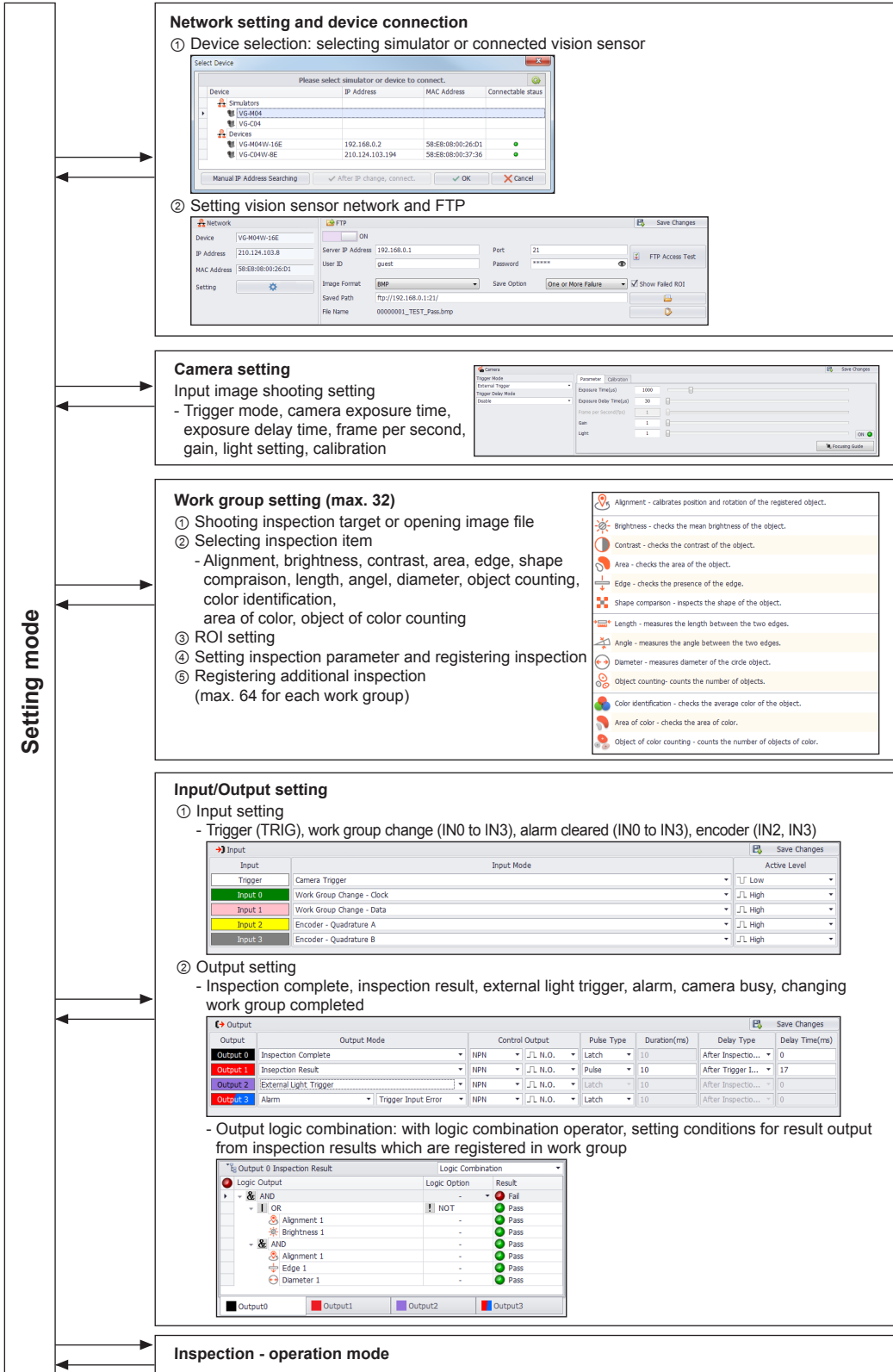



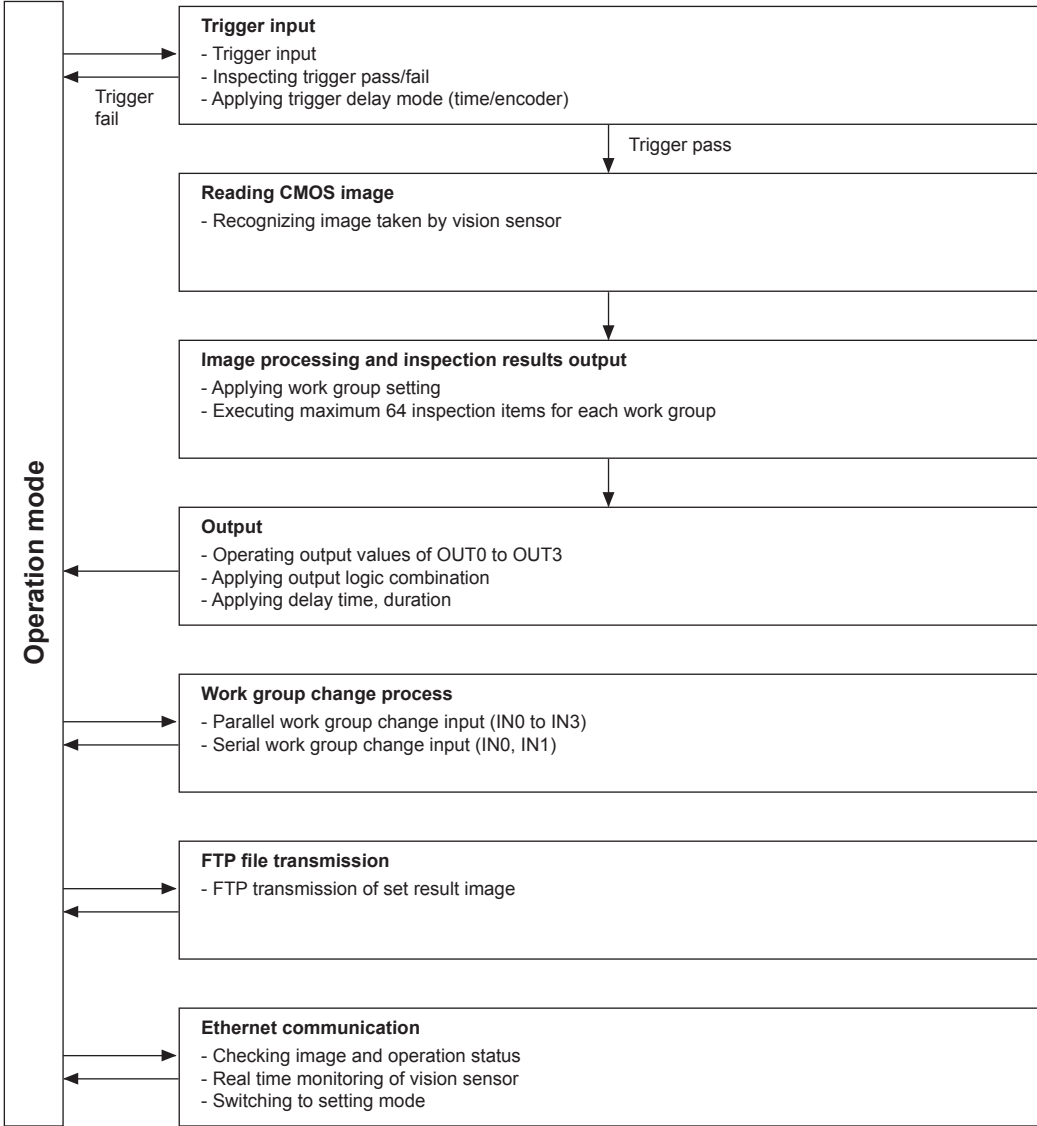









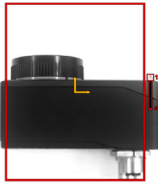

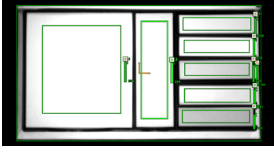
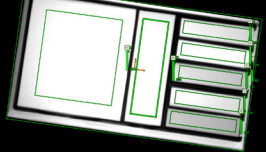
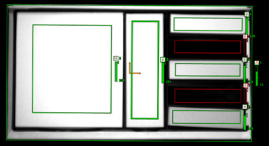



● Operation mode

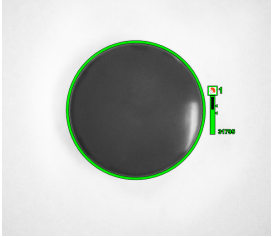
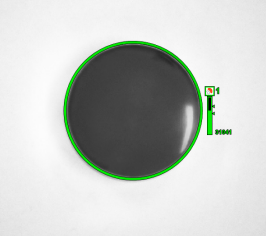
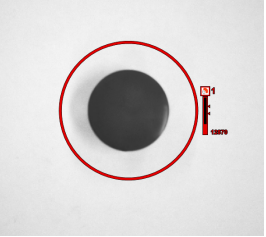





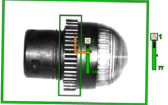



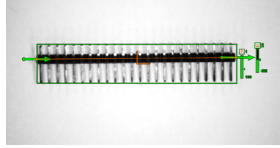
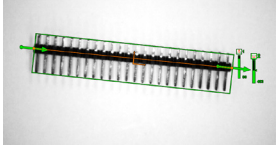
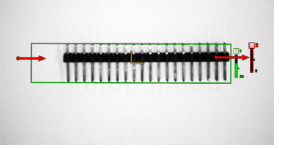

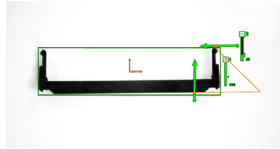
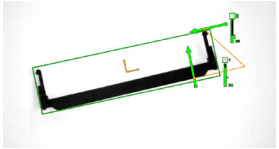
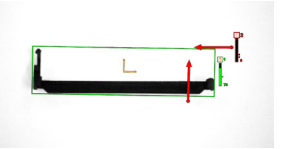
(A)	Photoelectric Sensors
(B)	Fiber Optic Sensors
(C)	Door/Area Sensors
(D)	Vision Sensor
(E)	Proximity Sensors
(F)	Pressure Sensors
(G)	Rotary Encoders
(H)	Connectors/ Connector Cables/ Sensor Distribution Boxes/Sockets
(I)	Temperature Controllers
(J)	SSRs / Power Controllers
(K)	Counters
(L)	Timers
(M)	Panel Meters
(N)	Tacho / Speed / Pulse Meters
(O)	Display Units
(P)	Sensor Controllers
(Q)	Switching Mode Power Supplies
(R)	Stepper Motors & Drivers & Controllers
(S)	Graphic/ Logic Panels
(T)	Field Network Devices
(U)	Software

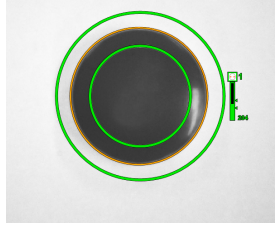
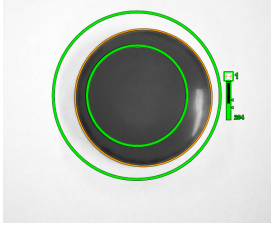
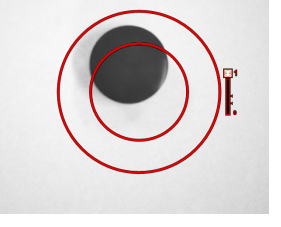
VG Series

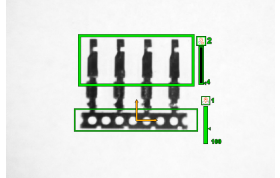
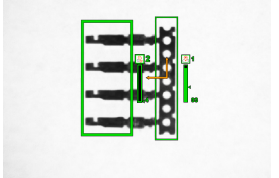
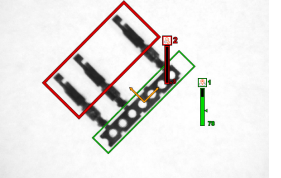
○ Inspection function

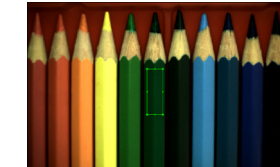
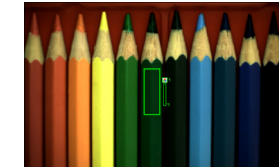
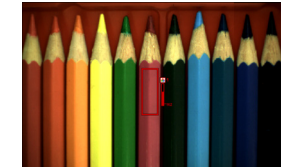

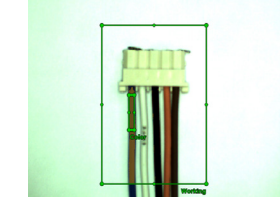
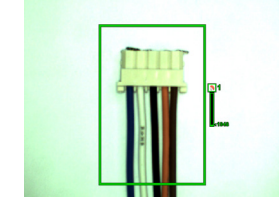
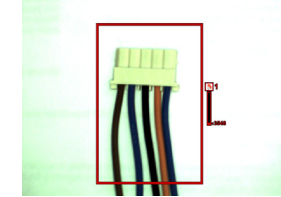
Item	Description		
 <p>Alignment</p>	<p>Compares features of the registered image and input image to search for a similar pattern position, and inspects the input image with information of the searched pattern position and rotation angle.</p>		
	<p><Template></p> 	<p><Pass></p> 	<p><Fail></p> 
 <p>Brightness</p>	<p>Inspects brightness of the ROI in the input image based on the mean brightness value of the ROI (Region of Interest) in the registered image.</p>		
	<p><Template></p> 	<p><Pass></p> 	<p><Fail></p> 
 <p>Contrast</p>	<p>Inspects contrast of the ROI in the input image based on contrast of the ROI in the registered image.</p>		
	<p><Template></p> 	<p><Pass></p> 	<p><Fail></p> 
 <p>Area</p>	<p>Inspects the ROI area of the input image based on the ROI area of the image registered by user.</p>		
	<p><Template></p> 	<p><Pass></p> 	<p><Fail></p> 
 <p>Edge</p>	<p>Inspects the direction of the edge in the input image based on the edge registered by user in the same area.</p>		
	<p><Template></p> 	<p><Pass></p> 	<p><Fail></p> 
 <p>Shape comparison</p>	<p>Compares shape of object in the ROI registered by user and that of the input image.</p>		
	<p><Template></p> 	<p><Pass></p> 	<p><Fail></p> 

Item	Description		
 <p>Length</p>	<p><Template></p> 	<p><Pass></p> 	<p><Fail></p> 
 <p>Angle</p>	<p><Template></p> 	<p><Pass></p> 	<p><Fail></p> 
 <p>Diameter</p>	<p><Template></p> 	<p><Pass></p> 	<p><Fail></p> 
 <p>Object counting</p>	<p><Template></p> 	<p><Pass></p> 	<p><Fail></p> 
 <p>Color identification</p>	<p><Template></p> 	<p><Pass></p> 	<p><Fail></p> 
 <p>Area of color</p>	<p><Template></p> 	<p><Pass></p> 	<p><Fail></p> 

- (A) Photoelectric Sensors
- (B) Fiber Optic Sensors
- (C) Door/Area Sensors
- (D) Vision Sensor
- (E) Proximity Sensors
- (F) Pressure Sensors
- (G) Rotary Encoders
- (H) Connectors/ Connector Cables/ Sensor Distribution Boxes/Sockets
- (I) Temperature Controllers
- (J) SSRs / Power Controllers
- (K) Counters
- (L) Timers
- (M) Panel Meters
- (N) Tacho / Speed / Pulse Meters
- (O) Display Units
- (P) Sensor Controllers
- (Q) Switching Mode Power Supplies
- (R) Stepper Motors & Drivers & Controllers
- (S) Graphic/ Logic Panels
- (T) Field Network Devices
- (U) Software

※These examples include position alignment. (except area, diameter, color identification, area of color, and object of color counting inspection)
 ※Color identification, area of color, and object of color counting are only for VG-C Series.

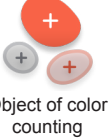
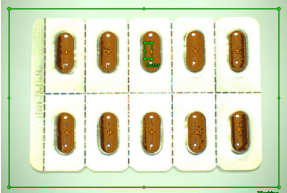
○ Inspection function

Item	Description
 <p>Object of color counting</p>	<p>Compares the number of objects in a certain color which are in the ROI of registered image and that of the input image.</p> <div style="display: flex; justify-content: space-around;"> <div data-bbox="330 315 638 535"> <p><Template></p>  </div> <div data-bbox="644 315 951 535"> <p><Pass></p>  </div> <div data-bbox="957 315 1265 535"> <p><Fail></p>  </div> </div>



※ These examples include position alignment. (except area, diameter, color identification, area of color, and object of color counting inspection)
 ※ Color identification, area of color, and object of color counting are only for VG-C Series.

■ Proper Usage

◎ Cautions during Use

- Follow instructions in Cautions during Use. Otherwise, it may cause unexpected accidents.
- 24VDC power supply should be insulated and limited voltage/current or Class 2, SELV power supply device.
- In order to avoid malfunction from static electricity or noise, ground shield wire of the power I/O cable.
- Do not disconnect the power supply while setting operation or saving set information.
It may cause data loss.
- Do not disconnect the power supply while updating firmware. It may cause product damage.
- Keep optical section of the sensor away from the contact with water, dust and oil.
It may cause malfunction.
- When changing the light or filter, use the assembly tool and observe installation instruction.
- When the sensor is not used for a long time, separate the power cable and to store.
- When connecting network, connection must be operated by technical expert.
- In the following case, disconnect the power supply immediately. It may cause fire or product damage.
 - ① When water or foreign substance is detected in the product
 - ② When the product is dropped or case is damaged
 - ③ When smoke or smell is detected from the product
- Do not use the product in the place where strong magnetic field or electric noise is generated.
- This unit may be used in the following environments.
 - ① Indoor (in the environment conditions in specifications)
 - ② Altitude max. 2,000m
 - ③ Pollution degree 2
 - ④ Installation category II

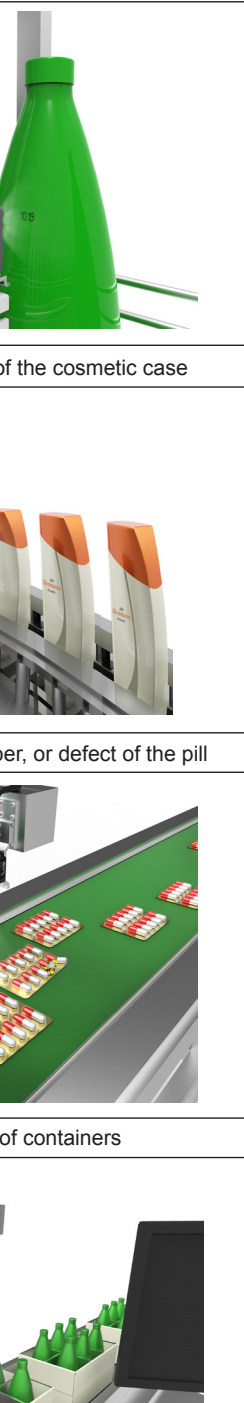
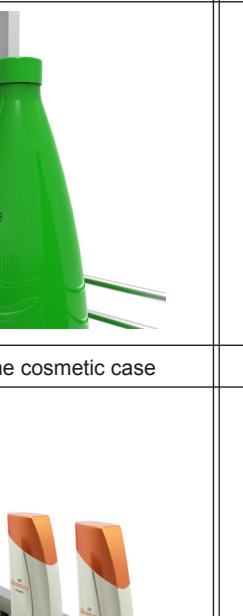
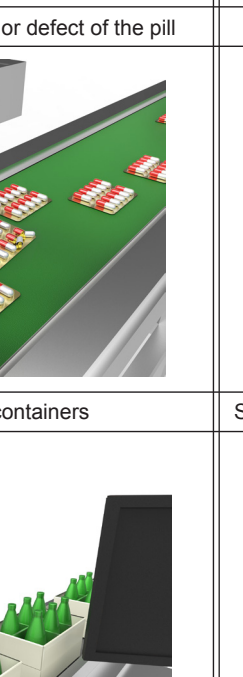
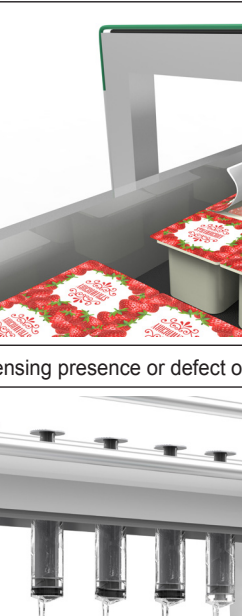
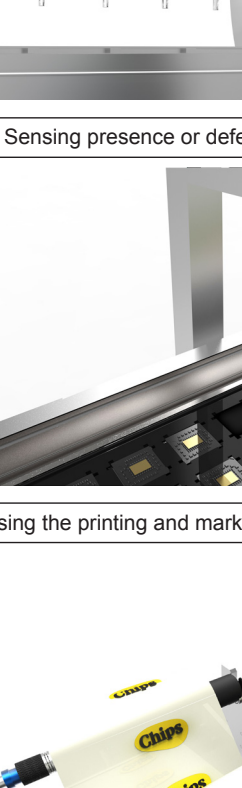

■ Applications

<p>Sensing presence of text on the food container</p>	<p>Sensing the sealing status of the container</p>
	
<p>Sensing the printing status of the cosmetic case</p>	<p>Sensing presence or defect of the syringe rubber seal</p>
	
<p>Sensing a different kind, number, or defect of the pill</p>	<p>Sensing presence or defect of the component</p>
	
<p>Sensing the number of containers</p>	<p>Sensing the printing and marking status of the package</p>
	

- (A) Photoelectric Sensors
- (B) Fiber Optic Sensors
- (C) Door/Area Sensors
- (D) Vision Sensor**
- (E) Proximity Sensors
- (F) Pressure Sensors
- (G) Rotary Encoders
- (H) Connectors/ Connector Cables/ Sensor Distribution Boxes/Sockets
- (I) Temperature Controllers
- (J) SSRs / Power Controllers
- (K) Counters
- (L) Timers
- (M) Panel Meters
- (N) Tacho / Speed / Pulse Meters
- (O) Display Units
- (P) Sensor Controllers
- (Q) Switching Mode Power Supplies
- (R) Stepper Motors & Drivers & Controllers
- (S) Graphic/ Logic Panels
- (T) Field Network Devices
- (U) Software

Applications

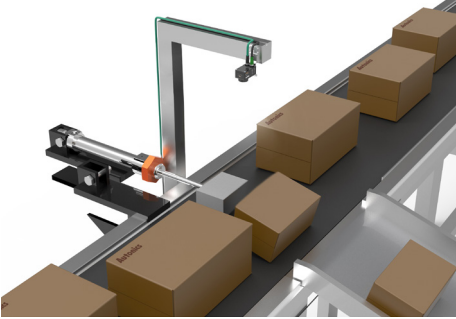
■ Applications

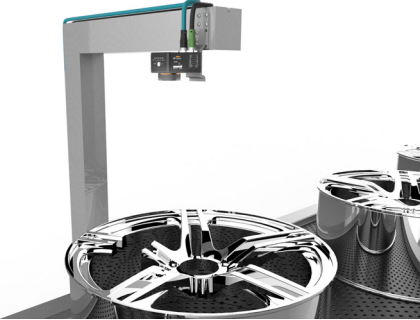
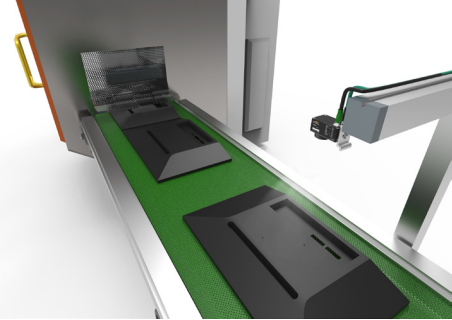
<p>Sensing the size of the product box</p> 	<p>Sensing the component shape of the spark plug</p> 
<p>Sensing the component shape of the automobile wheel</p> 	<p>Sensing finishing status of injection</p> 

■ Vision Sensor Overview

Vision sensor takes a picture of the sensing target and distinguishes features through image processing to output data or inspection result.

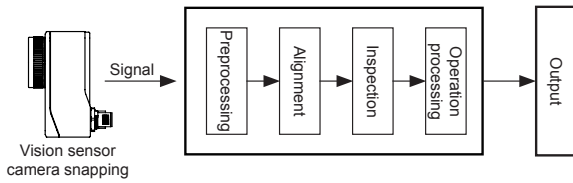

• Human and vision sensor

Item	Human	Vision sensor
Accuracy (error)	Subjective data according to a worker	Objective data by constant input
	Possibility of error occurrence according to worker's condition	Upgrading function and accuracy by system update
Continuity	Worker shift according to working time	Continuous work
Rapidity	Slower inspection speed due to limited inspection and distinction	Faster inspection speed according to the system configuration
Proficiency	Requiring worker's proficiency (training time)	Directly usable right after installing the system
Cost	A steady increase of personnel expenses	No additional cost after initial installation
Output	No output function, direct inspection and result input by workers	Various output with communication

• Photoelectric sensor and vision sensor

A vision sensor can replace multiple photoelectric sensor and can be connected with another device to set various input/output options.

Item	Photoelectric sensor	Vision sensor
Performance	Low	High
Setting	Simple	Flexibly settable with communication setting according to environment
Main application (inspection)	Simple sensing of presence	Sensing target object with various inspection function (alignment, brightness, contrast, area, edge, length, angle, diameter, object counting)

■ Use of Light and Filter

◎ Light

In order to get an image of stable quality, it is important to select the proper light for material, shape and gloss of the sensing target and brightness of the place.



◎ Color filter

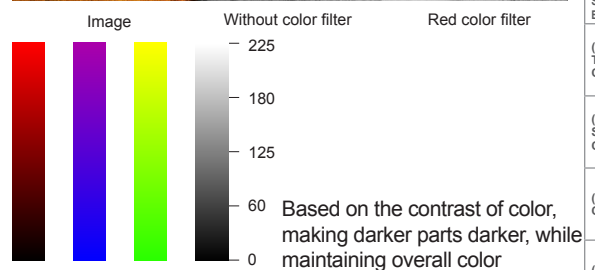

◎ Infrared cut-off filter

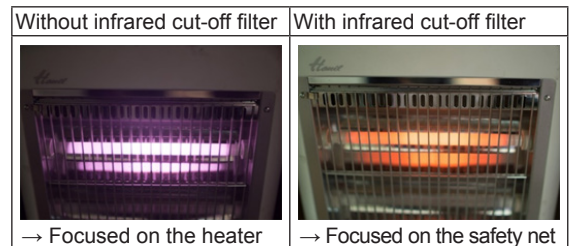

◎ Polarizing filter: cutting diffuse reflection

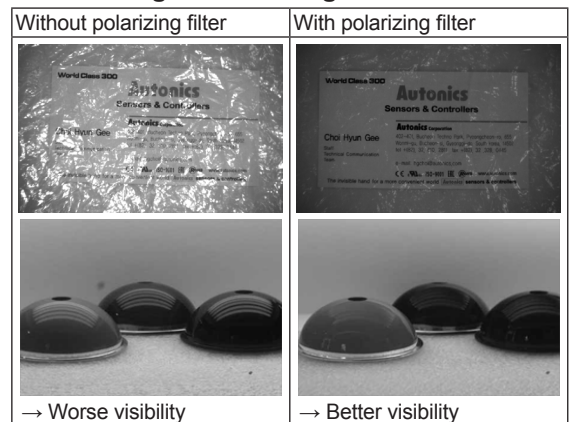

※Diffuse reflection: light is reflected from the uneven surface and scattered at many angles.

- (A) Photoelectric Sensors
- (B) Fiber Optic Sensors
- (C) Door/Area Sensors
- (D) Vision Sensor
- (E) Proximity Sensors
- (F) Pressure Sensors
- (G) Rotary Encoders
- (H) Connectors/ Connector Cables/ Sensor Distribution Boxes/Sockets
- (I) Temperature Controllers
- (J) SSRs / Power Controllers
- (K) Counters
- (L) Timers
- (M) Panel Meters
- (N) Tacho / Speed / Pulse Meters
- (O) Display Units
- (P) Sensor Controllers
- (Q) Switching Mode Power Supplies
- (R) Stepper Motors & Drivers & Controllers
- (S) Graphic/ Logic Panels
- (T) Field Network Devices
- (U) Software

Technical Description

■ Glossary

◎ Pixel

An image is made up of the square dots which are not divided, and the square dots, the smallest unit of an image, is called 'Pixel'.

The more pixels the image has, the more precise and detailed the image is.

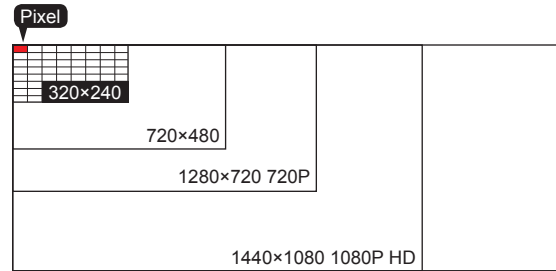

High number of pixels



Median number of pixels



Low number of pixels

◎ Shutter function

Shutter is the entrance of light to enter into the camera, and controls exposure with opening/closing time.

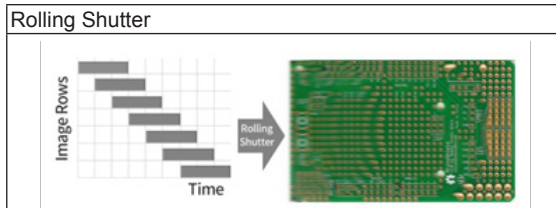

This method captures an images by scanning screen horizontally or vertically. Since the exposure timing of the sensor is different, image distortion can occur.

Global Shutter

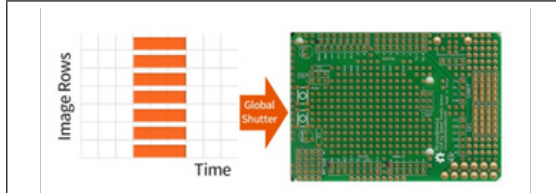

This method captures the whole part of an image at the same time. When taking pictures of fast moving object, this method helps take pictures without image distortion.

◎ CMOS (Complementary Metal Oxide Semiconductor) image sensor

Measurement method	Acquires an image by converting the signal of each pixel
Features	<ul style="list-style-type: none"> - Low power consumption - Stronger to impact or vibration - Faster by Individual A/D conversion - Minimized interference with operation by pixel - Economical price
Application	Object recognition, distance measurement, ultrafast camera shooting

◎ FOV (Field of View)

FOV is the size of the area that can be inspected at one time, and it is the area that vision sensor can see.

Depending on the effective focal length, working distance and sensing range are different.

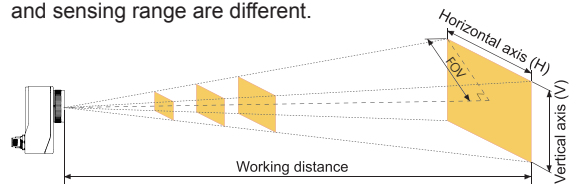

◎ ROI (Region of Interest)

ROI is the area of interest to inspect in the image captured by the camera.

