

EQUO Series
Portable Power Monitor
ZN-CTX21-□



Thank you for selecting OMRON product.
 This guide describes the quick procedures and operational method to start up this product.
 For further information, refer to the Instruction Sheet in the package and a user's manual.

Start-Up Guide

5337005-0E

⚠ Read PRECAUTIONS FOR SAFE USE and PRECAUTIONS FOR CORRECT USE described in the Instruction Sheet before using the product.

OMRON Corporation
 ©OMRON Corporation 2011 All Rights Reserved.

STEP 1 Checking the contents

- Main Unit 1
- AC Adapter or DC Cable 1
- Alarm Output Connector 1
- Instruction Sheet 1
- Start-Up Guide (This document) 1
- Magnet (mounted) 2

STEP 2 Preparing necessary items

- Split-core CT (connection cable provided)
 ZN-CTS11-□A/ZN-CTM11-□A
- Clamp-on CT (connection cable provided)
 ZN-CTS51-□A/ZN-CTM51-□A
- Branch cable: ZN-CTM11-C
- SD memory card (SDHC compatible)
 HMC-SD291(2 GB)(Operation checked.)
- Two AAA batteries
 Alkaline batteries or rechargeable nickel hydrogen (Ni-MH) batteries.
 • Use two batteries of the same type.

When recording measured data in the main unit

When operating the device with batteries

Exterior features

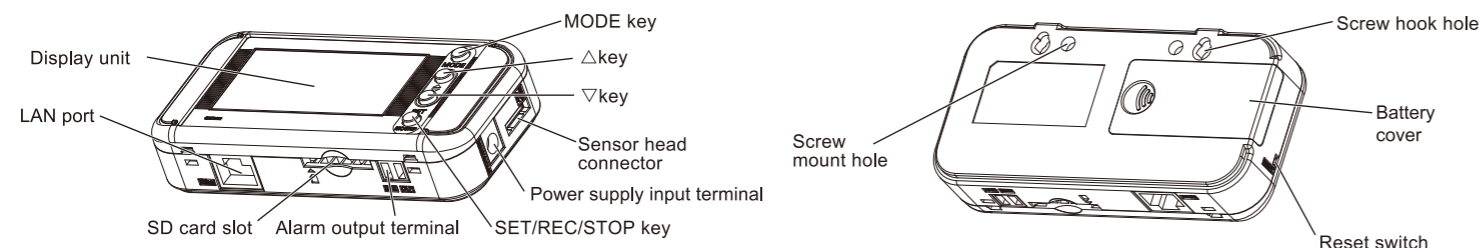

Control unit

Name	Main functions
MODE key	Switch operating modes. Release an alarm or an error (press and hold). Cancel settings before fixing.
Item selection key Δ key	Move up the setting items. Change display screens. Change setting values (increasing).
Item selection key ∇ key	Move down the setting items. Change display screens. Change setting values (decreasing).
SET/REC/STOP key	Fix setting values etc. Start/stop record (press and hold). Send the recorded data into the SD card.

Character display list

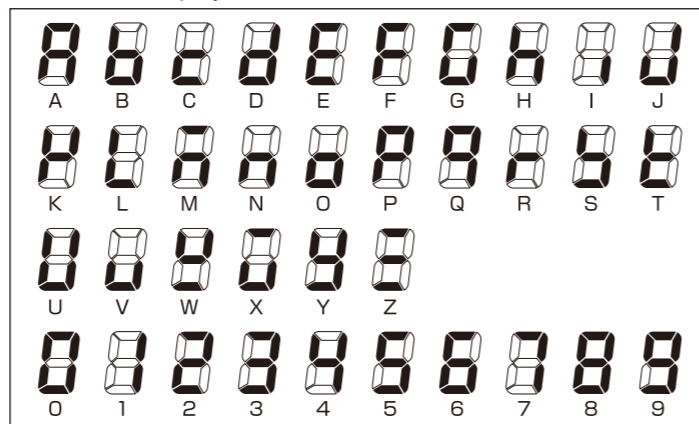

Major messages displayed

Display	Character strings	Display	Character strings	Display	Character strings
CLAR	CLEAR	RESTR	RESTR	SCT5A	SCT5A
CYCLE	CYCLE	BCKUP	BCKUP	LOCUT	LOCUT
TIMER	TIMER	CLOCK	CLOCK	RANGE	RANGE
STRIG	STRIG	YEAR	YEAR	AUTO	AUTO
STIME	STIME	MONTH	MONTH	RATE	RATE
ETRIG	ETRIG	DAY	DAY	CONV	CONV
ETIME	ETIME	TIME	TIME	REREC	REREC
ELPSD	ELPSD	OFF	OFF	INT H	INT H
MODE	MODE	ON	ON	RESET	RESET
REC	REC	DISP	DISP	DONE	DONE
INTEG	INTEG	NORM	NORM	DATA	DATA
USECH	USECH	SLEEP	SLEEP	NO SD	NO SD
TYPE	TYPE	HISPD	HISPD	SDLCK	SDLCK
CT	CT	NET	NET	HARD	HARD
VOLT	VOLT	IP	IP	SD ER	SD ER
PF	PF	SUB	SUB	BATLO	BATLO
FREQ	FREQ	CONT	CONT		
INIT	INIT	RING	RING		
ETC	ETC	DTAIL	DTAIL		

Display unit



Display	Meaning and operation when turned ON
Power icon	An integrated power consumption reset interval is set. The setting is OFF when this is not displayed.
LAN icon	Communication via LAN cable is in process.
REC icon	A LAN cable is connected and network communication is ready.
SD icon	Data is being recorded in the internal memory. Blinking: The timer is set for the unit to wait for recording start.
ALM icon	An SD memory card is inserted. Blinking: The SD card is being accessed.
Battery icon	An integrated power consumption has exceeded the specified upper threshold value. Power is supplied.
Battery level icon	The battery level is shown in 4 levels. Replace the batteries when this is blinking. This indication is not available when the measurement mode (MODE) is in NORM or HISPD.
Hi icon	Indicates the upper limit threshold value.
MAX icon	Indicates the maximum momentary power value.
MIN icon	Indicates the minimum momentary power value.
AVE icon	Indicates the average momentary power value.
RUN icon	The unit is currently operating in RUN mode.
FUN icon	The unit is currently operating in FUN mode.
THR icon	The unit is currently operating in THR mode.

STEP 3 Connecting the dedicated CT and turning the power ON

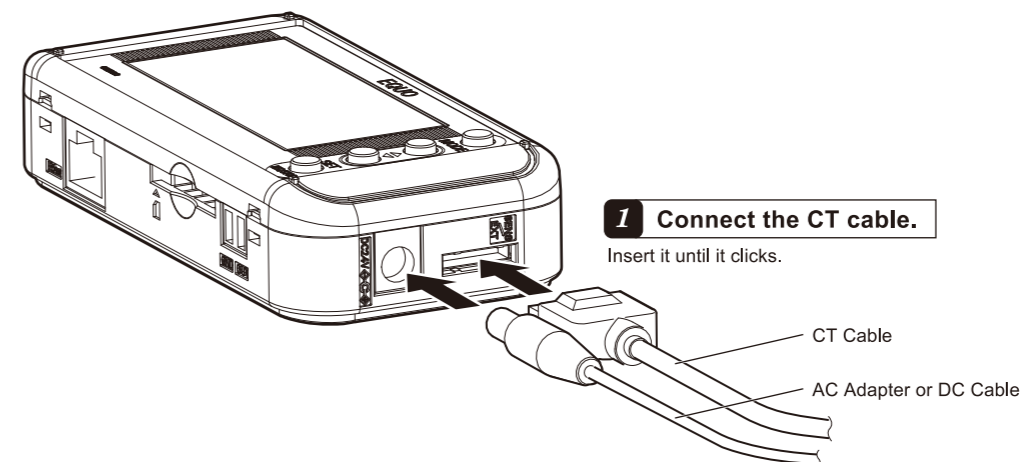

STEP 2 Connect the AC adapter or DC cable plug to the power supply input terminal.

Note: Only the provided AC adapter must be used when using AC power supply.
 Only the provided DC cable must be used when using DC power supply.

When operating the product with batteries

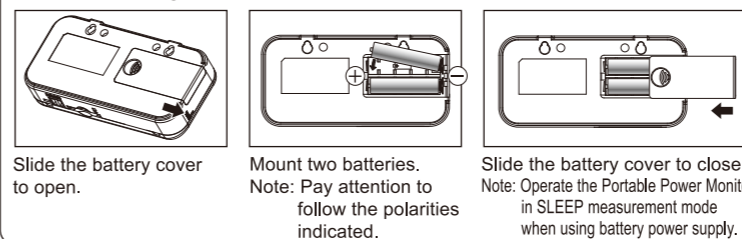

For connection and installation procedures of the alarm output cable, refer to the User's Manual.

STEP 3 Connect the AC plug of the AC adapter to an outlet when using AC power supply. To use DC power supply, connect the white-lined wire of the DC cable to the power input (24 VDC) and the non-lined wire to 0V.

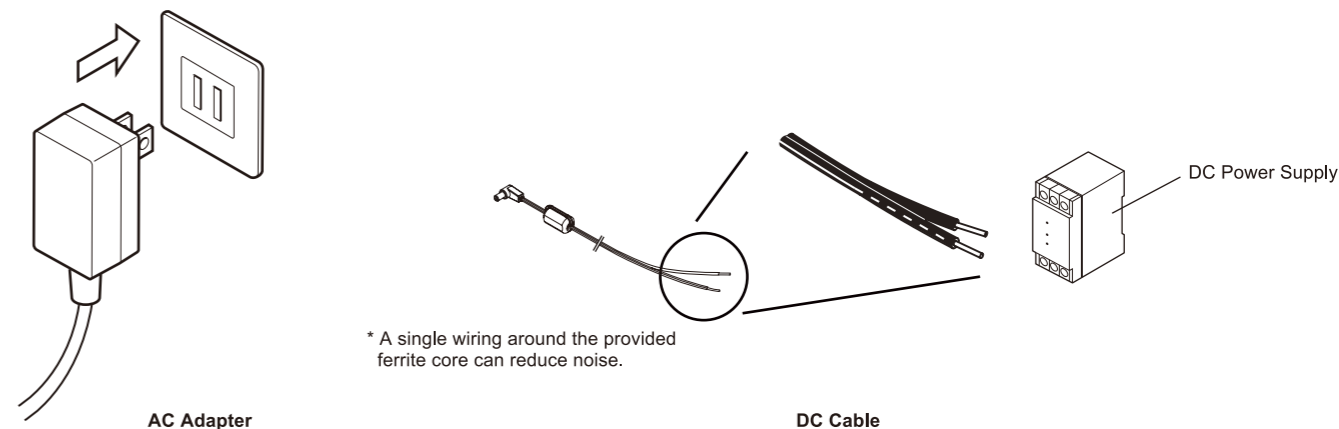

STEP 4 Mount the CT to the measurement conductor.

- For split-core CT, close the fixing hook until it clicks.
- Check the direction of the power supply side (K) and load side (L), and then clamp the CT. Correct measurement cannot be made if the setting direction is wrong.
- To connect multiple CTs, use a branch cable (ZN-CTM11-C).

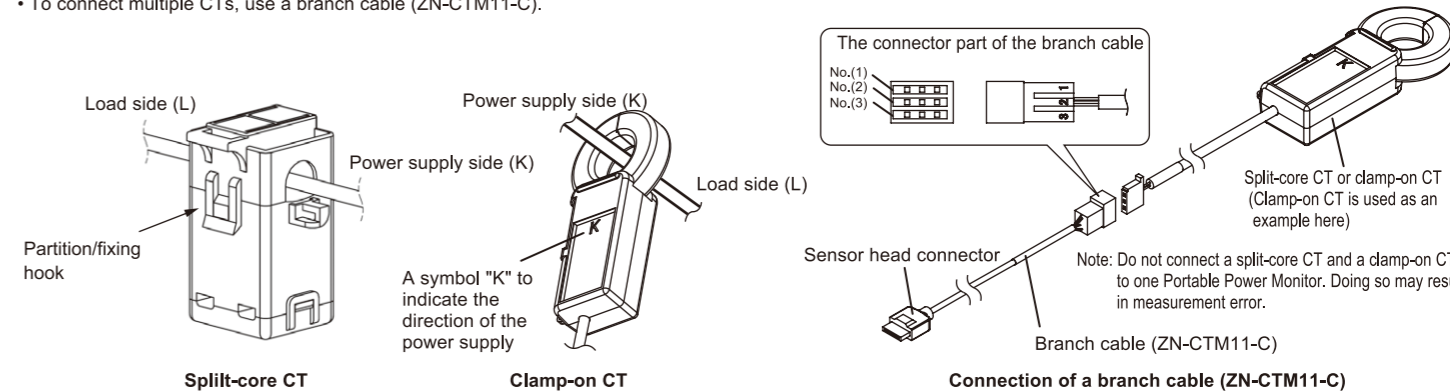

STEP 5 Turn the power ON. The CT enters free run (recording available) state and displays measurement value.

STEP 4 Setting measurement conditions

Set measurement conditions to the main unit. There are six conditions as follows: the number of used channels (USECH), applicable circuit (TYPE), dedicated CT type (CT), voltage (VOLT), power factor (PF), and frequency (FREQ). To set measurement conditions, use FUN mode.

1 Press the MODE key to blink "FUN".

If FUN is already blinking, this operation is not necessary.

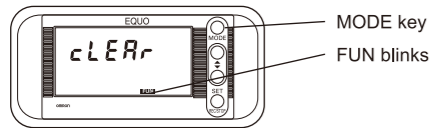

2 Set the number of channels to use (USECH). Example: Setting to "2CH".

(1) Press the Δ or ∇ key until "USECH" is shown in the upper line of the display. If the lower line shows "2CH", operations (2) to (4) are not required because "2CH" has been already set.

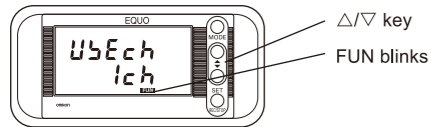

(2) Press the SET/REC/STOP key to make the display in the lower line blink.

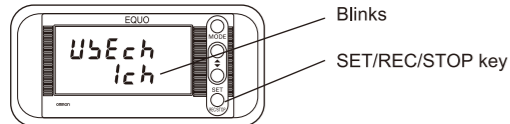

(3) Press the Δ or ∇ key until "2CH" is shown in the lower line.

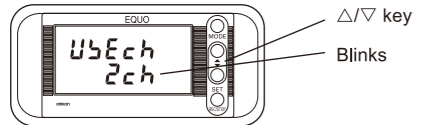

(4) Press the SET/REC/STOP key to apply "2CH" to the number of channels to use.

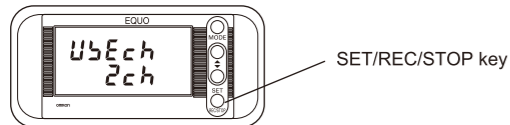

3 Set applicable circuit (TYPE).

(1) Press the Δ or ∇ key until "TYPE" is shown in the upper line of the display.

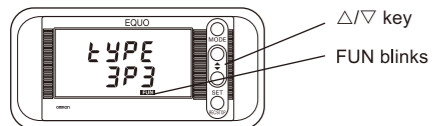

To set the applicable circuit (TYPE), follow the same procedure as the number of used channels (USECH) setting.

4 Set the dedicated CT type (CT).

(1) Press the Δ or ∇ key until "CT" is shown in the upper line of the display.

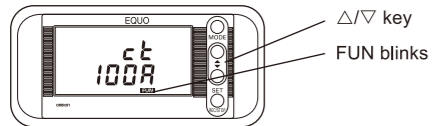

To set the dedicated CT type (CT), follow the same procedure as the number of used channels (USECH) setting.

5 Set the voltage (VOLT). Example: Set to 100.0 V

(1) Press the Δ or ∇ key until "VOLT" is shown in the upper line.

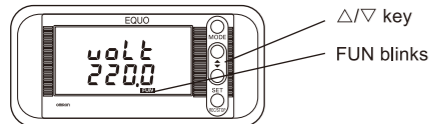

(2) Press the SET/REC/STOP key to make the display in the lower line blink.

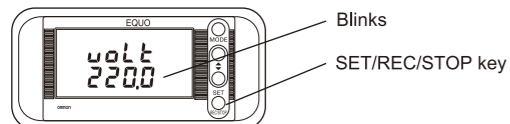

(3) Press the Δ or ∇ key until "100.0" is shown in the lower line.

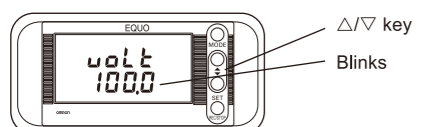

(4) Press the SET/REC/STOP key to confirm the voltage as "100.0".

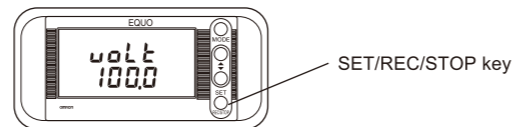

6 Set power factor (PF) and frequency (FREQ).

(1) To set power factor, display "PF" in the upper line, or to set frequency, display "FREQ".

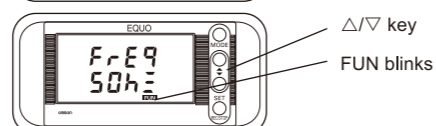
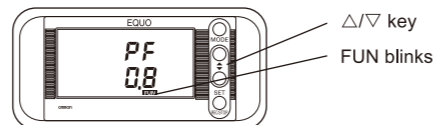

To perform the operations below, follow the same procedure as the measurement target voltage (VOLT) setting.

- A reset interval of the integrated power consumption can be set by displaying "INTEG" in the upper line of the display. For example, if you set the interval to 30 min, the integrated power consumption will be reset at 30-minute intervals such as 0:00 to 0:30, 0:30 to 1:00, 1:00 to 1:30. The initial value is set to OFF (no reset).
- Operation mode can be changed by displaying "MODE" in the upper line of the display. If you need more measurement accuracy, change the mode from SLEEP (default) to NORM. When operating in NORM mode, be sure to use an external power supply.

The measurement target type (TYPE) supports single-phase 2-wire (1P2), single-phase 3-wire (1P3), three-phase 3-wire (3P3) and three-phase 4-wire (3P4). Connect the CT for each type as shown below.
Note: Unbalanced loads cause a greater measurement error when measuring a three-phase 3-wire circuit by using only one channel.

<When the number of channels to use is 1CH>
Clamp to phase L for single-phase 2-wire and phase R for three-phase 3-wire.

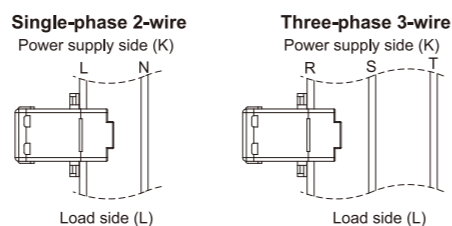

<When the number of channels to use is 2CH>
Clamp CH1 to phase R and CH3 to phase S for single-phase 3-wire. Clamp CH1 to phase R and CH3 to phase T for three-phase 3-wire.

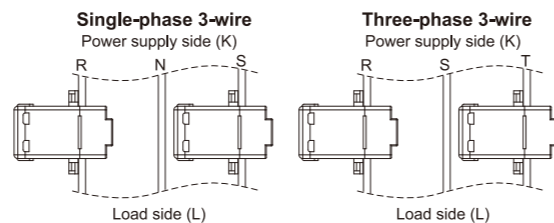

<When the number of channels to use is 3CH>
Clamp CH1 to phase R, CH2 to phase S and CH3 to phase T.

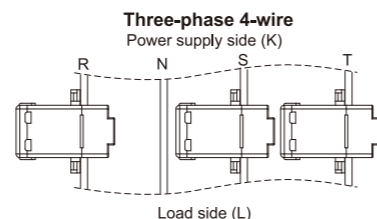

STEP 5 Installing Station Utility

Install Station Utility in advance.

Station Utility consists of a setting tool, logging tool and data display tool.

Product requirements

OS: Windows XP (32-bit)/Windows Vista (32-bit)/Windows 7 (32-bit/64-bit)
CPU: Intel (x86) compatible processor, 1.5 GHz or higher
Memory: 1 GB or more (2 GB or more recommended)
Display: Resolution 1024x768 or more, 65,535 colors (16-bit color) or more

HDD: A minimum of 30 MB free space is required to install Station Utility.
LAN port (supporting 10BASE-T and 100BASE-TX) : For network connections
SD card reader and writer/SD card slot : For unit recorded data reading

Installation

Installation data is downloaded in a PC from following URL.



<http://www.fa.omron.co.jp/station-u-e>

"When Setup.exe in the installation data is executed, the right screen is indicated."

Press the "Station Utility" button to start installation.

Follow the instructions displayed on the screen.

Installation should be implemented by an authorized user such as a system administrator.

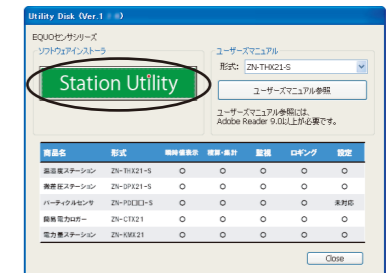

STEP 6 Connecting to a network

Network settings are required to connect a Portable Power Monitor to a PC via network.

Connect the LAN cable after completing the network settings for the Portable Power Monitor unit.

Connection Example

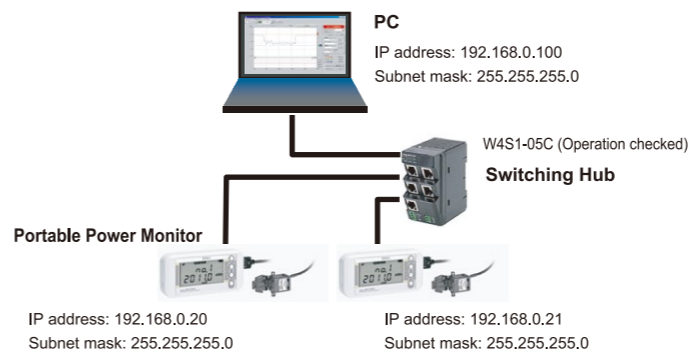

Setting Example

PC IP address	192.168.0.100
Portable Power Monitor IP address	(Unit 1) 192.168.0.20 (Factory default) (Unit 2) 192.168.0.21 (Change from the factory default)
Subnet mask	255.255.255.0 (Factory default)

Note

- A full understanding of LAN is required for network connection.
- Establish a dedicated LAN for connecting a Portable Power Monitor to a network.
- Connection to an in-house network or an existing LAN requires caution, since specific restrictions or rules may have been applied to the IP address management. Consult your network administrator. In case that such a network is used, however, OMRON cannot guarantee the performance of the Portable Power Monitor and the provided PC software.
- The IP addresses of the Portable Power Monitor and the PC must be individually unique and must not overlap each other in the network. If the subnet mask is changed from 255.255.255.0, the fourth segment of the IP addresses of all the connected units in the network still must be distinguished from one another.

Making unit settings

Make settings on the Portable Power Monitor in FUN mode.

1 Press the MODE key to blink "FUN".

If FUN is already blinking, this operation is not necessary.

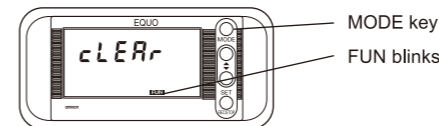

2 Display "MODE" in the upper line and set the lower line to "NORM".

(1) Press the Δ or ∇ key until "MODE" is shown in the upper line.

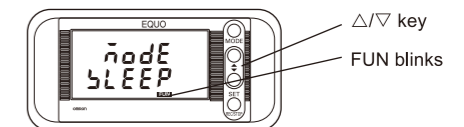

(2) Press the SET/REC/STOP key to make the display in the lower line blink.

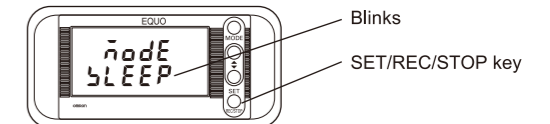

(3) Press Δ/∇ key until "NORM" is displayed at the lower row.

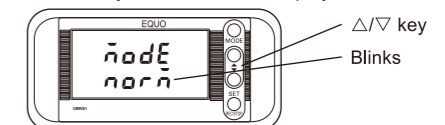

(4) Press the SET/REC/STOP key to confirm "NORM".

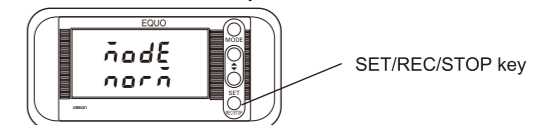

3 Display "ETC" in the upper line and set the lower line to "DISP".

(1) Press the Δ or ∇ key until "ETC" is shown in the upper line.

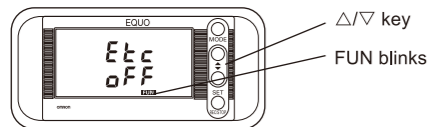

(2) Press the SET/REC/STOP key to make the display in the lower line blink.

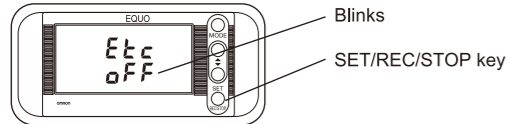

(3) Press Δ/∇ key until "DISP" is displayed at the lower row.

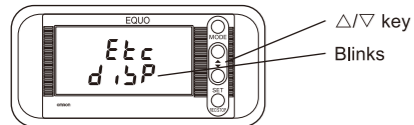

(4) Press the SET/REC/STOP key to confirm "DISP".

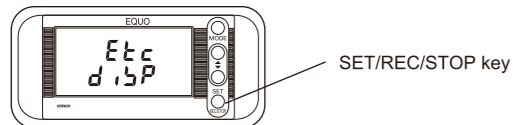

4 Display "NET" in the upper line and set the lower line to "ON".

(1) Press the Δ or ∇ key until "NET" is shown in the upper line.

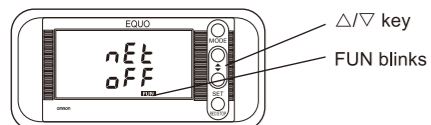

(2) Press the SET/REC/STOP key to make the display in the lower line blink.

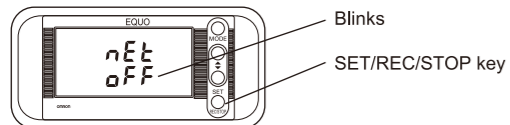

(3) Press Δ/∇ key until "ON" is displayed at the lower row.

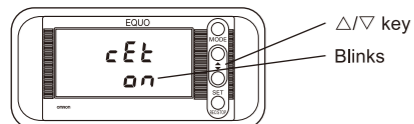

(4) Press the SET/REC/STOP key to confirm "ON".

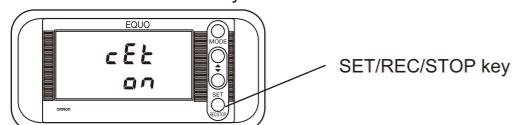

5 Display "IP" in the upper line in the same way as step 4, and set the lower line to "DISP".

6 Set the IP address.

The factory default is set to "192.168.0.20".
Change it to "192.168.0.21".

(1) Apply "IP" to "DISP". Then, press the ∇ key to display "IP1".
If "192" is not displayed, change the value referring to the changing "IP 4" example shown later.



(2) Press the ∇ key to display "IP2".
If "168" is not displayed, change the value referring to the changing "IP 4" example shown later.

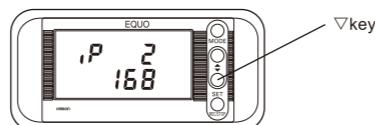

(3) Press the ∇ key to display "IP3".
If "0" is not displayed, change the value referring to the changing "IP 4" example shown later.

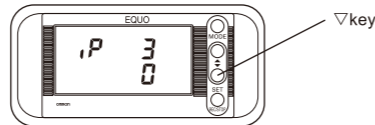

(4) Press the ∇ key to display "IP4".
Change "20" to "21".



(5) Press the SET/REC/STOP key. "20" in the lower line blinks.

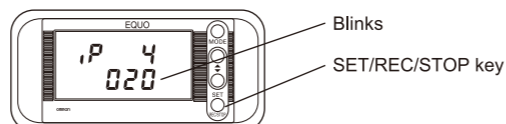

(6) Press the ∇ or Δ key to change the value to "21".

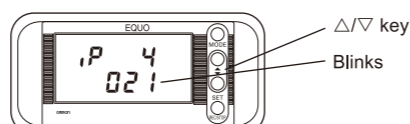

(7) Press the SET/REC/STOP key. The value is applied.

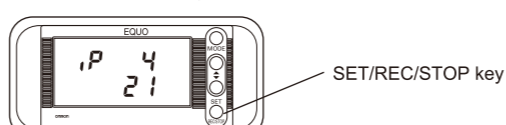

7 Set SUB 1 to 4 (subnet mask) in the same way as step 6.

Use "255.255.255.0" (Factory default) for subnet mask.
To change the subnet mask, contact your network administrator.

8 Press the MODE key. The unit is reset.

The unit is connected through the new IP address after restart.

STEP 7 Data Record

Measured values will be recorded in a Portable Power Monitor unit. Refer to Station Utility User's Manual for the procedure to acquire the data to a PC.

1 Press the MODE key to turn "RUN" ON.

If RUN is already on, this operation is not necessary.

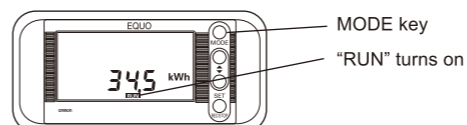

2 Press and hold the SET/REC/STOP key (for 3 seconds or longer) to start recording.

During recording, "REC" is turned ON.
Data is recorded in the internal memory.

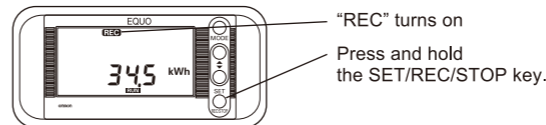

3 You can change the display contents with the Δ and ∇ keys.

* Instantaneous power and integrated power consumption are conversion values.

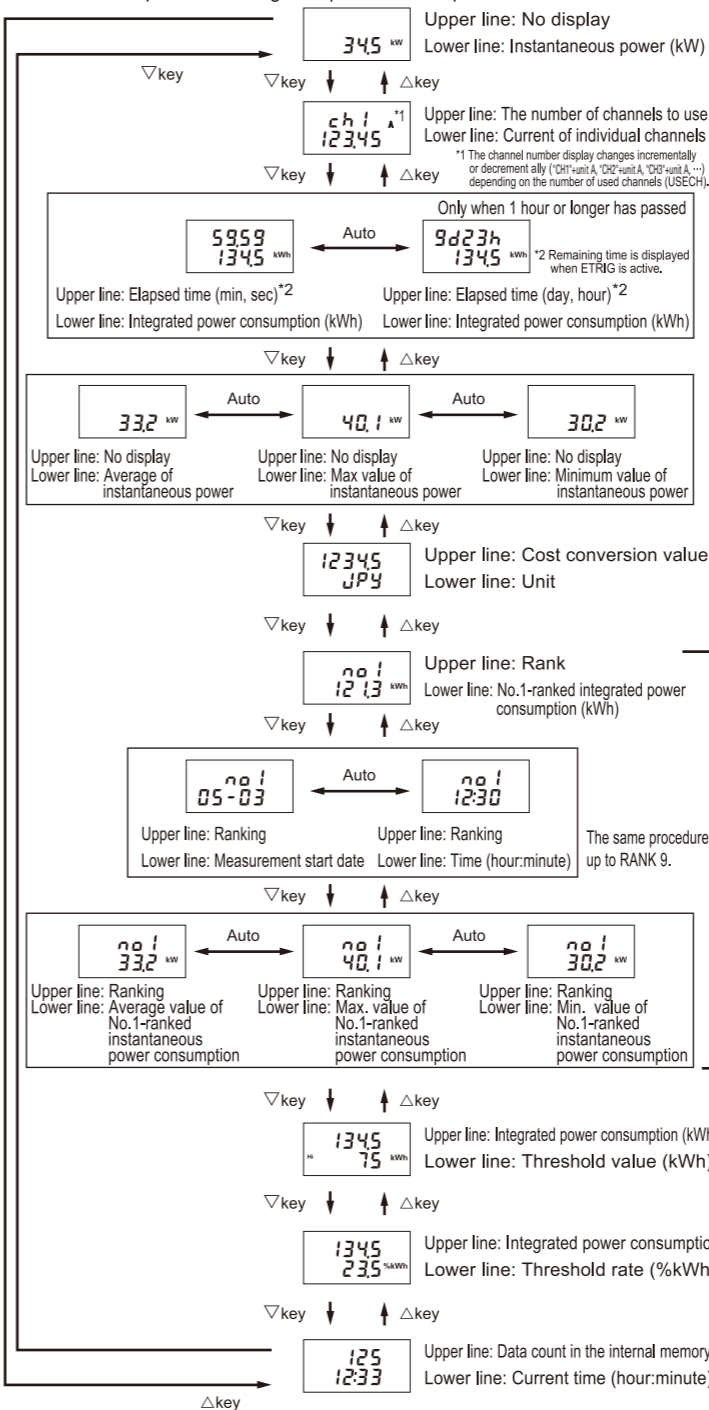

4 Insert an SD memory card to obtain the data recorded in the internal memory.

Insert the SD memory card with metal terminals facing upward until it clicks.
When it inserted correctly, "SD" turns on.

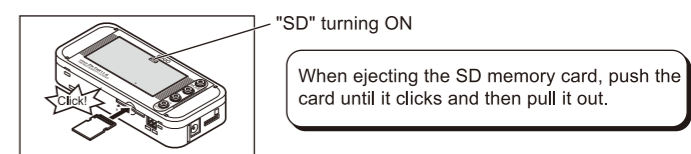

5 Press the SET/REC/STOP key to output the data to the SD memory card as a CSV file.

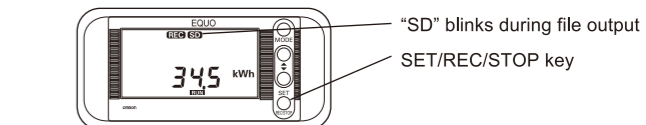

Caution
Do not eject the SD memory card while "SD" is blinking.
When "SD" changes from the blinking to turned-on status, writing is complete and you can eject the SD memory card.

- If you press and hold the SET/REC/STOP key less than 3 seconds, file output is carried out while recording in the internal memory continues.
- If you press and hold the SET/REC/STOP key more than 3 seconds, file output is carried out though recording into the internal memory is stopped. "REC" turns OFF.
- After "SD" stops blinking, you can eject the SD memory card.

- If the internal memory is used up, recording stops. However, when SD card has been inserted, data will be automatically output to the card as a file to continue recording (in the case when factory default is set to the CONTINUE Mode).
- If the screen display turns OFF during measurement, the device is set to the sleep mode. Pressing any key will resume display. Recording will be continued while display turns OFF.

Main error messages displayed

Display (Upper line/Lower line)	Meaning	Description
DATA E1100	Measured data writing failure	Failure in writing the measured data on the SD memory card due to no free memory or pulling out the card while writing. Insert a writable SD card. Press and hold the MODE key (for 3 seconds or longer) to release an error display. If an error occurs, insert a proper SD card and stop recording. After the data is properly written to the SD card, restart recording.
NO SD E3000	No SD memory card inserted.	No SD memory card is inserted. Insert an SD memory card. Press and hold the MODE key (for 3 seconds or longer) to release an error display.
SDLCK E3002	SD memory card writing is prohibited.	SD memory card writing is prohibited. Insert a writable SD memory card. Press and hold the MODE key (for 3 seconds or longer) to release an error display.

Making PC settings

Refer to the Portable Power Monitor User's Manual for the PC IP address setting.
User's Manual is downloaded in a PC from following URL.



<http://www.fa.omron.co.jp/products/family/3078/download/manual.html>

List of Portable Power Monitor Setting Items

For details, refer to the User's Manual.

Operating Modes

Portable Power Monitor has three operation modes. Measurement and recording are carried out in RUN mode.

Mode	Name	Display	Description
RUN	Measurement execution mode	"RUN" turns ON	Performs measurement
FUN	Function setting mode	"FUN" blinks	Sets various parameters.
THR	Threshold setting mode	"THR" blinks	Sets conditions for alarm output.

Change of operating modes is executed by the MODE key. Press the MODE key twice to change the mode from RUN to FUN. For other cases, press the MODE key once. Press the Δ key/ ∇ key to display the detailed screen. During recording into the device, transition from RUN mode to other modes is disable.

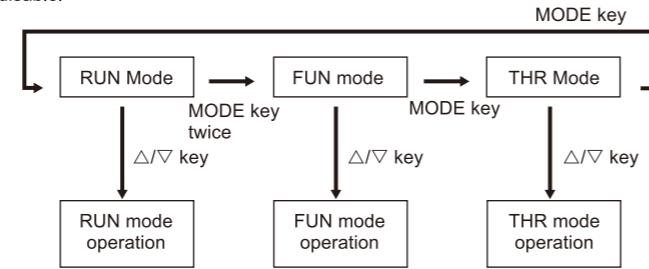

FUN mode

Settings regarding measurement and recording functions can be made in FUN mode.

Display items	Setting items	Contents	Factory default
CLEAR	Ranking clear	A press of the SET/REC/STOP key displays "CLEAR". Another press of the REC key clears the ranking.	-
CYCLE	Record interval	Set the update intervals of measured values. 1s (second)/2s/5s/10s/20s/30s/1 min (minute)	1s
TIMER (At ON)	STRIG	Start trigger Set the start trigger using the timer setting function. OFF/TIME (Starts recording at the specified time)	OFF
	STIME	Start time Set the record start time using the timer setting function. 00:00 to 23:59	00:00
	ETRIG	End trigger Set the end trigger using the timer setting function. OFF/TIME (Starts recording at the specified time)/ELPSD (The elapsed time from the record start to end)	OFF
	ETIME	End time Set the record end time using the timer setting function. 00:00 to 23:59	00:00
	ELPSD	Elapsed time Set the elapsed time from the record start to end using the timer setting function. 0.05 (0 minute 5 seconds) to 999.59 (999 minutes 59 seconds)	0.05
MODE	Measurement operating mode	Set the operation at measurement. After confirming NORM/SLEEP setting, changing the operation mode with the MODE key resets the setting and the Portable Power Monitor restarts.	SLEEP
REC	Recording mode	Sets operation for the case where the internal memory is used up. CONT/RING	CONT
INTEG	Reset interval of integrated power consumption	Specify the time interval to measure integrated power consumption. OFF/30 min/1 h/24 h	OFF
USECH	The number of channels to use	Set the number of channels to use. 1CH/2CH/3CH	1CH
TYPE	Applicable circuit	Set the power supply type of the measurement target. 1P2 (Single-phase 2-wire)/1P3 (Single-phase 3-wire)/3P3 (Three-phase 3-wire)/3P4 (Three-phase 4-wire)	3P3
CT	Dedicated CT type	Specify the CT type of the measurement target. 5A/50A/100A/200A/400A	100A
VOLT	Measurement target voltage	Specify the voltage of the measurement target. 1.0 to 9999.9	220
PF	Power factor	Specify the power factor of the measurement target. 0.01 to 1.00	0.8
FREQ	Frequency	Specify the frequency of the measurement target. 50Hz/60Hz	50Hz
INIT	Return to the factory default.	Press and hold the SET/REC/STOP key to start initializing. If the operating mode is changed with the MODE key after displaying DONE, the device is reset and starts again.	-
ETC (At DISP)	RESTR	Reading the setting data from the SD memory card Press and hold the SET/REC/STOP key to read the setting data from the SD memory card and set them on the main unit. If the operating mode is changed with the MODE key after displaying DONE, the device will be reset and reboot.	-
	BCKUP	Writing the setting data on the SD memory card Press and hold the SET/REC/STOP key to save the setting data on the SD memory card.	-
CLOCK (At DISP)	YEAR	Year	Sets the year.
	MONTH	Month	Sets the month.
	DAY	Day	Sets the day.
	TIME	Hour: Minute	Sets Hour and Minute.
NET	Network function	Specify if the network functions are required. OFF/ON	OFF
IP (At DISP)	IP	IP address 0 to 255	192.168.0.20
	SUB	Subnet mask 0 to 255	255.255.255.0
SCT5A (At DISP)	SCT5A	Rated primary side current value Set the rated primary current value. It is valid only when CT is configured as 5A. 5 to 9999	5A
	LOCUT	Low-cut current Specify the low-cut current. 0.1 to 19.9%	0.6%
DTAIL (At DISP)	RANGE	Measurement range Specifies the measurement range. NORM (Fixed measurement range)/AUTO (Automatic switching according to the measured current value)	AUTO
	RATE	Rate/CO2 conversion rate setting Specify the rate/CO2 conversion value setting (RATE). 00.000 to 99.999	0
CONV	Conversion unit setting	Specify the unit of the rate/CO2 conversion value setting (RATE). JPY (yen)/USD (U.S. dollar)/EUR (Euro)/CNY (Chinese yuan)/KRW (Korean won)/CO2 (CO2 emissions per kWh)	JPY
REREC	Power failure REC restoration	Specify if the unit writes data and resumes recording after restart in the event of a power failure during recording. OFF (Does not start recording)/ON (Starts recording after writing data)	OFF

Use the Δ key/ ∇ key to move among the setting items, and fix it with the SET/REC/STOP key.

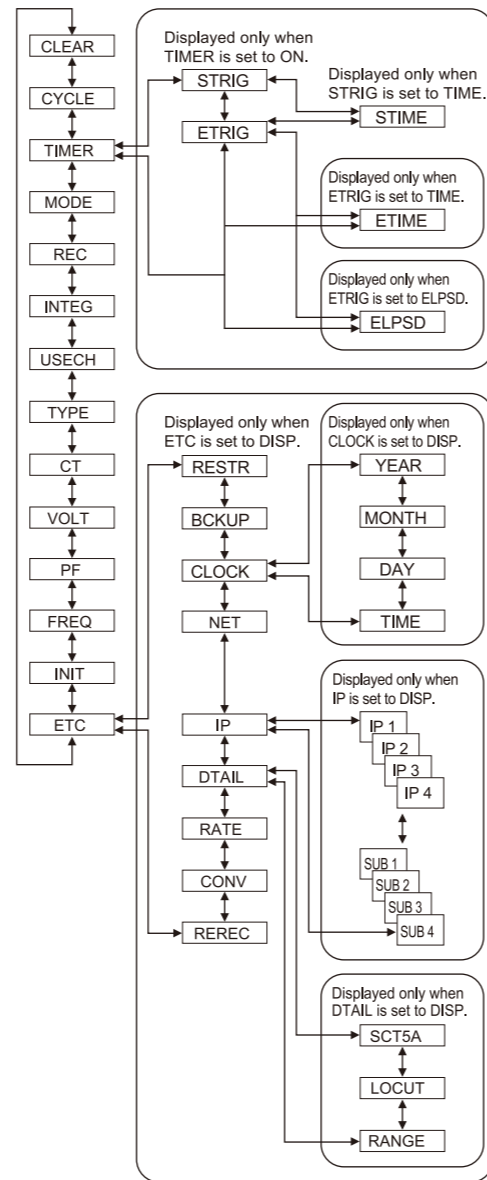

If "ETC", "CLOCK", "IP" or "DTAIL" is set to "DISP", the setting will return to "OFF" upon restart.

THR Mode

In THR mode, a threshold value for alarm output is set. When measurement is performed in RUN mode, if a measured value exceeds the threshold value, "ALM" is turned ON and alarm output becomes ON condition. (Alarm output will be unavailable if both items are set to 0.)

Display items	Setting items	Description	Factory default
INT H	Upper limit of integrated power consumption threshold value more than kWh	"ALM" and alarm output will turn ON when the measured integrated power consumption is higher than the set value. 0 kWh to 99999 kWh	0kWh
INT H	Upper limit of integrated power consumption threshold value less than kWh	"ALM" and alarm output will turn ON when the measured integrated power consumption is lower than the set value. 0 kWh to 99999 kWh	0Wh

Use the Δ key/ ∇ key to move among the items, and fix them with the SET/REC/STOP key.

About the registered trademarks

- Microsoft and Windows are registered trademarks or trademarks of Microsoft Corporation in the United States and/or other countries.
- Other company names and product names described herein are registered trademarks or trademarks of each company.

Suitability for Use: Refer to Suitability for Use in the Instruction Sheet

OMRON Corporation Industrial Automation Company
Tokyo, JAPAN
Contact: www.ia.omron.com

Regional Headquarters
OMRON EUROPE B.V.
Sensor Business Unit
Carl-Benz-Str. 4, D-71154 Nufringen, Germany
Tel: (49) 7032-811-0/Fax: (49) 7032-811-199

OMRON ELECTRONICS LLC
One Commerce Drive Schaumburg,
IL 60173-5302 U.S.A.
Tel: (1) 847-843-7900/Fax: (1) 847-843-7787

OMRON ASIA PACIFIC PTE. LTD.
No. 438A Alexandra Road # 05-05/08 (Lobby 2),
Alexandra Technopark,
Singapore 119967
Tel: (65) 6835-3011/Fax: (65) 6835-2711

OMRON (CHINA) CO., LTD.
Room 2211, Bank of China Tower,
200 Yin Cheng Zhong Road,
PuDong New Area, Shanghai, 200120, China
Tel: (86) 21-5037-2222/Fax: (86) 21-5037-2200

Authorized Distributor:

© OMRON Corporation 2011 All Rights Reserved.
In the interest of product improvement,
specifications are subject to change without notice.