

Smart Sensor

2D CMOS Laser Type

ZS-L Series (Ver 2.0)

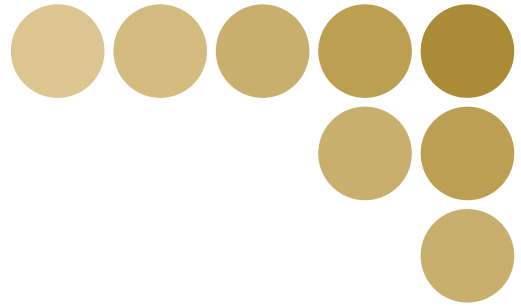

User's Manual



Introduction

This manual provides information regarding functions, performance and operating methods that are required for using the ZS-L Series.

When using the ZS-L Smart Sensor, be sure to observe the following:

- The ZS-L Smart Sensor must be operated by personnel knowledgeable in electrical engineering.
- To ensure correct use, please read this manual thoroughly to deepen your understanding of the product.
- Please keep this manual in a safe place so that it can be referred to whenever necessary.

■ How to Switch the Display Language to English

Turn the power ON with the MENU key held down. This displays the display language selection screen.

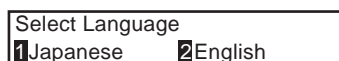

If you change and save the setting, the Controller will start up with messages displayed in English when it is next started up.

| | | |
|--------------|--|--------------|
| INTRODUCTION | APPLICATION CONSIDERATIONS (Please Read) | Introduction |
| SECTION 1 | FEATURES | Section 1 |
| SECTION 2 | INSTALLATION & CONNECTION | Section 2 |
| SECTION 3 | SETUP | Section 3 |
| SECTION 4 | EXTERNAL I/O | Section 4 |
| SECTION 5 | APPLICATION SETTING EXAMPLES | Section 5 |
| SECTION 6 | APPENDIX | Section 6 |

User's Manual

Smart Sensor
2D CMOS Laser Type
ZS-L Series

READ AND UNDERSTAND THIS DOCUMENT

Please read and understand this document before using the products. Please consult your OMRON representative if you have any questions or comments.

WARRANTY

OMRON's exclusive warranty is that the products are free from defects in materials and workmanship for a period of one year (or other period if specified) from date of sale by OMRON.

OMRON MAKES NO WARRANTY OR REPRESENTATION, EXPRESS OR IMPLIED, REGARDING NON-INFRINGEMENT, MERCHANTABILITY, OR FITNESS FOR PARTICULAR PURPOSE OF THE PRODUCTS. ANY BUYER OR USER ACKNOWLEDGES THAT THE BUYER OR USER ALONE HAS DETERMINED THAT THE PRODUCTS WILL SUITABLY MEET THE REQUIREMENTS OF THEIR INTENDED USE. OMRON DISCLAIMS ALL OTHER WARRANTIES, EXPRESS OR IMPLIED.

LIMITATIONS OF LIABILITY

OMRON SHALL NOT BE RESPONSIBLE FOR SPECIAL, INDIRECT, OR CONSEQUENTIAL DAMAGES, LOSS OF PROFITS OR COMMERCIAL LOSS IN ANY WAY CONNECTED WITH THE PRODUCTS, WHETHER SUCH CLAIM IS BASED ON CONTRACT, WARRANTY, NEGLIGENCE, OR STRICT LIABILITY.

In no event shall responsibility of OMRON for any act exceed the individual price of the product on which liability is asserted.

IN NO EVENT SHALL OMRON BE RESPONSIBLE FOR WARRANTY, REPAIR, OR OTHER CLAIMS REGARDING THE PRODUCTS UNLESS OMRON'S ANALYSIS CONFIRMS THAT THE PRODUCTS WERE PROPERLY HANDLED, STORED, INSTALLED, AND MAINTAINED AND NOT SUBJECT TO CONTAMINATION, ABUSE, MISUSE, OR INAPPROPRIATE MODIFICATION OR REPAIR.

SUITABILITY FOR USE

THE PRODUCTS CONTAINED IN THIS DOCUMENT ARE NOT SAFETY RATED. THEY ARE NOT DESIGNED OR RATED FOR ENSURING SAFETY OF PERSONS, AND SHOULD NOT BE RELIED UPON AS A SAFETY COMPONENT OR PROTECTIVE DEVICE FOR SUCH PURPOSES.

Please refer to separate catalogs for OMRON's safety rated products.

OMRON shall not be responsible for conformity with any standards, codes, or regulations that apply to the combination of products in the customer's application or use of the product.

At the customer's request, OMRON will provide applicable third party certification documents identifying ratings and limitations of use that apply to the products. This information by itself is not sufficient for a complete determination of the suitability of the products in combination with the end product, machine, system, or other application or use.

The following are some examples of applications for which particular attention must be given. This is not intended to be an exhaustive list of all possible uses of the products, nor is it intended to imply that the uses listed may be suitable for the products:

- Outdoor use, uses involving potential chemical contamination or electrical interference, or conditions or uses not described in this document.
- Nuclear energy control systems, combustion systems, railroad systems, aviation systems, medical equipment, amusement machines, vehicles, safety equipment, and installations subject to separate industry or government regulations.
- Systems, machines, and equipment that could present a risk to life or property.

Please know and observe all prohibitions of use applicable to the products.

NEVER USE THE PRODUCTS FOR AN APPLICATION INVOLVING SERIOUS RISK TO LIFE OR PROPERTY WITHOUT ENSURING THAT THE SYSTEM AS A WHOLE HAS BEEN DESIGNED TO ADDRESS THE RISKS, AND THAT THE OMRON PRODUCT IS PROPERLY RATED AND INSTALLED FOR THE INTENDED USE WITHIN THE OVERALL EQUIPMENT OR SYSTEM.

PERFORMANCE DATA

Performance data given in this document is provided as a guide for the user in determining suitability and does not constitute a warranty. It may represent the result of OMRON's test conditions, and the users must correlate it to actual application requirements. Actual performance is subject to the OMRON Warranty and Limitations of Liability.

CHANGE IN SPECIFICATIONS

Product specifications and accessories may be changed at any time based on improvements and other reasons.

It is our practice to change model numbers when published ratings or features are changed, or when significant construction changes are made. However, some specifications of the product may be changed without any notice. When in doubt, special model numbers may be assigned to fix or establish key specifications for your application on your request. Please consult with your OMRON representative at any time to confirm actual specifications of purchased products.

DIMENSIONS AND WEIGHTS

Dimensions and weights are nominal and are not to be used for manufacturing purposes, even when tolerances are shown.

ERRORS AND OMISSIONS

The information in this document has been carefully checked and is believed to be accurate; however, no responsibility is assumed for clerical, typographical, or proofreading errors, or omissions.

PROGRAMMABLE PRODUCTS

OMRON shall not be responsible for the user's programming of a programmable product, or any consequence thereof.

COPYRIGHT AND COPY PERMISSION

This document shall not be copied for sales or promotions without permission.

This document is protected by copyright and is intended solely for use in conjunction with the product. Please notify us before copying or reproducing this document in any manner, for any other purpose. If copying or transmitting this document to another, please copy or transmit it in its entirety.

Meanings of Signal Words

The following signal words are used in this manual.



WARNING

Indicates a potentially hazardous situation which, if not avoided, will result in minor or moderate injury, or may result in serious injury or death. Additionally there may be significant property damage.

Meanings of Alert Symbols

The following alert symbols are used in this manual.

| | |
|--|--|
| | Indicates the possibility of laser radiation. |
| | Indicates prohibition when there is a risk of minor injury from electrical shock or other source if the product is disassembled. |
| | Indicates general prohibitions for which there is no specific symbol. |

Alert statements in this Manual

The following alert statements apply to the products in this manual. Each alert statement also appears at the locations needed in this manual to attract your attention.

| | |
|--|--|
| WARNING | |
| This product is not designed or rated for ensuring safety of persons. Do not use it for such purposes. | |
| Never look into the laser beam. Doing so continuously will result in visual impairment. | |
| Do not disassemble the product. Doing so may cause the laser beam to leak, resulting in the danger of visual impairment. | |

Precautions for Safe Use

Please observe the following precautions for safe use of the products.

(1) Installation Environment

- Do not use the product in environments where it can be exposed to inflammable/explosive gas.
- To secure the safety of operation and maintenance, do not install the product close to high-voltage devices and power devices.

(2) Power Supply and Wiring

- The supply voltage must be within the rated range (DC24V±10%).
- Reverse connection of the power supply is not allowed.
- Open-collector outputs should not be short-circuited.
- Use the power supply within the rated load.
- High-voltage lines and power lines must be wired separately from this product. Wiring them together or placing them in the same duct may cause induction, resulting in malfunction or damage.

(3) Regulations and Standards

- EN61326-1
- Electromagnetic environment : Industrial electromagnetic environment (EN/IEC 61326-1 Table 2)
- The following condition is applied to the immunity test of this product.
: There may be cases that current or voltage output fluctuate within ±3%F.S. when a sensor is experienced electromagnetic interference.
- Notice for Korea Radio Law
A 급 기기 (업무용 방송통신기자재)
이 기기는 업무용 (A 급) 전자파적합기기로서 판매자 또는 사용자는 이 점을 주의하시기 바라며 , 가정외의 지역에서 사용하는 것을 목적으로 합니다.

(4) Others

- Do not attempt to dismantle, repair, or modify the product.
- Dispose of this product as industrial waste.

Precautions for Correct Use

Please observe the following precautions to prevent failure to operate, malfunctions, or undesirable effects on product performance.

(1) Installation Site

Do not install the product in locations subjected to the following conditions:

- Ambient temperature outside the rating
- Rapid temperature fluctuations (causing condensation)
- Relative humidity outside the range of 35 to 85%
- Presence of corrosive or flammable gases
- Presence of dust, salt, or iron particles
- Direct vibration or shock
- Reflection of intense light (such as other laser beams or electric arc-welding machines)
- Direct sunlight or near heaters
- Water, oil, or chemical fumes or spray
- Strong magnetic or electric field

(2) Power Supply and Wiring

- When using a commercially available switching regulator, make sure that the FG terminal is grounded.
- If surge currents are present in the power lines, connect surge absorbers that suit the operating environment.
- Before turning ON the power after the product is connected, make sure that the power supply voltage is correct, there are no incorrect connections (e.g. load short-circuit) and the load current is appropriate. Incorrect wiring may result in breakdown of the product.
- Before connecting/disconnecting the Sensor Head, make sure that the Smart Sensor is turned OFF. The Smart Sensor may break down if the Sensor Head is connected or disconnected while the power is ON.
- Use the Extension Cable (provided) for extending the cable between the Sensor Head and Sensor Controller. The total length varies according to the type of Extension Cable.
Extension Cable: ZS-XC_A: within 10 m (including Sensor Head cable. Extension Cable cannot be daisy-chained.)
Extension Cable: ZS-XC_B(R): within 22 m (including Sensor Head. Up to two Extension Cables can be daisy-chained.)
The cable may break at locations when it is made to bend. So, use the robot cable type Extension Cable (ZS-XC5BR).
- Use only combinations of Sensor Heads and Sensor Controllers specified in this manual.

(3) Orientation when Installing the Sensor Controller

To improve heat radiation, install the Sensor Controller only in the orientation shown below.

Right

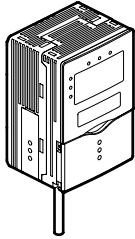

Do not install the Sensor Controller in the following orientations.

Wrong

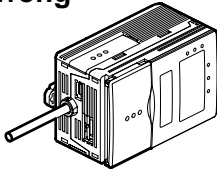

Wrong

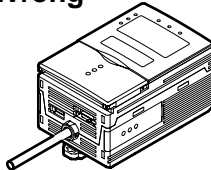

(4) Warming Up

After turning ON the power supply, allow the product to stand for at least 30 minutes before use. The circuits are still unstable immediately after the power supply is turned ON, so measured values may fluctuate gradually.

(5) Maintenance and Inspection

Do not use thinner, benzene, acetone or kerosene to clean the Sensor Head and Sensor Controller. If large dust particles adhere to the front filter of the Sensor Head, use a blower brush (used to clean camera lenses) to blow them off. Do not blow the dust particles with your mouth. To remove smaller dust particles, wipe gently with a soft cloth (for cleaning lenses) moistened with a small amount of alcohol. Do not use excessive force to wipe off dust particles. Scratches on the filter may cause errors.

(6) Sensing Objects

The product sometimes cannot accurately measure the following types of objects: Transparent objects, objects with an extremely low reflection factor, objects smaller than the spot diameter, objects with a large curvature, excessively inclined objects, etc.

Editor's Note

Page Format

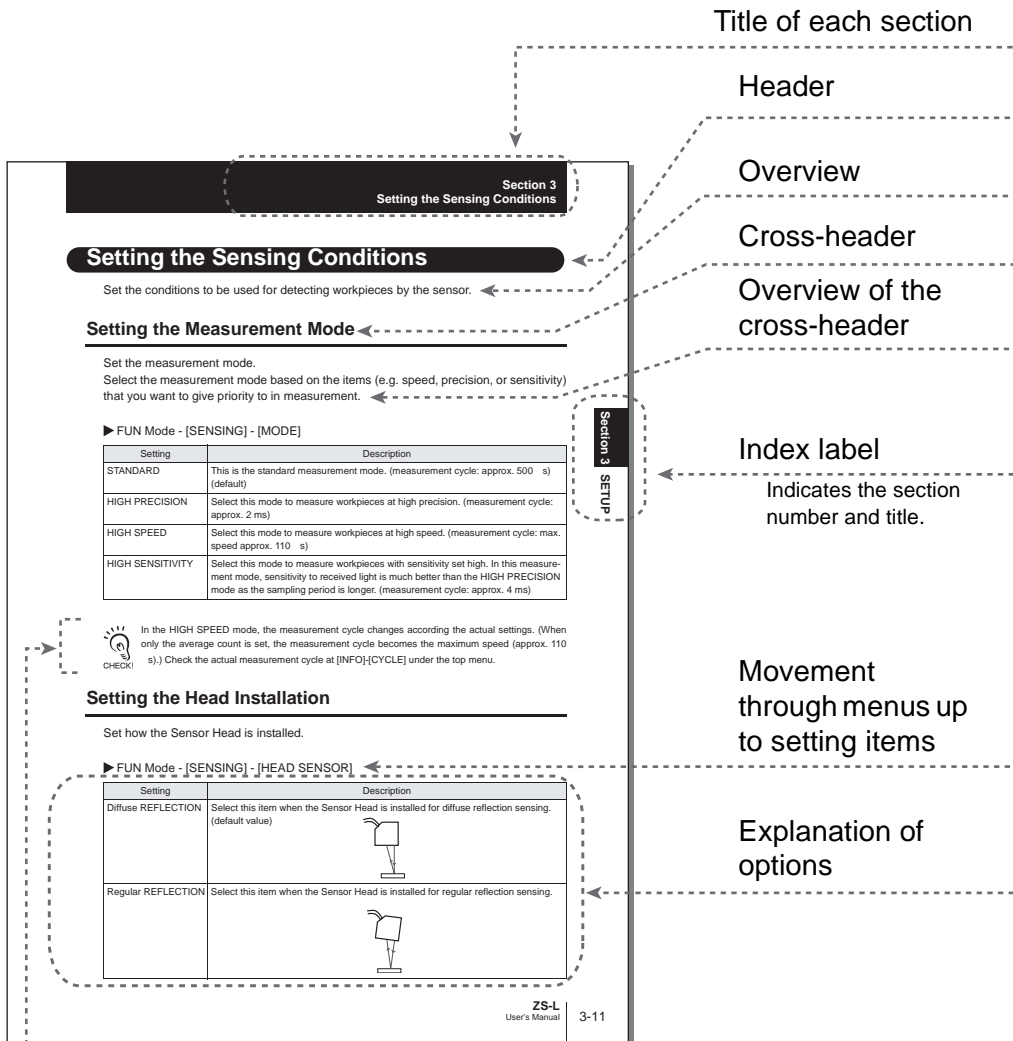

Supplementary Explanation

Helpful information regarding operation and reference pages are introduced here using symbols.



*This page has been made purely for explanatory purposes and does not exist.

■ Meaning of Symbols

Menu items that are displayed on the Sensor Controller's LCD screen, and windows, dialog boxes and other GUI elements displayed on the PC are indicated enclosed by brackets [].

■ Visual Aids



Indicates points that are important to ensure full product performance, such as operational precautions and application procedures.

CHECK!



Indicates pages where related information can be found.



Indicates information helpful in operation.

CONTENTS

| | |
|---|------------|
| Meanings of Signal Words | 5 |
| Meanings of Alert Symbols | 5 |
| Alert statements in this Manual | 5 |
| Precautions for Safe Use | 6 |
| Precautions for Correct Use | 7 |
| Editor's Note | 9 |
| Page Format | 9 |
| CONTENTS | 11 |
| Section 1 FEATURES | 1-1 |
| ZS-L Features | 1-2 |
| ZS-L Applications | 1-4 |
| Basic Configuration | 1-9 |
| Part Names and Functions | 1-10 |
| Section 2 INSTALLATION & CONNECTION | 2-1 |
| About Installation and Connection | 2-2 |
| Sensor Controller | 2-3 |
| Attaching the ferrite core | 2-3 |
| Installing the Sensor Controller | 2-4 |
| About the I/O cable | 2-7 |
| Sensor Head | 2-11 |
| Attaching the ferrite core | 2-11 |
| Installing the Sensor Head | 2-12 |
| Connecting Sensor Heads | 2-18 |
| SmartMonitor ZS | 2-19 |
| Installing SmartMonitor ZS on a personal computer | 2-19 |
| Starting up SmartMonitor ZS | 2-23 |
| Section 3 SETUP | 3-1 |
| Setting Flow | 3-2 |
| About Setup | 3-4 |
| Basic Knowledge for Operation | 3-4 |





| | |
|--|------|
| List of Setting Items | 3-9 |
| Setting the Sensing Conditions | 3-12 |
| Setting the Measurement Mode | 3-12 |
| Setting the Head Installation | 3-13 |
| Setting the Emitted Light Intensity | 3-13 |
| Setting the Measurement Object | 3-14 |
| Setting Prevention of Mutual Interference | 3-16 |
| Setting Gain | 3-17 |
| Setting the Filter Function | 3-18 |
| Setting Smooth | 3-18 |
| Setting Average | 3-19 |
| Setting Differentiation | 3-19 |
| Setting Output Processing of Sensing Information | 3-20 |
| Setting Scaling | 3-20 |
| Setting Hold Functions | 3-24 |
| Setting Zero Reset | 3-28 |
| Setting Threshold Values | 3-31 |
| Setting the Display Method | 3-32 |
| Setting the Digital Displays | 3-32 |
| Setting the LCD Display | 3-33 |
| HELP | 3-34 |
| Setting Banks | 3-34 |
| Switching banks | 3-34 |
| Clearing banks | 3-34 |
| Setting the System Environment | 3-35 |
| Saving setup data | 3-35 |
| Initializing setup data | 3-35 |
| Checking Sensor Controller information | 3-36 |
| Setting key lock | 3-36 |
| Setting the sensor load method | 3-36 |
| Setting the display language | 3-37 |

| | |
|---|------|
| Section 4 EXTERNAL I/O | 4-1 |
| Linear Input/Output | 4-2 |
| Setting Linear Output | 4-2 |
| Setting Judgment Output | 4-5 |
| Non-Measurement Settings | 4-6 |
| Input Signal Settings | 4-7 |
| I/O Assignment Settings | 4-7 |
| Timing Charts | 4-9 |
| RS-232C Input/Output | 4-11 |
| RS-232C Specifications | 4-11 |
| Setting the Communication Specifications | 4-12 |
| Section 5 APPLICATION SETTING EXAMPLES | 5-1 |
| Measuring the Front Side of Black Sheet Rubber | 5-2 |
| Measuring the Height of a PCB Surface | 5-5 |
| Measuring the Thickness of Glass | 5-7 |
| Section 6 APPENDIX | 6-1 |
| Troubleshooting | 6-2 |
| Error Messages and Countermeasures | 6-3 |
| Q&A | 6-5 |
| Glossary | 6-6 |
| Specifications and External Dimensions | 6-7 |
| Sensor Head | 6-7 |
| Sensor Controller | 6-18 |
| Panel Mount Adapters | 6-20 |
| RS-232C Cable for Connecting to a Personal Computer | 6-21 |
| Extension Cable | 6-22 |
| Laser Safety | 6-23 |
| Requirements from Regulations and Standards | 6-24 |
| Summary of Requirements to Manufactures | 6-24 |
| Summary of Requirements to User | 6-28 |
| Definitions of Laser Classification | 6-31 |
| Engineering Data | 6-33 |

| | |
|---------------------------------------|------|
| Linearity Characteristic by Materials | 6-33 |
| Version Up Information | 6-42 |
| INDEX | 6-43 |
| Revision History | 6-47 |

Section 1

FEATURES

| | |
|--|------|
|  ZS-L Features | 1-2 |
|  ZS-L Applications | 1-4 |
|  Basic Configuration | 1-9 |
|  Part Names and Functions | 1-10 |

ZS-L Features

The ZS-L Series is a 2D CMOS laser type displacement sensor. It is provided with a high-performance sensing function that uses a 2D CMOS image sensor, features a high-speed transmission capability free from data degradation as a result of 100% digital handling of data, and is extremely easy-to-use and handy.

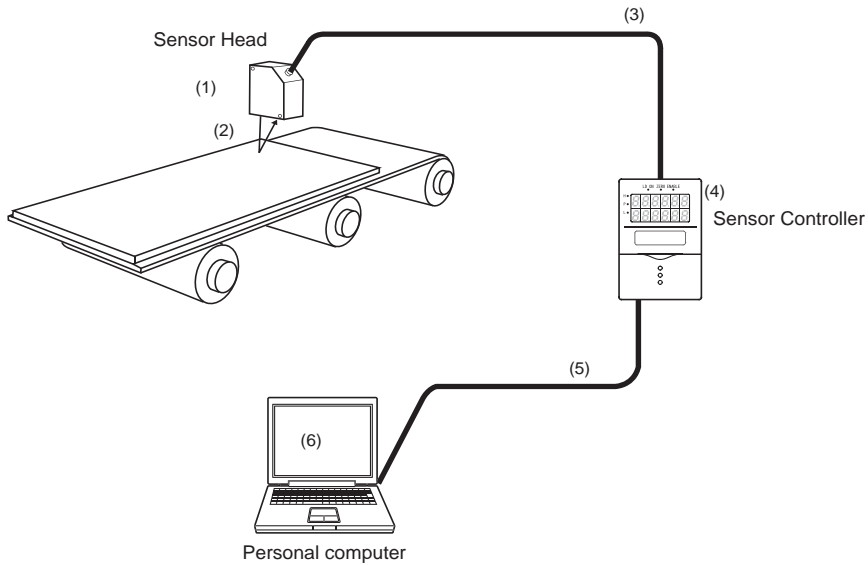

(1) Compact Sensor Head

A 2D CMOS image sensor, proprietary algorithms, and other sensing technology are incorporated in the compact Sensor Head. This achieves an improved dynamic range, high-speed sampling up to 110 μ s, and a high resolution.

(2) An Enhanced Lineup of Sensor Heads

| Regular Reflection Type | | Diffuse Reflection Type | | |
|---|---|--|--|---|
| ZS-LD20T | ZS-LD40T | ZS-LD50 | ZS-LD80 | ZS-LD200 |
| <p>Measurement distance: 20\pm1 mm</p> | <p>Measurement distance: 40\pm2.5 mm</p> | <p>Measurement distance: 50\pm5mm</p> | <p>Measurement distance: 80\pm15 mm</p> | <p>Measurement distance: 200\pm50 mm</p> |

(3) High-speed Digital Transfer

The LVDS (Low Voltage Differential Signaling) high-speed communication interface is used (an industry first) between the Sensor Head and the Sensor Controller. Data detected by the Sensor Head is transferred at high speed without any degradation. Moreover, the connection can be extended up to 22 m by 2 extension cables to suit your setup environment.



Connection extended up to 22 m p.1-7

(4) Business Card-size Sensor Controller

- The Sensor Controller is designed to be compact so that it can be installed at a wide range of sites.



External Dimensions p.6-18

- Large-size LCD screen and direct function keys ensure outstanding operability.
- The Sensor Controller supports various workpieces, which means that detailed and flexible settings can be made.
- Incorporates extensive functions such as Filter and Hold to support a wide range of applications.
- Mutual interference from 2 adjacent Sensor Heads can be prevented by shifting the timing of laser beam emission.



List of Setting Items p.3-9

(5) USB Connection

The Sensor Controller is provided with a USB port (compliant with Full-Speed USB2.0 specifications) as standard. This enables detection data and setting data to be easily uploaded to a personal computer.

(6) Dedicated Software “SmartMonitor ZS Professional”

The “SmartMonitor ZS Professional” software for setting up and monitoring multi-window displays and logging is provided (Sold separately). This software also supports the display and setup of data such as monitoring of waveforms and designation of area that is not possible on the Sensor Controller alone.

ZS-L Applications

- **Detection of rubber and other black workpieces**

The improved dynamic range enables the detection of black workpieces that reflect little light.



- **Detection of light-penetrating workpieces such as PCBs**

Proprietary sensing algorithms enable the detection of workpieces through which light penetrates.

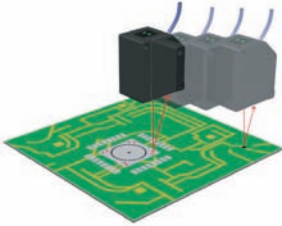

- **Detection of transparent workpieces such as glass**

Proprietary sensing algorithms enable the detection of workpieces through which light passes through.

Up to 3 sheets of glass can be detected, which means that the glass thickness and gap between glass sheets can be measured.

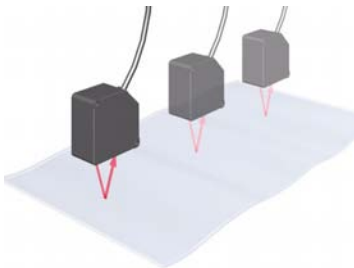

● **Detection of mirror-surface workpieces such as HDDs**

Workpieces having strong directivity of reflected light can be detected by a regular reflection type Sensor Head.

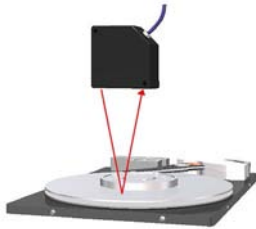

● **Display of various measurement information**

Various measurement information can be displayed on the sub-display (lower section) on the Sensor Controller.

LCD screens can be customized to change the display of desired information to easier-to-understand terminology.

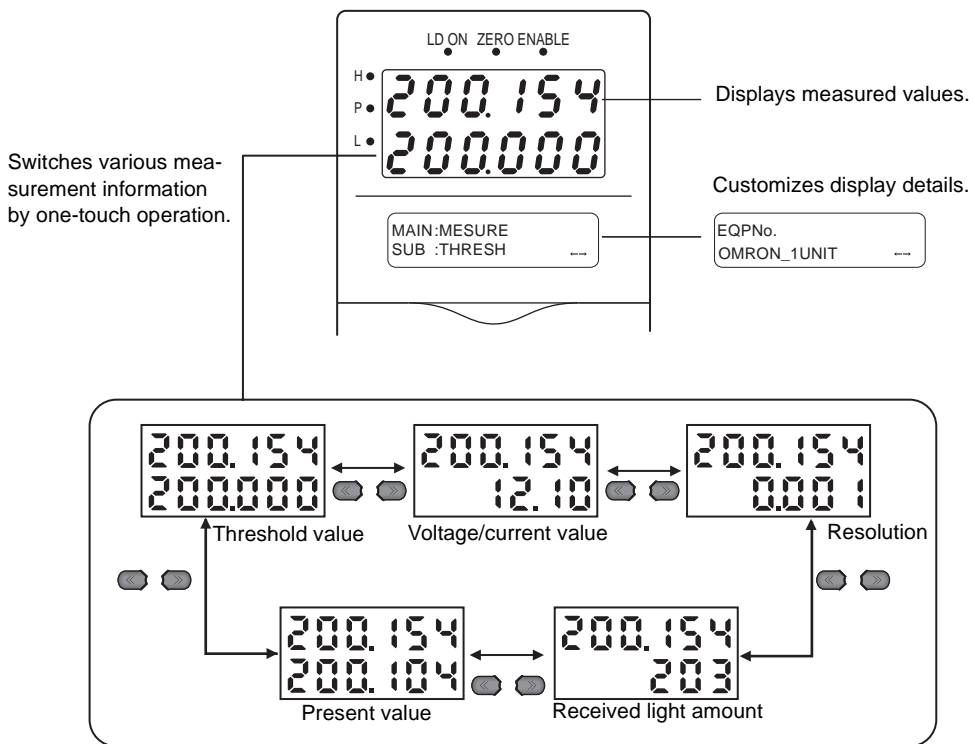

● Installable away from the sensing object

The ZS-L Series can be installed up to 95 mm (ZS-LD80) or up to 250 mm (ZS-LD200) away from the measuring point. This allows workpieces to be measured at a position that is not influenced by the workpiece flying up or the interference of peripheral mechanisms.



The ZS-L Series can be installed at positions that will not be affected by the rubber belt being cut or flying back which occurs during emergency stops.

● Simple Measurement of Glass Thickness and Gap between Glass

Two settings, [THICK] for measuring the thickness of glass and [GAP] for measuring the gap between glass, are provided as sensing object options. Just selecting these options allows you to set measurement conditions simply.

 Setting the Measurement Object p.3-14

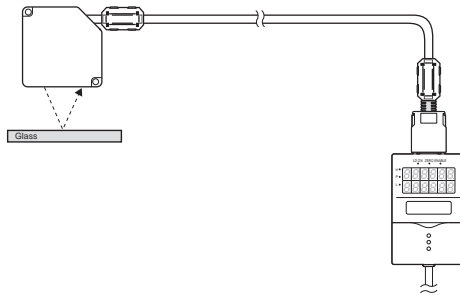

● Mutual Interference Prevented

Mutual interference between 2 Sensor Heads can be prevented by shifting the laser beam emission timing.

 Setting Prevention of Mutual Interference p.3-16

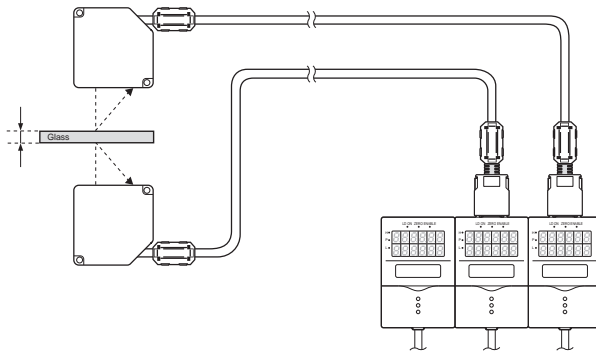

● **Installable on DIN Track or Panels**

The ZS-L Series can be installed on a DIN track and on a control panel or other panels using the optional Panel Mount Adapter.

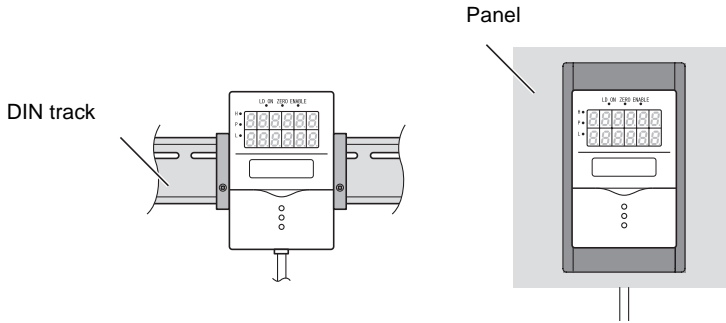

● **Connection Extendable up to 22 m**

The connection can be extended up to 22 m to suit your setup environment.

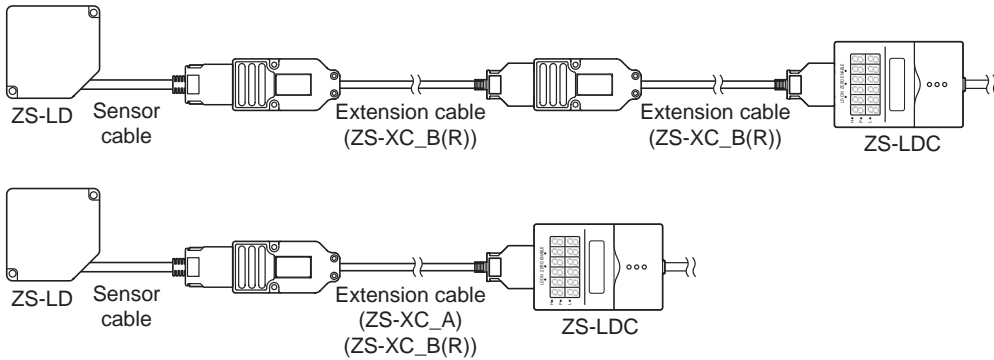

- Only the ZS-XC_B(R) cable allows this extended connected. Note, however, that the connection with the ZS-XC_A cannot be extended.
- The cable may break at locations when it is made to bend. So, use the robot cable type Extension Cable (ZS-XC5BR).

SmartMonitor ZS enables the following:

- **Easy Sensor Controller setup and log management**

Measurement conditions can be set up, and settings saved, read or copied.

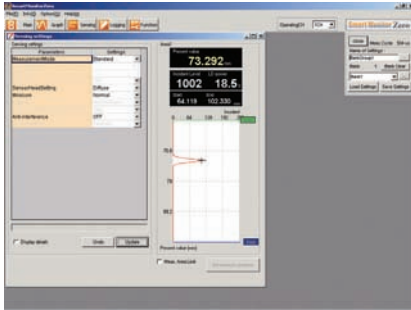

* The screen show here may differ from the actual screen.

- **Real-time verification of changes in detection workpiece height**

The measurement conditions can be changed while verifying the measurement state by a waveform.

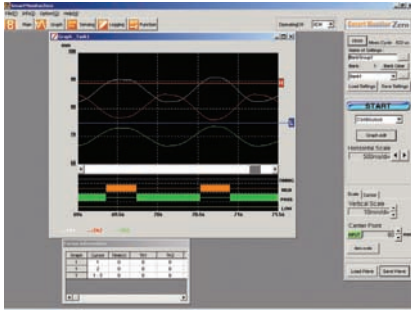

* The screen shown here may differ from the actual screen.

Basic Configuration

The figure below shows the Basic Configuration of the ZFV Series.

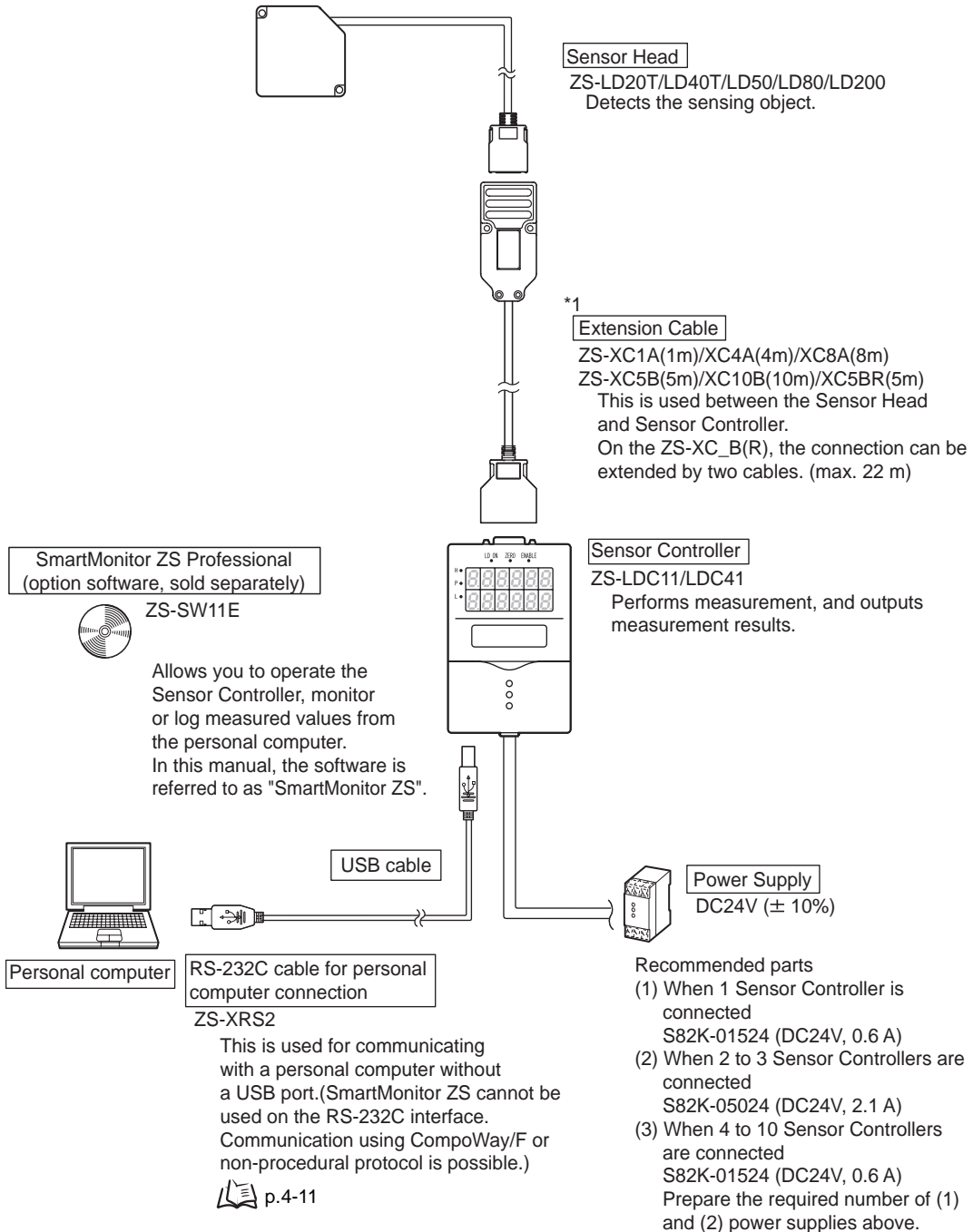

*1 Only two of the ZS-XC_B(R) cables can be connected in series. This is not possible on the ZS-XC_A. Cables may break at locations where bending occurs on the cable. Use the robot cable type extension cable (ZS-XC5BR).

Part Names and Functions

The following describes the names and functions of parts on the Sensor Controller and Sensor Head.

■ Sensor Controller

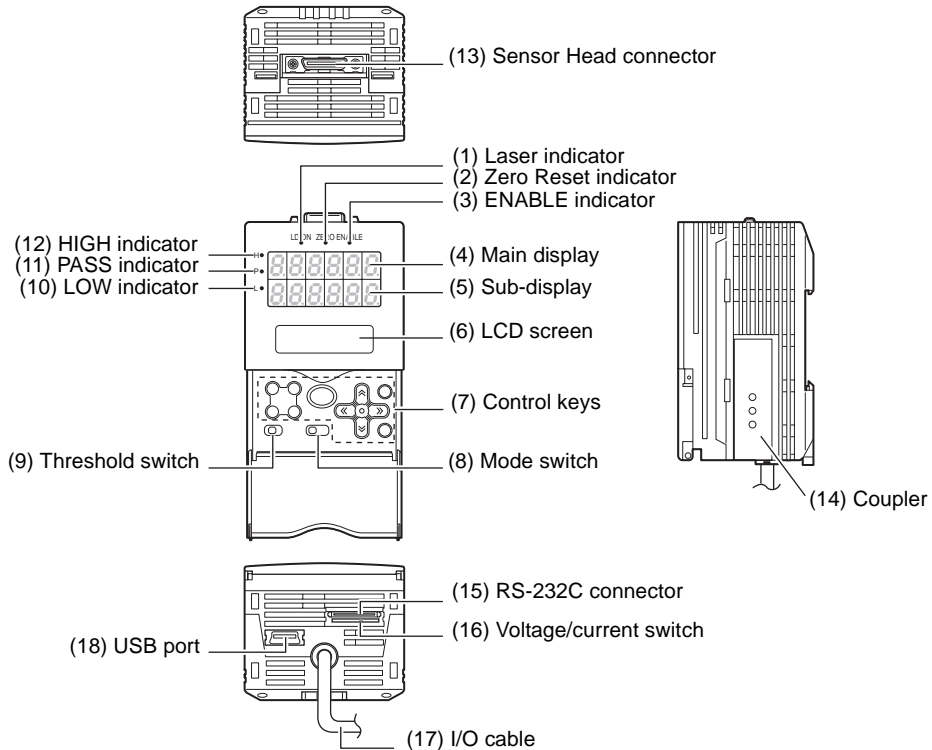

(1) Laser indicator

The Laser indicator is lit while the Sensor Head is emitting a laser beam.

(2) Zero Reset indicator

The Zero Reset indicator is lit when the zero reset function is enabled.

(3) ENABLE indicator

The ENABLE indicator lights when the Sensor is ready for measurement. It goes off when measurement is not possible (e.g. when the received light amount is excessive or insufficient, when the measuring range is exceeded, when the Sensor Head is not connected, or when measurement is not being performed in the FUN mode).

(4) Main Display

The Main Display shows measured values.

(5) Sub-display

The sub-display shows thresholds and additional information during measurement.

(6) LCD screen

RUN Mode :Displays additional information for the main display and the setup menu for display related information.

TEACH Mode:Displays the menu for setting up the thresholds.

FUN Mode :Displays the measurement condition setup menu.

(7) Control keys

The Control Keys are for setting measurement conditions and other information. The functions assigned to the Control Keys change according to the operating mode.



Displays and Key Operations p.3-5

(8) Mode Switch

The Mode Switch selects the operating mode.

RUN mode : Select this mode when performing regular measurement.

TEACH mode : Select this mode when setting the judgment thresholds.

FUN mode : Select this mode when setting measurement conditions.

(9) Threshold Selector Switch

The Threshold Selector switch selects whether to set (or display) the HIGH or LOW threshold.

(10) LOW indicator

The LOW indicator is lit when the condition “measured value < LOW threshold” is satisfied.

(11) PASS indicator

The PASS indicator is lit when the condition “LOW threshold ≤ measured value ≤ HIGH threshold” is satisfied.

(12) HIGH indicator

The HIGH indicator is lit when the condition “HIGH threshold < measured value” is satisfied.

(13) Sensor Head connector

This connector connects the Sensor Head.

(14) Coupler

This connector is used to connect two or more Sensor Controllers. It is located on both sides of the Sensor Controller.

(15) RS-232C connector

Connect the RS-232 cable when you are connecting the Sensor Controller to a personal computer that does not have a USB port.

(16) Voltage/Current switch

The Voltage/Current switch selects between voltage output and current output.



CHECK!

Before operating this switch, make sure that the Sensor Controller is turned OFF. Also, make sure that the load connected to “linear output wire (co-axial) – linear GND wire” satisfies the rating of the set state (voltage or current output) before turning the Sensor Controller ON. Otherwise, the Sensor Controller may be damaged.



Rating of connected load (I/O Circuit Diagrams) p.2-9

(17) I/O Cable

The I/O cable connects the Sensor Controller to the power supply and external devices, such as timing sensors or programmable controllers.

(18) USB port

Connect the USB cable to the USB port to connect to a personal computer.

■ Sensor Head

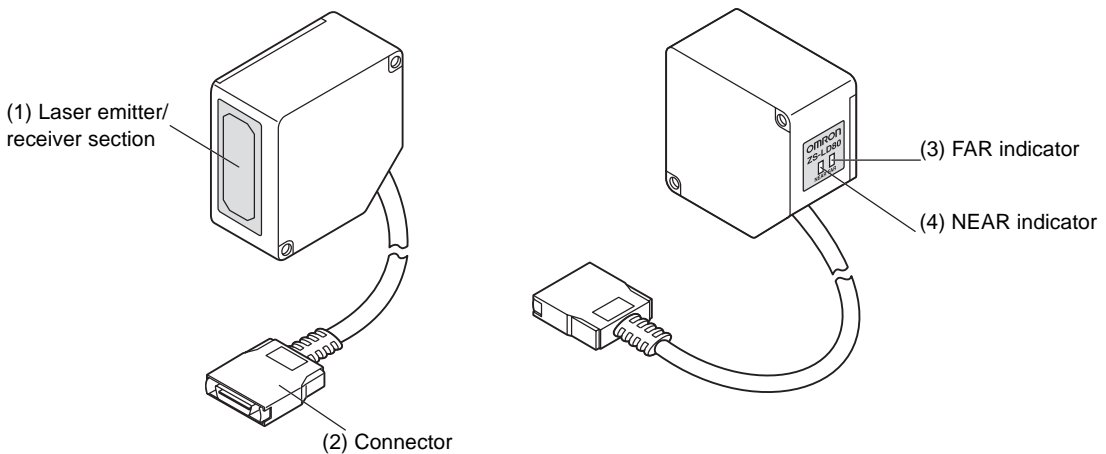

(1) Laser Emitter/Receiver Section

This is the section that emits the laser beam and receives reflected light.

(2) Connector

To be connected to the Sensor Controller

(3) FAR indicator, (4) NEAR indicator

These indicators lit as follows according to the distance between the front of the Sensor Head and workpiece.

Both NEAR and FAR indicators are lit : Measuring center distance ±
(measuring range x 10%)

NEAR indicator is lit : Near side within measuring range

FAR indicator is lit : Far side within measuring range

NEAR and FAR indicators are flashing : Outside measuring range



These indicators also function as laser alarm indicators.

- At least either of these indicator lights or flashes after the Sensor Head is turned ON.
- Both indicators go out for 15 to 25 seconds after the Sensor Head is turned ON to indicate that the laser beam is OFF.
- Either of these indicators lit or flashes while the laser beam is being emitted.
- Both indicators go out when the laser beam is OFF.

Section 2

INSTALLATION & CONNECTION

| | | |
|---|---|------|
| ☒ | About Installation and Connection | 2-2 |
| ☒ | Sensor Controller | 2-3 |
| | Attaching the ferrite core | 2-3 |
| | Installing the Sensor Controller | 2-4 |
| ☒ | About the I/O cable | 2-7 |
| ☒ | Sensor Head | 2-11 |
| | Attaching the ferrite core | 2-11 |
| | Installing the Sensor Head | 2-12 |
| | Connecting Sensor Heads | 2-18 |
| ☒ | SmartMonitor ZS | 2-19 |
| | Installing SmartMonitor ZS on a personal computer | 2-19 |
| | Starting up SmartMonitor ZS | 2-23 |

About Installation and Connection

■ Checking the installation environment

Read “Precaution for Safe Use” at the beginning of this manual, and check the installation environment.

■ Checking the installation site

Read “Precaution for Correct Use” at the beginning of this manual, and check the installation site.

■ About the power supply

Before installing and connecting the Smart Sensor, be sure to turn it OFF.
Also read “Precaution for Safe Use” and “Precaution for Correct Use” at the beginning of this manual, and check the power supply and wiring.

Sensor Controller

This section describes installation of the Sensor Controller, and connection of the I/O cable.



Before connecting/disconnecting peripheral devices, make sure that the Sensor Controller is turned OFF. The Sensor Controller may break down if the Sensor Controller is connected or disconnected while the power is ON.

Attaching the ferrite core

Attach the ferrite core (provided with the Sensor Controller) to the input/output cable of the Sensor Controller.

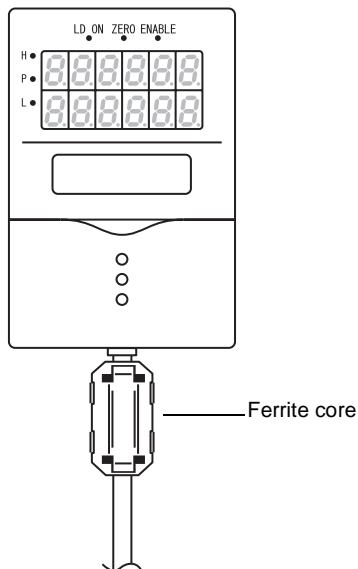

Installing the Sensor Controller

■ Installing on the DIN track

The following describes how to attach the 35 mm wide DIN track by quick, easy operation.

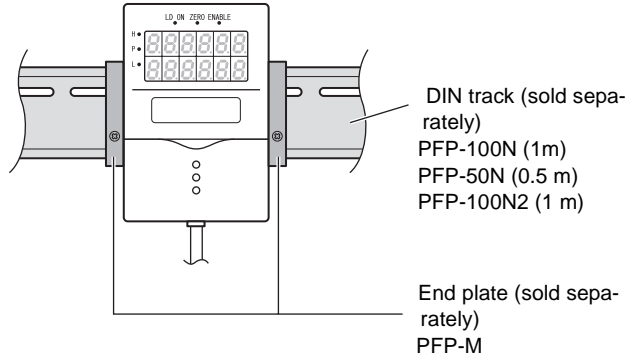

● Installation procedure

1. Hook the connector end of the Sensor Controller onto the DIN track.

2. Push the Sensor Controller down onto the DIN track until the hook on the I/O cable side is locked.

Push down until you hear it snap into place.

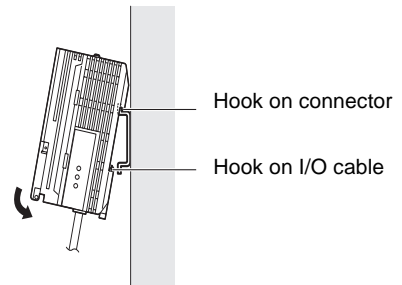

CHECK!

Always hook the connector end of the Sensor Controller on the DIN track first. Hooking the I/O cable end on the DIN track first may impair the mounting strength of the DIN track attachment.

● Removal procedure

The following describes how to remove the Sensor Controller from the DIN track.

1. Pull the hook on the I/O cable end of the Sensor Controller downwards.

2. Lift up the Sensor Controller from the I/O cable end, and remove it from the DIN track.

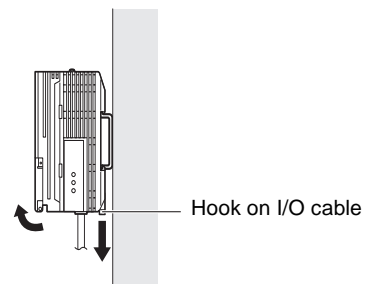

■ Mounting on a panel

The optional Panel Mount Adapters (ZS-XPM1) can be used to mount the Sensor Controller on a panel.

 Panel cutout dimensions p.6-20

1. Push out the Sensor Controller from the rear of the panel towards the front.

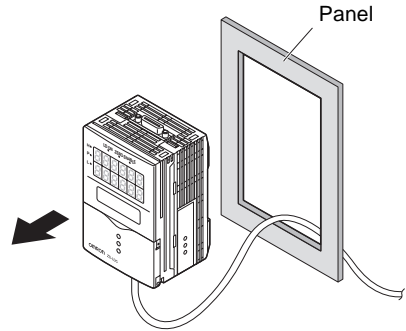

2. Install the small Mount Adapters on the four holes on the Sensor Controller.

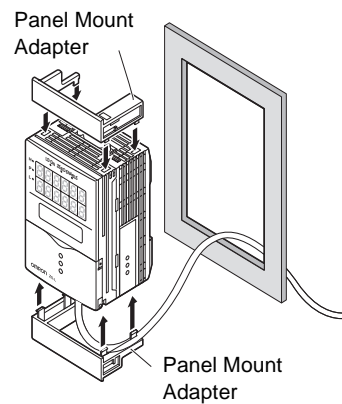

3. Install the long Mount Adapters on the two holes on the small Mount Adapter.

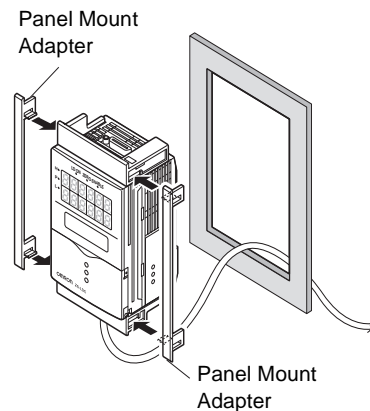

4. Install the Sensor Controller with Panel Mount Adapters attached onto the panel from the front.



Take care not to pinch the I/O cable.

CHECK!

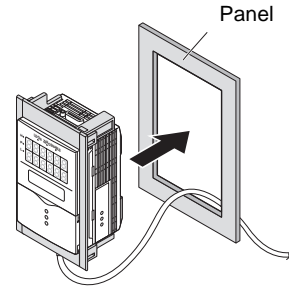

5. Hook the hooks of the mounting fixture onto the two holes of the smaller Mount Adapters and tighten the screws.

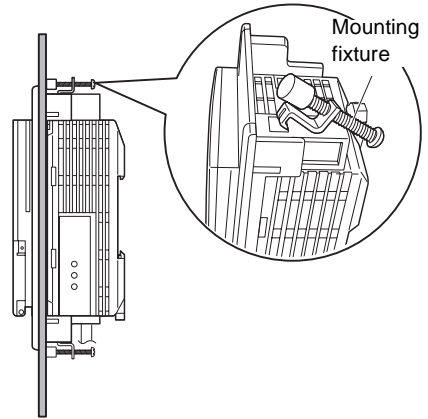

6. Make sure that the Sensor Controller is firmly fixed on the panel.

About the I/O cable

■ Wiring the I/O cable

The following shows the leads that comprise the I/O cable.

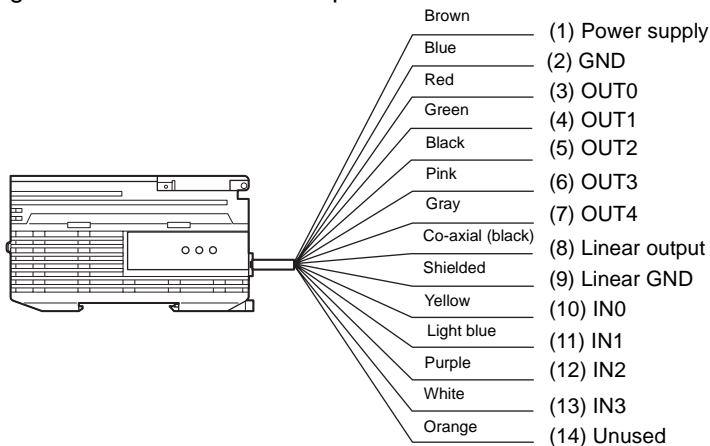

(1) Power supply

This connects the 24 VDC (± 10) power supply. When using a Sensor Controller with a PNP output, the power supply terminal is also the common I/O terminal for all I/O except for the linear output. Supply power from a DC power supply unit that has a countermeasure (safety ultra-low voltage circuit) built-in for preventing high voltages from occurring.



Recommended power supply unit p.1-9

Wire the power supply separately from other devices. Wiring them together or placing them in the same duct may cause induction, resulting in malfunction or damage.

(2) GND

The GND terminal is the 0V power supply terminal. When using a Sensor Controller with an NPN output, the GND terminal is also the common I/O terminal for all I/O except for the linear output.

(3) OUT0 (HIGH output)

This outputs judgment results (HIGH).

(4) OUT1 (PASS output)

This outputs judgment results (PASS).

(5) OUT2 (LOW output)

This outputs judgment results (LOW).

(6) OUT3 (ENABLE output)

This turns ON when the sensor is ready for measurement. This output is interlocked with the ENABLE indicator.

(7) OUT4 (BUSY output)

This turns ON during sampling with the hold function enabled. It allows you to check whether or not the self-trigger is functioning correctly. It also turns ON during bank switching.

(8) Linear output

The linear output outputs a current or voltage in accordance with the measured value.

(9) Linear GND

The linear GND terminal is the 0V terminal for the linear output.



This ground wire must be grounded separately from the other ground wires.
 Always ground the linear output terminal even when linear output is not used.

(10) to (13) IN0 to IN3

The following input signal assignments can be selected.

• Signal assignments

| Signal | When [Standard] is selected (default) | When [Bank] is selected |
|--------|---------------------------------------|-------------------------|
| IN0 | External trigger (timing) input | Bank input A |
| IN1 | Reset input | Bank input B |
| IN2 | LD-OFF input | LD-OFF input |
| IN3 | Zero reset input | Zero reset input |

I/O Assignment Settings p.4-7

• Signal functions

| Signal Name | Description |
|---------------------------------|--|
| External trigger (timing) input | This timing input is for signal input from external devices. Use it for hold function timing. |
| Reset input | This resets all executing measurements and outputs. While a reset is being input, judgment output conforms to the non-measurement setting. If this reset input switches ON while the hold function is used, the state in effect before the hold function was set will be restored. |
| LD-OFF input | If this LD-OFF signal is set to ON, the laser will stop emission, causing a light amount error. While LD-OFF is being input, judgment output conforms to the non-measurement setting. |
| Zero reset input | This is used to execute and clear a zero reset. |
| Bank input A, B | This is used for switching banks. Specify the bank No. in combinations of A and B. |

External I/O timing chart p.4-9

■ I/O Circuit Diagrams
● NPN type (ZS-LDC11)

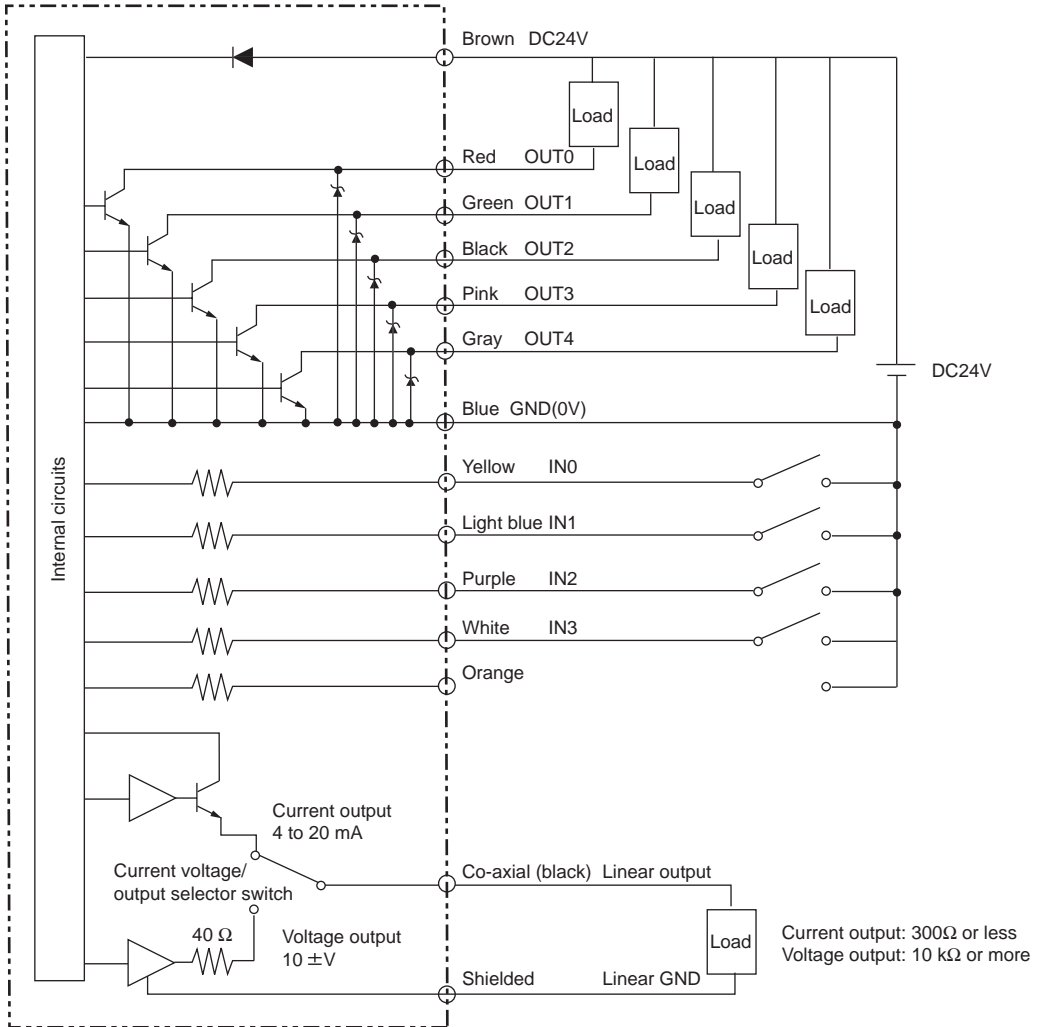

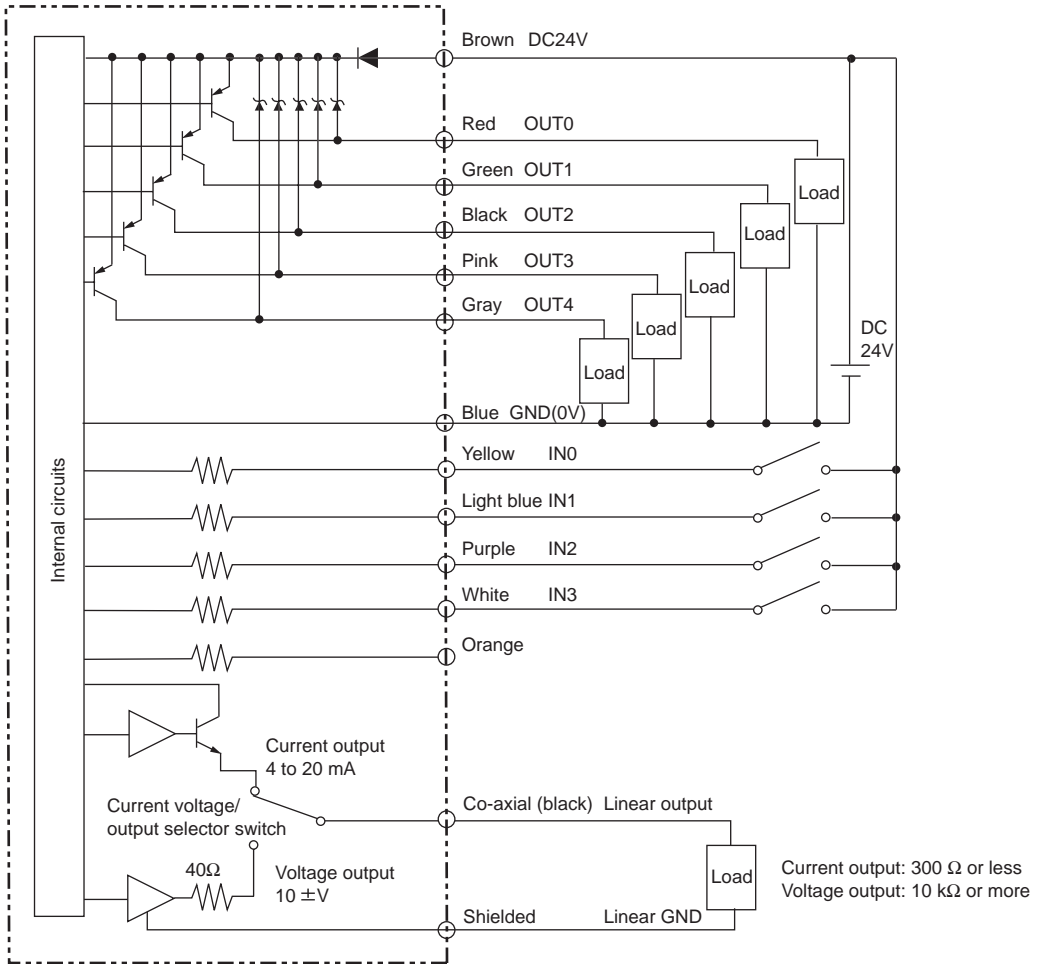

● PNP type (ZS-LDC41)



Sensor Head

This section describes how to install and connect the Sensor Head.

| | |
|---|---|
| ⚠ WARNING | |
| <p>Never look into the laser beam. Doing so continuously will result in visual impairment. Never look into the laser beam.</p> |  |
| <p>Do not disassemble the product. Doing so may cause the laser beam to leak, resulting in the danger of visual impairment. Do not disassemble the product.</p> |  |

Attaching the ferrite core

Attach the ferrite core (provided with the Sensor Head) to both ends of the Sensor Head cable.

If the ferrite core comes loose from the cable, fasten the ferrite core in place with the Insure Lock (supplied).

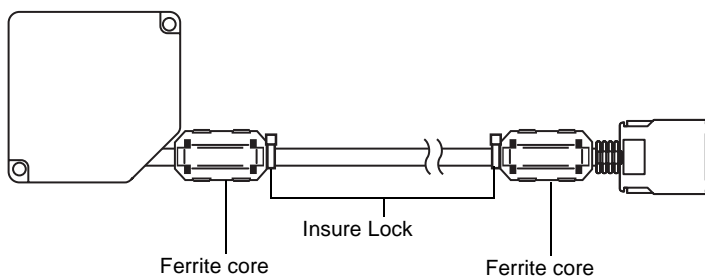

Installing the Sensor Head

This section describes how to install Sensor Heads.

■ Adjusting the installation position

The position of Sensor Head must be adjusted to match the workpiece to ensure correct measurement.

● Color/shiny surface boundary

Judgment error occurs when measuring workpieces of markedly different materials and color. This error can be minimized by installing the Sensor Head with the line formed by the emission and reception axes parallel to the boundary line on the workpiece as follows.

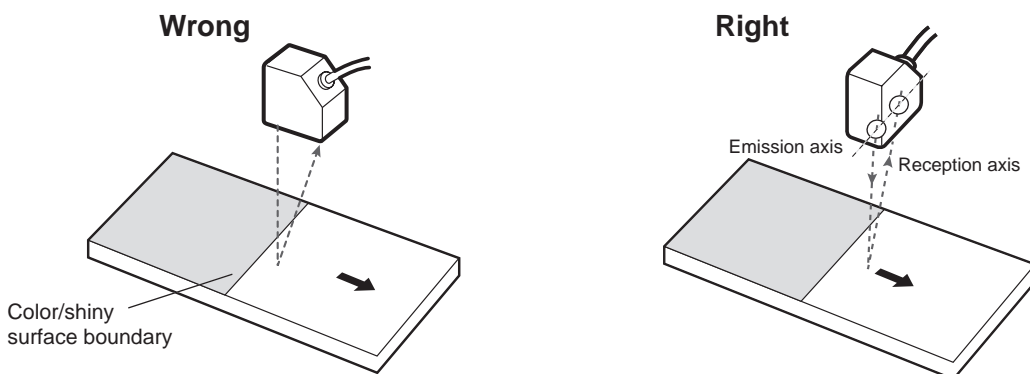

● Installing near walls

Measurement error occurs when the Sensor Head receives light reflected from walls. If a sufficient distance cannot be maintained between the Sensor Head and the wall, measurement error can be reduced by installing the Sensor Head with the line formed by the emission and reception axes parallel to the wall, and painting the wall with non-reflective black paint.

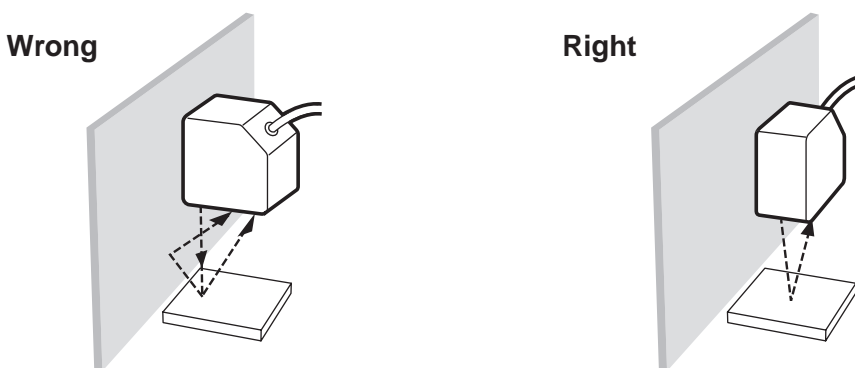

● **Measuring in narrow grooves**

When the workpiece is an indented section enclosed with inner walls or is located in a groove, install the Sensor Head so that the emission and reception axes are not blocked.

Wrong

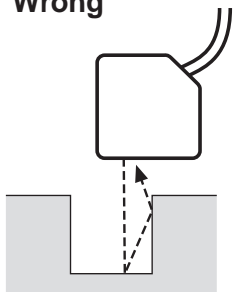

Right

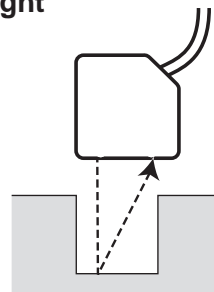

● **Measuring stepped workpieces**

When measuring stepped workpieces, you can minimize the influence caused by the different levels of the workpiece by installing the Sensor Head with the line formed by the emission and reception axes parallel to the step face.

Wrong

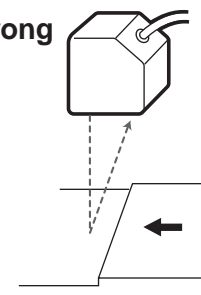

Right

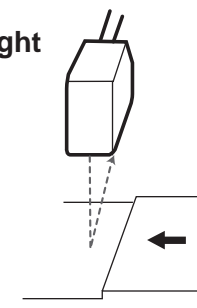

● **Rotating objects**

When measuring rotating workpieces, you can minimize the influence caused by vibration of the rotating object and positional shift by installing the Sensor Head with the line formed by the emission and reception axes parallel to the axis of rotation.

Wrong

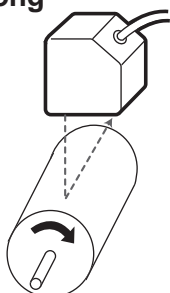

Right

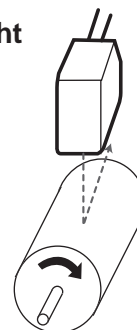

■ Adjusting mutual interference

When using two or more Sensor Heads next to each other, mutual interference will not occur if other beam spots are outside the shaded areas in the following diagrams.

- ZS-LD20T/LD20ST

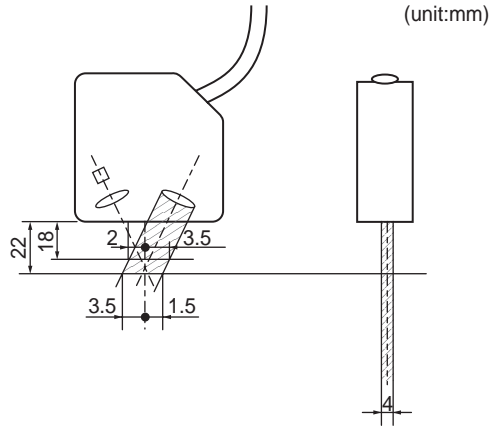

- ZS-LD40T

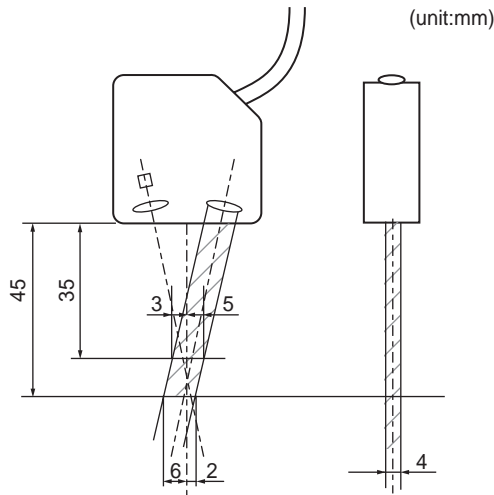

• ZS-LD50/LD50S

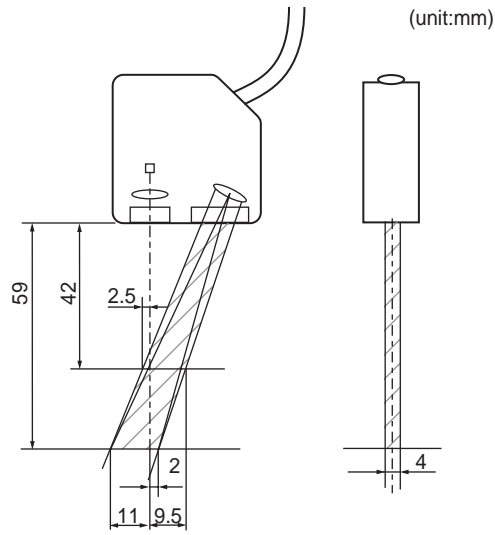

• ZS-LD80

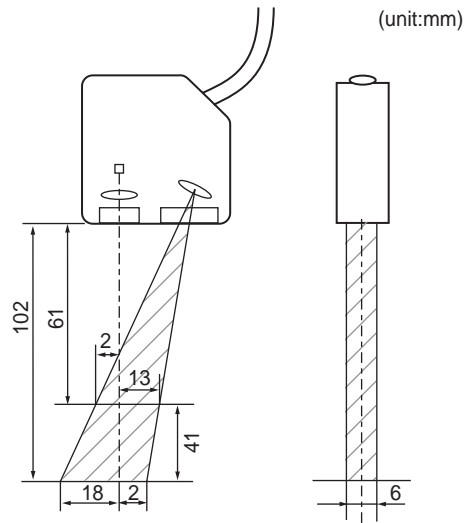

• ZS-LD130

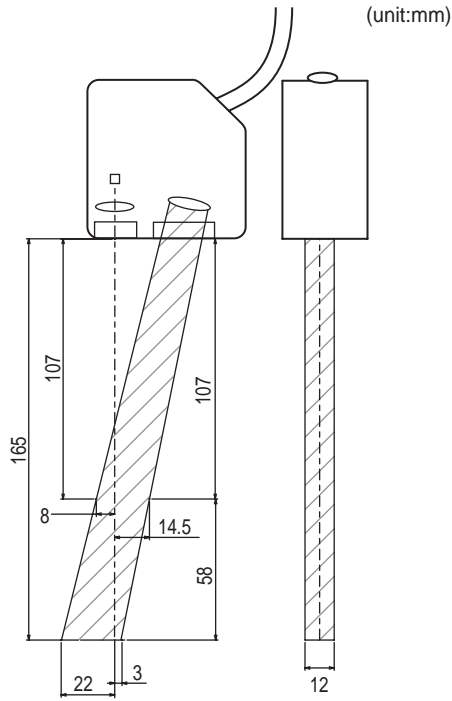

• ZS-LD200

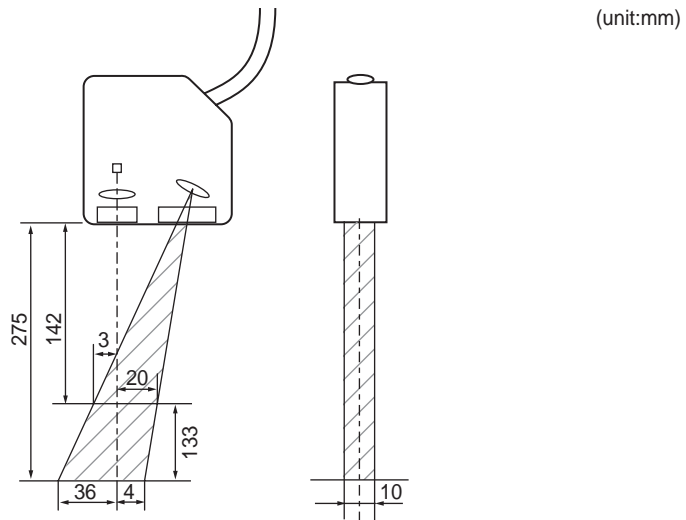

- ZS-LD350S

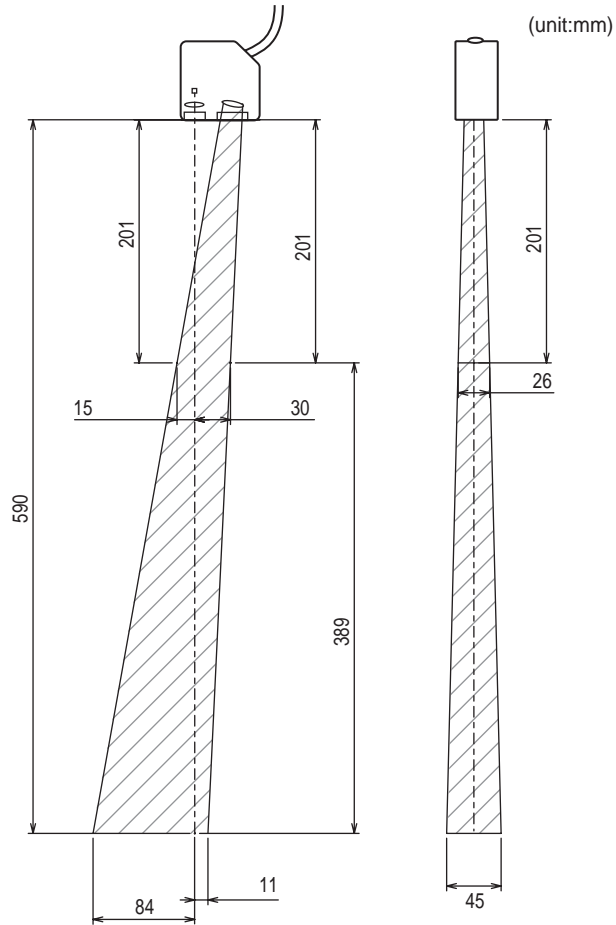

Connecting Sensor Heads

This section describes how to connect Sensor Heads.



Before connecting/disconnecting the Sensor Head, make sure that the Sensor Controller is turned OFF. The Sensor Controller may break down if the Sensor Head is connected or disconnected while the power is ON.

■ Connecting the Sensor Head

Insert the Sensor Head connector into the Sensor Controller until it locks in place.

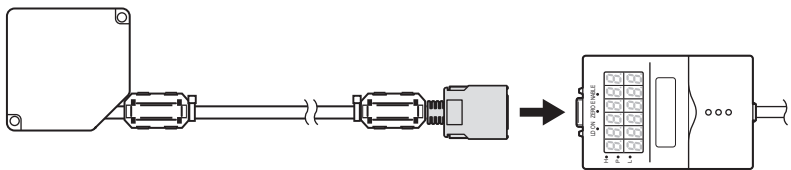

■ Disconnecting the Sensor Head

Pull out the Sensor Head while pressing in the hooks on both sides of the Sensor Head connector.

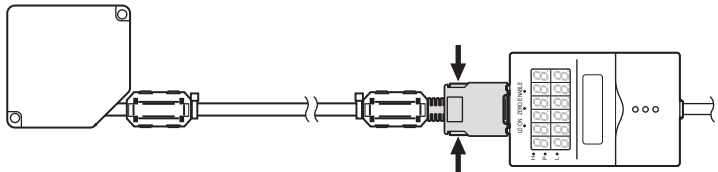

- Do not touch the terminals inside the connector.
- All settings on the Sensor Controller will be cleared if the Sensor Head is replaced with a different type.

SmartMonitor ZS

The ZS-L Series is provided with the SmartMonitor ZS software utility. This utility allows you to set up sensing functions and monitor the waveforms of measurement results on a personal computer. SmartMonitor ZS runs on the following operating environment:

| Item | Condition |
|---------|---|
| OS | Windows 2000/XP |
| CPU | Pentium III 850 MHz or faster |
| Memory | At least 128 MB (256MB or more recommended) |
| Display | 800 x 600 dots High Color (16 bits) or more |

- Windows is a trademark or registered trademark of Microsoft Corporation.
- Celeron is a trademark or registered trademark of Intel Corporation or its subsidiaries.

Installing SmartMonitor ZS on a personal computer

The following describes the preparations for using SmartMonitor ZS.

■ Installing SmartMonitor ZS



CHECK!

- Before you install SmartMonitor ZS, quit all other programs that are running. If virus detection software is enabled, installation may take time to complete.
- Log on as an Administrator or a user with system access rights.

1. Turn your PC ON and startup up Windows.
2. Insert your “SmartMonitor ZS” CD-ROM into the CD-ROM drive on your personal computer.
3. Auto-run automatically displays the installation screen. Follow the on-screen instructions to install SmartMonitor ZS.

■ Attaching a ferrite core to the USB cable

Attach the ferrite core (provided with the Sensor Controller) to the USB cable (provided with the Sensor Controller).

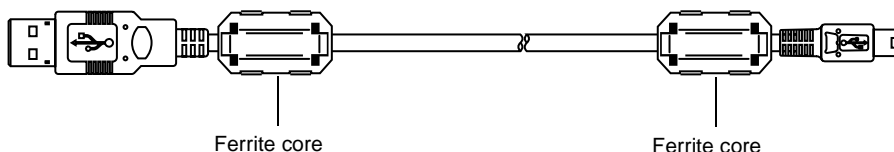

* SmartMonitor ZS cannot be used on the RS-232C interface.

■ Installing the USB driver

The USB driver must be installed on the personal computer to establish a connection between the personal computer and the Sensor Controller by the USB interface.



- The exclusive USB driver must be installed only when the Sensor Controller is connected to the personal computer for the first time. From the second startup onwards, the USB driver is automatically recognized and does not need to be re-installed.
- To install the USB driver, log on as an Administrator or a user with system access rights.
- Install SmartMonitor ZS before installing the USB driver.
- The error message "Failed to pass the Windows logo test" is sometimes displayed at installation. Press the [Continue] button to continue with the installation.

1. Turn your PC ON and startup up Windows.

2. Connect the Sensor Controller to the personal computer by the USB cable.

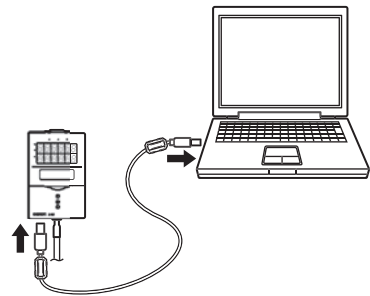

"Detected new hardware" will be displayed on the Windows tool bar, and the [New Hardware Detection Wizard] dialog box will appear.

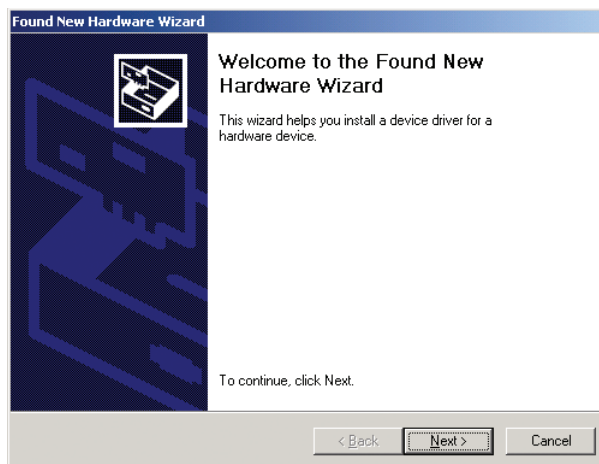

3. Click the [Next] button.

4. Select the [Search optimum driver for disk (recommended)] radio button, and click the [Next] button.



5. Mark the [CD-ROM drive] checkbox, and click the [Next] button.

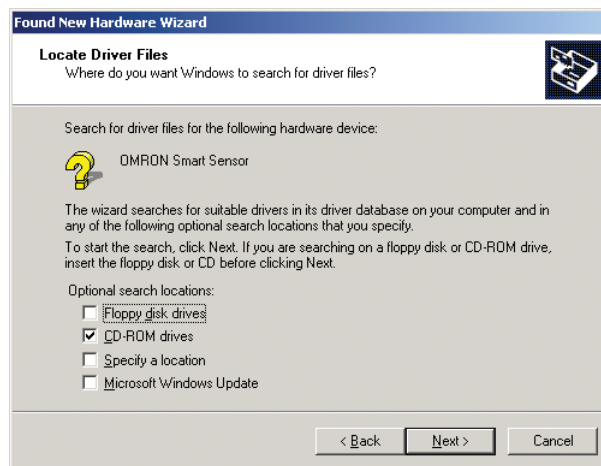

- If the Sensor Controller is not automatically detected, click the [Browse] button and select [USB] folder on the CD-ROM.
- To install on a personal computer not equipped with a CD-ROM drive, select the [Program Files]-[OMRON]-[SmartMonitorZS]-[usb] folder.

6. Make sure that the optimum driver has been detected, and click the [Next] button.

Installation begins.

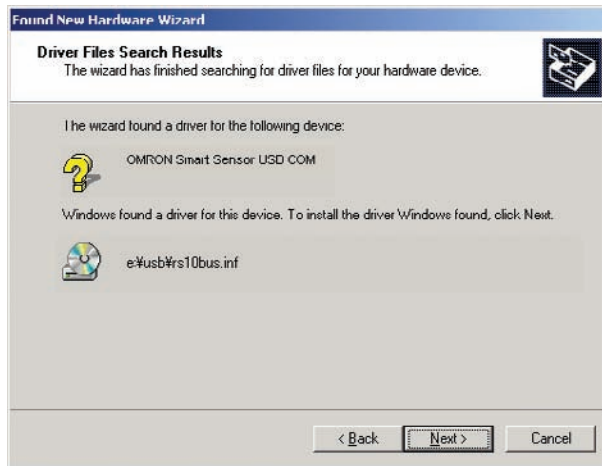

When installation ends, the completion message is displayed.



7. Click the [End] button.

The same screen in step 2 is displayed. Repeat the above procedure.

This completes installation of the USB driver.

Starting up SmartMonitor ZS

After installation is completed, start up SmartMonitor ZS by the following procedure.

1. Make sure that the Sensor Controller is connected to the personal computer.
2. Turn the Sensor Controller ON and set it to the RUN mode.
3. Select [Programs]-[OMRON]-[SmartMonitorZS] from the Windows [Start] menu.

■ When the connection between the personal computer and Sensor Controller cannot be established

Check the COM port No. assigned on the personal computer in Device Manager.

1. Right-click [My Computer] on the Windows desktop and click [Properties].
2. Click [Device Manager(D)] on the [Hardware] tab.
3. Open [Port (COM/LPT)], and check which number COM in [OMRON Smart Sensor USB COM] is set to.
4. Set this COM port No. to the [Communication Settings] screen on SmartZS Monitor.



CHECK!

If "OMRON Smart Sensor USB COM" is not recognized in Device Manager, re-install the USB driver and reboot the personal computer.

Section 3

SETUP

| | |
|--|------|
| ☒ Setting Flow | 3-2 |
| ☒ About Setup | 3-4 |
| Basic Knowledge for Operation | 3-4 |
| List of Setting Items | 3-9 |
| ☒ Setting the Sensing Conditions | 3-12 |
| Setting the Measurement Mode | 3-12 |
| Setting the Head Installation | 3-13 |
| Setting the Emitted Light Intensity | 3-13 |
| Setting the Measurement Object | 3-14 |
| Setting Prevention of Mutual Interference | 3-16 |
| Setting Gain | 3-17 |
| ☒ Setting the Filter Function | 3-18 |
| Setting Smooth | 3-18 |
| Setting Average | 3-19 |
| Setting Differentiation | 3-19 |
| ☒ Setting Output Processing of Sensing Information | 3-20 |
| Setting Scaling | 3-20 |
| Setting Hold Functions | 3-24 |
| Setting Zero Reset | 3-28 |
| ☒ Setting Threshold Values | 3-31 |
| ☒ Setting the Display Method | 3-32 |
| Setting the Digital Displays | 3-32 |
| Setting the LCD Display | 3-33 |
| HELP | 3-34 |
| ☒ Setting Banks | 3-34 |
| Switching banks | 3-34 |
| Clearing banks | 3-34 |
| ☒ Setting the System Environment | 3-35 |
| Saving setup data | 3-35 |
| Initializing setup data | 3-35 |
| Checking Sensor Controller information | 3-36 |
| Setting key lock | 3-36 |
| Setting the sensor load method | 3-36 |
| Setting the display language | 3-37 |

Setting Flow

Preparation for Measurement

Installation and Connection

Set the Sensor Head and Sensor Controller in place, and connect the personal computer.



Section 2 Installation and Connection
p.2-2

Power ON

Setting of Measurement Conditions

Setting the sensing conditions

Set the measurement conditions for detecting the workpiece by the Sensor Head.



- Setting the measurement mode p.3-12
- Setting the head installation p.3-13
- Setting the emitted light intensity p.3-13
- Setting the measurement target p.3-14
- Setting prevention of mutual interference p.3-16
- Setting gain p.3-17

Setting Filter Function

Set the conditions for filtering information obtained from the sensor.



- Smooth p.3-18
- Average p.3-19
- Differentiation p.3-19

Setting output processing of sensing information

Set how sensing information is to be processed for outputting the required values.



- Setting scaling p.3-20
- Setting hold functions p.3-24
- Setting zero reset p.3-28

Setting the Threshold

Set the threshold value for judging measured values.



p.3-31

Output Results

External I/O

Set how measured values are to be output.



p.4-1

Save Setup

Save Setup Data

Save the data you have set.



Saving setup data p.3-35



CHECK!

After you have made or changed settings, be sure to save the setup data. All settings will be deleted if you turn the power OFF without saving the data.

When a Problem Occurs...



The Smart Sensor does not operate correctly.

Troubleshooting p.6-2



An error message has appeared

When [Error] is Displayed on the Main Display p.6-3



Want to know the meanings of terms

Glossary p.6-6

Applied Use of Functions

Setting Banks

Set up the banks.



- Switching banks p.3-34
- Clearing banks p.3-34

Set Up the System Environment

Set up the system environment.



- Initializing setup data p.3-35
- Checking sensor controller information p.3-36
- Setting key lock p.3-36
- Setting the sensor load method p.3-36
- Setting Zero Reset Memory p.3-30
- Setting the display language p.3-37

Additional Functions

Setting the Display Method

Set what is to be displayed on the Sensor Controller during measurement in the RUN mode.



- Setting the digital displays p.3-32
- Setting the LCD screen p.3-33
- Help p.3-34

About Setup

The ZS-L Series can be set up on the Sensor Controller or on the SmartMonitor ZS software utility.

This manual describes setup on the Sensor Controller.

For details on how to set up the ZS-L Series on SmartMonitor ZS, refer to Help contained on the SmartMonitor ZS CD-ROM.

Basic Knowledge for Operation

The following describes basic operation of the Sensor Controller before you set up the ZS-L Series.

Switching Modes

The ZS-L Series has the following 3 operating modes. Switch to the desired mode before you start operation.

To switch the operating mode, use the Mode Switch.

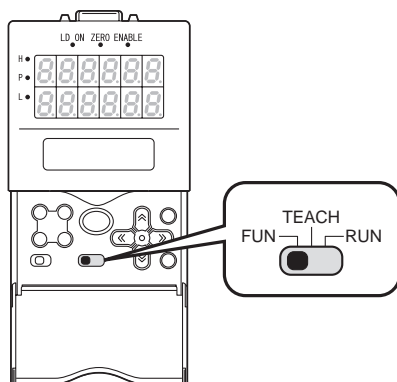

| Mode | Description |
|------------|---|
| RUN mode | Normal operating mode |
| TEACH mode | This mode is for setting the judgment threshold values. |
| FUN mode | Mode for setting the measurement conditions |



When you switch the operating mode after changing the measurement conditions, you will be prompted to save the settings. Save the settings as required. If you turn off the Sensor Controller without saving these settings, the newly set measurement conditions will be cleared from memory. You can also save all the settings later on.

Saving setup data p.3-35

■ Displays and Key Operations

The Sensor Controller has digital displays and an LCD screen. The details displayed on these differ according to the operating mode.

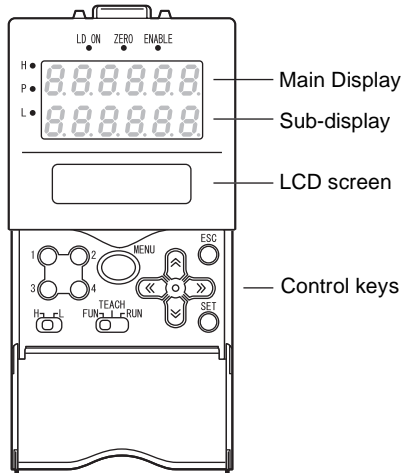

Alphabet characters that appear on the digital displays

| | | | | | | | | |
|---|---|---|---|---|---|---|---|---|
| A | B | C | D | E | F | G | H | I |
| R | b | c | d | E | F | G | h | I |
| J | K | L | M | N | O | P | Q | R |
| J | P | L | ñ | n | o | P | q | r |
| S | T | U | V | W | X | Y | Z | |
| S | t | U | v | Y | ü | y | ı | |

● FUN mode

The LCD screen displays the setup menus.

The No. at the top of each menu corresponds to a function key.

“← →” displayed at the top right of the LCD screen indicates that the setup menu is made up of two or more pages. Scroll pages by the LEFT or RIGHT key.

Top menu in FUN mode



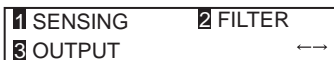

The currently selected bank No. will be displayed on the main display.



Pressing the MENU key in the FUN mode returns to the display.

Key Operations

| Key | | FUN Mode |
|---------------------------|--|--|
| Function keys | | Directly sets the No. preceding the items displayed on the LCD screen. |
| → LEFT key ← RIGHT key | | The function changes depending on the settings. <ul style="list-style-type: none"> • Scrolls pages in list menus. • Selects the digit of numerical values. |
| ↑ UP key ↓ DOWN key | | Changes numerical values during input. |

| Key | | FUN Mode |
|----------|---|--|
| MENU key | MENU  | Displays the top menu of the FUN mode. |
| SET key | SET  | Applies the item you are setting up. |
| ESC key | ESC  | Returns to the previous menu. |

The following example describes basic operations for changing the measurement mode to [HI-RESO].

1. Press function key 1 representing [SENSING].

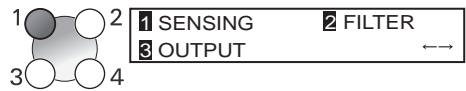

2. Press function key 1 representing [MODE].



The currently selected No. is displayed flashing.



3. Press function key 2 representing [HI-RESO].

The "Complete!" message is displayed.

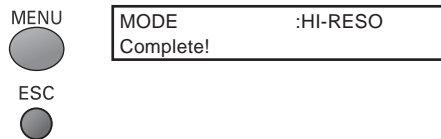

4. Press the MENU key to return to the top menu.

Pressing the ESC key returns to the previous menu.

● RUN Mode

In this mode, measured values are displayed on the main display, and threshold values and other information are displayed on the sub-display.

Pressing the MENU key displays the display customize menu.

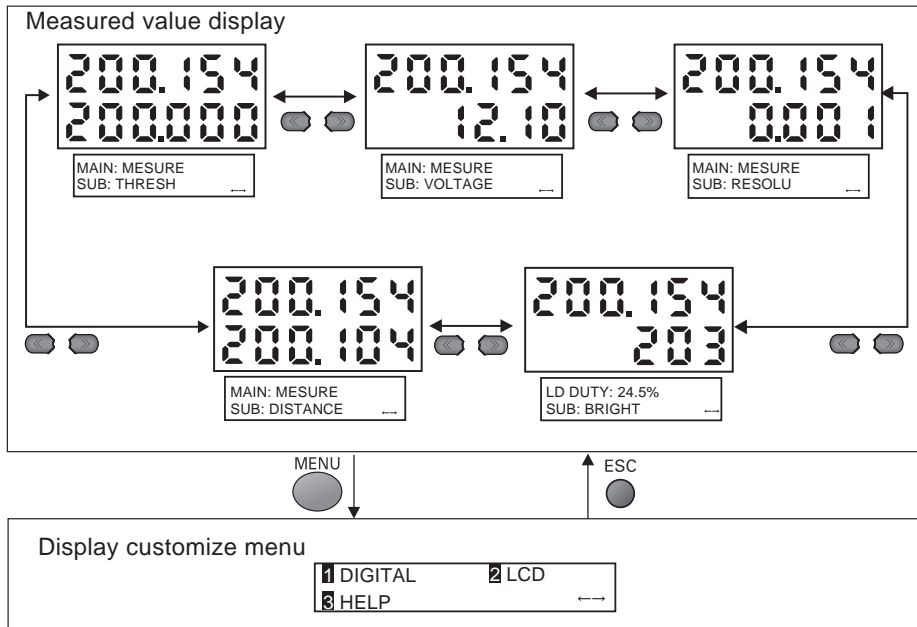





Details displayed on the sub-display

| Display Details | Description |
|-------------------|--|
| THRESH | Displays the HIGH/LOW threshold values according to the setting of the threshold switch. |
| VOLTAGE (CURRENT) | Displays the voltage (current) to be linearized. The display details change according to the setting of the current/voltage switch. (Values displayed here are reference values only. These values differ from actual linear output values.) |
| RESOLU | Displays the fluctuation width (peak to peak) of the measured value over a fixed amount of time. |
| BRIGHT | Displays the current received light amount. The current emitted light amount also is displayed on the LCD upper section. |
| DISTANCE | Displays the measured value before it is processed by hold or other functions. |

Key Operations

| Key | Measured Value Display | Display Customize Menu |
|-------------------------------|------------------------------|--|
| Function keys | Not used | Directly select functions. |
| → LEFT key ← RIGHT key | Changes sub-display content. | The function changes depending on the settings. • Scrolls pages in list menus. • Selects digits. |







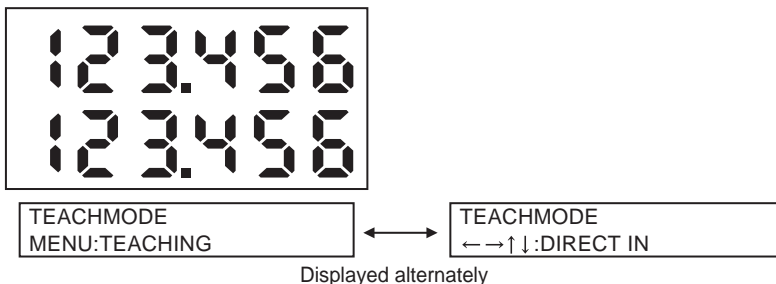

| Key | | Measured Value Display | Display Customize Menu |
|------------------------|--|--|--|
| ↑ UP key ↓ DOWN key |   | ■ UP key: Executes trigger input. ■ DOWN key: Executes reset input. | The function changes depending on the settings. <ul style="list-style-type: none"> • Changes numerical values. • Changes text. |
| MENU key | MENU  | Displays the display customize menu. | Returns to the top of the display customize menu. |
| SET key | SET  | Executes a zero reset. | Applies numerical value settings. |
| ESC key | ESC  | Hold down for at least two seconds to cancel a zero reset. | Returns to the previous menu. When the top menu is displayed, returns to the measured value display. |

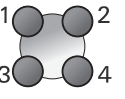
● **TEACH mode**

In this mode, the measured value is displayed at all times on the main display. The threshold values are displayed on the sub-display. Which of the HIGH or LOW threshold values is displayed changes according to the setting of the threshold selector switch.



Key Operations

| Key | | TEACHING | DIRECT IN |
|---------------------------|--|---|---|
| Function keys |  | Not used | Not used |
| → LEFT key ← RIGHT key |   | Not used | Selects the digit in the threshold numerical value. |
| ↑ UP key ↓ DOWN key |   | Not used | Changes the threshold numerical value. |
| MENU key | MENU  | Registers the measured value when this key is pressed as the threshold value. | Not used |
| SET key | SET  | Not used | Applies the newly set threshold value. |
| ESC key | ESC  | Not used | Cancels the newly set threshold value. |

List of Setting Items

■ FUN Mode

This is the mode for setting the measurement conditions.

| FUN Mode | | Settings | Default Value | Option/Setting Range | Pages |
|----------|--------------------------------|----------|---------------|--|---------|
| SENSING | MODE | | STAND | STAND, HI-RESO, HI-SPEED, HI-SENS, CUSTOM (EXPOSE, SKIP, LINE) | p.3-12 |
| | SETTING | | - (*2) | DIFFUSE, REGULAR | p.3-13 |
| | LASER | | AUTO | AUTO, RANGE, FIXED (upper limit 0.1 to 80%) | p.3-13 |
| | OBJECT | | NORMAL | NORMAL, PCB, MIRROR, GLASS, THICK, GAP | p.3-14 |
| | SYNC | | OFF | OFF, ON (timing A, timing B) | p.3-16 |
| | GAIN | | 1 | 1 to 5 | p.3-17 |
| | Measurement area setting (*1) | | - | - | - |
| | Measurement level setting (*1) | | - | - | - |
| | FILTER | SMOOTH | | ON | OFF, ON |
| AVERAGE | | | 128 | 1, 2, 4, 8, 16, 32, 64, 128, 256, 512, 1024, 2048, 4096 | p.3-19 |
| DIFF | | | OFF | OFF, ON | p.3-19 |
| OUTPUT | SCALING | | OFF | OFF, ON (AUTO, MAN) | p.3-20 |
| | HOLD | TYPE | OFF | OFF, PEAK, BOTTOM, P-P, AVERAGE, SAMPLE | p.3-24 |
| | | TRIGGER | EXT | EXT, SELF-UP, SELF-DN | p.3-25 |
| | | DELAY | OFF | OFF, ON (T-DELAY, T-TIME) | p.3-27 |
| | ORESET | TYPE | REAL | REAL, HOLD | p.3-29 |
| | | OFFSET | 0 | -999.99 to 999.999 | p.3-29 |

| | Settings | Default Value | Option/Setting Range | Pages | |
|---------|---------------|---------------|---|--|--------|
| I/O SET | NO-MEAS | CLAMP | KEEP, CLAMP | p.4-6 | |
| | JUDGE | HYS | 0.05% of Sensor Head measuring | 0 to 999.999 | p.4-5 |
| | | TIMER | OFF | OFF, OFF DELAY (1 to 5000ms), ON DELAY (1 to 5000ms), ONE SHOT (1 to 5000ms) | |
| | ANALOG | FOCUS | OFF | OFF, ON | p.4-2 |
| | | ADJUST | OFF | OFF, ON (-999 to 999) | p.4-4 |
| | INPUT | IN0 | ON | OFF, ON | p.4-7 |
| | | IN1 | ON | OFF, ON | |
| | | IN2 | ON | OFF, ON | |
| | | IN3 | ON | OFF, ON | |
| | I/O SET | IN | NORMAL | NORMAL, BANK | p.4-7 |
| DIGITAL | | ON | OFF, ON | | |
| BANK | CHANGE | BANK1 | BANK1, BANK2, BANK3, BANK4 | p.3-34 | |
| | CLEAR | - | (Initializes bank settings.) | p.3-34 | |
| SYSTEM | SAVE | - | (Saves Sensor Controller settings.) | p.3-35 | |
| | INIT | | (Initializes Sensor Controller settings.) | p.3-35 | |
| | INFO | CYCLE | - | (Displays the current measurement cycle.) | p.3-36 |
| | | VERSION | - | (Displays the Sensor Controller version.) | |
| | COM (RS-232C) | LENGTH | 8BIT | 8BIT, 7BIT | p.4-12 |
| | | PARITY | NON | NON, ODD, EVEN | |
| | | STOP | 1BIT | 1BIT, 2BIT | |
| | | BAUDRAT | 38400 | 9600, 19200, 38400, 57600, 115200 | |
| | | DELIMIT | CR | CR, LF, CR+LF | |
| | COM | MODE | COMPWAY | COMPWAY, NORMAL | p.4-12 |
| | | NODE | 0 | 0 to 16 | |
| | | KEYLOCK | OFF | OFF, ON | p.3-36 |
| | | Sen INFO | LOAD | LOAD, SAVE | p.3-36 |
| | ZERORST | OFF | OFF, ON | p.3-30 | |
| | LANGUAG | Japanese | Japanese, English | p.3-37 | |

*1: Item that be set only on SmartMonitor ZS

*2: Item whose default value varies according to the connected Sensor Head

"REGULAR" in the case of regular reflection type Sensor Head, and "DIFFUSE" in the case of diffuse reflection type Sensor Head

■ RUN Mode

In the RUN mode, you can customize the details that are displayed in the digital displays.

To call the display customize menu, press the MENU key in the RUN mode.

| RUN mode | | Settings | Default Value | Option/Setting Range | Pages |
|----------|---------|----------|--------------------|--|--------|
| DIGITAL | DOT | | -(^{*3}) | 0 to 5 | p.3-32 |
| | ECO | | NORMAL | NORMAL, ECO, OFF | p.3-32 |
| LCD | ON/OFF | | ON | ON, AUTOOFF, OFF | p.3-33 |
| | B.LIGHT | | ON | ON, AUTOOFF, OFF | p.3-33 |
| | CUSTOM | | U-OFF L-OFF | U-ON/OFF, L-ON/OFF U-CUSTM, L-CUSTM | p.3-33 |
| HELP | | | - | - | p.3-34 |

*3: Item whose default value varies according to the connected Sensor Head

"3 digits (3rd)" in the case of the ZS-LD50/80/200 and "4 digits (4th)" in the case of the ZS-LD20T/40T

■ TEACH mode

This is the mode for setting the threshold values

| TEACH mode | | Settings | Default Value | Option/Setting Range | Pages |
|------------|--|-----------|---------------|----------------------|--------|
| | | TEACHING | - | - | p.3-31 |
| | | DIRECT IN | - | - | |

Setting the Sensing Conditions

Set the conditions to be used for detecting workpieces by the sensor.

Setting the Measurement Mode

Set the measurement mode.

Select the measurement mode based on the items (e.g. speed, precision, or sensitivity) that you want to give priority to in measurement.

► FUN Mode-[SENSING]-[MODE]

| Setting | | Description |
|----------|--------|--|
| STAND | | This is the standard measurement mode. (measurement cycle: approx. 500 μ s) (default) |
| HI-RESO | | Select this mode to measure workpieces with sensitivity set high. (measurement cycle: approx. 2 ms) |
| HI-SPEED | | Select this mode to measure workpieces at high speed. (measurement cycle: max. speed approx. 110 μ s) |
| HI-SENS | | Select this mode to measure workpieces with sensitivity set high. In this measurement mode, sensitivity to received light is much better than the HIGH PRECISION mode as the sampling time is longer. (measurement cycle: approx. 4 ms) |
| CUSTOM | EXPOSE | Set this item when exposure is insufficient and the exposure time must be lengthened to increase the amount of received light. Range: 0.2 ms to 20 ms  When the internal measurement time is longer than the exposure time setting, the exposure time (= measurement cycle) sometimes is greater than the setting. Check the actual measurement cycle at [SYSTEM]-[INFO]-[CYCLE]. CHECK! |
| | SKIP | Set this item to extend the measurement line width without changing the measuring time. The effective line width is doubled when this setting is ON. Range: ON, OFF |
| | LINE | Set this item to make it mode difficult (increase the number of additional lines) for measurement to be influenced by the state of the workpiece surface, or to measure at a single pinpoint on the workpiece (reduce the number of additional lines). Range: 1 to 200 (The maximum number of lines changes according to the exposure time setting.) |



- In the HI-SPEED mode, the measurement cycle changes according to the actual settings. (When only the average count is set, the measurement cycle becomes the maximum speed (approx. 110 μ s.) Check the actual measurement cycle at [INFO]-[CYCLE] under the top menu.
- Set in order [EXPOSE]→[LINE]→[SKIP]. When the exposure time is changed, the maximum possible number of lines for that exposure time is automatically set. After this, change the LINE setting as desired. When SKIP is set to ON in this state, the effective line width is doubled.

Setting the Head Installation

Set how the Sensor Head is installed.

► FUN Mode-[SENSING]-[SETTING]

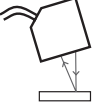
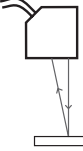
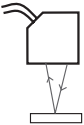
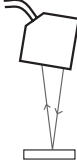
| Setting | Description |
|---------|--|
| DIFFUSE | Select this item when the Sensor Head is installed for diffuse reflection sensing.  ZS-LD20T/20ST/40T  ZS-LD50/50S/80/130/200/350S |
| REGULAR | Select this item when the Sensor Head is installed for regular reflection sensing.  ZS-LD20T/20ST/40T  ZS-LD50/50S/80/130/200 |

Setting the Emitted Light Intensity

Set the amount of light emitted from the Sensor Head to match the state of the workpiece surface.



✓ The response may slow down if workpieces having differing reflection factors such as black-and-white workpieces are measured with the FUN mode set to [AUTO]. In this case, narrow the adjustment range by setting [RANGE]. If this does not increase the response speed to keep up with measurement, select [FIXED].

► FUN Mode-[SENSING]-[LASER]

| Setting | Description | | | | | | | | | | | | | | | | | | | | | | | | | | | | |
|---------|---|-------------|---|--|--|-------|---|--|--|--|--|--|--|--|-------|-------------|--------------------|--|------|-----|--------|--|---|--|--|--|-----|------|------|
| AUTO | Automatically adjusts the emitted light amount according to the reflection factor of the workpiece. Note that the response time varies with each measurement. (default value) | | | | | | | | | | | | | | | | | | | | | | | | | | | | |
| RANGE | <table border="1"> <tr> <td>UPPER</td> <td colspan="3">Sets the adjustment range for the AUTO setting.</td> </tr> <tr> <td>LOWER</td> <td colspan="3">If the response speed cannot keep up with measurement at the default value, narrow the range.</td> </tr> <tr> <td></td> <td colspan="3">Range: 0.1 to 80% (default: LOWER 0.1%, UPPER 80%)</td> </tr> <tr> <td></td> <td>Level</td> <td>Sensitivity</td> <td>Color of workpiece</td> </tr> <tr> <td></td> <td>0.1%</td> <td>Low</td> <td>Bright</td> </tr> <tr> <td></td> <td>.</td> <td></td> <td></td> </tr> <tr> <td></td> <td>80%</td> <td>High</td> <td>Dark</td> </tr> </table> | UPPER | Sets the adjustment range for the AUTO setting. | | | LOWER | If the response speed cannot keep up with measurement at the default value, narrow the range. | | | | Range: 0.1 to 80% (default: LOWER 0.1%, UPPER 80%) | | | | Level | Sensitivity | Color of workpiece | | 0.1% | Low | Bright | | . | | | | 80% | High | Dark |
| UPPER | Sets the adjustment range for the AUTO setting. | | | | | | | | | | | | | | | | | | | | | | | | | | | | |
| LOWER | If the response speed cannot keep up with measurement at the default value, narrow the range. | | | | | | | | | | | | | | | | | | | | | | | | | | | | |
| | Range: 0.1 to 80% (default: LOWER 0.1%, UPPER 80%) | | | | | | | | | | | | | | | | | | | | | | | | | | | | |
| | Level | Sensitivity | Color of workpiece | | | | | | | | | | | | | | | | | | | | | | | | | | |
| | 0.1% | Low | Bright | | | | | | | | | | | | | | | | | | | | | | | | | | |
| | . | | | | | | | | | | | | | | | | | | | | | | | | | | | | |
| | 80% | High | Dark | | | | | | | | | | | | | | | | | | | | | | | | | | |
| FIXED | Sets the emitted light amount to a fixed value. For reference levels, see [RANGE]. Range: 0.1% to 80%. | | | | | | | | | | | | | | | | | | | | | | | | | | | | |

Setting the Measurement Object

Set the type of workpiece to be measured.

► FUN Mode-[SENSING]-[OBJECT]

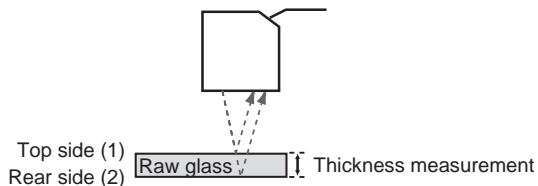
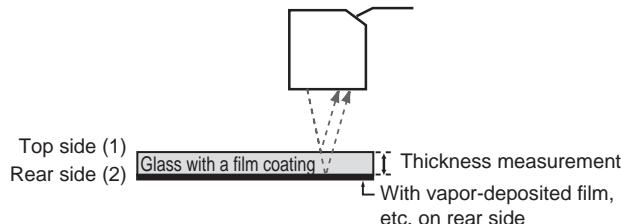
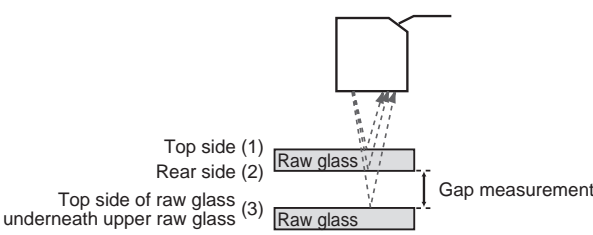
| Setting | | Description |
|---------|--------|---|
| NORMAL | | Usually, select this setting.(default value) |
| PCB | | Select this setting for workpieces such as PCBs through which light penetrates. |
| MIRROR | | Select this setting for workpieces having a mirror surface. |
| GLASS | | Select this setting for workpieces having a glass surface. |
| THICK | NORMAL | <p>Select this to measure the thickness of raw glass. Measures the thickness between (1) and (2).</p>  <p>Top side (1) Rear side (2)</p> |
| | FILM | <p>Select this to measure the thickness of glass with a film coating. Measures the thickness of the glass having different reflection factors on the front side (1) and the backside (2) such as backside deposited glass.</p>  <p>Top side (1) Rear side (2)</p> <p>With vapor-deposited film, etc. on rear side</p> |
| | STOP | Select this to measure the thickness of still workpieces. |
| | MOVE | Select this to measure the thickness of moving workpieces. |
| GAP | NORMAL | <p>Select this to measure the gap between raw glass. Measures the gap between (2) and(3).</p>  <p>Top side (1) Rear side (2)</p> <p>Top side of raw glass underneath upper raw glass (3)</p> |

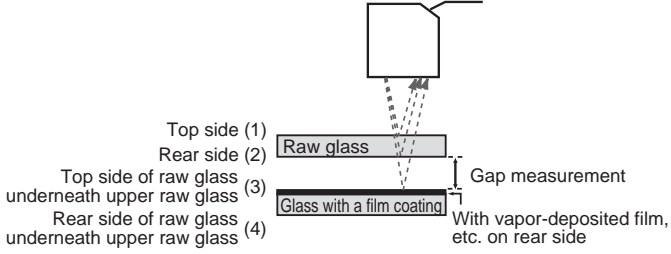
| Setting | | Description |
|---------|-------|--|
| GAP | OTHER | <p>Measures the gap (between (2) and (3) glass having greatly differently reflection factors such the gap between raw glass and front side deposited glass.</p>  |
| | STOP | Select this to measure the gap between still workpieces. |
| | MOVE | Select this to measure the gap between moving workpieces. |

About the [STOP] and [MOVE] settings for [THICK] and [GAP]

| Setting | Description |
|---------|--|
| STOP | <p>Multi-sensitivity processing functions to automatically sweep the amount of emitted light to obtain the optimum amount of reflected light on each measurement plane. (The emitted light beam appears to flicker.)For this reason, note that the measurement cycle increases to become longer than during regular measurement. About 76 times more than regular measurement. In the standard mode, the measurement cycle is about 40ms.)</p> <ul style="list-style-type: none"> • When [STOP] is set, the upper limit of the auto range for the amount of emitted light is automatically changed to 20%. • The measurement cycle can also be shortened by limiting the upper limit of the auto range for the amount of emitted light. • When measurement cannot be performed normally, adjust the upper and lower limits of the auto range for the amount of emitted light. • The mutual interface prevention function does not operate at this setting. |
| MOVE | <p>Thickness and gap can be measured stably at high speed by dividing the measurement area into separate sections for each plane to measure and adjusting the light intensity inside each range. Teaching (measurement) is performed when the [THICK] or [GAP] setting is completed, and the measurement area is automatically determined if measurement is possible.</p> <ul style="list-style-type: none"> • The set area can be confirmed in SmartMonitor ZS. Adjust the area to the optimum area according to the detection state. • The entire area is set if measurement was not possible during the setup.Use SmartMonitor ZS to adjust to the optimum area while verifying the detection state of the workpiece. <p> For details on adjustment of the measurement area, refer to the Help for SmartMonitor ZS.</p> <p>CHECK!</p> |

Setting Prevention of Mutual Interference

Mutual interference between two Sensor Heads can be prevented by shifting the laser beam emission timing. Use this function when Sensor Heads must be set up inside an area where mutual interference is likely to occur or when a transparent workpiece will be measured sandwiched between two Sensor Heads.

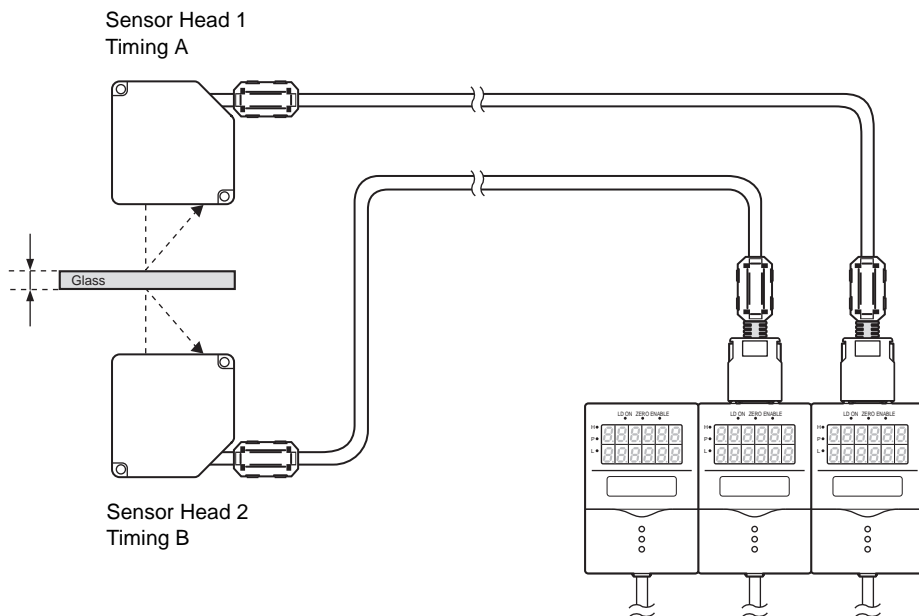

► FUN Mode-[SENSING]-[SYNC]

| Setting | Description | |
|---------|--|---|
| OFF | The mutual interference prevention function is not used. (default value) | |
| ON | Timing A | Sets the light emission timing to timing A. |
| ON | Timing B | Sets the light emission timing to timing B. |



The measurement cycle is changed when the mutual interference prevention mode is enabled.

- 8 times in the STAND, HI-RESO and HI-SENS modes
- About 15 times in the HI-SPEED mode
- The measurement cycle is also influenced by other settings.
- Check the current measurement cycle by FUN Mode-[SYSTEM]-[INFO]-[CYCLE].



- The same sensing mode must be set to each controller when the mutual interference prevention mode is used. When [HI-SPEED] or [CUSTOM] is selected as the measurement mode, the same conditions must be set. Setting different conditions will result in a different measurement cycle on each controller and mutual interference can no longer be prevented.
- The mutual interference prevention function does not operate when THICK or GAP is set.

Setting Gain

The ZS-L Series is equipped with a CMOS gain setup function so that even workpieces having an extremely low amount of reflected light or workpieces having a large tilt can be measured stably.



The measurement resolution sometimes drops when a large gain is set.

► FUN Mode-[SENSING]-[GAIN]

| Setting | Description |
|---------------|--|
| 1, 2, 3, 4, 5 | Adjusts the internal gain of the CMOS image sensor. (default value: 1) 1(gain small) → 5(gain large) |

Setting the Filter Function

Set the conditions for filtering information obtained from the sensor.

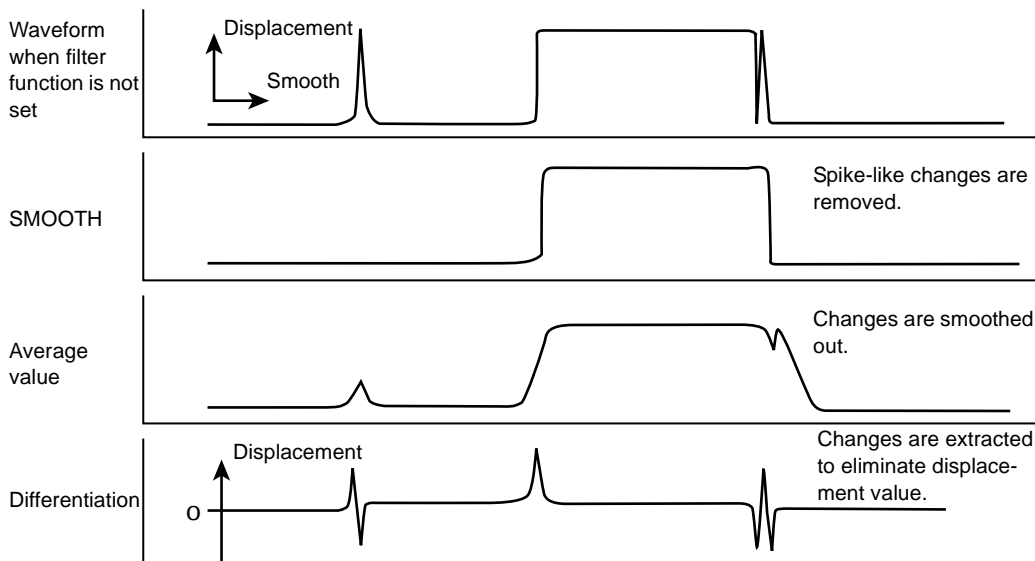

Setting Smooth

The intermediate value of multiple sets of data can be output as the measurement result. This function removes any abnormal values such as spiking that occur when the shape of the workpiece suddenly changes during measurement.

Example: To remove spiking

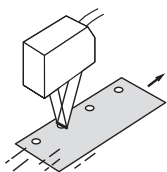

Abnormal values such as spiking that occur when the shape of the workpiece suddenly changes during measurement.

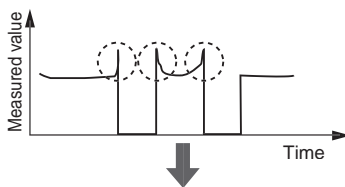

The smoothing function can remove spikes

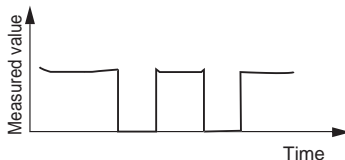

► FUM Mode-[FILTER]-[SMOOTH]

| Setting | Description |
|---------|---|
| OFF | The smooth function is not used. |
| ON | The intermediate value of the past 15 measured values is set as the measurement result at each measurement cycle. (default value) |

Setting Average

The average of the measured values obtained based on the preset number of samples can be output. Select this setting when you want to ignore sudden changes in measured values.

► FUN Mode-[FILTER]-[AVERAGE]

| Setting | Description |
|---|--|
| 1,2,4,8,16,32,64,128,256,512,1024,2048,4096 | Sets the average count. (default value: 128) |

Setting Differentiation

Use the differentiation function to detect only sudden changes in the measured values that occur during very short periods of time.

The differentiation function detects changes between the present value and the measured value that is in effect just before the comparing pitch. The coefficient of this comparing pitch is defined as the differentiation cycle.

Example: Differentiation cycle=10 ms

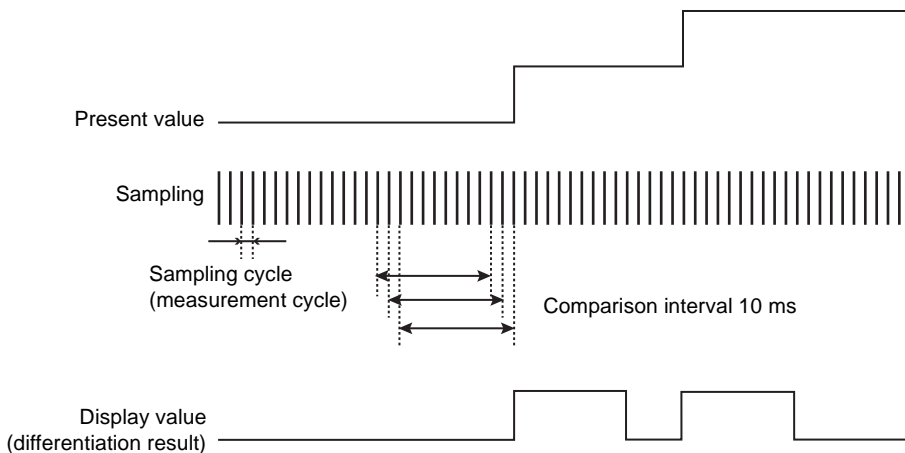

► FUN Mode-[FILTER]-[DIFF]

| Setting | Description |
|---------|---|
| OFF | The differentiation function is not used. (default value) |
| ON | Sets the cycle (ms) in which to perform differentiation. |

Setting Output Processing of Sensing Information

Set how sensing information is to be processed for outputting the required values.

Setting Scaling

Change the display scale when you want to display a value different on the main display to the actual measured value.

Place an actual sensing object in position for measurement.

There are three setting modes: “manual setting of correction values,” and “one-point scaling” and “two-point scaling” that automatically set the correction values of a placed sensing object.



CHECK!

The settings listed below return to the default settings when scaling is set. Set these items after scaling settings have been completed.

- Zero Reset

■ Setting One-point Scaling

Measurement is performed at one position and offset values are set for that measurement.

The offset and increment/decrement inversion (display inversion) can be set.

Example: Displaying the height of the sensing object

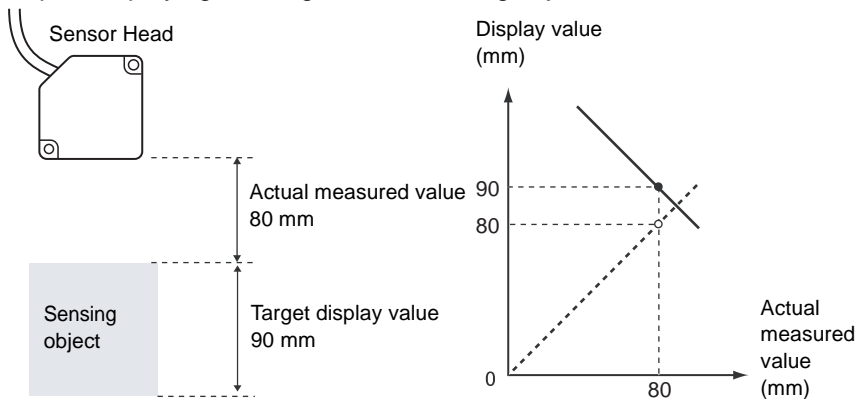

▶ FUN Mode-[OUTPUT]-[SCALING]-[ON]-[AUTO]

1. Set the sensing object in place, and enter the desired setting to be used as the offset.

The current measured value is displayed on the main display, and the offset value is displayed on the sub-display.

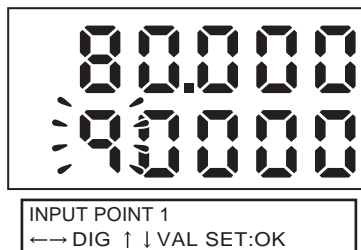

2. Press the SET Key to apply the setting.

3. Set the decimal point to determine the effective digits.



The decimal point set here becomes the new decimal point of the scaling setting. The position of the decimal point on the display follows the "DOT" setting of the display setup in the RUN mode.

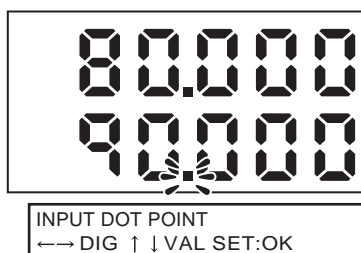

4. Press the SET key to apply the setting.

5. Press the SET key without entering any value for the second point.



6. Select [FORWARD] or [INVERS].



FORWARD: The larger the distance between the Sensor Head and the sensing object, the larger the measured value displayed on the Sensor Controller.

INVERS: The larger the distance between the Sensor Head and the sensing object, the smaller the measured value displayed on the Sensor Controller.

■ Setting Two-point Scaling

Measurement is performed at two positions and offset values are set for those measurements.

Example: Correcting display values to match actual distances

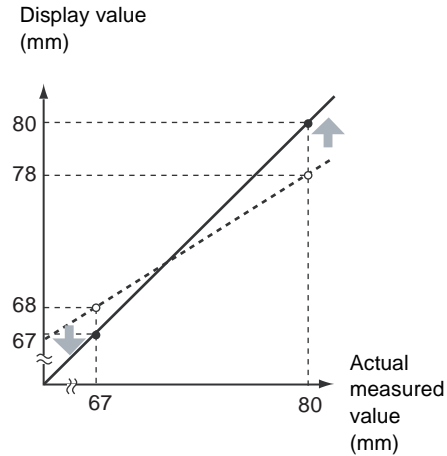
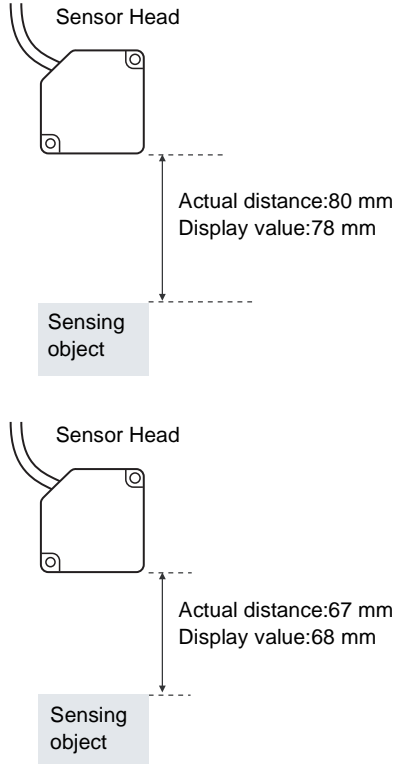

Separate the two specified points by at least 1% of the rated measurement range for the connected Sensor Head.

Example: For the ZS-LD80 (diffuse reflection type)

The two measured points must be separated by at least "30 mm x 0.01 = 0.3 mm" as the measuring range is "30 mm ± 15 mm".

► FUN Mode-[OUTPUT]-[SCALING]-[ON]-[AUTO]

1. Set the first point by following steps 1 to 4 of the one-point scaling procedure.



- Place the sensing object at the position (second point) to perform scaling, and enter the desired offset value (second point).

Press the LEFT key. The sub-display blinks.

- Press the SET key to apply the setting.

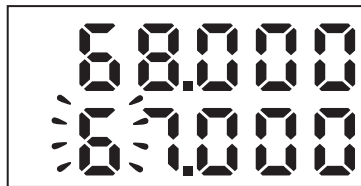

INPUT POINT 2
←→ DIG ↑ ↓ VAL SET:OK

Manual Setting

Enter numerical values for scaling correction values.

► FUN Mode-[OUTPUT]-[SCALING]-[ON]-[MANUAL]

| Setting | Description |
|---------|--|
| SPAN | <p>Sets the inclination of the sensor characters as a coefficient. Range:-2.0 to 2.0</p> |
| OFFSET | <p>Adds/subtracts a fixed value to or from the measured value. Range: -999.99 to 999.999</p> |

Setting Hold Functions

The hold functions hold data for specific points during the measurement period, such as the maximum or minimum value.

■ TYPE

Set the hold conditions for measured values.

► FUN Mode-[OUTPUT]-[HOLD]-[TYPE]

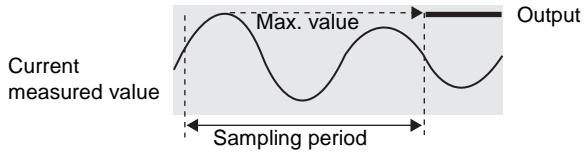
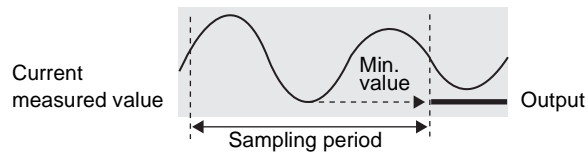
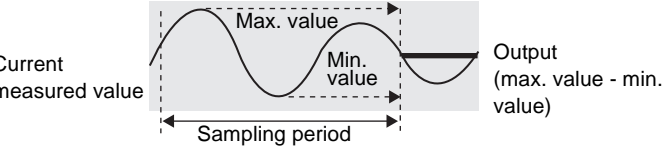
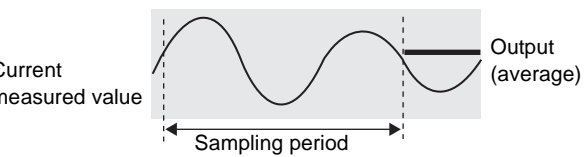

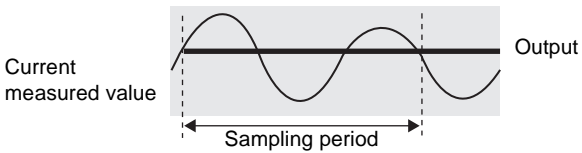

| Setting | Description |
|---------|--|
| OFF | Hold measurement is not performed. The measured value is output at all times. (default value) |
| PEAK | <p>Holds the maximum value during the sampling period. The output changes at the end of the sampling period and is held until the end of the next sampling period.</p>  |
| BOTTOM | <p>Holds the minimum value during the sampling period. The output changes at the end of the sampling period and is held until the end of the next sampling period.</p>  |
| P-P | <p>Holds the difference between the maximum and minimum values during the sampling period. This option is selected mainly when detecting vibration. The output changes at the end of the sampling period and is held until the end of the next sampling period.</p>  |
| AVERAGE | <p>Holds the average measured value during the sampling period. The output changes at the end of the sampling period and is held until the end of the next sampling period.</p>  |



| Setting | Description |
|---------|---|
| SAMPLE | <p>Holds the measured value at the start of the sampling period. The output changes at the start of the sampling period and is held until the start of the next sampling period.</p>  |

■ Triggers

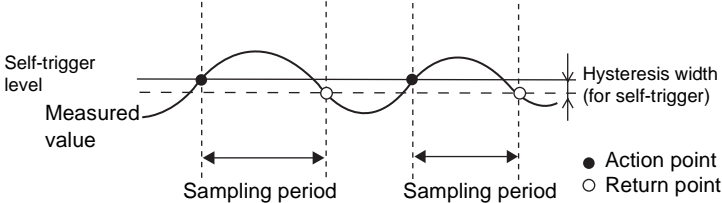
Set the input method for the timing of the start and end of the measurement period.

▶ FUN Mode-[OUTPUT]-[HOLD]-[TRIGGER]

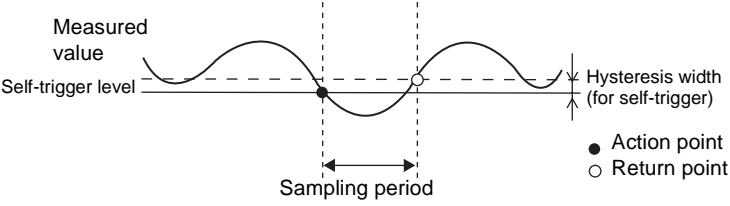
| Setting | Description |
|---------|---|
| EXT | <p>Enters the trigger for the start of sampling by using the timing input. The period that the timing signal is ON is the sampling period. (default value)</p>  <p> CHECK! When a delay time is set, the input OFF timing and the end of the sampling period will not be synchronous. Sampling will end after the specified sampling period has elapsed.</p> |
| SELF-UP | <p>The sampling period is the period that the measured value is greater than the specified self-trigger level. Hold measurement is possible without a sync input.</p>  <p>● Action point ○ Return point</p> <p>When SELF-UP is selected, the following items are subsequently displayed:</p> <ul style="list-style-type: none"> • TRG LEVEL Sets the desired self-trigger level. Range: -999.99 to 999.999 • TRG HYS Sets the hysteresis width for the self-trigger. Range: 0 to 999.999 <p> CHECK! When a delay time is set, the timing when the measured value becomes smaller than the self-trigger level and the end of the sampling period will not be synchronous. Sampling will end after the specified sampling period has elapsed.</p> |

| Setting | Description |
|---------|--|
| SELF-DN | <p>The sampling period is the period that the measured value is smaller than the specified self-trigger level. Hold measurement is possible without a sync input.</p>  <p>When SELF-DOWN is selected, the following items are subsequently displayed:</p> <ul style="list-style-type: none"> • TRG LEVEL Sets the desired self-trigger level. Range: -999.99 to 999.999 • TRG HYS Sets the hysteresis width for the self-trigger. Range: 0 to 999.999 <p> CHECK! When a delay time is set, the timing when the measured value becomes greater than the self-trigger level and the end of the sampling period will not be synchronous. Sampling will end after the specified sampling period has elapsed.</p> |



Set the hysteresis width based on the fluctuations in the measured values around the trigger level. The hysteresis will be applied from the start of the sampling period and will prevent timing input chattering.

■ DELAY

A delay time is set to ignore measured values immediately after the timing input. This is useful for avoiding bounding during device startup and the influence of machine vibration.

The delay time (the delay between timing input and the start of sampling) and the sampling period can be set.

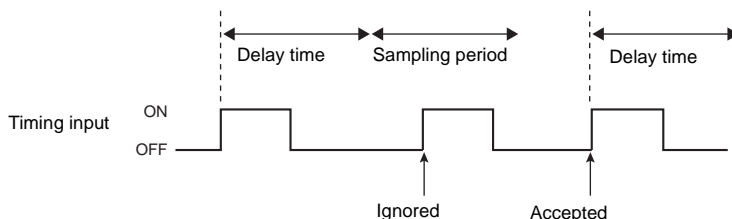

► FUN Mode-[OUTPUT]-[HOLD]-[DELAY]

| Setting | Description |
|---------|---|
| OFF | The delay time is not set. (default value) |
| ON | <p>Sets the delay time. When ON is selected, the following items are subsequently displayed:</p> <ul style="list-style-type: none"> • T-DELAY Sets the delay time. Range: 0 to 5000 (ms) • T-TIME Sets the sampling time. Range: 1 to 5000 (ms) <p> CHECK! Set so that the “delay time + sampling time” is less than the timing input ON interval. If the next timing input for measurement is received before the “delay time + sampling period” has elapsed, that timing input will be ignored and will not be reflected in the sampling.</p> |

Setting Zero Reset

When the zero reset function is used, the reference value "0" is registered as the height and the measured value can be displayed and output as a positive or negative deviation (tolerance) from the reference value. In the RUN mode, the measured value can be reset to 0 at any timing during measurement.

Example 1: Using the height of sensing object registered as the reference value and the tolerance output as the measured value

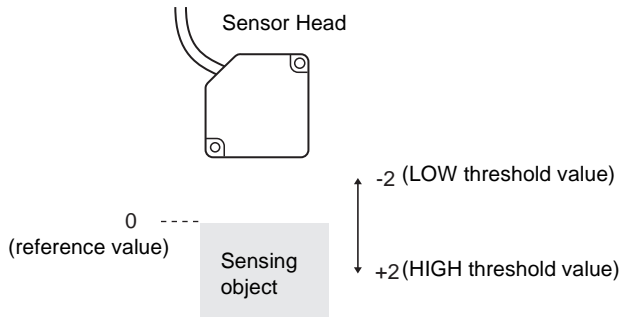

Example 2: Using the height of sensing object as the measured value with an offset set to 10

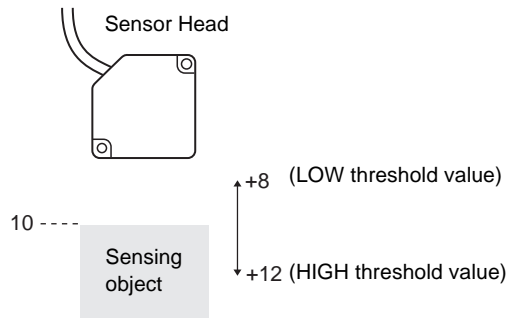

Example 3: Using zero reset to measure steps in sensing object (zero reset at each measurement)

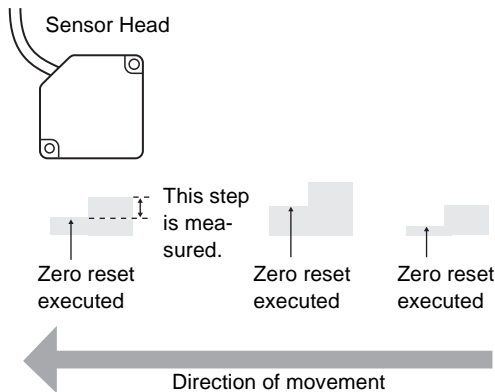

To execute a zero reset: Press the SET key in the RUN mode.

To cancel a zero reset: Hold down the ESC key for at least two seconds in the RUN mode.



Timing chart when inputting the zero reset signal from an external device p.4-9



When a zero reset is executed, the linear output becomes the voltage (or current) value at the center of the two preset points. Linear output becomes roughly 0V (12 mA) when focus is not set.

■ TYPE

Set how zero reset is to be executed.

▶ FUN Mode-[OUTPUT]-[0 RESET]-[TYPE]

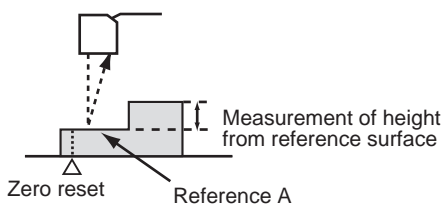
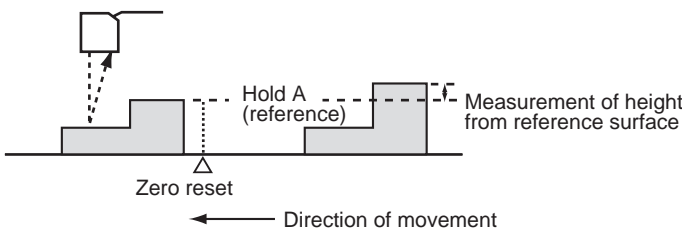
| Setting | Description |
|---------|--|
| REAL | <p>Sets the measured value when a zero reset is executed to zero. (default value)</p>  |
| HOLD | <p>Sets the measured value (hold value) when a zero reset is executed to zero. This setting is enabled when hold measurement is performed.</p>  |

■ Offset

Set an offset to set the reference value for zero reset to a value other than 0.

▶ FUN Mode-[OUTPUT]-[0 RESET]-[OFFSET]

| Setting | Description |
|---------|---|
| OFFSET | <p>Sets the reference value. Range: -999.99 to 999.999 (default value: 0)</p> |

■ Setting Zero Reset Memory

You can select whether or not to hold the measured value zero reset level even if the power is turned OFF.

▶ FUN Mode-[SYSTEM]-[ZERORST]

| Setting | Description |
|---------|--|
| OFF | Zero reset is canceled when the power is turned OFF.(default value) |
| ON | The zero reset level is saved to memory even if the power is turned OFF. |

Turn [OFF] zero reset memory if, as in the example below, the zero point is reset for each measurement.

Example: When the step of the sensing object is measured

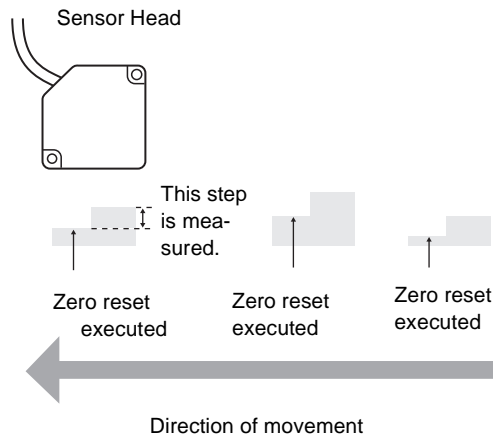

- When turning the power ON, if you want to keep the zero reset level data that was in effect when the power was turned OFF last time, make sure that zero reset memory is enabled. If zero reset memory is enabled, the zero reset level data will be written in the Sensor Controller non-volatile memory (EEPROM) at each zero reset. The EEPROM can be written a maximum of 100,000 times. Writing the zero reset level for each measurement can, therefore, use up the life of the memory and lead to malfunctions.
- Even if zero reset memory is enabled, the zero reset level will be held also when it is saved. Zero reset will continue after startup when these functions have been changed.

Setting Threshold Values

Threshold values are set to determine the range for PASS judgments. Both HIGH and LOW threshold values are set. There are three judgment outputs: HIGH, PASS and LOW.

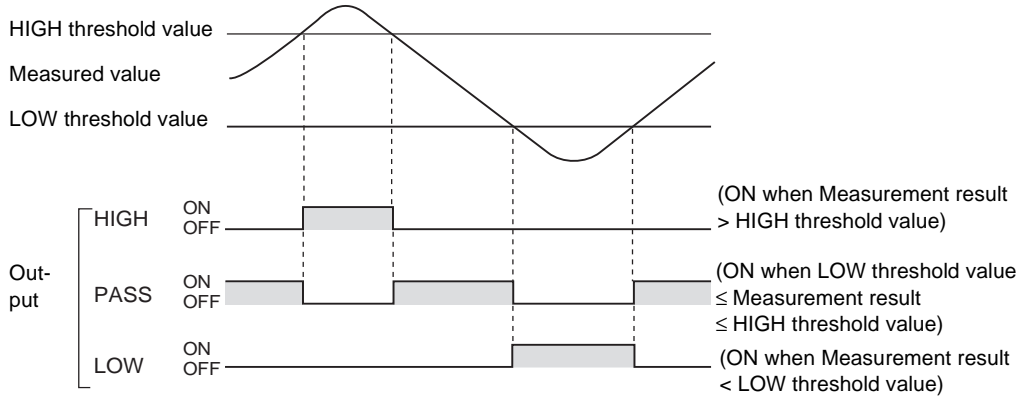

- Hysteresis (hysteresis width) can also be set to threshold values. Set hysteresis when judgments are unstable to prevent chattering.

CHECK!



Setting Judgment Output p.4-5

- When setting threshold values while still connected to an external device, set the Sensor Controller's LD-OFF input to ON so that the output to the external device remains unchanged. Judgment outputs in the TEACH mode are the same as in the RUN mode, i.e., HIGH, PASS, and LOW.

Before executing teaching, select which of the HIGH or LOW threshold values is to be set on the threshold switch on the ZS-L Series Controllers.

► TEACH Mode

| Method | Details |
|---------------------------------|--|
| TEACHING (MENU key) | <p>Performs measurement and uses the measurement results to set threshold values. Teaching is useful when threshold samples, i.e., with the upper and lower limits, can be obtained beforehand.</p> <div style="display: flex; justify-content: space-around;"> <div style="text-align: center;"> <p>Sensor Head</p> <p>Teaching point = LOW threshold value</p> <p>Threshold sample (upper limit)</p> </div> <div style="text-align: center;"> <p>Sensor Head</p> <p>Teaching point = HIGH threshold value</p> <p>Threshold sample (lower limit)</p> </div> </div> <p>Hold, trigger, and scaling settings that have been made before teaching are reflected in the teaching measurements.</p> |
| DIRECT IN (L/R/UP/DOWN keys) | <p>The threshold values can be set by directly inputting numerical values. Direct input is useful when you know the dimensions for an OK judgment or when you want to fine-tune threshold values after teaching.</p> |

Setting the Display Method

Set what you want to display on the Sensor Controller during measurement in the RUN mode.

To set the display method, switch to the RUN mode and display the top menu.

Setting the Digital Displays

Set what is displayed on the digital displays in the RUN mode.

■ Number of digits pasts the decimal point

Set the number of display digits in the main display and sub-display.

When five or less digits are set, the digits are disabled from the rightmost digit first.

▶ RUN Mode-MENU key-[DIGITAL]-[DOT]

| Setting | Description |
|----------------------------|---|
| 5th, 4th, 3rd, 2nd, 1st, 0 | Sets the number of display digits past the decimal point. (default value: "3rd" when the ZS-LD50/80/200 is connected, and "4th" when the ZS-LD20T/40T is connected) |

■ Setting the ECO display

Set the brightness of the main display and sub-displays.

▶ RUN Mode-MENU key-[DIGITAL]-[ECO]

| Setting | Description |
|---------|---|
| NORMAL | Sets the displays to normal brightness. (default value) |
| ECO | Suppresses the brightness by reducing current consumption to darken the displays. |
| OFF | Turns digital displays OFF. |

Setting the LCD Display

Set how the LCD screen is displayed in the RUN mode.

■ Setting display ON/OFF

Set whether or not to display the LCD screen.

▶ RUN Mode-MENU key-[LCD]-[ON/OFF]

| Setting | Description |
|---------|---|
| ON | Displays the LCD screen at all times. (default value) |
| AUTOOFF | Turns the LCD screen display OFF when no operations are performed for one minute. |
| OFF | Turns the LCD screen OFF. This setting is valid only in the RUN mode. Note, however, that pressing the MENU key displays the display customize menu. |

■ Setting the backlight ON/OFF

Set whether or not to turn the LCD screens backlight ON or OFF.

▶ RUN Mode-MENU key-[LCD]-[B.LIGHT]

| Setting | Description |
|---------|--|
| ON | Turns the LCD screen backlight ON at all times. (default value) |
| AUTOOFF | Turns the backlight OFF when no operations are performed for one minute. |
| OFF | Turns the LCD screen backlight OFF. |

■ Customizing the LCD Display

Set this item to display customized characters on the LCD screen.

▶ RUN Mode-MENU key-[LCD]-[CUSTOM]

| Setting | Description |
|---------|--|
| UPPER | Set this item to ON to display characters set at [U-CUST] on the upper section of the LCD screen. (default: U-OFF) |
| LOWER | Set this item to ON to display characters set at [L-CUST] on the lower section of the LCD screen. (default: L-OFF) |
| U-CUSTM | Use this setting to edit characters to display on the LCD screen.(max. 16 digits) <ul style="list-style-type: none"> •Call up the initial character of each character group using function keys 1 to 4. (Other signals are assigned to the latter half of each group.) 1: A to Z 2: a to z |
| L-CUSTM | <ul style="list-style-type: none"> 3: KANA (Japanese Characters) 4. Numbers, :, ;, <, =, >, ?, @ •Switch the characters in order using the UP or DOWN key. •Move the digits by the LEFT or RIGHT key. •To clear a character, select a space. |

HELP

Display Help for the functions assigned to the SET or ESC keys in the RUN mode.

- ▶ RUN Mode-MENU Key-[HELP]

Setting Banks

The ZS-LSeries can hold up to eight sets of settings. These settings can be switched externally when changing the device setup. A set of these settings is called a “bank”.

Switching banks

Bank 1 is selected as the default. Banks 2 and 4 are also available.



Banks can be switched from an external device by communication commands.

For details on command formats, refer to the “Communication Command Reference” (provided separately).

- ▶ FUN Mode-[BANK]-[CHANGE]

| Setting | Description |
|---------|--|
| CHANGE | Selects the target bank. Range: BANK1, BANK2, BANK3, BANK4 (default: BANK1) |

Clearing banks

“Clearing” initializes the settings of the currently selected bank.

- ▶ FUN Mode-[BANK]-[CLEAR]



Settings in [SYSTEM] and settings displayed in the RUN mode are not initialized.

Setting the System Environment

Set the system environment.

Saving setup data

Bank settings and system settings are saved internally on the Sensor Controller.



- The settings of all banks are saved regardless of the currently selected bank No.
- After you have made or changed settings, be sure to save the setup data. All settings will be deleted if you turn the power OFF without saving the data. A message prompting you to save data will be displayed if you change a mode without saving data after you have changed settings.

▶ FUN Mode-[SYSTEM]-[SAVE]

| Setting | Description |
|---------|-------------------------------|
| OK | Saves the setup data. |
| CANCEL | Does not save the setup data. |

Initializing setup data

Return all bank settings and system settings to their factory settings.



The settings of all banks and system settings are initialized regardless of the currently selected bank No.

▶ FUN Mode-[SYSTEM]-[INIT]

| Setting | Description |
|---------|-------------------------------------|
| OK | Initializes the setup data. |
| CANCEL | Does not initialize the setup data. |

Checking Sensor Controller information

Displays the measurement cycle and version of Sensor Controller system.

► FUN Mode-[SYSTEM]-[INFO]

| Setting | Description |
|---------|---|
| CYCLE | Displays the current measurement cycle. |
| INFO | Displays the version of the Sensor Controller system. |

Setting key lock

The key lock function disables all Sensor Controller keys. Once the keys have been disabled, no key input will be accepted until the lock is released. This function is useful to prevent inadvertent changes to settings.

Moving to the key lock menu or moving between menu hierarchies by the MENU or ESC keys are possible even when the key lock function is ON.

► FUN Mode-[SYSTEM]-[KEYLOCK]

| Setting | Description |
|---------|--|
| OFF | Cancels the key lock function. (default value) |
| ON | Turns the key lock function ON. |

Setting the sensor load method

Set whether or not to load information from the currently connected Sensor Head when the Sensor Controller is started up.

► FUN Mode-[SYSTEM]-[Sen INFO]

| Setting | Description |
|---------|--|
| LOAD | Reads the data currently saved on the Sensor Head each time that the Sensor Controller is started up. (default value) |
| SAVE | Data is not read from the Sensor Head when the Sensor Controller is started up if the same Sensor Head at the previous startup is connected.  When the combination of Sensor Controller and Sensor Head is fixed, selecting "SAVE" sometimes results in the Sensor Controller starting up more stably depending on the operating environment. CHECK! |

Setting the display language

Set the display language of the LCD screen.

► FUN Mode-[SYSTEM]-[LANGUAG]

| Setting | Description |
|----------|---|
| Japanese | Displays menus in Japanese. (default value) |
| English | Displays menus in English. |

MEMO

Section 4

EXTERNAL I/O

| | |
|--|------|
| ▣ Linear Input/Output | 4-2 |
| Setting Linear Output | 4-2 |
| Setting Judgment Output | 4-5 |
| Non-Measurement Settings | 4-6 |
| Input Signal Settings | 4-7 |
| I/O Assignment Settings | 4-7 |
| Timing Charts | 4-9 |
| ▣ RS-232C Input/Output | 4-11 |
| RS-232C Specifications | 4-11 |
| Setting the Communication Specifications | 4-12 |

Linear Input/Output

This section describes setting of the output method to external devices and the timing charts.

For details on wiring of the Sensor Controller's I/O cable, see Section 2.

 For details on the I/O cable p.2-7

Setting Linear Output

■ Setting focus

Linear output refers to the conversion of measurement results to a 4 to 20 mA current output or a -10 to +10 V voltage output. The relationship between displayed measured values and output values can be set freely. Match the settings to suit the connected external device.

Enter the output values for any two current values or voltage values to set the output range. (default value: OFF)

Example: Setting 70 mm to 4 mA and 90 mm to 20 mA (for current output)

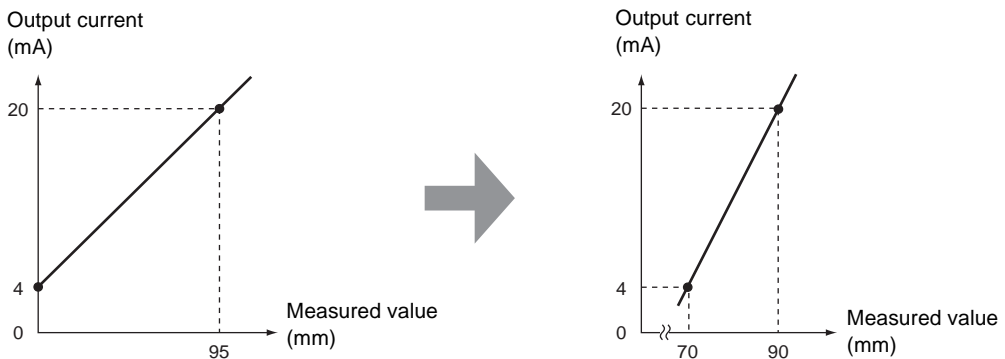

Separate the two specified points by at least 1% of the rated measuring range for the connected Sensor Head.

CHECK!

Example: For the ZS-LD80 (diffuse reflection type)

The two measured points must be separated by at least "30 mm x 0.01 = 0.3 mm" as the measuring range is "30 mm ±15 mm".

► FUN mode-[I/O SET]-[ANALOG]-[FOCUS]-[ON]

1. Set the output value (voltage or current value) of point 1.

The output value is displayed on the main display.



INPUT POINT 1
↑ ↓ CHANGE SET:OK

2. Press the SET Key to apply the setting.

3. Set the measurement value for point 1.

The measurement value is displayed on the sub-display.

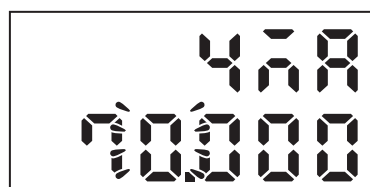

INPUT POINT 1
← → DIG ↑ ↓ VAL SET:OK

4. Press the SET Key to apply the setting.

5. Set point 2 in the same way as point 1.

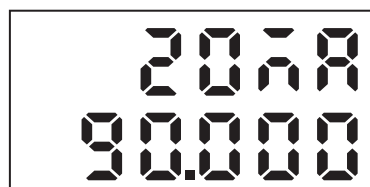

INPUT POINT 2
← → DIG ↑ ↓ VAL SET:OK



If the points are not set correctly, check the following:

- Is the measured value set on the sub-display within the measuring range (with scaling and calculation settings reflected if set)?
- Are the first and second measured points separated by at least 1% of the rated measuring range?
- Are the current (or voltage) values for the two points the same?

■ Correcting Linear Output Values

Discrepancies may occur between the linear output current (or voltage) values set on the Sensor Controller and the actual current (or voltage) values measured due to the conditions for the connected external device or other factors. The linear output correction function can be used to correct this discrepancy.

The output values are corrected by entering the correction value for the current (or voltage) values for any two points. (default value: OFF)

Range: -999 to 999



Set the focus function and select either current or voltage output beforehand. Also, connect the linear output to an external ammeter or voltmeter.

▶ FUN mode-[I/O SET]-[ANALOG]-[ADJUST]-[ON]

1. Set the output value of point 1.

The output value is displayed on the main display.

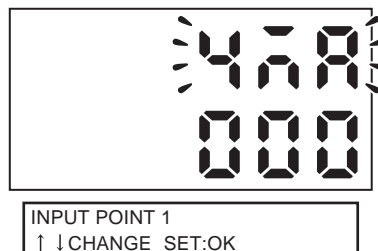

2. Press the SET Key to apply the setting.

3. Set the correction value for point 1.

The measurement value is displayed on the sub-display.

Adjust the correction value on the sub-display so that the ammeter (or voltmeter) reading and the output value shown on the main display are the same.

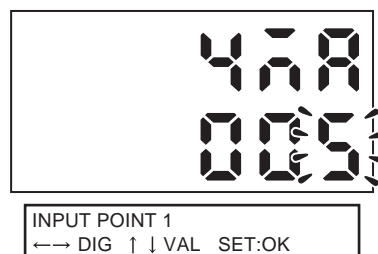

4. Press the SET Key to apply the setting.

5. Set point 2 in the same way as point 1.

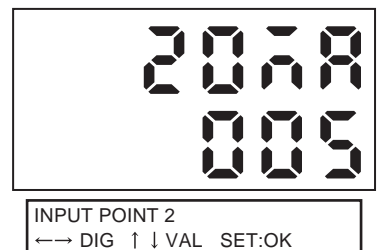

If the points are not set correctly, check to see if the current (or voltage) values of points 1 and 2 are the same.

Setting Judgment Output

Make the setting relating to judgment output.

 Threshold setting p.3-31

► FUN mode-[I/O SET]-[JUDGE]

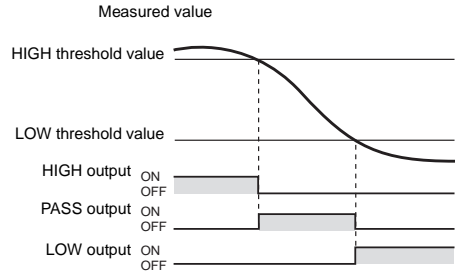
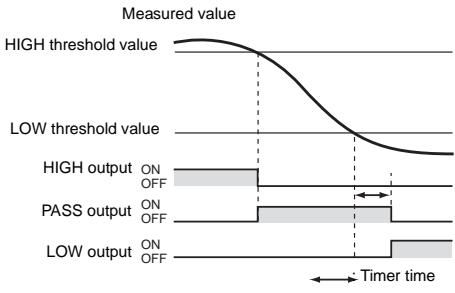
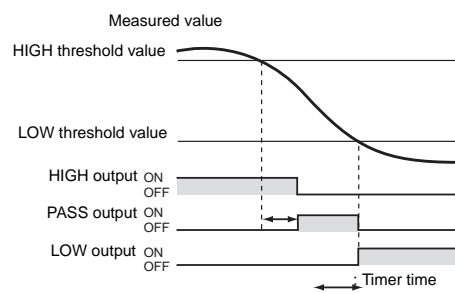
| Setting | Description |
|---------------------|--|
| HYS | <p>Set the hysteresis value for the upper and lower limits of judgments if the HIGH, PASS, or LOW judgment is unstable near the threshold values.</p> <p>Measuring range: 0 to 999.999 (default value: 0.05% of Sensor Head measuring range)</p> <p>Example: For ZS-LD80, this becomes 15 μm (0.05% of 30 mm) as the measuring range of the sensor head is ± 15 mm.</p> |
| TIMER | <p>Set the timing for judgment outputs to match the operation of external devices.</p> |
| OFF (default value) | <p>Outputs the judgment as soon as the judgment result has been applied.</p>  |
| OFF DELAY | <p>After the measurement result has been applied, delays turning OFF the PASS output for the time set to the timer.</p> <p>Also delays turning ON the HIGH and LOW outputs for the time set to the timer.</p> <p>Range: 1 to 5000 (ms)</p>  |
| ON DELAY | <p>After the measurement result has been applied, delays turning ON the PASS output for the time set to the timer.</p> <p>Also delays turning OFF the HIGH and LOW outputs for the timer time.</p> <p>Range: 1 to 5000 (ms)</p>  |

| Setting | Description | |
|----------|--|--|
| ONE SHOT | <p>When the judgment result changes to PASS, outputs the PASS output for the time set to the timer.</p> <p>Neither the HIGH nor the LOW output is output.</p> <p>Range: 1 to 5000 (ms)</p> | |

Non-Measurement Settings

Set how the measurement values are to be output when a non-measurement state occurs temporarily due to insufficient received light amount or the reset input state, for example.

Example: When the waveform skips due to insufficient received light amount

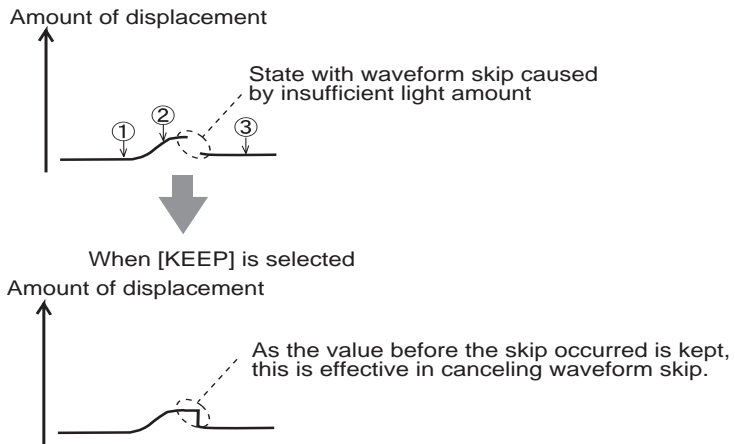
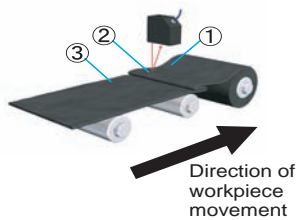

► FUN mode -[I/O SET]-[NON-MEAS]

| Setting | Outputs | |
|--------------------------|--|---|
| | Judgment output | Linear output |
| KEEP | The status immediately before measurement is stopped is held and output. | |
| CLAMP (default value) | All OFF | <p>Outputs the set CLAMP value.</p> <p>At current output : 4, 12 mA, 20 mA, MAX (approx. 25 mA, default value), MIN (approx. 2 mA)</p> <p>At voltage output : -10V, 0V, 10V, MAX (approx. 11 V, default value), MIN (approx. -11 V)</p> |



In hold measurement, the output before the first hold value is obtained will be the same as [CLAMP] even if [KEEP] is set.

Input Signal Settings

You can now set which of ON or OFF is set to an active state for each of the input wires.

► FUN mode-[I/O SET]-[IN]

| Setting | | Description |
|-------------------|-----|--|
| IN0 | OFF | The input wire is regarded as active when it is OFF. |
| IN1 IN2 IN3 | ON | The input wire is regarded as active when it is ON. |

I/O Assignment Settings

■ Switching the bank by external signal input

You can select the function to be assigned to external input signals IN0 to IN3 from two patterns,



- If you use SmartMonitor ZS, you can change the function assignments of IN2 and IN3 if [BANK] is selected. For details, refer to the Help for SmartMonitor ZS.
- These settings are stored in each bank and must be set separately for each bank.

► FUN mode-[I/O SET]-[I/O SET]-[IN]

| Setting | | Description | | | |
|---------|--|---|--------------|--------------|------------------|
| STAND | | Select this to use external input function as in standard applications so far.(default value) | | | |
| | | IN0 | IN1 | IN2 | IN3 |
| | | External trigger (timing) input | Reset input | LD-OFF input | Zero reset input |
| Bank | | Select this to switch banks using external inputs. | | | |
| | | IN0 | IN1 | IN2 | IN3 |
| | | Bank input A | Bank input B | LD-OFF input | Zero reset input |

For bank inputs A and B, the bank can be selected in the following combinations.

| Bank to be Selected | Bank input A | Bank input B |
|---------------------|--------------|--------------|
| BANK1 | OFF | OFF |
| BANK2 | OFF | ON |
| BANK3 | ON | OFF |
| BANK4 | ON | ON |



- Bank switching is begun 0.5 seconds after the input state changes.
- At most it takes about 30 seconds to switch banks.
- During bank switching the BUSY output becomes ON.

■ About Digital Output

Of CompoWay I/F or non-procedural communication commands, if you want to use the FlowDATA command to batch acquire data at high speed, set this setting to ON.

Note, however, that in measurement modes ([High] or [Custom]) having a short measurement cycle, the measurement cycle changes according to the setting of this digital output.



CHECK!

This setting automatically is set to ON when the graph display and logging functions of SmartMonitor ZS are used. For example, if the mode is set to the high-speed mode at this time, the measurement cycle becomes 1.5 times the measurement cycle.



CHECK!

When a measurement mode other than [High] or [Custom] is selected, this digital output setting does not cause the measurement cycle to change.

▶ FUN mode-[I/O SET]-[I/O SET]-[DIGITAL]

| Setting | Description |
|---------|---|
| OFF | Of the communication commands, the command (FlowDATA) for high-speed batch acquisition of data is disabled. When [High] is selected for the measurement mode, this setting automatically turns OFF, and the measurement cycles becomes the fastest measurement cycle. |
| ON | Of the communication commands, the command (FlowDATA) for high-speed batch acquisition of data is enabled. Set this to ON to batch acquire data at high speed using communication commands. Note, however, that in measurement modes ([High] or [Custom]) having a short measurement cycle, the measurement cycle becomes 1.5 times the measurement cycle when this setting is set to ON. |

Timing Charts

The following shows the timing charts when communication is performed with external devices.

The numerical values given below are reference values for when [STAND] is selected as the measurement mode.

● Zero reset input

Zero reset setting/cancel time

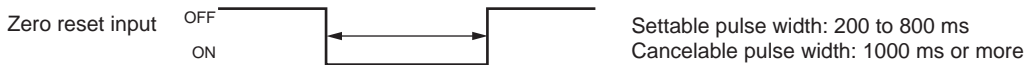

Response at execution of zero reset

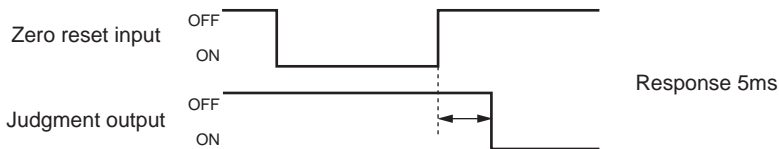

Response at cancellation of zero reset (average count = 1)

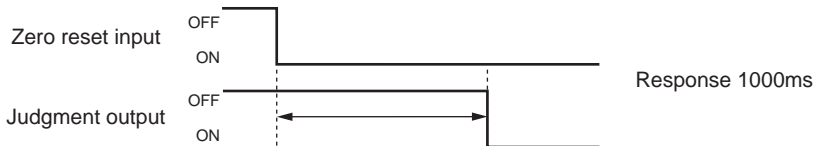

● Reset input

Response of reset (CLAMP is set to ON, average count = 1)

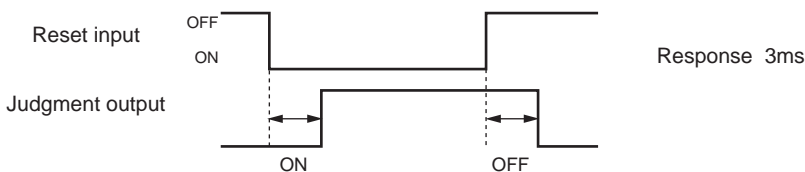

● Timing input

Response of timing input (sample hold type, average count = 1)

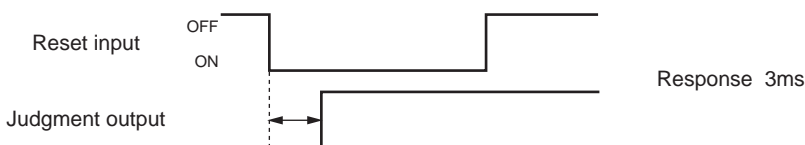

● LD-OFF input

Response at LD-OFF input

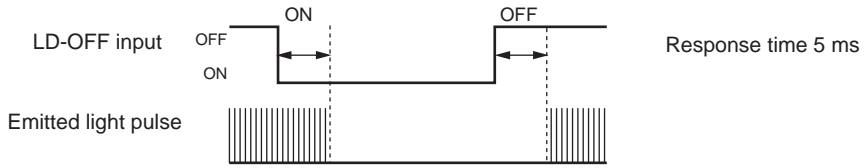

Linear output also is almost the same response time as judgment output.

RS-232C Input/Output

The Sensor Controller is also provided with an RS-232C port for connection to a personal computer that does not have a USB port. This allows communications with external devices using the OMRON proprietary communication protocol CompoWay/F or non-procedure (NORMAL). For details on command formats, refer to the "Communication Command Reference" (provided separately).



SmartMonitor ZS cannot be used on the RS-232C interface. To use SmartMonitor ZS, connect the Sensor Controller to the personal computer with the USB cable.

RS-232C Specifications

■ Connector pin assignments

An exclusive connector is used for the connector.

An RS-232C cable compatible with the exclusive connector is provided.

Recommended part: ZS-XRS2 (cable length: 2 m)

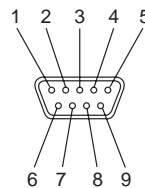
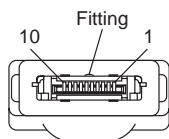
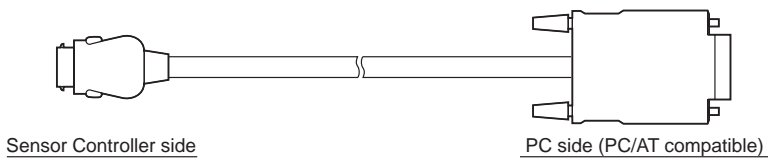

| Signal Name | Pin No. |
|-------------|---------|
| NC | 1 |
| SD(TXD) | 2 |
| RD(RXD) | 3 |
| RS(RTS) | 4 |
| CS(CTS) | 5 |
| NC | 6 |
| NC | 7 |
| NC | 8 |
| SG(GND) | 9 |
| NC | 10 |

| Pin No. | Signal Name |
|---------|-------------|
| 1 | NC |
| 2 | RD(RXD) |
| 3 | SD(TXD) |
| 4 | NC |
| 5 | SG(GND) |
| 6 | NC |
| 7 | RS(RTS) |
| 8 | CS(CTS) |
| 9 | NC |
| | |

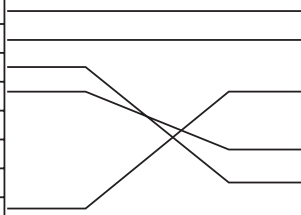

Setting the Communication Specifications

Set the RS-232C communications specifications.

Match the communication specifications of the ZS-L Series to those of the external device.

► FUN mode-[SYSTEM]-[COM]



| Setting | | Range |
|-----------------|---------|--|
| RS-232C | LENGTH | 8BIT, 7BIT (default value: 8BIT) |
| | PARITY | NON, OFF, EVEN (default value: NON) |
| | STOP | 1BIT, 2BIT (default value: 1BIT) |
| | BAUDRAT | 9600, 19200, 38400, 57600, 115200 (default value: 38400) |
| | DELIMIT | CR, LF, CR+LF (default: CR) |
| MODE | | CompoWay/F, non-procedural (default: CompoWay/F) |
| NODE (node No.) | | 0 to 16 |
| | |  The node No. refers to the connection group No. as seen from the host device (PLC). Not only the ZS Series but other multiple devices are connected to the PLC. The No. assigned to devices connected to a PLC such as this is referred to as a node No. CHECK! |



For details on communication protocol, refer to the "Communication Command Reference" (provided separately). For the Communication Command Reference, please contact your OMRON representative.

Section 5

APPLICATION SETTING EXAMPLES

| | |
|--|-----|
|  Measuring the Front Side of Black Sheet Rubber | 5-2 |
|  Measuring the Height of a PCB Surface | 5-5 |
|  Measuring the Thickness of Glass | 5-7 |

Measuring the Front Side of Black Sheet Rubber

This is an example of how to set when measuring the height from the front side of black sheet rubber that reflects little light.

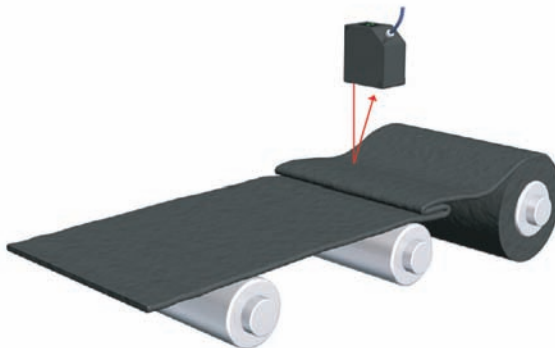

1. Install the Sensor Head.



CHECK!

Basically, install the Sensor Head for diffusion reflection measurement. Note, however, that the Sensor Head may be installed for regular reflection measurement if the amount of received light is little, for example, due to the rubber sheet having a glossy surface. Adjust the angle of the Sensor Head while verifying the amount of received light on the controller's sub-display so that the amount of received light reaches close to "1000".



Installing the Sensor Head p.2-12

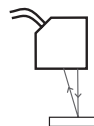

▶ FUN Mode-[SENSING]-[MODE]

2. Select the sensing mode.

Select the sensing mode taking the content of measurement to give priority to into consideration.



CHECK!

[HI-RESO] and [HI-SENS] are best suited for the measurement of black rubber.



Setting the Measurement Mode p.3-12



▶ FUN Mode-[SENSING]-[SETTING]

3. Select the sensor installation.

Select installation of the sensor for diffuse reflection measurement or regular reflection measurement.



 Setting the Head Installation p.3-13

▶ FUN Mode-[SENSING]-[OBJECT]

4. Select [NORMAL] as the type of measurement object.



 Setting the Measurement Object p.3-14

▶ FUN Mode-[FILTER]-[SMOOTH]

5. Set the Filter Function.

SMOOTH : ON

AVERAGE : 4 times



 Setting the average count to a low number will result in a more accurate trace of the state of the workpiece surface.

CHECK!

 Setting Average p.3-19

▶ FUN Mode-[SYSTEM]-[SAVE]

6. The save confirmation message is displayed.

Select [OK].

Save the settings to Sensor Controller internal memory.

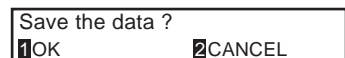

▶ RUN Mode

7. Confirm the resolution with the workpiece in a still state.

The minimum detectable resolution is displayed. Refer to this as a reference as to whether or not the resolution is at or below the required accuracy.

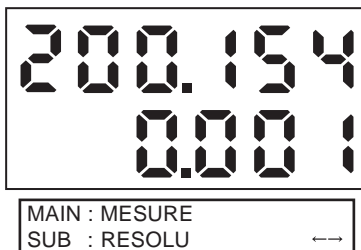

Generally speaking, moving the workpiece will impair the resolution.

▶ FUN Mode-[I/OSET]-[NO-MEAS]

8. Select [CLAMP] to confirm whether or not the workpiece can be measured if it is moved.



When measuring black or dark-colored workpieces having a low reflection factor, the waveform sometimes jumps due to light not returning to the light receiver section or considerable differences in the amount of received light. You can confirm whether or not there are jumps in the waveform by displaying the waveform in a clamped state.

Non-Measurement Settings p.4-6

▶ FUN Mode-[SYSTEM]-[SAVE]

9. The save confirmation message is displayed. Select [OK].

Save the settings to Sensor Controller internal memory.

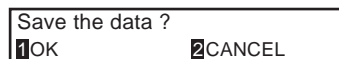

▶ RUN mode

10. Check for jumps in the waveform by using the graphic display on SmartMonitor ZS.



- When measuring black or dark-colored workpieces having a low reflection factor, the waveform sometimes jumps due to light not returning to the light receiver section or considerable differences in the amount of received light. You can judge whether or not the measurement state and sensing condition settings are acceptable by displaying the waveform in a clamped state.
- If jumps are occurring in the waveform, select [KEEP].

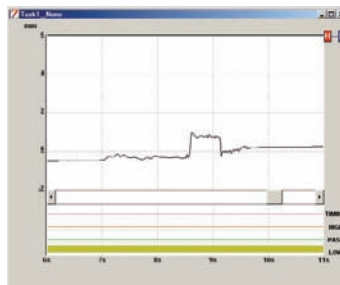

Measuring the Height of a PCB Surface

This is an example of how to measure the height of a workpiece such as a PCB through which the laser beam passes and the reflected light does not form a normal distribution.

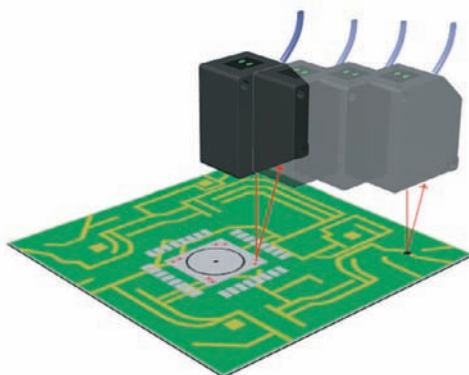

1. Install the Sensor Head.

▶ FUN Mode-[SENSING]-[MODE]

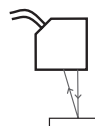

2. Select the sensing mode.

Select the sensing mode taking the content of measurement to give priority into consideration.

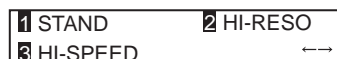

[NORMAL] and [HI-SENS] are best suited for the measurement of PCBs.

CHECK!



Setting the Measurement Mode p.3-12

Section 5 Measuring the Height of a PCB Surface

▶ FUN Mode-[SENSING]-[SETTING]

3. Select the sensor installation.

Select [DIFFUSE].

1 DIFFUSE 2 REGULAR



Setting the Head Installation p.3-13

▶ FUN Mode-[SENSING]-[OBJECT]

4. Select [PCB] as the type of measurement object.

1 NORMAL 2 PCB
3 MIRROR ←→



Setting the Measurement Object p.3-14

▶ FUN Mode-[SYSTEM]-[SAVE]

5. The save confirmation message is displayed.

Select [OK].

Save the settings to Sensor Controller internal memory.

Save the data ?
1 OK 2 CANCEL

Measuring the Thickness of Glass

This is an example of how to set when measuring the thickness of raw glass.

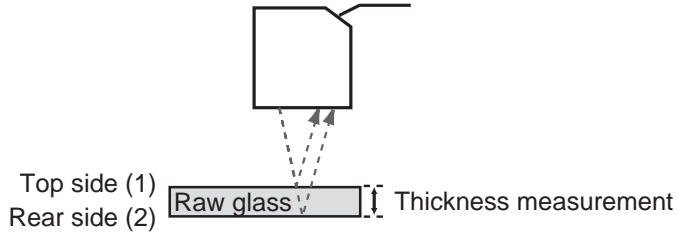

1. Install the Sensor Head.

Select installation for regular reflection measurement.

 Installing the Sensor Head p.2-12



▶ FUN Mode-[SENSING]-[MODE]

2. Select the sensing mode.

Select the sensing mode taking the content of measurement to give priority into consideration.



 [NORMAL] and [HI-SENS] are best suited for the measurement of glass thickness.

CHECK!  Setting the Measurement Mode p.3-12

▶ FUN Mode-[SENSING]-[SETTING]

3. Select the sensor installation,

Select [REGULAR].

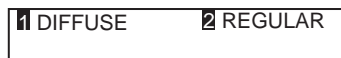

Setting the Head Installation p.3-13

▶ FUN Mode-[SENSING]-[OBJECT]-[THICK]

4. Select [NORMAL] as the type of measurement object.



Setting the Measurement Object p.3-14

▶ FUN Mode-[SYSTEM]-[SAVE]

5. The save confirmation message is displayed.

Select [OK].

Save the settings to Sensor Controller internal memory.

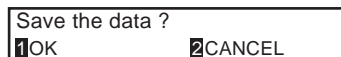

Section 6

APPENDIX

| | |
|---|------|
| ☒ Troubleshooting | 6-2 |
| ☒ Error Messages and Countermeasures | 6-3 |
| ☒ Q&A | 6-5 |
| ☒ Glossary | 6-6 |
| ☒ Specifications and External Dimensions | 6-7 |
| ☒ Laser Safety | 6-23 |
| ☒ Requirements from Regulations and Standards | 6-24 |
| ☒ Engineering Data | 6-33 |
| ☒ Version Up Information | 6-42 |
| ☒ INDEX | 6-43 |
| ☒ Revision History | 6-47 |

Troubleshooting

This section describes countermeasures for temporary hardware problems. Check the malfunction in this section before sending the hardware for repair.

| Problem | Probable cause and possible countermeasure | Pages |
|---|---|------------------|
| Device restarts during operation. | <ul style="list-style-type: none"> • Is the power supply device connected correctly? | p.2-7 |
| Judgments are not output to external device. | <ul style="list-style-type: none"> • Are all cables connected correctly? • Is the signal line disconnected? • Are reset inputs short-circuited? | p.2-7 |
| No input signal received | <ul style="list-style-type: none"> • Are all cables connected correctly? • Is the signal line disconnected? | p.2-7 |
| No communications with personal computer | <ul style="list-style-type: none"> • Is the USB cable connected correctly? • Is the RS-232 cable connected correctly? | p.2-19 p.4-11 |
| Strange linear output levels | <ul style="list-style-type: none"> • Is the voltage/current switch on the bottom of the Sensor Controller set to the correct position? • Has the correct selection (voltage/current) been made in the focus settings? Linear output levels can be fine-tuned. | p.1-10 p.4-2 |
| The main display remains on [----]. | <ul style="list-style-type: none"> • Has a timing input been made while the hold function is enabled and the trigger type has been set to [EXT]? • If the hold function is enabled and the trigger type is [SELF-UP] or [SELF-DOWN], has the self-trigger level been set to an appropriate value? | p.3-25 |
| An abnormal distance is displayed when the object is clearly outside the measuring range. | <ul style="list-style-type: none"> • This problem may occur due to the characteristics of the sensor. Make sure that the distance to the sensing object is appropriate. • This problem is sometimes rectified by setting the emitted light amount to a fixed distance. | p.3-13 |
| The measured values fluctuate and are not stable depending on day and time. | <ul style="list-style-type: none"> • This problem may be due to temperature characteristics. Execute zero reset periodically using the standard object to correct this problem. | p.3-28 |

Error Messages and Countermeasures

■ When [Error] Is Displayed on the Main Display

| Display Details | | Cause | Countermeasure |
|-------------------------------|---------------|---|--|
| LCD screen (upper section) | Overcurrent | Either or some of the judgment outputs are short-circuited. | Cancel the load short-circuit. |
| | Dark Error | Insufficient received light amount from workpiece. Distance measurement error. | <ul style="list-style-type: none"> • Change (increase) the gain setting. • Change the mode to [HIGH SENS]. • Change to a regular reflection type Sensor Head to suit the sensing object. • When mirror or glass is installed for regular reflection type sensing, check the angle of the regular reflection installation, and adjust to the optimum angle. • When the emitted light amount is fixed, set to [AUTO]. |
| | Bright Error | Saturated received light amount from the workpiece. Distance measurement error. | <ul style="list-style-type: none"> • Change (decrease) the gain setting. • Change the mode to [HIGH SPEED]. • When the emitted light amount is fixed, set to [AUTO]. |
| | Measure Error | When [NORMAL], [PCB], [MIRROR] is set for the measurement target, the number of surfaces currently being measured is 2 or more. | <ul style="list-style-type: none"> • Change the mode to [GLASS]. • Use SmartMonitor to limit the measurement area. • Lower the upper limit value of [LASER]-[RANGE]. • Set [LASER]-[FIXED] to stabilize the power. • Change the angle of the Sensor Head. |



■ When all digits on the main display and sub-display blink

| Display Details | | Cause | Countermeasure |
|-----------------|-------------------------------|---|--|
| LCD screen | SYSTEM ERROR HEAD COM(EEPROM) | The Sensor Head is not connected. | Connect the Sensor Head. |
| | SYSTEM ERROR BANK DATA | Bank data in the Sensor Controller in error | Hold the UP key down for 3 seconds, and then hold the DOWN key down for 3 seconds. The sensor is turned ON again and restored after the device is initialized. |
| | SYSTEM ERROR MAIN COM | Internal error | Turn the sensor ON again. |





■ Others

| Display Details | | Cause | Countermeasure |
|-------------------|------------------|--|---|
| LCD upper section | Disp range error | The measurement result exceeds the number of displayed digits. | Change the decimal point digit setting.  p.3-32 |
| Main Display | — — — — — | The sensor is standing by for measurement. | When hold is set, start sampling and apply the hold value. |

Q&A

| Question | Answer |
|---|--|
| <p>When scaling is executed, an error appears and settings cannot be made.</p> | <p>Scaling cannot be set for one of the following reasons:</p> <ul style="list-style-type: none"> • Scaling has been attempted when the measured value is outside the measuring range. • When two-point scaling has been executed, the distance between the measured values for the two points is not 1% or more of the rated measuring range. <p> p.3-20</p> |
| <p>When focusing is executed, an error appears and settings cannot be made.</p> | <p>Monitor focus settings cannot be made when the distance between the two specified points is not 1% or more of the rated measuring range.</p> <p> p.4-2</p> |
| <p>Is warm-up operation still required even if LD-OFF input is cancelled?</p> | <p>Yes. As when the power is turned ON, warm-up operation must be performed for about 30 minutes.</p> |

Glossary

| Term | Explanation |
|-----------------|--|
| Measured value | <p>The measured value is the measurement result displayed on the main display of the Sensor Controller in the RUN and TEACH modes. It is the value when each of the currently set functions (e.g. hold) has been processed.</p> <p> p.3-7</p> |
| Present value | <p>The present value is the current measurement result for the target Sensor Controller. It is the value before each of the currently set functions (e.g. hold) has been processed. Press the LEFT or RIGHT Key in the RUN mode to display the present value on the sub-display.</p> <p> p.3-7</p> |
| Linearity | <p>The linearity is given as the error on an ideal straight line displacement output when measuring the standard sensing object. The linearity shows how closely the linear output maintains a linear relationship to the displacement of the sensing object (i.e., it shows the accuracy of the linear output).</p> |
| Linear output | <p>The linear output is output from the linear output line. Either current or voltage output can be selected.</p> <p>The linear output is made based on the display value and focus settings.</p> <p>The actual value output (the output value) can be displayed on the sub-display by pressing the LEFT or RIGHT Key in RUN mode.</p> <p> p.3-7</p> |
| Judgment output | <p>“Judgment output” is a general term for the HIGH, PASS, and LOW outputs. Judgment outputs are made in the RUN or TEACH mode based on the display values and the threshold, hysteresis width, and timer settings.</p> |
| SmartMonitor ZS | <p>This is software that runs on a personal computer.</p> <p>This software enables communication with Sensor Controller, sets measurement conditions, saves setting data, and displays measurement results as a graph.</p> <p> p.2-19</p> |
| Measuring range | <p>This is the range (distance) that measurement is possible for the connected Sensor Head.</p> <p> p.6-8, p.6-11</p> |

Specifications and External Dimensions

Sensor Head

■ ZS-LD20T/LD20ST/LD40T

(Unit: mm)

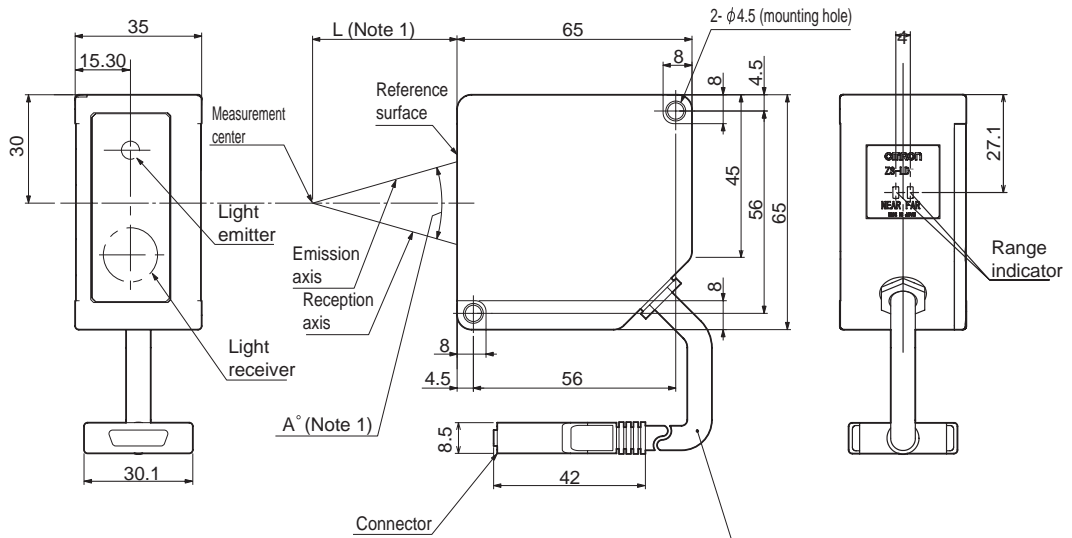





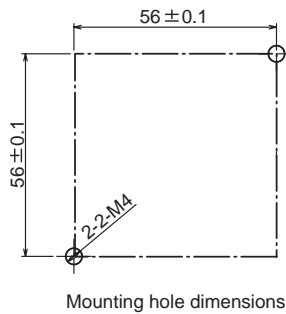

Note 1: ZS-LD20T/LD20ST: L=20, A=45°
ZS-LD40T: L=40, A=32°

Vinyl insulated round cable 6.2 mm dia.
Standard length 0.5 m, 2 m

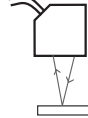

Mounting hole dimensions

| Item | ZS-LD20T | | ZS-LD20ST | | ZS-LD40T | |
|------------------------------------|---|--|---|---|--|---|
| Optical system | Regular reflection  | Diffuse reflection  | Regular reflection  | Diffuse reflection  | Regular reflection  | Diffuse reflection  |
| Measuring center distance | 20 mm | 6.3 mm | 20 mm | 6.3 mm | 40mm | 30mm |
| Measuring range | ±1mm | ±1mm | ±1mm | ±1mm | ±2.5mm | ±2mm |
| Light source | Visible semiconductor laser (wavelength 650 nm, 1 mW max., JIS Class 2 (*6)) | | | | | |
| Beam diameter (*1) | 25 x 900 μm | | 25 μm | | 35 x 2000 μm | |
| Linearity (*2) | ±0.1%F.S. | | | | | |
| Resolution (*3) | 0.25 μm | | | | 0.4 μm | |
| Temperature characteristic (*4) | 0.04%F.S./°C | | | | 0.02%F.S./°C | |
| Sampling cycle (*5) | 110 μs | | | | | |
| LED indicators | NEAR indicator | Lit near measuring center distance, and nearer than measuring center distance inside the measuring range Flashes when the measurement target is outside of the measuring range or when the received light amount is insufficient | | | | |
| | FAR indicator | Lit near measuring center distance, and further than measuring center distance inside the measuring range Flashes when the measurement target is outside of the measuring range or when the received light amount is insufficient | | | | |
| Operating ambient illumination | Illumination on received light surface 3000 lx or less (incandescent light) | | | | | |
| Ambient temperature | Operating: 0 to 50°C, Storage: -15 to 60°C (with no icing or condensation) | | | | | |
| Ambient humidity | Operating and storage: 35% to 85% (with no condensation) | | | | | |
| Degree of protection | Cable length 0.5 m: IP66, cable length 2 m: IP67 | | | | | |
| Vibration resistance (destructive) | 10 to 150 Hz (0.7 mm double amplitude) 80 min each in X, Y and Z directions | | | | | |
| Materials | Case: aluminum die-cast, front cover: glass | | | | | |
| Cable length | 0.5 m, 2 m | | | | | |
| Weight | Approx. 350 g | | | | | |

F.S.: Full scale of measurement

- (*1) Defined as 1/e² (13.5 %) of the center optical intensity in the measurement center distance (effective value). The beam diameter is sometimes influenced by the ambient conditions of the workpiece such as leaked light from the main beam.
- (*2) This is the error on the measured value with respect to an ideal straight line. The standard workpiece is white aluminum (glass in the case of the regular reflection mode). Linearity may change according to the workpiece.
- (*3) This is the "Peak-to-peak" displacement conversion value of the displacement output in the measuring center distance when the number of samples to average is set to 128, and the measuring mode is set to the high-resolution mode. The workpiece is white aluminum ceramics in the diffuse reflection mode and glass in the regular reflection mode.
- (*4) This is the value obtained in the measuring center distance when the sensor and workpiece are fixed by an aluminum jig (typical example).
- (*5) This value is obtained when the measuring mode is set to the high speed mode.
- (*6) Europe : Class2 of EN60825-1(IEC60825-1)

● When Used for Diffuse Reflection

- ZS-LD20T/LD20ST

(Unit: mm)

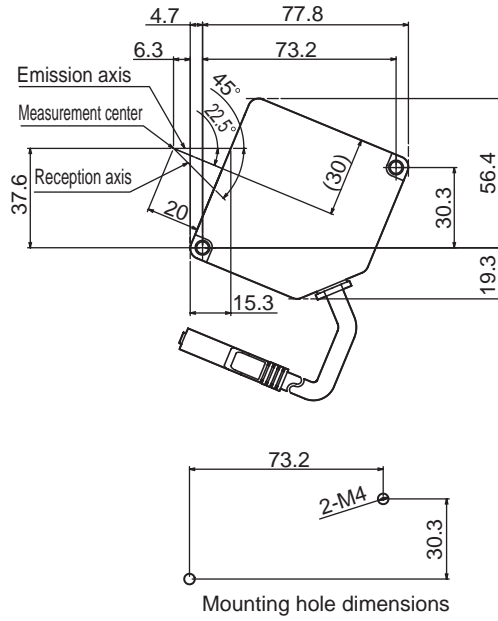

- ZS-LD40T

(Unit: mm)

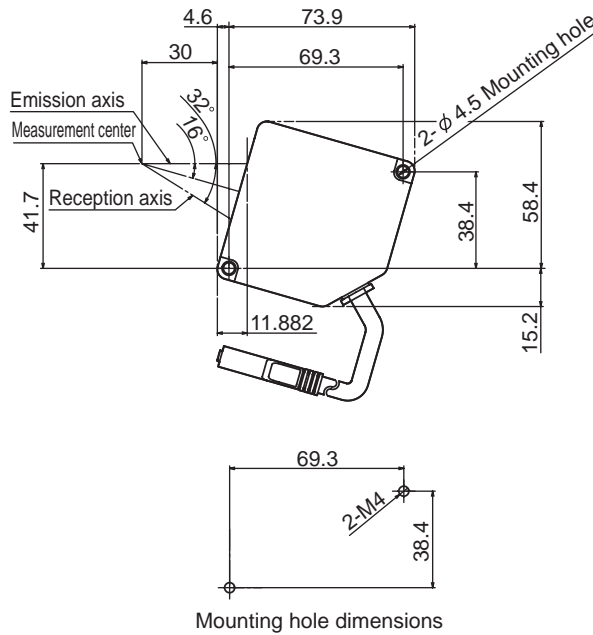

■ ZS-LD50/LD50ST/LD80/LD130/LD200/LD350S

(Unit: mm)

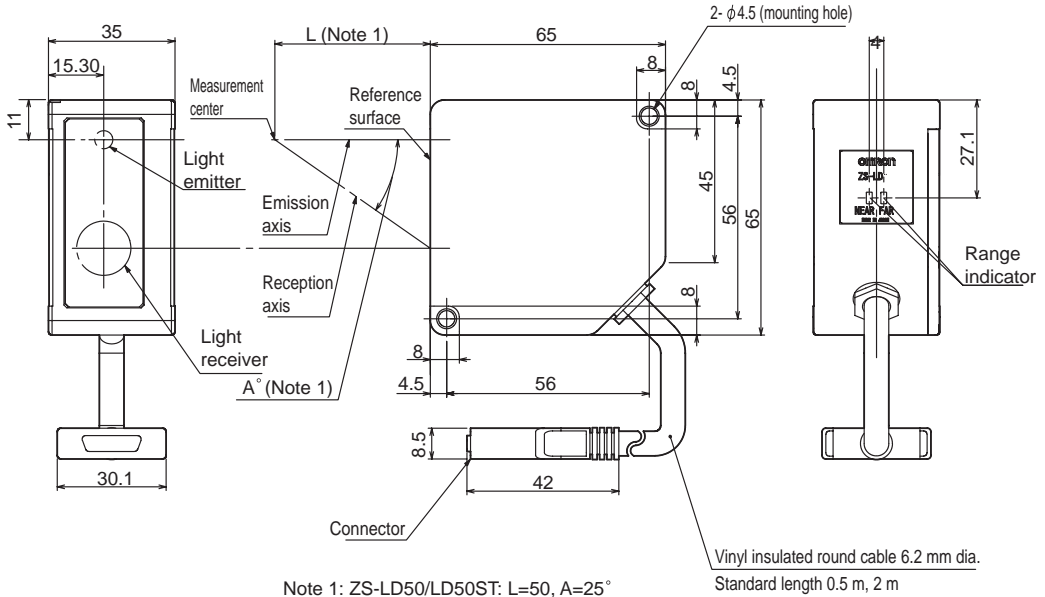

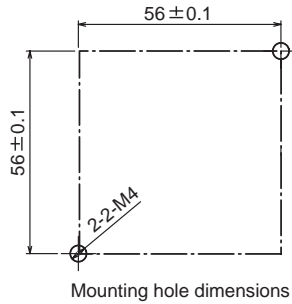

Note 1: ZS-LD50/LD50ST: L=50, A=25°
 ZS-LD80: L=80, A=15°
 ZS-LD130: L=130, A=12°
 ZS-LD200: L=200, A=8°
 ZS-LD350S: L=350, A=5°

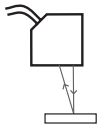
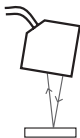
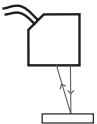
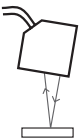
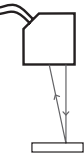
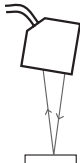

| Item | ZS-LD50 | | ZS-LD50S | | ZS-LD80 | |
|------------------------------------|---|--|---|---|--|---|
| Optical system | Diffuse reflection  | Regular reflection  | Diffuse reflection  | Regular reflection  | Diffuse reflection  | Regular reflection  |
| Measuring center distance | 50 mm | 47 mm | 50 mm | 47 mm | 80 mm | 78 mm |
| Measuring range | ±5 mm | ±4 mm | ±5 mm | ±4 mm | ±15 mm | ±14 mm |
| Light source | Visible semiconductor laser (wavelength 650 nm, 1 mW max., Class 2 (*6)) | | | | | |
| Beam diameter (*1) | 60 x 900 μm | | 50 μm | | 60 x 900 μm | |
| Linearity (*2) | ±0.1%F.S. | | | | | |
| Resolution (*3) | 0.8 μm | | | | 2 μm | |
| Temperature characteristic (*4) | 0.02%F.S./°C | | | | 0.01%F.S./°C | |
| Sampling cycle (*5) | 110 μs | | | | | |
| LED indicator | NEAR indicator | Lit near measuring center distance, and nearer than measuring center distance inside the measuring range Flashes when the measurement target is outside of the measuring range or when the received light amount is insufficient | | | | |
| | FAR indicator | Lit near measuring center distance, and further than measuring center distance inside the measuring range Flashes when the measurement target is outside of the measuring range or when the received light amount is insufficient | | | | |
| Operating ambient illumination | Illumination on received light surface 3000lx or less (incandescent light) | | | | | |
| Ambient temperature | Operating: 0 to 50°C, Storage: -15 to 60°C (with no icing or condensation) | | | | | |
| Ambient humidity | Operating and storage: 35% to 85% (with no condensation) | | | | | |
| Degree of protection | Cable length 0.5 m: IP66, cable length 2 m: IP67 | | | | | |
| Vibration resistance (destructive) | 10 to 150 Hz (0.7 mm double amplitude) 80 min each in X, Y an Z directions | | | | | |
| Materials | Case: aluminum die-cast, front cover: glass | | | | | |
| Cable length | 0.5 m, 2 m | | | | | |
| Weight | Approx. 350 g | | | | | |

F.S.: Full scale of measurement

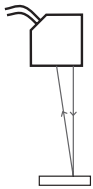
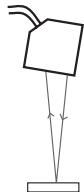
- (*1) Defined as 1/e² (13.5 %) of the center optical intensity in the measurement center distance (effective value). The beam diameter is sometimes influenced by the ambient conditions of the workpiece such as leaked light from the main beam.
- (*2) This is the error on the measured value with respect to an ideal straight line. The standard workpiece is white aluminum ceramics. (In the regular reflection mode on ZS-LD50, the standard workpiece is glass.)Linearity may change according to the workpiece.
- (*3) This is the “Peak-to-peak” displacement conversion value of the displacement output in the measuring center distance when the number of samples to average is set to 128, and the measuring mode is set to the high-resolution mode. The standard workpiece is white aluminum ceramics. (In the regular reflection mode on ZS-LD50, the standard workpiece is glass.)
- (*4) This is the value obtained in the measuring center distance when the sensor and workpiece are fixed by an aluminum jig (typical example).
- (*5) This value is obtained when the measuring mode is set to the high speed mode.
- (*6) Europe : Class2 of EN60825-1(IEC60825-1)

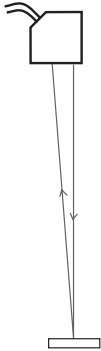
| Item | | ZS-LD130 | | ZS-LD200 | | ZS-LD350 |
|------------------------------------|----------------|--|---|---|--|---|
| Optical system | | Diffuse reflection  | Regular reflection  | Diffuse reflection  | Regular reflection  | Diffuse reflection  |
| Measuring center distance | | 130 mm | | 200 mm | | 350 mm |
| Measuring range | | ±15 mm | ±12 mm | ±50 mm | ±48 mm | ±135 mm |
| Light source | | Visible semiconductor laser (wavelength 650 nm, 1 mW max., Class 2 (*6)) | | | | |
| Beam diameter (*1) | | 600 x 70 μm | | 100 x 900 μm | | 240 dia. μm |
| Linearity (*2) | | ±0.1%F.S. | ±0.25%F.S. | ±0.1%F.S. | | ±0.1%F.S. |
| Resolution (*3) | | 3 μm | | 5 μm | | 20 μm |
| Temperature characteristic (*4) | | 0.02%F.S./°C | | | | 0.04%F.S./°C |
| Sampling cycle (*5) | | 110 μs | | | | |
| LED indicator | NEAR indicator | Lit near measuring center distance, and nearer than measuring center distance inside the measuring range Flashes when the measurement target is outside of the measuring range or when the received light amount is insufficient | | | | |
| | FAR indicator | Lit near measuring center distance, and further than measuring center distance inside the measuring range Flashes when the measurement target is outside of the measuring range or when the received light amount is insufficient | | | | |
| Operating ambient illumination | | Illumination on received light surface 2000lx or less (incandescent light) | | Illumination on received light surface 3000lx or less (incandescent light) | | |
| Ambient temperature | | Operating: 0 to 50°C, Storage: -15 to 60°C (with no icing or condensation) | | | | |
| Ambient humidity | | Operating and storage: 35% to 85% (with no condensation) | | | | |
| Degree of protection | | Cable length 0.5 m: IP66, cable length 2 m: IP67 | | | | |
| Vibration resistance (destructive) | | 10 to 150 Hz (0.7 mm double amplitude) 80 min each in X, Y an Z directions | | | | |
| Materials | | Case: aluminum die-cast, front cover: glass | | | | |
| Cable length | | 0.5 m, 2 m | | | | |
| Weight | | Approx. 350 g | | | | |

F.S.: Full scale of measurement

- (*1) Defined as $1/e^2$ (13.5 %) of the center optical intensity in the measurement center distance (effective value). The beam diameter is sometimes influenced by the ambient conditions of the workpiece such as leaked light from the main beam.
- (*2) This is the error on the measured value with respect to an ideal straight line. The standard workpiece is white aluminum ceramics. (In the regular reflection mode on ZS-LD50, the standard workpiece is glass.)Linearity may change according to the workpiece.
- (*3) This is the "Peak-to-peak" displacement conversion value of the displacement output in the measuring center distance when the number of samples to average is set to 128, and the measuring mode is set to the high-resolution mode. The standard workpiece is white aluminum ceramics. (In the regular reflection mode on ZS-LD50, the standard workpiece is glass.)
- (*4) This is the value obtained in the measuring center distance when the sensor and workpiece are fixed by an aluminum jig (typical example).
- (*5) This value is obtained when the measuring mode is set to the high speed mode.
- (*6) Europe : Class2 of EN60825-1(IEC60825-1)

● When Used for Regular Reflection

- ZS-LD50/LD50S

(Unit: mm)

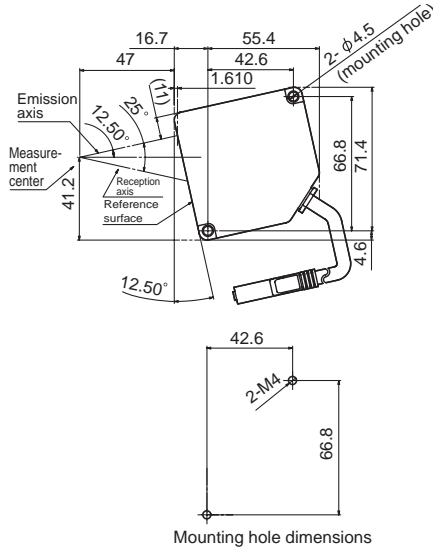

- ZS-LD80

(Unit: mm)

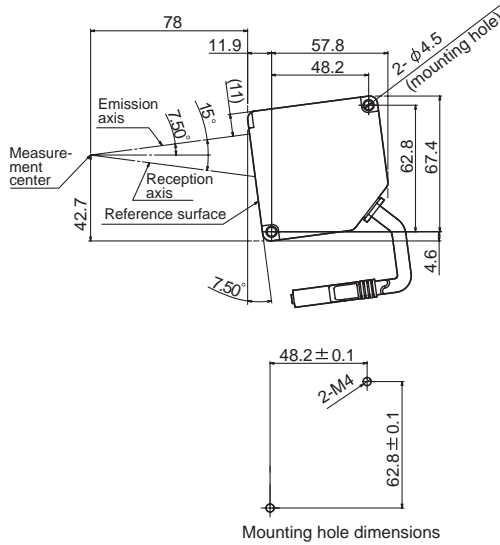

• ZS-LD130

(Unit: mm)

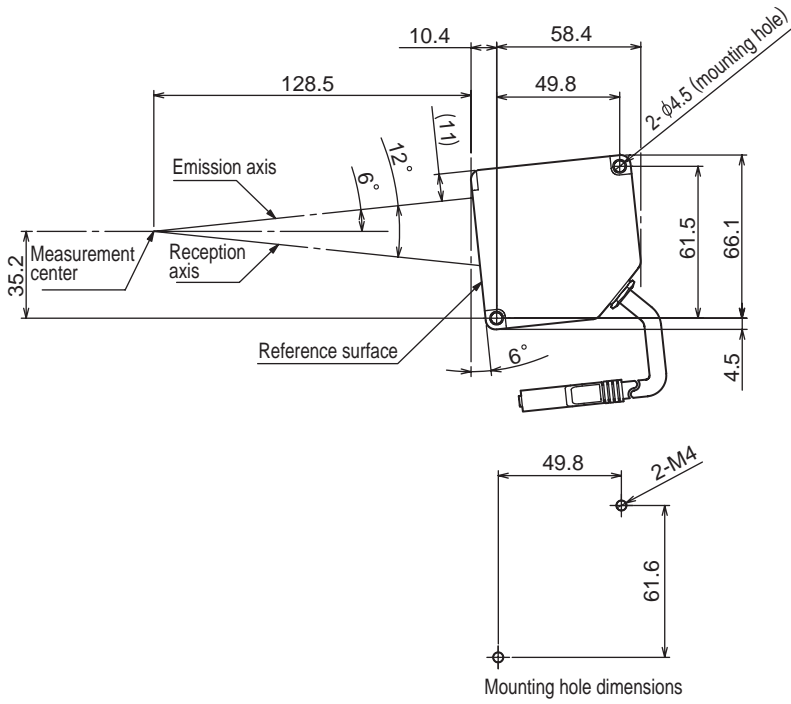

• ZS-LD200

(Unit: mm)

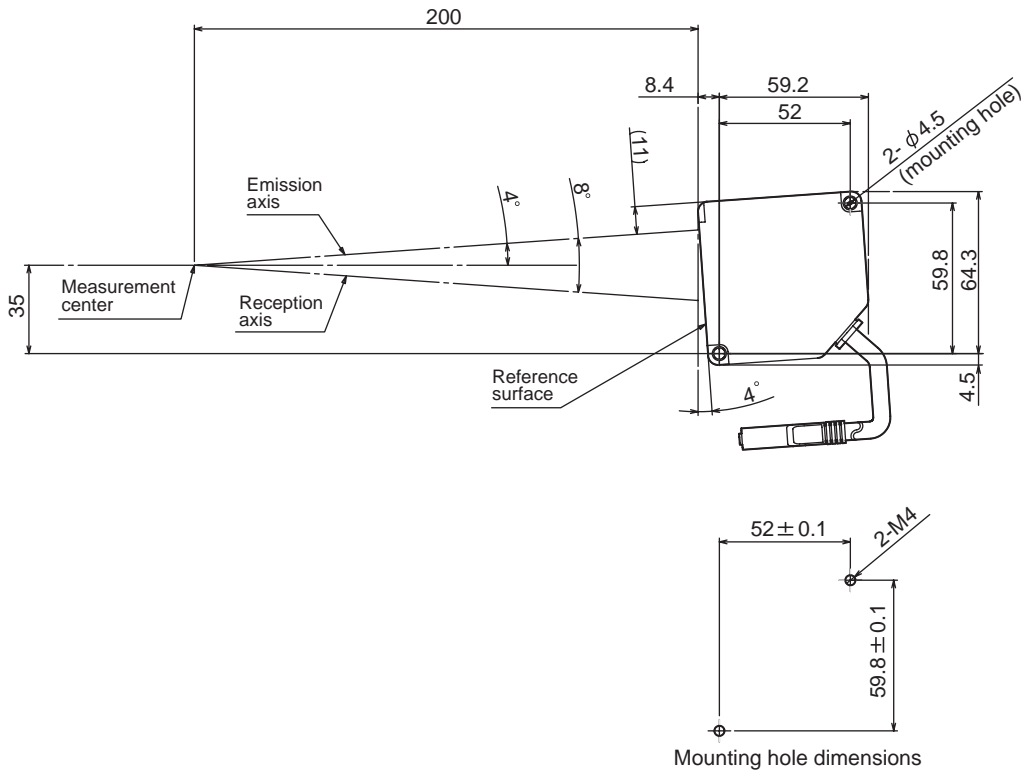

• ZS-LD350S

(Unit: mm)

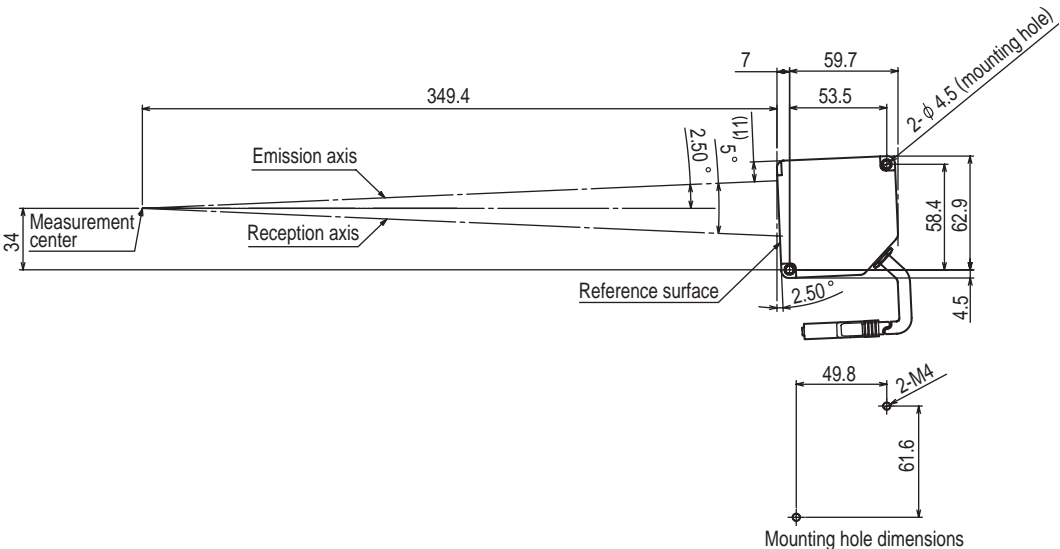

• ZS-LD10GT

(Unit: mm)

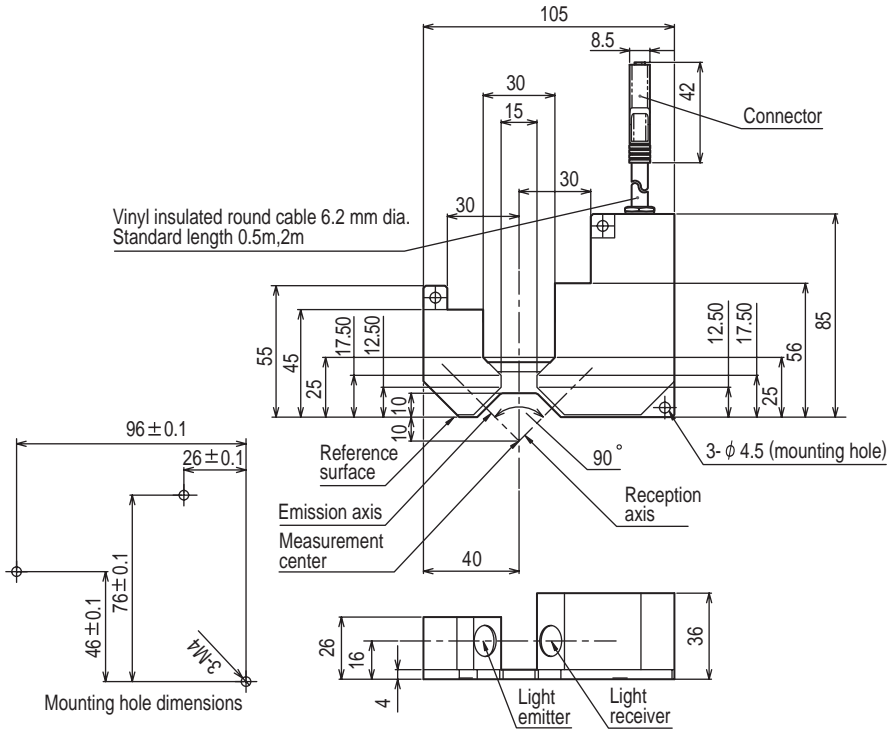

• ZS-LD15GT

(Unit: mm)

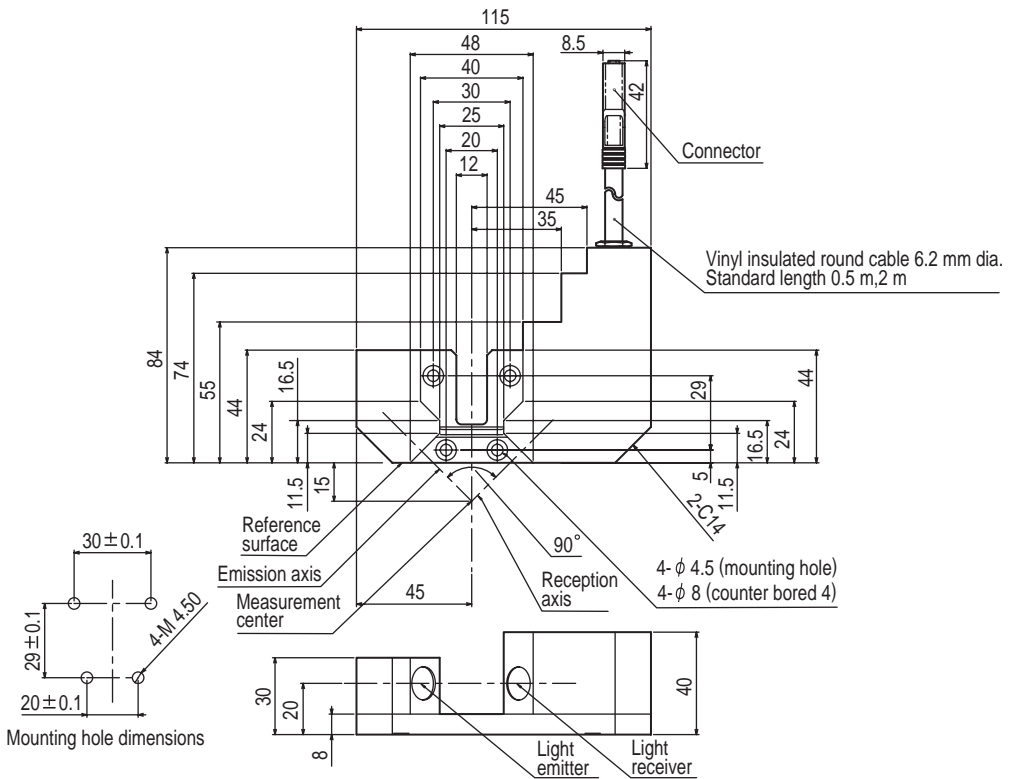

| Item | | ZS-LD10GT | ZS-LD15GT |
|------------------------------------|----------------|--|-----------|
| Optical system | | Regular reflection | |
| Measuring center distance | | 10 mm | 15 mm |
| Measuring range | | ±0.5 mm | ±0.75 mm |
| Light source | | Visible semiconductor laser (wavelength 650 nm, 1 mW max., Class 2 (*6)) | |
| Beam diameter (*1) | | 25 x 900 μm | |
| Linearity (*2) | | ±0.1%F.S. | |
| Resolution (*3) | | 0.25 μm | |
| Temperature characteristic (*4) | | 0.04%F.S./°C | |
| Sampling cycle (*5) | | 110 μs | |
| LED indicator | NEAR indicator | Lit near measuring center distance, and nearer than measuring center distance inside the measuring range Flashes when the measurement target is outside of the measuring range or when the received light amount is insufficient | |
| | FAR indicator | Lit near measuring center distance, and further than measuring center distance inside the measuring range Flashes when the measurement target is outside of the measuring range or when the received light amount is insufficient | |
| Operating ambient illumination | | Illumination on received light surface 3000lx or less (incandescent light) | |
| Ambient temperature | | Operating: 0 to 50°C, Storage: -15 to 60°C (with no icing or condensation) | |
| Ambient humidity | | Operating and storage: 35% to 85% (with no condensation) | |
| Degree of protection | | IP40 | |
| Vibration resistance (destructive) | | 10 to 150 Hz (0.7 mm double amplitude) 80 min each in X, Y an Z directions | |
| Materials | | Case: aluminum die-cast, front cover: glass | |
| Cable length | | 0.5 m, 2 m | |
| Weight | | Approx. 400 g | |

F.S.: Full scale of measurement

- (*1) Defined as $1/e^2$ (13.5 %) of the center optical intensity in the measurement center distance (effective value). The beam diameter is sometimes influenced by the ambient conditions of the workpiece such as leaked light from the main beam.
- (*2) This is the error on the measured value with respect to an ideal straight line. The standard workpiece is white aluminum ceramics. (In the regular reflection mode on ZS-LD50, the standard workpiece is glass.)Linearity may change according to the workpiece.
- (*3) This is the "Peak-to-peak" displacement conversion value of the displacement output in the measuring center distance when the number of samples to average is set to 128, and the measuring mode is set to the high-resolution mode. The standard workpiece is white aluminum ceramics. (In the regular reflection mode on ZS-LD50, the standard workpiece is glass.)
- (*4) This is the value obtained in the measuring center distance when the sensor and workpiece are fixed by an aluminum jig (typical example).
- (*5) This value is obtained when the measuring mode is set to the high speed mode.
- (*6) Europe : Class2 of EN60825-1(IEC60825-1)

Sensor Controller

ZS-LDC11/LDC41

(Unit: mm)

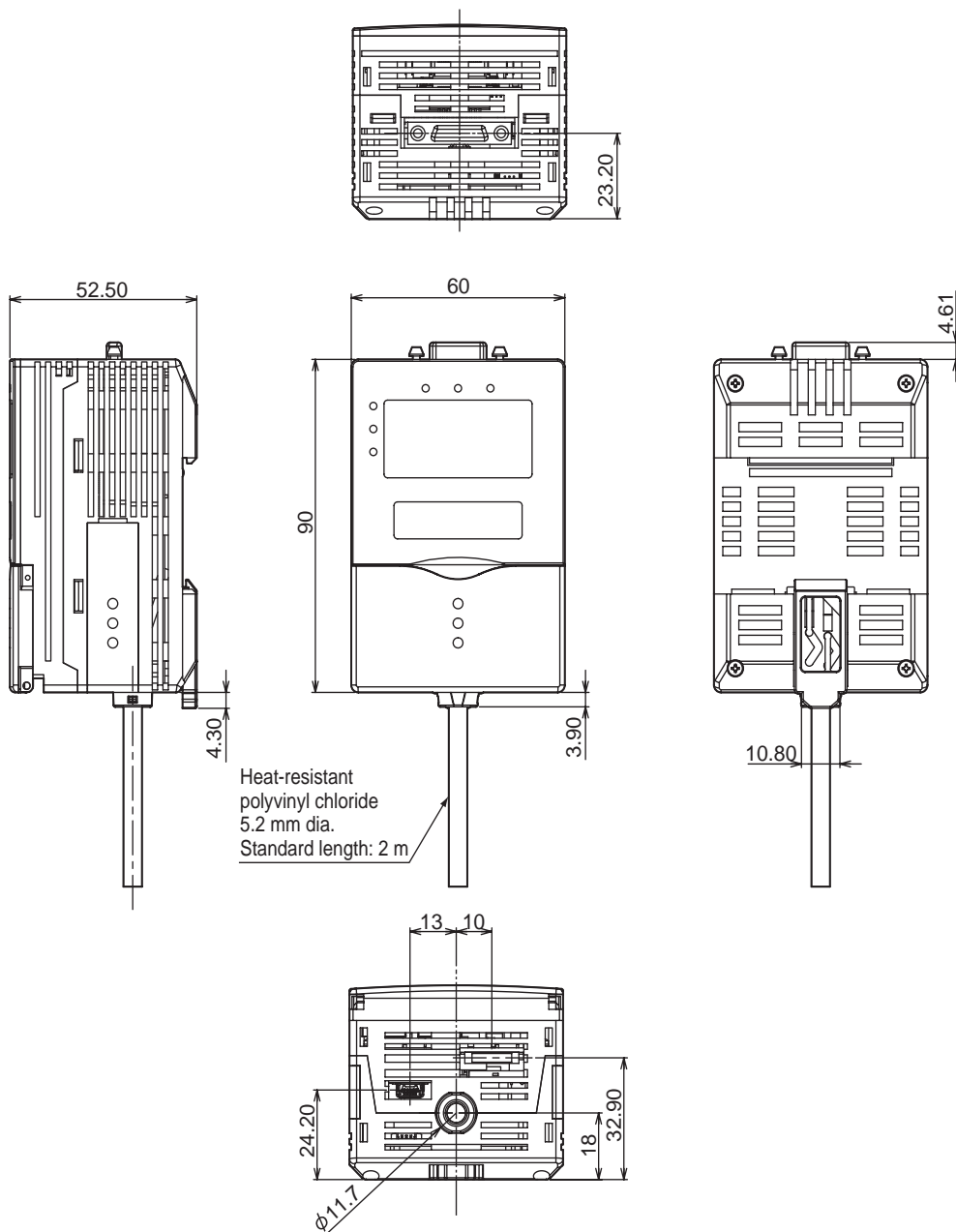

| Item | ZS-LDC11 | ZS-LDC41 |
|--------------------------------|--|----------|
| I/O type | NPN type | PNP type |
| No. of samples to average | 1, 2, 4, 8, 16, 32, 64, 128, 256, 512, 1024, 2048, or 4096 | |
| Number of mounted Sensor Heads | 1 per Sensor Controller | |

| Item | | ZS-LDC11 | ZS-LDC41 | |
|--|-------------------|---|--|---|
| Ex- ternal I/F | Connection method | | Serial I/O or connector Prewired (standard cable length: 2 m) | |
| | Serial I/O | USB2.0 | 1 port, FULL SPEED[12 Mbps], MINI-B | |
| | | RS-232C | 1 port, max. 115200 bps | |
| | Output | 3 judgment outputs: HIGH/PASS/LOW) | NPN open-collector, 30 VDC, 50 mA max. residual voltage; 1.2 V max. | PNP open-collector 50 mA max. residual voltage; 1.2 V max. |
| | | Linear output | Selectable from voltage/current (selected by slide switch on base) • At voltage output : -10 to +10 V, output impedance: 40 Ω • At current output : 4 to 20 mA, max. load resistance: 300 Ω | |
| | Input | LDOFF input (LD forced OFF) | ON: Short-circuited with 0V terminal or 1.5 V max. | ON: Supply voltage short-circuited or within supply voltage -1.5 V |
| ZERO reset input (ZERO reset execu- tion/cancel) | | OFF: Open (leakage current: 0.1 mA max.) | OFF: Open (leakage current: 0.1 mA max.) | |
| Timing input (sam- ple cycle specified when hold function is enabled) | | | | |
| RESET input (reset of hold state) | | | | |
| Status indicators | | HIGH (orange), PASS (green), LOW (orange), LDON (green), ZERO (green), ENABLE (green) | | |
| Segment display | Main display | 8-segment red display, 6 digits | | |
| | Sub-display | 8-segment green display, 6 digits | | |
| LCD | | 16 digits x 2 rows, color of characters: green, resolution per character: 5 x 8 pixel matrix | | |
| Setting input | Setting keys | Direction keys (UP/DOWN/LEFT/RIGHT), SET key, ESC key, MENU key, function keys (1 to 4) | | |
| | Slide switch | Threshold switch (H/L 2-state) | | |
| MODE switch (FUN/TEACH/RUN 3-state) | | | | |
| Power supply voltage | | 21.6 V to 26.4 V (including ripple) | | |
| Current consumption | | 0.5 A max. (when Sensor Head is connected) | | |
| Insulation resistance | | Across all lead wires and controller case: 20 M (at 250 V) | | |
| Dialectic strength | | Across all lead wires and controller case, 1000 VAC, 50/60 Hz, 1 min | | |
| Noise immunity | | 1500 V peak-to-peak, pulse width 0.1 μs, rising edge: 1 ns pulse | | |
| Vibration resistance (destructive) | | 10 to 150 Hz, 0.7-mm double amplitude, 80 min each in X, Y, and Z directions | | |
| Shock resistance (destructive) | | 300 m/s ² 3 times each in six directions (up/down, left/right, forward/ backward) | | |
| Ambient temperature | | Operating: 0 to 50°C Storage: -15 to +60°C (with no icing or condensation) | | |
| Ambient humidity | | Operating and storage: 35% to 85% (with no condensation) | | |
| Materials | | Case: Polycarbonate (PC) | | |
| Weight | | Approx. 280 g (excluding packing materials and accessories) | | |

Panel Mount Adapters

ZS-XPM1/XPM2

When mounting on a panel

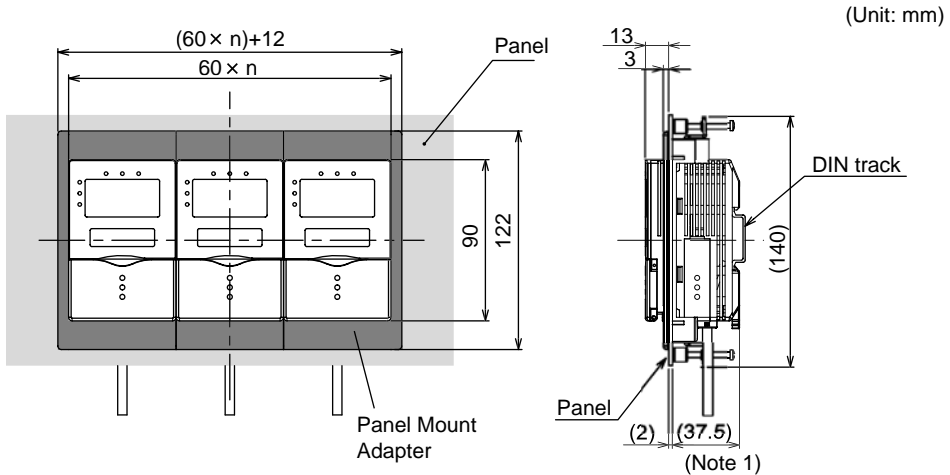

Note 1: Dimensions are shown for a panel thickness of 2.0 mm.

Panel cutout dimensions

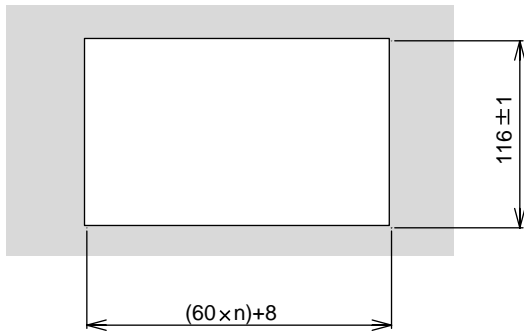

n: number of gang-mounted controllers (1 to 10)

| Item | ZS-XPM1 (for 1st unit) | ZS-XPM2 (for 2nd unit onwards) |
|------------------------------------|---|--------------------------------|
| Appearance | | |
| Applicable controller | ZS Series | |
| Vibration resistance (destructive) | 10 to 150 Hz, 0.7-mm double amplitude, 80 min each in X, Y, and Z directions | |
| Shock resistance (destructive) | 300 m/s ² 3 times each in six directions (up/down, left/right, forward/backward) | |
| Materials | Polycarbonate (PC), etc. | |
| Weight | Approx. 50g | |

RS-232C Cable for Connecting to a Personal Computer

ZS-XRS2

(Unit: mm)

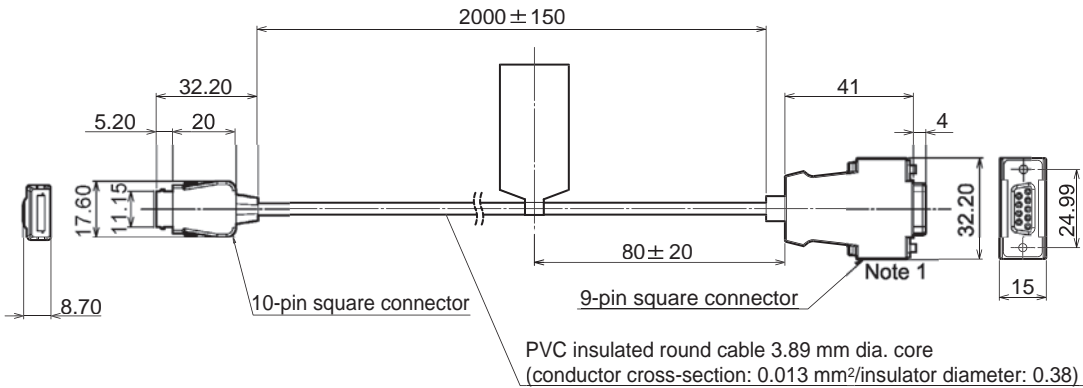

Note 1: Connector is socket type.

| Item | ZS-XRS2 |
|------------------------------------|---|
| Applicable controller | ZS Series |
| Ambient temperature | Operating: 0 to +50°C, Storage: -15 to +60°C (with no icing or condensation) |
| Ambient humidity | Operating and storage: 35% to 85% (with no condensation) |
| Dialectic strength | 1,000 VAC, 50/60 Hz for 1 min |
| Insulation resistance | 100 M (at 500 VDC) |
| Vibration resistance (destructive) | 10 to 150 Hz, 0.7-mm double amplitude, 80 min each in X, Y, and Z directions |
| Shock resistance (destructive) | 300 m/s ² 3 times each in six directions (up/down, left/right, forward/backward) |
| Materials | Cable sheath: PVC |
| Weight | Approx. 50g |

Extension Cable

ZS-XC_A/XC_B(R)

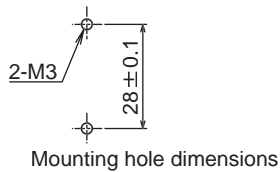
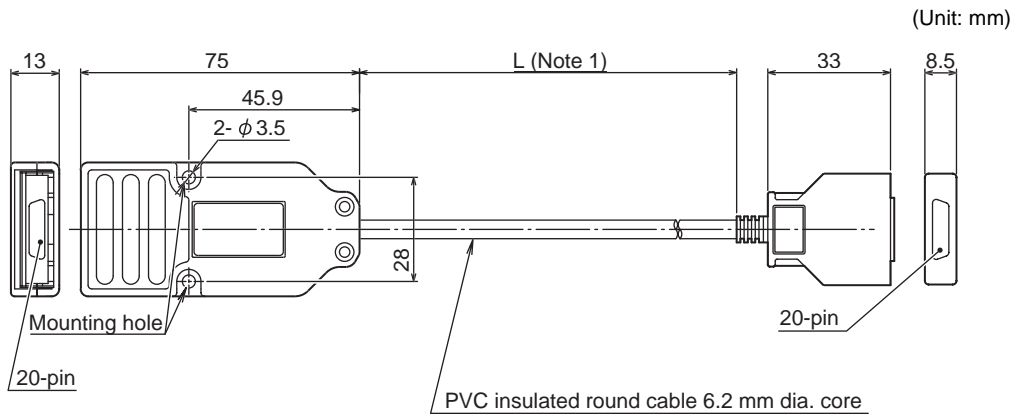

Note 1: ZS-XC_A: L=1m, 4m and 8m
ZS-XC_B: L=5m and 10m
ZS-XC_BR: L=5m

Note 2: Color of seal
ZS-XC_A: Black
ZS-XC_B(R): Silver

| Item | ZS-XC1A | ZS-XC4A | ZS-XC8A | ZS-XC5B | ZS-XC10B | ZS-XC5BR |
|------------------------|--|------------------|------------------|------------------|------------------|------------------|
| Applicable controller | ZS-L Series | | | | | |
| Applicable Sensor Head | ZS-L Series | | | | | |
| Ambient temperature | Operating: 0 to +50°C, Storage: -15 to +60°C (with no icing or condensation) | | | | | |
| Ambient humidity | Operating and storage: 35% to 85% (with no condensation) | | | | | |
| Connection method | Double-end connector | | | | | |
| Materials | Case: Polycarbonate (PC) | | | | | |
| Weight | Approx. 150 g | Approx. 320 g | Approx. 550 g | Approx. 350 g | Approx. 620 g | Approx. 350 g |
| Cable length | 1 m | 4 m | 8 m | 5 m | 10 m | 5 m |

Laser Safety

Various safety standards regarding laser devices are stipulated depending on the country of use.

(1) Using in U.S.

When using devices in which this product is installed in U.S., the devices are subjected to the U.S. FDA (Food and Drug Administration) laser regulations.

The ZS-LD20ST/LD50S/LD130/LD350S/LD10GT/LD15GT is scheduled to be registered to CDRH (Center for Devices and Radiological Health).

Please inquire about details like export to the foreign country.

Labels relating to laser use on this product

The product is provided with labels that comply with FDA technical guidelines. When using this product in the United States, swap the warning labels on the sensor body with the FDA labels provided. Attach the labels at the correct locations as indicated in the figure below.

The ZS-LD___ is intended to be installed in final system devices. When installing on these devices, follow these technical guidelines.

* US Federal Law: 21CFR 1040.10 and 1040.11

Technical Guidelines Relating to Laser Products and "Specific-application Laser Products"

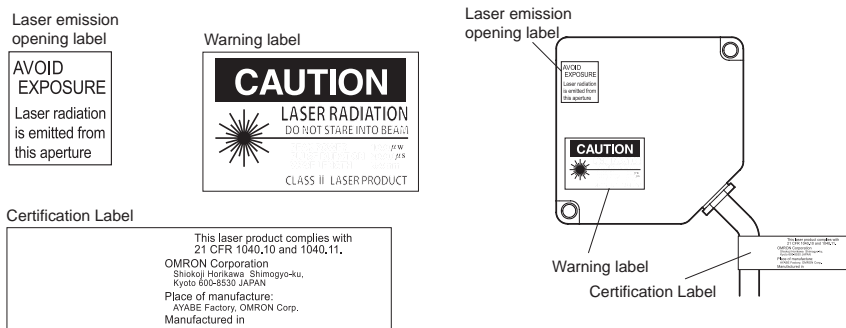

(2) Using in a country other than U.S.

For countries other than Japan and U.S., warning labels must be replaced by English ones (supplied with the product).

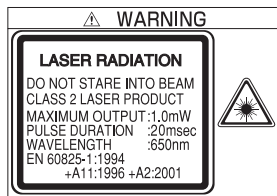

EN 60825 is provided for product exported to Europe, and the content of this standard differs.

The ZS-L Series is categorized as a Class II device as stipulated in EN60825-1 (IEC60825-1).

Requirements from Regulations and Standards

Summary of Requirements to Manufactures

■ For Europe

EN 60825-1 "Safety of Laser Products, Equipment Classification, Requirements and User's Guide"

Summary of Manufacturer's Requirements

| Requirements subclause | Classification | | | | | | |
|--|---|---|---|--|--|---|--|
| | Class 1 | Class 1M | Class 2 | Class 2M | Class 3R | Class 3B | Class 4 |
| Description of hazard class | Safe under reasonably foreseeable conditions | As for Class 1 except may be hazardous if user employs optics | Low power; eye protection normally afforded by aversion responses | As for Class 2 except may be more hazardous if user employs optics | Direct intra-beam viewing may be hazardous | Direct intra-beam viewing normally hazardous | High power; diffuse reflections may be hazardous |
| Protective housing | Required for each laser product; limits access necessary for performance of functions of the products | | | | | | |
| Safety interlock in protective housing | Designed to prevent removal of the panel until accessible emission values are below that for Class 3R | | | | Designed to prevent removal of the panel until accessible emission values are below that for Class 3B | | |
| Remote control | Not required | | | | | Permits easy addition of external interlock in laser installation | |
| Key control | Not required | | | | | Laser inoperative when key is removed | |
| Emission warning device | Not required | | | | Give audible or visible warning when laser is switched on or if capacitor bank of pulsed laser is being charged. For Class 3R only, applies invisible radiation is emitted | | |
| Attenuator | Not required | | | | | Give means beside the On/Off switch to temporarily to block beam | |
| Location controls | Not required | | | | Controls so located that there is no danger of exposure to AEL above Classes 1 or 2 when adjustments are made | | |
| Viewing optics | Not required | Emission from all viewing systems must be below Class 1M AEL | | | | | |
| Scanning | Scan failure shall not cause product to exceed its classification | | | | | | |
| Class label | Required wording | | Figures A required wording | | | | |
| Aperture label | Not required | | | | Specified wording required | | |
| Service entry label | Required as appropriate to the class of accessible radiation | | | | | | |
| Override interlock label | Required under certain conditions as appropriate to the class of laser used | | | | | | |

| Requirements subclause | Classification | | | | | | |
|------------------------------------|---|----------|---------|----------|----------|----------|---------|
| | Class 1 | Class 1M | Class 2 | Class 2M | Class 3R | Class 3B | Class 4 |
| Wavelength range label | Required for certain wavelength ranges | | | | | | |
| LED label | Make required word substitutions for LED products | | | | | | |
| User information | Operation manuals must contain instructions for safe use. Additional requirements apply for Class 1M and Class 2M | | | | | | |
| Purchasing and service information | Promotion brochures must specify product classification; service manuals must contain safety information | | | | | | |

- Note:** 1. This table is intended to provide a convenient summary of requirements. See text of this standard for complete requirements.
 2. For the safety medical laser products, IEC 60601-2-22 applies
 3. AEL: Accessible Emission Limit
 The maximum accessible emission level permitted within a particular class. For your reference, see ANSI Z136.1-1993, Section 2.

Symbol and border: black
 Background: yellow

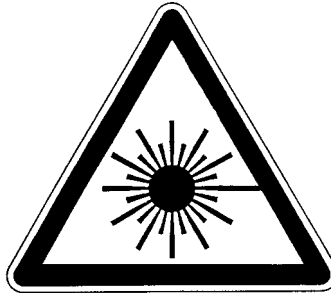

Figure A Warning label - Hazard symbol

Legend and border: black
 Background: yellow

■ For U.S.A

FDA (Compliance Guide for Laser Products, 1985, according to 21 CFR1040.10)

| Requirements | Class (see note 1) | | | | | |
|--|----------------------|----------------------|----------------------|----------------------|----------------------|----------------------|
| | I | Ila | II | IIIa | IIIb | IV |
| Performance (all laser products) | | | | | | |
| Protective housing | R (see note 2) | R (see note 2) | R (see note 2) | R (see note 2) | R (see note 2) | R (see note 2) |
| Safety interlock | R (see notes 3,4) | R (see notes 3,4) | R (see notes 3,4) | R (see notes 3,4) | R (see notes 3,4) | R (see notes 3,4) |
| Location of controls | N/A | R | R | | R | R |
| Viewing optics | R | R | R | R | R | R |
| Scanning safeguard | R | R | R | R | R | R |
| Performance (laser systems) | | | | | | |
| Remote control connector | N/A | N/A | N/A | N/A | R | R |
| Key control | N/A | N/A | N/A | N/A | R | R |
| Emission indicator | N/A | N/A | R | R | R (see note 10) | R (see note 10) |
| Beam attenuator | N/A | N/A | R | R | R | R |
| Reset | N/A | N/A | N/A | N/A | N/A | R (see note 13) |
| Performance (specific purpose products) | | | | | | |
| Medical | S | S | S | S (see note 8) | S (see note 8) | S (see note 8) |
| Surveying, leveling, alignment | S | S | S | S | NP | NP |
| Demonstration | S | S | S | S | S (see note 11) | (see note 11) |
| Labeling (all laser products) | | | | | | |
| Certification & identification | R | R | R | R | R | R |
| Protective housing | D (see note 5) | D (see note 5) | D (see note 5) | D (see note 5) | D (see note 5) | D (see note 5) |
| Aperture | N/A | N/A | R | R | R | R |
| Class warning | N/A | R (see note 6) | R (see note 7) | R (see note 9) | R (see note 12) | R (see note 12) |
| Information (all laser products) | | | | | | |
| User information | R | R | R | R | R | R |
| Product literature | N/A | R | R | R | R | R |
| Service information | R | R | R | R | R | R |

Abbreviations:

R: Required.

N/A: Not applicable.

S: Requirements: Same as for other products of that Class. Also see footnotes.

NP: Not permitted.

D: Depends on level of interior radiation.

Footnotes:

Note 1: Based on highest level accessible during operation.

Note 2: Required wherever & whenever human access to laser radiation above Class I limits is not needed for product to perform its function.

Note 3: Required for protective housings opened during operation or maintenance, if human access thus gained is not always necessary when housing is open.

Note 4: Interlock requirements vary according to Class of internal radiation.

Note 5: Wording depends on level & wavelength of laser radiation within protective housing.

Note 6: Warning statement label.

Note 7: CAUTION logotype.

Note 8: Requires means to measure level of laser radiation intended to irradiate the body.

Note 9: CAUTION if 2.5 mW cm^2 or less, DANGER if greater than 2.5 mW cm^2 .

Note 10: Delay required between indication & emission.

Note 11: Variance required for Class IIb or IV demonstration laser products and light shows.

Note 12: DANGER logotype.

Note 13: Required after August 20, 1986.

Summary of Requirements to User

■ For Europe

EN 60825-1

| Requirements subclause | Classification | | | | | | |
|---------------------------|---|---------------------------------------|-----------------|---------------------------------------|--|--|-----------------------|
| | Class 1 | Class 1M | Class 2 | Class 2M | Class 3R | Class 3B | Class 4 |
| Laser safety officer | Not required but recommended for applications that involve direct viewing of the laser beam | | | | Not required for visible emission Required for non-visible emission | Required | |
| Remote interlock | Not required | | | | | Connect to room or door circuits | |
| Key control | Not required | | | | | Remove key when not in use | |
| Beam attenuator | Not required | | | | | When in use prevents inadvertent exposure | |
| Emission indicator device | Not required | | | | Indicates laser is energized for non-visible wavelengths | Indicates laser is energized | |
| Warning signs | Not required | | | | | Follow precautions on warning signs | |
| Beam path | Not required | Class 1M as for Class 3B (see note 2) | Not required | Class 2M as for Class 3B (see note 3) | Terminate beam at end of useful length | | |
| Specular reflection | No requirements | Class 1M as for Class 3B (see note 2) | No requirements | Class 2M as for Class 3B (see note 3) | Prevent unintentional reflections | | |
| Eye protection | No requirements | | | | Not required for visible emission Required for non-visible emission | Required if engineering and administrative procedures not practicable and MPE exceeded | |
| Protective clothing | No requirements | | | | | Sometimes required | Specific requirements |
| Training | No requirements | Class 1M as for Class 3R (see note 2) | No requirements | Class 2M as for Class 3R (see note 3) | Required for all operator and maintenance personnel | | |

Note: 1. This table is intended to provide a convenient summary of requirements. See text of this standard for complete precautions.

2. Class 1M laser products that failed condition 1 of table 10 of the standard. Not required for Class 1M laser products that failed condition 2 of table 10 of the standard. See the text for details.

3. Class 2M laser products that failed condition 1 of table 10 of the standard. Not required for Class 2M laser products that failed condition 2 of table 10 of the standard. See the text for details.

■ For U.S.A

ANSI Z136.1:1993 “American National Standard for the Safe Use of Lasers” Control Measures for the Four Laser Classes

| Control measures | Classification | | | | | |
|---|---|----------|----------|-------------------|----------|----------|
| | 1 | 2a | 2 | 3a | 3b | 4 |
| Engineering Controls | 1 | 2a | 2 | 3a | 3b | 4 |
| Protective Housing(4.3.1) | X | X | X | X | X | X |
| Without Protective Housing (4.3.1.1) | LSO (see note 2) shall establish Alternate Controls | | | | | |
| Interlocks on Protective Housing (4.3.2) | ☆ | ☆ | ☆ | ☆ | X | X |
| Service Access Panel(4.3.3) | ☆ | ☆ | ☆ | ☆ | X | X |
| Key Control(4.3.4) | --- | --- | --- | --- | • | X |
| Viewing Portals(4.3.5.1) | --- | --- | MPE | MPE | MPE | MPE |
| Collecting Optics(4.3.5.2) | MPE | MPE | MPE | MPE | MPE | MPE |
| Totally Open Beam Path(4.3.6.1) | --- | --- | --- | --- | X NHZ | X NHZ |
| Limited Open Beam Path(4.3.6.2) | --- | --- | --- | --- | X NHZ | X NHZ |
| Enclosed Beam Path(4.3.6.3) | None is required if 4.3.1 and 4.3.2 fulfilled | | | | | |
| Remote Interlock Connector(4.3.7) | --- | --- | --- | --- | • | X |
| Beam Stop or Attenuator(4.3.8) | --- | --- | --- | --- | • | X |
| Activation Warning Systems(4.3.9) | --- | --- | --- | --- | • | X |
| Emission Delay(4.3.9.1) | --- | --- | --- | --- | --- | X |
| Indoor Laser Controlled Area(4.3.10) | --- | --- | --- | --- | X NHZ | X NHZ |
| Class 3b Laser Controlled Area (4.3.10.1) | --- | --- | --- | --- | X | --- |
| Class 4 Laser Controlled Area (4.3.10.2) | --- | --- | --- | --- | --- | X |
| Laser Outdoor Controls(4.3.11) | --- | --- | --- | --- | X NHZ | X NHZ |
| Laser in Navigable Airspace (4.3.11.2) | --- | --- | --- | • | • | • |
| Temporary Laser Controlled Area (4.3.12) | ☆ MPE | ☆ MPE | ☆ MPE | ☆ MPE | --- | --- |
| Remote Firing & Monitoring (4.3.13) | --- | --- | --- | --- | --- | • |
| Labels (4.3.14 and 4.7) | X | X | X | X | X | X |
| Area Posting(4.3.15) | --- | --- | --- | • | X NHZ | X NHZ |
| Administrative & Procedural Controls | 1 | 2a | 2 | 3a | 3b | 4 |
| Standard Operating Procedures(4.4.1) | --- | --- | --- | --- | • | X |
| Output Emission Limitations(4.4.2) | --- | --- | --- | LSO Determination | | |
| Education and Training(4.4.3) | --- | --- | • | • | X | X |
| Authorized Personnel(4.4.4) | --- | --- | --- | --- | X | X |
| Alignment Procedures(4.4.5) | --- | --- | X | X | X | X |
| Protective Equipment(4.4.6) | --- | --- | --- | --- | • | X |
| Spectator(4.4.7) | --- | --- | --- | --- | • | X |
| Service Personnel(4.4.8) | ☆ MPE | ☆ MPE | ☆ MPE | ☆ MPE | X | X |
| Demonstration with General Public(4.5.1) | MPE+ | --- | X | X | X | X |

| Control measures | Classification | | | | | |
|--|-----------------------|-----|-----|-----|----------|----------|
| Laser Optical Fiber Systems(4.5.2) | MPE | MPE | MPE | MPE | X | X |
| Laser Robotic Installations(4.5.3) | --- | --- | --- | --- | X NHZ | X NHZ |
| Eye Protection(4.6.2) | --- | --- | --- | --- | • MPE | X MPE |
| Protective Windows(4.6.3) | --- | --- | --- | --- | X NHZ | X NHZ |
| Protective Barriers and Cur- tains(4.6.4) | --- | --- | --- | --- | • | • |
| Skin Protection(4.6.5) | --- | --- | --- | --- | X MPE | X MPE |
| Other Protective Equipment(4.6.5) | Use may be required | | | | | |
| Warning Signs and Labels(4.7) (Design Requirements) | --- | --- | • | • | X NHZ | X NHZ |
| Service and Repairs(4.8) | LSO Determination | | | | | |
| Modification of Laser Systems(4.9) | LSO Determination | | | | | |

Note: 1.LEGEND

- X: Shall
- : Should
- : No requirement
- ☆: Shall if enclosed Class 3b or Class 4
- MPE: Shall if MPE is exceeded
- NHZ: Nominal Hazard Zone analysis required
- +: Applicable only to UV and IR Lasers(4.5.1.2)

2.LSO: Laser Safety Officer

An individual shall be designated the Laser Safety Officer with the authority and responsibility to monitor and enforce the control of laser hazards, and to effect the knowledgeable evaluation and control of laser hazards. For your reference, see ANSI Z136.1993, Section 1.3.

Definitions of Laser Classification

■ For Europe

Laser Product Classifications
EN

| Class | Description |
|----------|---|
| Class 1 | Lasers which are safe under reasonably foreseeable conditions of operation. |
| Class 2 | Lasers emitting visible radiation in the wavelength range from 400 nm to 700 nm. Eye protection is normally afforded by aversion responses including the blink reflex. |
| Class 3A | Lasers which are safe for viewing with the unaided eye. For laser emitting in the wavelength range from 400 nm to 700 nm, protection is afforded by aversion responses including the blink reflex. For other wavelengths the hazard to the unaided eye is no greater than for Class 1. Direct intrabeam viewing of Class 3A lasers with optical aides (e.g., binoculars, telescopes, microscopes) may be hazardous. |
| Class 3B | Direct intrabeam viewing of these lasers is always hazardous. Viewing diffuse reflections is normally safe (see note). |
| Class 4 | Lasers which are also capable of producing hazardous diffuse reflections. They may cause skin injuries and could also constitute a fire hazard. Their use requires extreme caution. |

Note: Conditions for safe viewing of diffuse reflections for Class 3B visible lasers are: minimum viewing distance of 13 cm between screen and cornea and a maximum viewing time of 10 s. Other viewing conditions require a comparison of the diffuse reflection exposure with the MPE.

■ For U.S.A

Comparison of Classifications between FDA and ANSI

| Class | FDA definition | ANSI description |
|--------------|---|---|
| Class I/1 | Limits applicable to devices that have emissions in the ultraviolet, visible, and infrared spectra, and limits below which biological hazards have not been established. | A Class 1 laser is considered to be incapable of producing damaging radiation levels during operation and maintenance and is, therefore, exempt from any control measures or other forms of surveillance. |
| Class IIa/2a | Limits applicable to products whose visible emission does not exceed Class I limits for emission durations of 1,000 seconds or less and are not intended for viewing. | Class 2 lasers are divided into two subclasses, 2 and 2a. A Class 2 laser emits in the visible portion of the spectrum (0.4 to 0.7 μm) and eye protection is normally afforded by the aversion response including the blink reflex. |
| Class II/2 | Limits applicable to products that have emissions in the visible spectrum (400 to 710 nm) for emission durations in excess of 0.25 second, providing that emissions for other durations and/or wavelengths do not exceed the Class I limits. Class II products are considered hazardous for direct long-term ocular exposure. | |

| Class | FDA definition | ANSI description |
|---------------|--|---|
| Class IIIa/3a | Limits to products that have emissions in the visible spectrum and that have beams where the total collectable radiant power does not exceed 5 milliwatts. | Class 3 lasers are divided into two sub-classes, 3a and 3b. A Class 3 laser may be hazardous under direct and specular reflection viewing conditions, but the diffuse reflection is usually not a hazard. |
| Class IIIb/3b | Limits applicable to devices that emit in the ultraviolet, visible, and infrared spectra. Class IIIb products include laser systems ranging from 5 to 500 milliwatts in the visible spectrum. Class IIIb emission levels are ocular hazards for direct exposure throughout the range of the Class, and skin hazards at the higher levels of the Class. | |
| Class IV/4 | Exceeding the limits of Class IIIb and are a hazard for scattered reflection as well as for direct exposure. | A Class 4 laser is a hazard to the eye or skin from the direct beam and sometimes from a diffuse reflection and also can be a fire hazard. Class 4 lasers may also produce laser-generated air contaminants and hazardous plasma radiation. |

Engineering Data

Linearity Characteristic by Materials

■ ZS-LD20T (mode: standard)

● Regular reflection

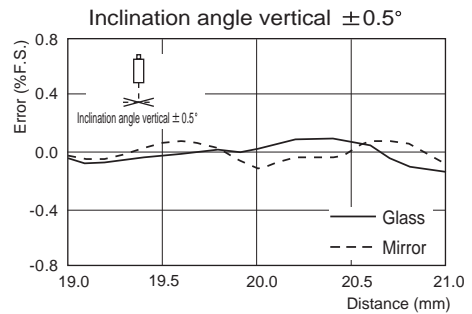
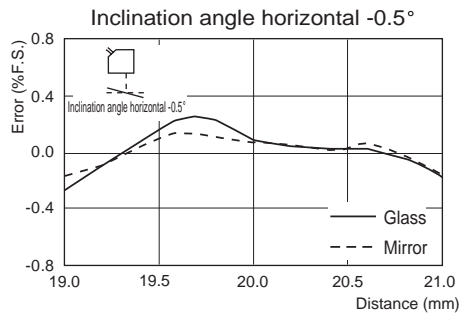
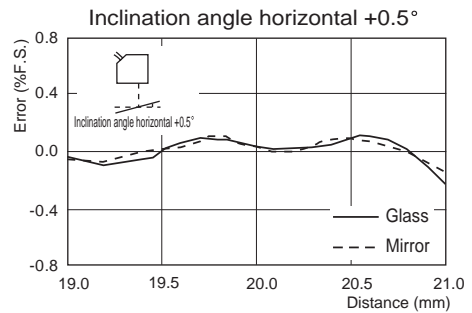
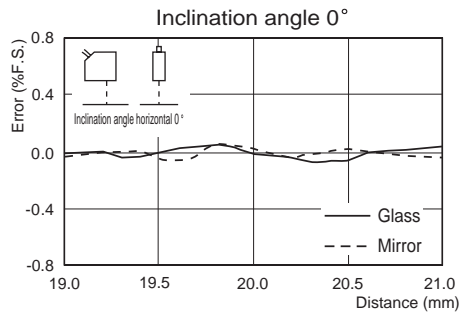

● Diffuse reflection

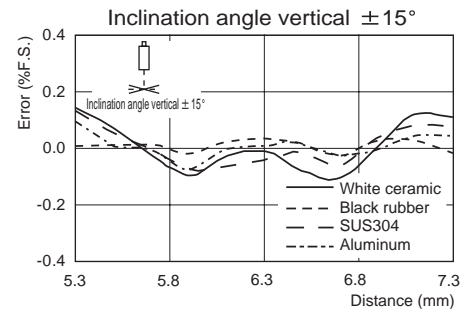
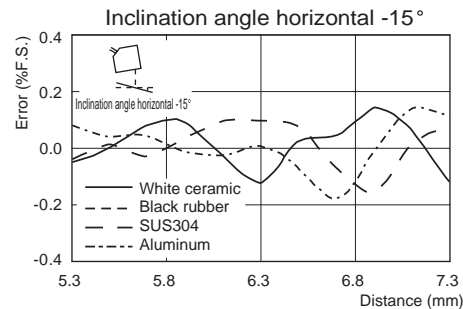
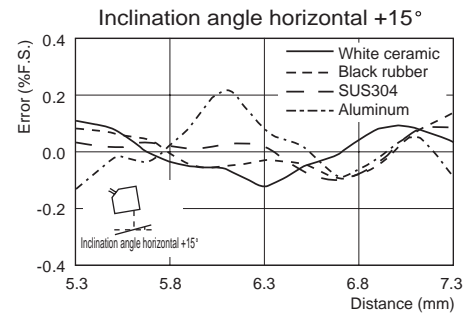
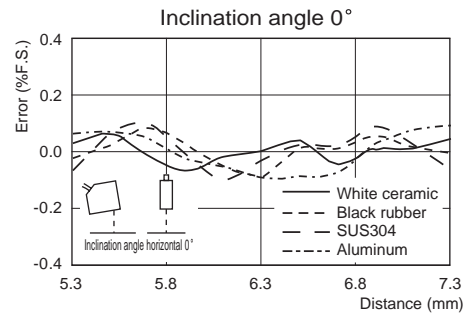

■ ZS-LD20ST (mode: standard)

● Regular reflection

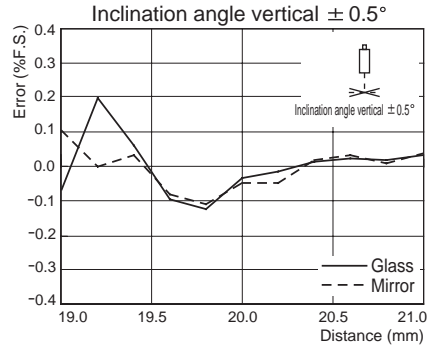
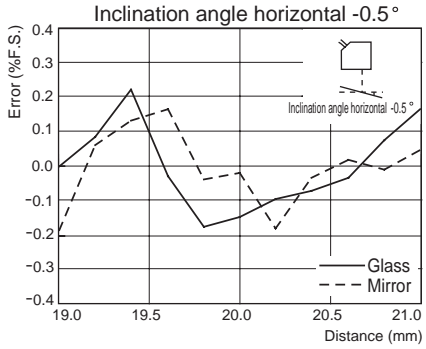
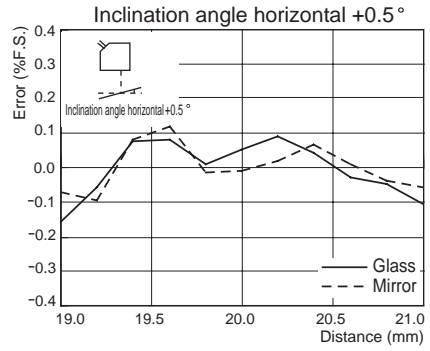
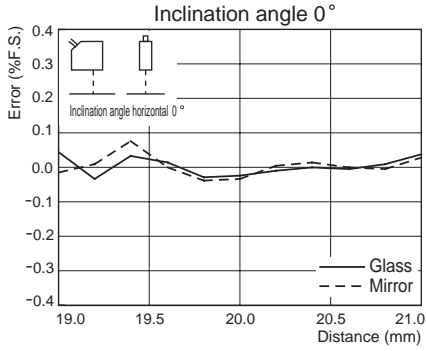

● Diffuse reflection

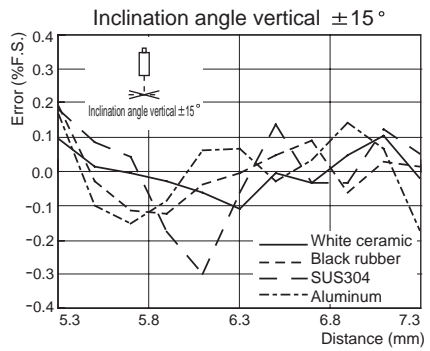
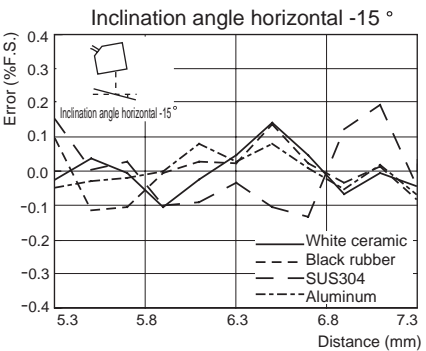
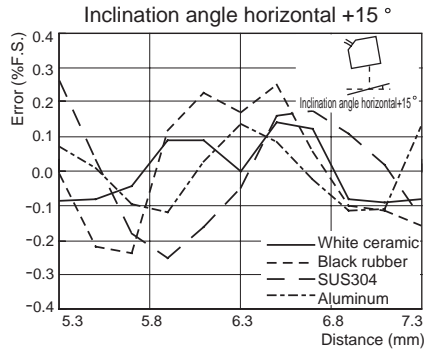
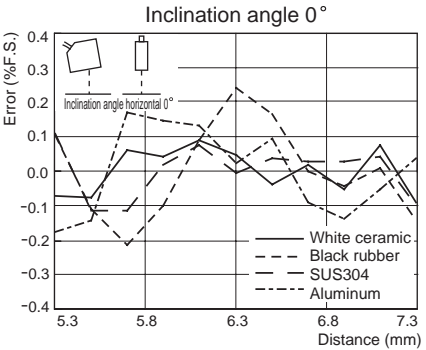

■ ZS-LD40T (mode: standard)

● Regular reflection

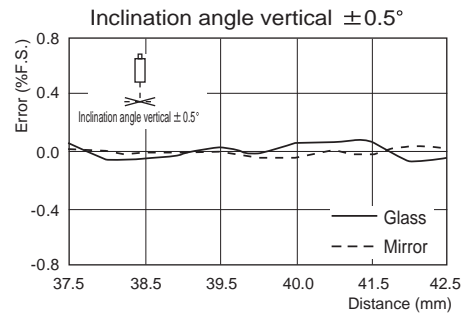
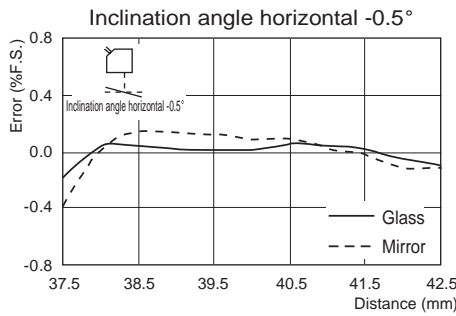
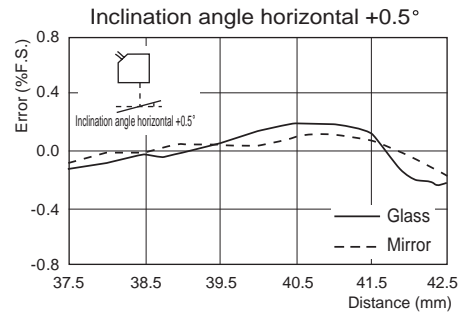
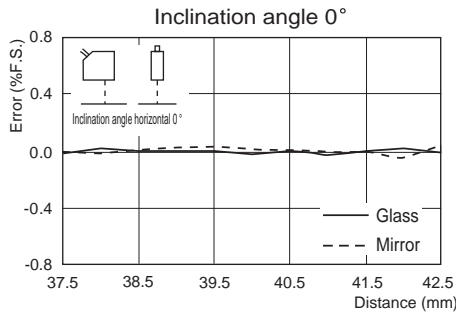

● Diffuse reflection

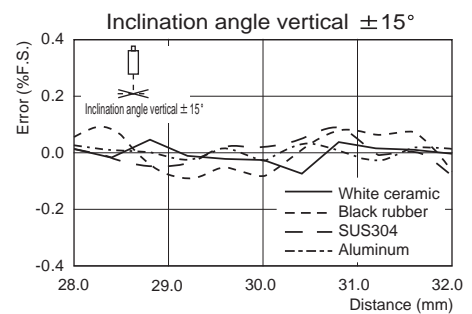
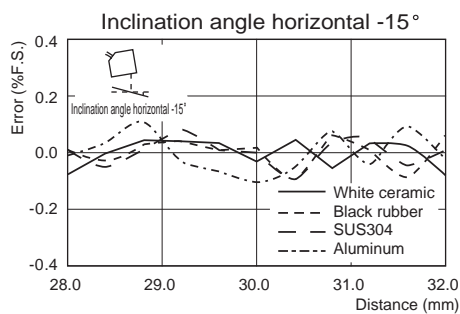
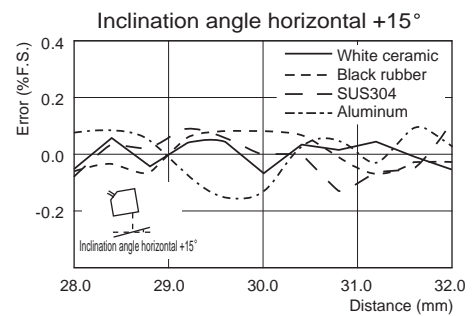
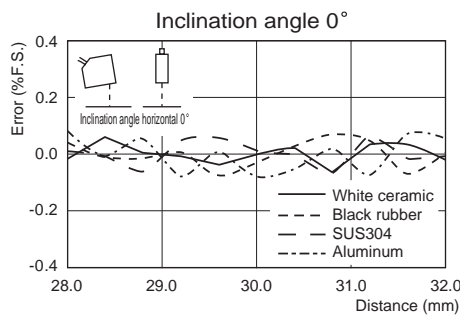

■ ZS-LD50 (mode: standard)

● Diffuse reflection

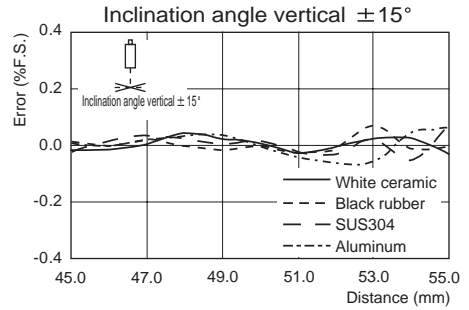
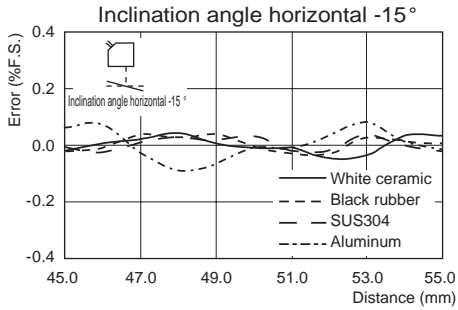
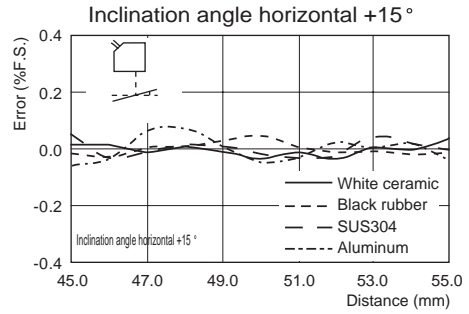
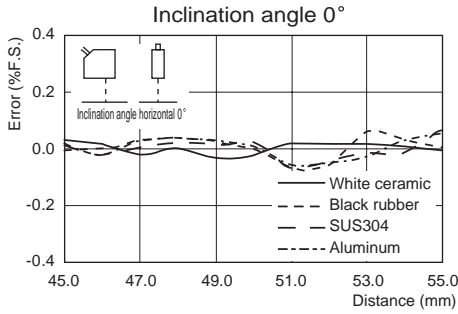

● Regular reflection

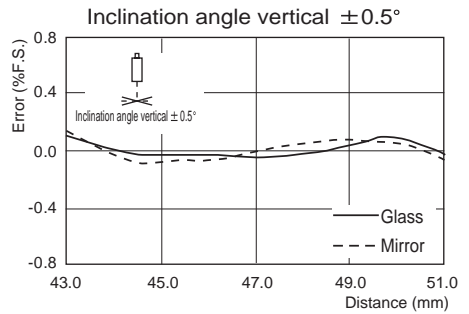
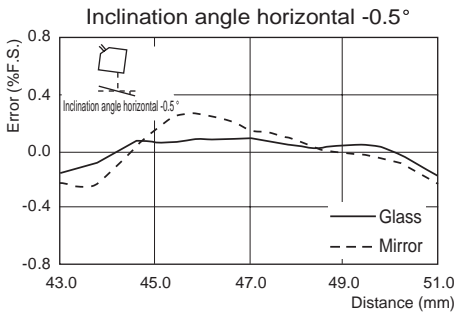
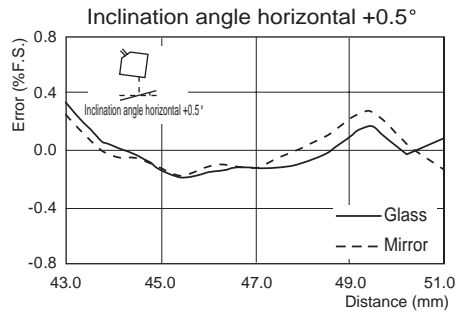
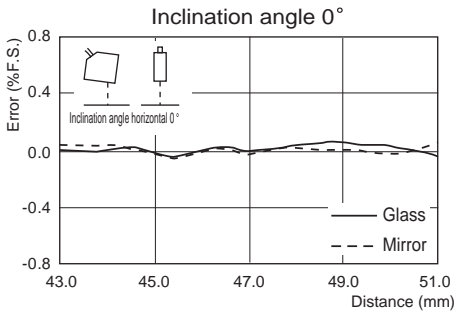

■ ZS-LD50S (mode: standard)

● Diffuse reflection

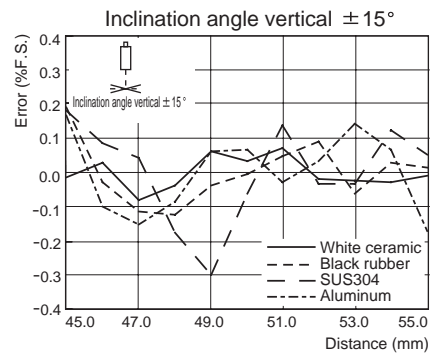
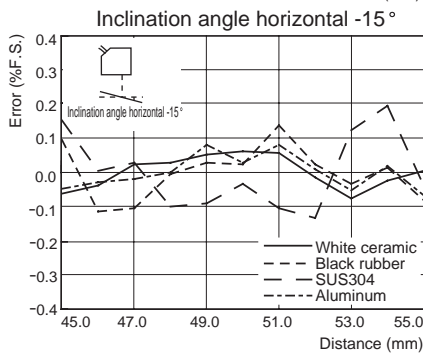
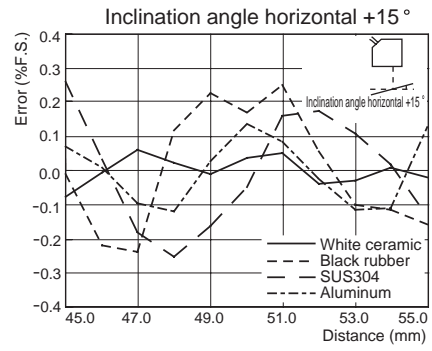
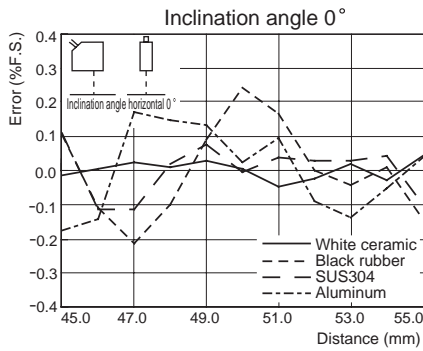

● Regular reflection

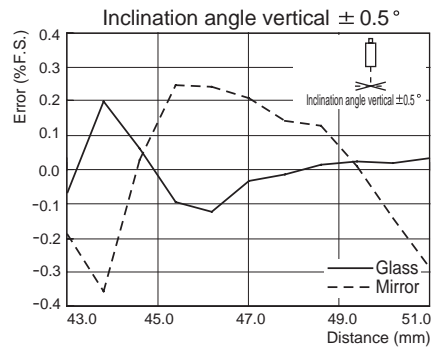
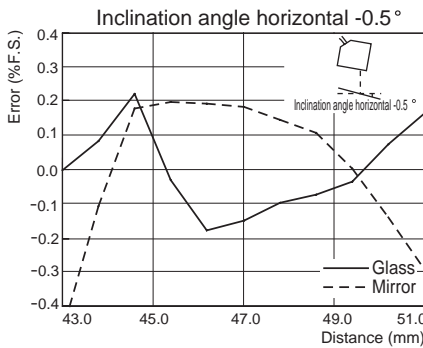
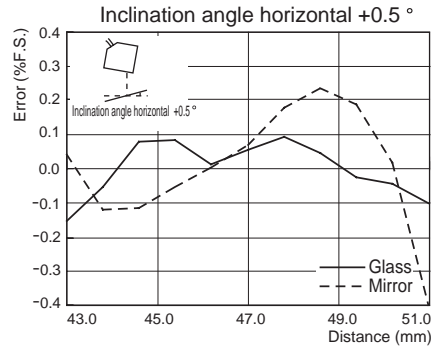
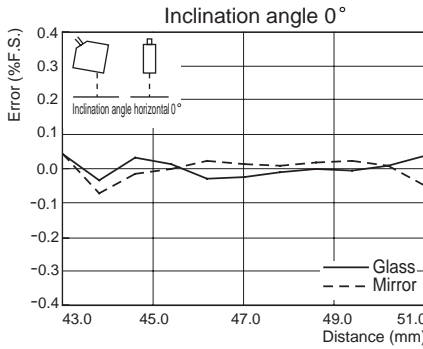

■ ZS-LD80 (mode: standard)

● Diffuse reflection

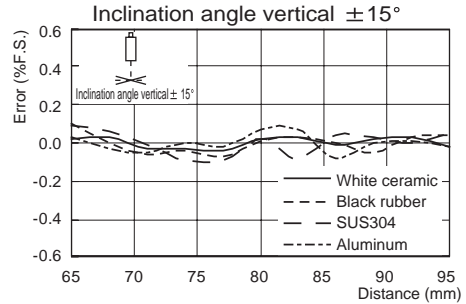
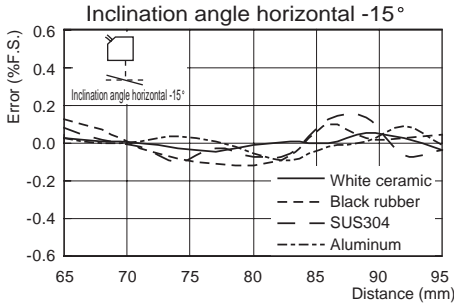
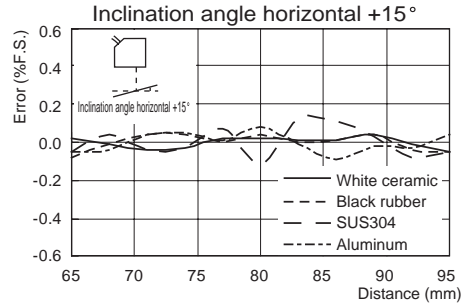
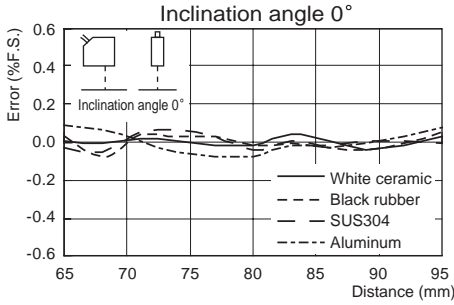

● Regular reflection

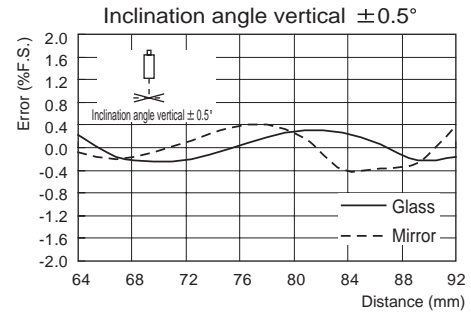
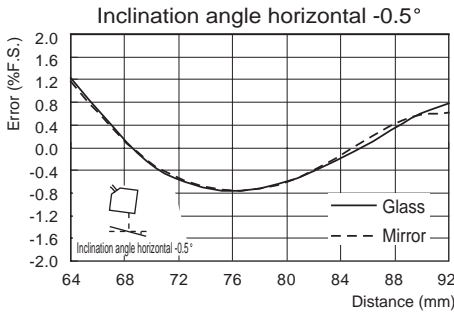
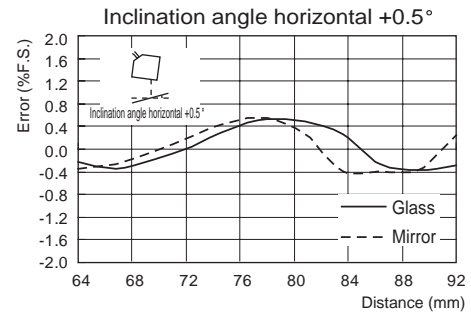
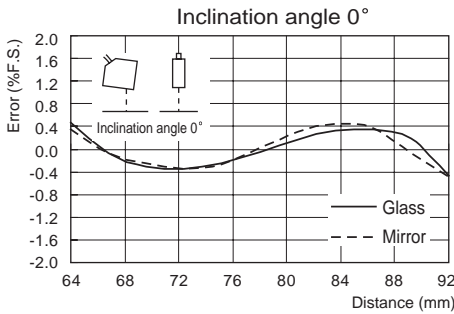

■ ZS-LD130 (mode: standard)

● Diffuse reflection

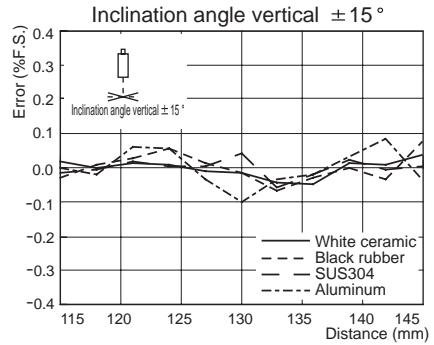
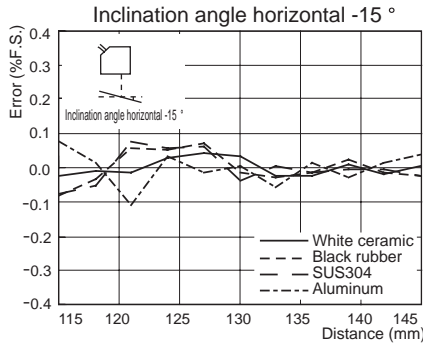
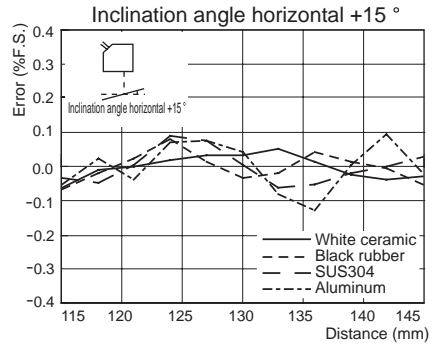
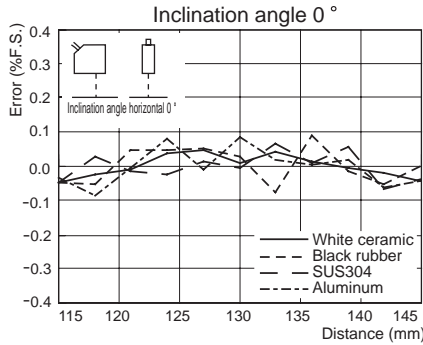

● Regular reflection

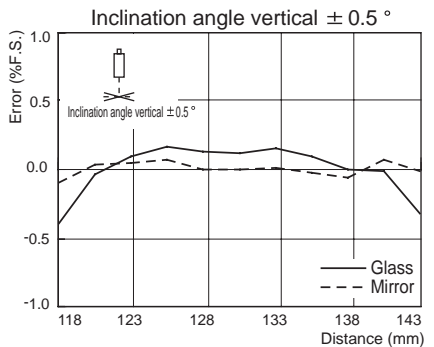
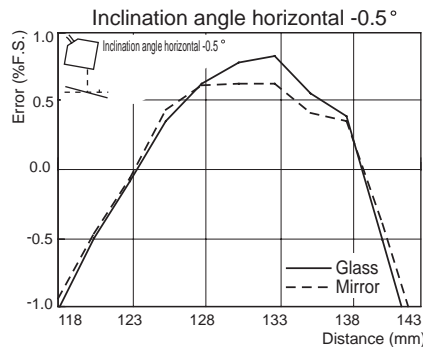
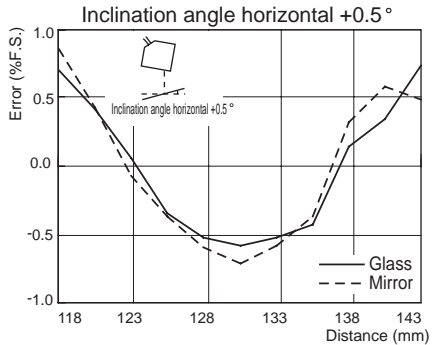
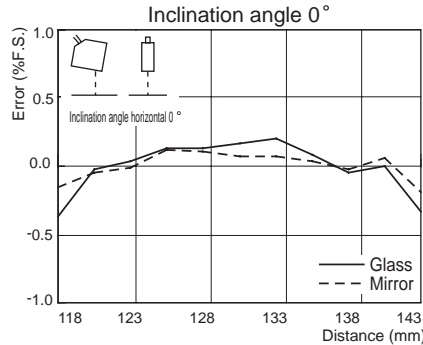

■ ZS-LD200 (mode: standard)

● Diffuse reflection

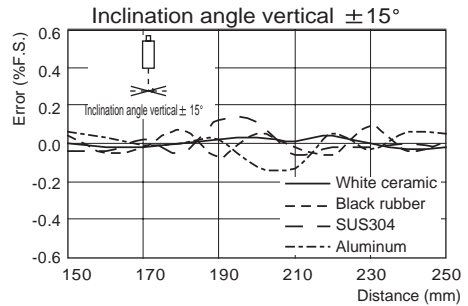
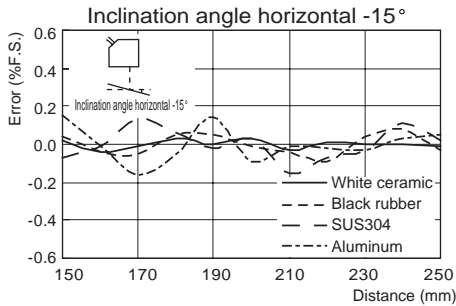
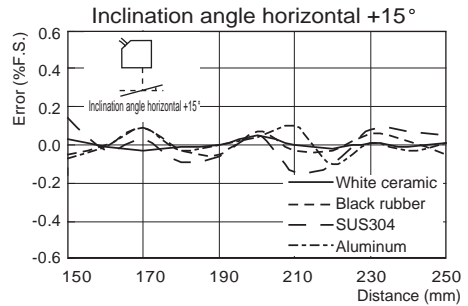
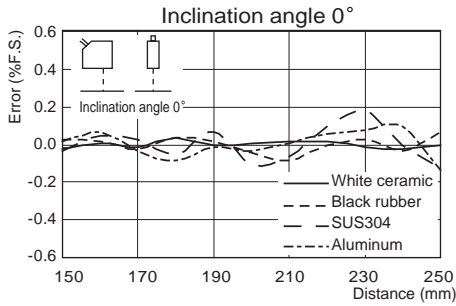

● Regular reflection

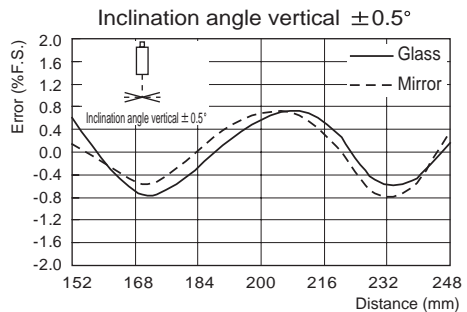
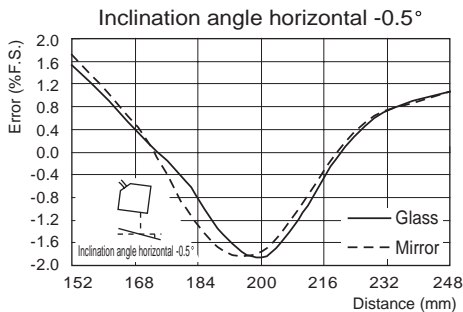
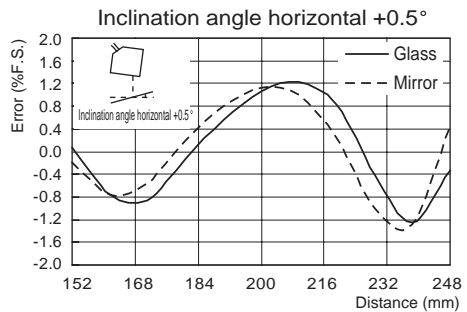
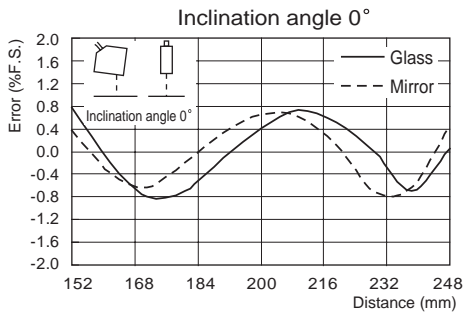

■ ZS-LD350S (mode: standard)

● Diffuse reflection

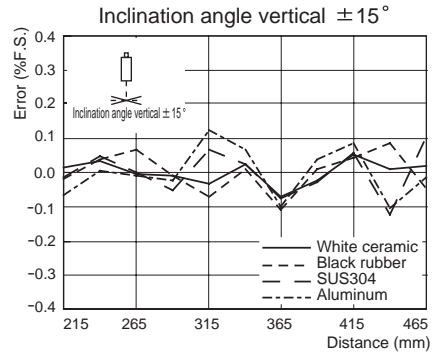
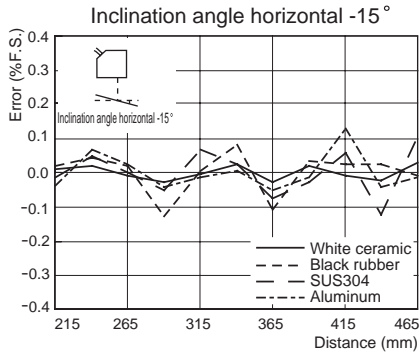
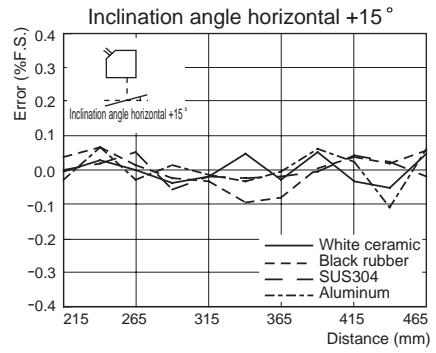
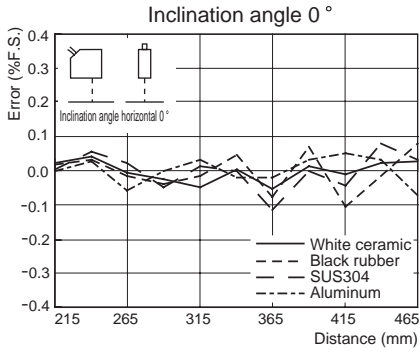

Version Up Information

This section describes the revisions made to the software.

■ Ver1.00 → Ver1.50

| Description of Change | Pages |
|--|--------|
| [CUSTOM] that allows flexible setting was added to the measurement value mode setting. | p.3-12 |
| [THICK] for measuring glass thickness and [GAP] for measuring the gap between glass was added to the sensing object setting. | p.3-14 |
| The CMOS gain setting was added. | p.3-17 |
| The zero reset memory function was added. | p.3-30 |
| The input signal setup function was added. | p.4-7 |
| The I/O assignment function was added. | p.4-7 |

■ Ver1.50 → Ver2.00

| Description of Change | Pages |
|--|--------|
| [STOP] and [MOVE] were added to the [THICK]-[FILM] settings to measure the thickness of glass with film that move. | p.3-14 |
| The mutual interference prevention function was added. | p.3-16 |
| RS-232C "DELIMIT", and "COMPWAY", "NORMAL" and "NODE" were added to the communication specifications. | p.4-11 |
| The Data Storage unit (ZS-DSU) was supported. | - |
| SmartMonitor ZS Professional was supported. | - |

INDEX

- A**
- ADJUST 4-4
 - AUTO 3-13
 - AUTOOFF 3-33
 - AVERAGE 3-19, 3-24
- B**
- B.LIGHT 3-33
 - BANK 3-34
 - Bank switching 3-34
 - Basic Configuration 1-9
 - BOTTOM 3-24
 - BRIGHT 3-7
 - BUSY output 2-8
- C**
- CLAMP 4-6
 - CLEAR 3-34
 - COM 4-12
 - Control keys 3-5
 - Coupler 1-11
 - current display 3-7
 - CUSTOM 3-12, 3-33
 - CYCLE 3-36
- D**
- DELAY 3-27
 - DIFF 3-19
 - DIFFUSE 3-13
 - DIGITAL 3-32
 - Digital Output 4-8
 - DIRECT IN 3-31
 - DOT 3-32
- E**
- ECO 3-32
 - Emitter section 1-12
 - ENABLE
 - indicator 1-10
 - Output 2-7
 - EXPOSE 3-12
 - EXT 3-25
 - Extension Cable 6-22
- F**
- FAR Indicator 1-12
 - Ferrite core
 - Controller 2-3
 - Sensor Head 2-11
 - USB cable 2-19
 - FILTER 3-18
 - FIXED 3-13
 - focus 4-3
 - FORWARD 3-21
 - FUN mode 3-5
- G**
- GAIN 3-17
 - GAP 3-14
 - NORMAL 3-14
 - OTHER 3-15
 - GLASS 3-14
- H**
- HIGH
 - indicator 1-11
 - Output 2-7
 - HI-RESO 3-12
 - HI-SENS 3-12
 - HI-SPEED 3-12
 - HOLD
 - DELAY 3-27
 - TRIGGER 3-25
 - TYPE 3-24
 - zero reset types 3-29
 - HYS 4-5
- I**
- I/O cable 2-7
 - I/O circuit diagrams 2-9
 - I/O SET 4-7, 4-8
 - IN 4-7
 - INFO 3-36
 - INIT 3-35
 - INVERS 3-21
- J**
- JUDGE 4-5
- K**
- KEEP 4-6
 - KEYLOCK 3-36
- L**
- LANGUAG 3-37
 - LASER 3-13
 - Laser indicator 1-10
 - LCD 3-33
 - LCD screen
 - CUSTOM 3-33
 - name 3-5
 - LD ON 1-10
 - LD-OFF input
 - Timing charts 4-10
 - LINE 3-12
 - linear 4-2
 - LOAD 3-36

| | | | |
|----------|--------------------------------|-----------------------|--|
| LOW | | | |
| | indicator | 1-11 | |
| | Output | 2-7 | |
| M | | | |
| | Main Display | 3-5 | |
| | Measuring range | | |
| | | 6-8, 6-11, 6-12, 6-17 | |
| | MIRROR | 3-14 | |
| | MODE | 3-12 | |
| | Mode Switch | 3-4 | |
| | mutual interference | 2-14 | |
| | mutual interference prevention | 3-16 | |
| N | | | |
| | NEAR Indicator | 1-12 | |
| | NON-MEAS | 4-6 | |
| | NORMAL | 3-14 | |
| O | | | |
| | OBJECT | 3-14 | |
| | OFF | 3-24 | |
| | OFFSET | | |
| | SCALING | 3-23 | |
| | Zero Reset | 3-29 | |
| | ON DELAY | 4-5 | |
| | ONE SHOT | 4-6 | |
| | OUT0 to 4 | 2-7 | |
| | OUTPUT | 3-21 | |
| | Output cable | 2-7 | |
| P | | | |
| | PASS | | |
| | indicator | 1-11 | |
| | Output | 2-7 | |
| | PCB | 3-14 | |
| | PEAK | 3-24 | |
| | Power supply | 1-9 | |
| | P-P | 3-24 | |
| R | | | |
| | RANGE | 3-13 | |
| | Receiver section | 1-12 | |
| | REGULAR | 3-13 | |
| | Reset input | | |
| | Timing charts | 4-9 | |
| | RS-232C | | |
| | cable external dimensions | | |
| | | 6-21 | |
| | cable wiring | 4-11 | |
| | Communications | | |
| | Specifications | 4-12 | |
| | Connector | 1-11 | |
| | RUN mode | 3-7 | |
| S | | | |
| | SAMPLE | 3-25 | |
| | SAVE | 3-35 | |
| | SCALING | 3-21 | |
| | SELF-DOWN | 3-26 | |
| | SELF-UP | 3-25 | |
| | Sen INFO | 3-36 | |
| | sensing | 3-12 | |
| | Sensor Controller | | |
| | Attaching the ferrite core | 2-3 | |
| | Installation | 2-4 | |
| | Part Names | 1-10 | |
| | Specifications, | | |
| | external dimensions | 6-18 | |
| | Sensor Head | | |
| | Adjusting the installation | | |
| | position | 2-12 | |
| | Attaching the ferrite core | | |
| | | 2-11 | |
| | connector | 1-11 | |
| | Part Names | 1-12 | |
| | Specifications, external | | |
| | dimensions | 6-7 | |
| | SETTING | 3-13 | |
| | SKIP | 3-12 | |
| | SmartMonitor ZS | | |
| | how to start up | 2-23 | |
| | installing | 2-19 | |
| | SMOOTH | 3-18 | |
| | SPAN | 3-23 | |
| | Sub-display | 3-5 | |
| | CHANGE | 3-34 | |
| | SYSTEM | 3-35 | |
| T | | | |
| | TEACH mode | 3-8 | |
| | TEACHING | 3-31 | |
| | THICK | 3-14 | |
| | FILM | 3-14 | |
| | NORMAL | 3-14 | |
| | Threshold Selector Switch | 1-11 | |
| | threshold values | | |
| | display | 3-7 | |
| | TIMER | 4-5 | |
| | Timing A, B | 3-16 | |
| | Timing charts | 4-9 | |
| | Timing input | | |
| | Timing charts | 4-9 | |
| | TRIGGER | 3-25 | |
| U | | | |
| | USB | | |
| | cable | 2-19 | |
| | driver | 2-20 | |
| | port | 1-12 | |

| | |
|------------------------|------|
| V | |
| voltage display | 3-7 |
| Voltage/Current switch | 1-11 |
| W | |
| wiring | 2-7 |
| Z | |
| Zero | 1-10 |
| Zero Reset | |
| OFFSET | 3-29 |
| Types | 3-29 |
| Zero reset | |
| indicator | 1-10 |
| key for executing | 3-28 |
| Timing Charts | 4-9 |
| Zero reset memory | 3-30 |

Revision History

A manual revision code appears as a suffix to the catalog number at the bottom of the front and back covers of this manual.

Cat. No. Z208-E1-03

↑
Revision code

| Revision code | Date | Revised contents |
|---------------|--------------|--|
| 01 | October 2004 | Original production |
| 02 | January 2007 | <p>Pages 2-20, 2-22, 6-34, and 6-36: Changed "Zero" to "ZS" at bottom of page.</p> <p>Page 4-7: Added "CHECK" in middle of page.</p> <p>Pages 6-7, 6-10: Added model numbers and cable length.</p> <p>Page 6-8: Added column, note, and "typical example."</p> <p>Page 6-9: Added model number.</p> <p>Page 6-11: Added column, moved two columns to the next page, and added "typical example."</p> <p>Page 6-13: Added three pages.</p> <p>Page 6-14: Added callout.</p> <p>Page 6-19: Replaced second paragraph.</p> <p>Page 6-24: Corrected Class 3R cell for eye protection.</p> <p>Pages 6-29 and 6-30: Corrected angles at four locations.</p> <p>Pages 6-30 to 6-33: Added models.</p> |
| 02A | March 2012 | Additions for Notice for Korea Radio Law |
| 03 | August 2015 | Additions corresponding to change of EN standard. |

OMRON Corporation Industrial Automation Company

Kyoto, JAPAN

Contact: www.ia.omron.com

Regional Headquarters

OMRON EUROPE B.V.

Sensor Business Unit

Carl-Benz-Str. 4, D-71154 Nufringen, Germany
Tel: (49) 7032-811-0/Fax: (49) 7032-811-199

OMRON ELECTRONICS LLC

2895 Greenspoint Parkway, Suite 200
Hoffman Estates, IL 60169 U.S.A.
Tel: (1) 847-843-7900/Fax: (1) 847-843-7787

OMRON ASIA PACIFIC PTE. LTD.

No. 438A Alexandra Road # 05-05/08 (Lobby 2),
Alexandra Technopark,
Singapore 119967
Tel: (65) 6835-3011/Fax: (65) 6835-2711

OMRON (CHINA) CO., LTD.

Room 2211, Bank of China Tower,
200 Yin Cheng Zhong Road,
PuDong New Area, Shanghai, 200120, China
Tel: (86) 21-5037-2222/Fax: (86) 21-5037-2200

Authorized Distributor:

© OMRON Corporation 2004 All Rights Reserved.
In the interest of product improvement,
specifications are subject to change without notice.

Cat. No. Z208-E1-03

0815