

Displacement Sensor

ZW series

Confocal Fiber Type Displacement Sensor

User's Manual

ZW-CE1□T



Introduction

Thank you for purchasing the ZW.

This manual provides information regarding functions, performance and operating methods that are required for using the ZW.

When using the ZW, be sure to observe the following:

- The ZW must be operated by personnel knowledgeable in electrical engineering.
- To ensure correct use, please read this manual thoroughly to deepen your understanding of the product.
- Please keep this manual in a safe place so that it can be referred to whenever necessary.

User's Manual

Terms and Conditions Agreement (Please Read)	
Basic configuration	1
Installation and Connections	2
Basic Operation	3
Settings for Function	4
Convenient Functions	5
Communications with External Devices	6
Offline Settings	7
Troubleshooting	8
Sensor controller operations	9
APPENDICES	10

Confocal Fiber Type
Displacement Sensor

ZW

Terms and Conditions Agreement

Read and understand this Manual

Please read and understand this catalog before purchasing the products. Please consult your OMRON representative if you have any questions or comments.

Warranty, Limitations of Liability

Warranties

• Exclusive Warranty

Omron's exclusive warranty is that the Products will be free from defects in materials and workmanship for a period of twelve months from the date of sale by Omron (or such other period expressed in writing by Omron). Omron disclaims all other warranties, express or implied.

• Limitations

OMRON MAKES NO WARRANTY OR REPRESENTATION, EXPRESS OR IMPLIED, ABOUT NON-INFRINGEMENT, MERCHANTABILITY OR FITNESS FOR A PARTICULAR PURPOSE OF THE PRODUCTS. BUYER ACKNOWLEDGES THAT IT ALONE HAS DETERMINED THAT THE PRODUCTS WILL SUITABLY MEET THE REQUIREMENTS OF THEIR INTENDED USE.

Omron further disclaims all warranties and responsibility of any type for claims or expenses based on infringement by the Products or otherwise of any intellectual property right.

• Buyer Remedy

Omron's sole obligation hereunder shall be, at Omron's election, to (i) replace (in the form originally shipped with Buyer responsible for labor charges for removal or replacement thereof) the non-complying Product, (ii) repair the non-complying Product, or (iii) repay or credit Buyer an amount equal to the purchase price of the non-complying Product; provided that in no event shall Omron be responsible for warranty, repair, indemnity or any other claims or expenses regarding the Products unless Omron's analysis confirms that the Products were properly handled, stored, installed and maintained and not subject to contamination, abuse, misuse or inappropriate modification. Return of any Products by Buyer must be approved in writing by Omron before shipment. Omron Companies shall not be liable for the suitability or unsuitability or the results from the use of Products in combination with any electrical or electronic components, circuits, system assemblies or any other materials or substances or environments. Any advice, recommendations or information given orally or in writing, are not to be construed as an amendment or addition to the above warranty.

See <http://www.omron.com/global/> or contact your Omron representative for published information.

Limitation on Liability; Etc

OMRON COMPANIES SHALL NOT BE LIABLE FOR SPECIAL, INDIRECT, INCIDENTAL, OR CONSEQUENTIAL DAMAGES, LOSS OF PROFITS OR PRODUCTION OR COMMERCIAL LOSS IN ANY WAY CONNECTED WITH THE PRODUCTS, WHETHER SUCH CLAIM IS BASED IN CONTRACT, WARRANTY, NEGLIGENCE OR STRICT LIABILITY.

Further, in no event shall liability of Omron Companies exceed the individual price of the Product on which liability is asserted.

Application Considerations

Suitability of Use

Omron Companies shall not be responsible for conformity with any standards, codes or regulations which apply to the combination of the Product in the Buyer's application or use of the Product. At Buyer's request, Omron will provide applicable third party certification documents identifying ratings and limitations of use which apply to the Product. This information by itself is not sufficient for a complete determination of the suitability of the Product in combination with the end product, machine, system, or other application or use. Buyer shall be solely responsible for determining appropriateness of the particular Product with respect to Buyer's application, product or system. Buyer shall take application responsibility in all cases.

NEVER USE THE PRODUCT FOR AN APPLICATION INVOLVING SERIOUS RISK TO LIFE OR PROPERTY WITHOUT ENSURING THAT THE SYSTEM AS A WHOLE HAS BEEN DESIGNED TO ADDRESS THE RISKS, AND THAT THE OMRON PRODUCT(S) IS PROPERLY RATED AND INSTALLED FOR THE INTENDED USE WITHIN THE OVERALL EQUIPMENT OR SYSTEM.

Programmable Products

Omron Companies shall not be responsible for the user's programming of a programmable Product, or any consequence thereof.

Disclaimers

Performance Data

Data presented in Omron Company websites, catalogs and other materials is provided as a guide for the user in determining suitability and does not constitute a warranty. It may represent the result of Omron's test conditions, and the user must correlate it to actual application requirements. Actual performance is subject to the Omron's Warranty and Limitations of Liability.

Change in Specifications

Product specifications and accessories may be changed at any time based on improvements and other reasons. It is our practice to change part numbers when published ratings or features are changed, or when significant construction changes are made. However, some specifications of the Product may be changed without any notice. When in doubt, special part numbers may be assigned to fix or establish key specifications for your application. Please consult with your Omron's representative at any time to confirm actual specifications of purchased Product.

Errors and Omissions

Information presented by Omron Companies has been checked and is believed to be accurate; however, no responsibility is assumed for clerical, typographical or proofreading errors or omissions.

Precautions for Safe Use

Please observe the following precautions for safe use of the products.

1. Installation Environment

- Do not use the product in environments where it can be exposed to inflammable/explosive gas.
- To secure the safety of operation and maintenance, do not install the product close to high-voltage devices and power devices.

2. Power Supply and Wiring

- Take care when using a power supply with an overcurrent detector, because this sensor uses DC-DC converter for its power supply circuit and inrush current may activate the protective circuit for a power supply with an overcurrent detector.

Recommended power supply: S8VS-06024 (Omron, DC24 V 2.5 A 60 W)

- The supply voltage must be within the rated range (DC24 V \pm 10 %).
- Reverse connection of the power supply is not allowed.
- Open-collector outputs should not be short-circuited.
- Use the power supply within the rated load.
- High-voltage lines and power lines must be wired separately from this product. Wiring them together or placing them in the same duct may cause induction, resulting in malfunction or damage.
- Use adequate safety measures, for example fail-safe circuits.
- Use a specified-sized wire when wiring. Do not connect wires other than those of the specification to the terminal block.
- For a power supply, use a DC power supply unit provided with a remedy, for example, safety ultralow voltage circuit, to prevent a high voltage from being generated.
- Route so that power supply wires are as short as possible.
- Use a power supply dedicated for this product, without sharing it with other products.
- Tighten fixing screws securely at a torque specified in this manual.
- Before performing any of the following activities, be sure to turn off the product, or breakdown may result.
 - Connecting or wiring cables
 - Connecting or disconnecting connectors
 - Installing or removing Calibration ROM
 - When inserting or removing an EtherCAT cable, do not put any stress on the calibration ROM.

3. Grounding

- Use a frame ground terminal of the specified size to be grounded. Do not connect a wire with an only twisted end directly to a terminal block.
 - Terminal screw: M4
 - Crimp-type terminal:



- Use D-type grounding (ground resistance of 100 Ω or less). Make the ground point as close as possible and make the ground wire used as short as possible.
- Never a ground wire with other equipment and never ground to building beams. Doing so could cause negative impacts.
- The power supply circuit of the Sensor Controller is not insulated from the internal circuits.
- When grounding the positive (+) terminal of the 24 VDC power supply, do not connect the Sensor Controller's frame ground terminal or PLC's frame ground terminal to ground. [(1), (2)]

The PC housing may be internally connected to the SG (0 V), in which case current will flow through the path shown below and may cause seizure.

- If there is no PC, or specifically there is no SG (0 V)/FG short-circuiting path, grounding the Sensor Controller's frame ground terminal will not cause seizure. Wire the PLC after checking the specification of your PLC.
- The dedicated RS-232C cable (ZW-XRS2/XPT2) has its cable shield isolated from the connector housing. [(3)]

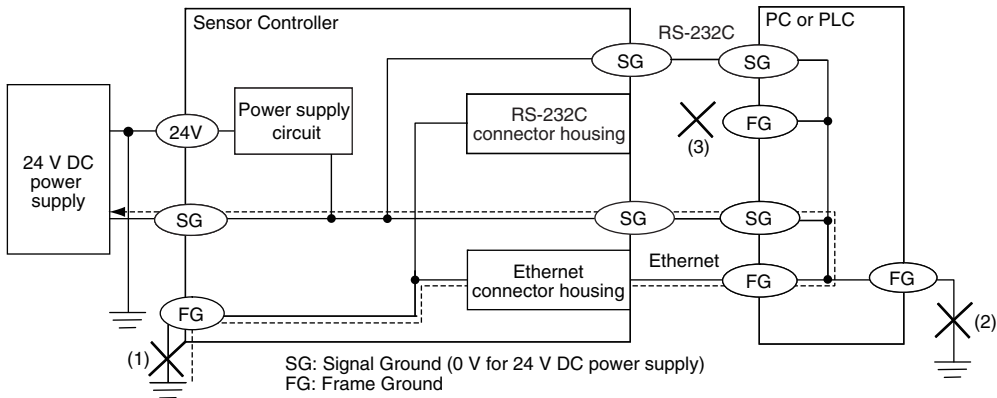

4. Regulations and Standards

- EN61326-1
- Electromagnetic environment : Industrial electromagnetic environment (EN/IEC 61326-1 Table 2)
- The following condition is applied to the immunity test of this product.
 - : There may be cases that current or voltage output fluctuate within $\pm 3\%$ F.S. when a sensor is experienced electromagnetic interference.
- Notice for Korea Radio Law

A 급 기기 (업무용 방송통신기자재)
이 기기는 업무용 (A 급) 전자파적합기기로서 판매자 또는 사용자는 이 점을 주의하시기 바라며 , 가정외의 지역에서 사용하는 것을 목적으로 합니다.

5. Others

- Do not use this product for nuclear facilities, or safety circuits involving human lives.
- Do not attempt to disassemble, repair, modify, apply pressure to deform or burn up the body.
- Dispose of this product as industrial waste.
- Use exclusive devices, including a sensor head, Calibration ROM, fiber cable or RS-232C cable, to connect, or ignition, burst, false operation or breakdown may be caused.
- Do not cut fiber cable. Glass at the cut section may cause injury. Also, if cut, it will not work normally anymore.
- Whenever any trouble, including, strange odor smelled, the body overheated or smoke escaped, was found, immediately stop the operation, and consult an OMRON branch or sales office with the system shut down.
- Do not drop or make a strong impact on the unit.
- Before using any equipment provided with a lock mechanism, make sure that it has been locked.

Precautions for Correct Use

Please observe the following precautions to prevent failure to operate, malfunctions, or undesirable effects on product performance.

1. Installation Site

Do not install the product in locations subjected to the following conditions:

- Ambient temperature outside the rating
- Rapid temperature fluctuations (causing condensation)
- Relative humidity outside the range of 35 to 85 %
- Presence of corrosive or flammable gases
- Presence of dust, salt, or iron particles
- Direct vibration or shock
- Reflection of intense light (such as other laser beams, electric arc-welding machines or ultraviolet shine)
- Direct sunlight or near heaters
- Water, oil, or chemical fumes, spray or mist atmospherics
- Strong magnetic or electric field

2. Power Supply and Wiring

- When using a commercially available switching regulator, make sure that the FG terminal is grounded.
- If surge currents are present in the power lines, connect surge absorbers that suit the operating environment.
- Before turning ON the power after the product is connected, make sure that the power supply voltage is correct, there are no incorrect connections (e.g. load short-circuit) and the load current is appropriate. Incorrect wiring may result in breakdown of the product.
- Use the specified voltage. If voltage exceeding the rating or AC voltage is applied, circuit parts may be burnt or rupture.
- Use the Extension Fiber Cable (ZW-XF□□R) for extending the fiber cable between the Sensor extension fiber cable, five total lengths, 2, 5, 10, 20 or 30 m, are available.
- Handling fiber cables
Use them in compliance with the following. This may result in damage to the fiber cable.
 - Fiber cable bend radiuses must be at least 20 mm.
 - Do not let bending cause stress at the root section of a fiber connector.
 - Do not yank hard on a fiber cable.
 - Do not step on a fiber cable or place anything heavy on it.
 - Do not apply any twisting stress to the fiber cable.
- Be sure to use a Sensor Head and Calibration ROM with the same serial number. A pair with different serial numbers cannot operate normally.
- Use the configuration software with the combination specified in this manual, or the system may operate faultily.
- Do not shut down the power supply when saving any data into the memory built in the Sensor Controller, or the data may be corrupted.
- While a fiber cable is disconnected, be sure to attach the included protective cap on both the Sensor Controller side and the fiber cable side. Leaving the fiber cable with the protective cap not attached, the optical fiber may fail due to any adhered foreign matter.

3. Warming Up

After turning ON the power supply, allow the product to stand for at least 30 minutes before use. The circuits are still unstable immediately after the power supply is turned ON, so measured values may fluctuate gradually.

4. Maintenance and Inspection

Do not use thinner, benzene, acetone or kerosene to clean the Sensor Head, fiber cable and Sensor Controller. If large dust particles adhere to the emitter/receiver of the Sensor Head or Sensor Controller, use a blower brush (used to clean camera lenses) to blow them off. Do not blow the dust particles with your mouth.

To remove smaller dust particles, dirt, oil, and fat, wipe gently with a soft cloth (for cleaning lenses). Do not use excessive force to wipe off dust particles. Scratches on the emitter/receiver may cause false operations or measuring errors.

For details on the method for cleaning the ends of fiber cables, refer to "Connecting Fiber Cable" (p.38).

Clean the ventilation port periodically to prevent any build up of dirt and dust. If the ventilation port is blocked, heat builds up inside and can cause breakdown.

5. Sensing Objects

The product sometimes cannot accurately measure the following types of objects: Transparent objects, objects with an extremely low reflection factor, objects smaller than the spot diameter, objects with a large curvature, excessively inclined objects, target objects with a thin film on the surface etc.

6. Effect caused by peripheral lights

Do not install the Sensor Head in a place where strong light hits the laser emitter/receiver section of the Sensor Head. Also, if an object has a shiny surface, the light from the lighting will be reflected and a malfunction may occur. In such a case, prevent reflection by, for example, covering the light to stop reflection.

 Basic precautions for installation p.30

7. Influence by Air Turbulences

Slow air turbulences around the Sensor Head may disperse measured values.

To avoid these possible air turbulences, wrap the Sensor Head with an appropriate cover.

8. Operations Outside Measurement Range

This sensor is highly sensitive, it may operate incorrectly outside the measurement range (too close in). In such a case, the problem can be solved by reducing the exposure time.

Editor's Note

■ Meaning of Symbols

Menu items that are displayed on the main or sub-display, and windows, dialog boxes and other GUI elements displayed on the personal computer are indicated enclosed by brackets [].

■ Visual Aids

Important

Indicates points that are important to achieve the full product performance, such as operational precautions.

Note

Indicates application procedures.



Indicates pages where related information can be found.

Optional

Indicates that the setting is optional in a configuration procedure.

Copyrights and Trademarks

- Sysmac is a trademark or registered trademark of OMRON corporation in Japan and other countries for our FA equipment products.

- Windows, Windows XP, Windows Vista, Windows 7, and Windows 8 are registered trademarks of Microsoft Corporation in the USA and other countries.
- EtherCAT® is registered trademark and patented technology that is licensed by Beckhoff Automation GmbH, Germany.
- Other system names and product names that appear in this manual are the trademarks or registered trademarks of the respective companies.

Notice

- Photocopying, duplication, or copying of all or part of this manual without permission is prohibited.
- Please understand that the specifications and other contents of this manual are subject to change for improvement without notice.
- Every effort has been made to ensure the accuracy of the contents of this manual, but if you should notice any mistake, questionable section, or the like in this manual, please contact an OMRON branch or sales office.
- If you do so, please also tell us the manual number, which is found at the end of the manual.

Related Manuals

The following manual is related to the NJ-series Controllers. Use this manual for reference.

Manual name	Cat. No.	Model numbers	Application	Description
Sysmac Studio Version 1 Operation Manual	W504	SYSMAC-SE2□□□	Learning about the operating procedures and functions of the Sysmac Studio.	Describes the operating procedures of the Sysmac Studio.

Table of Contents

Editor's Note	7
Copyrights and Trademarks	7
Notice	8
Related Manuals	8
Search from Settings	16

1. Basic configuration

1-1 ZW-series Displacement Sensors	18
Types of Sensor Controllers	18
1-2 Basic Operation Flow	19

2. Installation and Connections

2-1 System Configuration	22
System Configuration	22
Connection Compatibility	23
2-2 Part Names and Functions	25
Sensor Head	25
Calibration ROM	25
Sensor Controller	26
2-3 Installation	30
Installation of Sensor Head	30
Installation of Sensor Controller	35
Connecting Calibration ROM	37
Connecting Fiber Cable	38
Calibrating Sensor Head	42
2-4 Wiring	44
32-pole extension connector	44
Analog output terminal block	46
24 V input terminal block	47
Electrical Specifications	49
2-5 Installing the Sysmac Studio	51

3. Basic Operation

3-1 Launching a project	54
Connecting to the sensor with PC tool	54

Entering project information	55
3-2 Explanation of Screen Sections	56
PC tool	56
3-3 Switching operation modes	61
3-4 Bank switching	62
Multi-task and Bank Data	62
Switching Banks	64
3-5 Perform the Zero Reset	65
Zero reset	65
3-6 Setting Threshold Value	68
Threshold Value Settings	68
3-7 Saving a project	70
Saving a project	70
Exporting a project	70
Importing a project	70
3-8 Operating with Sensor Controller	71

4.Settings for Function

4-1 Setting Sensing	74
Selecting the Area Mode	74
Setting the Material of the Target to Measure	75
Setting the Noise Cut Level	76
Setting Smoothing Size	77
Setting Start Direction of Count Measurement Surfaces	78
Setting Exposure Time Control Mode	79
Setting the Measurement Area	80
4-2 Setting Measurement Items	83
What is a Measurement Item?	83
Measuring the Height	83
Measuring the Thickness	85
Performing Calculations	86
4-3 Setting the Output Conditions	87
Setting Scaling	87
Setting Filters	93
Setting Hold	98
Setting the Zero Reset	105
4-4 Setting the Banks	110
Changing the Bank Mode	110
Copying the Bank/System Settings	111
Saving the Bank/System Settings	112
Clearing the Bank Settings	113
4-5 Setting the System	114

Checking Information	114
Making Sensor Settings	115
Initializing Settings	116

5. Convenient Functions

5-1 Displaying measured values in graphs.	120
Specifying the sampling start and end conditions	122
Starting and ending sampling before and after the trigger condition is met ..	124
5-2 Saving measured values in a file.	125
Outputting the results of sampling as a file	125
Exporting the results of sampling	125
5-3 Displaying saved measured values.	128
5-4 Performing internal logging.	129
5-5 Storing the light reception wave form in a file	131
5-6 Recovering calibration ROM data	133
5-7 Printing the contents of settings	134
5-8 Controll input signal with PC tool	135

6. Communications with External Devices

6-1 Parallel I/O connection	138
I/O Signal Functions	138
Settings for Analog Output	140
Settings for Judgment Output	145
Settings for Processing When Measurement Is Not Possible	148
Settings for Bank Control	150
Settings for Internal Logging	151
Timing Chart	152
6-2 EtherCAT Connection.	159
Overview of EtherCAT Networks	159
ZW Communications Methods in an EtherCAT Connection	162
Setting Communications Specifications (EtherCAT Communications)	165
List of I/O Ports for Each Area (PDO Mapping) and Memory Assignments ..	166
Timing Chart (EtherCAT)	189
Sample Ladder Program (EtherCAT)	195
Sysmac Device Features	196
6-3 EtherNet/IP Connection	198
Introduction to EtherNet/IP	198
ZW Communications for EtherNet/IP Connections	200
Setting Communications Specifications (EtherNet/IP)	203
Tag Data Link Setting Methods	205
Memory Assignments and Commands	208
Timing Chart (EtherNet/IP)	220

Sample Ladder Program (EtherNet/IP)	225
6-4 No-protocol Connection	226
Outline of No-protocol Communications	226
Setting Up No-protocol Communications	227
Setting Communications Specifications (RS-232C Communications)	230
Setting for serial data output after application of measured value	231
Command List	235
Command Format	237

7.Offline Settings

7-1 Performing Settings Offline	262
7-2 Starting a Project in Offline Mode	263
7-3 Changing between Online and Offline	264
7-4 Offline Debugging of the Sensor Control Program and Sensor Operation	265

8.Troubleshooting

8-1 Error Messages	270
Errors for EtherCAT Connection (Sysmac Error Status)	270
Errors for EtherCAT Connection (SDO)	281
Errors for Ethernet or EtherNet/IP Connection	282
Errors Common to All Communication States	283
8-2 Troubleshooting	284

9.Sensor controller operations

9-1 Search from Menu Tree	288
FUN Mode Menu	288
RUN (run) Mode Menu	293
9-2 Functions of Operating Keys	294
9-3 Digital Displays	295
9-4 Switching operation modes	296
9-5 Functions and Operations during Measurement	298
Switching the RUN (Run) Mode Display	298
9-6 Setting Sensing	302
Setting the Material of the Target to Measure	302
Setting Start Direction of Count Measurement Surfaces	303
Setting Exposure Time Control Mode	304
9-7 Setting Measurement Items	305
Measuring the Height	305
Measuring the Thickness	306
Calculating	307

9-8 Setting the Output Conditions	310
Setting the Filter	310
Setting Scaling	314
Setting Hold	318
Setting the Zero Reset	322
9-9 Setting the Banks	326
Switching Banks	326
Changing the Bank Mode	327
Copying the Bank Settings	328
Saving the Bank/System Settings	329
Clearing the Bank Settings	330
9-10 Setting Threshold Value	331
Teaching	331
Direct	333
9-11 Setting the System	334
Checking Information	334
Setting the Key Lock	335
Calibrating Sensor Head	336
Initializing Settings	337
9-12 Connecting Parallel I/O	338
Settings for Analog Output	338
Settings for Judgment Output	342
Settings for Processing When Measurement Is Not Possible	344
Setting for Internal Logging	346
9-13 Connecting with EtherCAT	348
Setting Fieldbus	348
Setting GATE Signal ON Time	349
9-14 Connecting with EtherNet/IP	350
Network Settings of the Sensor	350
Setting Fieldbus	351
9-15 Connecting by No-protocol Communications	352
Initial Settings for No-protocol Communications	352
Setting Communications Specifications (RS-232C Communications)	353
Setting Serial Data Output	354
Set the delimiter	355

10.APPENDICES

10-1 Specifications and External Dimensions	358
Sensor Head	358
Sensor controller	370
PC tools (Sysmac Studio)	374
Accessories	375
EMC Directive Conformity	379

10-2 Firmware update	380
Use PC tools (Sysmac Studio) to update.	380
Performing the Update on Warp Engine ZW	381
10-3 Processing Item Data List	384
10-4 System data list.	388
10-5 Object Dictionary	390
Object Dictionary Area	390
Data type	390
Description Format of Objects	391
Communication Object	392
PDO Mapping Object	395
Sync Manager Communication Object	399
Manufacturer Unique Objects	402
Index	443
Revision History	446

Search from Settings

Settings	Set by Sysmac Studio	Set by Sensor Controller
Setting the Material for the Target to Measure	p.75	p.302
Setting Exposure Time Control Mode	p.79	p.304
Measuring the Height	p.83	p.305
Measuring the Thickness	p.85	p.306
Calculating	p.86	p.307
Setting the Filter	p.93	p.310
Setting the Scaling	p.87	p.314
Setting the Hold	p.98	p.318
Setting the Zero Reset	p.105	p.322
Changing the Bank Mode	p.110	p.327
Copying the Bank/System Settings	p.111	p.328 (Bank Settings only)
Saving the Bank/System Settings	p.112	p.329
Clearing the Bank Settings	p.113	p.330
Checking Information	p.114	p.334
Setting the Key Lock	p.115	p.335
Initializing Settings	p.116	p.337

Basic configuration

1-1 ZW-series Displacement Sensors	18
1-2 Basic Operation Flow	19

1-1 ZW-series Displacement Sensors

The ZW-series is a line of fiber coaxial displacement sensors.

They consist of Sensor Head and Sensor Controller, calibration ROM, and exclusive setting PC tool which runs on personal computers for system settings and monitoring.

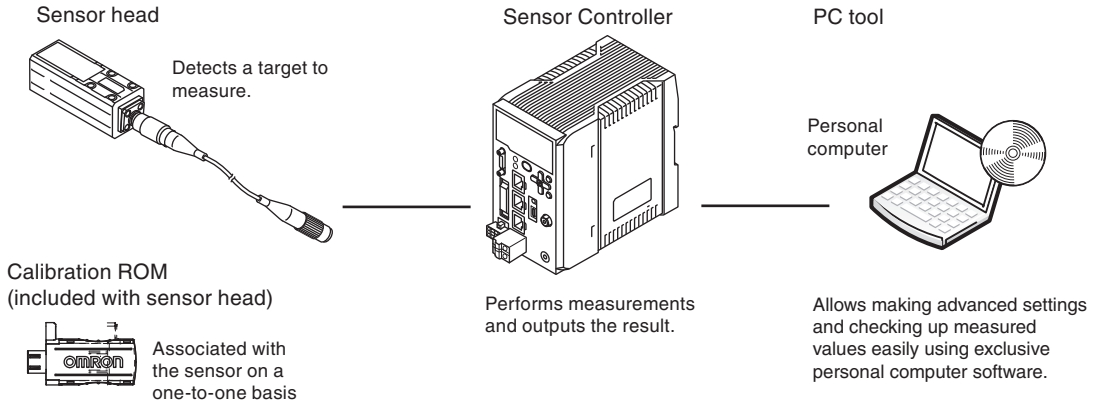

Types of Sensor Controllers

The ZW Series has two types of Controllers (hereinafter be referred to as "Sensor Controller" in this document.). Differences are described below.

Model	ZW-C1□T/ZW-C1□AT	ZW-CE1□T
I/O Specifications	EtherCAT and EtherNet/IP not mounted, Binary output device mounted	EtherCAT and EtherNet/IP mounted, Binary output device not mounted
PC tool	Sysmac Studio (Measurement Sensor Edition)/ Smart MonitorZW version 1.10 or later	Sysmac Studio (Standard Edition)/ Sysmac Studio (Measurement Sensor Edition)/Smart MonitorZW version 1.10 or later

1-2 Basic Operation Flow

The following is the basic operation flow for ZW Series.

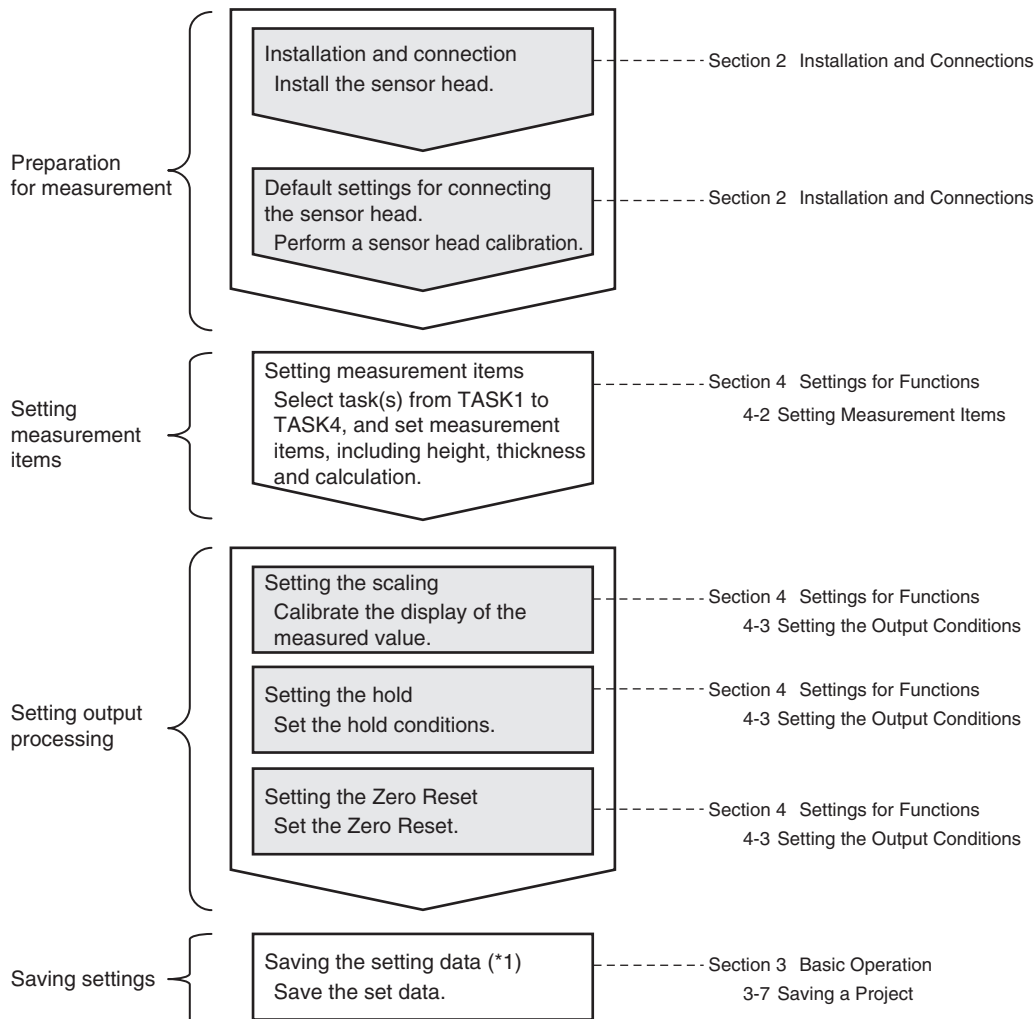

(*1) After you have made or changed settings, be sure to save the setup data. All set data will be cleared if you turn the power OFF without saving the data.

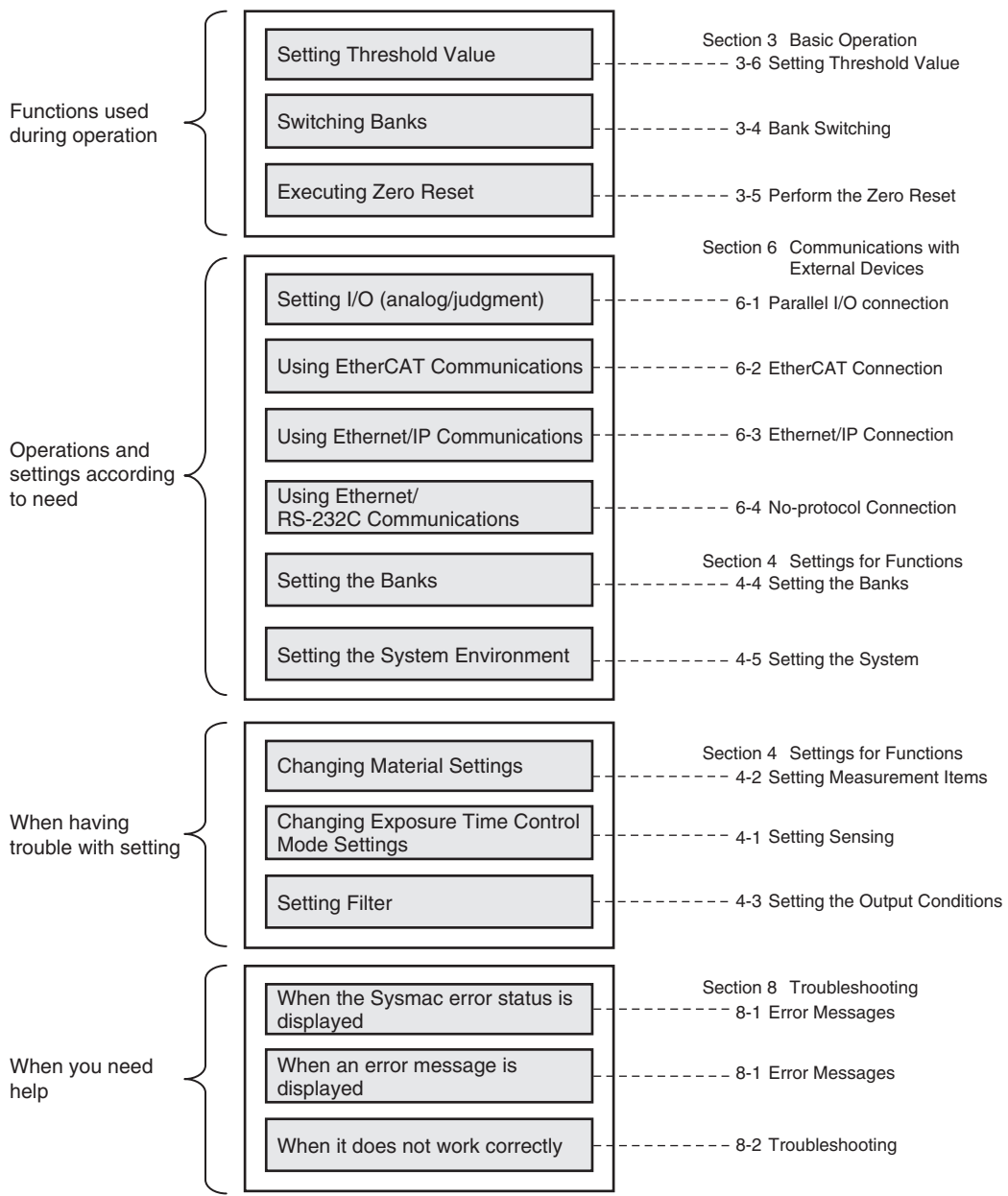

Installation and Connections

2-1 System Configuration	22
2-2 Part Names and Functions	25
2-3 Installation	30
2-4 Wiring	44
2-5 Installing the Sysmac Studio.	51

2-1 System Configuration

System Configuration

Connecting with EtherCAT (when the master is NJ Series)

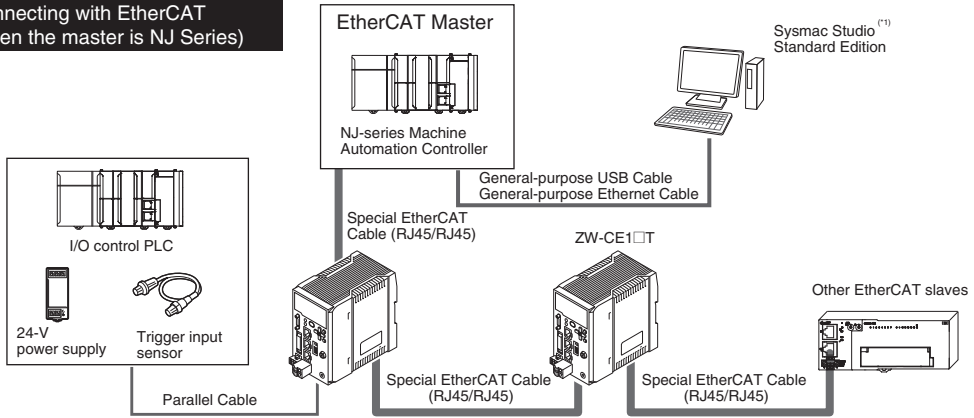

Connecting with EtherCAT (when the master is other than NJ Series)

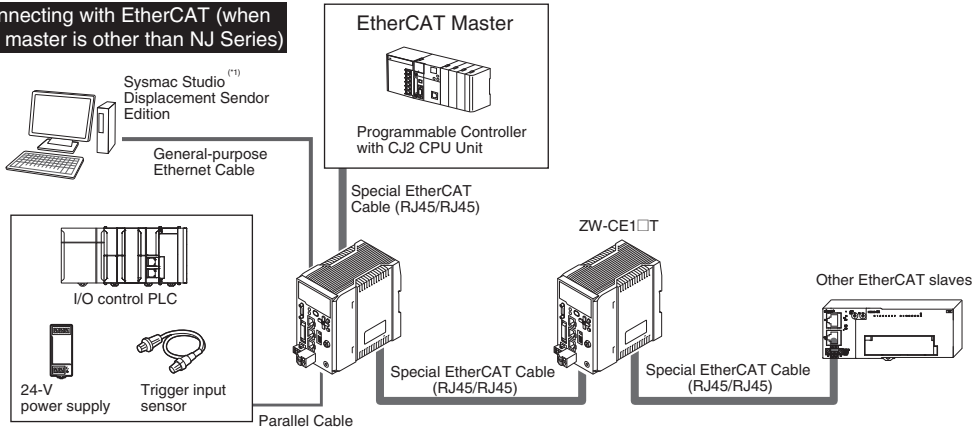

Ethernet/IP and No-protocol Ethernet Connections

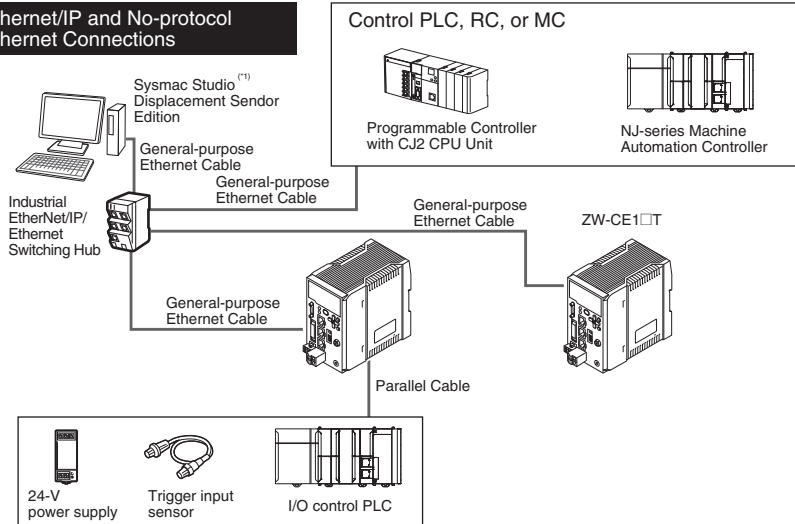

(*) If you use Smart Monitor ZW, Connect the PC and the ZW to control.

Connection Compatibility

Connected to ZW-CE1□T	Other connection				
	EtherCAT	EtherNet/IP	Ethernet (no-protocol)	RS-232C (no-protocol)	I/O Cable
EtherCAT	---	Not compatible	Compatible	Compatible	Compatible
EtherNet/IP	Not compatible	---	Compatible	Compatible	Compatible
Ethernet (no-protocol)	Compatible	Compatible	---	Compatible	Compatible
Ethernet (programmable no- protocol)	Compatible	Compatible	Compatible	---	Compatible

Important

- EtherCAT and EtherNet/IP connections cannot be used at the same time.
- Can be connected simultaneously via Ethernet with PC tools (Sysmac Studio, SmartMonitorZW) and another device (PLC etc). Can be connected simultaneously via Ethernet with PC tools (Sysmac Studio, SmartMonitorZW) and another device (PLC etc). The port number for the PC tool is fixed to 9600. When connecting different devices, set the port number to other than 9600 (default value is 9601).

Product	Model	Application
ZW	ZW-CE1□T	This Displacement Sensor performs measurements.
PC Tool	<p>Sysmac Studio Standard Edition</p> <ul style="list-style-type: none"> • SYSMAC-SE200D (no licenses included (media only)) • SYSMAC-SE201L (1-license edition) • SYSMAC-SE2□□L (multilicense editions (3, 10, 30, or 50 licenses)) <p>Sysmac Studio Measurement Sensor Edition</p> <ul style="list-style-type: none"> • SYSMAC-ME2□□L (1 or 3 licences) 	<p>This is the setup application. It is part of the Sysmac Studio Package and it runs on Windows.</p> <p>The Sysmac Studio comes in two different editions.</p> <ul style="list-style-type: none"> • Sysmac Studio Standard Edition The Sysmac Studio provides an integrated development environment for the NJ-series Controllers and other Machine Automation Controllers and EtherCAT Slaves. It supports setup, programming, debugging, operation, and maintenance. The Sysmac Studio Standard Edition DVD includes Support Software for EtherNet/IP, DeviceNet, serial communications, and PT screen design (CX-Designer). Refer to the Sysmac catalog (Cat. No. PXXX) for details. • Sysmac Studio Measurement Sensor Edition This license provides the functions that are required to set up ZW Vision Sensors from the Sysmac Studio. This model number is for the license only. You must also purchase the DVD for the Sysmac Studio Standard Edition Ver.1.05 or higher.
Special EtherCAT Cable	Refer to 10-1 Specifications and Dimensions	The Special EtherCAT Cable connects the Sensor to another Sensor or to another EtherCAT device.
General-purpose Ethernet cable	---	<p>Prepare commercially available Ethernet cable satisfying the following requirements:</p> <ul style="list-style-type: none"> • Category 5e or more, 30 m or less • RJ45 connector (8-pin modular jack) • For direct connection: Select cross cable. • For connection through an industrial switching hub: Select straight cable.
Special I/O Cable	<p>For connecting to a PLC or programmable terminal</p> <ul style="list-style-type: none"> • ZW-XPT2 <p>For connecting to a PC</p> <ul style="list-style-type: none"> • ZW-XRS2 	Connect the sensor with a PLC, programmable terminal, or personal computer etc..
Industrial EtherNet/IP / Ethernet Switching Hub	<ul style="list-style-type: none"> • W4S1-03B (3 ports type) • W4S1-05B • W4S1-05C (5 ports type) 	The Switching Hub connects multiple Sensors to one Touch Finder or one computer running PC Tool.

Product	Model	Application
EtherCAT Junction Slave	<ul style="list-style-type: none">• GX-JC03 (3 ports type)• GX-JC06 (6 ports type)	Used to connect multiple sensors or PLCs using EtherCAT.

2-2 Part Names and Functions

The following describes the names and functions of parts of the Sensor Head, Calibration ROM and Sensor Controller.

Sensor Head

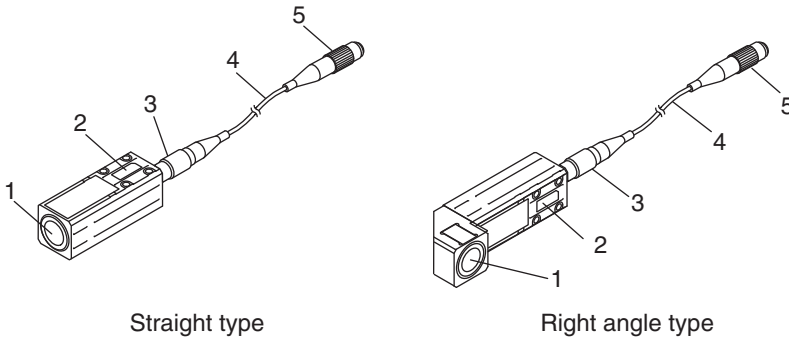

No.	Names	Functions
1	Projector/receiver	Projects and receives light.
2	Serial number.	Serial number. Only a calibration ROM with the same serial number is available.
3	Fiber interface	Interfaces the Sensor Head and optical fiber (unremovable).
4	Fiber Cable	Sends or receives light signals to/from the Sensor Controller.
5	Fiber Connector	Couples the Sensor Controller and fiber cable.

Calibration ROM

This ROM is associated with the sensor on a one-to-one basis, and operates connected to the Sensor Controller.

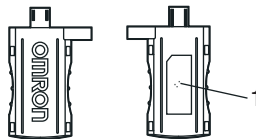

No.	Names	Functions
1	Serial number	Serial number. Only a Sensor Head with the same serial number is available.

Important

Use with the Calibration ROM always connected. If the Calibration ROM is not connected, an error is displayed.

Sensor Controller

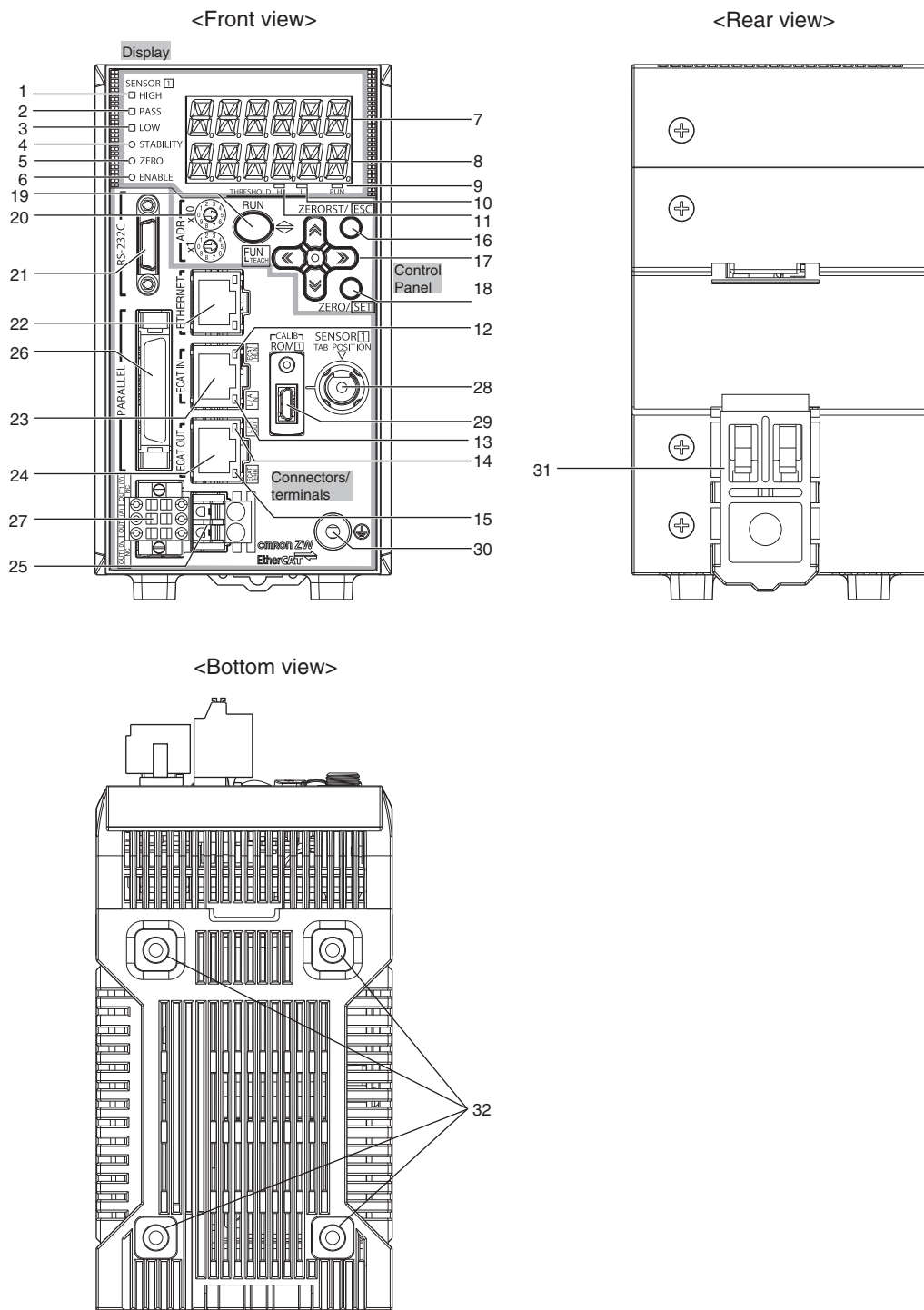

Front view

● Display

No.	Names (light color)	Functions
1	HIGH indicator (orange)	The HIGH indicator is lit while judgment is resulted in HIGH (HIGH threshold value < measured value).
2	PASS indicator (green)	The PASS indicator is lit while judgment is resulted in PASS (LOW threshold value ≤ measured value ≤ HIGH threshold value).
3	LOW indicator (orange)	The LOW indicator is lit while judgment is resulted in LOW (measured value < LOW threshold value).
4	STABILITY indicator (green)	The STABILITY indicator is lit while a measured value is within the measuring range. It goes out if a measured value is out of the measuring range.
5	ZERO indicator (green)	The Zero Reset indicator is lit while the zero reset function is enabled.
6	ENABLE indicator (green)	The ENABLE indicator lights when the Sensor is ready for measurement. It goes off when measurement is not possible (e.g. when the received light amount is excessive or insufficient, when the measuring range is exceeded, when the calibration ROM is not connected, or when measurement is not being performed in FUN mode).
7	Main display (red)	The main display shows measured values and/or function names.
8	Sub-display (green)	The sub-display shows additional information for measured values or setting values for functions.
9	RUN indicator (green)	The RUN indicator is lit in the RUN mode, and goes out in the FUN mode.
10	THRESHOLD-L indicator (orange)	The LOW threshold value indicator is lit when the Sub-display indicates a LOW threshold value.
11	THRESHOLD-H indicator (orange)	The HIGH threshold value indicator is lit when the Sub-display indicates a HIGH threshold value.
12	ECAT RUN indicator (green)	ECAT RUN indicator lights up when EtherCAT communication is established.
13	L/A IN indicator (green)	L/A IN indicator lights up when connected with the EtherCAT device. Flashes when communication (data input) is performed.
14	L/A OUT indicator (green)	L/A OUT indicator lights up when connected with the EtherCAT device. Flashes when communication (data output) is performed.
15	ECAT ERROR indicator (red)	ECAT ERROR indicator lights up when an EtherCAT communication error occurs.

● Control panel

No.	Names	Functions
16	ZERORST/ESC key	 9-2 Functions of Operating Keys p.294
17	← (LEFT) key → (RIGHT) key ↑ (UP) key ↓ (DOWN) key	
18	ZERO/SET key	
19	Mode switching key	
20	Node address setting switches	These switches are used to set the node address as an EtherCAT communications device. The setting range is 01 to 99.

● Connectors/terminals

No.	Names	Functions
21	RS-232C connector	Connect the RS-232C cable when you are connecting the system with a PLC or personal computer through RS-232C. For the RS-232C cable, please use the following exclusive products: If you use a cable not included in the exclusive products, a false operation or breakdown may result. <ul style="list-style-type: none"> • For connecting to a PLC or programmable terminal: ZW-XPT2 • For connecting to a PC: ZW-XRS2
22	Ethernet connector	This connector is used to connect with a personal computer through Ethernet. Prepare commercially available Ethernet cable satisfying the following requirements: <ul style="list-style-type: none"> • Category 5e or more, 30 m or less • RJ45 connector (8-pin modular jack) • For one-to-one connection: Select cross cable. • For connection through an industrial switching hub: Select straight cable. (Recommended hub: W4S1-0□ (Omron))
23	EtherCAT input connector	This connector is used to connect to EtherCAT-compatible devices. Use the recommended EtherCAT cable.
24	EtherCAT input output connector	This connector is used to connect to EtherCAT-compatible devices. Use the recommended EtherCAT cable.
25	24 V input terminal block	This connector is used to connect to Sensor Controller DC24 V power supply. The length of Cables should be less than 30 m.
26	32-pole extension connector	This connector connects the parallel I/Os, including output for judgment, ALARM, BUSY or ENABLE, or input for ZERO, RESET, TIMING, LED-OFF or LOGGING, or bank number output and bank number selection input.
27	Analog output terminal block	This connector connects the output for analog voltage and analog current. The length of Cables should be less than 30 m.
28	Fiber connector	The fiber connector connects the fiber cable.
29	ROM connector	The ROM connector connects the calibration ROM.
30	Frame ground terminal	This is the connector for frame ground. It connects grounding wire.

Rear view

No.	Names	Functions
31	DIN track attachment hook	Used when fixing the Sensor Controller on DIN track.

Bottom view

No.	Names	Functions
32	Installation screw hole	Used when fixing the Sensor Controller with screws.

Detailed LED specifications are given below.

LED name	Color	Status	Contents
ECAT RUN indicator	Green	OFF	Initialization status
		Blinking	Pre-Operational status
		Single flash	Safe-Operational status
		ON	Operational status
ECAT ERROR indicator	Red	OFF	No error
		Blinking	Communication setting error or PDO mapping error
		Single flash	Synchronization error or communications data error
		Double flash	Application WDT timeout
		ON	PDI WDT timeout
L/A IN indicator	Green	OFF	Link not established in physical layer
		Flickering	In operation after establishing link
		ON	Link established in physical layer
L/A OUT indicator	Green	OFF	Link not established in physical layer
		Flickering	In operation after establishing link
		ON	Link established in physical layer

Note

The timing of the flashing of the EtherCAT operation indicators is as follows:

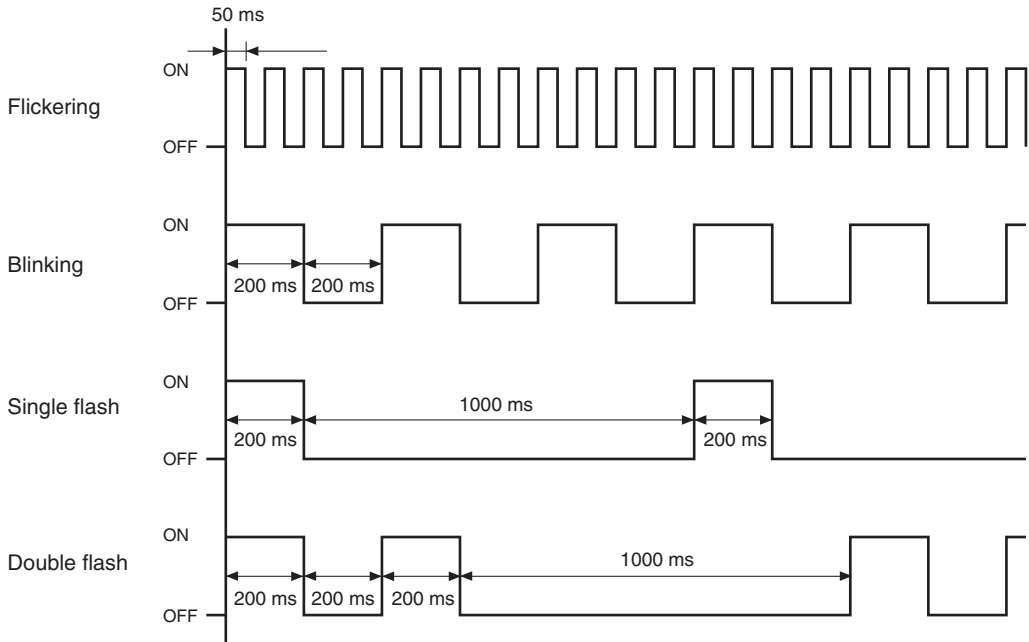

2-3 Installation

Installation of Sensor Head

Installation procedure

- 1 Place the Sensor Head with an appropriate distance from the target to measure, fixing it by tightening four M3 screw inserted into their respective installation holes.

Tightening torque: 0.54 N • m

 10-1 Specifications and External Dimensions p.358

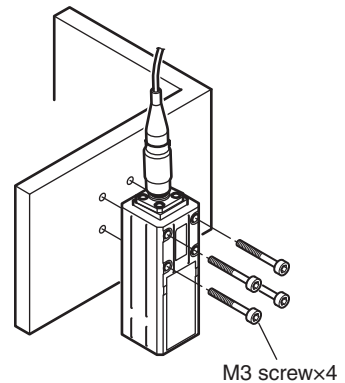

Important

- For the location screw holes, see the external dimensions.
- When measuring on a high-reflectivity object, such as a mirror or wafer, false measured values beyond the measuring range may be outputted. When an object with diffuse reflection is used, we recommend installing and adjusting while watching the position of the spot.

Basic precautions for installation

Do not install the Sensor Head in a place where strong light hits the laser emitter/receiver section of the Sensor Head. Also, if an object has a shiny surface, the light from the lighting will be reflected and a malfunction may occur. In such a case, prevent reflection by, for example, covering the light to stop reflection.

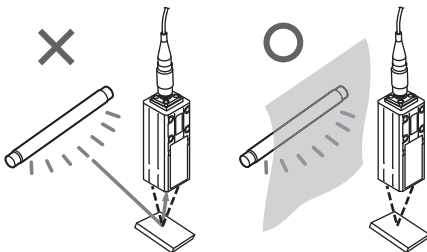

Measuring range

With the ZW series, the measurement center distance is expressed as 0 with the NEAR side as + and the FAR side as -.

Straight type

● ZW-S07

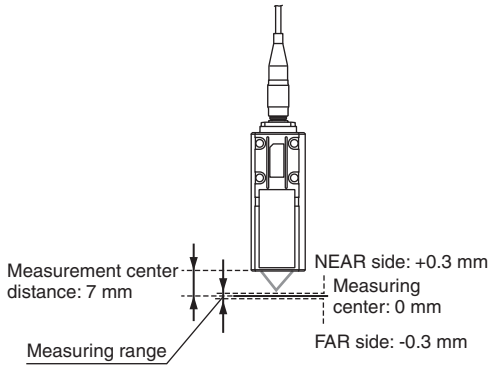

● ZW-S20

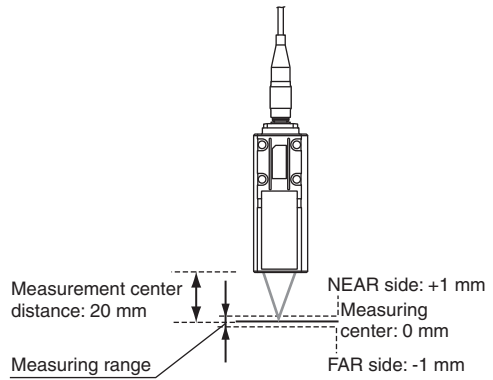

● ZW-S30

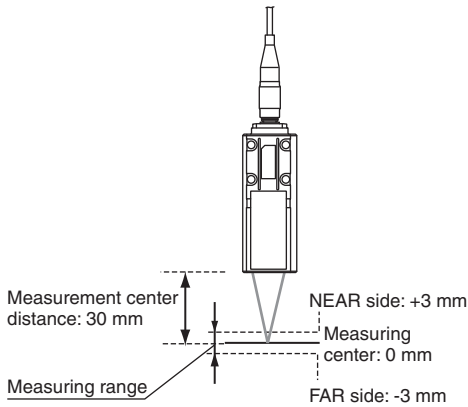

● ZW-S40

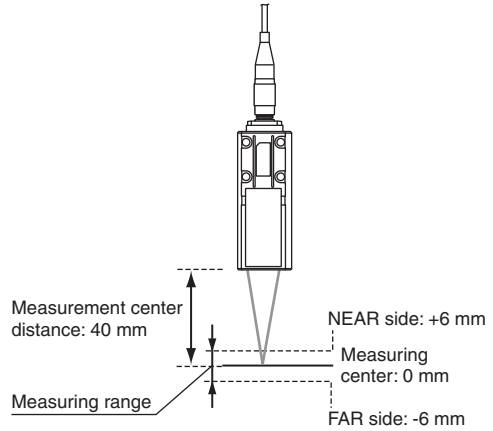

Right angle type

● ZW-SR07

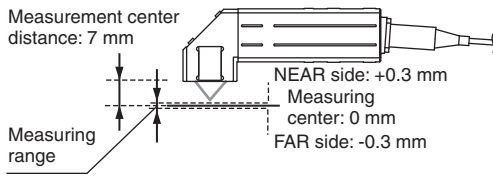

● ZW-SR20

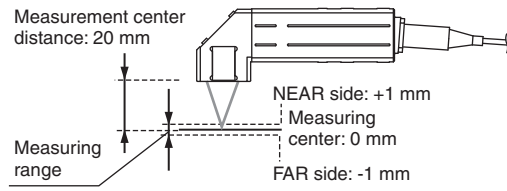

● ZW-SR40

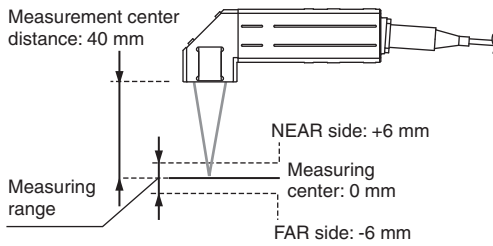

Mutual interference

When using two or more Sensor Heads next to each other, mutual interference will not occur if other beam spots are outside the ■ areas in the following diagrams.

Straight type

● ZW-S07

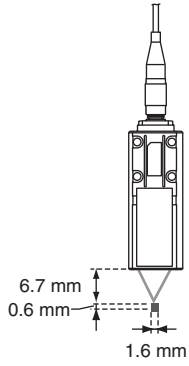

● ZW-S20

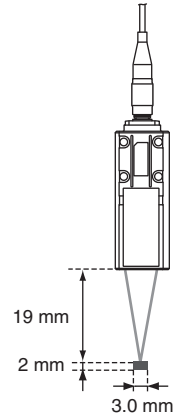

● ZW-S30

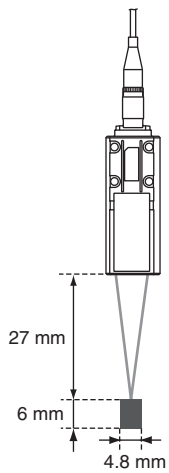

● ZW-S40

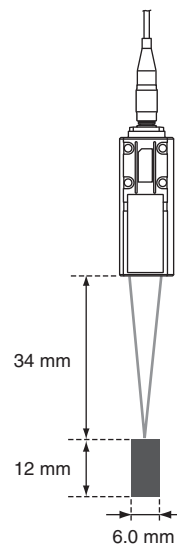

Right angle type

● ZW-SR07

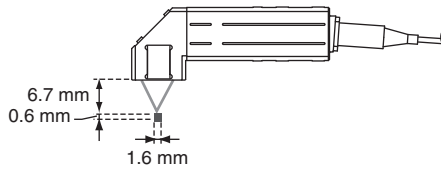

● ZW-SR20

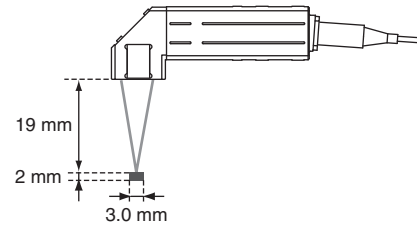

● ZW-SR40

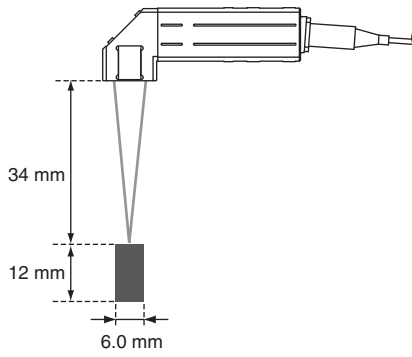

Installation of Sensor Controller

Precautions for installation

Install the Sensor Controller in the orientation indicated by the circle mark in the following figure. Do not install it laying on its side or upside down.

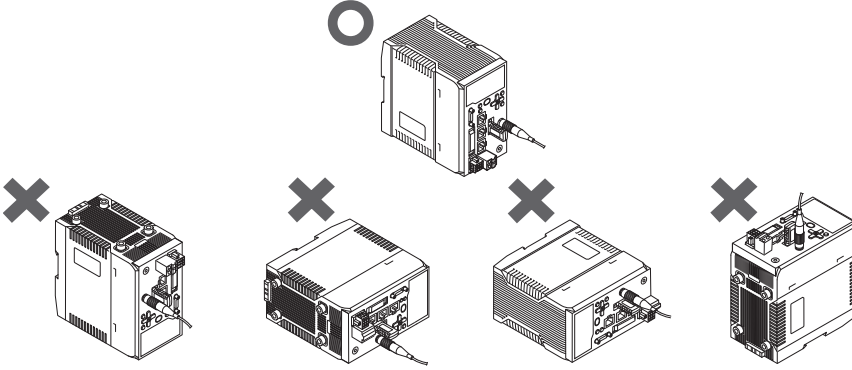

For adequate intake and/or exhaust, keep the Sensor Controller clear by 30 mm or more on its top, and by 10 mm or more from either side.

To secure the Sensor Head and cables connected safely, keep the front of the Sensor Controller clear by 65 mm or more.

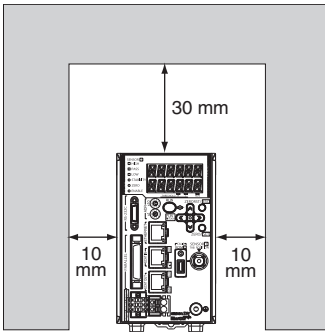

If more than one Sensor Controller must be placed in parallel, place them 10 mm or more apart each other, keep them clear by 30 mm or more on their top and 30 mm or more under them.

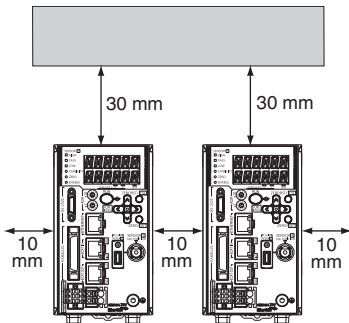

Important

Do everything possible to avoid installation in a location with vibration.

Installing on the DIN track

The following describes how to attach the Sensor Controller on a 35 mm-wide DIN track.

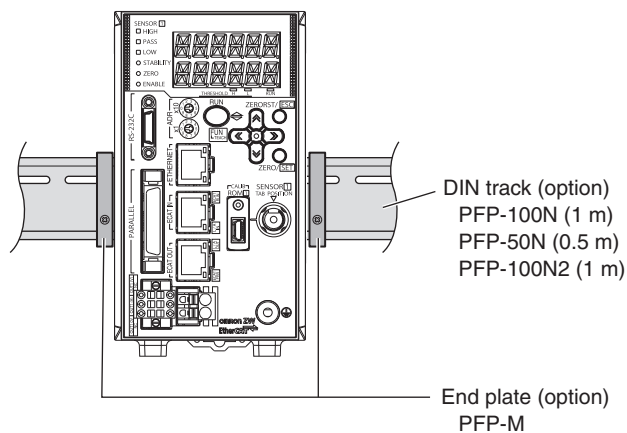

Installation procedure

- 1** Hook the upper edge of the Sensor Controller's back slot onto the upper edge of the DIN track.
- 2** Push the Sensor Controller down onto the DIN track until the DIN track attachment hook is locked. Push in until you hear a "click" sound.

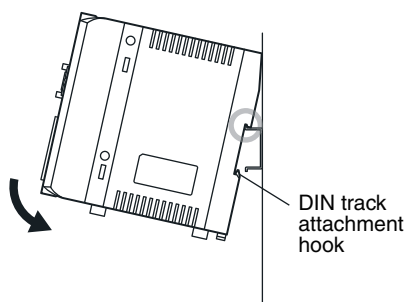

Important

Always hook the upper edge of the slot on the Sensor Controller's back first onto the DIN track. Hooking the Sensor Controller starting from the lower edge of the slot may impair the mounting strength. After completely installing the Sensor Controller, make sure that it is securely fixed.

Removal procedure

- 1** Pull DIN track attachment hook downwards using a slotted screwdriver or an equivalent.
- 2** Lift up the Sensor Controller from the lower side, and remove it from the DIN track.

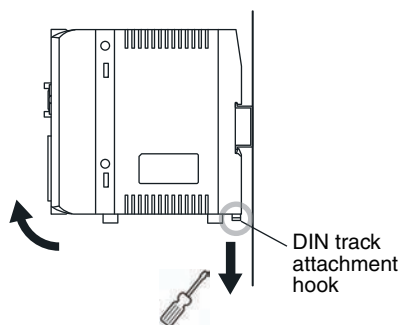

Installing on bottom

The following describes how to attach the Sensor Controller on its bottom.

1 Drill four installation holes on the base.

Important

For the location installation holes, see the external dimensions.

 10-1 Specifications and External Dimensions
p.358

2 Tighten four M4 screws to fix the Sensor Controller on the base.

Tightening torque: 1.2 N • m

Sensor Controller thread depth: 6 mm

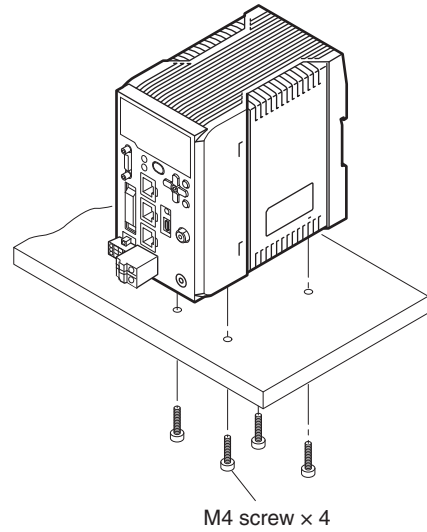

Connecting Calibration ROM

To connect the calibration ROM to the Sensor Controller, follow the steps below:

1 Connect the calibration ROM to the ROM connector on the Sensor Controller.

2 Fix the calibration ROM by tightening the supplied M2 screw.

Tightening torque: 0.15 N • m max.

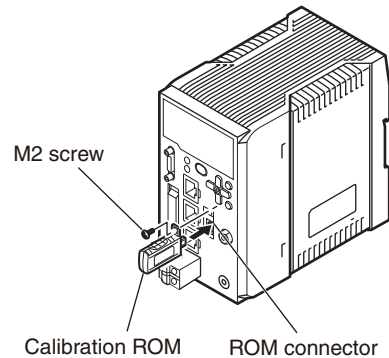

Important

- Before connecting or disconnecting the calibration ROM, make sure that the Sensor Controller's power supply is turned OFF. The Sensor Controller may break down if the calibration ROM is connected while the power is ON.
- Use with the Calibration ROM always connected. If the Calibration ROM is not connected, an error is displayed.
- Only a calibration ROM and Sensor Head with a same serial number are compatible. When connecting a calibration ROM with a Sensor Head, make sure that they have a same serial number, or measurement cannot be performed correctly.

Connecting Fiber Cable

Connect the fiber cable on the Sensor Head to the Sensor Head connector on the Sensor Controller as follows:

- 1 Remove the protective caps from the Sensor Controller's fiber connector and the fiber cable.**

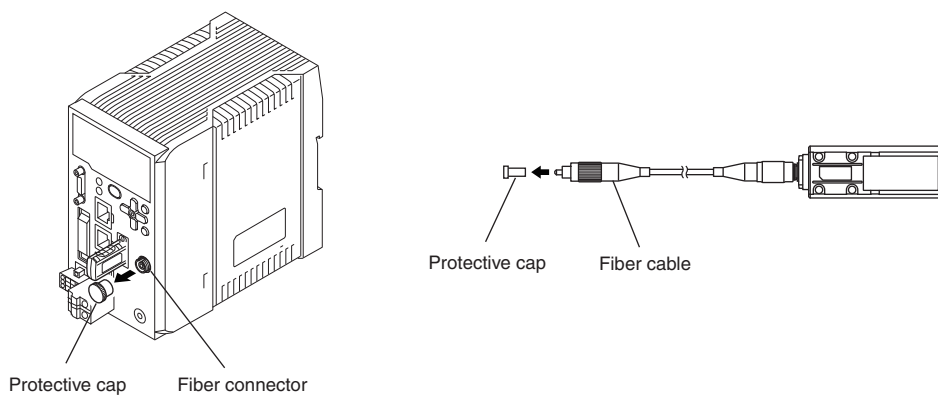

Important

Do not discard but keep the protective cap handy.

- 2 Mate the convex section on the fiber cable with the groove on the fiber connector and turn the threaded section clockwise while pushing in (see figure 1).**

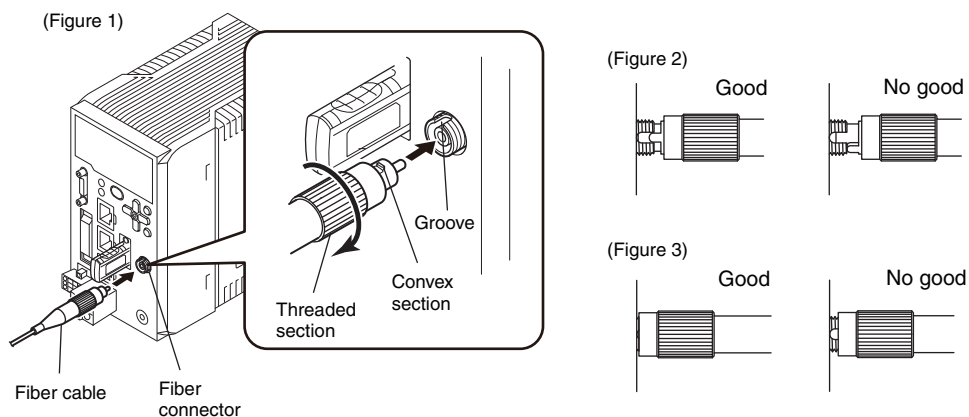

In the "No good" status in figure 2 and figure 3, optic signals cannot be transmitted and correct measurement is not possible. Always check that the system is in the "Good" status.

Important

- Handling fiber cables

Use them in compliance with the following.

- Fiber cable bend radiuses must be at least 20 mm.

- Do not let bending cause stress at the connecting section of a fiber connector.

- Do not yank hard on a fiber cable.

- Do not step on a fiber cable or place anything heavy on it.

- Do not touch the end surface of a fiber cable, or the cable may be degraded in performance. Should the end surface be touched or soiled, wipe the dirt away using a commercially available cleaner exclusive for fiber or dry and soft cloth. Do not use a cloth moistened with alcohol, or the dirt may be reattached.

We recommend the following product as the fiber cleaner.

Point	Item	Model	Manufacturer
Tip of fiber cable	OPTIPOP R1	ATC-RE-01	NTT Advanced Technology Corporation

- Use the optional ZW-XCL when cleaning the groove of the fiber connector.



Fiber connector cleaner p.376

- The fiber cable and fiber connectors should not be left with their protective caps removed, not even for a short period of time. Leaving them unprotected can let dirt get on the end surface and cause performance deterioration.
- Calibrate the Sensor Head after removing and inserting a fiber cable.



Calibrating Sensor Head p.42

Extending fiber cable

To extend the fiber cable on the Sensor Head, use an extension fiber cable and connecting adapter.

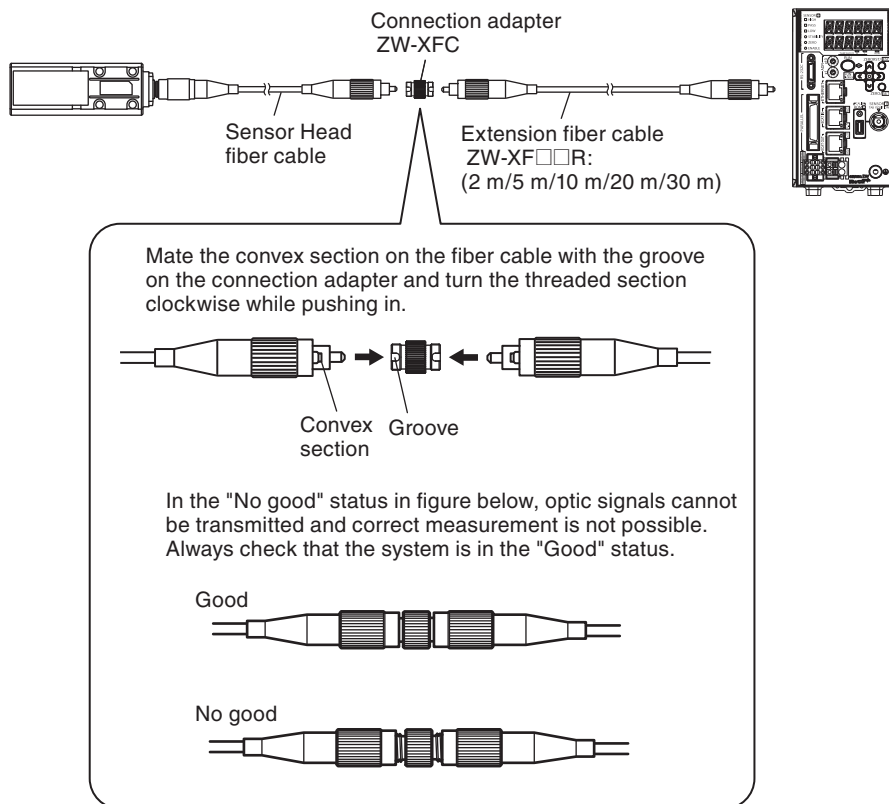

Extension fiber cable (option)

Model	Length
ZW-XF02R	2 m
ZW-XF05R	5 m
ZW-XF10R	10 m
ZW-XF20R	20 m
ZW-XF30R	30 m

Connecting adapter (option)

Model
ZW-XFC

Important

- The connection adapter (ZW-XFC) comes packed together with the extension fiber cable (ZW-XF□□R).
- Never use any extension fiber cable and/or connecting adapter other than those specified in the above.
- Hold the combined length of the normal and extension fiber cables to no more than 32 m.
- Only one fiber cable is allowed to extend the normal fiber cable. Never use two or more extension fiber cable connected together.
- Do not touch the end surface of a fiber cable, or the cable may be degraded in performance. Should the end surface be touched or soiled, wipe the dirt away using a commercially available cleaner exclusive for fiber or dry and soft cloth. Do not use a cloth moistened with alcohol, or the dirt may be reattached.

We recommend the following product as the fiber cleaner.

Point	Item	Model	Manufacturer
Tip of fiber cable	OPTIPOP R1	ATC-RE-01	NTT Advanced Technology Corporation

- Use the optional ZW-XCL when cleaning the groove of the fiber connector.

 Fiber connector cleaner p.376

- The fiber cable and fiber connectors should not be left with their protective caps removed, not even for a short period of time. Leaving them unprotected can let dirt get on the end surface and cause performance deterioration.
- Calibrate the Sensor Head after removing and inserting an optical fiber.

 Calibrating Sensor Head p.42

Calibrating Sensor Head

Calibrate the Sensor Head by obtaining the dark data in the no-incoming light status.

- When removing and inserting a fiber cable from/to the Sensor Controller (Including the initial connection).
- When extending a fiber cable.

The calibration data is stored inside the Sensor Controller. Therefore, if the sensor head is calibrated once, as long as the fiber connection state does not change (if it is not disconnected from or connected to the Sensor Controller or an extension added), this operation is not needed each time.

The Sensor Head should be calibrated without any object within the measuring range or with the tip of the Sensor Head shielded from light with an object with diffuse reflection.

(Correct calibration is not possible with a transparent object, semi-transparent object, or mirror.)

- Without any object within the measuring range
- With light shielded

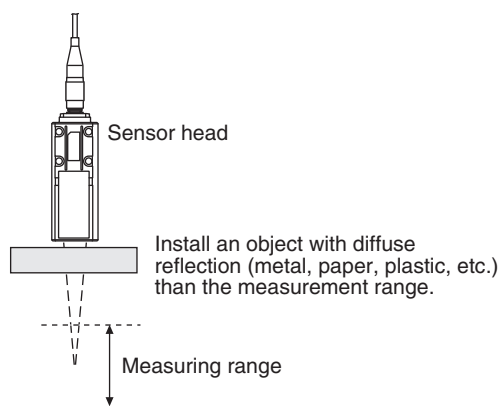
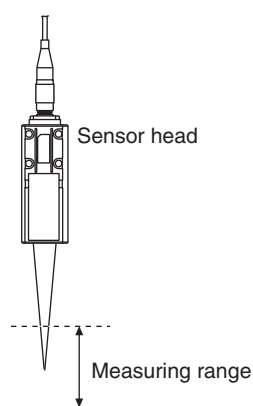

1 Set the operation mode to FUN mode.

 3-3 Switching operation modes p.61

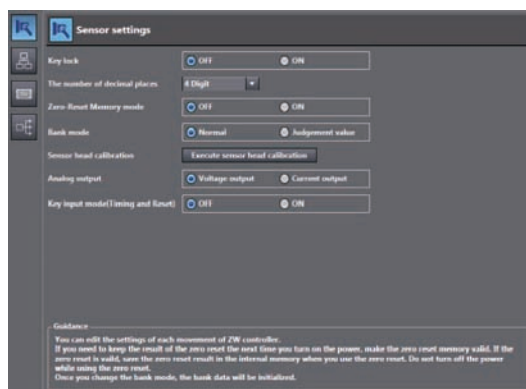

- ▶ Explorer pane : [Device Group] | [(Sensor Name)] | [System] | [System Data] (double click)
→ Edit pane: [Sensor Settings] icon ()

2 Click [Sensor head calibration] - [Execute sensor head calibration].

Sensor head calibration is executed.

Important

When Sensor Head calibration fails

If the Sensor Head is calibrated in an inappropriate environment, an error is displayed on the main display. If this happens, check the environment and try again. If an error continues even after calibrating the Sensor Head in an appropriate environment, the fiber connector on the Sensor Head or Sensor Controller may be stained. Clean the fiber cable or fiber connector referring to p.39.

Note

Calibrating Sensor Head can also be set by the operating keys on the Sensor Controller.



Calibrating Sensor Head p.336

2-4 Wiring

32-pole extension connector

Used for judgment output, control input, etc.

Compatible connector: FX2B series (Hirose Electric Co., Ltd.)

A parallel cable (ZW-XCP2E) for an extension connector with 2 m cable is included.

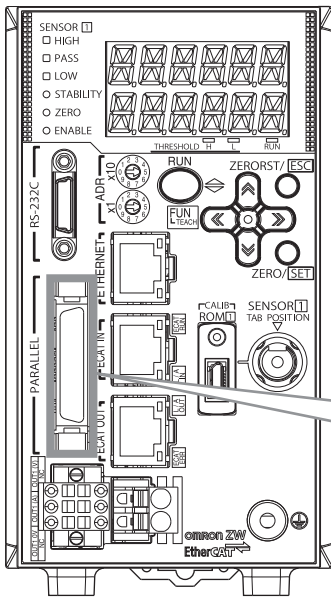

Color ^{(*)1}	Signal name	No. ^{(*)2}		Signal name	Color ^{(*)1}
Blue	COM_IN1	B16	A16	NC	Blue
Green	TIMING1	B15	A15	NC	Green
Yellow	RESET1	B14	A14	NC	Yellow
Orange	ZERO1	B13	A13	NC	Orange
Red	LED OFF1	B12	A12	NC	Red
Brown	COM_OUT1	B11	A11	NC	Brown
Black	HIGH1	B10	A10	NC	Black
White	PASS1	B9	A9	NC	White
Gray	LOW1	B8	A8	NC	Gray
Purple	ALARM	B7	A7	NC	Purple
Blue	BUSY1	B6	A6	NC	Blue
Green	ENABLE1	B5	A5	COM_IN2	Green
Yellow	COM_OUT2	B4	A4	BANK_SEL1	Yellow
Orange	BANK_OUT1	B3	A3	BANK_SEL2	Orange
Red	BANK_OUT2	B2	A2	BANK_SEL3	Red
Brown	BANK_OUT3	B1	A1	LOGGING	Brown

*1 Indicates ZW-XCP2E code color

*2 This is the layout for when the 32-pole extension connector on the Sensor Controller is viewed from front.

Important

Cut the unnecessary signal lines so that they do not touch other signal lines.

Class	Name	Description																																				
Parallel output	HIGH output	This outputs judgment results - HIGH (HIGH threshold values < Measured value).																																				
	PASS output	This outputs judgment results - PASS (LOW threshold values ≤ Measured value ≤ HIGH threshold values).																																				
	LOW output	This outputs judgment results - LOW (LOW threshold values > Measured value).																																				
	ALARM output	This turns ON when there is a system error.																																				
	BUSY output	This turns ON during sampling with the hold function enabled. It allows you to check whether or not the self-trigger is functioning correctly. It also turns ON during bank switching.																																				
	ENABLE output	This turns ON when the sensor is ready for measurement. This output is interlocked with the ENABLE indicator.																																				
	BANK_OUT output	This outputs the currently specified bank number. It expresses the bank number in combinations of BANK_OUT1, 2 and 3. <table border="1" data-bbox="491 556 1067 913"> <thead> <tr> <th>Bank Number</th> <th>BANK_OUT1</th> <th>BANK_OUT2</th> <th>BANK_OUT3</th> </tr> </thead> <tbody> <tr> <td>BANK1</td> <td>OFF</td> <td>OFF</td> <td>OFF</td> </tr> <tr> <td>BANK2</td> <td>ON</td> <td>OFF</td> <td>OFF</td> </tr> <tr> <td>BANK3</td> <td>OFF</td> <td>ON</td> <td>OFF</td> </tr> <tr> <td>BANK4</td> <td>ON</td> <td>ON</td> <td>OFF</td> </tr> <tr> <td>BANK5</td> <td>OFF</td> <td>OFF</td> <td>ON</td> </tr> <tr> <td>BANK6</td> <td>ON</td> <td>OFF</td> <td>ON</td> </tr> <tr> <td>BANK7</td> <td>OFF</td> <td>ON</td> <td>ON</td> </tr> <tr> <td>BANK8</td> <td>ON</td> <td>ON</td> <td>ON</td> </tr> </tbody> </table>	Bank Number	BANK_OUT1	BANK_OUT2	BANK_OUT3	BANK1	OFF	OFF	OFF	BANK2	ON	OFF	OFF	BANK3	OFF	ON	OFF	BANK4	ON	ON	OFF	BANK5	OFF	OFF	ON	BANK6	ON	OFF	ON	BANK7	OFF	ON	ON	BANK8	ON	ON	ON
Bank Number	BANK_OUT1	BANK_OUT2	BANK_OUT3																																			
BANK1	OFF	OFF	OFF																																			
BANK2	ON	OFF	OFF																																			
BANK3	OFF	ON	OFF																																			
BANK4	ON	ON	OFF																																			
BANK5	OFF	OFF	ON																																			
BANK6	ON	OFF	ON																																			
BANK7	OFF	ON	ON																																			
BANK8	ON	ON	ON																																			
Parallel input	ZERO input	This is used to execute and clear a zero reset.																																				
	RESET input	This resets all executing measurements and outputs. While a RESET is being input, judgment output conforms to the non-measurement setting. If this RESET input switches ON while the hold function is used, the state in effect before the hold function was set will be restored.																																				
	TIMING input	This is a signal input from an external device that is used to time the hold function with the continuous measurement function enabled. This is a signal input from an external device that is used to time the measurement with the trigger measurement function enabled.																																				
	LED OFF input	This LED-OFF signal puts out the measurement LED. While LED-OFF is being input, the analog output, binary output, and judgment output conform to the non-measurement setting.																																				
	BANK_SEL input	This is used for switching banks. Specify the bank number in combinations of BANK_SEL1, 2 and 3. However, if the bank mode is set to "JUDGEMENT", the bank cannot be switched at the external signal input because the number of banks increases to 32. <table border="1" data-bbox="491 1377 1067 1734"> <thead> <tr> <th>Bank Number</th> <th>BANK_SEL1</th> <th>BANK_SEL2</th> <th>BANK_SEL3</th> </tr> </thead> <tbody> <tr> <td>BANK1</td> <td>OFF</td> <td>OFF</td> <td>OFF</td> </tr> <tr> <td>BANK2</td> <td>ON</td> <td>OFF</td> <td>OFF</td> </tr> <tr> <td>BANK3</td> <td>OFF</td> <td>ON</td> <td>OFF</td> </tr> <tr> <td>BANK4</td> <td>ON</td> <td>ON</td> <td>OFF</td> </tr> <tr> <td>BANK5</td> <td>OFF</td> <td>OFF</td> <td>ON</td> </tr> <tr> <td>BANK6</td> <td>ON</td> <td>OFF</td> <td>ON</td> </tr> <tr> <td>BANK7</td> <td>OFF</td> <td>ON</td> <td>ON</td> </tr> <tr> <td>BANK8</td> <td>ON</td> <td>ON</td> <td>ON</td> </tr> </tbody> </table>	Bank Number	BANK_SEL1	BANK_SEL2	BANK_SEL3	BANK1	OFF	OFF	OFF	BANK2	ON	OFF	OFF	BANK3	OFF	ON	OFF	BANK4	ON	ON	OFF	BANK5	OFF	OFF	ON	BANK6	ON	OFF	ON	BANK7	OFF	ON	ON	BANK8	ON	ON	ON
	Bank Number	BANK_SEL1	BANK_SEL2	BANK_SEL3																																		
BANK1	OFF	OFF	OFF																																			
BANK2	ON	OFF	OFF																																			
BANK3	OFF	ON	OFF																																			
BANK4	ON	ON	OFF																																			
BANK5	OFF	OFF	ON																																			
BANK6	ON	OFF	ON																																			
BANK7	OFF	ON	ON																																			
BANK8	ON	ON	ON																																			
LOGGING input	This is used to start and end internal logging.																																					

Analog output terminal block

Used for analog output.

Compatible cable specifications: AWG 18 to 28, pin processed length: 7 mm

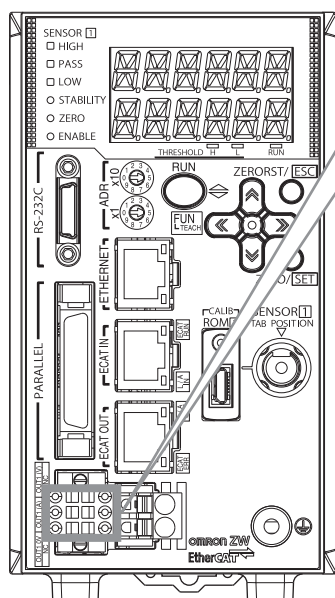

Signal name	No.	Signal name
OUT1(V)	1 4	NC
OUT1(A)	2 5	NC
OUT1 0V	3 6	NC

Important

Cut the unnecessary signal lines so that they do not touch other signal lines. The length of Cables should be less than 30 m.

Class	Name	Description
Analog output	OUT1 (V)	This outputs the measured value, from -10 V to +10 V as the voltage value. When measurement not possible: Approx. +10.8 V (default value; can be selected by user) Alarm: Approx. 10.8 V
	OUT1 (A)	This outputs the measured value, from 4 mA to 20 mA as the current value. When measurement not possible: Approx. +21mA (default value; can be selected by user) Alarm: Approx. +21 mA
	OUT1 0V	0 V for analog voltage output.

- 1 Loosen the two fixing screws using a screwdriver to remove Analog output terminal block from the Sensor Controller.

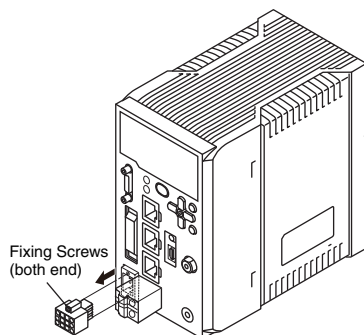

- 2 Push in and hold the release button next to the terminal hole using a screwdriver while pushing the wire fully into the terminal hole and remove the screwdriver.

After the connection has been established, pull the wire gently, to make sure that the connection has been made securely.

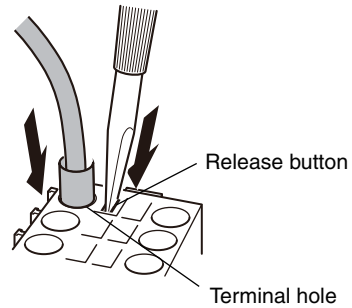

- 3 Reinstall the Analog output terminal block to the Sensor Controller.

24 V input terminal block

Used for 24 VDC power supply.

Compatible cable specifications: AWG 12 to 26, pin processed length: 10 mm

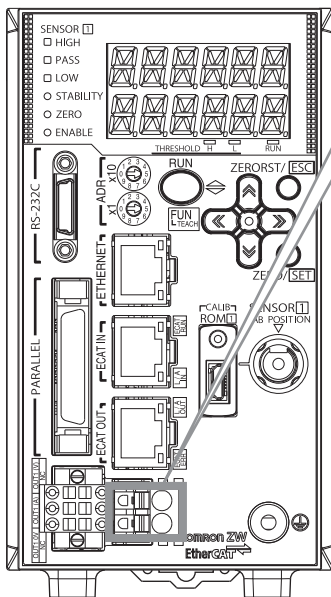

No.	Signal name
1	DC24V (-)
2	DC24V (+)

Class	Name	Description
Power Supply	DC24V (+)	Terminal for external power supply (24 V)
	DC24V (-)	Terminal for external power supply (0 V)

Important

- Wiring with the power on could result in a short-circuit or electric shock. Wire with the power off.
- Wire the power supply separate from other devices. Wiring together with other devices or using the same duct could cause a false operation or damage the sensor.
- Do not turn off the power during initial processing immediately after the Sensor Controller power is turned on, as the memory inside the Sensor Controller is being accessed. This may corrupt the data.
- Securely fasten the terminal block to prevent injury when you press in the release button with a screwdriver.
- The length of Cables should be less than 30 m.

- 1 Remove 24 V input terminal block from the Sensor Controller.**

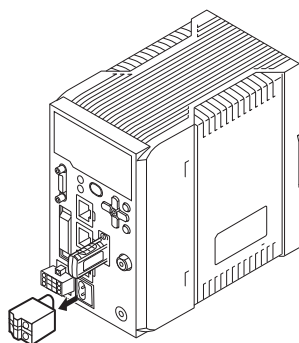

- 2 Push in and hold the release button next to the terminal hole using a screwdriver while pushing the wire fully into the terminal hole and remove the screwdriver.**

After the connection has been established, pull the wire gently, to make sure that the connection has been made securely.

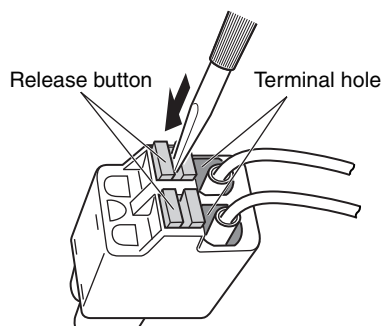

- 3 Reinstall the 24 V input terminal block to the Sensor Controller.**

Electrical Specifications

Input circuit

Item	Specifications	
Model	ZW-CE10T	ZW-CE15T
Input type	NPN	PNP
Input voltage	DC24 V \pm 10 % (21.6 to 26.4 V)	DC24 V \pm 10 % (21.6 to 26.4 V)
Input current	7 mA Typ. (DC24 V)	7 mA Typ. (DC24 V)
ON voltage/ON current *1	19 V min./3 mA min.	19 V min./3 mA min.
OFF voltage/OFF current *2	5 V max./1 mA max.	5 V max./1 mA max.
ON delay	0.1 ms max.	0.1 ms max.
OFF delay	0.1 ms max.	0.1 ms max.
Internal circuit diagram *3		

*1 ON voltage/ON current

This is the voltage value or current value that makes the signal go OFF to ON.

The ON voltage value becomes the potential difference between COM IN 1/2 and the input terminals.

*2 OFF voltage/OFF current

This is the voltage value or current value that makes the signal go ON to OFF.

The OFF voltage value becomes the potential difference between COM IN 1/2 and the input terminals.

*3 Below is a table giving the COM_IN (input common) and input signal connection correspondence.

Terminal name	COM_IN1	COM_IN2
Input terminal name	TIMING1	BANK_SEL1
	RESET1	BANK_SEL2
	ZERO1	BANK_SEL3
	LED OFF1	LOGGING

Important

Chattering countermeasures

- The sensor is designed with functions to deal with chattering, but if chattering of 100 μ s or more occurs, incorrect input due to chattering cannot be prevented. (Input signal changes of less than 100 μ s are ignored. The input signal is applied when the same level is maintained for 100 μ s or longer.)
- Always use non-contact relays (SSR, PLC transistor output) for input signals. If contact relays are used, contact bouncing may turn ON a TIMING input again during measuring.

Output circuit

Item	Specifications	
Model	ZW-CE10T	ZW-CE15T
Output type	NPN	PNP
Output voltage	DC21.6 to 30 V	DC21.6 to 30 V
Load current	50 mA max.	50 mA max.
ON residual voltage	1.2 V max.	1.2 V max.
ON leakage current	0.1 mA max.	0.1 mA max.
Internal circuit diagram *1		

*1 Below is a table giving the COM_OUT (output common) and output signal connection correspondence.

Terminal name	COM_OUT1	COM_OUT2
Output terminal name	HIGH1	BANK_OUT1
	PASS1	BANK_OUT2
	LOW1	BANK_OUT3
	ALARM	
	BUSY1	
	ENABLE1	

Important

- Connect a load that matches the output specifications. Short-circuit can cause sensor breakdown.
- Keep the load current less than or equal to the specification value. Exceeding the specification value could cause damage to the output circuit.

2-5 Installing the Sysmac Studio

The PC Tool used to set up ZW-series Displacement Sensors is installed from the Sysmac Studio Installer. Refer to the *Sysmac Studio Version 1 Operation Manual* (Cat. No. W504) for the system requirements and installation procedure.

MEMO

Basic Operation

3-1 Launching a project	54
3-2 Explanation of Screen Sections	56
3-3 Switching operation modes	61
3-4 Bank switching	62
3-5 Perform the Zero Reset	65
3-6 Setting Threshold Value	68
3-7 Saving a project	70
3-8 Operating with Sensor Controller	71

3-1 Launching a project

Connecting to the sensor with PC tool

Creating a new project

Create a new project, add a sensor to the project, then start communicating with the sensor.

1 Start up the PC tool.

2 Create a new project.

Click [New Project] and select [Displacement Sensor] from [Category] under [Select Device], and [ZW] from [Device].

Then enter [Project name], [Author], and [Comment].

Click [Create] to create a blank project.

Note

If there are existing projects, click [Open Project]. A list of the projects is displayed. Select the project you want to open and click [Open]. If an existing project is opened, it starts up in offline mode. For the details of offline mode, see below.

 Chapter 7 Offline Settings p.261

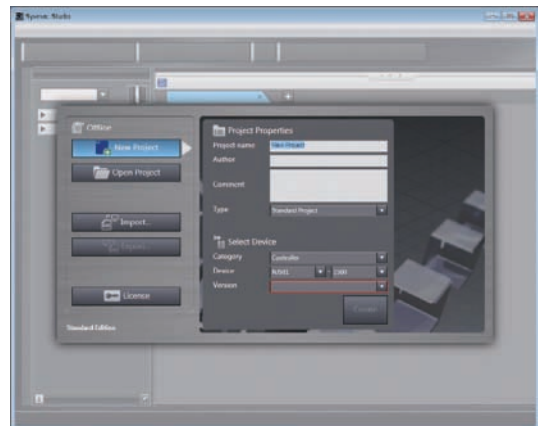

3 Specify the sensor to connect using one of the methods below.

- Directly specify the IP address of the sensor to connect. Check the [Specify a sensor] box. Then, directly enter the IP address and click [OK]. For the default value of the IP address, refer to p.203.
- When not connected with the sensor (offline) When setting a project offline without connecting to the actual sensor, check [Enter the type] to select. Then, select the sensor model and software version to use and click [OK].

 Chapter7 Offline Settings p.261

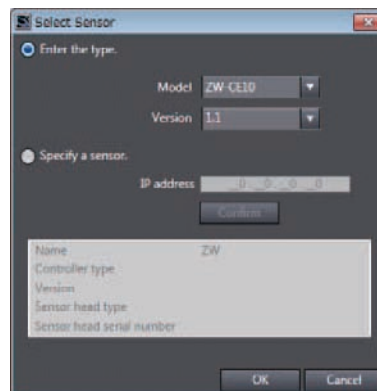

4 After the sensor is connected, the following window appears.

The Main pane appears on the Edit pane. The sensor starts up in RUN mode.

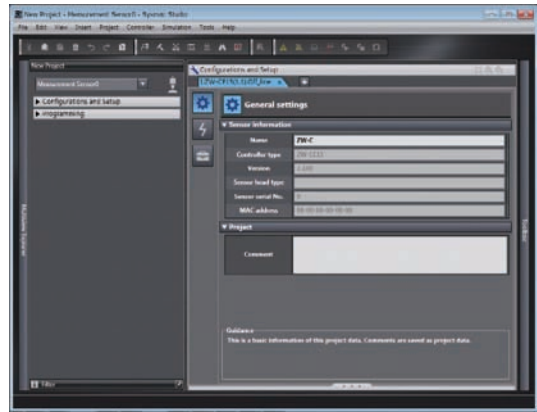

Adding a sensor to a project

After the project is created, additional sensors can be added to the project.

- **Explorer pane** : [Device Group] (right click) | [Add]

Entering project information

Comments about the project can be entered.

- **Explorer pane** : [Device Group] | [(Sensor Name)] (double click)
→ **Edit pane** : [General Settings] icon (⚙️)
- 1** Enter comments for the project in the [Comment] field.

3-2 Explanation of Screen Sections

PC tool

The following summarizes the names and functions of the window sections of Sysmac Studio.

Sysmac Studio Main window

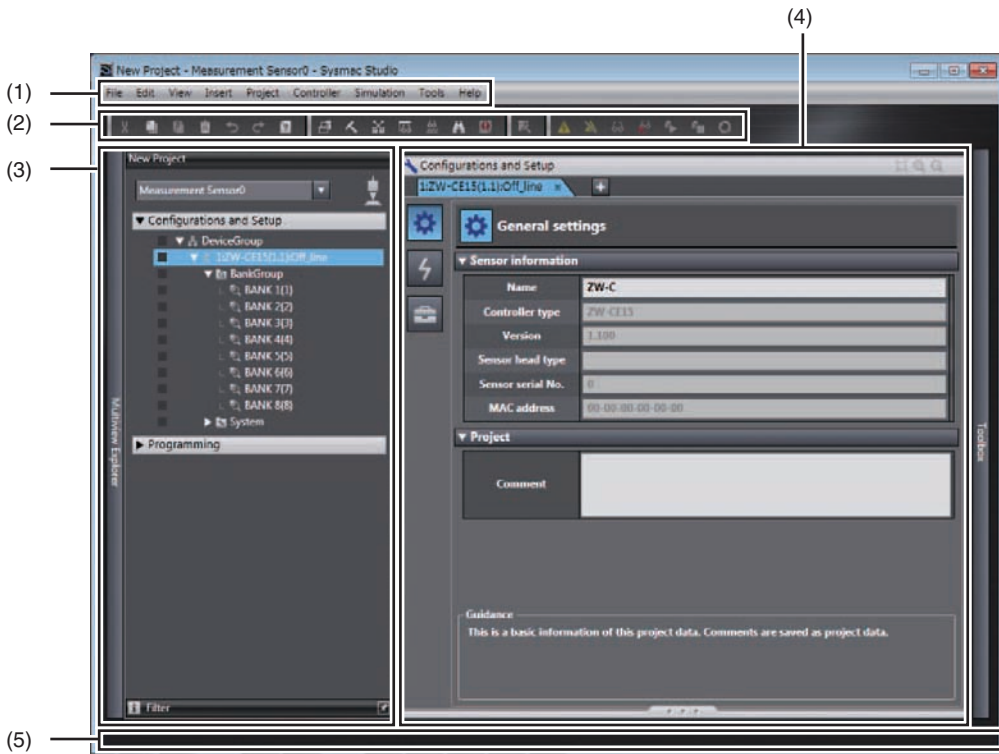

No.	Name	Description
(1)	Menu bar	Menu items that can be used with this tool is displayed.
(2)	Toolbar	Tool functions that can be used with this tool is displayed with icons.
(3)	Explorer pane	Displays the data hierarchy of the sensor with a hierarchy tree. Double clicking each data displays Main pane, Bank data edit pane, and System data edit pane on the Edit pane.
(4)	Edit pane	Edits and displays data selected in the Explorer pane. It mainly consists of Menu icon, Line bright monitor, setting items, and properties.
(5)	Status bar	Displays the status of setting operations.

Explorer pane

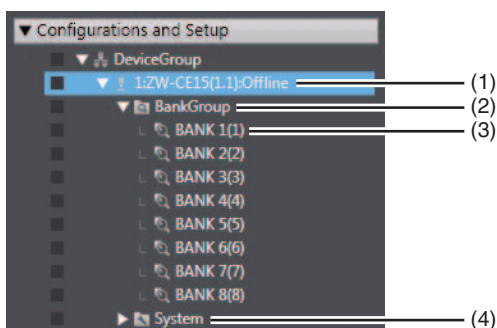

No.	Name	Description
(1)	Sensor model	Displays the sensor model. Displays online/offline status at the end.
(2)	Bank group	This is a group of bank data. Bank data can be registered up to 8 in NORMAL mode, and up to 32 in JUDGMENT VALUE BANK mode.
(3)	Bank data	This is used to set functions to perform measurements. It consists of sensing setting, task setting, and I/O setting.
(4)	System data	System data common to all banks.

A list of menu items displayed with right click

Tree view items	Menu	Description
Device group	Add ZW-C	Adds a sensor to the project.
	Paste	Pastes the copied sensor to the project.
	Rename	Changes the device group name.
Sensor model	Edit	Displays the main pane as the Edit pane.
	Delete	Deletes a sensor from the project.
	Copy	Copies a sensor.
	Online	Switches the connection status with the sensor to online.
	Offline	Switches the connection status with the sensor to offline.
	RUN	Switches the sensor to RUN mode.
	Setup	Switches the sensor to Setup mode.
	Save settings	Save the sensor settings data to nonvolatile memory.
	Initialize Sensor	Initialize the sensor.
	Restart	Restart the sensor.
	Print	Setting data is printed.
Bank data	Edit	Displays the bank data edit pane as the Edit pane.
	Copy	Copies a bank data.
	Paste	Overwrites the copied bank data.
	Initialize	Deletes (initializes) bank data.
	Rename	Changes the bank data name.
System data	Edit	Displays the system data edit pane as the Edit pane.
	Copy	Copies system data.
	Paste	Overwrites system data.

Edit pane



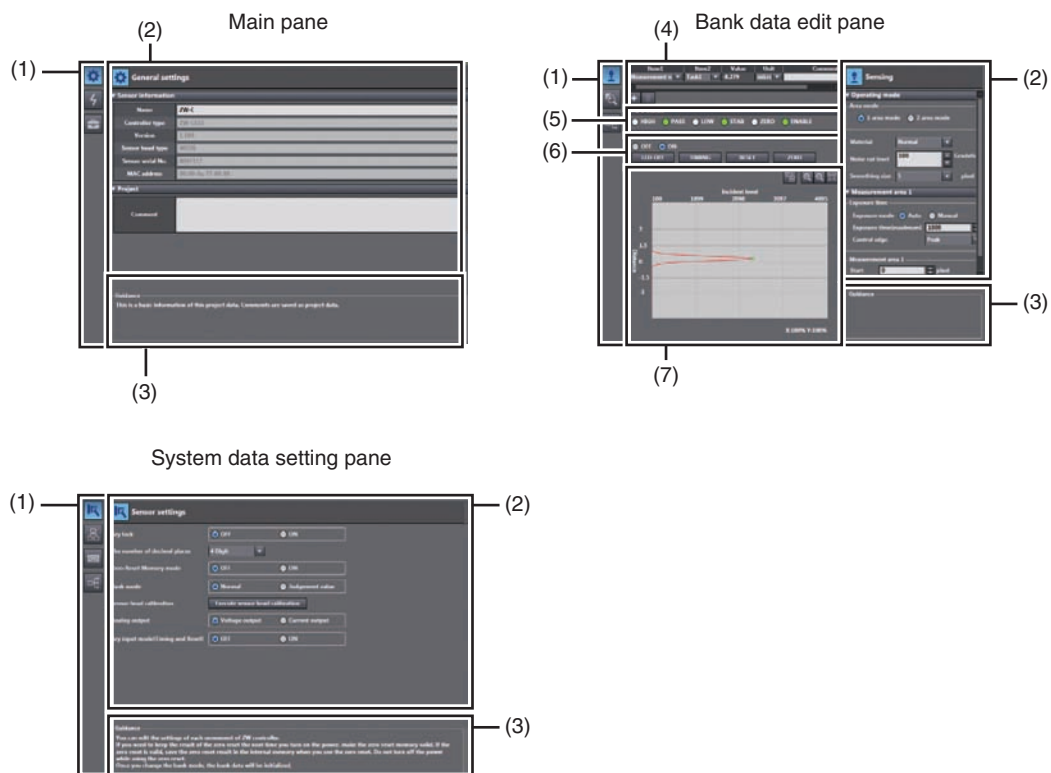







The Edit Pane changes as shown below based on what is selected in the Explorer Pane.



No.	Name	Description
(1)	Menu icon	Parameters to be edited on each edit pane can be changed.
(2)	Setting item	When editing each menu item selected with menu icons, a pop up window is called out.
(3)	Guidance	The description of the focused setting item is displayed.
(4)	Measurement value monitor	The selected measurement results or output values are displayed.
(5)	LED light	The status of each LED light is displayed when online.
(6)	I/O input	The status of I/O signals can be switched when online.
(7)	Line bright monitor	The line bright is displayed.

List of icons





(1) Menu icon

Edit pane type	Icon	Menu name	Description
Main pane		General settings	Sensor name and project information can be checked.
		Online	Switching between online and offline connections with the actual sensors, and switching the operating mode can be performed. Also, the internal logging process, saving set data, monitoring the measurement results can be performed.
		Tool	The initialization or upgrading the version of the actual sensor can be performed.
Bank data edit pane		Sensing	Switching the operation mode (1 area/2 area), and setting exposure time and measurement areas can be performed.
		Task 1	Allows you to perform setting to calculate the feature amounts of height, thickness and calculation using scaling, filter, and hold processes. Settings can be made individually for the task 1 to 4.
		I/O	Allow you to make settings for judgment output, and analog output.
System data setting pane		Sensor settings	Allows you to make sensor settings such as bank mode or analog output.
		Ethernet communication settings	Allows you to make settings for Ethernet communication.
		RS-232C communication settings	Allows you to make settings for RS-232C communication settings.
		Data output settings	Edit the data output settings.

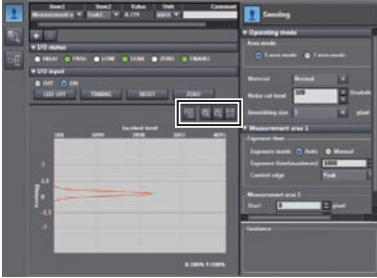
(2) Operation icons







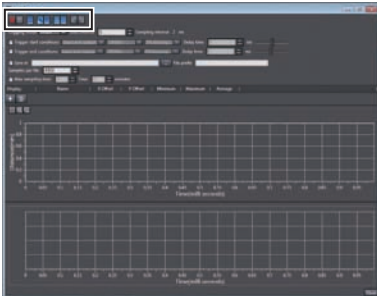

Bank data edit pane



Icon	Name	Description
	Zoom in	Zoom in the line bright.
	Zoom out	Zoom out the line bright.
	Fit to frame	Change the size of the line bright so it fits the window size.
	Export	Saves the line bright being displayed.

Trend monitor window



Icon	Name	Description
	Start sampling	Starts the sampling.
	Stop sampling	Stops the sampling.
	Show grid	Displays gridlines.
	Show configuration	Displays the logging condition setting window.
	Show data table	Displays the data window to be logged.
	Show Analog Chart	Displays the analog chart window.
	Show Digital Chart	Displays the digital chart window.
	Import	Imports the exported measurement results and display them on each chart.
	Export	Exports the measurement results displayed on each chart.

3-3 Switching operation modes

The Sensor Controller has two operation modes. One is RUN mode and the other is FUN mode. Switch to the desired mode depending on purpose.

(The Sensor Controller always starts up in the RUN mode when the power is turned on.)

Item	Setting item	Mode	Description
Online	Operation mode	RUN	Switches to RUN (operation) mode. Normal operation mode.
		Setup	Switches to Setup mode. Mode for setting the measurement conditions.

- ▶ **Explorer pane** : [Device Group] | [(Sensor Name)] (double click)
- **Edit pane** : [Online] icon (⚡)

1 Select the operation mode with [Operation mode].

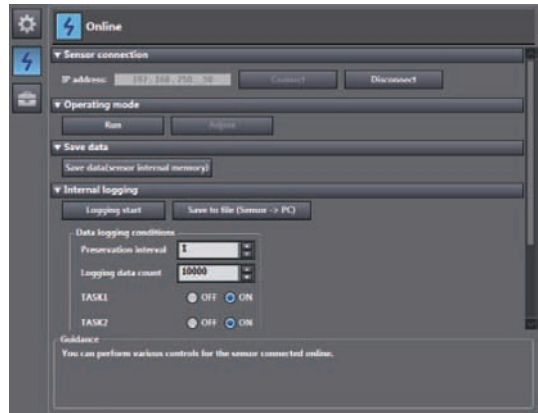

Note

Switching operation modes can also be set by the operating keys on the Sensor Controller.

9-4 Switching operation modes p.296

3-4 Bank switching

Multi-task and Bank Data

Multi-task Function

With the ZW Series, you can set multiple measurement processing for one sensing setting. This measurement processing is called a "task (TASK)."

Example: When measuring height and side run-out at the same time

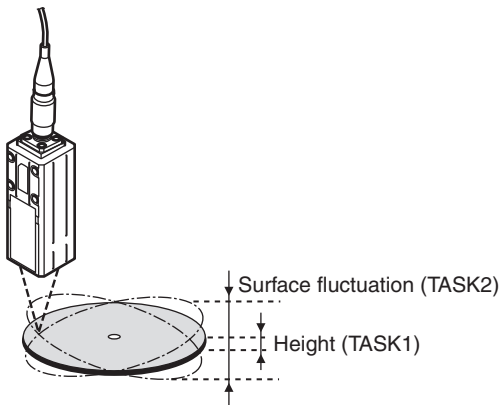

For tasks, TASK1 to TASK4 are available for registration.

You can measure and judge up to four characteristic points simultaneously because you can specify the desired measurement items such as peak, bottom, and average for each task.

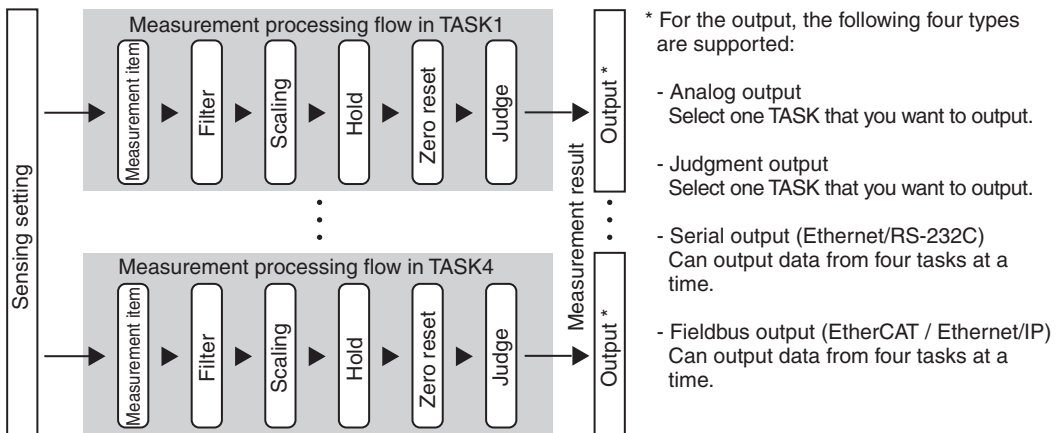

Bank Data

ZW series can hold up to eight sets of sensing settings, which are called "bank (BANK)". When the setup is changed, the bank can be switched externally.

What is Bank?

The sensing settings for measurement



are held as one bank.

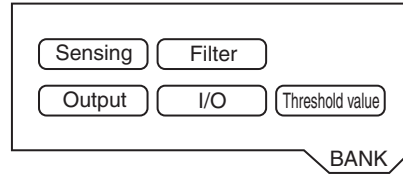

Example of switching bank for settings

If you register settings of various classes,

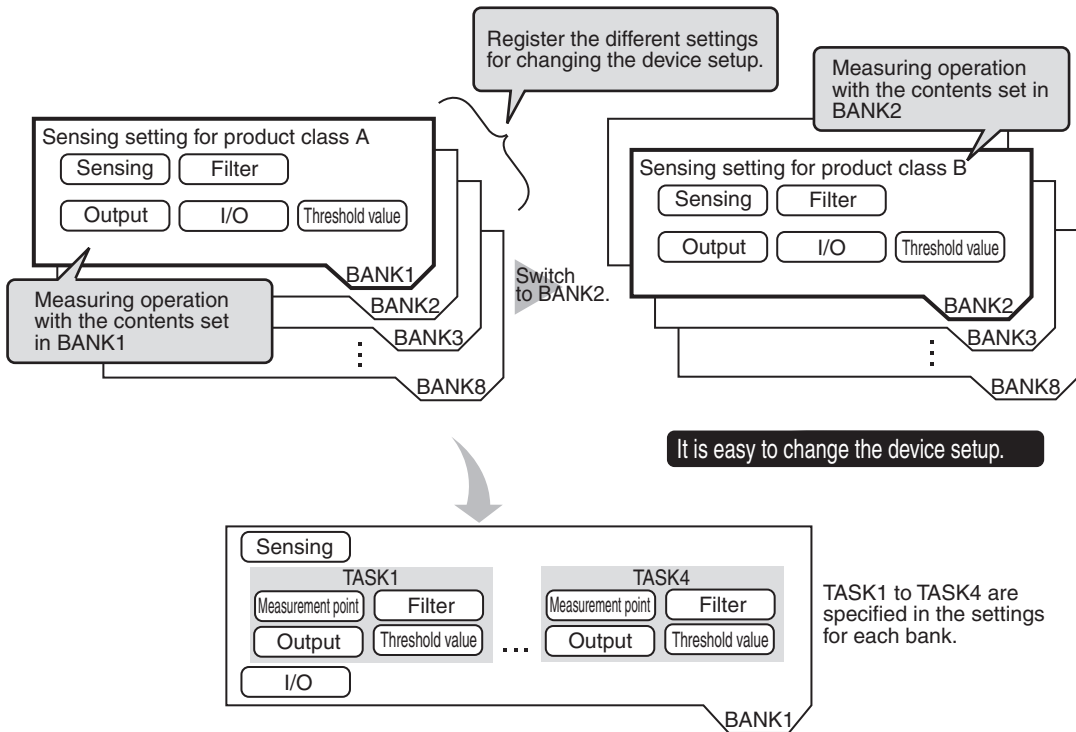

Important

- If you want to register multiple bank data having the same values set except for "threshold values (judgment values)", by changing the mode of the bank, you can increase the number of banks from 8 to 32.

Changing the Bank Mode p.110

- The "output destination" (current output value/voltage output value) in the I/O setting parameters is set the same for all banks. The output destination cannot be set separately for individual banks.

Setting the analog output destination p.140

Switching Banks

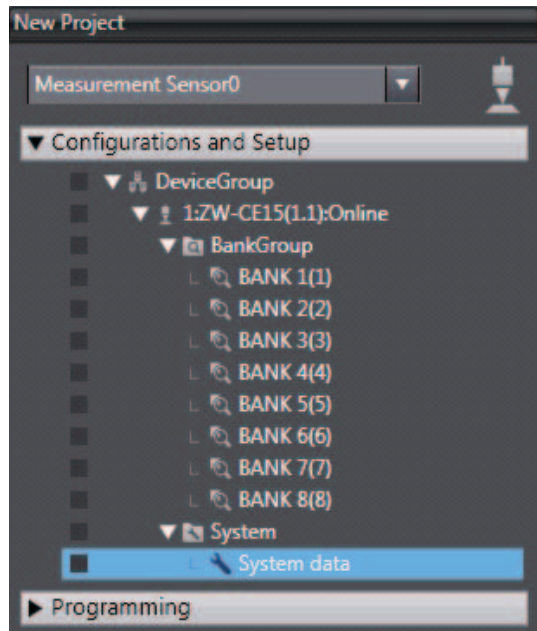

Switches banks.

- 1** Click the bank group on the Explorer pane to open.
- 2** Select the bank data to switch and double click or right click it to select the Edit menu. The bank in the Bank data edit pane that is active on the Edit pane becomes the current bank.



Important

You can also switch the bank by entering the non-procedural command or from SmartMonitor ZW.

-  Current bank data setting command <BS command> p.242
-  *SmartMonitor ZW Operation Manual*

Note

Switching Banks can also be set by the operating keys on the Sensor Controller.

-  Switching Banks p.326

3-5 Perform the Zero Reset

Zero reset

What is Zero Reset?

This function allows resetting the measured value to "0" at any timing during measurement in the RUN mode. The measured value can be displayed and output as a positive or negative deviation (tolerance) from the set reference value "0".

Example 1: Use the height of the sensing object as a reference value and the deviation is the measured value.

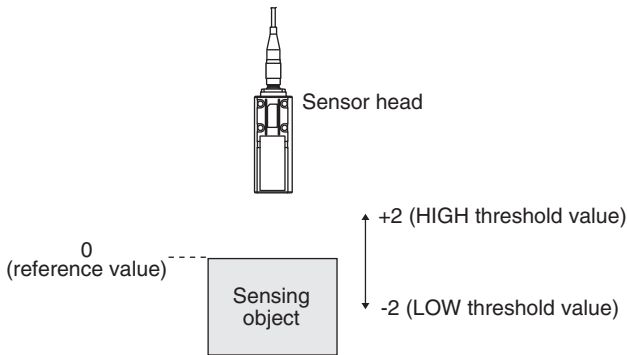

Example 2: Use the measured value according to the height of the sensing object (set 10 as an offset value)

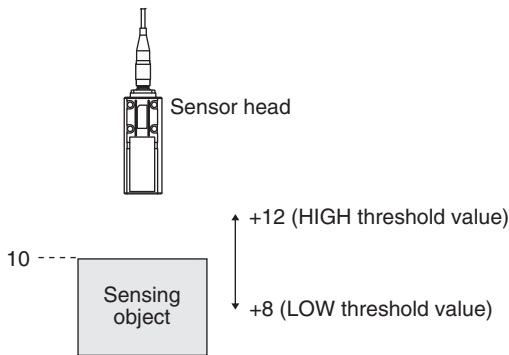

Example 3: Measure the level difference of the sensing object (execute zero reset at every measurement)

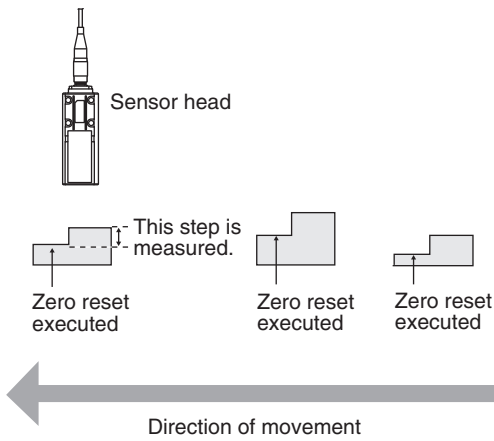

The zero reset function also allows setting the reference value to the hold value for a hold measurement or any value other than zero.

Setting the Zero Reset p.105 p.322

Executing Zero Reset

- 1 Place the reference sensing object in position.



- 2 Press the key.

The ZERO indicator illuminates and the current measured value is registered as 0.

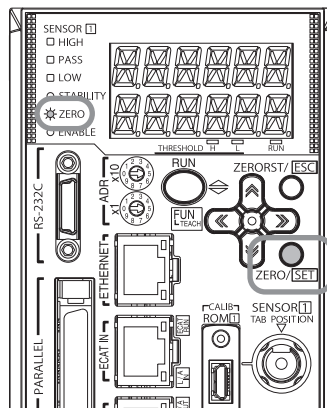

Important

- When a zero reset is executed, the analog output becomes the voltage or current value at the center of the two preset points. Analog output becomes roughly 0 V or 12 mA when focus is not set.

 Setting Monitor Focus p.142

- The Zero Reset function can also be executed by supplying a ZERO signal to the 32-pole extension connector.

 32-pole extension connector p.44

- The Zero Reset function can also be executed by turning ON the EtherCAT ZERO input signal.

 Zero reset execution p.166 p.173

Canceling Zero Reset

- 1 Press and hold the  key for two seconds.

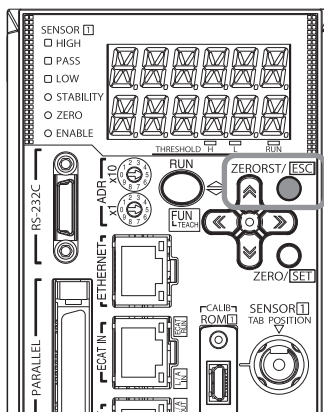
**Important**

- The Zero Reset function can also be executed by supplying a ZERO signal to the 32-pole extension connector.

 32-pole extension connector p.44

 ZERO input p.139

- The canceling Zero Reset function can also be executed by turning ON the EtherCAT ZEROCLR input signal.

 Zero reset cancel p.166 p.173

3-6 Setting Threshold Value

Threshold Value Settings

Switch the Sensor Controller to the FUN mode and set the range in order for the measured value to be judged as PASS.

Both HIGH and LOW threshold values are set.

As a judgment result, HIGH, PASS or LOW is output.

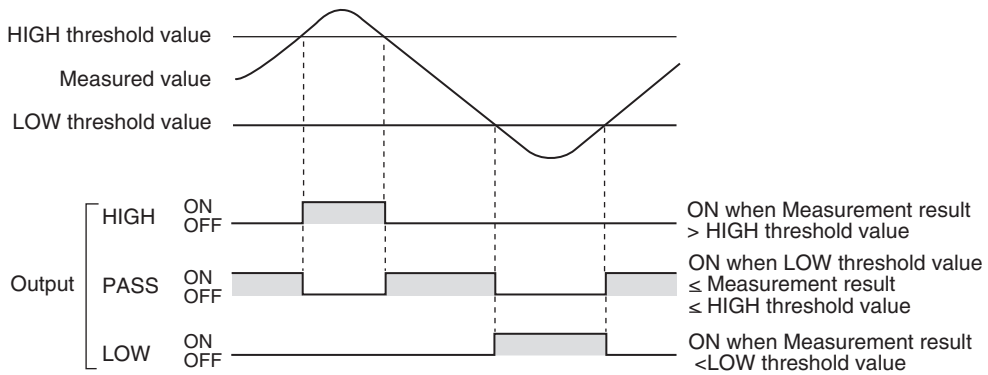

A judgment result appears on the Sensor Controller as follows.

- When the judgment result is "HIGH": HIGH indicator lights up
- When the judgment result is "PASS": PASS indicator lights up
- When the judgment result is "LOW": LOW indicator lights up

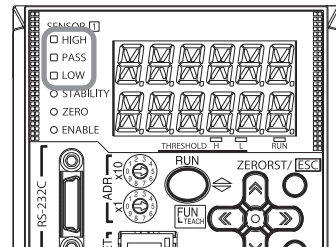

Item	Setting item	Setting value	Description
Judgment	LOW threshold	- 999.999999 to 0 (default value) to 999.999999 [mm]	Set the lower limit (LOW) threshold value.
	HIGH threshold	- 999.999999 to 0 (default value) to 999.999999 [mm]	Set the upper limit (HIGH) threshold value.

- ▶ **Explorer pane** : [Bank] | [(Bank Data Name)] (double click)
- **Edit pane** : [Task Settings] icon (🔍)
- **Task settings window** : [Judgment]

1 Enter the [LOW threshold] and [HIGH threshold].

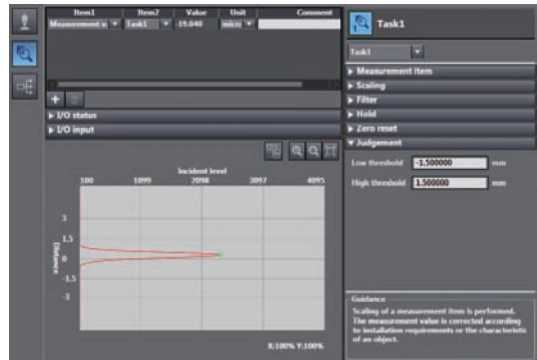

Important

- Hysteresis (hysteresis width) can also be set to threshold values. Set hysteresis when measured values are dispersed around a threshold value, and judgments are unstable, to prevent chattering.

📖 Setting Operation at Judgment Output p.146

- Threshold values can also be adjusted by directly entering values in the RUN mode. This helps you to make fine adjustments without shutting down the system.

📖 Changing Threshold Values p.301

Note

Threshold Value Settings can also be set by the operating keys on the Sensor Controller.

📖 9-10 Setting Threshold Value p.331

3-7 Saving a project

Saving a project

Save the project being edited with the PC tool.
The project to be saved has the following information.

Configuration data	Description
Project information	Information on the sensor registered in this project.
Entire sensor information	Entire sensor information.
Tool setting information	Information on tool setting parameters for each sensor registered in this project.

A project cannot be saved in RUN mode. Switch to the RUN mode to save.

Note

 3-3 Switching operation modes p.61

Important

- Save a project data when the setting of the Sensor Controller is changed. If the power is turned off without saving, the changed setting is cleared.

 Saving the Bank/System Settings p.112

1 Menu bar: Click [File] - [Save] to select.

Exporting a project

A project data (.smc) can be exported.
The exported data can be used by importing with the other personal computer's PC tool.

1 Menu bar: Click [File] - [Export] to select.

Importing a project

The exported data from other personal computers can be imported as project data.

1 Menu bar: Click [File] - [Import] to select.

3-8 Operating with Sensor Controller

Other than using PC tools, ZW Series can also be operated using the operation keys on the Sensor Controller. For details on how to operate with operation keys, see 9. Sensor controller operations.

MEMO

Settings for Function

4-1 Setting Sensing	74
4-2 Setting Measurement Items.....	83
4-3 Setting the Output Conditions	87
4-4 Setting the Banks	110
4-5 Setting the System.....	114

4-1 Setting Sensing

Selecting the Area Mode

Area modes can be used selectively according to the target to measure.

Item	Setting item	Setting value	Description
Operating mode	Area Mode	1 area mode	Usually, select this setting.
		2 area mode	We recommend measuring in the 2 area mode when the measurement object is a transparent object and the reflection characteristics of the target to measure are different. The sensing setting suitable for each the measurement surface can be used.

- **Explorer pane** : [Bank] | [(Bank Data Name)] (double click)
 → **Edit pane** : [Sensing setting] icon ()

1 Select the area mode at [Operating mode] - [Area mode].

Important

- When the 2 area mode is selected, [Measurement area 2] is added to the setting items for sensing setting.
- In the 2 area mode, the exposure time control mode and measurement area must each be set for [Measurement area 1] and [Measurement area 2].

 Setting Exposure Time Control Mode p.79

 Setting the Measurement Area p.80

- The measuring cycle for the 2-area measurement mode is twice as long as the one for Area 1 or 2, which is longer than the other.

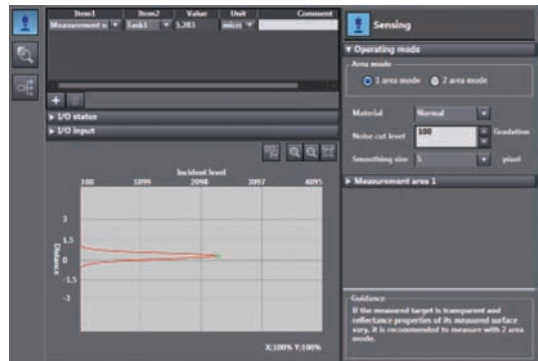

Setting the Material of the Target to Measure

Setting the material of the target to measure.

Item	Setting item	Setting value	Description
Operation mode	Material	Normal (default value)	A measurement can be performed at specific linearity regardless of the type of target to measure. Usually, select this setting.
		Mirror	Select this mode when specular reflection (regular reflection) occurs on the surface. (Glass, wafer, lustrous metal, etc.)
		Rough	Select this mode when diffuse reflection occurs on the surface.

- ▶ **Explorer pane** : [Bank] | [(Bank data name)] (double-click)
- **Edit pane** : [Sensing setting] icon ()
- **Sensing settings window** : [Operating mode]

- 1 Select the material of the target to measure at [Material].

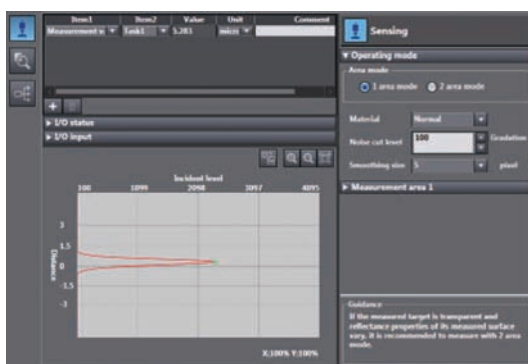

Important

Refer to p.362 for the linearity data of various materials according to each material setting.

Note

The material of the target to measure can also be set by the operating keys on the Sensor Controller.

 Setting the Material of the Target to Measure p.302

Setting the Noise Cut Level

The setting a larger value than the noise level, the noise can be cut.

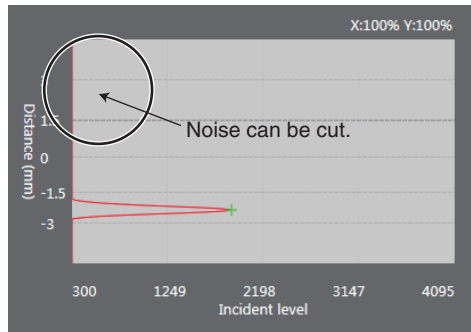

Item	Setting item	Setting value	Description
Operation mode	Noise cut level	0 to 4,095 [Gradation] (Default value :100)	Set the number of gradations when noise is cut from the line bright.

- ▶ Explorer pane : [Bank] | [(Bank Data Name)] (double click)
- Edit pane : [Sensing setting] icon ()
- Sensing settings window : [Operating mode]

1 Set [Noise cut level].



Setting Smoothing Size

When two measurement surfaces are close, the line bright may not be divided. The setting of smoothing size a smaller value, it becomes easy to divide.

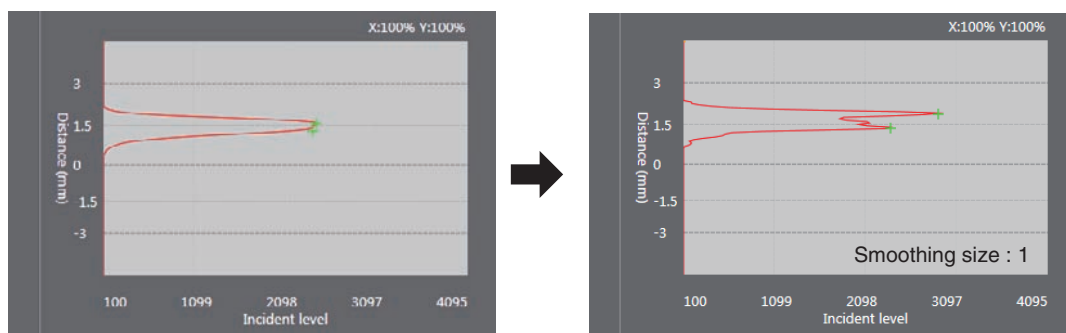

Item	Setting item	Setting value	Description
Operation mode	Smoothing size	1/3/5/7/9 [pixels] (Default value :5)	Set the pixel size to be used as the unit when smoothing the line bright.

- ▶ Explorer pane : [Bank] | [(Bank Data Name)] (double click)
- Edit pane : [Sensing setting] icon ()
- Sensing settings window : [Operating mode]

1 Set [Smoothing size].

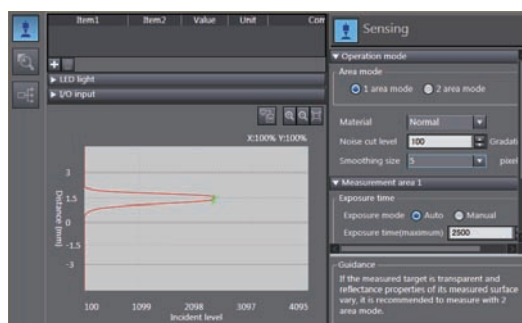

Important

Usually use the initial value, because the resolution may worsen when the setting a small value

Setting Start Direction of Count Measurement Surfaces

When a number of measurement surfaces exists, start direction can be selected from NEAR side or FAR side.

Example: NEAR

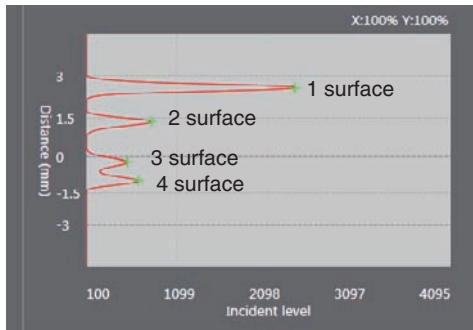

Example: FAR

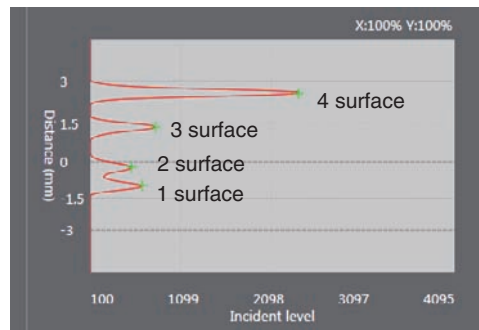

Item	Setting item	Setting value	Description
Operation mode	Start direction of count measurement surfaces	NEAR (default value)	Measurement surfaces are counted from NEAR side.
		FAR	Measurement surfaces are counted from FAR side.

Important

It cannot set and display using Sysmac Studio.

Note

The setting of start direction of count measurement surfaces can also be set by the operating keys on the Sensor Controller.



Setting Start Direction of Count Measurement Surfaces p.303

Setting Exposure Time Control Mode

Set the exposure time control mode and exposure time (maximum) or exposure time (fixed).

Item	Setting item	Setting value	Description
Exposure time	Exposure mode	Auto (default value)	Automatically sets the exposure time within the range that does not exceed the specified upper limit. Usually, select this setting.
		Manual	Select this mode when you want to specify the exposure time, and set the exposure time (fixed value).
	Exposure time (maximum)	1 to 1,000 (default value) to 5,000 [μ s]	Set the upper limit value of the exposure time when [Automatic] has been selected for the control mode.
	Exposure time (fixed)	1 to 1,000 (default value) to 5,000 [μ s]	Set the fixed value of the exposure time when [Fixed] has been selected for the control mode.
	Control edge	1 surface/2 surfaces/3 surfaces/4 surfaces/Peak (default value)	Select the measurement surface target for light adjustment. The peak is the surface of all measurement surfaces having the highest received light amount.

Important

Exposure time and measuring cycle

- For the "AUTO" exposure time control mode, the measuring cycle is twice the preset exposure time upper limit. (The measuring cycle remains the same even if the actual exposure time is the upper limit or less.)
- For the "MANUAL" exposure time control mode, the measuring cycle twice the exposure time is used.
- If the exposure time is 250 μ s or less, the measuring cycle is set to 500 μ s.

- **Explorer pane** : [Bank] | [(Bank Data Name)] (double click)
 → **Edit pane** : [Sensing setting] icon ()
 → **Sensing settings window** : [Measurement area 1] or [Measurement area 2] - [Exposure time]

- 1** Select the exposure mode from [Exposure mode].

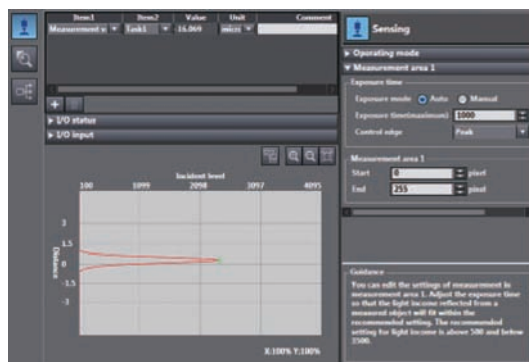

- 2** Set [Exposure time (maximum)] and [Control edge].

Note

The exposure time control mode can also be set by the operating keys on the Sensor Controller.

 Setting Exposure Time Control Mode p.304

Setting the Measurement Area

The measurement area can be limited, setting upper line and lower line of selected area.

The measurement object can be measured stably, cutting out the area that the object does not exist.

When the measurement object is set to "Glass," measurement may not be performed correctly as measurement will be influenced by reflection from the rear surface. If this happens, set the measurement area area of each measurement surface so that they can be correctly measured.

Item	Setting item	Setting value	Description
Measurement area	Upper line	Measuring range of Sensor Head [mm]	Set the measurement start position for the selected measurement area. When the window for the selected measurement area is open, the start position can also be edited by dragging the start line on the line bright monitor.
	Lower line	Measuring range of Sensor Head [mm]	Set the measurement end position for the selected measurement area. When the window for the selected measurement area is open, the end position can also be edited by dragging the end line on the line bright monitor.

- ▶ **Explorer pane** : [Bank] | [(Bank Data Name)] (double click)
- **Edit pane** : [Sensing setting] icon ()
- **Sensing settings window** : [Measurement area 1] or [Measurement area 2]

- 1 Set the [Upper line] and [Lower line] values at [Measurement area].

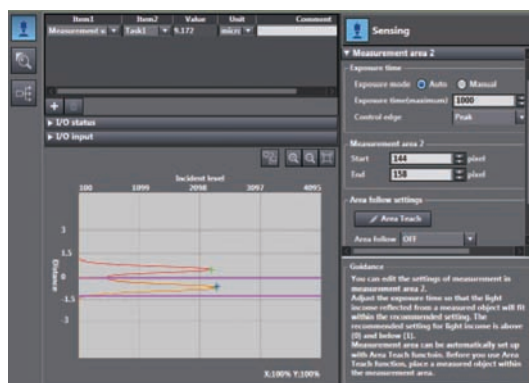

Important

- Ensure that the setting values for the measurement area satisfy the following relationship: [Start] < [End].
- To set the measurement area using any value by the above method at [Measurement area 2], set [Area follow] at [Area follow settings] to [OFF].

Automatically Following the Range of Measurement Area2

When 2 area mode is set, the measurement area 2 can be set automatically to measure the measurement surface (Follow), and the measurement area 2 range can be follow the measurement surface (Base) movement.

This function is used when a few surface of vibrating object is measured stable.

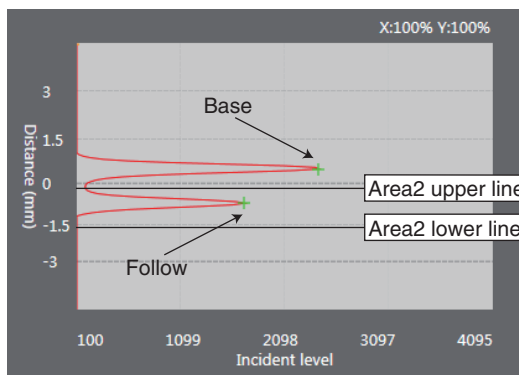

Item	Setting item	Setting value	Description
Area follow settings	Area follow	OFF (default value)	Area follow is not set. Select this to set any desired value.
		Upper line	Adjust the measurement area of measurement area 2 to track the [Start] setting value for measurement area 1.
		Lower line	Adjust the measurement area of measurement area 2 to track the [End] setting value of measurement area 1.
		Upper line and lower line	Adjust the measurement area of measurement area 2 to track the [Start] and [End] setting value of measurement area 1.
	Base	Edge1/Edge2/Edge3/Edge4/peak (default value: Edge1)	Select the measurement surface of measurement area 1 to be used as the reference for automatic tracking. The peak is the surface of all measurement surfaces having the highest received light amount.
	Follow	Edge1/Edge2/Edge3/Edge4/peak (default value: Edge2)	Select the measurement surface of measurement area 1 to be used as the reference for automatic tracking. The measurement area 2 is automatically set referenced to the surface selected when [Area Teach] is clicked. The peak is the surface of all measurement surfaces having the highest received light amount.

- ▶ **Explorer pane** : [Bank] | [(Bank Data Name)] (double click)
- **Edit pane** : [Sensing setting] icon ()
- **Sensing settings window** : [Measurement area 2] - [Area follow setting]

1 Set [Area follow].

2 Set [Reference surface] and [Following surface].

3 Click [Area Teach].

The range applied to measure the measurement surface (Follow) is automatically set as the measurement area 2.

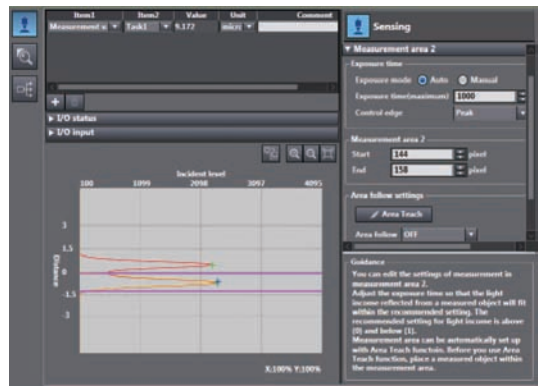

4-2 Setting Measurement Items

What is a Measurement Item?

Obtain the waveform data based on the specified sensing condition, and calculate the height/thickness of up to four surfaces included in the measuring range. Perform calculations using the output result of each task. Count the measurement surface closest to the Sensor Head first.

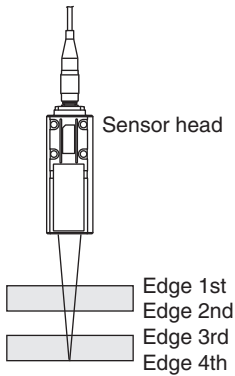

Measuring the Height

The setting for common height measurements as shown in the following diagram is registered for TASK1 in advance. In such a case, this setting is not required.

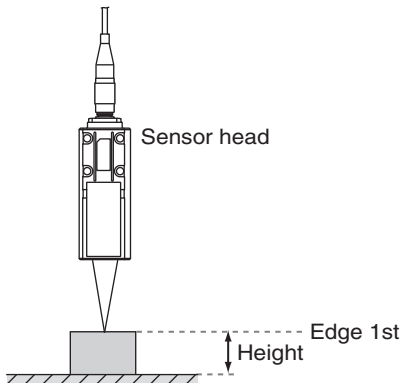

Set this item when measuring the height of an object below a transparent object as shown in the following diagram.

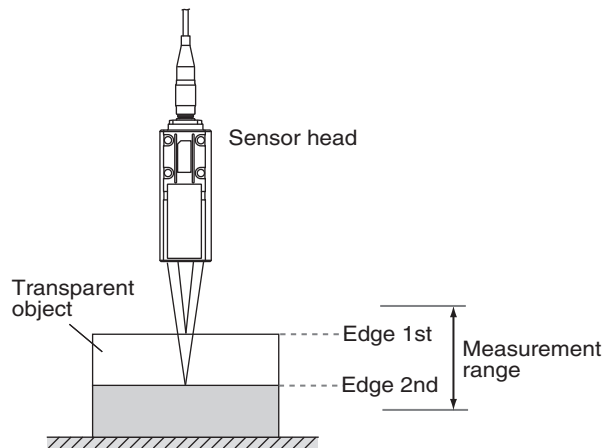

Item	Setting item	Setting value	Description
Height settings	Measurement area	Area 1 (default value)/Area 2	The area targeted for measurement can be switched.
	Measurement surface	Edge1/Edge2/Edge3/Edge4/peak (default value)	The measurement surface targeted for measurement can be switched. The peak is the surface of all measurement surfaces having the highest received light amount.

- ▶ **Explorer pane** : [Bank] | [(Bank Data Name)] (double click)
 - **Edit pane** : [Task Settings] icon (🔍)
 - **Task Settings window** : [Measurement mode] - [Height]

- 1** Select the measurement area targeted for measurement from [Measurement area].
- 2** Select the measurement surface targeted for measurement from [Measurement surface].

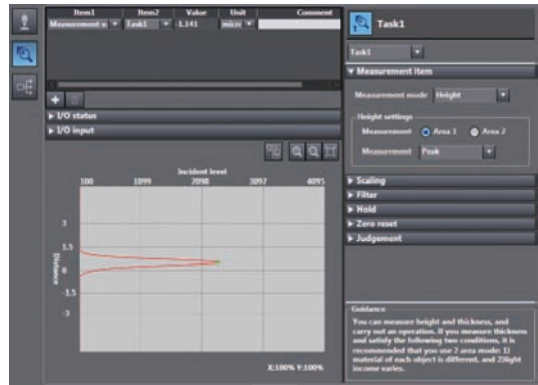

Important

[Height] and [Edge1] are preset to TASK1 as the measurement item and measurement surface, respectively. To measure the height in TASK2 to TASK4, set Edge1 first.

Note

Height measurement can also be set by the operating keys on the Sensor Controller.

 Measuring the Height p.305

Measuring the Thickness

If you have glass of known thickness, scaling can be adjusted referenced to that glass so that transparent objects can be measured more easily.

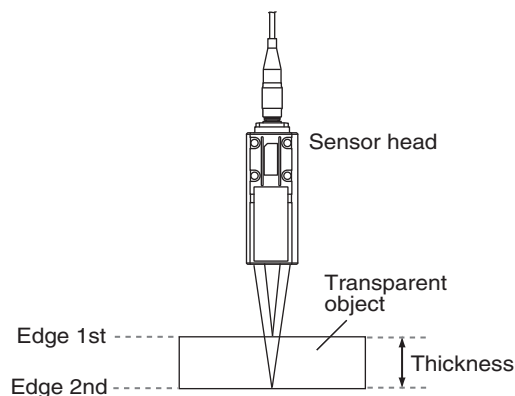

Item	Setting item	Setting value	Description
Thickness settings	Measurement area	Area 1 (default value)/Area 2	The area targeted for measurement can be switched.
	Measurement surface 1	Edge1/Edge2/Edge3/Edge4/ peak (default value)	The measurement surface (top surface) targeted for measurement can be switched. The peak is the surface of all measurement surfaces having the highest received light amount.
	Measurement surface 2	Edge1/Edge2/Edge3/Edge4/ peak (default value)	The measurement surface (rear surface) targeted for measurement can be switched. The peak is the surface of all measurement surfaces having the highest received light amount.

- ▶ **Explorer pane** : [Bank] | [(Bank Data Name)] (double click)
- **Edit pane** : [Task Settings] icon (🔧)
- **Task Settings window** : [Measurement mode] - [Thickness]

- 1** Select the measurement area targeted for measurement from [Measurement area].
- 2** Select the measurement surface (top surface) targeted for measurement from [Measurement surface 1].
- 3** Select the measurement surface (rear surface) targeted for measurement from [Measurement surface 2].

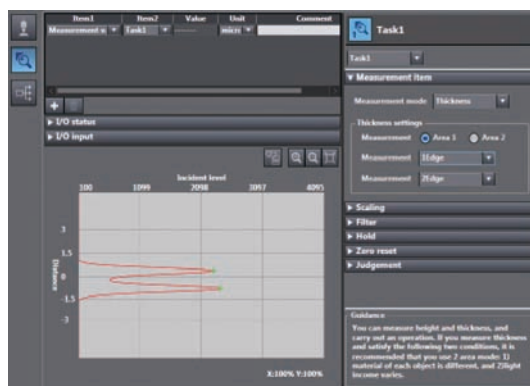

Note

- Thickness measurement can also be set by the operating keys on the Sensor Controller.

Measuring the Thickness p.306

- For the operation of the thickness scaling, refer to p.92.

Performing Calculations

Perform calculations using the results calculated by the tasks. The calculation formula is $mX+nY+K$.

Item	Setting item	Setting value	Description
Calculation	Parameter X	OFF (default value)/TASK1 to TASK4	The task to be calculated can be switched.
	Parameter Y	OFF (default value)/TASK1 to TASK4	The task to be calculated can be switched.
	Parameter K	-999.999999 to 999.999999 (default value: 0)	Set the offset value.
	Parameter m	-0.0 to 10.0 (Default value: 0)	Set the coefficient value.
	Parameter n	-0.0 to 10.0 (Default value: 0)	Set the coefficient value.

- ▶ **Explorer pane** : [Bank] | [(Bank Data Name)] (double click)
- **Edit pane** : [Task Settings] icon (🔍)
- **Task Settings window** : [Measurement mode] - [Calculation]

- 1** Select the task to be calculated from [Parameter X] and [Parameter Y].
- 2** Select the offset value from [Parameter K].
- 3** Select the coefficient from [Parameter m] and [Parameter n].

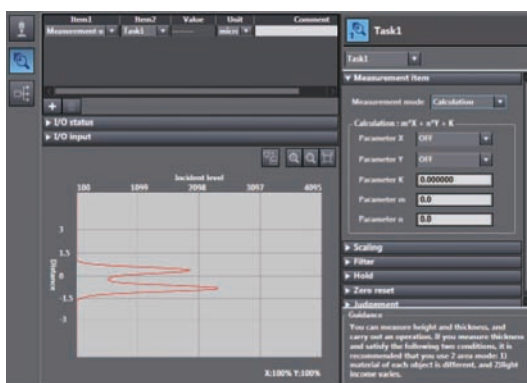

Note

Performing Calculations can also be set by the operating keys on the Sensor Controller.

 Calculating p.307

4-3 Setting the Output Conditions

Setting Scaling

This setting is used when you want to correct any errors that are generated due to the installation status of the Sensor Head, and display the corrected value on the main display as a measured value.

There are three types of setting: "auto scaling" ("1-point scaling" and "2-point scaling") that automatically sets the correction value of a placed sensing object, "fixed scaling" that manually sets the correction value and "thickness scaling" that automatically sets the correction value of a placed sensing object (transparent object).

Important

The "Zero reset" p.65 settings return to the default settings when scaling is set. If scaling is set, perform a zero reset as necessary.

Performing Manual Scaling

Set the scaling by entering the correction value.

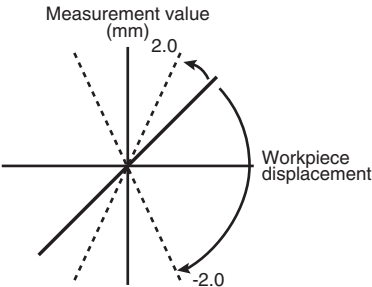
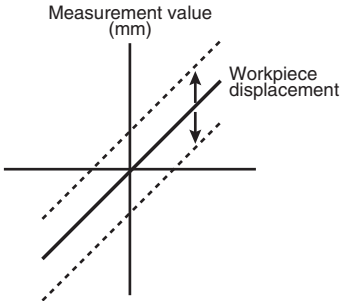
Item	Setting item	Setting value	Description
Scaling (Manual scaling)	Scaling	OFF (default value)/ON	Set scaling ON/OFF.
	Span	-2.0000 to 2.0000 (default value: 1.0000)	Set the inclination of the sensor characteristics as a coefficient. 
	Offset	-999.999999 to 999.999999 (default value: 0)	A fixed value is added to/subtracted from the measured value. 

- ▶ **Explorer pane** : [Bank] | [(Bank Data Name)] (double click)
- **Edit pane** : [Task Settings] icon (🔧)
- **Task Settings window** : [Scaling]

- 1 Select [Scaling].
- 2 Enter the correction value to [Span] and [Offset].

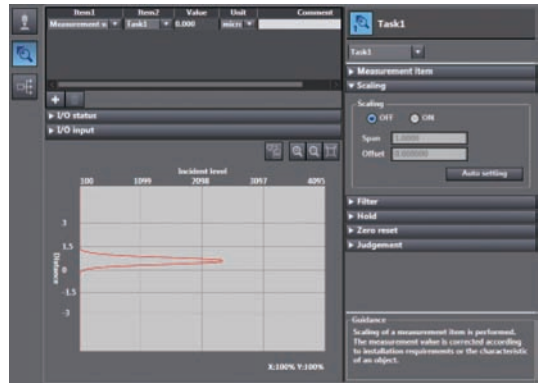

Note

Fixed scaling can also be executed by the operating keys on the Sensor Controller.

Performing Manual Scaling p.314

Automatically Setting Scaling

Performing 1-point Scaling

Measurement is performed at one position, and offset values are set for that measured value. The offset and increment/decrement inversion can be set.

Example: When displaying the distance to the sensing object

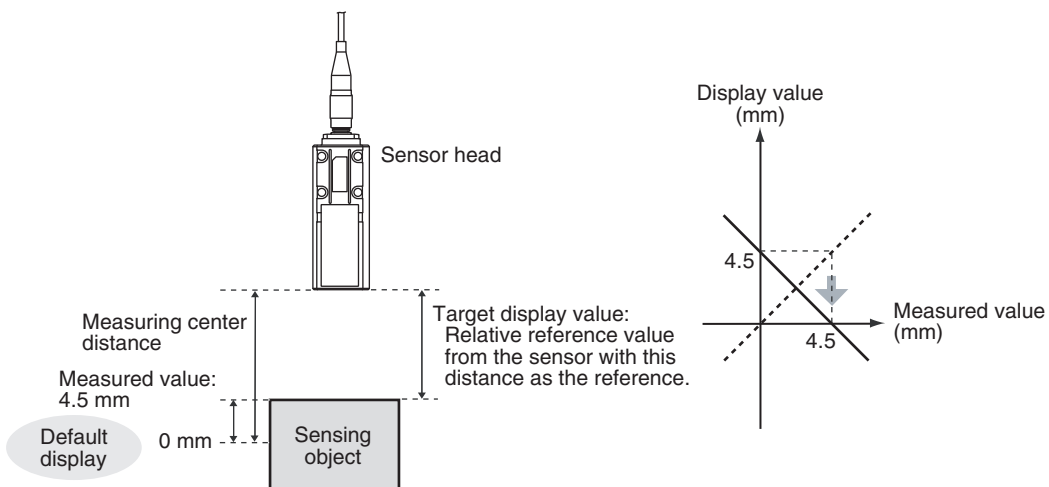

Item	Setting item	Setting value	Description
Actual scaling (one point)	Set value	-999.999999 to 999.999999 [mm]	Correct the measured value, and set the value to display.
	Scaling direction	Inverse change	The FAR side becomes a plus value.
		Forward change	The NEAR side becomes a plus value.

- ▶ **Explorer pane** : [Bank] | [(Bank Data Name)] (double click)
- **Edit pane** : [Task Settings] icon (🔧)
- **Task Settings window** : [Scaling]

- 1** Select [Scaling] ON.
- 2** Click [Auto setting].
The [Scaling] popup menu appears.
- 3** Select [Actual scaling (one point)], and click [Next >].
The [Scaling] popup menu display changes to [1st point settings], and the current measured value is displayed at [Current value].

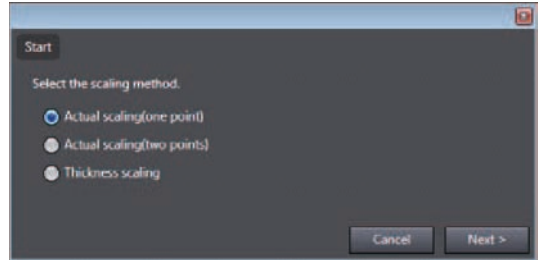

- 4** Click [STOP] to fix the [Current value], set [Set value] and click [Next >].
The [Scaling] popup menu display changes to [Direction settings].

Note

The [Current value] display is refreshed at a 100 ms cycle. When [STOP] is clicked, refreshing of the [Current value] display stops. Clicking the [STOP] button again resumes display refreshing.

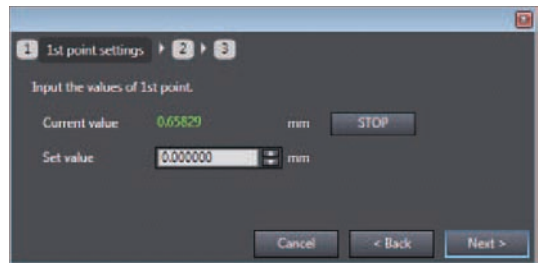

- 5** Set the change direction, and click [Next >].
The [Scaling] popup menu display changes to [Confirm the scaling parameters], and the span and offset values are displayed.

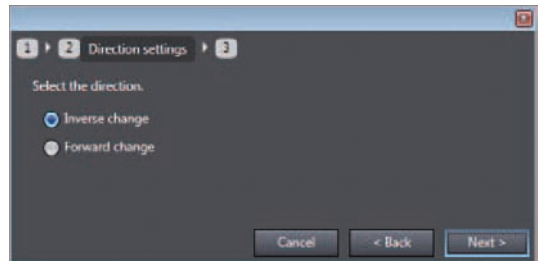

- 6** Click [OK].

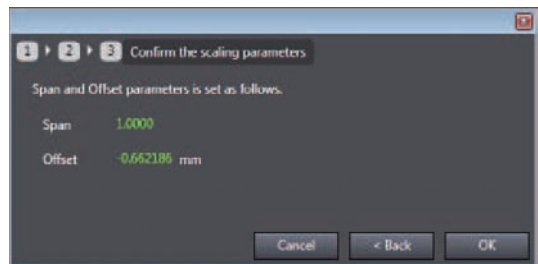

Note

1-point scaling can also be executed by the operating keys on the Sensor Controller.

 Performing 1-point Scaling p.315

Performing 2-point Scaling

Measurement is performed at two positions, and offset values are set for those measured values.

Example: When correcting display values to match actual distances

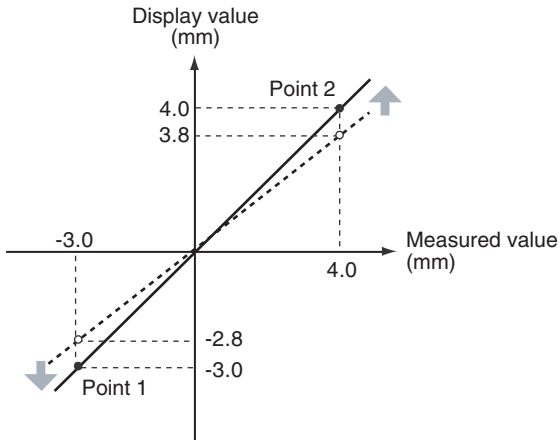

Item	Setting item	Setting value	Description
Actual scaling (two points)	Set value (1st point)	-999.999999 to 999.999999 [mm]	Correct the measured value of the 1st point, and set the value to display.
	Set value (2nd point)	-999.999999 to 999.999999 [mm]	Correct the measured value of the 2nd point, and set the value to display.

Important

Separate the two specified points by at least 1% of the rated measuring range for the connected Sensor Head.

For example, for the ZW-S40, the two measured points must be separated by at least $12 \text{ mm} \times 0.01 = 0.12 \text{ mm}$ as the measuring range is $12 \text{ mm} (\pm 6 \text{ mm})$.

- **Explorer pane** : **[Bank] | [(Bank Data Name)] (double click)**
- **Edit pane** : **[Task Settings] icon**
- **Task Settings window** : **[Scaling]**

- 1** Select **[Scaling] ON**.
- 2** Click **[Auto setting]**.
The **[Scaling]** popup menu appears.

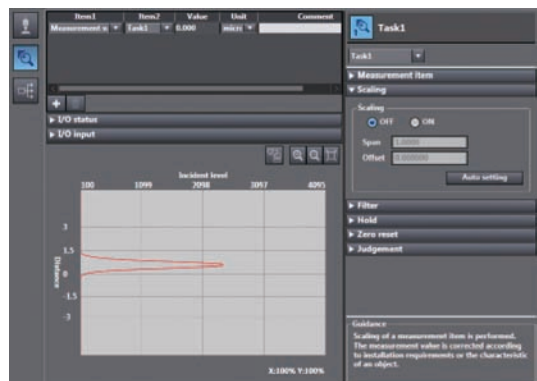

3 Select [Actual scaling (two points)], and click [Next >].
 The [Scaling] popup menu display changes to [1st point settings].

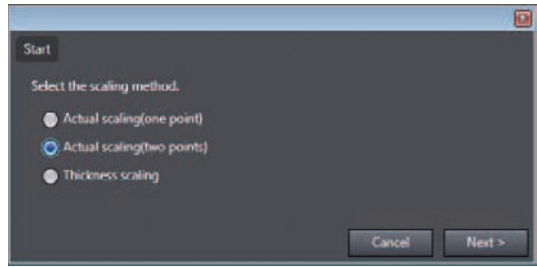

4 Set correction of the 1st point. Click [STOP] to fix the [Current value], set [Set value] and click [Next >].
 The [Scaling] popup menu display changes to [2nd point settings].

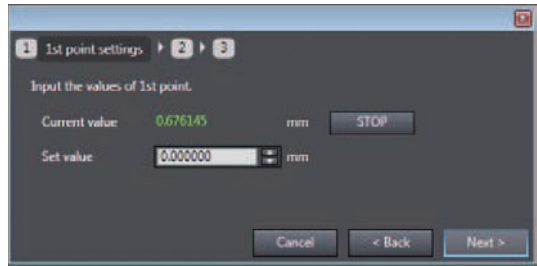

Note

The current measured value is displayed at [Current value], and is refreshed at 100 ms cycles. When [STOP] is clicked, refreshing of the [Current value] display stops. Clicking the [STOP] button again resumes display refreshing.

5 In the same way, set correction of the 2nd point.
 The [Scaling] popup menu display changes to [Direction settings]. When the change direction is set and [Next->] is clicked, the [Scaling] popup menu display changes to [Confirm the scaling parameters], and the span and offset values are displayed.

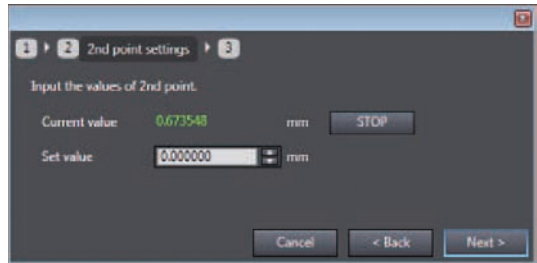

6 Click [OK].

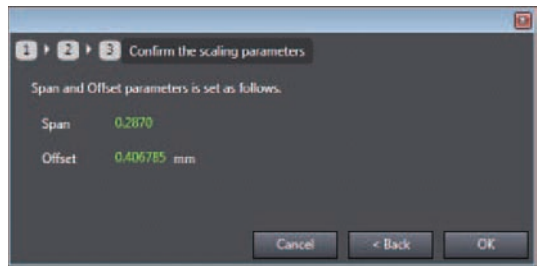

Note

2-point scaling can also be executed by the operating keys on the Sensor Controller.

 Performing 2-point Scaling p.316

Performing Thickness Scaling

The thickness is measured at one position and offset values are set for that measured value.

Item	Setting item	Setting value	Description
Thickness scaling	Setting value	-999.999999 to 999.999999 [mm]	Correct the measured value, and set the value to display.

- ▶ **Explorer pane** : [Bank] | [(Bank Data Name)] (double click)
- **Edit pane** : [Task Settings] icon 
- **Task Settings window** : [Scaling]

1 Select scaling ON/OFF from [Scaling].

2 Click [Auto setting].

The [Scaling] popup menu appears.

3 Select [Thickness scaling], and click [Next >].

The [Scaling] popup menu display changes to [Thickness settings].

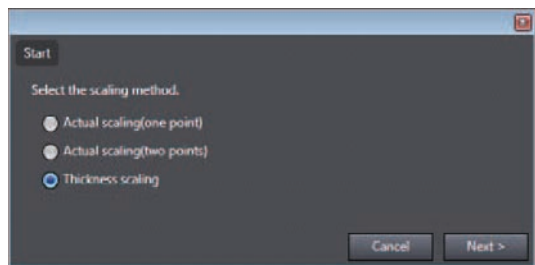

4 Click [STOP] to fix the [Current value], set [Set value] and click [Next >].

The [Scaling] popup menu display changes to [Confirm the scaling parameters], and the span and offset values are displayed.

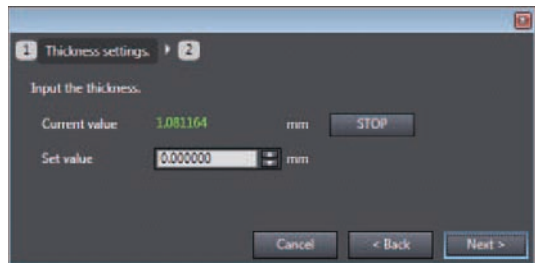

Note

The current measured value is displayed at [Current value], and is refreshed at 100 ms cycles. When [STOP] is clicked, refreshing of the [Current value] display stops. Clicking the [STOP] button again resumes display refreshing.

5 Click [OK].

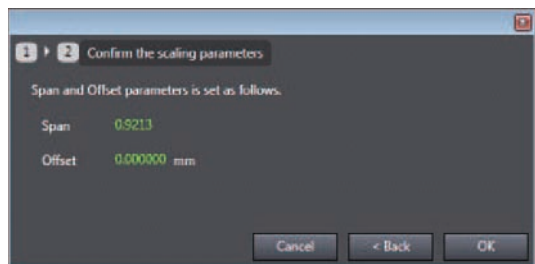

Note

Thickness scaling can also be executed by the operating keys on the Sensor Controller.

 Performing Thickness Scaling p.317

Setting Filters

Set the filter condition when filtering information obtained from the sensor before output. The following types of filters can be set depending on purpose.

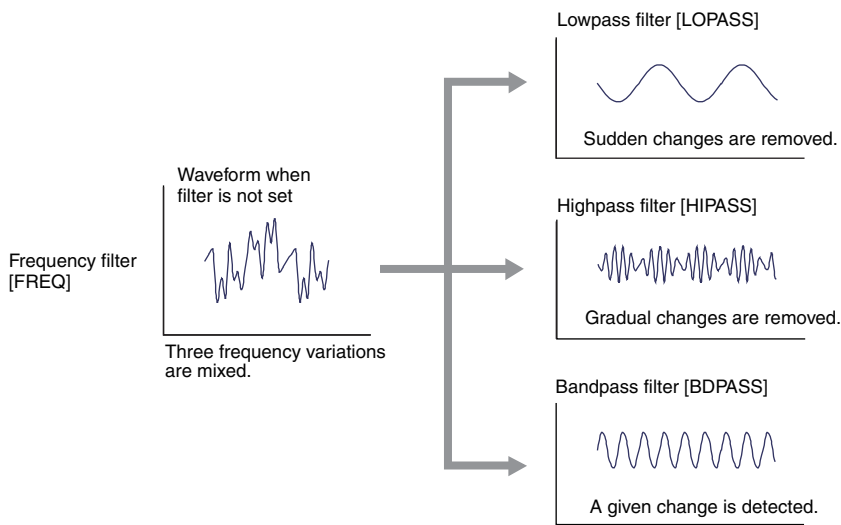
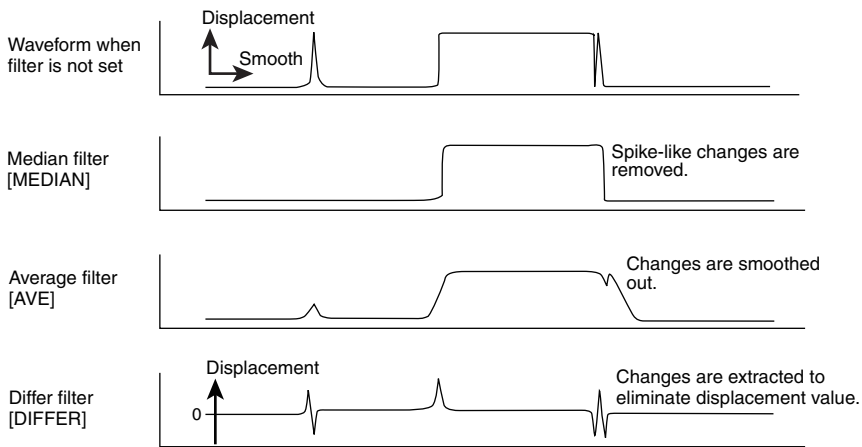

Setting the Median Filter

The intermediate value of multiple sets of data can be output as the measurement result.

Item	Setting item	Setting value	Description
Medial filter	Filter mode	OFF (default value)	Median filter is not used.
		LOW	Outputs the intermediate value of the last three measurements.
		Middle	Outputs the intermediate value of the latest nine measurements.
		HIGH	Outputs the intermediate value of the last 15 measurements.

- ▶ **Explorer pane** : [Bank] | [(Bank Data Name)] (double click)
- **Edit pane** : [Task Settings] icon 
- **Task Settings window** : [Filter]

- 1 Select how many of the latest intermediate values to output from [Medial filter] - [Filter mode].

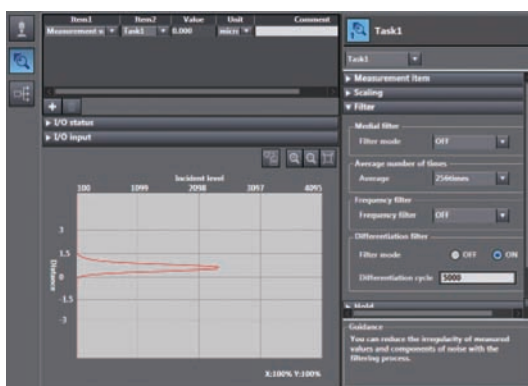

Note

The median filter can also be set by the operating keys on the Sensor Controller.

 Setting the Median Filter p.310

Setting the Average Filter

Output measured data as the average value of a preset count.
Set this, for example, to ignore sudden changes in measured value.

Item	Setting item	Setting value	Description
Average number of times	Average	1/2/4/8/16/32/64/128/256 (default value)/512/1024/2048/4096 [times]	Switches the average count.

- ▶ **Explorer pane** : [Bank] | [(Bank Data Name)] (double click)
- **Edit pane** : [Task Settings] icon (🔍)
- **Task Settings window** : [Filter]

- 1 Select how many times the latest measured values are to be averaged before output from [Average number of times] - [Average].

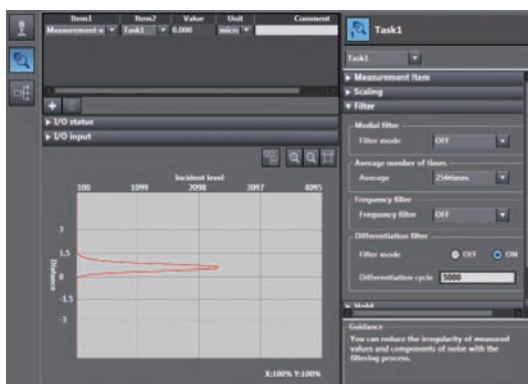

Important

When measurement is started, the measurement result is not updated and output until the measured values have been sampled for the preset average count.

Note

The average filter can also be set by the operating keys on the Sensor Controller.

 Setting the Average Filter p.311

Setting the Frequency Filter

Set a filter to ignore or detect the changes in a specific frequency in the measured data.

Item	Setting item	Setting value	Description
Frequency filter	Frequency filter	OFF (default value)	Frequency filter is not used.
		Lowpass filter	Ignores frequency components larger than the specified cut-off frequency. (Only gradual changes are captured.)
		Highpass filter	Detects frequency components smaller than the specified cut-off frequency. (Sudden changes are captured.)
		Bandpass filter	Detects the frequency components between the cut-off frequency (lower limit) and the cut-off frequency (upper limit).
	Cutoff frequency	0.001 (default value) to 999.999 [Hz]	Set this item when a low pass filter or a high pass filter is selected.
Cutoff frequency (Upper limit)	0.001 (default value) to 999.999 [Hz]	Set this item when a band pass filter is selected.	
Cutoff frequency (Lower limit)			

- **Explorer pane** : [Bank] | [(Bank Data Name)] (double click)
 → **Edit pane** : [Task Settings] icon (🔧)
 → **Task Settings window** : [Filter]

- 1 Select the frequency filter type from [Frequency filter].
- 2 Set the cutoff frequency from [Cutoff frequency]. When a band pass filter is selected, set [Cutoff frequency (upper limit)] and [Cutoff frequency (lower limit)].

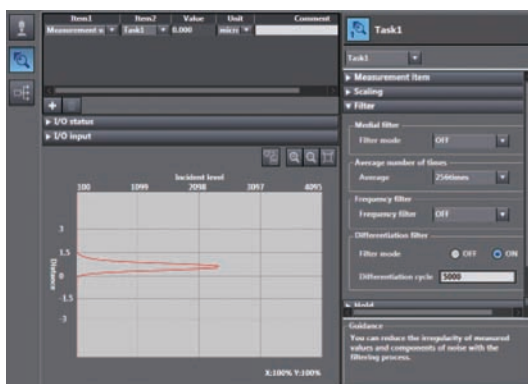

Note

The frequency filter can also be set by the operating keys on the Sensor Controller.

Setting the Frequency Filter p.312

Important

- Set the cut-off frequency to a value smaller than one-half of the sampling frequency. Otherwise, the frequency filter will not function properly. If a value outside of the appropriate range is set, the frequency filter will be applied with the values included in the range.
- If the cut-off frequency values (upper/lower limits) are too close, the frequency bandwidth to be detected cannot be properly detected.
- The sampling frequency is the inverse of the measuring cycle.
- The measuring cycle can be viewed in the "System Information" menu on the Sensor Controller.

Checking Information p.334

Setting the Differentiation Filter

Set this filter to detect sudden changes in measured values occurring within an extremely short time. The differentiation filter detects changes in the measured value and current value before a comparison interval. The time of this comparison interval is defined as the differential cycle. (Default value: OFF)

Item	Setting item	Setting value	Description
Differentiation filter	Filter mode	OFF (default value)/ON	Set the differentiation filter ON/OFF.
	Differentiation cycle	1 (default value) to 5000 [ms]	Set the internal time for the measurement value to be compared with the current value.

- **Explorer pane** : [Bank] | [(Bank Data Name)] (double click)
- **Edit pane** : [Task Settings] icon 
- **Task Settings window** : [Filter]

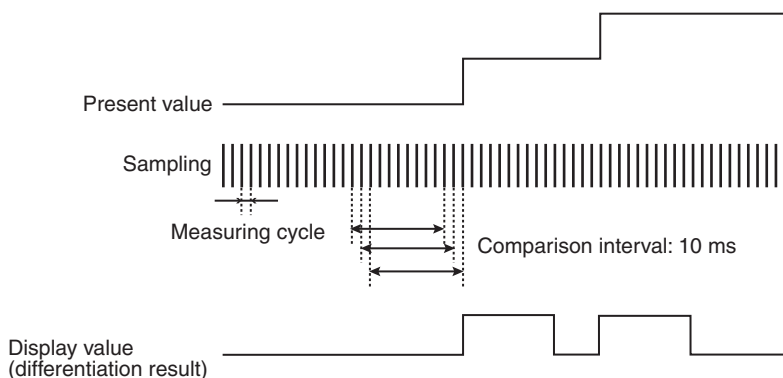

- 1** Select differentiation filter ON/OFF from [Differentiation filter] - [Filter mode].
- 2** Set the number of differential cycles from [Differentiation cycle].

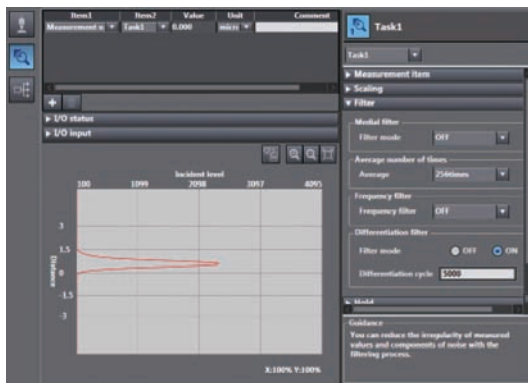

Note

The differentiation filter can also be set by the operating keys on the Sensor Controller.

 Setting the Differentiation Filter p.313

Setting Hold

Set the hold conditions of the measured value.

The hold function holds (retain) any value from the measured values during the specific time (sampling period), such as the maximum or minimum value.

Setting the Hold Mode

Set the hold mode of the measured value.

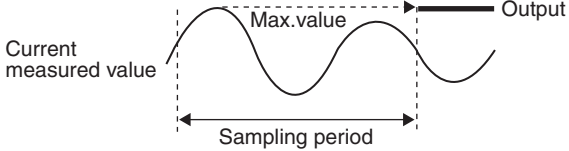
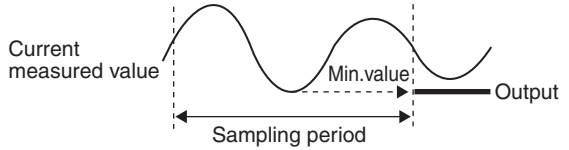
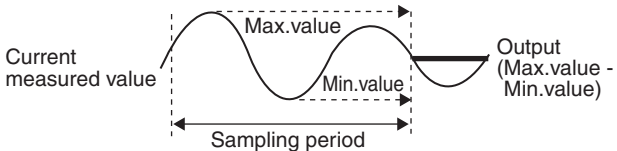
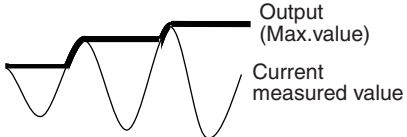
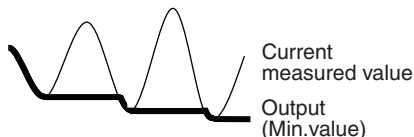
Item	Setting item	Setting value	Description
Hold	Hold mode	Peak	<p>Holds the "maximum value" of the sampling period. Output changes after sampling, and this state is held until the next sampling ends.</p> 
		Bottom	<p>Holds the "minimum value" of the sampling period. Output changes after sampling, and this state is held until the next sampling ends.</p> 
		Peak to Peak	<p>Holds the "difference between the maximum value and the minimum value" of the sampling period. Mainly select this when detecting vibration, for example. Output changes after sampling, and this state is held until the next sampling ends.</p> 
		Auto Peak	<p>Holds the "maximum value" of the measurement result. The output changes every time the maximum value is updated.</p> 
		Auto Bottom	<p>Holds the "minimum value" of the measurement result. The output changes every time the minimum value is updated.</p> 

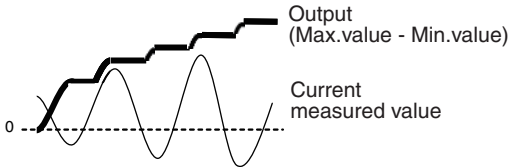
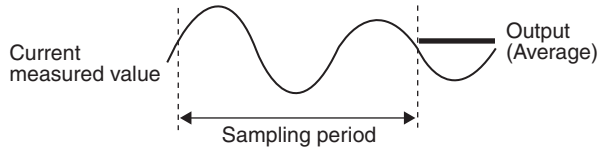
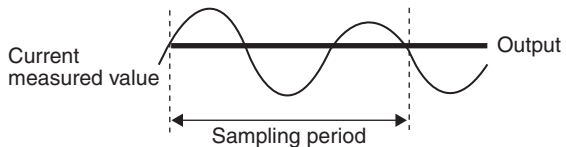
Item	Setting item	Setting value	Description
Hold	Hold mode	Auto Peak to Peak	Holds the difference between the maximum and minimum values of the measurement result. The output changes every time the maximum or the minimum value is updated. 
		Average	Holds the "average of the measured value" of the sampling period. Output changes after sampling, and this state is held until the next sampling ends. 
		Sampling	Holds the measured value the moment that control enters the sampling period. Output changes at the start of sampling, and this state is held until the next sampling is started. 
		Through (default value)	The hold function is not used. The measured value is always output.

- **Explorer pane** : [Bank] | [(Bank Data Name)] (double click)
 → **Edit pane** : [Task Settings] icon 
 → **Task Settings window** : [Hold]

- 1** Select the hold mode from [Hold mode].
 Setting items for required parameters are displayed depending on the selected hold mode.

 Setting Triggers p.101

 Setting a Trigger Delay p.104

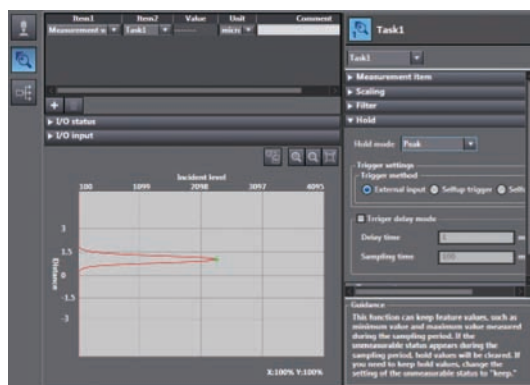

Note

The hold mode can also be set by the operating keys on the Sensor Controller.

 Setting the Hold Mode p.318

Hold clearing conditions

Held values can be cleared by the following operation.

- When FUN (adjustment) mode/RUN (operation) mode is switched
- When hold RESET is entered (32-pole extension connector,  key)
- Hold RESET command is entered.

(Example) Peak

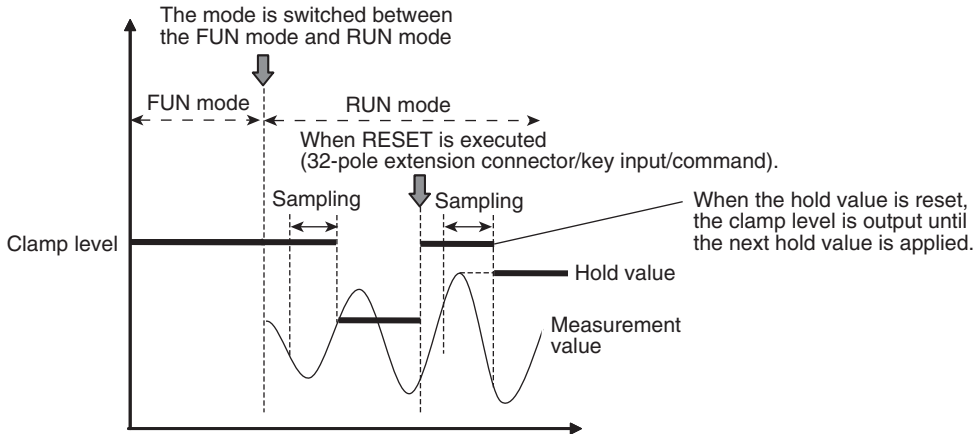

(Example) Auto Peak

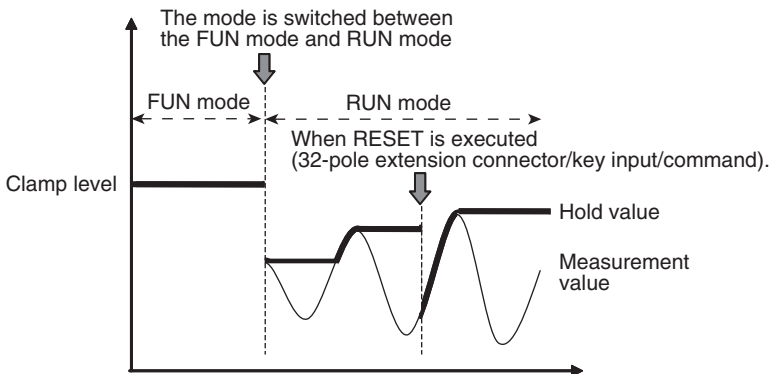

Important

If an abnormal measured value is obtained during sampling, the hold value is cleared. To not clear the hold value even if an abnormal measured value is obtained, set "KEEP" as the non-measurement setting.

 Setting operation when measurement is not possible p.148

Setting Triggers

Set how measurement start to end timing is to be input.

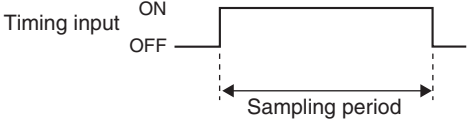
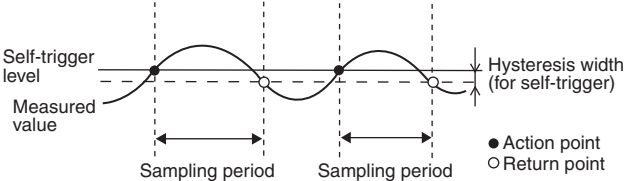
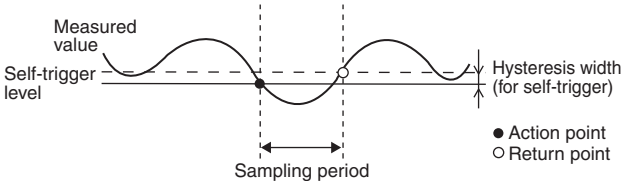
Item	Setting item	Setting value	Description
Trigger Settings	Trigger method	External input	<p>Enter the trigger for the start of sampling in "TIMING input" for the 32-pole terminal block. The period that the signal input to "TIMING input" is ON is the sampling period.</p>  <p>Important</p> <p>When a delay time is set, input OFF and sampling period end are not synchronized. End timing is after the specified sampling period has elapsed.</p>
		Selfup trigger	<p>The period in which the measured value exceeds the preset self-trigger level is taken to be the sampling period. Hold measurement can be performed without a synchronous input.</p>  <p>Important</p> <p>When a delay time is set, the timing that the measured value falls below the self-trigger level and the sampling period end are not synchronized. End timing is after the sampling period has elapsed.</p>
		Selfdown trigger	<p>The period in which the measured value falls below the preset self-trigger level is taken to be the sampling period. Hold measurement can be performed without a synchronous input.</p>  <p>Important</p> <p>When a delay time is set, the timing that the measured value exceeds the self-trigger level and the sampling period end are not synchronized. End timing is after the sampling period has elapsed.</p>
	Trigger level	-999.999999 to 999.999999 [mm] (default value: 0)	Set the self-trigger level when [SELF-UP] or [SELF-DOWN] are selected at [Trigger method].
	Trigger hysteresis	0 to 999.999999 [mm] (default value: 0.05% of measuring range)	Set the hysteresis width for the self-trigger when [SELF-UP] or [SELF-DOWN] are selected at [Trigger method].

- Explorer pane : [Bank] | [(Bank Data Name)] (double click)
- Edit pane : [Task Settings] icon (🔧)
- Task Settings window : [Hold]

1 Set the hold mode.

📖 Setting the Hold Mode p.98

2 Select the trigger method from [Trigger settings] - [Trigger method].

3 Enter [Trigger level] and [Trigger hysteresis] when [Selfup trigger] or [Selfdown trigger] are selected at [Trigger method].

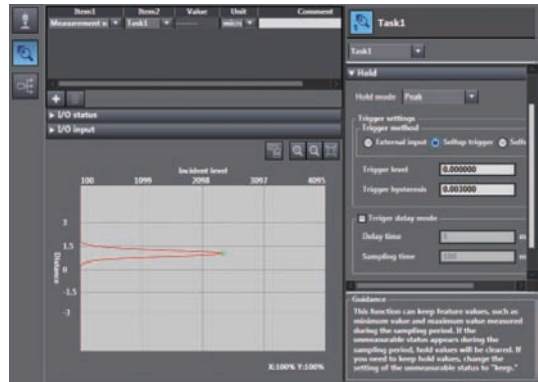

Important

Set "Trigger hysteresis" according to the fluctuation of the measured value near the trigger level. Hysteresis is applied simultaneously with start of measurement to prevent chattering of the TIMING input.

Note

The trigger can also be set by the operating keys on the Sensor Controller.

📖 Setting Triggers p.319

Performing Hold with a Key Input

The TIMING/RESET inputs can be held on the Sensor Controller by setting as follows.

Item	Setting item	Setting value	Description
Sensor settings	Timing/Reset key input	OFF (default value)/ON	Enables TIMING and RESET key inputs from the Sensor Controller.

 Setting the Hold Mode p.98

- ▶ **Explorer pane** : [System] (double-click)
→ **Edit pane** : [Sensor Settings] icon 

1 Set the operating mode to the FUN mode.

 3-3 Switching operation modes p.61

2 Select ON/OFF from [Key input mode(Timing and Reset)].

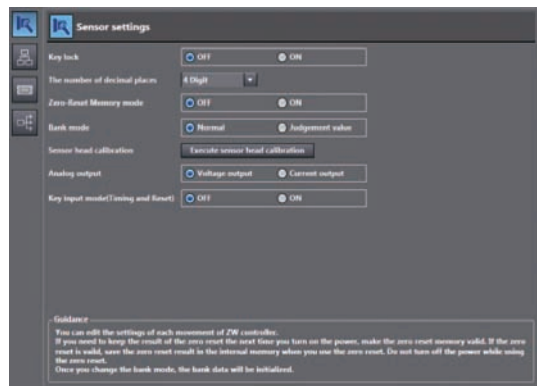

Note

The timing/reset key input can also be set by the operating keys on the Sensor Controller.

 Performing Hold with a Key Input p.320

Setting a Trigger Delay

Set this to ignore measure values following TIMING input to avoid the influence of bounding or mechanical vibration when a device is started up.

The delay time (the delay between timing input and the start of sampling) and the sampling time can be set.

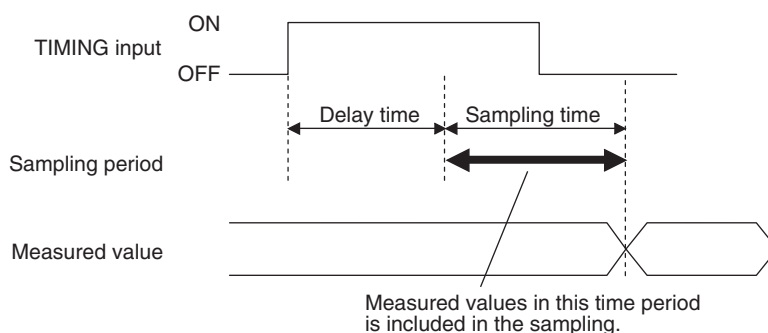

Item	Setting item	Setting value	Description
Trigger delay	Trigger delay mode	OFF (default value)/ON	Turns the trigger delay ON/OFF.
	Delay time	1 (default value) to 5,000 [ms]	Set the time from TIMING input ON up to start of sampling.
	Sampling time	1 to 5,000 [ms] (default value: 100ms)	Set to period during which sampling is to be performed.

► **Explorer pane** : [Bank] | [(Bank Data Name)] (double click)

→ **Edit pane** : [Task Settings] icon (🔍)

→ **Task Settings window** : [Hold]

1 Set the hold mode and trigger.

📖 Setting the Hold Mode p.98

📖 Setting Triggers p.101

2 Select ON/OFF from [Trigger delay] - [Trigger delay mode].

3 Enter [Delay time] and [Sampling time].

Important

Set so that the "delay time + sampling time" is shorter than the TIMING input interval. When the TIMING input turns ON again before the "delay time + sampling time" elapses, the TIMING input that is input later is ignored and is not reflected in sampling.

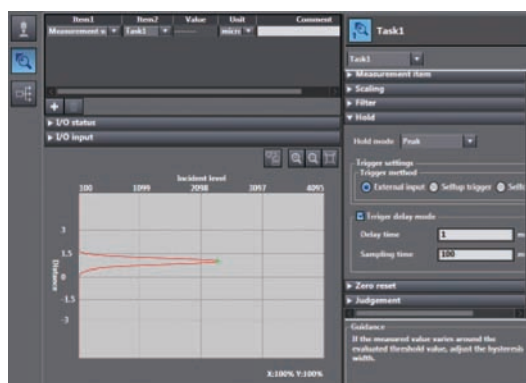

Note

The trigger delay can also be set by the operating keys on the Sensor Controller.

📖 Setting a Trigger Delay p.321

Setting the Zero Reset

Setting the Status

Set enable/disable of the zero reset function.

Important

The status is set for each task.

- ▶ **Explorer pane** : [Bank] | [(Bank Data Name)] (double click)
 - **Edit pane** : [Task Settings] icon (🔍)
 - **Task Settings window** : [Zero reset]

1 Select ON/OFF from [Status].

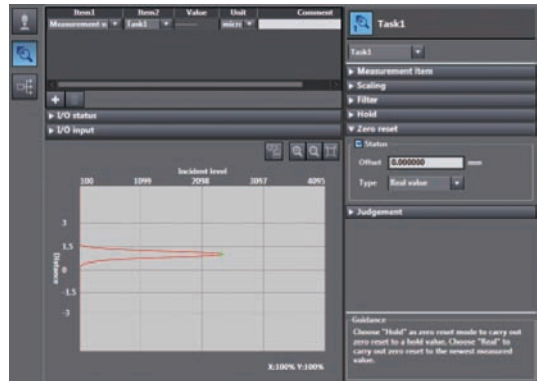

Note

The status can also be set by the operating keys on the Sensor Controller.

 Setting the Status p.322

Setting the Offset

Set this item to set the reference value by a zero reset to a value other than zero.

Item	Setting item	Setting value	Description
Zero reset	Offset	-999.999999 to 999.999999 [mm] (default value: 0)	Set the offset value.

- ▶ **Explorer pane** : [Bank] | [(Bank Data Name)] (double click)
 - **Edit pane** : [Task Settings] icon (🔍)
 - **Task Settings window** : [Zero reset]

1 Set [Status] to ON.

 Setting the Status p.105

Important

Offset can be set only when [Status] is set to ON.

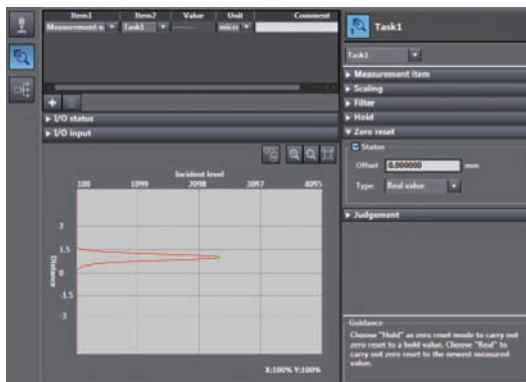

2 Enter an offset value at [Zero reset] - [Offset].

Note

The offset can also be set by the operating keys on the Sensor Controller.

 Setting the Offset p.323

Setting the Zero Reset Type

Set the zero reset type.

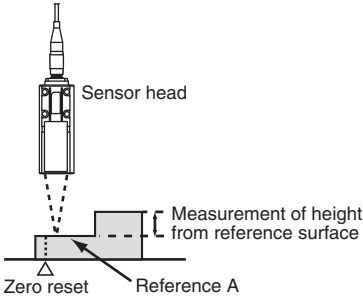
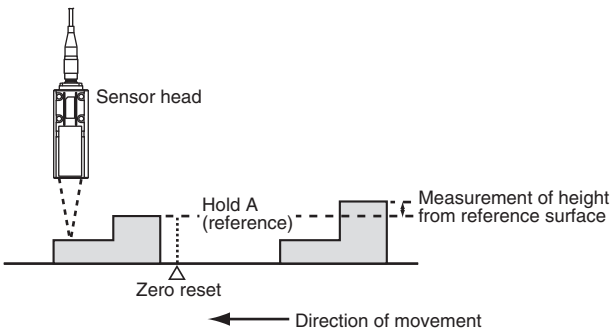
Item	Setting item	Setting value	Description
Zero reset	Zero reset type	Real value	<p>Sets the measured value when a zero reset is executed to zero.</p> 
		Hold value	<p>Sets the measured value (hold value) when a zero reset is executed to zero. This is enabled when hold measurement is performed.</p> 

- ▶ **Explorer pane** : [Bank] | [(Bank Data Name)] (double click)
- **Edit pane** : [Task Settings] icon (🔍)
- **Task Settings window** : [Zero reset]

1 Set [Status] to ON.

 Setting the Status p.105

Important

The zero reset type can be set only when [Status] is set to ON.

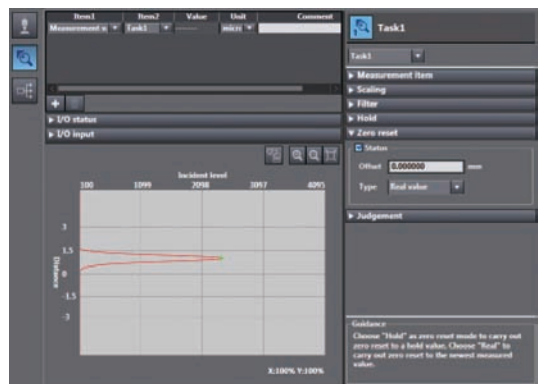

2 Select the zero reset type from [Type].

Note

The zero reset type can also be set by the operating keys on the Sensor Controller.

 Setting the Zero Reset Mode p.324

Setting the Zero Reset Memory

Select whether or not to hold the measured value zero reset level even if the power is turned OFF.

As shown in the figure below, use the zero reset memory still set to "OFF" when using this function to perform a zero reset at each measurement.

Example: When the level difference of a measurement target is measured

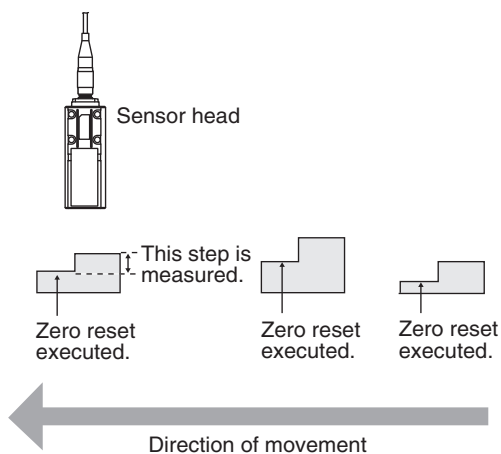



Item	Setting item	Setting value	Description
Sensor settings	Zero reset memory	OFF (default value)	The zero reset is canceled when the power is turned OFF.
		ON	The zero reset level is held even if the power is turned OFF.

Important

- When zero reset memory is set to "ON", the zero reset is written to EEPROM (non-volatile memory) in the Sensor Controller each time that a zero reset is performed. The EEPROM can be written a maximum of 1,000,000 times. Pay attention to the maximum number of writing allowed when this is set to "ON."
- Even if zero reset memory is disabled, the zero reset level will be held also when the setting is saved. In this instance, the zero reset will also be continued after a restart.

1 Set the operating mode to the FUN mode.

 3-3 Switching operation modes p.61

- ▶ **Explorer pane** : [System] (double-click)
- **Edit pane** : [Sensor Settings] icon 

2 Select ON/OFF from [Zero-Reset Memory mode].



Note

The zero reset mode can also be set by the operating keys on the Sensor Controller.

 Setting the Zero Reset Memory p.325

4-4 Setting the Banks

Changing the Bank Mode

Select the bank contents to be obtained from the settings or judgment value.

Item	Setting item	Setting value	Description
Sensor settings	Bank mode	Normal (default value)	Sensing setting, measurement setting and I/O setting that are set in the FUN (adjustment) mode are regarded as bank data. The number of banks is up to eight.
		Judgement value	Only the threshold value under the measurement setting is regarded as bank data. The number of banks increases up to 32.

1 Set the operating mode to the FUN mode.

 3-3 Switching operation modes p.61

- ▶ **Explorer pane** : [System] (double-click)
- **Edit pane** : [Sensor Settings] icon 

2 Select the bank mode from [Bank mode].



Note

The bank mode can also be set by the operating keys on the Sensor Controller.

 Changing the Bank Mode p.327

Copying the Bank/System Settings

Copy the selected bank setting to another bank.
Also, copy ZW system settings to a different ZW.

1 Set the operating mode to the FUN mode.

 3-3 Switching operation modes p.61

2 Copy the bank data or system data.

Select the copy source bank data or system data from the explorer pane, and select [Copy] from the right-click menu.

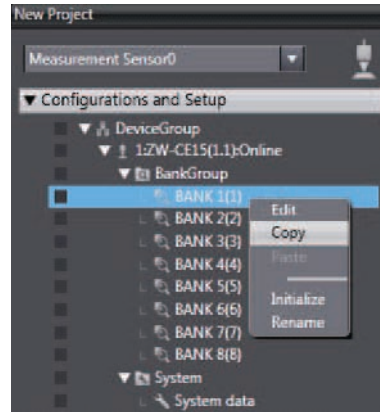

3 Paste the bank data or system data

Select the copy destination bank data or system data from the explorer pane, and select [Paste] from the right-click menu.

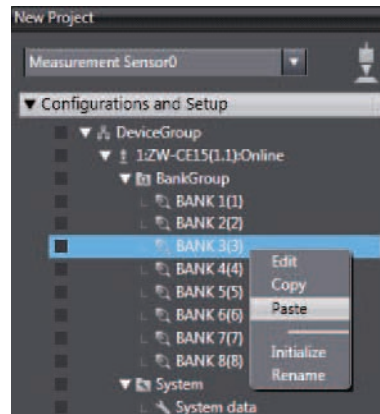

Note

The bank settings can also be copied by the operating keys on the Sensor Controller.

 Copying the Bank Settings p.328

Saving the Bank/System Settings

Save the bank/system settings to the Sensor Controller.

Important

- The settings of all banks are saved regardless of the currently selected bank number.
- After you have made or changed settings, be sure to save the setup data. All settings will be deleted if you turn the power OFF without saving the data.

1 Set the operating mode to the FUN mode.

 3-3 Switching operation modes p.61

- ▶ **Explorer pane** : [(ZW model name)] (double click)
 - **Edit pane** : [Online] icon ()
 - **Online setting window** : [Save data]

2 Select [Save data (Sensor internal memory)].

Bank/system settings are saved to Sensor internal memory.

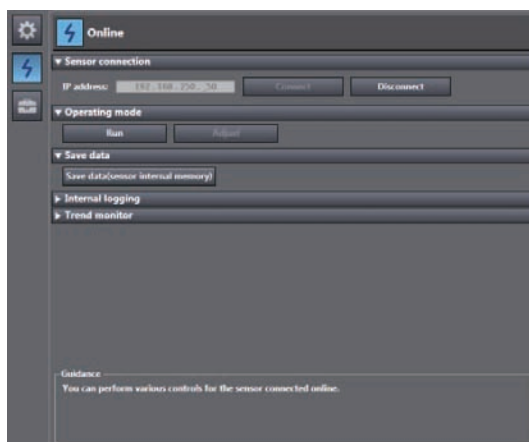

Note

- Settings can also be saved by selecting and right-clicking a [(ZW model)] from the explorer pane and selecting "Save settings" from the right-click menu.
- The bank/system settings can also be saved by the operating keys on the Sensor Controller.

 Saving the Bank/System Settings p.329

Clearing the Bank Settings

Select a bank and initialize its settings.

1 Set the operating mode to the FUN mode.

 3-3 Switching operation modes p.61

2 Select the bank data.

Select the bank data from the explorer pane, and select [Initialize] from the right-click menu.

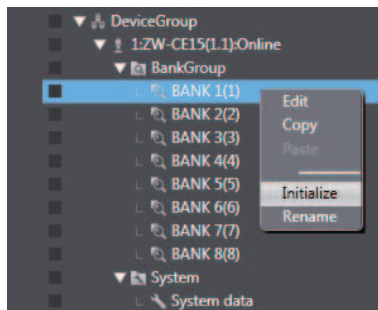

Note

The bank settings can also be cleared by the operating keys on the Sensor Controller.

 Initializing Settings p.337

4-5 Setting the System

Display/set the system environment.

Checking Information

Displays the information of the Sensor Controller and Sensor Head.

Item	Displayed item	Setting value	Description
General settings	Sensor information	Name	Displays the name of the Sensor Controller
		Sensor controller model	Displays the model information of the Sensor Controller.
		Software Version	Displays the version information of the software of the Sensor Controller.
		Sensor head model	Displays the model information of the Sensor Head.
		Sensor serial No.	Displays the serial No. of the Sensor Head.
		MAC address	Displays the MAC address that is set.

- ▶ **Explorer pane** : [(ZW model name)] (double click)
- **Edit pane** : [General Settings] icon (⚙️)

- 1** The Edit pane main pane is displayed in the Edit pane.
You can check the above information under [General settings] - [Sensor information].

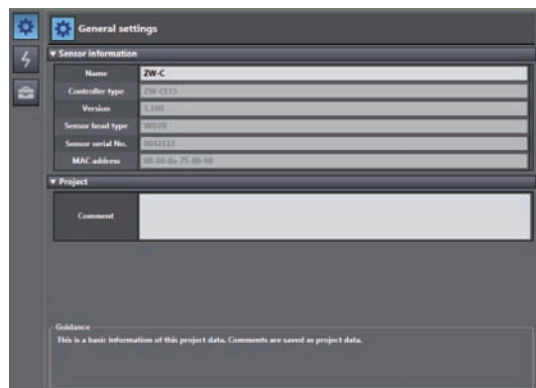

Note

In addition to the above information, the currently set measuring cycle can be checked by the operating keys on the Sensor Controller.

Checking Information p.334

Making Sensor Settings

Setting the Key Lock

This function disables all key inputs on the Sensor Controller.

Once the key lock is set, no key input will be accepted until the lock is released. This function is useful for preventing inadvertent changes to settings.

Item	Displayed item	Setting value	Description
Sensor settings	Key lock	OFF (default value)	Cancels the key lock function.
		ON	Turns the key lock function ON.

Important

Note that, moving to the key lock setting menu or moving between menu hierarchies are possible even when the key lock function is ON by the operating keys on the Sensor Controller.

1 Set the operating mode to the FUN mode.

 3-3 Switching operation modes p.61

► **Explorer pane** : [System] (double-click)
→ **Edit pane** : [Sensor Settings] icon 

2 Select ON/OFF from [Key lock].

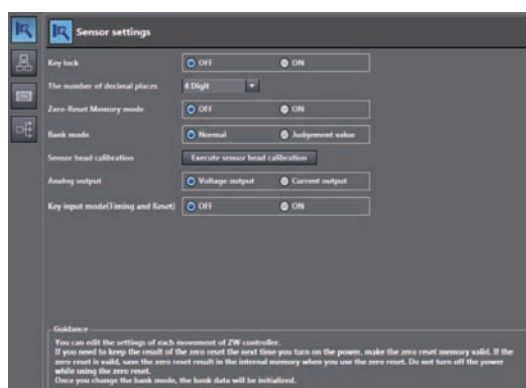

Note

The key lock can also be set by the operating keys on the Sensor Controller.

 Setting the Key Lock p.335

Setting the Number of Digits Displayed Past the Decimal Point

Set the number of digits displayed past the decimal point for when numerical values are displayed on the main display and sub-display of the Sensor Controller.

Item	Setting item	Setting value	Description
Sensor settings	The number of decimal places	0 to 5 Digit (default value: 4 digits)	Set the number of digits displayed past the decimal point for when numerical values are displayed on the Sensor Controller.

1 Set the operating mode to the FUN mode.

 3-3 Switching operation modes p.61

- ▶ **Explorer pane** : [System] (double-click)
- **Edit pane** : [Sensor Settings] icon 

2 Select the number of digits displayed past the decimal point from [The number of decimal places].

You can select from the above setting values.

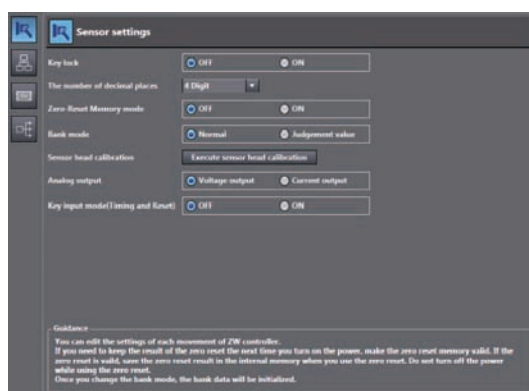

Initializing Settings

Returns all banks/system settings to their default settings.

Important

- The settings of all banks/system settings are returned to the default settings regardless of the currently selected bank number.
- Parameters for which the default values are decided by the Sensor Head measuring range (HYSTERESIS, TRIGGER HYSTERESIS, HIGH THRESHOLD, LOW THRESHOLD) are all set to the factory default value "0".

- ▶ **Explorer pane** : [(ZW model name)] (double click)
- **Edit pane** : [Tool] icon 

1 Click [Sensor setup] - [Initialize sensor].

Initialization is executed.

Note

- Settings can also be initialized by selecting and right-clicking a [(ZW model)] option from the explorer pane and selecting "Initialize sensor" from the right-click menu.
- Settings can also be initialized by the operating keys on the Sensor Controller.



Initializing Settings p.337

MEMO

Convenient Functions

5-1 Displaying measured values in graphs	120
5-2 Saving measured values in a file	125
5-3 Displaying saved measured values	128
5-4 Performing internal logging	129
5-5 Storing the light reception wave form in a file	131
5-6 Recovering calibration ROM data	133
5-7 Printing the contents of settings	134
5-8 Controll input signal with PC tool	135

5-1 Displaying measured values in graphs

The measured values can be displayed in graphs.

Important

This function can only be used with project of the displacement sensor (ZW).

With project of the controller (NJ), you can use the "Data trace" function to display graphs of measured values.

- ▶ **Explorer pane** : [(ZW model name)] (double click)
- **Edit pane** : [Online] icon (⚡)
- **Online setting window** : [Trend Monitor]

- 1 Click [Trend Monitor] - [Start monitor].
The Trend Monitor window starts up.

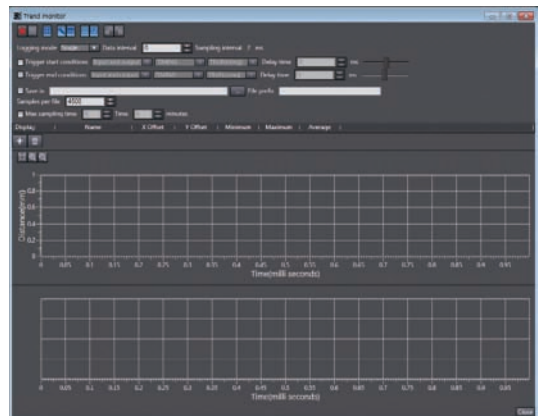
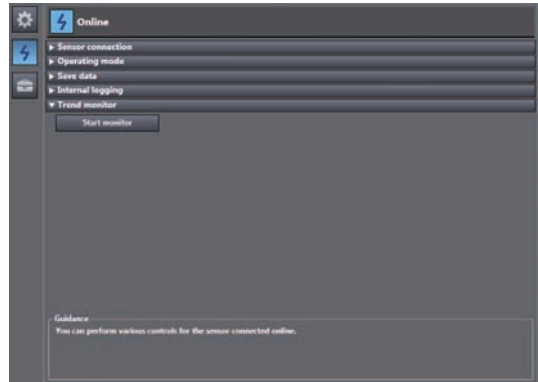

Display	Name	X Offset	Y Offset	Minimum	Maximum	Average
	TASK1	D	0.000000			
	PASS	D				

- 2 **Add the data to monitor the trend for.**
Add the data to monitor the trend for to the list.

Click the add target data icon (⊕).

Click the logging target data display icon (📄) to add to the list of data to be logged.

A new target data line is added.

Note

To delete target data from the list, select the line with the data to be deleted, then click the [Delete] or press the [Delete] key.

3 Select data to monitor the trend for.

Set data to monitor the trend for.

The types of data that can be set are as follows.

Item	Setting item	Description
Target data	TASK1	TASK1 measurement results
	TASK2	TASK2 measurement results
	TASK3	TASK3 measurement results
	TASK4	TASK4 measurement results
	TIMING	TIMING input signal (parallel I/O)
	ZERO	ZERO input signal (parallel I/O)
	BUSY	BUSY output signal (parallel I/O)
	ENABLE	ENABLE output signal (parallel I/O)
	HIGH	HIGH output signal (parallel I/O)
	PASS	PASS output signal (parallel I/O)
	LOW	LOW output signal (parallel I/O)

4 Set the logging sampling interval.

Set the logging sampling interval for the target data.

Item	Setting item	Range	Description
Sampling setting	Data interval	0 to 65535	Set the sampling interval for the target data.

5 Click the Start icon () to start the sampling.

When the sampling starts, the sampled data is displayed in the graph.

Note

You can also specify the timing (start trigger, end trigger) for the graph display.

6 Click the End icon () to end the sampling.

When the sampling ends, the graph display stops too.

Specifying the sampling start and end conditions

You can specify the conditions for starting and ending sampling.

1 Check the Trigger start conditions/Trigger end conditions checkbox.



2 Select the trigger condition.

Item	Setting item	Range	Description
Sampling setting	Trigger start conditions	Input and output	Specify parallel I/O (TIMING, ZERO, BUSY, ENABLE, HIGH, PASS, LOW) as the trigger condition.
		Data slope	Sets the change in the measured values for TASK1-4 as the start condition. Sets the trigger level. When the measured value rises above this value or falls below it, the start trigger is issued.
		Data window (In)	Sets the change in the measured values for TASK1-4 as the start condition. When the measured value is inside the range, the start trigger is issued.
		Data window (Out)	Sets the change in the measured values for TASK1-4 as the start condition. When the measured value is outside the range, the start trigger is issued.
	Trigger end conditions	Input and output	Specify parallel I/O (TIMING, ZERO, BUSY, ENABLE, HIGH, PASS, LOW) as the trigger condition.
		Data slope	Sets the change in the measured values for TASK1-4 as the start condition. Sets the trigger level. When the measured value rises above this value or falls below it, the end trigger is issued.
		Data window (In)	Sets the change in the measured values for TASK1-4 as the start condition. When the measured value is in the range, the end trigger is issued.
		Data window (Out)	Sets the change in the measured values for TASK1-4 as the start condition. When the measured value is outside the range, the end trigger is issued.
		Number of data	The sampling data is counted from when the start condition is met and when the specified number of data points have been sampled, the end trigger is issued.

3 Select the trigger target.

Item	Setting item	Range	Description
Trigger target	I/O	TIMING	TIMING input signal (parallel I/O)
		ZERO	ZERO input signal (parallel I/O)
		BUSY	BUSY output signal (parallel I/O)
		ENABLE	ENABLE output signal (parallel I/O)
		HIGH	HIGH output signal (parallel I/O)
		PASS	PASS output signal (parallel I/O)
		LOW	LOW output signal (parallel I/O)
	Data slope Data window (in) Data window (out)	TASK1	TASK1 measurement results
		TASK2	TASK2 measurement results
		TASK3	TASK3 measurement results
		TASK4	TASK4 measurement results

4 Set the trigger condition.

- When the trigger target is "Data slope"

Trigger start conditions: Data slope TASK1 0.000000 Delay time 0 ms

Item	Setting item	Range	Description
Trigger condition	Condition	=	When the measurement results are the same value as the judgment value, the trigger condition is considered to have been met.
		≠	When the measurement results are a different value from the judgment value, the trigger condition is considered to have been met.
		>	When the measurement results are greater than the judgment value, the trigger condition is considered to have been met.
		≥	When the measurement results are greater than or equal to the judgment value, the trigger condition is considered to have been met.
		<	When the measurement results are less than the judgment value, the trigger condition is considered to have been met.
	≤	When the measurement results are less than or equal to the judgment value, the trigger condition is considered to have been met.	
	Judgment	-999.999999 to 999.999999 mm	This is the judgment value for the measurement results.

- When the trigger target is "Data window (In)"

Trigger start conditions: Data window(In) TASK1 999.999999 999.999999 Delay time 0 ms

Item	Setting item	Range	Description
Trigger condition	Judgment value 1	-999.999999 to 999.999999 [mm]	When the measurement results are greater than or equal to judgment value 1 and less than or equal to judgment value 2, the trigger condition is considered to have been met.
	Judgment value 2	-999.999999 to 999.999999 [mm]	

- When the trigger target is "Data window (out)"

Item	Setting item	Range	Description
Trigger condition	Judgment value 1	-999.999999 to 999.999999 [mm]	When the measurement results are less than judgment value 1 or greater than judgment value 2, the trigger condition is considered to have been met.
	Judgment value 2	-999.999999 to 999.999999 [mm]	

- When the trigger target is "Input and output"

Trigger start conditions: Input and output TIMING TRUE(rising) Delay time 0 ms

Item	Setting item	Range	Description
Trigger condition	Condition	TRUE (rising)	When the I/O signal rises, the trigger condition is considered to have been met.
		False (falling)	When the I/O signal falls, the trigger condition is considered to have been met.

Starting and ending sampling before and after the trigger condition is met

You can adjust how long to start or end the sampling before or after the condition for starting and ending sampling is met.

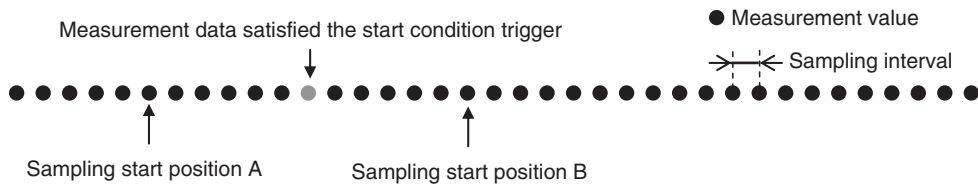

- Sampling start position A
To start sampling before the time when the trigger start condition is met, input a negative value for the delay time.
- Sampling start position B
To end sampling after the time when the trigger end condition is met, input a positive value for the delay time.

1 Input the delay time.



Item	Setting item	Range	Description
Trigger condition	Delay time	-999.999999 to 999.999999 ms	The sampling starts or ends at the time shifted by the set time from when the trigger condition is met.

5-2 Saving measured values in a file

Data sampled with the trend monitor can be exported and imported as a CSV format file.

Outputting the results of sampling as a file

Sampled measured values can be saved as a CSV format file.

A file is prepared each time the trigger condition is met.

- 1 Check the checkbox for the save destination.
- 2 Set the save condition.

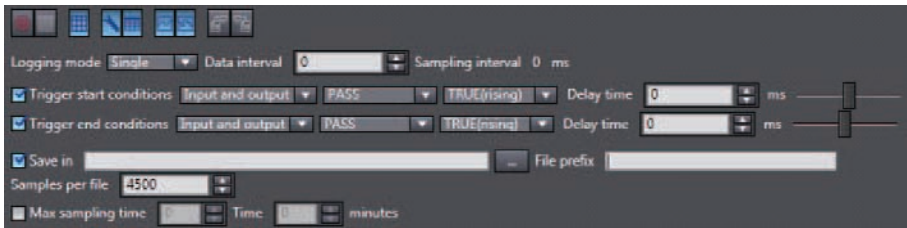

Item	Setting item	Range	Description
File settings	Logging mode	Single	When the trigger end condition is met, sampling stops.
		Continuous	Sampling does not stop until you press the End button. Each time the trigger start condition is met, a new file is prepared and saved.
	Save in	–	This is the folder to save the files in.
	File prefix	–	This is the prefix for the name of the file saved.
	Samples per file	100 to 10000000	This is the number of samples saved in one file. If more samples than this set number are taken, a new file is prepared.
	Max sampling time	0:0:0 to 24:59:59	This indicates the upper limit on the interval for saving a file.

Exporting the results of sampling

Sampled measured values can be exported as a CSV format file.

Item	Output items	Description
LoggingMode	Single Continuous	Indicates the sampling mode. Single or continuous
SamplePeriod	1 to 9999	Indicates the sampling interval.
TriggerStart	True False	Indicates whether the trigger start condition is "Enabled" or "Disabled".
TriggerStartType	IO DataSlope DataWindowIn DataWindowOut DataSize	Indicates the trigger start condition. IO: I/O result DataSlope: Data slope DataWindowIn: Data window (in) DataWindowOut: Data window (out)

Item	Output items	Description
TriggerStartObject	TASK1 TASK2 TASK3 TASK4 TIMING ZERO BUSY ENABLE HIGH PASS LOW	Indicates the target data for the trigger start condition.
TriggerStartConditions	EqualTo NotEqualTo AndMore MoreThan LessThan AndLess True (rising) False (falling)	Indicates the trigger start condition. EqualTo: = NotEqualTo: ≠ AndMore: ≥ MoreThan: > LessThan: < AndLess: ≤ True: Rising False: Falling
TriggerStartValue1	-999.999999 to 999.999999 mm	Indicates the judgment value for the trigger start condition. For data window (in/out), indicates the lower limit.
TriggerStartValue2	-999.999999 to 999.999999 mm	Indicates the judgment value for the trigger start condition. For data window (in/out), indicates the upper limit.
TriggerStartDelay	-999.999999 to 999.999999 mm	Indicates the delay time for the trigger start condition.
TriggerEnd	True False	Indicates whether the trigger end condition is "Enabled" or "Disabled".
TriggerEndType	IO DataSlope DataWindowIn DataWindowOut DataSize	Indicates the trigger end condition. IO: I/O result DataSlope: Data slope DataWindowIn: Data window (in) DataWindowOut: Data window (out) DataSize: Number of data points
TriggerEndObject	TASK1 TASK2 TASK3 TASK4 TIMING ZERO BUSY ENABLE HIGH PASS LOW	Indicates the target data for the trigger end condition.
TriggerEndConditions	EqualTo NotEqualTo AndMore MoreThan LessThan AndLess True (rising) False (falling)	Indicates the trigger end condition. EqualTo: = NotEqualTo: ≠ AndMore: ≥ MoreThan: > LessThan: < AndLess: ≤ True: Rising False: Falling
TriggerEndValue1	-999.999999 to 999.999999 mm	Indicates the judgment value for the trigger end condition. For data window (in/out), indicates the lower limit.
TriggerEndValue2	-999.999999 to 999.999999 mm	Indicates the judgment value for the trigger end condition. For data window (in/out), indicates the upper limit.
TriggerEndDelay	-999.999999 to 999.999999 mm	Indicates the delay time for the trigger end condition.
MaxSamplesPerFile	1 to 999999999	Indicates the number of samples in one file.
TargetDirectory		Indicates where the file is stored.
FilePrefix		Indicates the prefix.

- ▶ **Explorer pane** : [(ZW model name)] (double click)
- **Edit pane** : [Online] icon (🔌)
- **Online setting window** : [Trend Monitor]

- 1 Select [Trend Monitor].**
The Trend Monitor window starts up.
- 2 Execute the sampling.**

Note

 6-1 Parallel I/O connection p.138

- 3 After sampling execution, click the export icon (📄).**
- 4 Set the name of the export file.**

The data is output in the following format.

LoggingMode	Single
SamplePeriod	0:0:1:0:0
TriggerStart	True
TriggerStartType	DataSlope
TriggerStartObject	TASK1
TriggerStartConditions	EqualTo
TriggerStartValue1	1.1
TriggerStartValue2	
TriggerStartDelay	0
TriggerEnd	True
TriggerEndType	DataWindowIn
TriggerEndObject	TASK2
TriggerEndConditions	
TriggerEndValue1	-0.5
TriggerEndValue2	0.5
TriggerEndDelay	0
ExternalFileStorage	FALSE
MaxSamplesPerFile	4500
TargetDirectory	C:\Omron\Data\DataTrace\
FilePrefix	

Index	(DataName1)	(DataName2)
1	1.21314	1.21314
2	1.22098	1.22098
3	0.12334	0.12334
4	-0.1211	-0.1211
5	-1.23456	-1.23456
6	-1.22222	-1.22222

5-3 Displaying saved measured values

You can import a file to which measured values were exported and display those sampling results as a graph.

- ▶ **Explorer pane** : [(ZW model name)] (double click)
 - **Edit pane** : [Online] icon ()
 - **Online setting window** : [Trend Monitor]

- 1 Select [Trend Monitor].**
The Trend Monitor window starts up.
- 2 Click the import icon ()**.
- 3 Select the file to import.**
The file is imported and a graph displayed.

5-4 Performing internal logging

Up to 12,800 x 4tasks measured data can be logged in the Sensor Controller's internal memory.

Item	Output items	Description
LoggingMode	Internal	Indicates the internal logging.
SamplePeriod	1 to 99999	Indicates the storage interval.

- ▶ **Explorer pane** : [(ZW model name)] (double click)
- **Edit pane** : [Online] icon (🔌)
- **Online setting window** : [Internal Logging]

1 Set the logging conditions.

Select the [Preservation interval], [logging data count], and the TASK to store the data for.

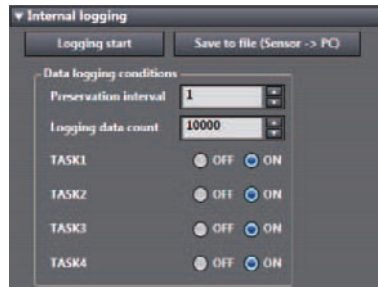

Item	Setting item	Range	Description
Data logging conditions	Preservation intervals	1 to 99999	Set the data storage interval. If "1" is set, all measured data is stored, and "2" is set, one measurement value is stored every two measurement.
	Logging data count	1 to 12800	Set the number of data points to store for each TASK.
	TASK1	OFF/ON	Set whether to store the measurement results for TASK 1.
	TASK2	OFF/ON	Set whether to store the measurement results for TASK 2.
	TASK3	OFF/ON	Set whether to store the measurement results for TASK 3.
	TASK4	OFF/ON	Set whether to store the measurement results for TASK 4.

2 Click the [Logging start] button to start internal logging.

A confirmation message is displayed. Click [Yes] to start internal logging.

Note

Starting internal logging can also be executed by No-protocol communications or parallel I/O.

3 After internal logging ends, click the [Save to file (Sensor → PC)] to output the data to a file.

A CSV format file in the following format is output.

LoggingMode	Internal			
SamplePeriod	1			
Index	Task1	Task2	Task3	Task4
0	1.21314	1.21314	1.21314	1.21314
1	1.22098	1.22098	1.22098	1.22098
2	0.12334	0.12334	0.12334	0.12334
3	-0.1211	-0.1211	-0.1211	-0.1211
4	-1.23456	-1.23456	-1.23456	-1.23456
5	-1.22222	-1.22222	-1.22222	-1.22222

5-5 Storing the light reception wave form in a file

The light reception wave form can be stored in a file as a record of the measurement state.

Item	Output items	Description
RegionNo	Area1 / Area2	Indicates the measurement area. Area1: Measurement Area 1 Area2: Measurement Area 2
StartPosition	0 to 255	Indicates the start position for the measurement area.
EndPosition	0 to 255	Indicates the end position for the measurement area.

► **Explorer pane** : [Bank] | [(Bank Data Name)] (double click)

1 Select the line bright storage icon ().

Input the name of the file to export to.

A CSV format file in the following format is output.

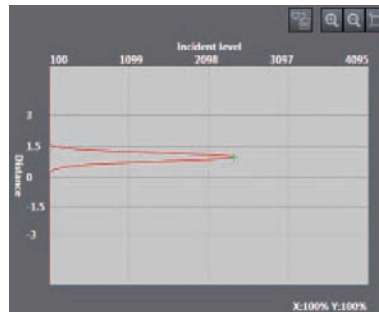

• For Area 1 mode

RegionNo	Area1
StartPosition	(Display area start point)
EndPosition	(Display area end point)
Position	Value
0	(Amount of light received 0)
1	(Amount of light received 1)
2	(Amount of light received 2)
3	(Amount of light received 3)
:	:
254	(Amount of light received 254)
255	(Amount of light received 255)

• For Area 2 mode

RegionNo	Area1	Area2
StartPosition	(Display area start point)	(Display area start point)
EndPosition	(Display area end point)	(Display area end point)
Position	Value	Value
0	(Amount of light received 0)	(Amount of light received 0)
1	(Amount of light received 1)	(Amount of light received 1)
2	(Amount of light received 2)	(Amount of light received 2)
3	(Amount of light received 3)	(Amount of light received 3)
:	:	:
254	(Amount of light received 254)	(Amount of light received 254)
255	(Amount of light received 255)	(Amount of light received 255)

5-6 Recovering calibration ROM data

If an abnormality occurs in the sensor's calibration ROM, you can recover the backed up calibration ROM data into the sensor.

1 Set the operating mode to the FUN mode.

 3-3 Switching operation modes p.61

- ▶ **Explorer pane** : [Device Group] | [(Sensor Name)] (double click)
- **Edit pane** : [Tool] icon 

2 Click the [ROM recovery] in [Sensor setup].
Select the calibration ROM backup data file.

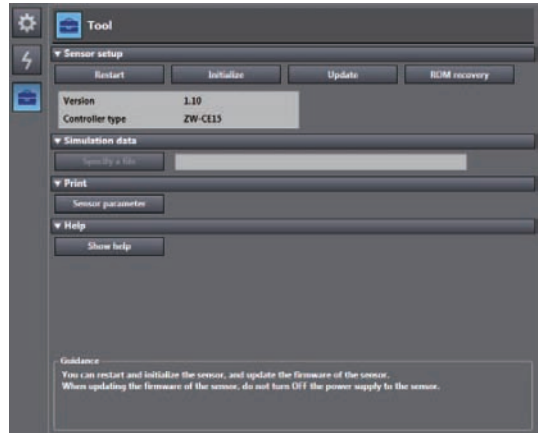

Important

The calibration ROM data is different for each sensor serial number. Select the backup file that matches the sensor serial number. Measurement will not be correct unless they match.

5-7 Printing the contents of settings

You can print the contents of bank data and system data settings.

Item	Setting item	Mode	Description
Print	Target data	All information	The sensor information, bank group data, and system data are all printed.
		Sensor information	The sensor information is printed.
		Bank Group	The bank group data (Banks 1 through 8) is printed.
		Bank	The specified bank data is printed.
		System	The system data is printed.
	Bank number	1 to 8	If bank data is selected as target data, specify the bank number to print the data for.

► **Explorer pane** : [Device Group] | [(Sensor Name)] (right-click)

1 Select [Print].

The [Print] window is displayed on the Edit pane.

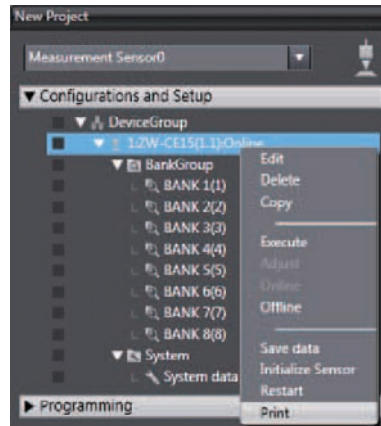

2 Select the data to print.

From [Target data], select the data to print. Select and expand the parameters to print.

If you click [Expand All], all the parameters are expanded.

To print the default values as well, check the [Display Default Values] checkbox.

Important

Only the expanded parameters are printed.

5-8 Controll input signal with PC tool

Following input signal can be controlled with PC tool.

- LED-OFF
- TIMING
- RESET
- ZERO

► **Explorer pane** : [Bank] | [(Bank data Name)] (double click)
 → **Edit pane** : [/I/O input]

1 Select ON from [/I/O input].

2 If each button is clicked, the Sensor Controller is controlled as corresponding input signal is turned ON.

While the button is clicked , corresponding input signal is status ON.

If the button is clicked again, the input signal is turned OFF.

Button	Effect
LED-OFF	The measurement LED is turned OFF.
TIMING	The TIMING input is turned ON.
RESET	The RESET input is turned ON.
ZERO	The ZERO input is turned ON.



MEMO

Communications with External Devices

6-1 Parallel I/O connection	138
6-2 EtherCAT Connection	159
6-3 EtherNet/IP Connection	198
6-4 No-protocol Connection	226

6-1 Parallel I/O connection

I/O Signal Functions

The following describes the functions of I/O signals.

Analog Output Terminals

Analog output

Name	Description
Analog voltage output	This outputs the measured value from -10 V to +10 V as the voltage value. When measurement not possible: Approx. 10.8V (default value, can be selected by user) At alarm: Approx. 10.8V
Analog current output	This outputs the measured value, from 4 mA to 20 mA as the current value. When measurement not possible: Approx. 21 mA (default value, can be selected by user) At alarm: Approx. 21 mA

32-pole expansion connector

Judgment output

Name	Description
HIGH output	Judgment result HIGH (HIGH threshold value < measured value) is output.
PASS Output	Judgment result PASS (LOW threshold value ≤ measured value ≤ HIGH threshold value) is output.
LOW output	Judgment result LOW (LOW threshold value > measured value) is output.

ALARM output

Name	Description
ALARM output	This turns ON when there is a system error.

BUSY output

Name	Description
BUSY output	This turns ON during sampling with the hold function enabled. It allows you to check whether or not the self-trigger is functioning correctly. It also turns ON during bank switching.

ENABLE output

Name	Description
ENABLE output	This turns ON when the sensor is ready for measurement. This output is interlocked with the ENABLE indicator.

ZERO input

Name	Description
ZERO input	This is used to execute and clear a zero reset.

RESET input

Name	Description
RESET input	This resets all executing measurements and outputs. While a RESET is being input, judgment output conforms to the non-measurement setting. If this RESET input switches ON while the hold function is used, the state in effect before the hold function was set will be restored.

TIMING input

Name	Description
TIMING input	This timing input is for signal input from external devices. Use it for hold function timing.

LED OFF input

Name	Description
LED OFF input	Turn off the measurement LED. While LED OFF is being input, the analog output and judgment output conform to the non-measurement setting.

LOGGING input

Name	Description
LOGGING input	This is used to start internal logging.

Settings for Analog Output

The following describes the settings for outputting the current measurement results from the analog output of the analog output terminal block.

Setting the analog output destination

With analog output, the measurement results can be output converted to a current from 4 to 20 mA or a voltage from -10 to +10 V.

Selects which to output, the current or the voltage.

Important

The same output destination is set for all banks. The output destination cannot be set separately for individual banks.

Item	Setting item	Setting value	Description
Sensor settings	Analog output	Voltage output (default value)	Voltage output
		Current output	Current output

1 Set the operating mode to the FUN mode.

 3-3 Switching operation modes p.61

- **Explorer pane** : [Device Group] | [(Sensor Name)] | [System] | [System Data] (double-click)
- **Edit pane** : [Sensor settings] icon ()

2 Select the output destination from [Analog output].

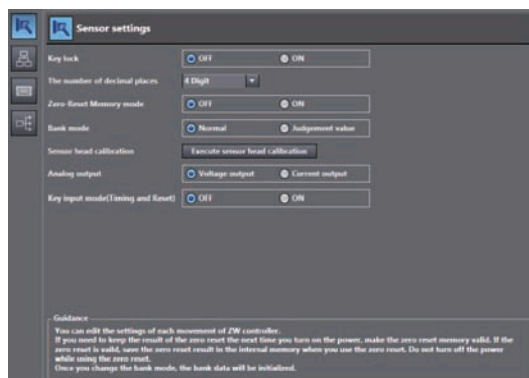

Note

The analog output destination can also be set with key operations on the Sensor Controller.

 Setting the analog output destination p.338

Assigning Analog Output

Set the task for which to output the results as analog.

Item	Setting item	Setting value	Description
Analog output	Output object	None/TASK1/TASK2/TASK3/TASK4	Select the task to output as analog.

1 Set the operating mode to the FUN mode.

 3-3 Switching operation modes p.61

- ▶ **Explorer pane** : [Bank] | [(Bank Data Name)] (double click)
- **Edit pane** : [I/O Settings] icon 
- **I/O Setting Screen** : [Analog output]

2 Select the task from [Output object].

You can select from the above setting values.
None/TASK1/TASK2/TASK3/TASK4

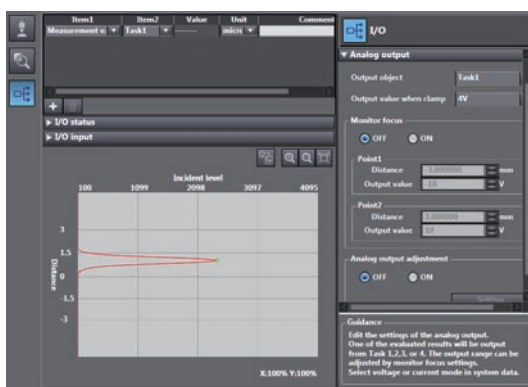

Note

Analog output can also be assigned with key operations on the Sensor Controller.

 Assigning Analog Output p.339

Setting Monitor Focus

With analog output, the relationship between the output value and measured value to be displayed can be set as desired to convert the measurement result to 4 to 20 mA current or -10 to +10 V voltage before output.

Set the focus to match the connected external device.

The output range can be set by entering the output value for the current or voltage values for any two points.

Example: When setting 4 mA output (1st point) for measured value of 0 mm and 20 mA output for measured value of 6 mm (2nd point) (current output)

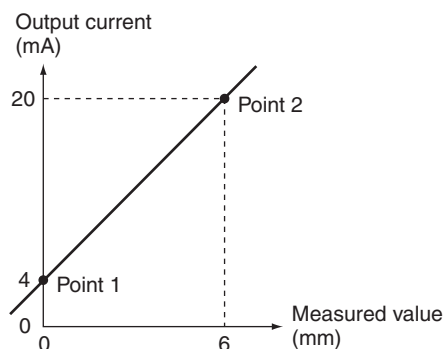

Important

Separate the two specified points by at least 1% of the rated measuring range of the connected Sensor Head or 40 μm .

For example, for the ZW-S40, the two measured points must be separated by at least $12 \text{ mm} \times 0.01 = 0.12 \text{ mm}$ as the measuring range is $12 \text{ mm} (\pm 6 \text{ mm})$.

Item	Setting item	Setting value	Description	
Monitor focus	Monitor focus	ON/OFF (default value)	Sets monitor focus ON/OFF.	
	Point1	Distance value	-999.999999 to -3.000000 (default value) to 999.999999 [mm]	Sets the reference measured value for output.
		Current output value	4 (default value) to 20 [mA]	When the analog output destination is set to current, sets the current to be output when the distance value is measured.
		Voltage output value	-10 (default value) to 10 [V]	When the analog output destination is set to voltage, sets the voltage to be output when the distance value is measured.
	Point2	Distance value	-999.999999 to 3.000000 (default value) to 999.999999 [mm]	Sets the reference measured value for output.
		Current output value	4 (default value) to 20 [mA]	When the analog output destination is set to current, sets the current to be output when the distance value is measured.
Voltage output value		-10 (default value) to 10 [V]	When the analog output destination is set to voltage, sets the voltage to be output when the distance value is measured.	

Note

The monitor focus can also be set with key operations on the Sensor Controller.



Setting Monitor Focus p.339

1 Set the operating mode to the FUN mode.

 3-3 Switching operation modes p.61

- ▶ Explorer pane : [Bank] | [(Bank Data Name)] (double click)
- Edit pane : [I/O Settings] icon 
- I/O Setting Screen : [Analog output]

2 Select ON/OFF from [Monitor Focus].

3 Enter the [Distance] and [Output value] at [Point1].

4 Likewise, enter the [Distance] and [Output value] at [Point2].

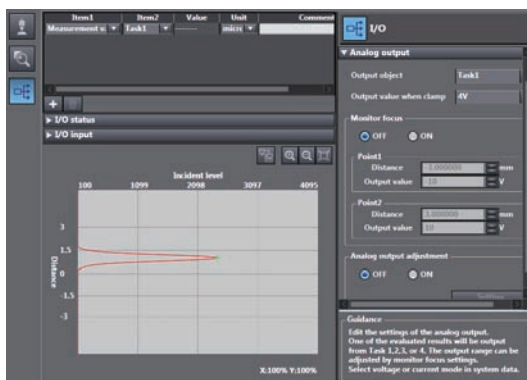

Adjusting the analog output value

Discrepancies may occur between the current value/voltage value output as analog set on the Sensor Controller and the current value/voltage value actually measured due to the conditions for the connected external device or other factors.

The analog output adjustment function can be used to correct this discrepancy.

The output values are corrected by entering the adjustment value for the current or voltage values for any two points.

Important

Set the output destination and select either current or voltage output beforehand. Also, connect the analog output signal line to an external ammeter or voltmeter.

Item	Setting item	Setting value	Description	
Analog output adjustment	Analog output adjustment		ON/OFF (default value)	Set analog output correction ON/OFF.
	Point1	Reference value (current/voltage)	4 to 20 [mA]/-10 to 10 [V]	Sets the current or voltage to be used as the correction reference in the entry field on the left.
		adjustment value	-999 to 999	Sets the adjustment value when the reference value is measured in the entry field on the right.
	Point2	Reference value (current/voltage)	4 to 20 [mA]/-10 to 10 [V]	Sets the current or voltage to be used as the correction reference in the entry field on the left.
adjustment value		-999 to 999	Sets the adjustment value when the reference value is measured in the entry field on the right.	

1 Set the operating mode to the FUN mode.

 3-3 Switching operation modes p.61

- ▶ Explorer pane : [Bank] | [(Bank Data Name)] (double click)
- Edit pane : [I/O Settings] icon 
- I/O Setting Screen : [Analog output]

2 Select ON from [Analog output adjustment].

3 Click [Setting].

The "Analog Output Adjust" popup menu appears.

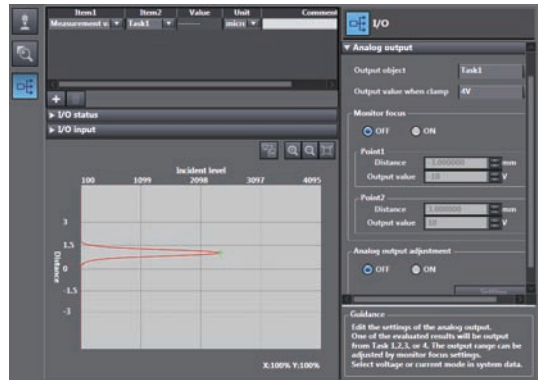

4 Enter the [Distance] and [Output value] at [Point1], and click [Output].

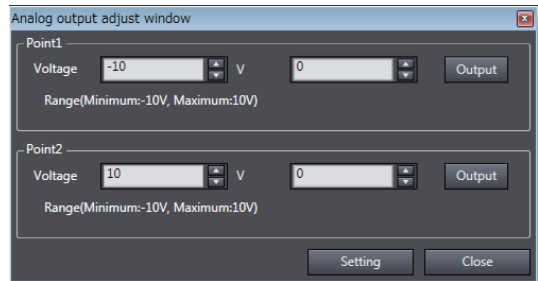

5 Likewise, enter the [Distance] and [Output value] at [Point2], and click [Output].

6 Click [Setting].

Note

Analog output values can also be adjusted with key operations on the Sensor Controller.

 Adjusting the analog output value p.341

Settings for Judgment Output

The following describes the settings for outputting the judgment results from the judgment output of the 32-pole extension connector.

Assigning judgment output

Set the task for which to output the judgment results.

The judgment results for the selected task are output from the following output terminals of the 32-pole extension connector.

HIGH1/PASS1/LOW1

Item	Setting item	Setting value	Description
Judgment	Output object	TASK1/TASK2/TASK3/TASK4	Select the task for which to output the judgment result.

1 Set the operating mode to the FUN mode.

 3-3 Switching operation modes p.61

- ▶ **Explorer pane** : [Bank] | [(Bank Data Name)] (double click)
 - **Edit pane** : [I/O Settings] icon 
 - **I/O Setting Screen** : [Judgment]

2 Select the task from [Output object].

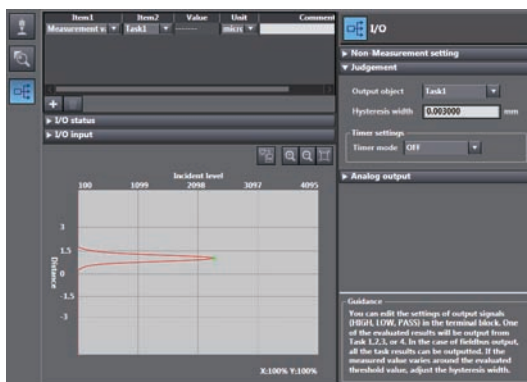

Note

Judgment output can also be assigned with key operations on the Sensor Controller.

 Assigning judgment output p.342

Setting Operation at Judgment Output

Set the hysteresis width of the judgment upper/lower limit values and judgment output timing.

 3-6 Setting Threshold Value p.68

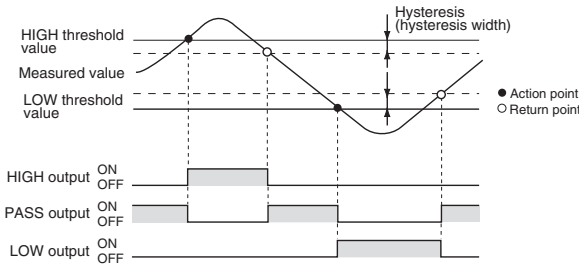
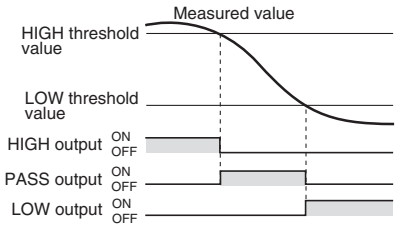
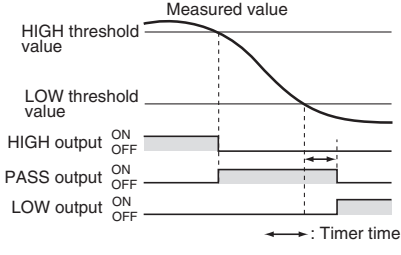
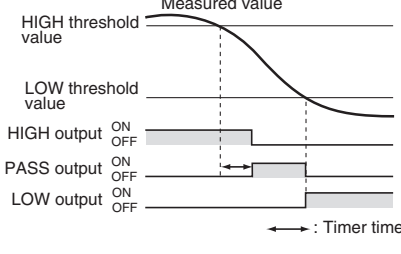
Item	Setting item	Setting value	Description
Judgment output	Hysteresis width	0 to 99.9999mm	<p>Sets the hysteresis value (difference between operating point and recovery point) of the judgment upper/lower limit values when HIGH/PASS/LOW judgment is unstable near the boundary.</p> 
	Timer mode	OFF (default value)	<p>Outputs the judgment as soon as the judgment result has been applied.</p> 
	Off Delay		<p>Delays the falling edge of the PASS output by the value set at [Timer Duration] after the judgment result has been applied.</p> 
	On Delay		<p>Delays the rising edge of the PASS output by the value set at [Timer Duration] after the judgment result has been applied.</p> 

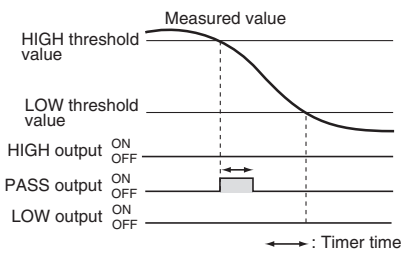
Item	Setting item	Setting value	Description
Judgment output	Timer mode	One Shot	When the judgment result changes to PASS, the PASS output is executed for the time set to [Timer Duration]. 
	Timer time	1 (default value) to 5000 [ms]	Sets the timer duration when the timer mode is other than OFF.

1 Set the operating mode to the FUN mode.

 3-3 Switching operation modes p.61

- ▶ **Explorer pane** : [Bank] | [(Bank Data Name)] (double click)
- **Edit pane** : [I/O Settings] icon 
- **I/O Setting Screen** : [Judgment]

2 Set [Hysteresis Width].

3 Select the judgment output timing to match operation of the external device from [Timer settings] - [Timer mode].

4 Sets [Timer time].

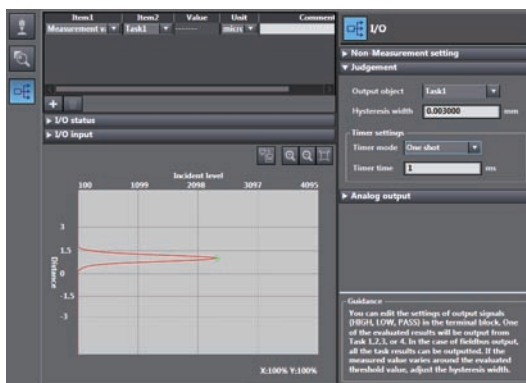

Note

The operations for judgment output can also be set with key operations on the Sensor Controller.

 Setting Operation at Judgment Output p.343

Settings for Processing When Measurement Is Not Possible

Setting operation when measurement is not possible

Set the output method when the sensor head temporarily enters a non-measurement state, for example, due to insufficient received light amount or a RESET input state.

Example: When skipping occurs in the waveform due to insufficient received light intensity

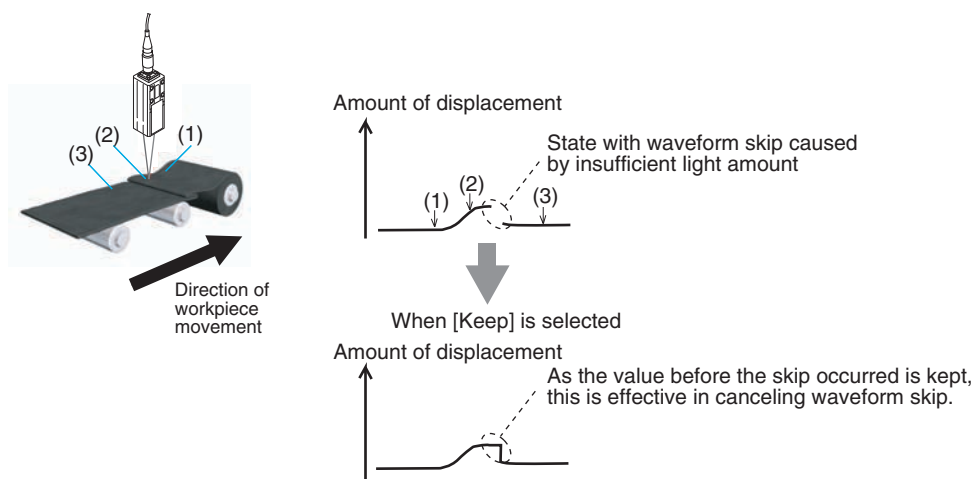

Important

When performing hold measurement, the output before the initial hold value is applied is the same as that for "Clamp" even if "Keep" is set.

Item	Setting item	Setting value	Description
Non-Measurement setting	Non-Measurement setting	Keep	The measured value before the non-measurement state was entered is held and output.
		Clamp	With analog output, the preset clamp value (abnormal value) is output. All judgment outputs become OFF.

1 Set the operating mode to the FUN mode.

3-3 Switching operation modes p.61

- ▶ **Explorer pane** : [Bank] | [(Bank Data Name)] (double click)
- **Edit pane** : [I/O Settings] icon
- **I/O Setting Screen** : [Non-Measurement Setting]

- 2 Select the operation during non-measurement at [Non-Measurement Setting].

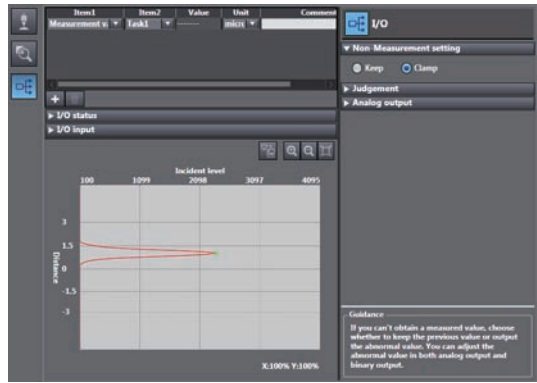

Note

The operations for when measurement is not possible can also be set with key operations on the Sensor Controller.

Setting operation when measurement is not possible p.344

Setting the Clamp Value

Set the clamp value to output when "Clamp" is selected as processing when measurement is not possible.

Item	Setting item	Setting value	Description
Analog output	Clamp output	When the analog output destination is set to current MIN (approx. 3.4mA)/4 to 20mA (1mA increments)/ MAX (default value: approx. 21mA) When the analog output destination is set to voltage MIN (approx. -10.8V)/-10 to 10V (1V increments)/ MAX (default value: approx. 10.8V)	Select the current/voltage at clamp output.

- 1 Set the operating mode to the FUN mode.

3-3 Switching operation modes p.61

- ▶ Explorer pane : [Bank] | [(Bank Data Name)] (double click)
- Edit pane : [I/O Settings] icon
- I/O Setting Screen : [Analog output]

- 2 Select the output value at [Output value when clamp].

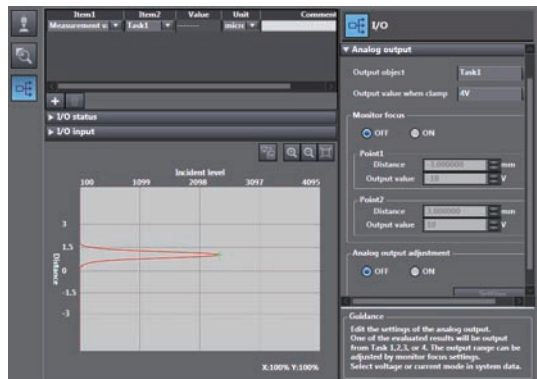

Note

Clamp values can also be set with key operations on the Sensor Controller.



Setting the Clamp Value p.345

Settings for Bank Control

This section describes the settings for controlling banks by using parallel I/O.

Selecting banks

The bank is selected in combinations of the bank select input signals (BANK_SEL1 to 3).

Bank selection input 1 (BANK_SEL1)	Bank selection input 2 (BANK_SEL2)	Bank selection input 3 (BANK_SEL3)	Selected bank
OFF	OFF	OFF	BANK1
ON	OFF	OFF	BANK2
OFF	ON	OFF	BANK3
ON	ON	OFF	BANK4
OFF	OFF	ON	BANK5
ON	OFF	ON	BANK6
OFF	ON	ON	BANK7
ON	ON	ON	BANK8

Important

- Bank switching is begun 0.2 seconds after the input state changes.
- At most it takes about 100ms to switch banks.
- During bank switching, the BUSY output becomes ON.
- If the bank mode is set to [JUDGE], the bank cannot be switched at the external signal input because the number of banks increases to 32.

Outputting the currently selected bank number

The currently selected bank number is output.

The output bank number depends on the combination of the bank number output signals (BANK_OUT1 to 3).

Bank number output 1 (BANK_OUT1)	Bank number output 2 (BANK_OUT2)	Bank number output 3 (BANK_OUT3)	Output bank
OFF	OFF	OFF	BANK1
ON	OFF	OFF	BANK2
OFF	ON	OFF	BANK3
ON	ON	OFF	BANK4
OFF	OFF	ON	BANK5
ON	OFF	ON	BANK6
OFF	ON	ON	BANK7
ON	ON	ON	BANK8

Settings for Internal Logging

Set the LOGGING save count and LOGGING save intervals

The following describes the settings for internal logging.

Item	Setting item	Setting value	Description
Internal logging	LOGGING save count	0 to 12800 (default value)	Sets the maximum data count to be internally logged.
	LOGGING save intervals	0 to 1 (default value) to 1000	Sets the intervals to be internally logged. If "1" is set , all measured data is stored, and "2" is set, one measured data is stored every two measurement. If "0" is set, only the applied measured data is stored when hold is set.

Important

- This settings are not applied when internal logging is started by sending No-protocol communications or the operating keys on the Sensor Controller.
- It cannot set and display using Sysmac Studio.

Note

The setting of LOGGING save count and LOGGING save intervals can also be set by the operating keys on the Sensor Controller.

 Setting for Internal Logging p.346

Timing Chart

The following shows the timing charts when communication is performed with external devices.

Basic operation

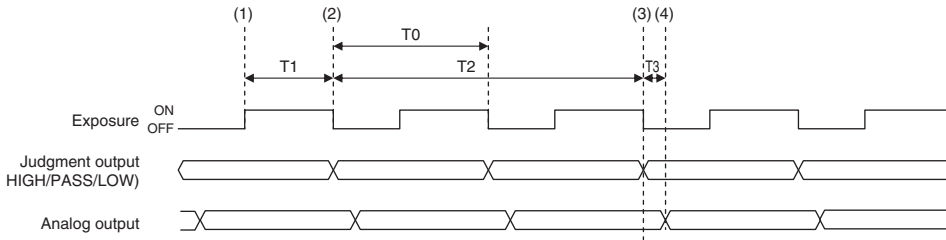

Item		Min.	Max.
T0	Measuring cycle	0.5ms	Depends on the set conditions (0.5 to 10.0 ms)
T1	Exposure time	1 μ s	Max. exposure time (1 to 5000 μ s)
T2	Response time of output	$T0 \times 2$	$T0 \times 2$
T3	Response time of analog output	–	0.1 ms

Explanation of operations

- (1) During each measuring cycle, the LEDs are lit and exposure is started.
- (2) After the end of exposure, measurement starts.
- (3) After the end of measurement, the judgment result is output.
- (4) After the judgment result output, the analog output is updated.

Hold (peak/bottom/peak to peak/average)

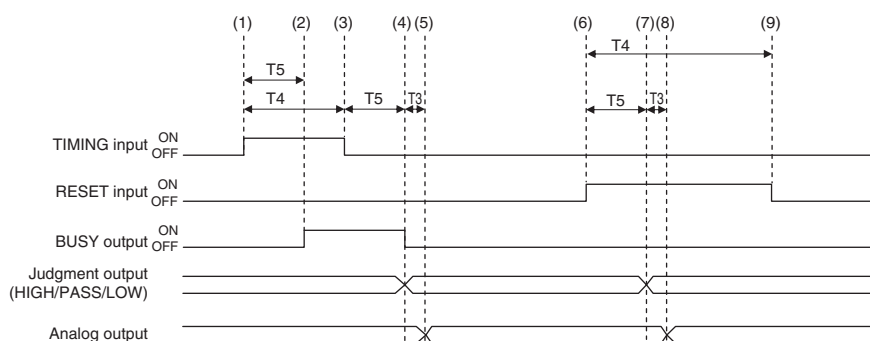

Item		Min.	Max.
T3	Response time of analog output	–	0.1 ms
T4	TIMING input/RESET input minimum time	3ms+T0	–
T5	Input response time	2ms+T0	3ms+T0 × 2

Explanation of operations

- (1) The TIMING input is turned ON.
- (2) During the TIMING input minimum time, when the TIMING input is ON, sampling is started and the BUSY output is turned ON.
- (3) The TIMING input is turned OFF.
- (4) After the TIMING input turns OFF, sampling is ended and the judgment results are output. The BUSY output is also turned OFF.
- (5) After the judgment result output, the analog output is updated.
- (6) The RESET input is turned ON. If the RESET input is turned ON during the RESET input minimum time, the measured value is reset.
- (7) The judgment result is reset.
- (8) After the judgment result reset, the analog output is reset.
- (9) The RESET input is turned OFF.

Important

When the setting for non-measurement is "CLAMP", if the sampling value is an abnormal value or an undetermined value *, sampling is not executed. If sampling has been started, it is stopped. The output value is as follows.

- Hold the clamp value.
- To start and continue sampling even if a sampling value is an abnormal value or an undetermined value, set "KEEP" as the non-measurement setting.

*: After the start of measurement, if measurement results are not obtained the number of times required to take the average, the measurement result is not applied.

Hold (auto peak/auto bottom/auto peak-to-peak)

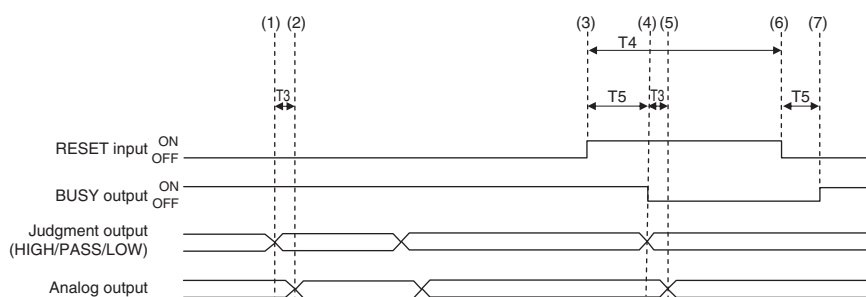

Item		Min.	Max.
T3	Response time of analog output	–	0.1 ms
T4	TIMING input/RESET input minimum time	$3\text{ms}+T_0$	–
T5	Input response time	$2\text{ms}+T_0$	$3\text{ms}+T_0 \times 2$

Explanation of operations

- (1) The peak value is updated and the judgment result is output.
- (2) After the judgment result output, the analog output is updated.
- (3) The RESET input is turned ON. If the RESET input is turned ON during the RESET input minimum time, the measured value is reset.
- (4) The judgment result is reset. The BUSY output is turned OFF.
- (5) After the judgment result reset, the analog output is reset.
- (6) The RESET input is turned OFF.
- (7) The BUSY output is turned ON.

Important

When the setting for non-measurement is "CLAMP", if the sampling value is an abnormal value or an undetermined value *, sampling is not executed. If sampling has been started, it is stopped. The output value is as follows.

- Hold the clamp value.
- The BUSY signal is turned OFF.
- To start and continue sampling even if a sampling value is an abnormal value or an undetermined value, set "KEEP" as the non-measurement setting.

*: After the start of measurement, if measurement results are not obtained the number of times required to take the average, the measurement result is not applied.

Hold (sampling)

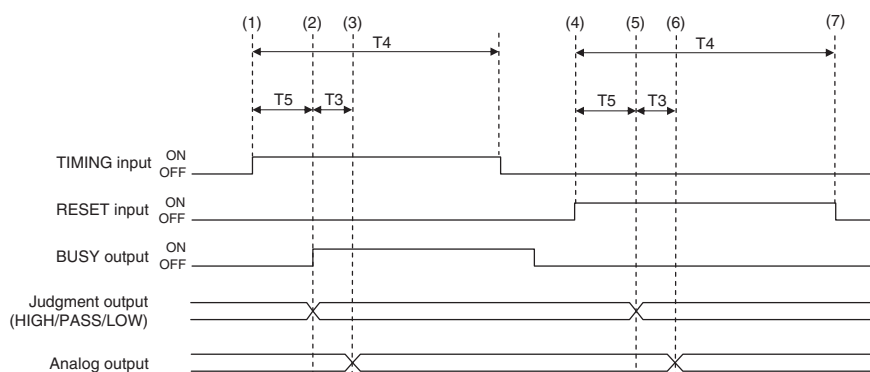

Item		Min.	Max.
T3	Response time of analog output	–	0.1 ms
T4	TIMING input/RESET input minimum time	3ms+T0	–
T5	Input response time	2ms+T0	3ms+T0 × 2

Explanation of operations

- (1) The TIMING input is turned ON.
- (2) During the TIMING input minimum time, when the TIMING input is ON, sampling is started and the BUSY output is turned ON. The measurement result is sampled and the judgment result is output.
- (3) After the judgment result output, the analog output is updated.
- (4) The RESET input is turned ON. If the RESET input is turned ON during the RESET input minimum time, the measured value is reset.
- (5) The judgment result and is reset.
- (6) After the judgment result output, the analog output is reset.
- (7) The RESET input is turned OFF.

Important

When the setting for non-measurement is "CLAMP", if the sampling value is an abnormal value or an undetermined value *, sampling is not executed. The output value is as follows.

- Hold the clamp value.
- The BUSY signal is not turned ON.

*: After the start of measurement, if measurement results are not obtained the number of times required to take the average, the measurement result is not applied.

Bank Switching

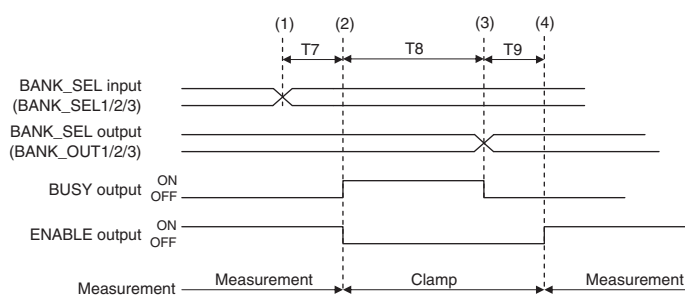

Item		Min.	Max.
T7	Input response time	–	200 ms
T8	Bank switching time	–	100 ms
T9	Measurement start response time	$3 \times T0$	Depends on the set conditions

Explanation of operations

- (1) The BANK_SEL signal is switched to the bank number to switch to.
- (2) After the input response time, the measurement stops and the BUSY output is turned ON, then the bank switching operation is started.
- (3) After bank switching ends, the BUSY output is turned OFF and the BANK_OUT output is switched.
- (4) Measurement is restarted and the ENABLE output is turned ON.

LED OFF

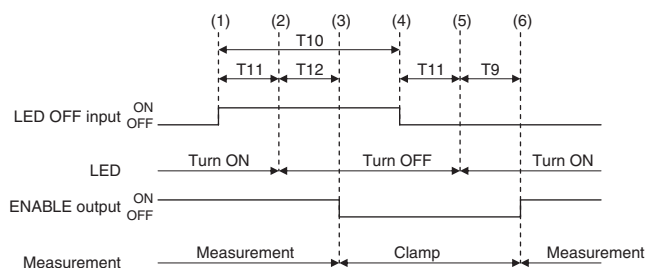

Item		Min.	Max.
T9	Measurement start response time	$3 \times T0$	Depends on the set conditions
T10	LED OFF input minimum time	100 μ s	–
T11	Time of receiving LED OFF input	–	100 μ s
T12	ENABLE response time after LEDs are turned OFF	–	$2 \times T0$

Explanation of operations

- (1) The LED OFF input is turned ON.
- (2) After the LED OFF input is turned ON, the LEDs are turned OFF.
- (3) After the LEDs are turned OFF, the ENABLE output is turned OFF.
- (4) The LED OFF input is turned OFF.
- (5) After the LED OFF input is turned OFF, the LEDs are turned ON.
- (6) After the LEDs are lit up, measurement is restarted and the ENABLE output is turned ON.

Zero reset

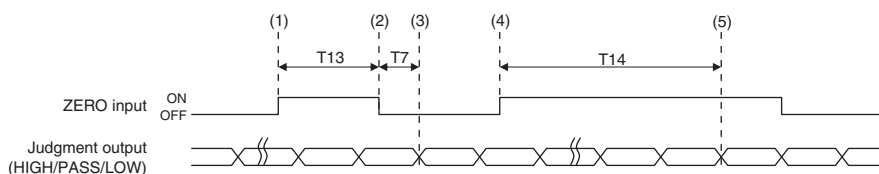

Item		Min.	Max.
T7	Input response time	$2\text{ms}+T_0$	$3\text{ms}+T_0 \times 2$
T13	ZERO input time	50 ms	0.8s
T14	ZERO input cancel time	1s	—

Explanation of operations

- (1) The ZERO input is turned ON.
- (2) After the ZERO input time, the ZERO input is turned OFF.
- (3) After the ZERO input is turned OFF, the zero reset is executed and the judgment results reflected in the measurement results are output.
- (4) The ZERO input is turned ON.
- (5) After at least the cancel time of ZERO input has passed, the zero reset is cancelled.

Operating Mode Switching

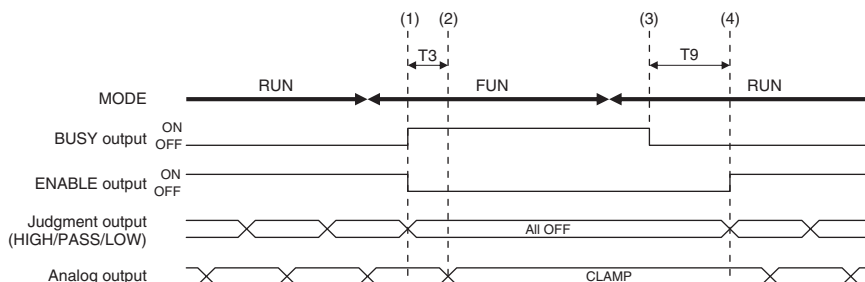

Item		Min.	Max.
T3	Response time of analog output	—	0.1 ms
T9	Measurement start response time	$3 \times T_0$	Depends on the set conditions

Explanation of operations

- (1) After the mode is switched from RUN to FUN mode, the BUSY output and ENABLE output are turned OFF. The judgment outputs all go OFF.
- (2) The response time of analog output after the BUSY output is turned ON, the analog output is output clamped.
- (3) After the mode is switched from the FUN mode to the RUN mode, the BUSY output is turned OFF.
- (4) Measurement is restarted and the ENABLE signal is turned ON, then the measurement results are output.

Internal logging

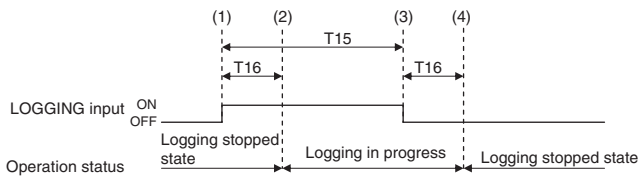

Item		Min.	Max.
T15	LOGGING input minimum time	$3\text{ms}+T_0$	–
T16	Input response time	$2\text{ms}+T_0$	$3\text{ms}+T_0 \times 2$

Explanation of operations

- (1) The LOGGING input is turned ON.
- (2) After the LOGGING input is turned ON, the internal logging is started.
- (3) The LOGGING input is turned OFF.
- (4) After the LOGGING input is turned OFF, the internal logging is ended.

6-2 EtherCAT Connection

Overview of EtherCAT Networks

EtherCAT (Ethernet Control Automation Technology) is a high-performance industrial network system based on Ethernet system and can realize faster and more efficient communications. Each node achieves a short communications cycle time by transmitting Ethernet frames at high speed. Furthermore, even though EtherCAT is a unique protocol, it offers excellent general-purpose applicability. For example, you can use Ethernet cables because EtherCAT utilizes standard Ethernet technology for the physical layer. And the effectiveness of EtherCAT can be fully utilized not only in large control systems that require high processing speeds and system integrity, but also in small and medium control systems.

Features of EtherCAT

EtherCAT has the following features.

● Extremely high-speed communications with speed of 100 Mbps

It dramatically shortens the I/O response time from generation of input signals to transmission of output signals. By fully utilizing the optimized Ethernet frame bandwidth to transfer data using a high-speed repeat method, it is possible to efficiently transmit a wide variety of data.

● Extremely High Compatibility with Ethernet

EtherCAT is an open network with extremely high compatibility with conventional Ethernet systems.

Structure of EtherCAT

EtherCAT does not send data to individual slave nodes on the network, instead, it passes Ethernet frames through all of the slave nodes.

When frame passes through a slave node, the slave node reads and writes data in the areas allocated to it in the frames in a few nanoseconds.

Ethernet frames sent from the EtherCAT Master Unit go through all the EtherCAT Slave Units without stopping on the way. Once they reach the final Slave Unit, they are sent back from the final Slave Unit, pass through all Slave Units again, and return to the EtherCAT Master Unit.

With this structure, EtherCAT secures high-speed and real-time data transmission.

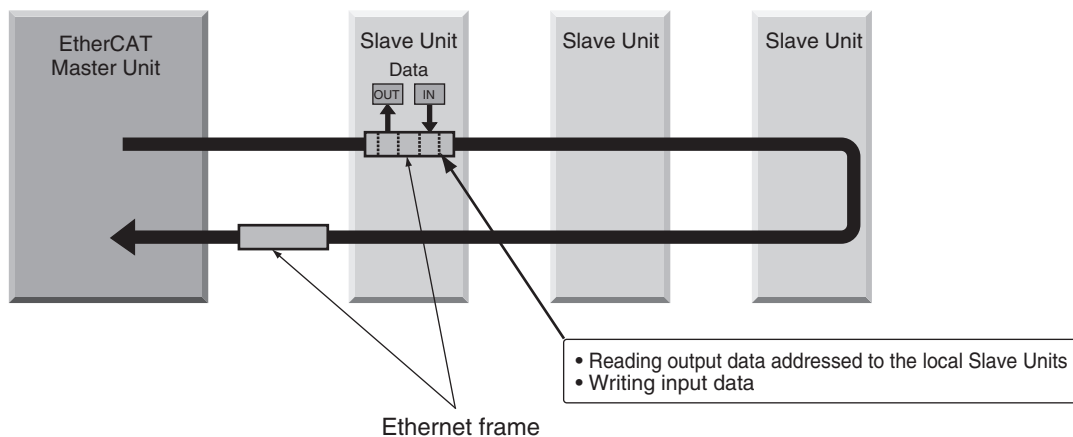

It is the "EtherCAT datagram" stored directly in an Ethernet frame that exchanges data regularly between the EtherCAT Master Unit and Slave Units.

Each "EtherCAT datagram" is configured with header (data length, including address of one or more Slave Units, etc.), data, working counter (check bit).

When an Ethernet frame is compared to a "train", an EtherCAT datagram can be considered as "railway car."

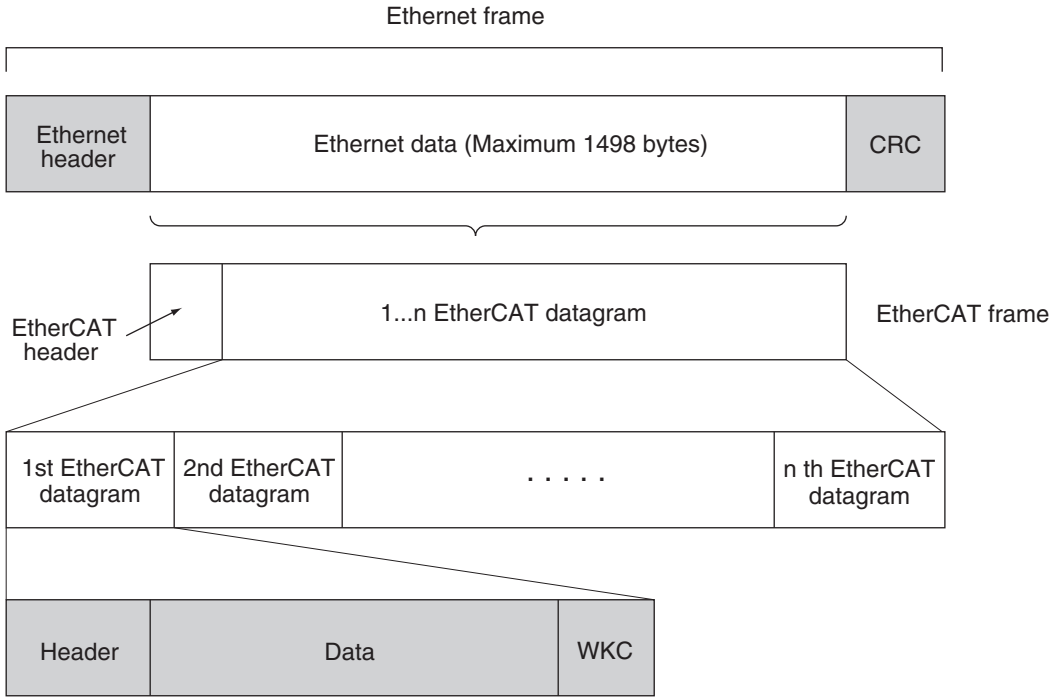

WKC : Working counter

Communications Types of EtherCAT

EtherCAT provides the following two types of communication functions.

PDO communications are always updating data per communication cycle on EtherCAT, while SDO communications are processed in between those updates.

● Process data communications functions (PDO communications)

This communication function is used to transfer process data in real time in a fixed-cycle.

By mapping logical process data space to each node by the EtherCAT Master Unit, it achieves fixed-cycle communications among the EtherCAT Master Unit and Slave Units.

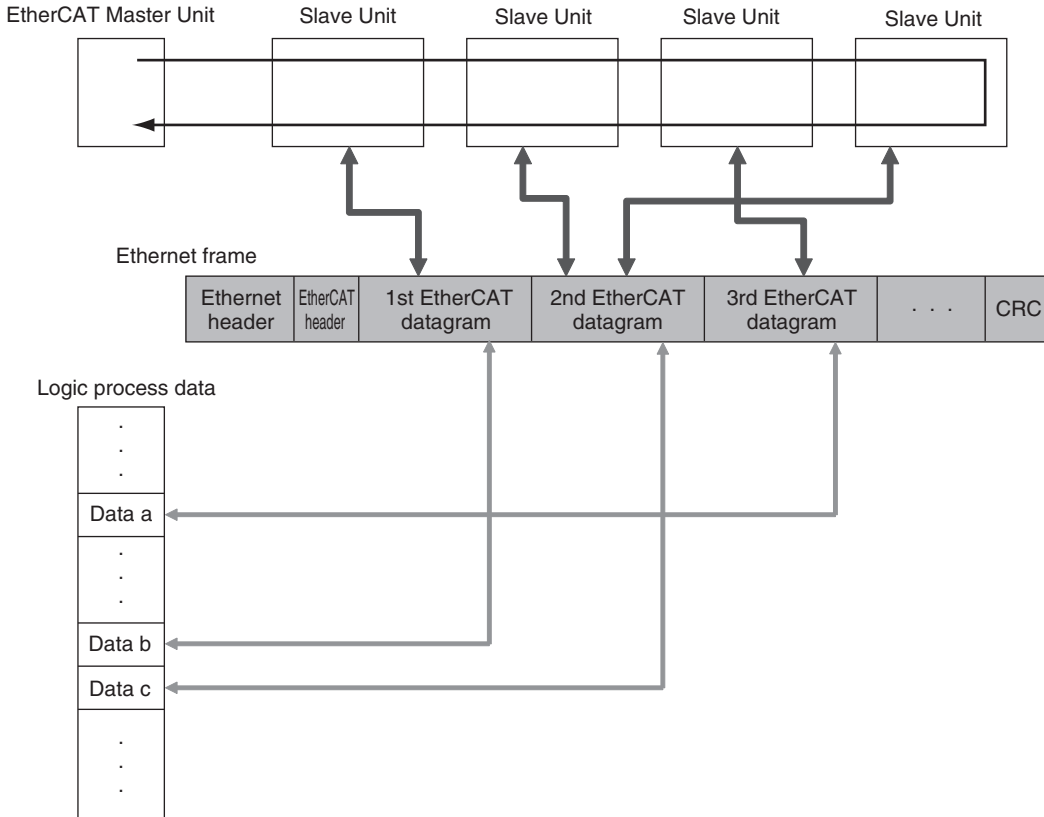

● Mailbox communications functions (SDO communications)

It refers to message communications.

At any timing, the EtherCAT Master Unit transmits commands to Slave Units and the Slave Units return responses to the EtherCAT Master Unit.

It performs the following data communications:

- Read and write process data

ZW Communications Methods in an EtherCAT Connection

Communications between the EtherCAT master and the displacement sensor is performed over EtherCAT to enable control from the master by control signals and data output after measured values are applied. When the displacement sensor is connected to an NJ series CPU Unit via EtherCAT, Sysmac Studio (standard edition) is used to register the ZW to the EtherCAT slave configuration on the network configuration edit pane. For details on registration methods, refer to *Sysmac Studio Version 1 Operation Manual* (SBCA-362) "4-2 Controller Configuration/Setting."

Important

If EtherCAT is set to enable to perform communications over EtherCAT, the EtherNet/IP communications setting is disabled and EtherNet/IP communications is no longer possible.

 Setting Communications Specifications (EtherCAT Communications) p.165

Communications method using process data objects (PDO)

● Control of displacement sensors by control/status signals

With EtherCAT communications, process data objects (PDO) are used to perform PDO communications (cyclic communications). Control of the displacement sensor is performed by storing control signals/command from the master to the displacement sensor, status signals from the displacement sensor to the master, and command responses to the I/O ports (or I/O memory) ^(*) of the Controller.

*1: When connected to the NJ series, "I/O ports" are used, and when connected to the CJ series, "I/O memory" is used. Explanations from here on are for when the connection is to the NJ series.

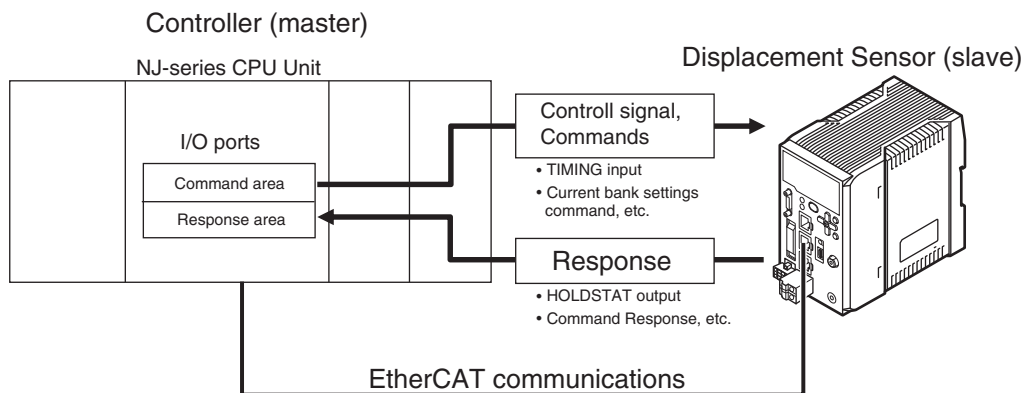

The Controller sends the instruction to the displacement sensor over EtherCAT by switching the control signal bit assigned with control to be executed to ON.

The displacement sensor executes the instruction, and updates the status signal bit according to the result to return it over EtherCAT. $\bar{A}B$

When instructions are executed by control commands, control commands are sent to the displacement sensor over EtherCAT by writing the control command, for example, to I/O port Command and then turning the control command execution (EXE) bit ON.

The displacement sensor executes that control command, and returns the response to the Controller over EtherCAT. The Controller stores the response to I/O port Response, for example.

● **Output of displacement sensor measurement data to output area**

The measurement data of all tasks is automatically output from the displacement sensor to I/O port Measurement Value of Task 1 to 4 immediately after the measured value is applied. This enables the measurement results of all tasks to be easily handed over to the Controller.

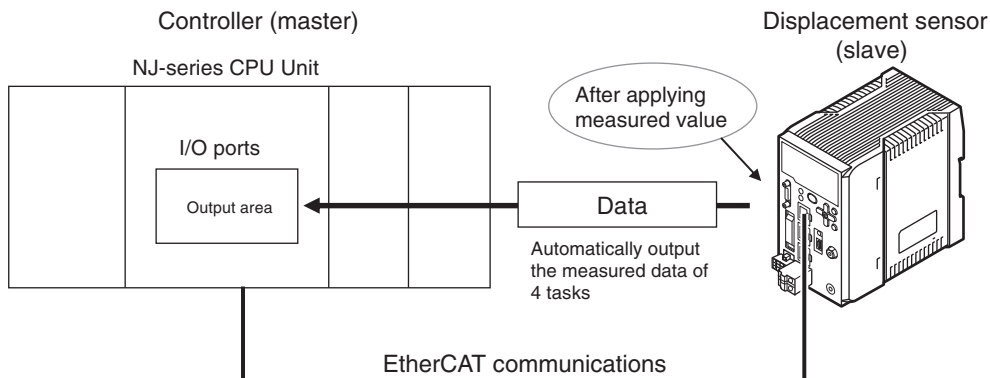

With EtherCAT communications, communications is performed via the I/O ports of the following four area on the Controller. Sysmac error status area I/O ports are used only when an NJ series CPU unit is connected as the master.

Control by control/status signals	(1) I/O ports of instruction area	I/O ports to which the user writes control signals to be executed on the displacement sensor and control commands
	(2) I/O ports of response area	I/O ports to which the displacement sensor writes the control signals written to the instruction area and the result of executing control commands
Data output after application of measured value	(3) I/O ports of output area	I/O ports to which the displacement sensor writes the output data accompanying measurement after application of the measured value
For error status	(4) I/O ports of Sysmac error status area	I/O ports to which the displacement sensor writes the error status

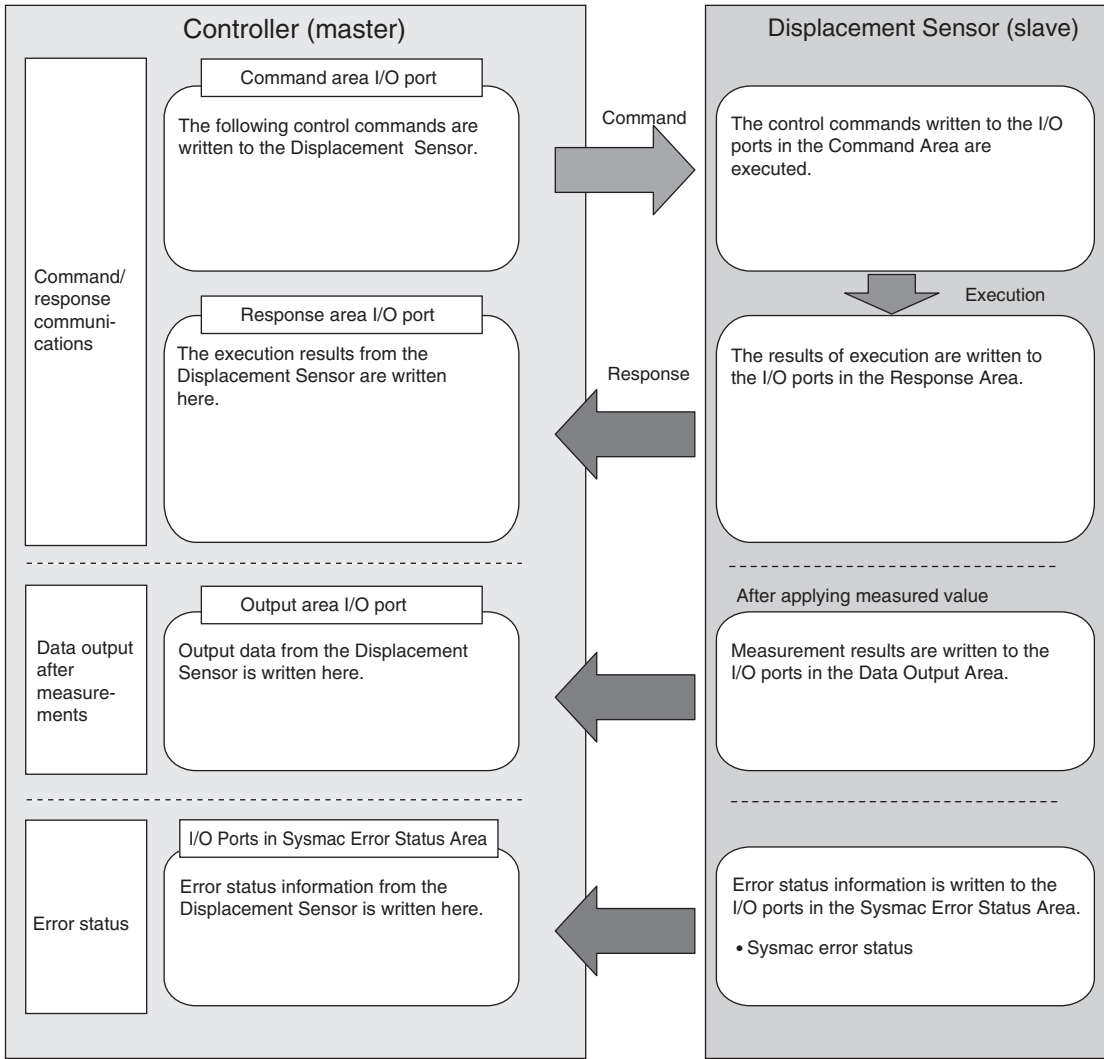

Communications method using service data objects (SDO)

The ZW series supports SDO communications. SDO communications is used for setting objects and monitoring the status of the ZW series. Objects can be set or the status monitored by reading and writing data to entries in the object dictionary of the host Controller.

Setting Communications Specifications (EtherCAT Communications)

Setting default settings for EtherCAT communications

Set the default settings for EtherCAT communications.

Item	Description	Range
Fieldbus	Select whether to use EtherNet/IP communications or EtherCAT communications.	OFF EtherNet/IP EtherCAT
GATE signal ON time	Set the output time of the GATE signal for notifying the timing that the measured value was updated when hold is output.	0 to 100ms

- **Explorer pane** : [Device Group] | [(Sensor Name)] | [System]
[System Data] (double-click)
→ **Edit pane** : [Ethernet Communications Settings] icon 

- 1 Set the fieldbus settings.**
Select [EtherCAT] at [Fieldbus].
- 2 Set the output time of the GATE signal.**
Set the value at [GATE signal ON time].

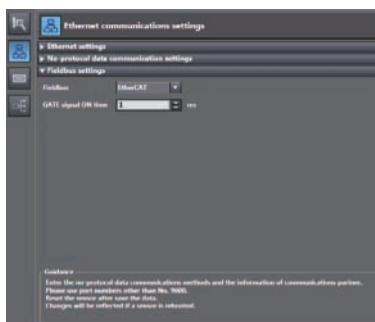

Note

The setting of default settings for EtherCAT communications can also be set by the operating keys on the Sensor Controller.

-  Setting Fieldbus p.348
Setting GATE Signal ON Time p.349

List of I/O Ports for Each Area (PDO Mapping) and Memory Assignments

When connection destination is an NJ series Controller

This section describes the respective I/O ports of the instruction area, response area, output area, and Sysmac error status area.

● I/O ports of instruction area

Controller (master) → Displacement sensor (slave)

I/O port name	Signal	Signal name	Function
Common Control Flag		Sensor head common control signal	
EXE	EXE	Control command execution	Turns ON when the user (Controller) instructs execution of control commands to the displacement sensor. (Turns ON after the control command code and parameters are set.) Is returned to OFF on condition (input condition) that the user (Controller) turns the control command completion signal (FLG signal) from the displacement sensor ON.
SYNC	SYNC	Measurement synchronous start	Turns ON when the user (Controller) instructs measurement synchronization to the displacement sensor. Is returned to OFF on condition (input condition) that the user (Controller) turns the measurement synchronization completion signal (SYNCFLG signal) ON.
ERCLR	ERCLR	Error clear	Turns ON when the displacement sensor error signal (ERR signal) turns OFF. Is returned to OFF on condition (input condition) that the user (Controller) turns the error signal (ERR signal) OFF.
Sensor Head1 Control Flag		Sensor head 1 control signal	
TIMING1	TIMING1	Timing	Turns ON when the user (Controller) instructs start of hold sampling to the displacement sensor. Turns OFF when the user (Controller) instructs end of hold sampling to the displacement sensor.
RESET1	RESET1	Reset	Turns ON when the user (Controller) instructs judgment processing and output reset to the displacement sensor. If the hold function is used, the state in effect before the hold function was set will be restored. Turns OFF when the user (Controller) ends judgment processing and output reset to the displacement sensor.
LIGHTOFF1	LIGHTOFF1	Light metering OFF	Turns ON when the user (Controller) instructs logical beam OFF to the displacement sensor. Turns OFF when the user (Controller) instructs logical beam ON to the displacement sensor.
ZERO1_T1 to 4	ZERO1_T1 to 4	Zero reset execution	Turns ON when the user (Controller) instructs execution of zero reset of TASK1 to 4 to the displacement sensor. Is returned to OFF on condition (input condition) that the user (Controller) turns the zero reset completion signal (ZEROSTAT signal) from the displacement sensor ON.
ZEROCLR1_T1 to 4	ZEROCLR1_T1 to 4	Zero reset cancel	Turns ON when the user (Controller) instructs zero reset cancel of TASK1 to 4 to the displacement sensor. Is returned to OFF on condition (input condition) that the user (Controller) turns the zero reset completion signal (ZEROSTAT signal) from the displacement sensor OFF.

I/O port name	Signal	Signal name	Function
Command	Command code	Command code	Stores the command code.
Command Parameter 1 to 3	Parameter 1-3	Command parameter	Stores the command parameter.

Note

- In the FUN mode, control signals other than ERCLR and LIGHTOFFx cannot be executed.
- Multiple control signals cannot be executed in the same cycle. Note, however, that when zero reset execution/cancellation are performed simultaneously on multiple tasks, ZEROx_T1 to 4 and ZEROCLR_x_T1 to 4 can be executed in the same cycle. Also, all control signals can be executed in the same cycle on ERCLR and LIGHTOFFx.
- When the status of control signals differs from that of the input status of parallel I/O, processing is executed of one of the statuses is ON.
- SYNC can be used only in EtherCAT communications. It cannot be used in EtherNet/IP communications.

● I/O ports of response area

Displacement sensor (slave) → Controller (master)

I/O port name	Signal	Signal name	Function
Common Status Flag		Sensor head common status signal	
FLG	FLG	Control command completion	Turns ON when the displacement sensor completes control command execution. (Turns ON after the control command code, response code and response status are stored.) Automatically turns OFF if the control command execution signal (EXE signal) from the user (Controller) turns OFF.
SYNCFLG	SYNCFLG	Measurement synchronization completion	Turns ON when the displacement sensor executes measurement synchronization processing and the state changes to one where normal measured values can be output. Automatically turns OFF if the measurement synchronization signal (SYNC signal) from the user (Controller) turns OFF.
READY	READY	Ready	Turns OFF when the displacement sensor cannot execute control commands or measurement synchronization processing. Turns ON when the displacement sensor can execute control commands or measurement synchronization processing.
RUN	RUN	Run screen	Turns ON when the displacement sensor is in the RUN mode. Turns OFF when the displacement sensor is in the FUN mode.
ERR	ERR	Error	Turns ON when a displacement sensor error is detected. Turns OFF when the displacement sensor is normal. After it turns ON, it never turns OFF until the error clear signal (ERCLR signal) from the user (Controller) turns ON.
BANKOUT1_A to E	BANKOUT1_A to E	Current bank number	This outputs the currently specified bank number. It expresses the bank number in combinations of BANKOUT _x _A to E. (For details of combinations, see Note .)

I/O port name	Signal	Signal name	Function
Sensor Head1 Status Flag		Sensor head 1 status signal	
HOLDSTAT1	HOLDSTAT1	Hold execution status	Turns ON when the displacement sensor is in the hold sampling period.
			Turns OFF when the displacement sensor is outside the hold sampling period.
RESETSTAT1	RESETSTAT1	Reset execution state	Turns ON when the displacement sensor is in the reset execution state.
			Turns OFF when the displacement sensor is in the reset non-execution state.
LIGHT1	LIGHT1	Logical beam lighting state	Turns ON when the logical beam is lit.
			Turns OFF when the logical beam is out.
STABILITY1	STABILITY1	Measurement position	Turns ON when the measured value is in the measuring range.
			Turns OFF when the measured value is outside the measuring range.
ENABLE1	ENABLE1	Measurement state	Turns ON when the displacement sensor is ready for measurement.
			Turns OFF when the displacement sensor cannot measure (excessive or insufficient received light, outside measuring range, Calibration ROM not mounted, during FUN mode non-measurement).
GATE1	GATE1	Data output completed	Turns ON when the displacement sensor completes control data output when hold is set.
			The displacement sensor automatically turns OFF one Gate period after turning ON.
OR1	OR1	Overall judgment result	Turns ON when even one of the judgment result of the displacement sensor TASK1 to 4 is other than PASS.
			Turns OFF when all of the judgment result of the displacement sensor TASK1 to 4 is PASS.
HIGH1_T1 to 4	HIGH1_T1-4	HIGH output	Turns ON when the judgment result of the displacement sensor TASK1 to 4 is HIGH (HIGH threshold < measured value).
			Turns OFF when the judgment result of the displacement sensor TASK1 to 4 is other than HIGH.
PASS1_T1 to 4	PASS1_T1-4	PASS Output	Turns ON when the judgment result of the displacement sensor TASK1 to 4 is PASS (LOW threshold ≤ measured value ≤ HIGH threshold).
			Turns OFF when the judgment result of the displacement sensor TASK1 to 4 is other than PASS.
LOW1_T1 to 4	LOW1_T1-4	LOW output	Turns ON when the judgment result of the displacement sensor TASK1 to 4 is LOW (LOW threshold > measured value).
			Turns OFF when the judgment result of the displacement sensor TASK1 to 4 is other than LOW.
ZEROSTAT1_T1 to 4	ZEROSTAT1_T1-4	Zero reset state	Turns ON when the displacement sensor TASK1 to 4 is in the zero reset execution state.
			Turns OFF when the displacement sensor TASK1 to 4 is in the zero reset non-execution state.
Response	Command code	Command code	The executed command code is returned.
Response Code	Response code	Response code	The response code of the executed command is stored.
Response Data	Response data	Response data	The response data of the executed command is stored.

Note

- The results of processing execution by parallel I/O also are reflected in the status signals.
- The table below shows the combinations of bank numbers and BANKOUT_x_A to E.
(BANK9 to 32 are used only in the judgment value mode. In the normal mode, BANKOUT_x_D to E are OFF at all times.)

Bank number	BANKOUT _x _A	BANKOUT _x _B	BANKOUT _x _C	BANKOUT _x _D	BANKOUT _x _E
BANK1	OFF	OFF	OFF	OFF	OFF
BANK2	ON	OFF	OFF	OFF	OFF
BANK3	OFF	ON	OFF	OFF	OFF
BANK4	ON	ON	OFF	OFF	OFF
BANK5	OFF	OFF	ON	OFF	OFF
BANK6	ON	OFF	ON	OFF	OFF
BANK7	OFF	ON	ON	OFF	OFF
BANK8	ON	ON	ON	OFF	OFF
BANK9	OFF	OFF	OFF	ON	OFF
BANK10	ON	OFF	OFF	ON	OFF
BANK11	OFF	ON	OFF	ON	OFF
BANK12	ON	ON	OFF	ON	OFF
BANK13	OFF	OFF	ON	ON	OFF
BANK14	ON	OFF	ON	ON	OFF
BANK15	OFF	ON	ON	ON	OFF
BANK16	ON	ON	ON	ON	OFF
BANK17	OFF	OFF	OFF	OFF	ON
BANK18	ON	OFF	OFF	OFF	ON
BANK19	OFF	ON	OFF	OFF	ON
BANK20	ON	ON	OFF	OFF	ON
BANK21	OFF	OFF	ON	OFF	ON
BANK22	ON	OFF	ON	OFF	ON
BANK23	OFF	ON	ON	OFF	ON
BANK24	ON	ON	ON	OFF	ON
BANK25	OFF	OFF	OFF	ON	ON
BANK26	ON	OFF	OFF	ON	ON
BANK27	OFF	ON	OFF	ON	ON
BANK28	ON	ON	OFF	ON	ON
BANK29	OFF	OFF	ON	ON	ON
BANK30	ON	OFF	ON	ON	ON
BANK31	OFF	ON	ON	ON	ON
BANK32	ON	ON	ON	ON	ON

● **I/O ports of output area**

Displacement sensor (slave) → Controller (master)

I/O port name	Signal	Signal name	Size of output data	Function
Measurement Value of Task1	Measurement Value of Task1	TASK1 measured value	4 bytes	The measured value of TASK1 is output.
Measurement Value of Task2	Measurement Value of Task2	TASK2 measured value	4 bytes	The measured value of TASK2 is output.
Measurement Value of Task3	Measurement Value of Task3	TASK3 measured value	4 bytes	The measured value of TASK3 is output.
Measurement Value of Task4	Measurement Value of Task4	TASK4 measured value	4 bytes	The measured value of TASK4 is output.

● **I/O ports of sysmac error status area**

Displacement sensor (slave) → Controller (master)

The Sysmac error status is mapped only when the connection destination is the NJ series.

I/O port name	Signal	Signal name	Function
Sysmac Error Status	Sysmac Error Status	Sysmac error status	Indicates the Sysmac error status.
	Observation	Monitor error	Turns ON when a monitor error occurs on the displacement sensor.
	Minor Fault	Light fault level error	Turns ON when a light fault level error occurs on the displacement sensor.

Assigning Device Variables to I/O Ports (PDO Mapping)

When connected to an NJ-series CPU Unit, the data for PDO communications in the Vision Sensor is displayed with I/O port names on the Sysmac Studio. You can assign device variables to the I/O ports in the Sysmac Studio I/O map to perform programming and monitoring.

- **Explorer pane (Connected to NJ-series CPU Unit): [Configurations and Setup] | [I/O Map] (Double-click)**

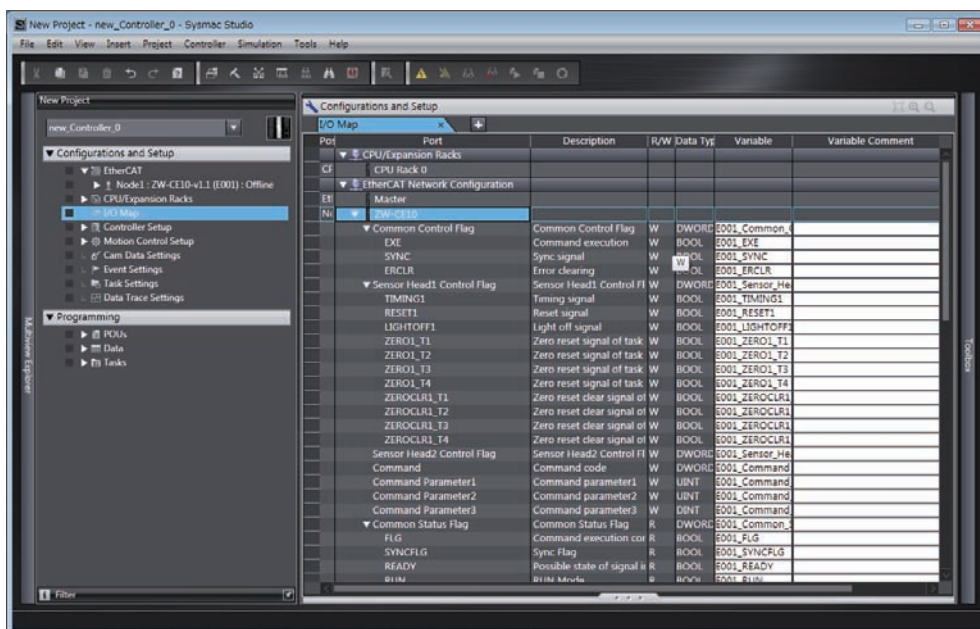

Right-click a slave or I/O port in the I/O map and select [Create Device Variable]. The device variable name is automatically created as a combination of the device name and the I/O port name. You can also select an I/O port and enter a variable name in the [Variable] column.

You can also select a registered variable from the variable table to use as a device variable. Refer to the *Sysmac Studio Version 1 Operation Manual* (Cat. No. W504) for details on registering device variables.

When the connection destination is a CJ series PLC

This section describes the respective area assignments of the instruction area, response area and output area.

● Instruction area

PLC (master) → Displacement sensor (slave)

Top channel	Bit																Description
	15	14	13	12	11	10	9	8	7	6	5	4	3	2	1	0	
+0	Reserved	Reserved	Reserved	Reserved	Reserved	Reserved	Reserved	Reserved	Reserved	Reserved	Reserved	Reserved	Reserved	Reserved	SYNC	EXE	Sensor head common control signal (32bit)
+1	Reserved	Reserved	Reserved	Reserved	Reserved	Reserved	Reserved	Reserved	Reserved	Reserved	Reserved	Reserved	Reserved	Reserved	Reserved	ERCLR	
+2	Reserved	Reserved	Reserved	Reserved	Reserved	Reserved	Reserved	Reserved	Reserved	Reserved	Reserved	Reserved	Reserved	LIGHT OFF1	RESET 1	TIMING 1	Sensor head 1 control signal(32bit)
+3	Reserved	Reserved	Reserved	Reserved	Reserved	Reserved	Reserved	Reserved	ZERO CLR_T4	ZERO CLR_T3	ZERO CLR_T2	ZERO CLR1_T1	ZERO1 _T4	ZERO1 _T3	ZERO1 _T1	ZERO1 _T1	
+4	Reserved	Reserved	Reserved	Reserved	Reserved	Reserved	Reserved	Reserved	Reserved	Reserved	Reserved	Reserved	Reserved	Reserved	Reserved	Reserved	Extended area (32bit)
+5	Reserved	Reserved	Reserved	Reserved	Reserved	Reserved	Reserved	Reserved	Reserved	Reserved	Reserved	Reserved	Reserved	Reserved	Reserved	Reserved	
+6	Command code																Command code (32bit)
+7																	
+8	Parameter 1																Parameter 1 (16bit)
+9	Parameter 2																Parameter 2 (16bit)
+10	Parameter 3																Parameter 3 (32bit)
+11																	

Signal	Signal name	Function
EXE	Control command execution	Turns ON when the user (PLC) instructs execution of control commands to the displacement sensor. (Turns ON after the control command code and parameters are set.) Is returned to OFF on condition (input condition) that the user (PLC) turns the control command completion signal (FLG signal) from the displacement sensor ON.
SYNC	Measurement synchronous start	Turns ON when the user (Controller) instructs measurement synchronization to the displacement sensor. Is returned to OFF on condition (input condition) that the user (Controller) turns the measurement synchronization completion signal (SYNCFLG signal) ON.
ERCLR	Error clear	Turns ON when the displacement sensor error signal (ERR signal) turns OFF. Is returned to OFF on condition (input condition) that the user (PLC) turns the error signal (ERR signal) OFF.
TIMING1	Timing	Turns ON when the user (PLC) instructs start of hold sampling to the displacement sensor. Turns OFF when the user (PLC) instructs end of hold sampling to the displacement sensor.
RESET1	Reset	Turns ON when the user (PLC) instructs judgment processing and output reset to the displacement sensor. If the hold function is used, the state in effect before the hold function was set will be restored. Turns OFF when the user (PLC) ends judgment processing and output reset to the displacement sensor.

Signal	Signal name	Function
LIGHTOFF1	Light metering OFF	Turns ON when the user (PLC) instructs logical beam OFF to the displacement sensor.
		Turns OFF when the user (PLC) instructs logical beam ON to the displacement sensor.
ZERO1_T1 to 4	Zero reset execution	Turns ON when the user (PLC) instructs execution of zero reset of TASK1 to 4 to the displacement sensor.
		Is returned to OFF on condition (input condition) that the user (PLC) turns the zero reset completion signal (ZEROSTAT signal) from the displacement sensor ON.
ZEROCLR1_T1 to 4	Zero reset cancel	Turns ON when the user (PLC) instructs zero reset cancel of TASK1 to 4 to the displacement sensor.
		Is returned to OFF on condition (input condition) that the user (PLC) turns the zero reset completion signal (ZEROSTAT signal) from the displacement sensor OFF.
Command code	Command code	Stores the command code.
Parameter 1-3	Command parameter	Stores the command parameter.

Note

- In the FUN mode, control signals other than ERCLR and LIGHTOFFx cannot be executed.
- Multiple control signals cannot be executed in the same cycle. Note, however, that when zero reset execution/cancellation are performed simultaneously on multiple tasks, ZEROx_T1 to 4 and ZEROCLR_x_T1 to 4 can be executed in the same cycle.
- When the status of control signals differs from that of the input status of parallel I/O, processing is executed of one of the statuses is ON.

● Response area

Displacement sensor (slave) → PLC (master)

Top channel	Bit																Description
	15	14	13	12	11	10	9	8	7	6	5	4	3	2	1	0	
+0	BANK1_E	BANK1_D	BANK1_C	BANK1_B	BANK1_A	Reserved	Reserved	Reserved	Reserved	Reserved	Reserved	RUN	Reserved	READY	SYNC FLG	FLG	Sensor head common control signal (32bit)
+1	Reserved	Reserved	Reserved	Reserved	Reserved	Reserved	Reserved	Reserved	Reserved	Reserved	Reserved	Reserved	Reserved	Reserved	Reserved	ERR	
+2	Reserved	Reserved	Reserved	Reserved	Reserved	Reserved	Reserved	Reserved	Reserved	OR1	GATE1	ENABLE 1	STABILITY1	LIGHT 1	RESET STAT1	HOLD STAT1	Sensor head 1 control signal (32bit)
+3	LOW1_T 4	PASS1_T 4	HIGH1_T 4	LOW1_T 3	PASS1_T 3	HIGH1_T 3	LOW1_T 2	PASS1_T 2	HIGH1_T 2	LOW1_T 1	PASS1_T 1	HIGH1_T 1	ZERO STAT1_T4	ZERO STAT1_T3	ZERO STAT1_T2	ZERO STAT1_T1	
+4	Reserved	Reserved	Reserved	Reserved	Reserved	Reserved	Reserved	Reserved	Reserved	Reserved	Reserved	Reserved	Reserved	Reserved	Reserved	Reserved	Extended area (32bit)
+5	Reserved	Reserved	Reserved	Reserved	Reserved	Reserved	Reserved	Reserved	Reserved	Reserved	Reserved	Reserved	Reserved	Reserved	Reserved	Reserved	
+6	Command code																Command code (32bit)
+7																	
+8	Response code																Response code (32bit)
+9																	
+10	Response data																Response data (32bit)
+11																	

Signal	Signal name	Function
FLG	Control command completion	Turns ON when the displacement sensor completes control command execution. (Turns ON after the control command code, response code and response status are stored.)
		Automatically turns OFF if the control command execution signal (EXE signal) from the user (PLC) turns OFF.

Signal	Signal name	Function
SYNCFLG	Measurement synchronization completion	Turns ON when the displacement sensor executes measurement synchronization processing and the state changes to one where normal measured values can be output. Automatically turns OFF if the measurement synchronization signal (SYNC signal) from the user (Controller) turns OFF.
READY	Ready	Turns OFF when the displacement sensor cannot execute control commands or measurement synchronization processing. Turns ON when the displacement sensor can execute control commands or measurement synchronization processing.
RUN	Run screen	Turns ON when the displacement sensor is in the RUN mode. Turns OFF when the displacement sensor is in the FUN mode.
ERR	Error	Turns ON when a displacement sensor error is detected. Turns OFF when the displacement sensor is normal. After it turns ON, it never turns OFF until the error clear signal (ERCLR signal) from the user (Controller) turns ON.
BANKOUT1_A to E	Current bank number	This outputs the currently specified bank number. It expresses the bank number in combinations of BANKOUTx_A to E. (For details of combinations, see Reference.)
HOLDSTAT1	Hold execution status	Turns ON when the displacement sensor is in the hold sampling period. Turns OFF when the displacement sensor is outside the hold sampling period.
RESETSTAT1	Reset execution state	Turns ON when the displacement sensor is in the reset execution state. Turns OFF when the displacement sensor is in the reset non-execution state.
LIGHT1	Logical beam lighting state	Turns ON when the logical beam is lit. Turns OFF when the logical beam is out.
STABILITY1	Measurement position	Turns ON when the measured value is in the measuring range. Turns OFF when the measured value is outside the measuring range.
ENABLE1	Measurement state	Turns ON when the displacement sensor is ready for measurement. Turns OFF when the displacement sensor cannot measure (excessive or insufficient received light, outside measuring range, Calibration ROM not mounted, during FUN mode non-measurement).
GATE1	Data output completed	Turns ON when the displacement sensor completes control data output when hold is set. The displacement sensor automatically turns OFF one Gate period after turning ON.
OR1	Overall judgment result	Turns ON when even one of the judgment result of the displacement sensor TASK1 to 4 is other than PASS. Turns OFF when all of the judgment result of the displacement sensor TASK1 to 4 is PASS.
HIGH1_T1-4	HIGH output	Turns ON when the judgment result of the displacement sensor TASK1 to 4 is HIGH (HIGH threshold < measured value). Turns OFF when the judgment result of the displacement sensor TASK1 to 4 is other than HIGH.
PASS1_T1-4	PASS Output	Turns ON when the judgment result of the displacement sensor TASK1 to 4 is PASS (LOW threshold ≤ measured value ≤ HIGH threshold). Turns OFF when the judgment result of the displacement sensor TASK1 to 4 is other than PASS.
LOW1_T1-4	LOW output	Turns ON when the judgment result of the displacement sensor TASK1 to 4 is LOW (LOW threshold > measured value). Turns OFF when the judgment result of the displacement sensor TASK1 to 4 is other than LOW.

Signal	Signal name	Function
ZEROSTAT1_T1-4	Zero reset state	Turns ON when the displacement sensor TASK1 to 4 is in the zero reset execution state.
		Turns OFF when the displacement sensor TASK1 to 4 is in the zero reset non-execution state.
Command code	Command code	The executed command code is returned.
Response code	Response code	The response code of the executed command is stored.
Response data	Response data	The response data of the executed command is stored.

Note

- The results of processing execution by parallel I/O also are reflected in the status signals.
- The table below shows the combinations of bank numbers and BANKOUTx_A to E.
(BANK9 to 32 are used only in the judgment value mode. In the normal mode, BANKOUTx_D to E are OFF at all times.)

Bank number	BANKOUTx_A	BANKOUTx_B	BANKOUTx_C	BANKOUTx_D	BANKOUTx_E
BANK1	OFF	OFF	OFF	OFF	OFF
BANK2	ON	OFF	OFF	OFF	OFF
BANK3	OFF	ON	OFF	OFF	OFF
BANK4	ON	ON	OFF	OFF	OFF
BANK5	OFF	OFF	ON	OFF	OFF
BANK6	ON	OFF	ON	OFF	OFF
BANK7	OFF	ON	ON	OFF	OFF
BANK8	ON	ON	ON	OFF	OFF
BANK9	OFF	OFF	OFF	ON	OFF
BANK10	ON	OFF	OFF	ON	OFF
BANK11	OFF	ON	OFF	ON	OFF
BANK12	ON	ON	OFF	ON	OFF
BANK13	OFF	OFF	ON	ON	OFF
BANK14	ON	OFF	ON	ON	OFF
BANK15	OFF	ON	ON	ON	OFF
BANK16	ON	ON	ON	ON	OFF
BANK17	OFF	OFF	OFF	OFF	ON
BANK18	ON	OFF	OFF	OFF	ON
BANK19	OFF	ON	OFF	OFF	ON
BANK20	ON	ON	OFF	OFF	ON
BANK21	OFF	OFF	ON	OFF	ON
BANK22	ON	OFF	ON	OFF	ON
BANK23	OFF	ON	ON	OFF	ON
BANK24	ON	ON	ON	OFF	ON
BANK25	OFF	OFF	OFF	ON	ON
BANK26	ON	OFF	OFF	ON	ON
BANK27	OFF	ON	OFF	ON	ON
BANK28	ON	ON	OFF	ON	ON
BANK29	OFF	OFF	ON	ON	ON
BANK30	ON	OFF	ON	ON	ON
BANK31	OFF	ON	ON	ON	ON
BANK32	ON	ON	ON	ON	ON

● Output area

Displacement sensor (slave) → PLC (master)

Top channel	Bit																Description
	15	14	13	12	11	10	9	8	7	6	5	4	3	2	1	0	
+0	Measurement Value of Task1																Output data 0 (32bit)
+1																	
+2	Measurement Value of Task2																Output data 1 (32bit)
+3																	
+4	Measurement Value of Task3																Output data 2 (32bit)
+5																	
+6	Measurement Value of Task4																Output data 3 (32bit)
+7																	
+8	Reserved																Output data 4 (32bit)
+9																	
+10	Reserved																Output data 5 (32bit)
+11																	
+12	Reserved																Output data 6 (32bit)
+13																	
+14	Reserved																Output data 7 (32bit)
+15																	

Signal	Signal name	Function
Measurement Value of Task1	Measurement Value of Task1	The measured value of TASK1 is output.
Measurement Value of Task2	Measurement Value of Task2	The measured value of TASK2 is output.
Measurement Value of Task3	Measurement Value of Task3	The measured value of TASK3 is output.
Measurement Value of Task4	Measurement Value of Task4	The measured value of TASK4 is output.

I/O Memory Assignment Method (PDO Mapping)

If you connect the Displacement Sensor to a CJ-series PLC, the OMRON CJ1W-NC□82 Position Control Unit is used as the EtherCAT master. This section describes the assignments in the I/O memory of the PLC for the Command, Response, and Data Output Areas for the Vision Sensor.

The areas for the Vision Sensor correspond to the areas for the Position Control Unit as shown in the following table.

Vision Sensor area	Position Control Unit area	Maximum number of words
Command area	Remote I/O Output Memory Area	12
Response area	Remote I/O Input Memory Area	12
Output area	Remote I/O Input Memory Area	8

The I/O memory assignment method is described below.

1. Network Settings

Double-click **I/O Table and Unit Setup** in the CX-Programmer, right-click **CJ1W-NC□82**, and select **Edit SIO Unit Parameters**.

2. Setting Common Parameters

The Support Software for Position Control Units will start. Set the areas and the first words for the Remote I/O Output Memory Area, the Axis Status Memory Area, and the Remote I/O Input Memory Area.

3. Checking the Remote I/O Area

Select [Network] and then click the [Remote I/O Assignment] Tab to check the I/O addresses that are set for remote I/O. (You can manually change the input offset and output offset.) In the following example, CIO 3800 is set as the first word of the remote I/O output area and CIO 3900 is set as the first word of the remote I/O input area.

The screenshot shows the 'Remote I/O Assignment' window in CX-Programmer. The left pane shows the project tree with 'ネットワーク設定(至き:70)' selected. The right pane shows the 'Remote I/O Assignment' tab with a table of assignments. Two callouts highlight the first addresses of the response and command areas.

ノードアドレス / 名称	入力オフセット	入力アドレス	入力サイズ	出力オフセット	出力アドレス	出力サイズ
#17 新規スレーブ	0	3900	56 Byte	0	3800	24 Byte
#18 新規スレーブ	28	3928	56 Byte	12	3812	24 Byte

Callout 1: First address in the response and data output areas of the ZW (points to 3900)

Callout 2: First address of the command area of the ZW (points to 3800)

In the case in the figure above, the memory map will be as follows.

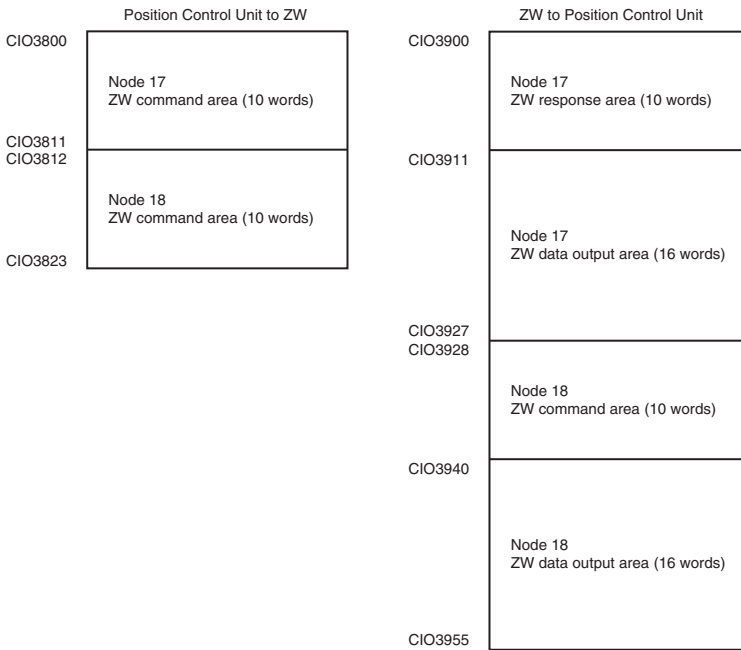

Refer to the *CJ-series Position Control Units Operation Manual* (Cat. No. W487) for details on I/O memory assignment methods.

If you connect more than one ZW Sensor to an OMRON Position Control Unit, the following addresses in the memory map are assigned in order for the I/O areas.

Set the node address setting switches on the Sensors to 0 to automatically set up the network. Node addresses 17 and higher will be automatically set for the remote I/O.

For the Position Control Unit, the areas are set only for node 17 (which has the first area for each of the three memory areas).

To access data from another node from a ladder program, add the correct offset from the first word of the first area for node 17 and access the resulting address.

Command List

This list explains each of the commands used by EtherCAT.

● Utility commands

Command area Top channel (Hex)		Command name	Function	Reference (Pages)
+7	+6			
0010	3011	Data save	Saves the current system data and bank data to the main unit.	p.181
0010	E000	Sensor Head calibration	Calibrate the Sensor Head.	p.182
0010	F010	Restart	Restarts the displacement sensor.	p.182

● Bank control command

Command area Top channel (Hex)		Command name	Function	Reference (Pages)
+7	+6			
0030	8000	Current bank settings	Replace the current bank number by the specified bank number.	p.183

● Data acquisition/setting commands

Command area Top channel (Hex)		Command name	Function	Reference (Pages)
+7	+6			
0040	1000	Processing unit data acquisition	Acquires the measurement data and setting data of the processing unit.	p.185
0050	1000	Processing unit data setting	Change the setting data of the processing unit.	p.186
0040	4000	System data acquisition	Acquires the system data.	p.187
0050	4000	System data settings	Sets the system data.	p.188

Command details

● Data save (command code: 3011 0010)

Command (Controller → displacement sensor)

Command area Top channel	Bit				Description
	15-12	11-8	7-4	3-0	
+6	0011	0000	0001	0001	Command code (32-bit)
+7	0000	0000	0001	0000	

Response (Controller ← displacement sensor)

Response area Top channel	Bit				Description
	15-12	11-8	7-4	3-0	
+6	0011	0000	0001	0001	Command code (32-bit) Stores the command code targeted for a response.
+7	0000	0000	0001	0000	
+8	0000	0000	0000	0000	Response code (32-bit) Command execution result OK
+9	0000	0000	0000	0000	
+8	0000	0000	0000	0001	Response code (32-bit) Command execution result NG (no corresponding command)
+9	1111	1111	1111	1111	
+8	0000	0000	0000	0010	Response code (32-bit) Command execution result NG (wrong parameter)
+9	1111	1111	1111	1111	
+8	0000	0000	0000	0100	Response code (32-bit) Command execution result NG (processing execution error)
+9	1111	1111	1111	1111	
+8	0000	0000	0000	1000	Response code (32-bit) Command execution result NG (mode error)
+9	1111	1111	1111	1111	

● **Sensor head calibration (command code: E000 0010)**

Command (Controller → displacement sensor)

Command area Top channel	Bit				Description
	15-12	11-8	7-4	3-0	
+6	1110	0000	0000	0000	Command code (32-bit)
+7	0000	0000	0001	0000	

Response (Controller ← displacement sensor)

Response area top channel	Bit				Description
	15-12	11-8	7-4	3-0	
+6	1110	0000	0000	0000	Command code (32-bit) Stores the command code targeted for a response.
+7	0000	0000	0001	0000	
+8	0000	0000	0000	0000	Response code (32-bit) Command execution result OK
+9	0000	0000	0000	0000	

+8	0000	0000	0000	0001	Response code (32-bit) Command execution result NG (no corresponding command)
+9	1111	1111	1111	1111	

+8	0000	0000	0000	0010	Response code (32-bit) Command execution result NG (wrong parameter)
+9	1111	1111	1111	1111	

+8	0000	0000	0000	0100	Response code (32-bit) Command execution result NG (processing execution error)
+9	1111	1111	1111	1111	

+8	0000	0000	0000	1000	Response code (32-bit) Command execution result NG (mode error)
+9	1111	1111	1111	1111	

● **Restart (command code: F010 0010)**

Command (Controller → displacement sensor)

Command area Top channel	Bit				Description
	15-12	11-8	7-4	3-0	
+6	1111	0000	0001	0000	Command code (32-bit)
+7	0000	0000	0001	0000	

Response (Controller ← displacement sensor)

Response area Top channel	Bit				Description
	15-12	11-8	7-4	3-0	

There is no response since the Controller is restarted.

● **Current bank setting (command code: 8000 0030)**

Command (Controller → displacement sensor)

Command area Top channel	Bit				Description
	15-12	11-8	7-4	3-0	
+6	1000	0000	0000	0000	Command code (32-bit)
+7	0000	0000	0011	0000	
+8	0000	0000	0000	0000	Bank number (16-bit: value obtained by subtracting 1 from bank number)
					<div style="border: 1px solid black; padding: 2px; display: inline-block;">Note</div> This is set to 0 when bank 1 is switched to.

Response (Controller ← displacement sensor)



Response area Top channel	Bit				Description
	15-12	11-8	7-4	3-0	
+6	1000	0000	0000	0000	Command code (32-bit) Stores the command code targeted for a response.
+7	0000	0000	0011	0000	
+8	0000	0000	0000	0000	Response code (32-bit) Command execution result OK
+9	0000	0000	0000	0000	
+8	0000	0000	0000	0001	Response code (32-bit) Command execution result NG (no corresponding command)
+9	1111	1111	1111	1111	
+8	0000	0000	0000	0010	Response code (32-bit) Command execution result NG (wrong parameter)
+9	1111	1111	1111	1111	
+8	0000	0000	0000	0100	Response code (32-bit) Command execution result NG (processing execution error)
+9	1111	1111	1111	1111	
+8	0000	0000	0000	1000	Response code (32-bit) Command execution result NG (mode error)
+9	1111	1111	1111	1111	

Response (Controller ← displacement sensor)

Response area Top channel	Bit				Description
	15-12	11-8	7-4	3-0	
+6	1000	0000	0000	0000	Command code (32-bit) Stores the command code targeted for a response.
+7	0000	0000	0011	0000	
+8	0000	0000	0000	0000	Response code (32-bit) Command execution result OK
+9	0000	0000	0000	0000	
+8	0000	0000	0000	0001	Response code (32-bit) Command execution result NG (no corresponding command)
+9	1111	1111	1111	1111	
+8	0000	0000	0000	0010	Response code (32-bit) Command execution result NG (wrong parameter)
+9	1111	1111	1111	1111	
+8	0000	0000	0000	0100	Response code (32-bit) Command execution result NG (processing execution error)
+9	1111	1111	1111	1111	
+8	0000	0000	0000	1000	Response code (32-bit) Command execution result NG (mode error)
+9	1111	1111	1111	1111	

● Processing unit data acquisition (command code: 1000 0040)

Command (Controller → displacement sensor)



Command area Top channel	Bit				Description
	15-12	11-8	7-4	3-0	
+6	0001	0000	0000	0000	Command code (32-bit)
+7	0000	0000	01000	0000	
+8	0000	0000	0000	0000	Unit number (16-bit)  10-3 Processing Item Data List p.384
+9	0000	0000	0000	0000	Data number (16-bit)  10-3 Processing Item Data List p.384

Response (Controller ← displacement sensor)

Response area Top channel	Bit				Description
	15-12	11-8	7-4	3-0	
+6	0001	0000	0000	0000	Command code (32-bit) Stores the command code targeted for a response.
+7	0000	0000	0100	0000	
+8	0000	0000	0000	0000	Response code (32-bit) Command execution result OK
+9	0000	0000	0000	0000	
+10	0000	0000	0000	0000	Response data (32-bit) Acquired data
+11	0000	0000	0000	0000	
+8	0000	0000	0000	0001	Response code (32-bit) Command execution result NG (no corresponding command)
+9	1111	1111	1111	1111	
+8	0000	0000	0000	0010	Response code (32-bit) Command execution result NG (wrong parameter)
+9	1111	1111	1111	1111	
+8	0000	0000	0000	0100	Response code (32-bit) Command execution result NG (processing execution error)
+9	1111	1111	1111	1111	
+8	0000	0000	0000	1000	Response code (32-bit) Command execution result NG (mode error)
+9	1111	1111	1111	1111	

● **Processing unit data setting (command code: 1000 0050)**

Command (Controller → displacement sensor)

Command area Top channel	Bit				Description
	15-12	11-8	7-4	3-0	
+6	0001	0000	0000	0000	Command code (32-bit)
+7	0000	0000	0101	0000	
+8	0000	0000	0000	0000	Unit number (16-bit)  10-3 Processing Item Data List p.384
+9	0000	0000	0000	0000	Data number (16-bit)  10-3 Processing Item Data List p.384
+10	0000	0000	0000	0000	Setting data (UDINT)
+11	0000	0000	0000	0000	

Response (Controller ← displacement sensor)

Response area Top channel	Bit				Description
	15-12	11-8	7-4	3-0	
+6	0001	0000	0000	0000	Command code (32-bit) Stores the command code targeted for a response.
+7	0000	0000	0101	0000	
+8	0000	0000	0000	0000	Response code (32-bit) Command execution result OK
+9	0000	0000	0000	0000	
+8	0000	0000	0000	0001	Response code (32-bit) Command execution result NG (no corresponding command)
+9	1111	1111	1111	1111	
+8	0000	0000	0000	0010	Response code (32-bit) Command execution result NG (wrong parameter)
+9	1111	1111	1111	1111	
+8	0000	0000	0000	0100	Response code (32-bit) Command execution result NG (processing execution error)
+9	1111	1111	1111	1111	
+8	0000	0000	0000	1000	Response code (32-bit) Command execution result NG (mode error)
+9	1111	1111	1111	1111	

● **System data acquisition (command code: 4000 0040)**

Command (Controller → displacement sensor)

Command area Top channel	Bit				Description
	15-12	11-8	7-4	3-0	
+6	0100	0000	0000	0000	Command code (32-bit)
+7	0000	0000	0100	0000	
+8	0000	0000	0000	0000	
					See data number (16-bit).  10-3 Processing Item Data List p.384

Response (Controller ← displacement sensor)

Response area Top channel	Bit				Description
	15-12	11-8	7-4	3-0	
+6	0100	0000	0000	0000	Command code (32-bit) Stores the command code targeted for a response.
+7	0000	0000	0100	0000	
+8	0000	0000	0000	0000	Response code (32-bit) Command execution result OK
+9	0000	0000	0000	0000	
+10	0000	0000	0000	0000	Response data (32-bit) Acquired data
+11	0000	0000	0000	0000	
+8	0000	0000	0000	0001	Response code (32-bit) Command execution result NG (no corresponding command)
+9	1111	1111	1111	1111	
+8	0000	0000	0000	0010	Response code (32-bit) Command execution result NG (wrong parameter)
+9	1111	1111	1111	1111	
+8	0000	0000	0000	0100	Response code (32-bit) Command execution result NG (processing execution error)
+9	1111	1111	1111	1111	
+8	0000	0000	0000	1000	Response code (32-bit) Command execution result NG (mode error)
+9	1111	1111	1111	1111	

● **System data setting (command code: 4000 0050)**

Command (Controller → displacement sensor)

Command area Top channel	Bit				Description
	15-12	11-8	7-4	3-0	
+6	0100	0000	0000	0000	Command code (32-bit)
+7	0000	0000	0101	0000	
+8	0000	0000	0000	0000	Data number (16-bit)  10-4 System data list p.388
+9	0000	0000	0000	0000	Fixed at "0"
+10	0000	0000	0000	0000	Setting data (32-bit)
+11	0000	0000	0000	0000	

Response (Controller ← displacement sensor)

Response area Top channel	Bit				Description
	15-12	11-8	7-4	3-0	
+6	0100	0000	0000	0000	Command code (32-bit) Stores the command code targeted for a response.
+7	0000	0000	0101	0000	
+8	0000	0000	0000	0000	Response code (32-bit) Command execution result OK
+9	0000	0000	0000	0000	
+8	0000	0000	0000	0001	Response code (32-bit) Command execution result NG (no corresponding command)
+9	1111	1111	1111	1111	
+8	0000	0000	0000	0010	Response code (32-bit) Command execution result NG (wrong parameter)
+9	1111	1111	1111	1111	
+8	0000	0000	0000	0100	Response code (32-bit) Command execution result NG (processing execution error)
+9	1111	1111	1111	1111	
+8	0000	0000	0000	1000	Response code (32-bit) Command execution result NG (mode error)
+9	1111	1111	1111	1111	

Timing Chart (EtherCAT)

● Control command execution

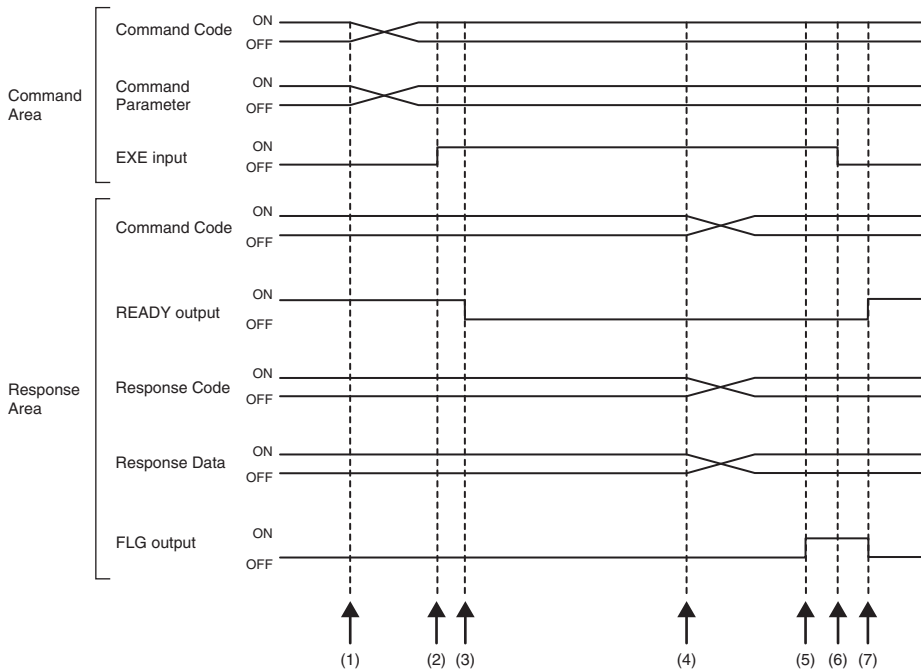

- (1) The command code and command parameter are set from the Controller.
- (2) The EXE input signal state is changed from OFF to ON. Execution is instructed to the displacement sensor.
- (3) When the displacement sensor receives the execution instruction, the READY output signal turns OFF and the command is executed.
- (4) When the displacement sensor completes execution, the command code, response code and response data are set.
- (5) The FLG output signal turns ON.
- (6) The Controller makes sure that the FLG output signal has turned ON, and then returns the EXE input signal to OFF.
- (7) The displacement sensor makes sure that the EXE input signal has turned OFF, and the FLG and READY output signals automatically turn OFF and ON, respectively.

● Measurement synchronization

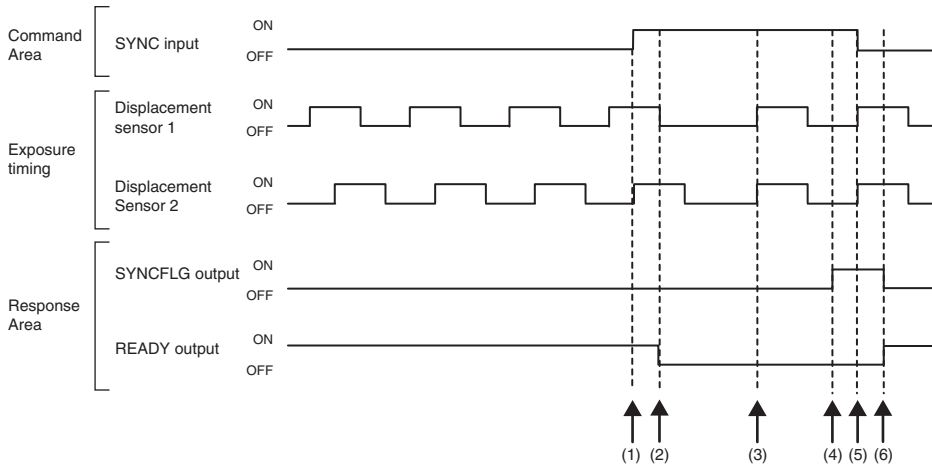

- (1) The Controller changes the state of the SYNC input signal from OFF to ON.
- (2) When receives the SYNC input signal, the displacement sensor turns off the READY output signal, and starts the measurement synchronization processing.
- (3) All displacement sensors that have received the SYNC input signal are synchronized with the end of exposure and measurement is resumed.
- (4) After the end of synchronization, the displacement sensor changes the state of the SYNCFLG output signal from OFF to ON.
- (5) The Controller makes sure that the SYNCFLG output signal has turned ON, and then changes the state of the SYNC input signal from ON to OFF.
- (6) The displacement sensor makes sure that the SYNC input signal has turned OFF, and the SYNCFLG and READY output signals automatically turn OFF and ON, respectively.

Important

- Be particularly careful of the following points when synchronizing measurement.
 - When the exposure time control mode is automatic: Set the exposure time upper limit the same for all displacement sensors for which measurement is to be synchronized.
 - When the exposure time control mode is fixed: Set the exposure time the same for all displacement sensors for which measurement is to be synchronized.
- By way of reference, the time from acceptance of the SYNC input up to when SYNCFLG output turns ON becomes "currently set exposure time upper limit + 720 μs".
- After multiple displacement sensors are synchronized, they gradually go out of sync. At most 1 μs of difference generates EtherCAT communication between the slave. Input SYNC input signals periodically. The maximum deviation time can be calculated with the following formula.

Difference in EtherCAT + Exposure time (maximum) × 2 × Average number of repetitions × 24 ppm

Example: Exposure time (maximum): 1 ms, average number of repetitions: 64

$$1 \mu\text{s} + 1 \text{ ms} \times 2 \times 64 \times 24/1000000 = 4.072 \mu\text{s}$$

The maximum deviation time will be 4.072 μs.
- The displacement sensor starts resetting the filtering process after receiving a SYNC signal. If the average number is set to 128 times, please note that the measurement value will not be finalized until the measurement is done 128 times. You can check whether the measurement value is finalized if either of HIGH, PASS or LOW signal turns on in the response area.

● Execution of hold (peak/bottom/peak to peak/average) and reset of hold value

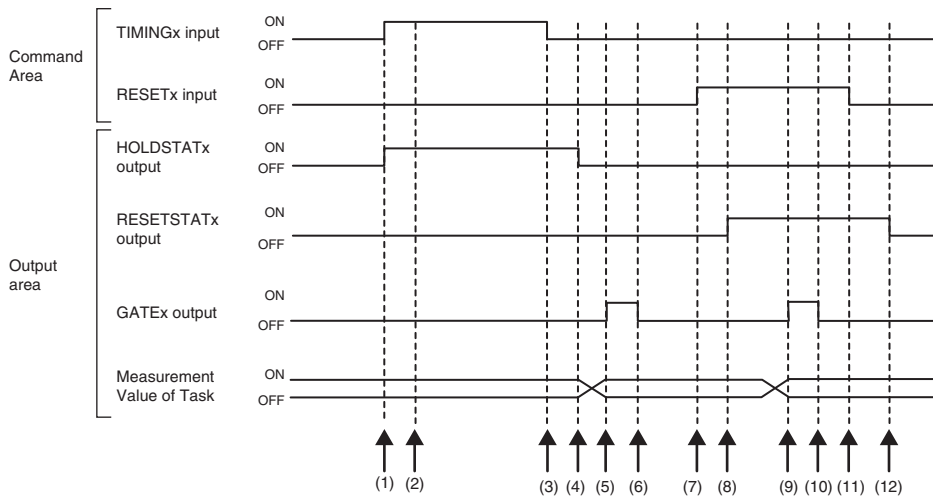

- (1) The Controller changes the state of the TIMINGx input signal from OFF to ON. At the rising edge of the TIMINGx input signal, the displacement sensor starts sampling.
- (2) At start of sampling, the displacement sensor changes the state of the HOLDSTATx output signal from OFF to ON.
- (3) The Controller turns the state of the TIMINGx input signal from ON to OFF. At the falling edge of the TIMINGx input signal, the displacement sensor end sampling.
- (4) At end of sampling, the displacement sensor changes the state of the HOLDSTATx output signal from ON to OFF.
- (5) When the hold value is applied, the displacement sensor changes the state of the GATEx output signal from OFF to ON. The Controller makes sure that the GATEx output signal has turned ON, and then captures the output data.
- (6) The displacement sensor turns OFF after the GATE signal ON duration has elapsed since the GATEx output signal turned ON.
- (7) The Controller changes the state of the RESETx input signal from OFF to ON. At the rising edge of the RESETx input signal, the displacement sensor starts the measured value reset period.
- (8) At the start of the measured value reset period, the displacement sensor changes the state of the RESETSTATx output signal from OFF to ON.
- (9) At completion of the measured value reset, the displacement sensor changes the state of the GATEx output signal from OFF to ON.
- (10) The displacement sensor turns OFF after the GATE signal ON duration has elapsed since the GATEx output signal turned ON.
- (11) The Controller changes the state of the RESETx input signal from ON to OFF. At the falling edge of the RESETx input signal, the displacement sensor end the measured value reset period.
- (12) At the end of the measured value reset period, the displacement sensor changes the state of the RESETSTATx output signal from ON to OFF.

Important

When hold is being performed by multiple tasks, HOLDSTATx output signal turns ON when even one task enters the sampling period and GATEx output signal turns ON when the measured value is applied.

● Execution of hold (auto peak, auto bottom, auto peak to peak) and reset of hold value

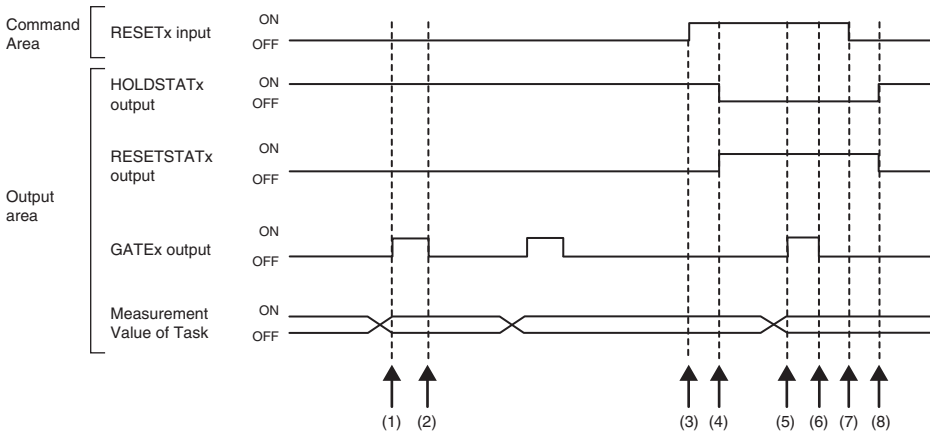

- (1) When the peak value is applied, the displacement sensor changes the state of the GATEx output signal from OFF to ON. The Controller makes sure that the GATEx output signal has turned ON, and then captures the output data.
- (2) The displacement sensor turns OFF after the GATE signal ON duration has elapsed since the GATEx output signal turned ON.
- (3) The Controller turns the state of the RESETx input signal from OFF to ON. At the rising edge of the RESETx input signal, the displacement sensor starts the measured value reset period.
- (4) At the start of the measured value reset period, the displacement sensor changes the state of the HOLDSTATx output signal from ON to OFF and the RESETSTATx from OFF to ON.
- (5) At completion of the measured value reset, the displacement sensor changes the state of the GATEx output signal from OFF to ON.
- (6) The displacement sensor turns OFF after the GATE signal ON duration has elapsed since the GATEx output signal turned ON.
- (7) The Controller changes the state of the RESETx input signal from ON to OFF. At the falling edge of the RESETx input signal, the displacement sensor end the measured value reset period.
- (8) At the end of the measured value reset period, the displacement sensor changes the state of the HOLDSTATx output signal from OFF to ON and the RESETSTATx from ON to OFF.

Important

When hold is being performed by multiple tasks, HOLDSTATx output signal turns ON when even one task enters the sampling period and GATEx output signal turns ON when the measured value is applied.

● Execution of hold (sample) and reset of hold value

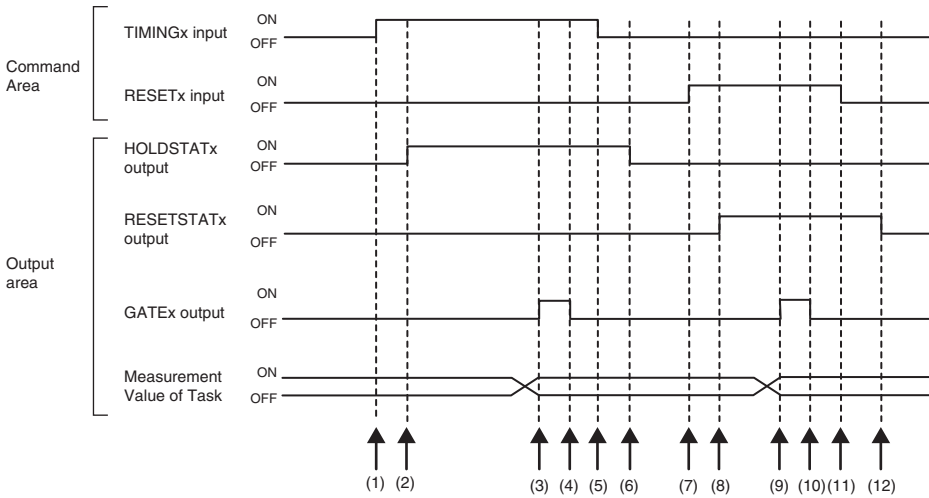

- (1) The Controller changes the state of the TIMINGx input signal from OFF to ON. At the rising edge of the TIMINGx input signal, the displacement sensor starts sampling.
- (2) At start of sampling, the displacement sensor changes the state of the HOLDSTATx output signal from OFF to ON.
- (3) When the hold value is applied, the displacement sensor changes the state of the GATEx output signal from OFF to ON. The Controller makes sure that the GATEx output signal has turned ON, and then captures the output data.
- (4) The displacement sensor turns OFF after the GATE signal ON duration has elapsed since the GATEx output signal turned ON.
- (5) The Controller turns the state of the TIMINGx input signal from ON to OFF. At the falling edge of the TIMINGx input signal, the displacement sensor end sampling.
- (6) At end of sampling, the displacement sensor changes the state of the HOLDSTATx output signal from ON to OFF.
- (7) The Controller changes the state of the RESETx input signal from OFF to ON. At the rising edge of the RESETx input signal, the displacement sensor starts the measured value reset period.
- (8) At the start of the measured value reset period, the displacement sensor changes the state of the RESETSTATx output signal from OFF to ON.
- (9) At completion of the measured value reset, the displacement sensor changes the state of the GATEx output signal from OFF to ON.
- (10) The displacement sensor turns OFF after the GATE signal ON duration has elapsed since the GATEx output signal turned ON.
- (11) The Controller changes the state of the RESETx input signal from ON to OFF. At the falling edge of the RESETx input signal, the displacement sensor end the measured value reset period.
- (12) At the end of the measured value reset period, the displacement sensor changes the state of the RESETSTATx output signal from ON to OFF.

Important

When hold is being performed by multiple tasks, HOLDSTATx output signal turns ON when even one task enters the sampling period and GATEx output signal turns ON when the measured value is applied.

● Measurement LED out

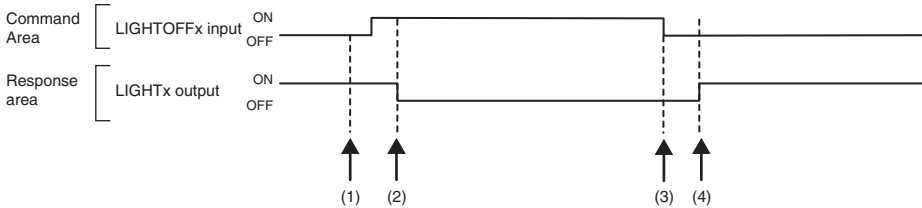

- (1) The Controller changes the state of the LIGHTOFFx input signal from OFF to ON. At the rising edge of the LIGHTOFFx input signal, the displacement sensor turns the measurement LED out.
- (2) At measurement LED out, the displacement sensor changes the state of the LIGHTx output signal from ON to OFF.
- (3) The Controller turns the state of the LIGHTOFFx input signal from ON to OFF. At the falling edge of the LIGHTOFFx input signal, the displacement sensor lights the measurement LED.
- (4) At measurement LED on, the displacement sensor returns the LIGHTx output signal to ON.

● Zero reset execution/zero reset cancel

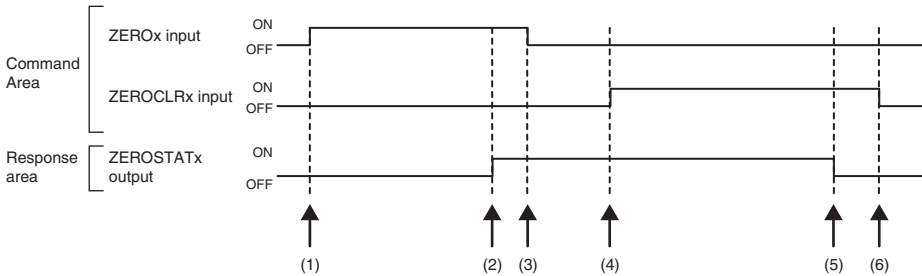

- (1) The Controller changes the state of the ZEROx_T1 to 4 input signals from OFF to ON. The displacement sensor makes sure that ZEROx_T1 to 4 input signals have turned ON, and then executes the zero reset.
- (2) At execution of zero reset, the displacement sensor changes the state of the ZEROSTATx_T1 to 4 output signal from OFF to ON.
- (3) The Controller makes sure that the ZEROSTATx_T1 to 4 output signals have turned ON, and then returns the ZEROx_T1 to 4 input signals to OFF.
- (4) The Controller changes the state of the ZEROCLRx_T1 to 4 input signals from OFF to ON. The displacement sensor makes sure that ZEROCLRx_T1 to 4 input signals have turned ON, and then executes the zero reset cancel.
- (5) At the zero reset cancel, the displacement sensor returns the ZEROSTATx_T1 to 4 output signals to ON.
- (6) The Controller makes sure that the ZEROSTATx_T1 to 4 output signals have turned OFF, and then returns the ZEROCLRx_T1 to 4 input signals to OFF.

Sample Ladder Program (EtherCAT)

● Command/Response Communications

The following sample program is used to perform replacement the current bank number.

The replacement the current bank number command (lower bytes: #8000, upper bytes: #0030) is sent to the Displacement Sensor.

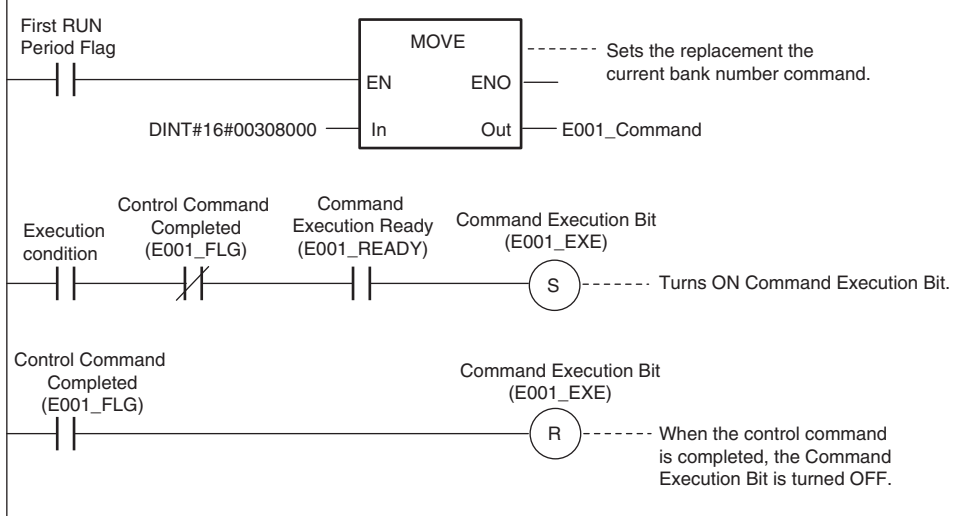

Important

Create the ladder program to control the EXE signal so that it does not turn ON while the READY signal is ON. If not, a EXE input error will occur and the ERR signal will turn ON.

Sysmac Device Features

The control device product designed according to standardized communications and user interface specifications for OMRON control devices are called a Sysmac Device.

And the features available with such a Device is called Sysmac Device Features.

This section describes the features the ZW series Displacement Sensor provides when combined with a Machine Automation Controller such as NJ series and automation software.

Sysmac Error Status

Because, in Sysmac Devices, errors that may occur in slaves are systematized, you can check the causes and remedies for errors with a common procedure.

The status of an error can be monitored in the Sysmac Error Status (2002-01 hex). To display the error status detected by the FQ-M series Vision Sensor in Sysmac Studio, the Sysmac Error Status (2002-01 hex) must be mapped to the PDO. Sysmac Studio, by default, uses the 512th transmit PDO Mapping assignment to map the Sysmac Error Status (2002-01 hex) automatically to the PDO.

Note

- For the Sysmac Error status (2002-01 hex), refer to 10-5 Object Dictionary p.390.
- For errors displayed in Sysmac Studio, refer to *NJ-series Troubleshooting Manual* (Cat. No. W503).

Saving the Node Address Setting

When the node address switch setting is "00" (Software Setup mode), the node address value you set in Sysmac Studio is enabled. If the node address switches are set to any other value, the value that is set on the switches is used as the node address.

In the Software Setup mode, in Sysmac Studio, execute [Write Slave Node Address] on the [EtherCAT Edit] screen to save the slave node address setting in the nonvolatile memory of the ZW series Displacement Sensor.

● Software Setting

The set value saved as Slave Information Interface (SII) information in the nonvolatile memory of the slave is the node address.

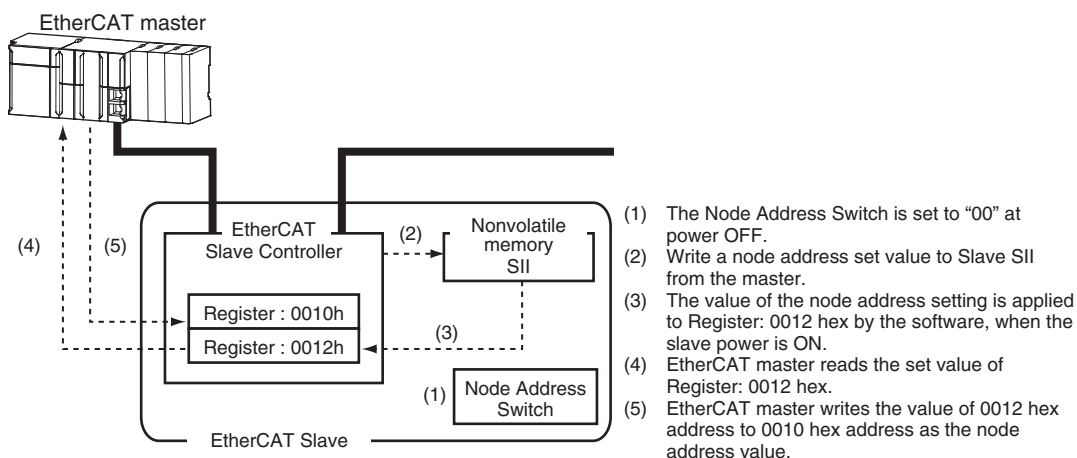

● Node Address Switch Setting

The value set on the node address switches is the node address.

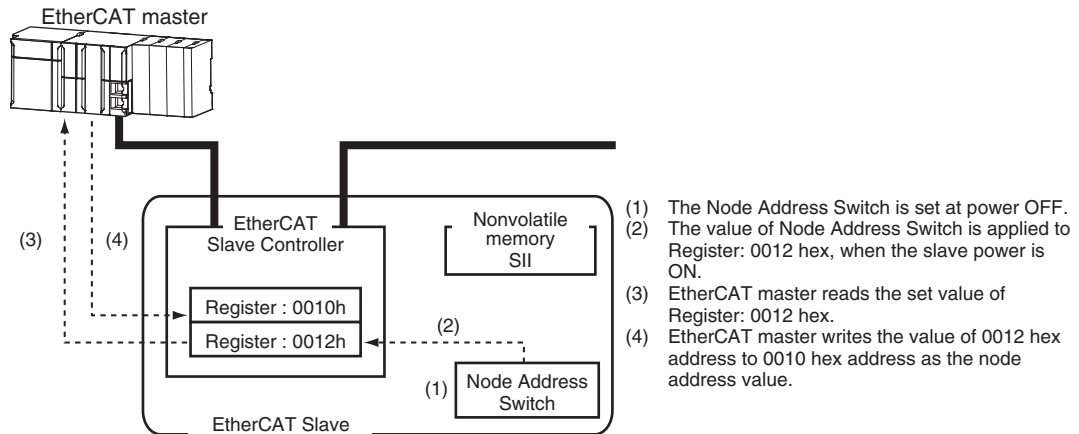

Serial Number Display

The serial number saved in the nonvolatile memory of the Displacement Sensor is displayed in the Serial Number (1018-04 hex). Controllers that support Sysmac Device Features can use this serial number to check the network configuration. To enable this check, in Sysmac Studio, set [Serial No. Check Condition] to [Set Value = Actual Unit] on the [EtherCAT Edit] screen. If the set condition is not met, a Network Configuration Check Error will occur.

Note

This network configuration check detects any slave devices that have been replaced, which prevents you from forgetting to set parameters on those slaves.

Compliance with ESI Specification (ETG.2000 S (R) V1.0.1)

The ESI Specification is a set of specifications that define the entries required in an EtherCAT Slave Information (ESI) file.

SII Data Check

The Slave Information Interface (SII) is an interface area in the nonvolatile memory of an EtherCAT slave that stores the configuration information specific to that EtherCAT slave.

Sysmac Device EtherCAT slaves check the SII information from the slave side.

If one of these slaves finds that SII information with which it cannot operate was written, it generates an SII Check Error (Error No. 88.3). If this error persists even after turning OFF and then ON the power again, contact your OMRON sales representative.

Important

Do not use third-party or any other configuration tools to edit the SII information.

6-3 EtherNet/IP Connection

Introduction to EtherNet/IP

EtherNet/IP is an industrial multi-vendor network that uses Ethernet.

The EtherNet/IP specifications are open standards managed by the ODVA (Open DeviceNet Vendor Association). EtherNet/IP is used by a wide range of industrial devices.

Because EtherNet/IP uses standard Ethernet technology, various general-purpose Ethernet devices can be used in the network.

EtherNet/IP has mainly the following features.

- **High-speed, High-capacity Data Exchange through Tag Data Links**

The EtherNet/IP protocol supports implicit communications, which allows cyclic communications called tag data links with EtherNet/IP devices.

- **Tag Data Links at Specified Communications Cycle for Each Application Regardless of the Number of Nodes**

Tag data links (cyclic communications) operate at the cyclic period that is specified for each application, regardless of the number of nodes. Data is exchanged over the network at the refresh cycle that is set for each connection. The communications refresh cycle will not increase even if the number of nodes is increased, i.e., the concurrency of the connection's data is maintained.

Because the refresh cycle can be set for each connection, each application can communicate at its ideal refresh cycle. For example, interprocess interlocks can be transferred at high speed, while the production commands and the status monitor information are transferred at low speed.

Important

On a network to which many devices are connected, performance may drop (e.g., responses may be delayed or packets lost) or communications errors may occur when there is temporarily high traffic on the network. Test the operation under actual conditions before you start actual operation of the system.

Data Exchange with EtherNet/IP

Data is exchanged cyclically between Ethernet devices on the EtherNet/IP network using tag data links as shown below.

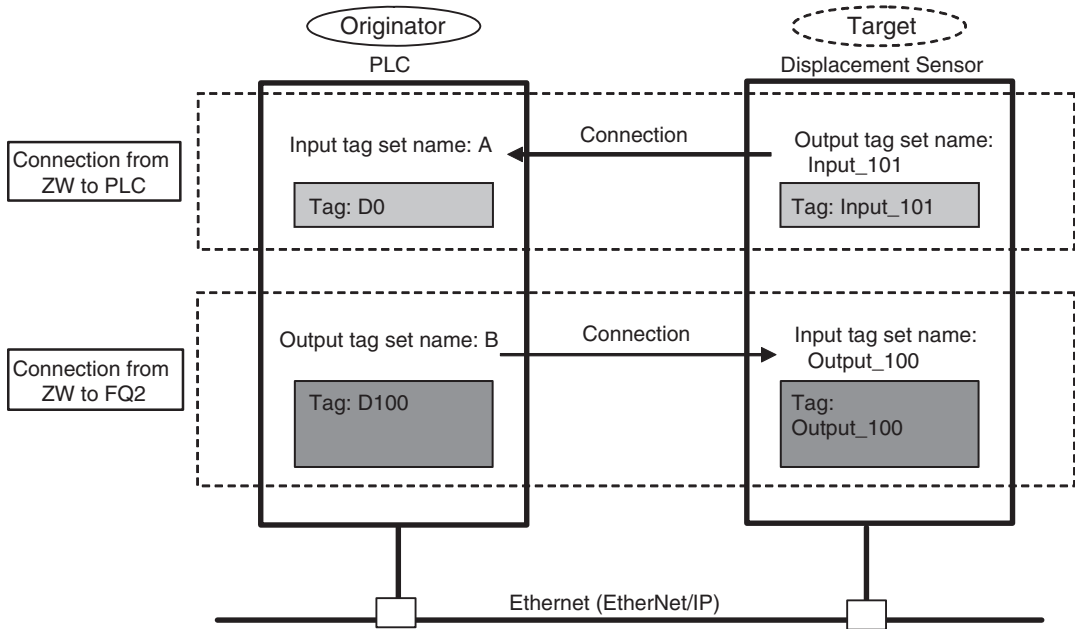

● Data Exchange Method

To exchange data, a connection is opened between two EtherNet/IP devices.

One of the nodes requests the connection to open a connection with a remote node.

The node that requests the connection is called the originator, and the node that receives the request is called the target.

● Data Exchange Memory Locations

The memory locations that are used to exchange data across a connection are specified as tags.

You can specify memory addresses or variables for tags.

A group of tags consists of an output tag set and an input tag set.

ZW Communications for EtherNet/IP Connections

You can use EtherNet/IP tag data links to communicate between the PLC and the Displacement Sensor to perform control via command/response communications or to output data after measurements. The ZW complies with EtherNet/IP conformance test version A9.

To connect to OMRON Controllers and communicate through EtherNet/IP, you use the Network Configurator to set up tag data links (i.e., tags, tag sets, and connection settings). Refer to the following manuals for details on the tag data link settings that are made with the Network Configurator.

- NJ-series CPU Unit Built-in EtherNet/IP Port User's Manual (Cat. No. W506)
- CS/CJ-series EtherNet/IP Units Operation Manual (Cat. No. W465)
- CJ-series EtherNet/IP Units Operation Manual for NJ-series CPU Unit (Cat. No. W495)

Types of Communications

● Command/Response Communications

With EtherNet/IP communications, cyclic tag data link communications are performed with the connections that are set between the PLC and Displacement Sensor.

Command/response control signals are handled by storing control commands from the PLC to the Displacement Sensor and responses from the Displacement Sensor to the PLC in the I/O memory of the PLC. This allows you to control the operation of the Displacement Sensor (e.g., perform continuous measurements or change the scene) without using special communications instructions.

- Input Connection to Sensor (PLC to Displacement Sensor)
The commands that are stored in the I/O memory of the PLC are sent to the Displacement Sensor.
- Output Connection to PLC (Displacement Sensor to PLC)
Responses from the Displacement Sensor to the control commands are stored in the PLC I/O memory addresses or variables that are specified for the response area.

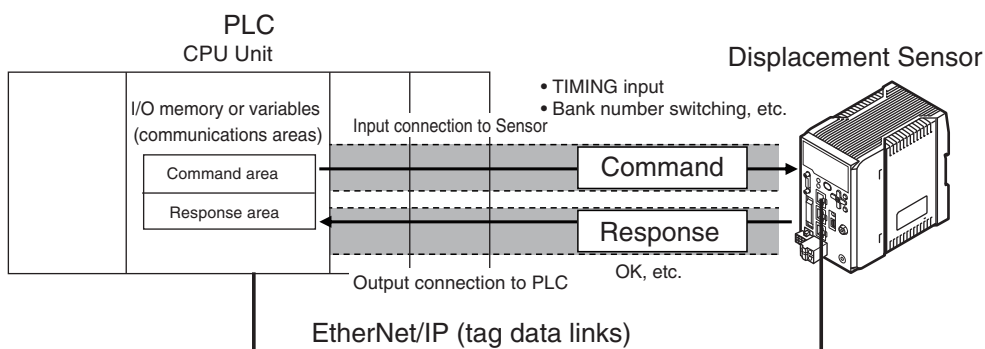

To send a control command, you write a control command to the command area (i.e., a variable or I/O memory address in the PLC) that is specified for the output tag, and then turn ON the Command Execution (EXE) Bit. As a result, the control command is sent through the input connection from the PLC to the Displacement Sensor.

A control command does not need to be sent to execute measurements for the TRIG bit. The measurement is executed simply by turning ON the TRIG bit.

The Displacement Sensor executes the control command and sends a response back to the PLC through the output connection from the Displacement Sensor to the PLC.

The PLC stores the response in the response area (i.e., I/O memory addresses or variable) that is specified for the input tag in the PLC.

● Data Output after Measurements

Immediately after the measured value has been applied, the measured value data of each task is output automatically to the specified I/O memory of the PLC specified to the input tag.

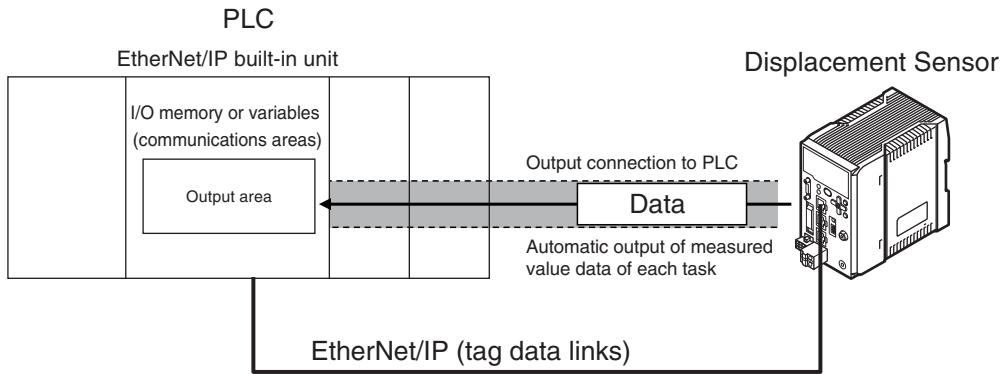

To output data, specify the I/O memory area or a variable (output area) on the PLC for storing that data in advance to the input tag.

Types of Communications Areas

For EtherNet/IP communications, the following three communications areas are used in the PLC to perform communications.

Areas Used for the Different Control Methods

Command/ response communications	(1) Command area	This is the area to which you write control commands for the Displacement Sensor to execute.
	(2) Response area	This is the area to which the Displacement Sensor writes the results of control commands executed from the command area.
Data output method after application of measured value	(3) Output area	The area to which the displacement sensor writes the measured value data of each task after application of the measured value.

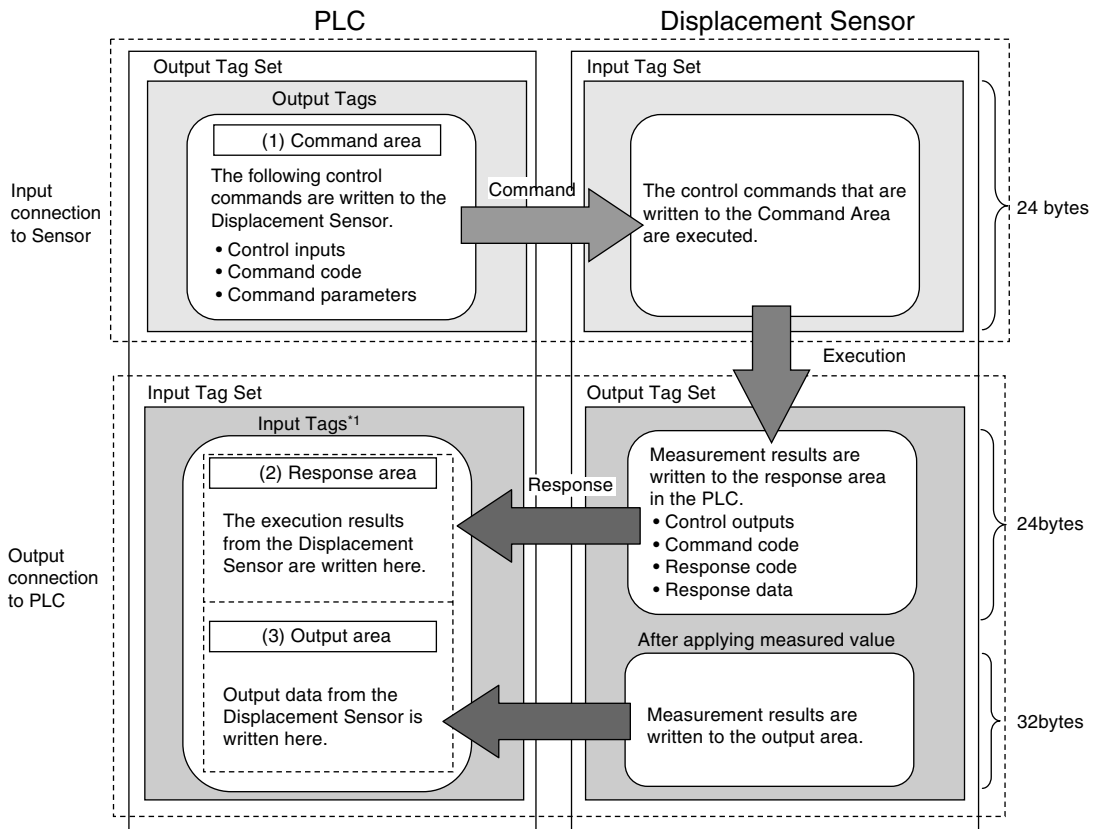

*1 The response area (2) and output area (3) are assigned to continuous memory addresses or to a variable.

Connectable Controller Models

Series	CPU Unit	Interface	
		Built-in port in CPU Unit	EtherNet/IP Unit
SYSMAC NJ	NJ501 or NJ301	Compatible	CJ1W-EIP21
SYSMAC CJ2	CJ2H or CJ2M	Compatible (model with built-in port only)	CJ1W-EIP21
SYSMAC CJ1	CJ1H or CJ1G	---	CJ1W-EIP21
	CJ1M	---	CJ1W-EIP21
SYSMAC CS	CS1H, CS1D, or CS1G	---	CS1W-EIP21

Setting Communications Specifications (EtherNet/IP)

Network Settings of the Sensor

This section describes how to set the network settings in the Displacement Sensor.

- **Explorer pane** : [Device group] | Sensor name | [System] | [System data] (Double-click)
 → **Edit Pane** : [Ethernet communication settings] Icon | [Ethernet settings]

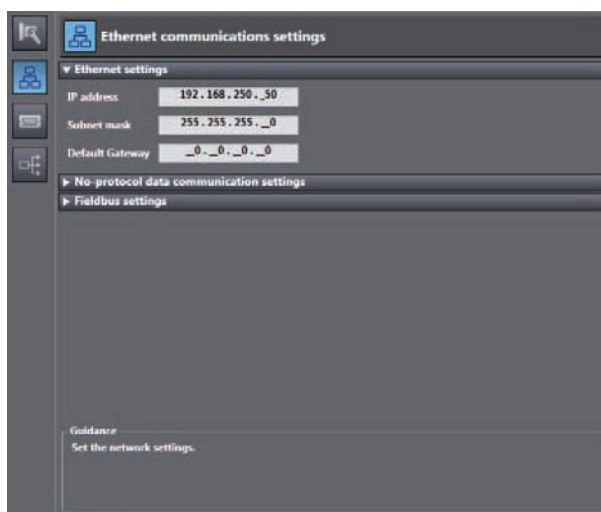

The following items can be set.

Item	Description	Setting range
IP address	Set the IP address of the Displacement Sensor.	a.b.c.d a: 1 to 223, b: 0 to 255, c: 0 to 255, d: to 254 (Default: 192.168.250.50)
Subnet mask	Set the subnet mask.	0.0.0.0 to 255.255.255.255 (Default: 255.255.255.0)
Default Gateway	Sets the default gateway.	0.0.0.0 to 255.255.255.255 (Default: 0.0.0.0)

Note

The network settings of the sensor can also be set with key operations on the Sensor Controller.

 Network Settings of the Sensor p.350

Switch to EtherNet/IP communication

- ▶ **Explorer pane** : [Device group] | Sensor name | [System] | [System data] (Double-click)
- **Edit pane** : [Ethernet Communications Settings] icon ()

1 Select [Ethernet/IP] at [Fieldbus].

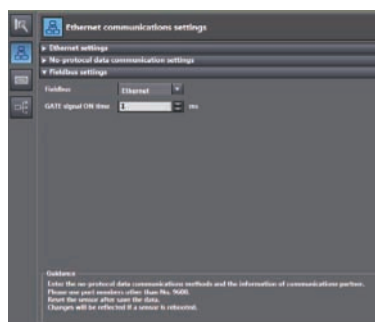

Important

To enable the settings, restart the Controller.

Note

The setting of default settings for EtherNet/IP communications can also be set by the operating keys on the Sensor Controller.

 Network Settings of the Sensor p.350

Tag Data Link Setting Methods

This section describes how to set data links for EtherNet/IP.

The communications areas in the PLC for which data links are created to the Sensor are specified as tags and tag sets, and the connections are set for tag data link communications.

Tags, tag sets, and connections are set from the Network Configurator.

Refer to the following manuals for details on the tag data link settings that are made with the Network Configurator.

- NJ-series CPU Unit Built-in EtherNet/IP Port User's Manual (Cat. No. W506)
- CS/CJ-series EtherNet/IP Units Operation Manual (Cat. No. W465)
- CJ-series EtherNet/IP Units Operation Manual for NJ-series CPU Unit (Cat. No. W495)

Important

- To connect the ZW to an NJ/CJ-series CPU Unit, install the EDS file that defines the connection information for the ZW in the Network Configurator. Download the EDS file from the OMRON website.
- After tag data links are set, the Displacement Sensor will automatically be restarted to enable the settings.

Tags, Tag Sets, and Connection Settings

The communications areas in the PLC are set as tag data link connections as shown in the following table.

- Tag and Tag Set Settings in the PLC

Parameter	Settings	
	Command area	Response area and output area
Type of tags and tag set	Output tag set	Input tag set
Tag and tag set names	I/O memory addresses or variable names	I/O memory addresses or variable names ^{*1}
Data size	24 bytes	56 bytes (total size of response area and output area)

*1 Specify the I/O memory address of the first word in the response area.
The output area is assigned immediately after the response area.
If you specify a variable name, the variable is assigned for both the response area and output area.
Refer to Accessing Communications Areas Using Variables with NJ-series Controllers on p. 213 for information on how to access the signals in the communications areas from the user program when variables are assigned.

● Settings in the ZW (Device Parameter Settings)

Parameter name	Value	Setting range
001 Input Size	The total size of response area and output area	56
002 Output Size	The data size of command area	24
003 RPI*	The requested packet interval	10000

* The packet interval (RPI) is set in the connection settings between the PLC and the Sensor. No setting is required here.

- 1 Right-click the ZW in the network on the Network Configurator and select [Parameter] - [Edit].
- 2 The Edit Device Parameters Dialog Box will be displayed. Make the required settings.

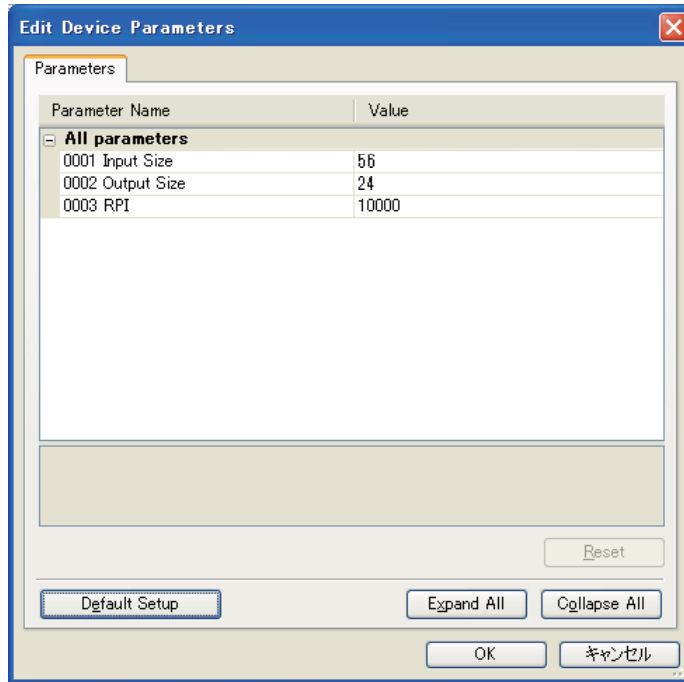

● Connection Settings

Parameter		Setting
Originator device (PLC)	Input tag set	<i>PLC_tag_set_name</i> -[**Byte] **: This is the total size of the response area and output area that you set.
	Connection type	Any (default: multi-cast connection) ^{*1}
	Output tag set	<i>PLC_tag_set_name</i> -[20Byte]
Target device (Displacement Sensor)	Output tag set	Input_101-[**Byte] **: This is the total size of the response area and output area that you set.
	Input tag set	Output_100-[20Byte]
Packet interval (RPI)		Any (default: 20.0) ^{*2}

- *1 If multi-cast connections are used, however, use an Ethernet switch that has multi-cast filtering, unless the tag set is received by all nodes in the network.
*2 Set the same value as you set for the refreshing task period in the EtherNet/IP communications settings.

Important

- If I/O memory addresses are specified for the communications areas, the information in the communications areas will be cleared when the operating mode of the PLC changes unless addresses in the CIO Area, which are maintained, are specified.
- The following assembly object is required to specify instances when the EDS file is not used.

Assembly Object Settings

Parameter name	Setting	Remarks
Instance ID	100	Output connection
	101	Input connection

Memory Assignments and Commands

Memory assignments

The following describes assignment of input connection instruction area to the sensor, output connection response area to the PLC and the output area.

● Input connection (PLC (originator)) to sensor → Displacement sensor (target)

- Instruction area

Top channel	Bit																Description
	15	14	13	12	11	10	9	8	7	6	5	4	3	2	1	0	
+0	Reserved	Reserved	Reserved	Reserved	Reserved	Reserved	Reserved	Reserved	Reserved	Reserved	Reserved	Reserved	Reserved	Reserved	Reserved	EXE	Sensor head common control signal (32bit)
+1	Reserved	Reserved	Reserved	Reserved	Reserved	Reserved	Reserved	Reserved	Reserved	Reserved	Reserved	Reserved	Reserved	Reserved	Reserved	ERCLR	
+2	Reserved	Reserved	Reserved	Reserved	Reserved	Reserved	Reserved	Reserved	Reserved	Reserved	Reserved	Reserved	Reserved	LIGHT OFF1	RESET1	TIMING1	Sensor head 1 control signal(32bit)
+3	Reserved	Reserved	Reserved	Reserved	Reserved	Reserved	Reserved	Reserved	ZERO CLR_T4	ZERO CLR_T3	ZERO CLR_T2	ZERO CLR1_T1	ZERO1 _T4	ZERO1 _T3	ZERO1 _T2	ZERO1 _T1	
+4	Reserved	Reserved	Reserved	Reserved	Reserved	Reserved	Reserved	Reserved	Reserved	Reserved	Reserved	Reserved	Reserved	Reserved	Reserved	Reserved	Extended area (32bit)
+5	Reserved	Reserved	Reserved	Reserved	Reserved	Reserved	Reserved	Reserved	Reserved	Reserved	Reserved	Reserved	Reserved	Reserved	Reserved	Reserved	
+6	Command code																Command code (32bit)
+7																	
+8	Parameter 1																Parameter 1 (16bit)
+9	Parameter 2																
+10	Parameter 3																Parameter 3 (32bit)
+11																	

Signal	Signal name	Function
EXE	Control command execution	<p>Turns ON when the user (PLC) instructs execution of control commands to the displacement sensor. (Turns ON after the control command code and parameters are set.)</p> <p>Is returned to OFF on condition (input condition) that the user (PLC) turns the control command completion signal (FLG signal) from the displacement sensor ON.</p>
ERCLR	Error clear	<p>Turns ON when the displacement sensor error signal (ERR signal) turns OFF.</p> <p>Is returned to OFF on condition (input condition) that the user (PLC) turns the error signal (ERR signal) OFF.</p>
TIMING1	Timing	<p>Turns ON when the user (PLC) instructs start of hold sampling to the displacement sensor.</p> <p>Turns OFF when the user (PLC) instructs end of hold sampling to the displacement sensor.</p>
RESET1	Reset	<p>Turns ON when the user (PLC) instructs judgment processing and output reset to the displacement sensor. If the hold function is used, the state in effect before the hold function was set will be restored.</p> <p>Turns OFF when the user (PLC) ends judgment processing and output reset to the displacement sensor.</p>

Signal	Signal name	Function
LIGHTOFF1	Light metering OFF	Turns ON when the user (PLC) instructs logical beam OFF to the displacement sensor.
		Turns OFF when the user (PLC) instructs logical beam ON to the displacement sensor.
ZERO1_T1 to 4	Zero reset execution	Turns ON when the user (PLC) instructs execution of zero reset of TASK1 to 4 to the displacement sensor.
		Is returned to OFF on condition (input condition) that the user (PLC) turns the zero reset completion signal (ZEROSTAT signal) from the displacement sensor ON.
ZEROCLR1_T1 to 4	Zero reset cancel	Turns ON when the user (PLC) instructs zero reset cancel of TASK1 to 4 to the displacement sensor.
		Is returned to OFF on condition (input condition) that the user (PLC) turns the zero reset completion signal (ZEROSTAT signal) from the displacement sensor OFF.
Command code	Command code	Stores the command code.
Parameter 1-3	Command parameter	Stores the command parameter.

Note

- In the FUN mode, control signals other than ERCLR cannot be executed.
- Multiple control signals cannot be executed in the same cycle. Note, however, that when zero reset execution/cancellation are performed simultaneously on multiple tasks, ZEROx_T1 to 4 and ZEROCLR_x_T1 to 4 can be executed in the same cycle.
- When the status of control signals differs from that of the input status of parallel I/O, processing is executed of one of the statuses is ON.

● Output connection (displacement sensor (originator) to PLC → PLC (target))

- Response area

Top channel	Bit																Description
	15	14	13	12	11	10	9	8	7	6	5	4	3	2	1	0	
+0	BANK1_E	BANK1_D	BANK1_C	BANK1_B	BANK1_A	Reserved	Reserved	Reserved	Reserved	Reserved	Reserved	RUN	Reserved	READY	Reserved	FLG	Sensor head common control signal (32bit)
+1	Reserved	Reserved	Reserved	Reserved	Reserved	Reserved	Reserved	Reserved	Reserved	Reserved	Reserved	Reserved	Reserved	Reserved	Reserved	ERR	
+2	Reserved	Reserved	Reserved	Reserved	Reserved	Reserved	Reserved	Reserved	Reserved	OR1	GATE1	ENABLE1	STABILITY1	LIGHT1	RESETSTAT1	HOLDSTAT1	Sensor head 1 control signal (32bit)
+3	LOW1_T4	PASS1_T4	HIGH1_T4	LOW1_T3	PASS1_T3	HIGH1_T3	LOW1_T2	PASS1_T2	HIGH1_T2	LOW1_T1	PASS1_T1	HIGH1_T1	ZEROSTAT1_T4	ZEROSTAT1_T3	ZEROSTAT1_T2	ZEROSTAT1_T1	
+4	Reserved	Reserved	Reserved	Reserved	Reserved	Reserved	Reserved	Reserved	Reserved	Reserved	Reserved	Reserved	Reserved	Reserved	Reserved	Reserved	Extended area (32bit)
+5	Reserved	Reserved	Reserved	Reserved	Reserved	Reserved	Reserved	Reserved	Reserved	Reserved	Reserved	Reserved	Reserved	Reserved	Reserved	Reserved	
+6	Command code																Command code (32bit)
+7																	
+8	Response code																Response code (32bit)
+9																	
+10	Response data																Response data (32bit)
+11																	

Signal	Signal name	Function
FLG	Control command completion	Turns ON when the displacement sensor completes control command execution. (Turns ON after the control command code, response code and response status are stored.)
		Automatically turns OFF if the control command execution signal (EXE signal) from the user (PLC) turns OFF.

Signal	Signal name	Function
READY	Ready	Turns OFF when the displacement sensor cannot execute control commands.
		Turns ON when the displacement sensor can execute control commands.
RUN	Run screen	Turns ON when the displacement sensor is in the RUN mode.
		Turns OFF when the displacement sensor is in the FUN mode.
ERR	Error	Turns ON when a displacement sensor error is detected.
		Turns OFF when the displacement sensor is normal. After it turns ON, it never turns OFF until the error clear signal (ERCLR signal) from the user (Controller) turns ON.
BANKOUT1_A to E	Current bank number	This outputs the currently specified bank number. It expresses the bank number in combinations of BANKOUTx_A to E. (For details of combinations, see Reference.)
HOLDSTAT1	Hold execution status	Turns ON when the displacement sensor is in the hold sampling period.
		Turns OFF when the displacement sensor is outside the hold sampling period.
RESETSTAT1	Reset execution state	Turns ON when the displacement sensor is in the reset execution state.
		Turns OFF when the displacement sensor is in the reset non-execution state.
LIGHT1	Logical beam lighting state	Turns ON when the logical beam is lit.
		Turns OFF when the logical beam is out.
STABILITY1	Measurement position	Turns ON when the measured value is in the measuring range.
		Turns OFF when the measured value is outside the measuring range.
ENABLE1	Measurement state	Turns ON when the displacement sensor is ready for measurement.
		Turns OFF when the displacement sensor cannot measure (excessive or insufficient received light, outside measuring range, Calibration ROM not mounted, during FUN mode non-measurement).
GATE1	Data output completed	Turns ON when the displacement sensor completes control data output when hold is set.
		The displacement sensor automatically turns OFF one Gate period after turning ON.
OR1	Overall judgment result	Turns ON when even one of the judgment result of the displacement sensor TASK1 to 4 is other than PASS.
		Turns OFF when all of the judgment result of the displacement sensor TASK1 to 4 is PASS.
HIGH1_T1-4	HIGH output	Turns ON when the judgment result of the displacement sensor TASK1 to 4 is HIGH (HIGH threshold < measured value).
		Turns OFF when the judgment result of the displacement sensor TASK1 to 4 is other than HIGH.
PASS1_T1-4	PASS Output	Turns ON when the judgment result of the displacement sensor TASK1 to 4 is PASS (LOW threshold ≤ measured value ≤ HIGH threshold).
		Turns OFF when the judgment result of the displacement sensor TASK1 to 4 is other than PASS.
LOW1_T1-4	LOW output	Turns ON when the judgment result of the displacement sensor TASK1 to 4 is LOW (LOW threshold > measured value).
		Turns OFF when the judgment result of the displacement sensor TASK1 to 4 is other than LOW.
ZEROSTAT1_T1-4	Zero reset state	Turns ON when the displacement sensor TASK1 to 4 is in the zero reset execution state.
		Turns OFF when the displacement sensor TASK1 to 4 is in the zero reset non-execution state.
Command code	Command code	The executed command code is returned.
Response code	Response code	The response code of the executed command is stored.
Response data	Response data	The response data of the executed command is stored.

Note

- The results of processing execution by parallel I/O also are reflected in the status signals.
- The table below shows the combinations of bank numbers and BANKOUT_x_A to E.
(BANK9 to 32 are used only in the judgment value mode. In the normal mode, BANKOUT_x_D to E are OFF at all times.)

Bank number	BANKOUT _x _A	BANKOUT _x _B	BANKOUT _x _C	BANKOUT _x _D	BANKOUT _x _E
BANK1	OFF	OFF	OFF	OFF	OFF
BANK2	ON	OFF	OFF	OFF	OFF
BANK3	OFF	ON	OFF	OFF	OFF
BANK4	ON	ON	OFF	OFF	OFF
BANK5	OFF	OFF	ON	OFF	OFF
BANK6	ON	OFF	ON	OFF	OFF
BANK7	OFF	ON	ON	OFF	OFF
BANK8	ON	ON	ON	OFF	OFF
BANK9	OFF	OFF	OFF	ON	OFF
BANK10	ON	OFF	OFF	ON	OFF
BANK11	OFF	ON	OFF	ON	OFF
BANK12	ON	ON	OFF	ON	OFF
BANK13	OFF	OFF	ON	ON	OFF
BANK14	ON	OFF	ON	ON	OFF
BANK15	OFF	ON	ON	ON	OFF
BANK16	ON	ON	ON	ON	OFF
BANK17	OFF	OFF	OFF	OFF	ON
BANK18	ON	OFF	OFF	OFF	ON
BANK19	OFF	ON	OFF	OFF	ON
BANK20	ON	ON	OFF	OFF	ON
BANK21	OFF	OFF	ON	OFF	ON
BANK22	ON	OFF	ON	OFF	ON
BANK23	OFF	ON	ON	OFF	ON
BANK24	ON	ON	ON	OFF	ON
BANK25	OFF	OFF	OFF	ON	ON
BANK26	ON	OFF	OFF	ON	ON
BANK27	OFF	ON	OFF	ON	ON
BANK28	ON	ON	OFF	ON	ON
BANK29	OFF	OFF	ON	ON	ON
BANK30	ON	OFF	ON	ON	ON
BANK31	OFF	ON	ON	ON	ON
BANK32	ON	ON	ON	ON	ON

- Output area

The output area is assigned to I/O memory area continuously from the response area.

Top channel	Bit																Description
	15	14	13	12	11	10	9	8	7	6	5	4	3	2	1	0	
+0	Measurement Value of Task1																Output data 0 (32bit)
+1																	
+2	Measurement Value of Task2																Output data 1 (32bit)
+3																	
+4	Measurement Value of Task3																Output data 2 (32bit)
+5																	
+6	Measurement Value of Task4																Output data 3 (32bit)
+7																	
+8	Reserved																Output data 4 (32bit)
+9																	
+10	Reserved																Output data 5 (32bit)
+11																	
+12	Reserved																Output data 6 (32bit)
+13																	
+14	Reserved																Output data 7 (32bit)
+15																	

Signal	Signal name	Function
Measurement Value of Task1	Measurement Value of Task1	The measured value of TASK1 is output.
Measurement Value of Task2	Measurement Value of Task2	The measured value of TASK2 is output.
Measurement Value of Task3	Measurement Value of Task3	The measured value of TASK3 is output.
Measurement Value of Task4	Measurement Value of Task4	The measured value of TASK4 is output.

Accessing Communications Areas Using Variables with NJ-series Controllers

With an NJ-series Controller, only variables can be used to access from the user program the I/O memory addresses that are assigned to the communications areas.

Use the following settings.

● Using Network Variables for Access

Create user-defined variables that match the structures of the communications areas of the Sensor.

Use the Sysmac Studio to define the variables.

Refer to the *Sysmac Studio Version 1 Operation Manual* (Cat. No. W504) for Sysmac Studio operating procedures.

1 Defining the Data Types of the Variables

Define data types for variables that match the structures of the communications areas.

(1) Defining a Data Type for Signal Access

First, define a BOOL array data type to access the control signals and status signals.

Here, a data type called "U_EIPFlag" is defined.

Name of data type : U_EIPFlag

Type of derivative data type : Union

Name of data type	Data type	
U_EIPFlag	UNION	
F	ARRAY[0..31]OF BOOL Specifies an array of BOOL data from 0 to 31.
W	DWORD 32-bit bit string data

(2) Defining Data Types for Communications Area Access

Data types are defined to access the communications areas, with one data type for the command area and another data type for the response and output areas.

Here, data types called "S_EIPOutput" and "S_EIPInput" are defined.

• Data Type to Access the Command Area

Name of data type : S_EIPOutput

Type of derivative data type : Structure

Name of data type	Data type	
S_EIPOutput	STRUCT	
CommonControlFlag	U_EIPFlag The data type that was defined above (1)
SensorHead1ControlFlag	U_EIPFlag The data type that was defined above (1)
SensorHead2ControlReserve	U_EIPFlag The data type that was defined above (1) (extended area)
CommandCode	DWORD 32-bit bit string data
CommandParam1	UINT 16-bit integer data
CommandParam2	UINT 16-bit integer data
CommandParam3	DINT 32-bit integer data

• Assignment Example for Variable Data Type That Matches the Command Area

		Bits (-: Reserved)															
		15	14	13	12	11	10	9	8	7	6	5	4	3	2	1	0
S_EIP Output	CommonControl-Flag	+0	-	-	-	-	-	-	-	-	-	-	-	-	-	-	EXE
		+1	-	-	-	-	-	-	-	-	-	-	-	-	-	-	ERCLR
	SensorHead1-ControlFlag	+2	-	-	-	-	-	-	-	-	-	-	-	-	LIGHT OFF1	RESET 1	TIMING 1
		+3	-	-	-	-	-	-	-	ZERO CLR_T4	ZERO CLR_T3	ZERO CLR_T2	ZERO CLR_T1	ZERO1_T4	ZERO1_T3	ZERO1_T2	ZERO1_T1
	SensorHead2-ControlReserve	+4	-	-	-	-	-	-	-	-	-	-	-	-	-	-	-
		+5	-	-	-	-	-	-	-	-	-	-	-	-	-	-	-
	CommandCode	+6	Command code														
		+7															
	CommandParam1	+8	Parameter 1														
	CommandParam2	+9	Parameter 2														
	CommandParam3	+10	Parameter 3														
+11																	

• Data Type to Access the Response and Output Areas

Name of data type : S_EIPInput

Type of derivative data type : Structure

Name of data type	Data type	
S_EIPInput	STRUCT	
CommonStatusFlag	U_EIPFlagThe data type that was defined above (1)
SensorHead1StatusFlag	U_EIPFlagThe data type that was defined above (1)
SensorHead2StatusReserve	U_EIPFlagThe data type that was defined above (1) (extended area)
CommandCodeEcho	DWORD32-bit bit string data
ResponseCode	UDINT32-bit integer data
ResponseData	DINT32-bit integer data
OutputData	ARRAY[0..7]OF DINTSpecifies an array of DINT data from 0 to 7.

- Assignment Example for Variable Data Type That Matches the Response and Output Areas

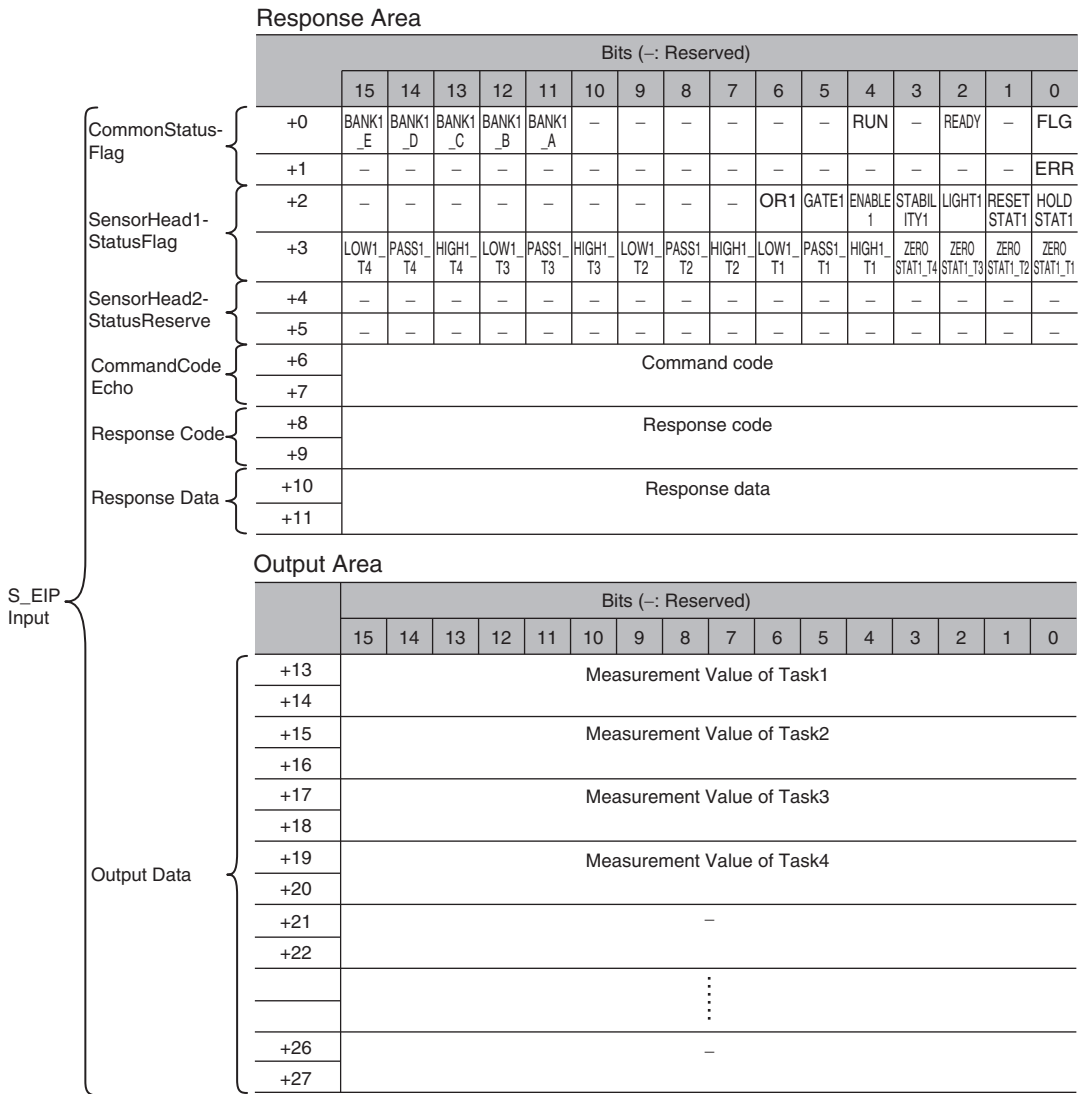

2 Defining the Variables

Define variables for the data links for the communications area data that is used in EtherNet/IP communications.

These variables use the data types that were defined above in procedure 1.

Variable	Variable type	Network Publish attribute	Data type	Application
EIPOutput	Global variable	Output	S_EIPOutput	For data links to the command area
EIPInput	Global variable	Input	S_EIPInput	For data links to the response and output areas

3 Exporting the Variables That Were Defined on Sysmac Studio

Export the variables that you defined so that you can use them on the Network Configurator.

An exported CSV file is created.

4 Network Configurator Settings

(1) Import to the Network Configurator the CSV file that you exported from the Sysmac Studio.

The variables that are imported will automatically be registered as tags.

(2) Set the connections as shown in the following table.

Originator device (PLC) settings	Target device (Sensor) settings
Input tag set: EIP Input	Output tag set: Input101
Output tag set: EIP Output	Input tag set: Output100

5 Accessing the Communications Areas from the User Program

The defined variables are used to access the communications areas for the Sensor using the following notation.

• Command Area

Signal name	Variable name
EXE	EIPOutput.CommonControlFlag.F[0]
ERCLR	EIPOutput.CommonControlFlag.F[16]
TIMING1	EIPOutput.SensorHead1ControlFlag.F[0]
RESET1	EIPOutput.SensorHead1ControlFlag.F[1]
LIGHTOFF1	EIPOutput.SensorHead1ControlFlag.F[2]
ZERO1_T1	EIPOutput.SensorHead1ControlFlag.F[16]
ZERO1_T2	EIPOutput.SensorHead1ControlFlag.F[17]
ZERO1_T3	EIPOutput.SensorHead1ControlFlag.F[18]
ZERO1_T4	EIPOutput.SensorHead1ControlFlag.F[19]
ZEROCLR1_T1	EIPOutput.SensorHead1ControlFlag.F[20]
ZEROCLR1_T2	EIPOutput.SensorHead1ControlFlag.F[21]
ZEROCLR1_T3	EIPOutput.SensorHead1ControlFlag.F[22]
ZEROCLR1_T4	EIPOutput.SensorHead1ControlFlag.F[23]
Command code	EIPOutput.CommandCode
Command parameter 1	EIPOutput.CommandParam1
Command parameter 2	EIPOutput.CommandParam2
Command parameter 3	EIPOutput.CommandParam3

• Response Area

Signal name	Variable name
FLG	EIPInput.CommonStatusFlag.F[0]
READY	EIPInput.CommonStatusFlag.F[2]
RUN	EIPInput.CommonStatusFlag.F[4]
BANK1_A	EIPInput.CommonStatusFlag.F[11]
BANK1_B	EIPInput.CommonStatusFlag.F[12]
BANK1_C	EIPInput.CommonStatusFlag.F[13]
BANK1_D	EIPInput.CommonStatusFlag.F[14]
BANK1_E	EIPInput.CommonStatusFlag.F[15]
ERR	EIPInput.CommonStatusFlag.F[16]
HOLDSTAT1	EIPInput.SensorHead1StatusFlag.F[0]
RESETSTAT1	EIPInput.SensorHead1StatusFlag.F[1]
LIGHT1	EIPInput.SensorHead1StatusFlag.F[2]
STABILITY1	EIPInput.SensorHead1StatusFlag.F[3]
ENABLE1	EIPInput.SensorHead1StatusFlag.F[4]
GATE1	EIPInput.SensorHead1StatusFlag.F[5]
OR1	EIPInput.SensorHead1StatusFlag.F[6]
ZEROSTAT1_T1	EIPInput.SensorHead1StatusFlag.F[16]
ZEROSTAT1_T2	EIPInput.SensorHead1StatusFlag.F[17]
ZEROSTAT1_T3	EIPInput.SensorHead1StatusFlag.F[18]
ZEROSTAT1_T4	EIPInput.SensorHead1StatusFlag.F[19]
HIGH1_T1	EIPInput.SensorHead1StatusFlag.F[20]
PASS1_T1	EIPInput.SensorHead1StatusFlag.F[21]
LOW1_T1	EIPInput.SensorHead1StatusFlag.F[22]
HIGH1_T2	EIPInput.SensorHead1StatusFlag.F[23]
PASS1_T2	EIPInput.SensorHead1StatusFlag.F[24]
LOW1_T2	EIPInput.SensorHead1StatusFlag.F[25]
HIGH1_T3	EIPInput.SensorHead1StatusFlag.F[26]
PASS1_T3	EIPInput.SensorHead1StatusFlag.F[27]
LOW1_T3	EIPInput.SensorHead1StatusFlag.F[28]
HIGH1_T4	EIPInput.SensorHead1StatusFlag.F[29]
PASS1_T4	EIPInput.SensorHead1StatusFlag.F[30]
LOW1_T4	EIPInput.SensorHead1StatusFlag.F[31]
Command code	EIPInput.CommandCodeEcho
Response code	EIPInput.ResponseCode
Response data	EIPInput.ResponseData

• Output Area

Signal name	Variable name
Measurement Value of Task1	EIPInput.OutputData[0]
Measurement Value of Task2	EIPInput.OutputData[1]
Measurement Value of Task3	EIPInput.OutputData[2]
Measurement Value of Task4	EIPInput.OutputData[3]

● Accessing Communications Areas by Specifying I/O Memory Addresses

AT specifications can be set for variables to individually specify the I/O memory addresses that are assigned in the communications areas.

1 Setting Tag Sets (Network Configurator)

Specify the tag names in the PLC directly by using the I/O memory addresses that are assigned in the communications areas. (Output tags are specified for the input connections to the Sensor and input tags are specified for output connections to the PLC.)

Setting Examples

Output tag : D0

Input tag : D100

2 Setting Variables (Sysmac Studio)

Define variables with AT specifications to the I/O memory addresses that are assigned in the communications areas as shown below.

Setting Examples

Variable: *a* (AT specification: D0.0)

Variable: *b* (AT specification: D1.1)

Variable: *c* (AT specification: D2.0)

Variable: *d* (AT specification: D2.1)

Variable: *e* (AT specification: D2.2)

⋮

3 Setting Connections

Set the connections as shown in the following table.

Originator device (PLC) settings	Target device (Sensor) settings
Input tag set: D0	Output tag set: Input101
Output tag set: D100	Input tag set: Output100

Example: Setting Example for Variables to Access the Command Area

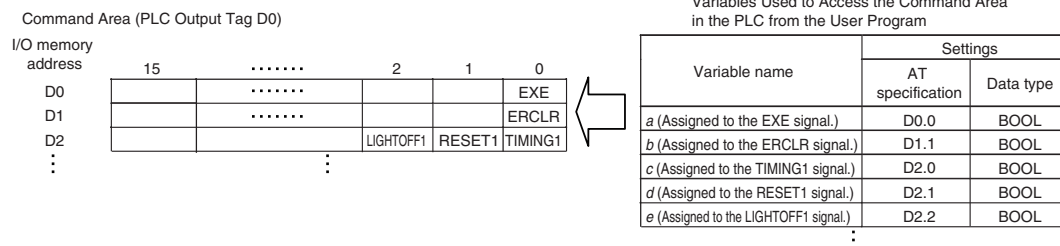

List of Commands (EtherNet/IP)

This list explains each of the commands used by EtherNet/IP.

● Utility commands

Instruction area Top channel (Hex)		Command name	Function	Reference (Pages)
+7	+6			
0010	3011	Data save	Saves the current system data and bank data to the main unit.	p.181
0010	E000	Sensor Head calibration	Calibrate the Sensor Head.	p.182
0010	F010	Restart	Restarts the displacement sensor.	p.182

● Bank control command

Instruction area Top channel (Hex)		Command name	Function	Reference (Pages)
+7	+6			
0030	8000	Current bank settings	Replace the current bank number by the specified bank number.	p.183

● Data acquisition/setting commands

Instruction area Top channel (Hex)		Command name	Function	Reference (Pages)
+7	+6			
0040	1000	Processing unit data acquisition	Acquires the measurement data and setting data of the processing unit.	p.185
0050	1000	Processing unit data setting	Change the setting data of the processing unit.	p.186
0040	4000	System data acquisition	Acquires the system data.	p.187
0050	4000	System data settings	Sets the system data.	p.188

Timing Chart (EtherNet/IP)

● Control command execution

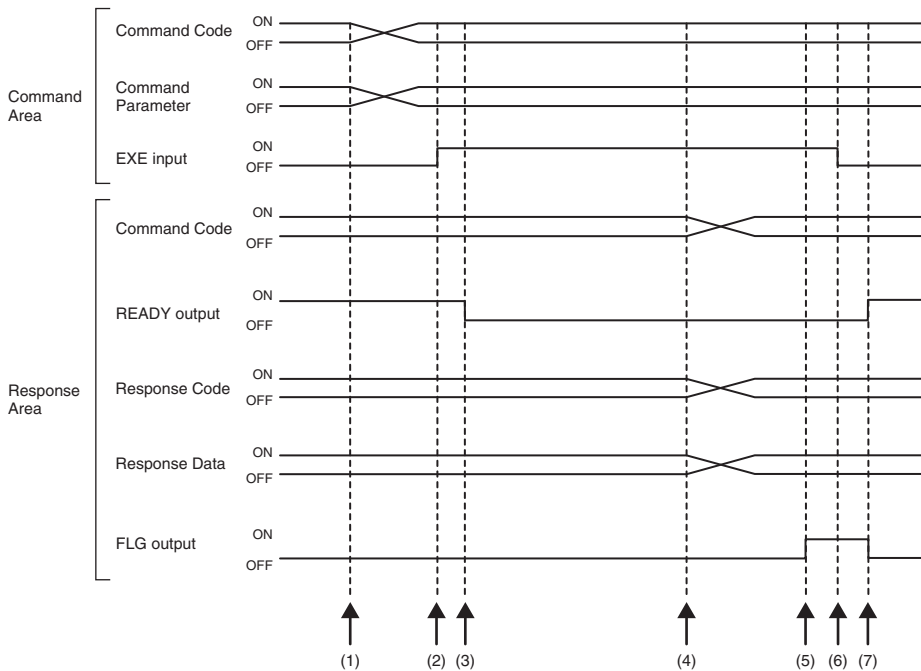

- (1) The command code and command parameter are set from the Controller.
- (2) The EXE input signal state is changed from OFF to ON. Execution is instructed to the displacement sensor.
- (3) When the displacement sensor receives the execution instruction, the READY output signal turns OFF and the command is executed.
- (4) When the displacement sensor completes execution, the command code, response code and response data are set.
- (5) The FLG output signal turns ON.
- (6) The Controller makes sure that the FLG output signal has turned ON, and then returns the EXE input signal to OFF.
- (7) The displacement sensor makes sure that the EXE input signal has turned OFF, and the FLG and READY output signals automatically turn OFF and ON, respectively.

● Execution of hold (peak/bottom/peak to peak/average) and reset of hold value

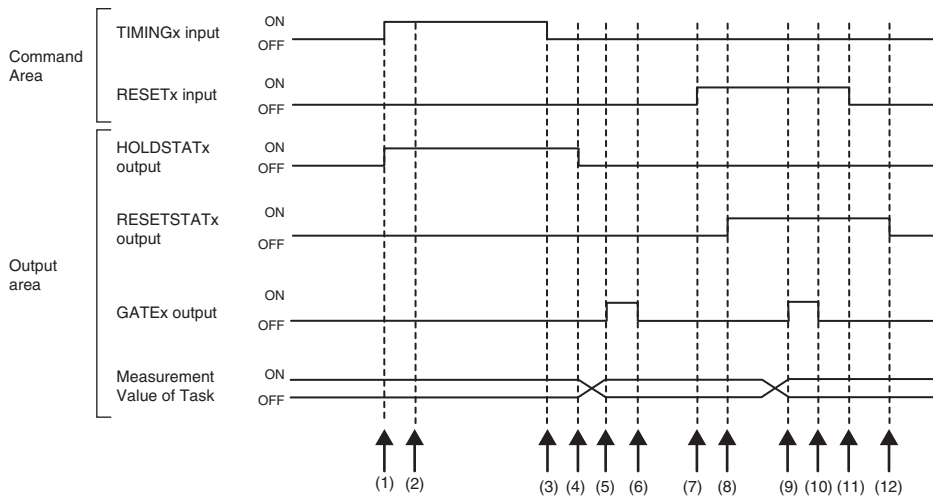

- (1) The Controller changes the state of the TIMINGx input signal from OFF to ON. At the rising edge of the TIMINGx input signal, the displacement sensor starts sampling.
- (2) At start of sampling, the displacement sensor changes the state of the HOLDSTATx output signal from OFF to ON.
- (3) The Controller turns the state of the TIMINGx input signal from ON to OFF. At the falling edge of the TIMINGx input signal, the displacement sensor end sampling.
- (4) At end of sampling, the displacement sensor changes the state of the HOLDSTATx output signal from ON to OFF.
- (5) When the hold value is applied, the displacement sensor changes the state of the GATEx output signal from OFF to ON. The Controller makes sure that the GATEx output signal has turned ON, and then captures the output data.
- (6) The displacement sensor turns OFF after the GATE signal ON duration has elapsed since the GATEx output signal turned ON.
- (7) The Controller changes the state of the RESETx input signal from OFF to ON. At the rising edge of the RESETx input signal, the displacement sensor starts the measured value reset period.
- (8) At the start of the measured value reset period, the displacement sensor changes the state of the RESETSTATx output signal from OFF to ON.
- (9) At completion of the measured value reset, the displacement sensor changes the state of the GATEx output signal from OFF to ON.
- (10) The displacement sensor turns OFF after the GATE signal ON duration has elapsed since the GATEx output signal turned ON.
- (11) The Controller changes the state of the RESETx input signal from ON to OFF. At the falling edge of the RESETx input signal, the displacement sensor end the measured value reset period.
- (12) At the end of the measured value reset period, the displacement sensor changes the state of the RESETSTATx output signal from ON to OFF.

Important

When hold is being performed by multiple tasks, HOLDSTATx output signal turns ON when even one task enters the sampling period and GATEx output signal turns ON when the measured value is applied.

● Execution of hold (auto peak, auto bottom, auto peak to peak) and reset of hold value

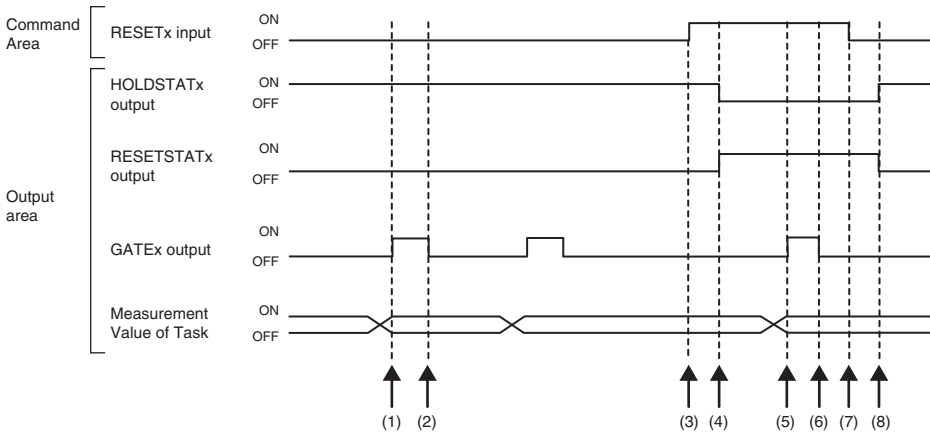

- (1) When the peak value is applied, the displacement sensor changes the state of the GATEx output signal from OFF to ON. The Controller makes sure that the GATEx output signal has turned ON, and then captures the output data.
- (2) The displacement sensor turns OFF after the GATE signal ON duration has elapsed since the GATEx output signal turned ON.
- (3) The Controller turns the state of the RESETx input signal from OFF to ON. At the rising edge of the RESETx input signal, the displacement sensor starts the measured value reset period.
- (4) At the start of the measured value reset period, the displacement sensor changes the state of the HOLDSTATx output signal from ON to OFF and the RESESTATx from OFF to ON.
- (5) At completion of the measured value reset, the displacement sensor changes the state of the GATEx output signal from OFF to ON.
- (6) The displacement sensor turns OFF after the GATE signal ON duration has elapsed since the GATEx output signal turned ON.
- (7) The Controller changes the state of the RESETx input signal from ON to OFF. At the falling edge of the RESETx input signal, the displacement sensor end the measured value reset period.
- (8) At the end of the measured value reset period, the displacement sensor changes the state of the HOLDSTATx output signal from OFF to ON and the RESESTATx from ON to OFF.

Important

When hold is being performed by multiple tasks, HOLDSTATx output signal turns ON when even one task enters the sampling period and GATEx output signal turns ON when the measured value is applied.

● Execution of hold (sample) and reset of hold value

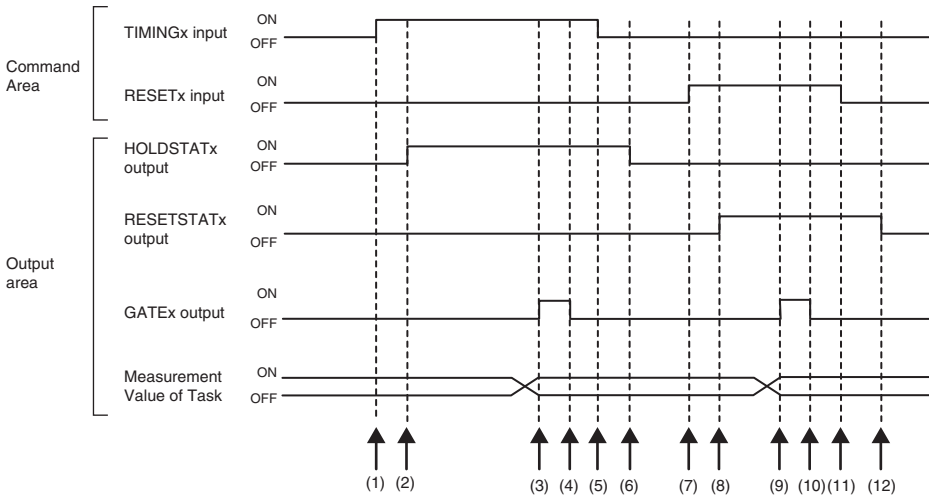

- (1) The Controller changes the state of the TIMINGx input signal from OFF to ON. At the rising edge of the TIMINGx input signal, the displacement sensor starts sampling.
- (2) At start of sampling, the displacement sensor changes the state of the HOLDSTATx output signal from OFF to ON.
- (3) When the hold value is applied, the displacement sensor changes the state of the GATEx output signal from OFF to ON. The Controller makes sure that the GATEx output signal has turned ON, and then captures the output data.
- (4) The displacement sensor turns OFF after the GATE signal ON duration has elapsed since the GATEx output signal turned ON.
- (5) The Controller turns the state of the TIMINGx input signal from ON to OFF. At the falling edge of the TIMINGx input signal, the displacement sensor end sampling.
- (6) At end of sampling, the displacement sensor changes the state of the HOLDSTATx output signal from ON to OFF.
- (7) The Controller changes the state of the RESETx input signal from OFF to ON. At the rising edge of the RESETx input signal, the displacement sensor starts the measured value reset period.
- (8) At the start of the measured value reset period, the displacement sensor changes the state of the RESETSTATx output signal from OFF to ON.
- (9) At completion of the measured value reset, the displacement sensor changes the state of the GATEx output signal from OFF to ON.
- (10) The displacement sensor turns OFF after the GATE signal ON duration has elapsed since the GATEx output signal turned ON.
- (11) The Controller changes the state of the RESETx input signal from ON to OFF. At the falling edge of the RESETx input signal, the displacement sensor end the measured value reset period.
- (12) At the end of the measured value reset period, the displacement sensor changes the state of the RESETSTATx output signal from ON to OFF.

Important

When hold is being performed by multiple tasks, HOLDSTATx output signal turns ON when even one task enters the sampling period and GATEx output signal turns ON when the measured value is applied.

● Measurement LED out

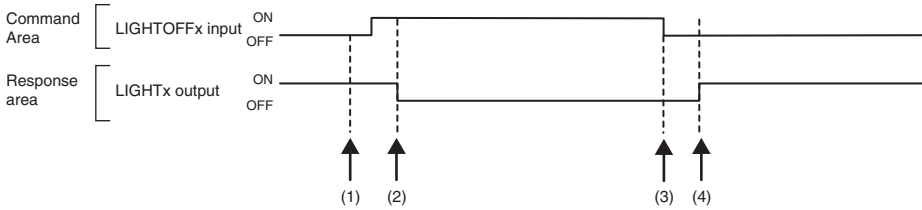

- (1) The Controller changes the state of the LIGHTOFFx input signal from OFF to ON. At the rising edge of the LIGHTOFFx input signal, the displacement sensor turns the measurement LED out.
- (2) At measurement LED out, the displacement sensor changes the state of the LIGHTx output signal from ON to OFF.
- (3) The Controller turns the state of the LIGHTOFFx input signal from ON to OFF. At the falling edge of the LIGHTOFFx input signal, the displacement sensor lights the measurement LED.
- (4) At measurement LED on, the displacement sensor returns the LIGHTx output signal to ON.

● Zero reset execution/zero reset cancel

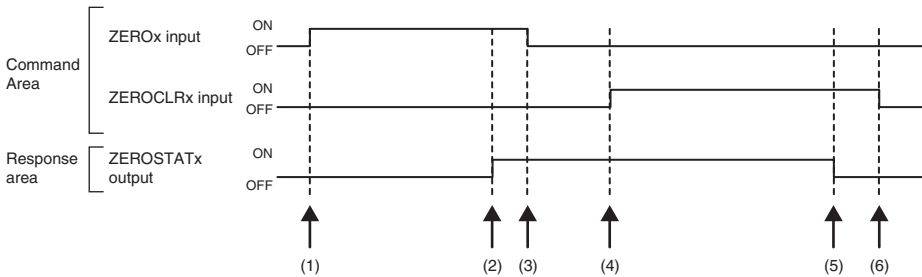

- (1) The Controller changes the state of the ZEROx_T1 to 4 input signals from OFF to ON. The displacement sensor makes sure that ZEROx_T1 to 4 input signals have turned ON, and then executes the zero reset.
- (2) At execution of zero reset, the displacement sensor changes the state of the ZEROSTATx_T1 to 4 output signal from OFF to ON.
- (3) The Controller makes sure that the ZEROSTATx_T1 to 4 output signals have turned ON, and then returns the ZEROx_T1 to 4 input signals to OFF.
- (4) The Controller changes the state of the ZEROCLRx_T1 to 4 input signals from OFF to ON. The displacement sensor makes sure that ZEROCLRx_T1 to 4 input signals have turned ON, and then executes the zero reset cancel.
- (5) At the zero reset cancel, the displacement sensor returns the ZEROSTATx_T1 to 4 output signals to ON.
- (6) The Controller makes sure that the ZEROSTATx_T1 to 4 output signals have turned OFF, and then returns the ZEROCLRx_T1 to 4 input signals to OFF.

Sample Ladder Program (EtherNet/IP)

● Command/Response Communications

The following sample program is used to perform replacement the current bank number.

The replacement the current bank number command (lower bytes: #8000, upper bytes: #0030) is sent to the Displacement Sensor.

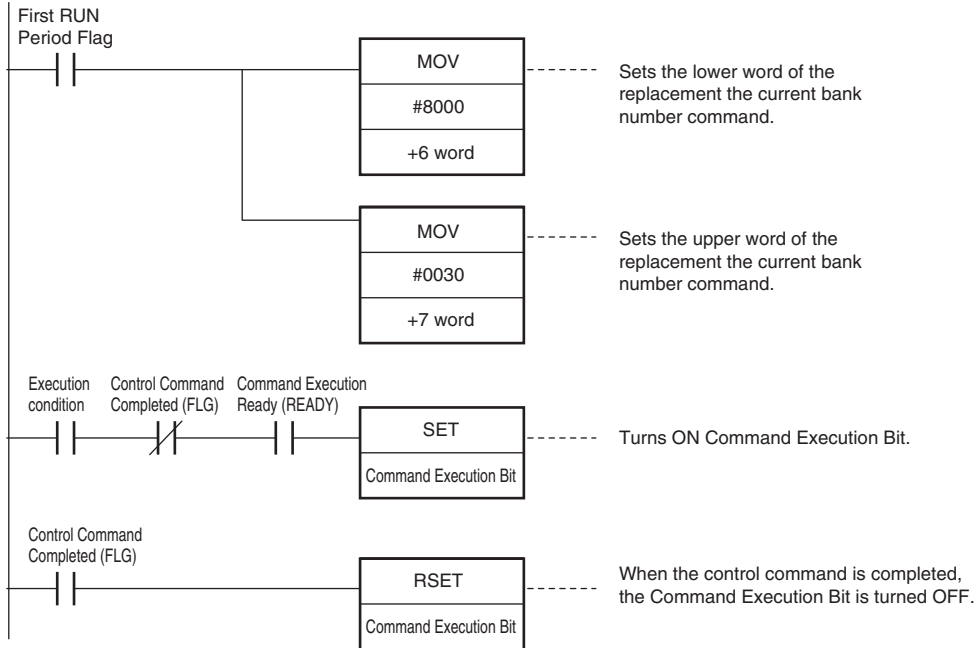

Important

Create the ladder program to control the EXE signal so that it does not turn ON while the READY signal is ON. If not, a EXE input error will occur and the ERR signal will turn ON.

6-4 No-protocol Connection

Outline of No-protocol Communications

A system is possible where no-protocol communications is performed between the displacement sensor and an external device (e.g. PLC) and control from the external device (e.g. PLC) is performed by commands/responses.

Communications with the external device is possible over Ethernet or the RS-232C interface. This control system functions in the RUN mode. Communications is not possible in the FUN mode. Also, when a system error occurs, commands from the external device are accepted, though setting commands are not executed.

● Command/response system

With no-protocol communications, a control command is sent to the displacement sensor from the external device (e.g. PLC) and the response is sent from the displacement sensor is received by the external device (e.g. PLC). By this, the measured value is acquired from the displacement value, and bank switch and various other controls are performed.

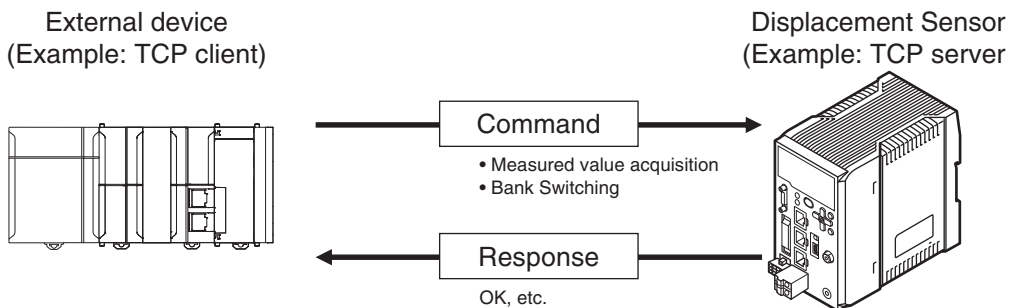

In actual terms, an ASCII character command (e.g. "MS" for acquiring the measured value) is issued from the external device (e.g. PLC). The displacement sensor returns responses such as "OK", "NG" or a value.

● Serial data output method after application of measured value

When hold is set, immediately after the measured value has been applied, the measured value data from the displacement sensor is output automatically to the output device (e.g. PLC).

This enables the measurement value data for all tasks to be easily handed over to an external device (e.g. PLC).

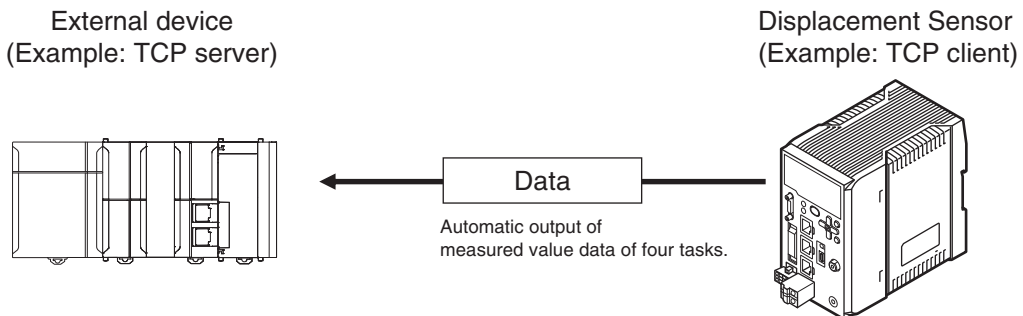

Data can be output with Ethernet or with RS-232C. Measured value data can be sent to an external device (e.g. PLC) serially (continuously) in ASCII format or binary format. External device There is no handshaking for whether or not an external device (e.g. PLC) can receive data.

Setting Up No-protocol Communications

Setting Network Settings in the Sensor

This section describes how to set the network settings in the Displacement Sensor.

- **Explorer pane** : [Device group] | Sensor name | [System] | [System data] (Double-click)
→ **Edit Pane** : [Ethernet communication settings] icon (🌐) | [Ethernet settings]

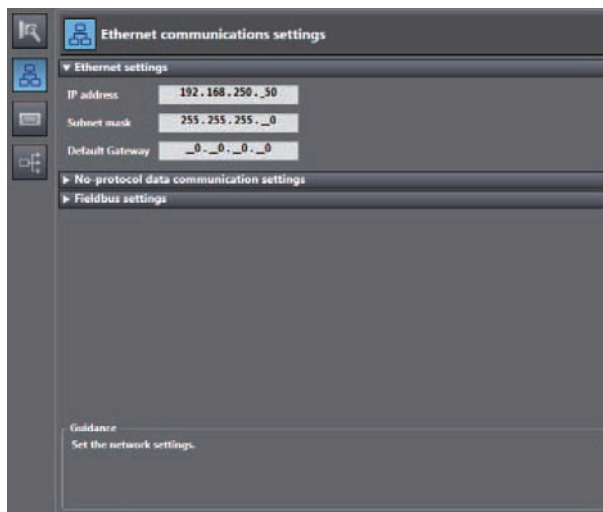

The following items can be set.

Item	Description	Setting range
IP address	Set the IP address of the Displacement Sensor.	a.b.c.d a: 1 to 223, b: 0 to 255, c: 0 to 255, d: to 254 (Default: 192.168.250.50)
Subnet mask	Set the subnet mask.	0.0.0.0 to 255.255.255.255 (Default: 255.255.255.0)
Default Gateway	Sets the default gateway.	0.0.0.0 to 255.255.255.255 (Default: 0.0.0.0)

Initial Settings for No-protocol Communications

You must set the communications method, destination IP address, and I/O port number of the destination external device to perform no-protocol communications.

- **Explorer pane** : [Device group] | Sensor name | [System] | [System data] (Double-click)
 → **Edit Pane** : [Ethernet communication settings] icon () |
 [No-Protocol data communication setting]

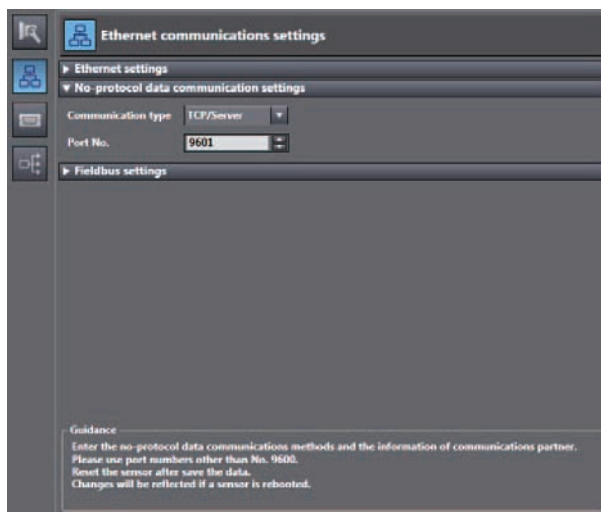

Item	Description	Setting range
Communication type	Select the communications method.	<ul style="list-style-type: none"> • OFF • TCP server • TCP client • UDP (Default: TCP server)
Port No. In	Sets the ZW port number when the UDP or TCP server is selected.	0 to 65,535 (Default: 9601) <ul style="list-style-type: none"> • The following port number is reserved and cannot be used: 9600
IP address	Set the IP address of the external device at the connection destination when the UDP or TCP client is selected. Set it in the form a.b.c.d. <div style="border: 1px solid black; padding: 2px; width: fit-content;"> Note </div> If you connect an external OMRON CS/CJ-series PLC to Ethernet, the following default IP address is assigned to the PLC. <ul style="list-style-type: none"> • IP address: 192.168.250.node_address 	a: 1 to 223, b: 0 to 255, c: 0 to 255, d: to 254 (Default: 192.168.250.100)
Port No. Out	Set the I/O port number of the external device at the connection destination when the UDP or TCP client is selected. Set the value to between 0 and 65,535.	0 to 65,535 Default: 9,600 (Default: 9,601)

Important

If set Communication type to TCP client, please start a ZW after make sure the external device to be TCP server is ready to communicate. In addition, the communication is interrupted for reasons such as the ethernet cable is disconnected, please restart the ZW If you can not reconnect.

Note

The initial setting for No-protocol Communications can also be set by the operating keys on the Sensor Controller.



Initial Settings for No-protocol Communications p.352

Setting Communications Specifications (RS-232C Communications)

Setting RS-232C communications on the sensor body

Set RS-232C communications on the displacement sensor body.

- ▶ **Explorer pane** : [Device Group] | [(Sensor Name)] | [System] | [System Data] (double-click)
- **Edit pane** : [RS-232C Communications Settings] icon 

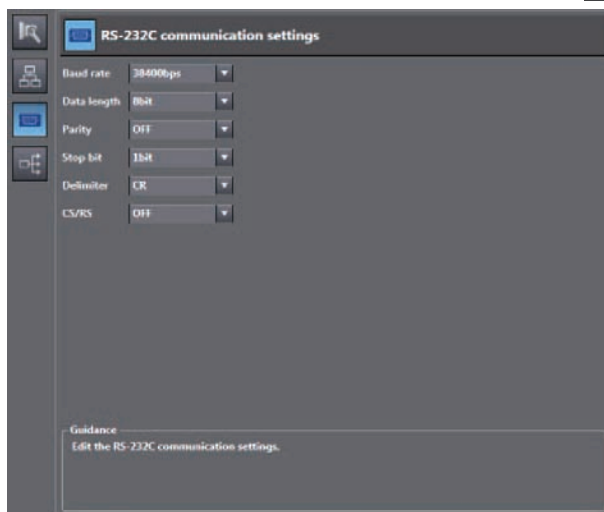

Item	Description	Range
Baud rate	Sets the data transfer speed.	9600bps, 19200bps, 38400bps (default value), 57600bps, 115200bps
Data length	Sets the data length.	8 bits (default value), 7 bits
Parity	Sets the parity bit (error detection sign).	None (default value), odd, even
Stop bit	Sets the stop bit.	1bit (default), 2bit
Delimiter	Sets the delimiter (data delimiter).	CR (default), LF, CR+LF
CS/RS	Sets the flow control.	OFF(default value)/ON

Note

- With the ZW series, communication cannot be established under the following condition.
Data length: 7-bit and Parity: None
- The RS-232C communication specifications can also be set with key operations on the Sensor Controller.

 9-15 Connecting by No-protocol Communications p.352

Setting for serial data output after application of measured value

When hold is set, the applied measured data can be output automatically.

Data that can be output

The data to be output is measured values applied at the time that the output cause occurs.
The data to be output is fixed to four tasks, TASK1 to TASK4, and can not be set individually.

Timing for outputting data

When hold (peak, bottom, peak-to-peak, average, sampling) is set, the measured value data is output when a measured value is applied for even one of the four tasks. For the trigger method, both timing input from the outside and self-triggering are supported.

Setting the data output destination

Serial data can be output from Ethernet or RS-232C. This section describes the procedure for the setting.

Item	Setting item	Description	Range
Data output settings	Data output destination	Sets the interface for serial data output.	OFF (default value)/Ethernet/RS-232C

► Explorer pane
→ Edit pane

: [System] (double-click)

: [Data output settings] icon ()

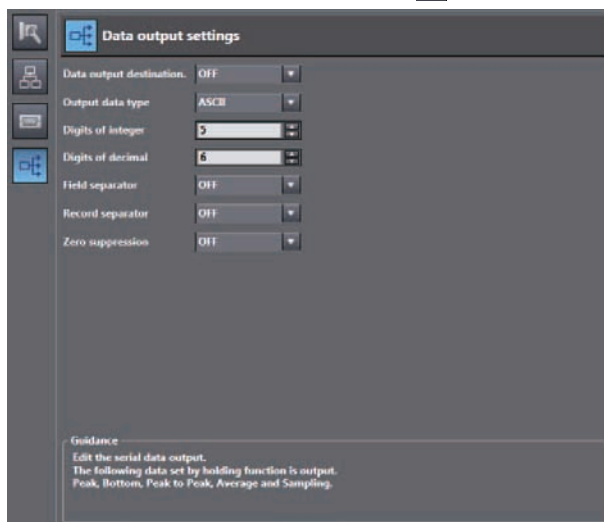

Note

-
- When the output timing is such that multiple records are buffered, data for up to 10 records is output together.
 - When output data is buffered faster than it is output, the outputting can not keep up and an overflow occurs in the ZW. If this happens, "OUT.OVR" appears on the main segment. You can recover from the error display by pressing the ESC/ZERORST key.
 - Up to 128 records of output can be buffered.
 - Data output destination can also be set by the operating keys on the Sensor Controller.



Setting Serial Data Output p.354

Setting the output format

Item	Setting item	Description	Range
Data output settings	Output data type	Select the output format.	ASCII, Binary (default value: ASCII)
	Digits of integer	Select the number of digits in the integer part.	1 to 5 [digits] (default value: 5 digits)
	Digits of decimal	Select the number of digits in the fractional part.	0 to 6 [digits] (default value: 6 digits)
	Zero suppression	Select whether or not to suppress leading zeros.	ON/OFF (default value: ON)
	Field separator	Select the type of field separator.	OFF, comma, tab, space, CR, LF, CR+LF, semicolon (default value: OFF)
	Record separator	Select the type of record separator.	OFF, comma, tab, space, CR, LF, CR+LF, semicolon (default value: OFF)

► **Explorer pane**
→ **Edit pane**

: **[System] (double-click)**
: **[Data output setting] icon** ()

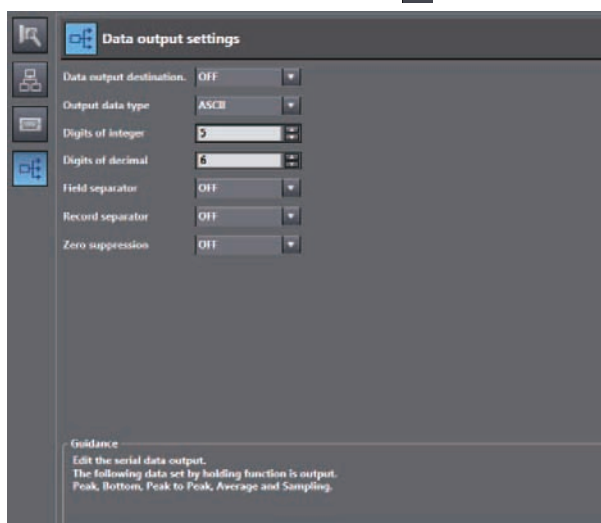

Note

The output format can also be set by the operating keys on the Sensor Controller.

 [Setting Serial Data Output p.354](#)

• When the output format is ASCII

Set the number of digits in the integer section, number of digits in the fraction section, negative number expression, zero suppression, field separator, and record separator items.

• Output Format

TASK1 measured value	,	TASK2 measured value	,	...	TASK4 measured value	CR
----------------------	---	----------------------	---	-----	----------------------	----

Note

The output format, number of digits and the data separator, etc. can be changed if necessary.

Example) Integer digits: "2 digits", fractional digits: "3 digits", zero suppression: "No", field separator: "comma", record separator: "CR"

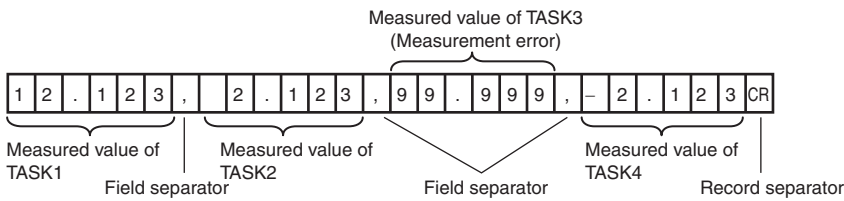

Note

If the measurement result is an abnormal value, the maximum value that can be expressed with the number of integer and fractional digits is output.
 If the measurement result can not be expressed because of the number of digits, the maximum value or minimum value that can be expressed is output.

• When the output format is binary

Set the numeric expression.
 Select whether fixed decimal point or floating decimal point.

• Output Format

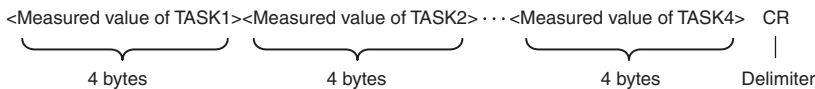

Measurement values expressed in mm are output continuously with 4 bytes per each data item.
 Negative numbers are output in 2's complement format.

(Example) When Task 1 is "37.385762 mm", Task 2 is "40.673256 mm", Task 3 is "Measurement value error", and Task 4 is "39.554658 mm".

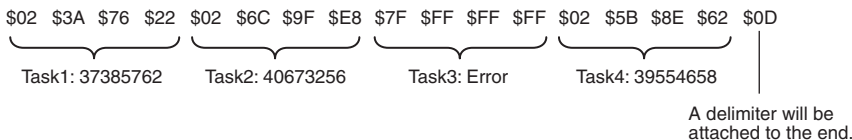

Note

- If the measurement result is an abnormal value, HEX7FFFFFFF is output.
- Unlike ASCII output, binary output has no separators between data such as field separators or record separators, etc.

Command List

This table lists no-protocol communications commands.
The available commands are listed as follows.

Command name	Format	Return value *1	Description	Pages
MS	MS <Task number> <Delimiter>	<Measured value> <Delimiter>	Acquires the current measured value. If the <task number> is omitted, the measured value displayed is acquired. If "4" is set for the <task number>, the measured values for all tasks are obtained.	p.237
JG	JG <Task number> <Delimiter>	<Judgment result> <Delimiter>	Acquires the judgment result of the specified task. If the <task number> is omitted, the result of the task of which the result is currently displayed is acquired. If "4" is set for the <task number>, the judgment results for all tasks are obtained.	p.238
DG	DG <unit number> <Data number> <Delimiter>	<Data> <Delimiter>	Acquires the measurement data and setting data of the processing unit.	p.239
DS	DS <unit number> <Data number> <Measured value> <Delimiter>	OK <Delimiter>	Change the setting data of the processing unit.	p.240
BG	BG <Delimiter>	<Bank number> <Delimiter>	Acquire the current bank number.	p.241
BS	BS <Bank number> <Delimiter>	OK <Delimiter>	Replace the current bank number by the specified bank number.	p.242
ZR	ZR <Task number> <Delimiter>	OK <Delimiter>	Execute a zero reset for the specified task. If the <task number> is omitted, the zero reset is executed for the task of which the result is currently displayed. If "4" is set for the <task number>, this is executed for all tasks.	p.243
ZC	ZC <Task number> <Delimiter>	OK <Delimiter>	Cancel the zero reset of the specified task. If the <task number> is omitted, the zero reset is executed for the task of which the result is currently displayed. If "4" is set for the <task number>, this is executed for all tasks.	p.244
TM	TM <0:OFF/ 1:ON> <Delimiter>	OK <Delimiter>	Executes TIMING input. * Calculates OR with the parallel input.	p.245
RT	RT <0:OFF/ 1:ON> <Delimiter>	OK <Delimiter>	Executes RESET input. * Calculates OR with the parallel input.	p.245
LD	LD <0: Lit/ 1: Out> <Delimiter>	OK <Delimiter>	Turns the logical beam ON/OFF.	p.246
VR	VR <Delimiter>	<Model/Version> <Delimiter>	Acquire the system version information. (Example) ZW-CE10T 1.100 <Delimiter>	p.246
CA	CA 0 <Delimiter>	OK <Delimiter>	Calibrate the Sensor Head.	p.247
LS	LS <Save intervals> <Number of saves> <Delimiter>	OK <Delimiter>	Start the internal logging of the data.	p.247
LE	LE <Delimiter>	OK <Delimiter>	End the internal logging of the data.	p.248

Command name	Format	Return value *1	Description	Pages
LO	LO <Task number> <First data number> <Output data count> <Delimiter>	<Internal logging data > <Delimiter>	Acquires the internal logging data. If the <task number> is omitted, internal logging data acquisition is executed for the task of which the result is currently displayed. If the <first data number> is omitted, internal logging data acquisition is executed from first data number "0". If the <output data count> is omitted, all internal logging data acquisition is executed.	p.248
LC	LC <Delimiter>	OK <Delimiter>	Clear the internal logging data.	p.249
LI	LI <Delimiter>	<Operation status> <Saved data count> <Delimiter>	Acquire the internal logging information.	p.250
DV	DV <Delimiter>	OK <Delimiter>	Save all bank data and system settings to EEPROM.	p.250
YG	YG <Data number>	<Numerical value data> <Delimiter>	Acquires the system data.	p.251
YS	YS <Data number> <Setting value>	OK <Delimiter>	Sets the system data.	p.252
IG	IG	<IP address> <Delimiter>	Acquires the Ethernet IP address.	p.253
IS	IS <IP address>	OK <Delimiter>	Sets the Ethernet IP address.	p.253
KG	KG <delimiter>	<Subnet mask> <Delimiter>	Acquires the subnet mask.	p.254
KS	KS <subnet mask >	OK <Delimiter>	Sets the subnet mask.	p.254
GG	GG <delimiter>	<Default gateway> <Delimiter>	Acquires the default gateway.	p.255
GS	GS <default gateway>	OK <Delimiter>	Sets the default gateway.	p.255
OG	OG <Socket No.>	<OUT IP address> <Delimiter>	Acquires the OUT IP address of the specified socket number.	p.256
OS	OS <Socket No.> <OUT IP address>	OK <Delimiter>	Sets the OUT IP address of the specified socket number.	p.257
MI	MI	<MAC ADDRESS> <Delimiter>	Acquires the MAC address.	p.258
HS	HS 0 <Delimiter>	<Head serial information> <Delimiter>	Acquires the head serial information.	p.258
RS	RS	OK <Delimiter>	Restarts	p.259

*1: If the command was not successfully processed, "ER <delimiter>" is returned.

Command Format

Measurement command <MS command>

Acquires the current measured value.

* The same can be processed with the M, MEASURE command, which is in a ZS series format.

<Command format>

M	S		*	CR
---	---	--	---	----

↑ Space
↑ Task number

<Response format>

Normal measurement (Task numbers 0 to 3)

(Example) -30.719923mm

		-	3	0	7	1	9	9	2	3	CR
--	--	---	---	---	---	---	---	---	---	---	----

- The return value is right-aligned and 11 characters + delimiter.
- The unit of the measured values is nm.
- Spaces will fill any missing portion from the left.
- If the task number is omitted, the measured value displayed is acquired.

Normal measurement (Task number 4)

(Example) TASK1 -3.071992mm, TASK2 -2.998122mm, TASK3 2.345678mm, and TASK4 2.471249mm

			-	3	0	7	1	9	9	2	,
			-	2	9	9	8	1	2	2	,
				2	3	4	5	6	7	8	,
				2	4	7	1	2	4	9	CR

When measurement is not possible

-	-	-	-	-	-	-	-	-	-	-	CR
---	---	---	---	---	---	---	---	---	---	---	----

When a command was not successfully processed

E	R	CR
---	---	----

<Parameter explanation>

Parameter	Description
Task number	Specifies the number of the task of which the measurement result is to be output. 0: TASK1 1: TASK2 2: TASK3 3: TASK4 4: TASK1 to 4

Judgment result acquisition command <JG command>

Acquires the judgment result of the specified task.

<Command format>

J	G		*	CR
---	---	--	---	----

↑ Space
↑ Task number

<Response format>

Normal processing (Task numbers 0 to 3)

(Example) When the judgment result is "HIGH"

1	CR
---	----

↑ Judgment result

Normal processing (Task number 4)

(Example) TASK1 judgment result "HIGH", TASK2/TASK3 judgment result "PASS", TASK4 judgment result "LOW"

1	,	0	,	0	,	2	CR
---	---	---	---	---	---	---	----

When a command was not successfully processed

E	R	CR
---	---	----

<Parameter explanation>

Parameter	Description
Task number	Specifies the number of the task of which the judgment result is to be output. 0: TASK1 1: TASK2 2: TASK3 3: TASK4 4: TASK1 to 4
Judgment result	Displays the judgment result. PASS: 0 HIGH: 1 LOW: 2 ERROR: 3

Processing unit data acquisition command <DG command>

Acquires the measurement data and setting data of the processing unit.

<Command format>

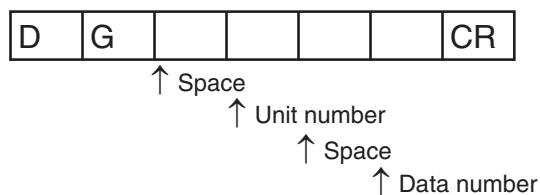

<Response format>

Normal processing

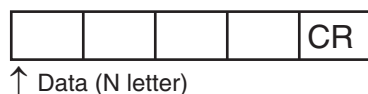

When a command was not successfully processed



<Parameter explanation>

Parameter	Description
Unit number	Specifies the unit number (0 to 255) to be acquired.
Data number	Specifies the data number (0 to 255) to be acquired.

Important

For unit numbers and data numbers, refer to "10-3 Processing Item Data List" (p.384).

Processing unit data setting command <DS command>

Change the setting data of the processing unit.

<Command format>

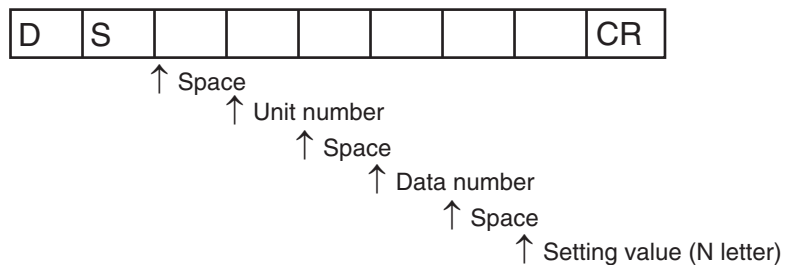

<Response format>

Normal processing

O	K	CR
---	---	----

When a command was not successfully processed

E	R	CR
---	---	----

<Parameter explanation>

Parameter	Description
Unit number	Specifies the unit number (0 to 255) to be acquired.
Data number	Specifies the data number (0 to 255) to be acquired.
Setting value	This is the setting value of the specified data.

Important

For unit numbers and data numbers, refer to "10-3 Processing Item Data List" (p.384).

Current bank data acquisition command <BG command>

Acquire the current bank number.

<Command format>

B	G	CR
---	---	----

<Response format>

Normal processing

	CR
--	----

↑ Bank number

When a command was not successfully processed

E	R	CR
---	---	----

<Parameter explanation>

Parameter	Description
Bank number	Displays the current bank number. 0: BANK1 1: BANK2 2: BANK3 3: BANK4 4: BANK5 5: BANK6 6: BANK7 7: BANK8

Current bank data setting command <BS command>

Replace the current bank number by the specified bank number.

<Command format>

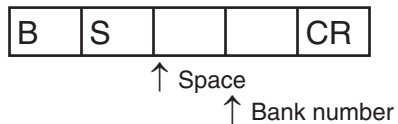

<Response format>

Normal processing



When a command was not successfully processed



<Parameter explanation>

Parameter	Description
Bank number	Specifies the bank number to switch to. 0: BANK1 1: BANK2 2: BANK3 3: BANK4 4: BANK5 5: BANK6 6: BANK7 7: BANK8

Zero reset execution command <ZR command>

Execute a zero reset for the specified task.

<Command format>

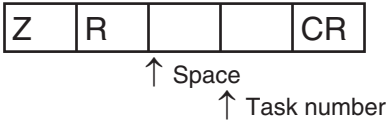

<Response format>

Normal processing



- If the task number is omitted, the zero reset is executed for the task of which the result is currently displayed.
- If "4" is set for the task number, the zero reset is executed for all tasks.

When a command was not successfully processed



<Parameter explanation>

Parameter	Description
Task number	Specifies the number of the task for which the zero reset is to be executed. 0: TASK1 1: TASK2 2: TASK3 3: TASK4 4: TASK1 to 4

Zero reset cancel command <ZC command>

Cancel the zero reset of the specified task.

<Command format>

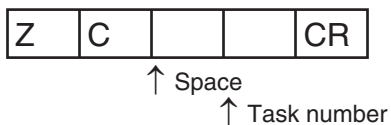

<Response format>

Normal processing

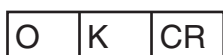

- If the task number is omitted, the zero reset is canceled for the task of which the result is currently displayed.
- If "4" is set for the task number, the zero reset is canceled for all tasks.

When a command was not successfully processed



<Parameter explanation>

Parameter	Description
Task number	Specifies the number of the task for which the zero reset is to be cancelled. 0: TASK1 1: TASK2 2: TASK3 3: TASK4 4: TASK1 to 4

TIMING input command <TM command>

Executes TIMING input.

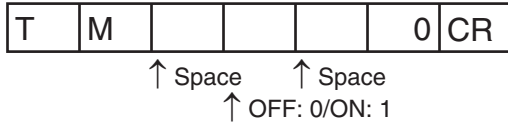
<Command format>**<Response format>**

Normal processing



When a command was not successfully processed

**RESET input command <RT command>**

Executes RESET input.

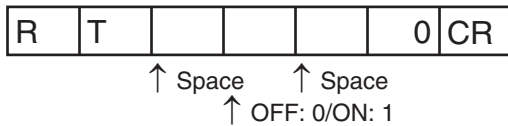
<Command format>**<Response format>**

Normal processing



When a command was not successfully processed



White LED OFF input command <LD command>

Turns the logical beam ON/OFF.

<Command format>

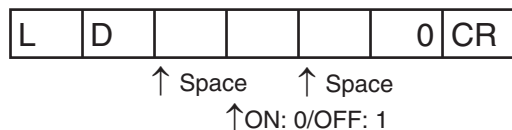

<Response format>

Normal processing



When a command was not successfully processed



Version information acquisition command <VR command>

Acquire the system version information.

<Command format>



<Response format>

Normal processing

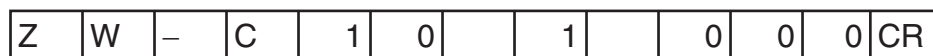

When a command was not successfully processed



Sensor head calibration command <CA command>

Calibrate the Sensor Head.

<Command format>

C	A		0	CR
---	---	--	---	----

↑ Space

<Response format>

Normal processing

O	K	CR
---	---	----

When a command was not successfully processed

E	R	CR
---	---	----

Internal logging start command <LS command>

Start the internal logging of the data.

<Command format>

L	S					CR
---	---	--	--	--	--	----

↑ Space
↑ Save intervals
↑ Space
↑ Save count

<Response format>

Normal processing

O	K	CR
---	---	----

When a command was not successfully processed

E	R	CR
---	---	----

<Parameter explanation>

Parameter	Description
Save intervals	Sets the intervals(0 to 1000) to be internally logged. If "1" is set , all measured data is stored, and "2" is set, one measured data is stored every two measurement. If "0" is set, only the applied measured data is stored when hold is set.
Save count	Sets the maximum data count (1 to 12,800) to be internally logged. The internal logging process ends when the number of internal logging data reaches the maximum.

Internal logging end command <LE command>

End the internal logging of the data.

<Command format>

L	E	CR
---	---	----

<Response format>

Normal processing

O	K	CR
---	---	----

When a command was not successfully processed/When internal logging is not started

E	R	CR
---	---	----

- The internal logging process ends without sending LE command when the number of internal logging data reaches the maximum.

Internal logging data acquisition command <LO command>

Acquires the internal logging data.

<Command format>

L	O							CR
---	---	--	--	--	--	--	--	----

↑ Space ↑ Space ↑ Space ↑ Output data count
 ↑ Task number ↑ First data number

- If the <task number> is omitted, internal logging data acquisition is executed for the task of which the result is currently displayed.
- If the <first data number> is omitted, internal logging data acquisition is executed from first data number "0".
- If the <output data count> is omitted, all internal logging data acquisition is executed.

<Response format>**Normal processing**

The internal logging data is output.

(Example) TASK1 -3.071992mm, TASK2 -2.998122mm, TASK3 2.345678mm, and TASK4 2.471249mm

			-	3	0	7	1	9	9	2	,
			-	2	9	9	8	1	2	2	,
				2	3	4	5	6	7	8	,
				2	4	7	1	2	4	9	CR

- The character format is ASCII.
- The return value is right-aligned and 11 characters + delimiter.
- The unit of the measured values is nm.
- Spaces will fill any missing portion from the left.

When a command was not successfully processed/When internal logging is not stopped

E	R	CR
---	---	----

<Parameter explanation>

Parameter	Description
Task number	Sets the task number under which to obtain internal log data. 0: TASK1 1: TASK2 2: TASK3 3: TASK4
First data number	Sets the first logging data number (0 to 12800) that is acquired from beginning. Beginning data number is "0".
Output data count	Sets the logging data count (0 to 12800) that is acquired. If stored internal logging data count is lower than setting, all logging data is acquired. If nothing is stored, command response is ER.

Internal logging data clear command <LC command>

Clear the internal logging data.

<Command format>

L	C	CR
---	---	----

<Response format>**Normal processing**

O	K	CR
---	---	----

When a command was not successfully processed/When internal logging is not stopped

E	R	CR
---	---	----

- If internal logging is started without clearing logging data, data is saved end of last logging data.
- When ZW internal memory size is not enough, internal logging is automatically ended. Overwrite is not executed.

Internal logging data information acquisition command <LI command>

Acquire the internal logging information.

<Command format>

L	I	CR
---	---	----

<Response format>

Normal processing

			CR
--	--	--	----

↑ Operation status

↑ Space

↑ Saved data count

When a command was not successfully processed

E	R	CR
---	---	----

<Parameter explanation>

Parameter	Description
Operation status	Displays the internal logging process status. 0: Internal logging stopped state 1: Internal logging in progress
Saved data count	Displays the number of saved logging data (0 and more).

Data save command <DV command>

Save all bank data and system settings to EEPROM.

<Command format>

D	V	CR
---	---	----

<Response format>

Normal processing

O	K	CR
---	---	----

When a command was not successfully processed

E	R	CR
---	---	----

System data acquisition <YG command>

Acquires the system data.

<Command format>

Y	G			CR
---	---	--	--	----

↑ Space
↑ Data number

<Response format>

Normal processing

			CR
--	--	--	----

↑ Data (N letter)
↑ Space

When a command was not successfully processed

E	R	CR
---	---	----

<Parameter explanation>

Parameter	Description
Data number	Specifies the data number (0 to 255) to be acquired.

Note

For data numbers, refer to "10-4 System data list."

System data setting <YS command>

Sets the system data.

<Command format>

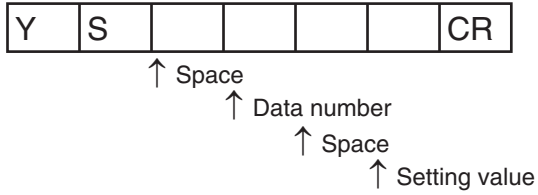

<Response format>

Normal processing

O	K	CR
---	---	----

When a command was not successfully processed

E	R	CR
---	---	----

<Parameter explanation>

Parameter	Description
Data number	Specifies the data number to be acquired.
Setting value	This is the setting value of the specified data.

Note

For data numbers, refer to "10-4 System data list."

IP address acquisition <IG command>

Acquires the IP address.

<Command format>

I	G	CR
---	---	----

<Response format>

Normal processing

(Example) When the IP address of the ZW is 192.168.250.50

1	9	2	.	1	6	8	.	2	5	0	.	5	0	CR
---	---	---	---	---	---	---	---	---	---	---	---	---	---	----

When a command was not successfully processed

E	R	CR
---	---	----

IP address setting <IS command>

Sets the IP address.

<Command format>

I	S		1	9	2	.	1	6	8	.	2	5	0	.	5	0	CR
---	---	--	---	---	---	---	---	---	---	---	---	---	---	---	---	---	----

↑ Space

<Response format>

Normal processing

O	K	CR
---	---	----

When a command was not successfully processed

E	R	CR
---	---	----

Subnet mask acquisition <KG command>

Acquires the subnet mask.

<Command format>

K	G	CR
---	---	----

<Response format>

Normal processing

(Example) When the ZW subnet mask is 255.255.255.0

2	5	5	.	2	5	5	.	2	5	5	.	0	CR
---	---	---	---	---	---	---	---	---	---	---	---	---	----

When a command was not successfully processed

E	R	CR
---	---	----

Subnet mask setting <KS command>

Sets the subnet mask.

<Command format>

(Example) When setting subnet mask 255.255.255.0 for the ZW

K	S		2	5	5	.	2	5	5	.	2	5	5	.	0	CR
---	---	--	---	---	---	---	---	---	---	---	---	---	---	---	---	----

↑ Space

<Response format>

Normal processing

O	K	CR
---	---	----

When a command was not successfully processed

E	R	CR
---	---	----

Default gateway acquisition <GG command>

Acquires the default gateway.

<Command format>

G	G	CR
---	---	----

<Response format>

Normal processing

(Example) When the ZW default gateway is 0.0.0.0

0	.	0	.	0	.	0	CR
---	---	---	---	---	---	---	----

When a command was not successfully processed

E	R	CR
---	---	----

Default gateway setting <GS command>

Sets the default gateway.

<Command format>

(Example) When setting the default gateway 0.0.0.0 for the ZW

G	S		0	.	0	.	0	.	0	CR
---	---	--	---	---	---	---	---	---	---	----

↑ Space

<Response format>

Normal processing

O	K	CR
---	---	----

When a command was not successfully processed

E	R	CR
---	---	----

OUT IP address acquisition of the specified socket number <OG command>

Acquires the OUT IP address.

<Command format>

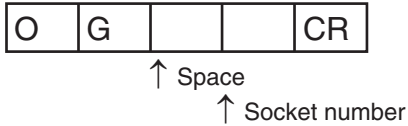

<Response format>

Normal processing

(Example) When the OUT IP address of the ZW is 192.168.250.100

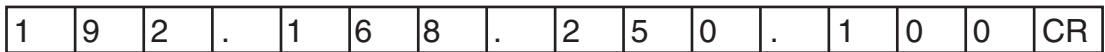

When a command was not successfully processed



<Parameter explanation>

Parameter	Description
Socket number	Specifies the socket number of which the serial data is to be output. 1: Socket 1 (fixed at 192.168.250.100) 2: Socket 2 3: Socket 3 (fixed at 192.168.250.100) 4: Socket 4 (fixed at 192.168.250.100) (* Sockets 3 and 4 are not used for serial data output.

OUT IP address setting of the specified socket number <OS command>

Sets the OUT IP address.

<Command format>

O	S				1	9	2	.	1	6	8	.	2	5	0	.	1	0	0	CR

↑ Space ↑ Space
 ↑ Socket number

<Response format>

Normal processing

O	K	CR
---	---	----

When a command was not successfully processed

E	R	CR
---	---	----

<Parameter explanation>

Parameter	Description
Socket number	Specifies the socket number of which the serial data is to be output. 1: Socket 1 (fixed at 192.168.250.100) 2: Socket 2 3: Socket 3 (fixed at 192.168.250.100) 4: Socket 4 (fixed at 192.168.250.100) (*1) Sockets 3 and 4 are not used for serial data output. (*2) Sockets 1, 3 and 4 are fixed and cannot be set by this command. Note, however, that OK is returned as the response.

MAC address acquisition <MI command>

Acquires the MAC address.

<Command format>

M	I	CR
---	---	----

<Response format>

(Example) When the MAC address of the ZW is 00.00.0A.75.00.00

Normal processing

0	0	.	0	0	.	0	A	.	7	5	.	0	0	.	0	0	CR
---	---	---	---	---	---	---	---	---	---	---	---	---	---	---	---	---	----

When a command was not successfully processed

E	R	CR
---	---	----

Head serial information acquisition <HS command>

Acquires the head serial information.

<Command format>

H	S		0	CR
---	---	--	---	----

↑ Space

<Response format>

Normal processing

(Example) When the head serial information is 1234567

1	2	3	4	5	6	7	CR
---	---	---	---	---	---	---	----

When a command was not successfully processed

E	R	CR
---	---	----

Restart <RS command>

Restarts the Sensor Controller

<Command format>

R	S	CR
---	---	----

<Response format>

Normal processing

O	K	CR
---	---	----

When a command was not successfully processed

E	R	CR
---	---	----

MEMO

Offline Settings

7-1 Performing Settings Offline.....	262
7-2 Starting a Project in Offline Mode.....	263
7-3 Changing between Online and Offline	264
7-4 Offline Debugging of the Sensor Control Program and Sensor Operation	265

7-1 Performing Settings Offline

The personal computer tools set enables the user to perform settings offline without connecting an actual sensor.

Parameters set offline can be saved as project data just like parameters set online, and conditions set offline can be transferred to the sensor as desired.

The following functions are disabled during offline setting.

Item			Reference (Pages)	
Main screen	Online		Internal logging	p.129
			Trend monitor	p.120
	Tool		Sensor setup	p.116 p.133 p.380
Bank data edit pane	Monitor		Measurement value monitor	p.58
			Line bright monitor	
			LED light	
			I/O input	
	Task	Filer	Scaling (automatic setting)	p.88
I/O	Analog output	Analog output correction	p.143	

7-2 Starting a Project in Offline Mode

To start a project in Offline Mode, select [Enter the type] on the Select Sensor Dialog Box after you create a project, then select the sensor type and version.

You cannot change the sensor type and version after you select them.

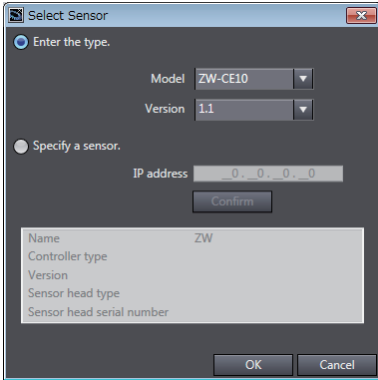

7-3 Changing between Online and Offline

Before you go offline, save all settings and parameter changes to the Sensor's internal memory. Saving your project does not save the data in the Sensor.

You can use the following two methods to change between offline and online.

► **Explorer pane** : **Right-click the Sensor model** | **[Offline/Disconnect]** or **[Online/Connect]**

► **Explorer pane** : **[Device group] | [(Sensor model)] (Double-click)**
→ **Edit pane** : **[Online] Icon** | **[Sensor connection] | [Connect] or [Disconnect]**

1 To go offline, click **[Disconnect]**. To go online, click **[Connect]**.

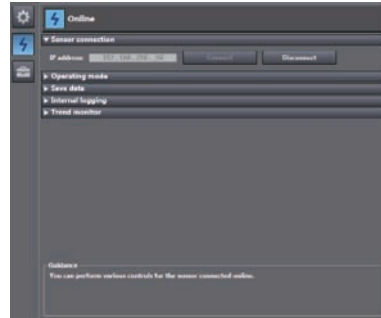

2 When you click **[Connect]**, the **Connect to Sensor Dialog Box** is displayed.

3 When you click **[Connect]**, you must **synchronize the data between the Sensor and the project.**

Follow the guidance and synchronize the data.

Note



Saving the Bank/System Settings p.112, p.329
Saving a project p.70

7-4 Offline Debugging of the Sensor Control Program and Sensor Operation

If an EtherCAT system is configured, you can perform a linked simulation between the sequence control of an NJ-series Controller and the operation of an ZW Sensor. The sensor control program can be debugged offline using measurement results saved by the data trace function.

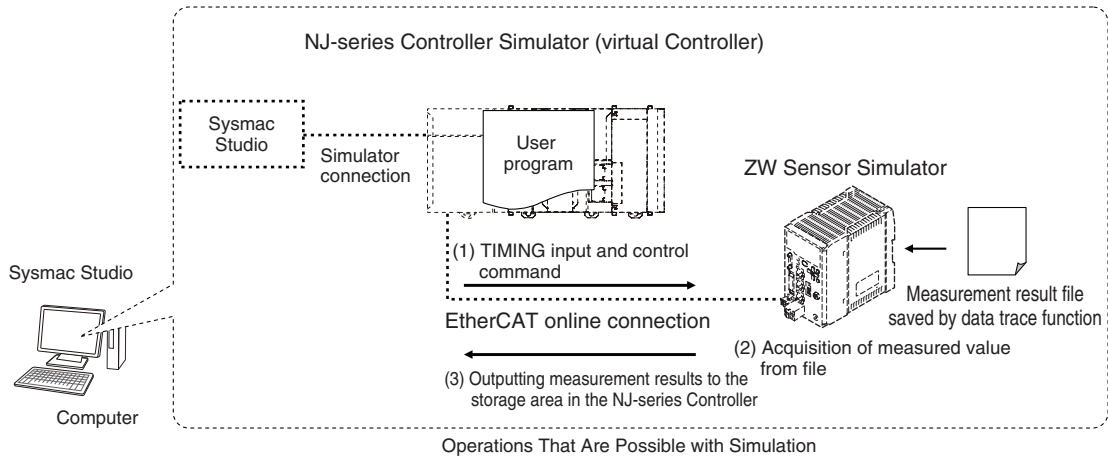

Note

Sensor measurement and other operation cannot be simulated. The measurement result acquired previously by the data trace function is output.

Important

Simulation is possible only on the Standard Edition of the Sysmac Studio.

Registering the ZW as an EtherCAT Slave

You use the Sysmac Studio (Standard Edition) to add the ZW to the EtherCAT slave configuration. Refer to the *Sysmac Studio Version 1 Operation Manual* (Cat. No. W504) for details on registering slaves. Only simplified procedures are provided here.

• Opening the Edit EtherCAT Configuration Tab Page

► **Explorer pane** : [Configurations and Setup] | [EtherCAT] (Double-click)

• Registering a Slave Offline (Building the Network Configuration)

1 Use either of the following methods to add an ZW slave to the master.

- Drag [ZW-CE1x] from the [Toolbox] to the master in the Edit Network Configuration Tab Page.
- Select the master in the Edit Network Configuration Dialog Box and then double-click [ZW-CE1x] in the [Toolbox].

- 2 Select the ZW that was added to the Edit Network Configuration Tab Page and change the node address of the ZW to the node address that is set on the ZW hardware switches.

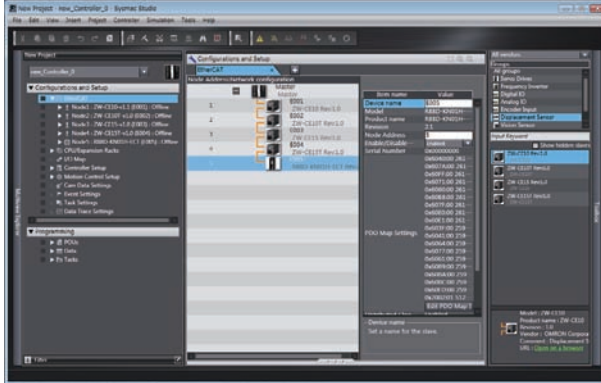

Setting Up the ZW

Set up the inspections in the ZW, e.g., set the inspection items.

- 1 Double-click the ZW that was added to the Edit Network Configuration Tab Page. The ZW Setup Pane is displayed for the Edit Pane. Make all of the required settings.

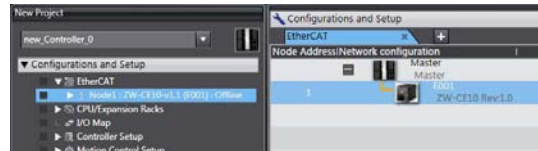

Executing the Simulation

- 1 Write and build the user program that will operate the machine. Refer to the *Sysmac Studio Version 1 Operation Manual* (Cat. No. W504) for details on programming.
- 2 Open the Edit screen. Right-click [(Sensor model)] in the Edit network configuration Tab page and select [Edit].

3 Specify the measurement result file for performing offline debugging.

Edit pane: [Tools] - [Simulation data] - [Specify a file]

Select the CSV file that is written in the following format.

You can also import files saved in the internal logging and trend graphs.

index, Task1, Task2, Task3, Task4

0,MV, MV, MV, MV

1,MV, MV, MV, MV

2,MV, MV, MV, MV

:

(MV: Measurement Value)

4 Select [Simulation] - [Execute].

The simulation will start.

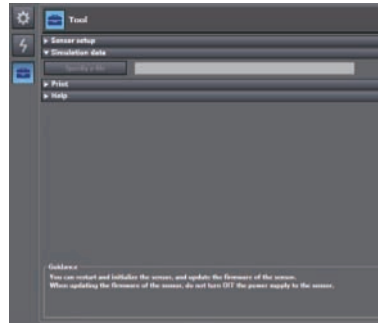

After the Simulator is connected, the NJ-series Controller and ZW Simulator will be internally connected online via EtherCAT and the NJ-series Controller will enter RUN mode.

Refer to the *Sysmac Studio Version 1 Operation Manual* (Cat. No. W504) for the operating procedures for the Simulator.

MEMO

Troubleshooting

8-1 Error Messages	270
8-2 Troubleshooting	284

8-1 Error Messages

Errors for EtherCAT Connection (Sysmac Error Status)

The Sysmac Studio Standard Version displays errors that occur in the EtherCAT system (including Sensor errors) as Sysmac error status.

Sysmac Error Status Table

This section provides a table of Sysmac error status that is related to the Sensor and describes the event codes.

Event levels are given as following in the tables.

Abbreviation	Name
Maj	Major fault level
Prt	Partial fault level
Min	Minor fault level
Obs	Observation
Info	Information

A version in parentheses in the Event code column is the unit version of the CPU Unit when the event was added.

Refer to the *NJ-series Troubleshooting Manual* (Cat. No. W503) for all NJ-series event codes.

Event Code	Event name	Meaning	Assumed cause	Level (*1)					Reference (Pages)
				Maj	Prt	Min	Obs	Info	
04D00000Hex [ALARM]	Hardware error	Some abnormality occurred on the displacement sensor hardware.	• Hardware damage			√			p.274
14B00000Hex [ALARM]	Linearity correction data error	The linearity correction data of the displacement sensor is damaged.	• Calibration ROM damage			√			p.274
14B10000Hex [ALARM]	Linearity correction data read error	Reading of the displacement sensor linearity correction data was not executed correctly.	• Calibration ROM not inserted • Calibration ROM damage			√			p.275
14B20000Hex [ALARM]	System setting error	The system settings saved to the displacement sensor are corrupt.	• The displacement sensor power was turned OFF during saving/loading of system settings.			√			p.275
14B30000Hex [ALARM]	Bank data error	The bank data saved to the displacement sensor is corrupt.	• The displacement sensor power was turned OFF during saving/loading of bank data.			√			p.276
24810000Hex [ALARM]	Ethernet communication parameter error	An invalid IP address is set for the displacement sensor.	• Invalid IP address setting			√			p.276
74900000Hex	Multiple control signal input error	Multiple control signals turned ON in the same cycle.	Multiple control signals turned ON in the same cycle.			√			p.277

Event Code	Event name	Meaning	Assumed cause	Level (*1)					Reference (Pages)
				Maj	Prt	Min	Obs	Info	
7491 0000Hex	EXE input error	EXE input processing was not executed correctly.	<ul style="list-style-type: none"> EXE input turned ON in the FUN mode. EXE input turned ON with READY output OFF. 			√			p.277
7492 0000Hex	SYNC input error	SYNC input processing was not executed correctly.	<ul style="list-style-type: none"> SYNC input turned ON in the FUN mode. 			√			p.278
7493 0000Hex	TIMING input error	TIMING input processing was not executed correctly.	<ul style="list-style-type: none"> TIMINGx input turned ON in the FUN mode. TIMINGx input turned ON or OFF while RESETx input was ON. TIMINGx input turned ON in a non-measurement state. TIMINGx input turned ON before the "delay time + sampling time" elapsed. 			√			p.278
7494 0000Hex	RESET input error	RESET input processing was not executed correctly.	<ul style="list-style-type: none"> RESETx input turned ON in the FUN mode. 			√			p.279
7495 0000Hex	ZERO input error	ZERO input processing was not executed correctly.	<ul style="list-style-type: none"> ZEROx input turned ON in the FUN mode. ZEROx input turned ON in a non-measurement state. ZEROx input turned ON for a task whose status is OFF. 			√			p.279
7496 0000Hex	ZEROCLR input error	ZEROCLR input processing was not executed correctly.	<ul style="list-style-type: none"> ZEROCLRx input turned ON in the FUN mode. 			√			p.280

Note When error marked by **ALARM** occur, the ALARM output of parallel I/O turns ON, and "SYSERR" and error code are displayed on the main and sub-displays, respectively.

*1: Fault Levels

• Major Fault Level

These errors prevent control operations for the entire Controller. If a major fault level error is detected, user program execution is stopped immediately and the loads for all slaves (including remote I/O) are turned OFF. You cannot reset major fault level errors from the user program, the Sysmac Studio, or an NS-series PT. To recover from a major fault level error, remove the cause of the error, and either cycle the power supply to the Controller or reset the Controller from the Sysmac Studio.

• Partial Fault Level

These errors prevent control operations in a certain function module in the Controller. The NJ-series CPU Unit continues to execute the user program even after a partial fault level error occurs. After you remove the cause of the error, execute one of the following to return to normal status.

- Reset the error from the user program, the Sysmac Studio, or an NS-series PT.
- Cycle the power supply to the Controller.
- Reset the Controller from the Sysmac Studio.

• Minor Fault Level

These errors prevent part of the control operations in a certain function module in the Controller. The troubleshooting for minor fault level errors is the same as the processing for partial fault level errors.

• Observations

These errors do not affect the control operations of the Controller. Observations serve as warnings to the user so that the error does not develop into an error at a higher level.

• Information

Events that are classified as information do not indicate errors.

Checking Sysmac Error Status

You can use the troubleshooting functions of the Sysmac Studio Standard Version to check the Sysmac error status. Refer to the *NJ-series Troubleshooting Manual* (Cat. No. W503) for information on troubleshooting functions.

- 1 Select [Troubleshooting] from the Tools Menu while online. You can also click the [Troubleshooting] Button in the toolbar.**

The Troubleshooting Dialog Box is displayed.

- 2 Click the [Controller Errors] Tab.**

A list of the current Sysmac error status and corresponding event codes will be displayed.

Clearing the Sysmac Error Status

- 1 Remove the cause of the error and then click the [Reset All] Button on the [Controller Errors] Tab Page of the [Troubleshooting] Pane.**

Note

Even if you reset the Sysmac error status, the errors will remain on the [Controller Event Log] Tab Page.

Error Descriptions

The items that are used to describe individual errors (events) are described in the following copy of an error table.

Event name	Gives the name of the error.		Event code	Gives the code of the error.		
Meaning	Gives a short description of the error.					
Source	Gives the source of the error.		Source details	Gives details on the source of the error.	Detection timing	Tells when the error is detected.
Error attributes	Level	Tells the level of influence on control.*1	Recovery	Gives the recovery method.*2	Log category	Tells which log the error is saved in.*3
Effects	User program	Tells what will happen to execution of the user program.*4	Operation	Provides special information on the operation that results from the error.		
Indicators	This is the status of the indicators for the EtherCAT port that is built into the NJ-series Controller. Indicator status is given only for errors in the EtherCAT Master Function Module and the EtherNet/IP Function Module.					
System-defined variables	Variable	Data type		Name		
	Lists the variable names, data types, and meanings for system-defined variables that provide direct error notification, that are directly affected by the error, or that contain settings that cause the error.					
Cause and correction	Assumed cause		Correction		Prevention	
	Lists the possible causes, corrections, and preventive measures for the error.					
Attached information	This is the attached information that is displayed by the Sysmac Studio or an NS-series PT.					
Precautions/Remarks	Provides precautions, restrictions, and supplemental information.					

*1: One of the following:
 Major fault: Major fault level
 Partial fault: Partial fault level
 Minor fault: Minor fault level
 Observation
 Information

*2: One of the following:
 Automatic recovery: Normal status is restored automatically when the cause of the error is removed.
 Error reset: Normal status is restored when the error is reset after the cause of the error is removed.
 Cycle the power supply: Normal status is restored when the power supply to the Controller is turned OFF and then back ON after the cause of the error is removed.
 Controller reset: Normal status is restored when the Controller is reset after the cause of the error is removed.
 Depends on cause: The recovery method depends on the cause of the error.

*3: One of the following:
 System: System event log
 Access: Access event log

*4: One of the following:
 Continues: Execution of the user program will continue.
 Stops: Execution of the user program stops.
 Starts: Execution of the user program starts.

Event name	Hardware error		Event code	04D0000Hex		
Meaning	Some abnormality occurred on the displacement sensor hardware.					
Source	EtherCAT master function module		Source details	Slave	Detection timing	At generation of hardware error
Error attributes	Level	Minor fault	Recovery	Error reset (cancellation of slave error)	Log category	System
Effects	User program	Continues	Operation	An error message is displayed on the displacement sensor's digital display, and the ALARM output of parallel I/O turns ON. The displacement sensor is in a stopped state until it is restarted.		
Indicators	EtherCAT NET RUN		EtherCAT NET ERR		EtherCAT LINK/ACT	
	-		-		-	
System-defined variables	Variable		Data type		Name	
	None		-		-	
Cause and correction	Assumed cause		Correction		Prevention	
	Hardware damage		Displacement sensor may be broken. Please contact an OMRON branch or sales office.		-	
Attached information	None					
Precautions/Remarks	None					

Event name	Linearity correction data error		Event code	14B0000Hex		
Meaning	The linearity correction data of the displacement sensor is damaged.					
Source	EtherCAT master function module		Source details	Slave	Detection timing	At displacement sensor startup
Error attributes	Level	Minor fault	Recovery	Error reset (after cancellation of slave error)	Log category	System
Effects	User program	Continues	Operation	An error message is displayed on the displacement sensor's digital display, and the ALARM output of parallel I/O turns ON. The displacement sensor is in a stopped state until it is restarted.		
Indicators	EtherCAT NET RUN		EtherCAT NET ERR		EtherCAT LINK/ACT	
	-		-		-	
System-defined variables	Variable		Data type		Name	
	None		-		-	
Cause and correction	Assumed cause		Correction		Prevention	
	Calibration ROM damage		Calibration ROM may be broken. Please contact an OMRON branch or sales office.		-	
Attached information	None					
Precautions/Remarks	<p>As a provisional measure, the measurement can be resumed using the data of the previously read Calibration ROM.</p> <p><Operation method> With error code 3 displayed on the sub-display, hold down the Mode switching key, then when [OK/CAN] is displayed, press the ZERO/SET key.</p> <p><Cautions></p> <ul style="list-style-type: none"> When using this method, always check the serial number of the previously read Calibration ROM in "controller information," then check that it matches the Sensor Head side serial number. Measurement will not be correct unless they match. When restarting the main unit, perform the same operations again. This operation is disabled for a displacement sensor into which no Calibration ROM has ever been inserted and started up. 					

Event name	Linearity correction data read error		Event code	14B10000Hex		
Meaning	Reading of the displacement sensor linearity correction data was not executed correctly.					
Source	EtherCAT master function module		Source details	Slave	Detection timing	At displacement sensor startup
Error attributes	Level	Minor fault	Recovery	Error reset (after cancellation of slave error)	Log category	System
Effects	User program	Continues	Operation	An error message is displayed on the displacement sensor's digital display, and the ALARM output of parallel I/O turns ON. The displacement sensor is in a stopped state until it is restarted.		
Indicators	EtherCAT NET RUN		EtherCAT NET ERR		EtherCAT LINK/ACT	
	-		-		-	
System-defined variables	Variable		Data type		Name	
	None		-		-	
Cause and correction	Assumed cause		Correction		Prevention	
	Calibration ROM not inserted		Turn the displacement sensor OFF, insert the Calibration ROM and turn the sensor ON again.		-	
	Calibration ROM damage		Calibration ROM may be broken. Please contact an OMRON branch or sales office.		-	
Attached information	None					
Precautions/Remarks	<p>As a provisional measure, the measurement can be resumed using the data of the previously read Calibration ROM.</p> <p><Operation method> With error code 3 displayed on the sub-display, hold down the Mode switching key, then when [OK/CAN] is displayed, press the ZERO/SET key.</p> <p><Cautions></p> <ul style="list-style-type: none"> When using this method, always check the serial number of the previously read Calibration ROM in "controller information," then check that it matches the Sensor Head side serial number. Measurement will not be correct unless they match. When restarting the main unit, perform the same operations again. This operation is disabled for a displacement sensor into which no Calibration ROM has ever been inserted and started up. 					

Event name	System setting error		Event code	14B20000Hex		
Meaning	The system settings saved to the displacement sensor are corrupt.					
Source	EtherCAT master function module		Source details	Slave	Detection timing	At displacement sensor startup
Error attributes	Level	Minor fault	Recovery	Error reset (after cancellation of slave error)	Log category	System
Effects	User program	Continues	Operation	An error message is displayed on the displacement sensor's digital display, and the ALARM output of parallel I/O turns ON. The displacement sensor is in a stopped state until it is restarted.		
Indicators	EtherCAT NET RUN		EtherCAT NET ERR		EtherCAT LINK/ACT	
	-		-		-	
System-defined variables	Variable		Data type		Name	
	None		-		-	
Cause and correction	Assumed cause		Correction		Prevention	
	The displacement sensor power was turned OFF during saving/loading of system settings.		After holding down the Mode switching key, press the ZERO/SET key to clear the system settings and the bank data, then resume the starting process.		Do not turn the displacement sensor OFF during saving/loading of system settings.	
Attached information	None					
Precautions/Remarks	None					

Event name	Bank data error		Event code	14B30000Hex		
Meaning	The bank data saved to the displacement sensor is corrupt.					
Source	EtherCAT master function module		Source details	Slave	Detection timing	At displacement sensor startup
Error attributes	Level	Minor fault	Recovery	Error reset (after cancellation of slave error)	Log category	System
Effects	User program	Continues	Operation	An error message is displayed on the displacement sensor's digital display, and the ALARM output of parallel I/O turns ON. The displacement sensor is in a stopped state until it is restarted.		
Indicators	EtherCAT NET RUN		EtherCAT NET ERR		EtherCAT LINK/ACT	
	-		-		-	
System-defined variables	Variable		Data type		Name	
	None		-		-	
Cause and correction	Assumed cause		Correction		Prevention	
	The displacement sensor power was turned OFF during saving/loading of bank data.		After holding down the Mode switching key, press the ZERO/SET key to clear the system settings and the bank data, then resume the starting process.		Do not turn the displacement sensor OFF during saving/loading of bank data.	
Attached information	None					
Precautions/Remarks	None					

Event name	Ethernet communication parameter error		Event code	24810000Hex		
Meaning	An invalid IP address is set for the displacement sensor.					
Source	EtherCAT master function module		Source details	Slave	Detection timing	All times
Error attributes	Level	Minor fault	Recovery	Error reset (after cancellation of slave error)	Log category	System
Effects	User program	Continues	Operation	An error message is displayed on the displacement sensor's digital display, and the ALARM output of parallel I/O turns ON. The displacement sensor is in a stopped state until it is restarted.		
Indicators	EtherCAT NET RUN		EtherCAT NET ERR		EtherCAT LINK/ACT	
	-		-		-	
System-defined variables	Variable		Data type		Name	
	None		-		-	
Cause and correction	Assumed cause		Correction		Prevention	
	Invalid IP address setting		Change to the correct IP address.		Do not set an invalid IP address such as "0.0.0.0".	
Attached information	None					
Precautions/Remarks	None					

Event name	Multiple control signal input error			Event code	7490 0000 Hex	
Meaning	Multiple control signals turned ON in the same cycle.					
Source	EtherCAT master function module		Source details	Slave	Detection timing	When instructed by the user
Error attributes	Level	Minor fault	Recovery	Error reset (after cancellation of slave error)	Log category	System
Effects	User program	Continues	Operation	Control signal ON is disabled, and the instruction is not executed.		
Indicators	EtherCAT NET RUN		EtherCAT NET ERR		EtherCAT LINK/ACT	
	-		-		-	
System-defined variables	Variable		Data type		Name	
	None		-		-	
Cause and correction	Assumed cause		Correction		Prevention	
	Multiple control signals turned ON in the same cycle.		Modify the program so that multiple control signals do not turn ON in a single cycle.		Program so that multiple control signals do not turn ON in a single cycle.	
Attached information	None					
Precautions/Remarks	<p>The following cases are not judged to be errors:</p> <ul style="list-style-type: none"> • ZEROx_T1 to 4 multiple signals turn ON in the same cycle. • ZEROCLR_T1 to 4 multiple signals turn ON in the same cycle. • ERCLR and LIGHTOFFx turn ON in the same cycle as other signals. 					

Event name	EXE input error			Event code	7491 0000 Hex	
Meaning	EXE input processing was not executed correctly.					
Source	EtherCAT master function module		Source details	Slave	Detection timing	When instructed by the user
Error attributes	Level	Minor fault	Recovery	Error reset (after cancellation of slave error)	Log category	System
Effects	User program	Continues	Operation	EXE input processing is not executed.		
Indicators	EtherCAT NET RUN		EtherCAT NET ERR		EtherCAT LINK/ACT	
	-		-		-	
System-defined variables	Variable		Data type		Name	
	None		-		-	
Cause and correction	Assumed cause		Correction		Prevention	
	EXE input turned ON in the FUN mode.		Switch to the RUN mode, and turn EXE input ON.		-	
Attached information	EXE input turned ON with READY output OFF.		Modify the program so that EXE input does not turn ON when the READY signal is OFF.		Program so that EXE input does not turn ON when the READY signal is OFF.	
	None					
Precautions/Remarks	None					

Event name	SYNC input error		Event code	74920000Hex	
Meaning	SYNC input processing was not executed correctly.				
Source	EtherCAT master function module		Slave		When instructed by the user
Error attributes	Level	Minor fault	Recovery	Error reset (after cancellation of slave error)	System
Effects	User program	Continues		SYNC input processing is not executed.	
Indicators	EtherCAT NET RUN		EtherCAT NET ERR		EtherCAT LINK/ACT
	-		-		-
System-defined variables	Variable		Data type		Name
	None		-		-
Cause and correction	Assumed cause		Correction		Prevention
	SYNC input turned ON in the FUN mode.		Switch to the RUN mode, and turn SYNC input ON.		-
Attached information	None				
Precautions/Remarks	None				

Event name	TIMING input error		Event code	74930000Hex		
Meaning	TIMING input processing was not executed correctly.					
Source	EtherCAT master function module		Source details	Slave	Detection timing	When instructed by the user
Error attributes	Level	Minor fault	Recovery	Error reset (after cancellation of slave error)	Log category	System
Effects	User program	Continues	Operation	TIMING input processing is not executed.		
Indicators	EtherCAT NET RUN		EtherCAT NET ERR		EtherCAT LINK/ACT	
	-		-		-	
System-defined variables	Variable		Data type		Name	
	None		-		-	
Cause and correction	Assumed cause		Correction		Prevention	
	TIMINGx input turned ON in the FUN mode.		Switch to the RUN mode, and turn TIMINGx input ON.		-	
	TIMINGx input turned ON or OFF while RESETx input was ON.		Modify the program so that TIMINGx input turns ON or OFF when RESETx input is OFF.		Program so that TIMINGx input turns ON or OFF when RESETx input is OFF.	
	TIMINGx input turned ON in a non-measurement state.		Modify the program so that TIMINGx input turns ON when the sensor is ready for measurement.		Program so that TIMINGx input turns ON when the sensor is ready for measurement.	
	TIMINGx input turned ON before the "delay time + sampling time" elapsed.		Modify the program so that the "delay time + sampling time" is shorter than the TIMING input interval.		Program so that the "delay time + sampling time" is shorter than the TIMING input interval.	
Attached information	None					
Precautions/Remarks	None					

Event name	RESET input error		Event code	74940000Hex		
Meaning	RESET input processing was not executed correctly.					
Source	EtherCAT master function module		Source details	Slave	Detection timing	When instructed by the user
Error attributes	Level	Minor fault	Recovery	Error reset (after cancellation of slave error)	Log category	System
Effects	User program	Continues	Operation	RESET input processing is not executed.		
Indicators	EtherCAT NET RUN		EtherCAT NET ERR		EtherCAT LINK/ACT	
	-		-		-	
System-defined variables	Variable		Data type		Name	
	None		-		-	
Cause and correction	Assumed cause		Correction		Prevention	
	RESETx input turned ON in the FUN mode.		Switch to the RUN mode, and turn RESETx input ON.		-	
Attached information	None					
Precautions/Remarks	None					

Event name	ZERO input error		Event code	74950000Hex		
Meaning	ZERO input processing was not executed correctly.					
Source	EtherCAT master function module		Source details	Slave	Detection timing	When instructed by the user
Error attributes	Level	Minor fault	Recovery	Error reset (after cancellation of slave error)	Log category	System
Effects	User program	Continues	Operation	ZERO input processing is not executed.		
Indicators	EtherCAT NET RUN		EtherCAT NET ERR		EtherCAT LINK/ACT	
	-		-		-	
System-defined variables	Variable		Data type		Name	
	None		-		-	
Cause and correction	Assumed cause		Correction		Prevention	
	ZEROx input turned ON in the FUN mode.		Switch to the RUN mode, and turn ZEROx input ON.		-	
	ZEROx input turned ON in a non-measurement state.		Modify the program so that ZEROx input turns ON when the sensor is ready for measurement.		Program so that ZEROx input turns ON when the sensor is ready for measurement.	
	ZEROx input turned ON for a task whose status is OFF.		Modify the program so that the task that turns ZEROx input ON turns the status ON.		Program so that the task that turns ZEROx input ON turns the status ON.	
Attached information	None					
Precautions/Remarks	None					

Event name	ZEROCLR input error		Event code	74960000Hex		
Meaning	ZEROCLR input processing was not executed correctly.					
Source	EtherCAT master function module		Source details	Slave	Detection timing	When instructed by the user
Error attributes	Level	Minor fault	Recovery	Error reset (after cancellation of slave error)	Log category	System
Effects	User program	Continues	Operation	ZEROCLR input processing is not executed.		
Indicators	EtherCAT NET RUN		EtherCAT NET ERR		EtherCAT LINK/ACT	
	-		-		-	
System-defined variables	Variable		Data type	Name		
	None		-	-		
Cause and correction	Assumed cause		Correction		Prevention	
	ZEROCLR _x input turned ON in the FUN mode.		Switch to the RUN mode, and turn ZEROCLR _x input ON.		-	
Attached information	None					
Precautions/Remarks	None					

Errors for EtherCAT Connection (SDO)

Abort Codes

The following table lists the abort codes for SDO communication error occurs.

Code	Meaning
05030000h	Toggle bit not changed.
05040000h	SDO protocol timeout.
05040001h	Client/Server command specified not valid or unknown.
05040005h	Out of memory.
06010000h	Unsupported access to an object.
06010001h	Attempt to read a write only object.
06010002h	Attempt to write to a read only object.
06020000h	The object does not exist in the object dictionary.
06040041h	The object can not be mapped into the PDO.
06040042h	The number and length of the objects to be mapped would exceed the PDO length.
06040043h	General parameter incompatibility reason.
06040047h	General internal incompatibility in the device.
06060000h	Access failed due to a hardware error.
06070010h	Data type does not match, length of service parameter does not match.
06070012h	Data type does not match, length of service parameter too high.
06070013h	Data type does not match, length of service parameter too low.
06090011h	Subindex does not exist
06090030h	Value range of parameter exceeded (only for write access).
06090031h	Value of parameter written too high.
06090032h	Value of parameter written too low.
06090036h	Maximum value is less than minimum value.
08000000h	General error.
08000020h	Data cannot be transferred or stored to the application.
08000021h	Data cannot be transferred or stored to the application because of local control.
08000022h	Data cannot be transferred or stored to the application because of the present device state.
08000023h	Object dictionary dynamic generation fails or no object dictionary is present.

Errors for Ethernet or EtherNet/IP Connection

The error log for the following errors that occur in Ethernet or EtherNet/IP communications can be checked on the digital displays.

Also, when the same error as "Sysmac error status" occurs during EtherNet/IP communications, the ERR output signal of the corresponding area turns ON. (Note, however, that the error code cannot be checked.)

Error Code	Name	Description	Cause	Remedy
03D0 Hex ALARM	Ethernet communication parameter error	An invalid IP address is set.	Invalid IP address setting	Change to the correct IP address.
03D3 Hex	Ethernet link not detected	The Ethernet link cannot be detected.	Link with switching hub not detected	Inspect the following items: <ul style="list-style-type: none"> • Are cables connected? • Are cables disconnected or loose? • Is there a lot of noise?
03D5 Hex	Tag data link error	Tag data link communications cannot be executed correctly.	Timeout occurred on the tag data link	Inspect the following items: <ul style="list-style-type: none"> • Are connection-registered nodes turned ON? • Are cables connected? • Are cables disconnected or loose? • Is there a lot of noise?

Note When error marked by ALARM occur, the ALARM output of parallel I/O turns ON, and "SYSERR" and error code are displayed on the main and sub-displays, respectively.

If an error code other than the one listed above is displayed, the displacement sensor may be broken. Please contact an OMRON branch or sales office.

Errors Common to All Communication States

These errors occur in common regardless of communication state. When these errors occur, the ALARM output of parallel I/O turns ON, and "SYSERR" and error code "CODE.XX" are displayed on the main and sub-displays, respectively.

Error Code	Name	Description	Cause	Remedy
02	Linearity correction data error	The linearity correction data is corrupted.	Calibration ROM damage	Check to make sure that the Calibration ROM is correctly inserted. If correctly inserted, the Calibration ROM or displacement sensor may be broken. Please contact an OMRON branch or sales office. ^(*)
03	Linearity correction data read error	Reading of the linearity correction data was not executed correctly.	Calibration ROM not inserted	
07	System setting error	The system settings saved to the Sensor Controller are corrupt.	The displacement sensor power was turned OFF during saving/loading of system settings.	After holding down the Mode switching key, press the ZERO/SET key to clear the system settings and the bank data, then resume the starting process.
08	Bank data error	The bank data saved to the Sensor Controller is corrupt.	The displacement sensor power was turned OFF during saving/loading of bank data.	
11	Firmware update error	Failed to update the firmware by WarpEngineZW.	WarpEngineZW was interrupted during an update.	Do not operate WarpEngineZW during an update. If this error occurs, turn the displacement sensor ON again and retry the update.
25	Ethernet communication parameter error	An invalid IP address is set.	Invalid IP address setting	Change to the correct IP address.

If an error code other than the one listed above is displayed, the displacement sensor may be broken. Please contact an OMRON branch or sales office.

- *1: As a provisional measure, the measurement can be resumed using the data of the previously read Calibration ROM.
- <Operation method>
 - With error code 3 displayed on the sub-display, hold down the Mode switching key, then when [OK/CAN] is displayed, press the ZERO/SET key.
 - <Cautions>
 - When using this method, always check the serial number of the previously read Calibration ROM in "controller information," then check that it matches the Sensor Head side serial number. Measurement will not be correct unless they match.
 - When restarting the main unit, perform the same operations again.
- This operation is disabled for a displacement sensor into which no Calibration ROM has ever been inserted and started up.

8-2 Troubleshooting

This section describes how to temporarily remedy hardware-related trouble.
Check the items below before sending the hardware for repair.

Error type	Phenomenon	Cause	Countermeasure	Pages
Startup error	Device restarts during operation.	The power supply device is not connected correctly.	Check if the power supply device conforms to the power supply specifications.	p.4
		The power supply capacity is insufficient.		
Display error	The main display remains on "- - - - -."	The target to measure is not in the measuring range.	Set the target to measure in the measuring range.	p.31 p.360
		TIMING input is not ON.	Turn the TIMING input ON.	p.44
		The trigger level is not appropriately set for self-trigger.	Set the self-trigger level to an appropriate value.	p.101 p.319
	Refer to the "The measured values fluctuate." and "The logical beam does not come out of the Sensor Head." items below.		-	
	The main display becomes "SYSERR."	A system error has occurred.	Identify the cause of the error based on the error code displayed on the sub-display and take an appropriate action.	p.283
Measurement error	Abnormal distances are displayed in areas clearly outside the measuring range.	Such phenomena are characteristic of the sensor.	<ul style="list-style-type: none"> • Check the target to measure and the measuring distance. • Lowering the exposure time setting value may improve the situation. 	p.79 p.304
		The measured values fluctuate.	The average count is not set correctly.	Set the average count correctly.
		The target to measure or the Sensor Head is vibrating.	Implement a vibration-control countermeasure.	-
		The fiber cable end surface or the lens surface of the Sensor Head is dirty.	Clean the surface.	p.7 p.38
		The connection between the Sensor Head and the Sensor Controller or the connection with the extension fiber cable is not normal.	Check the fiber cable connections.	p.38
		The fiber cable is disconnected.	Replace the fiber cable.	-
		The Sensor Head lens is broken.	The Sensor Head needs to be repaired. Please contact an OMRON branch or sales office. For Sensor Head repair, return as a set with the Calibration ROM.	-
		Water and/or oil droplets are attached.	Perform air purging and so forth to remove the droplets.	-

Error type	Phenomenon	Cause	Countermeasure	Pages
Measurement error	The measured values fluctuate.	Intense ambient light is present.	<ul style="list-style-type: none"> Shield the ambient light. Increase the background removal level. 	Smart Monitor ZW Operation Manual
		Mutual interference is occurring.	Check the Sensor Head installation position.	p.33
	The measured values fluctuate gradually.	The operating ambient temperature is fluctuating.	<ul style="list-style-type: none"> Maintain a certain operating ambient temperature. Execute zero reset periodically using the standard object. 	p.65 p.139
		The warm-up time is inadequate.	Wait 30 minutes after switching ON the power before using.	p.6
	The measured values differ from the intended values.	The target to measure is inclined or the position is offset.	Place the target to measure correctly in the measuring range.	p.31
		The scaling has not been done correctly.	Check the scaling setting.	p.87 p.314
		The zero reset value is not correct.	Set the zero reset correctly.	p.105 p.322
		The Sensor Head has not been calibrated correctly.	Recalibrate the Sensor Head.	p.42
	Measured values are output even though there is no target.	The fiber cable end surface or the lens surface of the Sensor Head is dirty.	Clean the surface.	p.38
		The connection between the Sensor Head and the Sensor Controller or the connection with the extension fiber cable is not normal.	Check the fiber cable connections.	p.38
		Intense ambient light is present.	<ul style="list-style-type: none"> Shield the ambient light. Increase the background removal level. 	Smart Monitor ZW Operation Manual
		Mutual interference is occurring.	Check the Sensor Head installation position.	p.33
	Measurement values are output even though the sensor head's fiber cable is not connected to the Sensor Controller.	The Sensor Controller side fiber connector is dirty.	Clean the surface.	p.38
	The logical beam is not emitted from the Sensor Head.	The connection between the Sensor Head and the Sensor Controller or the connection with the extension fiber cable is not normal.	Check the fiber cable connections.	p.38
The fiber cable end surface or the lens surface of the Sensor Head is dirty.		Clean the surface.	p.38	
The fiber cable is disconnected.		Replace the fiber cable.	p.38	
The LED_OFF input line is short-circuited.		Check the wiring.	p.44	
Input error	No input signal received.	Cables are not connected correctly.	Check the input circuit and the wiring for proper connection.	p.44
		The signal line is disconnected.		

Error type	Phenomenon	Cause	Countermeasure	Pages
Output error	The judgment result cannot be output to an external device.	Cables are not connected correctly.	Check the output circuit and the wiring for proper connection.	p.44
		The signal line is disconnected.		–
		The signal logic is not correct.	Check the logic of the signal.	–
		The RESET input line is short-circuited.	Check the input circuit and the wiring for proper connection.	p.44
		The non-measurement setting is set to "CLAMP", and measurement cannot be performed.	Set the non-measurement setting correctly. By selecting the non-measurement setting to "KEEP", the judgment result before measurement is disabled can be output.	p.148
	The analog output is not correct.	Cables are not connected correctly.	Check the output circuit and the wiring for proper connection.	p.46
		The signal line is disconnected.		–
		The voltage and current values are off the meter.	Set the correct monitor focus based on the measured value.	p.142
An oscilloscope or a high-speed A/D board is being used.		Use of these devices may reduce the resolution. Change the monitor focus to minimize the affect.	p.142	
Communication error	RS-232C communication cannot be established.	Cable wirings are wrong. Cables are not connected correctly.	Check the wiring to ensure proper connection.	–
		Communication settings are wrong.	Set the same communication setting for both the Sensor Controller and the external devices.	p.230
	Ethernet communication cannot be established.	The Ethernet cable is not connected correctly.	Use a cross cable when connecting the controller directly with the personal computer.	–
		The IP address and subnet mask are not set correctly.	Set the IP address and subnet mask correctly. * To enable the settings, restart the Controller.	p.227
		The Sensor Controller and an external device are not connected at a 1:1 ratio.	Connect the Sensor Controller and an external device at a 1:1 ratio.	–
		The Ethernet cable is disconnected or about to be disconnected.	Check if the Ethernet cable is disconnected.	–
		The industrial switching hub is faulty (when the switching hub is used).	Check if the industrial switching hub is faulty.	–
		The security setting is not appropriate.	Check if the communication is blocked due to the firewall setting on the external device.	–
	Communication cannot be established by EtherCAT.	The node address setting switch is not set correctly.	Check to make sure that the node address setting switch is set correctly.	p.27
		Devices are not connected correctly to the EtherCAT connector (input/output).	Check to make sure that devices are connected correctly to the EtherCAT connector (input/output).	p.28
Other	Key input is not allowed.	The key lock setting is turned ON.	Turn OFF the key lock setting.	p.115 p.335

Sensor controller operations

9-1 Search from Menu Tree	288
9-2 Functions of Operating Keys	294
9-3 Digital Displays	295
9-4 Switching operation modes	296
9-5 Functions and Operations during Measurement	298
9-6 Setting Sensing	302
9-7 Setting Measurement Items	305
9-8 Setting the Output Conditions	310
9-9 Setting the Banks	326
9-10 Setting Threshold Value	331
9-11 Setting the System	334
9-12 Connecting Parallel I/O	338
9-14 Connecting with EtherNet/IP	350
9-15 Connecting by No-protocol Communications	352

9-1 Search from Menu Tree

FUN Mode Menu

* - default value

		Setting	Option/Setting Range	Pages		
Sensing setting [SENS]	Material [OBJECT]	Material [OBJECT]	Normal [NORMAL]*/ Mirror surface [MIRROR]/ Diffusion surface [DIFF]	p.302		
		Exposure time control mode [EXPOSE]				
		Auto* [AUTO]	Upper limit [UPPER]	1 to 5000 μs (default value: 1000)	p.304	
	Manual [MANUAL]	Fixed exposure time [TIME]	1 to 5000 μs (default value: 1000)	p.304		
	Start direction of count measurement surfaces [SUR, DIR]	Start direction of count measurement surfaces [SUR, DIR]	NEAR [NEAR]*/FAR[FAR]	p.304		
Measurement setting [MEAS]	TASK1 [TASK1]	Measurement item [ITEM]	Height [HEIGHT]	Measurement surface [SUR]	Edge 1st [EDGE1]/Edge 2nd [EDGE2]/Edge 3rd [EDGE3]/Edge 4th [EDGE4]/Light Peak [PEAK]	p.305
			Thick [THICK]	Surface 1 [TOP]	Edge 1st [EDGE1]/Edge 2nd [EDGE2]/Edge 3rd [EDGE3]/Edge 4th [EDGE4]/Light Peak [PEAK]	p.306
				Surface 2 [END]	Edge 1st [EDGE1]/Edge 2nd [EDGE2]/Edge 3rd [EDGE3]/Edge 4th [EDGE4]/Light Peak [PEAK]	
			Calculation [CALC]	Parameter K [PARAM.K]	-999.999999 to 999.999999 mm (default value: 0)	p.307
				Parameter m [PARAM.M]	-10.0 to 10.0 (default value: 0)	
				Parameter n [PARAM.N]	-10.0 to 10.0 (default value: 0)	
				Parameter X [PARAM.X]	None [OFF]*/TASK1 [TASK1]/TASK2 [TASK2]/TASK3 [TASK3]/TASK4 [TASK4]	
				Parameter Y [PARAM.Y]	None [OFF]*/TASK1 [TASK1]/TASK2 [TASK2]/TASK3 [TASK3]/TASK4 [TASK4]	
			None [NONE]	-	-	-
			Filer [FILTER]	Median [MEDIAN]	Off [OFF]*/Low [LOW]/Mid [MID]/High [HIGH]	p.310
				Average [AVE]	1/2/4/8/16/32/64/128/256*/512/1024/2048/4096	p.311
				Differential [DIFFER]	Off [OFF]*/On [ON]	p.313
				Differential cycle [CYCLE]	1 to 5000 ms (default value: 1)	
Frequency [FREQ]	Off [OFF]*/Lowpass [LOPASS]/Highpass [HIPASS]/Bandpass [BDPASS]	p.312				
Cutoff frequency [CUTOFF]	Lowpass/highpass: 0.001 to 999.999Hz (default value: 0.001) Bandpass: 0.001 to 999.999Hz (default value: upper limit 999.999/lower limit 0.001)					

Setting	Option/Setting Range	Pages
Measurement setting [MEAS] (cont'd)		
TASK1 [TASK1] (cont'd)		
Output [OUTPUT]		
Scaling [SCALE]		
Auto [AUTO]	-	p.314
One-point scaling [1PT]	-	
Direction [DIR]	Forward [FWD]*/Reverse [REV]	
Two-point scaling [2PT]	-	
Manual [MANUAL]	-	
Span [SPAN]	-2.0000 to 2.0000 (default value: 1.0000)	
Offset [OFFSET]	-999.999999 to 999.999999 mm (default value: 0)	
Thick [THICK]	-	
Off [OFF]*	-	
Hold [HOLD]		
Type [TYPE]	Off [OFF]/Peak [PEAK]/Bottom [BOTTOM]/Peak to peak [P-P]/Auto peak [A.PEAK]/Auto bottom [A.BOTTM]/Auto peak to peak [A.P-P]/Average [AVE]/Sampling [SAMPLE]	p.318
Trigger [TRIG]	Timing [TIMING]*/Self up trigger [SELF-U]/Self down trigger [SELF-D]	p.319
Trigger level [LEVEL]	-999.999999 to 999.999999 mm (default value: 0)	
Trigger Hysteresis [HYS]	0 to 999.999999 mm (default value: 0.05% of measuring range)	
Delay [DELAY]	Off [OFF]*/On [ON]	p.321
Delay time [DL.Y.TIM]	1 to 5000 ms (default value: 1 ms)	
Sampling time [SMP.TIM]	1 to 5000 ms (default value: 100 ms)	
Zero reset [ZERO]		
Type [TYPE]	Real value [REAL]*/Hold value [HOLD]	p.324
Offset [OFFSET]	-999.999999 to 999.999999 mm (default value: 0)	p.323
Status [STATUS]	Off [OFF]/On [ON]*	p.322
Threshold [JUDGE]		
Teaching [TEACH]		
High threshold [H.JUDGE]	-999.999999 to 999.999999 mm (default value: +25% of measuring range)	p.331
Low threshold [L.JUDGE]	-999.999999 to 999.999999 mm (default value: -25% of measuring range)	
Direct [DIRECT]		
High threshold [H.JUDGE]	-999.999999 to 999.999999 mm (default value: +25% of measuring range)	p.333
Low threshold [L.JUDGE]	-999.999999 to 999.999999 mm (default value: -25% of measuring range)	
TASK2 [TASK2]	(Same content as TASK1)	
TASK3 [TASK3]	(Same content as TASK1)	
TASK4 [TASK4]	(Same content as TASK1)	

		Setting	Option/Setting Range	Pages		
I/O setting [I/O]	Non-measurement setting [HLD.RST]	Non-measurement setting [HLD.RST]	Keep [KEEP]/Clamp [CLAMP]*	p.344		
		Analog output [ANALOG]	Current output: MIN [MIN] (approx. 3.4 mA)/4mA/5mA/.../19mA/ 20mA/MAX [MAX] (approx. 21mA) (default value: MAX) Voltage output: MIN [MIN] (approx. -10.8V)/-10V/-9V/.../9V/10V/ MAX [MAX] (approx. 10.8V) (default value: MAX)	p.345		
	Judgment [JUDGE]	Output target [OUTPUT]	Output target [OUTPUT]	TASK1 [TASK1]/TASK2 [TASK2]/ TASK3 [TASK3]/TASK4 [TASK4]	p.342	
		Hysteresis [HYS]	Hysteresis [HYS]	0 to 99.9999 mm (default value: 0.05% of measuring range)	p.343	
		Timer [TIMER]	TIMER [TIMER]	Off [OFF]/Off delay [OFF.DLY]/ On delay [ON.DLY]/One shot [1SHOT]	p.343	
	Timer time [TIME]	Timer time [TIME]	1 to 5000 ms (default value: 1)			
	Analog output [ANALOG]	Output destination [V OR C]	Output destination [V OR C]	Voltage output*/Current output	p.338	
		Output target [OUTPUT]	Output target [OUTPUT]	Off [OFF]/TASK1 [TASK1]/ TASK2 [TASK2]/TASK3 [TASK3]/ TASK4 [TASK4]	p.339	
		Monitor focus [FOCUS]	Focus [FOCUS]	Focus [FOCUS]	Off [OFF]*/On [ON]	p.339
			Focus current/ voltage 1 [CUR1]/ [VOLT1]	Focus current/ voltage 1 [CUR1]/ [VOLT1]	Current: 4/5/6/7/8/9/10/11/12/13/14/15/ 16/17/18/19/20mA (default value: 4mA) Current: -10/-9/-8/-7/-6/-5/-4/-3/-2/-1/ 0/1/2/3/4/5/6/7/8/9/10V (default value: -10V)	
			Measurement value 1 [MEAS1]	Measurement value 1 [MEAS1]	-999.999999 to 999.999999 mm (default value: -0.5)	
			Focus current/ voltage 2 [CUR2]/ [VOLT2]	Focus current/ voltage 2 [CUR2]/ [VOLT2]	Current: 4/5/6/7/8/9/10/11/12/13/14/15/ 16/17/18/19/20mA (default value: 20mA) Current: -10/-9/-8/-7/-6/-5/-4/-3/-2/-1/ 0/1/2/3/4/5/6/7/8/9/10V (default value: 10V)	
	Measurement data2 [MEAS2]	Measurement data2 [MEAS2]	-999.999999 to 999.999999 mm (default value: 0.5)			
	Calibration [CALIB]	Calibration [CALIB]	Calibration [CALIB]	Off*/On	p.341	
		Calibration current/ voltage 1 [CUR1]/ [VOLT1]	Calibration current/ voltage 1 [CUR1]/ [VOLT1]	Current: 4/5/6/7/8/9/10/11/12/13/14/15/ 16/17/18/19/20mA (default value: 4mA) Current: -10/-9/-8/-7/-6/-5/-4/-3/-2/-1/ 0/1/2/3/4/5/6/7/8/9/10V (default value: -10V)		
Calibration value 1 [ADJ1]		Calibration value 1 [ADJ1]	-999 to 999 (default value: 0)			
Calibration current/ voltage 2 [CUR2]/ [VOLT2]		Calibration current/ voltage 2 [CUR2]/ [VOLT2]	Current: 4/5/6/7/8/9/10/11/12/13/14/15/ 16/17/18/19/20mA (default value: 20mA) Current: -10/-9/-8/-7/-6/-5/-4/-3/-2/-1/ 0/1/2/3/4/5/6/7/8/9/10V (default value: 10V)			
Calibration value 2 [ADJ2]		Calibration value 2 [ADJ2]	-999 to 999 (default value: 0)			

* The same "OUTPUT" is set for all banks. The output destination cannot be set separately for individual banks.

		Setting	Option/Setting Range	Pages
I/O setting [I/O] (cont'd)	Data output setting [COM.OUT]	Data output destination [OUTPUT]*	Off [OFF]*/Ethernet[ETN]/RS232C[RS232C]	-
		Output data format [FORMAT]	ASCII[ASCII]*/Binary[BINARY]	-
		Number of integer digits [INT.NUM]	1 / 2 / 3 / 4 / 5*	-
		Fractional digits [DEC.NUM]	0 / 1 / 2 / 3 / 4 / 5 / 6*	-
		Leading zeros suppressed. [ZEROSP]	Off* /On	-
		Field separator [FIELD]	None [NO]*/Comma [COMMA]/Tab [TAB]/Space [SPACE]/CR[CR]/LF[LF]/CR+LF[CRLF]/Semicolon [SEMICO]	-
		Record separator [RECORD]	None [NO]*/Comma [COMMA]/Tab [TAB]/Space [SPACE]/CR[CR]/LF[LF]/CR+LF[CRLF]/Semicolon [SEMICO]	-
LOGGING [PAR.LOG]	Save intervals [INTRVL]	0 to1000	p.346	
	Save count [COUNT]	0 to12800	p.346	
Bank setting [BANK]	Bank change [BK.CHG]	Bank number [BANK]	Bank1 [BANK1] to Bank8 [BANK8] (default value: Bank1) Up to Bank32 can be selected when the bank mode is "JUDGE".	p.326
	Bank mode [BK.MODE]	Bank mode [BK.MODE]	Normal [NORMAL]/Judgment value [JUDGE]	p.327
	Bank copy [BK.COPY]	Copy source [FROM]	Bank1 [BANK1] to Bank8 [BANK8]	p.328
		Copy destination [TO]	Bank1 [BANK1] to Bank8 [BANK8]	
Bank clear [BK.CLR]	Bank clear [BK.CLR]	Ok [OK]/Cancel [CAN]	p.330	

		Setting	Option/Setting Range	Pages
System setting [SYSTEM]	Save [SAVE]	Save [SAVE]	OK [OK]/Cancel [CAN]	p.329
	(cont'd)	Initialization [INIT]	Initialization [INIT]	OK [OK]/Cancel [CAN]
Communications [COM]	RS-232C [RS232C]	Data length [DATA]	7bit [7BIT]/8bit [8BIT]*	p.353
		Parity [PARITY]	None [OFF]/Odd [ODD]/Even [EVEN]	
Stop bit [STOP]		1bit [1BIT]/2 bit [2BIT]		
Baud rate [BAUD.RT]		9600/19200/38400*/57600/115200		
CS/RS [CS/RS]		Off [OFF]*/On [ON]		
Ethernet [ETN]		IP address 1 [IPADDR [IP1]	1 to 233 (default value: 192)	p.350
		IP address 2 [IP2]	0 to 255 (default value: 168)	
		IP address 3 [IP3]	0 to 255 (default value: 250)	
		IP address 4 [IP4]	1 to 254 (default value: 50)	
		Subnet mask1 [SUBNET [SUB1]	0 to 255 (default value: 255)	
		Subnet mask2 [SUB2]	0 to 255 (default value: 255)	
		Subnet mask3 [SUB3]	0 to 255 (default value: 255)	
		Subnet mask4 [SUB4]	0 to 255 (default value: 0)	
		Subnet mask4 [SUB4]	0 to 255 (default value: 0)	
		Protocol selection [PROTCL]	Off [OFF]/ TCP/Server [TCP.SV]*/TCP/Client [TCP.CL]/UDP [UDP]	
		Output IP address 1 [OUTIP [IP1]	1 to 233 (default value: 192)	
		Output IP address 2 [IP2]	0 to 255 (default value: 168)	
		Output IP address 3 [IP3]	0 to 255 (default value: 250)	
		Output IP address 1 [IP4]	1 to 254 (default value: 100)	
		Port numbers [PORT.IN]	0 to 65535 (default value: 9601)	
		Output destination port No. [PORT.OT]	0 to 65535 (default value: 9601)	













Setting	Option/Setting Range	Pages
System setting [SYSTEM] (cont'd)		
Communications [COM] (cont'd)		
Delimiter [DELIMI]	Delimiter [DELIMI] CR [CR] ^/LF [LF]/CR+LF [CRLF]	p.355
Fieldbus [MEMLINK]	Fieldbus [MEM.LINK] Off [OFF]/ EtherNet/IP [EIP]/ EtherCAT [E-CAT]*	-
GATE signal ON time [GATE.TM]	GATE signal ON [GATE.TM] 0 to 100 (default value: 1)	-
Sensor head Calibration [H.CALIB]	Sensor head calibration [H.CALIB] OK [OK]/Cancel [CAN]	p.336
Key lock [LOCK]	Key lock [LOCK] Off [OFF]^/On [ON]	p.335
Zero reset MEMORY [ZER.MEM]	Zero reset memory [ZER.MEM] Off [OFF]^/On [ON]	p.325
TIMING/ RESET key input [KEY.IN]	TIMING/ RESET key input [KEY.IN] OFF [OFF]^/ON [ON]	p.320
Measuring cycle [CYCLE]	Measuring cycle [CYCLE] Displays the current measuring cycle. 500 to 10000 μs (default value: 2000)	p.334
Controller information [C.INFO]	Software version [VER] Displays the version.	p.334
	MAC Address [MAC.ADR] Displays the current MAC address.	
	Error history [ERR.LOG] Clears/displays the error history.	-
	Error history display [LOG.DSP] No.01 to No.64 (default value: No.01)	-
	Error clear [LOG.CLR] OK [OK]/Cancel [CAN]	-
Sensor head information [H.INFO]	Model [MODEL] Displays the model.	p.334
	Serial No. [SER.NO] Displays the serial No..	

RUN (run) Mode Menu

Setting [DISPLAY]	Option/Setting Range [DISPLAY]	Pages
Task for displayed target [DISP]	TASK1/TASK2/TASK3/TASK4	p.300
HIGH threshold value [H.JUDGE]	Sensor Controller: -999.99 to 999.999 Smart Monitor ZW: -999.999999 to 999.999999	p.301
LOW threshold value [L.JUDGE]	Sensor Controller: -999.99 to 999.999 Smart Monitor ZW: -999.999999 to 999.999999	p.301
Decimal point digit [DEC.NUM]	0[0DIG]/1 [1DIG]/2 [2DIG]/3 [3DIG]/4 [4DIG]/5 [5DIG]	p.300







9-2 Functions of Operating Keys

The following table lists the names and functions of the operating keys on the Sensor Controller:

Name	Function		
	RUN Mode	FUN Mode	
← (LEFT) key → (RIGHT) key	 	Changes sub-display content.	Functions differently depending on the settings. <ul style="list-style-type: none"> • Function display switching • Numerical value digit selection • Setting cancellation
↑ (UP) key ↓ (DOWN) key	 	 key: Executes TIMING input.  key: Executes RESET input. * These keys are available only if key inputs for the hold functions have been enabled in the FUN mode.  Performing Hold with a Key Input p.103	Functions differently depending on the settings. <ul style="list-style-type: none"> • Selection menu switching • Setting value selection
Mode switching key	 	Hold down for at least two seconds to enter the FUN mode.	Hold down for at least two seconds to enter the RUN mode. <ul style="list-style-type: none"> • For operating mode switching, "SWITCH" is displayed on the main display and "OK/CAN" is displayed on the sub-display. Press the ZERO/SET key to switch the mode.  <ul style="list-style-type: none"> • When the mode is switched from FUN mode to RUN mode, "SAVE" is displayed on the main display and "OK/CAN" is displayed on the sub-display. Press the ZERO/SET key to save the settings and switch the operating mode.  <p>Press the ZERORST/ESC key to switch the operating mode without saving the settings. If you press for less than 2 seconds, the display shifts to RUN mode task switching and the threshold value setting menu. Also, this starts teaching to set threshold values when setting a threshold value.</p>
ZERO/SET key		Executes a zero reset.	Functions differently depending on the selections. <ul style="list-style-type: none"> • Application of selection conditions and numerical values • Switching to lower menus
ZERORST/ESC key		Hold down for at least two seconds to cancel a zero reset.	Functions differently depending on the selections. <ul style="list-style-type: none"> • Cancellation of selection conditions and numerical values • Switching to upper menus Hold down for at least two seconds to jump to the top menu on the FUN mode.

9-3 Digital Displays

The theme displayed on the main or sub-display varies depending on the currently selected operating mode. The following table lists the theme displayed, when turning the Sensor Controller ON, or in the RUN or FUN mode.

Operation mode	Main display (upper line, in red)	Sub-display (lower line, in green)
When turning ON	The Sensor Controller model name, "ZW-C□□" appears.	During the initialization, "INIT" is displayed.
The system enters the RUN mode after displaying "INIT" for a few seconds.		
RUN mode	The task measurement result appears. The task to display can be toggled.  Changing Display Details p.300	Press the  /  key to cycle through the sequence of the HIGH and LOW threshold values, analog output (voltage/current), judgment result, resolution (the max. and min. values for 1-min measured value), exposure time, distance (Sensor Head to the object to measure), effective bank, and displayed task in descending or ascending order.
Press and hold the  key for two seconds or more to switch between the RUN and FUN modes.		
FUN mode	Press the  /  keys to cycle through the function names in descending or ascending order.	When reaching the lowest layer, the setting value displayed on the main display appears.

Alphabetical notation

Alphabet characters are displayed on the main and sub-display as follows:

A	B	C	D	E	F	G	H	I	J	K	L	M
<i>A</i>	<i>b</i>	<i>C</i>	<i>d</i>	<i>E</i>	<i>F</i>	<i>G</i>	<i>H</i>	<i>I</i>	<i>J</i>	<i>K</i>	<i>L</i>	<i>M</i>
N	O	P	Q	R	S	T	U	V	W	X	Y	Z
<i>N</i>	<i>O</i>	<i>P</i>	<i>Q</i>	<i>R</i>	<i>S</i>	<i>T</i>	<i>U</i>	<i>V</i>	<i>W</i>	<i>X</i>	<i>Y</i>	<i>Z</i>

9-4 Switching operation modes

 3-3 Switching operation modes p.61

Use  key to switch between the operation modes.
The RUN indicator identifies the current operation mode.

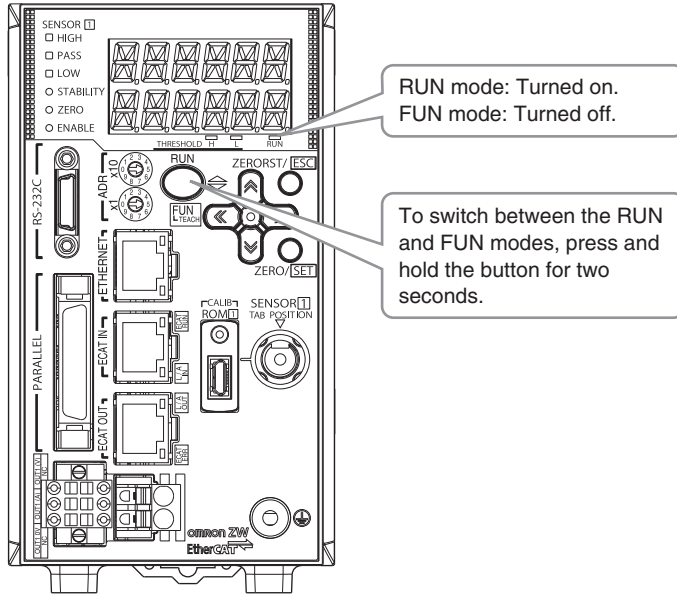

Entering Numerical Values

To enter numerical values, including parameters, for the sub-display, follow the steps below:

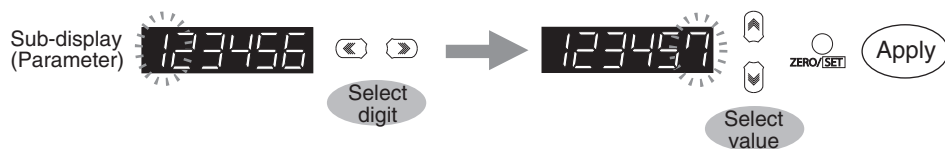

- (1) When entering numerical values, the sub-display displays the current setting value and its uppermost digit flashes.
- (2) Press the / keys to select a digit to enter a number.
Press the key on the rightmost digit to move blinking to the leftmost digit.
Press the key on the leftmost digit to move blinking to the rightmost digit.
- (3) Press the / keys to select a digit to enter a number.
- (4) Press the key to apply the entered value.

Positioning decimal point

To position a decimal point, follow the steps below:

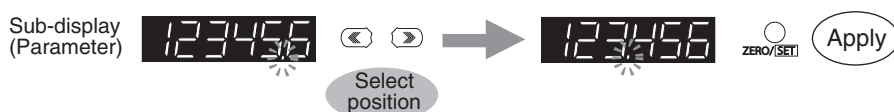

- (1) If a decimal point has been defined, it flashes on the sub-display.
- (2) Press the / keys to position the decimal point.
Position the decimal point at the rightmost digit to erase it.
Press the key on the rightmost digit to move blinking to the leftmost digit.
Press the key on the leftmost digit to move blinking to the rightmost digit.
- (3) Press the key to apply the position of the decimal point.

9-5 Functions and Operations during Measurement

Switching the RUN (Run) Mode Display

In the RUN mode, you can switch the measured value display by pressing the \leftarrow / \rightarrow keys during the operation. You can check the threshold value and analog output value while displaying the measured value on the main display.

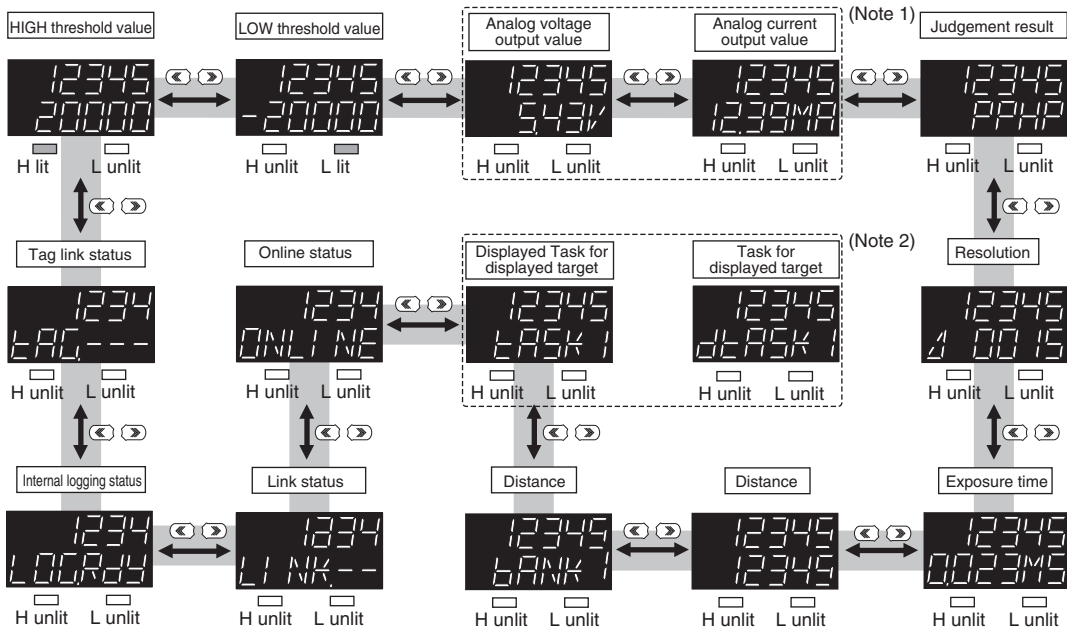

The above display screenshots are only samples and may differ from actual displays.

(Note 1) An output item not selected on the analog output (Voltage output/Current output) is displayed as "-----" on the sub-display. For example, if "Voltage output" is selected on the analog output, the analog current output value is displayed as "-----" on the sub-display.

(Note 2) "Displayed task" can be selected from TASK1 to TASK4. "Task for displayed target" is displayed as "dTASK□." □ indicates the task number. (Refer to p.300 for the task for displayed target.)) If the task for displayed target is TASK2, for example, "TASK1," "dTASK2," "TASK3" and "TASK4" will be displayed.

Details Displayed on the Main Display

The measured values always appear on the main display.

The measured values are initialized as follows:

- Reference value "0": Measurement center distance
- + display: NEAR (close range) side
- - display: FAR (far range) side

However, in the following cases, the measurement values are not displayed.

- When the amount of light received is inadequate, "DARK" is displayed; when the sensor is saturated, "BRIGHT" is displayed.
- When there is no surface present to measure, "NO.SRFC" is displayed.
- When the measurement LED is OFF, "LEDOFF" is displayed.
- When the measurement surface is far outside the measurement range or if no hold value is finalized when hold is set, then "-----" is displayed.

Details Displayed on the Sub-display

The items listed in the following table appears on the sub-display.

Press the ◀ / ▶ keys to toggle the display.

Display Details	Description
Threshold	Displays the HIGH and LOW threshold values for tasks for displayed target. THRESHOLD-H indicator lights for the HIGH threshold value. THRESHOLD-L indicator lights for the LOW threshold value.
Analog output	Displays the voltage or current value output in analog format. The display details for the output destination setting are different for voltage output and for current output. (Values displayed here are reference values only. These values differ from actual analog output values.)
Judgment result	The judgment result for each task appears. The TASK1, 2, 3 and 4 judgment results are displayed starting from the left. H: HIGH P: PASS L: LOW E: ERROR
Resolution	Displays the fluctuation width (peak to peak) of the measured value over a fixed amount of time.
Exposure time	Displays the current exposure time. The time is displayed in the range 1 to 5000 μs.
Distance	Displays the distance from the Sensor Head to a target to measure.
Effective bank	Displays the current bank number.
Displayed task	Displays the currently selected task number from TASK1 to TASK4. The measured value for the selected task appears on the main display.
Ethernet communication status	Whether Ethernet communications are possible is displayed. ONLINE: Communication possible OFFLINE: Communication not possible
Ethernet link status	Whether the Ethernet connection is enabled is displayed. LINK.OK: Connection established LINK.--: Connection not established
Tag link status	The status of EtherNet/IP tag link communication is displayed. TAG.INI: Initializing TAG.OK: Tag connection established TAG.--: Tag connection not established TAG.ER1: Tag link abnormality TAG.ER2: Other abnormality
Internal logging status	Displays the status of operation internal logging. LOG.RDY : Internal logging stopped state (When ZW start, When internal logging data is cleared, When internal logging stopped) LOG.RUN : Internal logging in progress LOG.END : Internal logging ended state(When internal logging is automatically ended)













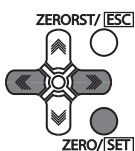

Changing Display Details

The measurement result displayed on the main display in RUN mode can be selected from TASK1 to 4. The number of digits displayed can also be changed.

Setting [DISPLAY]	Option [DISPLAY]
Task for displayed target [DISP]	TASK1/TASK2/TASK3/TASK4
Decimal point digit [DEC.NUM]	0 [0DIG]/1 [1DIG]/2 [2DIG]/3 [3DIG]/4 [4DIG]/5 [5DIG]

As an example, here is an explanation of the procedure for setting TASK2 as the task to be displayed target.

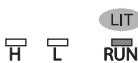
Operating procedure

Steps	Key operation	Display	Description
1			Press the  key in the RUN mode to display the setting menu.
2			Press the  /  keys to select "DISP" and press the  key.
3			Select the task to be the displayed target. The current setting value is displayed on the sub-display. Press  /  key to enter editing mode and the sub-display blinks. Select "TASK2" and press the  key.
4			Press the  key to leave the setting menu.

Changing Threshold Values

The threshold value for the task displayed on the main display in the RUN mode can be changed.



















Important

To change the target task, change the task displayed on the main display.

 Changing Display Details p.300

As an example, here is an explanation of the procedure for setting the HIGH threshold value by entering "1.000" directly.

Operating procedure

Steps	Key operation	Display	Description
1			Press the  key in the RUN mode to display the setting menu.
2			Press the  /  key to select H.JUDGE, then press the  key.
3			Set "1.000" as the HIGH threshold value. The current measured value is displayed on the main display and the current set threshold value is displayed on the sub-display. (At this time, the THRESHOLD-H indicator lights up.) Press  key to enter the editing mode, and the sub-display blinks. To edit numerical values, use the  /  /  /  keys. Input "1.000", then press the  key.
4			Press the  key to leave the setting menu.



















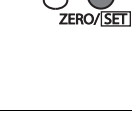

9-6 Setting Sensing

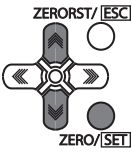
Setting the Material of the Target to Measure

 Setting the Material of the Target to Measure p.75

As an example, here is an explanation of the procedure for the "MIRROR" setting as the material.

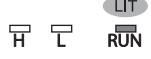
Operating procedure













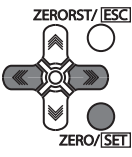

Steps	Key operation	Display	Description
1			Press and hold the  key for two seconds to enter the FUN mode.
2			Press the  /  keys to select "SENS" and press the  key.
3			Press the  /  keys to select "OBJECT" and press the  key.
4			Select the material. NORMAL: Normal MIRROR: Mirror DIFF: Diffusion surface The current setting value is displayed on the sub-display. Press  /  key to enter editing mode and the sub-display blinks. In this example, select "MIRROR" and press the  key.
5			Press the  key for two seconds to enter the RUN mode.

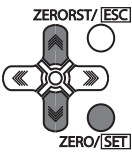
Setting Start Direction of Count Measurement Surfaces

 Setting Start Direction of Count Measurement Surfaces p.78

As an example, here is an explanation of the procedure for setting start direction of count measurement surface to "NEAR".

Operating procedure





























Steps	Key operation	Display	Description
1			Press and hold the  key for two seconds to enter the FUN mode.
2			Press the  /  keys to select "SUR.DUR" and press the  key.
3			Select the material. NEAR: NEAR direction FAR: FAR direction The current setting value is displayed on the sub-display. Press  /  key to enter editing mode and the sub-display blinks. In this example, select "NEAR" and press the  key.
4			Press the  key for two seconds to enter the RUN mode.

Setting Exposure Time Control Mode

 Setting Exposure Time Control Mode p.79

As an example, here is an explanation of the procedure for setting the exposure time control mode to "AUTO" and the exposure time (maximum) to "500 μ s".

Operating procedure

Steps	Key operation	Display	Description
1			Press and hold the  key for two seconds to enter the FUN mode.
2			Press the  /  keys to select "SENS" and press the  key.
3			Press the  /  keys to select "EXPOSE" and press the  key.
4			Select the exposure time control mode. AUTO: Automatic MANUAL: Fixed The current setting value is displayed on the sub-display. Press  /  key to enter editing mode and the sub-display blinks. In this example, select "AUTO" and press the  key.
5			Set the exposure time (maximum) or exposure time (fixed). In this example, "UPPER" is displayed on the main display, and the current setting value is displayed on the sub-display. Press  key to enter the editing mode, and the sub-display blinks. To edit numerical values, use the  /  /  /  keys. In this example, select "500" and press the  key.
6			Press the  key for two seconds to enter the RUN mode.



















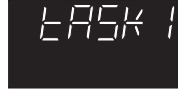



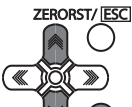

9-7 Setting Measurement Items

Measuring the Height

 Measuring the Height p.83

As an example, here is an explanation of the procedure for measuring the height of the surface (2nd surface) below a transparent object (as shown in the diagram on p.83).

Operating procedure



























Steps	Key operation	Display	Description
1			Press and hold the  key for two seconds to enter the FUN mode.
2			Press the  key to select MEAS, then press the  key.
3			Press the  key to select TASK1, then press the  key.
4			Press the  key to select "ITEM" and press the  key.
5			Press the  key to select "HEIGHT" and press the  key.
6			Select the measurement surface. EDGE1 to EDGE4: 1st surface to 4th surface PEAK: Peak "SUR" is displayed on the main display and the current setting value is displayed on the sub-display. Press  key to enter editing mode and the sub-display blinks. In this example, select "EDGE2" and press the  key.
7			Press the  key for two seconds to enter the RUN mode.

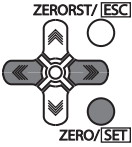



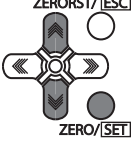







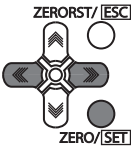

Measuring the Thickness

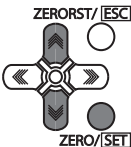
 Measuring the Thickness p.85

As an example, here is an explanation of the procedure for measuring the thickness from the top surface of glass on which specular reflection occurs as the 1st surface to the 2nd surface (as shown in the diagram on p.85).

Operating procedure

Steps	Key operation	Display	Description
1			Press and hold the  key for two seconds to enter the FUN mode.
2	Set the material of the target to "MIRROR." Optional  Setting the Material of the Target to Measure p.302 If the target object is a transparent object, such as glass, on which specular reflection occurs, set the material of the measurement object to "MIRROR" to obtain more accurate measurement result.		
3	Set the surface to "SUR.1ST."		
3-1			Press the  key to select MEAS, then press the  key.
3-2			Press the  key to select TASK1, then press the  key.
3-3			Press the  keys to select "ITEM" and press the  key.
3-4			Press the  keys to select "THICK" and press the  key.
3-5			Select "SUR1." Press the  keys to select "TOP" and press the  key.
3-6			Select the measurement surface. EDGE1 to EDGE4: 1st surface to 4th surface PEAK: Peak The current setting value is displayed on the sub-display. Press  key to enter editing mode and the sub-display blinks. In this example, select "EDGE1" and press the  key.
4	Set the surface2 to "SUR.2ND."		

Steps	Key operation	Display	Description
4-1			Press the  key to return to the previous menu.
4-2			Select "SUR2." Press the  /  keys to select "END" and press the  key.
4-3			Select the measurement surface. The current setting value is displayed on the sub-display. Press  /  key to enter editing mode and the sub-display blinks. In this example, select "EDGE2" and press the  key.
5	Scaling setting  Setting Scaling p.87		
6			Press the  key for two seconds to enter the RUN mode.

Calculating

Performing Calculations p.86









As an example, here is an explanation of the output of the calculation result below.











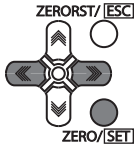













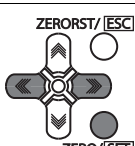



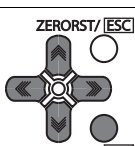







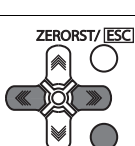







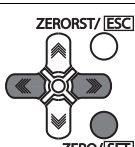

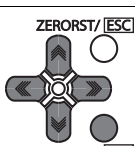

(Example)











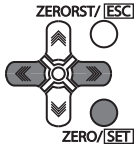



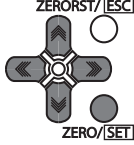









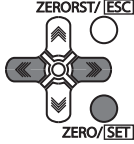



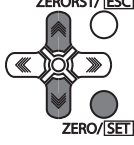







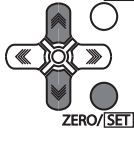

When calculating the amount of convexity and concavity on the object surface from the difference between the average value and the peaks and outputting this to TASK3

- TASK1: Surface peak hold
- TASK2: Surface average hold
- TASK3: TASK1 - TASK2 setting
- PARAMETER K: 0
- PARAMETER m: 1
- PARAMETER n: -1
- PARAMETERX: TASK1
- PARAMETERY: TASK2

Operating procedure

Steps	Key operation	Display	Description
1			Press and hold the  key for two seconds to enter the FUN mode.
2			Press the  /  key to select MEAS, then press the  key.

Steps	Key operation	Display	Description
3	 Setting Hold p.98		Sets the surface peak hold for TASK1 and the surface average hold for TASK2.
4			Press the  /  keys to select "TASK3" and press the  key.
5			Press the  /  keys to select "ITEM" and press the  key.
6			Press the  /  keys to select "CALC" and press the  key.
7			Select "PARAM.K" for the parameter type. Press the  /  keys to select "PARAM.K" and press the  key.
8			Set the parameter to "0". The current setting value is displayed on the sub-display. Press  key to enter the editing mode, and the sub-display blinks. To edit numerical values, use the  /  /  /  keys. Input "0", then press the  key.
9			The decimal point is displayed. Press the  /  key to move the decimal point. Determine the decimal point and then press the  key.
10			Press the  key to return to the previous menu.
11			Select "PARAM.M" for the parameter type. Press the  /  keys to select "PARAM.M" and press the  key.
12			Set the parameter to "1". The current setting value is displayed on the sub-display. Press  key to enter the editing mode, and the sub-display blinks. To edit numerical values, use the  /  /  /  keys. Input "1", then press the  key.
13			Press the  key to return to the previous menu.

Steps	Key operation	Display	Description
14			Select "PARAMn" for the parameter type. Press the  /  keys to select "PARAM.N" and press the  key.
15			Set the parameter to "-1". The current setting value is displayed on the sub-display. Press  key to enter the editing mode, and the sub-display blinks. To edit numerical values, use the  /  /  /  keys. Input "-1", then press the  key.
16			Press the  key to return to the previous menu.
17			Select "PARAM.X" for the parameter type. Press the  /  keys to select "PARAM.X" and press the  key.
18			Set the parameter to "TASK1". The current setting value is displayed on the sub-display. Press  /  key to enter editing mode and the sub-display blinks. Select "TASK1" and press the  key.
19			Press the  key to return to the previous menu.
20			Select "PARAMY" for the parameter type. Press the  /  keys to select "PARAM.Y" and press the  key.
21			Set the parameter to "TASK2". The current setting value is displayed on the sub-display. Press  /  key to enter editing mode and the sub-display blinks. Select "TASK2" and press the  key.
22			Press the  key for two seconds to enter the RUN mode.

9-8 Setting the Output Conditions

Setting the Filter











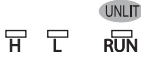

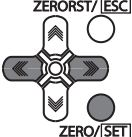



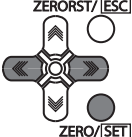



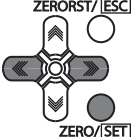



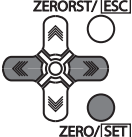

 Setting Filters p.93

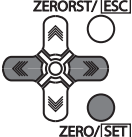
Setting the Median Filter

 Setting the Median Filter p.94

As an example, here is an explanation of the procedure for selecting the "MID" median filter setting.

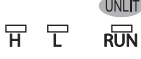
Operating procedure











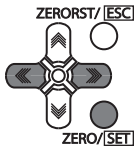

Steps	Key operation	Display	Description
1			Press and hold the  key for two seconds to enter the FUN mode.
2			Press the  /  key to select MEAS, then press the  key.
3			Press the  /  keys to select "TASK1" and press the  key.
4			Press the  /  keys to select "FILTER" and press the  key.
5			Select "MEDIAN" as the filter type. Press the  /  keys to select "MEDIAN" and press the  key.
6			Select the filter mode from the following: OFF / LOW / MID / HIGH The current setting value is displayed on the sub-display. Press  /  key to enter editing mode and the sub-display blinks. In this example, select "MID" and press the  key.
7			Press the  key for two seconds to enter the RUN mode.

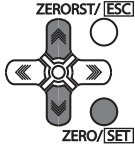
Setting the Average Filter

 Setting the Average Filter p.95

As an example, here is an explanation of the procedure for selecting the "128" average count setting.

Operating procedure











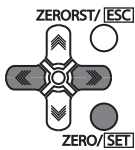



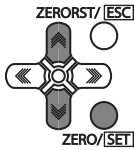

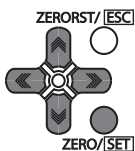

Steps	Key operation	Display	Description
1 to 4			For moving to "FILTER", see steps 1 to 4 on p.310.
5			Select "AVE" as the filter type. Press the  /  keys to select "AVE" and press the  key.
6			Select the average count. The current setting value is displayed on the sub-display. Press  /  key to enter editing mode and the sub-display blinks. In this example, select "128" and press the  key.
7			Press the  key for two seconds to enter the RUN mode.

Setting the Frequency Filter

 Setting the Frequency Filter p.96

As an example, here is an explanation of the procedure for selecting the "LOPASS" setting for the frequency filter type, and the "1Hz" cut-off frequency filter setting.

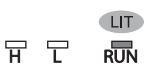
Operating procedure











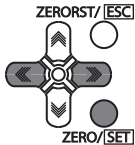



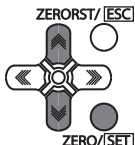





Steps	Key operation	Display	Description
1 to 4			For moving to "FILTER", see steps 1 to 4 in p.310.
5			Select "FRQNCY" as the filter type. Press the  /  keys to select "FREQ" and press the  key.
6			Select the frequency filter type. LO.PASS: LOWPASS FILTER HIPASS: HIGHPASS FILTER BD.PASS: BANDPASS FILTER Select "LOPASS" as the frequency filter type. The current setting value is displayed on the sub-display. Press  /  key to enter editing mode and the sub-display blinks. In this example, select "LO.PASS" and press the  key.
7			Set the cut-off frequency. "CUTOFF" is displayed on the main display and the current setting value is displayed on the sub-display. Press  key to enter the editing mode, and the sub-display blinks. To edit numerical values, use the  /  /  /  keys. In this example, input "1", then press the  key.
8			Press the  key for two seconds to enter the RUN mode.

Setting the Differentiation Filter

 Setting the Differentiation Filter p.97

As an example, here is an explanation of the procedure for selecting the "10ms" number of differential cycles.

Operating procedure

Steps	Key operation	Display	Description
1 to 4			For moving to "FILTER", see steps 1 to 4 in p.310.
5			Select "DIFFER" as the filter type. Press the  /  keys to select "DIFFER" and press the  key.
6			Enable the differentiation filter. The current setting value is displayed on the sub-display. Press  /  key to enter editing mode and the sub-display blinks. Select "ON", then press the  key.
7			Set the number of differential cycles. "CYCLE" is displayed on the main display and the current setting value is displayed on the sub-display. Press  key to enter the editing mode, and the sub-display blinks. To edit numerical values, use the  /  /  /  keys. In this example, input "10", then press the  key.
8			Press the  key for two seconds to enter the RUN mode.













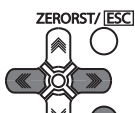

















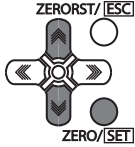



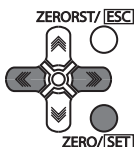





Setting Scaling

Performing Manual Scaling

 Performing Manual Scaling p.87

As an example, here is an explanation of the procedure for setting the manual scaling type to "SPAN" and the inclination coefficient to "1.2".

Operating procedure











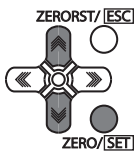



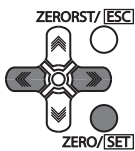







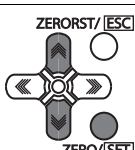
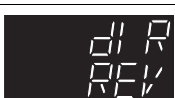

Steps	Key operation	Display	Description
1			Press the  key for two seconds to enter the FUN mode.
2			Press the  /  keys to select "MEAS" and press the  key.
3			Press the  /  keys to select "TASK 1" and press the  key.
4			Press the  /  keys to select "OUTPUT" and press the  key.
5			Press the  /  keys to select "SCALE" and press the  key.
6			Select "MANUAL" as the scaling type. The current setting value is displayed on the sub-display. Press the  /  keys to enter the editing mode, and the sub-display blinks. Select "MANUAL" and press the  key.
7			Set the manual scaling type. SPAN: Span OFFSET: Offset In this example, press the  /  keys, select "SPAN" and press the  key.
8			Set the inclination coefficient. The current setting value is displayed on the sub-display. Press the  key to enter the editing mode, and the sub-display blinks. To edit numerical values, use the  /  /  /  keys. In this example, select "1.2" and press the  key.
9			Press the  key for two seconds to enter the RUN mode.

Automatically Setting Scaling

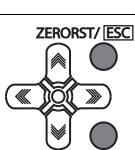
Performing 1-point Scaling

 Performing 1-point Scaling p.88











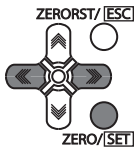







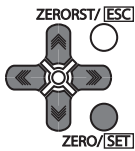









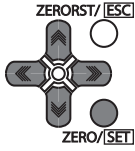

Operating procedure

Steps	Key operation	Display	Description
1 to 5			For moving to "SCALE", see steps 1 to 5 in p.314.
6			Select "AUTO" as the scaling type. The current setting value is displayed on the sub-display. Press  key to enter editing mode and the sub-display blinks. Select "AUTO" and press the  key.
7			Select "1POINT". Press the  keys to select "1PT" and press the  key.
8			Press the  key when the main display shows "POINT1".
9			The current measured value is displayed on the main display and the current setting value is displayed on the sub-display. To edit numerical values, use the  /  keys. Enter the setting value and then press the  key.
10			Set the increment/decrement direction. "DIRECT" is displayed on the main display and the incremental/ decremental directions ("FWD": the NEAR side as + and "REV": the FAR side as +) are displayed on the sub-display. Press  key to enter editing mode and the sub-display blinks. Enter the setting value and then press the  key.
11			"OK/CAN" is displayed on the sub-display. Press the  key to execute scaling or  key to cancel.
12			Press the  key for two seconds to enter the RUN mode.

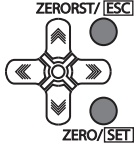
Performing 2-point Scaling

 Performing 2-point Scaling p.90











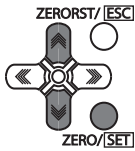



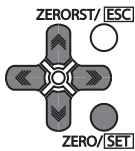



Operating procedure

Steps	Key operation	Display	Description
1 to 6			For moving to "SCALE" - "AUTO", see steps 1 to 6 in p.314.
7			Press the  /  keys to select "2PT" and press the  key.
8			Press the  key when the main display shows "POINT1".
9			Set the measured value of point 1. The current measured value is displayed on the main display and the current setting value is displayed on the sub-display. To edit numerical values, use the  /  /  /  keys. Enter the setting value and then press the  key.
10			Press the  key when the main display shows "POINT2".
11			Set the measured value of point 2. To edit numerical values, use the  /  /  /  keys. Enter the setting value and then press the  key.
12			"OK/CAN" is displayed on the sub-display. Press the  key to execute scaling or  key to cancel.
13			Press the  key for two seconds to enter the RUN mode.

Performing Thickness Scaling

 Performing Thickness Scaling p.92

Operating procedure

Steps	Key operation	Display	Description
1 to 5			For moving to "SCALE", see steps 1 to 5 in p.314.
6			<p>Select "THICK" as the scaling type. The current setting value is displayed on the sub-display.</p> <p>Press / key to enter editing mode and the sub-display blinks. Select "THICK" and press the  key.</p>
7			<p>The current measured value is displayed on the main display and the current setting value is displayed on the sub-display.</p> <p>Press  key to enter the editing mode, and the sub-display blinks.</p> <p>To edit numerical values, use the /// keys. Enter the setting value and then press the  key.</p>
8			<p>"OK/CAN" is displayed on the sub-display.</p> <p>Press the  key to execute scaling or  key to cancel.</p>
9			<p>Press the  key for two seconds to enter the RUN mode.</p>













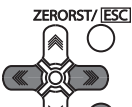











Setting Hold

Setting the Hold Mode

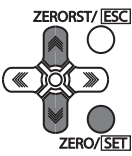
 Setting the Hold Mode p.98

As an example, here is an explanation of the procedure for selecting the "PEAK" hold mode setting.

Operating procedure











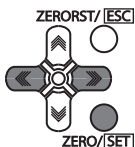

Steps	Key operation	Display	Description
1			Press and hold the  key for two seconds to enter the FUN mode.
2			Press the  key to select MEAS, then press the  key.
3			Press the  key to select TASK1, then press the  key.
4			Press the  keys to select "OUTPUT" and press the  key.
5			Press the  keys to select "HOLD" and press the  key.
6			Press the  keys to select "TYPE" and press the  key.
7			Set the hold mode. PEAK: Peak BOTTOM: Bottom P-P: PEAK TO PEAK AUTOPE: AUTO PEAK AUTOBT: AUTO BOTTOM AUTOPEP: AUTO PEAK TO PEAK AVE: AVERAGE SAMPLE: Sampling OFF: Through The current setting value is displayed on the sub-display. Press  key to enter editing mode and the sub-display blinks. In this example, select "PEAK" and press the  key.
8			Press the  key for two seconds to enter the RUN mode.

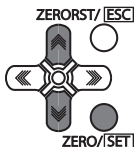
Setting Triggers

 Setting Triggers p.101



As an example, here is an explanation of the procedure for selecting the "TIMING" trigger type setting.

Operating procedure











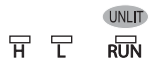

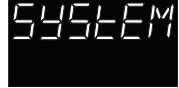



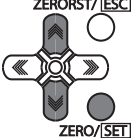

Steps	Key operation	Display	Description
1 to 5			For moving to "HOLD", see steps 1 to 5 in p.318.
6			Press the  /  keys to select "TRIG" and press the  key.
7			Set the trigger method. TIMING: External SELF-U: SELF-UP SELF-D: SELF-DOWN "TYPE" is displayed on the main display and the current setting value is displayed on the sub-display. Press  /  key to enter editing mode and the sub-display blinks. In this example, select "TIMING" and press the  key.
8			Press the  key for two seconds to enter the RUN mode.

Performing Hold with a Key Input

Press the / key on the Sensor Controller to enable the TIMING or RESET input.

- TIMING input is ON while the  key is pressed.
- RESET input is ON when the  key is pressed.

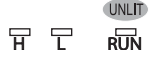
Note that the key input is disabled in the default setting. Set the following when using this function.

Steps	Key operation	Display	Description
1			Press and hold the  key for two seconds to enter the FUN mode.
2			Press the  /  keys to select "SYSTEM" and press the  key.
3			Press the  /  keys to select "KEY.IN" and press the  key.
4			Enable the key input. The current setting value is displayed on the sub-display. Press  /  key to enter editing mode and the sub-display blinks. Select "ON" and press the  key.
5			Press the  key for two seconds to enter the RUN mode.

Note















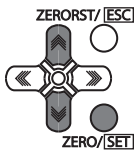





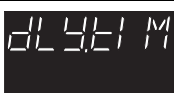













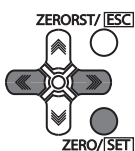









The above settings are also possible using the personal computer tools.

 Performing Hold with a Key Input p.103

Setting a Trigger Delay

 Setting a Trigger Delay p.104

Operating procedure

Steps	Key operation	Display	Description
1 to 5			For moving to "HOLD", see steps 1 to 5 in p.318.
6			Press the  /  keys to select "DELAY" and press the  key.
7			Enable the delay. "DELAY" is displayed on the main display and the current setting value is displayed on the sub-display. Press  /  key to enter editing mode and the sub-display blinks. Select "ON" and press the  key.
8			Select the delay time. Press the  /  keys to select "DLY.TIM" and press the  key.
9			Set the delay time. The current setting value is displayed on the sub-display. Press  key to enter the editing mode, and the sub-display blinks. To edit numerical values, use the  /  /  /  keys. In this example, input "10", then press the  key.
10			Press the key to return to the previous menu.
11			Select the sampling time. Press the  /  keys to select "SMP.TIM" and press the  key.
12			Set the sampling time. The current setting value is displayed on the sub-display. Press  key to enter the editing mode, and the sub-display blinks. To edit numerical values, use the  /  /  /  keys. In this example, input "10", then press the  key.
13	 	   	Press the  key for two seconds to enter the RUN mode.



















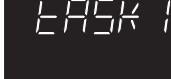













Setting the Zero Reset

Setting the Status

 Setting the Status p.105

As an example, here is an explanation of the procedure for selecting the "ON" (Enabled) zero reset type setting.

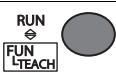
Operating procedure















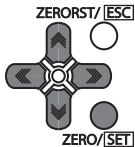
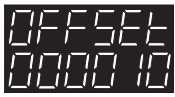



Steps	Key operation	Display	Description
1			Press and hold the  key for two seconds to enter the FUN mode.
2			Press the  /  key to select MEAS, then press the  key.
3			Press the  /  key to select TASK1, then press the  key.
4			Press the  /  keys to select "OUTPUT" and press the  key.
5			Press the  /  keys to select "ZERO" and press the  key.
6			Press the  /  keys to select "STATUS" and press the  key.
7			Set zero reset ON/OFF. The current setting value is displayed on the sub-display. Press  /  key to enter editing mode and the sub-display blinks. In this example, select "ON" and press the  key.
8			Press the  key for two seconds to enter the RUN mode.

Setting the Offset

 Setting the Offset p.106

As an example, here is an explanation of the procedure for selecting the "10 mm" reference value setting.

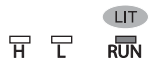
Operating procedure











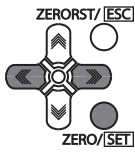

Steps	Key operation	Display	Description
1 to 5			For moving to "ZERO", see steps 1 to 5 in p.322.
6			Press the  /  keys to select "OFFSET" and press the  key.
7			Change the offset value. The current setting value is displayed on the sub-display. Press  key to enter the editing mode, and the sub-display blinks. To edit numerical values, use the  /  /  /  keys. In this example, input "10", then press the  key.
8			The decimal point is displayed. Press the  /  key to move the decimal point. Determine the decimal point and then press the  key.
9			Press the  key for two seconds to enter the RUN mode.

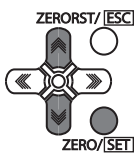
Setting the Zero Reset Mode

 Setting the Zero Reset Type p.107

As an example, here is an explanation of the procedure for selecting the "REAL" zero reset type setting.

Operating procedure



















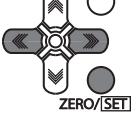

Steps	Key operation	Display	Description
1 to 5			For moving to "ZERO", see steps 1 to 5 in p.322.
6			Press the  /  keys to select "TYPE" and press the  key.
7			Select the zero reset mode. REAL: Real HOLD: Hold Select "REAL" as the zero reset type. The current setting value is displayed on the sub-display. Press  /  key to enter editing mode and the sub-display blinks. In this example, select "REAL" and press the  key.
8			Press the  key for two seconds to enter the RUN mode.

Setting the Zero Reset Memory

 Setting the Zero Reset Memory p.108

As an example, here is an explanation of the procedure for selecting the "ON" (enabled) zero reset memory setting.

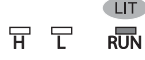
Operating procedure

Steps	Key operation	Display	Description
1			Press and hold the  key for two seconds to enter the FUN mode.
2			Press the  /  keys to select "SYSTEM" and press the  key.
3			Press the  /  keys to select "ZER.MEM" and press the  key.
4			Select zero reset memory ON/OFF. The current setting value is displayed on the sub-display. Press  /  key to enter editing mode and the sub-display blinks. In this example, select "ON" and press the  key.
5			Press the  key for two seconds to enter the RUN mode.











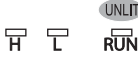





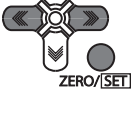

9-9 Setting the Banks

Switching Banks

 Switching Banks p.64

As an example, here is an explanation of the procedure for setting BANK2.

Operating procedure











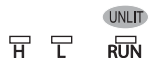





Steps	Key operation	Display	Description
1			Press and hold the key for two seconds to enter the FUN mode.
2			Press the  /  key to select BANK, then press the  key.
3			Press the  /  key to select BK.CHG, then press the  key.
4			Select BANK2 for the bank number. The current setting value is displayed on the sub-display. Press  /  key to enter editing mode and the sub-display blinks. Select "BANK2" and press the  key.
5			Press and hold the  key for two seconds to enter the RUN mode.

Changing the Bank Mode

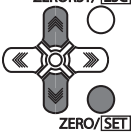
 Changing the Bank Mode p.110

As an example, here is an explanation of the procedure for selecting the "NORMAL" bank mode setting.

Operating procedure

Steps	Key operation	Display	Description
1			Press and hold the  key for two seconds to enter the FUN mode.
2			Press the  key to select BANK, then press the  key.
3			Press the  keys to select "BK.MODE" and press the  key.
4			Select the bank data. NORMAL: NORMAL JUDGE: JUDGEMENT The current setting value is displayed on the sub-display. Press  key to enter editing mode and the sub-display blinks. In this example, select "NORMAL" and press the  key.
5			Press the  key for two seconds to enter the RUN mode.























Copying the Bank Settings

Copy the selected bank setting to another bank.

 Copying the Bank/System Settings p.111

As an example, here is an explanation of the procedure for copying the BANK1 setting to BANK4.

Operating procedure

Steps	Key operation	Display	Description
1			Press and hold the  key for two seconds to enter the FUN mode.
2			Press the  key to select BANK, then press the  key.
3			Press the  keys to select "BK.COPY" and press the  key.
4			Select "BANK1" as the bank setting to be copied. "FROM" is displayed on the main display and the current setting value is displayed on the sub-display. Press  key to enter editing mode and the sub-display blinks. Select "BANK1" and press the  key.
5			Select "BANK4" as the target to copy the bank setting. "TO" is displayed on the main display and the current setting value is displayed on the sub-display. Press the  keys to enter the editing mode, and the sub-display blinks. Select "BANK4" and press the  key.
6			Press the  key for two seconds to enter the RUN mode.

Saving the Bank/System Settings











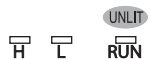







Save the bank/system settings to the Sensor Controller.

Important

- The settings of all banks are saved regardless of the currently selected bank number.
- After you have made or changed settings, be sure to save the setup data. All settings will be deleted if you turn the power OFF without saving the data.

Here is an explanation of the procedure for saving the bank/system settings.

Operating procedure

Steps	Key operation	Display	Description
1			Press and hold the  key for two seconds to enter the FUN mode.
2			Press the  /  keys to select "SYSTEM" and press the  key.
3			Press the  /  keys to select "SAVE" and press the  key.
4			"OK/CAN" is displayed on the sub-display. Press the  key to save the settings or the  key to cancel.
5			Press the  key for two seconds to enter the RUN mode.

Clearing the Bank Settings











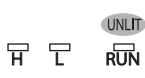

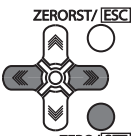

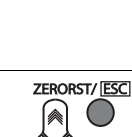

Clear (initialize) the setting of the currently selected bank.

 Clearing the Bank Settings p.113

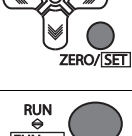
Important

Operations on the Sensor Controller do not initialize system settings and settings displayed in RUN mode.

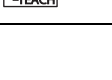
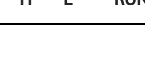

Operating procedure

Steps	Key operation	Display	Description
1			Press and hold the  key for two seconds to enter the FUN mode.
2			Press the  /  key to select BANK, then press the  key.
3			Press the  /  keys to select "BK.CLR" and press the  key.
4			"OK/CAN" is displayed on the sub-display. Press the  key to clear the settings or the  key to cancel.
5			Press the  key for two seconds to enter the RUN mode.

9-10 Setting Threshold Value

 3-6 Setting Threshold Value p.68

There are two ways of setting the threshold value.

Method	Operating key	Description
TEACHING		Perform the measurement and set the result as the threshold value. This is a convenient way when the upper or lower limit sample is available.
Direct		Set the threshold value by entering the numerical values directly. This is a convenient way when you know the dimensions of a quality product or when adjusting the threshold value set by teaching.





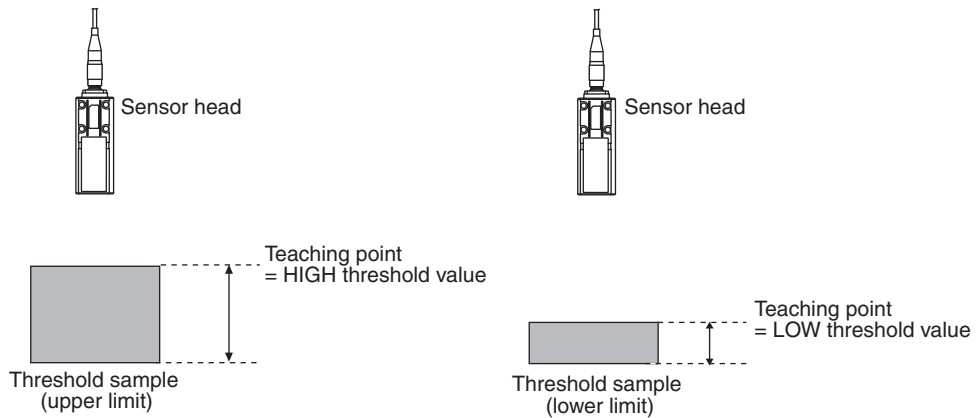







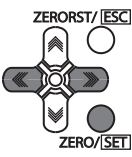











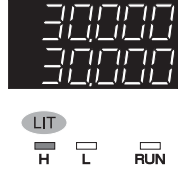

Teaching

Perform the measurement and set the result as the threshold value.



The existing settings for hold, trigger, and scaling are also reflected in the measurement during teaching.

As an example, here is an explanation of the procedure for setting the current measured value as a HIGH threshold value.





















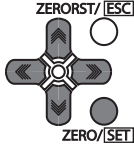







Steps	Key operation	Display	Description
1			Press and hold the  key for two seconds to enter the FUN mode.
2			Press the  key to select MEAS, then press the  key.
3			Press the  key to select TASK1, then press the  key.
4			Press the  key to select JUDGE, then press the  key.
5			Press the  key to select TEACH, then press the  key.
6			Select HIGH THRESHHOLD as the threshold value type. Press the  key to select H.JUDGE, then press the  key.
7			The current measured value is displayed on the main display and the current set threshold value is displayed on the sub-display. (At this time, the THRESHOLD-H indicator lights up.) Press the  key to display the current measured value on the lower line in the main display.
8			Press the  key to start a teaching. The indicator for the current measured value on the main display lights up, applying the value as a threshold value.
9			Press and hold the  key for two seconds to enter the RUN mode.

Direct

Set the threshold value by entering the numerical values directly.

As an example, here is an explanation of the procedure for setting a HIGH threshold value by entering "40.000" directly.

Operating procedure

Steps	Key operation	Display	Description
1 to 4			For moving to JUDGE, see steps 1 to 4 on p.332.
5			Press the  /  key to select DIRECT, then press the  key.
6			Select HIGH THRESHOLD as the threshold value type. Press the  /  key to select H.JUDGE, then press the  key.
7		    	Set "40.000" as the HIGH threshold value. The current measured value is displayed on the main display and the current set threshold value is displayed on the sub-display. (At this time, the THRESHOLD-H indicator lights up.) Press  key to enter the editing mode, and the sub-display blinks. To edit numerical values, use the  /  /  /  keys. Enter "40.000" and press the  key.
8		   	Press and hold the  key for two seconds to enter the RUN mode.

9-11 Setting the System

Display/set the system environment.











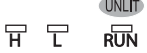

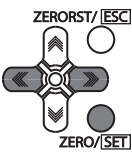











Checking Information

Display the set measuring cycle and information of the Sensor Controller and Sensor Head.

 Checking Information p.114

As an example, here is an explanation of the procedure for displaying the serial No. of the Sensor Head.

Operating procedure

Steps	Key operation	Display	Description
1			Press and hold the  key for two seconds to enter the FUN mode.
2			Press the  /  keys to select "SYSTEM" and press the  key.
3			Select the information to display. CYCLE: Currently set measurement cycle [ms] C.INFO: CONTROLLER INFORMATION H.INFO: SENSOR HEAD INFORMATION In this example, press the  /  keys, select "H.INFO" and press the  key.
4			When the Controller information and Sensor Head information have been changed, select the additional information to display: VER: Controller version information MAC.ADR: Controller MAC address MODEL: Sensor Head model information SER.NO: Sensor Head serial No. In this example, press the  /  keys, select "SER.NO" and press the  key.
5	-		"SER.1" is displayed on the main display and the higher-order digit of the serial No. is displayed on the sub-display.
6			When the  /  key is pressed, "SER.2" is displayed on the main display and the lower-order digit of the serial No. is displayed on the sub-display.
7			Press the  key for two seconds to enter the RUN mode.

Setting the Key Lock



















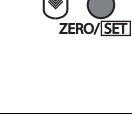

 Setting the Key Lock p.115

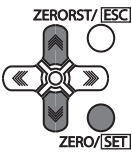
Important

Note that, moving to the key lock setting menu or moving between menu hierarchies are possible even when the key lock function is ON.

Here is an explanation of the procedure for turning the key lock ON.

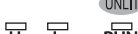













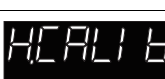

Operating procedure

Steps	Key operation	Display	Description
1			Press and hold the  key for two seconds to enter the FUN mode.
2			Press the  /  keys to select "SYSTEM" and press the  key.
3			Press the  /  keys to select "LOCK" and press the  key.
4			Select key lock ON/OFF. The current setting value is displayed on the sub-display. Press the  /  keys to enter the editing mode, and the sub-display blinks. In this example, select "ON" and press the  key.
5			Press the  key for two seconds to enter the RUN mode.

Calibrating Sensor Head

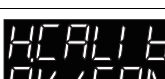
 Calibrating Sensor Head p.42

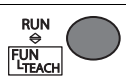
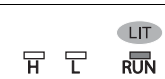
Operating procedure

Steps	Key operation	Display	Description
1			Press and hold the  key for two seconds to enter the FUN mode. (For details on the functions of the Mode switching key, see p.294.)
2			Press the  /  keys to select "SYSTEM" and press the  key.
3			Press the  /  keys to select "H.CALIB", then press the  key.
4			"OK/CAN" is displayed on the sub-display. Press the  key to execute calibration or the  key to cancel.
5			Press the  key for two seconds to enter the RUN mode.











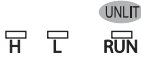







Important When Sensor Head calibration fails

If the Sensor Head is calibrated in an inappropriate environment, an error is displayed on the main display. If this happens, press the  key to return to the previous screen and try again. If an error continues even after calibrating the Sensor Head in an appropriate environment, the fiber connector on the Sensor Head or Sensor Controller may be stained. Clean the fiber cable or fiber connector referring to p.39.

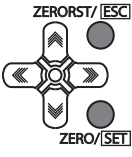
Initializing Settings

 Initializing Settings p.116

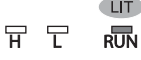
Operating procedure

Steps	Key operation	Display	Description
1			Press and hold the  key for two seconds to enter the FUN mode.
2			Press the  /  keys to select "SYSTEM" and press the  key.
3			Press the  /  keys to select "INIT" and press the  key.
4			"OK/CAN" is displayed on the sub-display. Press the  key to restore the default values, or  key to cancel.
5			Press the  key for two seconds to enter the RUN mode.

9-12 Connecting Parallel I/O













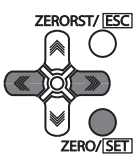







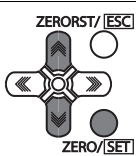

Settings for Analog Output

Setting the analog output destination

 Setting the analog output destination p.140

As an example, here is an explanation of the procedure for outputting the voltage.

Operating procedure











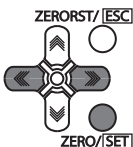

Steps	Key operation	Display	Description
1			Press and hold the  key for two seconds to enter the FUN mode.
2			Press the  /  keys to select "I/O" and press the  key.
3			Press the  /  keys to select "ANALOG" and press the  key.
4			Press the  /  keys to select "V OR C" and press the  key.
5			Select the output destination. VOLT: Voltage CUR: Current The current setting value is displayed on the sub-display. Press  /  key to enter editing mode and the sub-display blinks. In this example, select "VOLT" and press the  key.
6			Press the  key for two seconds to enter the RUN mode.

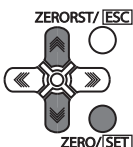
Assigning Analog Output

 Assigning Analog Output p.141

As an example, here is an explanation of the procedure for outputting the results of TASK1 as analog.

Operating procedure





Steps	Key operation	Display	Description
1 to 3			For moving to "ANALOG", see steps 1 to 3 in p.338.
2			Press the  /  keys to select "OUTPUT" and press the  key.
3			Select the task to output. TASK1 to TASK4/OFF The current setting value is displayed on the sub-display. Press  /  key to enter editing mode and the sub-display blinks. In this example, select "TASK1" and press the  key.
4			Press the   key for two seconds to enter the RUN mode.





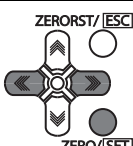





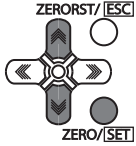



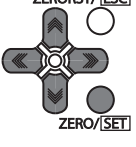



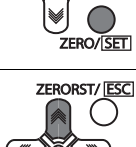







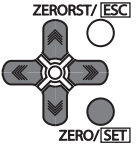



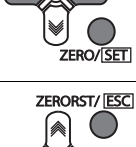













Setting Monitor Focus

 Setting Monitor Focus p.142

The following describes the procedure when setting 4 mA output (Point1) for measured value of 0 mm and 20 mA output for measured value of 6mm (Point2).

Operating procedure

Steps	Key operation	Display	Description
1 to 3			For moving to "ANALOG", see steps 1 to 3 in p.338.
4			Press the  /  keys to select "FOCUS" and press the  key.















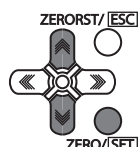



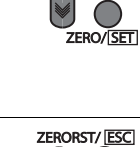



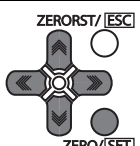







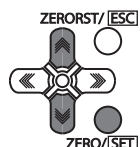



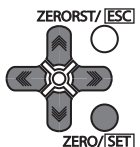



Steps	Key operation	Display	Description
5			Select monitor focus ON/OFF. The current setting value is displayed on the sub-display. Press  /  key to enter editing mode and the sub-display blinks. In this example, select "ON" and press the  key.
6			Set the distance value of the 1st point. The current setting value is displayed on the sub-display. Press  /  key to enter editing mode and the sub-display blinks. In this example, select "4mA" and press the  key.
7			Set the output value of the 1st point. The current setting value is displayed on the sub-display. Press  key to enter the editing mode, and the sub-display blinks. To edit numerical values, use the  /  /  /  keys. In this example, input "0", then press the  key.
8			The decimal point is displayed. Press the  /  key to move the decimal point. Determine the decimal point and then press the  key.
9			Set the distance value of the 2nd point. The current setting value is displayed on the sub-display. Press  /  key to enter editing mode and the sub-display blinks. In this example, select "20mA" and press the  key.
10			Set the output value of the 2nd point. The current setting value is displayed on the sub-display. Press  key to enter the editing mode, and the sub-display blinks. To edit numerical values, use the  /  /  /  keys. In this example, input "6", then press the  key.
11			The decimal point is displayed. Press the  /  key to move the decimal point. Determine the decimal point and then press the  key.
12			"OK/CAN" is displayed on the sub-display. Press the  key to reflect the settings or the  key to cancel.
13			Press the  key for two seconds to enter the RUN mode.

Adjusting the analog output value

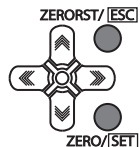
 Adjusting the analog output value p.143

As an example, the following explains the procedure for correcting 4 mA output (Point1) and 20 mA output (Point2).

Operating procedure

Steps	Key operation	Display	Description
1 to 3			For moving to "ANALOG", see steps 1 to 3 in p.338.
4			Press the  /  keys to select "CALIB" and press the  key.
5			Select analog output correction ON/OFF. The current setting value is displayed on the sub-display. Press  /  key to enter editing mode and the sub-display blinks. In this example, select "ON" and press the  key.
6			Set the reference value of the point1. The current set value for the point1 is displayed on the sub-display. Press  /  key to enter editing mode and the sub-display blinks. In this example, select "4mA" and press the  key.
7			Set the adjustment value of the point1. Press the  /  /  /  keys to input the adjustment value and press the  key. Next, check the ammeter value and press the  key. To re-adjust, press the  key.
8			Set the reference value of the point2. The current set value for the point2 is displayed on the sub-display. Press  /  key to enter editing mode and the sub-display blinks. In this example, select "20mA" and press the  key.
9			Set the adjustment value of the point2. Press the  /  /  /  keys to input the adjustment value and press the  key. Next, check the ammeter value and press the  key. To re-adjust, press the  key.
10			"OK/CAN" is displayed on the sub-display. Press the  key to execute correction or  key to cancel.
11			Press and hold the  key for two seconds to enter the RUN mode.























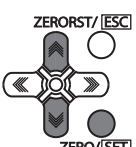

Settings for Judgment Output

Assigning judgment output

 Assigning judgment output p.145

As an example, the following explains the procedure for outputting the judgment results for TASK1.

Operating procedure











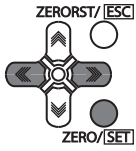



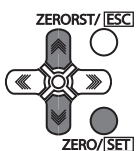



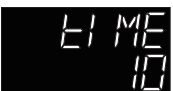

Steps	Key operation	Display	Description
1			Press and hold the  key for two seconds to enter the FUN mode.
2			Press the  /  keys to select "I/O" and press the  key.
3			Press the  /  keys to select "JUDGE" and press the  key.
4			Press the  /  keys to select "OUTPUT" and press the  key.
5			Select the task for which to output the judgment result. The current setting value is displayed on the sub-display. Press  /  key to enter editing mode and the sub-display blinks. In this example, select "TASK1" and press the  key.
6			Press the  key for two seconds to enter the RUN mode.

Setting Operation at Judgment Output

 Setting Operation at Judgment Output p.146

As an example, the following explains the procedure for setting the timer type to "1 SHOT" and the timer duration to "10ms".

Operating procedure

Steps	Key operation	Display	Description
1 to 3			For moving to "JUDGE", see steps 1 to 3 in p.342.
4			Select the judgment output setting item. HYS: Hysteresis width TIMER: Timer mode In this example, press the  /  keys, select "TIMER" and press the  key.
5			Select the timer mode. OFF: Not set OFF.DLY: Off Delay ONDLY: On Delay 1SHOT: One Shot Select "1SHOT" as the judgment output type. The current setting value is displayed on the sub-display. Press the  /  keys to enter the editing mode, and the sub-display blinks. Select "1SHOT" and press the  key.
6			Set the timer duration. The current setting value is displayed on the sub-display. Press  key to enter the editing mode, and the sub-display blinks. To edit numerical values, use the  /  /  /  keys. In this example, input "10", then press the  key.
7			Press and hold the  key for two seconds to enter the RUN mode.



















Settings for Processing When Measurement Is Not Possible

Setting operation when measurement is not possible

 Setting operation when measurement is not possible p.148

As an example, the following explains the procedure for setting processing for when measurement is not possible to "CLAMP".

Operating procedure











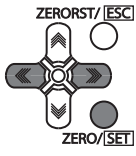

Steps	Key operation	Display	Description
1			Press and hold the  key for two seconds to enter the FUN mode.
2			Press the  /  keys to select "I/O" and press the  key.
3			Press the  /  keys to select "HLD.RST" and press the  key.
4			Select the operation when measurement is not possible. KEEP: KEEP CLAMP: CLAMP The current setting value is displayed on the sub-display. Press  /  key to enter editing mode and the sub-display blinks. In this example, select "CLAMP" and press the  key.

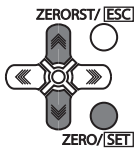
Setting the Clamp Value

 Setting the Clamp Value p.149

As an example, the following explains the procedure for setting the clamp value to "analog voltage output 10V".

Operating procedure

Steps	Key operation	Display	Description
1 to 4			For moving to "HLD.RST" - "CLAMP", see steps 1 to 4 in p.344.
2			Press the  /  keys to select "ANALOG" and press the  key.
6			Set the clamp value. The current setting value is displayed on the sub-display. Press  /  key to enter editing mode and the sub-display blinks. Select "10V" and press the  key.
7			Press the  key for two seconds to enter the RUN mode.











































Setting for Internal Logging



Setting LOGGING save count and LOGGING save intervals

 Settings for Internal Logging p.151

As an example, here is an explanation of the procedure for setting save intervals to "1" and save count to "100".

Operating procedure

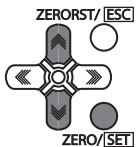
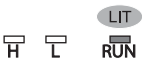
Steps	Key operation	Display	Description
1			Press and hold the  key for two seconds to enter the FUN mode.
2			Press the  /  keys to select "I/O" and press the  key.
3			Press the  /  keys to select "PAR.LOG" and press the  key.
4			Select the save intervals. Press the  /  keys to select "INTRVL" and press the  key.
5			Set the save intervals. The current setting value is displayed on the sub-display. Press  key to enter the editing mode, and the sub-display blinks. To edit numerical values, use the  /  /  /  keys. In this example, input "1", then press the  key.
6			Press the  key to return to the previous menu.
7			Select the save count. Press the  /  keys to select "COUNT" and press the  key.
8			Set the save count. The current setting value is displayed on the sub-display. Press  key to enter the editing mode, and the sub-display blinks. To edit numerical values, use the  /  /  /  keys. In this example, input "100", then press the  key.























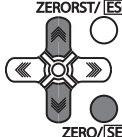

Steps	Key operation	Display	Description
9			Press the  key for two seconds to enter the RUN mode.

9-13 Connecting with EtherCAT

Setting Fieldbus

 Setting default settings for EtherCAT communications p.165

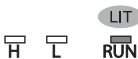











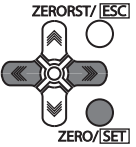











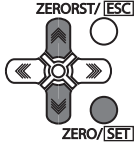

Operating procedure

Steps	Key operation	Display	Description
1			Press and hold the  key for two seconds to enter the FUN mode.
2			Press the  /  keys to select "SYSTEM" and press the  key.
3			Press the  /  keys to select "COM" and press the  key.
4			Press the  /  keys to select "MEMLNK" and press the  key.
5			Select the Fieldbus. E-CAT: EtherCAT communications EIP: EtherNet/IP communications OFF: OFF The current setting value is displayed on the sub-display. Press  /  key to enter editing mode and the sub-display blinks. Select "E-CAT" and press the  key.
6			Press the  key for two seconds to enter the RUN mode.

Setting GATE Signal ON Time

 Setting default settings for EtherCAT communications p.165

Operating procedure











































Steps	Key operation	Display	Description
1			Press and hold the  key for two seconds to enter the FUN mode.
2			Press the  /  keys to select "SYSTEM" and press the  key.
3			Press the  /  keys to select "COM" and press the  key.
4			Press the  /  keys to select "GATE.TM" and press the  key.
5			Select the GATE signal ON time. The current setting value is displayed on the sub-display. Press  /  key to enter editing mode and the sub-display blinks. To edit numerical values, use the  /  /  /  keys. In this example, input "1", then press the  key.
6			Press the  key for two seconds to enter the RUN mode.

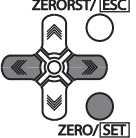

9-14 Connecting with EtherNet/IP

Network Settings of the Sensor

 Network Settings of the Sensor p.203

Operating procedure

Steps	Key operation	Display	Description
1			Press and hold the  key for two seconds to enter the FUN mode.
2			Press the  /  keys to select "SYSTEM" and press the  key.
3			Press the  /  keys to select "COM" and press the  key.
4			Press the  /  keys to select "ETN" and press the  key.
5			Select the IP address from the setting item. Press the  /  keys to select "IPADDR" and press the  key.
6			Press the  /  keys to select "IP1" and press the  key.
7			Set the value of P1. The current setting value is displayed on the sub-display. Press the  /  /  /  keys to enter the editing mode, and the sub-display blinks. Input the value of IP1, then press the  key.
8			Press the  key to return to the previous menu.
9	Repeat steps 6 to 8 to enter the "IP2", "IP3" and "IP4" setting values.		
10			Press the  key twice to return to the menu before last.
11			Select the subnet mask from the setting item. Press the  /  keys to select "SUBNET" and press the  key.
12	Perform the same steps to set the subnet mask.		

Steps	Key operation	Display	Description
13			Press the  key for two seconds to enter the RUN mode.













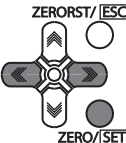





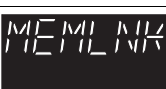

Important

- The default gateway cannot be set from the Sensor Controller.
- To enable the settings, restart the Sensor Controller.

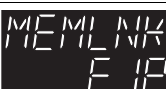
Setting Fieldbus

 Network Settings of the Sensor p.203

Operating procedure











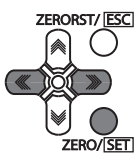









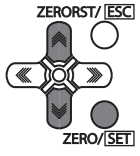



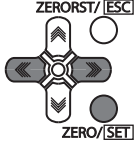

Steps	Key operation	Display	Description
1			Press and hold the  key for two seconds to enter the FUN mode.
2			Press the  /  keys to select "SYSTEM" and press the  key.
3			Press the  /  keys to select "COM" and press the  key.
4			Press the  /  keys to select "MEMLNK" and press the  key.
5			Select the Fieldbus. E-CAT: EtherCAT communications EIP: EtherNet/IP communications OFF: OFF The current setting value is displayed on the sub-display. Press  /  key to enter editing mode and the sub-display blinks. Select "EIP" and press the  key.
6			Press the  key for two seconds to enter the RUN mode.

9-15 Connecting by No-protocol Communications

Initial Settings for No-protocol Communications

 Initial Settings for No-protocol Communications p.228











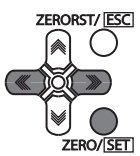







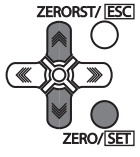



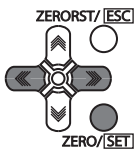

Operating procedure

Steps	Key operation	Display	Description
1 to 3			For moving to "COM", see steps 1 to 3 in p.350.
4			Press the  /  keys to select "RS232C" and press the  key.
5			Select the setting item: IPADDR: IP address SUBNET: Subnet mask PROTCL: Protocol OUTIP: Output IP address PORT.IN: Port number PORT.OT: Output destination port number In this example, press the  /  keys, select "PROTCL" and press the  key.
6			Selects the protocol. The current setting value is displayed on the sub-display. Press  /  key to enter editing mode and the sub-display blinks. Select "TCP.SV" and press the  key.
7			Press the  key to return to the previous menu.
8			Press the  /  keys to select "OUTIP" and press the  key.
9			Repeat steps 6 to 8 to set other items.
10			Press and hold the  key for two seconds to enter the RUN mode.

Setting Communications Specifications (RS-232C Communications)

 Setting Communications Specifications (RS-232C Communications) p.230











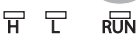





















Operating procedure

Steps	Key operation	Display	Description
1 to 3			For moving to "COM", see steps 1 to 3 in p.350.
4			Press the  /  keys to select "RS232C" and press the  key.
5			Select the setting item: BAUD.RT: baud rate DATA: data length PARITY: parity STOP: stop bit CS/RS: CS/RS control In this example, press the  /  keys, select "DATA" and press the  key.
6			Selects the data length. The current setting value is displayed on the sub-display. Press  /  key to enter editing mode and the sub-display blinks. Select the data length, and press the  key.
7			Press the  key to return to the previous menu.
8			Press the  /  keys to select "PARITY" and press the  key.
9			Repeat steps 6 to 8 to set other items.
10			Press and hold the  key for two seconds to enter the RUN mode.

Setting Serial Data Output

 Setting the data output destination p.231

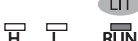









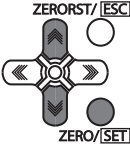

Operating procedure

Steps	Key operation	Display	Description
1			Press and hold the  key for two seconds to enter the FUN mode.
2			Press the  /  keys to select "I/O" and press the  key.
3			Press the  /  keys to select "COM.OUT" and press the  key.
4			Select the setting item: OUTPUT: Data output destination FORMAT: Output data type INT.NUM: Digits of integer DEC.NUM: Digits of decimal ZEROSP: Zero suppression FIELD: Field separator RECORD: Record separator In this example, press the  /  keys, select "OUTPUT" and press the  key.
5			Automatically Following the Range of Measurement Area2 The current setting value is displayed on the sub-display. Press  /  key to enter editing mode and the sub-display blinks. Select the data length, and press the  key.
6			Press the  key to return to the previous menu.
7			Select the save count. Press the  /  keys to select "FORMAT" and press the  key.
8	Repeat steps 5 to 7 to set other items.		
9			Press and hold the  key for two seconds to enter the RUN mode.

Set the delimiter

 Setting Communications Specifications (RS-232C Communications) p.230

Operating procedure

Steps	Key operation	Display	Description
1 to 3			For moving to "COM", see steps 1 to 3 in p.350.
4			Press the  /  keys to select "DELIMI" and press the  key.
5			Select the delimiter. The current setting value is displayed on the sub-display. Press  /  key to enter editing mode and the sub-display blinks. Select the delimiter, and press the  key.
6			Press and hold the  key for two seconds to enter the RUN mode.

MEMO

APPENDICES

10-1 Specifications and External Dimensions	358
10-2 Firmware update	380
10-3 Processing Item Data List	384
10-4 System data list	388
10-5 Object Dictionary	390

10-1 Specifications and External Dimensions

Sensor Head

Specifications

Item	Specifications							
	ZW-S07	ZW-S20	ZW-S30	ZW-S40	ZW-SR07	ZW-SR20	ZW-SR40	
Measurement center distance	7 mm	20 mm	30 mm	40 mm	7 mm	20 mm	40 mm	
Measuring range	±0.3 mm	±1 mm	±3 mm	±6 mm	±0.3 mm	±1 mm	±6 mm	
Static resolution *1	0.01 μm	0.02 μm	0.06 μm	0.08 μm	0.01 μm	0.02 μm	0.08 μm	
Linearity *2	±0.8 μm	±1.2 μm	±4.5 μm	±7.0 μm	±1.1 μm	±1.6 μm	±9.3 μm	
Spot diameter *3	Near	20 μm dia.	45 μm dia.	70 μm dia.	90 μm dia.	20 μm dia.	45 μm dia.	90 μm dia.
	Center	18 μm dia.	40 μm dia.	60 μm dia.	80 μm dia.	18 μm dia.	40 μm dia.	80 μm dia.
	Far	20 μm dia.	45 μm dia.	70 μm dia.	90 μm dia.	20 μm dia.	45 μm dia.	90 μm dia.
Measuring cycle	500 μs to 10 ms							
Operating ambient illumination	Illumination on object surface of 10000 lx or less (incandescent light)							
Ambient temperature range	Operation: 0 to +50°C, Storage: -15 to +60°C (No freezing and condensation)							
Ambient humidity range	Operation/storage: 35 or 85% (No condensation)							
Degree of protection	IP40 (IEC60529)							
Vibration resistance (destructive)	10 to 150 Hz (half amplitude 0.35 mm), 80 mins in each of X/Y/Z directions							
Shock resistance (destructive)	150 m/s ² , 6 direction, 3 times each (up/down, left/right, forward/backward)							
Temperature characteristic *4	0.6 μm/°C (0.45 μm/°C)	1.5 μm/°C (1.0 μm/°C)	2.8 μm/°C (2.0 μm/°C)	4.8 μm/°C (3.8 μm/°C)	0.6 μm/°C (0.45 μm/°C)	1.5 μm/°C (1.0 μm/°C)	4.8 μm/°C (3.8 μm/°C)	
Material	Chassis: aluminum die cast Fiber cable sheath: PVC Calibration ROM: PC							
Fiber cable length	0.3 m, 2 m (flex-resistant cable)							
Fiber cable minimum bend radius	20 mm							
Insulation resistance (Calibration ROM)	Between case and all terminals: 20 MΩ (by 250 V megger)							
Dielectric strength (Calibration ROM)	Between case and all terminals: 1000 VAC, 50/60 Hz, 1 min							
Weight	Approx. 105 g (chassis, fiber cable total)				Approx. 130 g (chassis, fiber cable total)			
Accessories	Instruction Manual, Calibration ROM fixing screws (M2), Note on Use							

*1: Capacity value when OMRON standard mirror surface target is measured at the measurement center distance as the average of 4,096 times

When connected with the controller for the Export Control Trade Ordinance (ZW-CE1□T/ZW-C1□□T), the minimum resolution is 0.25 μm, regardless of the Sensor Head and the number of measurements averaged.

*2: Material setting for the OMRON standard mirror surface target: Error from an ideal straight line when measuring on mirror surface
The reference values for linearity when targets to measure other than the above are as in the table below.

Target to Measure	ZW-S07	ZW-S20	ZW-S30	ZW-S40	ZW-SR07	ZW-SR20	ZW-SR40
Glass	±1.0 μm	±1.2 μm	±4.5 μm	±7.0 μm	±1.1 μm	±1.6 μm	±9.3 μm
SUS BA	±1.2 μm	±1.4 μm	±5.5 μm	±8.5 μm	±1.2 μm	±1.8 μm	±9.3 μm
White ceramic	±1.6 μm	±1.7 μm	±6.4 μm	±9.5 μm	±1.6 μm	±1.9 μm	±11.0 μm

*3: Capacity value defined by 1/e² (13.5%) of the center optical intensity in the measured area

*4: Temperature characteristic at the measurement center distance when fastened with an aluminum jig between the Sensor Head and the target and the Sensor Head and the Sensor Controller are set in the same temperature environment. Figures in parentheses are converted value obtained by subtracting the effect of expansion and contraction of the aluminum jig itself.

External Dimensions

● ZW-S07/S20/S30/S40

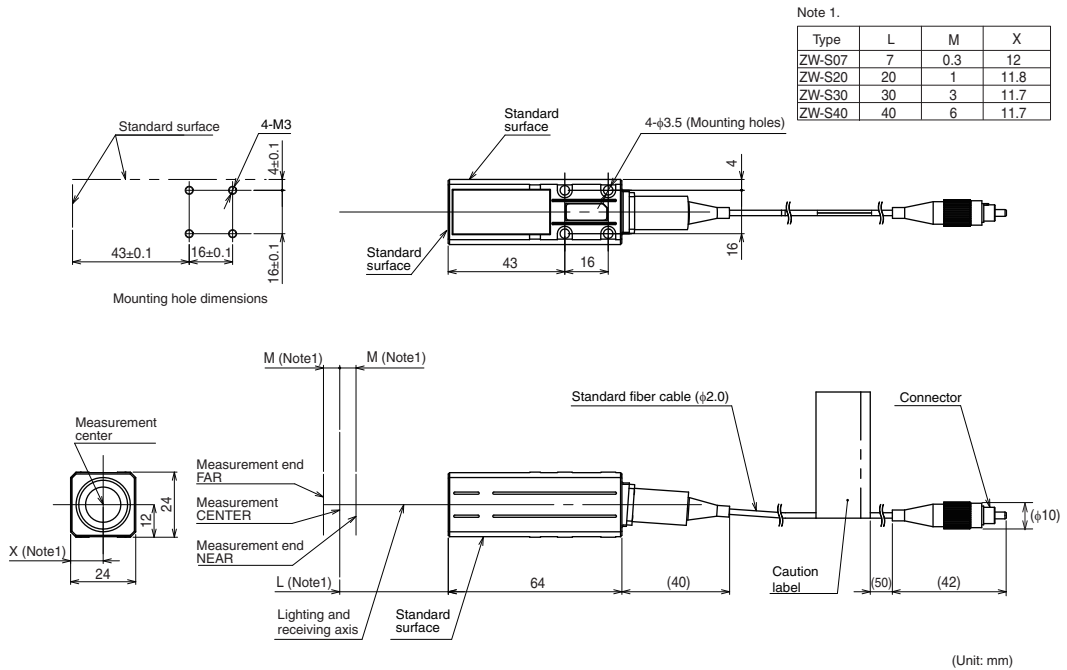

● ZW-SR07/SR20/SR40

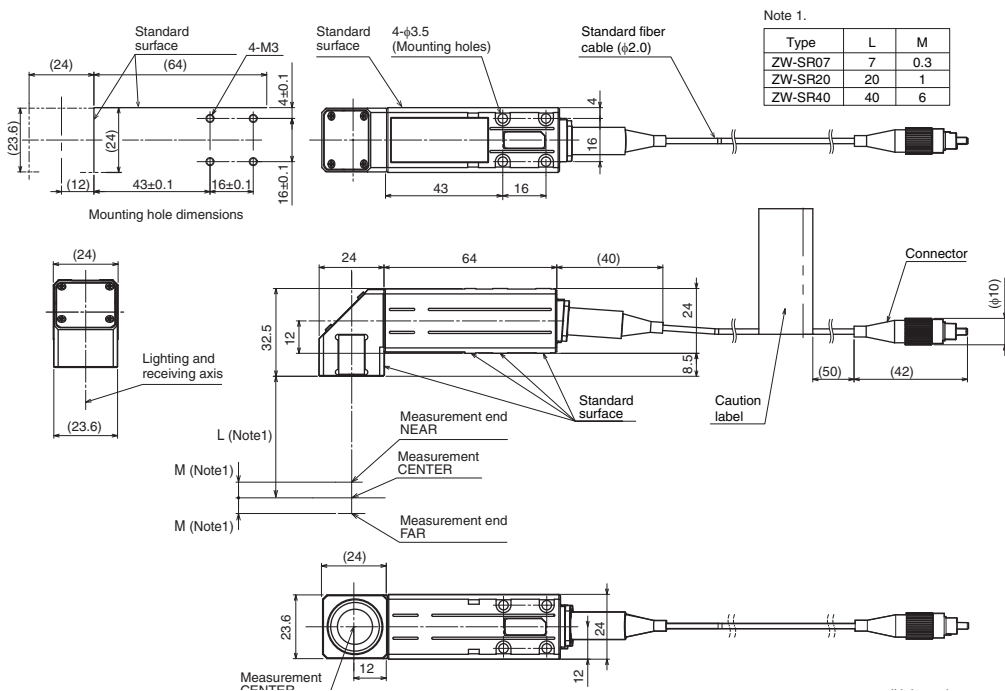

● Calibration ROM (ZW-XROM) *

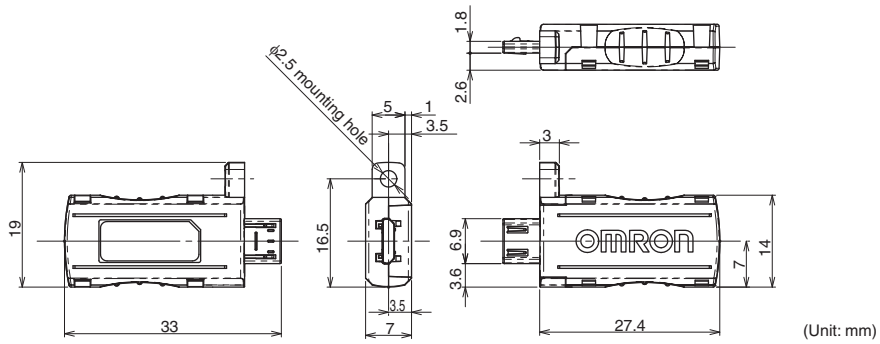

* This comes with the Sensor Head (ZW-S07/S20/S30/S40/SR07/SR20/SR40). Be sure to use a Calibration ROM together with the Sensor Head with the same serial number.

Spot diameter

Spot diameters of ZW-SR07, ZW-SR20, and ZW-SR40 are the same as spot diameters of ZW-S07, ZW-S20, and ZW-S40 respectively.

● ZW-S07

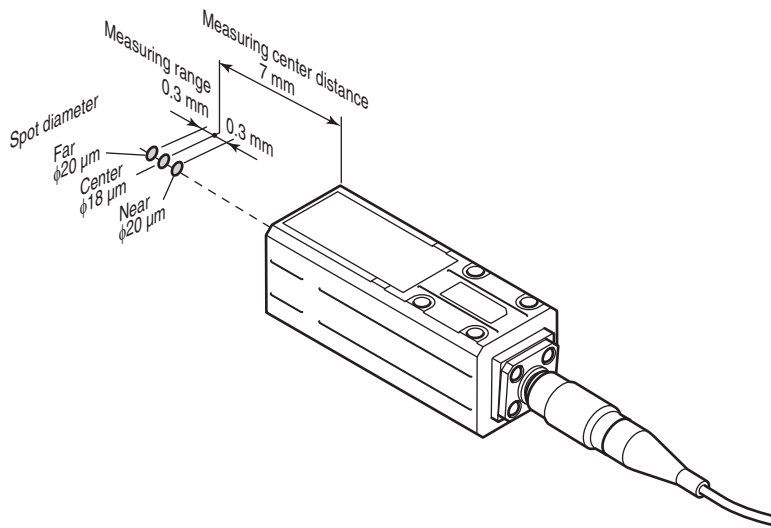

● ZW-S20

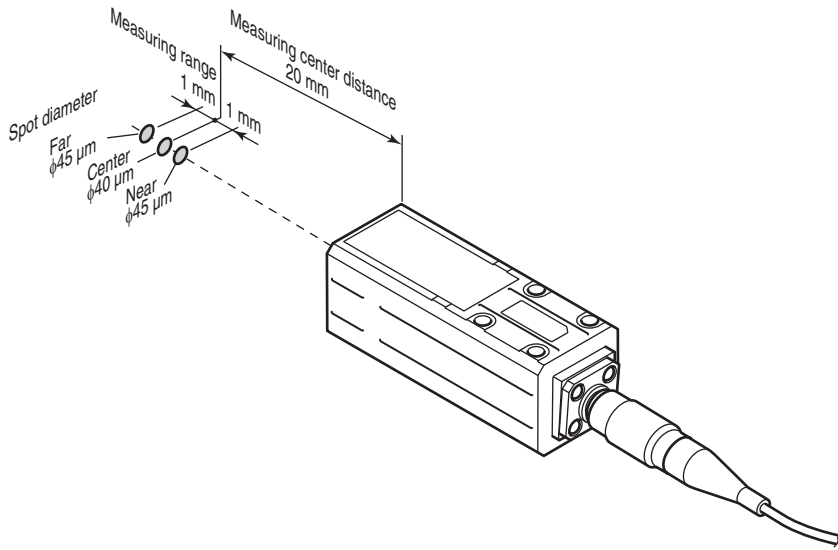

● ZW-S30

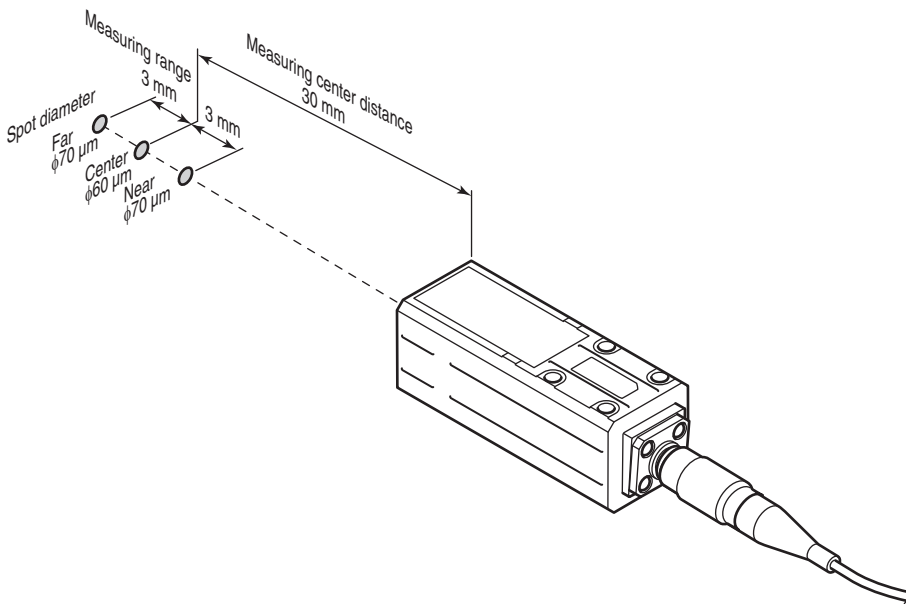

● ZW-S40

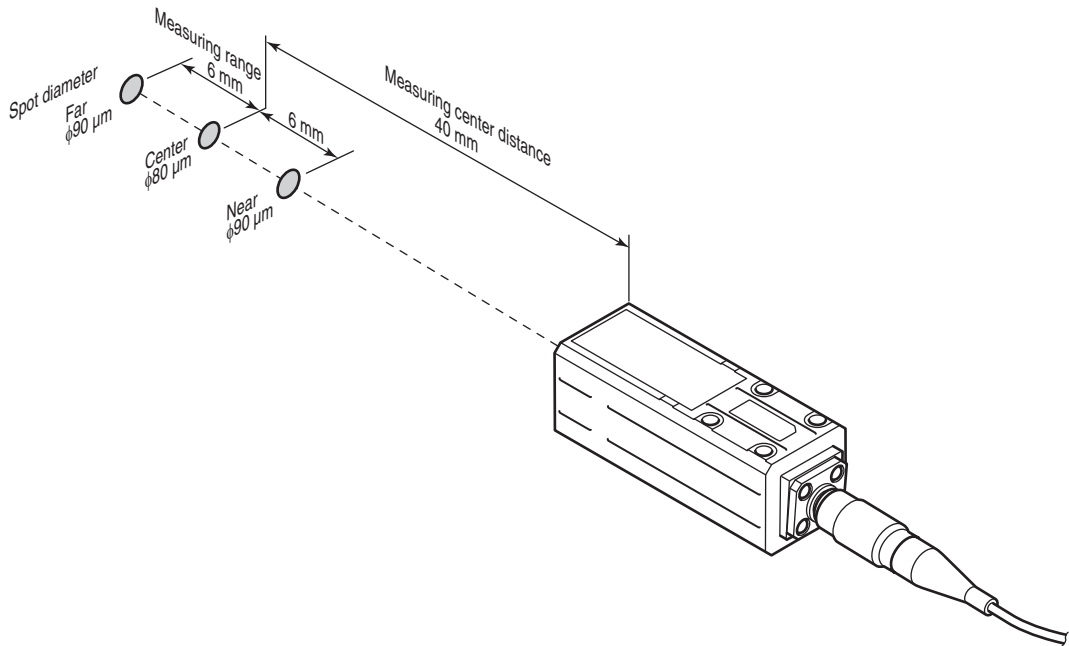

Linearity characteristic by material (typical examples)

Shows the measured distance displayed on the Sensor Controller's main display and the X-axis distance. The measured distance displayed on the main display expresses the measurement center distance as 0 with the near side from the sensor head as + and the far side as -.

● ZW-S07

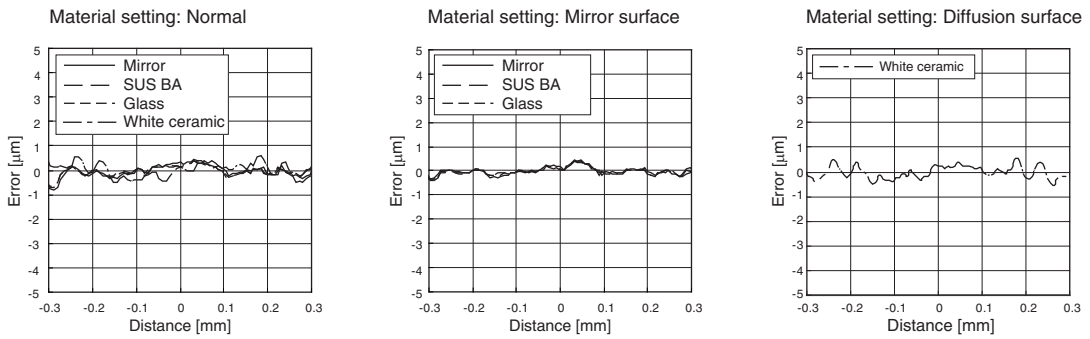

● ZW-S20

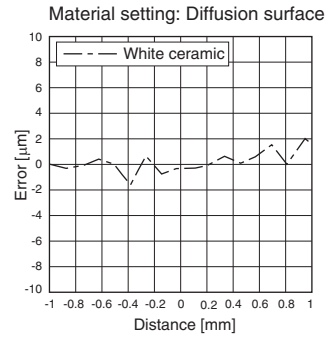
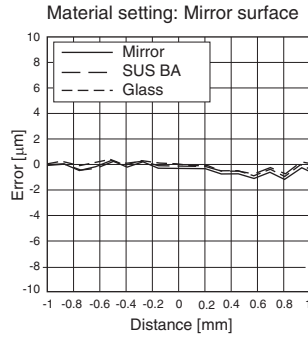
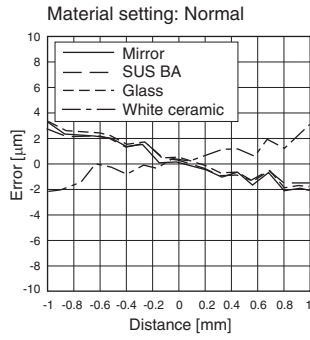

● ZW-S30

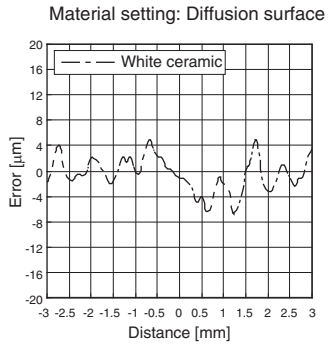
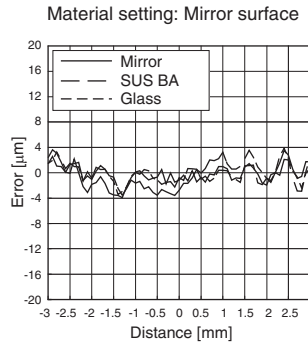
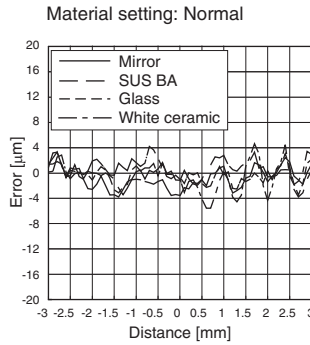

● ZW-S40

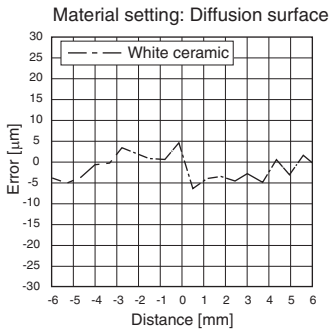
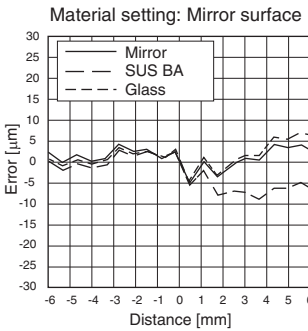
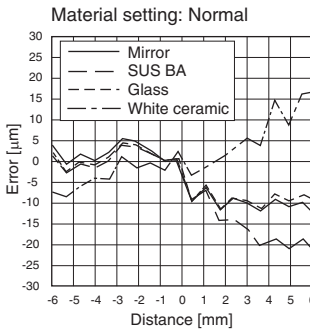

● ZW-SR07

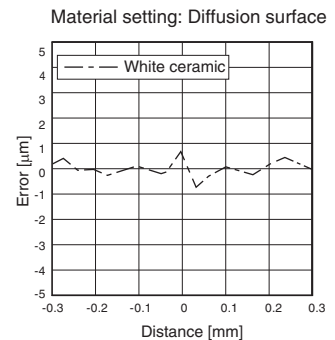
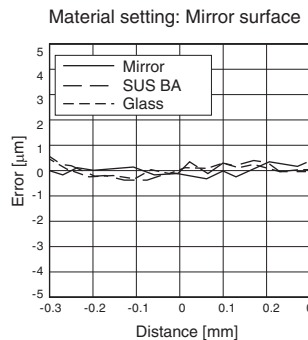
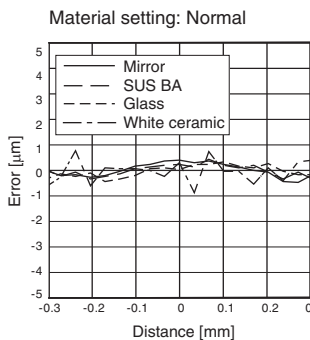

● ZW-SR20

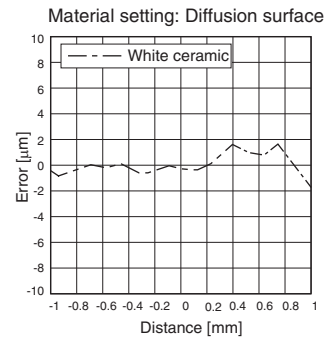
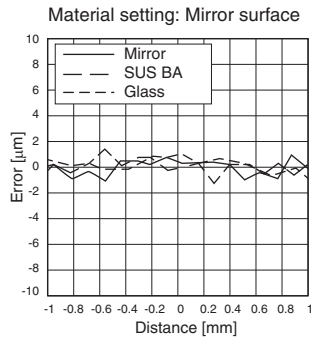
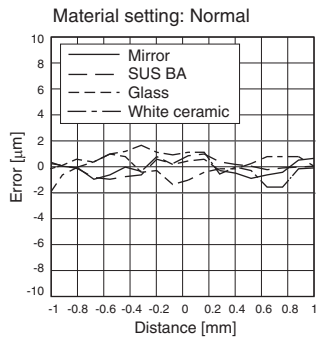

● ZW-SR40

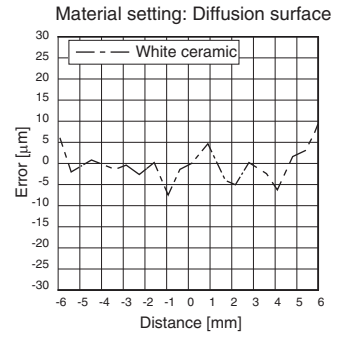
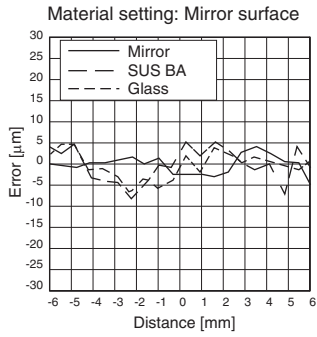
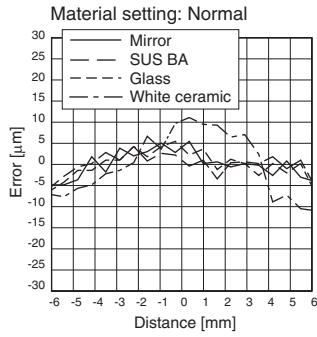

Angle Characteristic (typical examples)

The angle characteristic plots the slope of the target in the measuring range and the maximum value of the error generated in analog output.

Straight Type

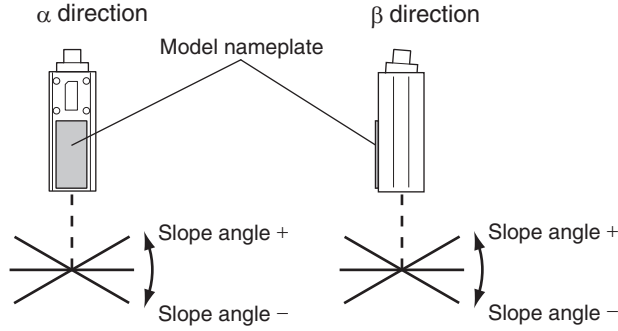

● ZW-S07

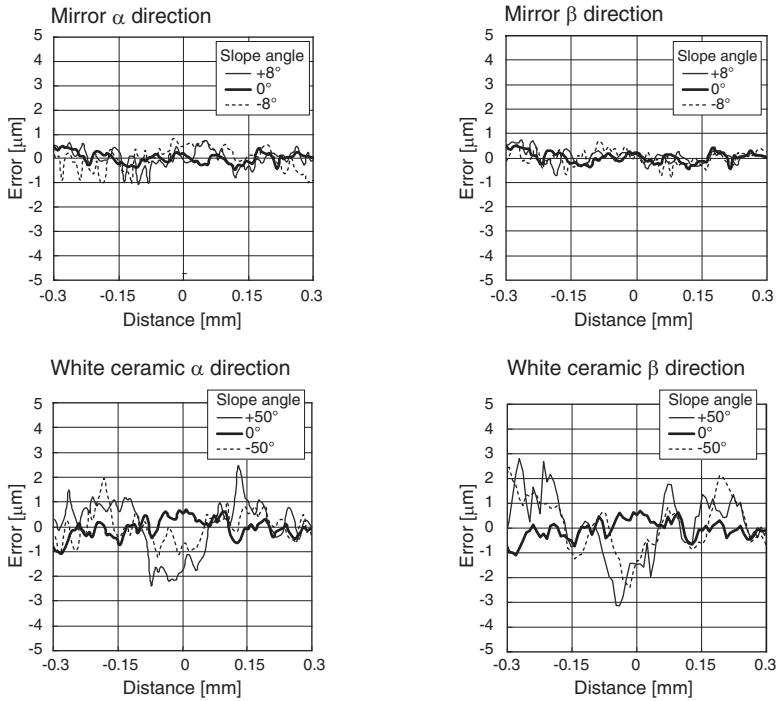

● ZW-S20

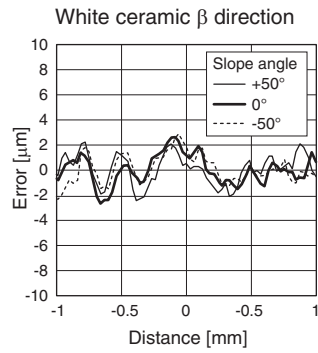
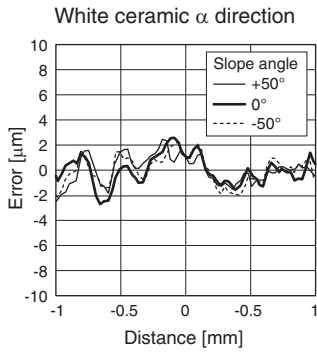
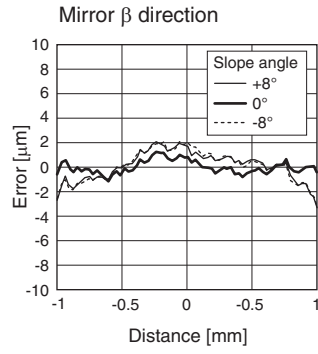
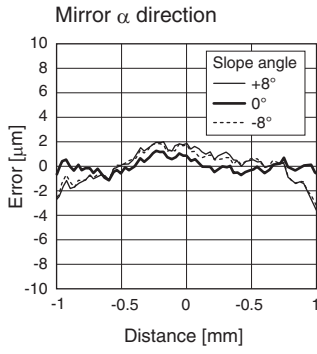

● ZW-S30

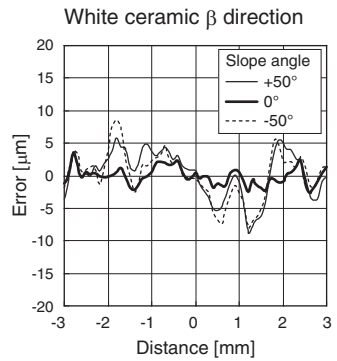
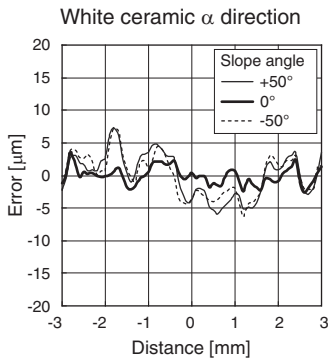
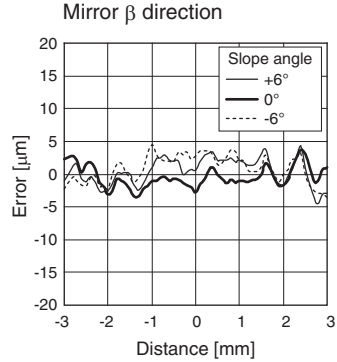
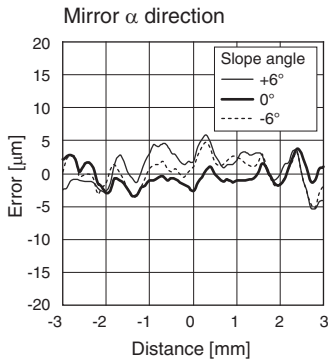

● ZW-S40

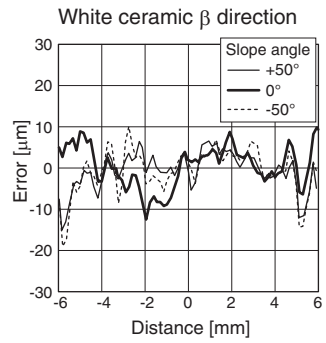
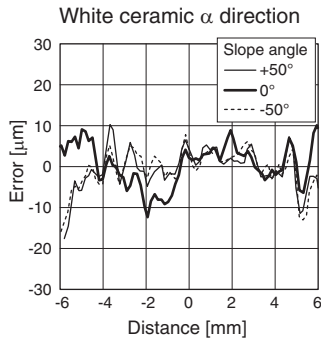
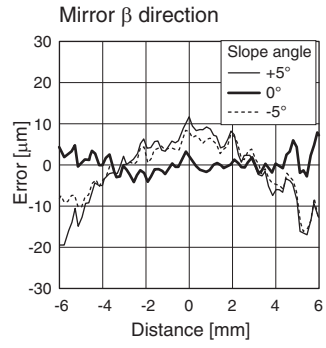
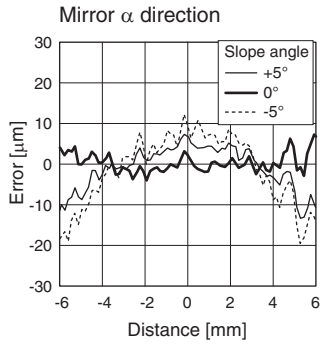

Right angle type

α direction

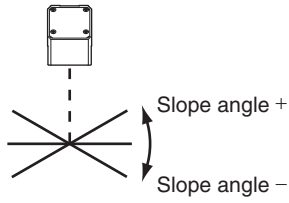

β direction

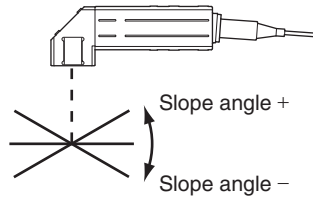

● ZW-SR07

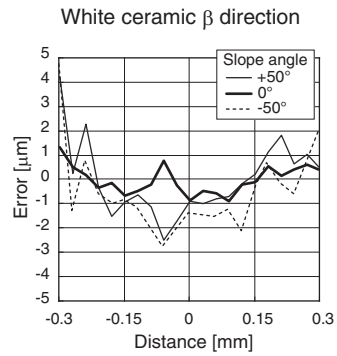
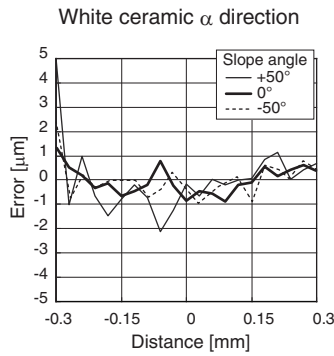
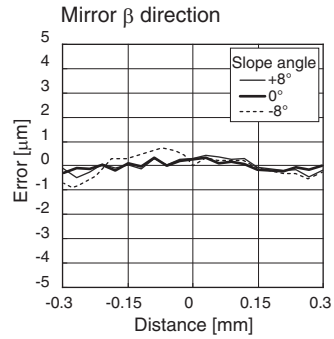
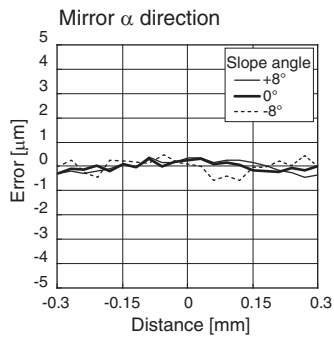

● ZW-SR20

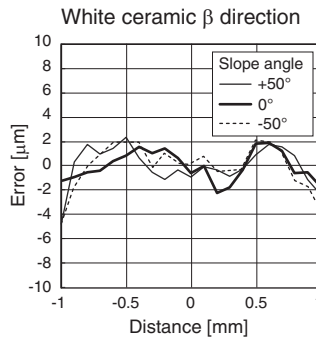
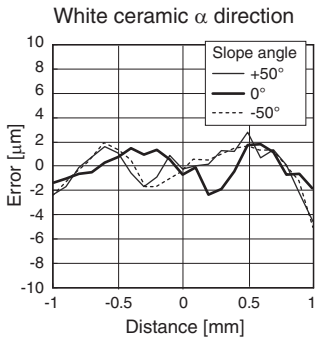
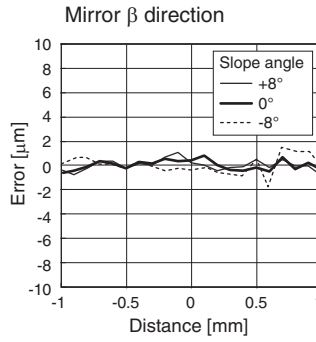
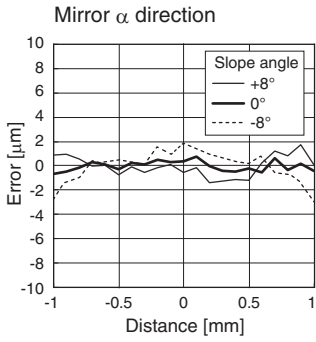

● ZW-SR40

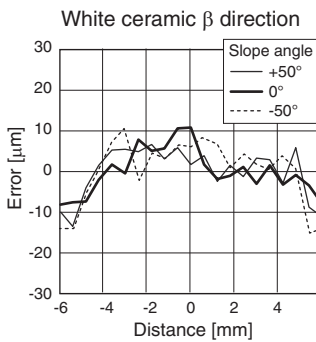
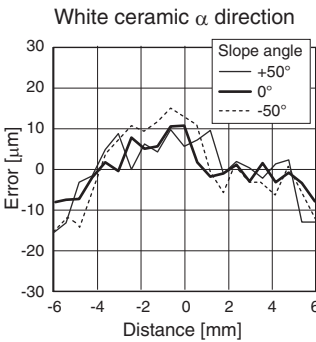
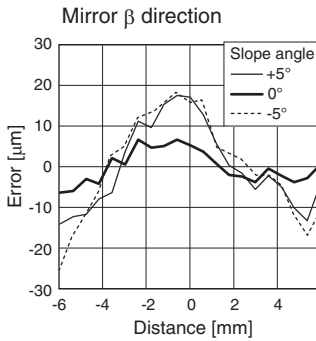
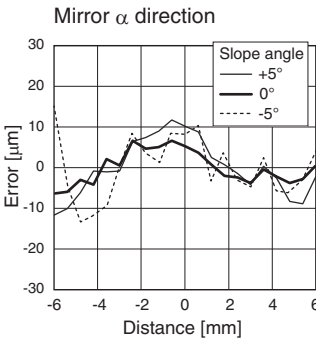

Sensor controller

Specifications

Item		Specifications		
		ZW-CE10T	ZW-CE15T	
Input/output type		NPN	PNP	
Number of connected sensor heads		1		
Sensor head compatibility		Available		
Light source for measurement		White LED		
Segment Display	Main display	11-segment red display, 6 digits		
	Sub-display	11-segment green display, 6 digits		
LED display	Status indicators	HIGH (orange), PASS (green), LOW (orange), STABILITY (green), ZERO (green), ENABLE (green), THRESHOLD-H (orange), THRESHOLD-L (orange), RUN (green)		
	EtherCAT indicator	ECAT RUN (green), L/A IN (Link/Activity IN) (green), L/A OUT (Link/Activity OUT) (green), ECAT ERR (red)		
External I/F	Ethernet		100BASE-TX/10BASE-T	
	EtherCAT		EtherCAT exclusive protocol 100BASE-TX	
	RS-232C		Max. 115,200 bps	
	Analog output terminal block	Analog voltage output (OUT 1 V)	-10 V to +10 V, output impedance: 100 Ω	
		Analog current output (OUT 1 A)	4 mA to 20 mA, max. load resistance: 300 Ω	
	32-pole expansion connector	Judgment output (HIGH 1/PASS 1/LOW 1)	Transistor output system Output voltage: 21.6 to 30 VDC Load current: 50 mA or less Residual voltage when turning ON: 1.2 V or less Leakage voltage when turning OFF: 0.1 mA or less	
		Busy output (BUSY 1)		
		Alarm output (ALARM)		
		Enable output (ENABLE 1)		
		LED OFF input (LED OFF 1)	DC input system Input voltage: 24 VDC ± 10% (21.6 to 26.4 VDC) Input current: 7 mA Type. (24 VDC)	
Zero reset input (ZERO 1)		ON voltage/ON current: 19 V/3 mA or less ON voltage/ON current: 5 V/1 mA or less		
Timing input (TIMING 1)				
Reset input (RESET 1)				
Logging input (LOGGING)				
Bank		Currently selected bank output (BANK_OUT 1 to 3)	Transistor output system Output voltage: 21.6 to 30 VDC Load current: 50 mA or less Residual voltage when turning ON: 1.2 V or less Leakage voltage when turning OFF: 0.1 mA or less	
	Bank Selection input (BANK_SEL 1 to 3)	DC input system Input voltage: 24 VDC ± 10% (21.6 to 26.4 VDC) Input current: 7 mA Type. (24 VDC) ON voltage/ON current: 19 V/3 mA or more OFF voltage/OFF current: 5 V/1 mA or less		

Item		Specifications
		ZW-CE10T
		ZW-CE15T
Main functions	Exposure time	Automatic/Fixed
	Measuring cycle	500 μ s to 10 ms
	Material setting	Standard/Mirror/Rough surfaces
	MEASUREMENT ITEM	Height/Thickness of transparent object/Calculation
	Filtering	Median/Average/Differentiation/High pass/Low pass/Band pass
	Output	Scaling/Different holds/Zero reset/Logging for a measured value
	Display	Measured value/Threshold value/Analog output voltage or current value/ Judgment result/Resolution/Exposure time
	Number of configurable banks	Max. 8 banks
	Task process	Multi-task (up to 4 tasks per bank)
	System	Save/Initialization/Display measured information/Communication settings/ Sensor head calibration/Key-lock/Zero reset memory/Timing input
Rating	Power supply voltage	21.6 to 26.4 VDC (including ripple)
	Current consumption	600 mA max.
	Insulation resistance	Across all lead wires and FG terminal: 20 M Ω (by 250 V megger)
	Dielectric strength	Between all lead wires and FG terminal: 500 VAC, 50/60 Hz, 1 minute
Environmental resistance	Degree of protection	IP20 (IEC60529)
	Vibration resistance (destructive)	10 to 55 Hz (half amplitude 0.35 mm), 50 mins in each of X/Y/Z directions
	Shock resistance (destructive)	150 m/s ² , 6 direction, 3 times each (up/down, left/right, forward/backward)
	Ambient temperature range	Operation: 0 to +40°C, Storage: -15 to +60°C (No freezing and condensation)
	Ambient humidity range	Operation/storage: 35 to 85% (No condensation)
Grounding	D-type grounding (grounding resistance of 100 Ω or less) Note: For conventional Class D grounding	
Material	Chassis: PC	
Weight	Approx. 750 g (main unit only), Approx. 150 g (Parallel cable)	
Accessories	Instruction Manual Member registration sheet Parallel cable (ZW-XCP2E)	

When this Sensor Controller is used, the minimum resolution is 0.25 μ m, regardless of the sensor head and the number of measurements averaged.

Status indicators

Mode	Status		Display	Output		Input		RS-232C/ Ethernet
				ANALOG Output	Judgment out- put (HIGH/PASS/ LOW)	LED OFF	Zero reset	
RUN	Normal measurement		Measurement result	Output according to measurement result	Judgment result	Enabled	Enabled	Enabled
	Measurement error	KEEP	Previous value					
		CLAMP	"-----"	Output at clamp level	Output OFF	Disabled		
	Measured value not applied		–					
LED OFF		–						
FUN	–		Display according to menu					Disabled
System error	–		"SYS.ERR" blinks	Voltage: 0 V output Current: 12 mA output		Disabled		Enabled Commands are accepted but not executed.
When starting	–		"INIT"	Output at clamp level (approx. -10.8 V)				Invalid (Note)

Note: Do not obtain data during start-up. The RS-232C output is indeterminate at this time.

External Dimensions

ZW-CE10T/CE15T

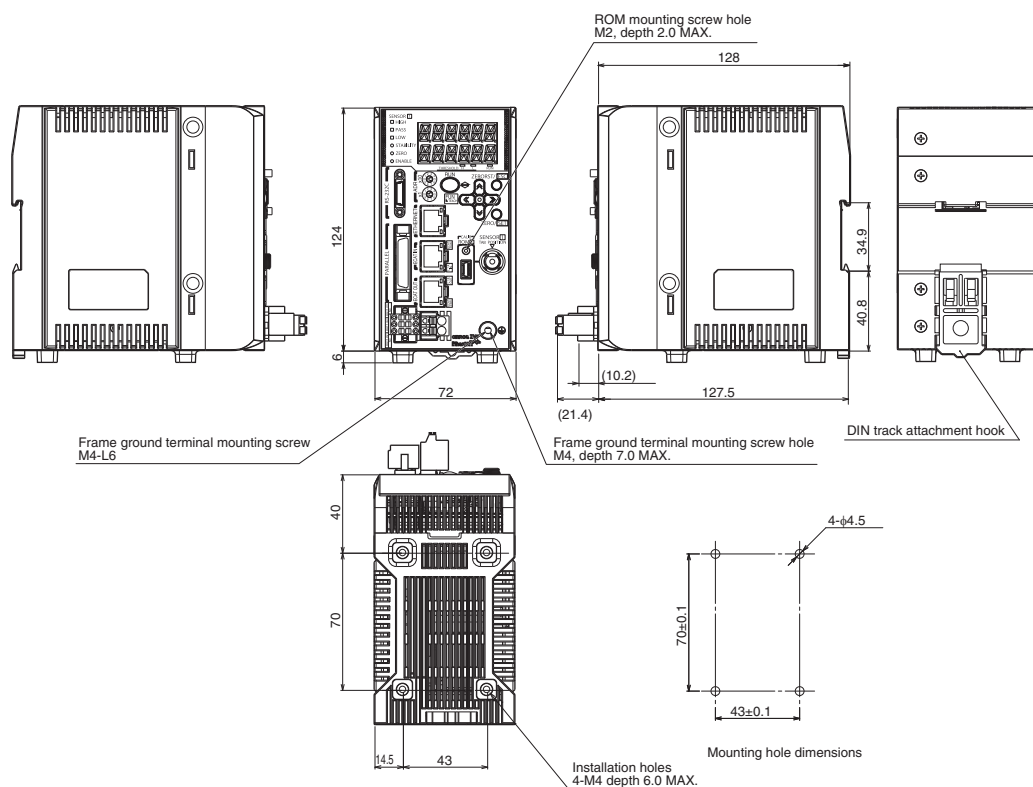

(Unit: mm)

EtherCAT communications specifications

Item	Specifications
Communications standard	IEC 61158 Type12
Physical layer	100BASE-TX (IEEE802.3)
Connector	RJ45 × 2 EtherCAT IN: EtherCAT input EtherCAT OUT: EtherCAT output
Communications media	Twisted pair cable Category 5 or higher (Straight, double-shielded cable comprising aluminum tape and braid is recommended.)
Communications distance	Distance between nodes: 100 m max.
Process data	Variable PDO mapping
Mailbox (CoE)	Emergency message, SDO request, SDO response, SDO information
Distributed block	Synchronization by DC mode
LED display	L/A IN (Link/Activity IN) × 1 L/A OUT (Link/Activity OUT) × 1 ECAT RUN × 1 ECAT ERR × 1

PC tools (Sysmac Studio)

Item	Operating environment
Operating system (OS) ⁽¹⁾ Japanese or English	Windows XP (Service Pack3 or later) / Vista (32bit version) / 7 (32bit version/64bit version) / 8 (32bit version/64bit version)
CPU	Windows PC mounted with Celeron 540 (1.8 GHz) or faster chip Core i5 M520 (2.4 GHz) or equivalent or faster product is recommended.
Main memory	2 GB or more
Hard disk	At least 1.6 GB of free space ⁽²⁾
Display	XGA 1024 × 768, 16,000,000 colors WXGA 1280 × 800 dots or higher resolution is recommended.
Disk drive	DVD-ROM drive
Communication port	USB2.0 compatible USB port or Ethernet port

*1: Note about Sysmac Studio compatible operating systems:
The required system and hard disk capacity differs according to the system environment.

*2: Separate logging memory is required to use the file logging function.

Accessories

Extension fiber cable

ZW-XF02R/XF05R/XF10R/XF20R/XF30R

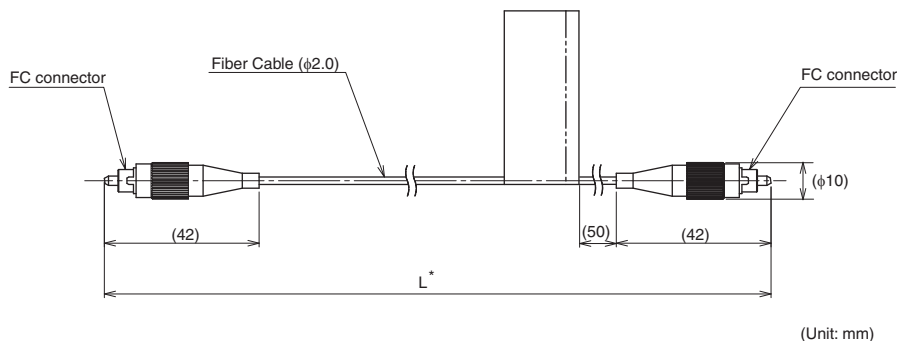

* The following table lists cable lengths per models.

Type	Specification	L (mm)
ZW-XF02R	2m	2000±20
ZW-XF05R	5m	5000±50
ZW-XF10R	10m	10000±100
ZW-XF20R	20m	20000±200
ZW-XF30R	30m	30000±300

Item	Specifications				
	ZW-XF02R	ZW-XF05R	ZW-XF10R	ZW-XF20R	ZW-XF30R
Ambient temperature	Operation: 0 to +50°C, Storage: -15 to +60°C (No condensation)				
Ambient humidity	Operation, storage: 35 to 85%RH (No condensation)				
Vibration resistance (destructive)	10 to 55 Hz (half amplitude 0.35 mm), 50 mins in each of X/Y/Z directions				
Shock resistance (destructive)	150 m/s ² , 6 direction, 3 times each (up/down, left/right, forward/backward)				
Fiber length	2 m	5 m	10 m	20 m	30 m
Material	Cable sheath: PVC, Connector: Bronze				
Fiber cable minimum bending radius	20 mm				
Weight	Approx. 30 g	Approx. 40 g	Approx. 60 g	Approx. 110 g	Approx. 150 g
Accessories	Connection adapter (ZW-XFC), Instruction Manual				

Important

Secure a minimum bending radius (R) for the fiber cable that is at least as large as the specification value. A bending radius smaller than the specification value could cause damage to the fiber cable.

Connection adapter (for connecting fiber cable)

ZW-XFC

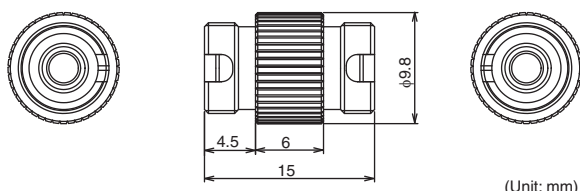

(Unit: mm)

The connection adapter (ZW-XFC) comes packed together with the extension fiber cable (ZW-XF□R), but the connection adapter alone can be purchased for maintenance.

Fiber connector cleaner

ZW-XCL

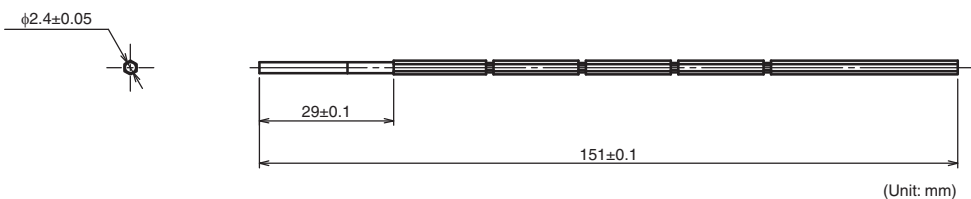

(Unit: mm)

This cleaner can be used only for the following locations:



- Grooves on the fiber connector of the Sensor Controller (ZW-CE□T)
- Grooves on the connection adapter (ZW-XFC) supplied with the extension fiber cable (ZW-XF□R)

Take note that this cleaner must not be used to clean the tips of fiber cables.

For cleaning of the tips of fiber cables, refer to "Connecting Fiber Cable" p.38.

Item	Specifications
Applicable item	<ul style="list-style-type: none"> • Grooves on the fiber connector of the Sensor Controller (ZW-CE1□T) • Grooves on the connection adapter (ZW-XFC) supplied with the extension fiber cable (ZW-XF□R)
Packed quantity	10 pcs/set
Number of times cleanable	Once
External size	Length 180 mm, φ2.4 mm
Operating ambient temperature range	5 to 35°C
Operating ambient humidity range	40 to 80%
Storage ambient temperature range	5 to 35°C
Storage ambient humidity range	40 to 80%
Material	Nylon plastic, polyolefin plastic, polyester
Weight	20 g
Accessories	Note on use

EtherCAT cable

Product name		Manufacturer	Cable length (m) *1	Model
Size/number of cores (number of pairs): AWG22 × 2P	Cable with connector at both ends (RJ45/RJ45) 	OMRON	0.3	XS5W-T421-AMD-K
			0.5	XS5W-T421-BMD-K
			1	XS5W-T421-CMD-K
			2	XS5W-T421-DMD-K
			5	XS5W-T421-GMD-K
			10	XS5W-T421-JMD-K
	Cable with connector at both ends (M12/RJ45) 	OMRON	0.3	XS5W-T421-AMC-K
			0.5	XS5W-T421-BMC-K
			1	XS5W-T421-CMC-K
			2	XS5W-T421-DMC-K
			5	XS5W-T421-GMC-K
			10	XS5W-T421-JMC-K
Size/number of cores (number of pairs): AWG24 × 4P	Cable	Tonichi Kyosan Cable, Ltd.		NETSTAR-C5E SAB 0.5 × 4P *2
		Kuramo Electric Co., LTD.		KETH-SB *2
		SWCC SHOWA CABLE SYSTEMS CO., LTD.		FAE-5004 *2
	RJ45 connector	Panduit Corp.		MPS588 *2
Size/number of cores (number of pairs): AWG22 × 2P	Cable	Kuramo Electric Co., LTD.		KETH-PSB-OMR *3
	RJ45 assembled type connector 	OMRON		XS6G-T421-1 *3

*1: This cable is available in 0.3, 0.5, 1, 2, 3, 5, 10, and 15 m lengths. For details, refer to the *industrial Ethernet connector catalog* (CDJC-006).

*2: Use of the above combinations of EtherCAT cables and RJ45 connector is recommended.

*3: Use of the above combinations of EtherCAT cables and RJ45 assembled type connector is recommended.

RS-232C cable

ZW-XPT2 (for PLC/programmable terminal connection)

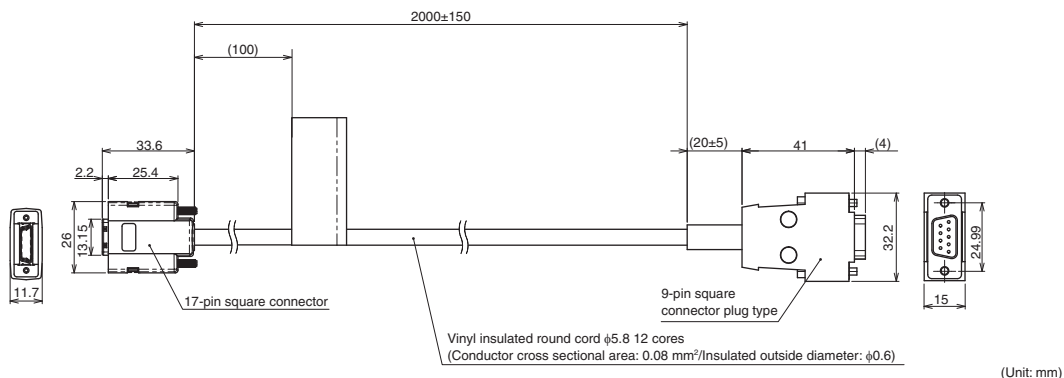

ZW-XRS2 (for PC connection)

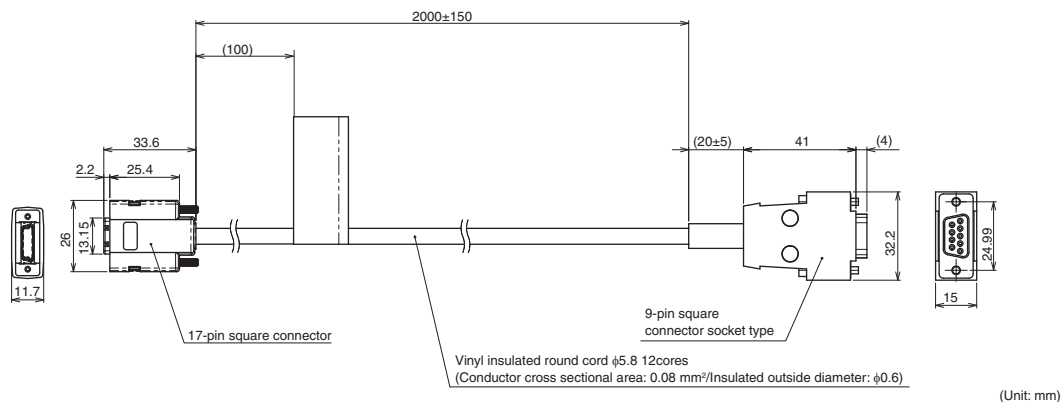

Item	Specifications	
	ZW-XPT2	ZW-XRS2
Applicable Controller	ZW series	
Ambient temperature	Operation: 0 to +50°C, Storage: -15 to +60°C (No freezing and condensation)	
Ambient humidity	Operation/storage: 35 or 85% RH (No condensation)	
Dielectric strength	1000 VAC, 50/60 Hz, 1 min	
Insulation resistance	20 MΩ (by 250 VDC megger)	
Vibration resistance (destructive)	10 to 55 Hz (half amplitude 0.35 mm), 50 mins in each of X/Y/Z directions	
Shock resistance (destructive)	150 m/s ² , 6 direction, 3 times each (up/down, left/right, forward/backward)	
Material	Cable sheath: PVC	
Cable minimum bending radius	35 mm	
Weight	Approx. 150 g	
Accessories	Instruction Manual	

Important

Secure a minimum bending radius (R) for the cable that is at least as large as the specification value. If the bending radius is smaller than the specification value, this can cause damage to the cable.

Parallel cable

ZW-XCP2E

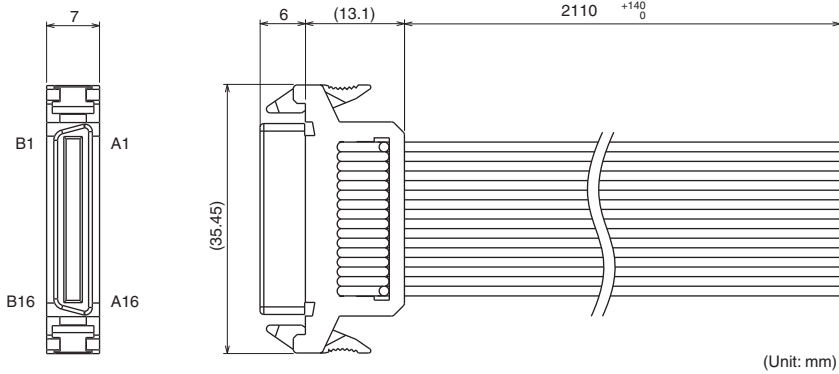

Item	Specifications
Applicable Controller	ZW-CE□□T series
Ambient temperature	Operation: 0 to +50°C, Storage: -15 to +60°C (No freezing and condensation)
Ambient humidity	Operation/storage: 35 or 85% RH (No condensation)
Dielectric strength	1000 VAC, 50/60 Hz, 1 min
Insulation resistance	20 MΩ (by 250 VDC megger)
Vibration resistance (destructive)	10 to 55 Hz (half amplitude 0.35 mm), 50 mins in each of X/Y/Z directions
Shock resistance (destructive)	150 m/s ² , 6 direction, 3 times each (up/down, left/right, forward/backward)
Material	Cable sheath: PVC
Cross section of flat cable	AWG28
Core wire pitch	1.27 mm
Cable minimum bending radius	5.5 mm
Weight	Approx. 150 g
Accessories	Instruction Manual

Important

Secure a minimum bending radius (R) for the cable that is at least as large as the specification value. If the bending radius is smaller than the specification value, this can cause damage to the cable.

EMC Directive Conformity

CE Marking	Applicable directive		Safety category
	Low voltage directive	EMC directive	
Conformed	Not applicable	Conformed	B

10-2 Firmware update

For information on how to obtain the latest version of the firmware, please contact your OMRON sales representative.

After obtaining the latest version of the firmware, follow the procedure below to update the firmware.

Important

Do not turn OFF the power supply to the Sensor Controller during updating. The Sensor Controller would no longer start up properly.

Use PC tools (Sysmac Studio) to update.

- **Explorer pane** : [Device Group] | [(Sensor Name)] (double click)
→ **Edit pane** : [Tools] icon ()

1 Click [Sensor setup] - [Update], and select the update file.

The update file extension is ".BIN". When the file is selected, the [FirmwareWriteInWindow] popup is displayed.

Important

The current firmware version is displayed at [Sensor setup]. Be sure to check the version before updating the firmware.

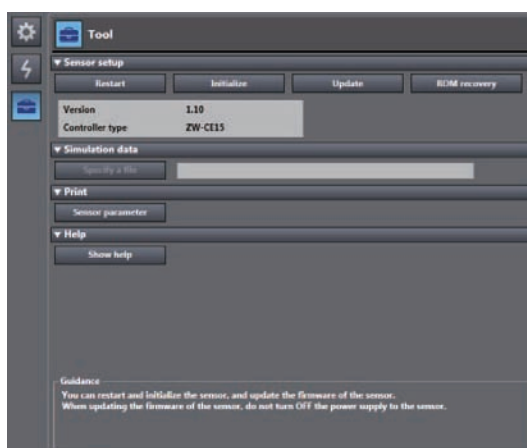

2 Click [Start the update.].

A message to confirm to start the update appears.

Important

When you click [Start the update.], if the "Different format" message is displayed, this means that the format information for the connected Sensor Controller and the specified file do not match. If this happens, never continue with the firmware update. The Sensor Controller breaks down and no longer starts up properly.

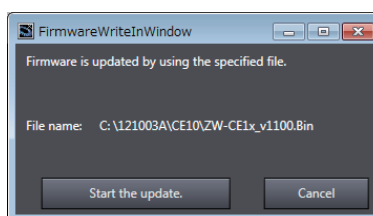

3 Check the content of the message, and click [OK].

The firmware update is started.

A progress bar is displayed during update processing. Wait for the [Firmware Write Completed] popup to be displayed. (The update takes several minutes to complete.)

Important

- Errors may occur on the Sensor Controller during updating, but just wait for the update to complete.
- If the update progress bar stops midway or the update does not end even after ten minutes, there is the possibility that the update has failed. In this case, contact an OMRON branch or sales office about the firmware version before update and the firmware version in the write file.

4 Click [Close].

The firmware update is completed.

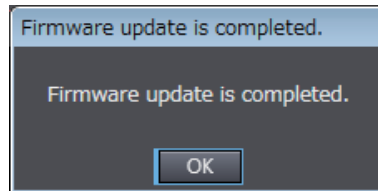

Performing the Update on Warp Engine ZW

Warp Engine ZW is automatically installed when Smart Monitor ZW is installed. For details on the Smart Monitor ZW, refer to the *Smart Monitor ZW Operation manual* (Cat. No.Z323-E1-01).

Before proceeding with this operation, connect the ZW to the personal computer where Warp Engine ZW is installed using an Ethernet cable.

Important

- Only start Warp Engine ZW when the computer has recognized the Sensor Controller normally.
- Do not change the IP address and the subnet mask when using Warp Engine ZW on the same personal computer with which SmartMonitor ZW is used. If you are using a different personal computer, refer to p.227 and change the IP address and the subnet mask of the Sensor Controller.

- 1 From the personal computer's Start menu, select [All Programs] - [OMRON] - [ZW] - [Warp Engine ZW].

The [Warp Engine ZW] screen is displayed.



If Warp Engine ZW fails to start up, a message and then the following screen is displayed.

In this case, set the connection port.

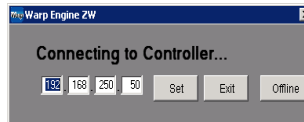

- 2 If necessary, click [Update Controller Information].

The model name and version of the currently connected Sensor Controller are displayed.

- 3 Click [Read Update File], and select the file to write to.

The model name and version of the Sensor Controller held in the file are displayed.

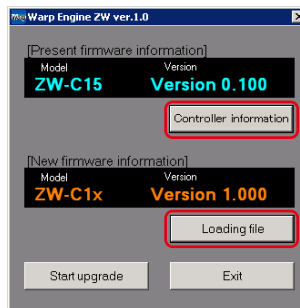

- 4 Click [Start Update].

A message to confirm to start the update appears.

Important

When you click [Start Update], if the "Different format" message is displayed, this means that the format information for the connected Sensor Controller and the specified file do not match. If this happens, never continue with the firmware update. The Sensor Controller breaks down and no longer starts up properly.

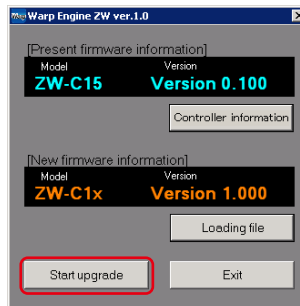

5 Check the content of the message, and click [OK].

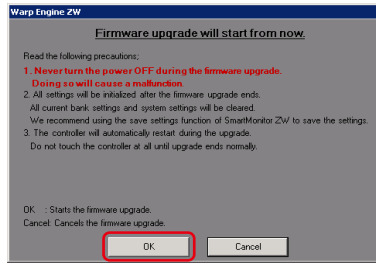

The firmware update is started.

A progress bar is displayed during update processing. Wait for the successful end message box to be displayed. (The update takes several minutes to complete.)



Important

- Errors may occur on the Sensor Controller during updating, but just wait for the update to complete.
- If the update progress bar stops midway or the update does not end even after ten minutes, there is the possibility that the update has failed. In this case, contact an OMRON branch or sales office about the firmware version before the update and the one in the write file.

6 When the update is successfully completed, a message appears. Click [OK].

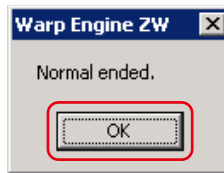

7 Click [Finish] and exit Warp Engine ZW.

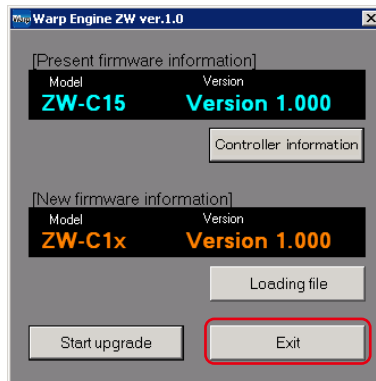

10-3 Processing Item Data List

Unit number	Processing Item	Data number	Parameter	default value	Setting range/output range	Acquisition Yes/No	Setting Yes/No
0	Image input	0	Measuring cycle	2000	500 to 10000 (μs)	Yes	No
		22	2 area mode	0	0: OFF 1: ON	Yes	Yes
		23	Area tracking mode	0	0: Tracking OFF 1: Start point tracking 2: End point tracking 3: End point/start point tracking	Yes	Yes
		30	Start direction of count measurement surfaces	0	0: NEAR 1: FAR	Yes	Yes
		39	Surface subject to area tracking (Reference surface)	0	0: SUR.1ST 1: SUR.2ND 2: SUR.3RD 3: SUR.4TH 4: LIGHT PEAK	Yes	Yes
		40	Surface subject to area tracking (Tracking surface)	1	0: SUR.1ST 1: SUR.2ND 2: SUR.3RD 3: SUR.4TH 4: LIGHT PEAK	Yes	Yes
		193	2 area teaching	–	1: Execute	No	Yes
1 (Note 1)	Exposure time control (When 2 area mode is OFF)	0	Exposure time control mode	0	0: Auto 1: Fixed	Yes	Yes
		2	Surface subject to exposure time control	4	0: SUR.1ST 1: SUR.2ND 2: SUR.3RD 3: SUR.4TH 4: LIGHT PEAK	Yes	Yes
		6	Exposure time fixed value	1000	1 to 5000 (μs)	Yes	Yes
		14	Exposure time upper limit	1000	1 to 5000 (μs)	Yes	Yes
		36	Exposure time	1000	1 to 5000 (μs)	Yes	No
		37	Received light amount (1 surface)	–	0 to 4095 (Gradation)	Yes	No
		38	Received light amount (2 surfaces)	–	0 to 4095 (Gradation)	Yes	No
		39	Received light amount (3 surfaces)	–	0 to 4095 (Gradation)	Yes	No
20	Measurement object	1	Material	0	0: Normal 1: Mirror surface 2: Diffusion surface	Yes	Yes
		4	Background removal level	100	0 to 4095 (Gradation)	Yes	Yes

(Note 1) When using exposure time control with 2 area mode ON,

Area 1 exposure time control: Unit number "4"

Area 2 exposure time control: Unit number "5"

Unit number	Processing Item	Data number	Parameter	default value	Setting range/output range	Acquisition Yes/No	Setting Yes/No
40	Measurement point	0	MEASUREMENT ITEM	1: TASK 1 0: TASK 2 to 3	0: None 1: Height 2: Thickness of transparent object 3: Calculation	Yes	Yes
		1	Measurement surface 1	4	0: SUR.1ST 1: SUR.2ND 2: SUR.3RD 3: SUR.4TH 4: LIGHT PEAK	Yes	Yes
		2	Measurement surface 2	4	0: SUR.1ST 1: SUR.2ND 2: SUR.3RD 3: SUR.4TH 4: LIGHT PEAK	Yes	Yes
		3	Calculation parameter X	0	0: None 1: TASK 1 2: TASK 2 3: TASK 3 4: TASK 4	Yes	Yes
		4	Calculation parameter Y	0	0: None 1: TASK 1 2: TASK 2 3: TASK 3 4: TASK 4	Yes	Yes
		5	Calculation parameter K	0	-999999999 to 999999999	Yes	Yes
		6	Calculation parameter m	0	-100 to 100 (1 div: 0.1)	Yes	Yes
		7	Calculation parameter n	0	-100 to 100 (1 div: 0.1)	Yes	Yes
		13	Measurement area	0	0: Area 1 1: Area 2	Yes	Yes
41	Scaling	2	Scaling mode	0	0: OFF 1: Height auto 2: Manual 3: Thickness auto	Yes	Yes
		3	Span value	10000	-20000 to 20000 (1 div: 0.1)	Yes	Yes
		4	Offset value	0	-999999999 to 999999999 (nm)	Yes	Yes
42	MEDIAN	2	Median filter mode	0	0: OFF 1: 3 times 2: 9 times 3: 15 times	Yes	Yes
43	AVERAGE	2	Average count	8: 256 times	0: Once 1: Twice 2: 4 times 3: 8 times 4: 16 times 5: 32 times 6: 64 times 7: 128 times 8: 256 times 9: 512 times 10: 1024 times 11: 2048 times 12: 4096 times	Yes	Yes

Unit number	Processing Item	Data number	Parameter	default value	Setting range/output range	Acquisition Yes/No	Setting Yes/No
44	Frequency filter	2	Filter type	0	0: OFF 1: High pass filter 2: Low pass filter 3: Band pass filter	Yes	Yes
		3	Cut-off frequency	1	1 to 999999 (1 div: 0.001)	Yes	Yes
		4	Cut-off frequency (upper)	999999	1 to 999999 (1 div: 0.001)	Yes	Yes
		5	Cut-off frequency (lower)	1	1 to 999999 (1 div: 0.001)	Yes	Yes
45	DIFFERENTIAL	2	Differential mode	0	0: OFF 1: ON	Yes	Yes
		3	Number of differential cycles	1	1 to 5000 (ms)	Yes	Yes
46	Hold	2	Hold mode	0	0: OFF 1: Peak 2: Bottom 3: Peak to peak 4: Auto peak 5: Auto bottom 6: AUTO PEAK TO PEAK 7: Average 8: Sample	Yes	Yes
		3	Trigger method	0	0: External 1: Self-up trigger 2: Self-down trigger	Yes	Yes
		4	Trigger level	0	-999999999 to 999999999 (nm)	Yes	Yes
		5	TRIGGER HYSTERESIS	0.05% of measuring range	0 to 999.999999 (mm)	Yes	Yes
		6	Trigger delay time	1	1 to 5000 (ms)	Yes	Yes
		7	Sampling time	100	1 to 5000 (ms)	Yes	Yes
		8	Trigger delay mode	0	0: OFF 1: ON	Yes	Yes
		47	Zero reset	5	Offset when a zero reset is executed Offset	0	-999999999 to 999999999 (nm)
7	ZERO RESET MODE			0	0: Real 1: Hold	Yes	Yes
64	Zero reset execution enabled/disabled (Status)			1	0: OFF 1: ON	Yes	Yes
49	Judgment output	2	LOW threshold value	-25% of measuring range	-999999999 to 999999999 (nm)	Yes	Yes
		3	HIGH threshold value	+25% of measuring range	-999999999 to 999999999 (nm)	Yes	Yes

Unit numbers 40 to 49 are parameters for the TASK 1 processing unit. To reference the parameters for the processing unit for TASK N, add $20 \times (N - 1)$ to the unit number you want to reference.
(Example)

To change the average processing for TASK 2, reference the parameters for
Processing unit number = $43 + 20 \times (2 - 1) = 63$
Data number = 2

Unit number	Processing Item	Data number	Parameter	default value	Setting range/output range	Acquisition Yes/No	Setting Yes/No
120	Judgment processing	0	Hysteresis width	0.05% of measuring range	0 to 999999999 (nm)	Yes	Yes
		1	Timer mode	0	0: OFF 1: Off delay 2: On delay 3: One shot	Yes	Yes
		2	Delay time	1	1 to 5000 (ms)	Yes	Yes
		3	Task subject to judgment output	0	0: TASK 1 1: TASK 2 2: TASK 3 3: TASK 4	Yes	Yes
121	Non-measurement processing	0	Mode at non-measurement	1	0: Keep 1: Clamp	Yes	Yes
122	Analog output	2	Monitor focus mode	0	0: OFF 1: ON	Yes	Yes
		3	Monitor focus output position 1	- (measuring range)/2	-999999999 to 999999999 (nm)	Yes	Yes
		4	Monitor focus output position 2	+ (measuring range)/2	-999999999 to 999999999 (nm)	Yes	Yes
		5	Monitor focus current lower limit	4	4 to 20 (mA)	Yes	Yes
		6	Monitor focus current upper limit value	20	4 to 20 (mA)	Yes	Yes
		7	Monitor focus voltage lower limit value	-10	-10 to 10 (V)	Yes	Yes
		8	Monitor focus voltage upper limit value	10	-10 to 10 (V)	Yes	Yes
		21	Output object task	1	0: None 1: TASK 1 2: TASK 2 3: TASK 3 4: TASK 4	Yes	Yes
		23	Output level during clamping	0	At current output 0: MAX (approx. 21 mA) 1: 20 mA 2: 19 mA : 16: 5 mA 17: 4 mA 18: MIN (approx. 3 mA) At voltage output 0: MAX (approx. 10.8 V) 1: 10 V 2: 9 V : 20: -9 V 21: -10V 22: MIN (approx. -10.8 V)	Yes	Yes

10-4 System data list

Data number	Parameter	default value	Setting range/output range	Acquisition Yes/No	Setting Yes/No
100	RS-232C data length	1	0: 7 bit 1: 8 bit	Yes	Yes
101	RS-232C parity	0	0: None 1: Off 2: Even	Yes	Yes
102	RS-232C stop bit	0	0: 1 bit 1: 2 bit	Yes	Yes
103	RS-232C baud rate	2	0: 9600 1: 19200 2: 38400 3: 57600 4: 115200	Yes	Yes
104	Flow control	0	0: None 1: ON	Yes	Yes
260	Ethernet protocol	1	0: None 1: TCP server 2: TCP client 3: UDP	Yes	Yes
261	IN port number	9601	0 to 65535	Yes	Yes
262	OUT port number	9601	0 to 65535	Yes	Yes
300	Memory link function	2	0: OFF 1: Ethernet/IP 2: EtherCAT	Yes	Yes
301	Communications delimiter	0	0: CR 1: LF 2: CR+LF	Yes	Yes
302	GATE period	1	0 to 100	Yes	Yes
400	Serial data output destination	0	0: OFF 1: Ethernet 2: RS-232C	Yes	Yes
401	Serial data output data format	0	0: ASCII 1: BINARY	Yes	Yes
402	Serial data output number of integer digits	5	1 to 5	Yes	Yes
403	Serial data output number of digits past decimal point	6	0 to 6	Yes	Yes
405	Serial data output field delimiter	0	0: None 1: Comma 2: Tab 3: Space 4: CR 5: LF 6: CR+LF 7: Semi-colon	Yes	Yes
406	Serial data output record delimiter	0	0: None 1: Comma 2: Tab 3: Space 4: CR 5: LF 6: CR+LF 7: Semi-colon	Yes	Yes
407	Serial data output zero suppress	0	0: None 1: ON	Yes	Yes

Data number	Parameter	default value	Setting range/output range	Acquisition Yes/No	Setting Yes/No
500	Analog output destination	0	0: Voltage 1: Current	Yes	Yes
600	Bank mode	0	0: Normal 1: Judgment value	Yes	Yes
601	Current bank number	0	0 to 7: Banks 1 to 8 (start bank number) 0 to 31: Banks 1 to 32 (start judgment value bank number)	Yes	Yes
750	LOGGING save count	12800	0 to 128000	Yes	Yes
750	LOGGING save intervals	1	0 to 1000	Yes	Yes
900	Number of digits displayed past decimal point	1	0 to 5: 0 to 5 digits	Yes	Yes
901	Key lock	0	0: OFF 1: ON	Yes	Yes
902	Timing/reset key input control	0	0: OFF 1: ON	Yes	Yes
1000	Zero reset memory	0	0: OFF 1: ON	Yes	Yes

10-5 Object Dictionary

Object Dictionary Area

The CAN application protocol over EtherCAT (CoE) is based on the object dictionary of the CAN application protocol. All objects are assigned a 4-digit hex index and comprise the following areas.

Index	Area	Description
0000 hex to 0FFF hex	Data type area	Definition of data type
1000 hex to 1FFF hex	CoE communications area	Definition of variables that can be used for all servers intended for exclusive communications
2000 hex to 2FFF hex	Manufacturer unique area 1	Variables defined in common to all OMRON products
3000 hex to 5FFF hex	Manufacturer unique area 2	Variables defined on ZW series EtherCAT slaves
6000 hex to 9FFF hex	Device profile area	Unused (not supported)
A000 hex to FFFF hex	Reserved area	Area reserved for use in the future

Data type

The following data types are used by this profile.

Data type	Abbreviation	Size	Range
Boolean	BOOL	1 bit	true (1), false (0)
Unsigned 8	U8	1 byte	0 to 255
Unsigned 16	U16	2 bytes	0 to 65535
Unsigned 32	U32	4 bytes	0 to 4294967295
Integer 8	INT8	1 byte	-128 to 127
Integer 16	INT16	2 bytes	-32768 to 32767
Integer 32	INT32	4 bytes	-2147483648 to 2147483647
Visible string	VS	–	–

Description Format of Objects

This manual describes objects in the following format.

Object description format

<Index>	<Object name>		
Setting range: <Setting range>	Unit: <Unit>	Factory setting: <Factory setting>	Data attribute: <Data attribute>
Size: <Size>	Access: <Access>	PDO map: <Yes/No>	

Object description format when objects have a sub-index

<Index>	<Object name>		
Sub-index 0			
Setting range: <Setting range>	Unit: <Unit>	Factory setting: <Factory setting>	Data attribute: <Data attribute>
Size: <Size>	Access: <Access>	PDO map: <Yes/No>	
.			
.			
.			
Sub-index N			
Setting range: <Setting range>	Unit: <Unit>	Factory setting: <Factory setting>	Data attribute: <Data attribute>
Size: <Size>	Access: <Access>	PDO map: <Yes/No>	

<> indicates the data. Data details are shown as follows.

- Index : Index of object indicated as a 4-digit hex number
- Object name : Object name
- Range : Range of numerical values that can be set
- Unit : Physical unit
- Factory setting : Default value set at shipment of product from the factory
- Data attributes : Timing that changes are enabled by writable objects
 - A: Enabled at all times
 - B: Count stopped → operation timing
 - C: Pre-operational state → safe operational state timing
 - D: Pre-operational state → initialization state timing
 - R: Power reset
 - : Not writable
- Size : The size of objects is indicated in bytes.
- Access : Indicates read-only or read/write.
 - RO: Read-only
 - RW: Read/write
- PDO map : Indicates mappability to PDO.

Communication Object

1000 hex	Device Type		
Setting range: –	Unit: –	Factory setting: 00000000 hex	Data attributes: –
Size: 4 bytes (U32)	Access: RO	PDO map: Not possible	

- The ZW series does not support device profiles.

1001 hex	Error Register		
Setting range: –	Unit: –	Factory setting: 00 hex	Data attributes: –
Size: 1 byte (U8)	Access: RO	PDO map: Not possible	

- Indicates the error type that occurred on the slave.

Bit	Name	Bit	Name
0	General error	4	Communication error
1	Current error	5	Error unique to device profile
2	Voltage error	6	(Reserved)
3	Temperature error	7	Manufacturer unique error

1008 hex	Manufacturer Device Name		
Setting range: –	Unit: –	Factory setting: For each slave type *	Data attributes: –
Size: 20 bytes (VS)	Access: RO	PDO map: Not possible	

- Displays the model of the slave.

1009 hex	Manufacturer Hardware Version		
Setting range: –	Unit: –	Factory setting: For each slave type *	Data attributes: –
Size: 20 bytes (VS)	Access: RO	PDO map: Not possible	

- Displays the hardware version of the slave.

100A hex	Manufacturer Software Version		
Setting range: –	Unit: –	Factory setting: For each slave type *	Data attributes: –
Size: 20 bytes (VS)	Access: RO	PDO map: Not possible	

- Displays the software version of the slave.

*: The device type, device name, hardware version, and software version factory settings are as follows according to the slave.

Model	Manufacture device name	Manufacture hardware version	Manufacture software version
ZW-CE10T ZW-CE15T	ZW-CE1x	Space (20 hex) 20 characters	"C1.00 " (Space (20 hex)) 15 characters

1011 hex	Restore Default Parameters		
Sub-index 0: Number of entries			
Setting range: –	Unit: –	Factory setting: 01 hex	Data attributes: –
Size: 1 byte (U8)	Access: RO	PDO map: Not possible	
Sub-index 1: Restore Default Parameters			
Setting range: –	Unit: –	Factory setting: 00000001 hex	Data attribute: A
Size: 4 bytes (U32)	Access: RW	PDO map: Not possible	

- Returns parameters to their factory setting values.
- Parameters are restored only when a specific numerical value is written to sub-index 1 so that parameters are not restored by mistake.
- Specific numerical value means "load".

MSB

LSB

d	a	o	l
64 hex	61 hex	6F hex	6C hex

- The ABORT code is indicated when a value other than the specific numerical value is written.
- During a read, 0000 0001 hex (command enabled) is indicated.
- This is not supported on the ZW series.

1018 hex	Identity Object		
Sub-index 0: Number of entries			
Setting range: –	Unit: –	Factory setting: 04 hex	Data attributes: –
Size: 1 byte (U8)	Access: RO	PDO map: Not possible	
Sub-index 1: Vendor ID			
Setting range: –	Unit: –	Factory setting: 00000083 hex	Data attributes: –
Size: 4 bytes (U32)	Access: RO	PDO map: Not possible	
Sub-index 2: Product Code			
Setting range: –	Unit: –	Factory setting: For each slave type*	Data attributes: –
Size: 4 bytes (U32)	Access: RO	PDO map: Not possible	
Sub-index 3: Revision Number			
Setting range: –	Unit: –	Factory setting: For each slave type*	Data attributes: –
Size: 4 bytes (U32)	Access: RO	PDO map: Not possible	
Sub-index 4: Serial Number			
Setting range: –	Unit: –	Factory setting: For each unit	Data attributes: –
Size: 4 bytes (U32)	Access: RO	PDO map: Not possible	

- This object indicates the device information.
- Sub-index 1 (Vendor ID) indicates the manufacturer identifier.
- For sub-index 2 (Product Code), a value assigned to each slave type is indicated.
- For sub-index 3 (Revision Number), the revision number of the unit is indicated.
- Bits 0 to 15: Minor revision number of device
- Bits 16 to 31: Major revision number of device
- For sub-index 4 (Serial Number), the serial number given to each product is indicated.
- In unit version Ver.1.0, the serial number is always indicated as 00000000 hex.

* The value of Identity object is as follows according to the slave.

Model	Product Code (hex)	Revision Number (hex)
ZW-CE10T ZW-CE15T	–	00010000

10F3 hex	Diagnosis History		
Sub-index 0: Number of entries			
Setting range: –	Unit: –	Factory setting: 0D hex	Data attributes: –
Size: 1 byte (U8)	Access: RO	PDO map: Not possible	
Sub-index 1: Maximum Messages			
Setting range: –	Unit: –	Factory setting: 00 hex	Data attributes: –
Size: 1 byte (U8)	Access: RO	PDO map: Not possible	
Sub-index 2: Newest Message			
Setting range: –	Unit: –	Factory setting: –	Data attributes: –
Size: 1 byte (U8)	Access: RO	PDO map: Not possible	
Sub-index 5: Flags			
Setting range: 0000 hex-0001 hex	Unit: –	Factory setting: 0000 hex	Data attributes: –
Size: 2 bytes (U16)	Access: RW	PDO map: Not possible	
Sub-index 6 to 13: Diagnosis Message 1 to 8			
Setting range: –	Unit: –	Factory setting: –	Data attributes: –
Size: 23 bytes (VS)	Access: RO	PDO map: Not possible	

- This object indicates a maximum of 8 diagnosis histories. It also sets emergency message enabled/disabled.
- Sub-index 1 (Maximum Messages) indicates the number of error messages.
- Sub-index 2 (Newest Messages) indicates the sub-index number of the latest diagnosis history.
- Sub-index 5 (Flags) is the control flag of the diagnosis history. This sets whether or not to notify error messages as emergency messages. 0001 hex sets to notify as an emergency message, and 0000 hex sets not to notify as an emergency message. When the power is started up, the setting is 0000 hex (Emergency non-notification).
- Sub-index 6 to 13 (Diagnosis message 1 to 8) indicates the diagnosis history.
From Sub-index 6 (Diagnosis message 1) to sub-index 13 (Diagnosis message 8), 8 errors are stored successively.
For the 9th error, sub-index 6 (Diagnosis message 1) is returned to and an error is stored there.
- The ZW series supports only Flags.

PDO Mapping Object

From index 1600 hex to 17FF hex and from 1A00 hex to 1BFF hex are used for setting receive PDO mapping and transmit PDO mapping, respectively. Sub-index 1 onwards indicate the information of application objects to be mapped.

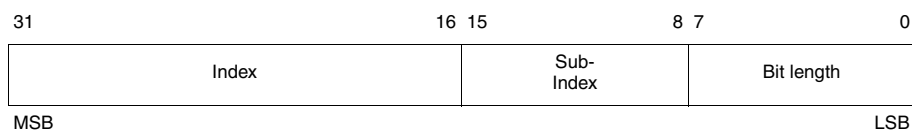

Bits 0 to 7 : Bit length of mapped object
(For example, in the case of 32 bits, 20 hex is indicated.)

Bits 8 to 15 : Sub-index of mapped object

Bits 16 to 31 : Index of mapped object

16FF hex	256th receive PDO Mapping		
Sub-index 0: Number of objects			
Setting range: –	Unit: –	Factory setting: 01 hex	
Size: 1 byte (U8)	Access: RO	PDO map: Not possible	
Sub-index 1: 1st Output Object to be mapped			
Setting range: –	Unit: –	Factory setting: 3000120 hex	
Size: 4 bytes (U32)	Access: RO	PDO map: Not possible	

- Mapping for applications that use displacement sensor functions.
- 3000 hex (control signal) is mapped in four bytes.
- This object is excluded from being applied when 1700 hex (257th receive PDO mapping) is selected.

1700 hex	257th receive PDO Mapping		
Sub-index 0: Number of objects			
Setting range: –	Unit: –	Factory setting: 20 hex	
Size: 1 byte (U8)	Access: RO	PDO map: Not possible	
Sub-index 1 to 32: 1st-32th Output Object to be mapped			
Setting range: –	Unit: –	Factory setting: 3000201 to 30002101 hex	
Size: 4 bytes (U32)	Access: RO	PDO map: Not possible	

- Mapping for applications that use displacement sensor functions.
- 3000 hex (control signal) is mapped in 1-byte units.
- This object is excluded from being applied when 16FF hex (257th receive PDO mapping) is selected.

1701 hex	258th receive PDO Mapping		
Sub-index 0: Number of objects			
Setting range: –	Unit: –	Factory settings: 04 hex	
Size: 1 byte (U8)	Access: RO	PDO map: Not possible	
Sub-index 1: 1st Output Object to be mapped			
Setting range: –	Unit: –	Factory settings: 30020020 hex	
Size: 4 bytes (U32)	Access: RO	PDO map: Not possible	
Sub-index 2: 2nd Output Object to be mapped			
Setting range: –	Unit: –	Factory setting: 30100120 hex	
Size: 4 bytes (U32)	Access: RO	PDO map: Not possible	
Sub-index 3: 3rd Output Object to be mapped			
Setting range: –	Unit: –	Factory setting: 30100220 hex	
Size: 4 bytes (U32)	Access: RO	PDO map: Not possible	
Sub-index 4: 4th Output Object to be mapped			
Setting range: –	Unit: –	Factory setting: 30100320 hex	
Size: 4 bytes (U32)	Access: RO	PDO map: Not possible	
<ul style="list-style-type: none"> • Mapping for applications that use displacement sensor functions. • 3002 hex (Command code) • 3010 hex (Command execution parameter 1-3) 			

1AFF hex	256th transmit PDO Mapping		
Sub-index 0: Number of objects			
Setting range: –	Unit: –	Factory setting: 01 hex	
Size: 1 byte (U8)	Access: RO	PDO map: Not possible	
Sub-index 1: 1st Input Object to be mapped			
Setting range: –	Unit: –	Factory setting: 30010120 hex	
Size: 4 bytes (U32)	Access: RO	PDO map: Not possible	
<ul style="list-style-type: none"> • Mapping for applications that use displacement sensor functions. • 3001 hex (status signal) is mapped in four bytes. • This object is excluded from being applied when 1B700 hex (257th transmit PDO mapping) is selected. 			

1B00 hex	257th transmit PDO Mapping		
Sub-index 0: Number of objects			
Setting range: –	Unit: –	Factory setting: 20 hex	
Size: 1 byte (U8)	Access: RO	PDO map: Not possible	
Sub-index 1 to 32: 1st-32th Input Object to be mapped			
Setting range: –	Unit: –	Factory setting: 30010201 to 30012101 hex	
Size: 4 bytes (U32)	Access: RO	PDO map: Not possible	
<ul style="list-style-type: none"> • Mapping for applications that use displacement sensor functions. • 3001 hex (status signal) is mapped in 1-byte units. • This object is excluded from being applied when 1AFF hex (256th transmit PDO mapping) is selected. 			

1B01 hex	258th transmit PDO Mapping		
Sub-index 0: Number of objects			
Setting range: –	Unit: –	Factory settings: 04 hex	
Size: 1 byte (U8)	Access: RO	PDO map: Not possible	
Sub-index 1: 1st Input Object to be mapped			
Setting range: –	Unit: –	Factory settings: 30030020 hex	
Size: 4 bytes (U32)	Access: RO	PDO map: Not possible	
Sub-index 2: 2nd Input Object to be mapped			
Setting range: –	Unit: –	Factory settings: 30040020 hex	
Size: 4 bytes (U32)	Access: RO	PDO map: Not possible	
Sub-index 3: 3rd Input Object to be mapped			
Setting range: –	Unit: –	Factory settings: 30050120 hex	
Size: 4 bytes (U32)	Access: RO	PDO map: Not possible	
Sub-index 4: 4th Input Object to be mapped			
Setting range: –	Unit: –	Factory settings: 30060020 hex	
Size: 4 bytes (U32)	Access: RO	PDO map: Not possible	
<ul style="list-style-type: none"> • Mapping for applications that use displacement sensor functions. • 3003 hex (Response command code) • 3004 hex (Response code) • 3005 hex (Response date 1) • 3006 hex (Extended data) 			

1B02 hex	259th transmit PDO Mapping		
Sub-index 0: Number of objects			
Setting range: –	Unit: –	Factory settings: 08 hex	
Size: 1 byte (U8)	Access: RO	PDO map: Not possible	
Sub-index 1-8: 1st-8th Input Object to be mapped			
Setting range: –	Unit: –	Factory settings: 30200120 to 30200820 hex	
Size: 4 bytes (U32)	Access: RO	PDO map: Not possible	
<ul style="list-style-type: none"> • Mapping for applications that use displacement sensor functions. • 3020 hex (Output data 1 to 8) 			

1B03 hex	260th transmit PDO Mapping		
Sub-index 0: Number of objects			
Setting range: –	Unit: –	Factory settings: 08 hex	
Size: 1 byte (U8)	Access: RO	PDO map: Not possible	
Sub-index 1 to 8: 1st-8th Input Object to be mapped			
Setting range: –	Unit: –	Factory settings: 30200920 to 30201020 hex	
Size: 4 bytes (U32)	Access: RO	PDO map: Not possible	
<ul style="list-style-type: none"> • Mapping for applications that use displacement sensor functions. • 3020 hex (Output data 9 to 16) • This object is excluded from being applied when 1B04 hex (261th transmit PDO mapping) or 1B05 hex (262th transmit PDO mapping) is selected. 			

1B04 hex	261th transmit PDO Mapping		
Sub-index 0: Number of objects			
Setting range: –	Unit: –	Factory settings: 18 hex	
Size: 1 byte (U8)	Access: RO	PDO map: Not possible	
Sub-index 1 to 24: 1st-24th Input Object to be mapped			
Setting range: –	Unit: –	Factory settings: 30200920 to 30202020 hex	
Size: 4 bytes (U32)	Access: RO	PDO map: Not possible	
<ul style="list-style-type: none"> • Mapping for applications that use displacement sensor functions. • 3020 hex (Output data 9 to 32) • This object is excluded from being applied when 1B03 hex (260th transmit PDO mapping) or 1B05 hex (262th transmit PDO mapping) is selected. 			

1B05 hex	262th transmit PDO Mapping		
Sub-index 0: Number of objects			
Setting range: –	Unit: –	Factory settings: 38 hex	
Size: 1 byte (U8)	Access: RO	PDO map: Not possible	
Sub-index 1 to 56: 1st-56th Input Object to be mapped			
Setting range: –	Unit: –	Factory settings: 30200920 to 30204020 hex	
Size: 4 bytes (U32)	Access: RO	PDO map: Not possible	
<ul style="list-style-type: none"> • Mapping for applications that use displacement sensor functions. • 3020 hex (Output data 9 to 64) • This object is excluded from being applied when 1B03 hex (260th transmit PDO mapping) or 1B04 hex (261th transmit PDO mapping) is selected. 			

1BFF hex	512th transmit PDO Mapping		
Sub-index 0: Number of objects in this PDO			
Setting range: –	Unit: –	Factory setting: 01 hex	Data attributes: –
Size: 1 byte (U8)	Access: RO	PDO map: Not possible	
Sub-index 1: 1st Input Object to be mapped			
Setting range: –	Unit: –	Factory setting: 20020108 hex	Data attributes: –
Size: 4 bytes (U32)	Access: RO	PDO map: Not possible	
<ul style="list-style-type: none"> • This object is mapping for the slave to notify that it detected an error. • 2002 hex to 01 hex: Sysmac error status is mapped. • When connected to the machine automation controller NJ series, 1C13 hex: This object is assigned to the Sync Manager 3PDO assignment. By the Sysmac Studio default setting, this object is automatically assigned. 			

Sync Manager Communication Object

Memory for EtherCAT is set by objects from 1C00 hex to 1C13 hex.

1C00 hex	Sync Manager Communication Type		
Sub-index 0: Number of used SM channels			
Setting range: –	Unit: –	Factory setting: 04 hex	Data attributes: –
Size: 1 byte (U8)	Access: RO	PDO map: Not possible	
Sub-index 1: Communication Type Sync Manager 0			
Setting range: –	Unit: –	Factory setting: 01 hex	Data attributes: –
Size: 4 bytes (U8)	Access: RO	PDO map: Not possible	
Sub-index 2: Communication Type Sync Manager 1			
Setting range: –	Unit: –	Factory setting: 02 hex	Data attributes: –
Size: 4 bytes (U8)	Access: RO	PDO map: Not possible	
Sub-index 3: Communication Type Sync Manager 2			
Setting range: –	Unit: –	Factory setting: 03 hex	Data attributes: –
Size: 4 bytes (U8)	Access: RO	PDO map: Not possible	
Sub-index 4: Communication Type Sync Manager 3			
Setting range: –	Unit: –	Factory setting: 04 hex	Data attributes: –
Size: 4 bytes (U8)	Access: RO	PDO map: Not possible	

• Sync Manager is set as follows:

- SM0: Mailbox receive (EtherCAT master → slave)
- SM1: Mailbox transmit (slave → EtherCAT master)
- SM2: Process data output EtherCAT master → slave)
- SM3: Process data output (slave → EtherCAT master)

1C10 hex	Sync Manager 0 PDO Assignment		
Sub-index 0: Number of assigned PDOs			
Setting range: 00 hex	Unit: –	Factory setting: 00 hex	Data attributes: –
Size: 1 byte (U8)	Access: RO	PDO map: Not possible	

- Indicates the number of PDO mappings used by this Sync Manager.
- The mailbox receive Sync Manager does not have PDOs.

1C11 hex	Sync Manager 1 PDO Assignment		
Sub-index 0: Number of assigned PDOs			
Setting range: 00 hex	Unit: –	Factory setting: 00 hex	Data attributes: –
Size: 1 byte (U8)	Access: RO	PDO map: Not possible	

- Indicates the number of PDO mappings used by this Sync Manager.
- The mailbox transmit Sync Manager does not have PDOs.

1C12 hex	Sync Manager 2 PDO Assignment		
Sub-index 0: Number of assigned receiving PDOs			
Setting range: –	Unit: –	Factory setting: 02Hex	Data attributes: –
Size: 1 byte (U8)	Access: RW*	PDO map: Not possible	
Sub-index 1 to 2: 1st-2nd PDO Mapping Object Index of assigned PDO			
Setting range: –	Unit: –	Factory setting: For each slave type*	Data attributes: –
Size: 2 bytes (U16)	Access: RW*	PDO map: Not possible	

*: When no receive PDO is held, access becomes "RO".

- Indicates the receive PDO used by this Sync Manager.

1C13 hex	Sync Manager 3 PDO Assignment		
Sub-index 0: Number of assigned transmit PDOs			
Setting range: –	Unit: –	Factory setting: 05 hex	Data attributes: –
Size: 1 byte (U8)	Access: RW*	PDO map: Not possible	
Sub-index 1 to 5: 1st-5th PDO Mapping Object Index of assigned PDO			
Setting range: –	Unit: –	Factory setting: For each slave type*	Data attributes: –
Size: 2 bytes (U16)	Access: RW*	PDO map: Not possible	

*: When no transmit PDO is held, access becomes "RO".

- Indicates the transmit PDO used by this Sync Manager.

*: The factory settings of Sync manager 2 PDO assignment and Sync manager 3 PDO assignment differ for OMRON tools and tools made by other manufacturers. Factory settings are as follows.

Factory settings for OMRON tools (when an NJ series Controller is used in Sysmac Studio)

Model		ZW-CE1□ (all models)	
Sync manager 2 PDO assignment (Hex)	Number of assignment RxPDO	02 hex	
	Assigned PDO	1	16FF hex (256th receive PDO Mapping)
		2	1701 hex (258th receive PDO Mapping)
Sync manager 3 PDO assignment (Hex)	Number of assignment RxPDO	04 hex	
	Assigned PDO	1	1AFF hex (256th transmit PDO Mapping)
		2	1B01 hex (258th transmit PDO Mapping)
		3	1B02 hex (259th transmit PDO Mapping)
		4	–
		5	1BFF hex (512th transmit PDO Mapping)

OMRON tool (when the position control unit CJ1W-NC□8□ is used in CX-Programmer)

Model		ZW-CE1□ (all models)	
Sync manager 2 PDO assignment (Hex)	Number of assigned RxPDOs	02 hex	
	Assigned PDO	1	16FF hex (256th receive PDO Mapping)
		2	1701 hex (258th receive PDO Mapping)
Sync manager 3 PDO assignment (Hex)	Number of assigned RxPDOs	03 hex	
	Assigned PDO	1	1AFF hex (256th transmit PDO Mapping)
		2	1B01 hex (258th transmit PDO Mapping)
		3	1B02 hex (259th transmit PDO Mapping)
		4	–
		5	–

Tools made by other manufacturers

Model		ZW-CE1□ (all models)	
Sync manager 2 PDO assignment (Hex)	Number of assignment RxPDO	02 hex	
	Assigned PDO	1	1700 hex (257th receive PDO Mapping)
		2	1701 hex (258th receive PDO Mapping)
Sync manager 3 PDO assignment (Hex)	Number of assignment RxPDO	03 hex	
	Assigned PDO	1	1B00 hex (257th transmit PDO Mapping)
		2	1B01 hex (258th transmit PDO Mapping)
		3	1B02 hex (259th transmit PDO Mapping)
		4	–
		5	–

Manufacturer Unique Objects

This section describes the CiA401 generic I/O module device profile mounted on ZW series EtherCAT slaves and mounted objects that are unique to ZW series EtherCAT slaves.

Siemac device common objects

• Manufacturer unique area 1

2100 hex	Error History Clear		
Setting range: –	Unit: –	Factory setting: 00000000 hex	Data attribute: A
Size: 4 bytes (U32)	Access: RW	PDO map: Not possible	

- This object clears the diagnosis history of 10F3 hex (Diagnosis History).
- The diagnosis history is cleared only when a specific numerical value is written. Specific numerical value means "elcl".

MSB

LSB

l	c	l	e
6C hex	63 hex	6C hex	65 hex

Writing of values other than these numeric values is invalid.

2002 hex	Sysmac Error		
Sub-index 0: Number of entries			
Setting range: –	Unit: –	Factory setting: 02 hex	Data attributes: –
Size: 1 byte (U8)	Access: RO	PDO map: Not possible	
Sub-index 1: Sysmac Error Status			
Setting range: –	Unit: –	Factory setting: 00 hex	Data attributes: –
Size: 1 byte (U8)	Access: RO	PDO map: Possible	
Sub-index 2: Sysmac Error Status Clear			
Setting range: –	Unit: –	Factory setting: 00 hex	Data attribute: A
Size: 1 byte (U8)	Access: RW	PDO map: Not possible	

- Notifies and clears Sysmac error status.
- Sub-index 1: Sysmac Error Status
 - This object is for the slave to notify that it detected an error.
 - When connected to a machine automation controller NJ series, this object is mapped to the PDO.
- Sub-index 2: Sysmac Error Status Clear
 - This object is for the Controller of the Sysmac device to reset the error occurring on the slave.

Note

With the Sysmac studio default setting, sub-index 1: System Error Status is automatically mapped to the PDO by the assignment of 1BFF hex: 512th transmit PDO mapping.

2200 hex	Communication Error Setting		
Setting range: 00 hex to 0F hex	Unit: Times	Factory setting: 01 hex	Data attribute: C
Size: 1 byte (U8)	Access: RW	PDO map: Not possible	

- This object is mounted only on slaves running in the DC mode.
- This object sets the continuous number of times that a communications error is detected.
- The setting range is 00 to 0Fh, and the detection count is "set count +1".
- When the slave is running in the DC mode, values can be rewritten. However, the slave runs at the preset value when the state migrates from pre-operational to save operational. The newly rewritten value is read as the read value at this time.

Note

With the factory setting of 01 hex, an error is detected when a communications error is detected twice consecutively.

2201 hex	Sync Not Received Timeout Setting		
Setting range: 0000 hex to 0258 hex	Unit: s	Factory setting: 0000 hex	Data attribute: C
Size: 2 bytes (U16)	Access: RW	PDO map: Not possible	

- This object is mounted only on slaves running in the DC mode.
- This object sets the standby time until the first sync interrupt signal (SYNC 0) is input after the state migrates to safe operational (state in which DC mode operation is determined).
- If no initial interrupt signal (SYNC 0) is input during this preset time, a sync error occurs.
- The setting range is 0000 hex to 0258 hex (600 s), and operation is performed at 120 s when 0000 hex is set.
- When the slave is running in the DC mode, values can be rewritten. However, the slave runs at the preset value when the state migrates from pre-operational to save operational. The newly rewritten value is read as the read value at this time.

Displacement Sensor Specific Objects

• Object specifications (PDO)

3000 hex	Common Control Flag		
Sub-index 0: Number of entries			
Setting range: –	Unit: –	Factory setting: –	
Size: 1 byte (U8)	Access: RO	PDO map: Not possible	
Sub-index 1: Common Control Flag			
Setting range: –	Unit: –	Factory setting: 00000000 hex	
Size: 4 bytes (U32)	Access: RW	PDO map: R	
Sub-index 2: EXE Bit			
Setting range: True (1) or False (0)	Unit: –	Setting range: False (0)	
Size: 1 bit (BOOL)	Access: RW	PDO map: R	
Sub-index 3: SYNC Bit			
Setting range: True (1) or False (0)	Unit: –	Factory setting: –	
Size: 1 bit (BOOL)	Access: RW	PDO map: R	
Sub-index 4 to 17: Common Control Reserve Bit 02 to 15			
Setting range: True (1) or False (0)	Unit: –	Setting range: False (0)	
Size: 1 bit (BOOL)	Access: RW	PDO map: R	
Sub-index 18: ERRCLR Bit			
Setting range: True (1) or False (0)	Unit: –	Setting range: False (0)	
Size: 1 bit (BOOL)	Access: RW	PDO map: R	
Sub-index 19 to 33: Common Control Reserve Bit 17 to 31			
Setting range: True (1) or False (0)	Unit: –	Setting range: False (0)	
Size: 1 bit (BOOL)	Access: RW	PDO map: R	

- This object controls the displacement sensor.
- EXE Bit: This is set to execute a command.
- ERRCLR bit: This is set to clear the ERR bit (XXX).

3001 hex	Sensor Head 1 Control Flag		
Sub-index 0: Number of entries			
Setting range: –	Unit: –	Factory setting: –	
Size: 1 byte (U8)	Access: RO	PDO map: Not possible	
Sub-index 1: Sensor Head 1 Control Flag			
Setting range: –	Unit: –	Factory setting: 00000000 hex	
Size: 4 bytes (U32)	Access: RW	PDO map: R	
Sub-index 2: TIMING 1 Bit			
Setting range: True (1) or False (0)	Unit: –	Setting range: False (0)	
Size: 1 bit (BOOL)	Access: RW	PDO map: R	
Sub-index 3: RESET 1 Bit			
Setting range: True (1) or False (0)	Unit: –	Setting range: False (0)	
Size: 1 bit (BOOL)	Access: RW	PDO map: R	
Sub-index 4: LIGHTOFF 1 Bit			
Setting range: True (1) or False (0)	Unit: –	Setting range: False (0)	
Size: 1 bit (BOOL)	Access: RW	PDO map: R	
Sub-index 5 to 17: Sensor Head 1 Control Reserve Bit 3 to 15			
Setting range: True (1) or False (0)	Unit: –	Setting range: False (0)	
Size: 1 bit (BOOL)	Access: RW	PDO map: R	
Sub-index 18 to 21: ZERO 1_T1 to T4 Bit			
Setting range: True (1) or False (0)	Unit: –	Setting range: False (0)	
Size: 1 bit (BOOL)	Access: RW	PDO map: R	
Sub-index 22 to 25: ZEROCLR 1_T1 to T4 Bit			
Setting range: True (1) or False (0)	Unit: –	Setting range: False (0)	
Size: 1 bit (BOOL)	Access: RW	PDO map: R	
Sub-index 26 to 33: Sensor Head 1 Control Reserve Bit 24 to 31			
Setting range: True (1) or False (0)	Unit: –	Setting range: False (0)	
Size: 1 bit (BOOL)	Access: RW	PDO map: R	

- This object controls sensor head 1 of the displacement sensor.

3003 hex	Command code		
Sub-index: –			
Setting range: –	Unit: –	Factory setting: –	
Size: 4 bytes (U32)	Access: RW	PDO map: R	

- Commands such as bank switching are stored.

3004 hex	Command parameter		
Sub-index 0: Number of entries			
Setting range: –	Unit: –	Factory setting: –	
Size: 1 byte (U8)	Access: RO	PDO map: Not possible	
Sub-index 1 to 2: Command parameter 1 to 2			
Setting range: –	Unit: –	Factory setting: –	
Size: 2 bytes (U16)	Access: RW	PDO map: R	
Sub-index 3: Command parameter 3			
Setting range: –	Unit: –	Factory setting: –	
Size: 4 bytes (U32)	Access: RW	PDO map: R	

- Command parameters are stored. (Example: When the bank switching command is executed, the bank number is stored.)

3010 hex	Common Status Flag		
Sub-index 0: Number of entries			
Setting range: –	Unit: –	Factory setting: –	
Size: 1 byte (U8)	Access: RO	PDO map: Not possible	
Sub-index 1: Status Flag			
Setting range: –	Unit: –	Factory setting: –	
Size: 4 bytes (U32)	Access: RO	PDO map: T	
Sub-index 2: FLG Bit			
Setting range: True (1) or False (0)	Unit: –	Factory setting: –	
Size: 1 bit (BOOL)	Access: RO	PDO map: T	
Sub-index 3: SYNCFLG Bit			
Setting range: True (1) or False (0)	Unit: –	Factory setting: –	
Size: 1 bit (BOOL)	Access: RO	PDO map: T	
Sub-index 4: READY Bit			
Setting range: True (1) or False (0)	Unit: –	Factory setting: –	
Size: 1 bit (BOOL)	Access: RO	PDO map: T	
Sub-index 5: Common Status Reserve Bit 03			
Setting range: True (1) or False (0)	Unit: –	Factory setting: –	
Size: 1 bit (BOOL)	Access: RO	PDO map: T	
Sub-index 6: RUN Bit			
Setting range: True (1) or False (0)	Unit: –	Factory setting: –	
Size: 1 bit (BOOL)	Access: RO	PDO map: T	
Sub-index 7 to 12: Common Control Reserve Bit 05 to 10			
Setting range: True (1) or False (0)	Unit: –	Factory setting: –	
Size: 1 bit (BOOL)	Access: RO	PDO map: T	
Sub-index 13 to 17: BANKOUT 1_A to E Bit			
Setting range: True (1) or False (0)	Unit: –	Factory setting: –	
Size: 1 bit (BOOL)	Access: RO	PDO map: T	

Sub-index 18: ERR Bit		
Setting range: True (1) or False (0)	Unit: –	Factory setting: –
Size: 1 bit (BOOL)	Access: RO	PDO map: T
Sub-index 19 to 33: Common Status Reserve Bit 17 to 31		
Setting range: True (1) or False (0)	Unit: –	Factory setting: –
Size: 1 bit (BOOL)	Access: RO	PDO map: T
• This object acquires the status of the displacement sensor.		
3011 hex	Sensor Head 1 Status Flag	
Sub-index 0: Number of entries		
Setting range: –	Unit: –	Factory setting: –
Size: 1 byte (U8)	Access: RO	PDO map: Not possible
Sub-index 1: Sensor Head 1 Status Flag		
Setting range: –	Unit: –	Factory setting: –
Size: 4 bytes (U32)	Access: RO	PDO map: T
Sub-index 2: HOLDSTAT 1 Bit		
Setting range: True (1) or False (0)	Unit: –	Factory setting: –
Size: 1 bit (BOOL)	Access: RO	PDO map: T
Sub-index 3: RESETSTAT 1 Bit		
Setting range: True (1) or False (0)	Unit: –	Factory setting: –
Size: 1 bit (BOOL)	Access: RO	PDO map: T
Sub-index 4: LIGHT 1 Bit		
Setting range: True (1) or False (0)	Unit: –	Factory setting: –
Size: 1 bit (BOOL)	Access: RO	PDO map: T
Sub-index 5: STABILITY 1 Bit		
Setting range: True (1) or False (0)	Unit: –	Factory setting: –
Size: 1 bit (BOOL)	Access: RO	PDO map: T
Sub-index 6: ENABLE 1 Bit		
Setting range: True (1) or False (0)	Unit: –	Factory setting: –
Size: 1 bit (BOOL)	Access: RO	PDO map: T
Sub-index 7: GATE 1 Bit		
Setting range: True (1) or False (0)	Unit: –	Factory setting: –
Size: 1 bit (BOOL)	Access: RO	PDO map: T
Sub-index 8: OR 1 Bit		
Setting range: True (1) or False (0)	Unit: –	Factory setting: –
Size: 1 bit (BOOL)	Access: RO	PDO map: T
Sub-index 9 to 17: Sensor Head 1 Status Reserve Bit 07 to 15		
Setting range: True (1) or False (0)	Unit: –	Factory setting: –
Size: 1 bit (BOOL)	Access: RO	PDO map: T
Sub-index 18 to 21: ZEROSTAT 1_T1 to T4 Bit		
Setting range: True (1) or False (0)	Unit: –	Factory setting: –
Size: 1 bit (BOOL)	Access: RO	PDO map: T

Sub-index 22: HIGH 1_T1 Bit		
Setting range: True (1) or False (0)	Unit: –	Factory setting: –
Size: 1 bit (BOOL)	Access: RO	PDO map: T
Sub-index 23: PASS 1_T1 Bit		
Setting range: True (1) or False (0)	Unit: –	Factory setting: –
Size: 1 bit (BOOL)	Access: RO	PDO map: T
Sub-index 24: LOW 1_T1 Bit		
Setting range: True (1) or False (0)	Unit: –	Factory setting: –
Size: 1 bit (BOOL)	Access: RO	PDO map: T
Sub-index 25: HIGH 1_T2 Bit		
Setting range: True (1) or False (0)	Unit: –	Factory setting: –
Size: 1 bit (BOOL)	Access: RO	PDO map: T
Sub-index 26: PASS 1_T2 Bit		
Setting range: True (1) or False (0)	Unit: –	Factory setting: –
Size: 1 bit (BOOL)	Access: RO	PDO map: T
Sub-index 27: LOW 1_T2 Bit		
Setting range: True (1) or False (0)	Unit: –	Factory setting: –
Size: 1 bit (BOOL)	Access: RO	PDO map: T
Sub-index 28: HIGH 1_T3 Bit		
Setting range: True (1) or False (0)	Unit: –	Factory setting: –
Size: 1 bit (BOOL)	Access: RO	PDO map: T
Sub-index 29: PASS 1_T3 Bit		
Setting range: True (1) or False (0)	Unit: –	Factory setting: –
Size: 1 bit (BOOL)	Access: RO	PDO map: T
Sub-index 30: LOW 1_T3 Bit		
Setting range: True (1) or False (0)	Unit: –	Factory setting: –
Size: 1 bit (BOOL)	Access: RO	PDO map: T
Sub-index 31: HIGH 1_T4 Bit		
Setting range: True (1) or False (0)	Unit: –	Factory setting: –
Size: 1 bit (BOOL)	Access: RO	PDO map: T
Sub-index 32: PASS 1_T4 Bit		
Setting range: True (1) or False (0)	Unit: –	Factory setting: –
Size: 1 bit (BOOL)	Access: RO	PDO map: T
Sub-index 33: LOW 1_T4 Bit		
Setting range: True (1) or False (0)	Unit: –	Factory setting: –
Size: 1 bit (BOOL)	Access: RO	PDO map: T
<ul style="list-style-type: none"> • This object acquires the status of sensor head 1 of the displacement sensor. 		
3013 hex	Response	
Sub-index: –		
Setting range: –	Unit: –	Factory setting: –
Size: 4 bytes (U32)	Access: RO	PDO map: T
<ul style="list-style-type: none"> • The executed command code is stored. 		

3014 hex	Response code	
Sub-index: –		
Setting range: –	Unit: –	Factory setting: –
Size: 4 bytes (U32)	Access: RO	PDO map: T
• The execution result of the command is stored. (OK: 00000000 hex, NG: FFFFFFFF hex)		

3015 hex	Response data	
Sub-index 0: Number of entries		
Setting range: –	Unit: –	Factory setting: –
Size: 1 byte (U8)	Access: RO	PDO map: Not possible
Sub-index 1: Response data 1		
Setting range: –	Unit: –	Factory setting: –
Size: 1 byte (U8)	Access: RO	PDO map: T
• The response data of the command execution result is stored. (Example: When the processing unit data acquisition command is executed, the acquired data is stored.)		

3020 hex	Measurement Value	
Sub-index 0: Number of entries		
Setting range: –	Unit: –	Factory setting: –
Size: 1 byte (U8)	Access: RO	PDO map: Not possible
Sub-index 1 to 4: Measurement Value of Task 1 to 4		
Setting range: –	Unit: –	Factory setting: –
Size: 4 bytes (U32)	Access: RO	PDO map: T
Sub-index 5 to 8: Measurement Value Reserve 01 to 04		
Setting range: –	Unit: –	Factory setting: –
Size: 4 bytes (U32)	Access: RO	PDO map: T
• The output data is stored.		

• Object specifications (current bank)

3100 hex	Sensor Head Number	
Sub-index: –		
Setting range: 0 to 1	Unit: –	Factory setting: 0
Size: 1 byte (U8)	Access: RW	PDO map: Not possible
• The target sensor head number is stored. (On the ZW-ECT1□, this is fixed at "0".)		

3101 hex	Picture Input	
Sub-index 0: Number of entries		
Setting range: –	Unit: –	Factory setting: –
Size: 1 byte (U8)	Access: RO	PDO map: Not possible
Sub-index 1: Measurement Cycle		
Setting range: –	Unit: μ s	Factory setting: –
Size: 4 bytes (U32)	Access: RO	PDO map: Not possible

Sub-index 2: Area 1 Upper Line		
Setting range: 0 to 255	Unit: pix	Factory setting: –
Size: 4 bytes (U32)	Access: RW	PDO map: Not possible
Sub-index 3: Area 1 Lower Line		
Setting range: 0 to 255	Unit: pix	Factory setting: –
Size: 4 bytes (U32)	Access: RW	PDO map: Not possible
Sub-index 4: Gain		
Setting range: 0 to 2	Unit: –	Factory setting: –
Size: 4 bytes (U32)	Access: RW	PDO map: Not possible
Sub-index 5: Area Mode		
Setting range: 0 to 1	Unit: –	Factory setting: –
Size: 4 bytes (U32)	Access: RW	PDO map: Not possible
Sub-index 6: Area Follow Mode		
Setting range: 0 to 3	Unit: –	Factory setting: –
Size: 4 bytes (U32)	Access: RW	PDO map: Not possible
Sub-index 7: Area 2 upper Line		
Setting range: 0 to 255	Unit: pix	Factory setting: –
Size: 4 bytes (U32)	Access: RW	PDO map: Not possible
Sub-index 8: Area 2 lower Line		
Setting range: 0 to 255	Unit: pix	Factory setting: –
Size: 4 bytes (U32)	Access: RW	PDO map: Not possible
Sub-index 9: Start offset of Follow		
Setting range: -999999999 to 999999999	Unit: nm	Factory setting: –
Size: 4 bytes (INT32)	Access: RW	PDO map: Not possible
Sub-index 10: End offset of Follow		
Setting range: -999999999 to 999999999	Unit: nm	Factory setting: –
Size: 4 bytes (INT32)	Access: RW	PDO map: Not possible
Sub-index 11: Measurement Cycle (Test)		
Setting range: –	Unit: μ s	Factory setting: –
Size: 4 bytes (INT32)	Access: RO	PDO map: Not possible
Sub-index 12: Measurement Center		
Setting range: –	Unit: nm	Factory setting: –
Size: 4 bytes (U32)	Access: RO	PDO map: Not possible
Sub-index 13: Measurement Range		
Setting range: –	Unit: nm	Factory setting: –
Size: 4 bytes (U32)	Access: RO	PDO map: Not possible
Sub-index 14: Measurement Cycle (Clk)		
Setting range: –	Unit: CLK	Factory setting: –
Size: 4 bytes (INT32)	Access: RO	PDO map: Not possible

Sub-index 15: Reference Measurement Value		
Setting range: –	Unit: nm	Factory setting: –
Size: 4 bytes (INT32)	Access: RO	PDO map: Not possible
Sub-index 16: Current Area		
Setting range: –	Unit: –	Factory setting: –
Size: 4 bytes (U32)	Access: RO	PDO map: Not possible
Sub-index 17: Base		
Setting range: 0 to 4	Unit: –	Factory setting: –
Size: 4 bytes (U32)	Access: RW	PDO map: Not possible
Sub-index 18: Follow		
Setting range: 0 to 4	Unit: –	Factory setting: –
Size: 4 bytes (U32)	Access: RW	PDO map: Not possible
Sub-index 19: Reference Teach		
Setting range: –	Unit: –	Factory setting: –
Size: 4 bytes (U32)	Access: WO	PDO map: Not possible
Sub-index 20: Area Teach		
Setting range: –	Unit: –	Factory setting: –
Size: 4 bytes (U32)	Access: WO	PDO map: Not possible
<ul style="list-style-type: none"> • Data relating to processing item "image input" is stored. 		
3102 hex	Exposure Time Control (2 area mode off)	
Sub-index 0: Number of entries		
Setting range: –	Unit: –	Factory setting: –
Size: 1 byte (U8)	Access: RO	PDO map: Not possible
Sub-index 1: Exposure Mode		
Setting range: 0 to 1	Unit: –	Factory setting: –
Size: 4 bytes (U32)	Access: RW	PDO map: Not possible
Sub-index 2: Control Edge		
Setting range: 0 to 4	Unit: –	Factory setting: –
Size: 4 bytes (U32)	Access: RW	PDO map: Not possible
Sub-index 3: Exposure Time (Fixed)		
Setting range: 1 to 5000	Unit: μ s	Factory setting: –
Size: 4 bytes (U32)	Access: RW	PDO map: Not possible
Sub-index 4: Exposure Time (Maximum)		
Setting range: 1 to 5000	Unit: μ s	Factory setting: –
Size: 4 bytes (U32)	Access: RW	PDO map: Not possible
Sub-index 5: Incident Level		
Setting range: –	Unit: –	Factory setting: –
Size: 4 bytes (U32)	Access: RO	PDO map: Not possible
Sub-index 6: Exposure Time Control Status		
Setting range: –	Unit: –	Factory setting: –
Size: 4 bytes (U32)	Access: RO	PDO map: Not possible

Sub-index 7: Incident Level (Average)		
Setting range: –	Unit: –	Factory setting: –
Size: 4 bytes (U32)	Access: RO	PDO map: Not possible
Sub-index 8: Exposure Time		
Setting range: –	Unit: μ s	Factory setting: –
Size: 4 bytes (U32)	Access: RO	PDO map: Not possible
Sub-index 9 to 12: Incident Level (1st Edge) to (4th Edge)		
Setting range: –	Unit: –	Factory setting: –
Size: 4 bytes (U32)	Access: RO	PDO map: Not possible
Sub-index 13: Enable Status		
Setting range: –	Unit: –	Factory setting: –
Size: 4 bytes (U32)	Access: RO	PDO map: Not possible
Sub-index 14: Optimum Incident Level Lower		
Setting range: –	Unit: –	Factory setting: –
Size: 4 bytes (U32)	Access: RO	PDO map: Not possible
Sub-index 15: Optimum Incident Level Upper		
Setting range: –	Unit: –	Factory setting: –
Size: 4 bytes (U32)	Access: RO	PDO map: Not possible
Sub-index 16: Total Density		
Setting range: –	Unit: –	Factory setting: –
Size: 4 bytes (U32)	Access: RO	PDO map: Not possible
Sub-index 17: Background Base Level		
Setting range: –	Unit: –	Factory setting: –
Size: 4 bytes (U32)	Access: RO	PDO map: Not possible
Sub-index 18: Number of Average Incident Level		
Setting range: 0 to 8	Unit: –	Factory setting: –
Size: 4 bytes (U32)	Access: RW	PDO map: Not possible
Sub-index 19: LED On/Off		
Setting range: 0 to 1	Unit: –	Factory setting: –
Size: 4 bytes (U32)	Access: RW	PDO map: Not possible

- Data relating to processing item "Exposure time control (when 2 area mode is OFF)" is stored.
- The data of exposure time control in the 2 area mode is stored to
Exposure time control of area 1: Index 3103 hex
Exposure time control of area 2: Index 3104 hex

3105 hex	Target to Measure		
Sub-index 0: Number of entries			
Setting range: –	Unit: –	Factory setting: –	
Size: 1 byte (U8)	Access: RO	PDO map: Not possible	
Sub-index 1: Material			
Setting range: 0 to 2	Unit: –	Factory setting: –	
Size: 4 bytes (U32)	Access: RW	PDO map: Not possible	
Sub-index 2: Average Number of Times			
Setting range: 0 to 15	Unit: –	Factory setting: –	
Size: 4 bytes (U32)	Access: RW	PDO map: Not possible	
Sub-index 3: Noise Cut Level			
Setting range: 0 to 4095	Unit: –	Factory setting: –	
Size: 4 bytes (U32)	Access: RW	PDO map: Not possible	
Sub-index 4: Measurement Value of Acceptance Edge			
Setting range: –	Unit: nm	Factory setting: –	
Size: 4 bytes (INT32)	Access: RO	PDO map: Not possible	
Sub-index 5: Measurement Value of Acceptance Edge (Absolute)			
Setting range: –	Unit: nm	Factory setting: –	
Size: 4 bytes (INT32)	Access: RO	PDO map: Not possible	

- Data relating to processing item "target to measure" is stored.

3106 hex	Measuring Point (Task 1)		
Sub-index 0: Number of entries			
Setting range: –	Unit: –	Factory setting: –	
Size: 1 byte (U8)	Access: RO	PDO map: Not possible	
Sub-index 1: Measurement Mode			
Setting range: 0 to 3	Unit: –	Factory setting: –	
Size: 4 bytes (U32)	Access: RW	PDO map: Not possible	
Sub-index 2: Measurement Surface 1			
Setting range: 0 to 4	Unit: –	Factory setting: –	
Size: 4 bytes (U32)	Access: RW	PDO map: Not possible	
Sub-index 3: Measurement Surface 2			
Setting range: 0 to 4	Unit: –	Factory setting: –	
Size: 4 bytes (U32)	Access: RW	PDO map: Not possible	
Sub-index 4: Parameter X			
Setting range: 0 to 4	Unit: –	Factory setting: –	
Size: 4 bytes (U32)	Access: RW	PDO map: Not possible	
Sub-index 5: Parameter Y			
Setting range: 0 to 4	Unit: –	Factory setting: –	
Size: 4 bytes (U32)	Access: RW	PDO map: Not possible	

Sub-index 6: Parameter K		
Setting range: -999999999 to 999999999	Unit: –	Factory setting: –
Size: 4 bytes (INT32)	Access: RW	PDO map: Not possible
Sub-index 7: Parameter M		
Setting range: -100 to 100	Unit: –	Factory setting: –
Size: 4 bytes (INT32)	Access: RW	PDO map: Not possible
Sub-index 8: Parameter N		
Setting range: -100 to 100	Unit: –	Factory setting: –
Size: 4 bytes (INT32)	Access: RW	PDO map: Not possible
Sub-index 9: Measurement Area		
Setting range: 0 to 1	Unit: –	Factory setting: –
Size: 4 bytes (U32)	Access: RW	PDO map: Not possible
Sub-index 10: Measurement Result		
Setting range: –	Unit: nm	Factory setting: –
Size: 4 bytes (INT32)	Access: RO	PDO map: Not possible
Sub-index 11: Measurement Value (Top)		
Setting range: –	Unit: nm	Factory setting: –
Size: 4 bytes (INT32)	Access: RO	PDO map: Not possible
Sub-index 12: Measurement Value (End)		
Setting range: –	Unit: nm	Factory setting: –
Size: 4 bytes (INT32)	Access: RO	PDO map: Not possible
<ul style="list-style-type: none"> • Data relating to TASK 1 processing item "measurement point" is stored. • The measurement point data of TASK 2 to 4 is stored to: <ul style="list-style-type: none"> TASK 2: Index 3110 hex TASK 3: Index 311A hex TASK 4: Index 3124 hex 		
3107 hex	Scaling (Task 1)	
Sub-index 0: Number of entries		
Setting range: –	Unit: –	Factory setting: –
Size: 1 byte (U8)	Access: RO	PDO map: Not possible
Sub-index 1: Scaling Mode		
Setting range: 0 to 3	Unit: –	Factory setting: –
Size: 4 bytes (U32)	Access: RW	PDO map: Not possible
Sub-index 2: Span		
Setting range: -20000 to 20000	Unit: –	Factory setting: –
Size: 4 bytes (INT32)	Access: RW	PDO map: Not possible
Sub-index 3: Offset		
Setting range: -999999999 to 999999999	Unit: –	Factory setting: –
Size: 4 bytes (INT32)	Access: RW	PDO map: Not possible

Sub-index 4: Result of Scaling		
Setting range: –	Unit: –	Factory setting: –
Size: 4 bytes (INT32)	Access: RO	PDO map: Not possible
Sub-index 5: Scaling Direction		
Setting range: 0 to 1	Unit: –	Factory setting: –
Size: 4 bytes (U32)	Access: RW	PDO map: Not possible
Sub-index 6: Setting Height (1 Point)		
Setting range: -999999999 to 999999999	Unit: nm	Factory setting: –
Size: 4 bytes (INT32)	Access: RW	PDO map: Not possible
Sub-index 7: Setting Height (2 Point)		
Setting range: -999999999 to 999999999	Unit: nm	Factory setting: –
Size: 4 bytes (INT32)	Access: RW	PDO map: Not possible
Sub-index 8: Setting Thickness (1 Point)		
Setting range: -999999999 to 999999999	Unit: nm	Factory setting: –
Size: 4 bytes (INT32)	Access: RW	PDO map: Not possible
Sub-index 9: Measurement Height Value (1 Point)		
Setting range: -999999999 to 999999999	Unit: nm	Factory setting: –
Size: 4 bytes (INT32)	Access: RW	PDO map: Not possible
Sub-index 10: Measurement Height Value (2 Point)		
Setting range: -999999999 to 999999999	Unit: nm	Factory setting: –
Size: 4 bytes (INT32)	Access: RW	PDO map: Not possible
Sub-index 11: Measurement Thickness Value (1 Point)		
Setting range: -999999999 to 999999999	Unit: nm	Factory setting: –
Size: 4 bytes (INT32)	Access: RW	PDO map: Not possible
Sub-index 12: Number of Scaling		
Setting range: 0 to 1	Unit: –	Factory setting: –
Size: 4 bytes (U32)	Access: RW	PDO map: Not possible
Sub-index 13: Execute Scaling		
Setting range: 0 to 1	Unit: –	Factory setting: –
Size: 4 bytes (U32)	Access: WO	PDO map: Not possible

- Data relating to TASK 1 processing item "scaling" is stored.
- The scaling data of TASK 2 to 4 is stored to:
 - TASK 2: Index 3111 hex
 - TASK 3: Index 311B hex
 - TASK 4: Index 3125 hex

3108 hex	Median Filter (Task 1)		
Sub-index 0: Number of entries			
Setting range: –	Unit: –	Factory setting: –	
Size: 1 byte (U8)	Access: RO	PDO map: Not possible	
Sub-index 1: Median Filter Mode			
Setting range: 0 to 3	Unit: –	Factory setting: –	
Size: 4 bytes (U32)	Access: RW	PDO map: Not possible	
Sub-index 2: Median Filter Result			
Setting range: –	Unit: –	Factory setting: –	
Size: 4 bytes (INT32)	Access: RO	PDO map: Not possible	
<ul style="list-style-type: none"> • Data relating to TASK 1 processing item "media" is stored. • The media data of TASK 2 to 4 is stored to: <ul style="list-style-type: none"> TASK 2: Index 3112 hex TASK 3: Index 311C hex TASK 4: Index 3126 hex 			

3109 hex	Average Filter (Task 1)		
Sub-index 0: Number of entries			
Setting range: –	Unit: –	Factory setting: –	
Size: 1 byte (U8)	Access: RO	PDO map: Not possible	
Sub-index 1: Average Number of Times			
Setting range: 0 to 12	Unit: –	Factory setting: –	
Size: 4 bytes (U32)	Access: RW	PDO map: Not possible	
Sub-index 2: Average Filter Result			
Setting range: –	Unit: –	Factory setting: –	
Size: 4 bytes (INT32)	Access: RO	PDO map: Not possible	
Sub-index 3: Resolution			
Setting range: –	Unit: –	Factory setting: –	
Size: 4 bytes (INT32)	Access: RO	PDO map: Not possible	
<ul style="list-style-type: none"> • Data relating to TASK 1 processing item "average" is stored. • The average data of TASK 2 to 4 is stored to: <ul style="list-style-type: none"> TASK 2: Index 3113 hex TASK 3: Index 311D hex TASK 4: Index 3127 hex 			

310A hex	Frequency Filter (Task 1)		
Sub-index 0: Number of entries			
Setting range: –	Unit: –	Factory setting: –	
Size: 1 byte (U8)	Access: RO	PDO map: Not possible	
Sub-index 1: Filter Mode			
Setting range: 0 to 3	Unit: –	Factory setting: –	
Size: 4 bytes (U32)	Access: RW	PDO map: Not possible	
Sub-index 2: Cutoff Frequency			
Setting range: –	Unit: MHz	Factory setting: –	
Size: 4 bytes (U32)	Access: RW	PDO map: Not possible	
Sub-index 3: Cutoff Frequency (Upper Limit)			
Setting range: 1 to 999999	Unit: MHz	Factory setting: –	
Size: 4 bytes (U32)	Access: RW	PDO map: Not possible	
Sub-index 4: Cutoff Frequency (Lower Limit)			
Setting range: 1 to 999999	Unit: MHz	Factory setting: –	
Size: 4 bytes (U32)	Access: RW	PDO map: Not possible	
Sub-index 5: Frequency Filter Result			
Setting range: –	Unit: nm	Factory setting: –	
Size: 4 bytes (INT32)	Access: RO	PDO map: Not possible	

- Data relating to TASK 1 processing item "frequency filter" is stored.
- The frequency filter data of TASK 2 to 4 is stored to:
 - TASK 2: Index 3114 hex
 - TASK 3: Index 311E hex
 - TASK 4: Index 3128 hex

310B hex	Differentiation Filter (Task 1)		
Sub-index 0: Number of entries			
Setting range: –	Unit: –	Factory setting: –	
Size: 1 byte (U8)	Access: RO	PDO map: Not possible	
Sub-index 1: Differentiation Mode			
Setting range: 0 to 1	Unit: –	Factory setting: –	
Size: 4 bytes (U32)	Access: RW	PDO map: Not possible	
Sub-index 2: Differentiation Cycle			
Setting range: 1 to 5000	Unit: ms	Factory setting: –	
Size: 4 bytes (U32)	Access: RW	PDO map: Not possible	
Sub-index 3: Differentiation Filter Result			
Setting range: –	Unit: –	Factory setting: –	
Size: 4 bytes (INT32)	Access: RO	PDO map: Not possible	
<ul style="list-style-type: none"> • Data relating to TASK 1 processing item "differentiation" is stored. • The differentiation data of TASK 2 to 4 is stored to: TASK 2: Index 3115 hex TASK 3: Index 311F hex TASK 4: Index 3129 hex 			

310C hex	Hold (Task 1)		
Sub-index 0: Number of entries			
Setting range: –	Unit: –	Factory setting: –	
Size: 1 byte (U8)	Access: RO	PDO map: Not possible	
Sub-index 1: Hold Mode			
Setting range: 0 to 10	Unit: –	Factory setting: –	
Size: 4 bytes (U32)	Access: RW	PDO map: Not possible	
Sub-index 2: Trigger Method			
Setting range: 1 to 2	Unit: ms	Factory setting: –	
Size: 4 bytes (U32)	Access: RW	PDO map: Not possible	
Sub-index 3: Trigger Level			
Setting range: -999999999 to 999999999	Unit: nm	Factory setting: –	
Size: 4 bytes (INT32)	Access: RO	PDO map: Not possible	
Sub-index 4: Trigger Hysteresis			
Setting range: 0 to 999999999	Unit: nm	Factory setting: –	
Size: 4 bytes (U32)	Access: RW	PDO map: Not possible	
Sub-index 5: Trigger Delay Time			
Setting range: 1 to 5000	Unit: ms	Factory setting: –	
Size: 4 bytes (U32)	Access: RW	PDO map: Not possible	
Sub-index 6: Sampling Time			
Setting range: 1 to 5000	Unit: ms	Factory setting: –	
Size: 4 bytes (U32)	Access: RW	PDO map: Not possible	

Sub-index 7: Trigger Delay Mode			
Setting range: 0 to 1	Unit: –	Factory setting: –	
Size: 4 bytes (U32)	Access: RW	PDO map: Not possible	
Sub-index 8: Value of Hold			
Setting range: –	Unit: nm	Factory setting: –	
Size: 4 bytes (INT32)	Access: RO	PDO map: Not possible	
Sub-index 9: Hold Status			
Setting range: –	Unit: –	Factory setting: –	
Size: 4 bytes (U32)	Access: RO	PDO map: Not possible	
Sub-index 10: Update Status			
Setting range: –	Unit: –	Factory setting: –	
Size: 4 bytes (U32)	Access: RO	PDO map: Not possible	
Sub-index 11: Trigger Input Status			
Setting range: 0 to 1	Unit: –	Factory setting: –	
Size: 4 bytes (U32)	Access: RW	PDO map: Not possible	
Sub-index 12: Hold off Input Status			
Setting range: 0 to 1	Unit: –	Factory setting: –	
Size: 4 bytes (INT32)	Access: RW	PDO map: Not possible	
<ul style="list-style-type: none"> • Data relating to TASK 1 processing item "hold" is stored. • The hold data of TASK 2 to 4 is stored to: <ul style="list-style-type: none"> TASK 2: Index 3116 hex TASK 3: Index 3120 hex TASK 4: Index 312A hex 			
310D hex	Zero Reset (Task 1)		
Sub-index 0: Number of entries			
Setting range: –	Unit: –	Factory setting: –	
Size: 1 byte (U8)	Access: RO	PDO map: Not possible	
Sub-index 1: Zero Reset Status			
Setting range: 0 to 1	Unit: –	Factory setting: –	
Size: 4 bytes (U32)	Access: RW	PDO map: Not possible	
Sub-index 2: Zero Reset Offset			
Setting range: -999999999 to 999999999	Unit: nm	Factory setting: –	
Size: 4 bytes (INT32)	Access: RW	PDO map: Not possible	
Sub-index 3: Zero Reset Type			
Setting range: 0 to 1	Unit: –	Factory setting: –	
Size: 4 bytes (U32)	Access: RW	PDO map: Not possible	
Sub-index 4: Zero Reset Measurement Value			
Setting range: –	Unit: nm	Factory setting: –	
Size: 4 bytes (INT32)	Access: RO	PDO map: Not possible	

Sub-index 5: Zero Reset Execution Enabled/Disabled Status		
Setting range: 0 to 1	Unit: –	Factory setting: –
Size: 4 bytes (U32)	Access: RW	PDO map: Not possible
Sub-index 6: Zero Reset Flag		
Setting range: –	Unit: –	Factory setting: –
Size: 4 bytes (U32)	Access: WO	PDO map: Not possible
Sub-index 7: Zero Reset Cancel Flag		
Setting range: –	Unit: –	Factory setting: –
Size: 4 bytes (U32)	Access: WO	PDO map: Not possible

- Data relating to TASK 1 processing item "zero reset" is stored.
- The zero reset data of TASK 2 to 4 is stored to:
TASK 2: Index 3117 hex
TASK 3: Index 3121 hex
TASK 4: Index 312B hex

310E hex	Non-Measurement Setting (Task 1)	
Sub-index 0: Number of entries		
Setting range: –	Unit: –	Factory setting: –
Size: 1 byte (U8)	Access: RO	PDO map: Not possible
Sub-index 1: Output Data		
Setting range: –	Unit: nm	Factory setting: –
Size: 4 bytes (INT32)	Access: RO	PDO map: Not possible

- Data relating to TASK 1 processing item "processing at non-measurement" is stored.
- The processing at non-measurement of TASK 2 to 4 is stored to:
TASK 2: Index 3118 hex
TASK 3: Index 3122 hex
TASK 4: Index 312C hex
- On the ZW, this is not required since settings are not made directly.

310F hex	Judgement Output (Task 1)	
Sub-index 0: Number of entries		
Setting range: –	Unit: –	Factory setting: –
Size: 1 byte (U8)	Access: RO	PDO map: Not possible
Sub-index 1: LOW Threshold		
Setting range: -999999999 to 999999999	Unit: nm	Factory setting: –
Size: 4 bytes (INT32)	Access: RW	PDO map: Not possible
Sub-index 2: HIGH Threshold		
Setting range: -999999999 to 999999999	Unit: nm	Factory setting: –
Size: 4 bytes (INT32)	Access: RW	PDO map: Not possible
Sub-index 3: Output Data		
Setting range: –	Unit: nm	Factory setting: –
Size: 4 bytes (INT32)	Access: RO	PDO map: Not possible

Sub-index 4: Output Judgement Status		
Setting range: –	Unit: –	Factory setting: –
Size: 4 bytes (U32)	Access: RO	PDO map: Not possible
Sub-index 5: HIGH Result		
Setting range: –	Unit: –	Factory setting: –
Size: 4 bytes (U32)	Access: RO	PDO map: Not possible
Sub-index 6: PASS Result		
Setting range: –	Unit: –	Factory setting: –
Size: 4 bytes (U32)	Access: RO	PDO map: Not possible
Sub-index 7: LOW Result		
Setting range: –	Unit: –	Factory setting: –
Size: 4 bytes (U32)	Access: RO	PDO map: Not possible
Sub-index 8: ERROR Result		
Setting range: –	Unit: –	Factory setting: –
Size: 4 bytes (U32)	Access: RO	PDO map: Not possible

- Data relating to TASK 1 processing item "judgment output" is stored.
- The judgment output of TASK 2 to 4 is stored to:
 - TASK 2: Index 3119 hex
 - TASK 3: Index 3123 hex
 - TASK 4: Index 312D hex

312E hex	Judgement Processing	
Sub-index 0: Number of entries		
Setting range: –	Unit: –	Factory setting: –
Size: 1 byte (U8)	Access: RO	PDO map: Not possible
Sub-index 1: Hysteresis Width		
Setting range: 0 to 999999999	Unit: nm	Factory setting: –
Size: 4 bytes (INT32)	Access: RW	PDO map: Not possible
Sub-index 2: Timer Mode		
Setting range: 0 to 3	Unit: –	Factory setting: –
Size: 4 bytes (U32)	Access: RW	PDO map: Not possible
Sub-index 3: Delay Time		
Setting range: 1 to 5000	Unit: ms	Factory setting: –
Size: 4 bytes (U32)	Access: RW	PDO map: Not possible
Sub-index 4: Output Object		
Setting range: 0 to 3	Unit: –	Factory setting: –
Size: 4 bytes (U32)	Access: RW	PDO map: Not possible

- Data relating to processing item "judgment processing" is stored.

312F hex	Non-Measurement Setting	
Sub-index 0: Number of entries		
Setting range: –	Unit: –	Factory setting: –
Size: 1 byte (U8)	Access: RO	PDO map: Not possible

Sub-index 1: Non-Measurement Mode		
Setting range: 0 to 1	Unit: –	Factory setting: –
Size: 4 bytes (U32)	Access: RW	PDO map: Not possible
Sub-index 2: Analog Clamp Output		
Setting range: –	Unit: –	Factory setting: –
Size: 4 bytes (U32)	Access: RW	PDO map: Not possible
Sub-index 3: Binary Clamp Output		
Setting range: 0 to 1	Unit: –	Factory setting: –
Size: 4 bytes (U32)	Access: RW	PDO map: Not possible

- Data relating to processing item "processing at non-measurement" is stored.

3130 hex	Analog Output	
Sub-index 0: Number of entries		
Setting range: –	Unit: –	Factory setting: –
Size: 1 byte (U8)	Access: RO	PDO map: Not possible
Sub-index 1: Monitor Focus Mode		
Setting range: 0 to 1	Unit: –	Factory setting: –
Size: 4 bytes (U32)	Access: RW	PDO map: Not possible
Sub-index 2 to 3: Monitor Focus Output Position 1 to 2		
Setting range: -999999999 to 999999999	Unit: nm	Factory setting: –
Size: 4 bytes (INT32)	Access: RW	PDO map: Not possible
Sub-index 4: Monitor Focus Current Low Limit		
Setting range: 4 to 20	Unit: mA	Factory setting: –
Size: 4 bytes (INT32)	Access: RW	PDO map: Not possible
Sub-index 5: Monitor Focus Current High Limit		
Setting range: 4 to 20	Unit: mA	Factory setting: –
Size: 4 bytes (INT32)	Access: RW	PDO map: Not possible
Sub-index 6: Monitor Focus Voltage Low Limit		
Setting range: -10 to 10	Unit: V	Factory setting: –
Size: 4 bytes (INT32)	Access: RW	PDO map: Not possible
Sub-index 7: Monitor Focus Voltage High Limit		
Setting range: -10 to 10	Unit: V	Factory setting: –
Size: 4 bytes (INT32)	Access: RW	PDO map: Not possible
Sub-index 8: Analog Output Adjustment Mode		
Setting range: 0 to 1	Unit: –	Factory setting: –
Size: 4 bytes (U32)	Access: RW	PDO map: Not possible
Sub-index 9: Analog Output Adjustment Span		
Setting range: –	Unit: –	Factory setting: –
Size: 4 bytes (INT32)	Access: RW	PDO map: Not possible
Sub-index 10: Analog Output Adjustment Offset		
Setting range: –	Unit: –	Factory setting: –
Size: 4 bytes (INT32)	Access: RW	PDO map: Not possible

Sub-index 11: Monitor Focus Clear		
Setting range: 1 to 1	Unit: –	Factory setting: –
Size: 4 bytes (U32)	Access: RW	PDO map: Not possible
Sub-index 12: Analog Output Adjustment Clear		
Setting range: 1 to 1	Unit: –	Factory setting: –
Size: 4 bytes (U32)	Access: RW	PDO map: Not possible
Sub-index 13: Test Adjustment Mode		
Setting range: 0 to 1	Unit: –	Factory setting: –
Size: 4 bytes (U32)	Access: RW	PDO map: Not possible
Sub-index 14: Test Adjustment Dac Output		
Setting range: 3069 to 61069	Unit: –	Factory setting: –
Size: 4 bytes (U32)	Access: RW	PDO map: Not possible
Sub-index 15: Clamp Dac Output		
Setting range: 3069 to 61069	Unit: –	Factory setting: –
Size: 4 bytes (U32)	Access: RW	PDO map: Not possible
Sub-index 16: Current/Voltage Mode		
Setting range: 0 to 1	Unit: –	Factory setting: –
Size: 4 bytes (U32)	Access: RW	PDO map: Not possible
Sub-index 17: Output Object		
Setting range: 0 to 4	Unit: –	Factory setting: –
Size: 4 bytes (U32)	Access: RW	PDO map: Not possible
Sub-index 18: Output Level During Clamping		
Setting range: –	Unit: –	Factory setting: –
Size: 4 bytes (U32)	Access: RW	PDO map: Not possible
Sub-index 19: Reference Data Address		
Setting range: –	Unit: –	Factory setting: –
Size: 4 bytes (INT32)	Access: RO	PDO map: Not possible
Sub-index 20: Analog Output Data		
Setting range: –	Unit: –	Factory setting: –
Size: 4 bytes (INT32)	Access: RO	PDO map: Not possible
Sub-index 21: Output Dac Low Limit		
Setting range: –	Unit: –	Factory setting: –
Size: 4 bytes (U32)	Access: RO	PDO map: Not possible
Sub-index 22: Output Dac High Limit		
Setting range: –	Unit: –	Factory setting: –
Size: 4 bytes (U32)	Access: RO	PDO map: Not possible
Sub-index 23: Dac Range of Analog Output Convert		
Setting range: –	Unit: –	Factory setting: –
Size: 4 bytes (U32)	Access: RO	PDO map: Not possible
Sub-index 24: Round Number of Analog Output Calculation		
Setting range: –	Unit: –	Factory setting: –
Size: 4 bytes (U32)	Access: RO	PDO map: Not possible

Sub-index 25: Analog Output Adjustment		
Setting range: –	Unit: –	Factory setting: –
Size: 4 bytes (U32)	Access: RO	PDO map: Not possible
Sub-index 26: Monitor Focus Output Position Low Limit		
Setting range: –	Unit: –	Factory setting: –
Size: 4 bytes (INT32)	Access: RO	PDO map: Not possible
Sub-index 27: Monitor Focus Output Position High Limit		
Setting range: –	Unit: –	Factory setting: –
Size: 4 bytes (INT32)	Access: RO	PDO map: Not possible
Sub-index 28: Monitor Focus Tilt Sign		
Setting range: –	Unit: –	Factory setting: –
Size: 4 bytes (U32)	Access: RO	PDO map: Not possible
Sub-index 29: Dac Limit Distance (Max.)		
Setting range: –	Unit: –	Factory setting: –
Size: 4 bytes (INT32)	Access: RO	PDO map: Not possible
Sub-index 30: Dac Limit Distance (Min.)		
Setting range: –	Unit: –	Factory setting: –
Size: 4 bytes (INT32)	Access: RO	PDO map: Not possible
Sub-index 31: Da Output After Adjustment		
Setting range: –	Unit: –	Factory setting: –
Size: 4 bytes (INT32)	Access: RO	PDO map: Not possible
Sub-index 32: Before Current Adjustment (1 Point)		
Setting range: 4 to 20	Unit: mA	Factory setting: –
Size: 4 bytes (INT32)	Access: RW	PDO map: Not possible
Sub-index 33: Before Current Adjustment (2 Point)		
Setting range: 4 to 20	Unit: mA	Factory setting: –
Size: 4 bytes (INT32)	Access: RW	PDO map: Not possible
Sub-index 34: Current Dac (1 Point)		
Setting range: -999 to 999	Unit: –	Factory setting: –
Size: 4 bytes (INT32)	Access: RW	PDO map: Not possible
Sub-index 35: Current Dac (2 Point)		
Setting range: -999 to 999	Unit: –	Factory setting: –
Size: 4 bytes (INT32)	Access: RW	PDO map: Not possible
Sub-index 36: Before Voltage Adjustment (1 Point)		
Setting range: -10 to 10	Unit: V	Factory setting: –
Size: 4 bytes (INT32)	Access: RW	PDO map: Not possible
Sub-index 37: Before Voltage Adjustment (2 Point)		
Setting range: -10 to 10	Unit: V	Factory setting: –
Size: 4 bytes (INT32)	Access: RW	PDO map: Not possible
Sub-index 38: Voltage Dac (1 Point)		
Setting range: -999 to 999	Unit: –	Factory setting: –
Size: 4 bytes (INT32)	Access: RW	PDO map: Not possible

Sub-index 39: Voltage Dac (2 Point)		
Setting range: -999 to 999	Unit: –	Factory setting: –
Size: 4 bytes (INT32)	Access: RW	PDO map: Not possible
Sub-index 40: Test Adjustment Output (1 Point)		
Setting range: 0 to 1	Unit: –	Factory setting: –
Size: 4 bytes (U32)	Access: RW	PDO map: Not possible
Sub-index 41: Test Adjustment Output (2 Point)		
Setting range: 0 to 1	Unit: –	Factory setting: –
Size: 4 bytes (U32)	Access: RW	PDO map: Not possible
Sub-index 42: Execute Adjustment		
Setting range: 0 to 1	Unit: –	Factory setting: –
Size: 4 bytes (U32)	Access: WO	PDO map: Not possible

- Data relating to processing item "analog output" is stored.

3133 hex	Parallel Output	
Sub-index 0: Number of entries		
Setting range: –	Unit: –	Factory setting: –
Size: 1 byte (U8)	Access: RO	PDO map: Not possible
Sub-index 1: Parallel Output Target		
Setting range: 0 to 4	Unit: –	Factory setting: –
Size: 4 bytes (U32)	Access: RW	PDO map: Not possible
Sub-index 2: Parallel Output Result		
Setting range: 0 to 4	Unit: –	Factory setting: –
Size: 4 bytes (U32)	Access: RO	PDO map: Not possible

- Data relating to processing item "parallel output" is stored.

3134 hex	Parallel Input	
Sub-index 0: Number of entries		
Setting range: –	Unit: –	Factory setting: –
Size: 1 byte (U8)	Access: RO	PDO map: Not possible
Sub-index 1: Parallel Input Mode		
Setting range: 0 to 1	Unit: –	Factory setting: –
Size: 4 bytes (U32)	Access: RW	PDO map: Not possible
Sub-index 2: Control Task		
Setting range: 0 to 5	Unit: –	Factory setting: –
Size: 4 bytes (U32)	Access: RW	PDO map: Not possible
Sub-index 3: Parallel 0 Input Status		
Setting range: –	Unit: –	Factory setting: –
Size: 4 bytes (U32)	Access: RO	PDO map: Not possible
Sub-index 4: Parallel 1 Input Status		
Setting range: –	Unit: –	Factory setting: –
Size: 4 bytes (U32)	Access: RO	PDO map: Not possible

Sub-index 5: Parallel 2 Input Status		
Setting range: –	Unit: –	Factory setting: –
Size: 4 bytes (U32)	Access: RO	PDO map: Not possible
Sub-index 6: Parallel 3 Input Status		
Setting range: –	Unit: –	Factory setting: –
Size: 4 bytes (U32)	Access: RO	PDO map: Not possible
Sub-index 7: Trigger		
Setting range: 0 to 1	Unit: –	Factory setting: –
Size: 4 bytes (U32)	Access: RW	PDO map: Not possible
Sub-index 8: Hold Reset		
Setting range: 0 to 1	Unit: –	Factory setting: –
Size: 4 bytes (U32)	Access: RW	PDO map: Not possible
Sub-index 9: Led off		
Setting range: 0 to 1	Unit: –	Factory setting: –
Size: 4 bytes (U32)	Access: RW	PDO map: Not possible
Sub-index 10: Zero Reset		
Setting range: 0 to 1	Unit: –	Factory setting: –
Size: 4 bytes (U32)	Access: RW	PDO map: Not possible
Sub-index 11: Zero Reset Cancel		
Setting range: 1 to 1	Unit: –	Factory setting: –
Size: 4 bytes (U32)	Access: RW	PDO map: Not possible

- Data relating to processing item "parallel input" is stored.

3135 hex	Line Bright	
Sub-index 0: Number of entries		
Setting range: –	Unit: –	Factory setting: –
Size: 1 byte (U8)	Access: RO	PDO map: Not possible
Sub-index 1: Upper Line		
Setting range: –	Unit: pix	Factory setting: –
Size: 4 bytes (U32)	Access: RW	PDO map: Not possible
Sub-index 2: Lower Line		
Setting range: –	Unit: pix	Factory setting: –
Size: 4 bytes (U32)	Access: RW	PDO map: Not possible
Sub-index 3: Thin Number		
Setting range: –	Unit: pix	Factory setting: –
Size: 4 bytes (U32)	Access: RW	PDO map: Not possible

- Data relating to processing item "measurement waveform" is stored.

3150 hex	Unit Data Read Execution	
Sub-index 0: Number of entries		
Setting range: –	Unit: –	Factory setting: –
Size: 1 byte (U8)	Access: RO	PDO map: Not possible

Sub-index 1: Unit No		
Setting range: 0 to #xFFFF	Unit: –	Factory setting: –
Size: 2 bytes (U16)	Access: RW	PDO map: Not possible
Sub-index 2: Data No		
Setting range: 0 to #xFFFF	Unit: –	Factory setting: –
Size: 2 bytes (U16)	Access: RW	PDO map: Not possible

3151 hex	Unit Data Read Result	
Sub-index: –		
Setting range: –	Unit: –	Factory setting: –
Size: 4 bytes (U32)	Access: RO	PDO map: Not possible

3152 hex	Unit Data Write Execution	
Sub-index 0: Number of entries		
Setting range: –	Unit: –	Factory setting: –
Size: 1 byte (U8)	Access: RO	PDO map: Not possible
Sub-index 1: Unit No		
Setting range: 0 to #xFFFF	Unit: –	Factory setting: –
Size: 2 bytes (U16)	Access: RW	PDO map: Not possible
Sub-index 2: Data No		
Setting range: 0 to #xFFFF	Unit: –	Factory setting: –
Sub-index 3: Write Data		
Setting range: –	Unit: –	Factory setting: –
Size: 4 bytes (U32)	Access: RW	PDO map: Not possible

• Object specifications (system information)

3200 hex	Controller System Information	
Sub-index 0: Number of entries		
Setting range: –	Unit: –	Factory setting: –
Size: 1 byte (U8)	Access: RO	PDO map: Not possible
Sub-index 1: Controller Serial No.		
Setting range: –	Unit: –	Factory setting: –
Size: 8 bytes (VS)	Access: RO	PDO map: Not possible
Sub-index 2: Model		
Setting range: –	Unit: –	Factory setting: –
Size: 16 bytes (VS)	Access: RO	PDO map: Not possible
Sub-index 3: Type		
Setting range: –	Unit: –	Factory setting: –
Size: 4 bytes (U32)	Access: RO	PDO map: Not possible
Sub-index 4: Number of Sensor Head		
Setting range: –	Unit: –	Factory setting: –
Size: 4 bytes (U32)	Access: RO	PDO map: Not possible

Sub-index 13: Mac Address		
Setting range: –	Unit: –	Factory setting: –
Size: –	Access: RO	PDO map: Not possible
Sub-index 14: Port No.		
Setting range: –	Unit: –	Factory setting: –
Size: 4 bytes (U32)	Access: RO	PDO map: Not possible
Sub-index 15: Ethernet Protocol		
Setting range: –	Unit: –	Factory setting: –
Size: 4 bytes (U32)	Access: RO	PDO map: Not possible
Sub-index 17: Host Major Version		
Setting range: –	Unit: –	Factory setting: –
Size: 4 bytes (U32)	Access: RO	PDO map: Not possible
Sub-index 17: Host Minor Version		
Setting range: –	Unit: –	Factory setting: –
Size: 4 bytes (U32)	Access: RO	PDO map: Not possible
3201 hex Sensor Head 1 Information		
Sub-index 0: Number of entries		
Setting range: –	Unit: –	Factory setting: –
Size: 1 byte (U8)	Access: RO	PDO map: Not possible
Sub-index 1: Sensor Serial No.		
Setting range: –	Unit: –	Factory setting: –
Size: 8 bytes (VS)	Access: RW	PDO map: Not possible
Sub-index 2: Model		
Setting range: –	Unit: –	Factory setting: –
Size: 16 bytes (VS)	Access: RW	PDO map: Not possible
Sub-index 3: Type		
Setting range: –	Unit: –	Factory setting: –
Size: 4 bytes (U32)	Access: RW	PDO map: Not possible
Sub-index 4: Work Distance		
Setting range: –	Unit: –	Factory setting: –
Size: 4 bytes (U32)	Access: RW	PDO map: Not possible
Sub-index 5: Measurement Range		
Setting range: –	Unit: –	Factory setting: –
Size: 4 bytes (U32)	Access: RW	PDO map: Not possible
Sub-index 8: Grouping		
Setting range: –	Unit: –	Factory setting: –
Size: 4 bytes (U32)	Access: RW	PDO map: Not possible
Sub-index 13 to 54: Linearity Calibration Data 1 to 42		
Setting range: –	Unit: –	Factory setting: –
Size: –	Access: RW	PDO map: Not possible

• Object specifications (other information)

3203 hex	Controller Information		
Sub-index 0: Number of entries			
Setting range: –	Unit: –	Factory setting: –	
Size: 1 byte (U8)	Access: RO	PDO map: Not possible	
Sub-index 1: LED Information			
Setting range: –	Unit: –	Factory setting: –	
Size: 2 bytes (U16)	Access: RO	PDO map: Not possible	
Sub-index 2: Expansion Flag			
Setting range: –	Unit: –	Factory setting: –	
Size: 1 byte (U8)	Access: RO	PDO map: Not possible	
Sub-index 3: Controller Version			
Setting range: –	Unit: –	Factory setting: –	
Size: 8 bytes (VS)	Access: RO	PDO map: Not possible	
Sub-index 4: Controller Type			
Setting range: –	Unit: –	Factory setting: –	
Size: 1 byte (U8)	Access: RO	PDO map: Not possible	
Sub-index 5: Number of All Sensor Head			
Setting range: –	Unit: –	Factory setting: –	
Size: 1 byte (U8)	Access: RO	PDO map: Not possible	
Sub-index 6: PIX			
Setting range: –	Unit: pix	Factory setting: –	
Size: 4 bytes (U32)	Access: RW	PDO map: Not possible	
Sub-index 7: Distance			
Setting range: –	Unit: nm	Factory setting: –	
Size: 4 bytes (U32)	Access: RW	PDO map: Not possible	
Sub-index 8: RUN/FUN Mode			
Setting range: –	Unit: –	Factory setting: –	
Size: 1 byte (U8)	Access: RW	PDO map: Not possible	
3205 hex	Measuring cycle		
Sub-index 0: Number of entries			
Setting range: –	Unit: –	Factory setting: –	
Size: 1 byte (U8)	Access: RO	PDO map: Not possible	
Sub-index 1: Basic Cycle Time			
Setting range: –	Unit: –	Factory setting: –	
Size: 4 bytes (U32)	Access: RO	PDO map: Not possible	
Sub-index 2: Measurement Cycle Time			
Setting range: –	Unit: –	Factory setting: –	
Size: 4 bytes (U32)	Access: RO	PDO map: Not possible	

3206 hex	Operation instruction		
Sub-index 0: Number of entries			
Setting range: –	Unit: –	Factory setting: –	
Size: 1 byte (U8)	Access: RO	PDO map: Not possible	
Sub-index 1 to 2: Parameter 1 to 2			
Setting range: –	Unit: –	Factory setting: –	
Size: 1 byte (U8)	Access: RW	PDO map: Not possible	
Sub-index 3: Command			
Setting range: –	Unit: –	Factory setting: –	
Size: 1 byte (U8)	Access: RW	PDO map: Not possible	

3207 hex	Command Execution Status		
Sub-index: –			
Setting range: –	Unit: –	Factory setting: –	
Size: 2 bytes (U16)	Access: RO	PDO map: Not possible	

- The same error code is stored as the Compoway error response code.

• System data

3204 hex	System Data		
Sub-index 0: Number of entries			
Setting range: –	Unit: –	Factory setting: –	
Size: 1 byte (U8)	Access: RO	PDO map: Not possible	
Sub-index 2: Data Length			
Setting range: –	Unit: –	Factory settings: 1	
Size: 1 byte (U8)	Access: RW	PDO map: Not possible	
Sub-index 3: Parity			
Setting range: –	Unit: –	Factory setting: 0	
Size: 1 byte (U8)	Access: RW	PDO map: Not possible	
Sub-index 4: Stop Bit			
Setting range: –	Unit: –	Factory setting: 0	
Size: 1 byte (U8)	Access: RW	PDO map: Not possible	
Sub-index 5: Baud Rate			
Setting range: –	Unit: –	Factory settings: 2	
Size: 1 byte (U8)	Access: RW	PDO map: Not possible	
Sub-index 6: Cs/Rs			
Setting range: –	Unit: –	Factory setting: 0	
Size: 1 byte (U8)	Access: RW	PDO map: Not possible	
Sub-index 8: Ip Address			
Setting range: –	Unit: –	Factory settings: 855288000	
Size: 4 bytes (U32)	Access: RW	PDO map: Not possible	

Sub-index 9: Subnet Mask		
Setting range: –	Unit: –	Factory settings: 1677215
Size: 4 bytes (U32)	Access: RW	PDO map: Not possible
Sub-index 10: Default Gateway		
Setting range: –	Unit: –	Factory setting: 0
Size: 4 bytes (U32)	Access: RW	PDO map: Not possible
Sub-index 13: Out Ip Address 1		
Setting range: –	Unit: –	Factory settings: 1694148800
Size: 4 bytes (U32)	Access: RW	PDO map: Not possible
Sub-index 14: Port No. Out 1		
Setting range: –	Unit: –	Factory settings: 9600
Size: 2 bytes (U16)	Access: RW	PDO map: Not possible
Sub-index 15: Port No. In 1		
Setting range: –	Unit: –	Factory settings: 9600
Size: 2 bytes (U16)	Access: RW	PDO map: Not possible
Sub-index 16: Socket Protocol 1		
Setting range: –	Unit: –	Factory settings: 1
Size: 1 byte (U8)	Access: RW	PDO map: Not possible
Sub-index 18: Out Ip Address 2		
Setting range: –	Unit: –	Factory settings: 1694148800
Size: 4 bytes (U32)	Access: RW	PDO map: Not possible
Sub-index 19: Port No. Out 2		
Setting range: –	Unit: –	Factory settings: 9601
Size: 2 bytes (U16)	Access: RW	PDO map: Not possible
Sub-index 20: Port No. In 2		
Setting range: –	Unit: –	Factory settings: 9601
Size: 2 bytes (U16)	Access: RW	PDO map: Not possible
Sub-index 21: Socket Protocol 2		
Setting range: –	Unit: –	Factory settings: 1
Size: 1 byte (U8)	Access: RW	PDO map: Not possible
Sub-index 23: Out Ip Address 3		
Setting range: –	Unit: –	Factory settings: 1694148800
Size: 4 bytes (U32)	Access: RW	PDO map: Not possible
Sub-index 24: Port No. Out 3		
Setting range: –	Unit: –	Factory setting: 0
Size: 2 bytes (U16)	Access: RW	PDO map: Not possible
Sub-index 25: Port No. In 3		
Setting range: –	Unit: –	Factory setting: 0
Size: 2 bytes (U16)	Access: RW	PDO map: Not possible
Sub-index 26: Socket Protocol 3		
Setting range: –	Unit: –	Factory setting: 0
Size: 1 byte (U8)	Access: RW	PDO map: Not possible

Sub-index 28: Out Ip Address 4		
Setting range: –	Unit: –	Factory settings: 1694148800
Size: 4 bytes (U32)	Access: RW	PDO map: Not possible
Sub-index 29: Port No. Out 4		
Setting range: –	Unit: –	Factory setting: 0
Size: 2 bytes (U16)	Access: RW	PDO map: Not possible
Sub-index 30: Port No. In 4		
Setting range: –	Unit: –	Factory setting: 0
Size: 2 bytes (U16)	Access: RW	PDO map: Not possible
Sub-index 31: Socket Protocol 4		
Setting range: –	Unit: –	Factory setting: 0
Size: 1 byte (U8)	Access: RW	PDO map: Not possible
Sub-index 33: Node No.		
Setting range: –	Unit: –	Factory setting: 0
Size: 1 byte (U8)	Access: RW	PDO map: Not possible
Sub-index 34: Non Procedural Communication Mode		
Setting range: –	Unit: –	Factory setting: 0
Size: 1 byte (U8)	Access: RW	PDO map: Not possible
Sub-index 35: Delimiter		
Setting range: –	Unit: –	Factory setting: 0
Size: 1 byte (U8)	Access: RW	PDO map: Not possible
Sub-index 36: Memory Link		
Setting range: –	Unit: –	Factory settings: 2
Size: 1 byte (U8)	Access: RW	PDO map: Not possible
Sub-index 37: Gate Time		
Setting range: 0 to 100	Unit: ms	Factory setting: 0
Size: 1 byte (U8)	Access: RW	PDO map: Not possible
Sub-index 39: Serial Data Output		
Setting range: –	Unit: –	Factory settings: 0
Size: 1 byte (U8)	Access: RW	PDO map: Not possible
Sub-index 40: Data Type		
Setting range: –	Unit: –	Factory settings: 0
Size: 1 byte (U8)	Access: RW	PDO map: Not possible
Sub-index 41: Integer Digit		
Setting range: –	Unit: –	Factory settings: 5
Size: 1 byte (U8)	Access: RW	PDO map: Not possible
Sub-index 42: Decimal Point		
Setting range: –	Unit: –	Factory settings: 6
Size: 1 byte (U8)	Access: RW	PDO map: Not possible
Sub-index 43: Minus Depiction		
Setting range: –	Unit: –	Factory settings: 0
Size: 1 byte (U8)	Access: RW	PDO map: Not possible

Sub-index 44: Separation Field		
Setting range: –	Unit: –	Factory settings: 0
Size: 1 byte (U8)	Access: RW	PDO map: Not possible
Sub-index 45: Separation Record		
Setting range: –	Unit: –	Factory settings: 0
Size: 1 byte (U8)	Access: RW	PDO map: Not possible
Sub-index 46: Zero Suppress		
Setting range: –	Unit: –	Factory settings: 0
Size: 1 byte (U8)	Access: RW	PDO map: Not possible
Sub-index 48: Analog Output Direction		
Setting range: –	Unit: –	Factory settings: 0
Size: 1 byte (U8)	Access: RW	PDO map: Not possible
Sub-index 50: Bank Mode		
Setting range: –	Unit: –	Factory settings: 0
Size: 1 byte (U8)	Access: RW	PDO map: Not possible
Sub-index 51: Current Bank No.		
Setting range: –	Unit: –	Factory settings: 0
Size: 1 byte (U8)	Access: RW	PDO map: Not possible
Sub-index 52: Current Judgement Bank No.		
Setting range: –	Unit: –	Factory settings: 0
Size: 1 byte (U8)	Access: RW	PDO map: Not possible
Sub-index 54: Logging Data Size		
Setting range: –	Unit: –	Factory settings: 128
Size: 2 bytes (U16)	Access: RW	PDO map: Not possible
Sub-index 55: Logging Sampling Interval		
Setting range: –	Unit: –	Factory settings: 0
Size: 2 bytes (U16)	Access: RW	PDO map: Not possible
Sub-index 56 to 59: Logging On/off Task 1 to 4		
Setting range: –	Unit: –	Factory settings: 0
Size: 1 byte (U8)	Access: RW	PDO map: Not possible
Sub-index 61: Internal Logging Data Size		
Setting range: –	Unit: –	Factory settings: 1000
Size: 2 bytes (U16)	Access: RW	PDO map: Not possible
Sub-index 62: Internal Logging Sampling Interval		
Setting range: –	Unit: –	Factory setting: 0
Size: 2 bytes (U16)	Access: RW	PDO map: Not possible
Sub-index 63 to 66: Internal Logging On/off Task 1 to 4		
Setting range: –	Unit: –	Factory setting: 0
Size: 1 byte (U8)	Access: RW	PDO map: Not possible
Sub-index 68: Input Polarity: Zero		
Setting range: –	Unit: –	Factory settings: 0
Size: 1 byte (U8)	Access: RW	PDO map: Not possible

Sub-index 69: Input Polarity: Reset		
Setting range: –	Unit: –	Factory settings: 0
Size: 1 byte (U8)	Access: RW	PDO map: Not possible
Sub-index 70: Input Polarity: Timing		
Setting range: –	Unit: –	Factory settings: 0
Size: 1 byte (U8)	Access: RW	PDO map: Not possible
Sub-index 71: Input Polarity: Led-off		
Setting range: –	Unit: –	Factory settings: 0
Size: 1 byte (U8)	Access: RW	PDO map: Not possible
Sub-index 72: Input Polarity: Reserve		
Setting range: –	Unit: –	Factory settings: 0
Size: 1 byte (U8)	Access: RW	PDO map: Not possible
Sub-index 73: Input Polarity: Bank		
Setting range: –	Unit: –	Factory settings: 0
Size: 1 byte (U8)	Access: RW	PDO map: Not possible
Sub-index 74: Input Polarity: Binary-Sel		
Setting range: –	Unit: –	Factory settings: 0
Size: 1 byte (U8)	Access: RW	PDO map: Not possible
Sub-index 76: Initial Task No.		
Setting range: –	Unit: –	Factory settings: 0
Size: 1 byte (U8)	Access: RW	PDO map: Not possible
Sub-index 77: Run Mode Display		
Setting range: –	Unit: –	Factory settings: 0
Size: 1 byte (U8)	Access: RW	PDO map: Not possible
Sub-index 78: Decimal Point Digit		
Setting range: –	Unit: –	Factory settings: 1
Size: 1 byte (U8)	Access: RW	PDO map: Not possible
Sub-index 79: Key Lock		
Setting range: –	Unit: –	Factory settings: 0
Size: 1 byte (U8)	Access: RW	PDO map: Not possible
Sub-index 80: Timing/Reset Key Input		
Setting range: –	Unit: –	Factory settings: 0
Size: 1 byte (U8)	Access: RW	PDO map: Not possible
Sub-index 82: Zero Reset Memory		
Setting range: –	Unit: –	Factory settings: 1
Size: 1 byte (U8)	Access: RW	PDO map: Not possible
Sub-index 84: Sensor Head Model		
Setting range: –	Unit: –	Factory settings: ZW-C
Size: 30 bytes (VS)	Access: RW	PDO map: Not possible

- The system data is stored.

• **Standard bank**

3301 hex	Bank Data 1	
Sub-index 0: Number of entries		
Setting range: –	Unit: –	Factory setting: –
Size: 1 byte (U8)	Access: RO	PDO map: Not possible
Sub-index 1: Identification String		
Setting range: –	Unit: –	Factory settings: ZW-C BANK 1010
Size: 16 bytes (VS)	Access: RW	PDO map: Not possible
Sub-index 2: Bank Name		
Setting range: –	Unit: –	Factory settings: BANK 1
Size: 30 bytes (VS)	Access: RW	PDO map: Not possible
Sub-index 4: Picture Input 1		
Setting range: –	Unit: –	Factory setting: –
Size: 30 bytes (VS)	Access: RW	PDO map: Not possible
Sub-index 5: Picture Input 2		
Setting range: –	Unit: –	Factory setting: –
Size: 2 bytes (VS)	Access: RW	PDO map: Not possible
Sub-index 6: Exposure Time Control (2 Areas Mode off)		
Setting range: –	Unit: –	Factory setting: –
Size: 25 bytes (VS)	Access: RW	PDO map: Not possible
Sub-index 7: Exposure Time Control Buffer		
Setting range: –	Unit: –	Factory setting: –
Size: 7 bytes (VS)	Access: RW	PDO map: Not possible
Sub-index 8: Exposure Time Control (Area 1)		
Setting range: –	Unit: –	Factory setting: –
Size: 24 bytes (VS)	Access: RW	PDO map: Not possible
Sub-index 9: Exposure Time Control (Area 2)		
Setting range: –	Unit: –	Factory setting: –
Size: 24 bytes (VS)	Access: RW	PDO map: Not possible
Sub-index 10: Target to Measure		
Setting range: –	Unit: –	Factory setting: –
Size: 24 bytes (VS)	Access: RW	PDO map: Not possible
Sub-index 11: Measuring Point (Task 1)		
Setting range: –	Unit: –	Factory setting: –
Size: 29 bytes (VS)	Access: RW	PDO map: Not possible
Sub-index 12: Measuring Point Buffer (Task 1)		
Setting range: –	Unit: –	Factory setting: –
Size: 3 bytes (VS)	Access: RW	PDO map: Not possible
Sub-index 13: Scaling (Task 1)		
Setting range: –	Unit: –	Factory setting: –
Size: 16 bytes (VS)	Access: RW	PDO map: Not possible

Sub-index 14: Median Filter (Task 1)		
Setting range: –	Unit: –	Factory setting: –
Size: 8 bytes (VS)	Access: RW	PDO map: Not possible
Sub-index 15: Average Filter (Task 1)		
Setting range: –	Unit: –	Factory setting: –
Size: 8 bytes (VS)	Access: RW	PDO map: Not possible
Sub-index 16: Frequency Filter (Task 1)		
Setting range: –	Unit: –	Factory setting: –
Size: 24 bytes (VS)	Access: RW	PDO map: Not possible
Sub-index 17: Differentiation Filter (Task 1)		
Setting range: –	Unit: –	Factory setting: –
Size: 8 bytes (VS)	Access: RW	PDO map: Not possible
Sub-index 18: Hold 1 (Task 1)		
Setting range: –	Unit: –	Factory setting: –
Size: 30 bytes (VS)	Access: RW	PDO map: Not possible
Sub-index 19: Hold 2 (Task 1)		
Setting range: –	Unit: –	Factory setting: –
Size: 10 bytes (VS)	Access: RW	PDO map: Not possible
Sub-index 20: Zero Reset (Task 1)		
Setting range: –	Unit: –	Factory setting: –
Size: 24 bytes (VS)	Access: RW	PDO map: Not possible
Sub-index 21: Non-Measurement Setting (Task 1)		
Setting range: –	Unit: –	Factory setting: –
Size: 8 bytes (VS)	Access: RW	PDO map: Not possible
Sub-index 22: Judgement Output (Task 1)		
Setting range: –	Unit: –	Factory setting: –
Size: 24 bytes (VS)	Access: RW	PDO map: Not possible
Sub-index 23: Measuring Point (Task 2)		
Setting range: –	Unit: –	Factory setting: –
Size: 29 bytes (VS)	Access: RW	PDO map: Not possible
Sub-index 24: Measuring Point Buffer (Task 2)		
Setting range: –	Unit: –	Factory setting: –
Size: 3 bytes (VS)	Access: RW	PDO map: Not possible
Sub-index 25: Scaling (Task 2)		
Setting range: –	Unit: –	Factory setting: –
Size: 16 bytes (VS)	Access: RW	PDO map: Not possible
Sub-index 26: Median Filter (Task 2)		
Setting range: –	Unit: –	Factory setting: –
Size: 8 bytes (VS)	Access: RW	PDO map: Not possible
Sub-index 27: Average Filter (Task 2)		
Setting range: –	Unit: –	Factory setting: –
Size: 8 bytes (VS)	Access: RW	PDO map: Not possible

Sub-index 28: Frequency Filter (Task 2)		
Setting range: –	Unit: –	Factory setting: –
Size: 24 bytes (VS)	Access: RW	PDO map: Not possible
Sub-index 29: Differentiation Filter (Task 2)		
Setting range: –	Unit: –	Factory setting: –
Size: 8 bytes (VS)	Access: RW	PDO map: Not possible
Sub-index 30: Hold 1 (Task 2)		
Setting range: –	Unit: –	Factory setting: –
Size: 30 bytes (VS)	Access: RW	PDO map: Not possible
Sub-index 31: Hold 2 (Task 2)		
Setting range: –	Unit: –	Factory setting: –
Size: 10 bytes (VS)	Access: RW	PDO map: Not possible
Sub-index 32: Zero Reset (Task 2)		
Setting range: –	Unit: –	Factory setting: –
Size: 24 bytes (VS)	Access: RW	PDO map: Not possible
Sub-index 33: Non-Measurement Setting (Task 2)		
Setting range: –	Unit: –	Factory setting: –
Size: 8 bytes (VS)	Access: RW	PDO map: Not possible
Sub-index 34: Judgement Output (Task 2)		
Setting range: –	Unit: –	Factory setting: –
Size: 24 bytes (VS)	Access: RW	PDO map: Not possible
Sub-index 35: Measuring Point (Task 3)		
Setting range: –	Unit: –	Factory setting: –
Size: 29 bytes (VS)	Access: RW	PDO map: Not possible
Sub-index 36: Measuring Point Buffer (Task 3)		
Setting range: –	Unit: –	Factory setting: –
Size: 3 bytes (VS)	Access: RW	PDO map: Not possible
Sub-index 37: Scaling (Task 3)		
Setting range: –	Unit: –	Factory setting: –
Size: 16 bytes (VS)	Access: RW	PDO map: Not possible
Sub-index 38: Median Filter (Task 3)		
Setting range: –	Unit: –	Factory setting: –
Size: 8 bytes (VS)	Access: RW	PDO map: Not possible
Sub-index 39: Average Filter (Task 3)		
Setting range: –	Unit: –	Factory setting: –
Size: 8 bytes (VS)	Access: RW	PDO map: Not possible
Sub-index 40: Frequency Filter (Task 3)		
Setting range: –	Unit: –	Factory setting: –
Size: 24 bytes (VS)	Access: RW	PDO map: Not possible
Sub-index 41: Differentiation Filter (Task 3)		
Setting range: –	Unit: –	Factory setting: –
Size: 8 bytes (VS)	Access: RW	PDO map: Not possible

Sub-index 42: Hold 1 (Task 3)		
Setting range: –	Unit: –	Factory setting: –
Size: 30 bytes (VS)	Access: RW	PDO map: Not possible
Sub-index 43: Hold 2 (Task 3)		
Setting range: –	Unit: –	Factory setting: –
Size: 10 bytes (VS)	Access: RW	PDO map: Not possible
Sub-index 44: Zero Reset (Task 3)		
Setting range: –	Unit: –	Factory setting: –
Size: 24 bytes (VS)	Access: RW	PDO map: Not possible
Sub-index 45: Non-Measurement Setting (Task 3)		
Setting range: –	Unit: –	Factory setting: –
Size: 8 bytes (VS)	Access: RW	PDO map: Not possible
Sub-index 46: Judgement Output (Task 3)		
Setting range: –	Unit: –	Factory setting: –
Size: 24 bytes (VS)	Access: RW	PDO map: Not possible
Sub-index 47: Measuring Point (Task 4)		
Setting range: –	Unit: –	Factory setting: –
Size: 29 bytes (VS)	Access: RW	PDO map: Not possible
Sub-index 48: Measuring Point Buffer (Task 4)		
Setting range: –	Unit: –	Factory setting: –
Size: 3 bytes (VS)	Access: RW	PDO map: Not possible
Sub-index 49: Scaling (Task 4)		
Setting range: –	Unit: –	Factory setting: –
Size: 16 bytes (VS)	Access: RW	PDO map: Not possible
Sub-index 50: Median Filter (Task 4)		
Setting range: –	Unit: –	Factory setting: –
Size: 8 bytes (VS)	Access: RW	PDO map: Not possible
Sub-index 51: Average Filter (Task 4)		
Setting range: –	Unit: –	Factory setting: –
Size: 8 bytes (VS)	Access: RW	PDO map: Not possible
Sub-index 52: Frequency Filter (Task 4)		
Setting range: –	Unit: –	Factory setting: –
Size: 24 bytes (VS)	Access: RW	PDO map: Not possible
Sub-index 53: Differentiation Filter (Task 4)		
Setting range: –	Unit: –	Factory setting: –
Size: 8 bytes (VS)	Access: RW	PDO map: Not possible
Sub-index 54: Hold 1 (Task 4)		
Setting range: –	Unit: –	Factory setting: –
Size: 30 bytes (VS)	Access: RW	PDO map: Not possible
Sub-index 55: Hold 2 (Task 4)		
Setting range: –	Unit: –	Factory setting: –
Size: 10 bytes (VS)	Access: RW	PDO map: Not possible

Sub-index 56: Zero Reset (Task 4)		
Setting range: –	Unit: –	Factory setting: –
Size: 24 bytes (VS)	Access: RW	PDO map: Not possible
Sub-index 57: Non-Measurement Setting (Task 4)		
Setting range: –	Unit: –	Factory setting: –
Size: 8 bytes (VS)	Access: RW	PDO map: Not possible
Sub-index 58: Judgement Output (Task 4)		
Setting range: –	Unit: –	Factory setting: –
Size: 24 bytes (VS)	Access: RW	PDO map: Not possible
Sub-index 59: Judgement Processing		
Setting range: –	Unit: –	Factory setting: –
Size: 16 bytes (VS)	Access: RW	PDO map: Not possible
Sub-index 60: Non-Measurement Setting		
Setting range: –	Unit: –	Factory setting: –
Size: 8 bytes (VS)	Access: RW	PDO map: Not possible
Sub-index 61: Analog Output 1		
Setting range: –	Unit: –	Factory setting: –
Size: 30 bytes (VS)	Access: RW	PDO map: Not possible
Sub-index 62: Analog Output 2		
Setting range: –	Unit: –	Factory setting: –
Size: 10 bytes (VS)	Access: RW	PDO map: Not possible
Sub-index 63: Binary Output 1 [*]		
Setting range: –	Unit: –	Factory setting: –
Size: 30 bytes (VS)	Access: RW	PDO map: Not possible
Sub-index 64: Binary Output 2 [*]		
Setting range: –	Unit: –	Factory setting: –
Size: 10 bytes (VS)	Access: RW	PDO map: Not possible
Sub-index 65: Logging		
Setting range: –	Unit: –	Factory setting: –
Size: 8 bytes (VS)	Access: RW	PDO map: Not possible
Sub-index 66: Parallel Output		
Setting range: –	Unit: –	Factory setting: –
Size: 16 bytes (VS)	Access: RW	PDO map: Not possible
Sub-index 67: Stub		
Setting range: –	Unit: –	Factory setting: –
Size: 8 bytes (VS)	Access: RW	PDO map: Not possible
Sub-index 68: Parallel Input		
Setting range: –	Unit: –	Factory setting: –
Size: 8 bytes (VS)	Access: RW	PDO map: Not possible
Sub-index 69: Line Bright		
Setting range: –	Unit: –	Factory setting: –
Size: 8 bytes (VS)	Access: RW	PDO map: Not possible

Sub-index 70: Test Item		
Setting range: –	Unit: –	Factory setting: –
Size: 8 bytes (VS)	Access: RW	PDO map: Not possible
Sub-index 76: Byte Count of Parameter		
Setting range: –	Unit: –	Factory setting: –
Size: 4 bytes (U32)	Access: RW	PDO map: Not possible
Sub-index 77: Sum		
Setting range: –	Unit: –	Factory setting: –
Size: 4 bytes (U32)	Access: RW	PDO map: Not possible
Sub-index 78: Xor		
Setting range: –	Unit: –	Factory setting: –
Size: 4 bytes (U32)	Access: RW	PDO map: Not possible

- This is bank data 1 for backup use.
- The indexes for bank data 2 onwards are as follows:
 - Bank data 2: 3302 hex
 - Bank data 3: 3303 hex
 - Bank data 4: 3304 hex
 - Bank data 5: 3305 hex
 - Bank data 6: 3306 hex
 - Bank data 7: 3307 hex
 - Bank data 8: 3308 hex

*: ZW-CE1□T does not output sub-indexes 63/64.

• Judgment value bank

3401 hex	Bank Data1 (Judge Mode)	
Sub-index 0: Number of entries		
Setting range: –	Unit: –	Factory setting: –
Size: 1 byte (U8)	Access: RO	PDO map: Not possible
Sub-index 1: Identification String		
Setting range: –	Unit: –	Factory setting: –
Size: 16 bytes (VS)	Access: RW	PDO map: Not possible
Sub-index 2: Name of Bank		
Setting range: –	Unit: –	Factory setting: –
Size: 30 bytes (VS)	Access: RW	PDO map: Not possible
Sub-index 4 to 7: TASK 1 to 4		
Setting range: –	Unit: –	Factory setting: –
Size: 12 bytes (VS)	Access: RW	PDO map: Not possible
Sub-index 9: SUM		
Setting range: –	Unit: –	Factory setting: –
Size: 4 bytes (U32)	Access: RW	PDO map: Not possible
Sub-index 10: XOR		
Setting range: –	Unit: –	Factory setting: –
Size: 4 bytes (U32)	Access: RW	PDO map: Not possible

- This is bank data for backup use when the bank mode is Judgment Value. The following also must be backed up in addition to the bank data. (When the bank mode is Normal, all 0's are stored.)
- The indexes for bank data (Judgment Value) 2 onwards are as follows:
Bank data (Judgment Value) 2: 3402 hex
Bank data (Judgment Value) 3: 3403 hex
.
.
.
Bank data (Judgment Value) 32: 3420 hex

• **Line bright (measurement waveform)**

3500 hex	Line Bright		
Sub-index 0: Number of entries			
Setting range: –	Unit: –	Factory setting: –	
Size: 1 byte (U8)	Access: RO	PDO map: Not possible	
Sub-index 1: Taking Sensor Head Channel			
Setting range: –	Unit: –	Factory setting: –	
Size: 1 byte (U8)	Access: RW	PDO map: Not possible	
Sub-index 2: Taking Line Bright Area			
Setting range: –	Unit: –	Factory setting: –	
Size: 1 byte (U8)	Access: RW	PDO map: Not possible	

- The line bright data is stored.

3501 hex	Line Bright		
Sub-index 0: Number of entries			
Setting range: –	Unit: –	Factory setting: –	
Size: 1 byte (U8)	Access: RO	PDO map: Not possible	
Sub-index 1 to 39: Line Bright Data1 to 39			
Setting range: –	Unit: –	Factory setting: –	
Size: 30 bytes (VS)	Access: RO	PDO map: Not possible	

- The line bright data is stored.
- Only sub-index 39, size is 8byte (VS).

Index

<hr/>	
Numeric	
24 V input terminal block	28
Terminal functions	47
Wiring	47
32-pole extension connector	28
Signal functions	45
Terminal functions	44
Wiring	44
<hr/>	
A	
Analog output	299
Adjusting output value	143
Assigning	141
Setting monitor focus	142
Analog output terminal block	28
Terminal functions	46
Wiring	46
<hr/>	
B	
Bank	63
Bank Settings	
Clearing	113
Copy	111
Saving the Bank/System Settings	112
<hr/>	
C	
Calibration ROM	
Connecting	37
Names of parts	25
Communications command	
Current bank data acquisition command	241
Current bank data setting command	242
Data save command	250
Default gateway acquisition	255
Default gateway setting	255
Head serial information acquisition	258
Internal logging data acquisition command	248
Internal logging data clear command	249
Internal logging data information acquisition command	250
Internal logging start command	247, 248
IP address acquisition	253
IP address setting	253
Judgment result acquisition command	238
MAC address acquisition	258
Measurement command	237
OUT IP address acquisition of the specified socket number	256
OUT IP address setting of the specified socket number	257
Processing unit data acquisition command	239
Processing unit data setting command	240
RESET input command	245
Restart	259
Sensor head calibration command	247
Subnet mask acquisition	254
Subnet mask setting	254
System data acquisition	251
System data setting	252
TIMING input command	245
Version information acquisition command	246
White LED OFF input command	246
Zero reset cancel command	244
Zero reset execution command	243
Connection adapter	40, 376
<hr/>	
D	
Delimiter	230
Digital Displays	295
Alphabetical notation	295
Changing Display Details	300
Changing Threshold Values	301
Entering Numerical Values	297
Positioning decimal point	297
DIN track attachment hook	28, 36
Displayed task	299
Distance	299
<hr/>	
E	
Edit pane	58
Effective bank	299
Electrical Specifications	
Input circuit	49
Output circuit	50
ENABLE indicator	27
Error Messages	
Common	283
EtherCAT (SDO)	281
EtherCAT (Sysmac Error Status)	270
Ethernet, Ethernet/IP	282
ESI Specification (V1.0)	197
EtherCAT	159
EtherCAT telegram	160
Ethernet connector	28
Ethernet frames	159
Explorer pane	57
Exposure time	299
Extension fiber cable	375
<hr/>	
F	
Fiber cable	
Connect	38
Extend	40
Fiber cleaner	39, 41
Fiber connector cleaner	376
Filters	93
Average Filter	95
Differentiation Filter	97

Frequency Filter	96
Median Filter	94
<hr/>	
H	
HIGH indicator	27
Hold	
Clearing conditions	100
Performing with Key Input	320
Trigger	101
Trigger Delay	104
<hr/>	
I	
Icons	59
Installation screw hole	28
<hr/>	
J	
Judgment Output	
Assigning	145
Setting Operation at Judgment Output	146
Judgment result	299
<hr/>	
L	
LEFT/RIGHT key	27, 294
LOW indicator	27
<hr/>	
M	
Main display	27, 298
Measuring range	31
Mode switching key	27, 294
Multi-task Function	62
<hr/>	
N	
Node Address Setting, Saving	196
Non-Measurement setting	148
Clamp Value	149
No-protocol	226
<hr/>	
O	
Object Dictionary	390
Offline	265
Offline, Debugging	263
Offline, Settings	262
Operating Keys	294
Operation modes	61
<hr/>	
P	
Parallel cable	379
PASS indicator	27
PC tool	23, 374
Project	
Export	70
Import	70
Launching	54
Save	70
<hr/>	
R	
Resolution	299
RS-232C connector	28
RUN indicator	27
<hr/>	
S	
Scaling	87
1-point Scaling	88
2-point Scaling	90
Manual Scaling	87

Thickness Scaling	92
Sensor Controller	
External Dimensions	373
Installing on bottom	37
Installing on the DIN track	36
Names of parts	26
Precautions for installation	35
Specifications	370
Sensor Head	
Angle Characteristic	365
Calibrate	42
External Dimensions	359
Installation	30
Interference	33
Linearity characteristic	362
Measuring range	31
Names of parts	25
Precautions for installation	30
Specifications	358
Spot diameter	360
Serial Number Display	197
Setting Exposure Time Control Mode	76, 77, 78, 79
Setting Measurement Items	83
Calculation	86
Height	83
Thickness	85
Setting the System	114
Sensor Information	114
Setting Threshold Value	68
Direct	68, 333
Teaching	331
Settings for Bank Control	150, 151
Output the currently selected bank number	150
Selecting banks	150, 151
SII Data Check	197
STABILITY indicator	27
Sub-display	27
Sysmac Device	196
Sysmac Error Status	196, 270
Sysmac Error Status, Checking	272
Sysmac Error Status, Clearing	272
Sysmac Error Status, Descriptions	273
Sysmac Studio Main Window	56
Sysmac Studio Measurement Sensor Edition	23
Sysmac Studio Standard Edition	23
Sysmac Studio, Installing	51
Sysmac Studio, window sections	56
System Configuration	22
<hr/>	
T	
Threshold	299
THRESHOLD-H indicator	27
THRESHOLD-L indicator	27
Timing Chart	
EtherCAT	189
EtherNet/IP	220

Parallel I/O	152
<hr/>	
U	
UP/DOWN key	294
<hr/>	
Z	
ZERO indicator	27
Zero reset	65, 105
Cancel	67
Execute	66
Offset	106
Type	107
ZERO/SET key	27, 294
ZERORST/ESC key	27, 294

Revision History

A manual revision code appears as a suffix to the catalog number at the bottom of the front and back covers of this manual.

Cat. No. Z332-E1-07

↑
Revision code

Revision code	Date	Revision Contents
01	October 2012	Original production
02	May 2013	Minor corrections
03	July 2013	Mistake corrections
04	October 2013	Minor correction about EtherCAT connection
05	December 2013	Minor corrections for compatibility with Windows 8
06	August 2014	Addition of Sensor Head, minor corrections
07	August 2015	Additions corresponding to change of EN standard.

OMRON Corporation Industrial Automation Company
Kyoto, JAPAN

Contact: www.ia.omron.com

Regional Headquarters

OMRON EUROPE B.V.

Sensor Business Unit

Carl-Benz-Str. 4, D-71154 Nufringen, Germany
Tel: (49) 7032-811-0/Fax: (49) 7032-811-199

OMRON ELECTRONICS LLC

2895 Greenspoint Parkway, Suite 200
Hoffman Estates, IL 60169 U.S.A.
Tel: (1) 847-843-7900/Fax: (1) 847-843-7787

OMRON ASIA PACIFIC PTE. LTD.

No. 438A Alexandra Road # 05-05/08 (Lobby 2),
Alexandra Technopark,
Singapore 119967
Tel: (65) 6835-3011/Fax: (65) 6835-2711

OMRON (CHINA) CO., LTD.

Room 2211, Bank of China Tower,
200 Yin Cheng Zhong Road,
PuDong New Area, Shanghai, 200120, China
Tel: (86) 21-5037-2222/Fax: (86) 21-5037-2200

Authorized Distributor:

© OMRON Corporation 2012 All Rights Reserved.
In the interest of product improvement,
specifications are subject to change without notice.

Cat. No. Z332-E1-07

0815