



CJ Series

EtherNet/IP™ Connection Guide

OMRON Corporation

ZW-series Displacement Sensor

About Intellectual Property Right and Trademarks

Microsoft product screen shots reprinted with permission from Microsoft Corporation.

Windows is a registered trademark of Microsoft Corporation in the USA and other countries.

ODVA and EtherNet/IP™ are trademarks of ODVA.

Ethernet is a registered trademark of the Xerox Corporation.

Company names and product names in this document are the trademarks or registered trademarks of their respective companies.

Table of Contents

1. Related Manuals	1
2. Terms and Definitions	2
3. Remarks	3
4. Overview	5
5. Applicable Devices and Support Software	6
5.1. Applicable Devices	6
5.2. Device Configuration	7
6. EtherNet/IP Connection Procedure	9
6.1. EtherNet/IP Communications Settings.....	9
6.2. Work Flow.....	12
6.3. Setting Up the Displacement Sensor.....	13
6.4. Setting Up the PLC.....	21
6.5. Checking the EtherNet/IP Communications.....	44
7. Initialization Method	49
7.1. Initializing the PLC.....	49
7.2. Initializing the Displacement Sensor.....	50
8. Revision History	51

1. Related Manuals

The table below lists the manuals related to this document.

To ensure system safety, make sure to always read and heed the information provided in all Safety Precautions, Precautions for Safe Use, and Precaution for Correct Use of manuals for each device which is used in the system.

Cat. No.	Model	Manual name
W472	CJ2H-CPU6[]-EIP CJ2H-CPU6[] CJ2M-CPU[] []	CJ-series CJ2 CPU Unit Hardware User's Manual
W473	CJ2H-CPU6[]-EIP CJ2H-CPU6[] CJ2M-CPU[] []	CJ-series CJ2 CPU Unit Software User's Manual
W465	CJ1W-EIP21 CJ2H-CPU6[]-EIP CJ2M-CPU3[]	EtherNet/IP™ Unit Operation Manual
W446	-	CX-Programmer Operation Manual
Z332	ZW-CE1[]	ZW Series Displacement Sensor (Confocal Fiber Type) User's Manual



2. Terms and Definitions

Term	Explanation and Definition
Tag data link	A function that enables cyclic tag data exchanges on an EtherNet/IP network between PLCs or between PLCs and with other devices without using a user program in the PLCs.
Tag	A tag is a unit that is used to exchange data with tag data links. Data is exchanged between the local network variables and remote network variables specified in the tags or between specified I/O memory areas.
Tag set	When a connection is established, from 1 to 8 tags (including Controller status) is configured as a tag set. Each tag set represents the data that is linked for a tag data link connection.
Connection	A connection is used to exchange data as a unit within which data synchronicity is maintained. Thus, data synchronicity is maintained for all the data exchanged for the tags in one data set.
Originator and Target	To perform tag data links, one node requests the opening of a communications line called "connection" to perform tag data links. The node that requests opening the connection is called "originator", and the node that receives the request is called "target".
Node	With EtherNet/IP network, 1 node is 1 EtherNet/IP port.
Tag data link parameter	The tag data link parameter is the setting data to perform the tag data link. It includes the data to set tags, tag sets, and connections.
EDS file	A file that contains the I/O points of EtherNet/IP devices and the parameters that can be set via EtherNet/IP.

3. Remarks

- (1) Understand the specifications of devices which are used in the system. Allow some margin for ratings and performance. Provide safety measures, such as installing safety circuit in order to ensure safety and minimize risks of abnormal occurrence.
- (2) To ensure system safety, always read and heed the information provided in all Safety Precautions, Precautions for Safe Use, and Precaution for Correct Use of manuals for each device used in the system.
- (3) The users are encouraged to confirm the standards and regulations that the system must conform to.
- (4) It is prohibited to copy, to reproduce, and to distribute a part of or whole part of this document without the permission of OMRON Corporation.
- (5) This document provides the latest information as of April 2013. The information on this manual is subject to change without notice for improvement.

The following notation is used in this document.

 WARNING	Indicates a potentially hazardous situation which, if not avoided, could result in death or serious injury. Additionally, there may be severe property damage.
 Caution	Indicates a potentially hazardous situation which, if not avoided, may result in minor or moderate injury, or property damage.



Precautions for Safe Use

Precautions on what to do and what not to do to ensure safe usage of the product.



Precautions for Correct Use

Precautions on what to do and what not to do to ensure proper operation and performance.



Additional Information

Additional information to read as required.

This information is provided to increase understanding or make operation easier.

Symbols



The triangle symbol indicates precautions (including warnings).
The specific operation is shown in the triangle and explained in text.
This example indicates a general precaution.

4. Overview

This document describes the procedure to connect the Displacement Sensor (ZW series) of OMRON Corporation (hereinafter referred to as OMRON) with CJ-series Programmable Controller + Ethernet/IP Unit (hereinafter referred to as the PLC), and the procedure to check their connection.

Refer to *Section 6. Connection Procedure* to understand the setting method and key points to connect the devices via EtherNet I/P.

In this document, CJ-series EtherNet/IP Unit and the built-in EtherNet/IP port of CJ-series CJ2 CPU Unit are collectively called as the "EtherNet/IP Unit".

5. Applicable Devices and Support Software

5.1. Applicable Devices

The applicable devices are as follows:

Manufacturer	Name	Model
OMRON	CJ2 CPU Unit	CJ2[]-CPU[][]
OMRON	EtherNet/IP Unit	CJ1W-EIP21 CJ2H-CPU6[]-EIP CJ2M-CPU3[]
OMRON	Confocal Fiber Type Displacement Sensor Controller	ZW-CE1[] ZW-CE1[]T
OMRON	Sensor Head	ZW-S[][]



Additional Information

As applicable devices above, the devices with the models and versions listed in Section 5.2. are actually used in this document to describe the procedure for connecting devices and checking the connection.

You cannot use devices with versions lower than the versions listed in Section 5.2.

To use the above devices with versions not listed in Section 5.2 or versions higher than those listed in Section 5.2, check the differences in the specifications by referring to the manuals before operating the devices.



Additional Information

This document describes the procedure to establish the network connection. Except for the connection procedure, it does not provide information on operation, installation or wiring method. It also does not describe the functionality or operation of the devices. Refer to the manuals or contact your OMRON representative.

5.2. Device Configuration

The hardware components to reproduce the connection procedure of this document are as follows:

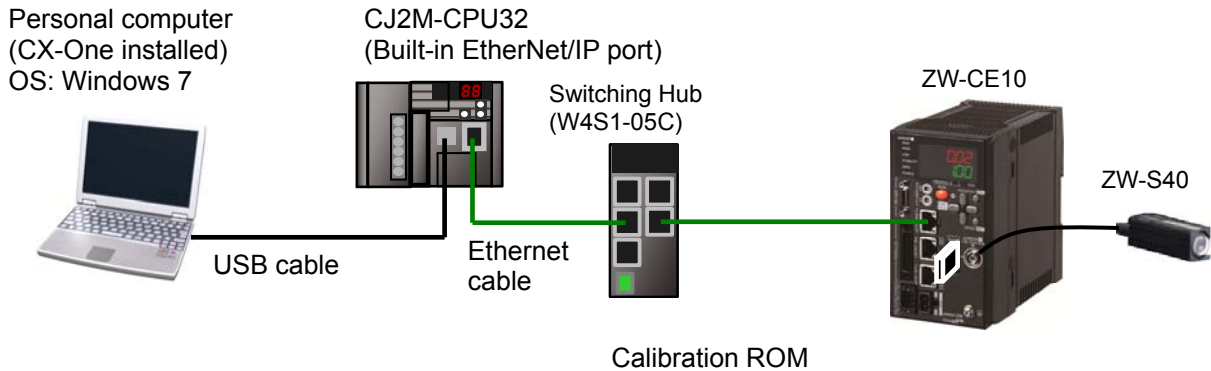

Manufacturer	Name	Model	Version
OMRON	CPU Unit (Built-in EtherNet/IP port)	CJ2M-CPU32 (with built-in CJ2M-EIP21)	Ver.2.0 (Ver.2.1)
OMRON	Power Supply Unit	CJ1W-PA202	
OMRON	Switching Hub	W4S1-05C	Ver.1.0
OMRON	CX-One	CXONE-AL□□C-V4 /AL□□D-V4	Ver.4.□□
OMRON	CX-Programmer	(Included in CX-One.)	Ver.9.41
OMRON	Network Configurator	(Included in CX-One.)	Ver.3.55
-	Personal computer (OS: Windows 7)	-	
-	USB cable	-	
OMRON	Ethernet cable (with industrial Ethernet connector)	XS5W-T421-□M□-K	
OMRON	Displacement Sensor Controller	ZW-CE10	Ver.1.110
OMRON	Displacement Sensor Sensor Head	ZW-S40	
OMRON	Calibration ROM	(Included with Sensor Head.)	
OMRON	Recommended power supply: 24VDC 2.5A 60W	S8VS-06024	

 **Precautions for Correct Use**

Update the CX-Programmer and Network Configurator to the versions specified in this section or higher versions using the auto update function.

If a version not specified in this section is used, the procedures described in Section 6 and subsequent sections may not be applicable. In that case, use the equivalent procedures described in the CX-Programmer Operation Manual (Cat. No. W446) and Network Configurator Online Help.



Additional Information

The system configuration in this document uses USB for the connection between the personal computer and PLC. When installing the USB driver, please refer to *A-5 Installing the USB Driver* in the *CJ-series CJ2 CPU Unit Hardware User's Manual* (Cat. No. W472).

6. EtherNet/IP Connection Procedure

This section explains the procedure for connecting the Displacement Sensor to the PLC via EtherNet/IP.

6.1. EtherNet/IP Communications Settings

The settings shown in the table below are used to explain the procedure for connecting the PLC.

This document explains the procedure for setting up the PLC and Displacement Sensor from the factory default setting. For the initialization, refer to *Section 7 Initialization Method*.

6.1.1. Settings

The settings of the PLC (EtherNet/IP Unit) and the Displacement Sensor are as follows:

	PLC (EtherNet/IP Unit) (node 1)	Displacement Sensor (node 2)
Unit number	0	-
Node address	1	2
IP address	192.168.250.1	192.168.250.2
Subnet mask	255.255.255.0	255.255.255.0 (default)
MEMLNK (Memory link function)	-	EIP (EtherNet/IP)

6.1.2. Tag Data Link Allocation

The tag data link allocation of the Displacement Sensor is as follows:

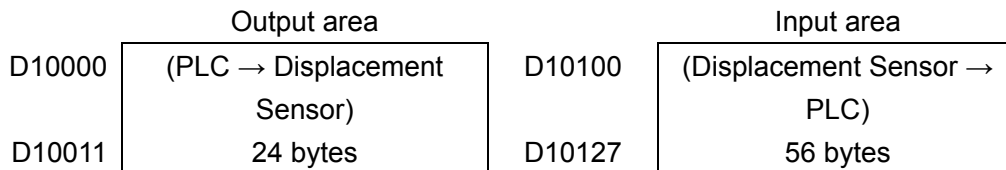

•Output area (PLC → Displacement Sensor)

	Bit																Description
	15	14	13	12	11	10	9	8	7	6	5	4	3	2	1	0	
D10000															SYNC	EXE	Control input ^{*1} (2 words)
D10001																ERCLR	
D10002														LIGHT OFF	RESET1	TMNG1	Control input ^{*2} (2 words)
D10003								ZERO CLR T4	ZERO CLR T3	ZERO CLR T2	ZERO CLR T1	ZERO1 T4	ZERO1 T3	ZERO1 T2	ZERO1 T1		
D10004																	Control input ^{*3} (2 words)
D10005																	
D10006	Command code (2 words)																-
D10007																	
D10008	Command parameter 1																Command parameters (Up to 4 words)
D10009	Command parameter 2																
D10010	Command parameter 3																
D10011																	

- *1: Sensor head common control signal
- *2: Sensor head 1 control signal
- *3: Sensor head 2 control signal (Reserved)

•Input area (Displacement Sensor → PLC)

	Bit																Description
	15	14	13	12	11	10	9	8	7	6	5	4	3	2	1	0	
D10100	BANK 1_E	BANK 1_D	BANK 1_C	BANK 1_B	BANK 1_A							RUN		READY	SYNC FLG	FLG	Control output ^{*1} (2 words)
D10101																ERR	
D10102									OR1	GATE 1	ENABLE1	STABLIT Y1	LIGHT1	RESETS TAT1	HOLDST AT1	Control output ^{*2} (2 words)	
D10103	LOW1 _T4	PASS 1 _T4	HIGH 1_T4	LOW1 _T3	PASS 1 _T3	HIGH 1_T3	LOW 1_T2	PASS 1 _T2	HIGH 1_T2	LOW 1_T1	PASS 1 _T1	HIGH1_T 1	ZEROST AT_T4	ZEROST AT_T3	ZEROST AT_T2		ZEROST AT_T1
D10104																	Control output ^{*3} (2 words)
D10105																	
D10106	Command code (2 words)																-
D10107																	-
D10108	Response code (2 words)																-
D10109																	-
D10110	Response data (2 words)																-
D10111																	-
D10112	Output data 0																Output data (16 words)
D10113																	
D10114	Output data 1																
D10115																	
D10116	Output data 2																
D10117																	
D10118	Output data 3																
D10119																	
D10120	Output data 4																
D10121																	
D10122	Output data 5																
D10123																	
D10124	Output data 6																
D10125																	
D10126	Output data 7																
D10127																	

*1: Sensor head common status signal

*2: Sensor head 1 status signal

*3: Sensor head 2 status signal (Reserved)



Additional Information

For details on the command codes and response codes, refer to 6-3 *EtherNet/IP Connection* under *Chapter 6 Communications with External Devices* in the *ZW Series Displacement Sensor (Confocal Fiber Type) User's Manual* (Cat. No. Z332).

6.2. Work Flow

Take the following steps to set the tag data link for EtherNet/IP.

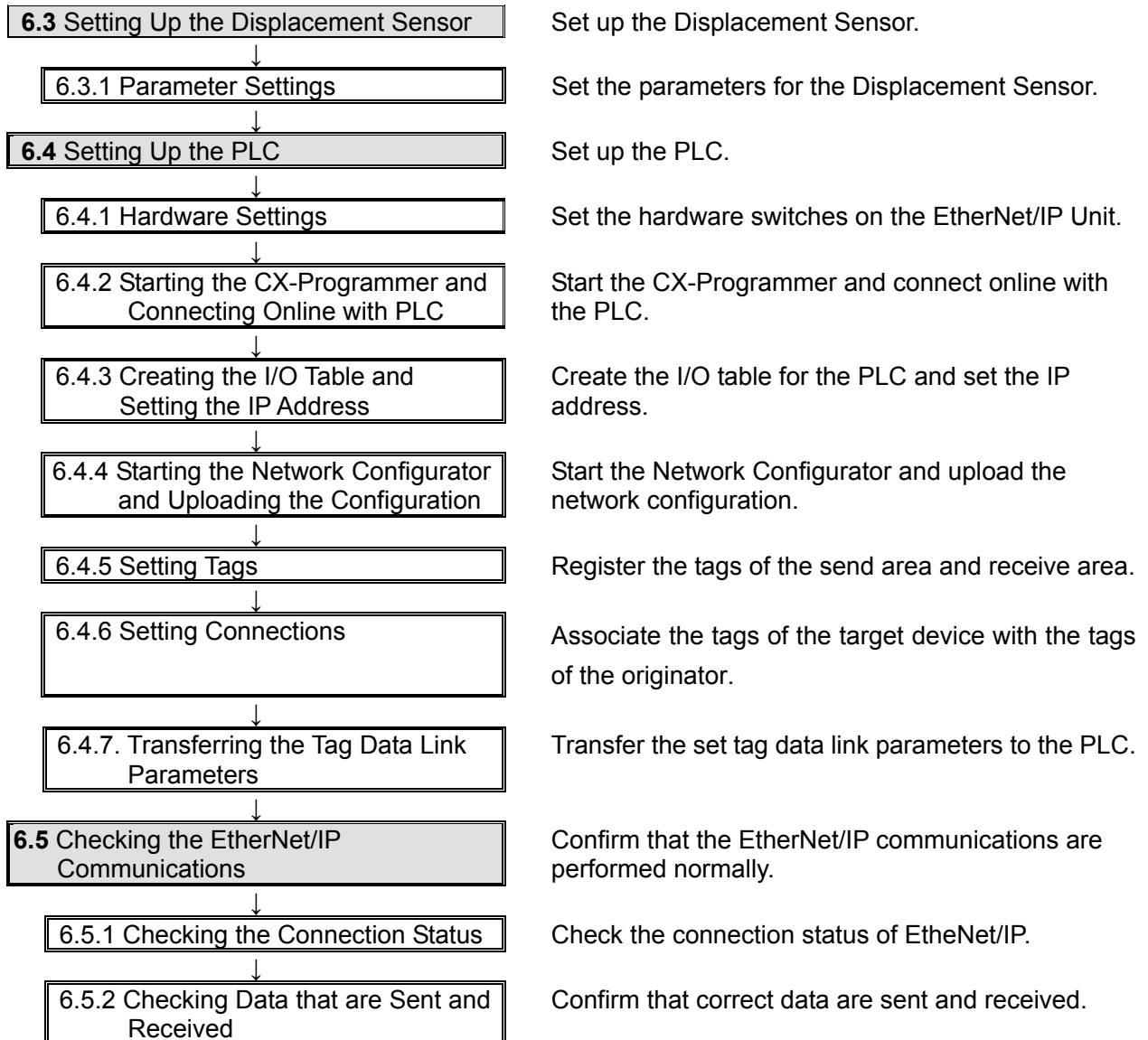

6.3. Setting Up the Displacement Sensor

Set up the Displacement Sensor.

6.3.1. Parameter Settings

Set the parameters for the Displacement Sensor.

- 1 Check the keys and display used to set parameters for the Displacement Sensor.
 Connect the Controller to the Sensor Head and connect the Calibration ROM.
 Connect the Ethernet cable.
 Turn ON the power supply to the Displacement Sensor.

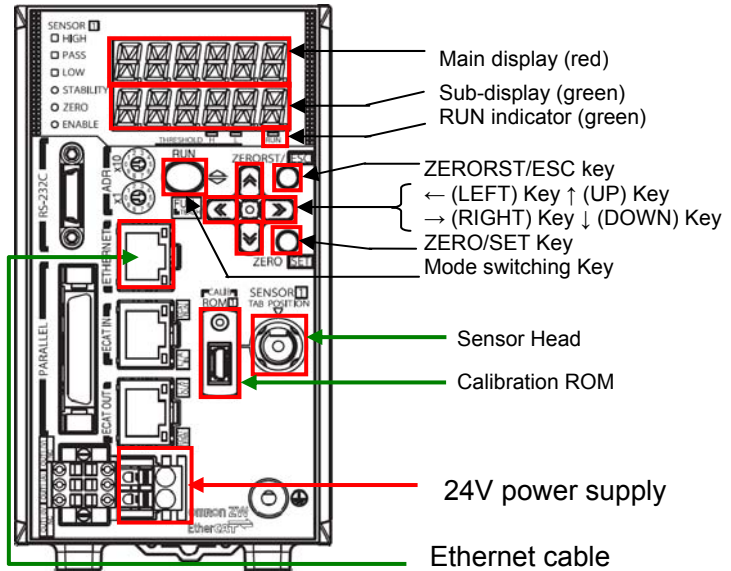

- 2 After the startup screen is displayed, the RUN mode screen is displayed. The RUN indicator is lit as shown on the right. Hold down the **Mode switching** Key for two seconds.



Hold down the **Mode switching** Key for two seconds.

- 3 A confirmation screen for mode switching is displayed. Press the **ZERO/SET** Key.



Press the **ZERO/SET** Key once.

4 The RUN mode screen is displayed.
The RUN indicator is not lit as shown on the right.



Press → (RIGHT) Key or ← (LEFT) Key to change the main display content from SENS to SYSTEM.



Press the → (RIGHT) Key or ← (LEFT) Key.

Press the **ZERO/SET** Key.



Press the **ZERO/SET** Key once.

5 SAVE is displayed on the main display.



Press → (RIGHT) Key or ← (LEFT) Key and change the main display content from SAVE to COM.







Press the → (RIGHT) Key or ← (LEFT) Key.

Press the **ZERO/SET** Key.



Press the **ZERO/SET** Key once.

<p>6</p>	<p>RS232C is displayed on the main display.</p> <p>Press the → (RIGHT) Key and change the main display content from RS232C to ETN.</p> <p>Press the ZERO/SET Key.</p>	 <p>↓ Press the → (RIGHT) Key once.</p>  <p>↓ Press the ZERO/SET Key once.</p>
<p>7</p>	<p>IPADDR is displayed on the main display.</p> <p>Press the ZERO/SET Key.</p>	 <p>↓ Press the ZERO/SET Key once.</p>
<p>8</p>	<p>IP1 is displayed on the main display.</p> <p>Press the ZERO/SET Key.</p> <p>Confirm that 192 is displayed on the sub-display.</p> <p>*If the setting value is different, change the value by referring to step 11 and step 12.</p> <p>*In this step, you set 192 that is the first octet of IP address 192.168.250.2.</p> <p>Press the ZERORST/ESC Key once. The first screen in this step is displayed again.</p> <p>Press the → (RIGHT) Key once.</p>	 <p>↓ Press the ZERO/SET Key once.</p>  <p>↓ Press the ZERORST/ESC Key once.</p> <p>IP1 is displayed.</p> <p>↓ Press the → (RIGHT) Key once.</p>

9 IP2 is displayed on the main display.

Press the **ZERO/SET** Key.

Confirm that 168 is displayed on the sub-display.

*If the setting value is different, change the value by referring to step 11 and step 12.

*In this step, you set 168 that is the second octet of IP address 192.168.250.2.

Press the **ZERORST/ESC** Key once. The first screen in this step is displayed again.

Press the → (RIGHT) Key once.



Press the **ZERO/SET** Key once.



Press the **ZERORST/ESC** Key once.

IP2 is displayed.



Press the → (RIGHT) Key once.

10 IP3 is displayed on the main display.

Press the **ZERO/SET** Key.

Confirm that 250 is displayed on the sub-display.

*If the setting value is different, change the value by referring to step 11 and step 12.

*In this step, you set 250 that is the third octet of IP address 192.168.250.2.

Press the **ZERORST/ESC** Key once. The first screen in this step is displayed again.

Press the → (RIGHT) Key once.



Press the **ZERO/SET** Key once.



Press the **ZERORST/ESC** Key once.

IP3 is displayed.



Press the → (RIGHT) key once.

11 IP4 is displayed on the main display.



Press the **ZERO/SET** Key.

 Press the **ZERO/SET** Key once.

The default value is displayed on the sub-display.



Press the **ZERO/SET** Key.

 Press the **ZERO/SET** Key once.

The sub-display content changes and you can change the values.
 Select a digit whose value you want to change by pressing the → (RIGHT) or ← (LEFT) Key.
 You can change the value of a blinking digit.
 Change the value by pressing the ↑ (UP) or ↓ (DOWN) Key.
 Change to 000002.



 Press the → (RIGHT) or ← (LEFT) Key.
 Press the ↑ (UP) or ↓ (DOWN) Key.

12 000002 is displayed on the sub-display.

Press the **ZERO/SET** Key.



2 is displayed on the sub-display.

 Press the **ZERO/SET** Key once.

*In this step, you set 2 that is the fourth octet of IP address 192.168.250.2.

Press **ZERORST/ESC** Key once. The first screen in step 11 is displayed again.



Press the **ZERORST/ESC** Key once.

 Press the **ZERORST/ESC** Key once.

IP4 is displayed.

 Press the **ZERORST/ESC** Key once.

13 IPADDR is displayed on the main display.



Press the → (RIGHT) Key once and change the main display content to SUBNET.



Press the → (RIGHT) Key once.



Press the ZERO/SET Key.



Press the ZERO/SET Key once.

14 The main display content is changed to SUB1.



Press the ZERO/SET Key.



Press the ZERO/SET Key once.

255 is displayed on the sub-display.



Press the ZERORST/ESC Key once.



Press the ZERORST/ESC Key once.

15 Press the → (RIGHT) Key and change the main display content to SUB2, SUB3 and SUB4. Press the ZERO/SET Key to check the setting values. Check that the values between SUB2 and SUB4 are as follows:

- SUB2, SUB3: 255
- SUB4: 0



*In steps 14 and 15, you set 255.255.255.0 subnet mask.



After checking, press the ZERORST/ESC Key three times.



Press the ZERORST/ESC Key three times.

16 ETN is displayed on the main display.



Press the → (RIGHT) Key and change the main display content to DELIMI.

Press the → (RIGHT) Key once.



Press the → (RIGHT) Key and change the main display content to MEMKNK.

Press the → (RIGHT) Key once.



Press the **ZERO/SET** Key.

Press the **ZERO/SET** Key once.

17 E-CAT is displayed on the sub-display.



Press the ↑ (UP) Key once to blink EIP on the sub-display. Press the **ZERO/SET** Key.

Press the ↑ (UP) Key once.

EIP is blinking.

Press the **ZERO/SET** Key once.

*The memory link function setting changes to EtherNet/IP.



<Setting range>
None/EIP/E-CAT
Default: E-CAT

Hold down the **Mode switching** Key for two seconds.

Hold down the **Mode switching** Key for two seconds.

18 A confirmation screen for mode switching is displayed.



Press the **ZERO/SET** Key.



Press the **ZERO/SET** Key once.

The save confirmation screen is displayed.



Press the **ZERO/SET** Key.



Press the **ZERO/SET** Key once.

The RUN mode screen is displayed.



19 Cycle the power supply to the Displacement Sensor.

*The new settings will take effect after restarting.

6.4. Setting Up the PLC

Set up the PLC.

6.4.1. Hardware Settings

Set the hardware switches on the EtherNet/IP Unit.



Precautions for Correct Use

Make sure that the power supply is OFF when you perform the setting up.

1	<p>Make sure that the PLC power is OFF.</p> <p>*If the power supply is turned ON, the following procedure may not be applicable.</p>			
2	<p>Refer to the right figure and check the hardware switches located on the front panel of the EtherNet/IP Unit.</p>	<p>LED Indicators</p> <p>Unit number setting switch</p> <p>Node address setting switches</p>		
3	<p>Set the Unit number setting switch to 0.</p>	<p>The unit number is used to identify individual CPU Bus Units when more than one CPU Bus Unit is mounted to the same PLC. Use a small screwdriver to make the setting, taking care not to damage the rotary switch. The unit number is factory-set to 0.</p> <table border="1" style="margin-left: auto;"> <tr><td>Setting range:</td></tr> <tr><td>0 to F</td></tr> </table>	Setting range:	0 to F
Setting range:				
0 to F				
4	<p>Set the node address setting switches to the following default values.</p> <p>[NODE No.x16¹]: 0 [NODE No.x16⁰]: 1</p> <p>*Set the IP address to 192.168.250.1.</p> <p>*By default, the upper three octets are fixed to 192.168.250, and the values set with the node address setting switches are the fourth octet of the local IP address.</p>	<p>With the FINS communications service, when there are multiple EtherNet/IP Units connected to the Ethernet network, the EtherNet/IP Units are identified by node addresses. Use the node address switches to set the node address between 01 and FE hexadecimal (1 to 254 decimal). Do not set a number that has already been set for another node on the same network.</p> <table border="1" style="margin-left: auto;"> <tr><td>Setting range:</td></tr> <tr><td>01 to FE (1 to 254 decimal)</td></tr> </table> <p>The left switch sets the sixteens digit (most significant digit) and the right switch sets the ones digit (least significant digit). The node address is factory-set to 01.</p> <p>Default IP address = 192.168.250.node address With the factory-default node address setting of 01, the default IP address is 192.168.250.1.</p>	Setting range:	01 to FE (1 to 254 decimal)
Setting range:				
01 to FE (1 to 254 decimal)				

- 5 Connect the LAN cable to the EtherNet/IP port of the PLC, and connect the USB cable to the USB port. As shown in 5.2. Device Configuration, connect the personal computer, Switching Hub and PLC.

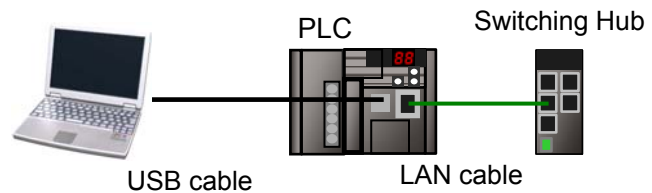



- 6 Turn ON the power supply to the PLC.
The set IP address is displayed on the seven-segment LED indicators from right to left. Afterwards, the rightmost 8 bits of the IP address are displayed in hexadecimal during normal operation.

6.4.2. Starting the CX-Programmer and Connecting Online with PLC

Start the CX-Programmer and connect online with the PLC.

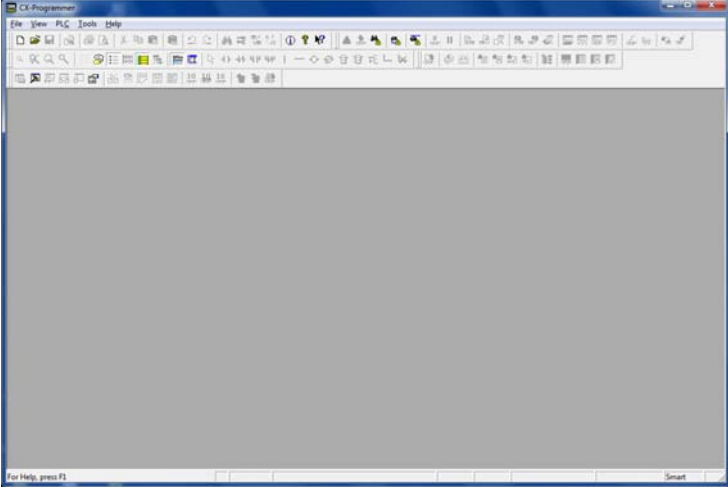
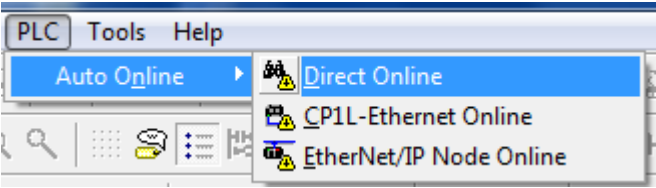
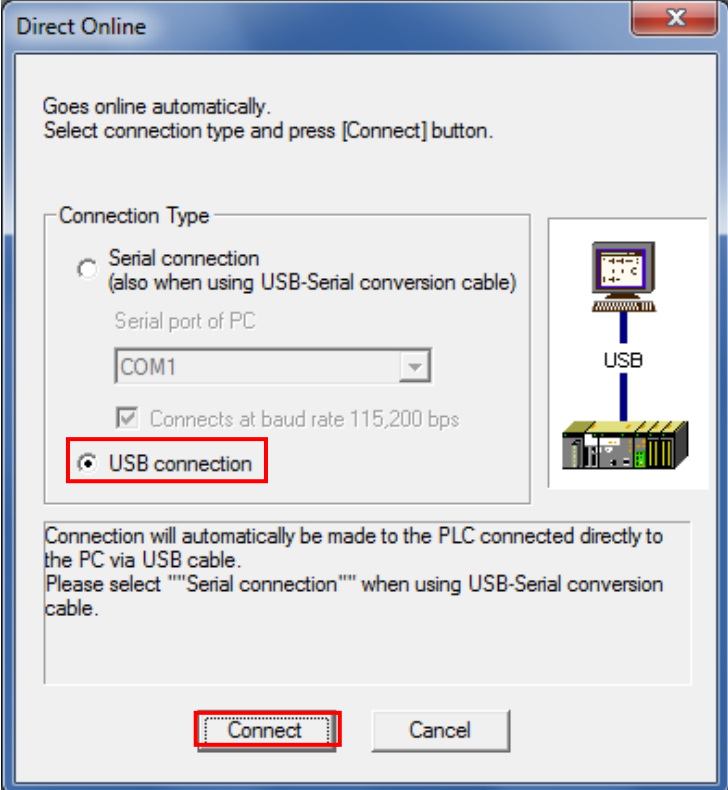
Install the CX-One and USB driver in the personal computer beforehand.

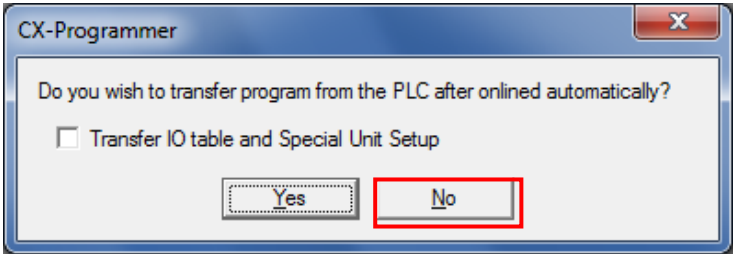
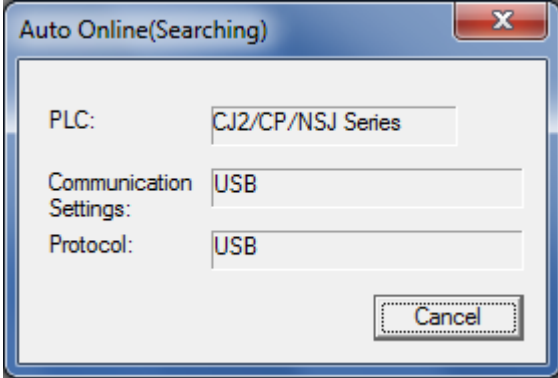
1	Start the CX-Programmer.	
2	Select Auto Online - Direct Online from the PLC Menu.	
3	The Direct Online Dialog Box is displayed. Select the USB Connection Option for the Connection Type and click the Connect Button.	

<p>4 The dialog box on the right is displayed. Click the No Button.</p>	
<p>5 The dialog box on the right is displayed and the CX-Programmer and the PLC is automatically connected.</p>	
<p>6 Confirm that the CX-Programmer and the PLC are connected online.</p> <p>*The  icon is shown during online connection.</p>	



Additional Information

If the CX-Programmer and PLC are not connected online, please check the connection of the cable. Or, return to step 2, check the settings and perform each step again.

Refer to *Connecting Directly to a CJ2 CPU Unit Using a USB Cable* in Chapter 3

Communications in *PART 3: CX-Server Runtime* of the *CX-Programmer Operation Manual* (Cat. No. W466) for details.



Additional Information

The dialogs explained in the following procedures may not be displayed depending on the environmental setting of CX-Programmer.

For details on the environmental setting, refer to *Options and Preferences* in Chapter 3 *Project Reference* in *PART 1: CX-Programmer* of the *CX-Programmer Operation Manual* (Cat. No. W466).

This document explains the setting procedure when the setting item "Confirm all operations affecting the PLC" is selected.

6.4.3. Creating the I/O Table and Setting the IP Address

Create the I/O table for the PLC and set the IP address.

1 If the operating mode of the PLC is RUN Mode or Monitor Mode, change it to Program Mode by following steps (1) to (3).

(1) Select **Operating Mode - Program** from the PLC Menu of CX-Programmer.

(2) The dialog box on the right is displayed. Click the **Yes** Button.

*Refer to *Additional Information* on the previous page for the settings concerning the dialog display.

(3) Confirm that Stop/Program Mode is shown on the right side of the PLC model in the Project Workspace of CX-Programmer.

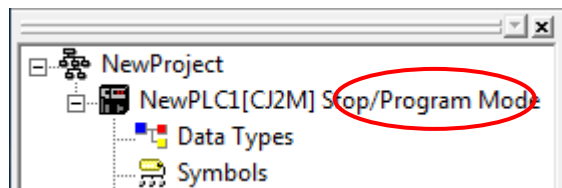
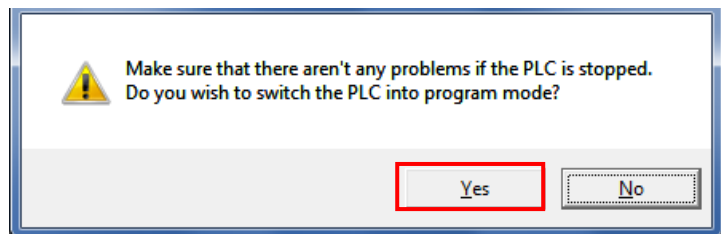
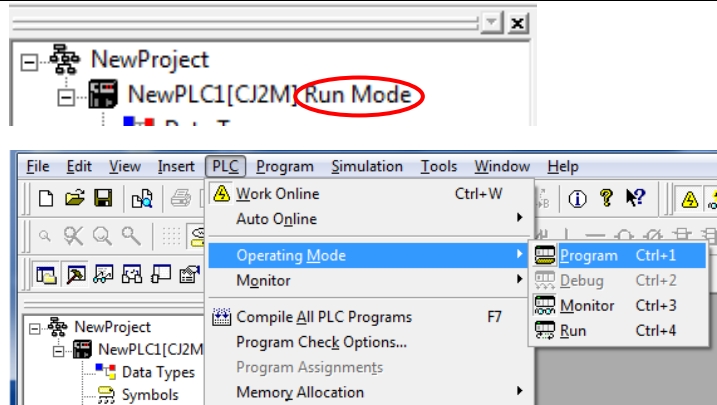

- 2 Select **Edit - I/O Table and Unit Setup** from the PLC Menu of the CX-Programmer.

The PLC IO Table Window is displayed.

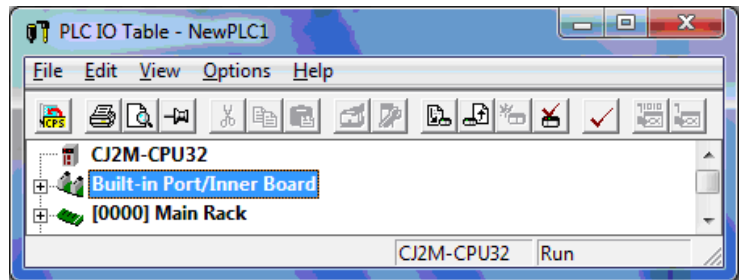
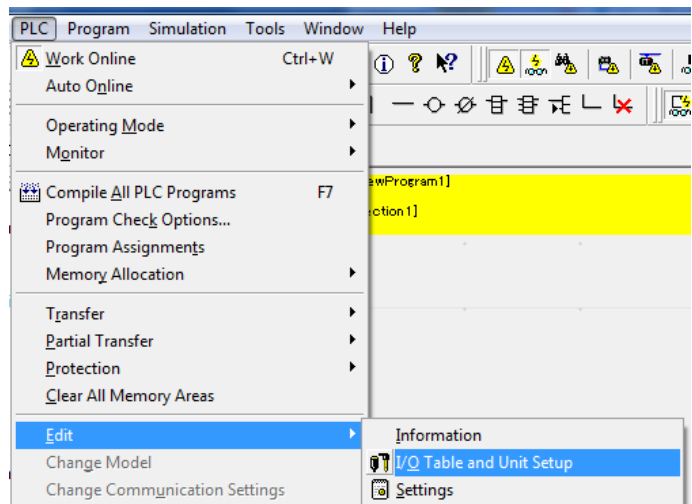

- 3 Select **Create** from the Options Menu of the PLC IO Table Window.

The dialog box on the right is displayed. Click the **Yes** Button.

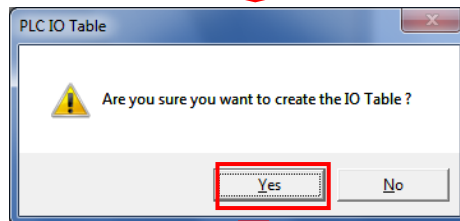
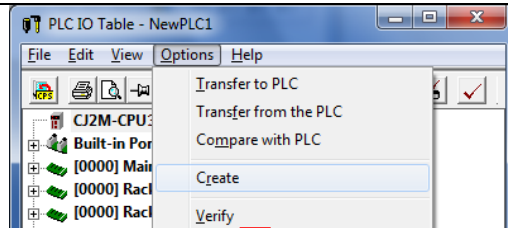

The dialog box on the right is displayed. Click the **Yes** Button.

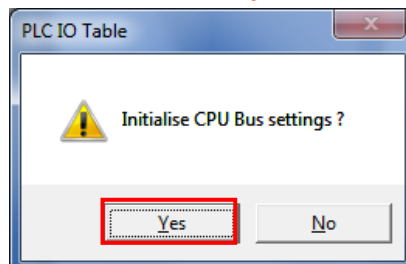

- 4 The Transfer from PLC Dialog Box is displayed. Select the *I/O Table* Check Box and the *SIO Unit Parameters* Check Box, and click the **Transfer** Button.

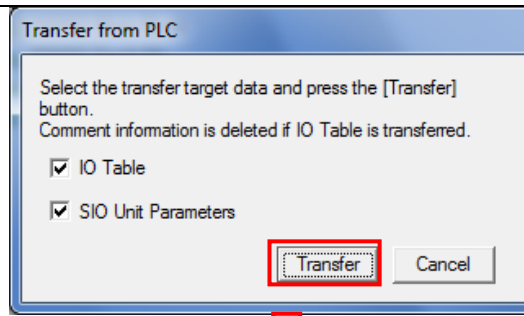

When the transfer is completed, Transfer Results Dialog Box is displayed. Read the message in the dialog box and confirm that the transfer was normally executed.

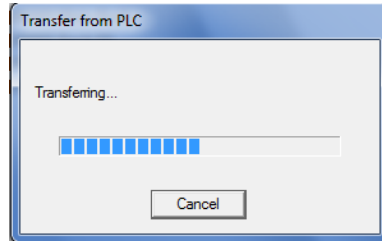

When the I/O table is created normally, the dialog box shows the following:
 Transfer Success: 1 Unit
 Transfer Unsuccessful: 0 Unit
 Click the **OK** Button.

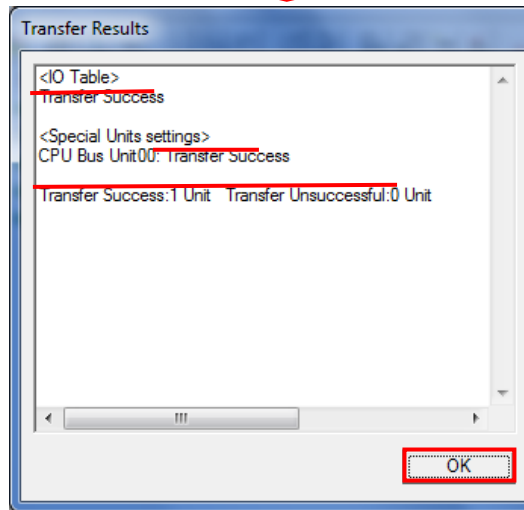

- 5 On the PLC IO Table Window, click + to the left of Built-in Port/Inner Board to display CJ2M-EIP21.

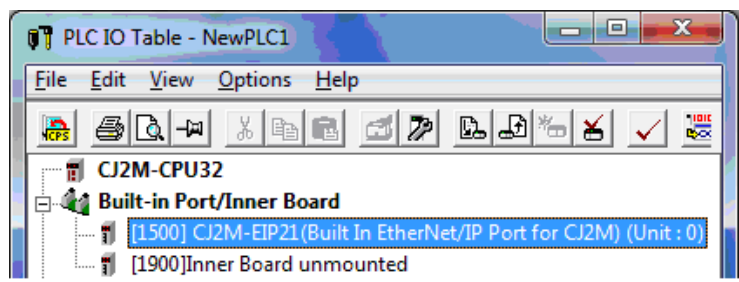

*The right figure displays the CPU Unit (built-in EtherNet/IP port) specified in 5.2. Device Configuration. When you use an EtherNet/IP Unit not specified in 5.1. Applicable Devices, the display position and name are different from this figure.

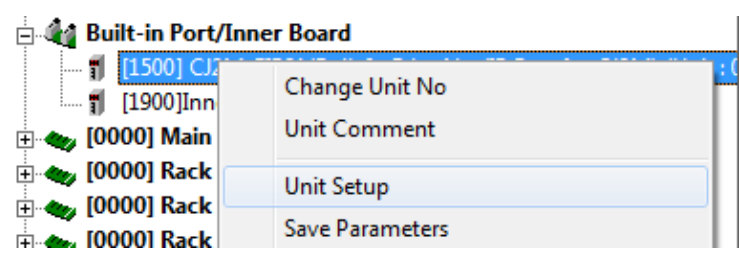

Right-click CJ2M-EIP21 and select **Unit Setup**.

6 The Edit Parameters Dialog is displayed. Select the TCP/IP Tab. Make the following settings in the IP Address Field.

- Use the following address: Select
- IP address: 192.168.250.1
- Subnet mask: 255.255.255.0

Click the **Transfer[PC to Unit]** Button.

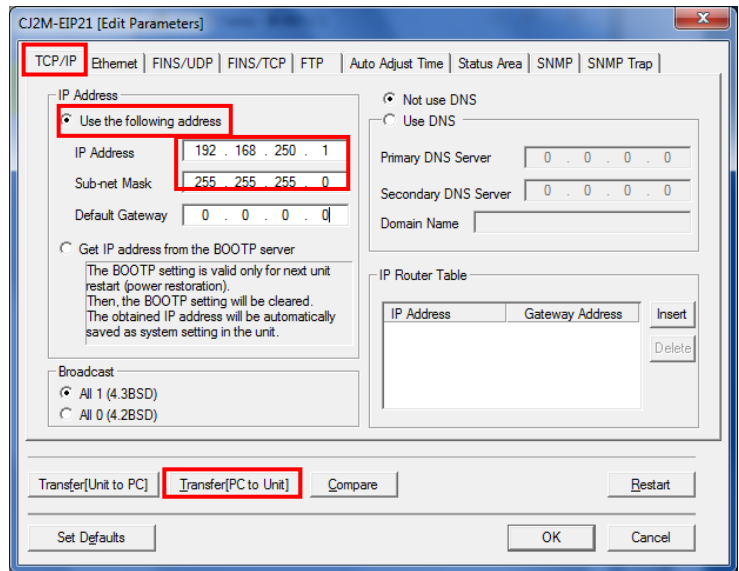

7 The dialog box on the right is displayed. Click the **Yes** Button.

Confirm that parameters were normally transferred to the Unit, and click the **OK** Button.

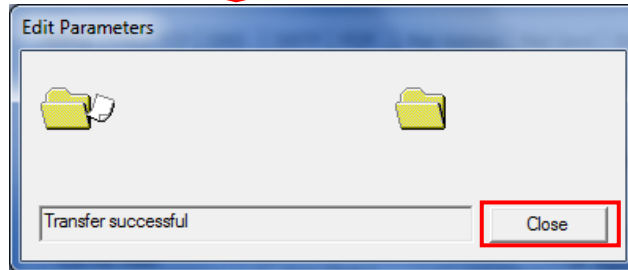
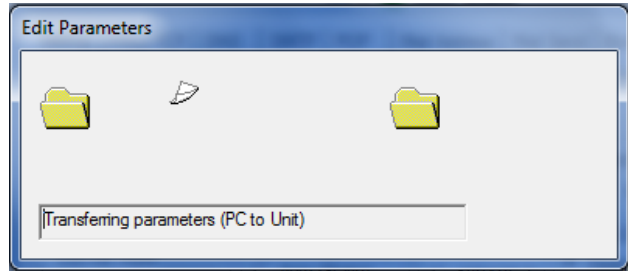
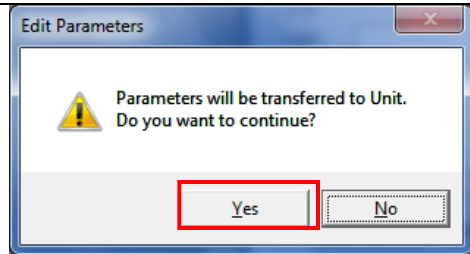

8 The right dialog box is displayed. Click the **Yes** Button.

When the unit is restarted, the dialog box on the right is displayed. Click the **OK** Button.

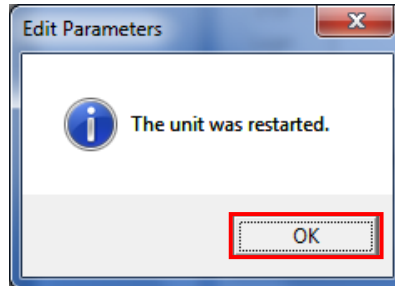
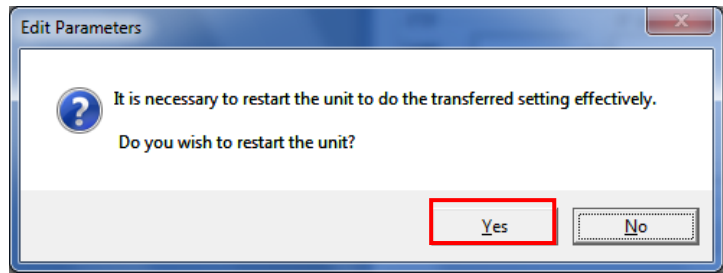

9 To confirm that the IP address was correctly changed, click the **Compare** Button.

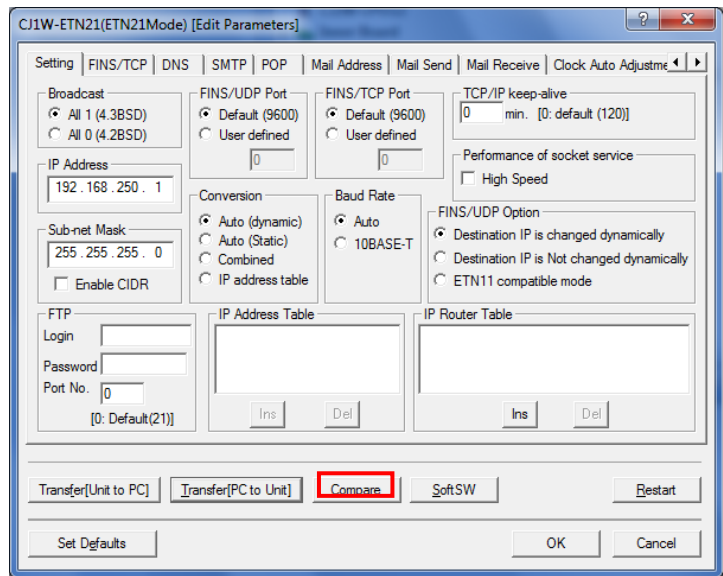

10 After confirming that parameters match, select the **Close** Button.

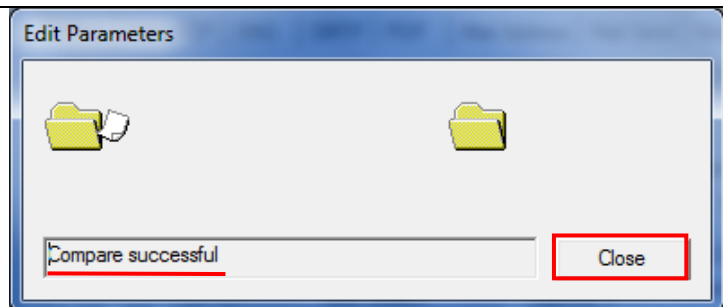

- 11 On the Edit Parameters Dialog Box, click the **OK** Button.

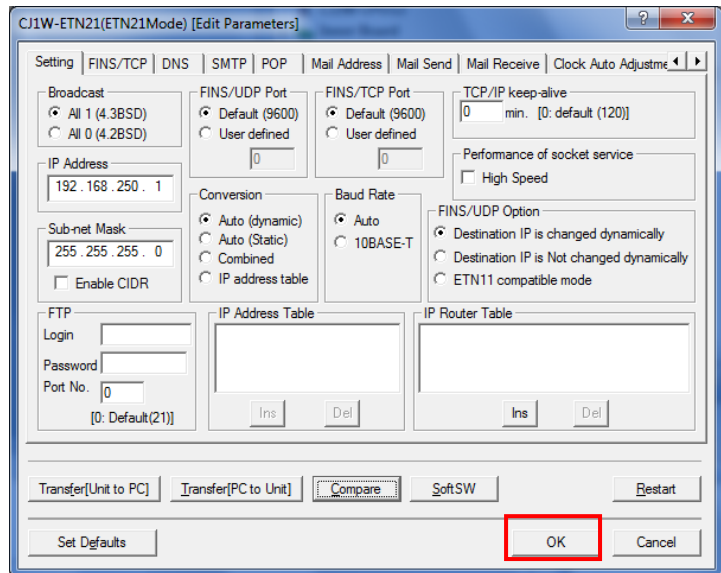

6.4.4. Starting the Network Configurator and Uploading the Configuration

Start the Network Configurator and upload the network configuration.



Precautions for Correct Use

Please confirm that the LAN cable is connected before performing the following procedures. When it is not connected, turn OFF the power supply to each device and then connect the LAN cable.

- 1 Right-click CJ2M-EIP21 on the PLC IO Table Window, and select **Start Special Application - Start with Settings Inherited**.

The Select Special Application Dialog Box is displayed. Select Network Configurator and click the **OK** Button.

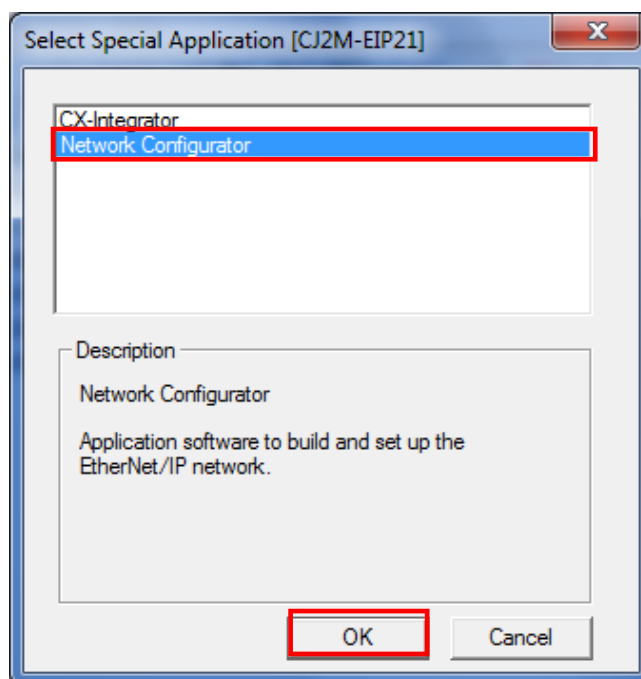
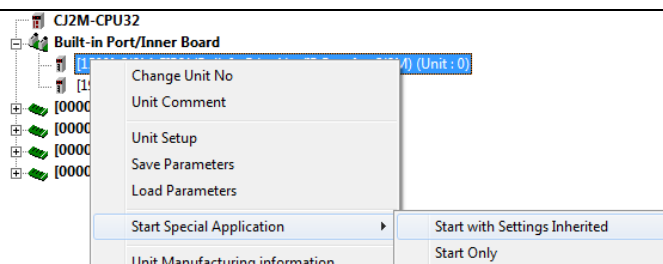

- 2 Network Configurator is started.

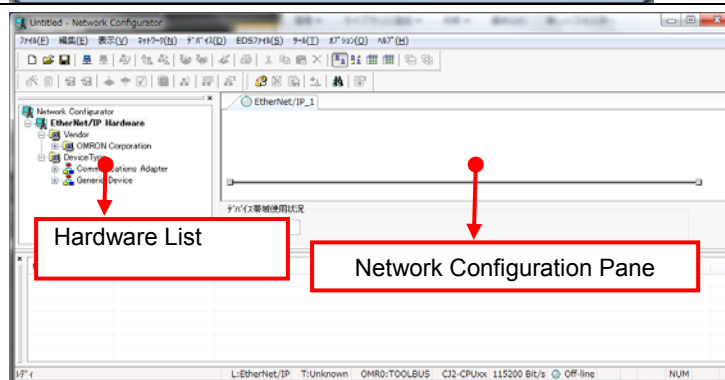

- 3 Select **Connect** from the Network Menu.

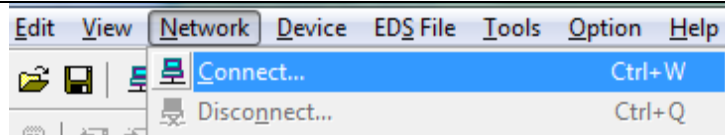

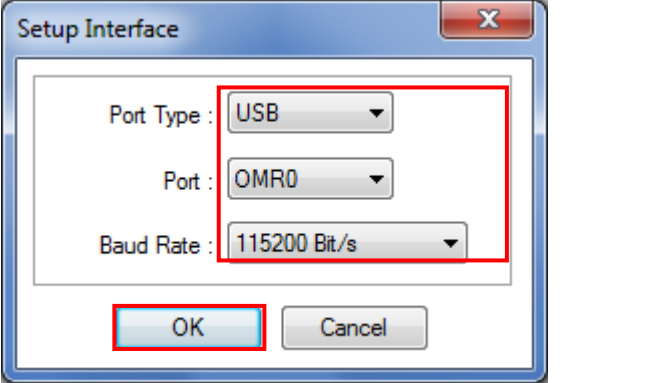
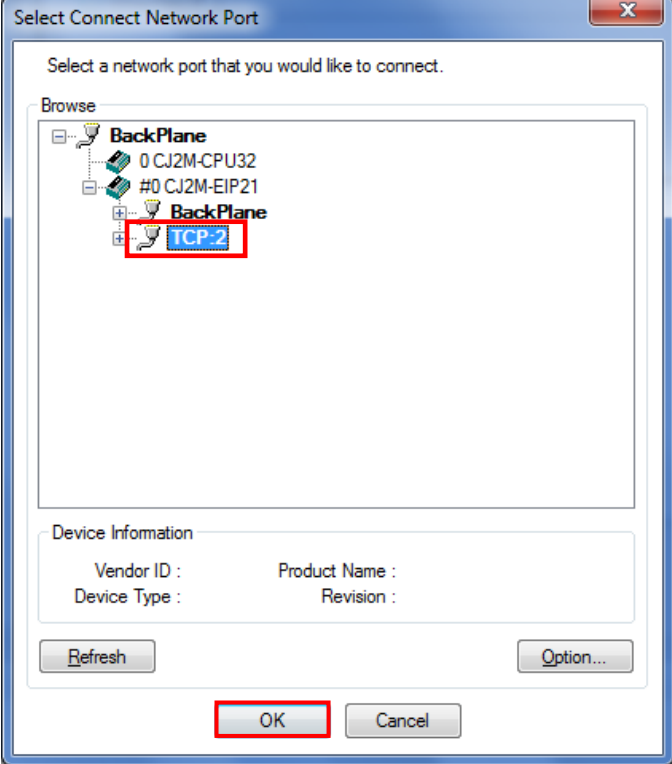
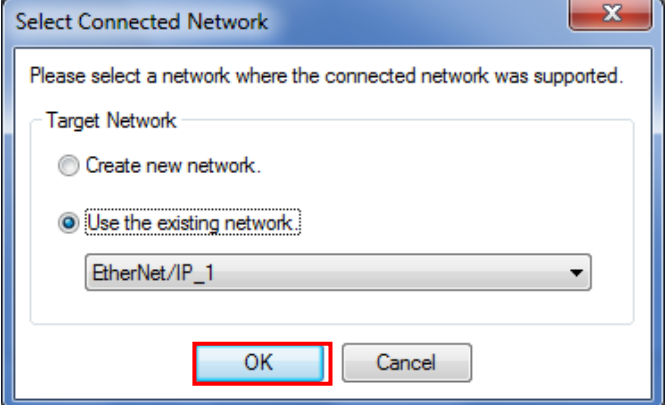
<p>4 The Setup Interface Dialog Box is displayed.</p> <p>Confirm that the following settings are made.</p> <ul style="list-style-type: none"> •Port Type: USB •Port: OMR0 •Baud Rate: 115200 Bit/s <p>Click the OK Button.</p>	
<p>5 The Select Connect Network Port Dialog Box is displayed.</p> <p>Select Back Plane - CJ2M-EIP21 - TCP:2, and click the OK Button.</p>	
<p>6 The Select Connected Network Dialog Box is displayed. Click the OK Button.</p>	



Additional Information

If the CX-Programmer and PLC are not connected online, please check the connection of the cable. Or, return to step 1, check the settings and try each step again.

For details, refer to *6-2-9 Connecting the Network Configurator to the Network* in *Section 6 Tag Data Link Functions of the EtherNet/IP Unit Operation Manual (Cat. No. W465)*.

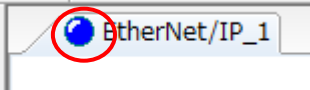
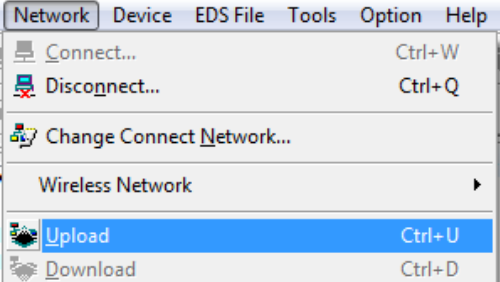
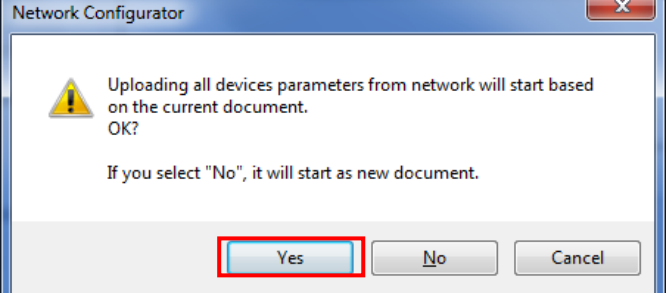
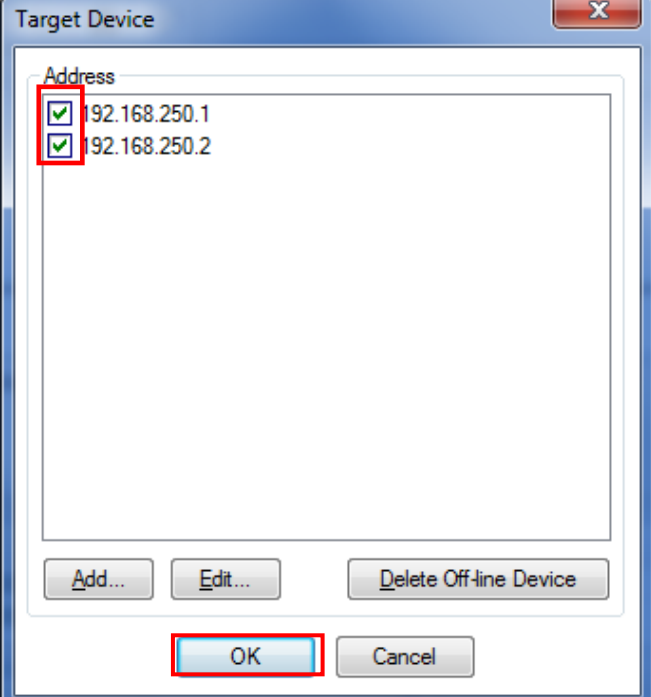
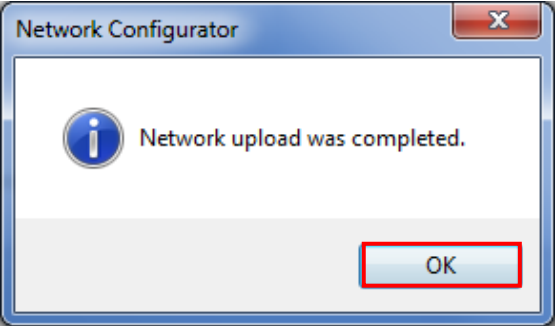
<p>7 When an online connection is established normally, the color of the icon on the figure changes to blue.</p>	
<p>8 Select Upload from the Network Menu to read the device information on the network.</p>	
<p>9 The dialog box on the right is displayed. Click the Yes Button.</p>	
<p>10 The Target Device Dialog Box is displayed. Select the 192.168.250.1 Checkbox and the 192.168.250.2 Checkbox, and click the OK Button.</p> <p>*If 192.168.250.1 or 192.168.250.2 is not displayed on the dialog box, click the Add Button to add the address.</p> <p>*The displayed addresses depend on the status of the Network Configurator.</p>	
<p>11 The device parameters are uploaded. When uploading is completed, the dialog box on the right is displayed. Click the OK Button.</p>	

- 12 After uploading is completed, confirm that the Network Configuration Pane shows the updated IP addresses of the devices.
- IP address of node 1:
192.168.250.1
- IP address of node 2:
192.168.250.2

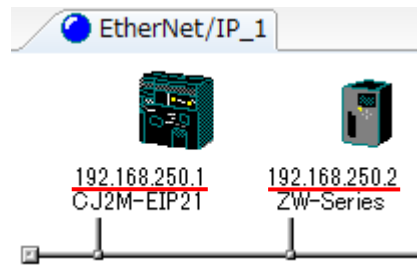

6.4.5. Setting Tags

Register the tags of the receive area and send area.

This section explains the receive settings and then send settings of the target node.

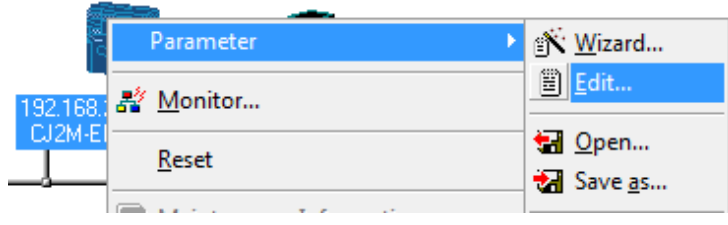
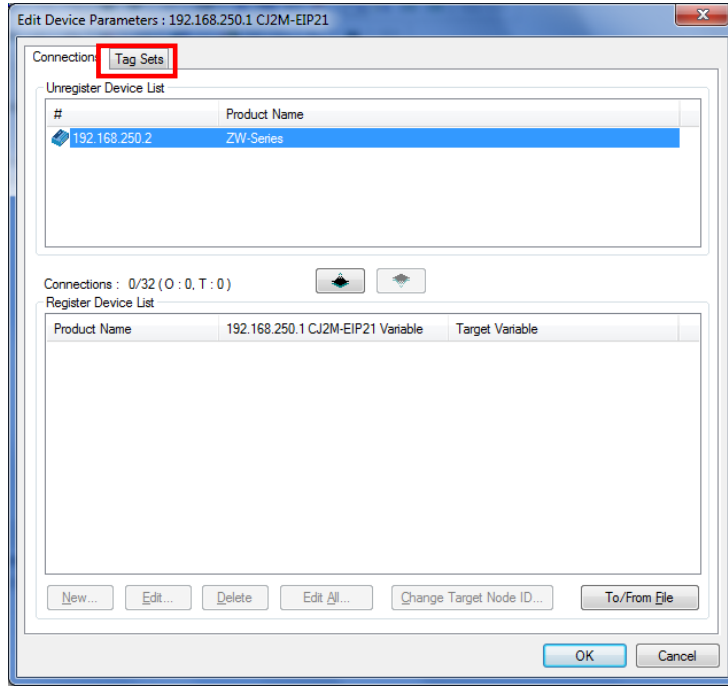
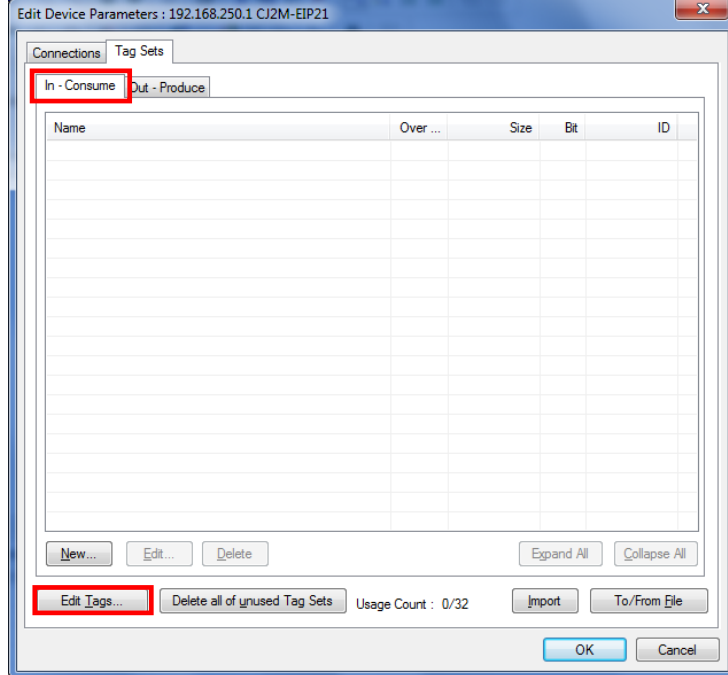
<p>1 On the Network Configuration Pane of the Network Configurator, right-click the node 1 device and select Parameter - Edit.</p>	
<p>2 The Edit Device Parameters dialog is displayed. Select the Tag Sets tab.</p>	
<p>3 The data on the Tag Sets Tab is displayed. Select the In-Consume Tab and click the Edit Tags. Here, register an area (node 2 → node 1) where node 1 consumes data.</p>	

4 The Edit Tags Dialog Box is displayed. Select the In - Consume Tab and click the **New** Button. Here, register an area (node 2 → node 1) where node 1 consumes data.

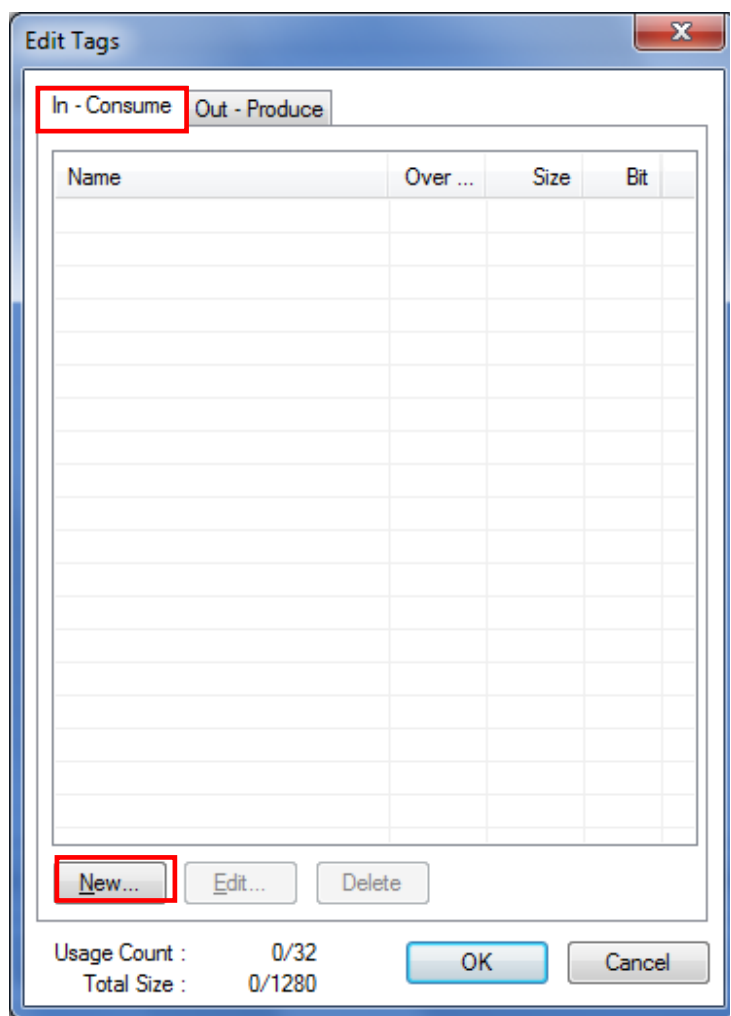

5 The Edit Tag Dialog Box is displayed. Enter the following values in the parameters.
 •Name: D10100 (Start address of the input data to node 1)
 •Size: 56 (bytes)

After entering, click the **Regist** Button.

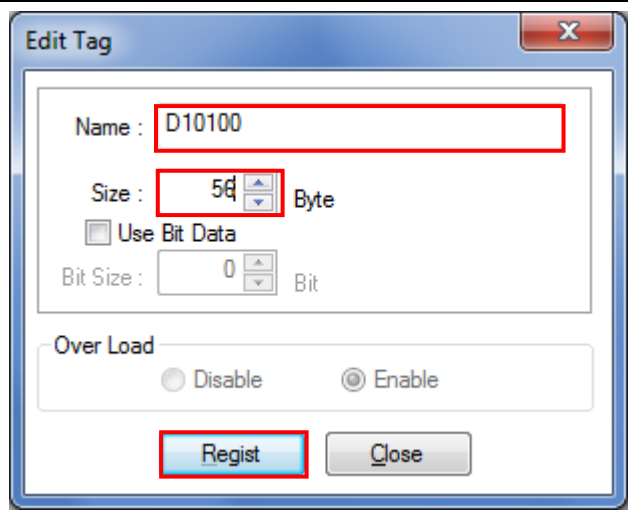

6 The Edit Tag Dialog Box is displayed. Click the **Close** Button.

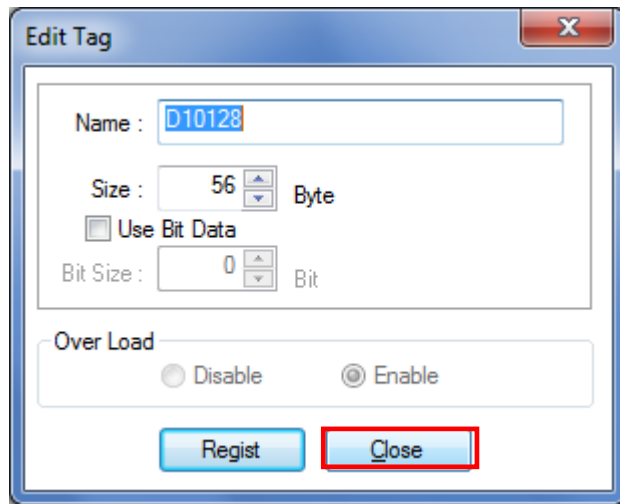

7 Select the Out - Produce Tab and click the **New** Button. Here, register the send data of node 1. (Data sent from node 1 to node 2).

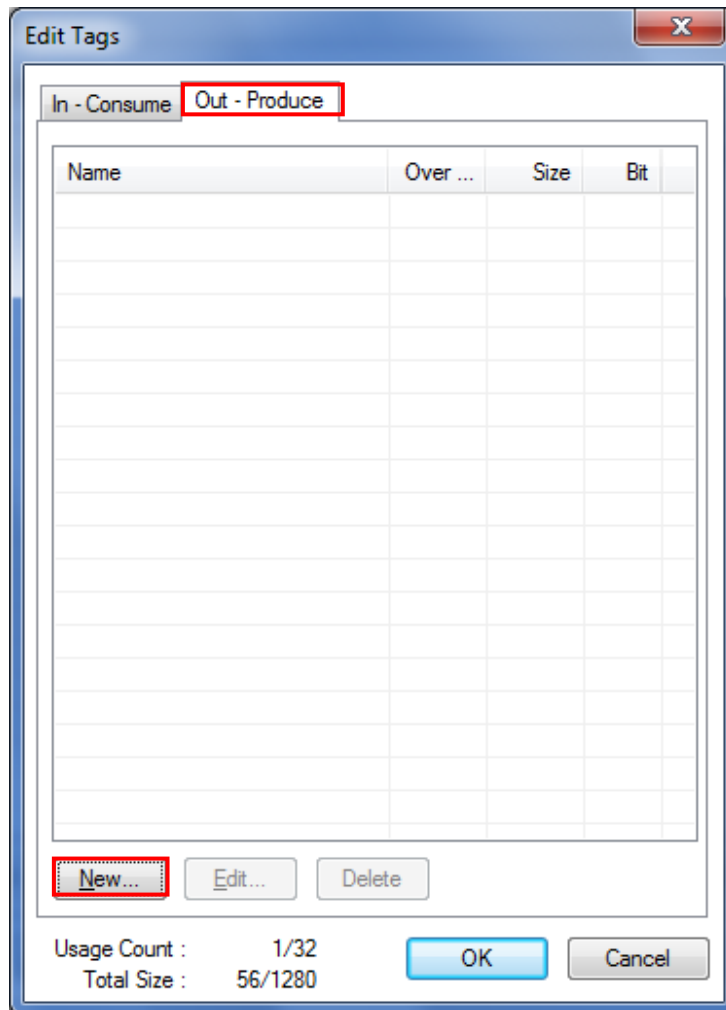

8 The Edit Tag Dialog Box is displayed.
 Enter the following values in the parameters.
 •Name: D10000 (Start address of the output data from node 1)
 •Size: 24 (bytes)
 After entering, click the **Regist** Button.

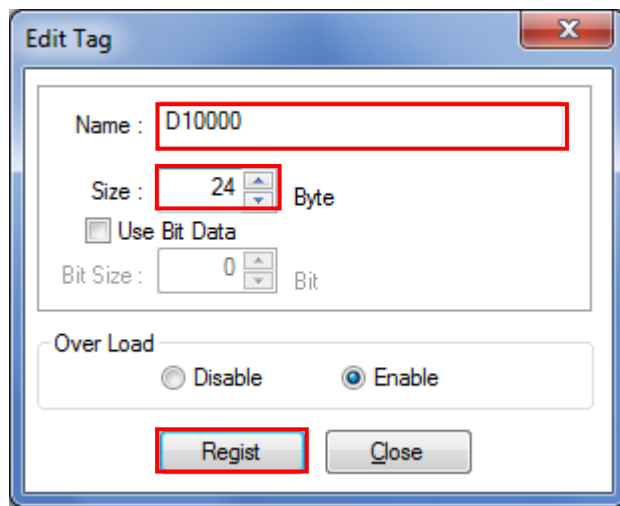

9 The Edit Tag Dialog Box is displayed. Click the **Close** Button.

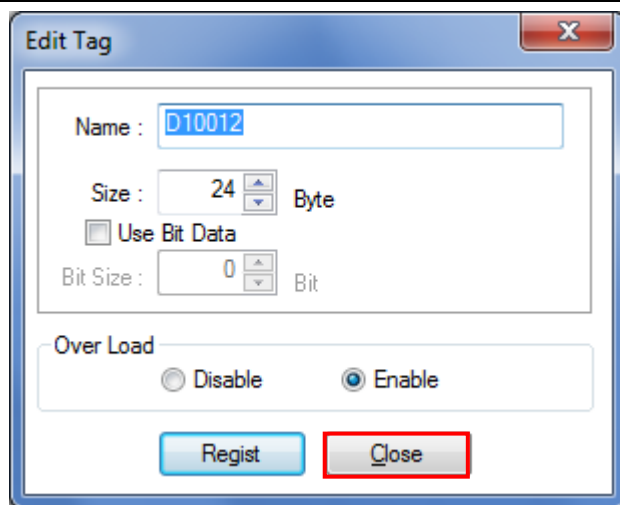

10 When you finish the registration, click the **OK** Button on the Edit Tag Dialog Box.

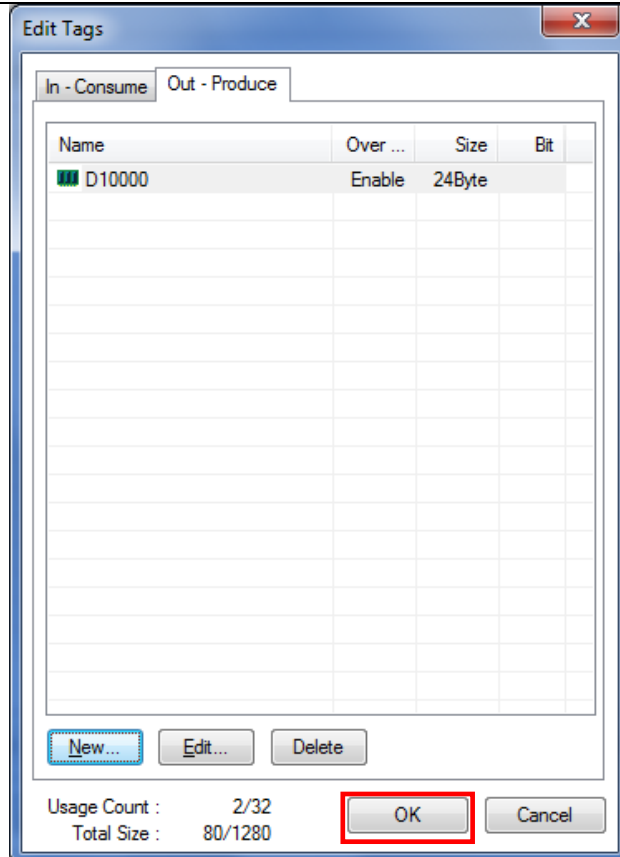

11 The dialog box on the right is displayed. Click the **Yes** Button.

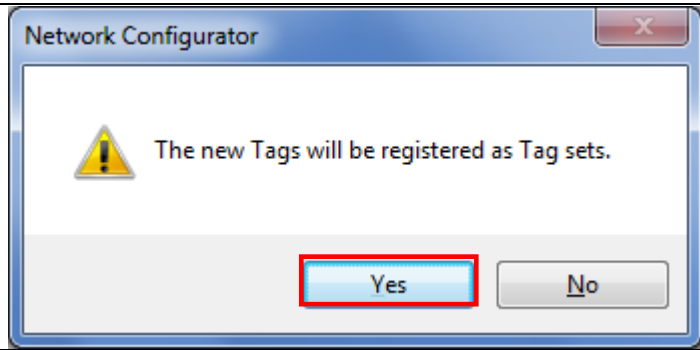

12 The Edit Device Parameters Dialog Box is displayed again.

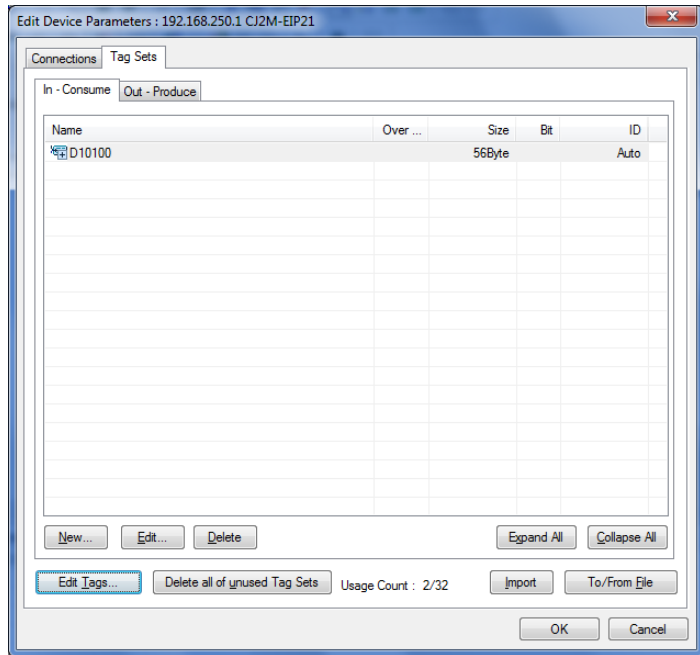

6.4.6. Setting Connections

Associate the tags of target device (node that receives the open request) with the tags of originator (node that requests opening).

- 1 Select the Connections Tab in the Edit Device Parameters Dialog Box. Then, select 192.168.250.2 in the Unregister Device List Field. Click the Down Button that is shown in the dialog box.

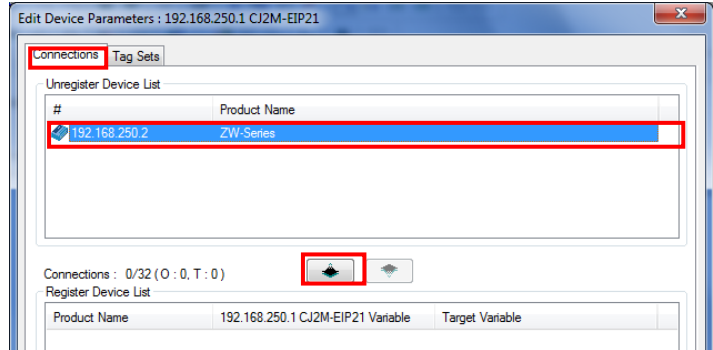

- 2 192.168.250.2 is registered in the Register Device List. Select 192.168.250.2 and click the **New** Button.

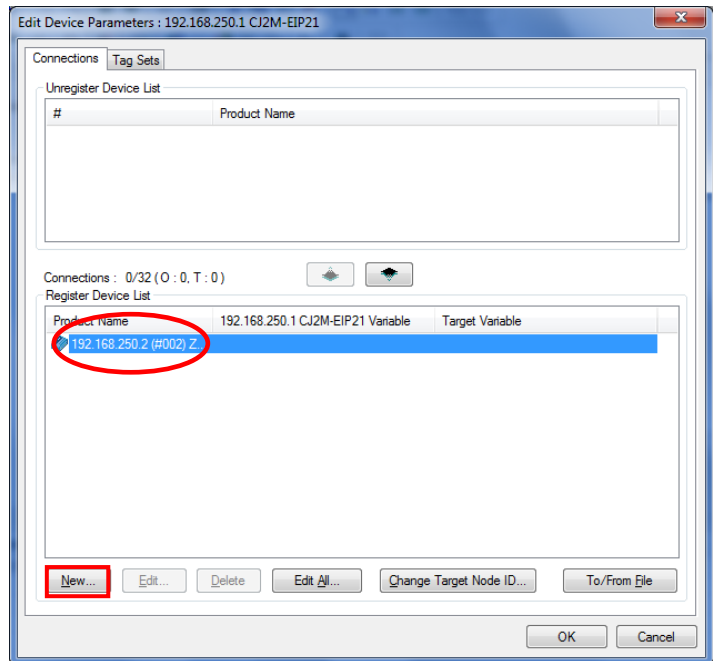

- 3 The Edit Connection Dialog Box is displayed. Select *Discrete Exclusive Owner* from the Connection I/O Type pull-down list. Set the values listed in the table below by using the pull-down lists in Originator Device Field and Target Device Field.

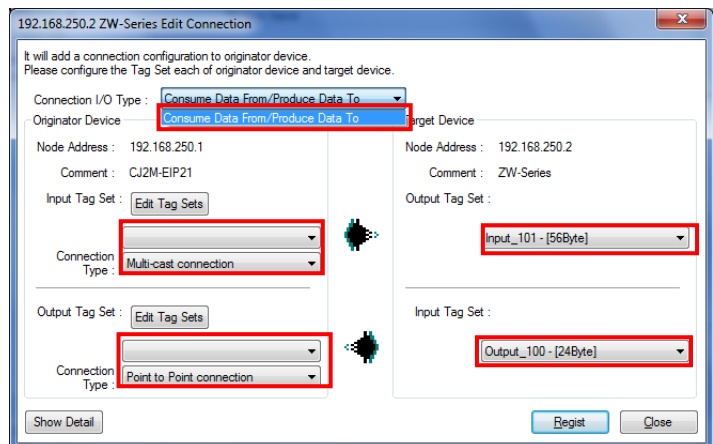

■ Settings of Connection

Connection I/O type		Consume Data From/Produce Data To
Originator device	Input Tag Set	D10100 - [56Byte]
	Connection Type	Multi-cast connection
	Output Tag Set	D10000 - [24Byte]
	Connection Type	Point to Point connection
Target Device	Output Tag Set	Input_101- [56Byte]
	Input Tag Set	Output_100- [24Byte]

4 Confirm that the settings are correct and click the **Regist** Button.

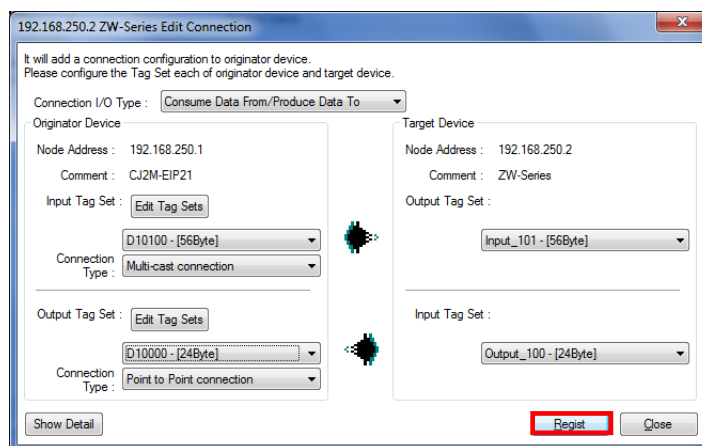

5 The Edit Connection Dialog Box is displayed. Do not make any setting and click the **Close** Button.

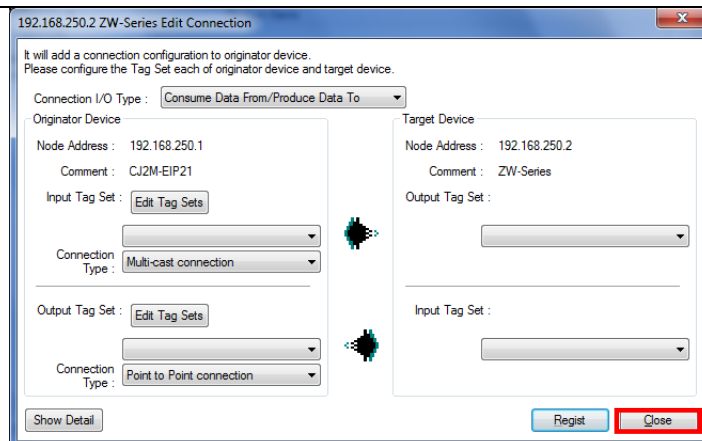

6 The Edit Device Parameters Dialog Box is displayed again. Click the **OK** Button.

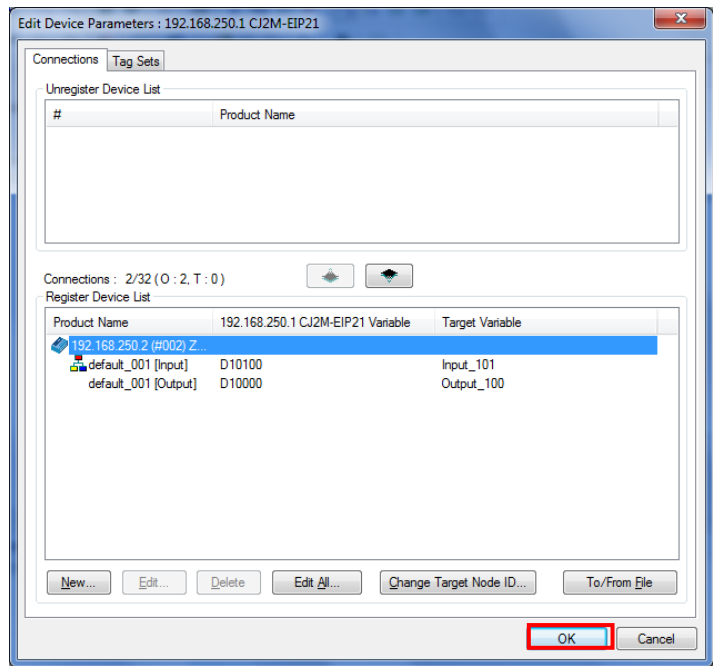

7 When the connection setting is completed, the registered node address is displayed under the device icon of node 2 on the Network Configuration Pane.

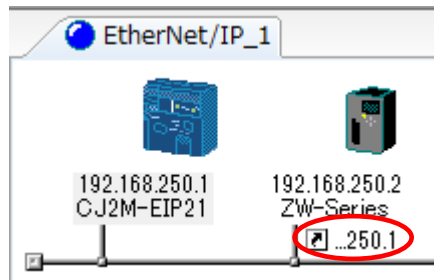

6.4.7. Transferring the Tag Data Link Parameters

Transfer the set tag data link parameters to the PLC.

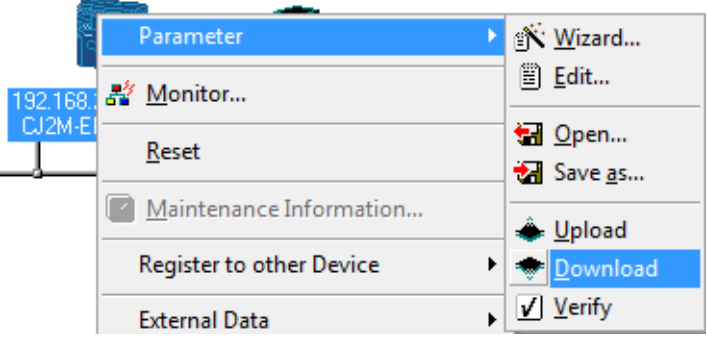
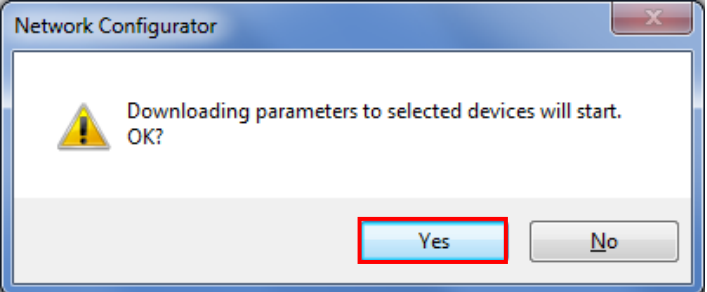
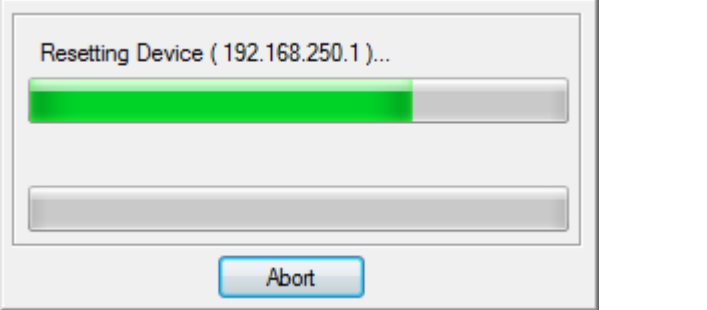
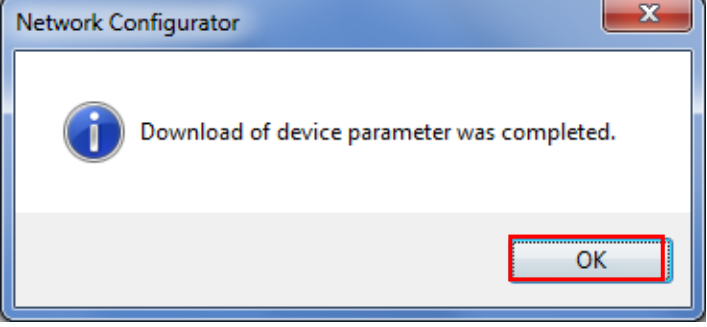
<p>1</p>	<p>Right-click node 1 device on the Network Configuration Pane and select Parameter - Download.</p> <p>The dialog box on the right is displayed. Click the Yes Button.</p>	 
<p>2</p>	<p>The tag data link parameters are downloaded from Network Configurator to the PLC.</p>	
<p>3</p>	<p>The dialog box on the right is displayed. Click the OK Button</p>	

6.5. Checking the EtherNet/IP Communications

Confirm that the EtherNet/IP communications are performed normally.

6.5.1. Checking the Connection Status

Check the connection status of EtherNet/IP.

- 1 Confirm that the tag data links are normally in operation by checking the status information on the Device Monitor Window of the Network Configurator.

- PLC (EtherNet/IP Unit)
LED indicators in normal status.
[MS]: Lit green
[NS]: Lit green
[COMM]: Lit yellow
[100M] or [10M]: Lit yellow

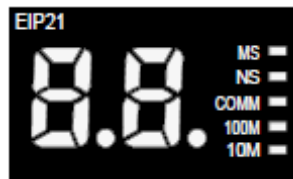

(EtherNet/IP Unit)

- Displacement Sensor
During normal connection, the red and green indicators on the ETHERNET connector are lit.

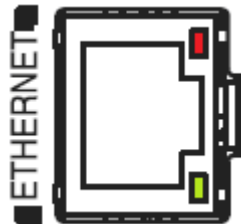

(Displacement Sensor Controller)

- 2 Confirm that the tag data links are normally in operation by checking the status information on the Device Monitor Window of the Network Configurator.

Right-click the device icon of node 1 on the Network Configuration Pane and select the **Monitor**.

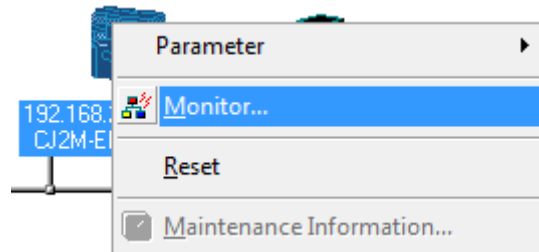

3 The dialog box on the right displays the Status 1 Tab Page of the Device Monitor Dialog Box.

When the items in the right dialog are selected, the data links are normally in operation.

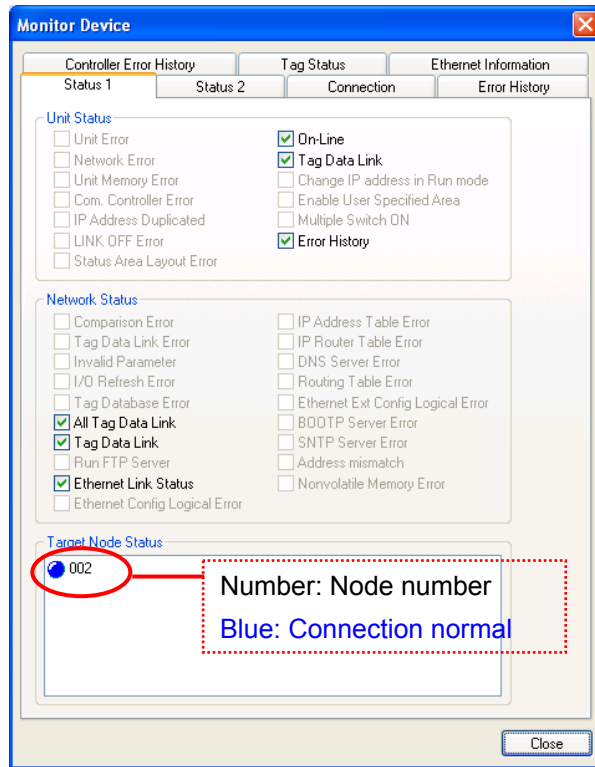

4 Select **Disconnect** from the Network Menu to go offline. The color of the icon on the figure changes from blue. Select **Exit** from the File Menu to exit the Network Configurator.

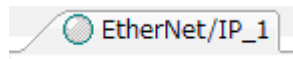

6.5.2. Checking Data that are Sent and Received

Confirm that correct data are sent and received.

Caution

Confirm safety sufficiently before monitoring power flow and present value status in the Ladder Section window or before monitoring present values in the Watch window. If force-set/reset or set/reset operations are incorrectly performed by pressing short-cut keys, the devices connected to Output Units may malfunction, regardless of the operating mode of the CPU Unit.

1 Confirm that the operating mode of the PLC is Stop/Program Mode.

*If the PLC is not in Program Mode, change to Program Mode by referring to step 1 of 6.4.3. Setting the IP Address.

2 Select **Edit - Memory** from the PLC Menu.

- 3 Double-click *D* from the list in the PLC Memory Window that is displayed.

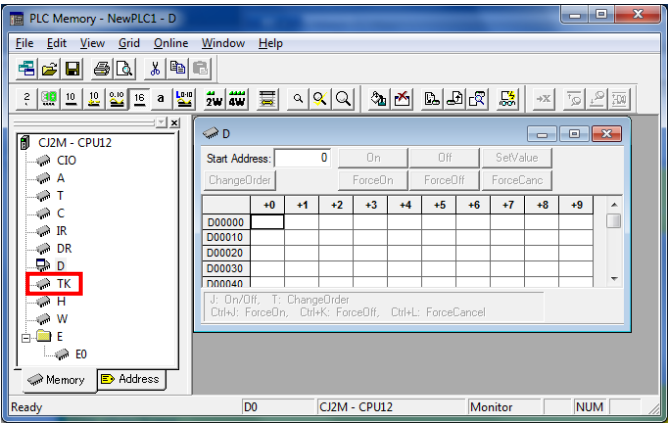
- 4 Select **Display - Binary** from the View Menu.

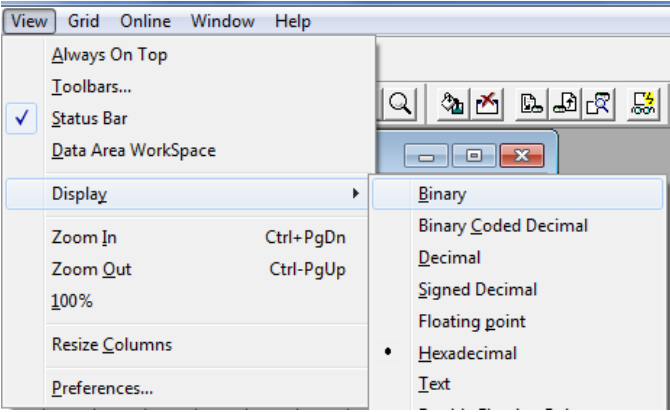
- 5 Select **Monitor** from the Online Menu.

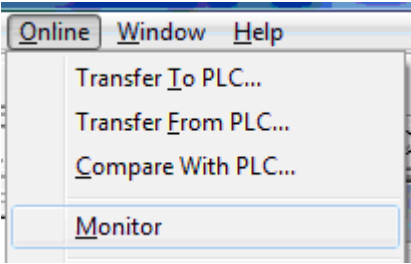
- 6 The Monitor Memory Areas Dialog Box is displayed. Select the *D* Checkbox and click the **Monitor** Button.

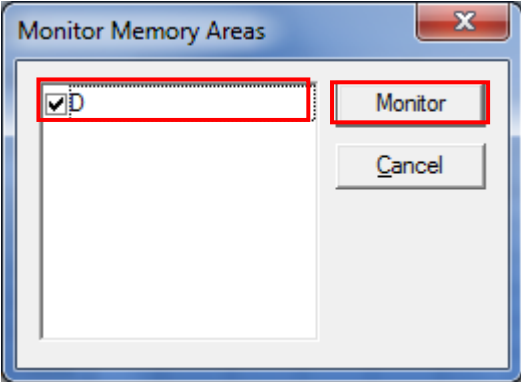
- 7 Enter 10000 in the Start Address Field in the D Window. Confirm that the start address was changed to D10000.

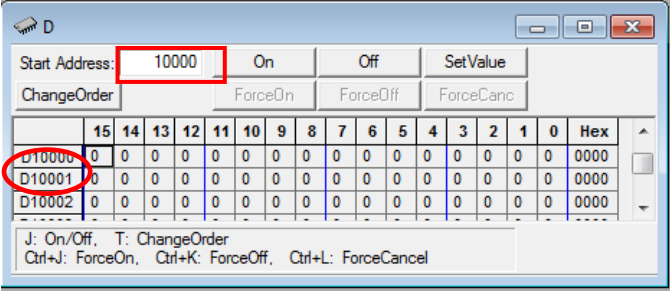

- 8 Select the bits below and click the **On** Button. (After turning them ON, the values change to 1.)
 Bit 14 of DM10006
 Bit 6 of DM10007
 Bits 2, 7, 8, 9 of DM10008

Then, turn ON bit 0 of DM10000.

*DM10006 and DM10007 are an area for a command code and contain 4000 (Hex) and 0040 (Hex) (System data acquisition).
 DM10008 is an area for Command Parameter 1 and contains 0384 (Hex) (900 in decimal) (the number of decimal places).
 Bit 0 of D10000 is a command execution (EXE) flag.

	15	14	13	12	11	10	9	8	7	6	5	4	3	2	1	0	Hex
D10000	0	0	0	0	0	0	0	0	0	0	0	0	0	0	0	1	0001
D10001	0	0	0	0	0	0	0	0	0	0	0	0	0	0	0	0	0000
D10002	0	0	0	0	0	0	0	0	0	0	0	0	0	0	0	0	0000
D10003	0	0	0	0	0	0	0	0	0	0	0	0	0	0	0	0	0000
D10004	0	0	0	0	0	0	0	0	0	0	0	0	0	0	0	0	0000
D10005	0	0	0	0	0	0	0	0	0	0	0	0	0	0	0	0	0000
D10006	0	1	0	0	0	0	0	0	0	0	0	0	0	0	0	0	4000
D10007	0	0	0	0	0	0	0	0	0	1	0	0	0	0	0	0	0040
D10008	0	0	0	0	0	0	1	1	1	0	0	0	0	0	1	0	0384
D10009	0	0	0	0	0	0	0	0	0	0	0	0	0	0	0	0	0000
D10010	0	0	0	0	0	0	0	0	0	0	0	0	0	0	0	0	0000
D10011	0	0	0	0	0	0	0	0	0	0	0	0	0	0	0	0	0000

- 9 Enter 10100 in the Start Address Field on the D Window.
 Confirm that the start address was changed to D10100.

	15	14	13	12	11	10	9	8	7	6	5	4	3	2	1	0	Hex
D10100	0	0	0	0	0	0	0	0	0	0	0	1	0	0	0	1	0011
D10101	0	0	0	0	0	0	0	0	0	0	0	0	0	0	0	0	0000
D10102	0	0	0	0	0	0	0	0	0	0	0	0	0	1	0	0	0004
D10103	0	0	0	0	0	0	0	0	0	0	0	0	0	0	0	0	0000
D10104	0	0	0	0	0	0	0	0	0	0	0	0	0	0	0	0	0000
D10105	0	0	0	0	0	0	0	0	0	0	0	0	0	0	0	0	0000
D10106	0	1	0	0	0	0	0	0	0	0	0	0	0	0	0	0	4000
D10107	0	0	0	0	0	0	0	0	0	1	0	0	0	0	0	0	0040
D10108	0	0	0	0	0	0	0	0	0	0	0	0	0	0	0	0	0000
D10109	0	0	0	0	0	0	0	0	0	0	0	0	0	0	0	0	0000
D10110	0	0	0	0	0	0	0	0	0	0	0	0	0	0	0	1	0001

- 10 Confirm that values of DM10106 to DM10110 are set as shown on the right.

*DM10106 and DM10107 contain the command code, and DM10108 and DM10109 contain the command execution result (0: OK).
 DM10110 contains 0001 (Hex) (1 digit) that is response data (the number of decimal places).

	15	14	13	12	11	10	9	8	7	6	5	4	3	2	1	0	Hex
D10100	0	0	0	0	0	0	0	0	0	0	0	1	0	0	0	1	0011
D10101	0	0	0	0	0	0	0	0	0	0	0	0	0	0	0	0	0000
D10102	0	0	0	0	0	0	0	0	0	0	0	0	0	1	0	0	0004
D10103	0	0	0	0	0	0	0	0	0	0	0	0	0	0	0	0	0000
D10104	0	0	0	0	0	0	0	0	0	0	0	0	0	0	0	0	0000
D10105	0	0	0	0	0	0	0	0	0	0	0	0	0	0	0	0	0000
D10106	0	1	0	0	0	0	0	0	0	0	0	0	0	0	0	0	4000
D10107	0	0	0	0	0	0	0	0	0	1	0	0	0	0	0	0	0040
D10108	0	0	0	0	0	0	0	0	0	0	0	0	0	0	0	0	0000
D10109	0	0	0	0	0	0	0	0	0	0	0	0	0	0	0	0	0000
D10110	0	0	0	0	0	0	0	0	0	0	0	0	0	0	0	1	0001

7. Initialization Method

This document explains the setting procedure from the factory default setting.

Some settings may not be applicable as described in this document unless you use the devices with the factory default setting.

7.1. Initializing the PLC

To initialize the settings of the PLC, you need to initialize the CPU Unit and EtherNet/IP Unit. Change to the PROGRAM mode before the initialization.

7.1.1. EtherNet/IP Unit

(1) Select **Edit - I/O Table and Unit Setup** from the PLC Menu of the CX-Programmer.

Right-click the *EtherNet/IP Unit* on the PLC IO Table Window and select **Unit Setup** from the menu.

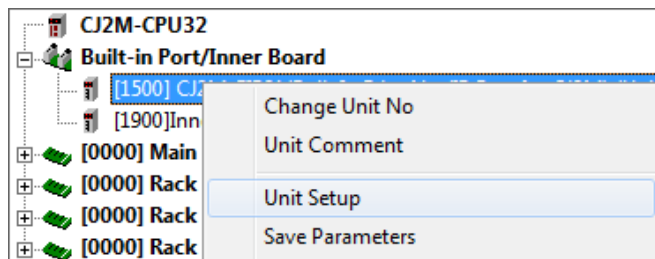

(2) Click the **Restart** Button on the Edit Parameters Dialog Box.

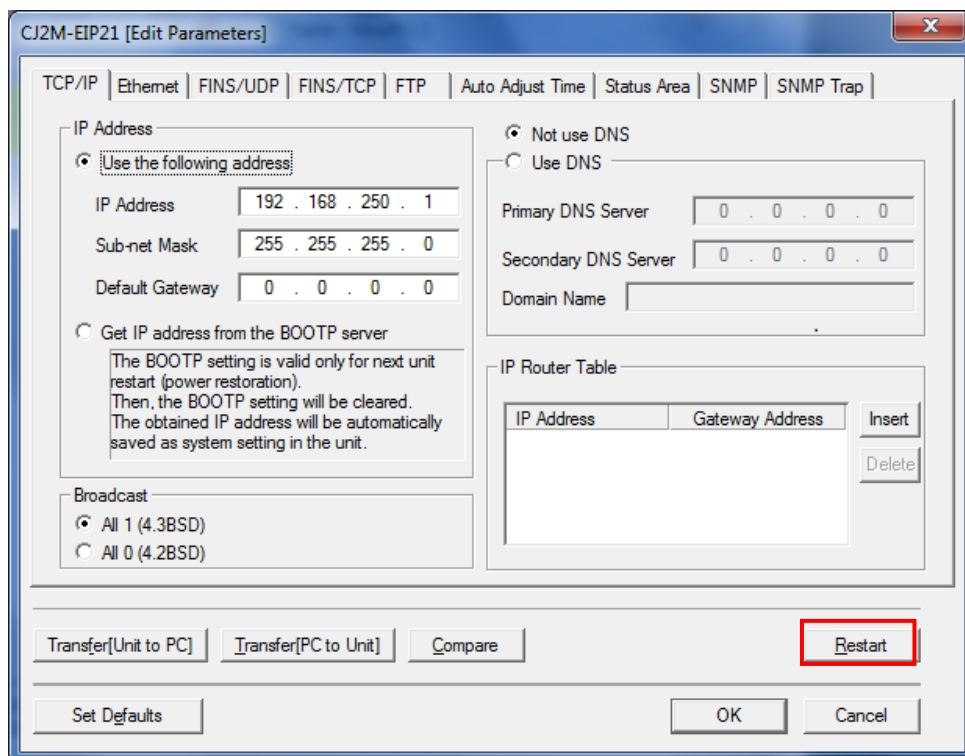

(3) An execution confirmation dialog is displayed. Click the **Yes** Button.

On the Restart Unit Dialog Box, select the *Return to out-of-box configuration, and then emulate cycling power* Option, and click the **OK** Button.

A dialog box indicating the execution is completed is displayed. Click the **OK** Button.

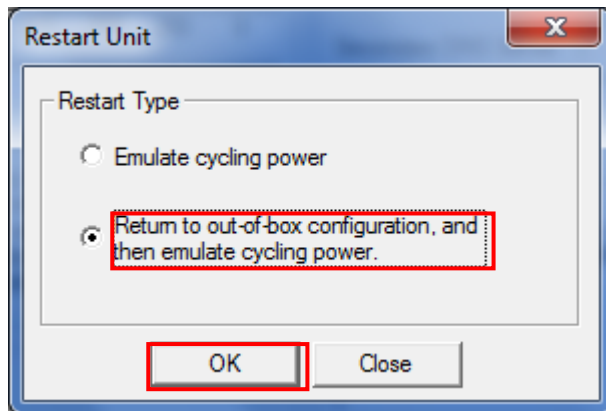

7.1.2. CPU Unit

To initialize the settings of the CPU Unit, select **Clear All Memory Areas** from the PLC Menu of the CX-Programmer. On the Confirm All Memory Area Clear Dialog Box, select the *Initialize* Option and click the **OK** Button.

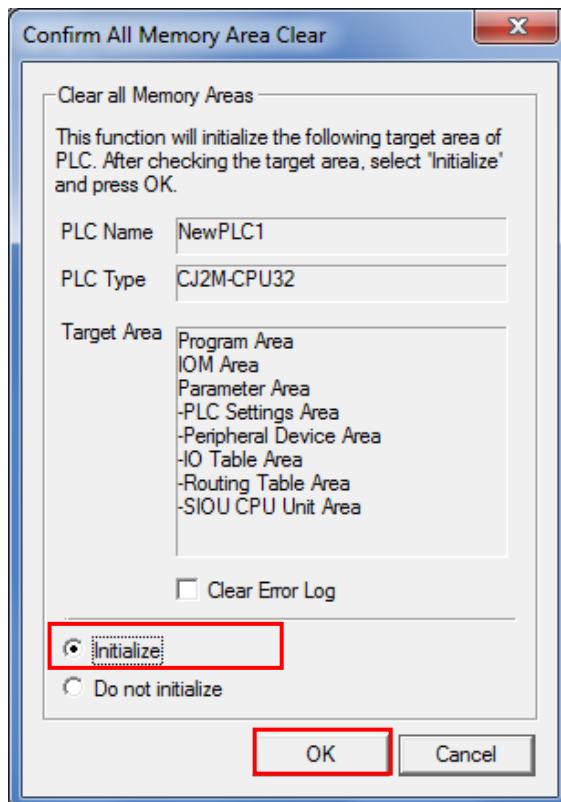

7.2. Initializing the Displacement Sensor

For the initialization of the Displacement Sensor, refer to *Initializing Settings* under 9-11 *Setting the System* in the *ZW Series Displacement Sensor (Confocal Fiber Type) User's Manual* (Cat. No. Z332).

8. Revision History

Revision code	Date of revision	Revision reason and revision page
01	April 26, 2013	First edition

OMRON Corporation Industrial Automation Company

Tokyo, JAPAN

Contact: www.ia.omron.com

Regional Headquarters

OMRON EUROPE B.V.

Wegalaan 67-69-2132 JD Hoofddorp
The Netherlands

Tel: (31)2356-81-300/Fax: (31)2356-81-388

OMRON ELECTRONICS LLC

One Commerce Drive Schaumburg,
IL 60173-5302 U.S.A.

Tel: (1) 847-843-7900/Fax: (1) 847-843-7787

OMRON ASIA PACIFIC PTE. LTD.

No. 438A Alexandra Road # 05-05/08 (Lobby 2),
Alexandra Technopark,
Singapore 119967

Tel: (65) 6835-3011/Fax: (65) 6835-2711

OMRON (CHINA) CO., LTD.

Room 2211, Bank of China Tower,
200 Yin Cheng Zhong Road,
PuDong New Area, Shanghai, 200120, China

Tel: (86) 21-5037-2222/Fax: (86) 21-5037-2200

Authorized Distributor:

© OMRON Corporation 2013 All Rights Reserved.
In the interest of product improvement,
specifications are subject to change without notice.

Cat. No. P536-E1-01

0911(-)