

# Robotics packaging line solution

Bringing innovation to manufacturing sites

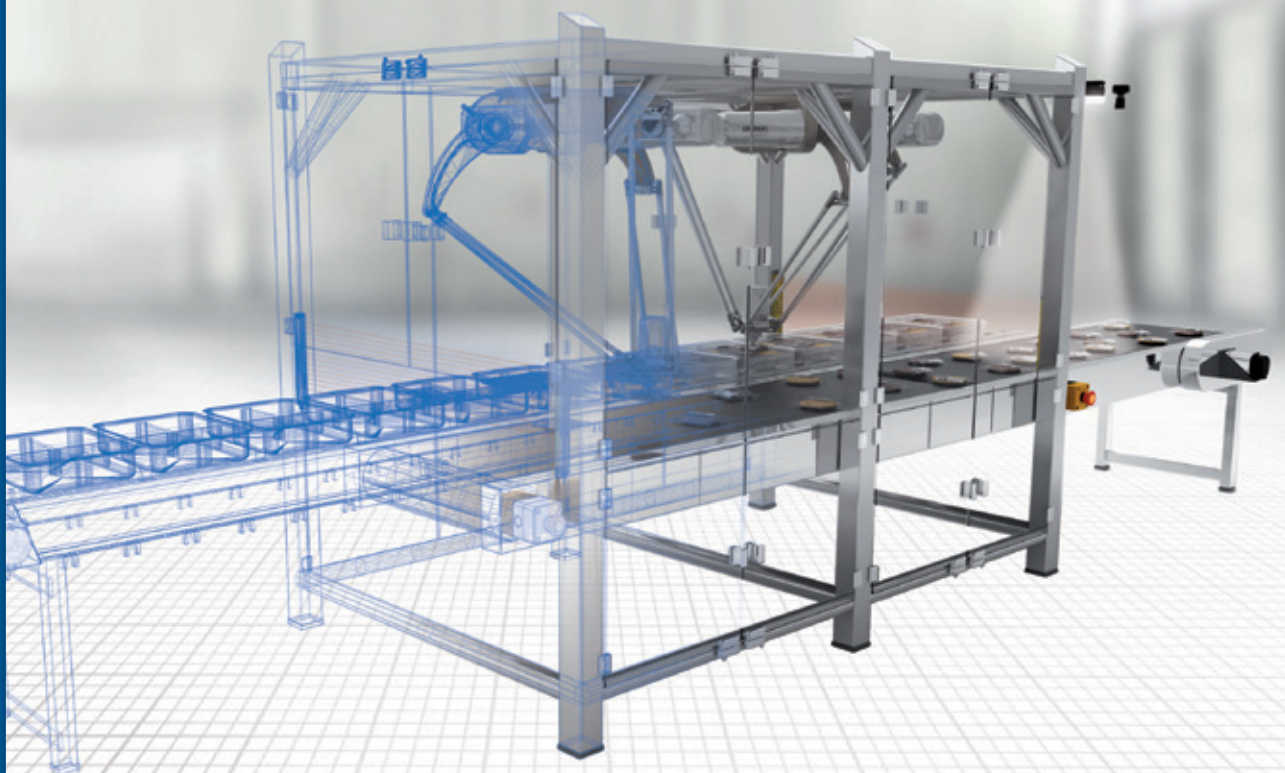

- Flexible robotic solution
- Seamless integration of Virtual and Real
- Global robotic service

# Intuitive robotics add flexibility to packaging

## The future of intuitive robotics and configurable-modular packing line

Omron offers a complete solution to automating packaging line helping our customers reach high demanding production. Embedded robots and robotic modules are integrated into packaging machines to increase productivity.

### Flexible line: Production line using Omron Adept Technologies Inc. robots

Omron's unique combination of control and robotics technologies for advanced production lines

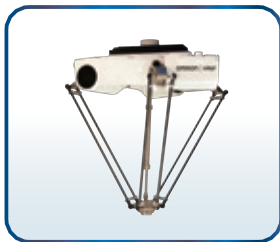

Parallel Robot Hornet



Parallel Robot Quattro



Table/Floor type SCARA Robot eCobra 600/800



Inverted SCARA Robot eCobra 800 Inverted



Articulated Robot Viper



Mobile Robot LD

### Flexible machine: Easy to reuse and reconfigure machines using NJ Robotics

One controller for high-speed synchronous control of devices and robots

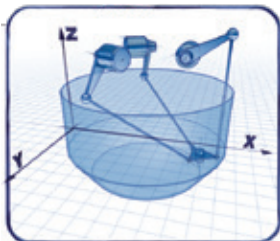

Delta Robot 3 axis

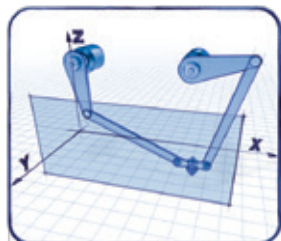

Delta Robot 2 axis

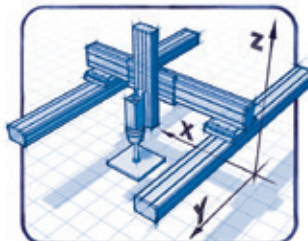

Gantry Robot

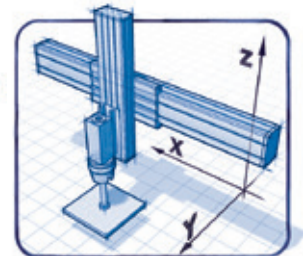

Cartesian Robot 2 axis

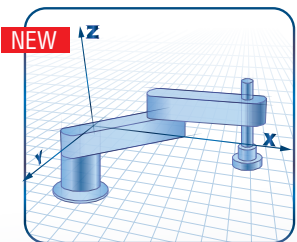

SCARA Robot

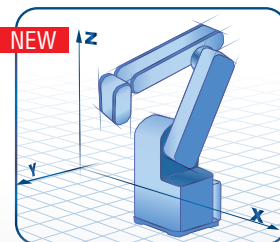

Articulated Robot 3 axis



Machine Automation Controller NJ Robotics CPU Unit

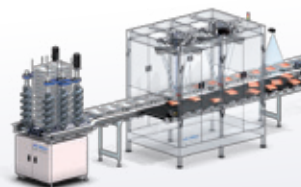

line



# The Omron's unique benefits

The new Omron Robotic Automation enhances the most demanding manufacturing lines providing benefits

## Performance

Overall through-put is guaranteed by the synchronization of our machine control with the new vision guided robots

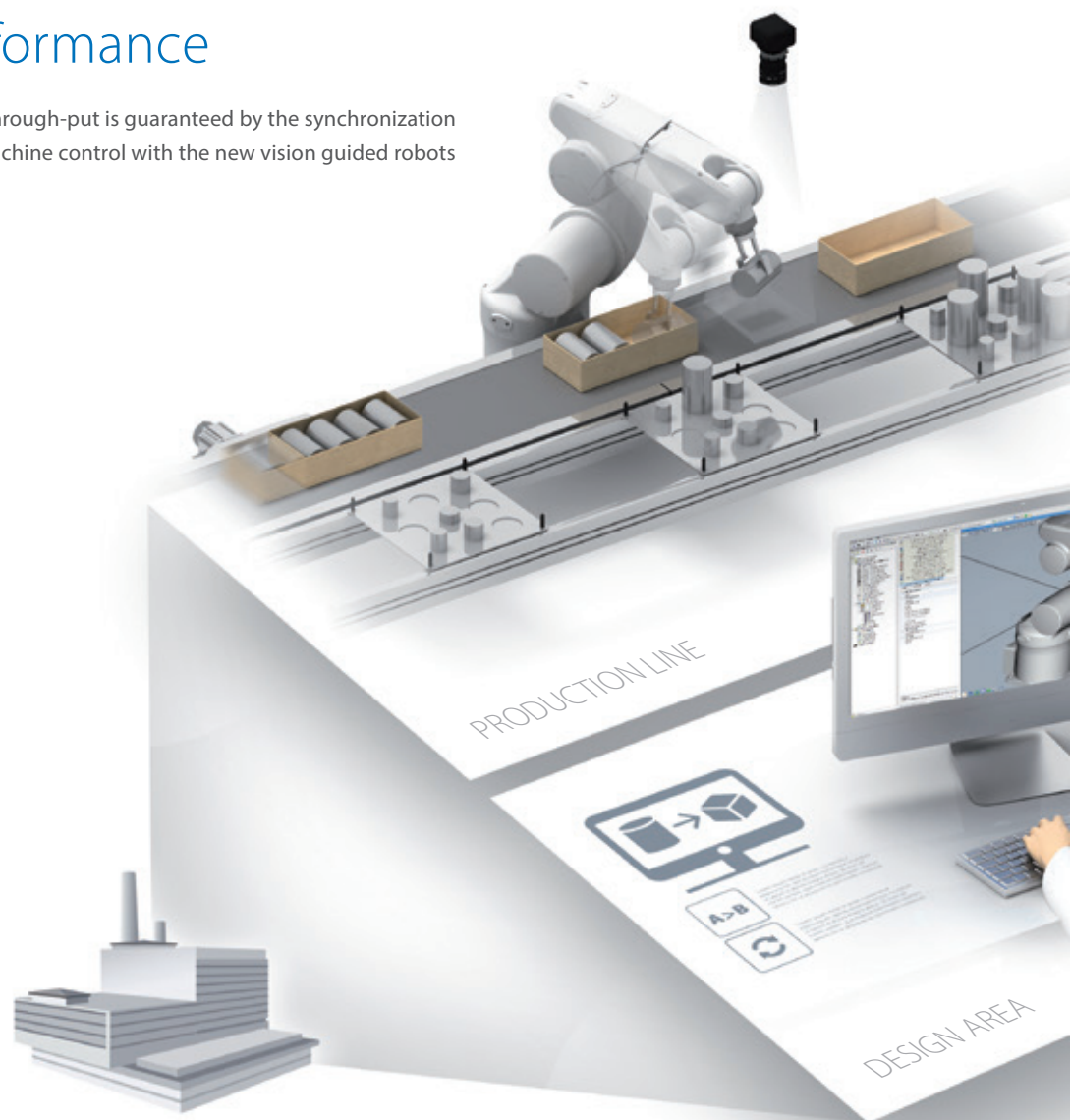

Smart Factory

## Quick Delivery

6 huge automated warehouses to provide parts in short time

## Simple

Shortening the system verification, startup, and maintenance time by the integrated software environment that bridges real and virtual world

## Efficient

All the production data coming from the robots, controllers, sensors, and other devices integrated within the Sysmac concept are collected, shared, and managed to optimize the productivity

## Flexible

ACE (software assisted system) generates automatically the new programming code based on the application



# Vision-guided robots: Virtual meets Real

The needs for Pick & Place machines using robots and vision sensors are increasing. Our own Robotics and Vision technology provides the most seamless integration achieved into a single software environment. The machines can be analyzed in the virtual environment that allows studying the application in advance, without having the real machine.

< VIRTUAL

Sysmac Studio

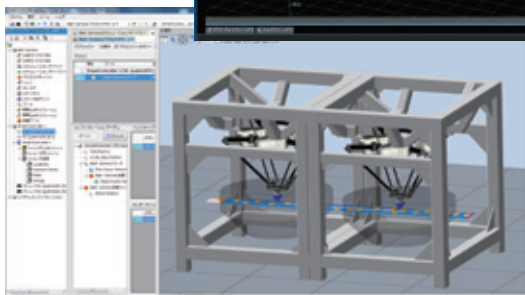
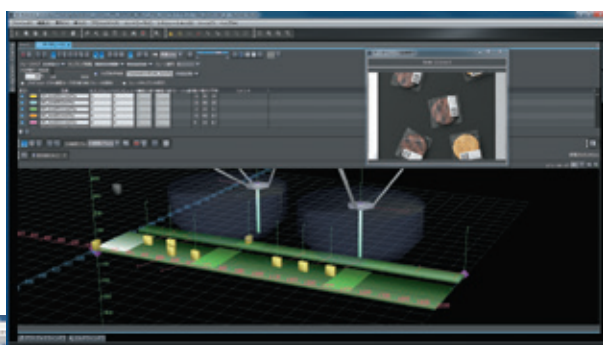

ACE

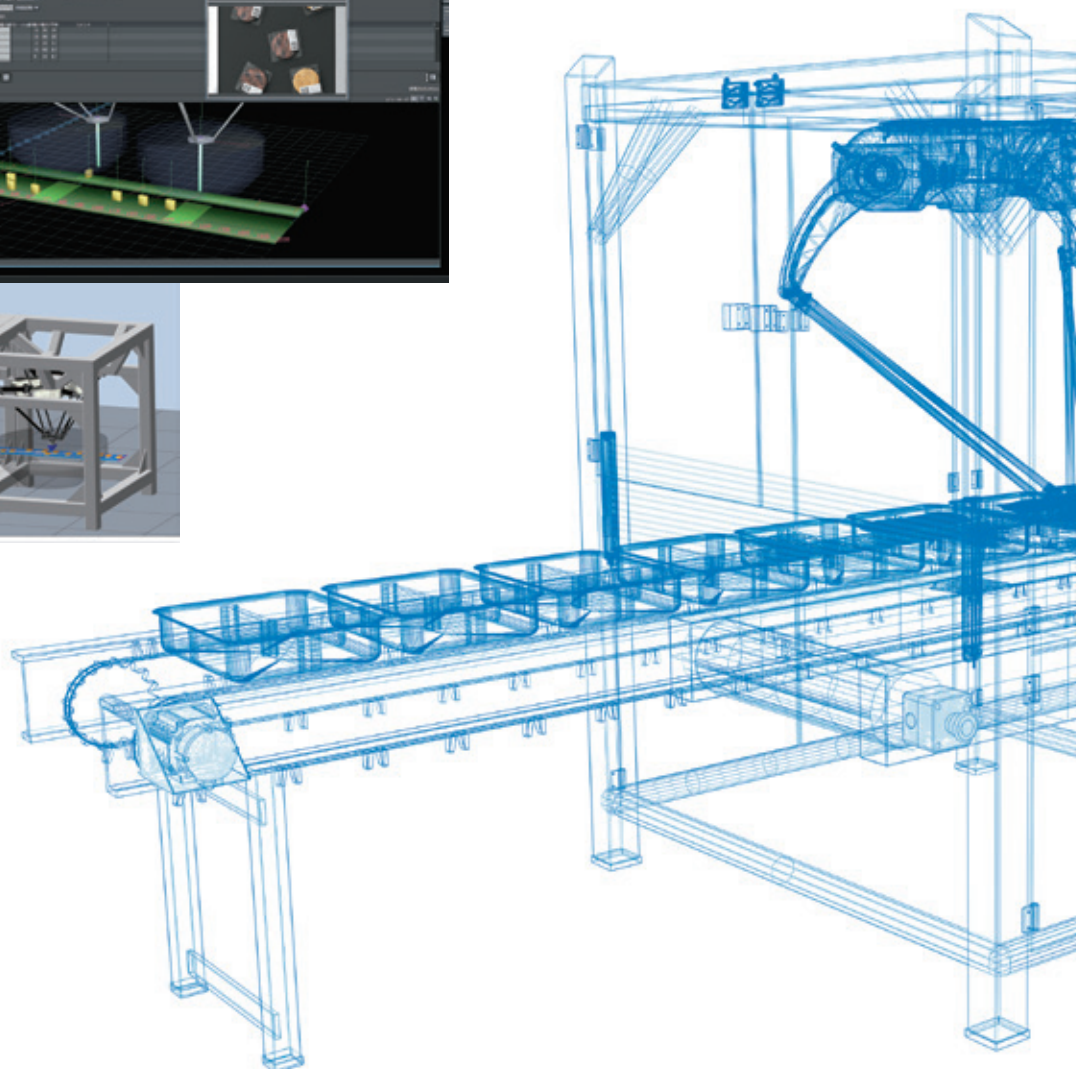

✓ VIRTUAL:

The virtual simulation using the Ace PackXpert or Sysmac Studio is highly reliable since it's based on the same software running in the real robotics and vision system

✓ REAL:

Building high performance Pick & Place machines becomes an easy job thanks to the usability of the fully integrated platform with integrated Vision and Robotics functionality

REAL >

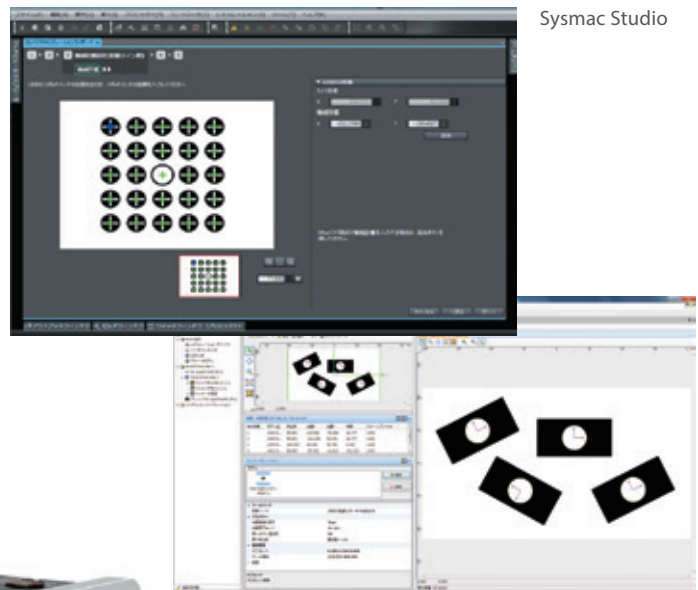

ACE

Benefits include time optimization and reduction for the complete project



Note. In-house comparison. Based on Omron investigation in November 2015.

# Total solution for your packaging line

## Integration and Functionality

Sysmac is an integrated automation platform dedicated to providing complete control and management of your automation plant.

At the core of this platform, the Machine Controller series offers synchronous control of all machine devices and advanced functionality such as motion, robotics and database connectivity. This multidisciplinary concept allows you to simplify solution architecture, reduce programming and optimize productivity.





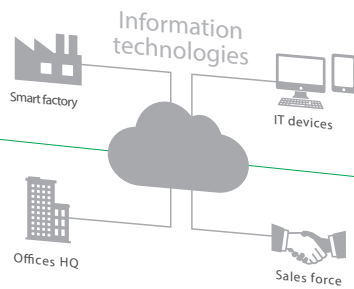

Big Data Database



Ethernet

Flexible line

Flexible machine



Sysmac Library

NJ/NX/NY Controller



Machine Automation Controller  
NJ Robotics



Safety  
NX Safety

EtherCAT

MX2 Inverter

Motion

G5/1S Servo Drive

Robotics  
G5/1S Servo Drive

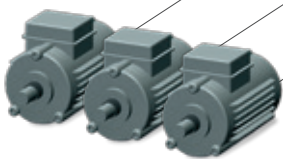

Motors



Motors

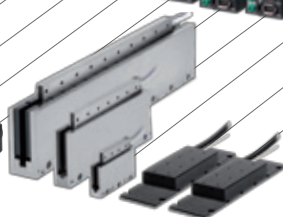

Linear motors

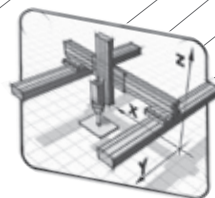

Kinematics

# Global robotic service

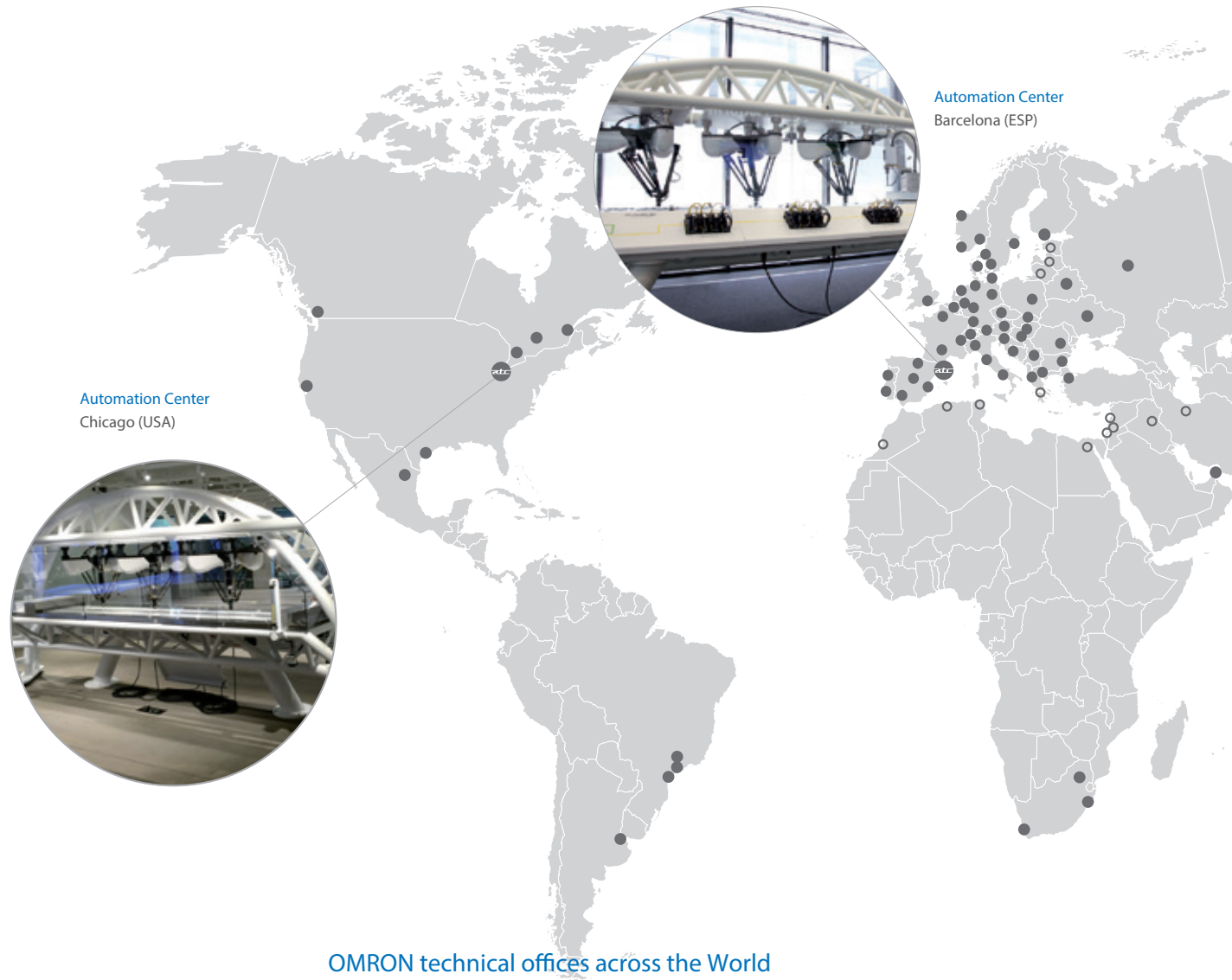

## PRESENCE



### Automation Center

Mishima (JPN), Shanghai (CHN), Barcelona (ESP), Jakarta (IDN),  
Mumbai (IND), Chicago (USA), Seoul (KOR)

● Technical office ○ Premium Partner

## COMPETENCE

OMRON

### Design

Our wide network of machine automation specialists will help you to select the right automation architecture and products to meet your requirements. Our flat structure based on expert-to-expert contact ensures that you will have ONE accountable and responsible expert to deal with on your complete project.

### Proof of concept

As your project matures make use of our Automation centers to test and catch-up with technology trends in motion, robotics, networking, safety, quality control etc. Make use of our Tsunagi (connectivity) laboratory to interface, test and validate your complete system with our new machine network (EtherCAT) and factory network (EtherNet/IP).

We will assign a dedicated application engineer to assist with initial programming and proof testing of the critical aspects of your automation system. Our application engineers have in-depth expertise in and knowledge of networks, PLCs, motion, safety and HMIs when applied to machine automation.

Give us a call / Send us your sample / We can simulate the application for you and send you a test report.

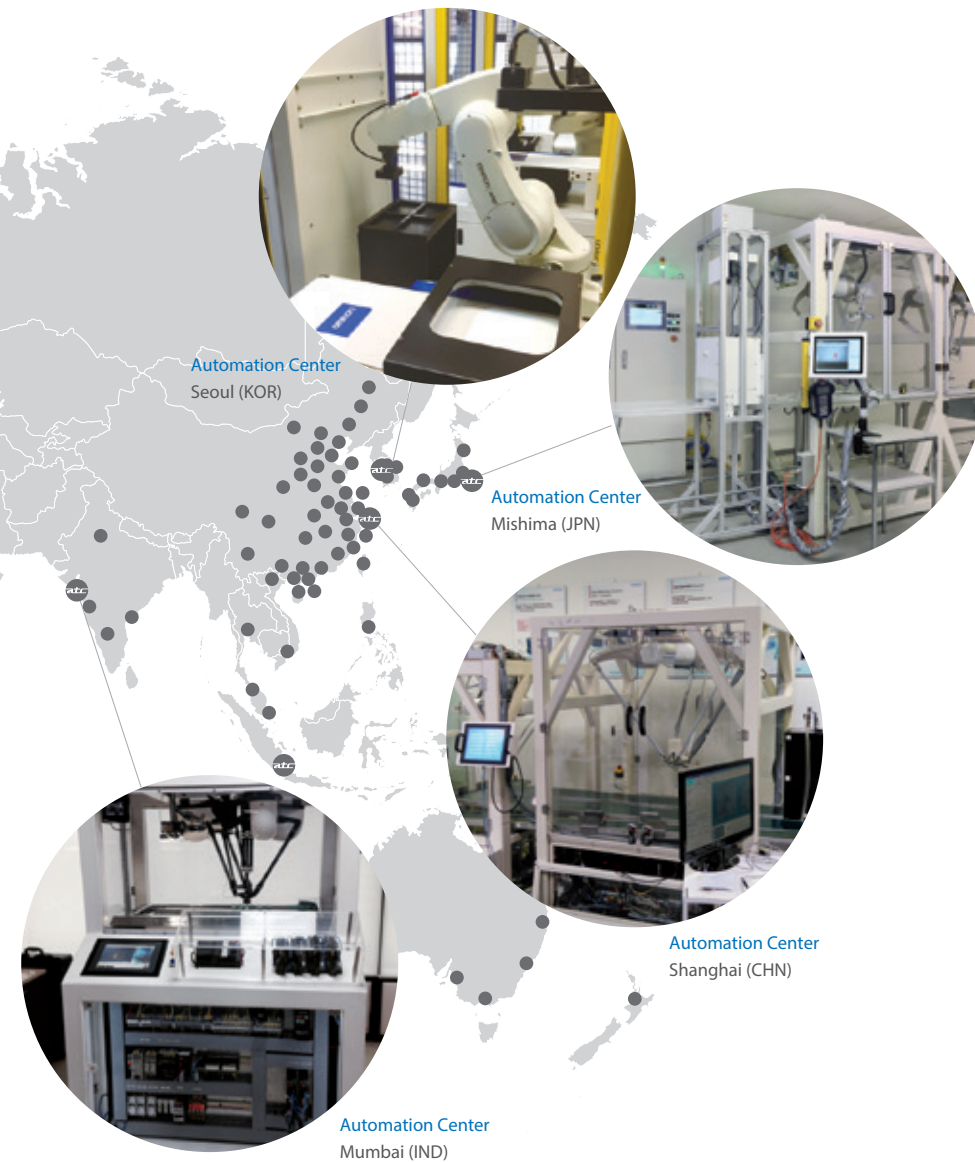

Test report as a service is based on virtual machine simulation and product samples testing:

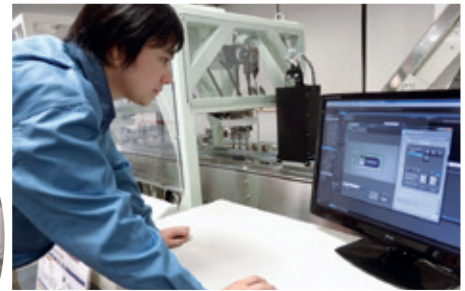

Checking of real product samples



3D machine simulation environment

## CONFIDENCE

### Development

During your prototyping phase you will need flexibility in technical support, product supply and exchange. We will assign an inside sales contact to help you source the correct products fast during your prototyping phase.

### Commissioning

With our world-wide network for service and support the export of your product is made simple, we will support you on-site with your customer, anywhere in the world. We can arrange a liaison sales engineer to facilitate training, spare parts supply or even machine commissioning. All this in a localised language with localised documentation – giving you complete peace of mind.

## ASSURANCE

### Serial production

As your production increases we will engage in supplying you within 24hrs and repairing within 3 days. All our products are global products meeting global standards - CE, cULus, NK, LR -

# Omron continues to develop robot systems to meet your needs.

Omron offers a wide range of solutions ideal for applications in the food and beverage, automotive, and electronic components industries.



## · Post-press process (Automotive industry)

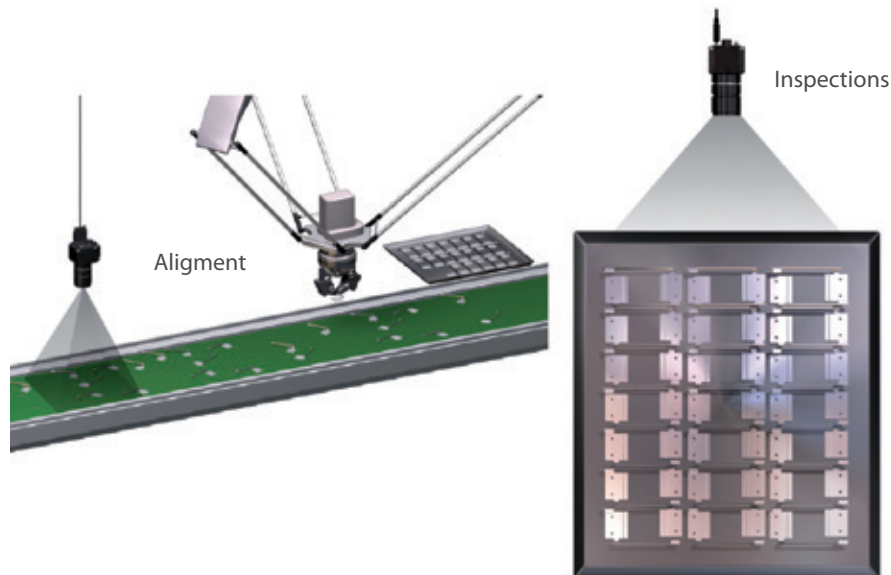

FROM

TO

When both alignment and inspection were performed, individual vision system controllers were required for each process, which consumed space and increased cost. The previous controller that could be connected with two cameras could not process simultaneously due to waiting time.

Up to eight cameras can be connected with one vision system controller, saving space and cost. Parallel processing by a CPU eliminates waiting time and reduces cycle time.

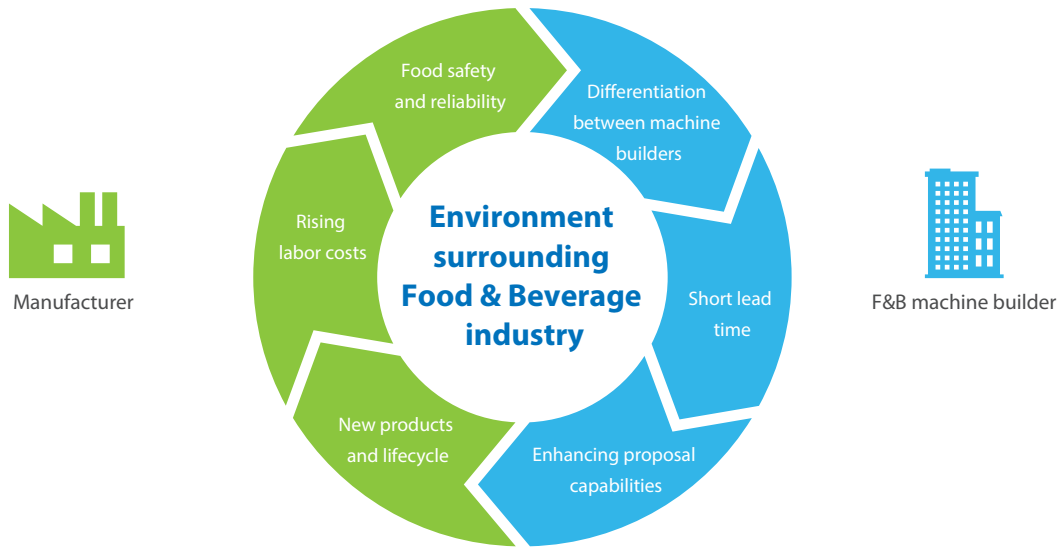

· Packing process (Food & beverage industry)







Pattern search provided by general vision sensors sometimes could not detect folded laminate pouches or detected the incorrect position, generating picking errors.

Search algorithm Shape Search III can reliably detect objects even under adverse conditions. Accurate picking position measurement minimizes picking errors. The sensor can distinguish the top and bottom of the pouch by detecting characteristic points. This makes more efficient use of the space inside boxes when pouches are packed in boxes.

# 200,000 products

## — Flexible line

CONTROLLERS				
				
Product name	NX701	NJ501	NJ301	NJ101
<b>Description</b>	Ideal for large-scale, fast, and highly-accurate control with up to 256 axes.	NJ5 series Machine Controller with Sequence and Motion functionality	NJ3 series Machine Controller with Sequence and Motion functionality	Ideal for simple machines
<b>Software</b>	Sysmac Studio	Sysmac Studio	Sysmac Studio	Sysmac Studio
<b>Programming</b>	<ul style="list-style-type: none"> <li>Ladder (within In-line ST)</li> <li>Structured Text</li> <li>In-line ST</li> </ul>	<ul style="list-style-type: none"> <li>Ladder (within In-line ST)</li> <li>Structured Text</li> <li>In-line ST</li> </ul>	<ul style="list-style-type: none"> <li>Ladder (within In-line ST)</li> <li>Structured Text</li> <li>In-line ST</li> </ul>	<ul style="list-style-type: none"> <li>Ladder (within In-line ST)</li> <li>Structured Text</li> <li>In-line ST</li> </ul>
<b>Standard programming</b>	<ul style="list-style-type: none"> <li>IEC 61131-3</li> <li>PLCopen Function Blocks for Motion Control</li> </ul>	<ul style="list-style-type: none"> <li>IEC 61131-3</li> <li>PLCopen Function Blocks for Motion Control</li> </ul>	<ul style="list-style-type: none"> <li>IEC 61131-3</li> <li>PLCopen Function Blocks for Motion Control</li> </ul>	<ul style="list-style-type: none"> <li>IEC 61131-3</li> <li>PLCopen Function Blocks for Motion Control</li> </ul>
<b>Program capacity</b>	80MB	20 MB	5 MB	3MB
<b>Variables capacity</b>	<b>No Retain attribute</b>	256MB	4MB	2MB
	<b>Retain attribute</b>	4MB	2MB	0.5MB
<b>Memory card</b>	SD/SDHC memory card	SD/SDHC memory card	SD/SDHC memory card	SD/SDHC memory card
<b>Built-in ports</b>	<ul style="list-style-type: none"> <li>EtherNet/IP</li> <li>EtherCAT</li> <li>USB 2.0</li> </ul>	<ul style="list-style-type: none"> <li>EtherNet/IP</li> <li>EtherCAT</li> <li>USB 2.0</li> </ul>	<ul style="list-style-type: none"> <li>EtherNet/IP</li> <li>EtherCAT</li> <li>USB 2.0</li> </ul>	<ul style="list-style-type: none"> <li>EtherNet/IP</li> <li>EtherCAT</li> <li>USB 2.0</li> </ul>
<b>Number of EtherCAT slaves</b>	512	192	192	64
<b>Number of motion control axes</b>	256, 128	64, 32, 16	8, 4	2, 0
<b>Motion control</b>	<ul style="list-style-type: none"> <li>Axes groups interpolation and single axis moves</li> <li>Electronic cams and gearboxes</li> <li>Direct position control for axis and groups</li> </ul>	<ul style="list-style-type: none"> <li>Axes groups interpolation and single axis moves</li> <li>Electronic cams and gearboxes</li> <li>Direct position control for axis and groups</li> </ul>	<ul style="list-style-type: none"> <li>Axes groups interpolation and single axis moves</li> <li>Electronic cams and gearboxes</li> <li>Direct position control for axis and groups</li> </ul>	<ul style="list-style-type: none"> <li>Axes groups interpolation and single axis moves</li> <li>Electronic cams and gearboxes</li> <li>Direct position control for axis and groups</li> </ul>
<b>Ordering information</b>	P089 NJ/NX Catalog			



### Sysmac Library



The Sysmac Library is a collection of software functional components that can be used in programs for the NJ/NX Machine Automation Controllers or Industrial PC Platform NY IPC Machine Controller.

Please download it from following URL and install to Sysmac Studio Automation Software.







[http://www.ia.omron.com/sysmac\\_library/](http://www.ia.omron.com/sysmac_library/)

- The Adept Robot Control Library allows you to control parallel, SCARA, and articulated robots manufactured by Omron Adept Technologies Inc. from the NJ/NX Machine Automation Controller or Industrial PC Platform NY IPC Machine Controller by using the same instructions and programming methods.

CONTROLLERS

				
<b>Product name</b>		<b>NX1P</b>	<b>NY51□-1</b>	<b>NY53□-1</b>
<b>Description</b>		Compact controller with up to 4-axis motion control, up to 4-axis single-axis control, and built-in I/O	Two operating systems: Windows and Real-Time OS	
<b>Software</b>		Sysmac Studio	Sysmac Studio	Sysmac Studio
<b>Programming</b>		<ul style="list-style-type: none"> <li>Ladder (within in-line ST)</li> <li>Structured Text</li> <li>In-line ST</li> </ul>	<ul style="list-style-type: none"> <li>Ladder (within in-line ST)</li> <li>Structured Text</li> <li>In-line ST</li> </ul>	<ul style="list-style-type: none"> <li>Ladder (within in-line ST)</li> <li>Structured Text</li> <li>In-line ST</li> </ul>
<b>Standard programming</b>		<ul style="list-style-type: none"> <li>IEC61131-3</li> <li>PLCopen Function Blocks for Motion Control</li> </ul>	<ul style="list-style-type: none"> <li>IEC61131-3</li> <li>PLCopen Function Blocks for Motion Control</li> </ul>	<ul style="list-style-type: none"> <li>IEC61131-3</li> <li>PLCopen Function Blocks for Motion Control</li> </ul>
<b>Program capacity</b>		1.5MB	40MB	
<b>Variables capacity</b>	<b>No Retain attribute</b>	2MB	64MB	
	<b>Retain attribute</b>	32KB	4MB	
<b>Memory card</b>		SD/SDHC memory card	SSD, HDD	
<b>Built-in ports</b>		<ul style="list-style-type: none"> <li>EtherNet/IP</li> <li>EtherCAT</li> </ul>	<ul style="list-style-type: none"> <li>EtherNet/IP</li> <li>EtherCAT</li> <li>USB2.0/3.0</li> </ul>	
<b>Number of EtherCAT slaves</b>		16	192	
<b>Number of motion control axes</b>		4, 2, 0 *	64, 32, 16	
<b>Motion control</b>		<ul style="list-style-type: none"> <li>Axes groups interpolation and single axis moves</li> <li>Electronic cams and gearboxes</li> <li>Direct position control for axis and groups</li> </ul>	<ul style="list-style-type: none"> <li>Axes groups interpolation and single axis moves</li> <li>Electronic cams and gearboxes</li> <li>Direct position control for axis and groups</li> </ul>	<ul style="list-style-type: none"> <li>Axes groups interpolation and single axis moves</li> <li>Electronic cams and gearboxes</li> <li>Direct position control for axis and groups</li> </ul>
<b>Ordering information</b>		PT15 NX1P Catalog	PT18 Industrial PC Platform Catalog	

\* Motion control axes and 4 single-axis position control axes.

INDUSTRIAL ROBOTS				
				
<b>Product name</b>	<b>Homet 565</b>		<b>Quattro 650/800</b>	<b>Viper 650/850</b>
<b>Robot type</b>	Parallel robot			Articulated robot
<b>Number of axes</b>	3, 4		4	6
<b>Maunting</b>	Inverted		Inverted	Table / Floor / Inverted
<b>Payload capacity</b>	3 kg (8 kg: without rotation axis)		<ul style="list-style-type: none"> <li>• Quattro 650 6 kg (No rotation: 15 kg)</li> <li>• Quattro 800 4 kg (No rotation: 10 kg)</li> </ul>	5 kg
<b>Working volume (Radius)</b>	565 mm		650 to 800 mm	---
<b>Reach</b>	---		---	653 to 855 mm
<b>Position repeatability</b>	±0.10 mm		±0.10 mm	±0.02 to 0.03 mm
<b>Protection/ Cleanroom Classes</b>	<b>Specifications</b>	IP67: arms and platform IP65: underside of robot IP20: topside of robot Class 1000	<ul style="list-style-type: none"> <li>• H type IP67: arms and platform Class 1000</li> <li>• HS type IP67: arms and platform IP66: robot base Class 1000</li> </ul>	IP40
	<b>Option</b>	IP65: topside of robot	<ul style="list-style-type: none"> <li>• H type IP65: robot base</li> </ul>	IP54: robot main body IP65: robot joints (J4, J5, J6) Class10 Cleanroom model
<b>Ordering information</b>		I822 Industrial Robots Datasheets		
				
<b>Product name</b>	<b>Cobra 350</b>		<b>eCobra 600/800</b>	<b>eCobra 800 Inverted</b>
<b>Robot type</b>	SCARA robot			
<b>Number of axes</b>	4		4	4
<b>Maunting</b>	Table / Floor		Table / Floor	Inverted
<b>Payload capacity</b>	5 kg		5.5 kg	5.5 kg
<b>Working volume (Radius)</b>	---		---	---
<b>Reach</b>	350 mm		600 to 800 mm	800 mm
<b>Position repeatability</b>	±0.015 mm		±0.017 mm	±0.017 mm
<b>Protection/ Cleanroom Classes</b>	<b>Specifications</b>	IP20	IP20	IP20
	<b>Option</b>	Class10 Cleanroom model	<ul style="list-style-type: none"> <li>• eCobra 600 Class10 Cleanroom model</li> <li>• eCobra 800 IP65, Class10 Cleanroom model</li> </ul>	IP65, Class10 Cleanroom model
<b>Ordering information</b>		I822 Industrial Robots Datasheets		



MOBILE ROBOTS



Product name		LD	
Robot type	Mobile robot		
Product type	OEM	Cart Transporter	
Maximum load	60, 90 kg	105, 130 kg	
Maximum speed	1.8 m/s, 1.35 m/s	1.35 m/s, 0.9 m/s	
Maximum rotation speed	300°/s, 225°/s	180°/s	
Stop position accuracy	± 100 mm: Position, ± 2°: Rotation (±10 mm: Position, ±0.5°: Rotation with option (High Accuracy Positioning System))		
Protection/Cleanroom Classes	IP20 Class 100	IP20	
Ordering information	I828 Mobile Robots Datasheet		

# — Flexible Machine

## MACHINE CONTROLLERS



<b>Product name</b>		<b>NJ- series Robotics</b>
		<b>NJ501</b>
<b>Description</b>		Machine Controller with Sequence, Motion and Robotics functionality
<b>Software</b>		Sysmac Studio
<b>Programming</b>		<ul style="list-style-type: none"> <li>Ladder (within In-line ST)</li> <li>Structured Text</li> <li>In-line ST</li> </ul>
<b>Standard programming</b>		<ul style="list-style-type: none"> <li>IEC 61131-3</li> <li>PLCopen Function Blocks for Motion Control</li> </ul>
<b>Program capacity</b>		20 MB
<b>Variables capacity</b>	<b>No Retain attribute</b>	4MB
	<b>Retain attribute</b>	2MB
<b>Memory card</b>		SD/SDHC memory card
<b>Built-in ports</b>		<ul style="list-style-type: none"> <li>EtherNet/IP</li> <li>EtherCAT</li> <li>USB 2.0</li> </ul>
<b>Number of EtherCAT slaves</b>		192
<b>Number of axes</b>		64, 32, 16
<b>Motion control</b>		<ul style="list-style-type: none"> <li>Axes groups interpolation and single axis moves</li> <li>Electronic cams and gearboxes</li> <li>Direct position control for axis and groups</li> <li>Up to 8 parallel, Cartesian, and serial robot control</li> </ul>
<b>Ordering information</b>		P089 NJ/NX Catalog

# — Lineup for Omron Robotic Automation

## SOFTWARE

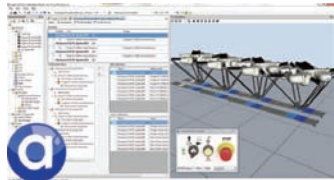

Model	Automation Control Environment (ACE)	Sysmac Studio Standard Edition Ver.1.□□	Sysmac Library
	<p>The ACE is a PC-based software package that helps you quickly and easily set up your robot system. The software makes it easy to configure single and multi-robot systems.</p> <p>ACE PackXpert is the intelligent software choice designed to manage packaging systems from integration to deployment</p> <ul style="list-style-type: none"> <li>• ACE PackXpert provides the underlying robot programming based on the system configuration</li> <li>• Built-in customization allows for any line configuration and advanced load balancing</li> <li>• Wizard-based user-friendly interface to calibrate and teach the robots</li> <li>• Tightly-integrated vision option (ACE Sight) enables vision-guided conveyor-tracking</li> </ul>	<p>The Sysmac Studio is the software that provides an integrated environment for setting, programming, debugging and maintenance of machine automation controllers including the NJ/NX CPU Units, NY Industrial PC, EtherCAT Slave, and the HMI.</p> <ul style="list-style-type: none"> <li>• One software for motion, logic sequencing, safety, drives, vision and HMI</li> <li>• Fully compliant with open standard IEC 61131-3</li> <li>• Supports Ladder, Structured Text and Function Block programming with a rich instruction set</li> <li>• CAM editor for easy programming of complex motion profiles</li> <li>• One simulation tool for sequence and motion in a 3D environment</li> <li>• Advanced security function with 32 digit security password</li> <li>• IEC standard and PLCopen Function Blocks for Motion Control and Safety</li> </ul> <p><b>Robot Additional Option*</b> Sysmac Studio Robot Additional Option is a license to enable the Vision &amp; Robot integrated simulation.</p>	<p>The Sysmac Library is a collection of software functional components that can be used in programs for the NJ/NX Machine Automation Controllers or Industrial PC Platform NY IPC Machine Controller. Packed with Omron's rich technical know-how on control programs, the Sysmac Library makes advanced control easy. Install the Sysmac Library to use it in the Sysmac Studio.</p> <ul style="list-style-type: none"> <li>• For a wide range of applications</li> <li>• Available to download from OMRON's website</li> <li>• High quality product with reliable global support</li> </ul> <p><b>SYSMAC-XR009</b> <b>Adept Robot Control Library</b> The Adept Robot Control Library allows parallel, SCARA, and articulated robots manufactured by Omron Adept Technologies Inc. to be controlled directly from the NJ/NX Machine Automation Controller or Industrial PC Platform NY IPC Machine Controller by using the same instructions and programming method as the controller.</p>
<b>Ordering information</b>	I822 Industrial Robots Datasheets	Refer to your OMRON website for details.	

\* This product is a license only. You need the Sysmac Studio Standard Edition DVD media to install it.

## VISION SENSORS







<b>Series</b>		<b>FH</b>
<b>Product name</b>		Vision System
<b>Hardware features</b>		Flexible configuration of cameras and controller to suit your applications
<b>Software FEATURE</b>		Flexible setting with flowchart
<b>Processing items</b>		Processing items covering general applications
<b>Processing resolution</b>	<b>300,000 pixels</b>	640 (H) x 480 (V)
	<b>2 million pixels</b>	2040 (H) x 1088 (V)
	<b>4 million pixels</b>	2040 (H) x 2048 (V)
	<b>12 million pixels</b>	4084(H)x 3072(V)
<b>Communications interfaces</b>		EtherCAT, Ethernet, parallel I/O, encoder input
<b>Ordering information</b>		Q197 FH Catalog

## PROGRAMMABLE TERMINALS



<b>Model</b>	<b>NA5-15W</b>	<b>NA5-12W</b>	<b>NA5-9W</b>	<b>NA5-7W</b>
<b>Display device</b>	TFT LCD	TFT LCD	TFT LCD	TFT LCD
<b>Screen size</b>	15.4-inch widescreen	12.1-inch widescreen	9.0-inch widescreen	7.0-inch widescreen
<b>Resolution</b>	1280 x 800 dots (horizontal x vertical)	1280 x 800 dots (horizontal x vertical)	800 x 480 dots (horizontal x vertical)	800 x 480 dots (horizontal x vertical)
<b>Colors</b>	16,770,000 colors (24 bit full colors)	16,770,000 colors (24 bit full colors)	16,770,000 colors (24 bit full colors)	16,770,000 colors (24 bit full colors)
<b>Operation</b>	<ul style="list-style-type: none"> <li>• Touch panel: Analog resistive membrane type</li> <li>• Function keys: 3 inputs (capacitance inputs)</li> </ul>	<ul style="list-style-type: none"> <li>• Touch panel: Analog resistive membrane type</li> <li>• Function keys: 3 inputs (capacitance inputs)</li> </ul>	<ul style="list-style-type: none"> <li>• Touch panel: Analog resistive membrane type</li> <li>• Function keys: 3 inputs (capacitance inputs)</li> </ul>	<ul style="list-style-type: none"> <li>• Touch panel: Analog resistive membrane type</li> <li>• Function keys: 3 inputs (capacitance inputs)</li> </ul>
<b>Built-in ports</b>	<ul style="list-style-type: none"> <li>• 2 Ethernet ports</li> <li>• 2 USB host ports</li> <li>• 1 USB slave port</li> </ul>	<ul style="list-style-type: none"> <li>• 2 Ethernet ports</li> <li>• 2 USB host ports</li> <li>• 1 USB slave port</li> </ul>	<ul style="list-style-type: none"> <li>• 2 Ethernet ports</li> <li>• 2 USB host ports</li> <li>• 1 USB slave port</li> </ul>	<ul style="list-style-type: none"> <li>• 2 Ethernet ports</li> <li>• 2 USB host ports</li> <li>• 1 USB slave port</li> </ul>
<b>Allowable power supply voltage range</b>	19.2 to 28.8 VDC	19.2 to 28.8 VDC	19.2 to 28.8 VDC	19.2 to 28.8 VDC
<b>Programming software</b>	Sysmac Studio	Sysmac Studio	Sysmac Studio	Sysmac Studio
<b>Degree of protection</b>	Front-panel controls: IP65 oil-proof type	Front-panel controls: IP65 oil-proof type	Front-panel controls: IP65 oil-proof type	Front-panel controls: IP65 oil-proof type
<b>Memory card</b>	SD/SDHC memory card	SD/SDHC memory card	SD/SDHC memory card	SD/SDHC memory card
<b>Features</b>	<ul style="list-style-type: none"> <li>• Sharing NJ controller variables in the NA project</li> <li>• Increased security with password protection</li> <li>• Visual Basic programming</li> <li>• Testing NA with the NJ control program via Simulator in Sysmac Studio</li> </ul>	<ul style="list-style-type: none"> <li>• Sharing NJ controller variables in the NA project</li> <li>• Increased security with password protection</li> <li>• Visual Basic programming</li> <li>• Testing NA with the NJ control program via Simulator in Sysmac Studio</li> </ul>	<ul style="list-style-type: none"> <li>• Sharing NJ controller variables in the NA project</li> <li>• Increased security with password protection</li> <li>• Visual Basic programming</li> <li>• Testing NA with the NJ control program via Simulator in Sysmac Studio</li> </ul>	<ul style="list-style-type: none"> <li>• Sharing NJ controller variables in the NA project</li> <li>• Increased security with password protection</li> <li>• Visual Basic programming</li> <li>• Testing NA with the NJ control program via Simulator in Sysmac Studio</li> </ul>
<b>Frame colors</b>	Black, silver	Black, silver	Black, silver	Black, silver
<b>Ordering information</b>	V413 NA Catalog			

I/O			
			
Series	<b>NX</b>		<b>GX</b>
Type	Modular I/O		Block I/O
Communications interface	EtherCAT		EtherCAT
Number of connectable units	<ul style="list-style-type: none"> <li>63 units max.</li> <li>Input: 1,024 bytes max., output: 1,024 bytes max.</li> </ul>		One expansion unit can be connected with one digital I/O terminal (16 inputs + 16 outputs)
I/O types	<ul style="list-style-type: none"> <li>Digital I/O</li> <li>Pulse output</li> </ul>	<ul style="list-style-type: none"> <li>Analog I/O</li> <li>Temperature input</li> </ul>	<ul style="list-style-type: none"> <li>Encoder input</li> <li>Safety</li> </ul>
Features	<ul style="list-style-type: none"> <li>Over 100 models of I/O units including position interface, temperature inputs and integrated safety</li> <li>High-speed I/O units synchronized with the EtherCAT cycle</li> <li>NsynX technology provides deterministic I/O response with nanosecond resolution</li> <li>Detachable front connector with push-in type screw-less terminals in all NX I/O units</li> <li>Up to 32 digital inputs or outputs</li> </ul>		<ul style="list-style-type: none"> <li>Wide variety of lineup: digital I/O, analog I/O, and encoder input units</li> <li>Easy maintenance: removable I/O terminal</li> <li>Easy set-up: automatic and manual address setting</li> </ul>
Mounting	DIN track		DIN track
Ordering information	R183 NX Catalog		Refer to your OMRON website for details.

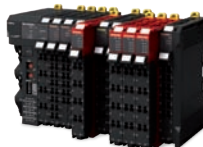
SAFETY			
			
Product name	<b>NX Safety CPU Unit</b>	<b>NX Safety Input Unit</b>	<b>NX Safety Output Unit</b>
Network	FSoE – Safety over EtherCAT	FSoE – Safety over EtherCAT	FSoE – Safety over EtherCAT
Applicable Standards	EN ISO 13849-1, 2 (PLe/Safety Category 4), IEC 61508 (SIL3), EN 62061 (SIL CL3), EN 61131-2	EN ISO 13849-1, 2 (PLe/Safety Category 4), IEC 61508 (SIL3), EN 62061 (SIL CL3), EN 61131-2	EN ISO 13849-1, 2 (PLe/Safety Category 4), IEC 61508 (SIL3), EN 62061 (SIL CL3), EN 61131-2
Programming	<ul style="list-style-type: none"> <li>IEC 61131-3 standard</li> <li>PLCopen Function Blocks for Safety</li> </ul>	---	---
Number of safety master connections	32/128	---	---
Number of safety input/output points	---	<ul style="list-style-type: none"> <li>4 points</li> <li>8 points</li> </ul>	<ul style="list-style-type: none"> <li>2 points</li> <li>4 points</li> </ul>
Number of test output points	---	2 points	---
Terminal block	---	Screwless clamping terminal block	Screwless clamping terminal block
Features	<ul style="list-style-type: none"> <li>Freely mixing with standard NX I/O</li> <li>Reusable certified programs</li> <li>NX variables sharing in the NJ controller project</li> </ul>	<ul style="list-style-type: none"> <li>Freely mixing with standard NX I/O</li> <li>The 4-point unit can be directly connected with OMRON non-contact switches and singlebeam sensors</li> <li>I/O data monitoring in the NJ controller project</li> </ul>	<ul style="list-style-type: none"> <li>Freely mixing with standard NX I/O</li> <li>The 2-point unit is characterized by large output breaking current of 2.0 A</li> <li>I/O data monitoring in the NJ controller project</li> </ul>
Mounting	DIN track	DIN track	DIN track
Ordering information	Refer to your OMRON website for details.		

## SERVOMOTORS/LINEAR MOTORS/DRIVES



Product name	G5 Servo Drives	1S Servo Drives
Type	Built-in EtherCAT Communications	Built-in EtherCAT Communications
Linear Type	Yes (Refer to the G5 Series Catalog (Cat.No.I815) for details.)	No
100 VAC Applicable motor capacity/force	50 to 400 W	100 to 400W
200 VAC Applicable motor capacity/force	50 W to 15 kW	100 to 3kW
400 VAC Applicable motor capacity/force	400 W to 15 kW	600 to 3kW
Applicable servomotor	G5 rotary servomotor	1S servomotor
Control mode	Position, speed and torque control	Position, speed and torque control
Safety approvals	<ul style="list-style-type: none"> <li>ISO13849-1 (PL-c,d)</li> <li>EN61508 (SIL2)</li> <li>EN62061 (SIL2)</li> <li>IEC61800-5-2 (STO)</li> </ul>	<ul style="list-style-type: none"> <li>ISO13849-1 (PL-e/PL-d)</li> <li>EN61508 (SIL3/SIL2)</li> <li>EN62061 (SIL3/SIL2)</li> <li>IEC61800-5-2 (STO)</li> </ul>
Full closed loop	Built-in	No
Ordering information	I815 G5 Catalog	I821 1S Catalog





Product name	G5 Servomotors		1S Servomotors	
Rated rotation speed	3,000 r/min	2,000 r/min	3,000 r/min	2,000 r/min
Momentary maximum rotation speed	4,500 to 6,000 r/min	3,000 r/min	5000 to 6000 r/min	3000 r/min
Rated torque	0.16 to 15.9 Nm	1.91 to 23.9 Nm	0.318 to 9.55N-m	4.77 to 14.3 N-m
Capacity	50 W to 5 kW	400 W to 5 kW	100W to 3 kW	400W to 3kW
Applicable servo drive	G5 Servo Drive (for rotary servomotor)		1S Servo Drive	
Encoder resolution	20-bit incremental/ 17-bit absolute	20-bit incremental/ 17-bit absolute	23-bit absolute	23-bit absolute
Protective structure	IP67	IP67	IP67	IP67
Ordering information	I815 G5 Catalog		I821 1S Catalog	







Product name	G5 Servomotors		1S Servomotors	
Rated rotation speed	1,500 r/min	1,000 r/min	1,000 r/min	
Momentary maximum rotation speed	2,000 to 3,000 r/min	2,000 r/min	2000 r/min	
Rated torque	47.8 to 95.5 Nm	8.59 to 57.3 Nm	8.59 to 28.7 N-m	
Capacity	7.5 to 15 kW	900 W to 6 kW	900 W to 3kW	
Applicable servo drive	G5 Servo Drive (for rotary servomotor)		1S Servo Drive	
Encoder resolution	17-bit absolute	20-bit incremental/ 17-bit absolute	23-bit absolute	
Protective structure	IP67	IP67	IP67	
Ordering information	I815 G5 Catalog		I821 1S Catalog	

## INVERTERS

		
Series	RX-V1	MX2-V1
<b>Three-phase 400 V</b>	0.4 to 132 kW	0.4 to 15 kW
<b>Three-phase 200 V</b>	0.4 to 55 kW	0.1 to 15 kW
<b>Single-phase 200 V</b>	---	0.1 to 2.2 kW
<b>Control methods</b>	<ul style="list-style-type: none"> <li>V/F control</li> <li>Sensorless vector control</li> <li>Vector control with a PG</li> </ul>	<ul style="list-style-type: none"> <li>V/F control</li> <li>Sensorless vector control</li> </ul>
<b>Starting torque</b>	<ul style="list-style-type: none"> <li>200% at 0.3 Hz in open loop</li> <li>Full torque at 0 Hz in closed loop</li> </ul>	200% at 0.5 Hz
<b>Communications</b>	Optional EtherCAT communication unit	Optional EtherCAT communication unit
<b>PLC functionality (Drive Programming)</b>	Provided as standard	Provided as standard
<b>Ordering information</b>	I919 3G3RX-V1 Catalog	I920 MX2-V1 Catalog

## DISPLACEMENT/FIBER/LASER/CONTACT/PROXIMITY SENSORS

				
Series	ZW-7000	ZW	N-Smart	E3X/E3C/E2C
<b>Measurement method</b>	White light confocal principle	White light confocal principle	---	---
<b>Applications</b>	Height, thickness	Height, thickness	---	---
<b>Measuring range</b>	Min: 10±0.5 mm, Max: 30±2 mm	Min: 7 ± 0.3 mm, Max: 40 ± 6 mm	---	---
<b>Static resolution</b>	0.004 to 0.016 μm	0.01 to 0.08 μm	---	---
<b>Linearity</b>	±0.45 to 2.0 μm	±0.8 to 9.3 μm	---	---
<b>Features</b>	<ul style="list-style-type: none"> <li>Measuring shiny objects with an inclination of ±25°</li> <li>±0.5 μm or less linearity for various materials</li> <li>Ultra-compact, Lightweight sensor</li> <li>Synchronous control and setting of multiple sensors via Ethernet</li> <li>Wide variety of interfaces (EtherCAT/Ethernet/RS-232C/Analog voltage and current)</li> </ul>	<ul style="list-style-type: none"> <li>Ultra-compact sensing head</li> <li>Easy to install and high resolution</li> <li>Synchronous control and setting of multiple sensors via Ethernet</li> <li>Wide variety of interfaces (EtherCAT/Ethernet/RS-232C/Analog voltage and current)</li> </ul>	Connect fiber, laser and contact sensors to EtherCAT at low initial cost	Easily connect fiber, laser photoelectric and proximity sensors to EtherCAT
<b>Network specification</b>	---	---	EtherCAT communication unit	EtherCAT communication unit
<b>Maximum connectable sensors</b>	---	---	30	30
<b>Connectable sensor amplifier units</b>	---	---	<ul style="list-style-type: none"> <li>E3NX-FAO</li> <li>E3NX-CAO</li> <li>E3NC-LAO</li> <li>E3NC-SAO</li> <li>E9NC-TAO</li> </ul>	<ul style="list-style-type: none"> <li>E3X-HDO</li> <li>E3X-MDAO</li> <li>E3C-LDAO</li> <li>E2C-EDAO</li> </ul>
<b>Mounting</b>	DIN track (controller)	DIN track (controller)	DIN track	DIN track
<b>Ordering information</b>	Q250 ZW-7000/5000 Catalog	E421 ZW Catalog	Refer to your OMRON website for details.	

**OMRON Corporation** Industrial Automation Company  
Kyoto, JAPAN

Contact: [www.ia.omron.com](http://www.ia.omron.com)

**Regional Headquarters**

**OMRON EUROPE B.V.**

Wegalaan 67-69, 2132 JD Hoofddorp  
The Netherlands  
Tel: (31)2356-81-300/Fax: (31)2356-81-388

**OMRON ELECTRONICS LLC**

2895 Greenspoint Parkway, Suite 200  
Hoffman Estates, IL 60169 U.S.A.  
Tel: (1) 847-843-7900/Fax: (1) 847-843-7787

**OMRON ASIA PACIFIC PTE. LTD.**

No. 438A Alexandra Road # 05-05/08 (Lobby 2),  
Alexandra Technopark,  
Singapore 119967  
Tel: (65) 6835-3011/Fax: (65) 6835-2711

**OMRON (CHINA) CO., LTD.**

Room 2211, Bank of China Tower,  
200 Yin Cheng Zhong Road,  
PuDong New Area, Shanghai, 200120, China  
Tel: (86) 21-5037-2222/Fax: (86) 21-5037-2200

**Authorized Distributor:**

© OMRON Corporation 2015-2017 All Rights Reserved.  
In the interest of product improvement,  
specifications are subject to change without notice.

CSM\_4\_3\_1217

Cat. No.Y127-E1-04

0317(1115)