

**Amplifier-separated Type Inductive Proximity Sensor  
Amplifier GA-311 Sensor head GH-□SE**

MJE-GA311 No.0034-54V

Thank you very much for purchasing Panasonic products. Please read this Instruction Manual carefully and thoroughly for the correct and optimum use of this product. Kindly keep this manual in a convenient place for quick reference.

**⚠ WARNING**

- Never use this product as a sensing device for personnel protection.
- In case of using sensing devices for personnel protection, use products which meet laws and standards, such as OSHA, ANSI or IEC etc., for personnel protection applicable in each region or country.

**1 SPECIFICATIONS**

● **Sensor head**

Item	Model No.	Cylindrical type				
		GH-2SE	GH-3SE	GH-5SE	GH-8SE	GH-F8SE
Applicable amplifier		GA-311				
Stable sensing range (Note 1)		0 to 0.6mm	0 to 0.8mm	0 to 1.0mm	0 to 2.0mm	
Max. operation distance (Note 1)		1.2mm	1.8mm	2.4mm	4.0mm	
Standard sensing object		Iron 5 × 5 × 11mm			Iron 10 × 10 × 11mm	
Hysteresis (Note 2)		0.07mm or less	0.05mm or less		0.04mm or less	
Protection		IP67 (IEC), IP67g (JEM)				
Ambient temperature		-10 to +60°C, Storage: -20 to +70°C				
Ambient humidity		35 to 85% RH, Storage: 35 to 85% RH				
Temp. characteristic (Note 3)		Within ±7%		Within ±5%		
Material		Enclosure: SUS303 Sensing part: PVC	Enclosure: SUS303 Sensing part: ABS	Enclosure: SUS303 Sensing part: PAR	Enclosure: SUS303 Sensing part: ABS	Enclosure: SUS303 Sensing part: Fluorine resin
Cable (Note 4)		Connector attached oil resistant high frequency coaxial cable, 3m long [Spatter resistant cable for GH-F8SE (Outer shield: Fluorine resin)]				
Weight		15g approx.	35g approx.	40g approx.	55g approx.	

- Notes: 1) The stable sensing range represents the sensing range for which the sensor can satisfy all the given specifications with the standard sensing object. The maximum operation distance represents the maximum distance for which the sensor can detect at +20°C constant ambient temperature. Usage within the stable sensing range is recommended for accurate sensing applications.
- 2) Value is given for the stable sensing range.
- 3) The value represents the variation in the operation distance, that has been set within the stable sensing range at +20°C, for an ambient temperature drift from 0 to +55°C. (The value is for sensor head on its own.)
- 4) The length of the sensor head cable cannot be changed.

● **Amplifier**

Item	Type	GA-311
Supply voltage		12 to 24V DC ±10 % Ripple P-P10 % or less
Current consumption		25mA or less
Output		NPN open-collector transistor • Maximum sink current: 100mA • Applied voltage: 30V DC or less (between output and 0V) • Residual voltage: 1V or less [at 100mA (Note 1) sink current]
Output operation		Normally open / closed Selectable with the operation mode switch
Short-circuit protection		Incorporated
Max. response frequency		3.3kHz
Operation indicator		Orange LED (lights up when the output is ON)
Disconnection alarm indicator		Red LED (lights up when the sensor head is disconnected or mis-contacted)
Sensitivity adjuster		18-turn potentiometer
Ambient temperature		-10 to +60°C (if 4 to 7 units are connected in cascade: -10 to +50°C, if 8 to 16 units are connected in cascade: -10 to +45°C) (No dew condensation or icing allowed), Storage: -20 to +70°C
Ambient humidity		35 to 85% RH, Storage: 35 to 85% RH
Temp. characteristic (Note 2)		Within ±5%
Material		Enclosure: Heat-resistant ABS, Case cover: Polycarbonate
Weight		15g approx.

- Notes: 1) 50mA, if five, or more, amplifiers are connected in cascade.
- 2) The value represents the variation in the operation distance, that has been set within the stable sensing range at +20°C, for an ambient temperature drift from 0 to +55°C. (The value is for amplifier on its own.)
- 3) The cable for amplifier connection is not supplied as an accessory. Make sure to use the optional quick-connection cable given below.  
 Main cable (3-core): **CN-73-C1** (cable length 1m), **CN-73-C2** (cable length 2m), **CN-73-C5** (cable length 5m)  
 Sub-cable (1-core): **CN-71-C1** (cable length 1m), **CN-71-C2** (cable length 2m), **CN-71-C5** (cable length 5m)

**2 CAUTIONS**

- This product has been developed / produced for industrial use.
- Make sure that the power supply is off while wiring or adding the units.
- Take care that wrong wiring will damage the sensor.
- Verify that the supply voltage variation is within the rating.
- In case noise generating equipment (switching regulator, inverter motor, etc.) is used in the vicinity of this product, connect the frame ground (F.G.) terminal of the equipment to an actual ground.
- If power is supplied from a commercial switching regulator, ensure that the frame ground (F.G.) terminal of the power supply is connected to an actual ground.
- Do not use during the initial transient time (0.5 sec.) after the power supply is switched on.
- Do not run the wires together with high-voltage lines or power lines or put them in the same raceway. This can cause malfunction due to induction.
- Be sure to use the optional quick-connection cable for amplifier connection. Furthermore, extension up to 100m (50m: 5 to 8 units are connected in cascade, 20m: 9 to 16 units are connected in cascade) is possible with 0.3mm<sup>2</sup> or more, cable. However, in order to reduce noise, make the wiring as short as possible.
- Take care that when the cable is extended, the residual voltage rises.
- Do not shorten or lengthen the sensor head cable.
- This sensor is suitable for indoor use only.
- Do not use the sensor at places having intense vibrations, as this can cause malfunction.
- Take care that the sensor does not come in direct contact with water, oil, grease, organic solvents, such as, thinner etc., or strong acid, and alkaline.
- Make sure that the sensing end is not covered with metal dust, scrap or spatter. It will result in malfunction.
- Take care that stress by forcible bending or pulling is not applied directly to the sensor head cable joint.

**3 MOUNTING**

Be sure to use a sensor head and amplifier as a set.

● **Mounting of amplifier**

**How to mount the amplifier**

- ① Fit the rear part of the mounting section of the amplifier on a 35mm width DIN rail.
- ② Press down the rear part of the mounting section of the unit on the 35mm width DIN rail and fit the front part of the mounting section to the DIN rail.

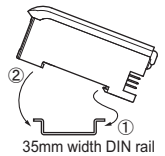

**How to remove the amplifier**

- ① Push the amplifier forward.
- ② Lift up the front part of the amplifier to remove it.

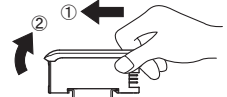

Note: Take care that if the front part is lifted without pushing the amplifier forward, the hook on the rear portion of the mounting section is likely to break.

● **Connection of sensor head**

**Connection method**

- ① Insert the the sensor head connector into the connector inlet till a click is felt.
- ② Fit the cover on the connector.

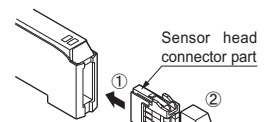

**Disconnection method**

- ① Pressing the projection on the sensor head connector, pull out the connector.

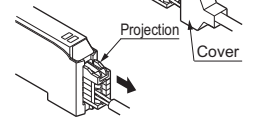

Note: Take care that if the connector is pulled out without pressing the projection, the projection may break. Do not use a sensor head connector whose projection has broken. Furthermore, do not pull by holding the cable, as this can cause a cable-break.

● **Mounting of sensor head**

**Mounting with a set screw**

- The tightening torque for mounting should be as given right. Furthermore, be sure to use a set screw with a cup-point end.

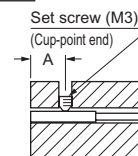

Model No.	A (mm)	Tightening torque
GH-2SE	3 or more	0.17N · m
GH-3SE	4 or more	0.17N · m
GH-5SE	5 or more	0.78N · m
GH-8SE	5 or more	0.59N · m

Note: Do not tighten it with excessive strength.

**Influence of surrounding metal**

- The surrounding metal will affect the sensing performance. Keep the minimum distance specified in the table right.

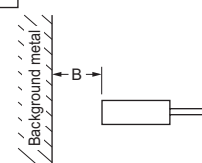

Model No.	B (mm)
GH-2SE	3
GH-3SE	4
GH-5SE	5
GH-8SE	9

### ● Mutual interference

- When two or more sensors are installed in parallel or face to face, keep the minimum separation distance specified below to avoid mutual interference.

#### Face to face mounting

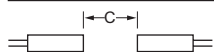

#### Parallel mounting



Model No.	C (mm)	D (mm)
GH-2SE	15	10
GH-3SE	20	15
GH-5SE	25	20
GH-8SE	40	26
GH-F8SE		

### ● Sensing range

- The sensing range is specified for the standard sensing object. With a non-ferrous metal, the sensing range is obtained by multiplying with the correction coefficient specified below.

#### Correction coefficient

Model No.	GH-2SE	GH-3SE	GH-5SE	GH-8SE GH-F8SE
Iron	1	1	1	1
Stainless steel (SUS304)	0.68 approx.	0.55 approx.	0.69 approx.	0.64 approx.
Brass	0.53 approx.	0.35 approx.	0.41 approx.	0.37 approx.
Aluminum	0.51 approx.	0.33 approx.	0.39 approx.	0.32 approx.

Note: The sensing range also changes if the sensing object is plated.

## 4 CONNECTION

Make sure that the power supply is off while connecting / disconnecting the quick-connection cable.

#### Connection method

- Holding the connector of the quick-connection cable, align its projection with the groove at the top portion of the amplifier connector.
- Insert the connector till a click is felt.

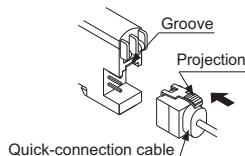

#### Disconnection method

- Pressing the projection at the top of the quick-connection cable connector, pull out the connector.

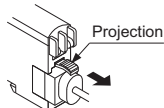

Note: Take care that if the connector is pulled out without pressing the projection, the projection may break. Do not use a quick-connection cable whose projection has broken.

Furthermore, do not pull by holding the cable, as this can cause a cable-break.

## 5 CASCADING UNITS

- Make sure that the power is off while cascading / removing the amplifiers.
- Be sure to check the allowable ambient temperature, as it depends on the number of amplifiers connected in cascade.
- In case two, or more, amplifiers are connected in cascade, make sure to mount them on a DIN rail.
- When the amplifiers move on the DIN rail depending on the attaching condition, fitting them between the optional end plates (MS-DIN-E) mounted at the two ends.
- When connecting in cascade, mount the amplifiers close to each other, fitting them between the optional end plates (MS-DIN-E) mounted at the two ends.
- When connecting more than two amplifiers in cascade, use the sub cable (CN-71-C□) as the quick-connection cable for the second amplifier onwards.
- This product does not incorporate the communication function. When this product used by cascading along with other than this product, mount at the either side of the cascaded products.

Refer to the ' 3 MOUNTING ' for mounting / dismantling the amplifiers.

#### Cascading method

- Mount the amplifiers, one by one, on the 35mm width DIN and set them close to each other without any gap between them.
- Connect the quick-connection cables to the amplifiers.
- Mount the end plate (MS-DIN-E) (optional) at both ends of the units between their flat sides.
- Tighten the screws to fix the end plates (MS-DIN-E).

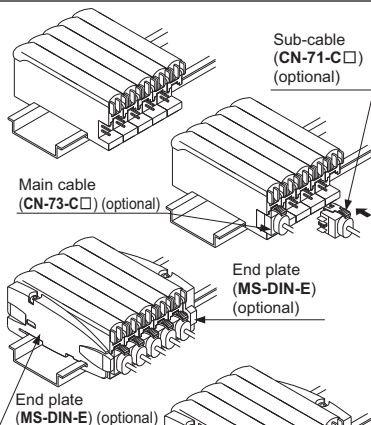

#### Dismantling

- Pressing the projection at the top of the quick connection cable connector, pull out the connector.
- Remove the amplifiers.

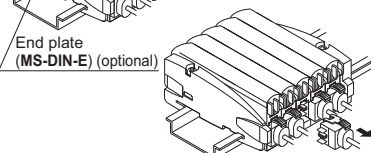

## 6 I/O DIAGRAMS

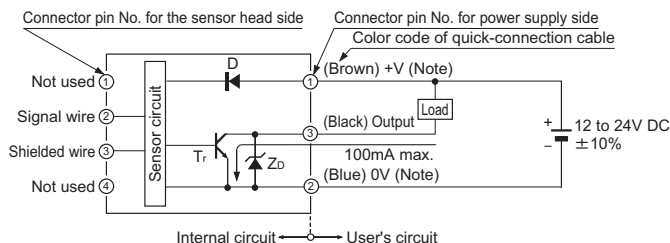

Note: The quick-connection cable does not have +V (Brown) and 0V (Blue). The supply voltage is supplied through the main cable connector.

Symbols... D : Reverse supply polarity protection diode  
Zd : Surge absorption zener diode  
Tr : NPN output transistor

### ● Terminal arrangement diagram

#### Sensor head side connector

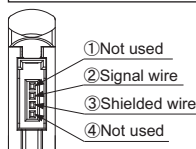

#### Power supply side connector

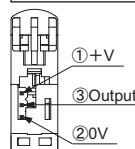

## 7 PART DESCRIPTION

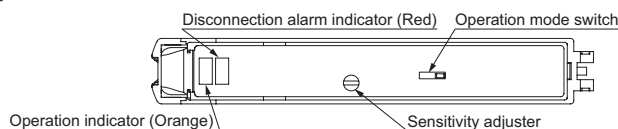

## 8 SENSITIVITY ADJUSTMENT

Step	Sensing condition	Adjustment	Sensitivity adjuster
①	Set the operation mode switch to NORM. (Initial setting)	Turn the sensitivity adjuster fully counterclockwise. (Minimum sensitivity)	MIN MAX
②	Approach along sensing axis	Place the sensing object within the stable sensing range. Turn the sensitivity adjuster clockwise and set it at the point (A) where the operation indicator (orange) lights up.	(A) MAX
	Approach perpendicular to sensing axis	Place the sensing object within the stable sensing range. Turn the sensitivity adjuster clockwise, and set it at the optimum sensing point (B) which is a little beyond the point (A) where the operation indicator (orange) lights up.	(A) (B) MAX
③	Select the operation mode as per your application. (NORM.: Normally open, INV.: Normally closed)		

Note: Use a flathead screwdriver (please arrange separately) to turn the adjuster slowly. Turning with excessive strength will cause damage to the adjuster.

## 9 DIMENSIONS (Unit: mm)

### ● GH-□SE / Sensor head

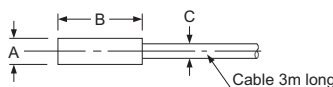

Model No.	A	B	C
GH-2SE	φ 2.8	12	φ 1.6
GH-3SE	φ 3.8	15	φ 2.5
GH-5SE	φ 5.4	15	φ 2.5
GH-8SE	φ 8.0	15	φ 2.5
GH-F8SE	φ 8.0	15	φ 2.65

### ● GA-311 / Amplifier

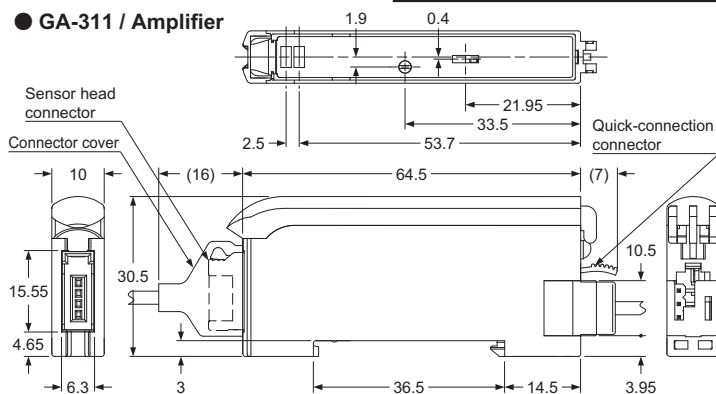

Note: The side view is with the sensor head connector and the quick-connection cable.

## Panasonic Industrial Devices SUNX Co., Ltd.

<http://panasonic.net/id/pidsx/global>

Overseas Sales Division (Head Office)  
2431-1 Ushiyama-cho, Kasugai-shi, Aichi, 486-0901, Japan  
Phone: +81-568-33-7861 FAX: +81-568-33-8591

About our sale network, please visit our website.

PRINTED IN JAPAN

© Panasonic Industrial Devices SUNX Co., Ltd. 2012