

Machine Automation Controller NX Series

# IO-Link Connection Guide

## OMRON Corporation

Safety Light Curtain

Safety Light Curtain/Multi-Beam Safety Sensor

(F3SG-□SR□)

(F3SG-□PG□)

Intelligent Tap

(F39-SGIT-IL3)

[IO-Link Master Unit]

OMRON Corporation

NX-series IO-Link Master Unit

(NX-ILM□□□)



Network  
Connection  
Guide

## **Copyrights and Trademarks**

---

Microsoft product screen shots reprinted with permission from Microsoft Corporation.

Windows is a registered trademark of Microsoft Corporation in the United States and other countries.

Sysmac and SYSMAC are trademarks or registered trademarks of OMRON Corporation in Japan and other countries for OMRON factory automation products.

Company names and product names in this document are the trademarks or registered trademarks of their respective companies.

---

**Contents**

- 1. Related Manuals .....1**
- 2. Terms and Definitions .....2**
- 3. Precautions .....3**
- 4. Introduction.....4**
- 5. Target Devices and Device Configurations.....6**
- 6. Communication Related Settings.....10**
- 7. Mounting the IO-Link Master Unit ..... 11**
- 8. IO-Link Master Unit Communications Setup.....13**
- 9. Checking IO-Link Communications .....22**
- 10. Programming Using IO-Link .....25**
- 11. Initialization Method .....45**
- 12. Revision History .....47**

## 1. Related Manuals

To ensure the safe use of systems, be sure to obtain the manuals, instruction sheets and other documentation for the devices and equipment that comprise the system, and check Safety Precautions, Precautions for Safe Use, and other safety related precautions before using the system.

The following table lists the manuals relating to this document.

Cat.No.	Model	Manual name
W593	NX102-□□□□	NX-series NX102 CPU Unit Hardware User's Manual
W501	NX701-□□□□ NX102-□□□□ NX1P2-□□□□ NJ501-□□□□ NJ301-□□□□ NJ101-□□□□	NJ/NX-series CPU Unit Software User's Manual
Z930	NX-SL□□□□ NX-SI□□□□ NX-SO□□□□	NX-series Safety Control Unit User's Manual
W504	SYSMAC-SE2□□□	Systemac Studio Version 1 Operation Manual
W570	NX-ILM□□□ GX-ILM□□□	IO-Link System User's Manual
Z405	F3SG-□SR□ F3SG-□PG□	Safety Light Curtain F3SG-SR Series Multi-Beam Safety Sensor F3SG-PG Series User's Manual



## 2. Terms and Definitions

Term	Description and Definition
IO-Link device	A device with a sensor or actuator that can perform IO-Link communications with the IO-Link Master Unit.
IO-Link Master Unit	A device that performs IO-Link communications with the IO-Link devices in the IO-Link System and simultaneously functions as a slave for host communications. In this document, IO-Link Master Unit is used to refer to a specific unit.
IO-Link Mode	A communications mode on the IO-Link Master Unit for performing IO-Link communications with IO-Link devices.
Cyclic communications	Communications that exchange data in a fixed period with no need for programming.
I/O data	<p>All target data in cyclic communications with the host.</p> <p>There are the following two types of data in an IO-Link System.</p> <ul style="list-style-type: none"> <li>• Target data in cyclic communications with the host in the IO-Link Master Unit</li> <li>• Target data in the IO-Link devices for cyclic communications with the IO-Link Master Unit</li> </ul>
Process Data	I/O data in the IO-Link devices. A maximum of 32 bytes of process data can be allocated in the master.
IODD files	These files contain IO-Link device definitions. Parameter settings for IO-Link devices can be made by loading these files to the CX-ConfiguratorFDT.
OSSD	An output that is turned ON when safety has been confirmed. This is used for safety applications.

## 3. Precautions

- (1) When developing actual systems, check the specifications of the devices and equipment that comprise the systems, ensure that devices and equipment are used with sufficient margin given to ratings and characteristics, and adopt safety measures such as safety circuits that minimize danger in the event of a malfunction.
- (2) To ensure the safe use of systems, be sure to obtain the manuals, instruction sheets and other documentation for the devices and equipment that comprise the systems, and check Safety Precautions, Precautions for Safe Use and other safety related precautions before using the system.
- (3) It is up to the customer themselves to check the ratings and regulations or standards that the system must comply with.
- (4) No part of this publication may be reproduced, stored in a retrieval system, or redistributed, in any form, or by any means, mechanical, electronic, photocopying, recording, or otherwise, without the permission of OMRON Corporation.
- (5) The content of this document is current as of September, 2020.  
Product specifications and accessories given in this document may be changed at any time based on improvements and other reasons.

Special information in this document is classified as follows:

 <b>WARNING</b>	Indicates a potentially hazardous situation which, if not avoided, could result in death or serious injury. Additionally, there may be severe property damage.
 <b>Caution</b>	Indicates a potentially hazardous situation which, if not avoided, may result in minor or moderate injury, or property damage.



### **Precautions for Correct Use**

Precautions on what to do and what not to do to ensure proper operation and performance.



### **Additional Information**

Additional information to read as required.

This information is provided to increase understanding or make operation easier.

### **Symbols**



The circle and slash symbol indicates operations that you must not do. The specific operation is shown in the circle and explained in text. This example indicates prohibited actions.



The filled circle symbol indicates operations that must be done. The specific operation is shown in the circle and explained in text. This example indicates mandatory actions.

## 4. Introduction

This document describes the procedure for connecting the OMRON Safety Light Curtain/Multi-Beam Safety Sensor F3SG-SR/PG series (simply referred to as "safety light curtain" from here on) to the OMRON Machine Automation Controller NX series (simply referred to as "controller" from here on) via the OMRON Intelligent Tap by the IO-Link System.



### Additional Information

This document describes the connection procedure up to establishment of communications on the IO-Link System. It does not describe operation, installation and wiring of safety I/O functions such as OSSD, and the functions and operations of devices. For details on safety I/O functions, refer to the manuals, instruction sheets and other documentation for the safety controllers, or contact OMRON.

### 4.1 What Is an IO-Link System?

An IO-Link System allows the following possibilities.

- **Reading of ON/OFF information and other various information is possible**

The controller can cyclically read the following ON/OFF information:

- Input signals and status from IO-Link devices\*1
- Disconnections, short-circuits, I/O power supply ON status, etc., between the IO-Link Master Unit and devices

\*1: Examples for photoelectric sensors: unstable detection and sensor errors.

The information from these is called "process data," and this is shared periodically between the safety light curtain and IO-Link Master Unit.

In this document, a sample program for making checking of the following easier is introduced in *10.1 Sample Program for Acquiring Process Data*.

- Power supply voltage of receiver

- **Reading of user-specified data in IO-Link devices from the controller is possible**

User-specified data in IO-Link devices can be read from the controller by executing communications instructions in the controller.

Because an IO-Link System can cyclically read analog data such as the amount of incident light in addition to ON/OFF information, it can be used for predictive maintenance based on detection of such things as decreases in the amount of light.

This enables the status of the safety light curtain to be monitored.

The information of these is called "service data," and any information can be acquired from the safety light curtain by executing communications instructions from the controller when necessary.

In this document, sample programs for making checking of the following easier are introduced in *10.2 Sample Program for Acquiring Service Data (Error Code)* and *10.3 Sample Program for Acquiring Service Data (Amount of Incident Light)*.

- Acquisition of error codes
- Acquisition of amount of incident light

#### •Item required for connection via an IO-Link System

The Intelligent Tap (F39-SGIT-IL3) is required for connecting the safety light curtain to the IO-Link Master Unit.

In addition to an IO-Link System connection function, the Intelligent Tap has functions such as changing safety light curtain settings and for restoring backed up settings by means of DIP switches.



Intelligent Tap (F39-SGIT-IL3)

#### •Separate use of safety I/O functions and IO-Link System

Safety I/O functions are used mainly for safety applications such as OSSD. On an IO-Link System, these functions monitor the various data of the safety light curtain.

Connect each of the safety I/O functions and IO-Link System as follows.

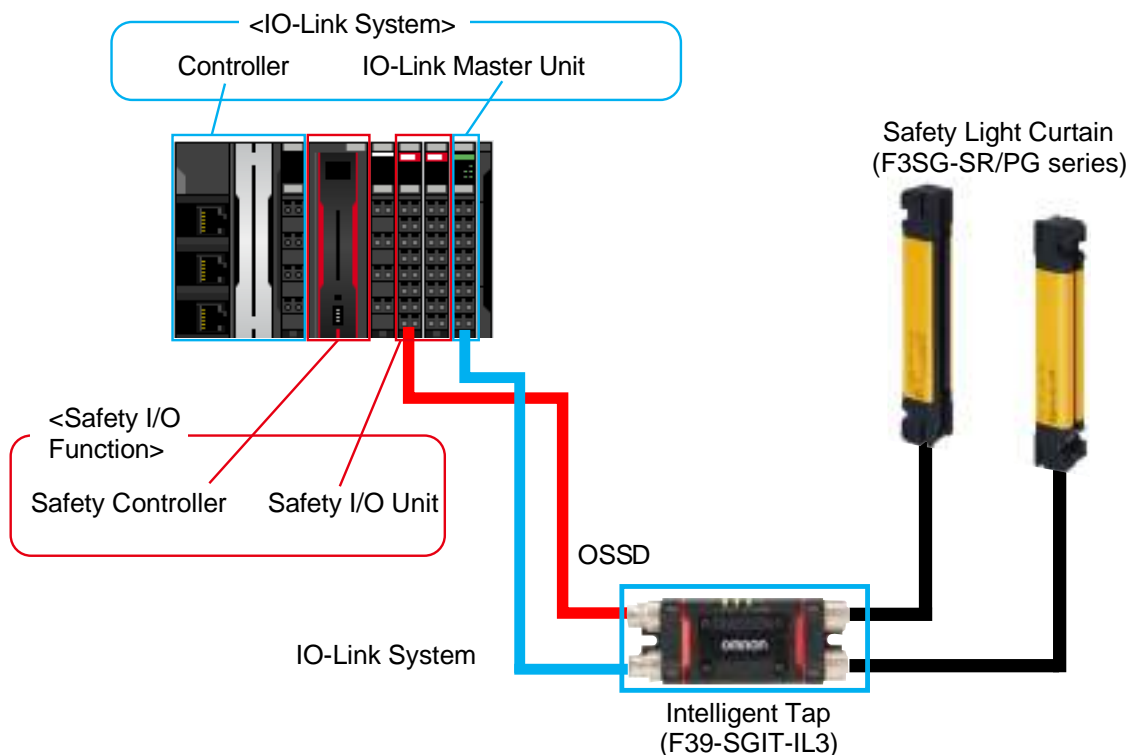

## ⚠ WARNING

Do not use output signals from an IO-Link System for safety applications.  
Malfunction of the F3SG-SR/PG might result in serious injury.





## 5. Target Devices and Device Configurations

### 5.1 Target Devices

The following table lists the devices to be connected.

Type	Name	Manufacturer	Model
CPU Unit	NX-series CPU Unit	OMRON	NX102-□□□□
Safety Control Units	NX-series Safety Control Units	OMRON	NX-SL□□□□/-SI□□□□/-SO□□□□
Communication Units	NX-series IO-Link Master Unit	OMRON	NX-ILM□□□
Intelligent Tap	Intelligent Tap for F3SG-SR/PG Series	OMRON	F39-SGIT-IL3
Safety Light Curtain	F3SG-SR Safety Light Curtain	OMRON	F3SG-□SR□
	F3SG-PG Multi-Beam Safety Sensor	OMRON	F3SG-□PG□



#### Precautions for Correct Use

Of the target devices above, models and versions of devices given in *Section 5.2* are used in connection procedures and connection checks described in this document.

Devices of a version earlier than that given in *Section 5.2* cannot be used.

Before using models of target devices above not given in *Section 5.2* or versions of target devices later than those given in *Section 5.2*, first check for differences in specifications in the manuals, instruction sheets and other documentation for the respective target device.



#### Additional Information

This document describes the connection procedure up to establishment of communications. It does not describe operation, installation and wiring other than the connection procedure, and the functions and operations of devices.

Refer to the manuals, instruction sheets and other documentation, or contact OMRON.

## 5.2 Examples of Device Configurations

The following shows the device configuration for reproducing the connection procedure described in this document.

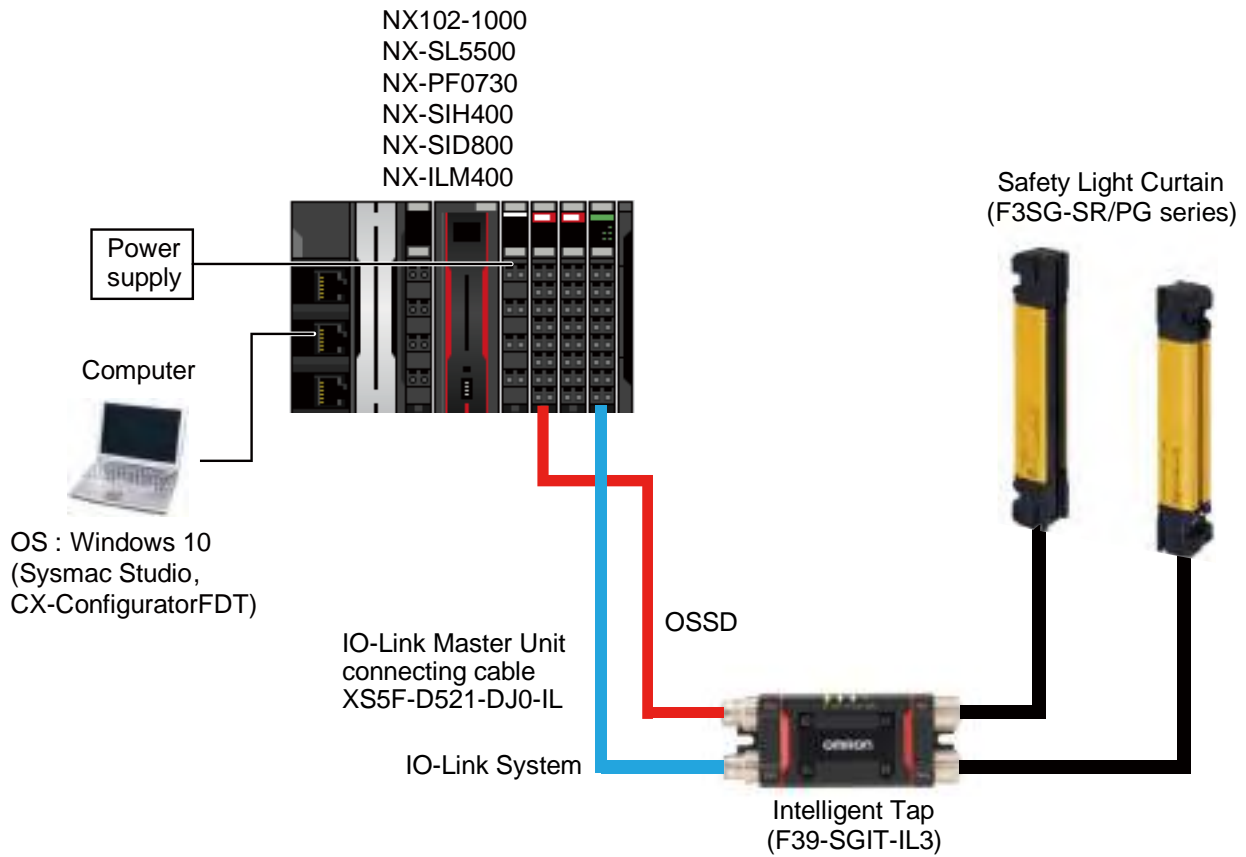

Manufacturer	Name	Model	Version
OMRON	NX-series CPU Unit	NX102-1000	Version 1.40 or later
---	Power supply for controller (24 VDC)	---	---
OMRON	NX series Safety CPU Unit	NX-SL5500	Version 1.3 or later
OMRON	NX series Additional I/O Power Supply Unit	NX-PF0730	Version 1.0 or later
OMRON	NX series IO-Link Master Unit	NX-ILM400	Version 1.1 or later
OMRON	NX series Safety Input Unit	NX-SIH400	Version 1.1 or later
OMRON	NX series Safety Output Unit	NX-SID800	Version 1.1 or later
OMRON	Sysmac Studio	SYSMAC-SE2□□□	Version 1.29 or later
OMRON	CX-ConfiguratorFDT	(Bundled with Sysmac Studio)	Version 2.5 or later
---	Computer (OS: Windows 10)	---	---
---	Communications cables	---	---
---	I/O power supply (24 VDC)	---	---
OMRON	Safety light curtain	F3SG-□SR□ F3SG-□PG□	Version 1.00 or later
OMRON	Intelligent Tap	F39-SGIT-IL3	Version 1.00 or later
OMRON	IO-Link Master Unit connecting cable	X5F-D521-DJO-IL	---

**WARNING**

Do not use output signals from an IO-Link System for safety applications. Malfunction of the F3SG-SR/PG might result in serious injury.

**Precautions for Correct Use**

Update Sysmac Studio and CX-ConfiguratorFDT to the versions given in this section or later. With versions later than the versions given in this section, there may be differences in procedures and screens in descriptions from *Section 8* onwards. If that happens, refer to the *Sysmac Studio Version 1 Operation Manual* (Cat No. W504) and *CX-ConfiguratorFDT Online Help*, and adopt the same actions.

**Additional Information**

This section does not describe operation, installation and wiring of safety I/O functions such as OSSD, and the functions and operations of devices. For details on safety I/O functions, refer to either the manuals, instruction sheets and other documentation for the safety controllers, or contact OMRON.

**Additional Information**

Refer to the *NX-series IO-Link Master Unit User's Manual* (Cat. No. W567) for information on the unit power supply to the IO-Link Master Unit and specifications of power supplies that can be used as the I/O power supply.

**Additional Information**

For details on the power supply and wiring specifications of the safety light curtain and settings that use the Intelligent Tap, refer to the *Safety Light Curtain/Multi-Beam Safety Sensor F3SG-□SR□/F3SG-□PG□ User's Manual* (Cat. No. Z405).

## 5.3 IO-Link Connection Procedure

This section describes the procedure for using the Intelligent Tap to make an IO-Link connection to the safety light curtain.

In this document, the IO-Link Master Unit is mounted on the same CPU as on the NX-series Controller.



### Additional Information

Descriptions in this document presume that the controller and IO-Link Master Unit are in the factory default state. For details on initialization of devices, refer to *11. Initialization Method*.

### 5.3.1 Operating Procedure

<b>7. Mounting the IO-Link Master Unit</b>	Perform installation and wiring of the IO-Link Master Unit.
▼	
7.1 Mounting the IO-Link Master Unit	Mount the IO-Link Master Unit on a DIN Track.
▼	
7.2 Wiring the Terminals	Wire the Intelligent Tap to the IO-Link Master Unit.
▼	
<b>8. IO-Link Master Unit Communications Setup</b>	Make the settings for performing communications on an IO-Link System.
▼	
8.1 Setting Up the System Configuration	Start up Sysmac Studio, and set up the system configuration that includes the IO-Link Master Unit. This document describes a setup method in the offline mode.
▼	
8.2 IO-Link Master Unit Settings	Set up the IO-Link Master Unit.
▼	
8.2.1 How to Use <b>IO-Link Master Simple Settings</b> 8.2.2 Setting Device Variables	Set up the I/O ports and device variables to be used by the IO-Link Master Unit.
▼	
8.3 Transferring the Project Data	Place Sysmac Studio online, and transfer the project data to the controller.
▼	
<b>9. Checking IO-Link Communications</b>	Make sure that cyclic communications are being executed on the IO-Link System.
▼	
9.1 Checking the Connection Status	Check the connection status of each device.
▼	
9.2 Checking Receive Data	Make sure that the correct data is being received.

## 6. Communication Related Settings

This section describes the settings of parameters that are set in this document and the settings of device variables.

### 6.1 IO-Link Connection Parameters

The following describes the parameter settings for connecting the IO-Link Master Unit and safety light curtain by IO-Link.

In this document, the safety light curtain is connected to port 1 of the IO-Link Master Unit.

<IO-Link Master Unit settings>

Item	Set value
Port 1 IO-Link device configuration settings information/Master Control	IO-Link Mode (default)

### 6.2 Device Variables

The I/O data (process data) of the safety light curtain is assigned to device variables on the controller as the data for PDO communications with the IO-Link Master Unit. The device variables are named automatically from a combination of the **Device name** and the port names. For details on the device variables of the safety light curtain, refer to *NX/GX-series IO-Link System User's Manual* (Cat. No. W570) and *Safety Light Curtain/Multi-Beam Safety Sensor F3SG-□SR□/F3SG-□PG□* (Cat. No. Z405).



#### Additional Information

The device variables are named automatically from a combination of the device name and the port names.

The default device name are "N" followed by a serial number that starts from 1 in the case of units mounted on an NX bus master.



#### Additional Information

On Sysmac Studio, there are two ways as follows for specifying an array as the data type. After input, (1) is converted to (2), and the display is (2) at all times.

(1) BOOL[16]/(2) ARRAY[0..15] OF BOOL

(The example above means a BOOL type data having 16 array elements.)

## 7. Mounting the IO-Link Master Unit

### 7.1 Mounting the IO-Link Master Unit

This section describes the procedure for mounting the IO-Link Master Unit of the NX Unit on a DIN Track.

Refer to the user's manual of the CPU Unit to which the NX Unit is connected for information on preparations for mounting and installation in a control panel.



#### Precautions for Correct Use

Perform the settings with the power turned OFF.

- 1 From the front of the previously mounted IO-Link Master Unit, engage the Unit hookup guides on a new IO-Link Master Unit with the Unit hookup guides on the previously mounted IO-Link Master Unit.

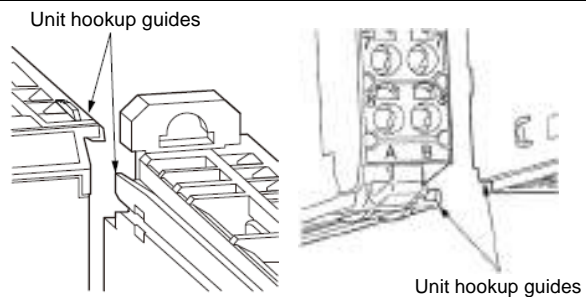

- 2 Slide the IO-Link Master Unit on the hookup guides.

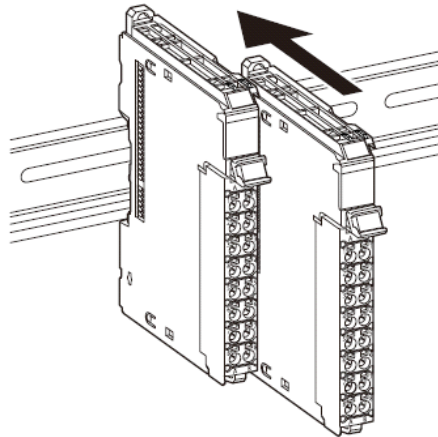

- 3 Press the IO-Link Master Unit with a certain amount of force against the DIN Track until you hear the DIN Track mounting hook lock into place.  
When mounting the IO-Link Master Unit, it is not necessary to release the DIN Track mounting hook on the IO-Link Master Unit.  
After mounting is complete, make sure that NX Unit is locked to the DIN Track.

## 7.2 Wiring the Terminals

Wire the Intelligent Tap to the IO-Link Master Unit.

The IO-Link Master Unit uses a screwless clamping terminal block. So, ferrules that are attached to the twisted wires can be easily wired simply by inserting into the terminal holes of the terminal block.

Refer to the NX-series IO-Link Master Unit User's Manual for information on the wiring and ferrules to connect to the screwless clamping terminal block.

- 1 Connect the Intelligent Tap to port 1 of the IO-Link Master Unit.

Note: For details on connecting the safety light curtain and the Intelligent Tap, refer to 3-2. *Connection in the Safety Light Curtain/Multi-Beam Safety Sensor F3SG-□SR□/F3SG-□PG□□ User's Manual (Cat. No. Z405).*

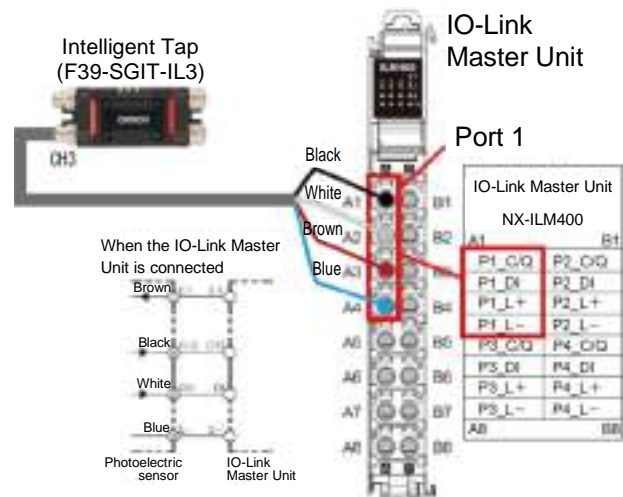

- 2 Insert the ferrule straight into the terminal hole.  
It is not necessary to press a flat-blade screwdriver into the release hole.

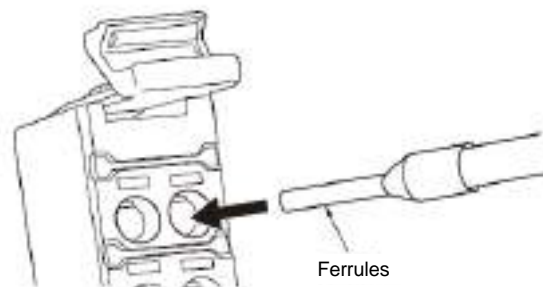

- 3 After making the connection, make sure that the ferrule is securely connected to the terminal block.

## 8. IO-Link Master Unit Communications Setup

### 8.1 Setting Up the System Configuration

Set up the system configuration that includes the IO-Link Master Unit.



#### Additional Information

For details on how to create a new project, refer to *3-3 Creating a Project* in the *Sysmac Studio Version 1 Operation Manual* (Cat. No. W504).

- 1 Start the Sysmac Studio.  
Note: If an access permission confirmation dialog box is displayed when Sysmac Studio is started up, select the option to start up Sysmac Studio.



- 2 Sysmac Studio starts up. Click **New Project**.



- 3 Enter the **Project name** (mandatory), **Author** (optional), **Comment** (optional), and select **Type** (mandatory) in the **Project Properties** Screen.

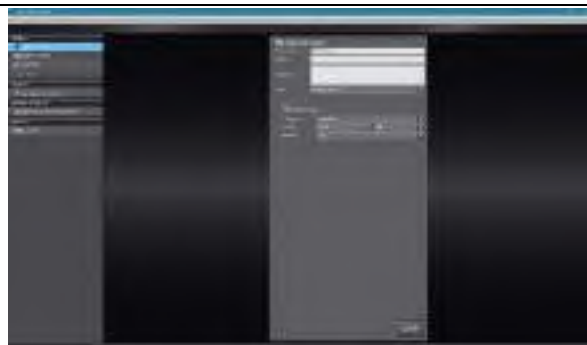

- 4 Set the device selection as follows.  
**Category: Controller**  
**Device: NX102-1000**  
**Version: 1.4**

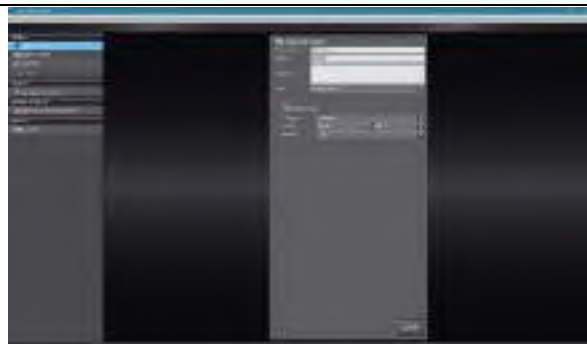

- 5 Click the **Create** button.



- 6** A project file is created and the window on the right is displayed.

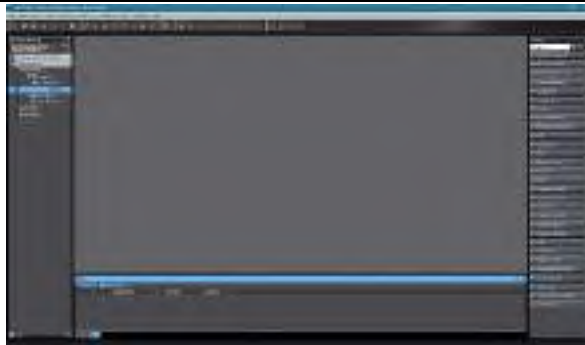

A project file is created with the specified device already inserted.

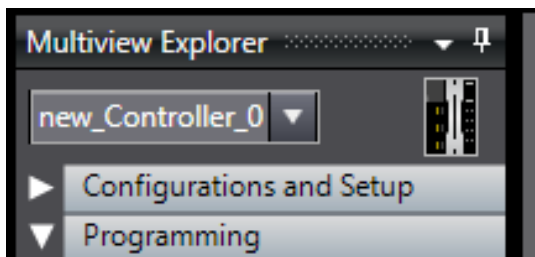

- 7** Select **Configurations and Setup** in the Multiview Explorer.

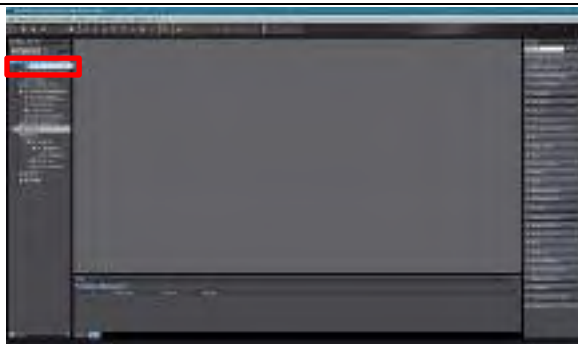

- 8** Double-click **CPU/Expansion Racks - CPU Rack**.

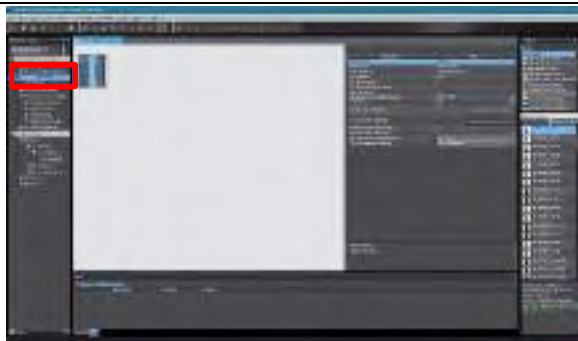

- 9** Select **Safety CPU Device** from the Groups List in the Toolbox, and double-click **NX-SL5500 Ver1.3**.

**NX-SL5500 Ver1.3** is added to the CPU and Expansion Racks tab page.

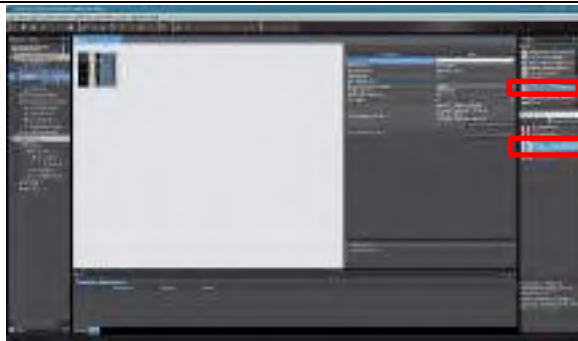

- 10** Select **System Unit Device** from the Groups List in the Toolbox, and double-click **NX-PF0730 Ver1.0**.

**NX-PF0730 Ver1.0** is added to the CPU and Expansion Racks tab page.

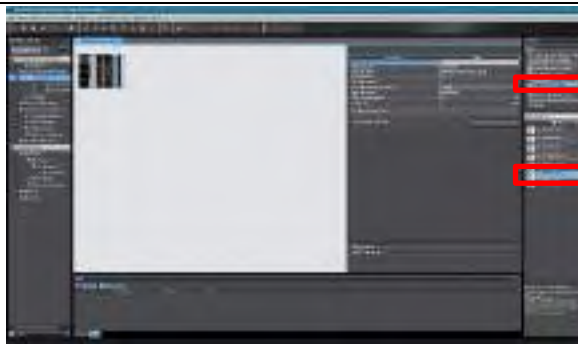

- 11** Select **Safety Digital Input Device** from the Groups List in the Toolbox, and double-click **NX-SIH400 Ver1.1**.

**NX-SIH400 Ver1.1** is added to the CPU and Expansion Racks tab page.

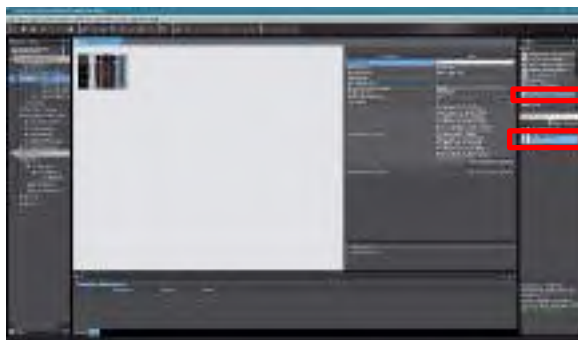

- 12** Select **Safety Digital Input Device** from the Groups List in the Toolbox, and double-click **NX-SID800 Ver1.0**.

**NX-SID800 Ver1.0** is added to the CPU and Expansion Racks tab page.

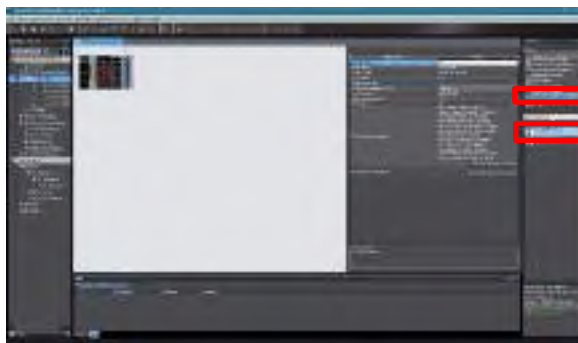

- 13** Select **IO-Link** from the Groups List in the Toolbox, and double-click **NX-ILM400 Ver1.1**.

**NX-ILM400 Ver1.1** is added to the CPU and Expansion Racks tab page.

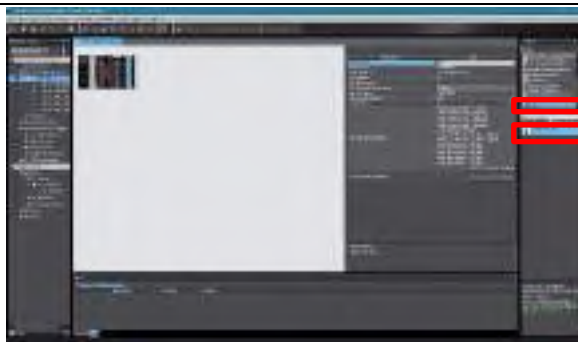

Make sure that the CPU/Expansion Racks configuration is as follows.

Unit0 : NX102-1000  
 1 : NX-SL5500  
 2 : NX-PF0730  
 3 : NX-SIH400  
 4 : NX-SID800  
 5 : NX-ILM400

## 8.2 IO-Link Master Unit Settings

Set up the controller.

### 8.2.1 How to Use IO-Link Master Simple Settings

Set the device variables to be used on the IO-Link Master Unit at **IO-Link Master Simple Settings**.

- 1 Make sure that the IO-Link Master Unit is in the offline mode. If the IO-Link Master Unit is online, set it to the offline mode.

- 2 Double-click **CPU/Expansion Rack - CPU Rack** in the Multiview Explorer.



- 3 Right-click the IO-Link Master Unit displayed in the **CPU/Expansion Racks** area, and select **IO-Link Master Simple Settings**.

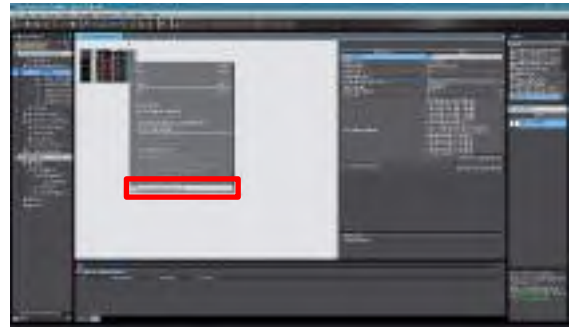

- 4 In the device registration area, select the port to connect the IO-Link device to. Then, in the Toolbox, double-click the F39-SGIT-IL3 (Intelligent Tap), or right-click the F39-SGIT-IL3 and select **Insert**. An IO-Link device can also be registered by dragging and dropping it to a port in the device registration area.

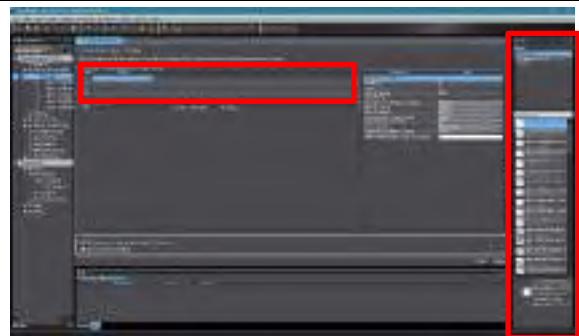

#### Additional Information

- When IO-Link devices are connected to the IO-Link Master Unit, Sysmac Studio can be connected online to the controller to register IO-Link devices actually connected to the IO-Link Master Unit. To use this function, right-click in the device registration area and select **Compare and Merge with Actual Unit Configuration**.
- When IO-Link devices are connected to the IO-Link Master Unit, the tool can be connected online to obtain the serial numbers of the IO-Link devices. To use this function, right-click in the device registration area and select **Get Serial Numbers of All NX Units**.
- If the IO-Link device to register is not displayed in the Toolbox, its IODD file must be installed. To install an IODD file, right-click in the device registration area and select **Install IODD File**.

- 5 At I/O map select **Generate process data structure of the IO-Link device.**

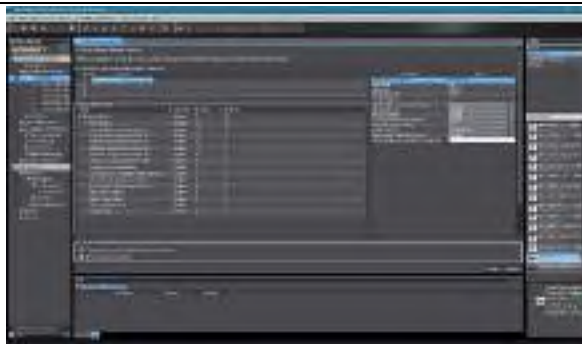

#### **Precautions for Correct Use**

When the CPU Unit version of the NJ/NX/NY controller is 1.40 or later, the function to generate I/O ports according to the process data structure of the preset IO-Link devices to the I/O Map is supported.

- 6 Click the **OK** button at the lower right of the IO-Link Master Simple Settings Tab Page. The following dialog box is displayed. Check the display content and then click the **OK** button.

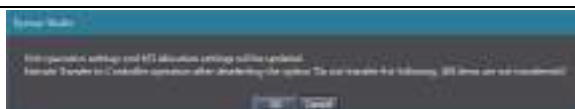

This completes the parameter setting and I/O data size editing procedure for the IO-Link Master Unit.



#### **Precautions for Correct Use**

Clicking the **OK** button changes the unit operation settings and I/O allocation settings. Be sure to clear the **Do not transfer the following. (All items are not transferred.)** check box before executing **Transfer To Controller**.

## 8.2.2 Setting Device Variables

- 1 Double-click **I/O Map** in the Multiview Explorer.

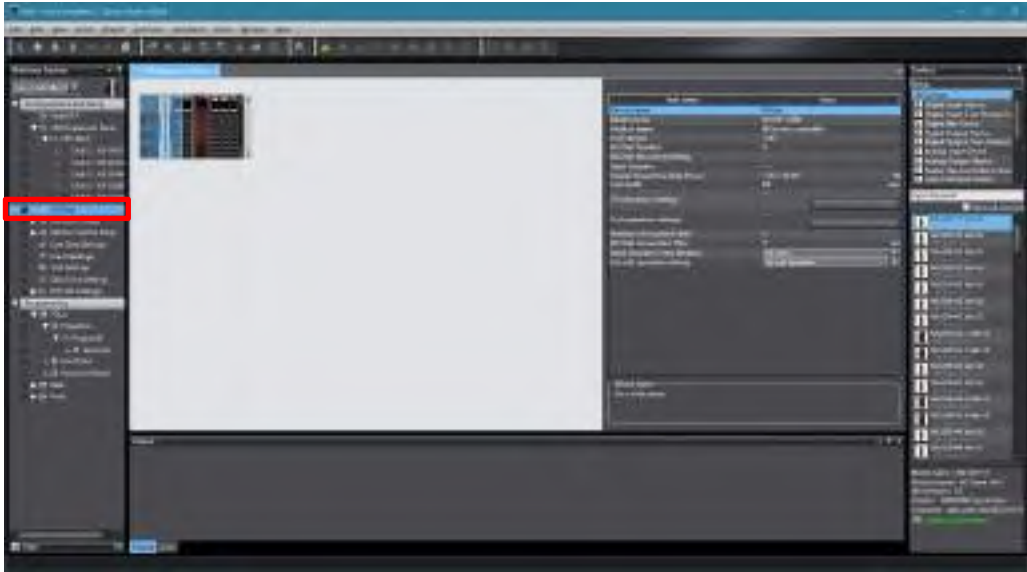

- 2 Navigate to **NX Bus Master - NX-ILM400**.

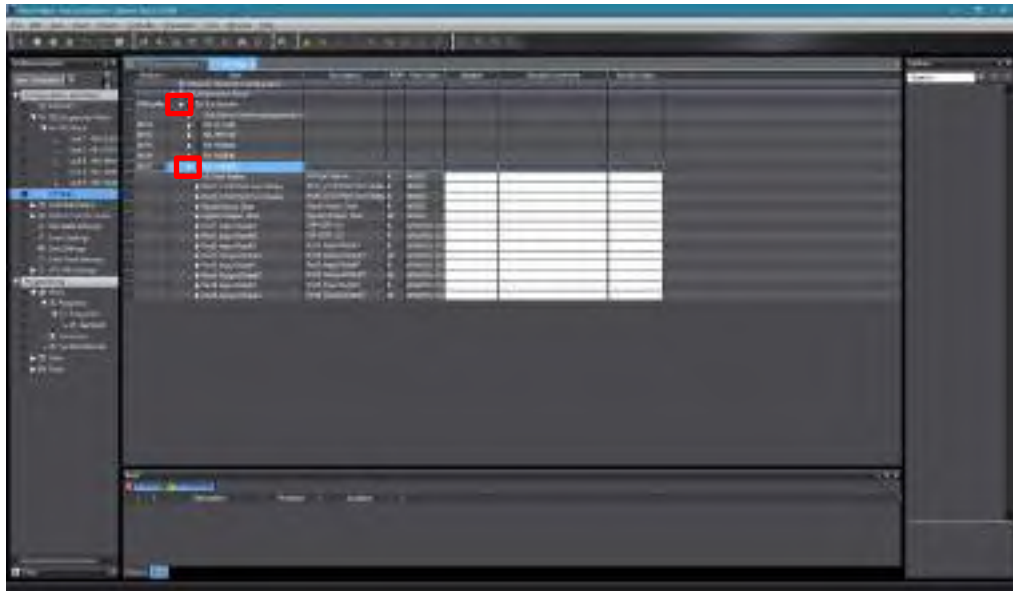

- 3 Right-click **NX-ILM400** and click **Display Node Location Port**.

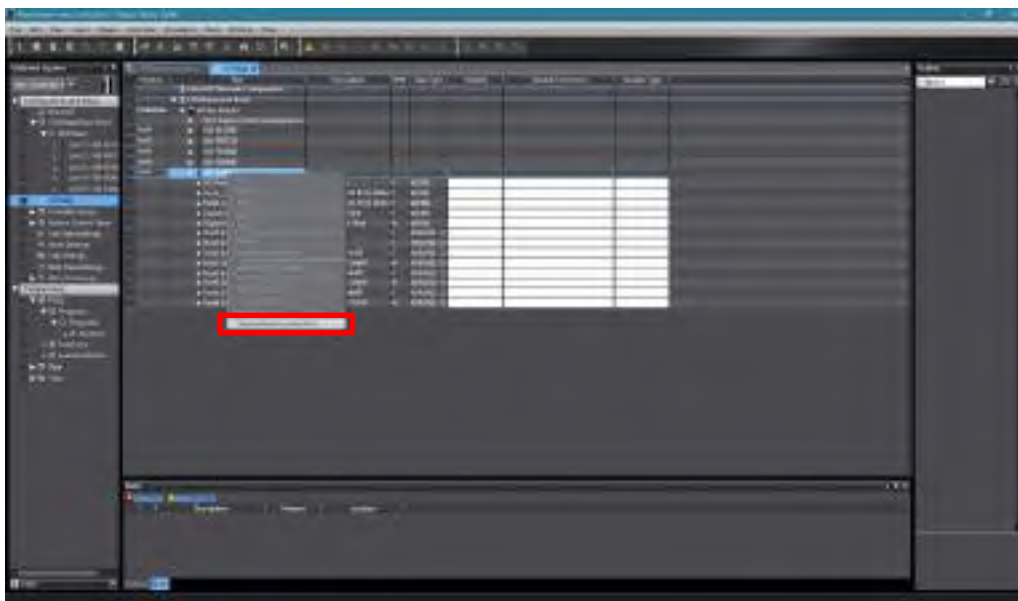

- 4 Right-click **NX-ILM400** and click **Create Device Variable**.  
The variable name is added to the **Variable** column.  
This completes setting of the device variable.

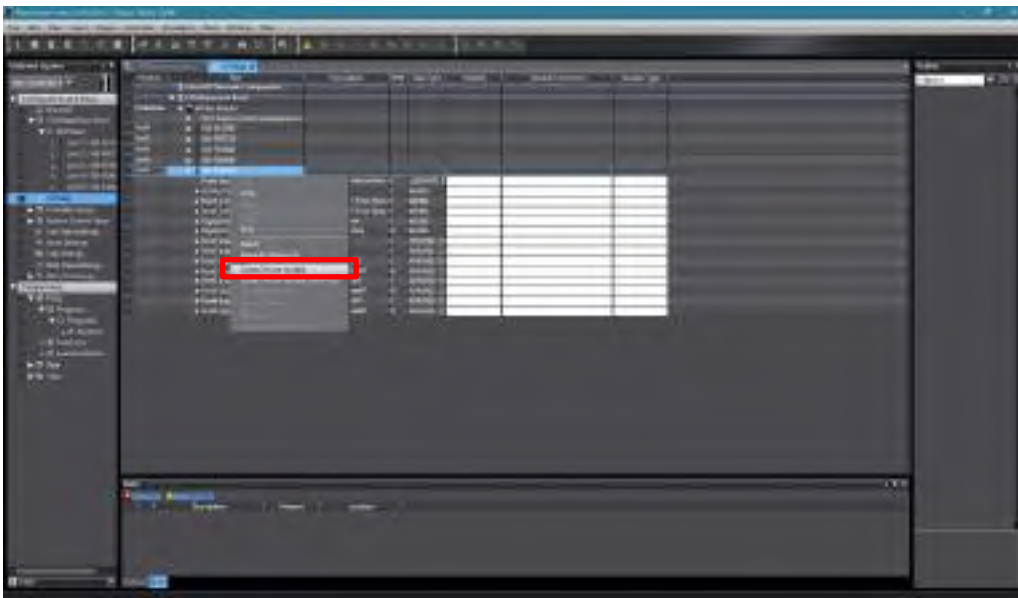

#### Additional Information

The device variables are named automatically from a combination of the device name and the port names.

The default device name are "N" followed by a serial number that starts from 1 in the case of units mounted on an NX bus master.



#### Additional Information



In this document, device variables are named automatically in individual slave units. Device variable names can be set using a user-specified name not by individual slave units but by each individual port.

### 8.3 Transferring the Project Data

Place the Sysmac Studio online, and transfer the project data to the controller.

**WARNING**

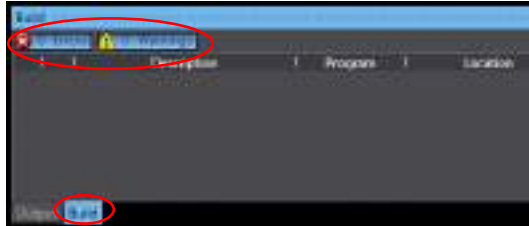
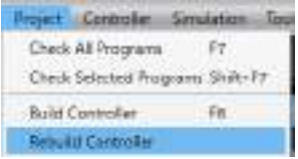
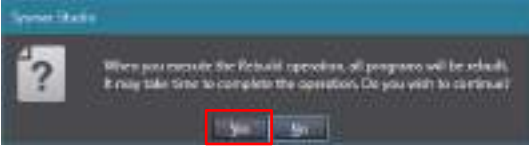
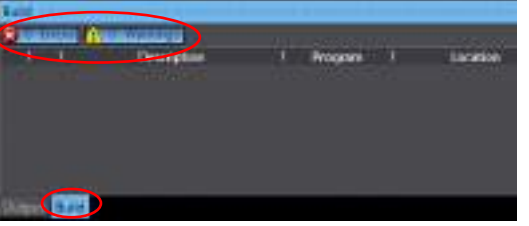
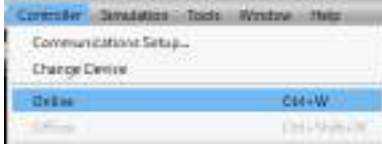
When transferring a user program, configuration data, setup data, device variables, or values in memory used for CJ-series Units from Sysmac Studio, the devices or machines may perform unexpected operation regardless of the operating mode of the CPU Unit. Before transferring project data, check the safety of the transfer destination slave.

- |          |   |  |
|----------|---|--|
| <b>1</b> | Select <b>Project - Check All Programs</b> on the menu bar.   |    |
| <b>2</b> | The <b>Build</b> Tab Page is displayed. Make sure that "0" is displayed for both errors and warnings. |    |
| <b>3</b> | Select <b>Project - Rebuild Controller</b> on the menu bar.   |   |
| <b>4</b> | The dialog box on the right is displayed. Confirm that there are no problems, and click <b>Yes</b> .  |  |
| <b>5</b> | Make sure that "0" is displayed for both errors and warnings in the <b>Build</b> Tab Page.            |  |
| <b>6</b> | Select <b>Controller - Online</b> on the menu bar.  |  |
|          | When the controller becomes online, a yellow-framed area is displayed under the toolbar.              |  |
| <b>7</b> | Select <b>Controller - Synchronize...</b> on the menu bar.  |  |

- 8** The **Synchronization** dialog box is displayed. Make sure that the check box of the data to transfer (in the figure on the right, **NX102**) is selected. Clear the **Do not transfer the following. (All items are not transferred.)** check box, and click **Transfer to Controller**.

Note: When **Transfer to Controller** is executed, Sysmac Studio data is transferred to the controller and data is synchronized.

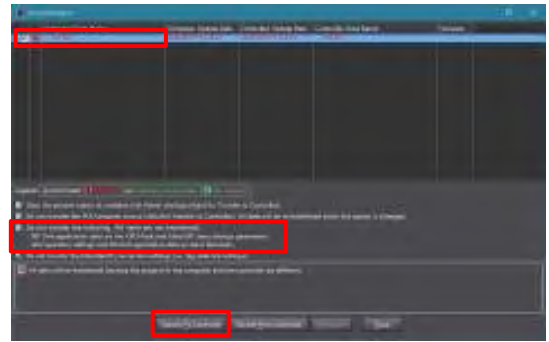

- 9** The dialog box on the right is displayed. Confirm that there are no problems, and click **Yes**.

The synchronization in progress window is displayed.

The dialog box on the right is displayed. Confirm that there are no problems, and click **OK**.

The synchronization in progress window is displayed.

The dialog box on the right is displayed. Confirm that there are no problems, and click **No**.

Note: Do not return the mode to **Run Mode...**

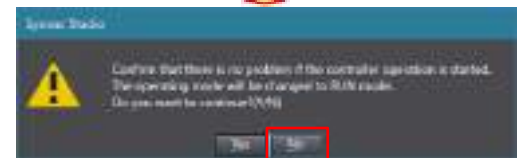
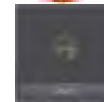
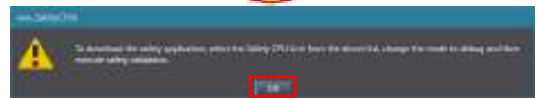
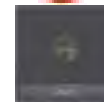
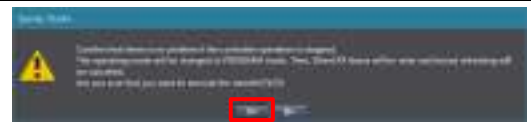

- 10** Make sure that the color of the text of the synchronized data is the same color as the text at **Synchronized** displayed in the legend at the right, that the message **The Synchronization process successfully finished.** is displayed, and click **Close**.

Note: That the color of the text of the synchronized data is the same color as the text at **Synchronized** indicates that Sysmac Studio project data matches the data on the controller.

Note: If synchronization fails, check the wiring, and repeat the procedure from Step 1.

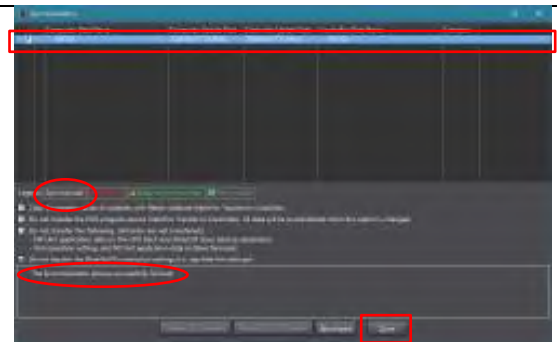

- 11** Check that the IO-Link Master Unit is ready for communication by the following LED indications:

TS : Lit yellow  
 1-C : Lit green  
 1-E : Not lit  
 C/Q : Not lit

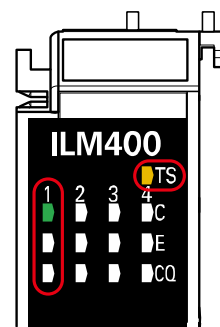



## 9. Checking IO-Link Communications

Make sure that cyclic communications are being executed on the IO-Link System.

### ⚠ Caution

When performing I/O wiring, the device may be damaged if the power supply is still turned ON.

Before performing wiring, check safety precautions in the manuals, instruction sheets and other documentation for the devices to ensure that wiring is performed in the appropriate state.



### ⚠ Caution

When values of variables are changed online in the Watch Tab Page, devices connected to output units may operate regardless of the operating mode of the CPU Unit.

Sufficiently confirm safety before changing the values of variables on the Watch Tab Page when Sysmac Studio is online with the CPU Unit.



### 9.1 Checking the Connection Status

Check the connection status of each device.

- 1 Check the LEDs on the IO-Link Master Unit.  
LED indications in a normal status are as follows:

TS : Lit green  
1-C : Lit green  
1-E : Not lit

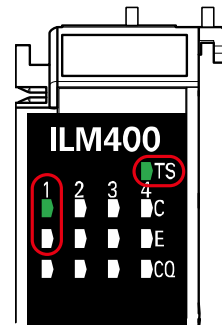

- 2 Check the LEDs of the Intelligent Tap currently connected to the safety light curtain.

LED indications in a normal status are as follows:  
IO-Link indicator : Flashing green





## 9.2 Checking Receive Data

This section describes how to check that the CPU Unit is correctly receiving data from the safety light curtain by the IO-Link connection.

To check this, the data that is being received by the Intelligent Tap from the safety light curtain is checked to see if it matches the data on Sysmac Studio that is being received by the CPU Unit.

In the following description, the data of the safety output information is monitored for checking receive data.

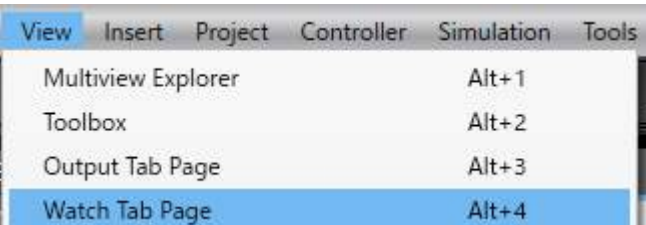
Safety output information refers to information about the presence of an object in the detection zone of the safety light curtain.

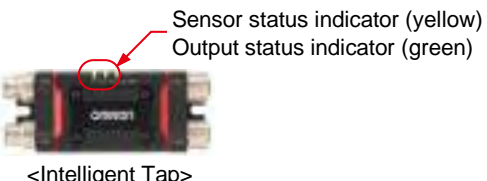
1	<p>Select <b>View - Watch Tab Page</b> on the menu bar.</p>	
2	<p>Select the <b>Watch (Project)1</b> Tab Page.</p>	
3	<p>Enter the <b>Name</b> of the variable to monitor as follows. Name: N5_Port1_Safety_output</p>	
<p>Note: N5 is the device name set to NX-ILM400 at <b>CPU/Expansion Racks</b>. When a different device name is set, change N5 to that device name.</p>		
<p>This variable reads the safety output information. When the output is safe (there is no object present in the detection zone of the safety light curtain), <b>True</b> is displayed at <b>Online value</b>, and when the output is not safe (there is an object present in the detection zone of the safety light curtain), <b>False</b> is displayed at <b>Online value</b>.</p>		
4	<p>Remove the object from the detection zone of the safety light curtain, and make sure that the sensor status indicator (yellow) and output status indicator (green) on the Intelligent Tap are lit.</p>	 <p style="text-align: center;">&lt;Intelligent Tap&gt;</p>
5	<p>Select <b>Controller - Online</b> on the menu bar to set to the online mode.</p>	

- 6** Make sure that **True** is displayed at online value in the **Watch (Project)1** Tab Page when the mode changes to online.

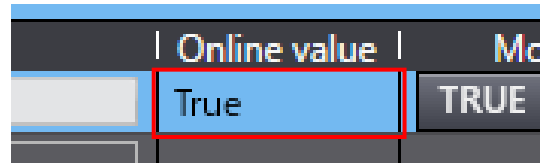

The safety output information being received by the Intelligent Tap from the safety light curtain can be checked to see if it matches the safety output information on Sysmac Studio that is being received by the CPU Unit.

- 7** Insert an object into the detection zone of the safety light curtain, and make sure that the sensor status indicator on the Intelligent Tap goes out and the output status indicator is lit red.

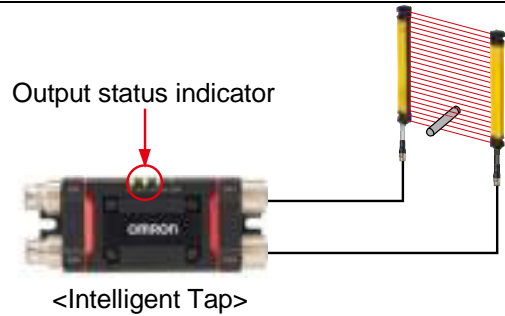

- 8** Make sure that **False** is displayed at online value in the **Watch (Project)1** Tab Page.

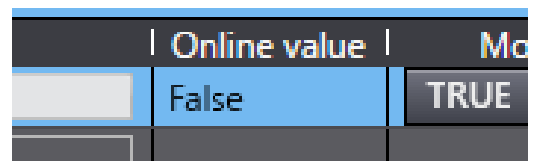

The safety output information being received by the Intelligent Tap from the safety light curtain can be checked to see if it matches the safety output information on Sysmac Studio that is being received by the CPU Unit.

## 10. Programming Using IO-Link

This section describes how to create a program in Sysmac Studio and the procedure for acquiring each of the process data and service data of the safety light curtain.

### 10.1 Sample Program for Acquiring Process Data

#### 10.1.1 Reading the Power Supply Voltage of the Receiver

The values of the power supply voltage of the receiver are read from the process data that is shared between the safety light curtain and the IO-Link Master Unit by cyclic communications.

The power supply voltage of the receiver is each split into the following two 1-byte parts before being stored.

Device variable	Stored information
Nx_Portx_Power_supply_high	Power supply voltage of receiver (upper 8 bits)
Nx_Portx_Power_supply_low	Power supply voltage of receiver (lower 8 bits)

x: Depends on the system configuration.







<Sample programming 1>

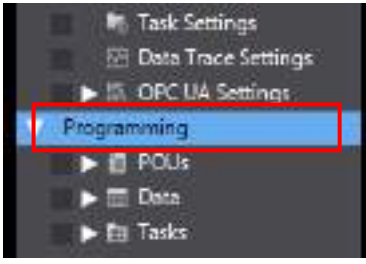

<Variables used in the sample program>

Variable table	Name	Data type	Description	Remarks
External variables (global variables)	N5_Port1_IN_Data_Enable	BOOL	Device variable Becomes True when the process data of port1 is enabled.	This is generated at execution of <i>Create Device Variable</i> in 8.2.2 <i>Setting Device Variables</i> .
	N5_Port1_Power_supply_high	BYTE	Device variable The power supply voltage supplied to the receiver are stored to the upper 8 bits and lower 8 bits, respectively.	This is generated at execution of <i>Create Device Variable</i> in 8.2.2 <i>Setting Device Variables</i> .
	N5_Port1_Power_supply_low			
	SLC_Power_Supply	WORD	Stores the power supply voltage of the receiver that was acquired in the sample program.	This is generated in Steps 9 to 11 of 10.1.2 <i>Programming</i> .

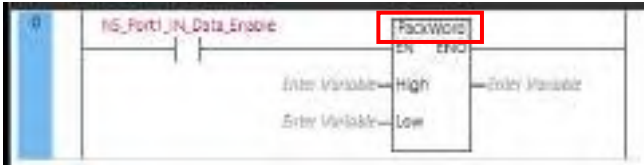
10.1.2 Programming

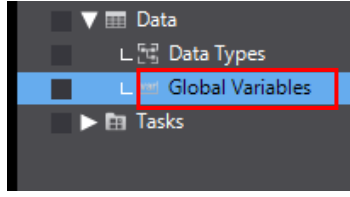
1	<p>Make sure that the IO-Link Master Unit is in the offline mode. If the IO-Link Master Unit is online, set it to the offline mode.</p>
2	<p>Select <b>Programming</b> in the Multiview Explorer.</p> 
3	<p>Open <b>POUs - Programs - Program0 - Section0</b>. When <b>Section0</b> is already used for another program, right-click <b>Program0</b> and click <b>Add - Section</b>.</p>
4	<p>Right-click on the first ladder in the <b>Section0-Program0</b> Pane in the Edit Pane, and click <b>Insert Input (C)</b>.</p> 
5	<p>Click <b>Enter Variable</b>, and enter the following variable name. Variable name: N5_Port1_IN_Data_Enable</p> 
6	<p>Right-click on the ladder at the right of the inserted input, and click <b>Insert Function</b>.</p> 
7	<p>Join the data of the power supply voltage that was split into two 1-byte parts into one 2-byte (one word) data item.  Enter the following function name. Function name: PackWord</p> 
8	<p>Click <b>Enter Variable</b> at <b>High</b> and <b>Low</b> in the PackWord block, and enter each of the following variable names. High: N5_Port1_Power_supply_high Low: N5_Port1_Power_supply_low</p> 
9	<p>Create the variable for outputting the power supply voltage.  Double-click <b>Data - Global Variables</b> in the Multiview Explorer.</p> 

- 10 Right-click the bottommost variable in the list of global variables, and click **Create New**.

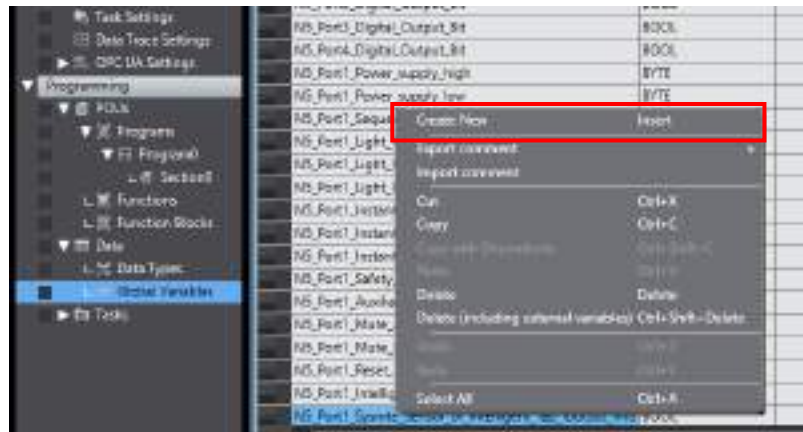

- 11 Set the following variable name and data type.  
Variable name: SLC\_Power\_Supply  
Data type: WORD

- 12 Select **Programming** in the Multiview Explorer, and open **Programming - POU's - Programs - Program0 - Section0**.

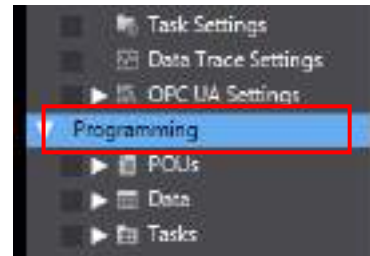

- 13 Enter the following variable name that was created in Steps 9 to 11 to the output on the right of the PackWord block.  
Variable name: SLC\_Power\_Supply



- 14 Select **Project - Build Controller**.

### 10.1.3 Monitoring Process Data Values

This section describes how to check process data after it has been output by the program created in 10.1.2 *Programming*. Monitoring is performed by setting in the Watch Tab Page.

1 Select **View - Watch Tab Page**.

2 Enter the following variable that was created in 10.1.2 *Programming* to **Name**.  
Variable name: SLC\_Power\_Supply

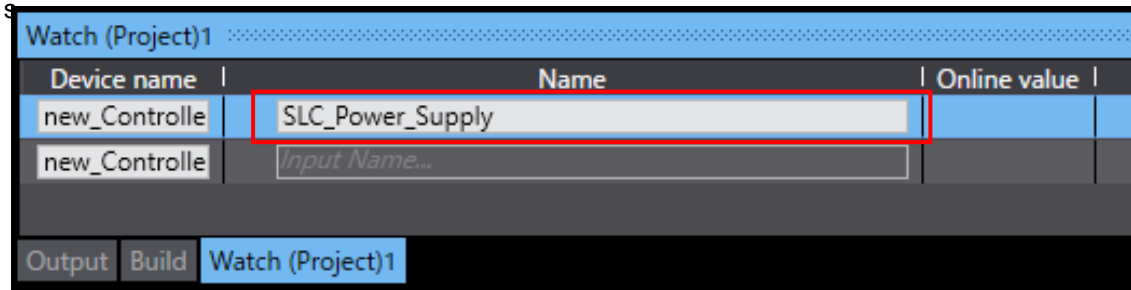

3 Select **Controller - Online**.

4 Select **Controller - Synchronize...**  
The **Synchronization** dialog box is displayed.

5 Make sure that the check box of the data to transfer (in the figure on the right, **NX102**) is selected. Clear the **Do not transfer the following. (All items are not transferred.)** check box, and click **Transfer to Controller**.

Note: When **Transfer to Controller** is executed, Sysmac Studio data is transferred to the controller and data is synchronized.

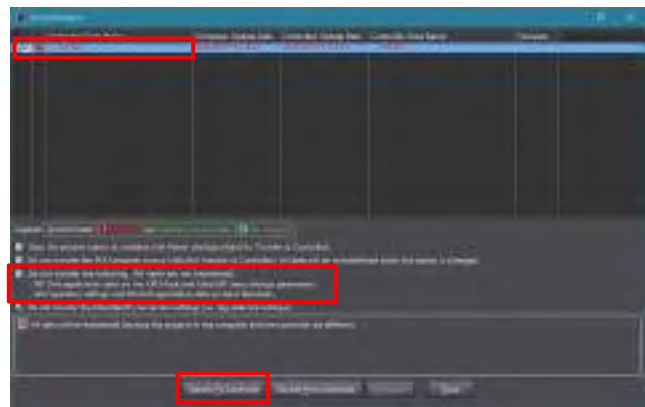

6 The dialog box on the right is displayed. Confirm that there are no problems, and click **Yes**.

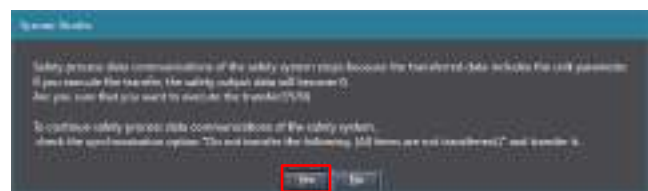

The dialog box on the right is displayed. Confirm that there are no problems, and click **Yes**.

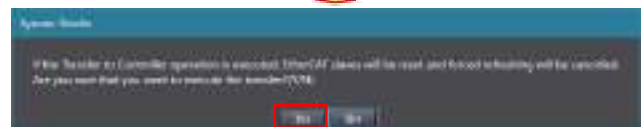

The synchronization in progress window is displayed.

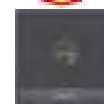

The dialog box on the right is displayed. Confirm that there are no problems, and click **OK**.

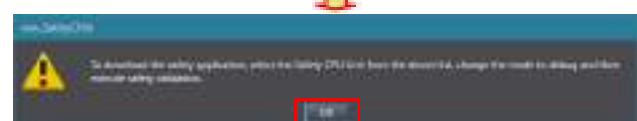

Note: Do not return the mode to **Run Mode...**

**7** Make sure that the color of the text of the synchronized data is the same color as the text at **Synchronized** displayed in the legend at the right, that the message **The Synchronization process successfully finished.** is displayed, and click **Close**.

Note: That the color of the text of the synchronized data is the same color as the text at **Synchronized** indicates that Sysmac Studio project data matches the data on the controller.

Note: If synchronization fails, check the wiring, and repeat the procedure from Step 17.

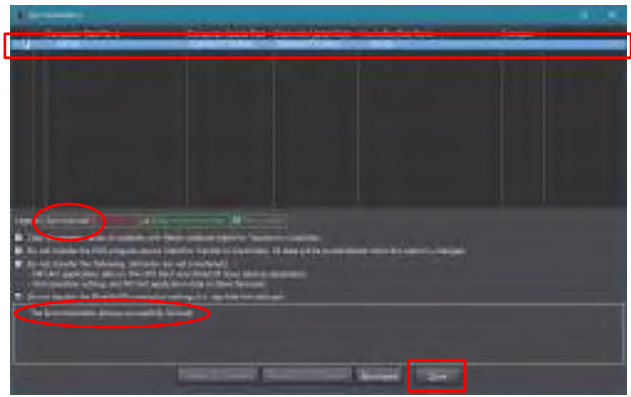

**8** Change **Display format** on the Watch Tab Page to **Decimal**.

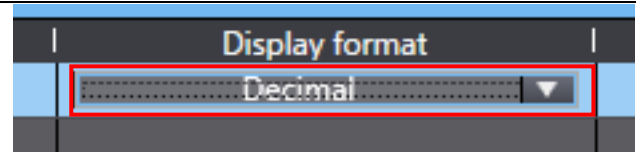

**9** Select **Controller - Mode - Run Mode....**

**10** The dialog box on the right is displayed. Confirm that there are no problems, and click **Yes**.

Note: The mode switches to **Run Mode....**

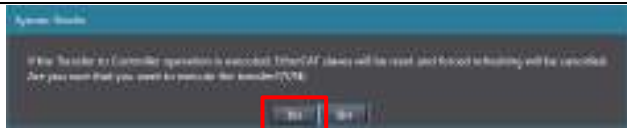

**11** The online value in Watch Tab Page changes, allowing the power supply voltage of the safety light curtain to be checked.

Note: The power supply voltage is indicated in mV. The example on the right shows 23678 mV (or 23.678 V).





## 10.2 Sample Program for Acquiring Service Data (Error Code)

### 10.2.1 Reading Error Codes

Error codes for the primary sensor receiver of the safety light curtain are acquired from the service data that is acquired via IO-Link.

Index(Dec)	Sub-Index(Dec)	Stored information
81 (Error code: Primary sensor receiver)	0	Data length: 32 bytes (8 bytes x 4) Error codes are output in 8 bytes. Starting from the leading byte, 1 byte: Error code 4 bytes: Power-on time (counted every 15 minutes) 3 bytes: Query data The four most recent error codes can be acquired. When an SLC is not connected or there is no amount of incident light, "0" is the error code.

<Sample programming 2>

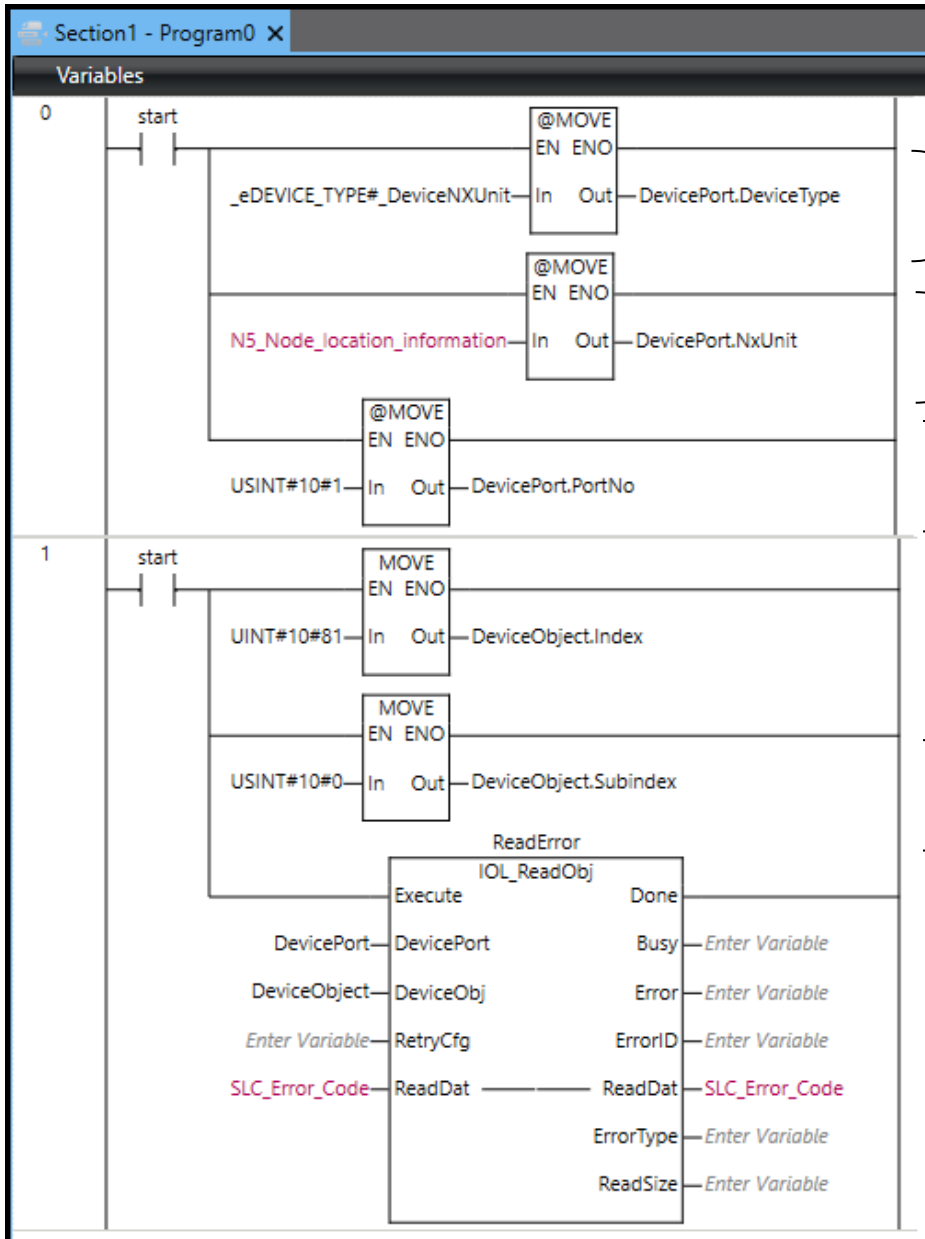

- (1) Specify the location of the safety light curtain to read error codes from as follows:
  - Specify the unit type from which the data is read as NX Unit.
  - Specify the node location where the IO-Link Master Unit is mounted by the value of device variable N5\_Node\_location\_information.
  - Specify the port No. of the safety light curtain as "1".
- (2) Specify the No. of the service data where the error code is stored as follows:
  - Specify Index No. 81 where the error code of the safety light curtain is stored.
  - Specify Sub-Index No. 0 where the error code of the safety light curtain is stored.
- (3) Read the error codes of the safety light curtain specified above by executing IO-Link communications instructions.
  - Specify the location of the safety light curtain by the value of DevicePort (specified in (1)), and the error codes to be read by the value of DeviceObject (specified in (2)).
  - After they are read, error codes are stored to SLC\_Error\_Code.

<Variables and instructions used in the sample program>

Variables are generated automatically by the procedure in 8.2.2 *Setting Device Variables*.

Variable table	Name	Data type	Description	Remarks
External variables (global variables)	N5_Node_location_information	_sNXUNIT_ID	Device variable Node location information is stored.	This is generated at execution of <i>Create Device Variable</i> in 8.2.2 <i>Setting Device Variables</i> .
	SLC_Error_Code	ARRAY[0..255] OF BYTE	Stores the error codes of the safety light curtain that are acquired in the sample program.	This is generated in Steps 27 and 28 of 10.2.2 <i>Programming</i> .
Internal variables	DevicePort	_sDEVICE_PORT	This object stores the information that specifies the device to acquire service data from.	This is generated in Step 8 of 10.2.2 <i>Programming</i> .
	DeviceType	_eDEVICE_TYPE	Stores the target unit type to read data from.	This is set in step 9 of 10.2.2 <i>Programming</i> .
	NxUnit	_sNXUUNIT_ID	Stores the node location of the target Master Unit to be read.	This is set in step 12 of 10.2.2 <i>Programming</i> .
	PortNo	USINT	Stores the port No. of the Master Unit to which the target to be read is connected.	This is set in step 12 of 10.2.2 <i>Programming</i> .
	DeviceObject	_sIOLOBJ_ACCESS	This object stores the information that specifies which service data to read.	This is generated in Step 18 of 10.2.2 <i>Programming</i> .
	Index	UINT	This stores the index.	This is generated in Step 19 of 10.2.2 <i>Programming</i> .
	Subindex	USINT	Stores the sub-index.	This is generated in Step 22 of 10.2.2 <i>Programming</i> .
	start	BOOL	This is executed once by the False state changing to True in the sample program.	This is generated in Step 5 of 10.2.2 <i>Programming</i> .

**10.2.2 Programming**

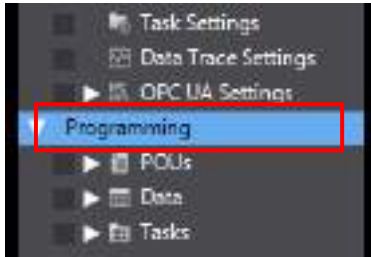
- 1 Make sure that the IO-Link Master Unit is in the offline mode. If the IO-Link Master Unit is online, set it to the offline mode.
- 2 Select **Programming** in the Multiview Explorer.
 
- 3 Open **POUs - Programs - Program0 - Section0**. When **Section0** is already used for another program, right-click **Program0** and click **Add - Section**.

- 4 Right-click on the first ladder in the **Section0-Program0** Pane in the Edit Pane, and click **Insert Input (C)**.



- 5 Click **Enter Variable**, and enter the following variable name.  
Variable name: start



- 6 Right-click on the ladder at the right of the inserted input, and click **Insert Function**.

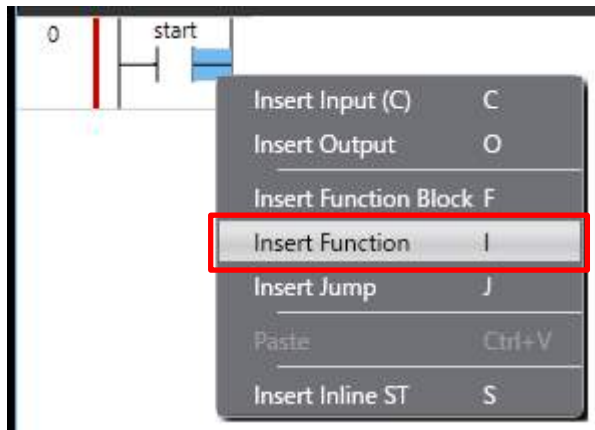

- 7 Enter the following function name.  
Function name: @MOVE

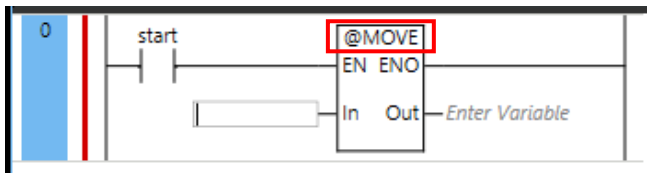

- 8 Click **Enter Variable** at **In** and **Out** in the @MOVE block, and enter each of the following variable names.

In:  
Variable name:  
\_eDEVICE\_TYPE#\_DeviceNXUnit  
Out:  
Variable name: DevicePort  
Data type: \_sDEVICE\_PORT

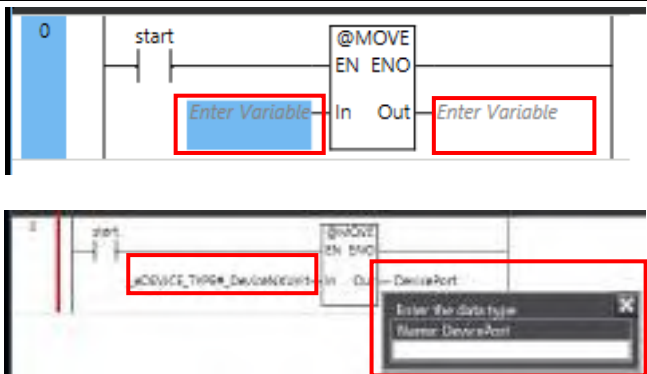

- 9 Click **DevicePort** at **Out**, and change to the following variable name.

Variable name:  
DevicePort.DeviceType

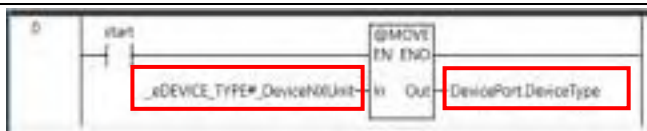

- 10 Right-click the @MOVE block, and click **Copy**.

- 11** Right-click the @MOVE block, and click **Paste**.  
The block is reused for creating the block that specifies the node location where the IO-Link Master Unit is mounted.

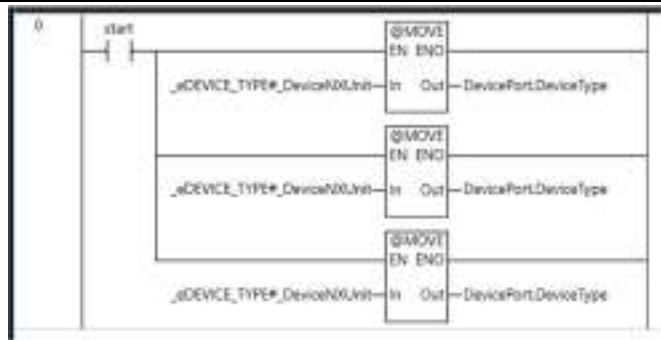

Again, right-click the @MOVE block, and click **Paste**.  
The block is reused for creating the block that specifies the port No. of the safety light curtain.

- 12** Change **In** and **Out** of the @MOVE block on the second tier to each of the following:

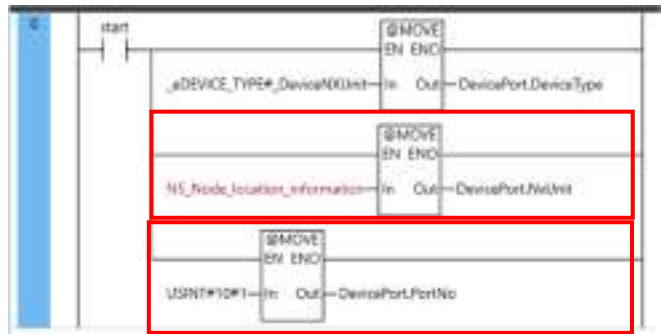

In: N5\_Node\_location\_information  
Out: DevicePort.NxUnit

Change **In** and **Out** of the @MOVE block on the third tier to each of the following:

In: USINT#10#1  
Out: DevicePort.PortNo

 **Additional Information**

As the value to substitute in DevicePort.PortNo, specify the port No. of the IO-Link Master Unit to which the IO-Link device is connected.

- 13** Press the R key on the keyboard, and add a ladder.

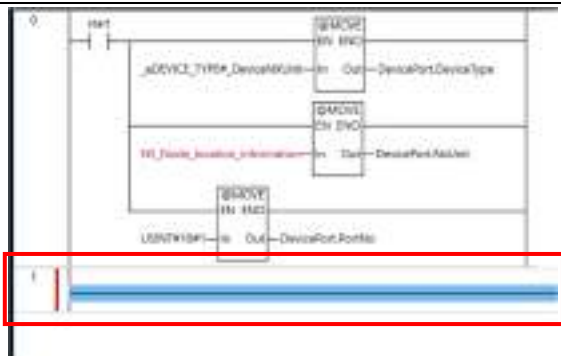





- 14** Right-click on the ladder, and click **Insert Input (C)**.

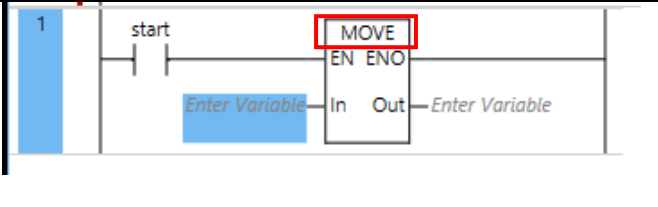
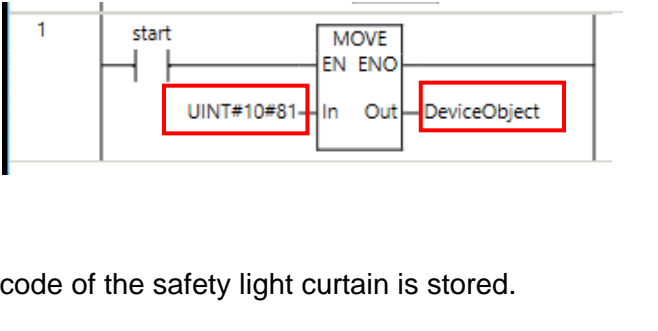
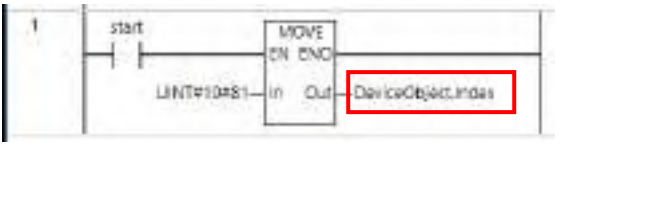
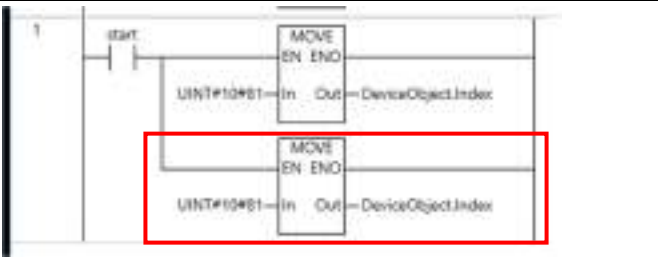

- 15** Click **Enter Variable**, and enter the following variable name.  
Variable name: start

- 16** Right-click on the ladder at the right of the inserted input, and click **Insert Function**.

<p><b>17</b></p>	<p>Enter the following function name. Function name: MOVE</p>	
<p><b>18</b></p>	<p>Click Enter Variable at <b>In</b> and <b>Out</b> in the MOVE block, and enter each of the following variable names.</p> <p>In: UINT#10#81 Out: Variable name: DeviceObject Data type: _sIOLOBJ_ACCESS Specify the index No. where the error code of the safety light curtain is stored.</p>	
<p><b>19</b></p>	<p>Click DeviceObject at <b>Out</b>, and change to the following variable name.</p> <p>Variable name: DeviceObject.Index</p>	
<p><b>20</b></p>	<p>Right-click the MOVE block, and click <b>Copy</b>.</p>	
<p><b>21</b></p>	<p>Right-click the MOVE block, and click <b>Paste</b>. The block is reused for creating the block that specifies the Sub-Index No. where the error code of the safety light curtain is stored.</p>	
<p><b>22</b></p>	<p>Change <b>In</b> and <b>Out</b> of the MOVE block on the second tier to each of the following.</p> <p>In: USINT#10#0 Out: DeviceObject.Subindex</p>	
<p><b>23</b></p>	<p>Right-click the MOVE block on the second tier, and click <b>Insert Function Block</b>.</p>	
<p><b>24</b></p>	<p>Click <b>Enter Type Name</b>, and enter the following function block name. Function block name: IOL_ReadObj</p>	

**25** Drag-and-drop the IOL\_ReadObj block onto the MOVE block on the second tier.

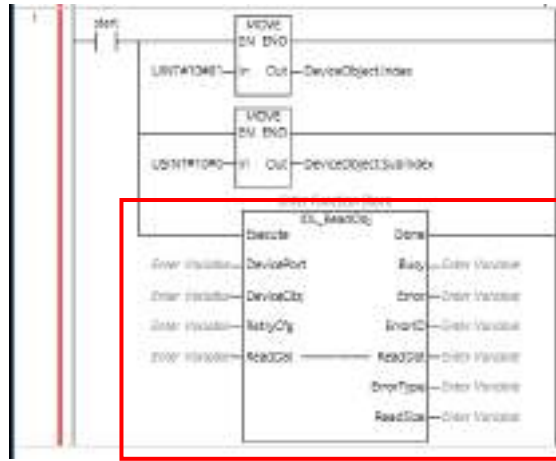

**26** Double-click **Data - Global Variables** in the Multiview Explorer.

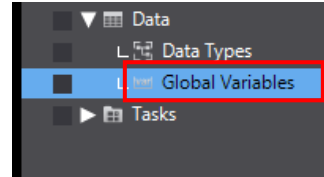

- 27 Right-click the bottommost variable in the list of global variables, and click **Create New**.

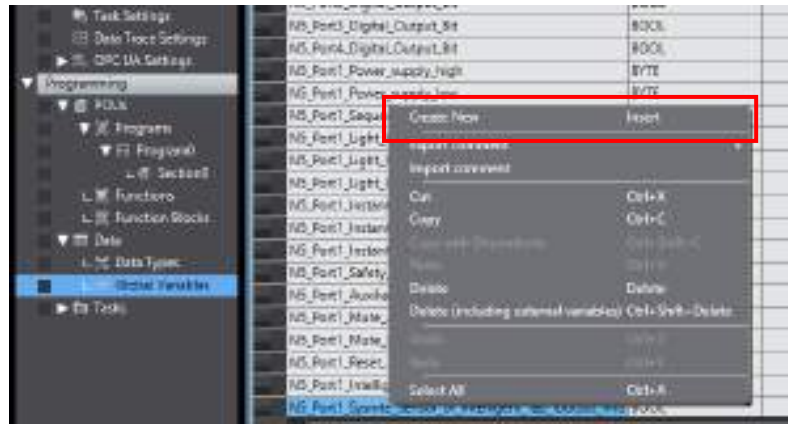

- 28 Set the following variable name and data type.  
 Variable name: SLC\_Error\_Code  
 Data type: ARRAY[0..255] OF BYTE

- 29 Select **Programming** in the Multiview Explorer.

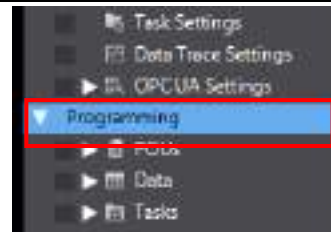

- 30 Set the I/O of the IOL\_ReadObj block as follows.  
 Click **Enter Function Block**, and enter the following instance variable name.  
 Instance variable name: ReadError  
**DevicePort:** DevicePort  
**DeviceObj:** DeviceObject  
**ReadDat:** SLC\_Error\_Code

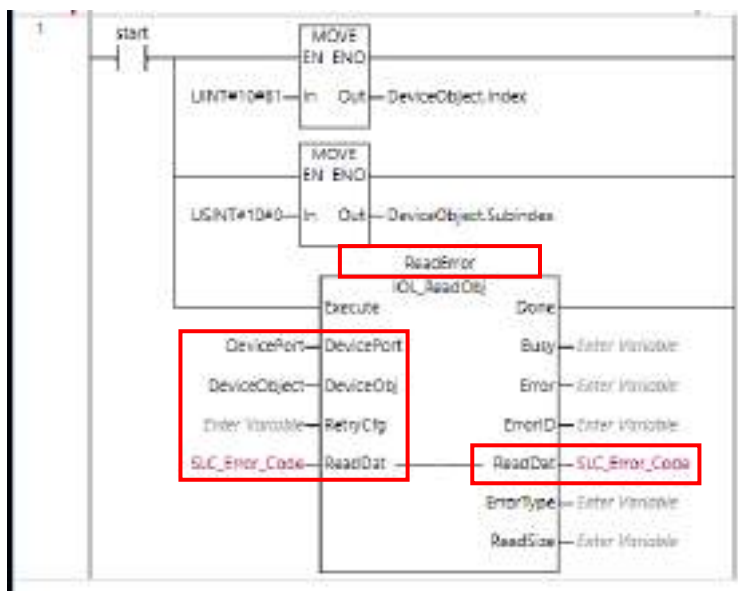

- 31 Select **Project - Build Controller**.



### 10.2.3 Monitoring Service Data (Error Codes) Values

This section describes how to check service data after it has been output by the program created in 10.2.2 *Programming*. Monitoring is performed by setting in the Watch Tab Page.

- 1 Select **View - Watch Tab Page(Table)**.

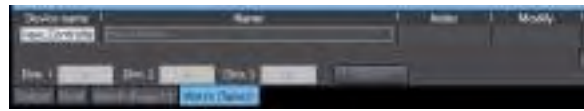

- 2 Enter the following variable that was created in Steps 27 to 29 to **Name**.  
Variable name: SLC\_Error\_Code



- 3 Select **Controller - Online**.

- 4 Select **Controller - Synchronize...**  
The **Synchronization** dialog box is displayed.

- 5 Make sure that the check box of the data to transfer (in the figure on the right, **NX102**) is selected.  
Clear the **Do not transfer the following. (All items are not transferred.)** check box, and click **Transfer to Controller**.

Note: When **Transfer to Controller** is executed, Sysmac Studio data is transferred to the controller and data is synchronized.

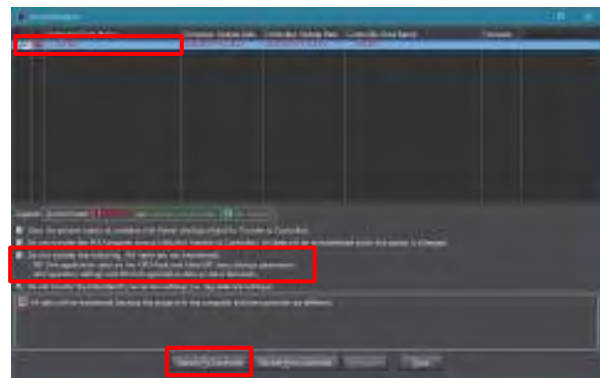

- 6 The dialog box on the right is displayed. Confirm that there are no problems, and click **Yes**.

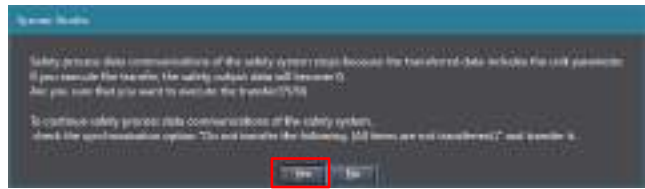

The dialog box on the right is displayed. Confirm that there are no problems, and click **Yes**.



The synchronization in progress window is displayed.

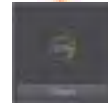

The dialog box on the right is displayed. Confirm that there are no problems, and click **OK**.

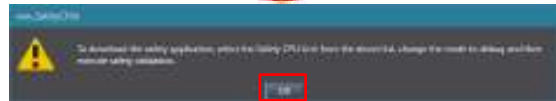

The synchronization in progress window is displayed.

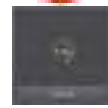

The dialog box on the right is displayed. Confirm that there are no problems, and click **No**.

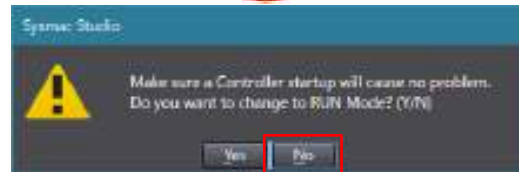

Note: Do not return the mode to **Run Mode**....

- 7 Make sure that the color of the text of the synchronized data is the same color as the text at **Synchronized** displayed in the legend at the right, that the message **The Synchronization process successfully finished.** is displayed, and click **Close**.

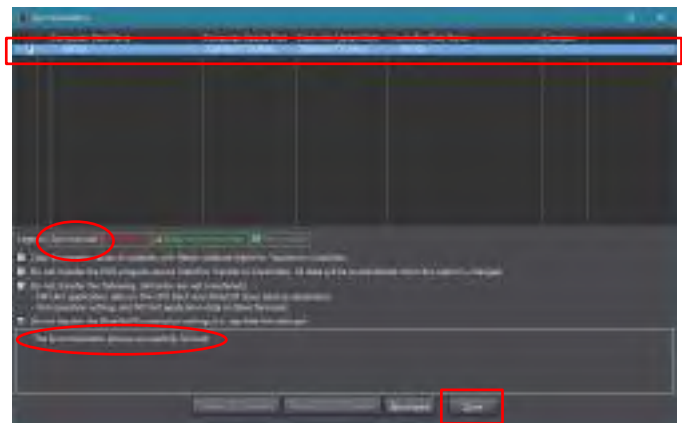

Note: That the color of the text of the synchronized data is the same color as the text at **Synchronized** indicates that Sysmac Studio project data matches the data on the controller.

Note: If synchronization fails, check the wiring, and repeat the procedure from Step 35.

- 8 Select **Controller - Mode - Run Mode**....

- 9 The dialog box on the right is displayed. Confirm that there are no problems, and click **Yes**.

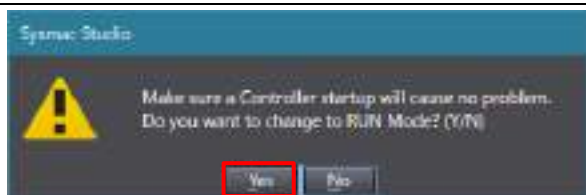

Note: The mode switches to **Run Mode**....

10 Double-click **start** on the ladder, and click **True**.

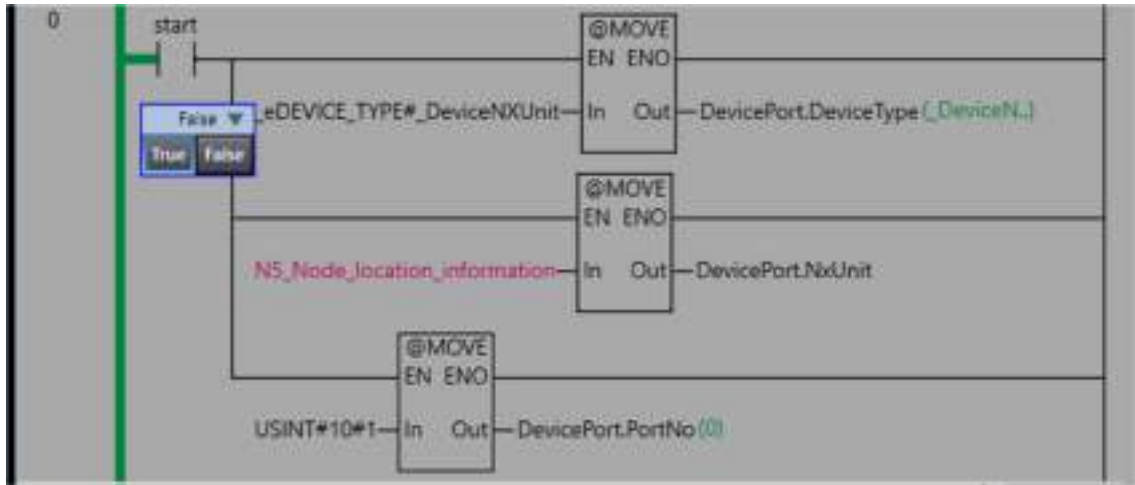

11 If an error has occurred, the values of "0" to "7" changes.



In this example, error code "4F" is displayed. The meaning of this error code is as follows.

Error description	Troubleshooting
Cap error	A probable cause is that the cap has come loose. Attach the cap properly.

For details on error codes, refer to *Safety Light Curtain/Multi-Beam Safety Sensor F3SG-□SR□/F3SG-□PG□* (Cat. No. Z405).

### 10.3 Sample Program for Acquiring Service Data (Amount of Incident Light)

#### 10.3.1 Acquiring the Amount of Incident Light

The amount of incident light of each optical axis of the safety light curtain is acquired from the service data of the safety light curtain.

The service data of sample program 3 is reused to create this sample program.

Index(Dec)	Sub-Index(Dec)	Stored information
71 (Amount of incident light level: Primary sensor receiver)	0	Information of 1 byte x 232 optical axes The amount of incident light of each axis is output as 0 to 255 (8 bits) for each individual optical axis (1 byte). When an SLC is not connected, "0" is the error code.

<Sample programming 3>

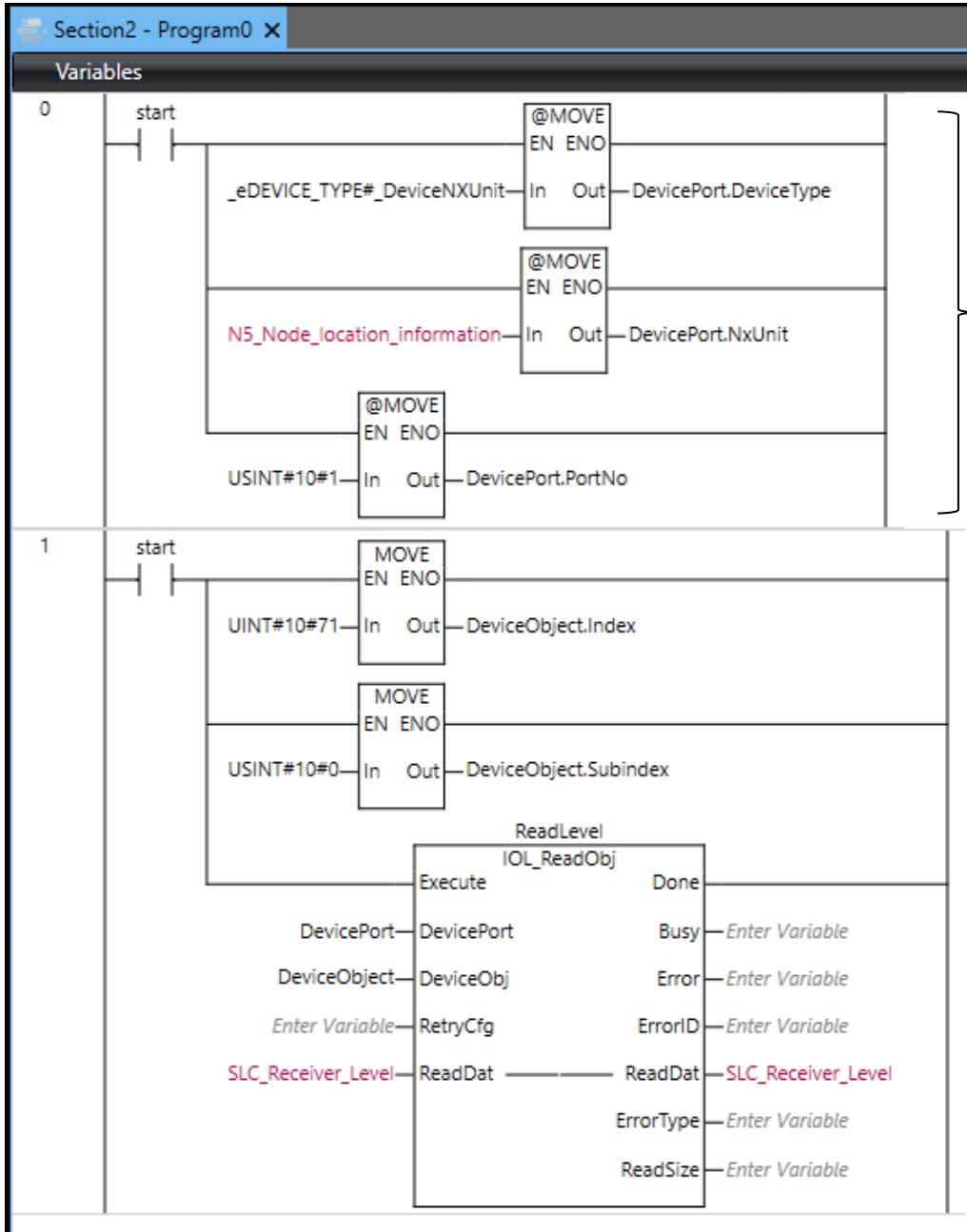

Program 2 for the operation check is used as it is.

(1) Specify the No. of the service data where the amount of incident light of each optical axis of the safety light curtain is stored as follows:

- Specify Index No. 71 where the amount of incident light of each optical axis of the safety light curtain is stored.

- Specify Index No. 0 where the amount of incident light of each optical axis of the safety light curtain is stored.

(2) Read the amount of incident light of each optical axis of the safety light curtain specified above by executing IO-Link communications instructions.

After they are read, error codes are stored to SLC\_RECEIVER\_LEVEL.

<Variables and instructions used in the sample program>

Variable table	Name	Data type	Description	Remarks
External variables (global variables)	N5_Node_location_information	_sNXUNIT_ID	Device variable Node location information is stored.	This is generated at execution of <i>Create Device Variable</i> in 8.2.2 <i>Setting Device Variables</i> .
	SLC_Receiver_Level	ARRAY[0..255] OF BYTE	Stores the amount of incident light of each individual axis of the receiver that was acquired in the sample program.	This is generated in Step 28 of 10.3.2 <i>Programming</i> .
Internal variables	DevicePort	_sDEVICE_PORT	This object stores the information that specifies the device to acquire service data from.	This is generated in Step 8 of 10.2.2 <i>Programming</i> .
	DeviceType	_eDEVICE_TYPE	Stores the target unit type to read data from.	This is set in step 9 of 10.2.2 <i>Programming</i> .
	NxUnit	_sNXUINT_ID	Stores the node location of the target Master Unit to be read.	This is set in step 12 of 10.2.2 <i>Programming</i> .
	PortNo	USINT	Stores the port No. of the Master Unit to which the target to be read is connected.	This is set in step 12 of 10.2.2 <i>Programming</i> .
	DeviceObject	_sIOLOBJ_ACCESS	This object stores the information that specifies which service data to read.	This is generated in Step 18 of 10.2.2 <i>Programming</i> .
	Index	UINT	This stores the index.	This is generated in Step 19 of 10.2.2 <i>Programming</i> .
	Subindex	USINT	This stores the sub-index.	This is generated in step 22 of 10.2.2 <i>Programming</i> .
	start	BOOL	This is executed once by the False state changing to True in the sample program.	This is generated in Step 5 of 10.2.2 <i>Programming</i> .

### 10.3.2 Programming

A sample program for reading the amount of incident light can be created by copying the sample program created in 10.2.2 *Programming* and changing the following points.

Step 18 Change **Enter Variable** at **In** as follows.  
Specify the index No. where the **amount of incident light level** of the safety light curtain is stored.  
In:  
**UINT#10#71**

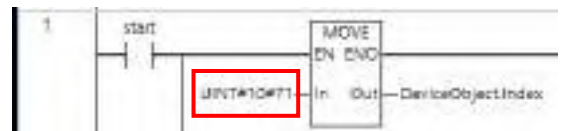

Step 28 Change the new global variable to create as follows:  
Create the variable for reading the **amount of incident light level** of the safety light curtain.  
Variable name: **SLC\_Receiver\_Level**  
Data type: ARRAY[0..255] OF BYTE

- Step 30 Change the I/O of the **IOL\_ReadObj** block to be set as follows.  
 Click **Enter Function Block**, and enter the following instance variable name:  
 Instance variable name: **ReadLevel**  
**DevicePort**: DevicePort  
**DeviceObj**: DeviceObject  
**ReadDat**: **SLC\_Receiver\_Level**



### 10.3.3 Monitoring Service Data (Amount of Incident Light Level) Values

This section describes how to check service data after it has been output by the program created in 10.3.2 Programming.

The amount of incident light level can be monitored by changing the following point in the procedure of 10.2.3 Monitoring Service Data (Error Codes) Values.

- Step 2 Change **Name** to set to the Watch Tab Page as follows.  
 Variable name: **SLC\_Receiver\_Level**

Device name	Name																			Index
new_Controller	SLC_Receiver_Level																			[0]
[0]	[1]	[2]	[3]	[4]	[5]	[6]	[7]	[8]	[9]	[10]	[11]	[12]	[13]	[14]	[15]	[16]	[17]	[18]	[19]	
D0	D0	D1	D2	D1	D0	D1	D2	D2	D2	D2	D3	D1	D0	D0	D1	D1	D2	D2	D2	
D1	D0	D0	D1	D2	D2	D2	D2	D1	D0	D0	00	00	00	00	00	00	00	00	00	

For details on error codes, refer to *Safety Light Curtain/Multi-Beam Safety Sensor F3SG-□SR□/F3SG-□PG□ User's Manual* (Cat. No. Z405).

## 11. Initialization Method

This document presumes that the device is in the factory default state.

When using a device that has been changed from its initial setting state, programming sometimes cannot be proceeded with according to the procedure.

### 11.1. Initializing the Controller

To set the controller to the initial setting state, the CPU Unit must be initialized.

Set the operating mode of the controller to the program mode, and select **Controller - Clear All Memory...** from the Sysmac Studio menu bar. The **Clear All Memory...** dialog box is displayed. Check the content of the dialog box, and click **OK**.

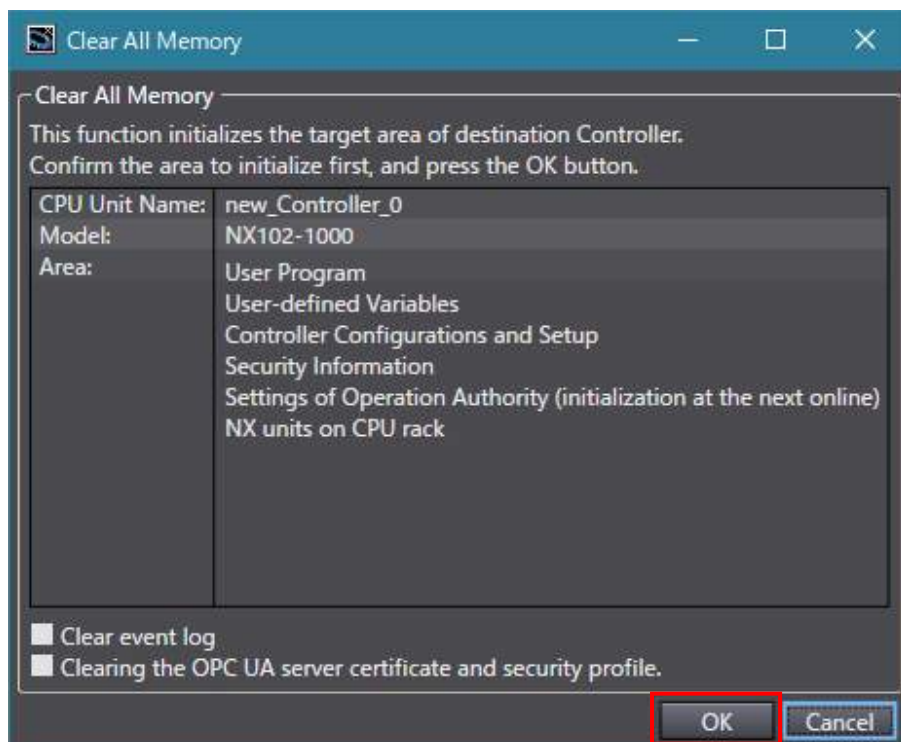



## 11.2 Initializing the IO-Link Master Unit

This section describes the procedure for returning the IO-Link Master Unit to its initial setting state.

- 1 Double-click **CPU/Expansion Racks - CPU Rack** in the Edit Pane to display the **CPU/Expansion Racks** area.
- 2 Double-click NX Unit No. 5 (IO-Link Master Unit).
- 3 Select **Controller - Online**.
- 4 Click **Return to Default Value**.  
This returns all parameters of the IO-Link Master Unit to their default values.

Click **Transfer to Unit**.

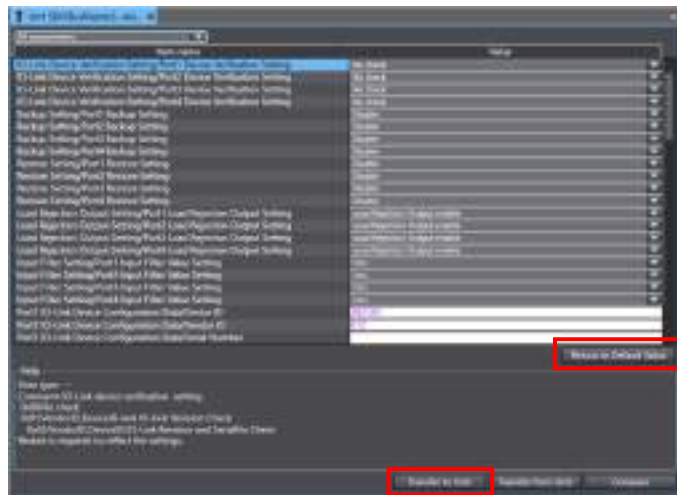

### Precautions for Correct Use

By initializing an IO-Link Master Unit, the backup data of IO-Link devices saved on the IO-Link Master Unit is not cleared. If the backup data saved on the IO-Link Master Unit must be cleared, refer to 7-6-5 *Clearing Backup Data* in the *NX/GX-series IO-Link System User's Manual* (Cat. No. W570) and clear the backup data.

## 12. Revision History

Revision code	Date	Revised content
01	October 2019	Original production
02	September 2020	Revised

**OMRON Corporation Industrial Automation Company**  
Kyoto, JAPAN

Contact: [www.ia.omron.com](http://www.ia.omron.com)

**Regional Headquarters**

**OMRON EUROPE B.V.**

Wegalaan 67-69, 2132 JD Hoofddorp  
The Netherlands  
Tel: (31)2356-81-300/Fax: (31)2356-81-388

**OMRON ELECTRONICS LLC**

2895 Greenspoint Parkway, Suite 200  
Hoffman Estates, IL 60169 U.S.A.  
Tel: (1) 847-843-7900/Fax: (1) 847-843-7787

**OMRON ASIA PACIFIC PTE. LTD.**

No. 438A Alexandra Road # 05-05/08 (Lobby 2),  
Alexandra Technopark,  
Singapore 119967  
Tel: (65) 6835-3011/Fax: (65) 6835-2711

**OMRON (CHINA) CO., LTD.**

Room 2211, Bank of China Tower,  
200 Yin Cheng Zhong Road,  
PuDong New Area, Shanghai, 200120, China  
Tel: (86) 21-5037-2222/Fax: (86) 21-5037-2200

**Authorized Distributor:**

© OMRON Corporation 2019-2020 All Rights Reserved.  
In the interest of product improvement,  
specifications are subject to change without notice.

**Cat. No. F108-E1-02**

0920 (1019)