

# 2D 270° Laser Scanners



## LSC Series PRODUCT MANUAL

For your safety, read and follow the considerations written in the instruction manual, other manuals and Autonics website.

The specifications, dimensions, etc. are subject to change without notice for product improvement. Some models may be discontinued without notice.

### Major Features

- Wide detection range up to 270°, 25 m
- Supports flexible field configuration with a total of 16 field sets (1 set: 3 fields)
- Accurate and stable object detection by supporting various filter functions
- Small size (L 60 × W 60 × H 86 mm) suitable for various installation environments
- Supports Ethernet communication
- Supports atLiDAR dedicated software
- ROS, API supported
- Sold separately
  - Ethernet cable (C18-2R-A, C18-5R-A, C18-10R-A, C48-2R-A, C48-5R-A, C48-10R-A)
  - Power I/O cable (CID-2-VG, CID-5-VG, CID-10-VG, CLD-2-VG, CLD-5-VG, CLD-10-VG)

### Safety Considerations

- Observe all 'Safety Considerations' for safe and proper operation to avoid hazards.
- ⚠ symbol indicates caution due to special circumstances in which hazards may occur.

**⚠ Warning** Failure to follow instructions may result in serious injury or death.

- 01. Fail-safe device must be installed when using the unit with machinery that may cause serious injury or substantial economic loss. (e.g. nuclear power control, medical equipment, ships, vehicles, railways, aircraft, combustion apparatus, safety equipment, crime / disaster prevention devices, etc.)**  
Failure to follow this instruction may result in economic loss, personal injury or fire.
- 02. Do not use the unit in the place where flammable / explosive / corrosive gas, high humidity, direct sunlight, radiant heat, vibration, impact, or salinity may be present.**  
Failure to follow this instruction may result in fire or explosion.
- 03. This product is not safety sensor and does not observe any domestic nor international safety standard.**  
**Do not use this product with the purpose of injury prevention or life protection, as well as in the place where economic loss maybe expected.**
- 04. Do not connect the unit while connected to a power source.**  
Failure to follow this instruction may result in fire.
- 05. Check connections and connect cables.**  
Failure to follow this instruction may result in fire.
- 06. Do not disassemble or modify the unit.**  
Failure to follow this instruction may result in fire.

**⚠ Caution** Failure to follow instructions may result in injury or product damage.

- 01. Do not stare at the laser emitter.**  
Failure to follow this instruction may result in eye damage.
- 02. Use the unit within the rated specifications.**  
Failure to follow this instruction may result in fire or product damage.
- 03. Use dry cloth to clean the unit. Do not use water or organic solvent when cleaning the unit.**  
Failure to follow this instruction may result in fire.
- 04. Do not apply high pressure to the laser scanner to clean it.**

### Cautions during Use

- Follow instructions in 'Cautions during Use'.  
Otherwise, it may cause unexpected accidents.
- Power supply should be insulated and limited voltage / current or Class 2, SELV power supply device.
- After supplying power, the sensor performs self-check for about 10 sec. When self-checking, error occurrence, and teaching, the laser scanner outputs the same as it sensed obstacle.
- In order to avoid malfunction from static electricity or noise, ground shield wire of the power I/O cable or housing fixing screws.
- Mutual optical interference between laser scanners and photoelectric sensors may result in malfunction.
- Mutual optical interference between laser scanners may result in malfunction.
- Objects cannot be scanned when covering the front cover of the laser scanner.
- When the laser scanner is moved to another position, use it after re-teaching.
- Do not drop the unit. It may cause malfunction.
- Installing the laser scanner in the place where smoke, fog, dust, or corrosion is heavy may result in malfunction.
- Keep away from high voltage lines or power lines to prevent inductive noise. In case of installing power line and input signal line closely, use line filter or varistor at power line and shield wire at input signal line.
- Do not use the laser scanner near the equipment which generates strong magnetic force or high frequency noise.
- Cover with shields, hoods, or etc. to prevent direct incidence of strong light (direct rays of sunlight, incandescent) into the laser scanner beam spread angle.

- Fix the laser scanner in position with the fixing screw. Vibration may result in malfunction.
- When IP address of the laser scanner and wireless router is same, the communication does not connected. Set the wireless network (Wifi) to "Disable" in the network settings of the Windows operating system.
- This unit may be used in the following environments.
  - Indoors (in the environment condition rated in 'Specifications')
  - Altitude max. 2,000 m
  - Pollution degree 2
  - Installation category II

## Ordering Information

This is only for reference, the actual product does not support all combinations. For selecting the specified model, follow the Autonics website.

**LSC - C ① C T3 - ET**

### ① Detection distance

5: 5 m  
10: 10 m  
25: 25 m

## Product Components

- Product
- Instruction manual
- M3 × 8 mm bolt (SUS) × 4
- Connector cap × 1

## Sold Separately

- Power I / O cable: CID-□-VG, CLD-□-VG
- Ethernet cable: C18-□R-A, C48-□R-A

## Network Setting

- Configure the network settings of LiDAR sensor via atLiDAR.
- For initial IP address, refer to the table as below.

IP address	192.168.0.1
Subnet mask	255.255.255.0
Gateway	192.168.0.2

## Installation Order

For details of atLiDAR settings, refer to the software manual.

### 01. Install the laser scanner.

Secure the device to the installation location using four M3 × 8 mm bolts.

### 02. Install the laser scanner program to PC.

Download the software provided by Autonics website.

### 03. Connect the laser scanner and the PC, and set the network.

Refer to the Network Setting.

### 04. Laser scanner function setting

Use atLiDAR, set each function to adequate the installation environment of the laser scanner and the obstacles to be detected.

## Cautions for Installation

- Refer to the figure on the right and install the unit according to the direction you want to detect the object.
- Install the unit correctly with the usage environment, location, and the designated specifications.
- Impact with hard objects or excessive bending of the wire lead-out may result in damage on the waterproof function.
- Use this device after testing. Check if the indicator is working properly depending on whether the obstacle exists.

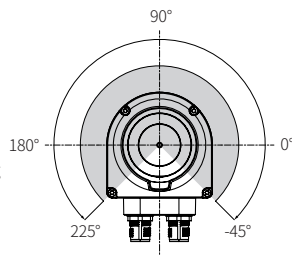

## Software

Download the installation file and the manuals from the Autonics website. Supported devices are different for each software version.

### ■ atLiDAR (V2.0 or later)

atLiDAR is the management program for laser scanner parameter settings, status information and monitoring data, etc. This program communicates with the laser scanner via Ethernet communication.

## Connections

### ■ Power I / O connector wiring (M12 12-pin connector, Plug-Male)

Pin	Cable color	Signal	Function	Pin	Cable color	Signal	Function
1	Brown	+V	+V	7	Black	IN3	Choose a field set
2	Blue	GND	GND	8	Gray	IN2	
3	White	OUT2	Output when object is detected in subfield 2	9	Red	IN1	Output when object is detected in subfield 3
4	Green	OUT1	Output when object is detected in subfield 1	10	Purple	OUT3	
5	Pink	IN GND	IN GND	11	Gray / Pink	N.C	
6	Yellow	IN4	Choose a field set	12	Red / Blue	OUT4	Ready / Error, Sync output

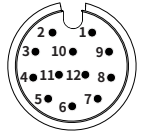

### ■ Ethernet connector wiring (M12 8-pin-RJ45 connector, Plug-Male)

M12 8-pin	RJ45		
Pin	Signal	Pin	Signal
6	RX+	1	TX+
4	RX-	2	TX-
5	TX+	3	RX+
8	TX-	6	RX-
1		5	
7		4	
2		7	
3		8	

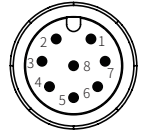

## Input / Output Specifications

### ■ Input specifications

The input operates with rising / falling edge and H / L level and can be selected.

Input	Options	Descriptions
IN1	Select field set	-
IN2	Select field set	-
IN3 <sup>01)</sup>	Select field set or Scan input	It can be used as scan start and stop signal.
IN4 <sup>01)</sup>	Select field set or Teaching	It can be used as an external input signal for teaching.

01) Default: Select field set

### ■ Output specifications

The output operates at PNP / NPN and can be selected.

RESTART sets to time.

Output	Descriptions
OUT1	Subfield 1 output
OUT2	Subfield 2 output
OUT3	Subfield 3 output
OUT4 <sup>01)</sup>	Ready / Error output fixed Sync pulse output at 90°

01) Refer to the scan angle image in Cautions for Installation.

## Circuit

### ■ Photocoupler input

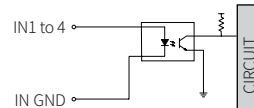

### ■ NPN open collector output

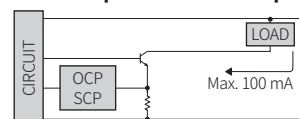

### ■ PNP open collector output

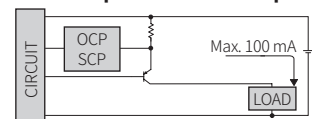

- OCP (over current protection), SCP (short circuit protection)
- If short-circuit the control output terminal or supply current over the rated specification, normal control signal is not output due to the output short over current protection circuit.

## Dimensions

- Unit: mm, For the detailed drawings, follow the Autonics website.

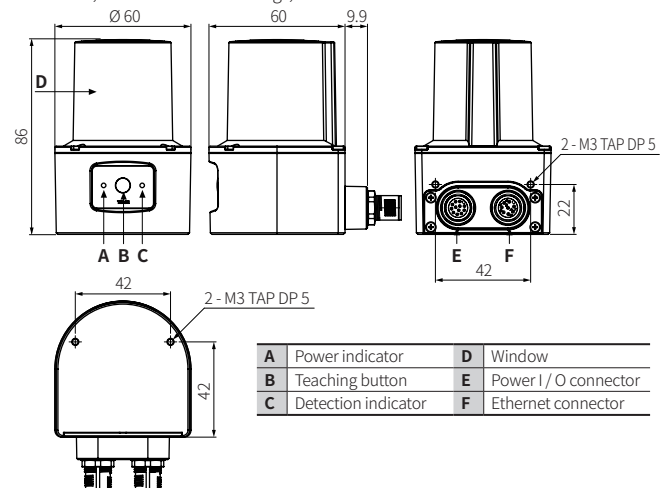

## Indicators

Status	Indicator		Other description
	Power (green)	Detection (red)	
Power on	Light on then off		When the power is applied normally, it turns off.
Normal operation	ON	-	-
ERROR	-	Flashing	-
Obstacle detection	ON	ON	-
Teaching	Step 1 <sup>01)</sup> Flashing	-	Teaching preparation stage : Start teaching with the teaching button, IN4 signal or software.
	Step 2 <sup>02)</sup> Flashing	Flashing	Teaching progress stage : There must be no moving objects in the teaching area.
	Step 3	ON	Turns on after teaching is completed. (normal operation)
Apply parameters	Flashing (once)	Flashing (once)	Flashes during application of parameters set by software.

01) Teaching preparation stage time selection among 5 / 10 / 15 sec by software

02) Teaching progress stage time selection among 10 / 20 / 30 / 40 / 50 / 60 sec by software

## Specifications

Model	LSC-C5CT3-ET	LSC-C10CT3-ET	LSC-C25CT3-ET
Environment of use	Indoor		
Emitting property	Infrared laser		
Laser class	CLASS 1		
Wave length band	905 nm		
Max. pulse output power	6 W		
Beam conversion angle	9.5 mrad		
Scanning frequency	15 Hz		
Response time	Typ. 67 ms		
Detection distance range	0.05 to 5 m	0.05 to 10 m	0.05 to 25 m
Max. detection distance of 10 % reflector	5 m	8 m	
Detection distance error	System error: Typ. ± 60 mm, statistical error: Typ. 20 mm (1 σ)		
Min. object size <sup>01)</sup>	At detection distance of 8 m: ≈ 121 mm		
Angular resolution	0.33°		
Aperture angle	270°		
Object reflectivity	> 4 %		
Number of field sets	16 (1 set: Consists of subfields 1, 2, 3)		
Number of field sets that can be used concurrently	1		
Unit weight (package)	≈ 228 g (314 g)		
Approval	CE,		

01) Even objects smaller than the set min. object size can be detected depending on the environment.

Power supply	9 - 28 VDC≐
Power consumption <sup>01)</sup>	< 4 W
Input	4 Photocoupler inputs - H: ≥ 9 - 28 VDC≐, L: ≤ 3 VDC≐
Output signal	NPN-PNP open collector output setting (software)
Load voltage	9 - 28 VDC≐
Load current	≤ 100 mA
Residual voltage	≤ 3.0 VDC≐
Insulation resistance	≥ 5 MΩ (500 VDC≐ megger)
Dielectric strength	500 VAC ~ 50 / 60 Hz for 1 minute
Vibration	10 sweep cycles in each X, Y, Z axes at sine wave, 10 to 500 Hz, acceleration 5 G
Vibration (malfunction)	10 minutes in each X, Y, Z axes at sine wave, 10 to 500 Hz, acceleration 5 G
Vibration (irregular)	5 hours in each X, Y, Z axes at 5 to 250 Hz, 42.4 m/s <sup>2</sup> RMS
Shock	3 times in each X, Y, Z axes at sine half wave, acceleration 50 G, duration 11 ms
	1000 times in each X, Y, Z axes at sine half wave, acceleration 25 G, duration 6 ms
	5000 times in each X, Y, Z axes at sine half wave, acceleration 50 G, duration 3 ms
Shock (malfunction)	6 times in each X, Y, Z axes at sine half wave, acceleration 50 G, duration 11 ms
Ambient illuminance	≤ 80,000 lx
Ambient temperature	-10 to 50 °C, storage: -30 to 70 °C (no freezing or condensation)
Ambient humidity	0 to 95 %RH, storage: 0 to 95 %RH (no freezing or condensation)
Protection structure	IP67 (IEC standard)
Connector specification	Power I / O: M12 12-pin, Ethernet: M12 8-pin
Material	Case: AL, Window: PC

01) Excluding power supplied to the load

## Communication Interface

### ■ Ethernet

Communication protocol	TCP/IP
Communication speed	100BASE-TX
Baud rate	100 Mbps

## Components: Connector Cap

- Connector cap protects unused Ethernet connector from foreign substances.



## Sold Separately: Power I/O Cable (CID-□-VG, CLD-□-VG)

- Unit: mm, For the detailed drawings, follow the Autonics web site.
- Cable length L (m): 2 m, 5 m, 10 m

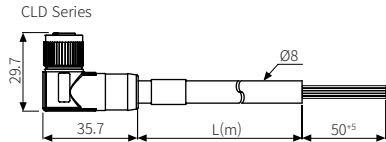
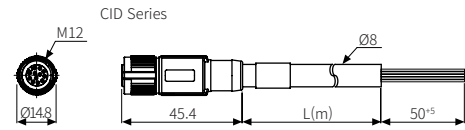

## Sold Separately: Ethernet Cable (C18-□R-A, C48-□R-A)

- Unit: mm, For the detailed drawings, follow the Autonics web site.
- Cable length L (m): 2 m ± 45 mm, 5 m ± 45 mm, 10 m ± 45 mm

C18-□R-A Series

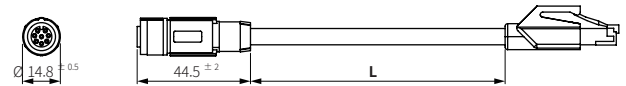

C48-□R-A Series

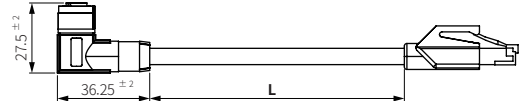

## Filter

### ■ Particle

It uses continuous scan data to block the measurement of fine objects such as static objects or dust when detecting backgrounds.

- Factory default: OFF (disable)
- Setting range: ON / OFF

### ■ Median

Outputs the median of the measurements at three adjacent scan angles. Displays to three decimal places.

- Factory default: OFF (disable)
- Setting range: ON / OFF

Scan angle	0°	0.33°	0.66°	1°	1.33°	1.66°
Ex) Scan 1 (m)	8.3	8.52	8.51	8.49	8.5	8.5
Scan 1 output <sup>01)</sup> (m)	8.51					8.5

01) The number of data is reduced by 1/3 as the Scan 1 output value when the Median filter is applied.

### ■ Average

Scans the same place multiple times (up to 4 times) and outputs the average value which is calculated except when the scan value is 0. Displays to three decimal places. This filter makes the distance value rise smoothly.

- Factory default: OFF (disable)
- Setting range: OFF, 2 to 4

Ex) The table below is the scan value for each round of a specific angle. If the moving average setting value is set to 4, the average of 4 consecutive scan values is output.

Scan numbers	1	2	3	4	5	6
Scan value (m)	8.3	8.52	8.51	8.49	8.5	0

Scan 1 output value (m) = 8.455 (average of scan values from 1 to 4th)

Scan 2 output value (m) = 8.505 (average of scan values from 2 to 5th)

Scan 3 output value (m) = 8.5 (average of scan values from 3 to 5th, except 6th scan value as 0)

## Field set

Field to scan an object area is available to set up to 16.

Each set of fields consists of subfield 1 (OUT1) to subfield 3 (OUT3).

A combination of signals IN1 to IN4 activates the desired field set. Refer to the table below.

Field set	IN1	IN2	IN3	IN4	Initial value of subfield 1	
					Model <sup>01)</sup>	Size <sup>02)</sup>
1	0	0	0	0	Rectangle	L (m) × W (m) = 1 × 2
2	1	0	0	0		L (m) × W (m) = 1.25 × 2
3	0	1	0	0		L (m) × W (m) = 1.5 × 2
4	1	1	0	0		L (m) × W (m) = 1.75 × 2
5	0	0	1	0		L (m) × W (m) = 1 × 2
6	1	0	1	0		L (m) × W (m) = 1.25 × 2
7	0	1	1	0		L (m) × W (m) = 1.5 × 2
8	1	1	1	0		L (m) × W (m) = 1.75 × 2
9	0	0	0	1	Semicircle (180°)	R (m) = 2
10	1	0	0	1		R (m) = 3
11	0	1	0	1		R (m) = 4
12	1	1	0	1		R (m) = 5
13	0	0	1	1	Sector (270°)	R (m) = 2
14	1	0	1	1		R (m) = 3
15	0	1	1	1		R (m) = 4
16	1	1	1	1		R (m) = 5

01) Each subfield can be configured in the form of rectangles, circles, segments, etc. by adjusting the mouse cursor and pixels in the software.

02) Automatically set to  
initial value of subfield 2 = 50 % of initial value of subfield 1  
initial value of subfield 3 = 25 % of initial value of subfield 1

## Teaching

The ability to pre-train field sets. During teaching, objects within the detection range are not detected.

If there is no additional setting, teaching applies to subfield 1 of field set 1.

For the other field set teaching, select the field set number in the software before teaching or export the teaching data file applied to field set 1 and import into the desired field set.

- Re-teaching when the environment changes or objects are added or removed in the same space.
- Teach in an environment where there is no mutual interference between laser scanners.

### ■ Teaching button

After selecting the teaching button activation function of the software, press the teaching button on the front of the product for more than 3 seconds to start teaching.

### ■ IN4 signal

After selecting the teaching input activation function of IN4 in software, if a signal is applied to IN4 for more than the debounce setting time, teaching starts.

- Debounce factory default: 100 ms
- Setting range: 1 to 5000 ms

### ■ Software

Use atLiDAR to execute the teaching function.