

Safety Slim Type Door Lock Switch



SFDL2 Series PRODUCT MANUAL

For your safety, read and follow the considerations written in the instruction manual, other manuals and Autonics website.

The specifications, dimensions, etc. are subject to change without notice for product improvement. Some models may be discontinued without notice.

Main Features

- Slim size W 90 x H 105 x D 35.5 mm
- Head unit can be rotated to change insert direction of operation key
 - : Operation key can be inserted from 4 directions (top/sides)
- Various contact types (up to 6-contacts)
 - : Lock N.C. 2/N.O. 1+Door N.C. 2/N.O.1
 - Lock N.C. 3+Door N.C. 2/N.O.1
 - Lock N.C. 2/N.O. 1+Door N.C. 3
 - Lock N.C. 3+Door N.C. 3
- Manual unlock function (release key) for emergencies during installation or testing
 - : Standard (cross) type and special type release keys, rear release button
- Two lock-release methods
 - : Mechanical lock-solenoid release, solenoid lock-mechanical release models
- Different installation types depending on operation key insertion position
 - : Front / rear installation models
- Excellent strength and durability with metal head model

Safety Considerations

- Observe all 'Safety Considerations' for safe and proper operation to avoid hazards.
- ⚠ symbol indicates caution due to special circumstances in which hazards may occur.

⚠ Warning Failure to follow instructions may result in serious injury or death.

- 01. Fail-safe device must be installed when using the unit with machinery that may cause serious injury or substantial economic loss. (e.g. nuclear power control, medical equipment, ships, vehicles, railways, aircraft, combustion apparatus, safety equipment, crime/disaster prevention devices, etc.)**
Failure to follow this instruction may result in personal injury, economic loss or fire.
- 02. System manager means followings;**
 - a personnel who is fully aware of installation, setting, operation, and maintenance of the product
 - a personnel who well observes standard/regulation/statute on the product by type of machine the product installed in and nation/region the product used in

Machine user means a personnel who is appropriately trained about using machine by the system manager, so that machine user can operate the machine correctly.
System manager has duty to train the machine user about operation of the product.
Machine user has to report directly to the system manager when unusual status has been found while system is operating.
- 03. The product has to be installed, set, and combined with machine control system by the qualified system manager.**
Failure to follow this instruction may result in personal injury due to unintended operation and unstable detection.
- 04. Before using the product, check that function of the product operates as intended while machine is turned off after installation.**
Failure to follow this instruction may result in personal injury due to unintended operation and unstable detection.
- 05. Do not use the unit in the place where flammable/explosive/corrosive gas, high humidity, direct sunlight, radiant heat, vibration, impact, salinity, moisture, or steam, or dust may be present.**
Failure to follow this instruction may result in explosion or fire.
- 06. Do not disassemble or modify the unit.**
Failure to follow this instruction may result in personal injury or fire due to loss of safety function.
- 07. Do not defeat, tamper, modify, or bypass the switch and enter the door.**
Failure to follow this instruction may result in personal injury.
- 08. Be cautious about the installing place of the operation key in order to protect worker from hitting the operation key when the door is opened.**
Failure to follow this instruction may result in personal injury.
- 09. Do not use a head of other product.**
Failure to follow this instruction may result in personal injury or fire due to loss of safety function.
- 10. Install separate safety device to fix door closed, or door can be opened because of vibration or weight of the door.**
Failure to follow this instruction may result in personal injury.
- 11. Check the installed status of the switch, operating status of the switch, and signs of damage, modification, tampering of the switch at the following situation and on a weekly basis.**
 - when operating the safety system at first
 - when replacing component of the system
 - when the system has not been operated for a long time
- 12. Solenoid Lock/Mechanical Release type switch is locked with power connected and is unlocked without power. Be cautious that the switch can be unlocked before complete stop of the machine when blackout occurs.**
Failure to follow this instruction may result in personal injury.
- 13. Check 'Connections' before wiring.**
Failure to follow this instruction may result in fire.

⚠ Caution Failure to follow instructions may result in injury or product damage.

- 01. Use the unit within the rated specifications.**
Failure to follow this instruction may result in fire or product damage.
- 02. Since solenoid has polarity, wire cables and supply voltage ensuring correct polarity. Do not supply voltage above the rated voltage specification.**
Failure to follow this instruction may result in fire or solenoid damage.
- 03. Be sure to install the cover after wiring work, and do not apply power with the cover open.**
Failure to follow this instruction may result in electric shock.
- 04. Use a dry cloth to clean the unit, and do not use water or organic solvent.**
Failure to follow this instruction may result in fire.
- 05. Keep the door switch away from debris and tighten the screw securely when replacing the head.**
Failure to follow this instruction may result in malfunction.
- 06. Keep the product away from metal chip, dust, and wire residue which might flow into the unit.**
Failure to follow this instruction may result in fire, product damage or malfunction.
- 07. Do not use metallic cable gland.**
Failure to follow this instruction may result in electric shock due to the damage on the service entrance.
- 08. Do not use the switch as a guard door stopper. Install separate mechanical stopper.**
Failure to follow this instruction may result in product damage.
- 09. Carefully manage the spare operation key in order to prevent use of the key without permission.**
Failure to follow this instruction may result in loss of safety function due to insertion of the spare operation key.
- 10. Use only Autonics operation key.**
Failure to follow this instruction may result in product damage.

- Install the operation key tightly within the range written in 'Installation' with welding, rivet, or special bolt in order not to be easily released from the switch.
Failure to follow this instruction may result in product damage.
- When it comes to the Solenoid Lock/Mechanical Release model, make it to be locked by supplying power after the door is closed.
Failure to follow this instruction result in malfunction, if the power is supplied when the door is opened.
- When changing the direction of the head, make sure that the cam inside the head does not rotate.
Failure to follow this instruction result in malfunction.

Cautions during Use

- Follow instructions in 'Cautions during Use'. Otherwise, it may cause unexpected accidents.
- Use the switch with the dedicated controller. Do not use the switch with another controller randomly.
- This unit may be used in the following environments.
 - Indoors (in the environment condition rated in 'Specifications')
 - Altitude max. 2,000m
 - Pollution degree 3
 - Installation category III
 - Enclosure Type 1

Product Components

- Product
- Instruction manual
- Special type release key (Special type release key model)

Sold Separately

- Operation key: SFD-K□□

Ordering Information

This is only for reference, the actual product does not support all combinations. For selecting the specified model, follow the Autonics website.

SFDL2 - ① ② 6 ③ - ④ ⑤ ⑥ ⑦ - ⑧

① Head material

No mark: Metallic
P: Plastic

② Lock/Release method

M: Mechanical Lock/Solenoid Release
S: Solenoid Lock/Mechanical Release

③ Contact composition

A: Lock 2 N.C./1 N.O. + Door 2 N.C./1 N.O.
B: Lock 3 N.C. + Door 2 N.C./1 N.O.
C: Lock 2 N.C./1 N.O. + Door 3 N.C.
D: Lock 3 N.C. + Door 3 N.C.

④ Installation direction

No-mark: Front installation
B: Rear installation

⑤ Connection outlet specification

M20: M20 thread
G1/2: G1/2 thread

⑥ Release key type

No-mark: Cross type
K: Special type

⑦ Rear release button

No-mark: None
B: Exist

⑧ Release key position

No-mark: Front
T: Bottom

Specifications

| Model | SFDL2-□□□□□□-□ SFDL2-□□□□□□K-□ | SFDL2-□□□□□□ B-□ SFDL2-□□□□□□KB-□ |
|----------------------------|---|--------------------------------------|
| Directing opening force | ≥ 80 N | |
| Directing opening distance | ≥ 10 mm | |
| Locking pullout strength | ≥ 1,300 N | |
| Operating speed | 0.05 to 1 m/s | |
| Operating frequency | ≤ 20/min | |
| Mechanical life cycle | ≥ 1,000,000 operations (20/min) | |
| Indicator | Solenoid status or contact status (orange, depending on connection) | - |
| Vibration (malfunction) | 0.35mm amplitude at frequency of 10 to 55 Hz (for 1 min) in each X, Y, Z direction for 10 min | |
| Shock | 1,000 m/s ² (≈ 100 G) in each X, Y, Z direction for 3 times | |
| Shock (malfunction) | 80 m/s ² (≈ 8 G) in each X, Y, Z direction for 3 times | |
| Ambient temperature | -10 to 55°C, storage: -25 to 65°C (a non freezing or condensation environment) | |
| Ambient humidity | 35 to 85%RH, storage: 35 to 85%RH (a non freezing or condensation environment) | |
| Protection structure | IP67 ⁽¹⁾ (IEC standard, except for head) | |
| Material | Head: zinc or PA, case: PA | |
| Approval | CE (TUV NORD) | |
| Accessory | SFDL2-□□□□□□K/KB-□ (Special type release key): rotating key | |
| Unit weight (packaged) | Normal type: ≈ 400 g (≈ 490 g), rear release button type: ≈ 395 g (≈ 485 g) | |

(1) Rated protection structure is for the switch body. Be cautious about preventing the head part from entering the foreign materials such as dust and water.

| Contact block | |
|-----------------------------------|--|
| Rated voltage/current for load | Resistive load: 6 A/250 VAC~, 0.6 A/250 VDC= Inductive load (IEC): AC-15 3 A/240 VAC~, DC-13 0.27 A/250 VDC= Inductive load (UL): A300, Q300 |
| Impulse dielectric strength | Between the terminals of same polarity: 2.5 kV Between the terminals of different polarity: 4 kV Between each terminal and non-live part: 6 kV |
| Insulation resistance | ≥ 100 MΩ (500 VDC= megger) |
| Contact resistance | ≤ 100 mΩ |
| Electrical life cycle | ≥ 100,000 operations (250 VAC~/6 A) |
| Conditional short-circuit current | 100 A |
| Solenoid | |
| Rated voltage | 24 VDC=, class 2 |
| Current consumption | Supplying power: 0.26A Normal: max. 0.2A (approx. 3 seconds after supplying power) |
| Insulation class | Class E |
| Indicator LED | |
| Rated voltage | 24 VDC= |
| Current consumption | 2.2 mA |

Contact Composition and Operation

Connection diagram represents the locked status with the operation key inserted.

■ ON, □ OFF

⊖ Direct opening action possible

| Model | Contact (lock monitor+ door monitor) | Connection diagram | | | | Contact operation |
|-----------------------|--------------------------------------|--------------------|--------------|--|--|--|
| | | Door monitor | Lock monitor | | | |
| | | | | | | Operation key complete insertion Operation key extraction |
| SFDL2-□□□6A -□□□□□ | 2N.C./1N.O.+ 2N.C./1N.O. | | | | | Lock position 11-42 21-52 33-34 63-64 |
| SFDL2-□□□6B -□□□□□ | 3N.C.+2N.C./1N.O. | | | | | Lock position 11-42 21-52 33-34 61-62 |
| SFDL2-□□□6C -□□□□□ | 2N.C./1N.O.+3N.C. | | | | | Lock position 11-42 21-52 31-32 63-64 |
| SFDL2-□□□6D -□□□□□ | 3N.C.+3N.C. | | | | | Lock position 11-42 21-52 31-32 61-62 |

Installation

- The head of the switch can be rotated by loosening the four screws from the corners of the head and reinstalling the head in the desired orientation.
- Be sure to install the switch with the minimum radius at a hinged door as shown in the table.

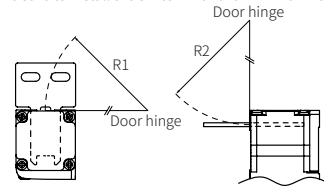

| Operation key | Minimum radius | |
|---------------|----------------|--------|
| | R1 | R2 |
| SFD-KH | 300 mm | 300 mm |
| SFD-KL | 300 mm | 300 mm |
| SFD-KHR | 300 mm | 300 mm |
| SFD-KLR | 300 mm | 300 mm |
| SFD-KLF | 50 mm | 300 mm |
| SFD-KLF2 | 50 mm | 300 mm |

- Inspect the inserted operation key remains within the set zone (0.5 to 3 mm).
- Recommended screw tightening torque

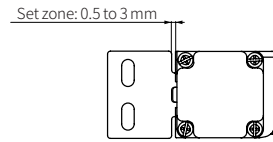

| Screw | Tightening torque |
|---------------------------|-------------------|
| Terminal screw (M3.5) | 0.6 to 0.8 N m |
| Terminal block screw (M3) | 0.3 to 0.5 N m |
| Coverscrew (M3) | 0.7 to 0.9 N m |
| Head mounting screw (M3) | 0.7 to 0.9 N m |
| Cable gland | 2.7 to 3.3 N m |
| M20 NUT, G1/2 NUT | 1.3 to 1.5 N m |

- Install the operation key within ± 1 mm from the center of the operation key hole.
- Cable gland specification and recommended product

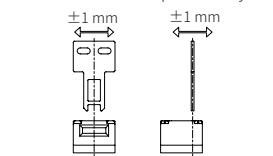

| Thread spec | MFR | Model | Cable Ø |
|-------------|-----------|------------------------|-------------------------|
| G1/2 | CP SYSTEM | FCGL-G12B FCGL-G16B | 4 - 8 mm 7 - 12.3 mm |
| M20 | LAPP | ST-M20X1.5 / 5311-1020 | 6 - 13 mm |

- In case of using the cable gland with the 9 mm screw thread or longer, a gap between the switch and cable may affect the protection structure.
- When closing the cover, set the release key to the LOCK position. It may cause product damage.
- If the seal rubber is detached or lifted, or if foreign substances are attached to the seal rubber, it may cause deterioration of the sealing force. Check that there is no problem with the seal rubber before use.
- Do not use other than regular screws. There is a risk that the sealing power may decrease.

Connections

- When wiring with the ring crimp terminal, connect the terminals as shown in figure for the cable not to override to the case and cover.
- Use the UL approved ring crimp terminal listed in below. Bend the terminal as following figure to use.

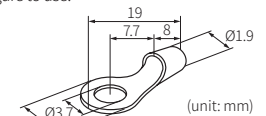
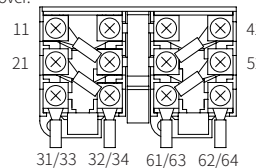

| Manufacturer | Model |
|--------------|---|
| JST | FN0.5-3.7 (flared type) N0.5-3.7 (straight type) |

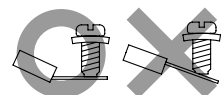

Manual Unlock

- Do not use the release key or rear release button to stop the machine.

Release key

| Release key | Normal | Manual unlock |
|--------------|--------|---------------|
| Cross type | | |
| Special type | | |

- Release key position

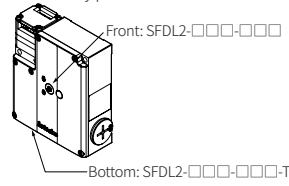

- You can manually unlock the switch in the emergency situation such as blackout, when wiring, before supplying power, or when testing operation of the switch.
- When using the release key, turn it to the marked position completely. Otherwise (under 90°), switch can be damaged or malfunction.
- Do not apply the power over 0.2 N·m on the release key. It can be result in product damage.

Rear release button

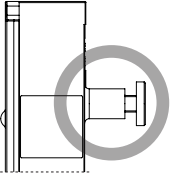

- It is possible to manually unlock by pressing the rear release button. Use only for emergency evacuation when workers are trapped in the work area.
- When using the rear release button, press it all the way down, and after use, pull it all the way back to its original state. Otherwise, the switch may be damaged or may not function properly.
- The door will not lock while the button is pressed.

Dimensions

- Unit: mm, For the detailed dimensions of the product, follow the Autonics web site.

Front installation

- The parts marked with a dotted line are dimensions applicable only to the rear release button existing type.

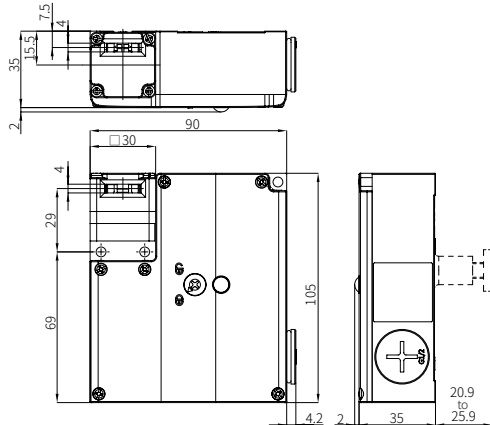

Rear installation

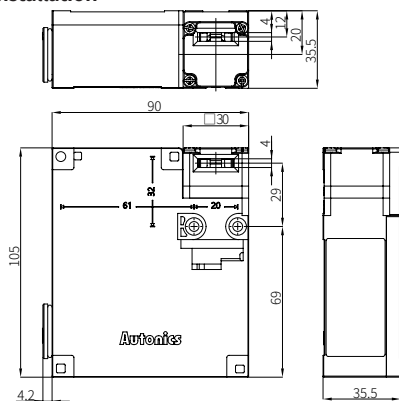

Panel cut-out

- Front installation

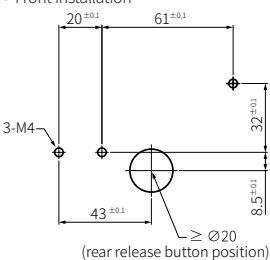

- Rear installation

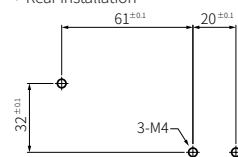

Sold Separately: Operation Key

- Unit: mm, For the detailed dimensions of the product, follow the Autonics web site.

SFD-KH

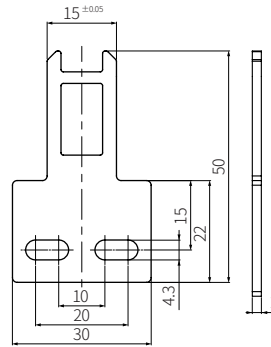

SFD-KL

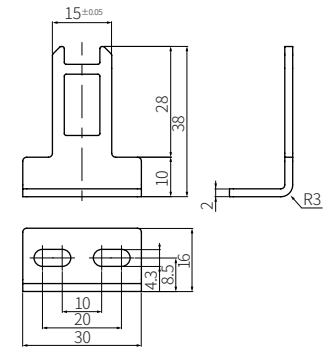

SFD-KHR

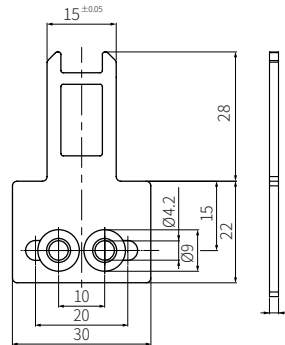

SFD-KLR

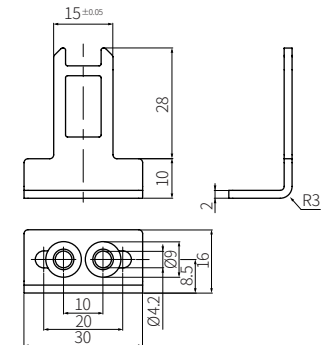

SFD-KLF, SFD-KLF2

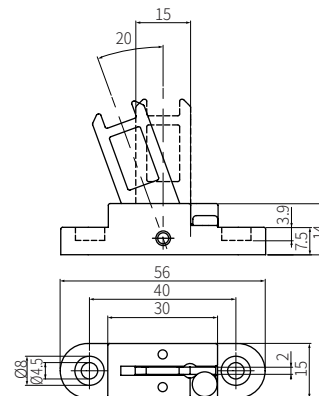

| Model | Material |
|----------|---|
| SFD-KLF | Operation key: stainless steel 304, base: polyamide |
| SFD-KLF2 | Operation key: stainless steel 304, base: zinc |