

# Mitsubishi Electric AC Servo System MELSERVO-JET

Innovate Together

MITSUBISHI ELECTRIC SERVO SYSTEM  
**MELSERVO-JET**



# GLOBAL IMPACT OF MITSUBISHI ELECTRIC



Through Mitsubishi Electric's vision, "Changes for the Better" are possible for a brighter future.

## ***Changes for the Better***

"Changes for the Better" represents the Mitsubishi Electric Group's attitude to "always strive to achieve something better", as we continue to change and grow. Each one of us shares a strong will and passion to continuously aim for change, reinforcing our commitment to creating "an even better tomorrow".

Mitsubishi Electric is involved in many areas including the following:

### **Energy and Electric Systems**

A wide range of power and electrical products from generators to large-scale displays.

### **Electronic Devices**

A wide portfolio of cutting-edge semiconductor devices for systems and products.

### **Home Appliance**

Dependable consumer products like air conditioners and home entertainment systems.

### **Information and Communication Systems**

Commercial and consumer-centric equipment, products and systems.

### **Industrial Automation Systems**

Maximizing productivity and efficiency with cutting-edge automation technology.

Our advances in AI and IoT are adding new value to society in diverse areas from automation to information systems. The creation of game-changing solutions is helping to transform the world, which is why we are honored to be recognized in the 2019 "Forbes Digital 100" as one of world's most influential digital corporations.



# OVERVIEW

■ <b>Concept</b> .....	4
■ <b>Product Lines</b> .....	8
■ <b>Servo System</b> .....	10
■ <b>Servo System Controllers</b> .....	18
■ <b>Embedded Type Servo System Controller</b> .....	52
■ <b>MELSERVO-JET</b> .....	60
■ <b>Mitsubishi Electric Solutions/Partners/FA Global Website</b> .....	74
■ <b>Common Specifications (Combinations of Rotary Servo Motors and Servo Amplifiers, etc.)</b> .....	1-1
■ <b>Product Specifications of Servo System Controllers</b> .....	2-1
■ <b>MELSERVO-JET Product Specifications</b>	
Servo Amplifiers .....	3-1
Rotary Servo Motors .....	4-1
Linear Servo Motors.....	5-1
Options/Peripheral Equipment .....	6-1
Low-Voltage Switchgear/Wires .....	7-1
■ <b>Product List</b> .....	8-1
■ <b>Precautions</b> .....	9-1
■ <b>Support</b> .....	10-1





# Create new value with MELSERVO-JET. Unlock performance with a total drive solution.

Optimize system performance



## Easy, Simple & Practical

- Simple top & bottom wiring
- Quick tuning
- Unified height and depth across all servo amplifier capacities



## Superior Performance

- Speed frequency response: 2.5 kHz
- Encoder resolution: 22 bit
- Maximum torque: 350 %



## Better Flexibility

- Supports EtherCAT®

# Crafted from a different perspective, increase your productivity with a next

The MELSERVO-JET Series servo system performs basic functions at a high level, while its high-speed, high-precision capabilities help increase the productivity of your machines.

CC-Link **IE TSN**

MELSEC **iQ-F**  
series

MELSEC **iQ-R**  
series



FX5-40SSC-G  
FX5-80SSC-G

RD78GH

RD78G

Motion Module

CC-Link **IE TSN**

Personal Computer Embedded Type  
Servo System Controller



Motion Control Software  
SWM-G

## CC-Link IE TSN

CC-Link IE TSN supports TCP/IP communications and applies it to industrial architectures through its support of TSN enabling real-time communications. With its flexible system architecture and extensive setup and troubleshooting features make CC-Link IE TSN ideal for building an IIoT infrastructure across the manufacturing enterprise.

The communications speed is 1 Gbps.

\* TSN: Time Sensitive Networking  
\* IIoT: Industrial Internet of Things

CC-Link **IE TSN**

## Servo System Controllers

The personal computer-compatible SWM-G Motion Control Software is available in our product line in addition to MELSEC iQ-R/iQ-F Motion modules.

### Motion Modules

The Motion modules utilize a multi-core processor to achieve enhanced basic performance.

The Simple Motion mode is available in addition to PLCopen® motion control FB mode.

### Motion Control Software

SWM-G Motion Control Software enables software-based motion control in a PC environment.

# generation servo system

CC-Link **IE TSN** Ether**CAT**®



**Servo amplifiers**  
MR-JET-G (CC-Link IE TSN)  
MR-JET-G-N1 (EtherCAT®)

Speed frequency response  
**2.5 kHz**

Minimum communication cycle  
**125 μs**



**Rotary servo motors**  
HG-KNS  
HG-SNS

Encoder \*1  
**Absolute position encoder**

Encoder resolution  
**22 bit**

Max. speed \*2  
**6000 r/min**

\*1. A battery is required when configuring an absolute position detection system.  
\*2. The servo motor speed varies by the models.

## Servo Amplifiers

The MELSERVO-JET series high-performance servo amplifiers feature a unique control engine that is more powerful than ever before.

These servo amplifiers can connect to CC-Link IE TSN to perform high-speed, high-precision control.

The servo amplifiers also support CC-Link IE Field Network Basic.

EtherCAT® is supported by MR-JET-G-N1.

## Rotary Servo Motors

The HG-KNS/HG-SNS series rotary servo motors are equipped with a 22-bit resolution absolute/incremental position encoder.

The servo motors have the same dimensions and use the same power and encoder cables as the prior HG series servo motors.

MITSUBISHI ELECTRIC SERVO SYSTEM  
**MELSERVO-JET**

# Innovate Together

## CONTROLLER

### Programmable Controllers



MELSEC iQ-R



MELSEC iQ-F

### CC-Link IE TSN- Compatible Motion Control Software

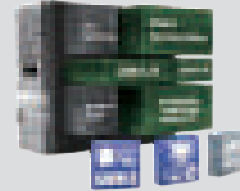

SWM-G

### CC-Link IE TSN-Compatible Motion Modules



RD78G



RD78GH



FX5-SSC-G

## INTERFACE

### CC-Link IE TSN

### EtherCAT®



## SERVO AMPLIFIER

### CC-Link IE TSN-Compatible Servo Amplifiers



MR-JET-G

### EtherCAT®-Compatible Servo Amplifiers

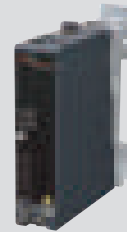

MR-JET-G-N1

\* MR-JET-G is also compatible with CC-Link IE Field Network Basic.

\* Use an EtherCAT®-compatible master module.

## SERVO MOTOR

### Rotary Servo Motors



Small capacity,  
low inertia  
**HG-KNS Series**  
Capacity: 0.1 to 0.75 kW



Medium capacity,  
medium inertia  
**HG-SNS Series**  
Capacity: 0.5 to 3.0 kW

### Linear Servo Motors



Core type  
**LM-H3 Series**  
Rating: 70 to 720 N



Core type  
**LM-AJ Series**  
Rating: 68.1 to 446.8 N



**NEW**  
Coreless type  
**LM-AU Series**  
Rating: 28 to 350 N

Create new value with MELSERVO-JET.  
Unlock performance with a total drive solution.

■ Servo System Controllers

Servo system controllers		Maximum number of control axes	Features
Motion modules	RD78G RD78GH	RD78G: 4, 8, 16, 32, 64 RD78GH: 128, 256 <sup>(Note 2)</sup>	MELSEC iQ-R series CC-Link IE TSN-compatible Motion module <ul style="list-style-type: none"> <li>Performs motion control (positioning, synchronous, cam, speed, and torque control)</li> <li>Maximum number of connectable stations: 120</li> <li>Minimum operation cycle RD78G: 62.5 [μs], RD78GH: 31.25 [μs] <sup>(Note 3)</sup></li> <li>Number of slots occupied RD78G: 1, RD78GH: 2</li> </ul>
	FX5-SSC-G	FX5-40SSC-G: 4 FX5-80SSC-G: 8	MELSEC iQ-F series CC-Link IE TSN-compatible Motion module <ul style="list-style-type: none"> <li>Performs motion control (positioning, synchronous, cam, speed, and torque control)</li> <li>Maximum number of connectable stations FX5-40SSC-G: 20, FX5-80SSC-G: 24</li> <li>Minimum operation cycle: 500 [μs]</li> <li>Number of connectable modules: 4 modules/FX5U or FX5UC</li> </ul>
Motion Control Software	SWM-G	16, 32, 64, 128	CC-Link IE TSN-compatible Motion Control Software for personal computers <sup>(Note 1)</sup> <ul style="list-style-type: none"> <li>Performs motion control (positioning, synchronous, cam, speed, and torque control)</li> <li>Maximum number of connectable stations: 128</li> <li>Includes Real Time OS (RTX64), which enables SWM-G to perform a real-time operation without being affected by the operation on Windows®</li> <li>Programming language: Visual C++®</li> </ul>

Notes: 1. A personal computer and Visual Studio® are not included and must be prepared by the user.  
2. When MR-JET-G servo amplifiers are used for all axes, the maximum number of the control axes is 120.  
3. When an MR-JET-G is connected to the controller, the minimum operation cycle is 125 μs.

■ Servo Amplifiers

●: Supported

Servo amplifiers	Power supply specifications	Rated output [kW] <sup>(Note 1)</sup>	Interface <sup>(Note 2)</sup>	Control mode			Fully closed loop control
				Position	Velocity	Torque	
MR-JET-G	200 V AC	0.1, 0.2, 0.4, 0.75, 1.0, 2.0, 3.0	CC-Link IE TSN	●	●	●	●
MR-JET-G-N1			EtherCAT®				

Notes: 1. The value listed is the servo amplifier rated output. Refer to "Combinations of Rotary Servo Motors and Servo Amplifiers" for compatible servo motors.  
2. MR-JET-G is also compatible with CC-Link IE Field Network Basic.

■ Rotary Servo Motors

●: Supported

Rotary servo motor series	Rated speed (maximum speed) [r/min]	Rated output [kW]	With an electro-magnetic brake (B)	With an oil seal (J)	IP rating <sup>(Note 1)</sup>	Features
Small capacity HG-KNS series	3000 (6000)	0.1, 0.2, 0.4, 0.75	●	●	IP65	Low inertia 22-bit absolute position encoder <sup>(Note 3)</sup>
Medium capacity HG-SNS series	2000 (3000/2500) <sup>(Note 2)</sup>	0.5, 1.0, 1.5, 2.0, 3.0	●	●	IP67	Medium inertia 22-bit absolute position encoder <sup>(Note 3)</sup>

Notes: 1. The shaft-through portion is excluded.  
2. The maximum speed of the servo motor of 3.0 kW is 2500 r/min.  
3. A battery is required when configuring an absolute position detection system.

■ Linear Servo Motors

Linear servo motor series	Maximum speed [m/s]	Continuous thrust [N]	Maximum thrust [N]	Features	Application examples
LM-H3 series	3.0	70, 120, 240, 360, 480, 720	175, 300, 600, 900, 1200, 1800	Suitable for space-saving Compact size and high thrust Maximum speed: 3 m/s	Mounters Wafer cleaning systems FPD assembly machines Material handlings
LM-AJ series	2.0 to 6.5	68.1, 117.0, 136.2, 174.5, 223.4, 234.0, 348.9, 446.8	214.7, 369.0, 429.4, 550.2, 704.5, 738.1, 1100.4, 1409.1	Low installation height, and suitable for compact X-Y tables	Semiconductor manufacturing systems FPD assembly machines
LM-AU series	2.0 to 4.5	28, 44, 57, 85, 88, 113, 132, 176, 264, 350	122, 274, 280, 411, 549, 561, 842, 970, 1684, 1764	No cogging and small speed fluctuation No magnetic attraction force structure extends life of the linear guides.	Screen printing systems Scanning exposure systems Inspection systems Material handlings

SOFTWARE

MELSOFT GX Works3	MELSOFT MR Configurator2	Drive System Sizing Software Motorizer
----------------------	-----------------------------	---



## Construct a high-performance servo system using our extensive product line

We understand that each system is different and has unique drive control requirements.

To meet these demands, we have expanded the product line for our next-generation servo system to offer engineering software, servo system controllers, servo amplifiers, servo motors, and a variety of other components.

Mitsubishi Electric is dedicated to satisfying all of our customers' needs.

### Simple programming

CC-Link IE TSN-compatible SWM-G  
Motion Control Software

Motion modules  
FX5-40SSC-G  
FX5-80SSC-G

Motion modules  
RD78G  
RD78GH

GOT

MELIPC

Servo amplifier  
MR-JET-G

MITSUBISHI ELECTRIC SERVO SYSTEM  
**MELSERVO-JET**

Servo motors



### Collaborating with our extensive group of partners allows us to flexibly support your system needs

Servo systems are constructed using iQ Platform devices such as controllers, servo drivers, actuators, and sensors, and collaboration with our partner companies allows us to expand the number of possibilities available to customers. For example, partner products such as stepping motors, direct drive motors, vision systems, and various types of software are available to keep your equipment on the cutting edge.

### Single network

CC-Link I E TSN



Servo System

Servo System Controllers

Embedded Type Servo System Controller

Servo Amplifiers / Servo Motors



# Open integrated networking across the manufacturing enterprise

## CC-Link IE TSN

CC-Link IE TSN supports TCP/IP communications and applies it to industrial architectures through its support of TSN enabling real-time communications. With its flexible system architecture and extensive setup and troubleshooting features make CC-Link IE TSN ideal for building an IIoT infrastructure across the manufacturing enterprise.

\* TSN: Time Sensitive Networking  
 \* IIoT: Industrial Internet of Things

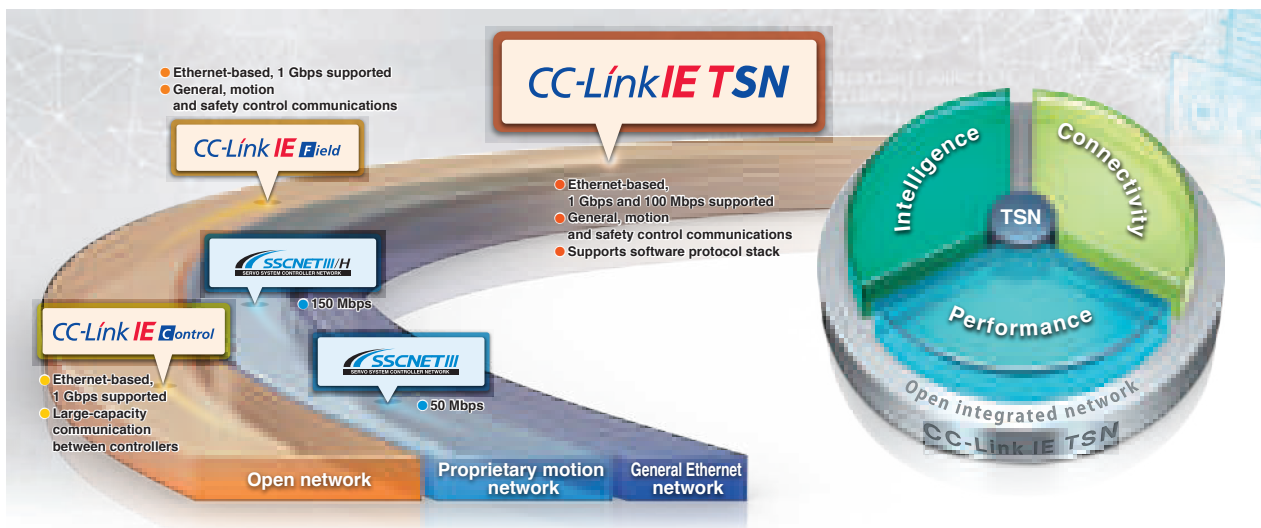

### Real-Time Network Performance Even When Integrated with Information Data

TSN technology enables mixing of deterministic communications with IT system information data on the same network. Giving higher priority to CC-Link IE TSN cyclic communications and TCP/IP communications by allocating increased network bandwidth, devices using general Ethernet communications can be connected on the same network while maintaining real-time control communication performance.

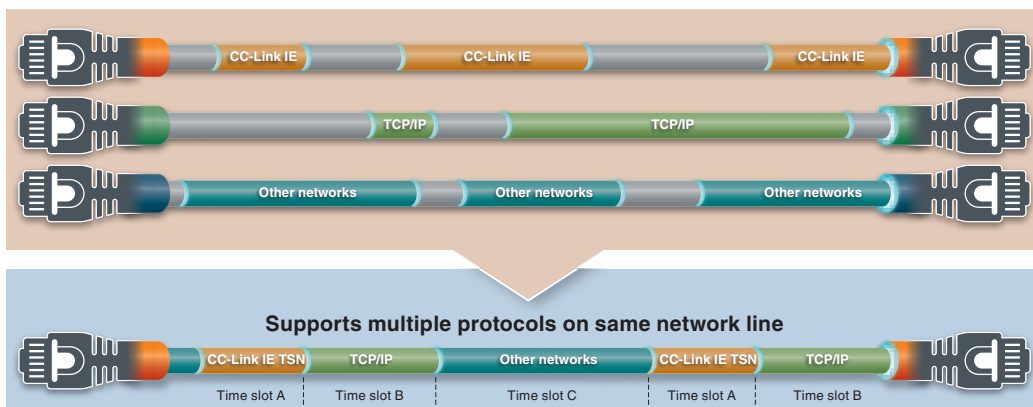

## Deterministic Control Even When Mixed with TCP/IP Communication

Deterministic performance of cyclic communication is maintained even when mixed with slower information data (non real-time). This enables TCP/IP communication devices to be used without affecting overall control.

\* Some devices cannot be connected to CC-Link IE TSN depending on the system configuration.

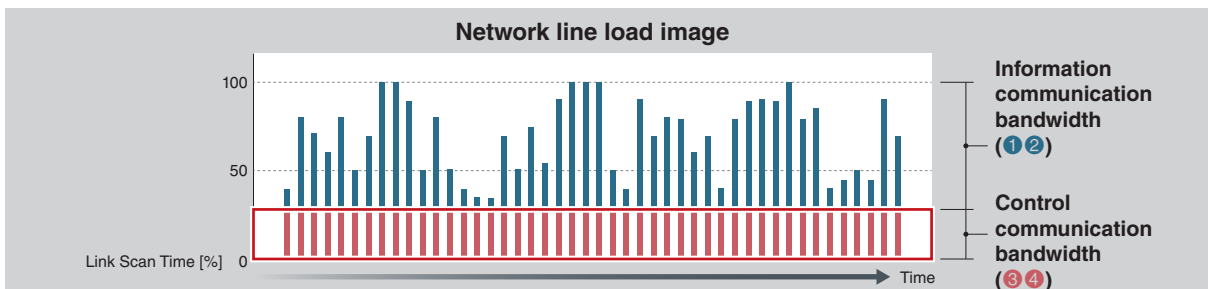
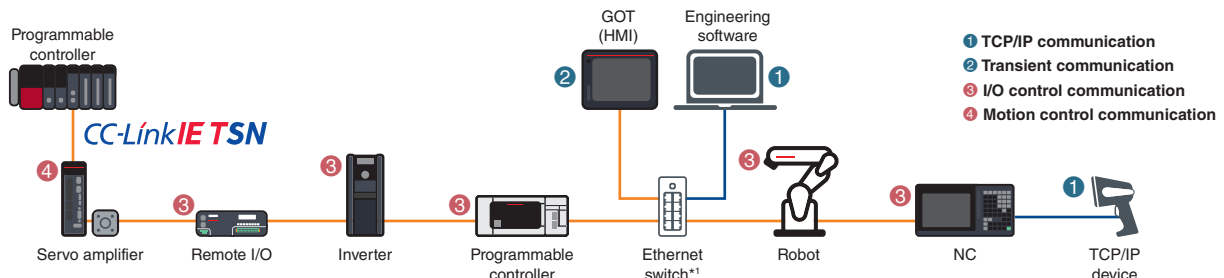

Network configuration example (includes functions and products planned for future support/release.)

\*1. Class B switching hub supporting CC-Link IE TSN recommended by the CC-Link Partner Association.

## Integrated Network

Current network systems use multiple networks to enable communication between IT and control systems on the shop floor. CC-Link IE TSN is a one-stop solution for integrating different networks, thereby realizing flexibility in topology and reducing wiring cost.

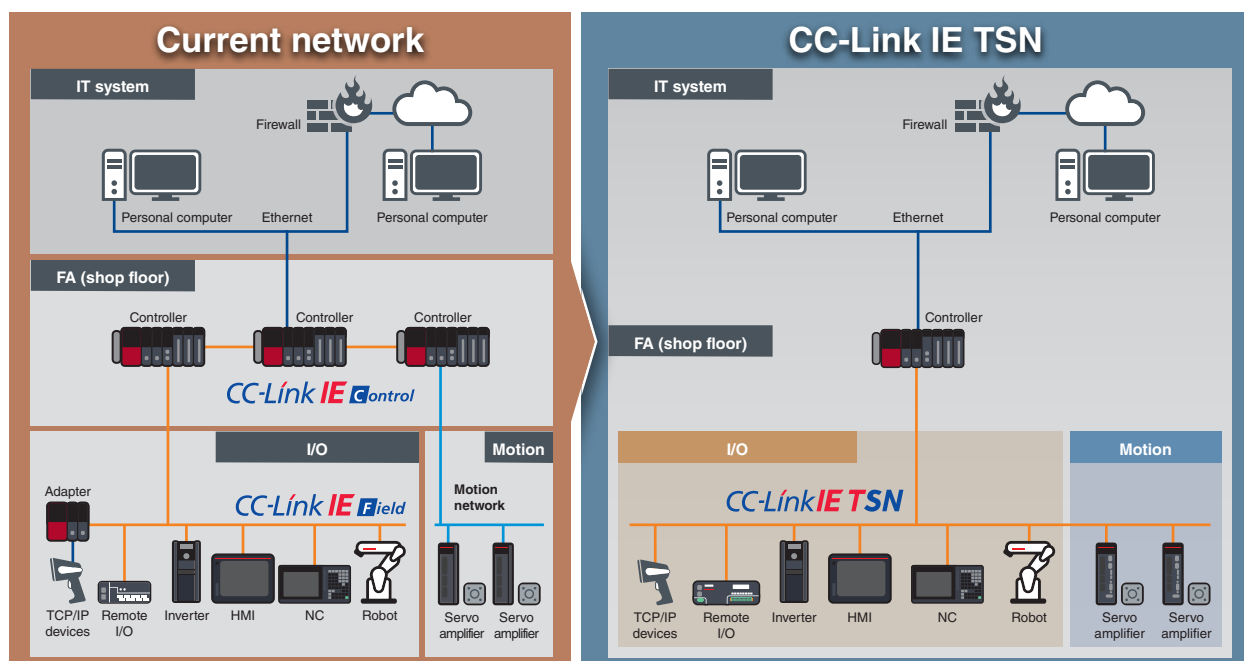

Network configuration example (includes functions and products planned for future support/release.)

## High-Speed, High-Accuracy Motion Control

CC-Link IE TSN controls I/O modules while also maintaining high-speed motion control. The single network boosts machine performance.

- Motion control (high-speed processing)
- I/O control (low-speed processing)

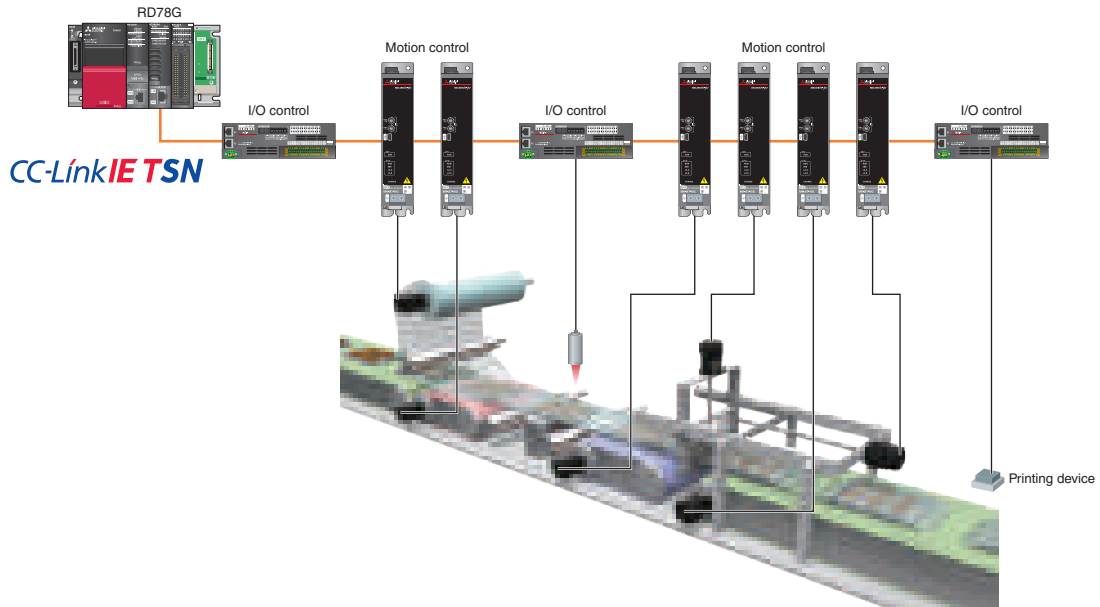

## Time Synchronization

Set time is completely synchronized among servo amplifiers, Motion modules, and PLC CPUs. This time synchronization enables accurate recording of the event history in chronological order, making it simple to identify the cause of errors.

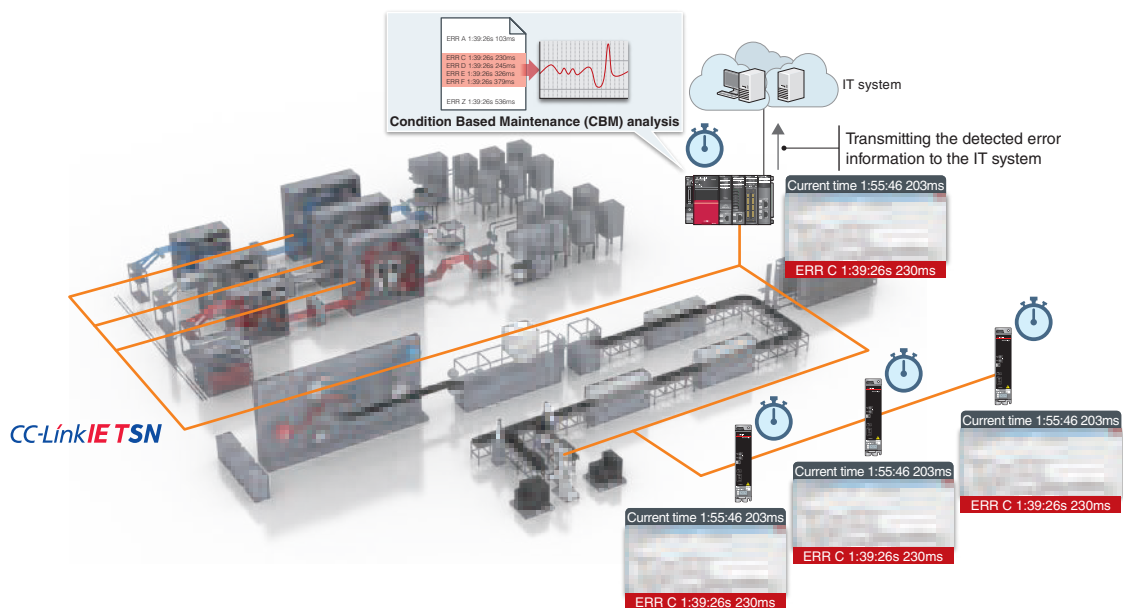

## Seamless Connectivity Between TCP/IP Devices and a Servo System

TCP/IP communication (information communication) can be mixed in the same line with the real-time control communications of CC-Link IE TSN.

CC-Link IE TSN device stations and TCP/IP devices can be connected on the same network, achieving a flexible and integrated network system. Note that the TCP/IP devices must be connected after servo amplifiers and I/O modules.

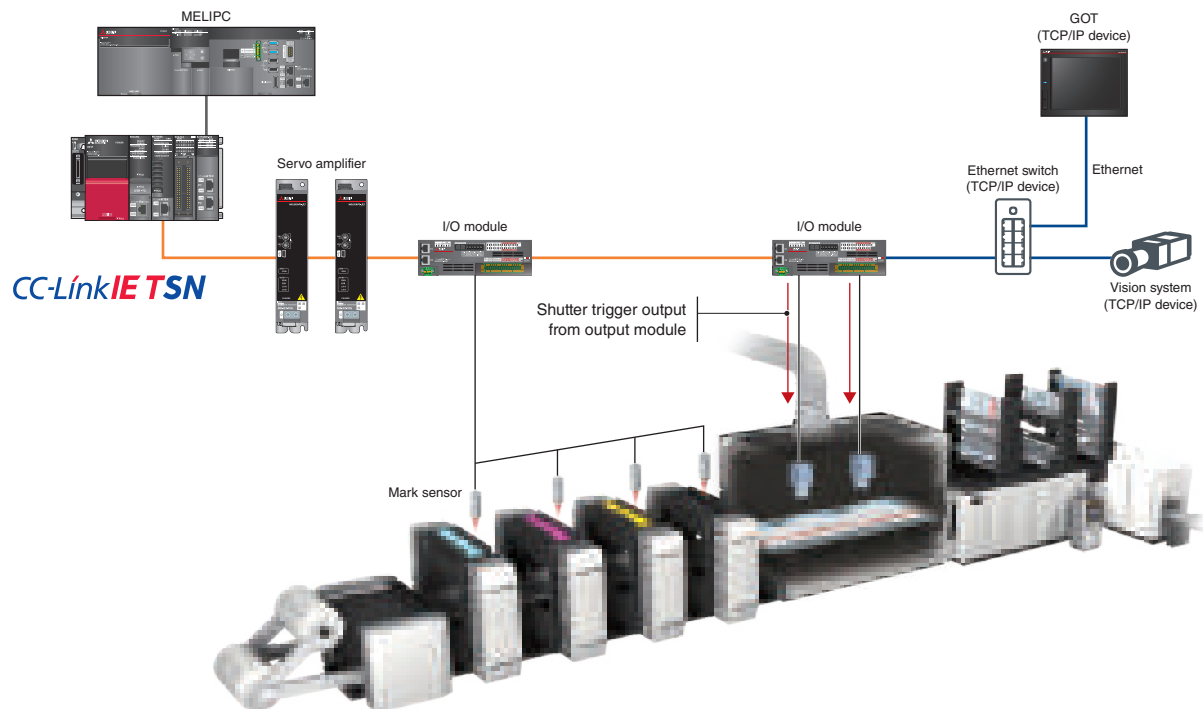

## Large-Capacity Data Communications

CC-Link IE TSN is a high-speed, large-capacity 1 Gbps communications network that is capable of sending and receiving large amounts of data, such as manufacturing, quality, and control data from the production process. The network can transmit large recipe data or traceability data at high speeds without degrading the performance of servo system communications. In addition, Ethernet supported devices can directly and seamlessly connect to controllers on the same network line.

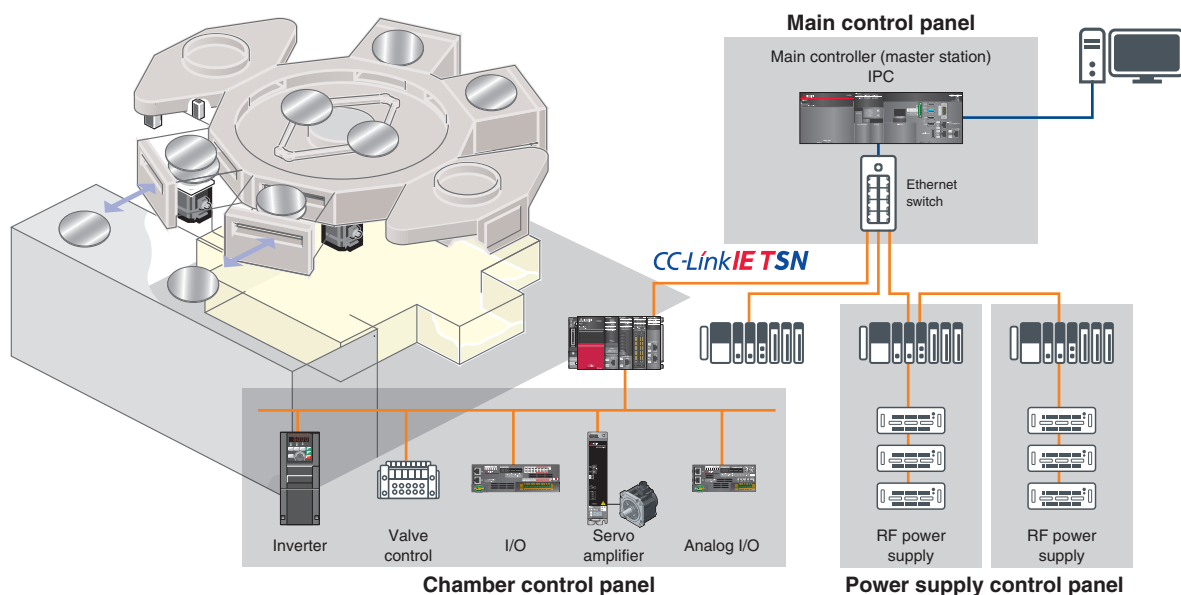

Network configuration example (includes functions and products planned for future support/release.)

An engineering environment that provides common, consistent usability throughout all product development phases

Programmable Controller Engineering Software

# MELSOFT GX Works3

Program creation is largely dependent on the ability of the programmer; therefore, an enormous amount of time is often spent on creating a servo program where a high level of programming expertise is required.

"MELSOFT GX Works3" introduces a more intuitive, efficient, and user-friendly programming environment that revolutionizes the programming process and minimizes hassles.

## Engineering Environment for Maximizing Your Machine Performance

- Mitsubishi Electric offers a complete, consistent engineering environment which covers all aspects of the product development cycle - from sizing motors all the way to programming with function blocks, startup, and maintenance.

### System Design

### Programming

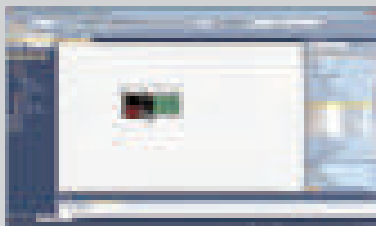

System configuration



Network configuration

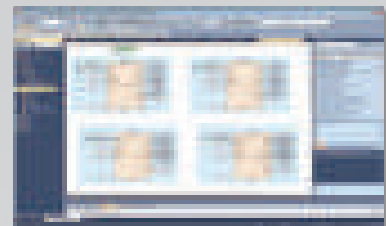

Programming

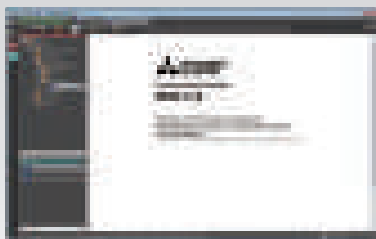

e-Manual

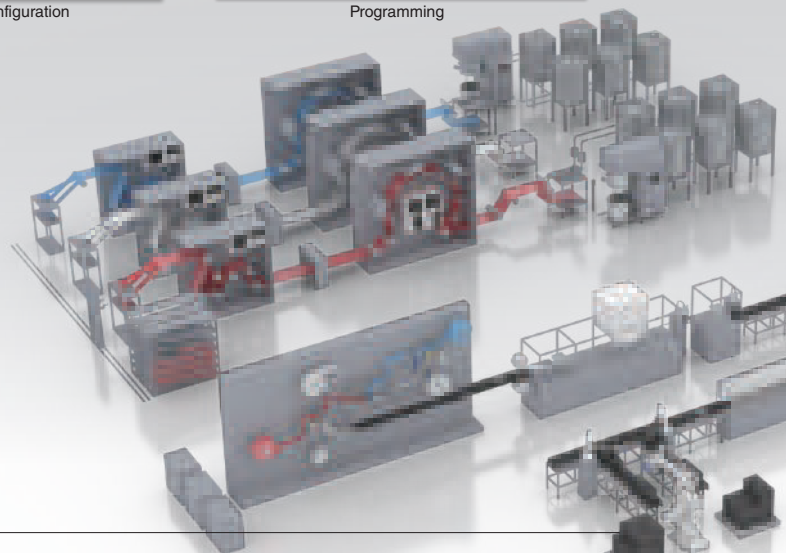

## Useful Servo Software

### [Drive system sizing software: "Motorizer"]

Our upgraded drive system sizing software enables you to more flexibly select a suitable servo system for your machine. The upgraded features include expansion of selectable load mechanisms (13 types), multiple sizing results, and the ability to size a multi-axis system.



Drive system sizing software

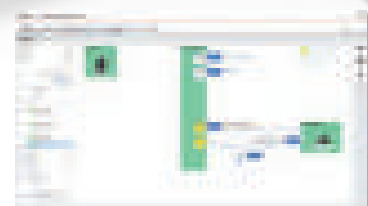

FA Integrated Selection Tool

### [FA Integrated Selection Tool]

Servo amplifiers, servo motors, and indispensable options such as encoder cables can all be selected.



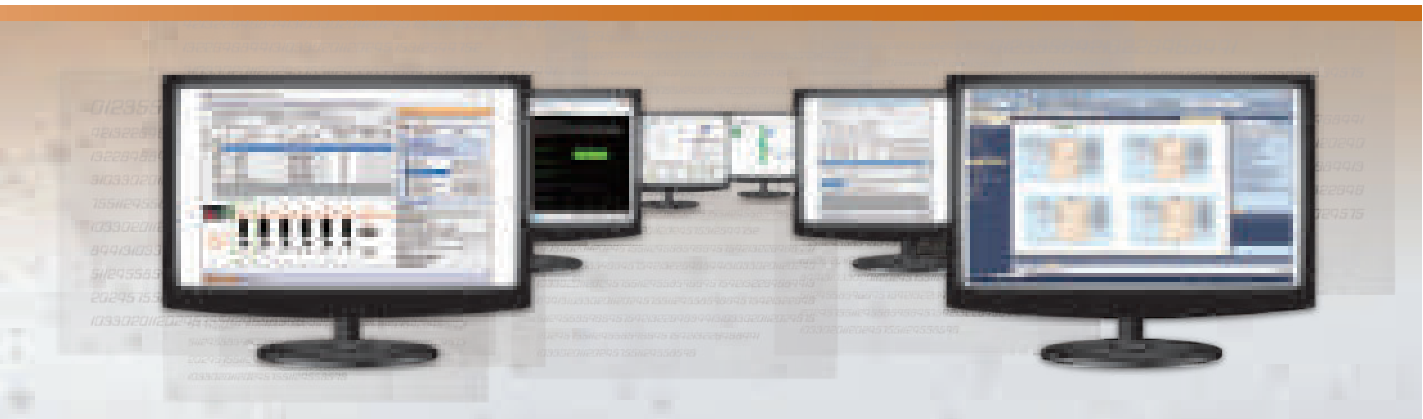

- All-in-one engineering platform MELSOFT GX Works3 allows you to set different modules in a single project, including the setting of a wide range of areas from servo amplifier parameters to PLC CPU data.

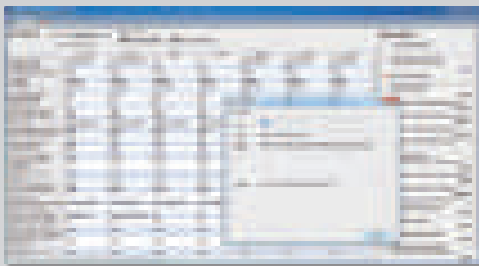

Monitor

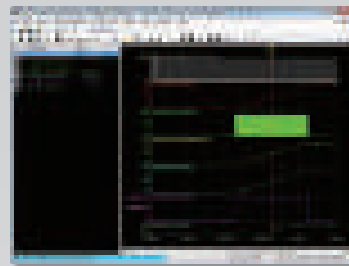

Real-time monitor

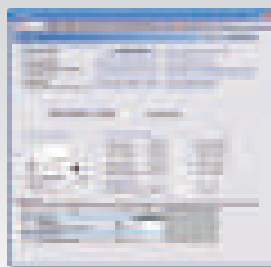

Servo adjustment<sup>\*1</sup>

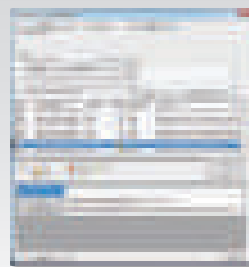

Event history

<sup>\*1</sup>. The servo adjustment is enabled via MR Configurator2.

## Globalization

### [PLCopen® Motion Control FB]

PLCopen® Motion Control FB is a standardized interface, and therefore people other than the program designer can understand the programming, leading to reduced design and maintenance time.



### [Conforms to IEC 61131-3]

MELSOFT GX Works3 realizes structured programming such as ladder and ST, making project standardization across multiple users even easier.

### [Multi-language support for global operations]

To adhere to today's global production needs, MELSOFT GX Works3 supports multi-language features at various levels, from the multiple language software menu system to device comment language switching features.

Supported languages: English, Japanese, and Chinese.

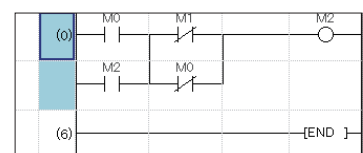

Heritage



# Simple Motion Mode Simple Motion

The Simple Motion mode is a new operation mode that enables the Motion module to utilize an existing project for driving servo amplifiers via CC-Link IE TSN. Reusing the existing projects helps reduce the program development time.

**CC-Link IE TSN**

Motion Module

**MELSEC iQ-R**  
series

**RD78G**

**MELSEC iQ-F**  
series

**FX5-SSC-G**



Motion profile table

Advanced synchronous control

Digital oscilloscope



## Features of Simple Motion Mode

- Executes positioning control with the motion profile table and advanced synchronous control with parameter settings.
- Connects remote devices via CC-Link IE TSN. The PLC CPU reads/writes the data of the remote devices.
- Supports the digital oscilloscope that collects data synchronized with the motion operation cycle and displays the waveforms data, helping users check the operations.

### An example of programming in Simple Motion mode

**Program**  
Ladder, FBD/LD, ST language

**Motion module**  
Simple Motion Module Setting

Motion profile table method

No.	Operation pattern	Control system	Acceleration time No.	Deceleration time No.	Positioning address	Command speed
1	1: CONT	0Bh: INC Linear 2	0: 1000	0: 1000	200000.0 μm	20000.0 mm/min
2	0: END	0Bh: INC Linear 2	0: 1000	0: 1000	-200000.0 μm	10000.0 mm/min

Starts positioning

Advanced synchronous control

Positioning control

Synchronous control

## Product Lines



**CC-Link IE TSN**  
**MELSEC iQ-R**  
series

- RD78G4: 4 axes
- RD78G8: 8 axes
- RD78G16: 16 axes



**CC-Link IE TSN**  
**MELSEC iQ-F**  
series

- FX5-40SSC-G: 4 axes
- FX5-80SSC-G: 8 axes



Progressiveness



# PLCopen® Motion Control FB Mode PLCopen®

The PLCopen® motion control FB mode is the operation mode that supports programming with PLCopen® Motion Control FBs, enabling structured/component programming for standardization. When selecting this mode, the Motion module executes motion control with various advanced technologies such as programming using PLCopen® Motion Control FBs in ST language and logging of motion control data.

**CC-Link I<sup>E</sup> TSN**

Motion Module

**MELSEC iQ-R**  
series

**RD78GH**

**RD78G**



**ST language**

**PLCopen® Motion Control FB**

**Logging**

**Advanced synchronous control FB** NEW

Select

## Features of PLCopen® Motion Control FB Mode

- Supports ST language for programming while a PLC CPU supports ladder, FBD/LD, and ST language.
- Utilizes the library of PLCopen® Motion Control FBs, which are compliant with international standards, for programming.
- Enables users to analyze the operation status with logging data on GX LogViewer, improving debug efficiency.

### An example of programming by PLC CPU

[Programming by PLC CPU only]

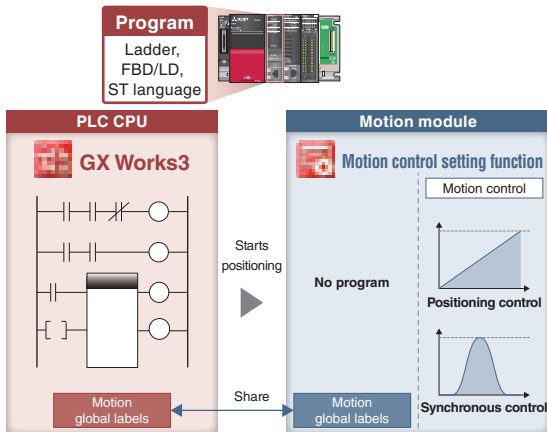

A PLC CPU program starts operation of the Motion module, eliminating the need for users to create another program for the Motion module, reducing programming burden.

### An example of programming by each module

[Programming by PLC CPU and Motion modules]

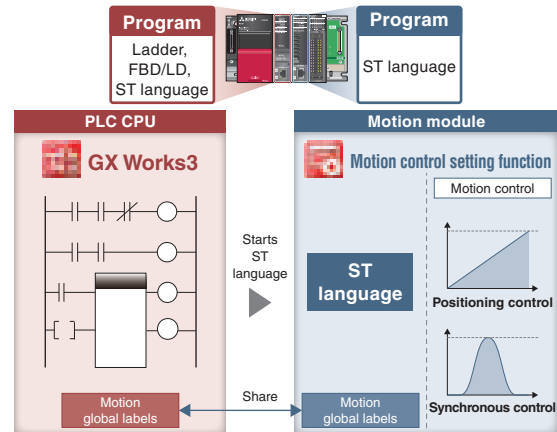

Motion modules can execute operations in place of the PLC CPU. This reduces the operation burden on the PLC CPU and results in a shorter cycle time.

## Product Lines

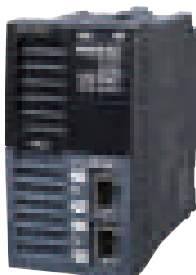

**CC-Link I<sup>E</sup> TSN**

**MELSEC iQ-R**  
series

**RD78GHV: 128 axes**

**RD78GHW: 256 axes**



**CC-Link I<sup>E</sup> TSN**

**MELSEC iQ-R**  
series

**RD78G4: 4 axes**

**RD78G8: 8 axes**

**RD78G16: 16 axes**

**RD78G32: 32 axes**

**RD78G64: 64 axes**

## Taking evolution to the next step with Simple Motion mode

# Simple Motion Mode Simple Motion

CC-Link I<sup>E</sup> TSN

Motion Module

MELSEC iQ-R<sub>series</sub>

RD78G

MELSEC iQ-F<sub>series</sub>

FX5-SSC-G



Combined with a CC-Link IE TSN-compatible servo amplifier, the Motion modules create a high-performance servo system that improves machine capability.

- Connects remote I/O modules and FR-A800-GN inverters via CC-Link IE TSN. The data of these devices can be read/written by a CPU module.
- Connects TCP/IP devices, enabling a flexible system configuration.
- Possible to reuse the existing projects of Simple Motion modules.

### Product Lines

Simple Motion



MELSEC iQ-R<sub>series</sub>

RD78G4

RD78G8

RD78G16

- Maximum number of control axes:  
16 axes/module (RD78G16)
- Minimum operation cycle\*<sup>1</sup>: 250 [μs]



MELSEC iQ-F<sub>series</sub>

FX5-40SSC-G

FX5-80SSC-G

- Maximum number of control axes:  
4 axes/module (FX5-40SSC-G),  
8 axes/module (FX5-80SSC-G)
- Minimum operation cycle\*<sup>1</sup>: 500 [μs]
- Maximum number of connected modules\*<sup>2</sup>:  
4 modules/system

\*1. The operation cycle varies by the number of control axes and the models.

\*2. This refers to the total number of the Motion modules and one FX5-CCLGN-MS (master station).

### Reuse of Existing Projects

The existing projects of a Simple Motion module can be reused. This enables reduction in program development time.

#### RD77MS→RD78G

Select [Change Module] in the navigation menu of GX Works3 to convert the Simple Motion module project to a Motion module project.

After the conversion, set the network parameters, servo amplifier parameters, and other parameters.

#### QD77MS→RD78G

Select [Import Simple Motion Module Data] in the navigation menu of GX Works3 to import the parameters of QD77MS.

After the import, set the network parameters, servo amplifier parameters, and other parameters.

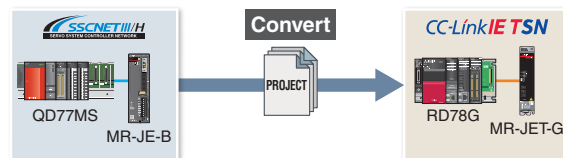
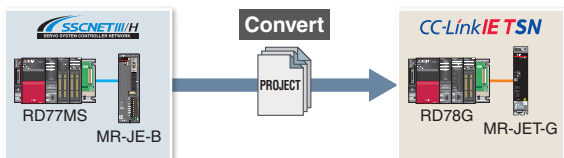

## Improved Performance

Simple Motion

The minimum operation cycle of RD78G in Simple Motion mode is approximately 1.7 to 3.5 times faster than that of the previous models. The data from the servo amplifiers and input/output signals can be received at high speeds, which reduces the cycle time.

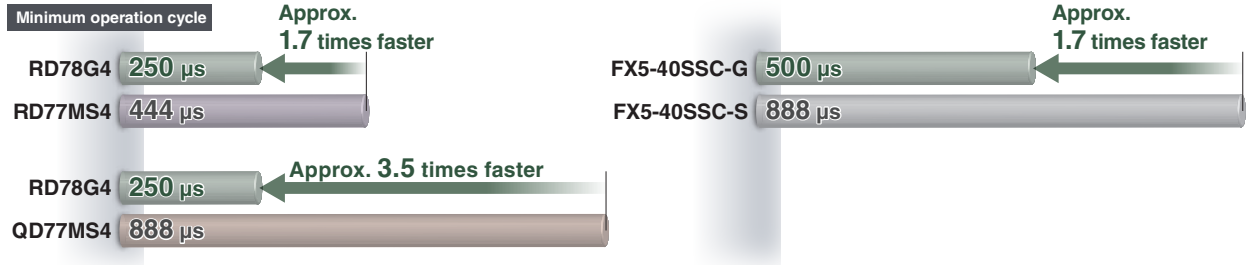

## System Configuration

Simple Motion

The Motion module can function as a master station of CC-Link IE TSN.<sup>\*1</sup>

This feature enables users to create a system more flexibly by connecting various devices, such as servo amplifiers, remote I/O modules, and TCP/IP devices, to the Motion module.<sup>\*5</sup>

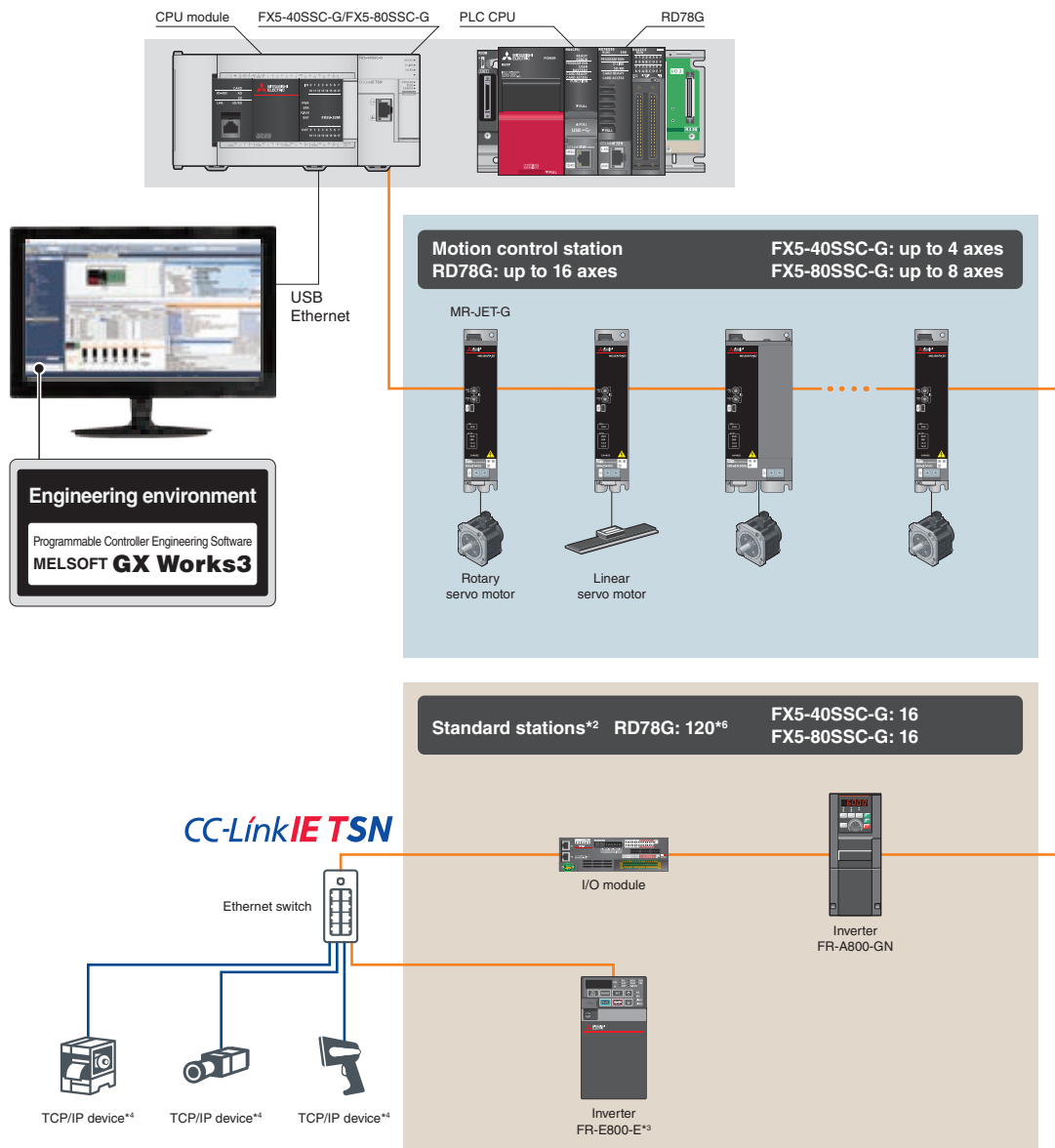

\*1. Sub-master station is not supported.

\*2. Standard stations refer to remote stations other than motion control stations on CC-Link IE TSN.

\*3. When connecting FR-E800-E to RD78G, set the communication speed of CC-Link IE TSN to 100 Mbps.

\*4. TCP/IP devices are not included in the standard stations.

\*5. Refer to manuals for precautions when CC-Link IE TSN Class B and A devices are mixed.

\*6. RD78G can connect up to 120 devices, which is the total number of the motion control stations and standard stations. FX5-40SSC-G/FX5-80SSC-G can connect 16 standard stations and the stations for the number of control axes.

## Positioning Control Simple Motion

Positioning control is easily executed using a motion profile table.

- To meet various application needs, the Motion module offers various types of positioning control, such as linear interpolation, 2-axis circular interpolation, fixed-pitch feed, and continuous path control.
- An automatic operation can be executed easily by setting the positioning address, the speed, and other setting items in a sequence program.
- Powerful sub-functions, such as M-code output, skip, speed change, and target position change functions, are available.

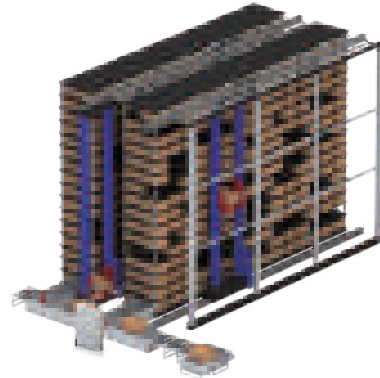

### Programming

The Motion module easily executes positioning operation with the instruction in a sequence program that starts a positioning data of the motion profile table. To meet various application needs, the Motion module offers various types of control, such as linear interpolation, two-axis circular interpolation, fixed-pitch feed, and continuous path control.

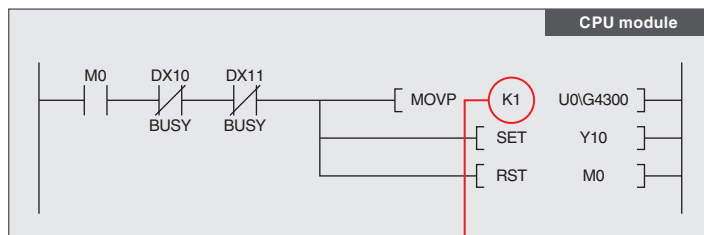

Motion profile table						
#1			#2			
No.	Operation pattern	Control system	Acceleration time No.	Deceleration time No.	Positioning address	Command speed
1	1: CONT	0Bh: INC Linear 2	0: 1000	0: 1000	200000.0 $\mu\text{m}$	20000.0 mm/min
2	0: END	0Bh: INC Linear 2	0: 1000	0: 1000	-200000.0 $\mu\text{m}$	10000.0 mm/min

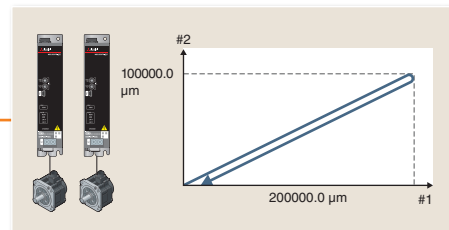

### Target Position Change Function

The target position can be changed at any time even when the products are being moved (1-axis linear control). The product is examined with the vision system while being moved to the next line. If a faulty product is found, the target position is changed so that the faulty product is put in a separate tray for those rejected.

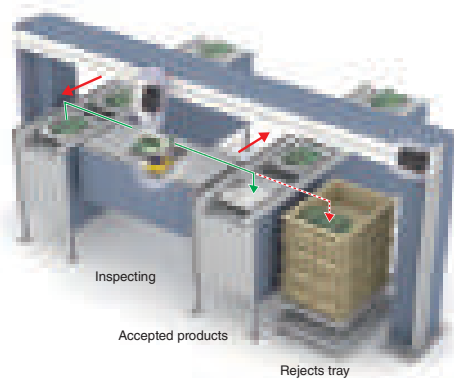

— Normal transfer route for accepted products  
 ..... Change to the rejects tray route

[Time chart]

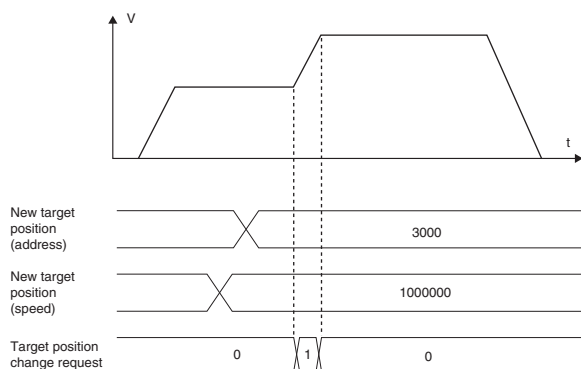

**Advanced Synchronous Control** Simple Motion

Synchronous control can be achieved using software instead of controlling mechanically with gear, shaft, clutch, speed change gear or cam, etc.

- Synchronous control can be flexibly started/ended for each axis, enabling the synchronous control axis and positioning control axis to be used within the same program.
- Command generation axis or servo input axis can be set as the input axis.
- The output axis is operated with a cam. The following three operations can be performed with the cam functions: linear operation, two-way operation, and feed operation.

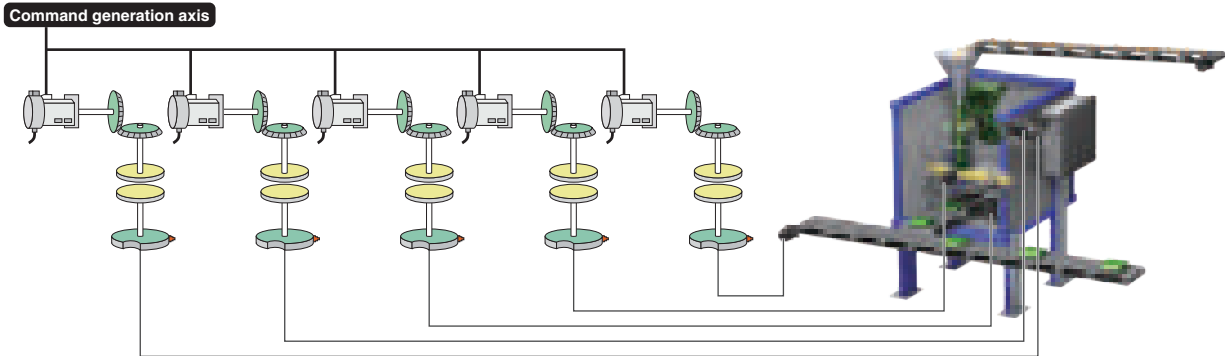

**[Command generation axis]**

Command generation axis is the axis that performs only the command generation. It is controlled independently of other axes connected to servo amplifiers. (not counted as a control axis)

**Parameter Settings**

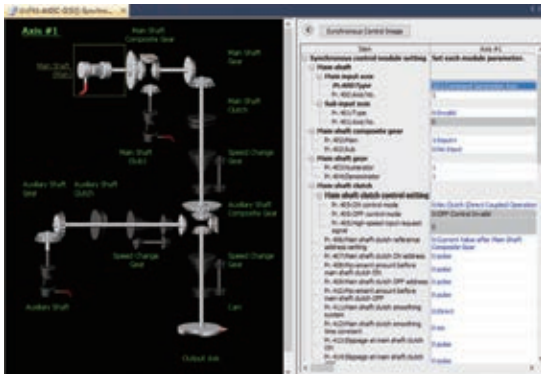

Synchronous control is executed by setting parameters of the input axis, output axis, gear, and clutch for synchronous control and turning on the synchronous control start signal.

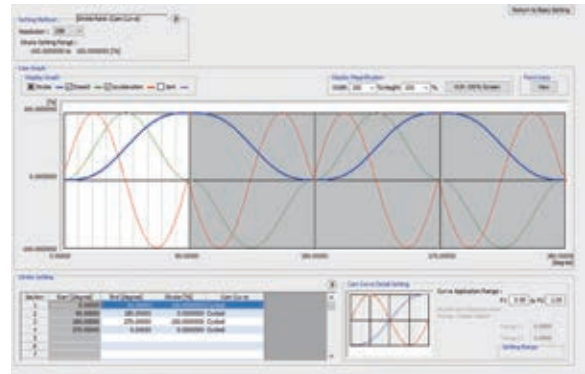

The cam graph can be flexibly and easily created through drag & drop. The waveform is changed according to the pointer's movement.

**Start/Stop**

Synchronous control can be executed after synchronous parameters are set for each output axis. When synchronous control start signal is turned on, the synchronous control parameters are analyzed, and the status is changed to during synchronous control. The output axis is operated by the commands transmitted from the input axis.

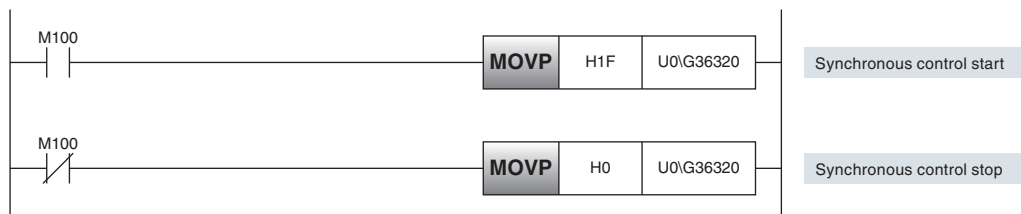

Servo System  
Servo System Controllers  
Embedded Type Servo System Controller  
Servo Amplifiers / Servo Motors

## Selectable Speed Control to Best Fit Your System Needs Simple Motion

Two types of speed control are available: speed control that includes position loop and speed control that does not include position loop.

### Speed Control That Does Not Include Position Loop

- Control mode setting of the servo amplifier: velocity control mode
- Minimizes speed deviation by flexibly responding to speed changes, such as those that occur when the load changes.
- Suitable for machines which keep driving the motors at constant speed, such as a wind/unwind machine.

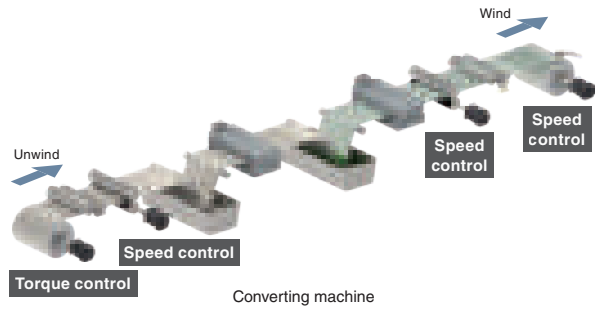

### Speed Control That Includes Position Loop

- Control mode setting of the servo amplifier: position control mode
- Suitable for operations that repeatedly switch between speed and position control.

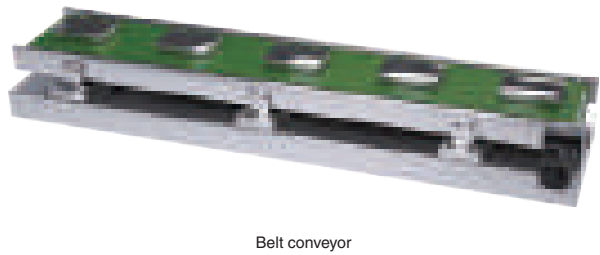

## Torque Control Simple Motion

### Torque Control

The axes in torque control are controlled to run at the constant torque following the torque command. When the load is light and the speed increases to the set limit, the torque control switches to speed control.



### Continuous Operation to Torque Control

When using this control, you can switch from position control to torque control continuously without stopping the servo motor.

- The current positions are always tracked even in torque control, and therefore positioning is executed smoothly in position control after switched from the torque control.
- Position control is smoothly switched to torque control without stopping the servo motor.

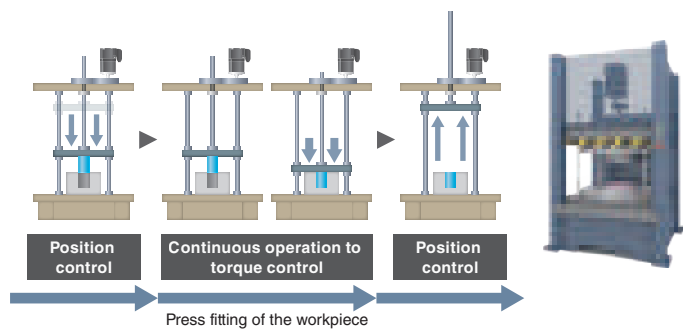



**Auxiliary Functions** Simple Motion

**Inter-Module Synchronization\*1** NEW

The inter-module synchronization function can synchronize the control timings among multiple Motion modules on the same base unit.  
A CPU and each I/O module are synchronized, and thus the I/O signals from different machines can be synchronized.

**[An example of synchronized operation between machines using inter-module synchronization]**

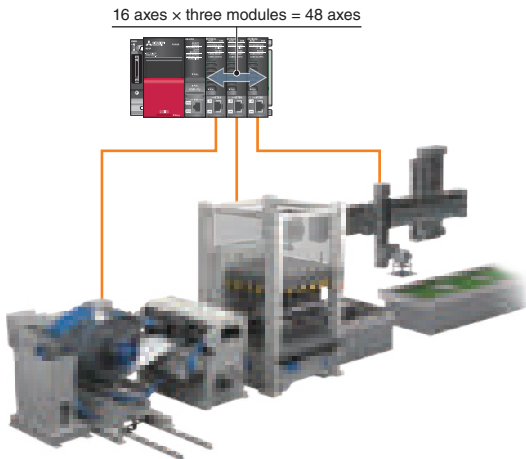

\*1. The function is available with RD78G.

**Read/Write Operation of Standard Stations**

- The PLC CPU sends/receives link devices to/from standard stations (remote stations other than the motion control stations) through a Motion module.
- One-to-one communication is possible between the master and remote stations.
- The PLC CPU can be programmed using the signals of the remote stations.

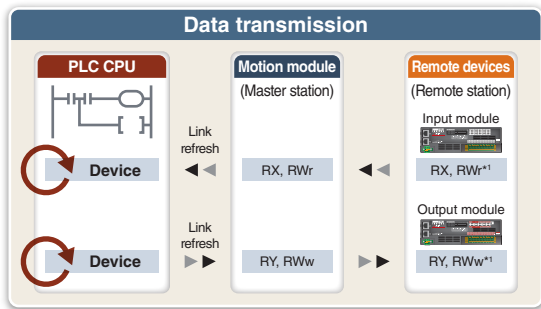

\*1. RX and RY are not available for some remote devices.

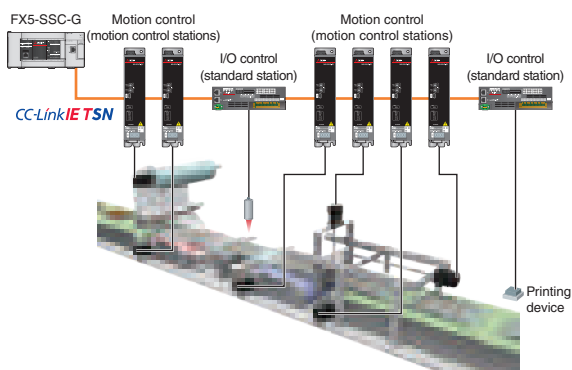

**Automatic Return**

When remote stations are back to normal status after disconnected due to a data link error, this function automatically returns the disconnected stations to the network and restarts data link.

When defective components need to be replaced in one of the machines in a production line or one of the units in a machine, only the machine or the unit can be partly turned off without powering off the whole system.

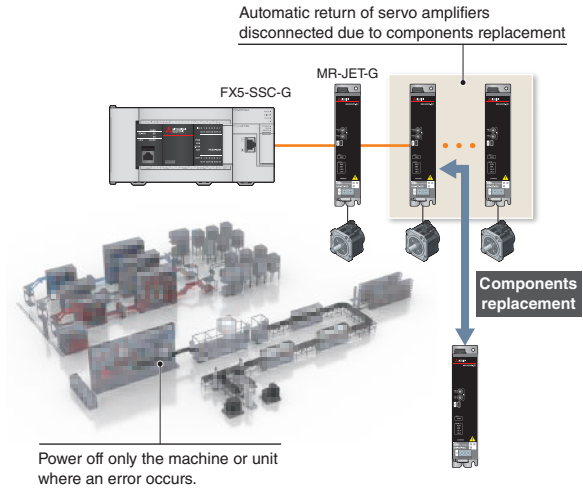

**Mark Detection** NEW

This function latches data responding to a trigger signal input to a servo amplifier.

The compensation amount is calculated based on the latched data, and the error is compensated using a compensation axis.

A high-accuracy mark detection at 1 μs is available.

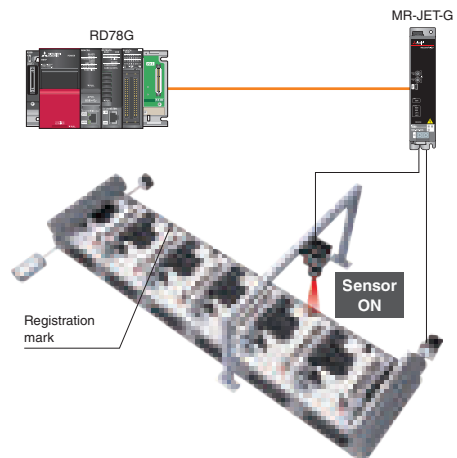

Servo System  
Servo System Controllers  
Embedded Type Servo System Controller  
Servo Amplifiers / Servo Motors



## Optional Data Monitor

Servo operation is monitored with extensive servo data acquired via CC-Link IE TSN. The acquired data can be transferred to IT system or transferred and displayed on any user-created GOT screen in the network. The target data for monitoring can be flexibly changed during operation.

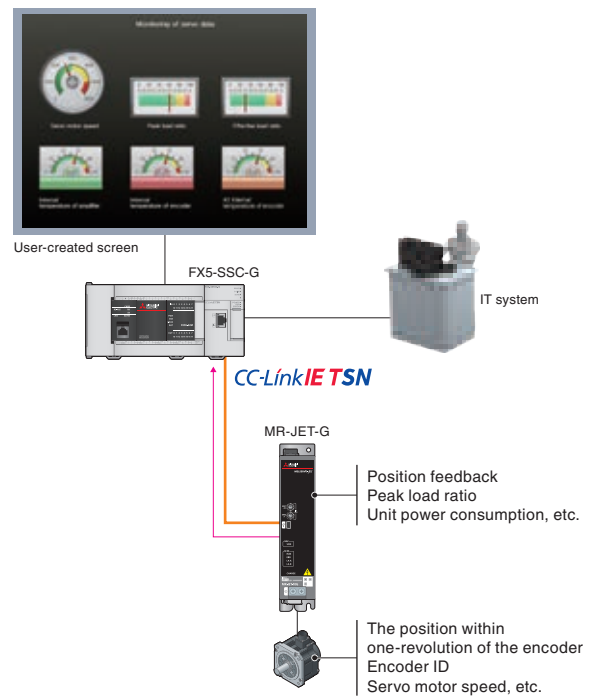

**A Wide Variety of Features**

Simple Motion

**JOG operation**

Moves a workpiece in the designated direction while the JOG start signal is ON.

JOG operation can be executed without completing home position return.

**Stop operation functions**

The forced stop, the axis stop, and the forced stop of servo amplifiers are available.

**Absolute position system**

Restores the absolute position of the designated axis. Once the home position return is executed at the start of the system, it is unnecessary to perform the home position return again when the power is turned ON next time.

**Virtual servo amplifier**

Enables operations of a virtual servo amplifier as if an actual unit is connected.

When the virtual servo amplifier is set as a servo input axis of synchronous control, the Motion module executes synchronous control with virtually generated input commands.

In addition, this function is used to simulate an axis without an actual connection.

**Stroke limit functions**

Establish the physical movable range for a machine. The hardware stroke limit function and the software stroke limit function are available.

**Home position return control**

Establishes a position as the starting point (or "Home position") of positioning control and performs positioning toward that starting point.

**Target position change**

Changes a target position to a newly designated target position at any timing during the position control (1-axis linear control).

**Torque limit function**

Limits the torque generated by the servo motor to the preset torque limit value.

**Acceleration/deceleration processing function**

Adjusts the acceleration/deceleration of each motion control so that the acceleration/deceleration curve is suitable for the machine.

**Event history**

Saves the error information and the operation for the module as an event in the CPU module and the motion system.

**Override**

Changes the command speed by a specified percentage (0 to 300 %) for all controls to be executed.

## One software, many possibilities

Programmable Controller Engineering Software

# GX Works3

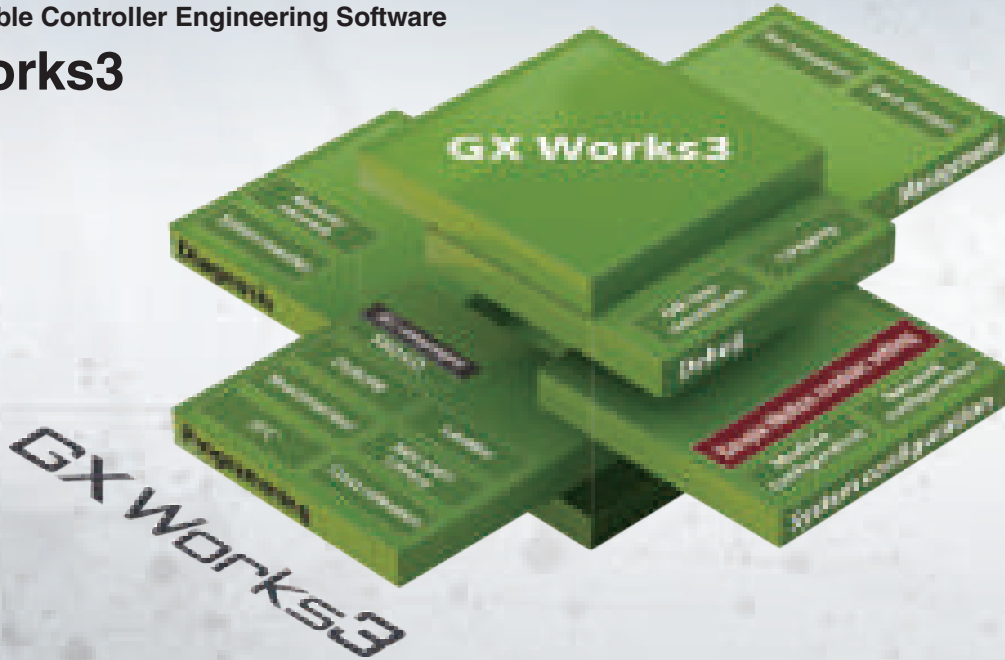

MELSOFT GX Works3 has a variety of features which help users create projects and conduct maintenance more flexibly and easily. Our variety of engineering software (GX Works3, drive system sizing software, FA Integrated Selection Tool, etc.) fully covers all stages of development processes from parameter settings to maintenance of Motion module, servo amplifier, and servo motors.

### **GX Works3**

This software supports overall development processes for PLC CPUs from system design to maintenance.

### **Servo Setup Software MR Configurator2**

Tuning, monitor display, diagnosis, reading/writing parameters, and test operations are easily performed on a personal computer. This powerful software tool supports a stable machine system and optimum control, and moreover, shortens setup time.

### **FA Integrated Selection Tool**

Servo amplifiers, servo motors, and indispensable options such as encoder cables can all be selected.

### **Simple Motion Module Setting**

This software covers various development processes for the Motion module from parameter settings, debug, to maintenance.

### **Drive System Sizing Software "Motorizer"**

The most suitable servo motors, servo amplifiers, and regenerative options for your machine can be selected just by setting machine specifications and operation patterns.



**Engineering Environment** Simple Motion

Our variety of engineering software (GX Works3, drive system sizing software, FA Integrated Selection Tool, etc.) fully covers all stages of development processes from parameter settings to maintenance of Motion modules, servo amplifiers, and servo motors.

**System Design** System Design

Module configuration



Network configuration

- Module configuration
- Network configuration
- Data settings for servo amplifiers
- Settings for remote I/O

**Programming (Positioning)** Programming

Positioning data setting



Offline simulation

Automatic calculation of command speed

- Programming with Ladder, SFC, FBD/LD
- Positioning data settings
- Offline simulation, automatic calculation of command speed

**Programming (Advanced Synchronous Control)** Programming

Synchronous control parameter

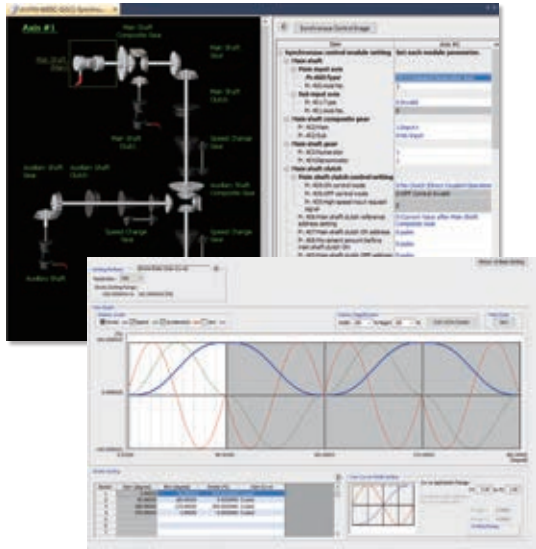

Cam data creation

- Synchronous control parameter
- Cam data creation, cam data list

**Debug/Maintenance** Debug Maintenance

Axis monitor

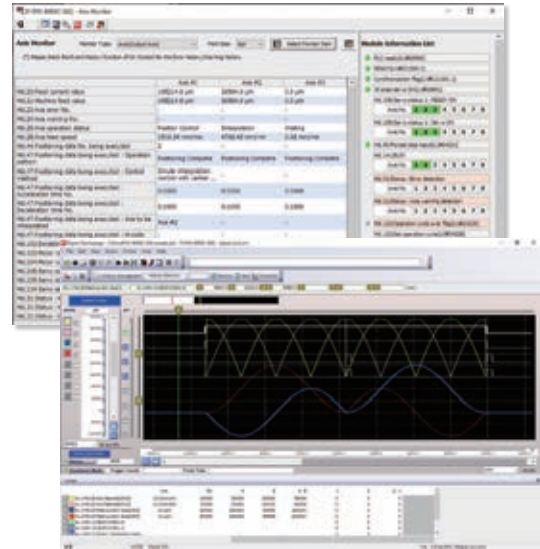

Digital oscilloscope

- Event history
- Current value history, start history, axis monitor
- Servo monitor
- Digital oscilloscope

Servo System  
Servo System Controllers  
Embedded Type Servo System Controller  
Servo Amplifiers / Servo Motors

## Unlock new system capabilities together with CC-Link IE TSN

# PLCopen® Motion Control FB Mode PLCopen®

**CC-Link IE TSN**  
Motion Module

# RD78GH

# RD78G



These Motion modules with multiple-core processors enable to configure a high-speed, large system by supporting the CC-Link IE TSN real-time open network.

- Performs positioning control such as linear interpolation using function blocks. The programming is easy: users just need to set positioning data to the function blocks.
- Connects to various modules such as servo amplifiers and I/O modules via CC-Link IE TSN. This connectivity allows you to configure a servo system more flexibly.
- Supports a consistent engineering environment that is capable of handling tasks ranging from system design to debugging and maintenance.

### Product Lines

PLCopen®



**CC-Link IE TSN**  
**MELSEC iQ-R**  
series

**RD78GHV**  
**RD78GHW**

- Maximum number of control axes:  
128 axes/module (RD78GHV)  
256 axes/module (RD78GHW)
- Minimum operation cycle \*1: 31.25 μs
- ST language program capacity:  
Built-in ROM max. 64 MB  
+ SD memory card

RD78GHV/RD78GHW are designed with a quad-core processor that enables higher-speed control. These Motion modules can be directly programmed to distribute load control with PLC CPUs.

This ensures that performance will not be degraded even when the number of axes is increased.



**CC-Link IE TSN**  
**MELSEC iQ-R**  
series

**RD78G4/RD78G8**  
**RD78G16/RD78G32**  
**RD78G64**

- Maximum number of control axes:  
64 axes/module (RD78G64)
- Minimum operation cycle \*1: 62.5 μs
- ST language program capacity:  
Built-in ROM max. 16 MB + SD memory card

RD78G4/RD78G8/RD78G16/RD78G32/RD78G64 are designed with a dual-core processor, and can be programmed to enable various types of control, such as positioning, synchronous, cam, speed, and torque control.

\*1. The operation cycle varies by the number of control axes and the models.

**Improved Performance**



The minimum operation cycle of RD78GH in PLCopen® motion control FB mode is approximately 4.1 to 6.2 times faster than that of the previous models, and the number of maximum control axes is 4 to 8 times more. The data from the servo amplifiers and input/output signals can be received at high speeds, which reduces the cycle time.

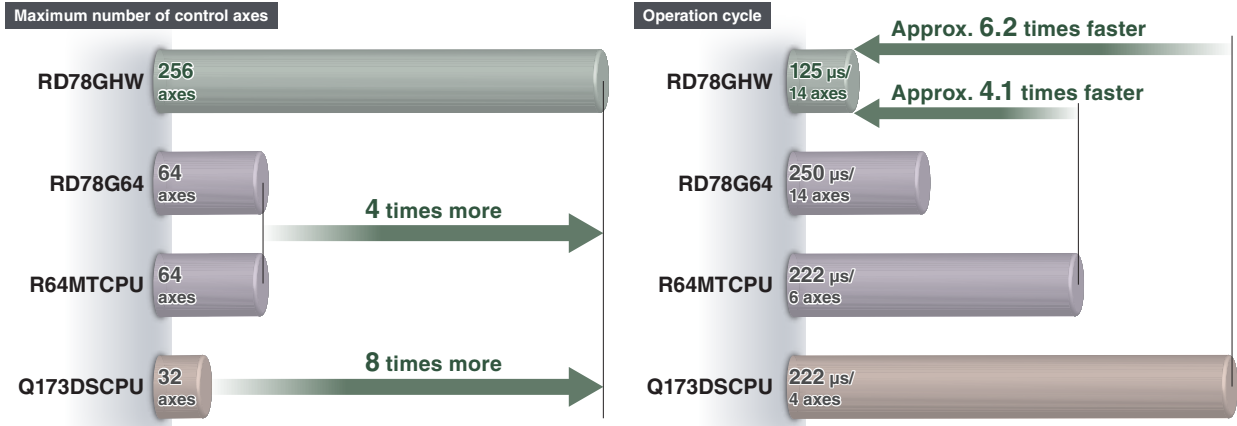

## System Configuration

PLCopen®

The Motion Module executes motion control while functioning as a master station of CC-Link IE TSN<sup>\*1</sup>. This dual functionality results in reduced system costs.

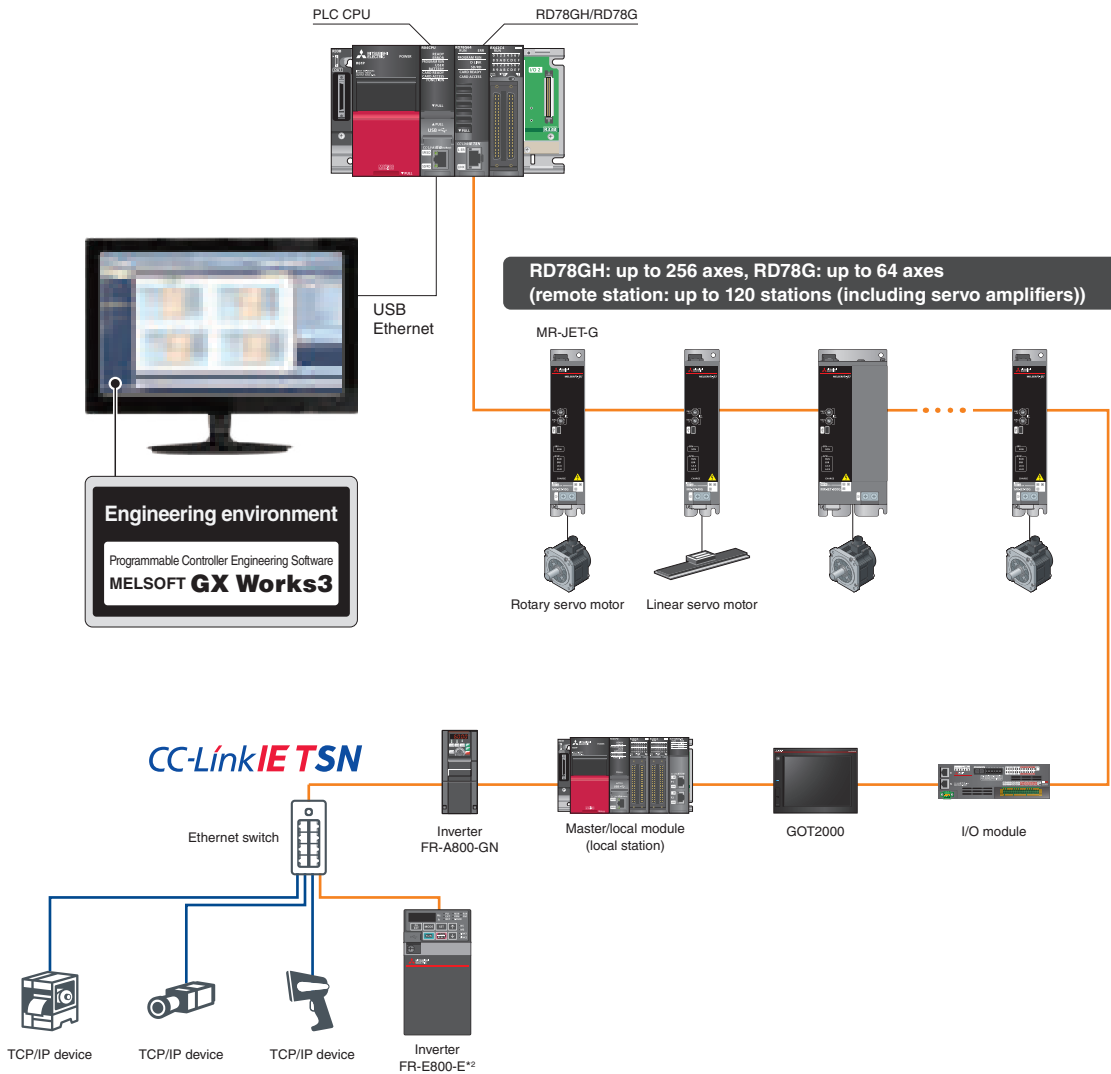

\*1. Sub-master station is not supported.

\*2. When connecting FR-E800-E to RD78G, set the communication speed of CC-Link IE TSN to 100 Mbps.



**Inter-Module Synchronization** Enhanced functions PLCopen®

The inter-module synchronization function can synchronize the control timings among multiple Motion modules on the same base unit.

- A CPU and each I/O module are synchronized, and thus the I/O signals from different machines can be synchronized.
- The control load can be distributed among the PLC CPU and the Motion modules, and therefore the number of axes can be increased without sacrificing performance.

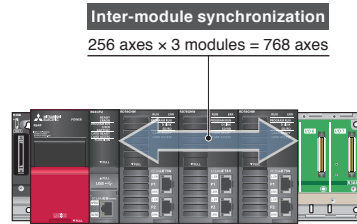

**Flexible System Configuration with Multiple Topologies** PLCopen®

Line and star topologies are supported, allowing a flexible system configuration.

**[Line topology]**

Use a line topology for high-speed, high-performance control. This is realized when a system is configured with CC-Link IE TSN-compatible device stations only without additional branch lines.

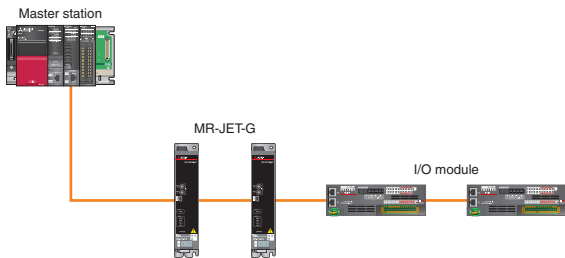

**[Star topology]**

Choose a star topology if a more flexible system configuration is needed. Using Ethernet switches, device stations can be easily distributed to achieve the desired system configuration.

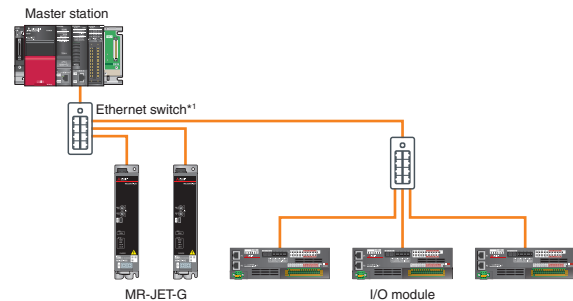

\*1. Class B switching hub supporting CC-Link IE TSN recommended by the CC-Link Partner Association

Servo System  
Servo System Controllers  
Embedded Type Servo System Controller  
Servo Amplifiers / Servo Motors

## Positioning Control PLCopen®

Two types of positioning control are available: single-axis and multi-axis positioning control. This variety allows you to meet various control needs.

Item	Control types	
Single-axis control	Positioning	Absolute positioning
		Relative positioning
	Homing	
	JOG operation	

Item	Control types	
Multi-axis control	Linear interpolation	Absolute linear interpolation
		Relative linear interpolation
	Circular interpolation	Absolute circular interpolation
		Relative circular interpolation
Multi-axis path control		

### Main Control

#### Linear interpolation

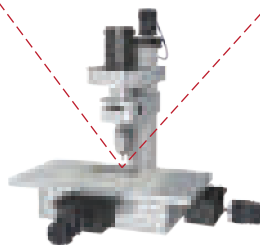
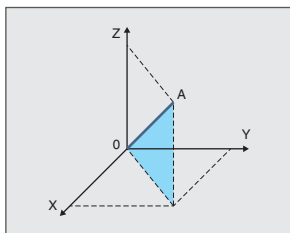

#### Circular interpolation

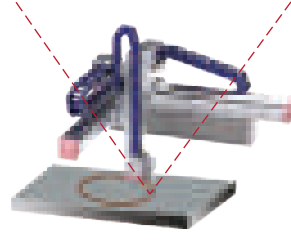
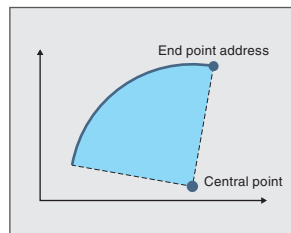

#### Multi-axis path control \*1

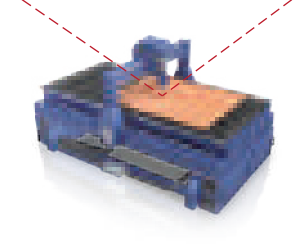
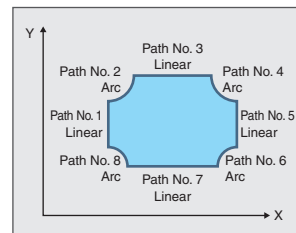

\*1. The multi-axis path control is possible using the buffer mode.

## Acceleration/Deceleration Methods PLCopen®

Three types of acceleration/deceleration methods are available: trapezoidal acceleration/deceleration, jerk acceleration/deceleration, and acceleration/deceleration time fixed.

#### [Trapezoidal acceleration/deceleration]

After starting, maximum acceleration is maintained until the target speed is reached. For example, when a vehicle loaded with a workpiece accelerates suddenly, the workpiece will swing back and forth due to the impact of the sudden acceleration. To reduce impacts and vibrations in a case such as this, the vehicle must accelerate at a slower rate. The speed creates a trapezoidal shape.

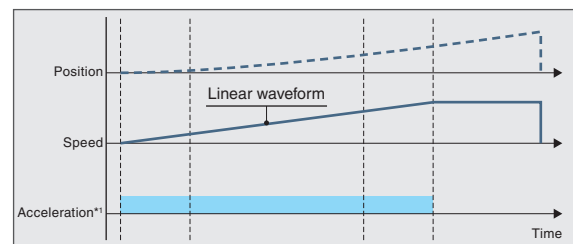

#### [Jerk acceleration/deceleration]

The acceleration changes gradually. For example, when a vehicle loaded with a workpiece accelerates gradually, the load will not swing back and forth after acceleration. The jerk is maintained during acceleration. When the vehicle has almost reached the target speed, the jerk is decelerated. Adjusting jerk in this way achieves smooth acceleration/deceleration while also shortening the time it takes to reach the target speed. The speed creates a S-curve shape.

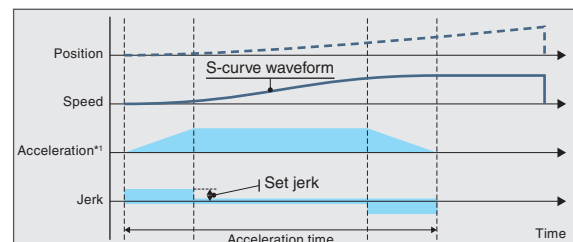

#### [Acceleration/deceleration time fixed method]

This method executes acceleration/deceleration based on the time specified, regardless of the commanded speed.

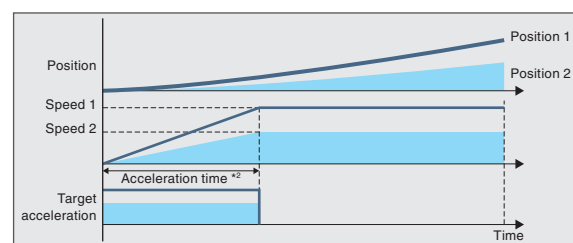

\*1. Input acceleration.  
\*2. Specify acceleration time.

**MEMO**

# Synchronous Control PLCopen®

## Flexibly Combining Synchronous Control FBs

Synchronous control is performed using function blocks that operate as software-based mechanical modules such as gear, shaft, speed change gear, and cam.

- The number and the combination of the synchronous modules are flexibly selected, achieving optimized operation.
- The following two types of cam data are available: cam data and cam data for a rotary knife
- Complex cam control is possible by flexibly switching cams.
- Positioning and synchronous control can be performed together in the same program.
- Cam for a rotary knife can be easily created in MELSOFT GX Works3 or by using function blocks.

### [An example of packing machine program]

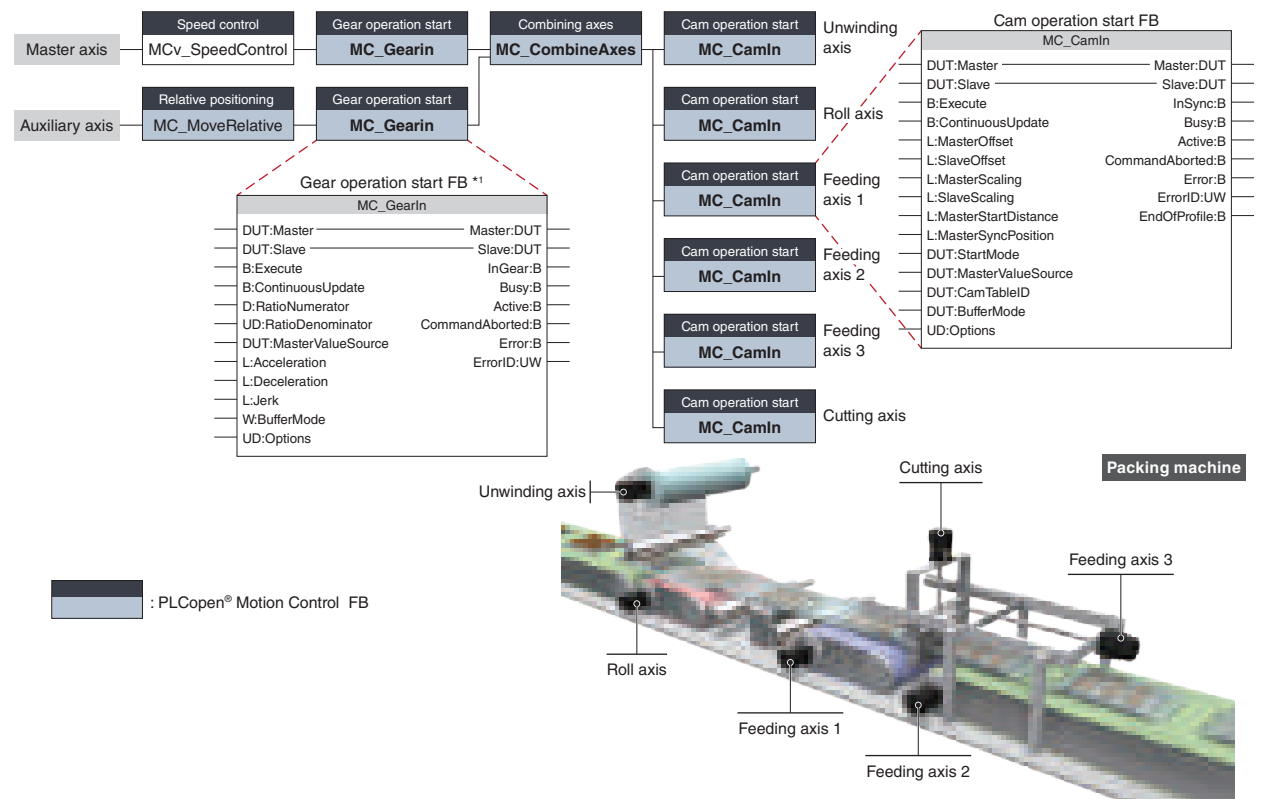

### [Time chart]

This program synchronizes all the axes, from the cutting axis through the unwinding axis, with the master axis. The following shows the time chart of the film cutting operation.

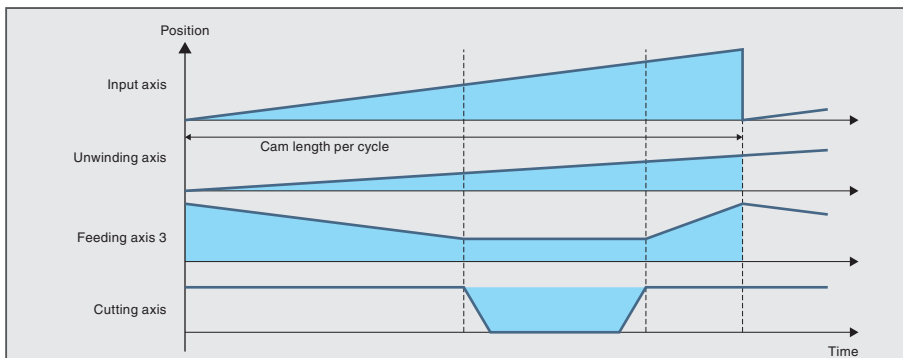

Advanced Synchronous Control FB Settings with Graphic-Based Interface



In addition to PLCopen® Motion Control FB, the advanced synchronous control data can be used in the program. The advanced synchronous control can be easily executed by setting the auxiliary shaft, gear, clutch, and speed change gear with the advanced synchronous control data (parameters) and starting the synchronous control.

- Set the auxiliary shaft, gear, clutch, and speed change gear with a parameter
- The enabled synchronous module images are highlighted, allowing easy confirmation of set data through visualization
- Cam control can be easily executed by creating cam data and setting parameters

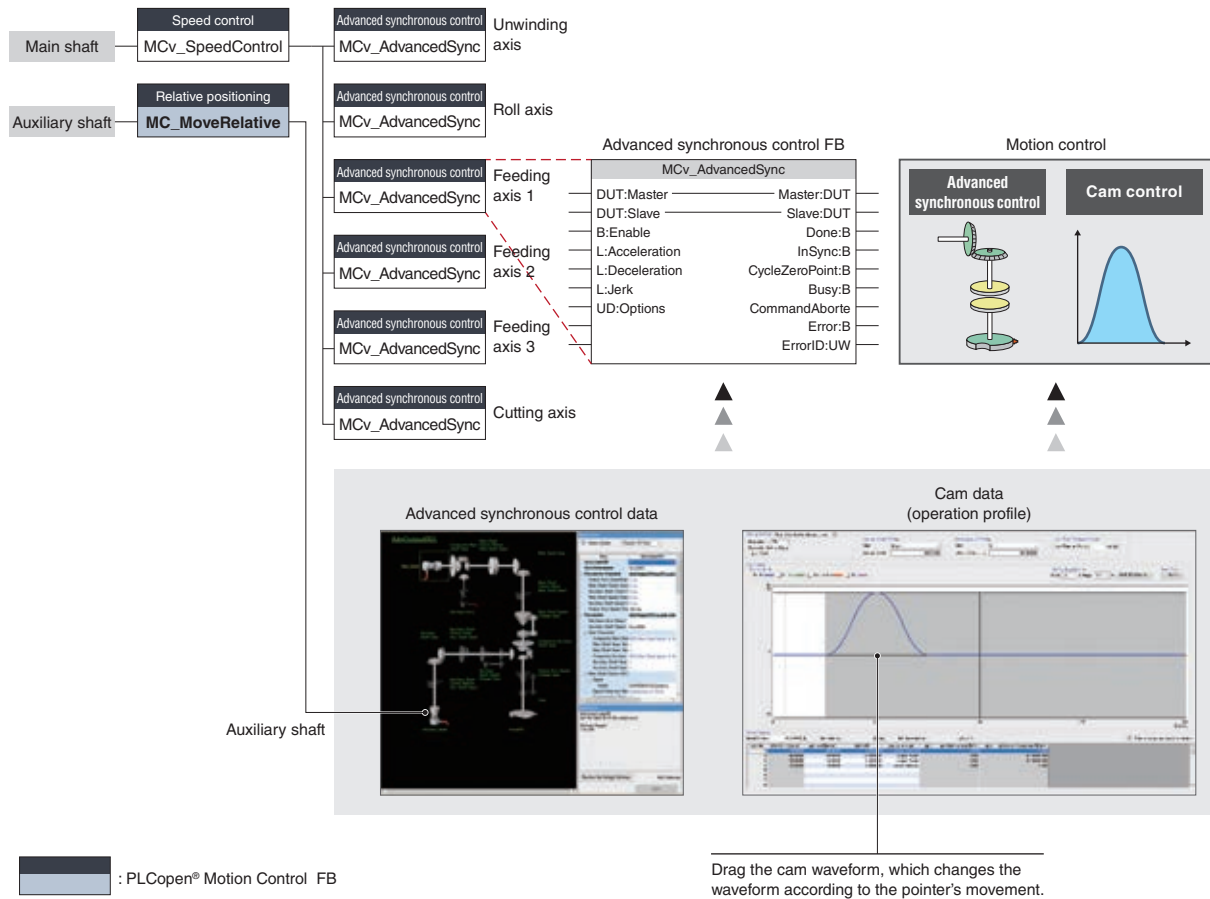

Advanced synchronous control data

- Input axis data
- Synchronous parameter (output axis)
- Auxiliary shaft data
- Clutch data
- Gear data
- Speed change gear data
- Cam data (operation profile)
- Cam waveform type

Servo System  
Servo System Controllers  
Embedded Type Servo System Controller  
Servo Amplifiers / Servo Motors



**Clutch**

**NEW**

The clutch is used to transmit/disengage command pulses from the main/auxiliary shaft input side through turning the clutch ON/OFF, which controls the operation/stop of the output axis.

The clutch can be set to the main shaft clutch and the auxiliary shaft clutch.

Clutch ON control mode	Clutch OFF control mode
Invalid (Direct coupled operation)	Invalid (OFF control invalid)
Clutch command	Clutch command (One-shot operation)
Clutch command leading edge	Clutch command leading edge
Clutch command trailing edge	Clutch command trailing edge
Address mode	Address mode
I/O data specification	I/O data specification

Advanced synchronous control data

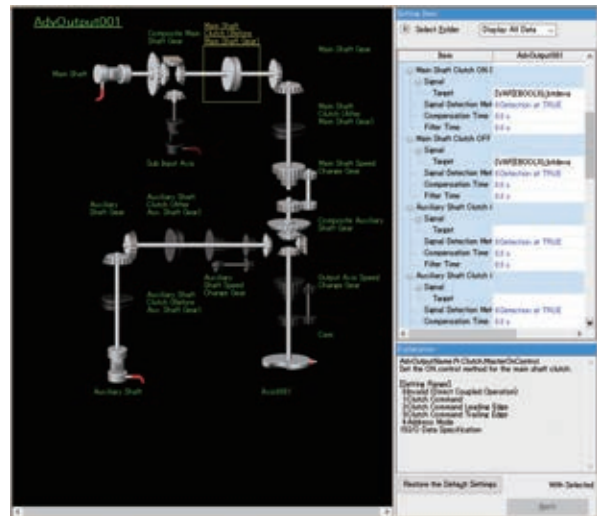

**Restarting synchronous control**

**NEW**

In case that the synchronous positions become misaligned after an emergency stop, etc., new synchronous positions are calculated from each axis position, and then the synchronous control can be restarted at the specified positions.

1. In synchronous control analysis mode, the cam set positions of each output axis (axis1, 2, and 3) are updated based on the current position per cycle of the input axis.
2. The output axes perform positioning to the updated cam set positions.
3. Turn OFF the synchronous control analysis mode, and turn ON the axes to start synchronous control.

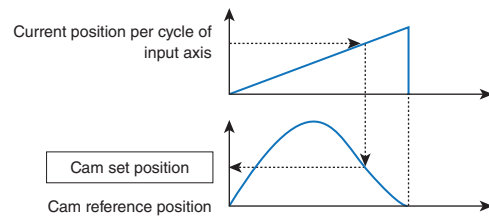

## Cam Control

The cam being executed can be flexibly switched to another cam, and cam control can smoothly switch to positioning control without stopping the servo motor.

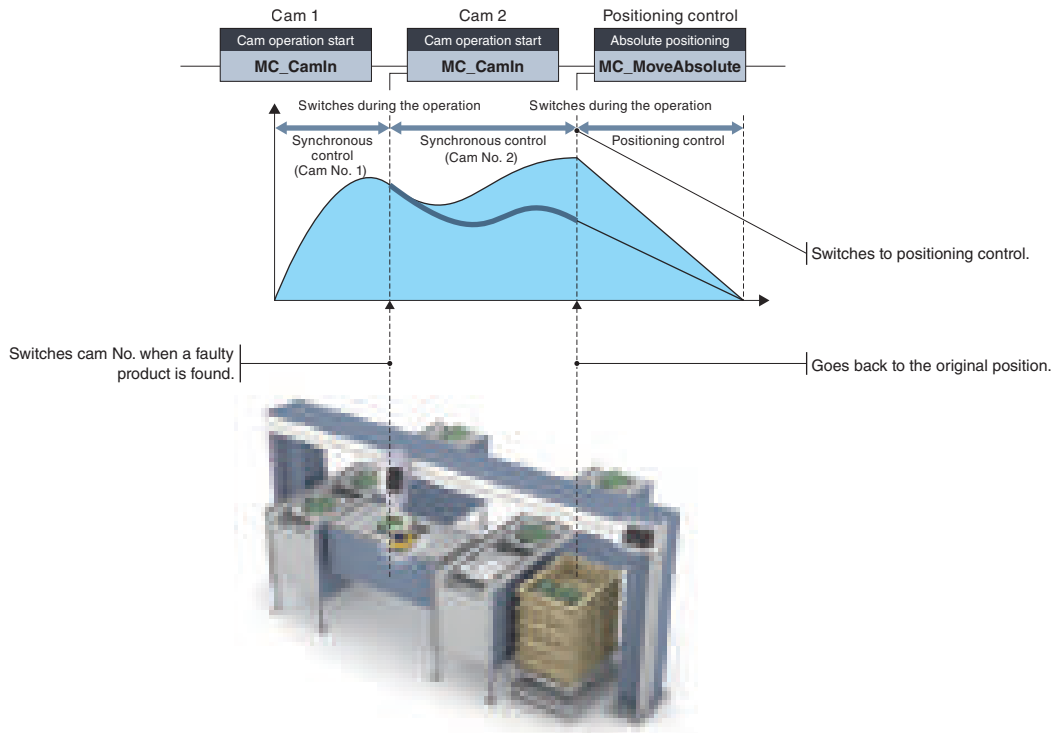

## Servo System Recorder

PLCopen®

The Motion module automatically collects data of all real drive axes when an error occurs. The collected data, such as the command and the feedback values, greatly helps you analyze the error cause.

- Automatic collection of data, such as the command and feedback values, without programming
- Data collection of all axes, which helps you locate the error cause even when the error is caused by the other axes without an error

### [Data collection]

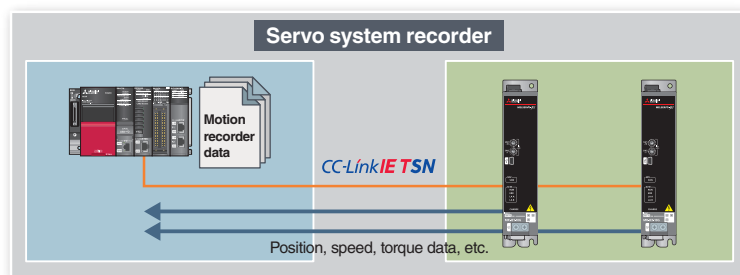
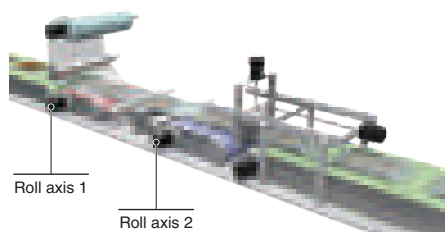

### GX LogViewer

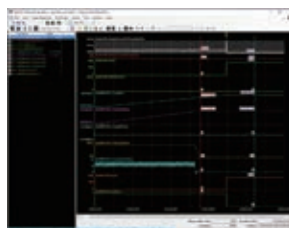

- Displays the collected data and events graphically.
- Enables users to adjust a graph easily by automatic adjustment function and drag operation.

# Cam Data PLCopen®

Create operation profile data\*<sup>1</sup> (cam data) according to your application. The created cam data is used to control output axis. The following three cam operations are available: linear operation, two-way operation, and feed operation. Choose one according to your application.

\*1. "Operation profile data" is a general name for waveform data, which is used for various applications.

## Operation Profile Data (Cam Data)

### Linear operation

The cam pattern is a linear line. This pattern is used for a ball screw and a rotary table.

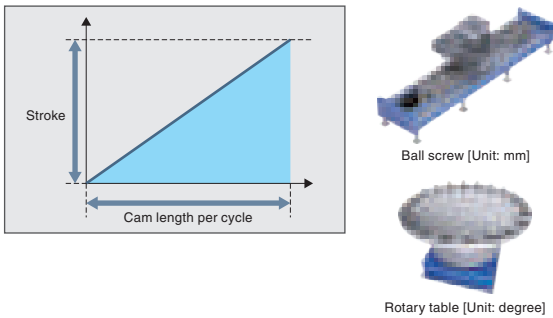

### Two-way operation

The beginning and the end of the cam pattern are the same. Mechanical cams fall into this category.

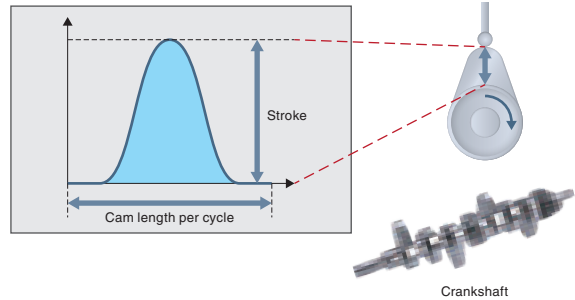

### Feed operation

The beginning and the end of the cam pattern differ. This pattern is used for fixed-amount feed operations and intermittent operations. Set the end point for the feed operation to a position of your choice.

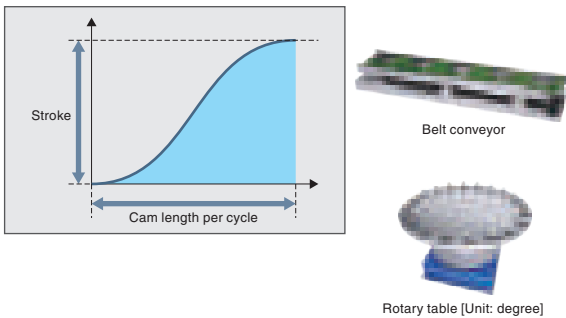

## Application examples

**[Machine with all axes synchronized]**

All the axes of the machine are in synchronization.

**[Machine with only certain of the axes synchronized]**

Only two axes synchronized

Only two axes are synchronized. The other axes perform positioning operation while the two axes execute synchronous control.

Two arms synchronized

The two arms can avoid interference by synchronizing with each other, shortening the cycle time.

**Operation Profile Data** PLCopen®

The operation profile data is divided into the following two types of cam data.

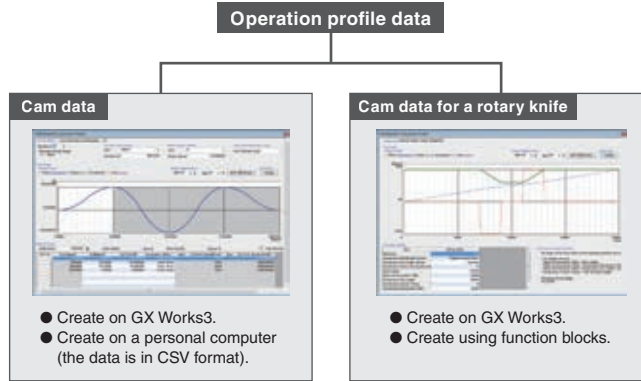

**Importing Operation Profile Data in CSV Format**

The operation profile data in a CSV format on a personal computer can be imported directly to a Motion module.

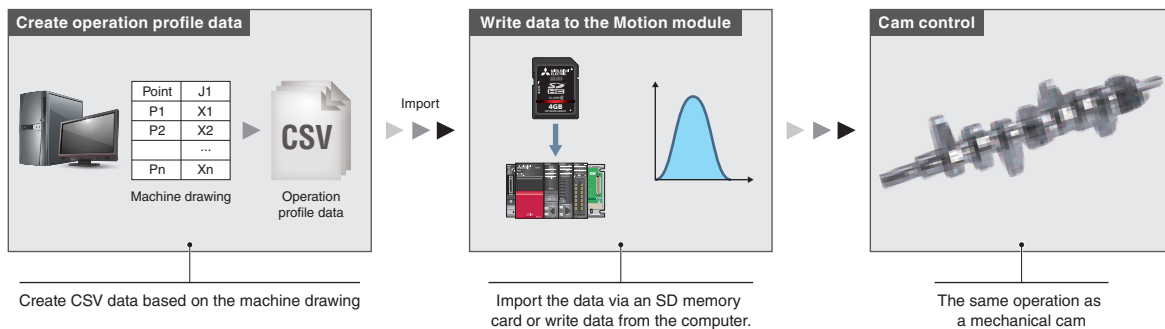

**Easy Cam Creation for a Rotary Knife**

Cam data for a rotary knife is automatically generated with MELSOFT GX Works3 or by using a function block.

- (Using function block) The operation profile data (cam data) is created just by setting the sheet length and sheet synchronization width, etc., to the function block and starting it.
- (Using MELSOFT GX Works3) Set the sheet length and sheet synchronization width, etc., which automatically generates cam data for a rotary knife.

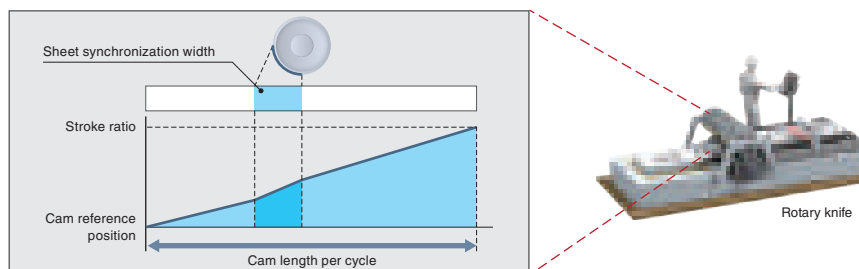

Servo System  
 Servo System Controllers  
 Embedded Type Servo System Controller  
 Servo Amplifiers / Servo Motors

## Servo Amplifier Control Mode PLCopen®

The servo amplifier has three control modes: position, velocity, and torque control modes.

**[Control mode]**

- Position control mode: Accurately move to the target position  
(Speed control that includes position loop)
- Velocity control mode: Drive at the specified speed  
(Speed control that does not include position loop)
- Torque control mode: Drive at the specified torque

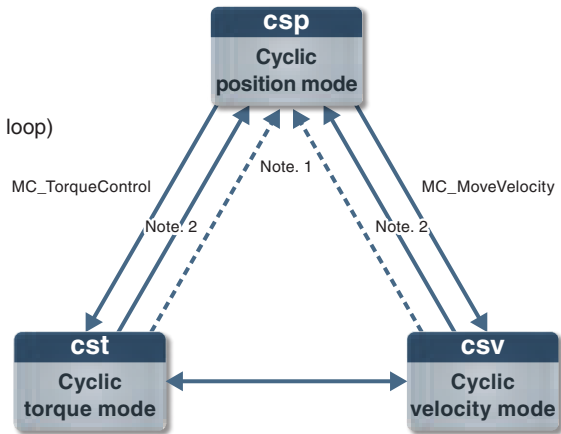

Note 1: Transits at stop completion or error occurrence.  
 Note 2: Transits when Aborting or Buffered is executed to an instruction other than MC\_MoveVelocity/MC\_TorqueControl.

## Selectable Speed Control to Best Fit Your System Needs PLCopen®

Two types of speed control are available: speed control that includes position loop and speed control that does not include position loop.

### Speed Control That Does Not Include Position Loop

- Control mode setting of the servo amplifier: velocity control mode
- Minimizes speed deviation by flexibly responding to speed changes, such as those that occur when the load changes.
- Suitable for machines which keep driving the motors at constant speed, such as a wind/unwind machine.

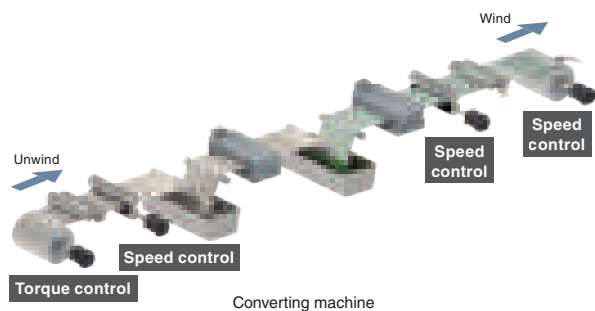

### Speed Control That Includes Position Loop

- Control mode setting of the servo amplifier: position control mode
- Suitable for operations that repeatedly switch between speed and position control.

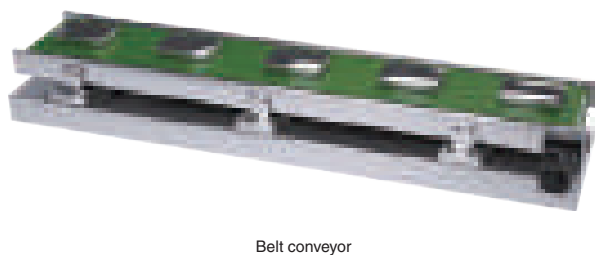

Belt conveyor

**Torque Control** PLCopen®

**Torque Control Mode**

The axes in torque control are controlled to run at the constant torque following the torque command. When the load is light and the speed increases to the set limit, the torque control switches to speed control.

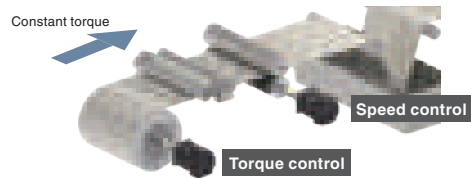

**Application example**

**[Unwinding axis of converting machines]**

Torque control unwinds film at constant tension to prevent wrinkling in the film. The tension can be kept constant by sequentially controlling the torque commands. This type of control is perfect for unwinding machines that need to keep the tension of unwound materials constant.

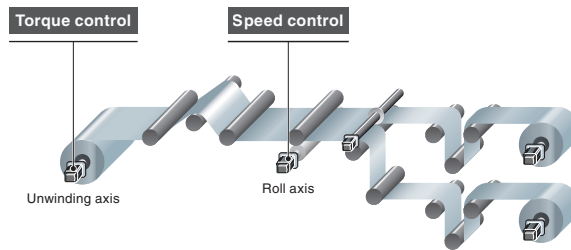

**Continuous Operation to Torque Control Mode**

When using this mode, you can switch from position control to torque control continuously without stopping the servo motor.

- The current positions are always tracked even in torque control, and therefore positioning is executed smoothly in position control after switched from the torque control.
- Position control is smoothly switched to torque control without stopping the servo motor.

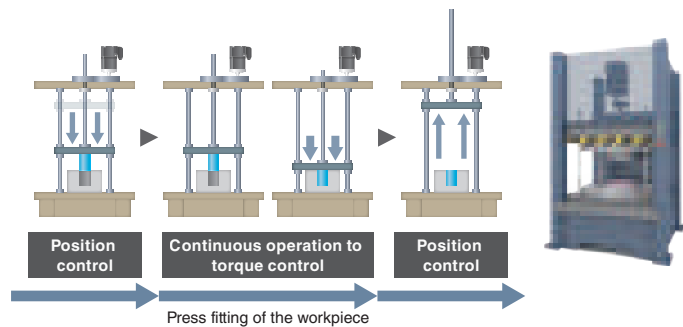

**Application example**

**[An example of continuous operation to torque control]**

This control is applicable to a variety of machines, such as bonding, press-fit, punching, and clamping machines.

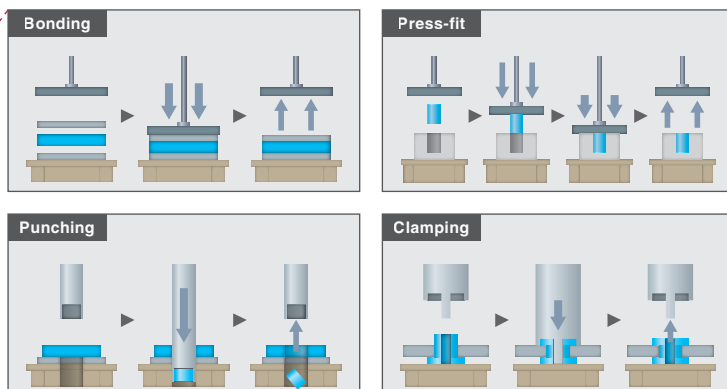
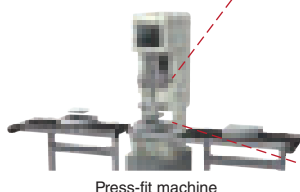

Servo System  
Servo System Controllers  
Embedded Type Servo System Controller  
Servo Amplifiers / Servo Motors



Touch Probe Function **NEW**

PLCopen®

This function latches data responding to a trigger signal input to a servo amplifier.

The compensation amount is calculated based on the latched data, and the error is compensated using a compensation axis. A high-accuracy touch probe at 1  $\mu$ s is available.

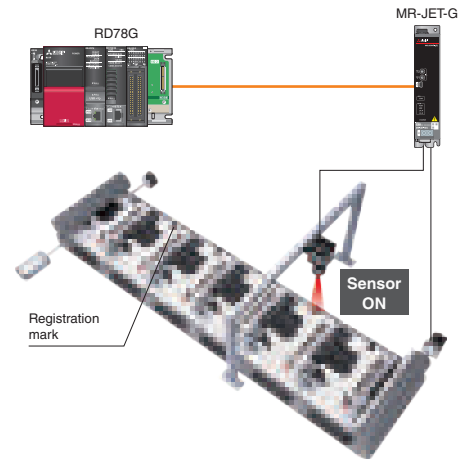

## A Wide Variety of Features

PLCopen®

### JOG operation

Outputs commands from the motion system to an axis and operates the axis to the specified direction while the positive/reverse rotation JOG command is inputted by using MCv\_Jog (JOG Operation).

### Absolute position system

Restores the absolute position of the designated axis. Once the home position return is executed at the start of the system, it is unnecessary to perform the home position return again when the power is turned ON next time.

### Stroke limit functions

Establish the physical movable range for a machine. The hardware stroke limit function and the software stroke limit function are available.

### Target position change

A target position can be changed using the buffer mode by starting a FB to a new target position at any timing during the position control of another FB.

### Acceleration/deceleration processing function

Adjusts the acceleration/deceleration of each motion control so that the acceleration/deceleration curve is suitable for the machine.

### Override

Sets the factor for the velocity and performs the control to change the target velocity. The following two methods are available for changing the override factor: a method of using the dedicated FB and a method of changing the control data.

### Stop operation functions

The forced stop, the axis stop, the axes group stop, and the forced stop of the servo amplifier are available.

### Axis emulate

Enables operations of a virtual servo amplifier as if an actual unit is connected. This function enables to debug the user program at the startup of the device or verify the positioning operation.

### File transfer

Executes file operation and data backup/restore based on the specified command.

### Torque limit function

Limits the torque generated by the servo motor to the preset torque limit value. The following two methods are available for changing the torque limit value: a method of using the dedicated FB and a method of changing the control data.

### Event history

Saves the error information and the operation for the module as an event in the CPU module and the motion system.

## One software, many possibilities

Programmable Controller Engineering Software

# GX Works3

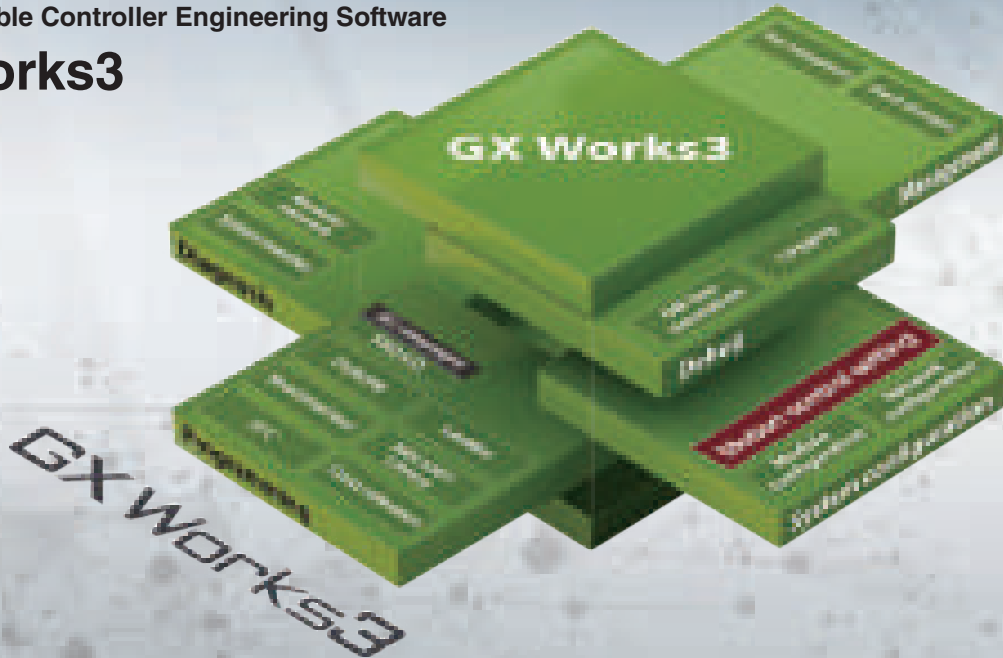

MELSOFT GX Works3 has a variety of features which help users create programs and conduct maintenance more flexibly and easily. This software includes motion control setting to support all Motion module development stages - from setting parameters to programming, debugging, and maintenance.

### Development Environment Designed for Ease of Use

This all-in-one software covers all aspects of the product development cycle, resulting in boosted efficiency in programming while also improving user-operability by providing a common interface across all the phases.



#### System Design

- Network configuration settings
- Automatic detection of network configuration

#### Programming

- Easy programming in ST language
- More intuitive programming, which eliminates the need to remember devices or buffer memory addresses
- Easy access to axis information
- Operation profile data

#### Debug

- Various monitor functions, such as axis monitor, and ST language program monitor
- A simulator that debugs a program without an actual machine
- Real-time monitor of GX LogViewer

#### Maintenance

- Various monitor functions, such as axis monitor, and event history
- Security key authentication **NEW**

## Network Configuration Settings PLCopen®

### [Network configuration settings]

- Intuitive network settings with drag-and-drop operations and a graphical screen view

### [Automatic detection]

- By clicking the [Connected/Disconnected Module Detection] button, the connection status of device station is automatically detected and the CC-Link IE TSN configuration screen is generated.

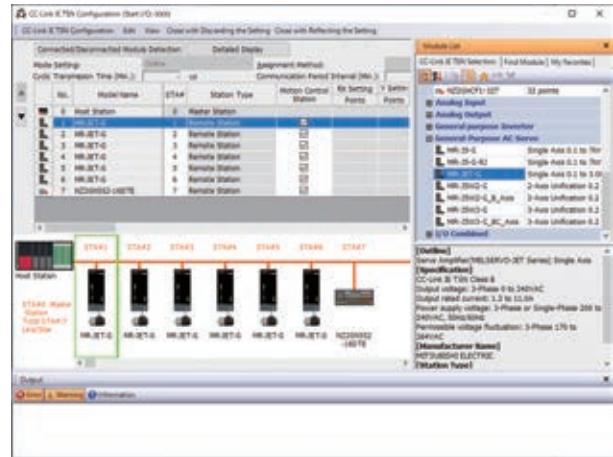

## Operation Profile Data with Simple Settings PLCopen®

Operation profile data, such as cam data and cam data for a rotary knife, is easily created.

- The cam graph can be flexibly and easily created through drag & drop. The waveform is changed according to the pointer's movement.
- Stroke, speed, acceleration, and jerk can be set while monitoring the changes on the graph.
- By setting "5th Curve (Adj)" for the cam curve types, the speed on a section border becomes smooth.
- Operation profile data for a rotary knife can be automatically generated by settings sheet length, synchronization width, cam resolution, etc.
- The created operation profile data can be checked on the list.

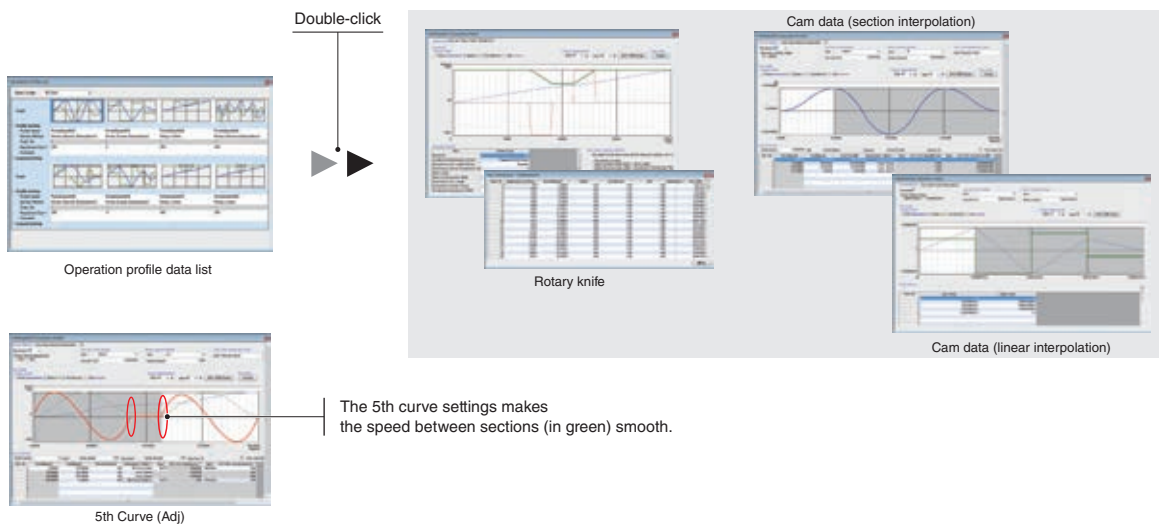

Servo System  
Servo System Controllers  
Embedded Type Servo System Controller  
Servo Amplifiers / Servo Motors

## Easy Programming Through Structured Text Language PLCopen®

- Structured text programs are composed of function blocks, increasing program readability.
- Modularization of the programs increases their reusability.
- The consistent, common operability on a single engineering tool improves usability further.
- A wide selection of programming elements in the MELSOFT Library contributes to reducing programming time.
- The program is created by dragging & dropping programming elements, which simplifies the programming process.
- A startup time is reduced using the simulator of MELSOFT GX Works3 that can debug a program without an actual machine.

### Programming Using Labels

- The control axes of the Motion modules and I/O signals are defined as label variables, which enables easy reuse of programs and helps to improve programming efficiency.
- The global labels created in the Motion module project can be used in PLC CPUs.

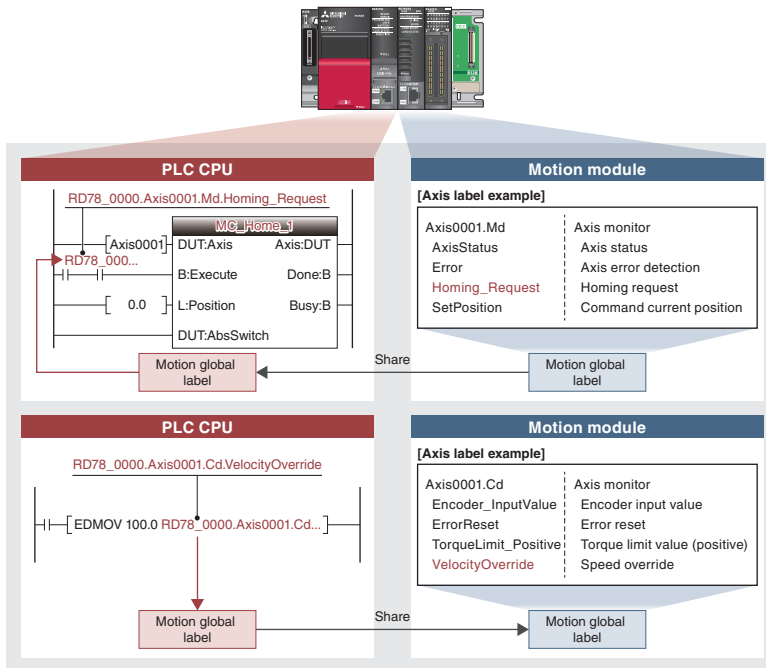

#### [Reading label data in Motion module]

The axis label data created in the Motion module can be read by the PLC CPU.

#### [Writing data to labels in Motion module]

Data in the PLC CPU program can be written to the axis labels in the Motion module.

### Axis Information is Easily Accessible

- Axis label variables can be used as an argument to refer axes in positioning function blocks.
- IntelliSense® function reduces programming mistakes.
- Access by variable names increases readability.

#### [Structured text editor]

```

18 // ● Current position change (MC_SetPosition) initial setting
19 bExecute0 := TRUE; //Execute==TRUE
20 lsPosition0 := 0.0; //target position is 0.0
21 bRelative0 := FALSE; //Relative position selection = absolute position
22 sExecutionMode0 := 1; //Start mode=1:acQueued (Stop and run)
23 dsOptions0 := 0; //option (Do not allow cancellation)
24
25 // ● Speed command
26 bExecute1 := TRUE;
27 bCentInpos0 := FALSE;
28 lsVelocity0 := 0.0;
29 lsAcceleration0 := 0.0;
30 lsDeceleration0 := 0.0;
31 lsJerk0 := 5;
32 iDirection0 := 1;
33 iBufferPulse0 := 0;
34 dsOptions1 := 0;
35
36 // ● Acceleration limit
37 AccelerationLimit := 1000;
38 AccelerationOverride := 0.5;
39 AccelerationZeroBehavior := 0;
40 Analyzing := FALSE;
41 AutoDeceleration := FALSE;
42 AxisName := 'X';
43 AxisStatus := 0;
44 BufferingPulse := 0;
45 CmdInPos := TRUE;
46 CmdInPos_Width := 0;
47
48 // ● Acceleration limit value
49 AccelerationOverrideCoefficient := 0.5;
50 OperationSelectionAtStartAcceleration := 0;
51 Analyzing := FALSE;
52 AutomaticallyDecelerating := FALSE;
53 AxisName := 'X';
54 AxisStatus := 0;
55 NumberofBufferingPulses := 0;
56 CommandInPosition := TRUE;
57 CommandInPositionWidth := 0;
58
59 // ● Settings
60
61
62
63
64
65
66
67
68
69
    
```

**GX LogViewer with Enhanced Waveform Display** PLCopen®

The graph data of both PLC CPU modules and Motion modules can be viewed on a single tool, GX LogViewer. This tool helps you efficiently analyze data from two different modules. The following two functions are provided for logging: data logging function (offline) and real-time monitor.

**Data Logging Function (Offline)**

The function performs data logging by a specified time interval based on the logging setting (trigger condition, data collection) written to the motion system from the engineering tool. The results are saved as a data logging file. Up to 10 data settings can be simultaneously logged for the motion system.

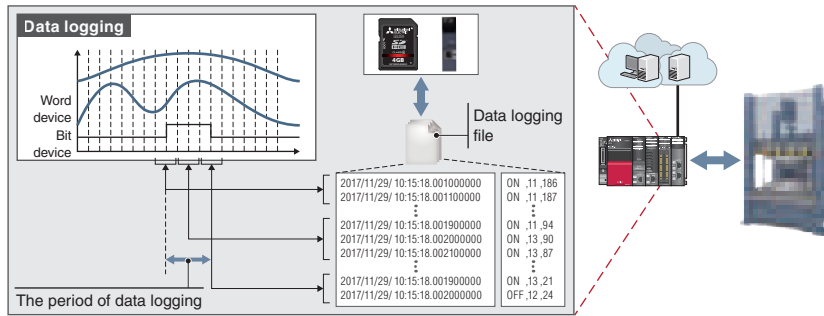

**Real-Time Monitor**

Up to 32 collected motion system data can be displayed in real time.

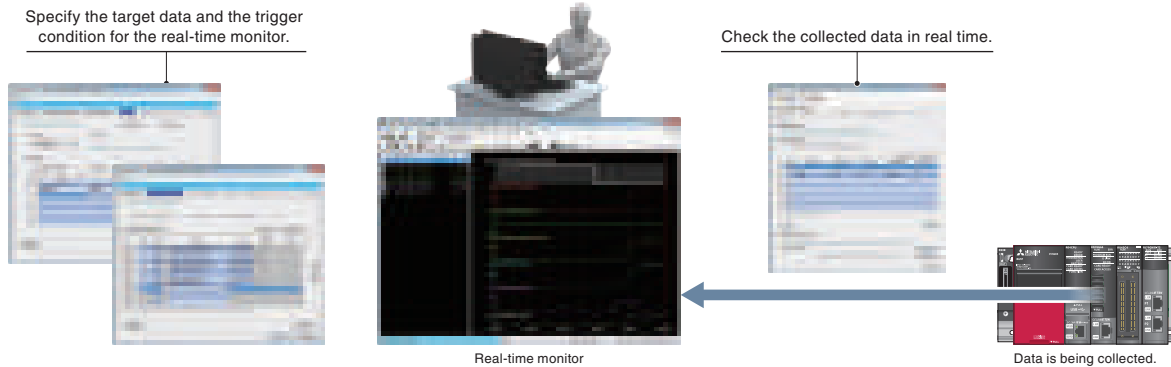

Servo System  
Servo System Controllers  
Embedded Type Servo System Controller  
Servo Amplifiers / Servo Motors



Easy Troubleshooting by Simulation Before an Actual Operation and Monitor Functions **PLCopen®**

The system simulator enables the Motion module and PLC CPU programs to be simulated interactively. A program operation can be checked without an actual machine during debugging process, which shortens the startup time.

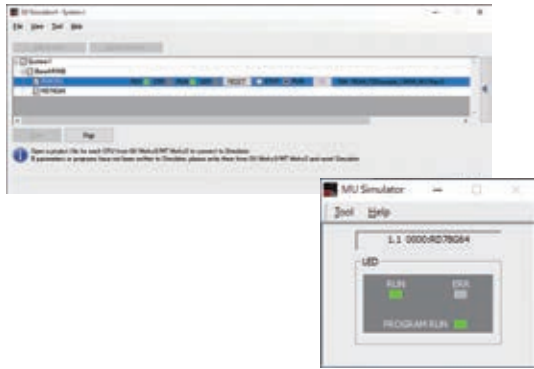

Users can customize the axis monitor items according to their machine, improving debug efficiency. The axis monitor can also be used during simulation.



Event history lists information about executed operations and errors that have occurred on each module in chronological order, which helps to conduct troubleshooting.

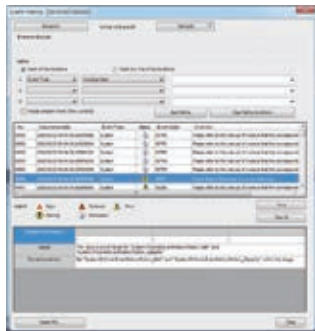

Debugging can be executed through both the program monitor and the watch window by using the common interface.



ST language program monitor

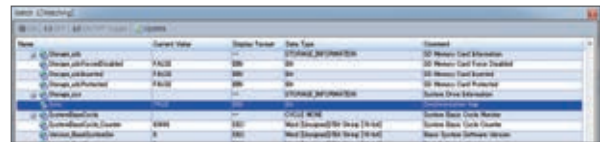

Watch window

System Design

Programming

Debug

**Maintenance****Security Key Authentication Function****NEW****PLCopen®**

The security key authentication prevents programs from being opened on personal computers where the security key has not been registered. Furthermore, because programs can be executed only by Motion modules with the security key registered, the integrity of customer technologies and other intellectual property is not compromised.



Servo System

Servo System Controllers

Embedded Type Servo System Controller

Servo Amplifiers / Servo Motors

## Software-based controller for high-precision motion control

CC-Link **IE TSN**

Motion Control Software

# SWM-G



Installed on a personal computer, SWM-G Motion Control Software can perform motion and network control.

- Supports a CC-Link IE TSN servo control system with the personal computer where RTX64 (real-time extension) is installed. (RTX64 is included with SWM-G.)
- Meets various application needs by offering various types of motion control, such as positioning, synchronous, cam, speed, and torque control using API library for motion control.
- Utilizes network control to connect and set various device stations (remote I/O modules, etc.) and TCP/IP devices.

### Product Lines



Download Motion Control Software from Mitsubishi Electric FA global website.



#### SWM-G Motion Control Software

- SWM-G Engine
- SWM-G API
- Network API
- SWM-G Operating Station
- Real Time OS



Purchase the USB key (license).

#### USB key

- For 16 axes
- For 64 axes
- For 32 axes
- For 128 axes

CC-Link **IE TSN**

Motion Control Software\*1

## SWM-G

- Maximum number of control axes: 128
- Minimum operation cycle\*2: 125  $\mu$ s
- Programming language: Visual C ++<sup>®</sup>

### USB key for Motion Control Software

- MR-SWMG16-U: 16 axes
- MR-SWMG32-U: 32 axes
- MR-SWMG64-U: 64 axes
- MR-SWMG128-U: 128 axes

\*1. SWM-G Motion Control Software includes SWM-G Engine, SWM-G API, Network API, SWM-G Operating Station, and Real Time OS (RTX64).

\*2. The minimum operation cycle depends on the number of control axes and the CPU of the personal computer.

### Covering a Wide Range of Multi-Axis Applications

- SWM-G Motion Control Software is available in 16 to 128-axis control models, enabling multi-axis synchronization of various scales of machines.

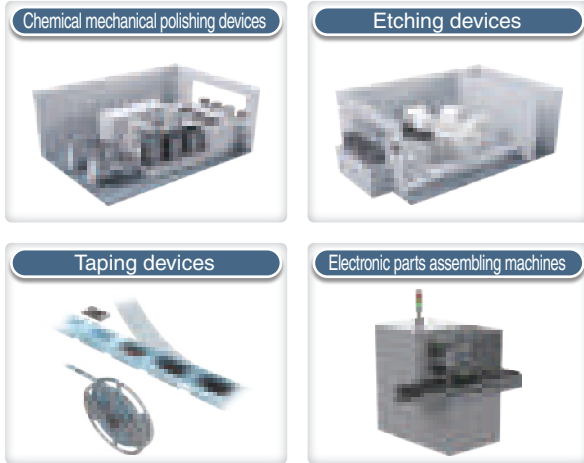

- A CPU core of the industrial personal computer is assigned for running SWM-G processing, and that enables SWM-G to perform a high-speed, real-time operation without being affected by the operation on Windows®.

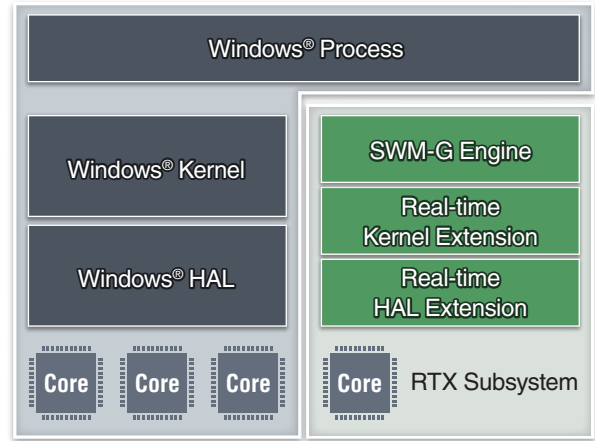

### Reduced Machine Design and Startup Time

- The integrated test tool SWM-G Operating Station covers the development processes of SWM-G from design to simulation, contributing to reduction in the total cost of ownership.
- The Operating Station enables users to check the communication settings and status of the master/remote stations, leading to reduced design time.

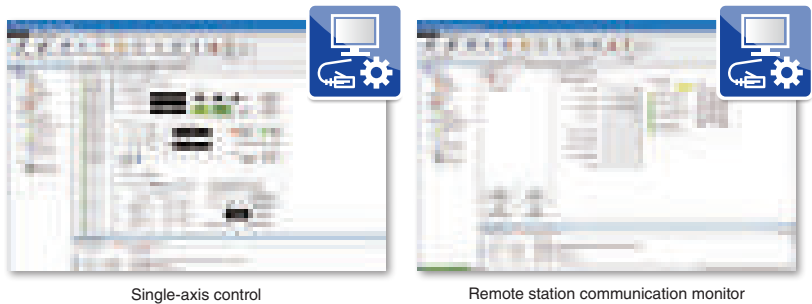

### Maintenance Solution by MELIPC with SWM-G Installed

When SWM-G is installed and operated on the MELIPC (industrial personal computer), the system offers a powerful maintenance solution utilizing the Edgexcross-compatible software.

#### [Predictive/preventive maintenance]

- The user application collects data of machine diagnosis function, etc. from MR-JET-G through the communication API of SWM-G.
- The MELIPC analyzes the collected data by using the Edgexcross-compatible real-time data analyzer.

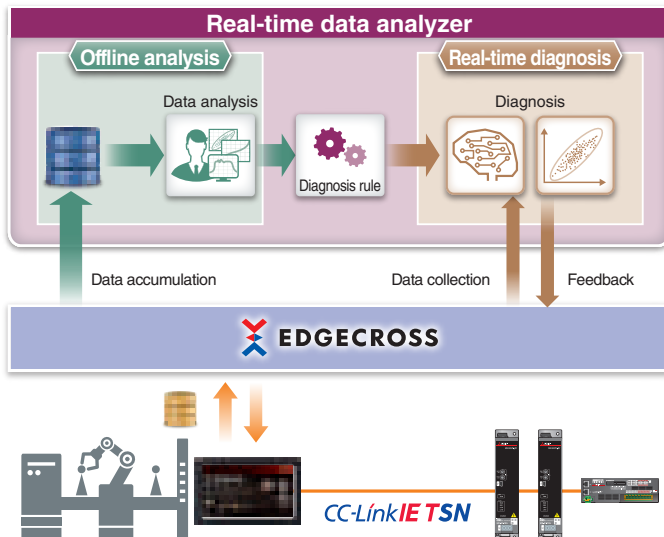

#### [Corrective maintenance]

- SWM-G collects data from the drive recorder of MR-JET-G through TCP/IP communications, which reduces troubleshooting time.

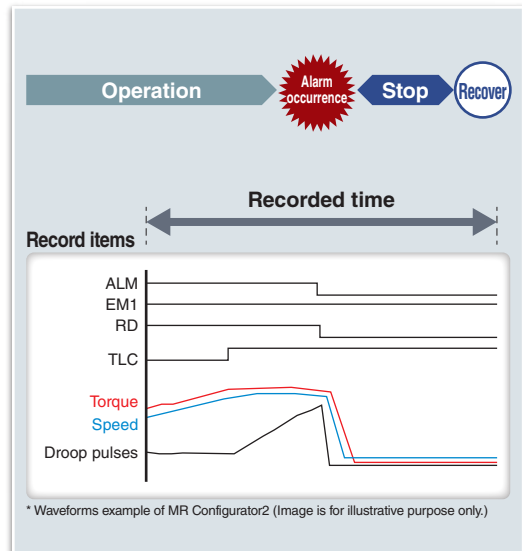

# System Configuration

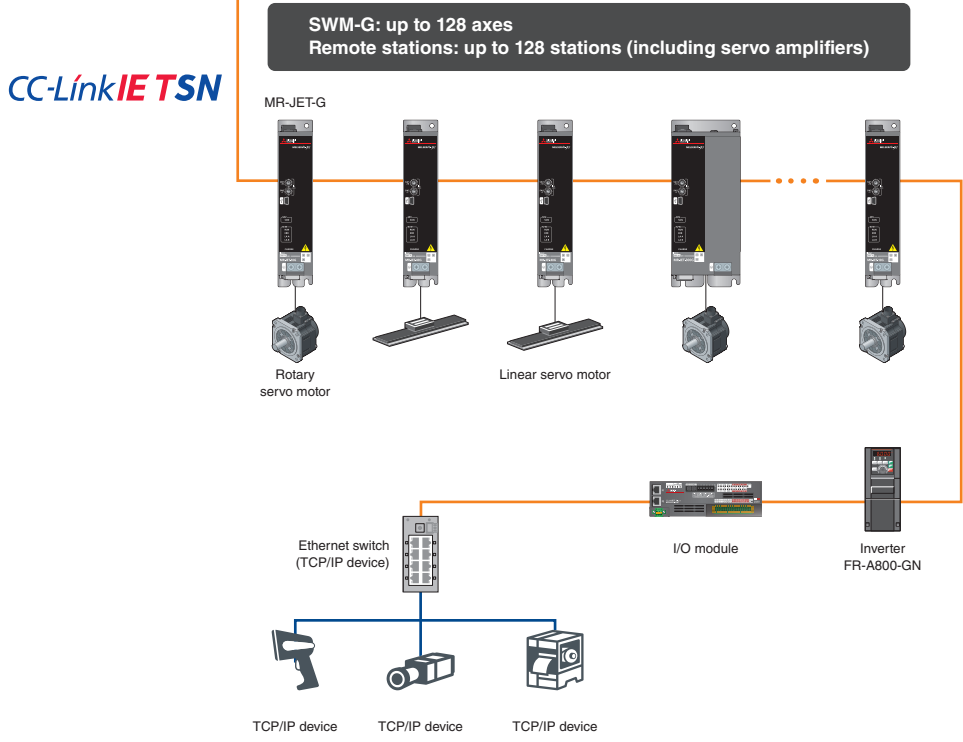
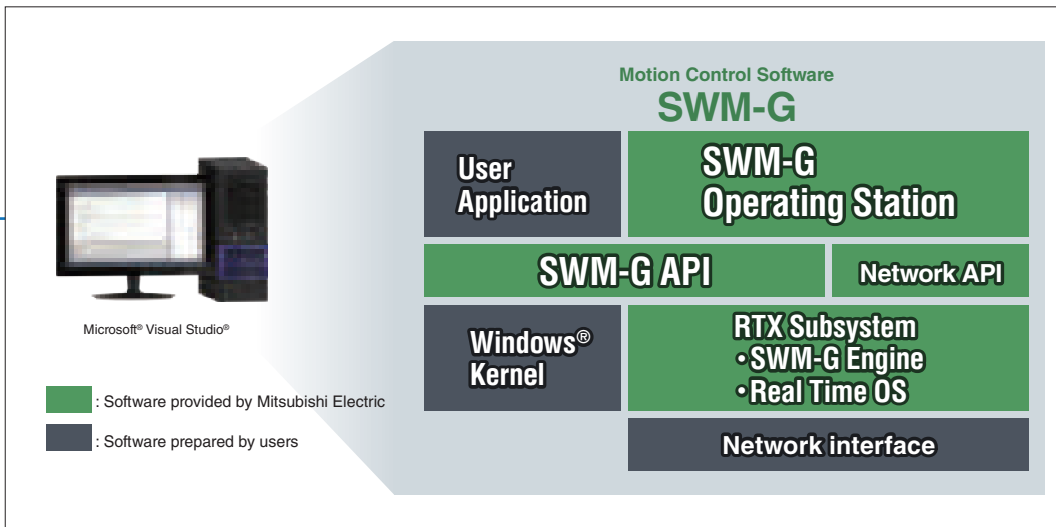
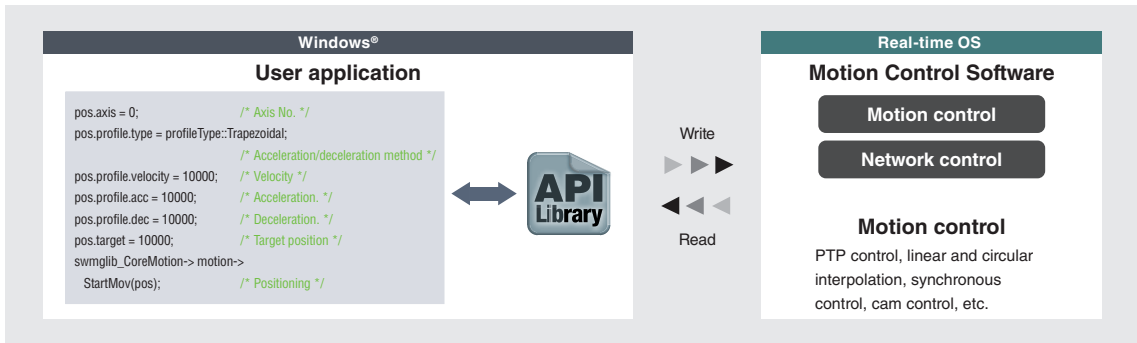
\* Motion Control Software can function as a master station of CC-Link IE TSN. The following functions are not provided: sub-master station, local station, multi-master configuration, backup/restore function, data communication function with standard stations, and safety communication.

## Integrated Test Tool SWM-G Operating Station

This tool provides a variety of features - parameter settings required for application development and the test operation for JOG, inching, and positioning operations. In addition, each axis status and sampled waveforms can be displayed to help user check the start timing and the operation pattern.

### SWM-G Operating Station

#### [Communication monitor]

- Displays a list of the master communication setting
- Displays the system status, allowing users to check communication status

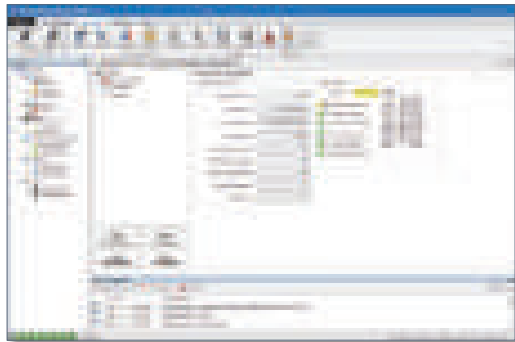

#### [Single-axis control]

- Performs a test operation for single-axis control
- Performs a reciprocating operation that is often used for a test operation

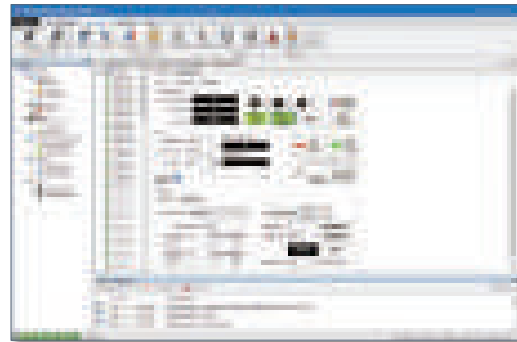

## Multiple Servo Amplifier Settings and Adjustments

MR Configurator2 enables users to easily set and adjust multiple servo amplifiers through CC-Link IE TSN which enables mixing of TCP/IP communication and other communications.

Using MR Configurator2 with the integrated test tool, users can adjust servo amplifiers while checking the servo amplifier communication status.

- Manages a multi-axis system as one project
- Offers an easy-to-set user interface for machine diagnosis function



\*MR Configurator2 is not included with SWM-G Motion Control Software.

Servo System  
Servo System Controllers  
Embedded Type Servo System Controller  
Servo Amplifiers / Servo Motors



# Positioning Control

## Linear interpolation

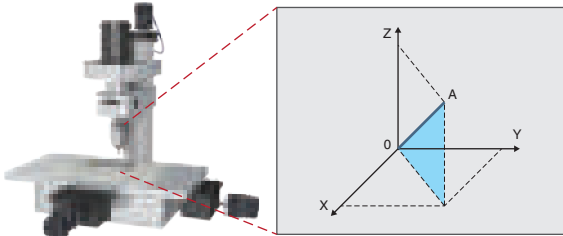

## Circular interpolation

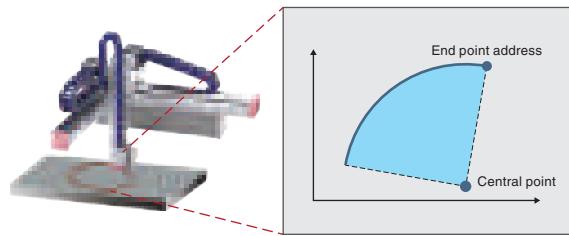

## Continuous path control (path interpolation)

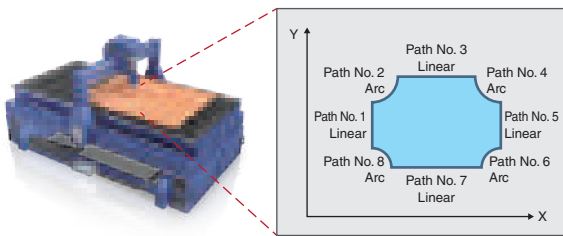

## Helical interpolation

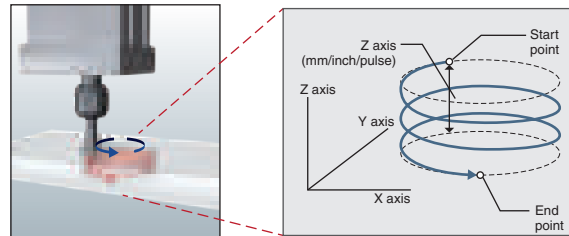

## Jerk acceleration/deceleration

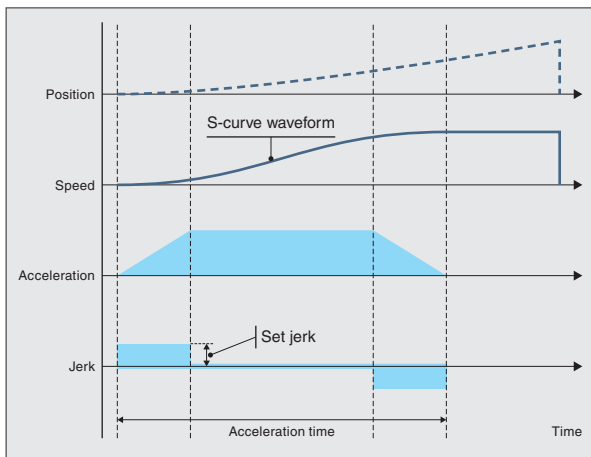

In this method, an axis can be accelerated gradually through adjusting jerk so that the vibrations of the machine can be minimized.

In the example above, the constant positive jerk is applied at the start of the operation to achieve smooth acceleration. When the axis is shifted to the constant-speed operation, the same amount of negative jerk is applied.

Adjusting jerk in this way achieves smooth acceleration/deceleration while also shortening the time it takes to reach the target speed.

The speed creates a S-curve shape.

## Triggered motion

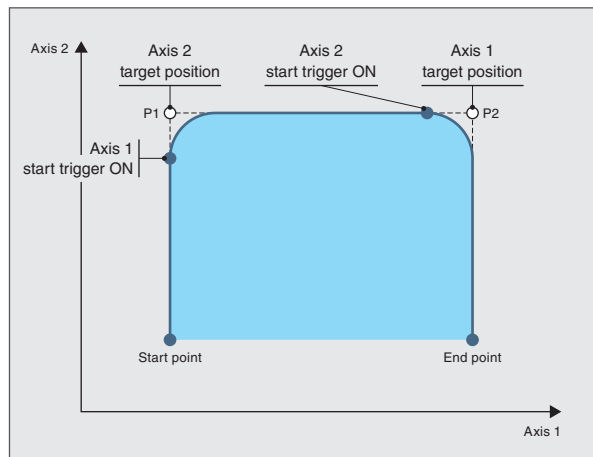

The triggered motion is a type of command that delays the execution of the motion command until the specified trigger condition is satisfied.

Axes can be started automatically based on the specified conditions by using this command, reducing the cycle time of conveyor systems, etc.

In the operation example above, right after the axis 2 starts execution of normal motion commands, the axis 1 executes the triggered motion command (delaying the execution of the command until the condition is satisfied).

When the condition is satisfied (start trigger ON) during the axis 2 operation, the axis 1 starts executing the motion command.



**Synchronous control (tandem drive)**

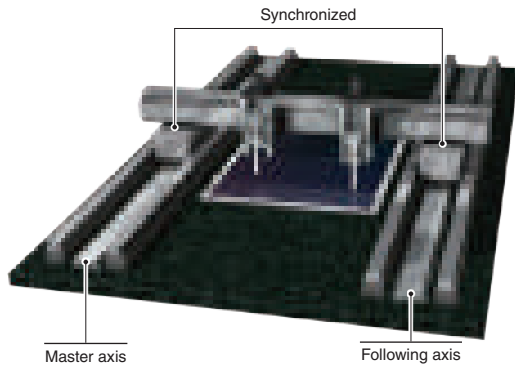

Motion Control Software enables tandem operation where the same commands can be outputted to master and following axes.

**Gantry home position return**

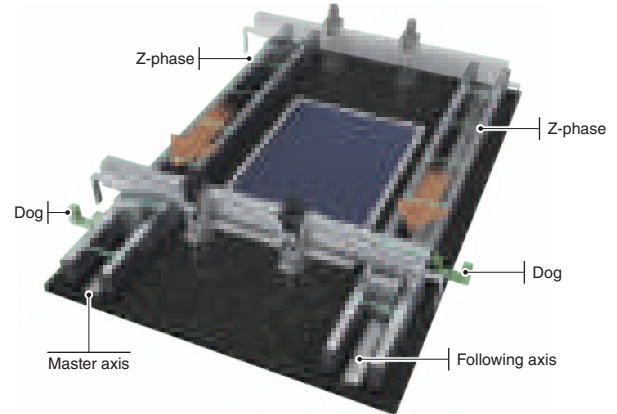

After the master and following axes pass their respective dogs, the gantry home position return stops both of the axes at the Z-phase of the master axis. This method enables two or more axes to execute home position return simultaneously, supporting gantry systems.

**A Wide Variety of Features**



**Hot connect (disconnection/reconnection)**

The hot connect enables a topology change during operation without requesting a communication stop. The user application disconnects and reconnects the network through API library.

**Monitoring of servo data**

The controller obtains the status data of MR-JET-G servo amplifiers, such as machine diagnosis information and encoder temperature, via CC-Link IE TSN. This enables visualization of machine status.

**Position synchronous output (cam switch)**

The output signal is turned on when a specified condition is satisfied. This function can be used as an alternative to a limit switch.

**Touch probe (mark detection)**

The current value of the servo motor can be read when the touch probe signal is inputted. Software and hardware touch probes are available. Select the touch probe according to your application.

**Pitch error compensation**

The set offset is applied at regularly spaced command positions. The position error of ball screws can be compensated, improving the operation accuracy.

**Backlash compensation**

The set offset is applied when the axis changes the travel direction. The backlash of ball screws can be compensated, which improves operation accuracy of machines.

**Acceleration/deceleration methods**

The controller offers 24 types of acceleration/deceleration methods, such as trapezoidal, S-curve, jerk ratio, parabolic, sine curve, time acceleration trapezoidal, etc. Select the method according to your application.

## Programming Utilizing API Library



### ■ Development environment \*1 (Microsoft® Visual Studio®)

Add the SWM-G API library to the project of Microsoft® Visual Studio® and create a user program.

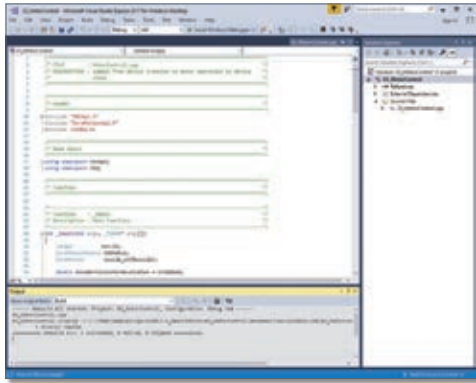

- C++, C# compile
- Debug of C language programs

\*1. Prepare a development environment with Microsoft Visual Studio®.

### ■ A program that starts positioning

```

void sample()
{
    Motion::PosCommand pos;

    /* Position command data settings */
    pos.axis = 0;                /* Axis = axis 0 */
    pos.profile.type = ProfileType::Trapezoidal; /* Acceleration = trapezoidal */
    pos.profile.velocity = 10000.0; /* Velocity = 10000.0 [U/s] */
    pos.profile.acc = 10000.0;    /* Acceleration = 10000.0 [U/s^2] */
    pos.profile.dec = 10000.0;   /* Deceleration = 10000.0 [U/s^2] */
    pos.target = 30000.0;        /* Travel distance = 30000.0 [U] */

    /* Relative positioning start */
    err = ssclib_cm.motion->StartMov(&pos);
    if (err != ErrorCode::None) { /* Error processing */ }

    /* Waiting for positioning completion */
    ssclib_cm.motion->Wait(0);
}
    
```

```

/* Relative positioning start */
err = ssclib_cm.motion->StartMov(&pos);
if (err != ErrorCode::None) { /* Error processing */ }
    
```

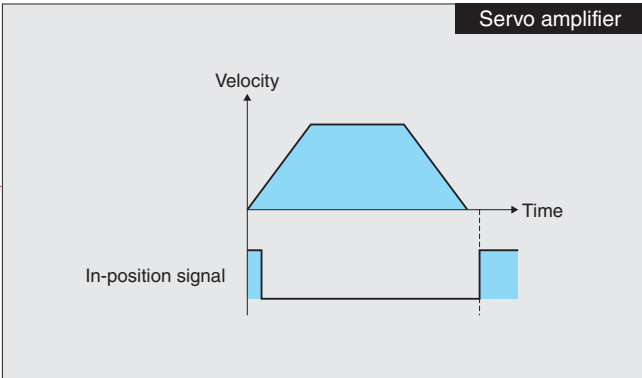

■ A program that continuously starts positioning of another axis based on the specified trigger condition

```

void sample()
{
    Motion::PosCommand pos;
    Motion::TriggerPosCommand tpos;

    /* Position command data settings (axis 0) */
    pos.axis = 0; /* Axis = axis 0 */
    pos.profile.type = ProfileType::Trapezoidal; /* Acceleration = trapezoidal */
    pos.profile.velocity = 10000.0; /* Velocity = 10000.0 [U/s] */
    pos.profile.acc = 10000.0; /* Acceleration = 10000.0 [U/s^2] */
    pos.profile.dec = 10000.0; /* Deceleration = 10000.0 [U/s^2] */
    pos.target = 30000.0; /* Travel distance = 30000.0 [U] */

    /* Relative positioning start (axis 0) */
    err = sscLib_cm.motion->StartMov(&pos);
    if (err != ErrorCode::None) { /* Error processing */ }

    /* Triggered motion position command data settings (axis 1) */
    tpos.axis = 1; /* Axis = axis 1 */
    tpos.profile.type = ProfileType::Trapezoidal; /* Acceleration = trapezoidal */
    tpos.profile.velocity = 10000.0; /* Velocity = 10000.0 [U/s] */
    tpos.profile.acc = 10000.0; /* Acceleration = 10000.0 [U/s^2] */
    tpos.profile.dec = 10000.0; /* Deceleration = 10000.0 [U/s^2] */
    tpos.target = 20000.0; /* Travel distance = 20000.0 [U] */
    tpos.trigger.triggerAxis = 0; /* Trigger axis = axis 0 */
    tpos.trigger.triggerType = TriggerType::RemainingDistance; /* Trigger condition = remaining distance */
    tpos.trigger.triggerValue = 1500.0; /* Remaining distance = 1500.0 [U] */

    /* Triggered motion relative positioning start (axis 1) */
    err = sscLib_cm.motion->StartMov(&tpos);
    if (err != ErrorCode::None) { /* Error processing */ }

    /* Waiting for positioning completion */
    sscLib_cm.motion->Wait(1);
}
    
```

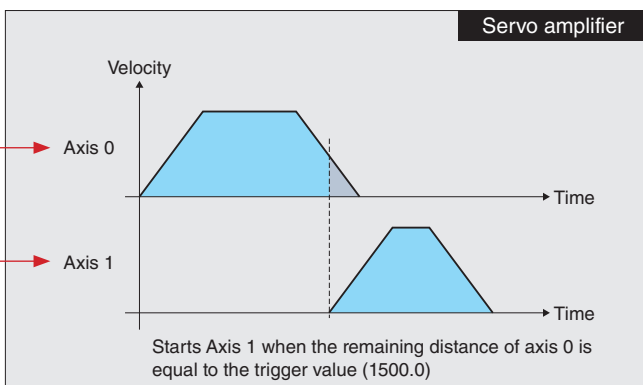

## All-in-One World Class Servo

### Servo amplifiers

MITSUBISHI ELECTRIC SERVO SYSTEM  
**MELSERVO-JET**



**CC-Link IE TSN**  
**MR-JET-G**

**EtherCAT**  
**MR-JET-G-N1**

Supports Ethernet-based CC-Link IE TSN, featuring high-speed, large-capacity communication (1 Gbps). Communication cycle of  $\geq 125 \mu\text{s}$  and speed frequency response of 2.5 kHz enable advanced motion control.

The servo amplifiers also support CC-Link IE Field Network Basic. MR-JET-G-N1 servo amplifiers support EtherCAT®. (100 Mbps)

## Product Lines

### ■ Servo amplifier

●: Supported

Model	Power supply specifications	Command interface <sup>(Note 1)</sup>	Rated output	Rotary servo motor	Linear servo motor	Control mode			Fully closed loop control
						Position	Velocity	Torque	
MR-JET-G	200 V AC	CC-Link IE TSN	0.1 kW to 3.0 kW	●	●	●	●	●	●
MR-JET-G-N1		EtherCAT®							

Notes: 1. MR-JET-G also supports CC-Link IE Field Network Basic.

Rotary servo motors

# HG-KNS Series

# HG-SNS Series

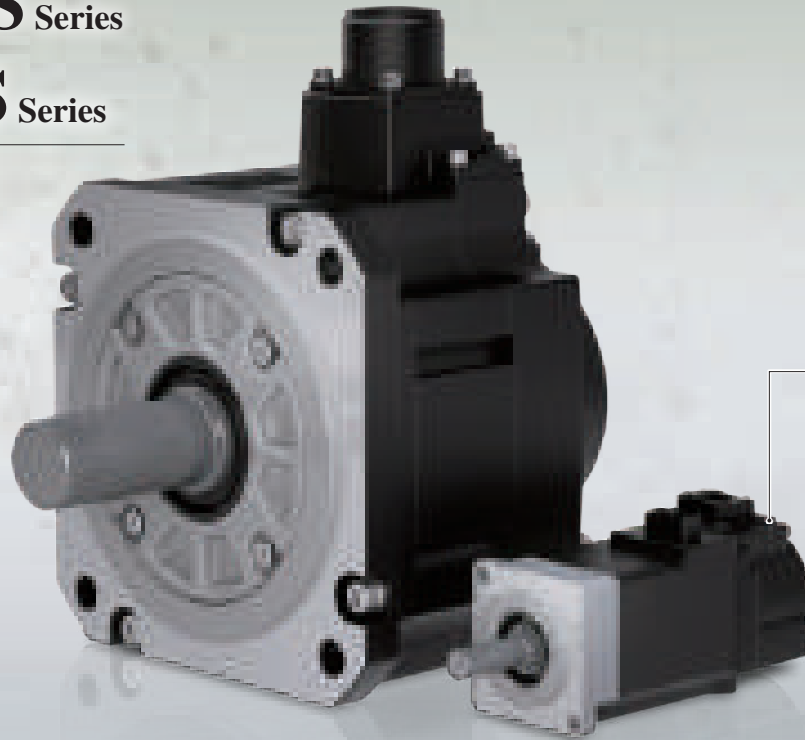

Equipped with a 22-bit absolute position encoder.

\* A battery is required when configuring an absolute position detection system.

Small capacity, low inertia



## HG-KNS Series

Servo motors with a 22-bit absolute position encoder  
 Rated speed: 3000 r/min  
 Maximum speed: 6000 r/min

Medium capacity, medium inertia



## HG-SNS Series

Servo motors with a 22-bit absolute position encoder  
 Rated speed: 2000 r/min  
 Maximum speed: 3000 r/min

\* The maximum speed varies by the models.

### Rotary Servo Motors

\* : Motor flange size [Unit: mm]

HG-KNS Series						HG-SNS Series			
40 × 40 *		60 × 60 *		80 × 80 *		130 × 130 *		176 × 176 *	
Model	Capacity [kW]	Model	Capacity [kW]	Model	Capacity [kW]	Model	Capacity [kW]	Model	Capacity [kW]
HG-KNS13J	0.1	HG-KNS23J	0.2	HG-KNS73J	0.75	HG-SNS52J	0.5	HG-SNS202J	2.0
		HG-KNS43J	0.4			HG-SNS102J	1.0	HG-SNS302J	3.0
						HG-SNS152J	1.5		

Servo System  
 Servo System Controllers  
 Embedded Type Servo System Controller  
 Servo Amplifiers / Servo Motors



## Compact Servo Amplifiers with Simple Wiring

### Simple, Efficient Wiring

The servo amplifier offers simple wiring by having connectors on the top and bottom surfaces, and allows all cables and wires to be routed through wiring ducts. LEDs and switches are located on the front surface of the servo amplifiers for easy operation.

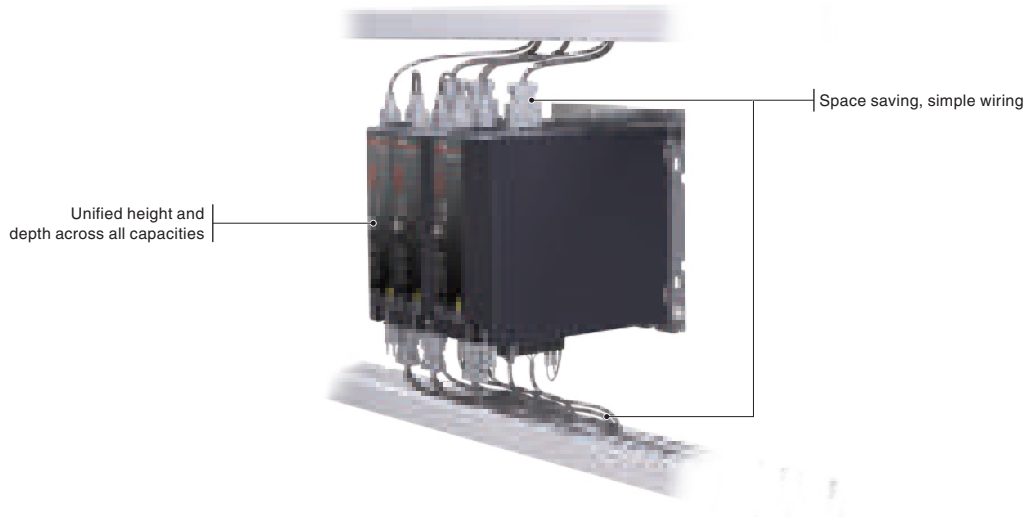
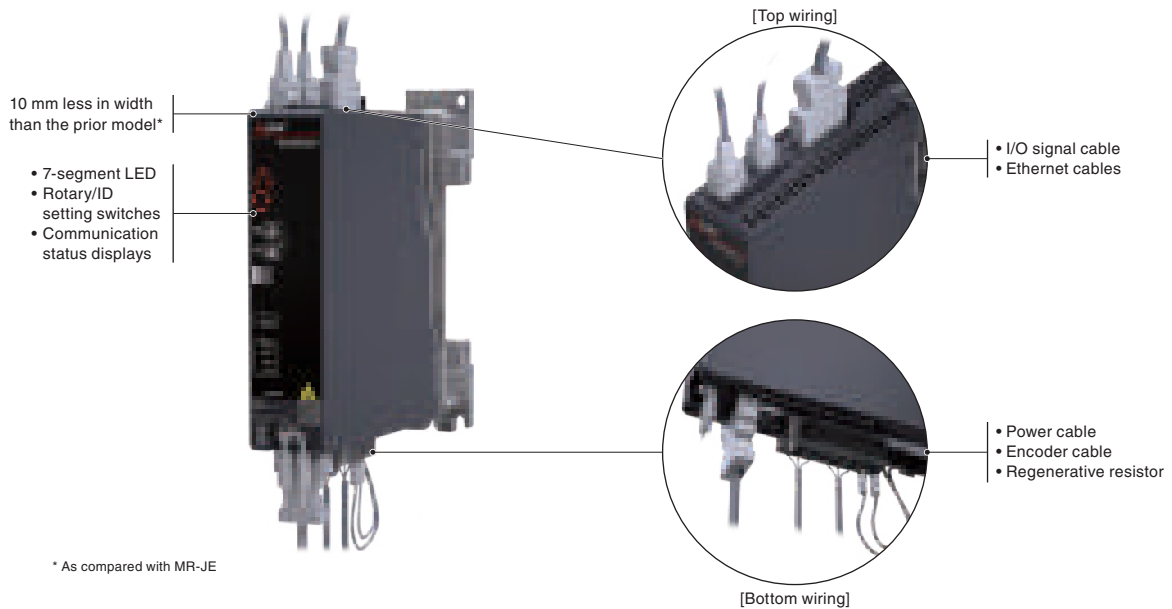

## Easy Replacement of MR-JE-Compatible Servo Motors HG-KN/HG-SN

### Mount/Cable Compatibility

HG-KNS/HG-SNS series has the same dimension as the MR-JE-compatible HG-KN/HG-SN series and uses the same power and encoder cables.

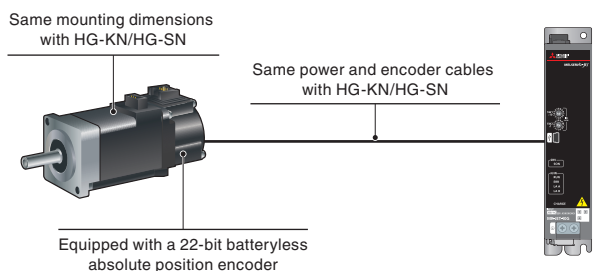

# Tuning Functions

Use the tuning methods that are optimal for your machines.

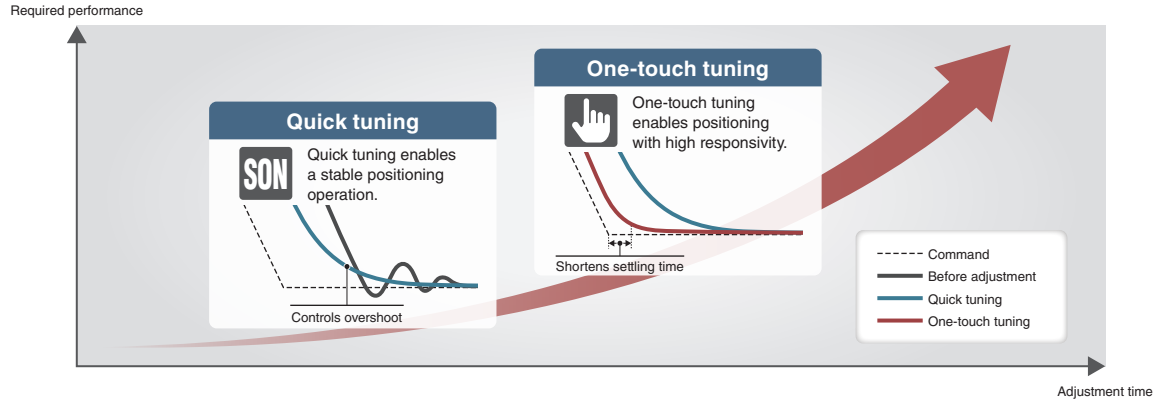

## Quick Tuning

This function automatically performs easy-to-use auto tuning that controls vibration and overshoot just by turning on the servo-on command. Before normal operation, the servo amplifier sets control gain and machine resonance suppression filters in 0.3 seconds by inputting torque to the servo motor automatically. After completing the setting, the servo amplifier starts operation normally.

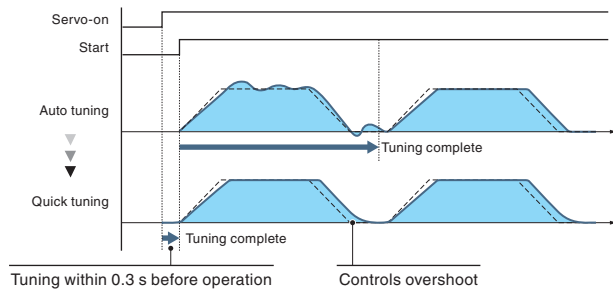

## One-Touch Tuning

This function automatically completes servo gain adjustment according to the mechanical characteristics and reduces the settling time just by turning on the one-touch tuning. The servo gain adjustment includes the machine resonance suppression filter, advanced vibration suppression control II, and the robust filter. Controlling overshoot and vibration is improved, maximizing your machine performance.

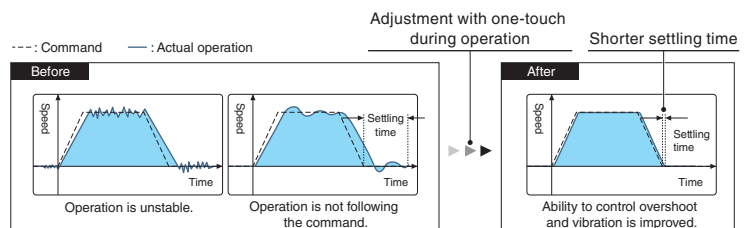

## Advanced Vibration Suppression Control II

This function suppresses two types of low frequency vibrations, owing to vibration suppression algorithm which supports three-inertia system. This function is effective in suppressing residual vibration with relatively low frequency of approximately 100 Hz or less generated at the end of an arm and in a machine, enabling a shorter settling time. Adjustment is easily performed on MR Configurator2.

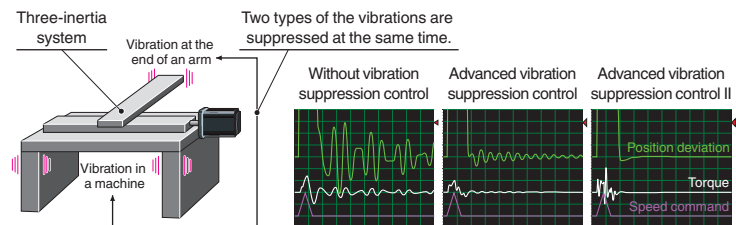

## Command Notch Filter

The frequency can be set close to the machine vibration frequency because the command notch filter has an applicable frequency range between approximately 1 Hz and 2000 Hz.

## Machine Resonance Suppression Filter

The expanded applicable frequency range is between 10 Hz and 8000 Hz. Five filters are simultaneously applicable, improving vibration suppression performance of a machine. The machine resonance frequency is detected by the machine analyzer function in MR Configurator2.

## Preventive Maintenance

### Machine Diagnosis Function

This function detects changes in mechanical parts (ball screw, guide, bearing, belt, etc.) by analyzing changes in machine friction, load moment of inertia, unbalanced torque, and vibration components from the data inside a servo amplifier, supporting timely maintenance of these parts.

● Friction estimation function

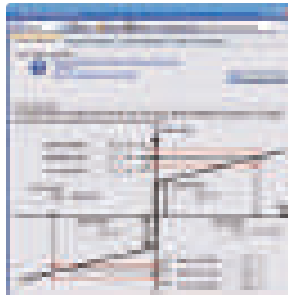

● Vibration estimation function

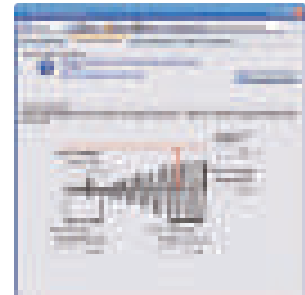

### Servo Amplifier Life Diagnosis

This function displays the cumulative energization time and the number of inrush relay on/off times. The data can be used to check the service life of the parts as a rough guide.

- Cumulative energization time (Smoothing condenser/cooling fan life span)
- The number of inrush relay on/off times (Inrush relay life)

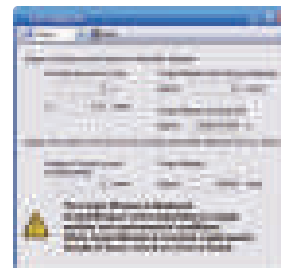

## Corrective Maintenance

### Drive Recorder

This function continuously monitors the servo status and records the status transition such as a trigger condition before and after an alarm for a fixed period of time. Reading the servo data on MR Configurator2 helps you analyze the cause of the alarm. In addition to the monitor values and the waveform of the past 16-time alarms in the alarm history, the system configuration and the servo parameters are displayed. Alarm occurrence time is also displayed when the servo amplifier and the controller are normally in communication on CC-Link IE TSN. The data can be outputted to a GX LogViewer format file.

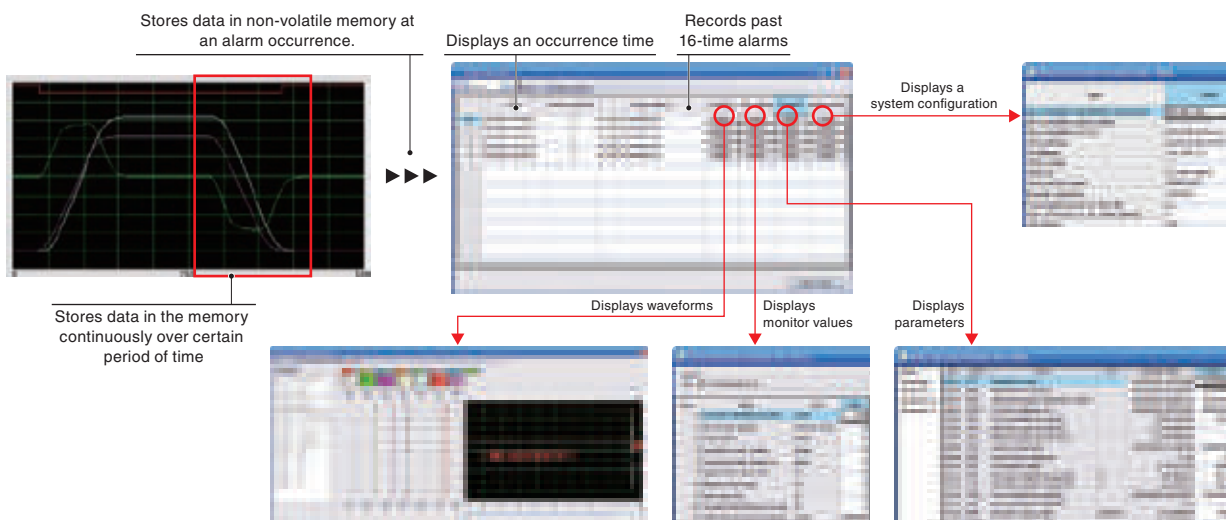

## Connection/Communication Diagnosis

### Disconnection Detection

The servo amplifiers detect an open phase condition on the output side. The alarm can be distinguished from other alarms such as the overload alarm, reducing the time required to restore the system.

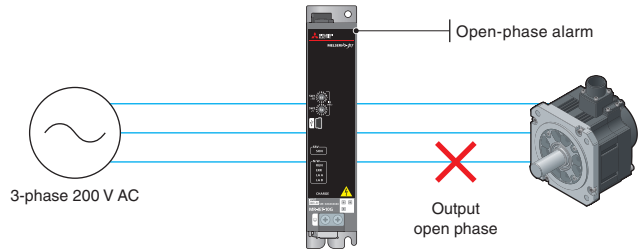

### Encoder Communication Diagnosis

The encoder communication diagnosis checks the encoder communication circuit in the servo amplifier. This function is useful for classifying the cause of errors (such as disconnected encoder cables) when the encoder communication alarm occurs.

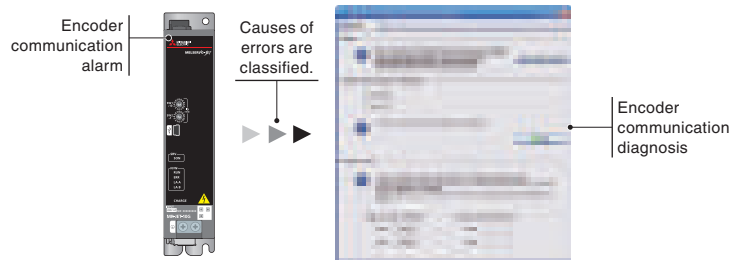

## Path Control

### Super Trace Control

This function reduces a position deviation to nearly zero not only during constant-velocity operation, but also during constant acceleration/deceleration. The path accuracy will be improved in high-rigidity machines.

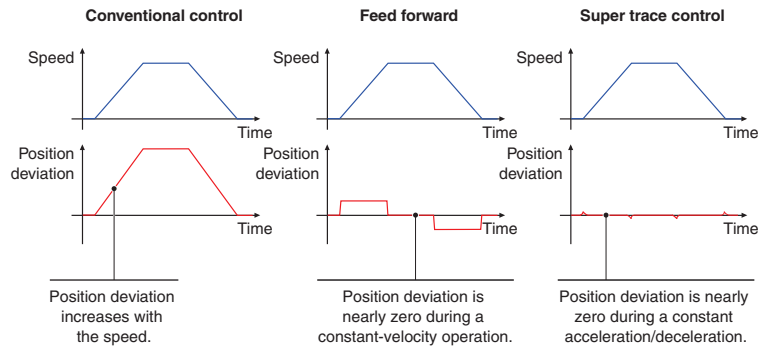

### Lost Motion Compensation

This function suppresses quadrant protrusion caused by friction and torsion generated when the servo motor rotates in a reverse direction. Therefore, the accuracy of circular path will be improved in path control used in XY table, etc.

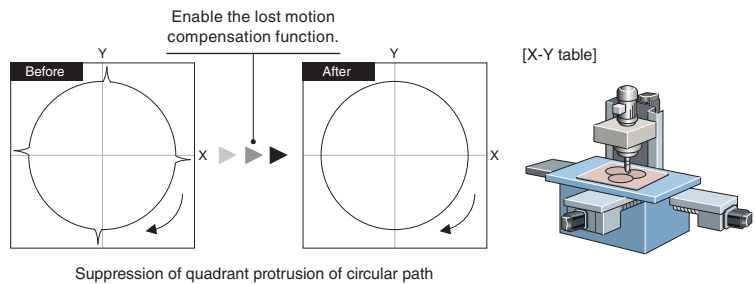

### Path Tracking Model Adaptive Control

This function reduces path errors which occur when the servo motor reciprocates. Normally, when positioning control is executed, the model adaptive control adjusts the control to shorten a settling time. Instead, this function reduces overshooting to improve path accuracy, which is suitable for machines that require high-accuracy path control such as processing machines.

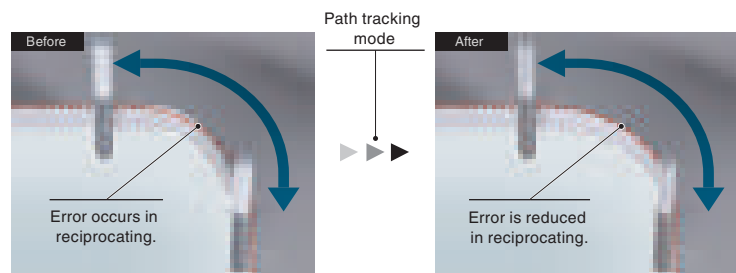

## Supporting Flexible Driving System

### Fully Closed Loop Control

Enhanced functions

Supporting a fully closed loop control system as standard \*1, the servo amplifiers enable further precise positioning.

\*1. The servo amplifiers are compatible only with two-wire type serial encoders.  
Use the servo amplifier manufactured in July 2022 or later.  
Note that, depending on the stock status, the servo amplifiers with both the former and the new specifications may be distributed in the market around the same time. Contact your local sales office when the fully closed loop control is needed.

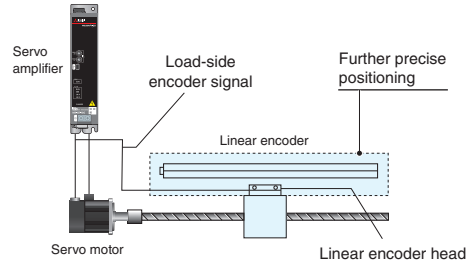

### Touch Probe Function

Enhanced functions

When a touch probe (sensor) that detects the position of workpieces is connected to a servo amplifier, the touch probe function latches (stores) the position detected by the touch probe. The controller reads and uses the latched value for position correction. The latch accuracy of this function is 1 μs.\*1

\*1. Use the servo amplifier manufactured in July 2022 or later.  
Note that, depending on the stock status, the servo amplifiers with both the former and the new specifications may be distributed in the market around the same time. Contact your local sales office when the touch probe function is needed.

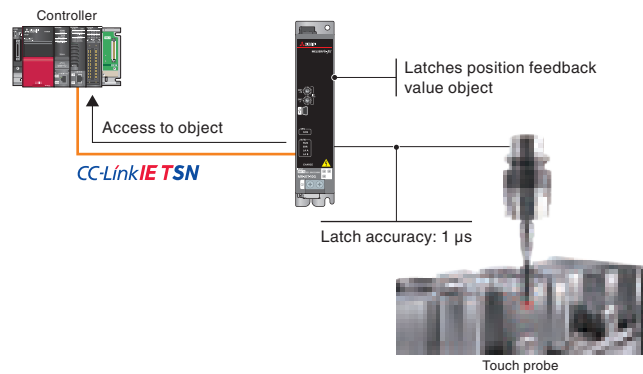

### Positioning by Using a CC-Link IE TSN-Compatible RJ71GN11-T2

An RJ71GN11-T2 master/local module that supports CANopen can control the servo amplifiers.\*1 The servo amplifiers support both the profile mode (position/velocity/torque) and the positioning mode (point table).\*2 With these operation modes, a positioning system can be simply configured without a Positioning module. In the profile position mode, for example, the target positions and speeds can be set from the master station. The servo amplifier generates commands to the target positions with a start signal and starts positioning operations.

\*1. RD78G/FX5-SSC-G Motion modules also support CANopen.  
\*2. For the modes supported by the master station, refer to the master station specifications.

#### [Profile position mode continuous operation]

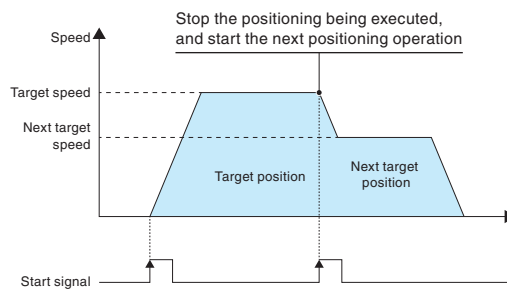

#### [Profile position mode continuous operation (point table)]

Point table No.	Position data	Servo motor speed	Acceleration time constant	Deceleration time constant	Dwell	Auxiliary function	M code
1	1000	2000	200	200	0	1	1
2	2000	1600	100	100	0	0	2
⋮	⋮	⋮	⋮	⋮	⋮	⋮	⋮
255	3000	3000	100	100	0	2	99

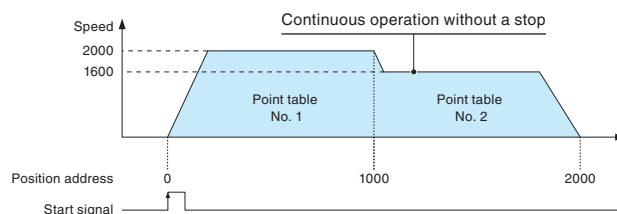

Servo System  
Servo System Controllers  
Embedded Type Servo System Controller  
Servo Amplifiers / Servo Motors

## Command Interface

### CC-Link IE TSN JET-G

The servo amplifiers receive commands (position/velocity/torque) from a CC-Link TSN-compatible controller at regular intervals through synchronous communication and drive the servo motors.

When combined with a Motion module or Motion Control Software, the servo amplifiers perform exact synchronous operation of axes and machines through high-speed, high-precision time synchronization.

The servo amplifiers support CiA 402 drive profile and enable the profile mode (position/velocity/torque) and the positioning mode (point table). When combined with the controllers supporting the profile mode, the servo amplifiers generate a positioning command to a target position, reducing loads of the controllers.

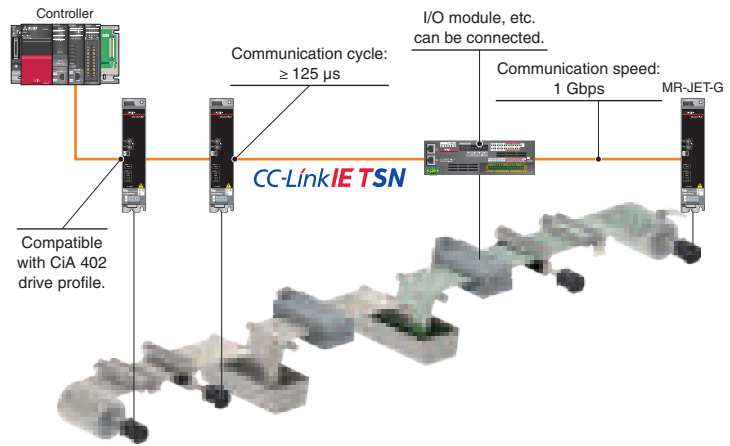

### CC-Link IE Field Network Basic JET-G

CC-Link IE Field Network Basic-compatible master stations such as an FX5U CPU module can control MR-JET-G servo amplifiers. The servo amplifier can be operated as a CANopen device via a link device.

The profile mode (position/velocity/torque) and the positioning mode (point table) are supported.

MR-JET-G servo amplifiers can be connected to existing systems using MR-JE-C.

In addition, MR-JET-G supports the line topology.\*1

\*1. When a device which does not support the line topology is used, the line/star mixed topology is applicable.

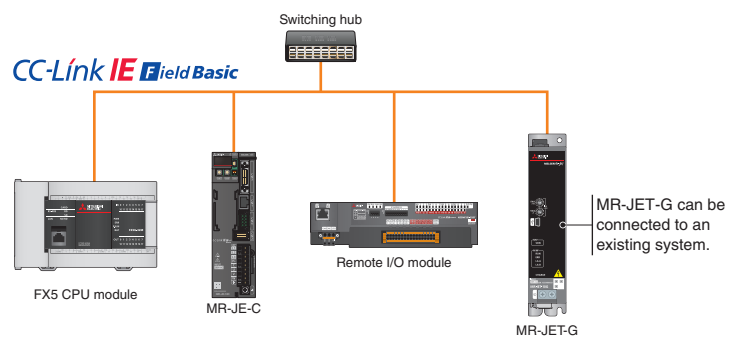

### EtherCAT® JET-G-N1

Configure an EtherCAT® system with the high-performance MR-JET series servo amplifiers.

MR-JET-G-N1 servo amplifiers support EtherCAT®.

Communication specification	CANopen over EtherCAT® (CoE)
Drive profile	CiA 402
Communication cycle	125 μs, 250 μs, 500 μs, 1 ms, 2 ms, 4 ms, 8 ms
Control mode	Cyclic synchronous position mode (csp) Cyclic synchronous velocity mode (csv) Cyclic synchronous torque mode (cst) Profile position mode (pp) Profile velocity mode (pv) Profile torque mode (tq) Homing mode (hm)

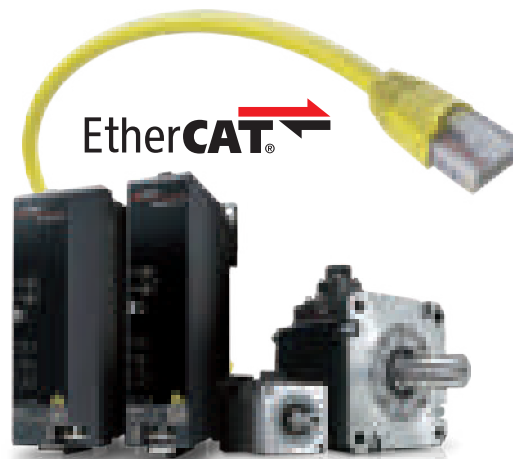



## Servo Setup Software MR Configurator2

Tuning, monitor display, diagnosis, reading/writing parameters, and test operations are easily performed on a personal computer. This powerful software tool supports a stable machine system and optimum control, and moreover, shortens setup time.

### Parameter setting and docking help

Set parameters using the function display in the list without worries about the parameter No. and digits. Information related to the parameter being set is displayed in the docking help window. The latest e-Manual is also displayed in the docking help.

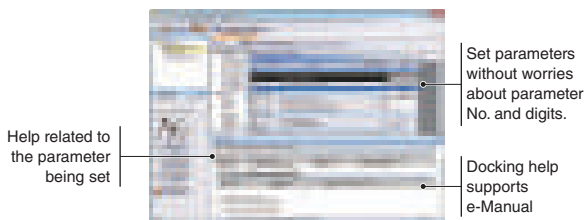

### Supporting multi-axis project

Set parameters and monitor operation for multiple servo amplifiers through connecting to one of the servo amplifiers. Connecting via the Ethernet switching hub and the controller is also possible.

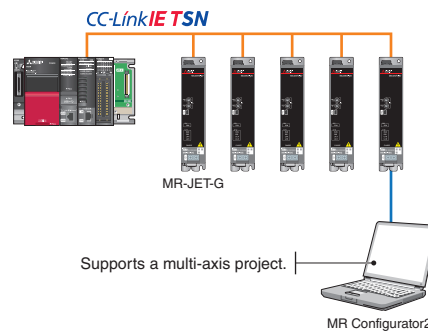

### Tuning function

Adjust control gains finely on the [Tuning] window manually for further performance after the quick tuning and the one-touch tuning.

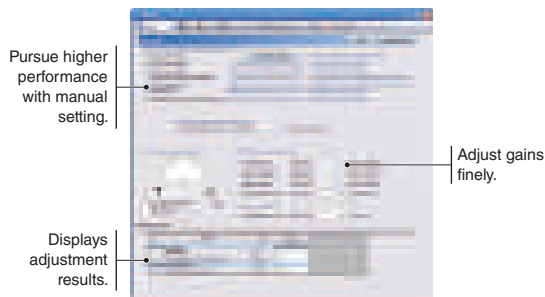

### Graph function

Obtain graphs of 7 channels for analog and 8 channels for digital. Various servo statuses are displayed in the waveform at one measurement, supporting setting and adjustment. Convenient functions such as [Overwrite] for overwriting multiple data and [Select history] for displaying graph history are available. Two types of signals can be used as a trigger signal with an OR/AND condition.

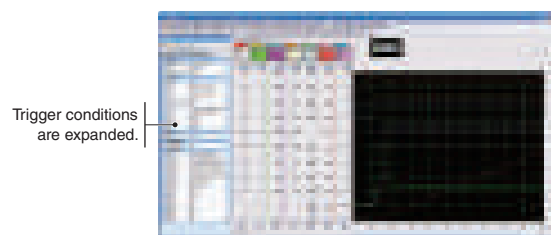

### Machine analyzer function

Input random torque to the servo motor automatically and analyze frequency characteristics (0.1 Hz to 8 kHz) of a machine system just by clicking the [Start] button. This function supports setting of machine resonance suppression filter, etc.

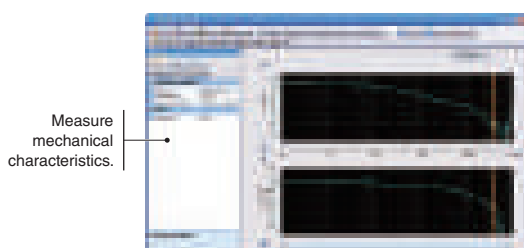

### Software reset

Reset the software for the servo amplifier with this new function. Setting switches and parameters is enabled without turning off the main circuit power supply of the servo amplifier.

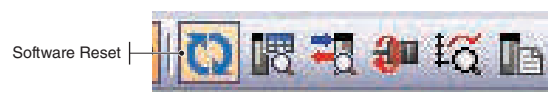

## Drive System Sizing Software "Motorizer"

Select the most suitable servo motors, servo amplifiers, and regenerative options for your machine just by setting machine specifications and operation patterns. You can select a suitable combination from various results. This software also supports multi-axis systems, enabling you to set operation patterns and select options for multiple axes.

Specification input

The screenshot shows the Motorizer software interface. On the left is a navigation sidebar with steps: Step 1 Load mechanism, Step 2 Transmission mechanism, Step 3 Operation pattern, Filter Setting, Motor selection, and Drive selection. The main area is titled 'Specification settings' and includes a 'Select load mechanism' dropdown set to 'Ball screw'. Below this are input fields for: Mass of load (W<sub>L</sub>: 2.500 kg), Mass of table (W<sub>T</sub>: 20.000 kg), Counter weight mass (W<sub>CW</sub>: 0.000 kg), Lead of ball screw (P<sub>L</sub>: 10.000 mm), Ball screw inertia moment (J<sub>B</sub>: 0.500 kg·cm<sup>2</sup>), Friction coefficient (μ: 0.100), Overall machine efficiency (η: 0.800), and Thrust load (F<sub>L</sub>: 0.000 N). An 'Option' section is also present. To the right is a 3D diagram of a ball screw mechanism with labels J<sub>OL</sub>, J<sub>OM</sub>, W<sub>L</sub>, W<sub>T</sub>, F<sub>C</sub>, W<sub>CW</sub>, and θ. Below the specification fields is a 'Selection candidate list' table with columns: Motor, Motor capacity, Drive, Drive capacity(W), Torque effective load, Peak load rate(%), and Effective load rate at stop(%). The table lists several motor and drive combinations with their respective performance metrics.

- 13 common load mechanisms
- Able to add mechanical transmissions

The selection result can be read by FA Integrated Selection Tool.

### Flexible support for load mechanisms

- Select a load mechanism from 13 common types.
- Add transmission mechanisms such as a coupling.
- Set an inclination angle of the load mechanisms as desired.

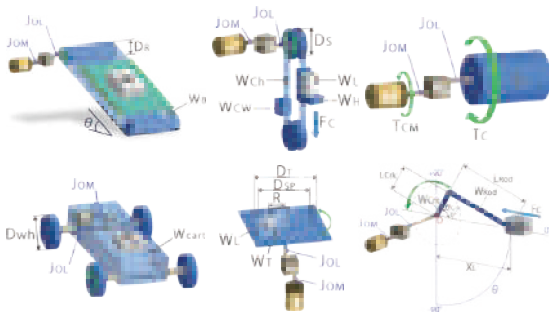

### Compatible with multi-axis systems

- Supports the multi-axis servo amplifiers and the converters.
- Set operation patterns for multiple axes.
- Select regenerative options for a multi-axis system.

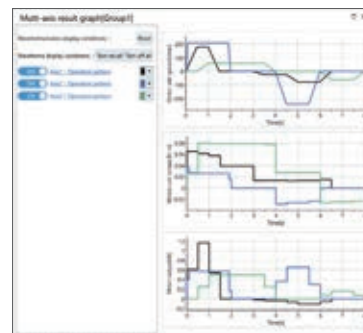

### Selection of several patterns

- Displays a list of load to motor inertia ratio, peak torque, etc., of each selection.
- Compatible with the expanded combinations of the servo amplifiers and the servo motors.
- Set threshold values for judgment.
- Displays energy-saving effect by multi-axis system.

Motor	Motor capacity	Drive	Drive capacity(W)	Torque effective load	Peak load rate(%)	Effective load rate at stop(%)
HG-KNS13	0.200	MR-JT-100(S-N1)	0.200	16.8	16.8	12.7
HG-KNS13	0.100	MR-JT-100(S-N1)	0.100	16.8	16.8	12.7
HG-KNS12	0.500	MR-JT-100(S-N1)	0.750	12.3	26.8	12.3
HG-KNS12	0.500	MR-JT-100(S-N1)	0.750	12.3	26.8	12.3

### Tutorial video

- Illustrates how to use the software and select drive systems in the video.



## FA Integrated Selection Tool

FA Integrated Selection Tool is available on the global website, so you can select multiple devices/entire system with one tool. Using "Select by device" or "Select by network" helps you to select devices such as programmable controllers and AC servos. Select necessary options such as encoder cables. Easily create system configuration diagrams and lists of necessary purchases to prevent mistakes when ordering.

### Selection Tool

FA Integrated Selection Tool

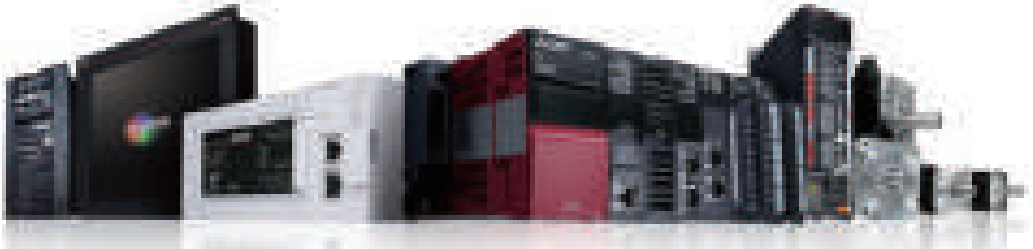

#### Selection of controllers/servo motors/servo amplifiers

- Read selection results from the drive system sizing software (Motorizer).

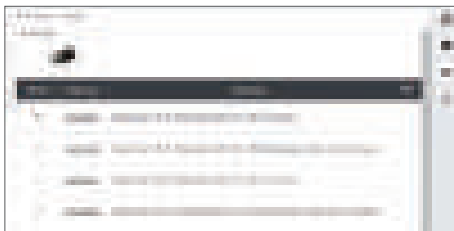

#### Selection of options

- Prevent selection mistakes.

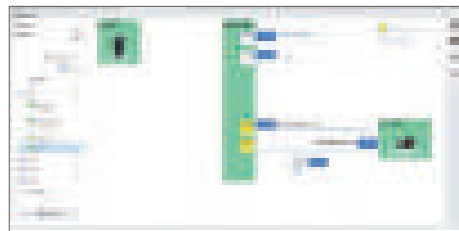

#### Configuration

- Check a configuration of each axis.

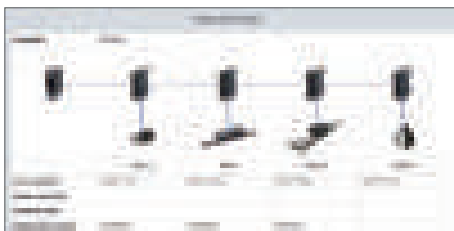

#### Purchase list

- Export to a file in Excel format.

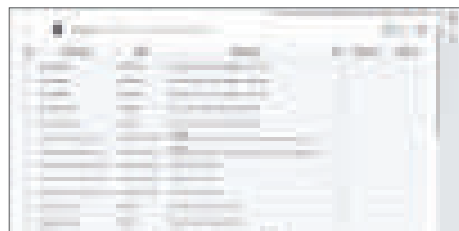

## e-Manual

Instruction manuals for the MELSERVO-JET series are available in e-Manual format. These manuals are linked with manuals for other products such as servo motors and controllers. The e-Manual lets you obtain necessary information quickly and also allows you to keep an enormous number of manuals as one database. Currently supported languages: English, Chinese

#### Features

- Use all necessary manuals as one database
- Download and use manuals in your local environment
- Use the e-Manual application on tablets
- Download and update manuals quickly and easily
- Search for desired information across multiple manuals



Check manuals across the controllers, the servo amplifiers and the servo motors

## Servo motors for high-speed, high-accuracy, linear drive systems

Linear Servo Motors

# LM Series



### Product Lines

Three series are available depending on applications.



### LM-H3 Series

Max. speed: 3 m/s  
Rated thrust: 70 to 720 N  
Max. thrust: 175 to 1800 N  
Suitable for space-saving, high speed and high acceleration/ deceleration.



### LM-AJ Series

Max. speed: 2 to 6.5 m/s  
Rated thrust: 68.1 to 446.8 N  
Max. thrust: 214.7 to 1409.1 N  
Low installation height, and suitable for compact X-Y tables.



### LM-AU Series

Maximum speed: 2 to 4.5 m/s  
Rated thrust: 28 to 350 N  
Max. thrust: 122 to 1764 N  
No cogging, small speed fluctuation.  
No magnetic attraction force, longer life of the linear guides.

# Linear Servo Motors

## Basic Performance

- Maximum speed: 2 m/s to 6.5 m/s
- Maximum thrust range: 122 N to 1800 N. Small size and high thrust are achieved by the increased winding density and the optimized core and magnet geometries as a result of electromagnetic field analysis.
- Three series are available: core (two series) and coreless (one series) types.

- The linear servo motors are compatible with a variety of serial interface linear encoders. The linear encoder resolution ranges from 1 nm and up.
- High-performance systems such as high-accuracy tandem synchronous control are achieved with CC-Link IE TSN.
- LM-H3 series features environmental resistance, designed for an altitude of 2000 m and an ambient temperature of up to 60 °C.\*1,2

\*1. Derate the speed/thrust when using the linear servo motors at an altitude exceeding 1000 m and at high ambient temperatures.

\*2. LM-AJ series/LM-AU series are designed for an altitude of 1000 m and an ambient temperature of up to 40 °C.

## Higher Machine Performance

### For higher machine performance

- Improved productivity due to high-speed driving part.

### For easier use

- The linear servo motors enable a simple and compact machine with high rigidity.
- Smooth operation and clean systems are achieved.

### For flexible machine configurations

- Multi-head and tandem systems are easily configured.
- The linear servo motors are suitable for long-stroke applications.

[Offers more advantage than conventional ball screw driving systems]

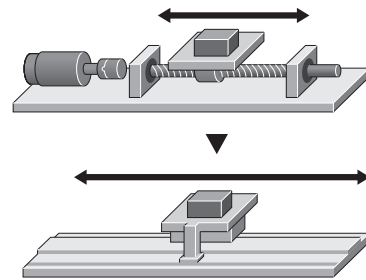

# Application Examples

Optimum for a linear drive system which requires a high speed and high accuracy. Easily achieve a tandem configuration or multi-head configuration.

### Tandem configuration

The linear servo motors configured in tandem are suitable for large systems that require highly accurate synchronous operation between two axes.

### Multi-head configuration

Multi-head systems enable control of two motor coils independently, thereby simplifying machine mechanisms. This system is suitable for machines that require a short cycle time.

<p>Machine tools XYZ stage</p>	<p>Semiconductor/FPD manufacturing systems Electrical parts assembling/manufacturing systems</p>	<p>Screen printing systems and large FPD coaters</p>
<p>Material handling systems</p>		<p>Multi-head material handling between machines</p>

Servo System  
Servo System Controllers  
Embedded Type Servo System Controller  
Servo Amplifiers / Servo Motors

Mitsubishi Electric Solutions

e-F@ctory

Maximize productivity and reduce costs with an intelligent smart factory solution

Intelligent smart factories utilize high-speed networks with large data bandwidths to meet current manufacturing needs. The combination of CC-Link IE TSN and Mitsubishi Electric's e-F@ctory solution ensures robust integration between IT and factory automation systems, providing an intelligent smart factory solution that reduces total cost while improving operations, production yield, and efficient management of the supply chain. e-F@ctory is the Mitsubishi Electric solution for adding value across the manufacturing enterprise by enhancing productivity, thereby simultaneously reducing maintenance and operating costs, and enabling the seamless flow of information throughout the plant. e-F@ctory uses a combination of factory automation and IT technologies in combination with various best-in-class partner products through its alliance program.

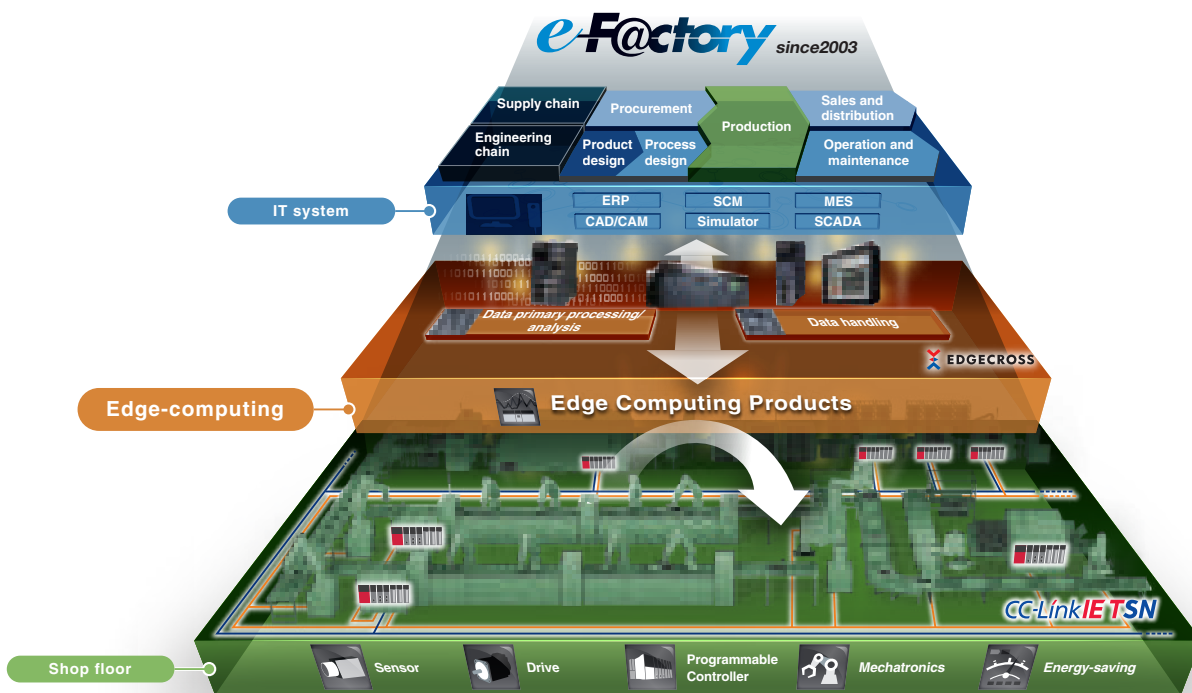

**e-F@ctory**

CC-Link IE TSN

- IT integration
- High speed, Time synchronization
- Open technology
- Network integration

MELSEC iQ-R series

**GOT2000**

MELSEC iQ-F series

**MELFA FR** SERIES

MITSUBISHI ELECTRIC SYRVO SYSTEM

**MELSERVO-J5**

**FREQROL-A800/E800**

MITSUBISHIELECTRIC CNC C80



SMART FACTORY



Productivity



Quality



Flexibility



Maintenance

Mitsubishi Electric Partners

**e-F@ctory Alliance**

The e-F@ctory Alliance is a FA manufacturer partnering program that strongly links the connection compatibility of Mitsubishi Electric FA equipment utilizing excellent software and machinery offered by partners, thereby enabling systems to be built by systems integration partners and the proposal of optimal solutions to customers.



**Mitsubishi Electric Servo System Partners**

Servo system includes controllers, servo drivers, actuators, sensors, etc. The servo system takes a step further to accelerate the equipment revolution by collaborating with our partner companies. Now that a wide variety of partner products are available such as stepping motors, pressure-resistance, explosion-proof type motors, linear encoders, your system will be configured flexibly. The Mitsubishi Electric Servo System Partner Association is a subcommittee of e-F@ctory Alliance. Partner product lines supporting CC-Link IE TSN and MELSERVO have been and will continue to be expanded sequentially.

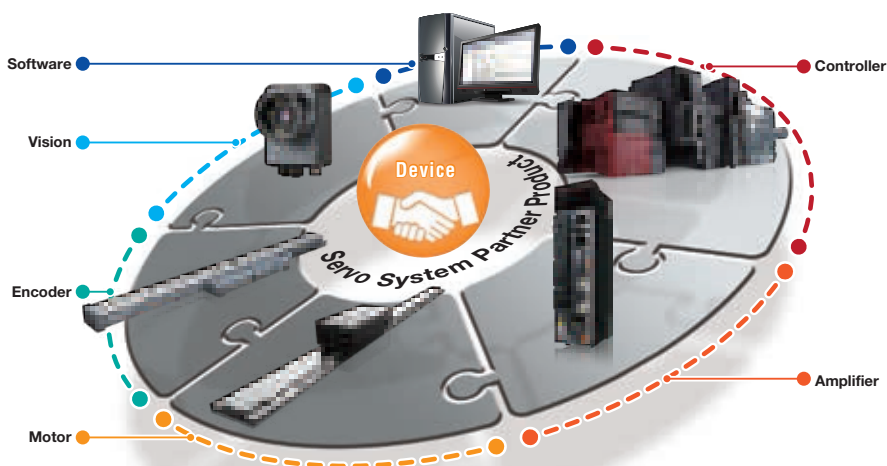



## Mitsubishi Electric FA Global Website

Mitsubishi Electric Factory Automation provides a mix of services to support its customers worldwide, through a consolidated global website. It offers a selection of support tools and a window to its local Mitsubishi Electric sales and support network.

### Global & Local Websites

Mitsubishi Electric Factory Automation  
Global website  
[www.MitsubishiElectric.com/fa](http://www.MitsubishiElectric.com/fa)



Local websites



Global website

### e-Manual

Instruction manuals are available in e-Manual format.

- Use the e-Manual application on tablets
- Download and update manuals quickly and easily
- Search for desired information across multiple manuals



### FA Integrated Selection Tool

FA Integrated Selection Tool is now available, so you can select options such as encoder cables and power cables which are required to use with controllers, servo motors, servo amplifiers, and regenerative options of your choice.

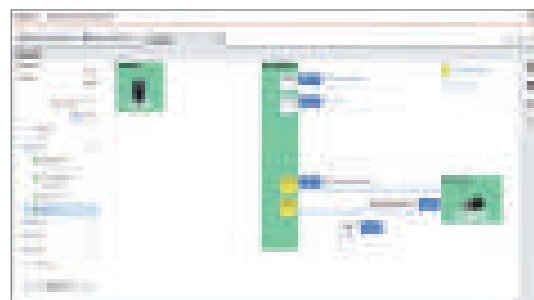

FA Integrated Selection Tool

# 1

## Common Specifications

Combinations of Rotary Servo Motors and Servo Amplifiers.....	1-2
Combinations of Linear Servo Motors and Servo Amplifiers.....	1-3
Environment.....	1-4
Compliance with Global Standards and Regulations.....	1-6

\* Refer to p. 6-32 in this catalog for conversion of units.

## Common Specifications

### Combinations of Rotary Servo Motors and Servo Amplifiers (Note 1)

○: Supported

Rotary servo motor (Note 2)			Servo amplifier MR-JET-						
			10G_	20G_	40G_	70G_	100G_	200G_	300G_
HG-KNS series	40 × 40	HG-KNS13J	○	-	-	-	-	-	-
	60 × 60	HG-KNS23J	-	○	-	-	-	-	-
		HG-KNS43J	-	-	○	-	-	-	-
80 × 80	HG-KNS73J	-	-	-	○	-	-	-	
HG-SNS series	130 × 130	HG-SNS52J	-	-	-	○	-	-	-
		HG-SNS102J	-	-	-	-	○	-	-
		HG-SNS152J	-	-	-	-	-	○	-
	176 × 176	HG-SNS202J	-	-	-	-	-	○	-
		HG-SNS302J	-	-	-	-	-	-	○

Notes: 1. The combinations of MR-JET-G-N1 and servo motors are the same as those described in this table.

2. The combinations of servo motors with an electromagnetic brake and servo amplifiers are the same as those described in this table.

Combinations of Linear Servo Motors and Servo Amplifiers (Note 1)

○: Supported

Linear servo motor			Servo amplifier MR-JET-		
	Primary side (coil)	Secondary side (magnet)	40G_	70G_	200G_
LM-H3 series (Note 2)	LM-H3P2A-07P-BSS0	LM-H3S20-288-BSS0	○	-	-
		LM-H3S20-384-BSS0			
		LM-H3S20-480-BSS0			
		LM-H3S20-768-BSS0			
	LM-H3P3A-12P-CSS0	LM-H3S30-288-CSS0	○	-	-
		LM-H3S30-384-CSS0			
		LM-H3S30-480-CSS0			
		LM-H3S30-768-CSS0			
LM-H3P7A-24P-ASS0	LM-H3S70-288-ASS0	-	○	-	
	LM-H3S70-384-ASS0				
	LM-H3S70-480-ASS0				
	LM-H3S70-768-ASS0				
LM-AJ series (Note 2)	LM-AJP1B-07K-JSS0	LM-AJS10-080-JSS0	○	-	-
		LM-AJS10-200-JSS0			
	LM-AJP1D-14K-JSS0	LM-AJS10-400-JSS0	-	○	-
		LM-AJS20-080-JSS0			
	LM-AJP2B-12S-JSS0	LM-AJS20-200-JSS0	○	-	-
		LM-AJS20-400-JSS0			
	LM-AJP3B-17N-JSS0	LM-AJS30-080-JSS0	○	-	-
		LM-AJS30-200-JSS0			
LM-AJP3D-35R-JSS0	LM-AJS30-400-JSS0	-	○	-	
	LM-AJS40-080-JSS0				
LM-AJP4B-22M-JSS0	LM-AJS40-200-JSS0	○	-	-	
	LM-AJS40-400-JSS0				
LM-AU series (Note 3)	LM-AUP3A-03V-JSS0	LM-AUS30-120-JSS0	○	-	-
		LM-AUS30-180-JSS0			
		LM-AUS30-240-JSS0			
		LM-AUS30-300-JSS0			
	LM-AUP3D-11R-JSS0	LM-AUS30-600-JSS0	○	-	-
		LM-AUS40-120-JSS0			
	LM-AUP4B-09R-JSS0	LM-AUS40-180-JSS0	-	○	-
		LM-AUS40-240-JSS0			
	LM-AUP4C-13P-JSS0	LM-AUS40-300-JSS0	-	○	-
		LM-AUS40-600-JSS0			
LM-AUP4D-18M-JSS0	LM-AUS40-120-JSS0	-	-	○	
	LM-AUS40-180-JSS0				
LM-AUP4F-26P-JSS0	LM-AUS40-240-JSS0	-	-	○	
	LM-AUS40-300-JSS0				
LM-AUP4H-35M-JSS0	LM-AUS40-600-JSS0	-	-	○	
	LM-AUS40-120-JSS0				

- Notes: 1. The combinations of MR-JET-G-N1 and servo motors are the same as those described in this table.  
 2. Use the servo amplifier with firmware version of B2 or later. If the servo amplifier with a firmware version earlier than B2, an alarm occurs.  
 3. Use the servo amplifiers with firmware version D0 or later. If the servo amplifiers with the previous firmware version are connected, an alarm occurs.

Common Specifications  
 Servo System Controllers  
 Servo Amplifiers  
 Rotary Servo Motors  
 Linear Servo Motors  
 Options/Peripheral Equipment  
 LVSWires  
 Product List  
 Precautions  
 Support

# Common Specifications

## Environment

### Motion module

Item	Operation	Storage
Ambient temperature	0 °C to 55 °C (when not using the extended temperature range base unit) 0 °C to 60 °C (when using the extended temperature range base unit) <sup>(Note 2)</sup>	-25 °C to 75 °C (non-freezing)
Ambient humidity	5 %RH to 95 %RH (non-condensing)	
Ambience	Indoors (no direct sunlight); no corrosive gas, inflammable gas, oil mist or dust	
Altitude	2000 m or less	
Vibration resistance	Under intermittent vibration (directions of X, Y, and Z axes): 5 Hz to 8.4 Hz, displacement amplitude 3.5 mm 8.4 Hz to 150 Hz, acceleration amplitude 9.8 m/s <sup>2</sup> Under continuous vibration: 5 Hz to 8.4 Hz, displacement amplitude 1.75 mm 8.4 Hz to 150 Hz, acceleration amplitude 4.9 m/s <sup>2</sup>	

### Servo amplifier

Item	Operation	Transportation	Storage
Ambient temperature	0 °C to 55 °C (non-freezing) Class 3K3 (IEC 60721-3-3)	-25 °C to 70 °C (non-freezing) Class 2K12 (IEC 60721-3-2)	-25 °C to 70 °C (non-freezing) Class 1K4 (IEC 60721-3-1)
Ambient humidity	5 %RH to 95 %RH (non-condensing)		
Ambience	Indoors (no direct sunlight); no corrosive gas, inflammable gas, oil mist or dust		
Altitude/atmospheric pressure	Altitude: 2000 m or less <sup>(Note 1)</sup>	Overland/sea transportation, or transporting on an airplane whose cargo compartment is pressurized at 700 hPa or higher	Atmospheric pressure: 700 hPa to 1060 hPa (Equivalent to altitudes from -400 m to 3000 m)
Vibration resistance	Under intermittent vibration: 10 Hz to 57 Hz, displacement amplitude 0.075 mm 57 Hz to 150 Hz, acceleration amplitude 9.8 m/s <sup>2</sup> Class 3M1 (IEC 60721-3-3) Under continuous vibration (directions of X, Y, and Z axes): 10 Hz to 55 Hz, acceleration amplitude 5.9 m/s <sup>2</sup>	2 Hz to 9 Hz, displacement amplitude (single amplitude) 7.5 mm 9 Hz to 200 Hz, acceleration amplitude 20 m/s <sup>2</sup> Class 2M3 (IEC 60721-3-2)	2 Hz to 9 Hz, displacement amplitude (single amplitude) 1.5 mm 9 Hz to 200 Hz, acceleration amplitude 5 m/s <sup>2</sup> Class 1M2 (IEC 60721-3-1)

### Rotary servo motor (HG series)

Item	Operation	Storage
Ambient temperature	0 °C to 40 °C (non-freezing)	-15 °C to 70 °C (non-freezing)
Ambient humidity	10 %RH to 80 %RH (non-condensing)	10 %RH to 90 %RH (non-condensing)
Ambience <sup>(Note 3)</sup>	Indoors (no direct sunlight); no corrosive gas, inflammable gas, oil mist or dust	
Altitude	2000 m or less <sup>(Note 4)</sup>	
Vibration resistance	Refer to the specifications of each rotary servo motor.	

Notes: 1. Refer to "MR-JET User's Manual" for the restrictions on using the servo amplifiers at an altitude exceeding 1000 m and up to 2000 m.

2. The extended temperature range base unit is compatible with RD78G only.

3. Do not use the servo motors in the environment where the servo motors are exposed to oil mist, oil and/or water.

4. Refer to "Rotary Servo Motor User's Manual (For MR-JET)" for the derating condition when using the servo motors at an altitude exceeding 1000 m and up to 2000 m.

**Environment**

Linear servo motor (LM-H3 series)

Item	Operation	Storage
Ambient temperature	0 °C to 60 °C (non-freezing) <sup>(Note 2)</sup>	-15 °C to 70 °C (non-freezing)
Ambient humidity	10 %RH to 80 %RH (non-condensing)	10 %RH to 90 %RH (non-condensing)
Ambience <sup>(Note 1)</sup>	Indoors (no direct sunlight); no corrosive gas, inflammable gas, oil mist or dust	
Altitude	2000 m or less <sup>(Note 3)</sup>	
Vibration resistance	Refer to the specifications of each linear servo motor.	

Linear servo motor (LM-AJ series/LM-AU series)

Item	Operation	Storage
Ambient temperature	0 °C to 40 °C (non-freezing)	-15 °C to 70 °C (non-freezing)
Ambient humidity	10 %RH to 80 %RH (non-condensing)	10 %RH to 90 %RH (non-condensing)
Ambience <sup>(Note 1)</sup>	Indoors (no direct sunlight); no corrosive gas, inflammable gas, oil mist or dust	
Altitude	1000 m or less	
Vibration resistance	Refer to the specifications of each linear servo motor.	

- Notes:
1. Do not use the servo motors in the environment where the servo motors are exposed to oil mist, oil and/or water.
  2. Refer to "Linear Servo Motor User's Manual (LM-H3/LM-U2/LM-F/LM-K2)" for the restrictions on the ambient temperature.
  3. Refer to "Linear Servo Motor User's Manual (LM-H3/LM-U2/LM-F/LM-K2)" for the restrictions on using the linear servo motor at an altitude exceeding 1000 m and up to 2000 m.

Common Specifications

Servo System Controllers

Servo Amplifiers

Rotary Servo Motors

Linear Servo Motors

Options/Peripheral Equipment

LV/SW/res

Product List

Precautions

Support

# Common Specifications

## Compliance with Global Standards and Regulations

Compliance with the indicated global standards and regulations is current as of the release date of this catalog.

### Motion module



Europe/UK	Low Voltage Directive/The Electrical Equipment (Safety) Regulations	-
	Electromagnetic Compatibility - Directive/ Electromagnetic Compatibility Regulations	EN/BS EN IEC 61131-2
	Machinery Directive/The Supply of Machinery (Safety) Regulations	-
	Restriction of the Use of Certain Hazardous Substances in Electrical and Electronic Equipment (RoHS) - Directive/ The Restriction of the Use of Certain Hazardous Substances in Electrical and Electronic Equipment Regulations	EN/BS EN 63000
North America	UL standard	UL 61010-1, UL 61010-2-201
	CSA standard	CSA C22.2 No. 61010-1, CSA C22.2 No. 61010-2-201
China	National Standard of the People's Republic of China (GB)	GB/T15969.2
	China RoHS	Article 13 (Names and the content of hazardous substances are described in User's Manuals.) Article 14 (Marking for the Restricted Use of Hazardous Substances is labeled.)
	China Compulsory Certificate system	N/A
Korea	Korea Certification (EMC)	KN 61131-2

### Servo amplifier



Europe/UK	Low Voltage Directive/The Electrical Equipment (Safety) Regulations	EN/BS EN 61800-5-1
	Electromagnetic Compatibility - Directive/ Electromagnetic Compatibility Regulations	EN/BS EN IEC 61800-3 Category C2/C3 second environment
	Restriction of the Use of Certain Hazardous Substances in Electrical and Electronic Equipment (RoHS) - Directive/ The Restriction of the Use of Certain Hazardous Substances in Electrical and Electronic Equipment Regulations	EN/BS EN IEC 63000
North America	UL standard	UL 61800-5-1
	CSA standard	CSA C22.2 No. 274
China	National Standard of the People's Republic of China (GB)	GB 12668.501, GB 12668.3
	China RoHS	Article 13 (Names and the content of hazardous substances are described in User's Manuals.) Article 14 (Marking for the Restricted Use of Hazardous Substances is labeled.)
	China Compulsory Certificate system	N/A
Korea	Korea Certification (EMC)	KN 61800-3 (KS C 9800-3)

### Rotary servo motor



Europe/UK	Low Voltage Directive/The Electrical Equipment (Safety) Regulations	EN 60034-1
	Electromagnetic Compatibility - Directive/ Electromagnetic Compatibility Regulations	EN 61800-3 Category C3
	Machinery Directive/The Supply of Machinery (Safety) Regulations	-
	Restriction of the Use of Certain Hazardous Substances in Electrical and Electronic Equipment (RoHS) - Directive/ The Restriction of the Use of Certain Hazardous Substances in Electrical and Electronic Equipment Regulations	EN IEC 63000
North America	UL standard	UL 1004-1, UL 1004-6
	CSA standard	CSA C22.2 No. 100
China	National Standard of the People's Republic of China (GB)	GB/T 755
	China RoHS	Article 13 (Names and the content of hazardous substances are described in User's Manuals.) Article 14 (Marking for the Restricted Use of Hazardous Substances is labeled.)
	China Compulsory Certificate system	N/A
Korea	Korea Certification (EMC)	N/A



**Compliance with Global Standards and Regulations**

Compliance with the indicated global standards and regulations is current as of the release date of this catalog.



**Linear servo motor (LM-H3 series)**

Europe/UK	Low Voltage Directive/The Electrical Equipment (Safety) Regulations	DIN VDE 0580
	Electromagnetic Compatibility - Directive/ Electromagnetic Compatibility Regulations	-
	Machinery Directive/The Supply of Machinery (Safety) Regulations	-
	Restriction of the Use of Certain Hazardous Substances in Electrical and Electronic Equipment (RoHS) - Directive/ The Restriction of the Use of Certain Hazardous Substances in Electrical and Electronic Equipment Regulations	EN IEC 63000
North America	UL standard	UL 1004-6
	CSA standard	CSA C22.2 No. 100
China	National Standard of the People's Republic of China (GB)	Not subject to GB standards
	China RoHS	Article 13 (Names and the content of hazardous substances are described in User's Manuals.) Article 14 (Marking for the Restricted Use of Hazardous Substances is labeled.)
	China Compulsory Certificate system	N/A
Korea	Korea Certification (EMC)	N/A

**Linear servo motor (LM-AJ series/LM-AU series)**



Europe/UK	Low Voltage Directive/The Electrical Equipment (Safety) Regulations	DIN VDE 0580
	Electromagnetic Compatibility - Directive/ Electromagnetic Compatibility Regulations	-
	Machinery Directive/The Supply of Machinery (Safety) Regulations	-
	Restriction of the Use of Certain Hazardous Substances in Electrical and Electronic Equipment (RoHS) - Directive/ The Restriction of the Use of Certain Hazardous Substances in Electrical and Electronic Equipment Regulations	EN IEC 63000
China	National Standard of the People's Republic of China (GB)	Not subject to GB standards
	China RoHS	Article 13 (Names and the content of hazardous substances are described in User's Manuals.) Article 14 (Marking for the Restricted Use of Hazardous Substances is labeled.)
	China Compulsory Certificate system	N/A

Common Specifications

Servo System Controllers

Servo Amplifiers

Rotary Servo Motors

Linear Servo Motors

Options/Peripheral Equipment

LV/SWires

Product List

Precautions

Support

## Common Specifications

MEMO



# 2 Servo System Controllers

Motion Module.....	2-2
Engineering Software.....	2-14
Motion Control Software.....	2-15

\* Refer to p. 6-32 in this catalog for conversion of units.

# Servo System Controllers

## Motion Module RD78G (Simple Motion Mode)

### Control specifications

Items in bold: differences

Item	Specifications			Comparison with the previous models (Simple Motion modules)	
	RD78G4	RD78G8	RD78G16	RD77MS	QD77MS
Maximum number of control axes [axis]	4	8	16	2, 4, 8, 16	2, 4, 16 (QD77MS2 and QD77MS4 use the buffer memory assignment for 4 axes)
Command interface	<b>CC-Link IE TSN</b>			SSCNET III/H	
Operation cycle (operation cycle setting) [ $\mu$ s]	<b>250, 500, 1000, 2000, 4000</b>			444, 888, 1777, 3555	888, 1777
Interpolation function	Linear interpolation (up to 4 axes), 2-axis circular interpolation, helical interpolation			Linear interpolation (up to 4 axes), 2-axis circular interpolation	
Control method	Positioning control, path control (linear, arc, and helical <sup>(Note 1)</sup> ), speed control, speed-torque control, synchronous control, continuous operation to torque control				
Acceleration/deceleration processing	Trapezoidal acceleration/deceleration, S-curve acceleration/deceleration				
Compensation function	Backlash compensation, electronic gear, near pass function				
Synchronous control	Synchronous encoder input, command generation axis, cam, phase compensation			Synchronous encoder input, cam, phase compensation	Synchronous encoder input, command generation axis, cam, phase compensation
Cam control	Maximum number of cam registrations <sup>(Note 2)</sup>	256			
	Cam data	Stroke ratio data format, coordinate data format			
	Cam auto-generation	Cam auto-generation for rotary knife			
Positioning control method	Motion profile table				
Control unit	mm, inch, degree, pulse				
Number of positioning data	600 data (positioning data No. 1 to 600)/axis <b>(Set with MELSOFT GX Works3 or a sequence program (No. 1 to 600).)</b>			600 data (positioning data No. 1 to 600)/axis (Set with MELSOFT GX Works3 or a sequence program (No. 1 to 100).)	600 data (positioning data No. 1 to 600)/axis (Set with MELSOFT GX Works2 or a sequence program (QD77MS16 (No. 1 to 100), QD77MS2/QD77MS4 (No. 1 to 600).))
Backup	Parameters, positioning data, and block start data can be saved on flash ROM (batteryless backup)				
Home position return	<b>Driver home position return</b> <sup>(Note 3)</sup>			Proximity dog method, count method 1, count method 2, data set method, scale home position signal detection method, driver home position return <sup>(Note 3)</sup>	Proximity dog method, count method 1, count method 2, data set method, scale home position signal detection method
Positioning control	Linear interpolation control (up to 4 axes <sup>(Note 4)</sup> (vector speed, reference axis speed)), fixed-pitch feed control (up to 4 axes), 2-axis circular interpolation (auxiliary point-specified, central point-specified), helical interpolation control, speed control (up to 4 axes), speed-position switching control (INC mode, ABS mode), position-speed switching control, current value change (positioning data, start No. for a current value changing) NOP instruction, JUMP instruction (conditional, unconditional), LOOP, LEND, block start, condition start, wait start, simultaneous start, repeated start				
Manual control	JOG operation	Provided			
	Inching operation	Provided			
	Manual pulse generator operation	Up to 1 module (incremental), unit magnification (1 to 10000 times), <b>via a CPU</b> <sup>(Note 7)</sup> <b>(buffer memory)</b>		Up to 1 module (incremental), unit magnification (1 to 10000 times), <b>via an internal interface</b>	
Speed-torque control	Speed control not including position loop, torque control, continuous operation to torque control				
Absolute position system	<b>Provided</b>			Supported when a battery is mounted on a servo amplifier	
Synchronous encoder operation function	Up to the number of axes of the connected servo amplifiers (via a servo amplifier <sup>(Note 6)</sup> or a CPU <sup>(Note 7)</sup> )			Up to 4 channels <b>Via an internal interface</b> , a CPU (buffer memory), or a servo amplifier <sup>(Note 6)</sup>	
Speed limit	Speed limit value, JOG speed limit value				
Torque limit function	Torque limit value same setting, torque limit value individual setting				
Forced stop	Via a buffer memory, valid/invalid setting			<b>Via an internal interface</b> or a buffer memory, valid/invalid setting	
Software stroke limit function	Movable range check with feed current value or with machine feed value				
Hardware stroke limit function	Provided				
Speed change	Provided				
Override	<b>0 to 300 [%]</b>				1 to 300 [%]

**Motion Module RD78G (Simple Motion Mode)**

Control specifications

Items in bold: differences

Item	Specifications			Comparison with the previous models (Simple Motion modules)	
	RD78G4	RD78G8	RD78G16	RD77MS	QD77MS
Acceleration/deceleration processing change	Provided				
Torque limit change	Provided				
Target position change	Speed to a target position address and a target position are changeable.				
M-code output function	WITH mode/AFTER mode				
Other functions	Step function	Deceleration unit step, data No. unit step			
	Skip function	Via a CPU or an external command signal			
Parameter initialization function	Provided				
External input signal select function	Via a CPU or a servo amplifier			<b>Via an internal interface</b> , a CPU (buffer memory), or a servo amplifier	
Mark detection function	Continuous detection mode, specified number of detections mode, ring buffer mode				
	Mark detection signal	<b>Up to the number of axes of the connected servo amplifiers</b>		20	4 (QD77MS2: 2 points)
	Mark detection setting	16			16 (QD77MS4/QD77MS2: 4 settings)
Optional data monitor function	Up to 4 points/axis				
Functional safety <sup>(Note 6)</sup>	<b>Safety communication (network connection)</b> , DI/O connection of the servo amplifier			DI/O connection of the servo amplifier	
Driver communication <sup>(Note 6)</sup>	Provided				
Inter-module synchronization	Provided				
Automatic return	<b>Provided</b>			Connect/disconnect function of SSCNET communication	
Digital oscilloscope function	Bit data: 16 channels <sup>(Note 5)</sup> , word data: 16 channels <sup>(Note 5)</sup>				For QD77MS16, Bit data: 16 channels <sup>(Note 5)</sup> , Word data: 16 channels <sup>(Note 5)</sup> For QD77MS4/QD77MS2, Bit data: 8 channels, Word data: 4 channels

- Notes: 1. The helical interpolation is available with RD78G and RD77MS.  
 2. The number of cam registrations depends on the memory capacity, cam resolution, and number of coordinates.  
 3. The home position return method set in a driver (servo amplifier) is used.  
 4. 4-axis linear interpolation control is enabled only at the reference axis speed.  
 5. Eight channels of each word data and bit data can be displayed in real time.  
 6. This function is not supported by MR-JET-G/MR-JE-B servo amplifiers.  
 7. Use a high-speed counter module.

Common Specifications  
 Servo System Controllers  
 Servo Amplifiers  
 Rotary Servo Motors  
 Linear Servo Motors  
 Options/Peripheral Equipment  
 LV/SW/ires  
 Product List  
 Precautions  
 Support

# Servo System Controllers

## Motion Module FX5-40SSC-G/FX5-80SSC-G (Simple Motion Mode)

### Control specifications

Items in bold: differences

Item	Specifications		Comparison with the previous models (Simple Motion modules)	
	FX5-40SSC-G	FX5-80SSC-G	FX5-40SSC-S	FX5-80SSC-S
Maximum number of control axes [axis]	4	8	4	8
Command interface	<b>CC-Link IE TSN</b>		SSCNET III/H	
Operation cycle (operation cycle setting) [ $\mu$ s]	<b>500, 1000, 2000, 4000</b>		888, 1777	
Interpolation function	Linear interpolation (up to 4 axes), 2-axis circular interpolation			
Control method	Positioning control, path control (linear and arc), speed control, speed-torque control, synchronous control, continuous operation to torque control			
Acceleration/deceleration processing	Trapezoidal acceleration/deceleration, S-curve acceleration/deceleration			
Compensation function	Backlash compensation, electronic gear, near pass function			
Synchronous control	Synchronous encoder input, command generation axis, cam, phase compensation			
Cam control	Maximum number of cam registrations <sup>(Note 1)</sup>	<b>128</b>	64	128
	Cam data	Stroke ratio data format, coordinate data format		
	Cam auto-generation	Cam auto-generation for rotary knife		
Positioning control method	Motion profile table			
Control unit	mm, inch, degree, pulse			
Number of positioning data	600 data (positioning data No. 1 to 600)/axis (Can be set with MELSOFT GX Works3 or a sequence program (No. 1 to 100))			
Backup	Parameters, positioning data, and block start data can be saved on flash ROM (batteryless backup)			
Home position return	<b>Driver home position return</b> <sup>(Note 2)</sup>		Proximity dog method, count method 1, count method 2, data set method, scale home position signal detection method, driver home position return <sup>(Note 2)</sup>	
Positioning control	Linear interpolation control (up to 4 axes <sup>(Note 3)</sup> (vector speed, reference axis speed)), fixed-pitch feed control (up to 4 axes), 2-axis circular interpolation (auxiliary point-specified, central point-specified), speed control (up to 4 axes), speed-position switching control (INC mode, ABS mode), position-speed switching control (INC mode), current value change (positioning data, start No. for a current value changing) NOP instruction, JUMP instruction (conditional, unconditional), LOOP, LEND, block start, condition start, wait start, simultaneous start, repeated start			
Manual control	JOG operation	Provided		
	Inching operation	Provided		
	Manual pulse generator operation	Up to 1 module (incremental), unit magnification (1 to 10000 times), <b>via a CPU (buffer memory)</b>	Up to 1 module (incremental), unit magnification (1 to 10000 times), <b>via an internal interface</b>	
Speed-torque control	Speed control not including position loop, torque control, continuous operation to torque control			
Absolute position system	<b>Provided</b>		Supported when a battery is mounted on a servo amplifier	
Synchronous encoder operation function	Up to 4 modules (via a servo amplifier <sup>(Note 6)</sup> or a CPU)		Up to 4 modules ( <b>via an internal interface</b> , a servo amplifier <sup>(Note 6)</sup> , or a CPU)	
Speed limit	Speed limit value, JOG speed limit value			
Torque limit function	Torque limit value same setting, torque limit value individual setting			
Forced stop	Via a buffer memory, valid/invalid setting			
Software stroke limit function	Movable range check with feed current value or with machine feed value			
Hardware stroke limit function	Provided			
Speed change	Provided			
Override	<b>0 to 300 [%]</b>		1 to 300 [%]	
Acceleration/deceleration processing change	Provided			
Torque limit change	Provided			
Target position change	Speed to a target position address and a target position is changeable.			
M-code output function	WITH mode/AFTER mode			
Other functions	Step function	Deceleration unit step, data No. unit step		
	Skip function	Via a CPU or an external command signal		
Parameter initialization function	Provided			
External input signal select function	Via a CPU or a servo amplifier			
Mark detection function	Continuous detection mode, specified number of detections mode, ring buffer mode			
Optional data monitor function	Mark detection signal	<b>Up to the number of axes of the connected servo amplifiers</b>		Up to 4 points
	Mark detection setting	16 settings		
Optional data monitor function	Up to 4 points/axis			

**Motion Module FX5-40SSC-G/FX5-80SSC-G (Simple Motion Mode)**

Control specifications

Items in bold: differences

Item	Specifications		Comparison with the previous models (Simple Motion modules)	
	FX5-40SSC-G	FX5-80SSC-G	FX5-40SSC-S	FX5-80SSC-S
Functional safety <sup>(Note 6)</sup>	DI/O connection of the servo amplifier <sup>(Note 4)</sup>			
Driver communication <sup>(Note 6)</sup>	-		Provided	
Automatic return	<b>Provided</b>		Connect/disconnect function of SSCNET communication	
Digital oscilloscope function	Bit data: 16 channels, word data: 16 channels <sup>(Note 5)</sup>			

- Notes:
1. The number of cam registrations depends on the memory capacity, cam resolution, and number of coordinates.
  2. The home position return method set in a driver (servo amplifier) is used.
  3. 4-axis linear interpolation control is enabled only at the reference axis speed.
  4. The safety extension module can be combined with a Motion module with version 1.001 or later.
  5. Eight channels of each word data and bit data can be displayed in real time.
  6. This function is not supported by MR-JET-G/MR-JE-B servo amplifiers.

Common Specifications

Servo System Controllers

Servo Amplifiers

Rotary Servo Motors

Linear Servo Motors

Options/Peripheral Equipment

LV/SWires

Product List

Precautions

Support



## Servo System Controllers

### Motion Module (RD78G(H)/FX5-40SSC-G/FX5-80SSC-G) Synchronous Control Specifications

#### Synchronous control

Item	Number of settable axes				
	RD78G4	RD78G8	RD78G16	FX5-40SSC-G	FX5-80SSC-G
Servo input axis [axes/module]	4	8	16	4	8
Synchronous encoder input axis [axes/module]	4	8	16	4	4
Command generation axis [axes/module]	4	8	8	4	8
Composite main shaft gear [module/output axis]	1				
Main shaft main input axis [module/output axis]	1				
Main shaft sub input axis [module/output axis]	1				
Main shaft gear [module/output axis]	1				
Main shaft clutch [module/output axis]	1				
Auxiliary shaft [module/output axis]	1				
Auxiliary shaft gear [module/output axis]	1				
Auxiliary shaft clutch [module/output axis]	1				
Composite auxiliary shaft gear [module/output axis]	1				
Speed change gear [module/output axis]	1				
Output axis (cam axis) [axes/module]	4	8	16	4	8

#### Cam control

Item		Specifications									
		RD78G4	RD78G8	RD78G16	FX5-40SSC-G	FX5-80SSC-G					
Memory capacity	Cam storage area	256 k bytes			128 k bytes						
	Cam working area	1 M bytes									
Maximum number of registrations		256			128						
Comment		Up to 32 characters for each cam data									
Cam data	Stroke ratio data type	Maximum number of cam registrations	Cam resolution	256	512	1024	2048	4096	8192	16384	32768
			RD78G	256	128	64	32	16	8	4	2
			FX5-SSC-G	128	64	32	16	8	4	2	-
	Stroke ratio		-214.7483648 to 214.7483647 [%]								
	Coordinate data type	Maximum number of cam registrations	Cam resolution	128	256	512	1024	2048	4096	8192	16384
RD78G			256	128	64	32	16	8	4	2	
FX5-SSC-G			128	64	32	16	8	4	2	-	
Coordinate data		Input value: 0 to 2147483647 Output value: -2147483648 to 2147483647									
Cam auto-generation		Cam for rotary knife									

MEMO

Common Specifications

Servo System Controllers

Servo Amplifiers

Rotary Servo Motors

Linear Servo Motors

Options/Peripheral Equipment

LV/SWires

Product List

Precautions

Support

# Servo System Controllers

## Motion Module RD78GH/RD78G (PLCopen® Motion Control FB Mode)

### Control specifications

Item		Specifications	
		Motion module	
		RD78GH	RD78G
Maximum number of control axes <sup>(Note 1)</sup>		RD78GHV: 128 axes RD78GHW: 256 axes	RD78G4: 4 axes RD78G8: 8 axes RD78G16: 16 axes RD78G32: 32 axes RD78G64: 64 axes
Maximum number of connectable stations		120 stations	
Command interface		CC-Link IE TSN	
Operation cycle (operation cycle settings) <sup>(Note 2, 3)</sup>		[μs] 31.25, 62.5, 125, 250, 500, 1000, 2000, 4000, 8000	62.5, 125, 250, 500, 1000, 2000, 4000, 8000
Axis	Real drive axis, virtual drive axis, real encoder axis, virtual encoder axis, virtual linked axis		
	Axes group	0: Unset 1 or later: the axes group No. for the setting axis	
	Real drive axis	Servo amplifier	
	Real encoder axis	Via a servo amplifier <sup>(Note 4)</sup>	
Interpolation function		Linear interpolation (2 to 4 axes), 2-axis circular interpolation	
Control method		Positioning control, direct control	
Acceleration/deceleration processing		Trapezoidal acceleration/deceleration, jerk acceleration/deceleration, acceleration/deceleration time fixed method	
Compensation function		Driver unit conversion	
Synchronous control	Module	Master axis, cam, gear	
	Master axis	Real drive axis, virtual drive axis, real encoder axis, virtual encoder axis, virtual linked axis	
Operation profile (cam data)	Cam data	Cam data, cam for a rotary knife	
	Motion control FB (Cam auto-generation)	Cam for a rotary knife	
Control unit		Unit character string and decimal digit can be defined by users. (The following are given units: mm, inch, degree, pulse)	
Programming language		PLC CPU: ladder diagram, function block diagram/ladder diagram, structured text language Motion module: structured text language	
Backup		Parameters and programs can be saved on a flash ROM (batteryless backup)	
Start/stop operation		Start, stop, restart, buffer mode, forced stop	
Homing	Homing method	Driver homing method (The homing method set in the driver is used.)	
Positioning control	Linear control	Linear interpolation (2 to 4 axes)	
	2-axis circular interpolation	Border point-specified, central point-specified, radius-specified circular interpolation	
Manual control		JOG operation	
Direct control	Speed control	Speed control not including position loop, speed control including position loop	
	Torque control	Torque control, continuous operation to torque control	
Absolute position system		Provided (batteryless)	
Functions that limit control	Speed limit	Speed command range	
	Torque limit	Torque limit value (positive/negative direction)	
	Forced stop	Valid/Invalid setting	
	Software stroke limit	Movable range check with an address of the set position or the feed machine position.	
	Hardware stroke limit	Provided	
Functions that change control details	Command speed change	Provided	
	Current value change	Provided	
	Acceleration/deceleration processing change	Acceleration/deceleration, acceleration/deceleration time	
	Torque limit value change	Provided	
	Target position change	Target position change, movement distance change	
	Override	Provided	
Other functions	History data	Event history, position data history	
	Logging	Data logging, real-time monitor	
	Axis emulate	Provided	
	Touch probe (mark detection)	Provided	
	Monitoring of servo data	Cyclic transmission, transient transmission	
	Servo system recorder	Provided	
	Safety communication <sup>(Note 4)</sup>	Provided	
Inter-module synchronization	Provided		

Notes: 1. When MR-JET-G servo amplifiers are used for all axes, RD78GH controls a maximum of 120 axes.

2. The number of controllable axes varies depending on the operation cycle.

3. When an MR-JET-G is connected to RD78GH, the minimum operation cycle is 125 μs.

2-8 4. This function is not supported by MR-JET-G servo amplifiers.

## Motion Module RD78GH/RD78G (PLCopen® Motion Control FB Mode)

### Program specifications

Item	RD78GH	RD78G
Program capacity	Built-in ROM max. 64 [MB] + SD memory card	Built-in ROM max. 16 [MB] + SD memory card
Maximum program capacity memory	160 [MB]	96 [MB]
Variable memory	Label area	ST language program capacity and label memory capacity are settable.
Data memory	Equivalent to program capacity	
Maximum number of files	Program	512 files (1 program definable per file)
	FB/FUN	128 files (64 FBs/FUNs definable per file)
	Global label	1 file (16384000 labels definable per file)
Code size per program	Depends on the program memory	

### Synchronous control specifications

FB	Description
MC_CamIn	Starts cam operation.
MC_GearIn	Starts gear operation.
MC_CombineAxes	Combines the motion of 2 axes.
MCv_ChangeCycle	Changes the current value per cycle.

Notes: 1. The number of usable function blocks depends on the program capacity.

### Operation profile (cam) specifications

Item	RD78GH	RD78G
Memory capacity	Built-in ROM max. 64 [MB] + SD memory card	Built-in ROM max. 16 [MB] + SD memory card
Maximum number of cam registration	60000 (1024 out of 60000 can be set on engineering tool)	
Cam data	Cam type	Cam data, cam for a rotary knife
	Interpolation method	Section interpolation, linear interpolation, spline interpolation
	Profile ID	1 to 60000
	Resolution	8 to 65535 (any resolution within the range)
	Units for cam length per cycle	mm, inch, pulse, degree
	Units for stroke	%, mm, inch, pulse, degree
Cam auto-generation	Cam for a rotary knife	

Common Specifications  
Servo System Controllers  
Servo Amplifiers  
Rotary Servo Motors  
Linear Servo Motors  
Options/Peripheral Equipment  
LV/SWires  
Product List  
Precautions  
Support

## Servo System Controllers

### Motion Module RD78GH/RD78G (PLCopen® Motion Control FB Mode)

#### Function blocks (FB) list

Type	Name	Description
MCFB (motion)	MC_CamIn	Starts cam operation.
	MC_CombineAxes	Combines the motion of 2 axes.
	MC_GearIn	Starts gear operation.
	MC_GroupStop	Executes a forced stop for an axes group.
	MC_Home	Executes homing.
	MC_MoveAbsolute	Executes positioning (absolute).
	MC_MoveRelative	Executes positioning (relative).
	MC_MoveVelocity	Executes speed control.
	MC_Stop	Executes a forced stop.
	MC_TorqueControl	Executes torque control.
	MCv_BacklashCompensationFilter	Compensates backlash.
	MCv_DirectionFilter	Restricts rotation direction.
	MCv_Jog	Executes JOG operation.
	MCv_MoveCircularInterpolateAbsolute	Executes circular interpolation control (absolute).
	MCv_MoveCircularInterpolateRelative	Executes circular interpolation control (relative).
	MCv_MoveLinearInterpolateAbsolute	Executes linear interpolation control (absolute).
	MCv_MoveLinearInterpolateRelative	Executes linear interpolation control (relative).
	MCv_SmoothingFilter	Enables smoothing filter.
	MCv_SpeedControl	Executes speed control (including position loop).
	MCv_SpeedLimitFilter	Enables speed limit filter.
MCv_AdvancedSync	Performs advanced synchronous control.	
MCFB (administrative)	MC_CamTableSelect	Selects cam tables.
	MC_GroupDisable	Disables an axes group.
	MC_GroupEnable	Enables an axes group.
	MC_GroupReset	Resets an axes group error.
	MC_GroupSetOverride	Sets the values of override for an axes group.
	MC_Power	Controls the power stage (ON or OFF) for a single axis.
	MC_Reset	Resets an axis error.
	MC_SetOverride	Sets the values of override.
	MC_SetPosition	Changes the current position.
	MC_TouchProbe	Enables the touch probe.
	MC_AbortTrigger	Disables the touch probe.
	MC_ReadParameter	Reads parameters.
	MC_WriteParameter	Writes parameters.
	MCv_AllPower	Controls the power stage (ON or OFF) for all axes.
	MCv_ChangeCycle	Changes the current value per cycle.
	MCv_MotionErrorReset	Resets motion errors.
	MCv_SetTorqueLimit	Sets torque limits.
	MCv_AdvPositionPerCycleCalc	Calculates the current position per cycle in advanced synchronous control.
MCv_AdvCamSetPositionCalc	Calculates the cam set position in advanced synchronous control.	
General FB	MCv_ReadProfileData	Reads profile data.
	MCv_WriteProfileData	Writes profile data.

**Motion Module RD78GH/RD78G (PLCopen® Motion Control FB Mode/Simple Motion Mode)**

CC-Link IE TSN

Item	Motion module			
	PLCopen® motion control FB mode		Simple Motion mode	
	RD78GH/RD78G	RD78G	FX5-40SSC-G	FX5-80SSC-G
Communications speed [bps]	1 G/100 M			
Maximum number of connectable stations per network	121 stations (including the master station)		21 stations (including the master and four motion control stations)	25 stations (including the master and eight motion control stations)
Connection cable	Ethernet cable (category 5e or higher, double shielded/STP) straight cable			
Maximum distance between stations [m]	100			
Maximum number of networks	239			
Topology	Line, star, line/star mixed			
Communications method	Time-sharing method			
Maximum transient transmission capacity	1920 bytes			
Maximum link points per network				
RX/Ry	16K points		8K points	
RWr/RWw	8K points		1K points	
Maximum link points per station				
RX/Ry	16K points		8K points	
RWr/RWw	8K points		1K points	
Safety communications <sup>(Note 1)</sup>				
Maximum number of safety connections per station	120 connections		-	
Maximum number of link points per safety connection	8 words (input: 8 words, output: 8 words)		-	

Notes: 1. This function is not supported by MR-JET-G servo amplifiers.

[Note when connecting devices]

Connect class A remote stations after class B remote stations.

CC-Link IE TSN Class

CC-Link IE TSN certifies nodes and switches to a specific class level according to its functionality and performance classification. Products can be classified as either class A or B. For the CC-Link IE TSN Class of each product, please check the CC-Link Partner Association website or the relevant product catalog or manual. Supported functions and system configuration may differ according to the CC-Link IE TSN Class of products used. For example, products compatible with class B are necessary to configure a high-speed motion control system. For details of configuring systems with both class A and class B devices, please refer to relevant master product manual.

System configuration

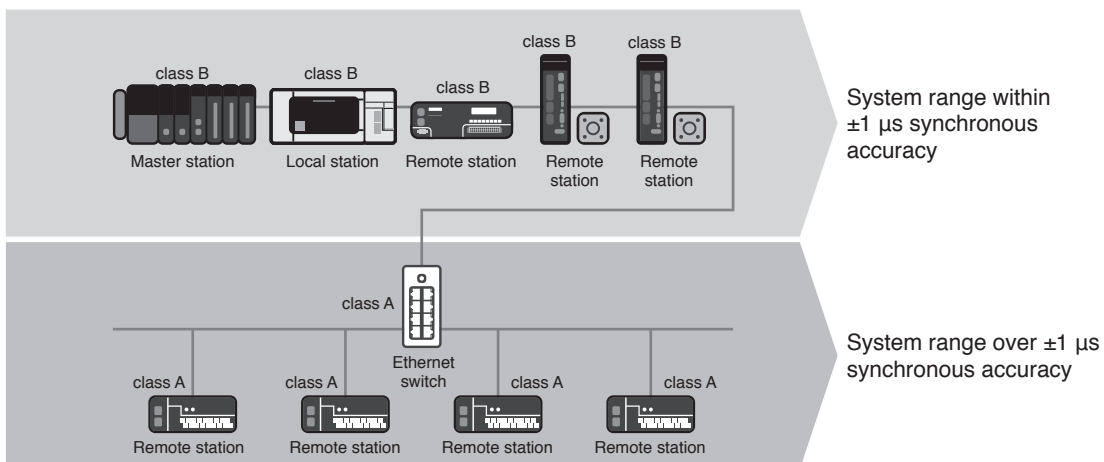

- Synchronous accuracy of a system varies relative to the combination of connected devices and switches CC-Link IE TSN Class
- Use class B Ethernet switch when configuring a star topology with class B devices
- Use class B devices when configuring a system within  $\pm 1 \mu s$  high-accuracy synchronization, connect class A devices to a separate branch line from class B devices (for details of system configuration, please refer to relevant master product manual)
- Mitsubishi Electric's block type remote modules include modules complying both class B and A.

Common Specifications  
Servo System Controllers  
Servo Amplifiers  
Rotary Servo Motors  
Linear Servo Motors  
Options/Peripheral Equipment  
LV/SWires  
Product List  
Precautions  
Support

## Servo System Controllers

### Motion Module

#### Module specifications RD78GH/RD78G

Item	RD78GH	RD78G
Maximum number of control axes	RD78GHV: 128 axes RD78GHW: 256 axes	RD78G4: 4 axes RD78G8: 8 axes RD78G16: 16 axes RD78G32: 32 axes RD78G64: 64 axes
Maximum number of connectable stations	121 stations (including the master station)	
Servo amplifier connection method	CC-Link IE TSN	
CC-Link IE TSN Class	B	
Maximum distance between stations [m]	100	
PERIPHERAL I/F	Via a CPU module (USB, Ethernet)	
Extended memory	SD memory card	
Number of ports for CC-Link IE TSN	2 ports	1 port
Number of I/O points occupied	48 points (I/O assignment: 16 points (empty slot) + 32 points)	32 points
Number of slots occupied	2 slots	1 slot
5 V DC internal current consumption [A]	2.33	1.93
Mass [kg]	0.44	0.26
Dimensions [mm]	106.0 (H) × 56.0 (W) × 110.0 (D)	106.0 (H) × 27.8 (W) × 110.0 (D)

#### Module specifications FX5-40SSC-G/FX5-80SSC-G

Item	FX5-40SSC-G	FX5-80SSC-G
Maximum number of control axes	4 axes	8 axes
Maximum number of connectable stations	21 stations (including the master and four motion control stations)	25 stations (including the master and eight motion control stations)
Servo amplifier connection method	CC-Link IE TSN	
CC-Link IE TSN Class	B	
Maximum distance between stations [m]	100	
24 V DC external current consumption [A]	0.24	
Mass [kg]	0.3	
Dimensions [mm]	90 (H) × 50 (W) × 83 (D)	
Applicable CPU <sup>(Note 1)</sup>	FX5U, FX5UC <sup>(Note 2)</sup>	

- Notes: 1. Use a CPU module with firmware version 1.230 or later.  
The following CPU modules can be updated to that firmware version.
- CPU module with serial No. 17X\*\*\*\* or later
  - FX5UC-32MT/DS-TS and FX5UC-32MT/DSS-TS with serial No. 178\*\*\*\* or later.
2. FX5-CNV-IFC is required to connect the Motion module to an FX5UC CPU module.

## ■Products on the Market

### Manual Pulse Generator

Mitsubishi Electric has confirmed the operation of the following manual pulse generator. Contact the manufacturer for details.

Product name	Model	Description	Manufacturer
Manual pulse generator <sup>(Note 1)</sup>	RE46A2CO2B	Number of pulses per revolution: 25 pulses/rev (100 pulses/rev after magnification by 4)	Tokyo Sokuteikizai Co.,Ltd.

- Notes: 1. Connect the manual pulse generator to a CPU module or a high-speed pulse input/output module. Refer to user's manuals and each product manual for details.



**Motion Module**

Dimensions

- RD78G4/RD78G8/RD78G16/RD78G32/RD78G64

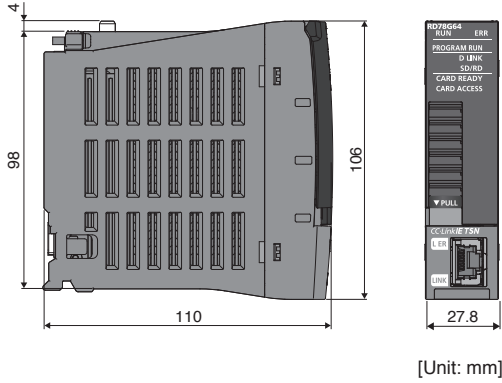

- RD78GHV/RD78GHW

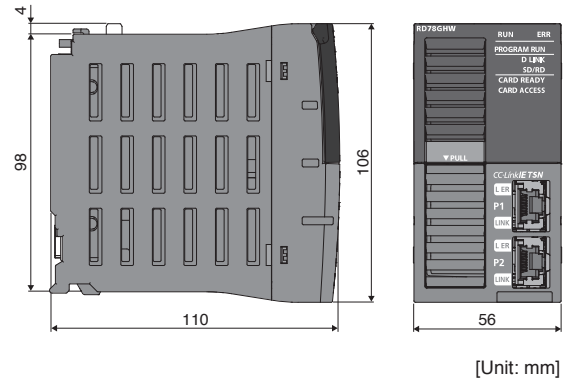

Dimensions

- FX5-40SSC-G

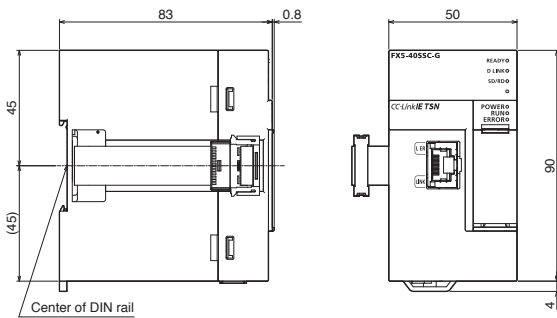

- FX5-80SSC-G

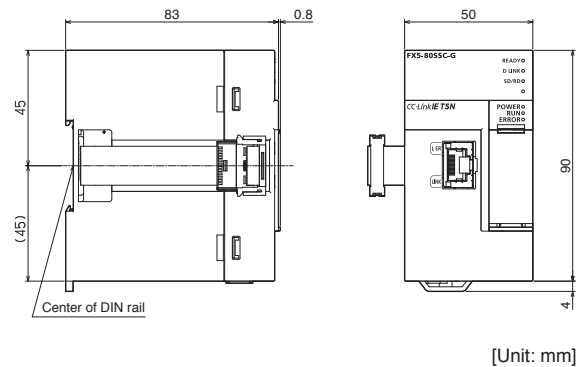

Mounting

- RD78G4/RD78G8/RD78G16/RD78G32/RD78G64  
RD78GHV/RD78GHW

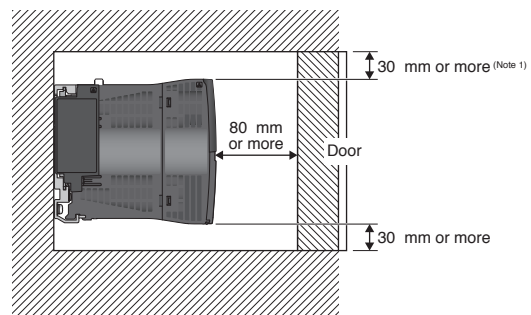
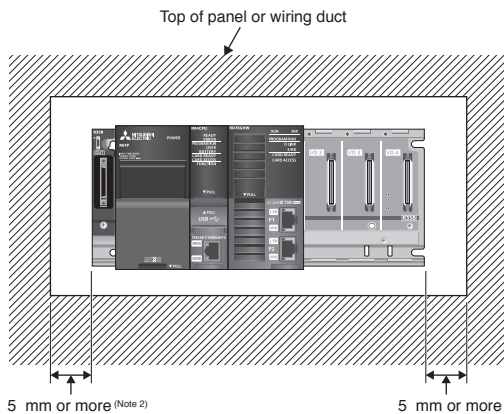

Notes: 1. Provide clearance of 30 mm or more when the height of a wiring duct is 50 mm or less. In other cases, provide clearance of 40 mm or more.  
 2. Provide clearance of 20 mm or more when an extension cable is connected/removed without removing a power supply module.

# Servo System Controllers

## Engineering Software

### MELSOFT GX Works3 operating environment <sup>(Note 1)</sup>

Item	Description	
OS	Microsoft® Windows® 11 (Home, Pro, Enterprise, Education)	
	Microsoft® Windows® 10 (Home, Pro, Enterprise, Education, IoT Enterprise 2016 LTSC <sup>*1</sup> , IoT Enterprise 2019 LTSC <sup>*1</sup> ) <sup>*1: 64-bit version only</sup>	
CPU	Windows® 11	2 or more cores on a compatible 64-bit processor or System on a Chip (SoC)
	Windows® 10	Intel® Core™ 2 Duo Processor 2 GHz or more recommended
Required memory	Windows® 11	Recommended 4 GB or more
	Windows® 10	64-bit OS: Recommended 2 GB or more 32-bit OS: Recommended 1 GB or more
Free hard disk space	For installation: 22 GB or more free hard disk capacity For operation: 512 MB or more free virtual memory capacity	
Monitor	Resolution 1024 × 768 pixels or higher	

Notes: 1. Refer to Installation Instructions for precautions and restrictions regarding the operating environment.

### Engineering software list

Item	Model	Description	
MELSOFT GX Works3	SW1DND-GXW3-E	<ul style="list-style-type: none"> <li>Programmable Controller Engineering Software [MELSOFT GX Works3, GX Works2, GX Developer, PX Developer]</li> <li>MITSUBISHI ELECTRIC FA Library</li> </ul>	DVD
MELSOFT iQ Works	SW2DND-IQWK-E	FA engineering software <sup>(Note 1)</sup> <ul style="list-style-type: none"> <li>System Management Software [MELSOFT Navigator]</li> <li>Programmable Controller Engineering Software [MELSOFT GX Works3, GX Works2, GX Developer, PX Developer]</li> <li>Motion Controller Engineering Software [MELSOFT MT Works2]</li> <li>Screen Design Software [MELSOFT GT Works3]</li> <li>Robot Programming Software [MELSOFT RT ToolBox3 <sup>(Note 2)</sup>]</li> <li>Inverter Setup Software [MELSOFT FR Configurator2]</li> <li>Servo setup software [MELSOFT MR Configurator2]</li> <li>C Controller setting and monitoring tool [MELSOFT CW Configurator]</li> <li>MITSUBISHI ELECTRIC FA Library</li> </ul>	DVD

Notes: 1. Refer to each product manual for the software supported by the model.

2. RT ToolBox3 mini (simplified version) will be installed if iQ Works product ID is used. When RT ToolBox3 (with simulation function) is required, please purchase RT ToolBox3 product ID.

## Motion Control Software SWM-G

### Control specifications

Item	Specifications	
Maximum number of control axes <sup>(Note 1)</sup>	16, 32, 64, 128 axes	
Command interface	CC-Link IE TSN	
Communication cycle (operation cycle settings) [μs]	125, 250, 500, 1000, 2000, 4000, 8000	
Network	CC-Link IE TSN	
CC-Link IE TSN Class	B	
Communication specifications	Mixture of hot connect, SDO communication, and TCP/IP communication	
Development environment	<ul style="list-style-type: none"> <li>• Microsoft® Visual Studio® 2017, 2019</li> <li>• Programming languages supported by API library: C/C++, .NET (C#, VB.NET, etc.)</li> </ul>	
Functions	Control method	Position, speed, torque
	Positioning	Up to 128 axes simultaneously (absolute value command, relative value command), override
	Acceleration/deceleration processing	Trapezoidal, S-curve, jerk ratio, parabolic, sine, time acceleration trapezoidal, etc. (24 types)
	Interpolation	2- to 4-axis linear interpolation, 2-axis/3-axis circular interpolation, 3-axis helical interpolation, PVT
	Continuous path	Combination of linear and circular interpolation, spline interpolation, pre-read speed automatic control, linear/circular continuous path with rotation stage
	JOG operation	Provided
	Real-time control	Event, triggered motion, position synchronous output
	Synchronous control	Simple synchronization, synchronous gear ratio, synchronous phase offset, synchronous compensation, dynamic establishment/cancellation of synchronization, multiple pairs (up to 64 pairs) of synchronization between 1 axis and multiple axes (synchronous group)
	Electronic cam	Cam curves of eight systems can be defined, cam curve per communication cycle, phase operation, clutch
	Home position return <sup>(Note 2)</sup>	Home position return using the Z-phase, home position sensor, limit sensor, limit proximity sensor, external input signal, mechanical end, and gantry axis can be performed.
	I/O size	Input: 8000 bytes, output: 8000 bytes
	Compensation function	Backlash/pitch error compensation, plane strain (straightness) compensation
Auxiliary function	Touch probe, logging	

Notes: 1. The maximum number of control axes differs among the USB keys for Motion Control Software.  
 2. SWM-G does not support the home position return mode of the servo amplifier.

### CC-Link IE TSN

Item	Specifications
Communications speed [bps]	1 G/100 M <sup>(Note 3)</sup>
Connectable stations per network	Up to 128 stations
Connection cable	Ethernet cable (category 5e or higher, double shielded/STP) straight cable
Maximum distance between stations [m]	100
Topology <sup>(Note 4)</sup>	Line, star, line/star mixed
Communications method	Time-sharing method
Maximum transient transmission capacity	1920 bytes

Notes: 3. A 1 Gbps device and a 100 Mbps device cannot be used on the same network.  
 4. Use class B Ethernet switch when configuring a star topology with class B devices.

### Operating environment

Item	Specifications
Personal computer	Microsoft® Windows® supported personal computer
OS	Microsoft® Windows® 10 (Home, Pro, Enterprise, Education, IoT Enterprise LTSC <sup>(Note 5)</sup> ) (64-bit)
CPU	Intel® Atom™ 2 GHz, 2Core or higher is recommended
Memory	4 GB or more
Free hard disk space	For installation: 5 GB or more
Network interface (recommended network interface cards)	Intel® I210 (Vendor ID: 0x8086, Device ID: 0X1533) Intel® I350 (Vendor ID: 0x8086, Device ID: 0X1521) Intel® I211-AT (Vendor ID: 0x8086, Device ID: 0X1539)

Notes: 5. Windows® 10 IoT Enterprise LTSC is recommended.

### Product list

Product name	Model	Applications
Motion Control Software <sup>(Note 6)</sup>	SW1DNN-SWMG-M	<ul style="list-style-type: none"> <li>• SWM-G Engine</li> <li>• SWM-G Operating Station</li> <li>• Network API</li> <li>• SWM-G API</li> <li>• Real Time OS (RTX64)</li> </ul>
USB key for Motion Control Software	MR-SWMG16-U	Maximum number of control axes: 16 axes, USB key (license)
	MR-SWMG32-U	Maximum number of control axes: 32 axes, USB key (license)
	MR-SWMG64-U	Maximum number of control axes: 64 axes, USB key (license)
	MR-SWMG128-U	Maximum number of control axes: 128 axes, USB key (license)

Notes: 6. Download and install Motion Control Software from Mitsubishi Electric FA global website.

Common Specifications  
 Servo System Controllers  
 Servo Amplifiers  
 Rotary Servo Motors  
 Linear Servo Motors  
 Options/Peripheral Equipment  
 LV/SWires  
 Product List  
 Precautions  
 Support

# Servo System Controllers

## API Library

Simpler programming by using a dedicated library suite for access to Motion Control Software.

### ■ Main functions of API library

Class	Function	Description
SSCApi	StartEngine	Starts SWM-G engine.
	StopEngine	Stops SWM-G engine.
	CreateDevice	Creates a device to interface with the SWM-G engine.
	CloseDevice	Closes a device.
	StartCommunication	Starts communication with the servo network.
	StopCommunication	Stops communication with the servo network.
CoreMotion	GetStatus	Reads the current system status from SWM-G engine.
AxisControl	SetServoOn	Executes servo on or servo off.
	SetAxisCommandMode	Sets the command mode of the axis.
	GetAxisCommandMode	Obtains the command mode of the axis.
	GetPosCommand	Obtains the commanded position of the axis.
	GetPosFeedback	Obtains the feedback position of the axis.
	GetVelCommand	Obtains the commanded velocity of the axis.
	GetVelFeedback	Obtains the feedback velocity of the axis.
Config	SetParam	Sets the system parameters.
	GetParam	Obtains the system parameters.
	SetAxisParam	Sets the axis parameters.
	GetAxisParam	Obtains the axis parameters.
	Export	Exports the system and axis parameters to xml file.
Home	Import	Imports the system and axis parameters from xml file.
	StartHome	Starts home position return.
Motion	SetCommandPos	Sets the commanded position to a specified value.
	StartPos	Executes positioning (absolute position).
	StartMov	Executes positioning (relative position).
	StartLinearIntplPos	Starts linear interpolation (absolute position).
	StartLinearIntplMov	Starts linear interpolation (relative position).
	StartCircularIntplPos	Starts circular interpolation (absolute position).
	StartCircularIntplMov	Starts circular interpolation (relative position).
	StartHelicalIntplPos	Starts helical interpolation (absolute position).
	StartHelicalIntplMov	Starts helical interpolation (relative position).
	StartJog	Starts JOG operation.
	Stop	Decelerates the axis to stop.
	ExecQuickStop	Decelerates the axis to stop with Quick Stop Dec parameter.
	ExecTimedStop	Decelerates the axis to stop with the specified time.
	Wait	Executes the blocking wait command.
	Pause	Pauses the positioning operation.
	Resume	Restarts the paused positioning operation.
	OverridePos	Overrides the target position (absolute position) during positioning operation.
	OverrideMov	Overrides the target position (relative position) during positioning operation.
	OverrideProfile	Overrides the velocity pattern during positioning, JOG operation, and speed control.
	StopJogAtPos	Decelerates the axis in JOG operation to stop at the specified position.

Class	Function	Description
Sync	SetSyncMasterSlave	Establishes synchronization between the master and following axes.
	ResolveSync	Cancels synchronization of the specified following axes.
Velocity	StartVel	Starts speed control.
	Stop	Stops speed control.
Torque	StartTrq	Starts torque control.
	StopTrq	Stops torque control.
AdvMotion	CreatePathIntplBuffer	Assigns the buffer memory for path interpolation to an axis.
	FreePathIntplBuffer	Frees up the buffer memory for path interpolation.
	StartPathIntplPos	Starts path control (absolute position).
	StartPathIntplMov	Starts path control (relative position).
	StartPathIntpl3DPos	Starts 3D path interpolation (absolute position).
AdvSync	StartECAM	Starts E-CAM control.
	StopECAM	Stops E-CAM control.
Event	SetEvent	Sets an event.
	SetSoftwareTouchProbe	Sets the parameter of the software touch probe channel.
	GetSoftwareTouchProbeStatus	Obtains the parameters and the current status of software touch probe.
	SetHardwareTouchProbe	Sets the parameters of hardware touch probe.
	GetHardwareTouchProbeStatus	Obtains the parameters and the current status of hardware touch probe.
Io	StartPSO	Starts the position synchronous output channel.
	SetOutBit	Sets the output bit values.
	SetOutByte	Sets the output byte values.
	SetOutAnalogDataShort	Sets two-byte output data.
	GetInBit	Obtains the input bit values.
	GetInByte	Obtains the input byte values.
UserMemory	GetInAnalogDataShort	Obtains two-byte input data.
	SetMBit	Sets the user memory bit values.
	SetMByte	Sets the user memory byte values.
	SetMAnalogDataShort	Sets two-byte user memory data.
	GetMBit	Obtains the user memory bit value.
	GetMByte	Obtains the user memory byte value.
Log	GetMAnalogDataShort	Obtains two-byte user memory data.
	StartLog	Starts logging data.
	StopLog	Stops logging data.
CCLink	SetLog	Specifies the data to be collected by logging operation.
	StartHotconnect	Starts the hot connect.
	SdoDownload	Downloads the SDO data of the specified remote station.
	SdoUpload	Uploads the SDO data of the specified remote station.
	SetAxisMode	Sets the control mode of the axis of the specified remote station.
	StartAxisHM	Starts HM mode control of the axis of the specified remote station.
	SImpSendBySlaveId	Transmits SLMP to the specified remote station.

Common Specifications

Servo System Controllers

Servo Amplifiers

Rotary Servo Motors

Linear Servo Motors

Options/Peripheral Equipment

LV/SWires

Product List

Precautions

Support

MEMO



# 3

## Servo Amplifiers

Model Designation.....	3-2
MR-JET-G_ Connections with Peripheral Equipment.....	3-3
MR-JET-G_ Specifications.....	3-4
MR-JET-G_ Standard Wiring Diagram Example.....	3-5
Power Supply Connection Example.....	3-6
1-phase 200 V AC Class Power Supply Input Using a Neutral Point of 3-phase 400 V AC Class Power Supply.....	3-7
Servo Motor Connection Example.....	3-8
Linear Encoder Connection Example.....	3-13
External Encoder Connection Specifications.....	3-13
MR-JET-G_ Dimensions.....	3-14
Positioning Function.....	3-16
Restrictions.....	3-18

\* Refer to p. 6-32 in this catalog for conversion of units.



# Servo Amplifiers

## Model Designation

M R - J E T - 1 0 G -

Mitsubishi Electric  
AC servo amplifier  
MELSERVO-JET  
Series

• Network compatible

Symbol	Network specifications
None	CC-Link IE TSN
N1	EtherCAT®

Symbol	Rated output [kW]
10	0.1
20	0.2
40	0.4
70	0.75
100	1
200	2
300	3

**MR-JET-G\_ Connections with Peripheral Equipment** (Note 1)

Peripheral equipment is connected to MR-JET-G\_ as described below. Connectors, cables, options, and other necessary equipment are available so that users can set up the servo amplifier easily and start using it right away.

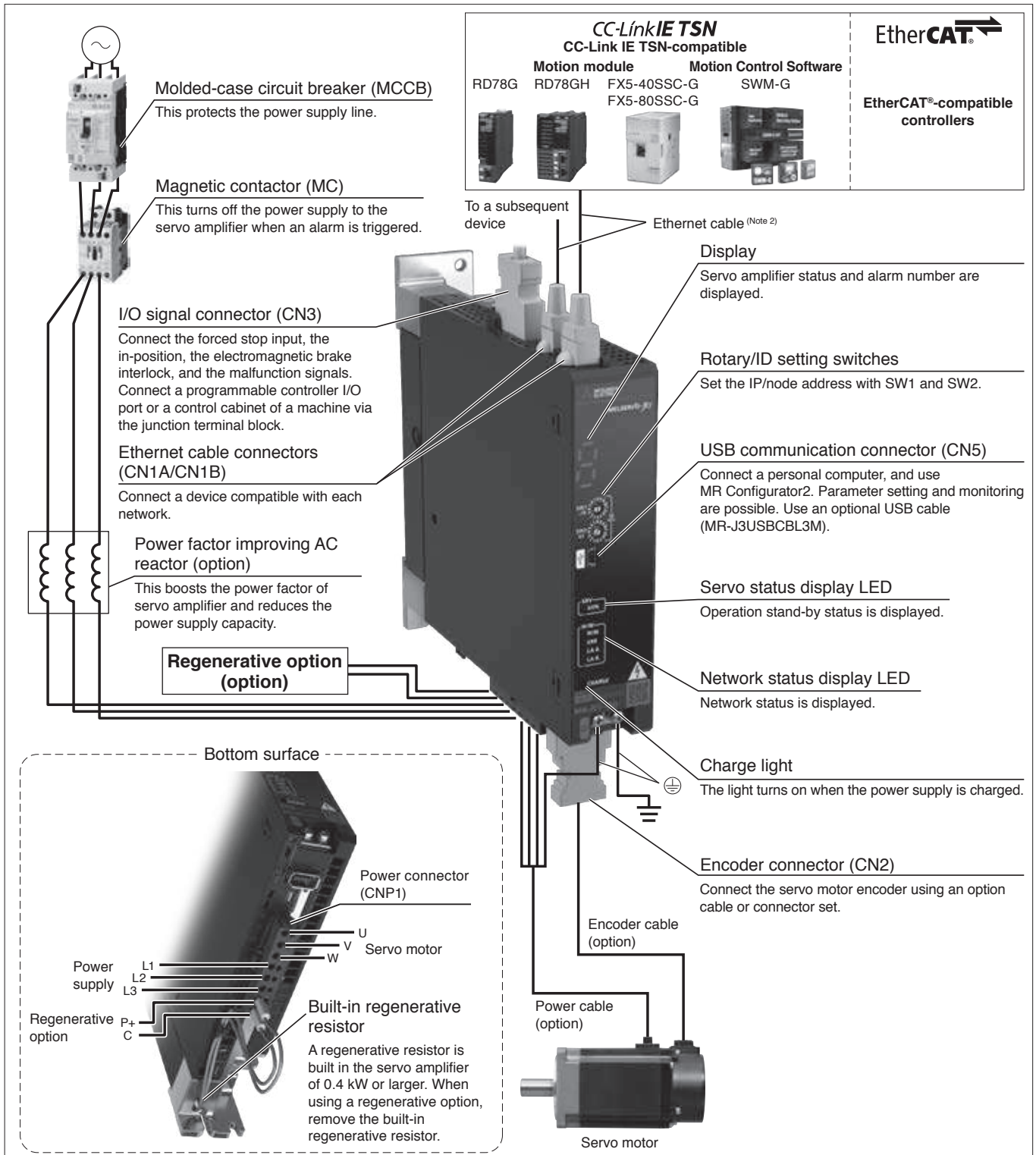

Notes: 1. Refer to "MR-JET User's Manual" for the actual connections.  
2. For specifications of the Ethernet cable, refer to "Ethernet Cable Specifications" on p. 6-19 in this catalog.

Common Specifications  
Servo System Controllers  
Servo Amplifiers  
Rotary Servo Motors  
Linear Servo Motors  
Options/Peripheral Equipment  
LV/SWires  
Product List  
Precautions  
Support

# Servo Amplifiers

## MR-JET-G\_ (Network Compatible) Specifications

Servo amplifier model MR-JET-_(N1)		10G	20G	40G	70G	100G	200G	300G
Output	Voltage	3-phase 0 V AC to 240 V AC						
	Rated current [A]	1.3	1.8	2.8	5.8	6.0	11.0	11.0
Power supply input	Voltage/frequency <sup>(Note 1)</sup>	3-phase or 1-phase 200 V AC to 240 V AC, 50 Hz/60 Hz			3-phase or 1-phase 200 V AC to 240 V AC, 50 Hz/60 Hz <sup>(Note 6)</sup>			3-phase 200 V AC to 240 V AC, 50 Hz/60 Hz
	Rated current <sup>(Note 5)</sup> [A]	0.9	1.5	2.6	3.8	5.0	10.5	14.0
	Permissible voltage fluctuation	3-phase or 1-phase 170 V AC to 264 V AC			3-phase or 1-phase 170 V AC to 264 V AC <sup>(Note 6)</sup>			3-phase 170 V AC to 264 V AC
	Permissible frequency fluctuation	±5 % maximum						
Interface power supply		24 V DC ± 10 % (required current capacity: 0.3 A)						
Control method		Sine-wave PWM control/current control method						
Permissible regenerative power of the built-in regenerative resistor <sup>(Note 2, 3)</sup> [W]		-	10	30	100			
Dynamic brake <sup>(Note 4)</sup>		Built-in						
CC-Link IE TSN Class B <sup>(Note 10)</sup> (MR-JET-G)	Communication cycle <sup>(Note 7, 12)</sup>	125 μs, 250 μs, 500 μs, 1 ms, 2 ms, 4 ms, 8 ms						
	Protocol version	1.0/2.0 <sup>(Note 11)</sup>						
CC-Link IE TSN Class A <sup>(Note 10, 11, 13)</sup> (MR-JET-G)	Communication cycle <sup>(Note 7)</sup>	500 μs to 500 ms						
	Protocol version	2.0						
EtherCAT® (MR-JET-G-N1)	Communication cycle <sup>(Note 7, 12)</sup>	125 μs, 250 μs, 500 μs, 1 ms, 2 ms, 4 ms, 8 ms						
CC-Link IE Field Network Basic <sup>(Note 11, 13)</sup> (MR-JET-G)		Supported						
Communication function	USB	Connect a personal computer (MR Configurator2 compatible)						
Positioning mode <sup>(Note 11, 12)</sup>		Point table method						
Fully closed loop control <sup>(Note 14)</sup>		Two-wire type communication method						
Load-side encoder interface		Mitsubishi Electric high-speed serial communication, A/B/Z-phase differential input signal <sup>(Note 15)</sup>						
Servo functions		Advanced vibration suppression control II, adaptive filter II, robust filter, quick tuning, auto tuning, one-touch tuning, tough drive function, drive recorder function, machine diagnosis function, power monitoring function, lost motion compensation function, super trace control, continuous operation to torque control mode <sup>(Note 9)</sup>						
Protective functions		Overcurrent shut-off, regenerative overvoltage shut-off, overload shut-off (electronic thermal), servo motor overheat protection, encoder error protection, regenerative error protection, undervoltage protection, instantaneous power failure protection, overspeed protection, error excessive protection, magnetic pole detection protection, linear servo control fault protection						
Structure (IP rating)		Natural cooling, open (IP20)					Force cooling, open (IP20)	
Close mounting	3-phase power supply input	Possible <sup>(Note 8)</sup>						
	1-phase power supply input	Possible <sup>(Note 8)</sup>				Not possible		-
Mass [kg]		0.8			1.6		2.1	

- Notes:
- Rated output and speed of a rotary servo motor; and continuous thrust and maximum speed of a linear servo motor are applicable when the servo amplifier is operated within the specified power supply voltage and frequency.
  - Select the most suitable regenerative option for your system with our drive system sizing software Motorizer.
  - Refer to "Regenerative Option" in this catalog for the permissible regenerative power [W] when a regenerative option is used.
  - When using the dynamic brake, refer to "MR-JET User's Manual" for the permissible load to motor inertia ratio and the permissible load to mass ratio.
  - This value is applicable when a 3-phase power supply is used.
  - When the servo amplifier is used with a 1-phase power supply and combined with a servo motor of over 750 W, use the servo amplifiers at 75 % or less of the effective load ratio.
  - The communication cycle depends on the controller specifications and the number of device stations connected.
  - When the servo amplifiers are closely mounted, keep the ambient temperature within 0 °C to 45 °C, or use the servo amplifiers at 75 % or less of the effective load ratio.
  - The continuous operation to torque control mode is not available with MR-JET-\_(N1). For the servo amplifier firmware version supporting this function, refer to "MR-JET User's Manual".
  - A communication speed of 1 Gbps/100 Mbps can be selected. When 100 Mbps is selected, the minimum communication cycle is 500 μs.
  - For the servo amplifier firmware version supporting each function, refer to "MR-JET User's Manual".
  - For the restrictions on the communication cycle, refer to "Restrictions" in this catalog.
  - For the restrictions on the network, refer to "MR-JET User's Manual".
  - Use the servo amplifiers with firmware version C4 or later and manufactured in July 2022 or later. Note that, depending on the stock status, the servo amplifiers with both the former and the new specifications may be distributed in the market around the same time. Contact the local sales office when the fully closed loop control is needed.
  - The fully closed loop control does not support the A/B/Z-phase differential input signal.

MR-JET-G\_ Standard Wiring Diagram Example

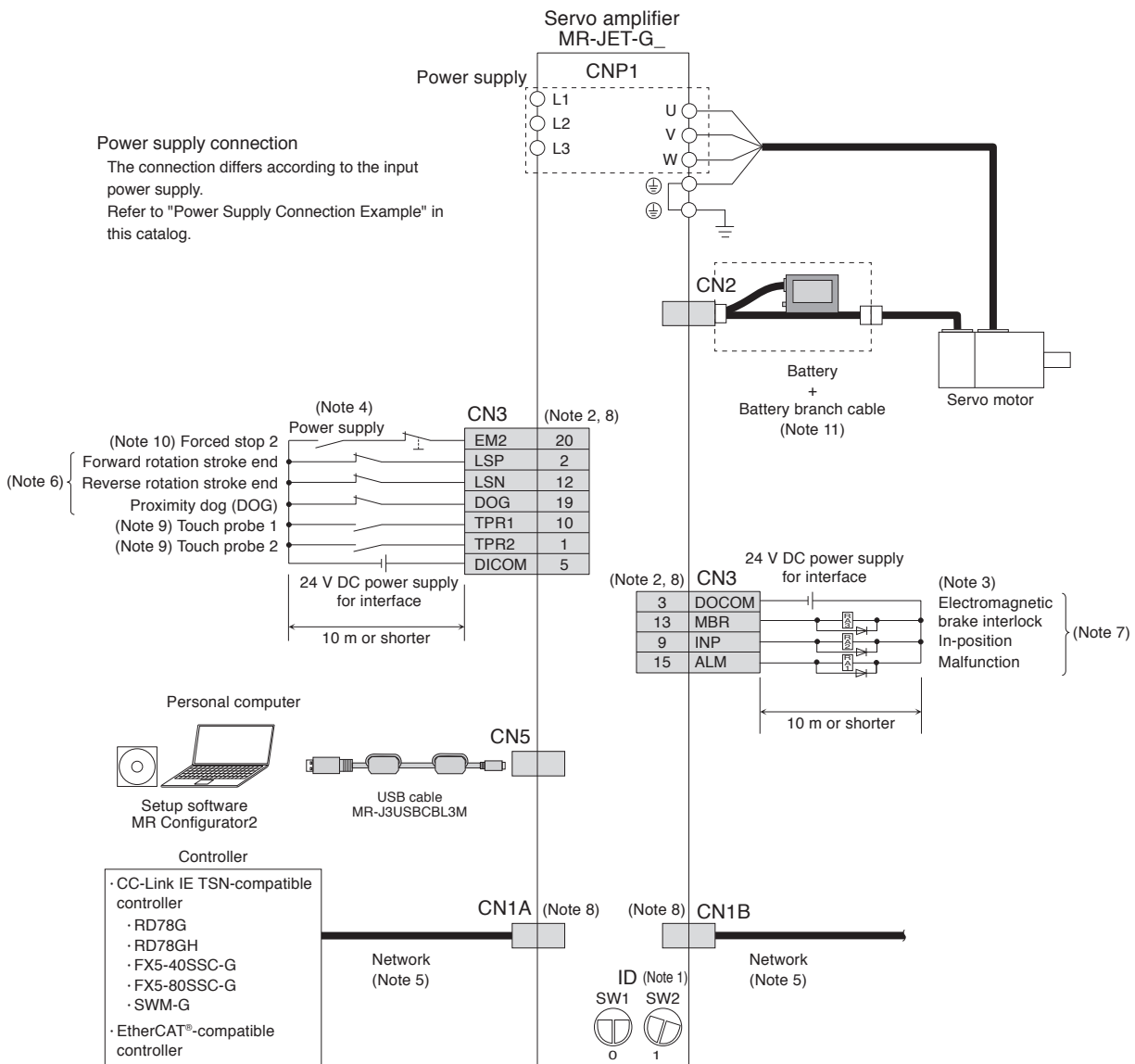

- Notes:
- The node address or the 4th octet of the IP address can be set between 1 and 254 with a combination of the ID setting switches or the rotary switches (SW1 and SW2). Note that the number of the connectable device stations depends on the controller specifications.
  - This is for sink wiring. Source wiring is also possible.
  - When using a linear servo motor, use MBR (Electromagnetic brake interlock) for an external brake mechanism.
  - To prevent an unexpected restart of the servo amplifier, create a circuit to turn off EM2 (Forced stop 2) when the power is turned off.
  - When branching off CC-Link IE TSN (synchronous communication function) with a switching hub, use a switching hub (Class B) recommended by CC-Link Partner Association. When a switching hub (Class A) is used, there are restrictions on the topologies to be used. Refer to the controller user's manual for details.
  - Devices for these pins can be changed with [Pr. PD03], [Pr. PD04], and [Pr. PD05].
  - Devices for these pins can be changed with [Pr. PD07], [Pr. PD08], and [Pr. PD09].
  - Attach a cap to unused CN3/CN1A/CN1B connectors.
  - Use the servo amplifiers with firmware version C4 or later and manufactured in July 2022 or later. Note that, depending on the stock status, the servo amplifiers with both the former and the new specifications may be distributed in the market around the same time. Contact the local sales office when the touch probe function is needed.
  - The forced stop signal is issued for the servo amplifier. For overall system, apply the emergency stop on the controller side.
  - When configuring an absolute position detection system with a rotary servo motor having a battery backup type absolute position encoder, whether a battery (MR-BAT6V1SET-B) is required depends on the system configuration. In addition, use the battery branch cable (MR-BT6V4CBL03M) when using the battery. Refer to "Battery" in this catalog for information on whether a battery is required, details, and connections of the battery.



Be sure to read through User's Manual for the actual wiring and use. Use the equipment after you have a full knowledge of the equipment, safety information and instructions.

Common Specifications  
Servo System Controllers  
Servo Amplifiers  
Rotary Servo Motors  
Linear Servo Motors  
Options/Peripheral Equipment  
LV/SWires  
Product List  
Precautions  
Support

# Servo Amplifiers

## Power Supply Connection Example

### ● For 3-phase 200 V AC

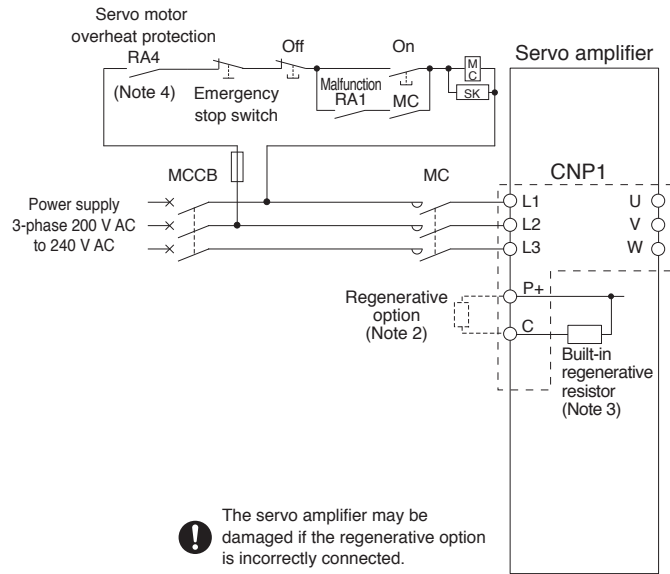

### ● For 1-Phase 200 V AC

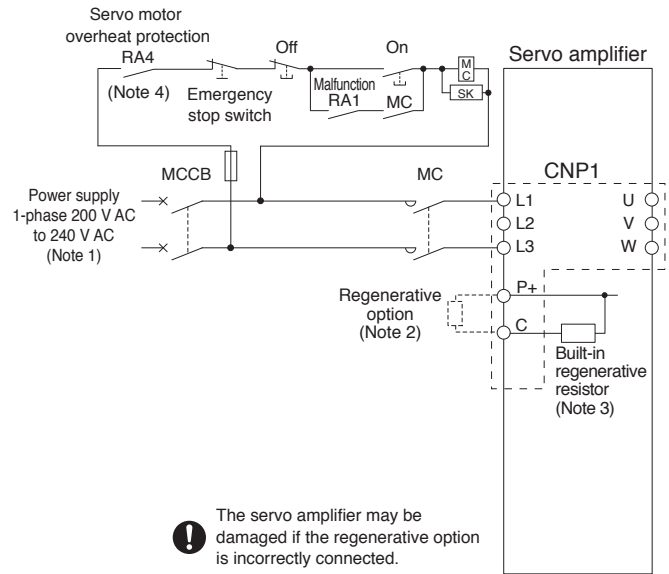

- Notes:
1. For 1-phase 200 V AC to 240 V AC, connect the power supply to L1 and L3 terminals. Do not connect anything to L2.
  2. When connecting a regenerative option externally, disconnect the wires for the built-in regenerative resistor (between P+ and C), and then remove the resistor.
  3. The servo amplifiers of 0.2 kW or smaller do not have a built-in regenerative resistor.
  4. When connecting a linear servo motor with a thermal protector, add a contact to shut off by being interlocked with the thermal protector output of the linear servo motor.



Be sure to read through User's Manual for the actual wiring and use. Use the equipment after you have a full knowledge of the equipment, safety information and instructions.

### 1-phase 200 V AC Class Power Supply Input Using a Neutral Point of 3-phase 400 V AC Class Power Supply

A 1-phase 200 V AC class power can be supplied with a use of a neutral point of a 3-phase 400 V AC class power supply. Use a step-down transformer as necessary to keep the power supply voltage between 200 V AC and 240 V AC.

**!** Do not input a 3-phase 400 V AC class power supply directly to the 200 V class servo amplifier. Doing so may cause the servo amplifier to malfunction.

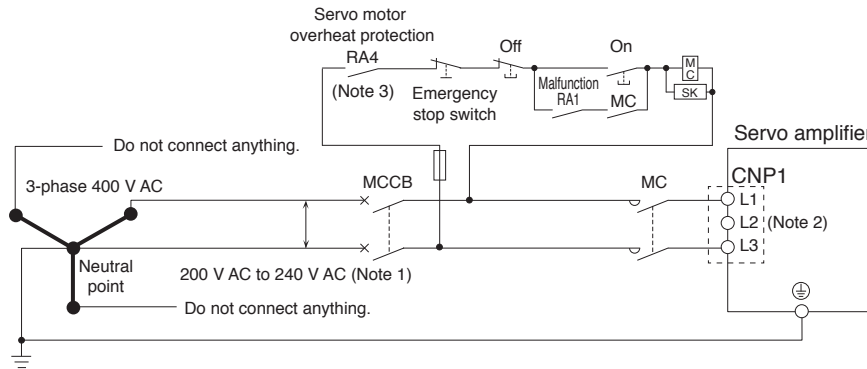

- Notes:
1. Use a step-down transformer as necessary to keep the power supply voltage between 200 V AC and 240 V AC.
  2. For 1-phase 200 V AC to 240 V AC, connect the power supply to L1 and L3 terminals. Do not connect anything to L2.
  3. When connecting a linear servo motor with a thermal protector, add a contact to shut off by being interlocked with the thermal protector output of the linear servo motor.

**!** Be sure to read through User's Manual for the actual wiring and use. Use the equipment after you have a full knowledge of the equipment, safety information and instructions.

# Servo Amplifiers

## Servo Motor Connection Example (Rotary Servo Motor) (Semi Closed Loop Control System)

### ● For HG-KNS series

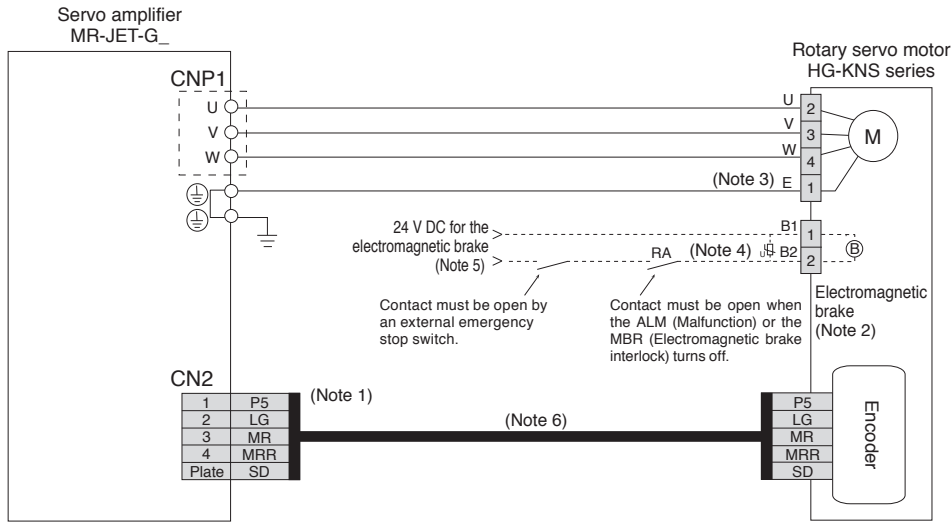

### ● For HG-SNS series

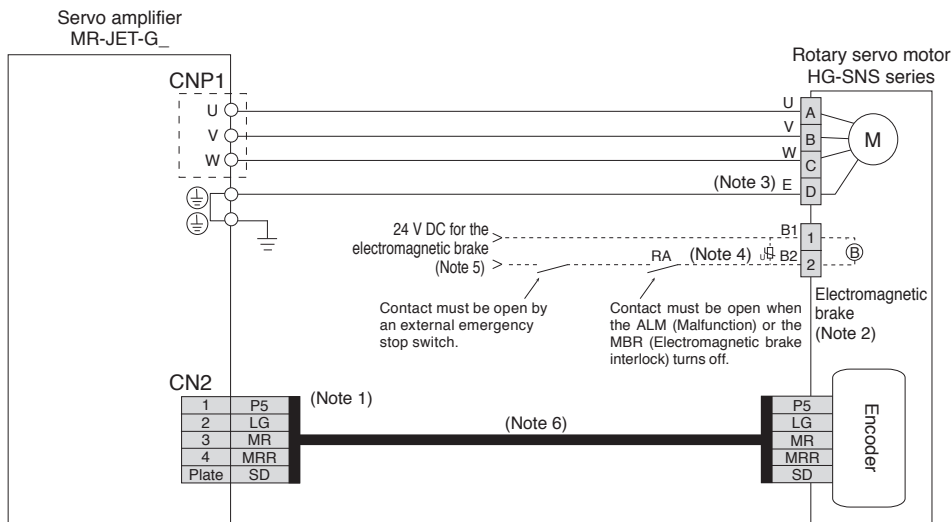

- Notes:
1. The signals shown are applicable when a two-wire type encoder cable is used. A four-wire type is also compatible.
  2. This is for the servo motors with an electromagnetic brake. The electromagnetic brake terminals do not have polarity.
  3. Connect the grounding wire to the cabinet protective earth (PE) terminal via the servo amplifier for grounding the servo motor.
  4. Install a surge absorber between B1 and B2.
  5. Do not use the 24 V DC interface power supply for the electromagnetic brake. Provide a dedicated power supply to the electromagnetic brake.
  6. Encoder cables are available as an option. Refer to "Rotary Servo Motor User's Manual (For MR-JET)" when fabricating the cables.



Be sure to read through User's Manual for the actual wiring and use. Use the equipment after you have a full knowledge of the equipment, safety information and instructions.



Servo Motor Connection Example (Rotary Servo Motor) (Fully Closed Loop Control System)

● For HG-KNS series

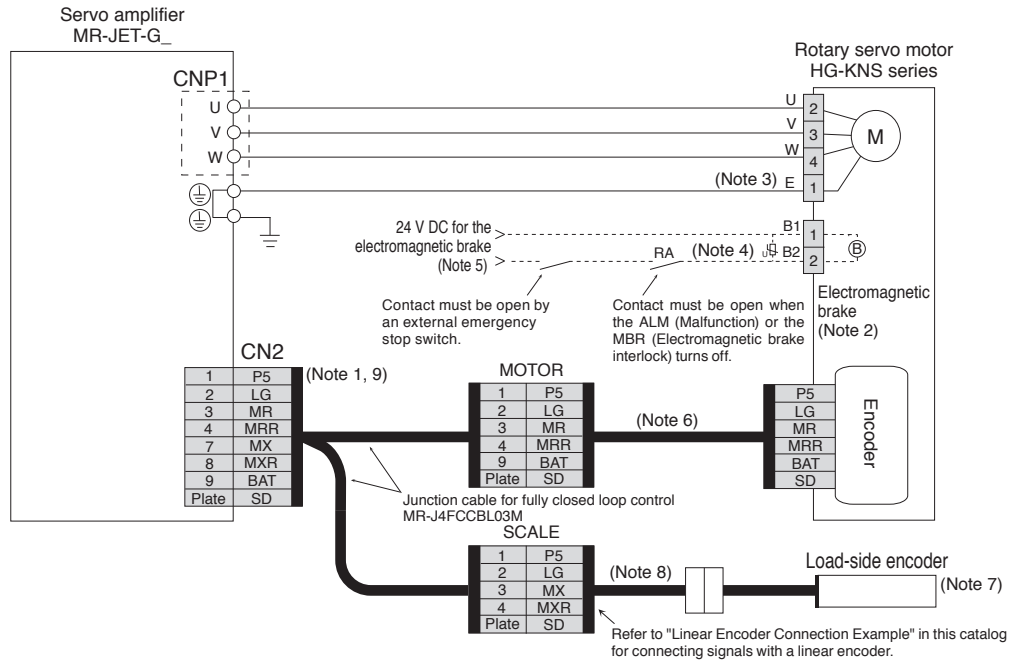

● For HG-SNS series

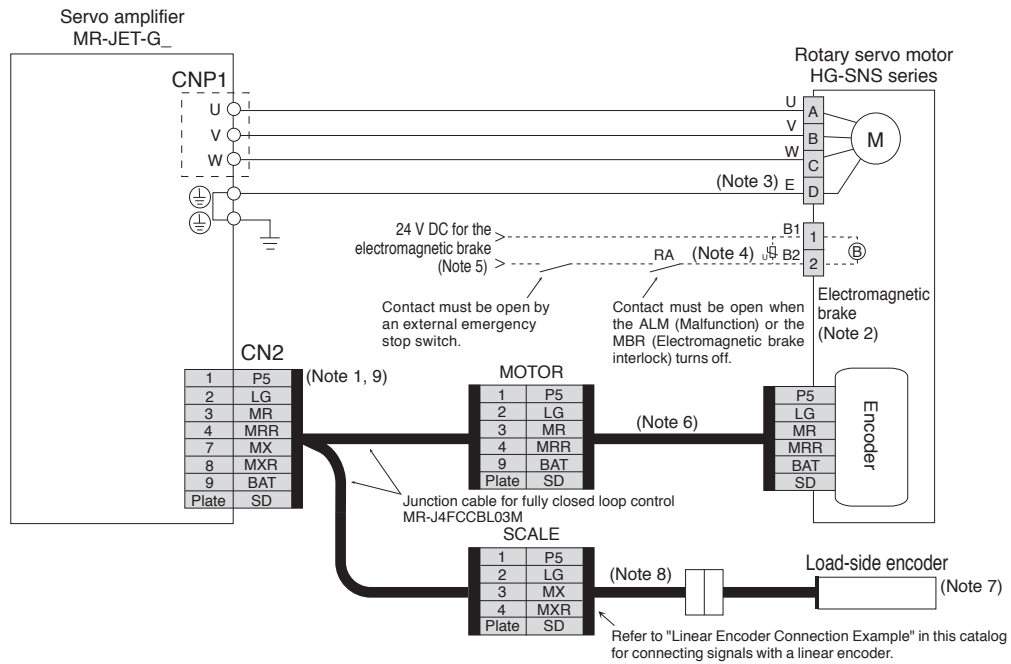

- Notes:
1. For fully closed loop control, the load-side encoder and the servo motor encoder are compatible only with two-wire type communication method. Four-wire type cannot be used.
  2. This is for the servo motors with an electromagnetic brake. The electromagnetic brake terminals do not have polarity.
  3. Connect the grounding wire to the cabinet protective earth (PE) terminal via the servo amplifier for grounding the servo motor.
  4. Install a surge absorber between B1 and B2.
  5. Do not use the 24 V DC interface power supply for the electromagnetic brake. Provide a dedicated power supply to the electromagnetic brake.
  6. Encoder cables are available as an option. Refer to "Rotary Servo Motor User's Manual (For MR-JET)" when fabricating the cables.
  7. For linear encoders, refer to "List of Linear Encoders" in this catalog. Refer to "MR-JET User's Manual" for the fully closed loop control with a rotary encoder.
  8. Necessary encoder cables vary depending on the load-side encoder. Refer to "MR-JET User's Manual" and "Rotary Servo Motor User's Manual (For MR-JET)".
  9. When configuring a fully closed loop control system, connect MR-J4FCCBL03M junction cable or a junction cable fabricated using MR-J3THMCN2 connector set to CN2 connector.

**!** Be sure to read through User's Manual for the actual wiring and use. Use the equipment after you have a full knowledge of the equipment, safety information and instructions.

Common Specifications

Servo System Controllers

Servo Amplifiers

Rotary Servo Motors

Linear Servo Motors

Options/Peripheral Equipment

LVSWires

Product List

Precautions

Support

# Servo Amplifiers

## Servo Motor Connection Example (LM-H3 Series Linear Servo Motor)

### ●Connecting a serial linear encoder

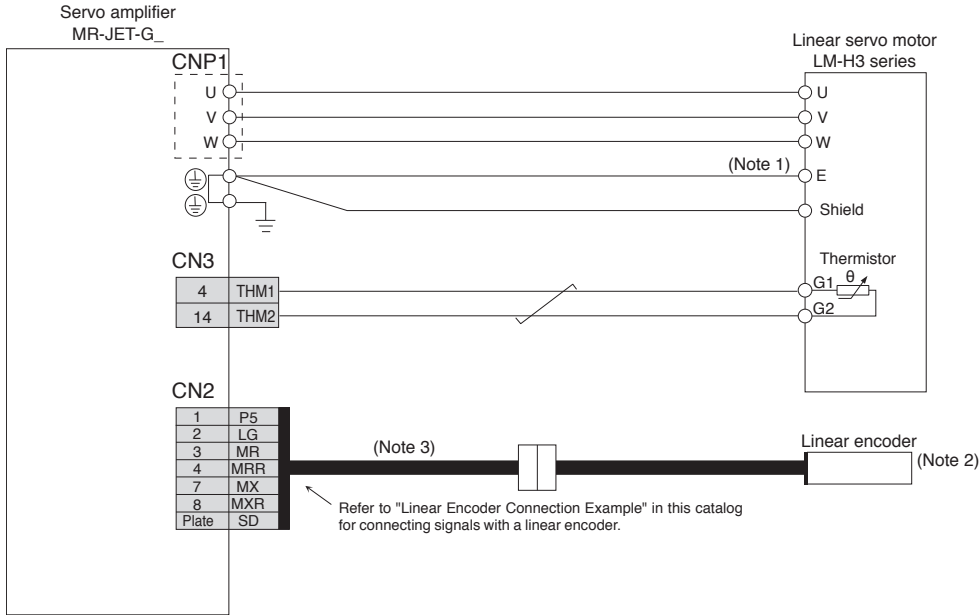

### ●Connecting an A/B/Z-phase differential output linear encoder

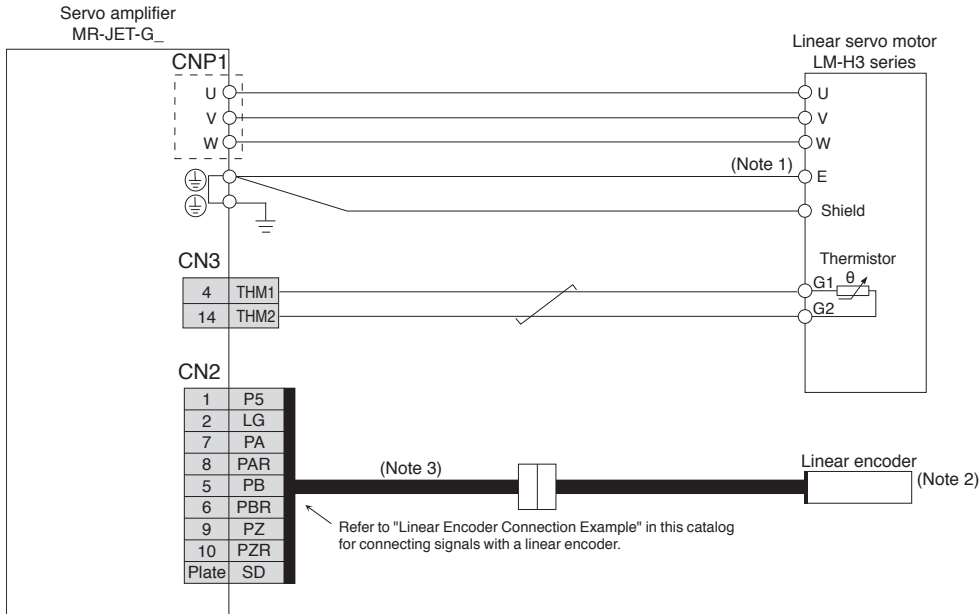

- Notes:
1. Connect the grounding wire to the cabinet protective earth (PE) terminal via the servo amplifier for grounding the servo motor.
  2. For linear encoders, refer to "List of Linear Encoders" in this catalog.
  3. Necessary cables vary depending on the linear encoder. Refer to "MR-JET Partner's Encoder User's Manual" for details.



Be sure to read through User's Manual for the actual wiring and use. Use the equipment after you have a full knowledge of the equipment, safety information and instructions.

### Servo Motor Connection Example (LM-AJ Series Linear Servo Motor)

●Connecting a serial linear encoder

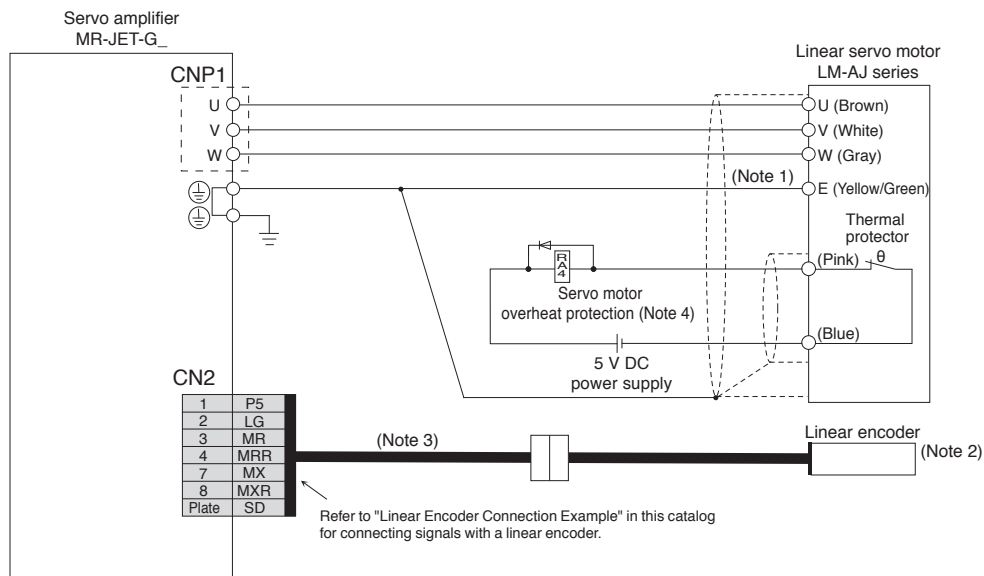

●Connecting an A/B/Z-phase differential output linear encoder

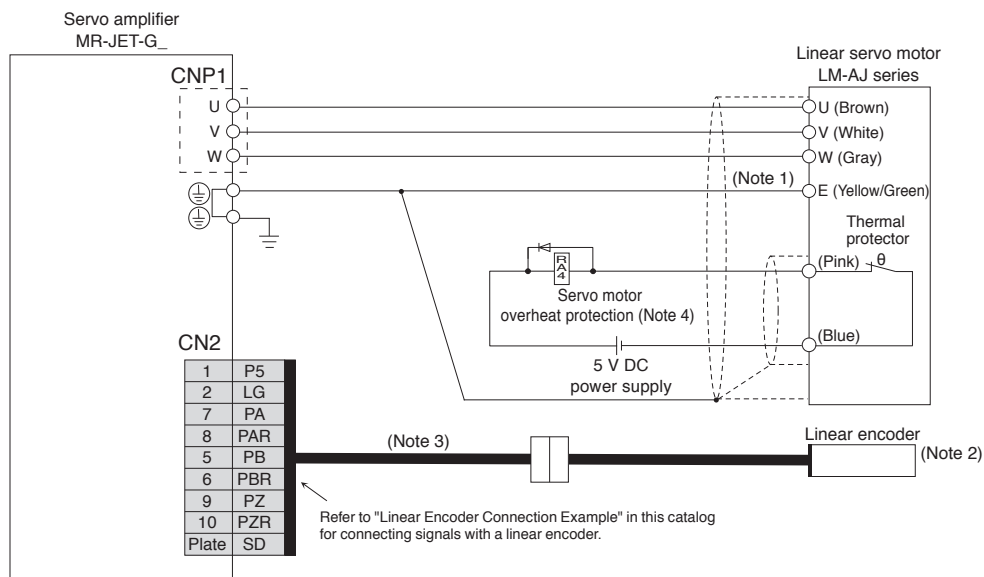

- Notes:
1. Connect the grounding wire to the cabinet protective earth (PE) terminal via the servo amplifier for grounding the servo motor.
  2. For linear encoders, refer to "List of Linear Encoders" in this catalog.
  3. Necessary cables vary depending on the linear encoder. Refer to "MR-JET Partner's Encoder User's Manual" for details.
  4. Create a relay circuit to turn off the main circuit power supply when the thermal protector is opened by overheating. Use a relay designed for a flowing current of 1000 mA or less. If a mechanical relay is used, use a relay designed for a flowing current of 50 mA to 1000 mA.



Be sure to read through User's Manual for the actual wiring and use. Use the equipment after you have a full knowledge of the equipment, safety information and instructions.

Common Specifications  
 Servo System Controllers  
 Servo Amplifiers  
 Rotary Servo Motors  
 Linear Servo Motors  
 Options/Peripheral Equipment  
 LV/SWires  
 Product List  
 Precautions  
 Support

# Servo Amplifiers

## Servo Motor Connection Example (LM-AU Series Linear Servo Motor)

### ●Connecting a serial linear encoder

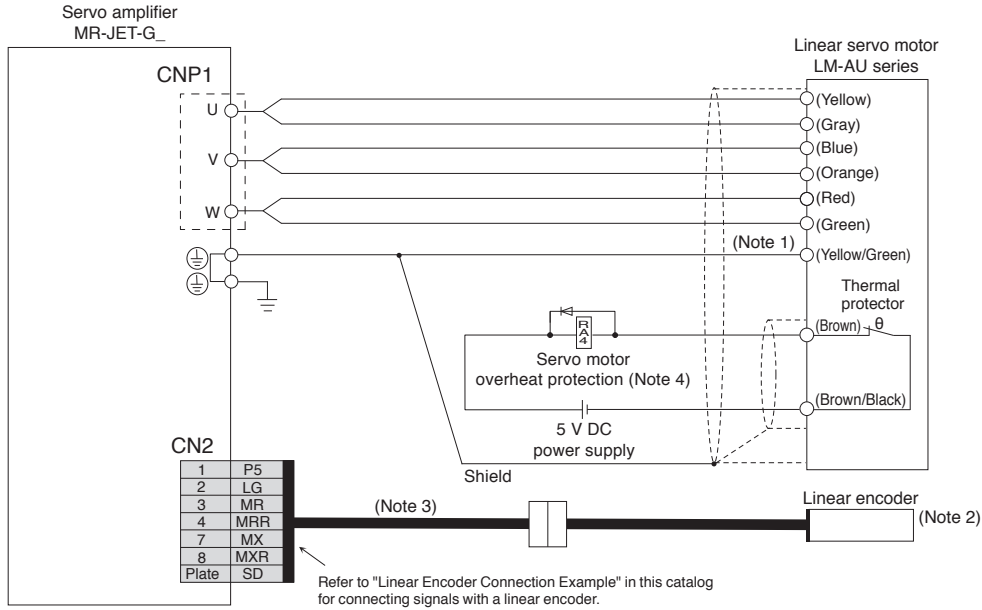

### ●Connecting an A/B/Z-phase differential output linear encoder

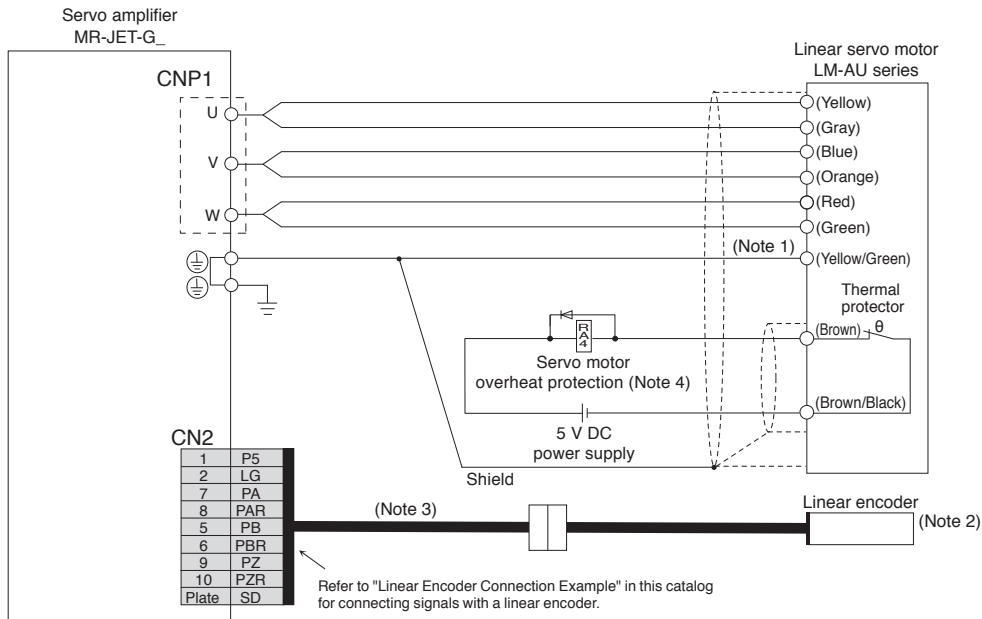

- Notes:
1. Connect the grounding wire to the cabinet protective earth (PE) terminal via the servo amplifier for grounding the servo motor.
  2. For linear encoders, refer to "List of Linear Encoders" in this catalog.
  3. Necessary cables vary depending on the linear encoder. Refer to "MR-JET Partner's Encoder User's Manual" for details.
  4. Create a relay circuit to turn off the main circuit power supply when the thermal protector is opened by overheating. Use a relay designed for a flowing current of 1000 mA or less. If a mechanical relay is used, use a relay designed for a flowing current of 50 mA to 1000 mA.



Be sure to read through User's Manual for the actual wiring and use. Use the equipment after you have a full knowledge of the equipment, safety information and instructions.

### Linear Encoder Connection Example

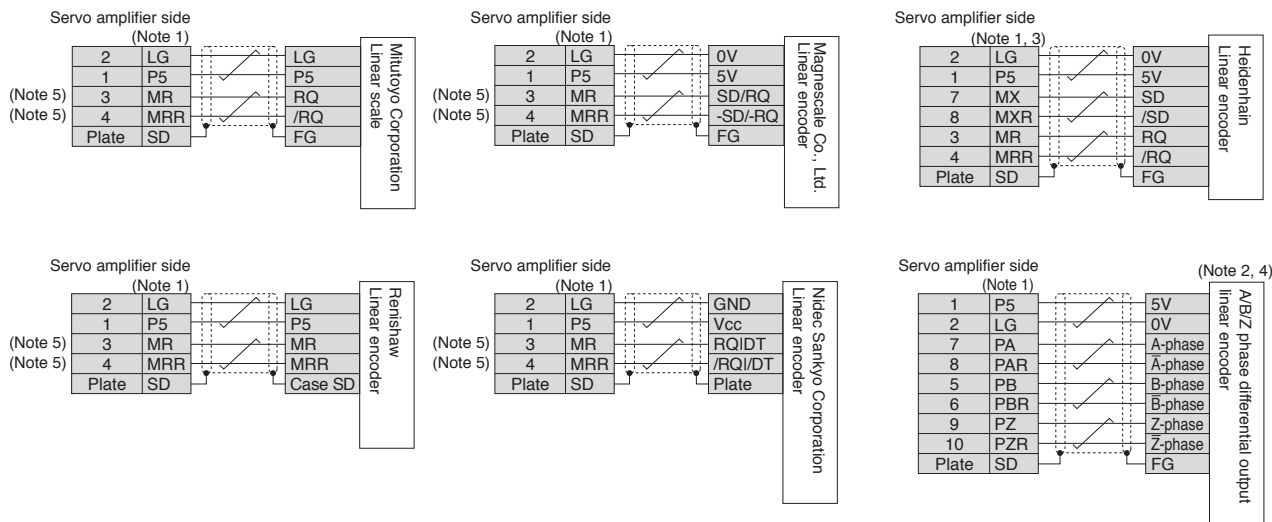

- Notes:
1. For the number of the wire pairs for LG and P5, refer to "MR-JET Partner's Encoder User's Manual."
  2. If the encoder's current consumption exceeds 350 mA, supply power from an external source.
  3. When the fully closed loop control system is configured with a rotary servo motor, the load-side encoder and the servo motor encoder are compatible only with two-wire type communication method. Four-wire type cannot be used.
  4. When the fully closed loop control system is configured with a rotary servo motor, the A/B/Z-phase differential output type linear encoder is not supported.
  5. For the fully closed loop control, MR and MRR of the servo amplifier-side connectors will be connected to MX and MXR of the SCALE connectors of MR-J4FCCBL03M.

**!** Be sure to read through User's Manual for the actual wiring and use. Use the equipment after you have a full knowledge of the equipment, safety information and instructions.

### External Encoder Connection Specifications

Refer to the following table for the encoder communication method compatible with each system and for the servo amplifier connector to which a load-side encoder should be connected.

Operation mode	External encoder communication method	Connector to be connected with the external encoder
Linear servo system <sup>(Note 3)</sup>	Two-wire type	CN2
	Four-wire type	
	A/B/Z-phase differential output method	
Fully closed loop control system <sup>(Note 4)</sup>	Two-wire type	CN2 <sup>(Note 1)</sup>
	Four-wire type	- <sup>(Note 2)</sup>
	A/B/Z-phase differential output method	

- Notes:
1. MR-J4FCCBL03M junction cable is required.
  2. For fully closed loop control systems, four-wire type and A/B/Z-phase differential input external encoders are not available.
  3. Use the servo amplifiers with firmware version B2 or later.
  4. Use the servo amplifiers with firmware version C4 or later and manufactured in July 2022 or later.





# Servo Amplifiers

## Positioning Function: Point Table Method

Set the position and speed data to the point table, and select the point table No. with the command interface signal to start the positioning operation.

Item	Description	
Command interface	Object dictionary	
Operation specifications	Positioning by specifying the point table No. (255 points)	
System	Signed absolute value command method	
Position command input	Absolute value command method	Setting in the point table Setting range of feed length for one point: -2147483648 to 2147483647 [ $\mu\text{m}$ ], -214748.3648 to 214748.3647 [inch], -2147483648 to 2147483647 [pulse], -360.000 to 360.000 [degree]
Speed command input	Set the servo motor speed in the point table. Set the acceleration/deceleration time constants and acceleration/deceleration in the point table. Set the S-pattern acceleration/deceleration time constant in [Pr. PT51]. The speed unit can be selected ([r/min], command unit/s) The acceleration/deceleration unit can be selected ([ms], command unit/s <sup>2</sup> ).	
Torque limit	Set by the servo parameter or object dictionary.	
Point table mode (pt)	One positioning operation	Point table No. input method Perform one positioning operation based on the position command and speed command.
	Continuous positioning operation	Speed change operation (2nd gear to 255th gear)/ Continuous positioning operation (2 points to 255 points)/ Continuous operation to the point table selected at startup/ Continuous operation to the point table No. 1
JOG operation mode (jg)	JOG operation	Perform inching operation in the network communication function based on the speed command.
Homing mode (hm) <sup>(Note 1)</sup>	Dog type (rear end detection, Z-phase reference), stopper type (stopper position reference), count type (front end detection, Z-phase reference), dog type (rear end detection, rear end reference), count type (front end detection, front end reference), dog cradle type, dog type last Z-phase reference, dog type front end reference, dogless Z-phase reference, Homing on negative limit switch and index pulse (method 1), Homing on positive limit switch and index pulse (method 2), Homing on positive home switch and index pulse (method 3, 4), Homing on negative home switch and index pulse (method 5, 6), Homing on home switch and index pulse (method 7, 8, 9, 10, 11, 12, 13, 14), Homing without index pulse (method 17, 18, 19, 20, 21, 22, 23, 24, 27, 28), Homing on index pulse (method 33, 34), Homing on current position (method 35, 37)	
Function on positioning operation	Absolute position detection/external limit switch/software position limit/function for positioning to the home, etc.	

Notes: 1. For the servo amplifier firmware version supporting the methods of No. 9, 10, 13, 14, 17, 18, refer to "MR-JET User's Manual".



## Positioning Function: Point Table Method

Absolute value command method: travels to a specified address (absolute value) with reference to the home position

Item	Setting range	Description
Point table No.	1 to 255	Specify a point table in which a target position, servo motor speed, acceleration/deceleration, acceleration time constant/deceleration time constant, dwell, auxiliary function, and M code will be set.
Target position <sup>(Note 1)</sup> (position data)	-2147483.648 to 2147483.647 [mm] -214748.3648 to 214748.3647 [inch] -360.000 to 360.000 [degree] -2147483648 to 2147483647 [pulse]	Set a travel distance. (1) When using as absolute position command method Set a target address (absolute value). (2) When using as relative position command method Set a travel distance. Reverse rotation command is applied with a minus sign.
Servo motor speed <sup>(Note 2)</sup>	0 to maximum speed [r/min] 0 to 2147483.647 [mm/s] 0 to 214748.3647 [inch/s] 0 to 2147483.647 [degree/s] 0 to 2147483647 [pulse/s]	Set a command speed for the servo motor in positioning.
Acceleration	0 to 2147483.647 [mm/s <sup>2</sup> ] 0 to 214748.3647 [inch/s <sup>2</sup> ] 0 to 2147483.647 [degree/s <sup>2</sup> ] 0 to 2147483647 [pulse/s <sup>2</sup> ]	Set an acceleration for the servo motor to reach the set speed. (Acceleration time [s] = Servo motor speed/Acceleration)
Acceleration time constant	0 to 20000 [ms]	Set a time period for the servo motor to reach the rated speed.
Deceleration	0 to 2147483.647 [mm/s <sup>2</sup> ] 0 to 214748.3647 [inch/s <sup>2</sup> ] 0 to 2147483.647 [degree/s <sup>2</sup> ] 0 to 2147483647 [pulse/s <sup>2</sup> ]	Set a deceleration for the servo motor to decelerate from the set speed to a stop. (Deceleration time [s] = Servo motor speed/Deceleration)
Deceleration time constant	0 to 20000 [ms]	Set a time period for the servo motor to decelerate from the set speed to a stop.
Dwell	0 to 20000 [ms]	Set a dwell. When the dwell is set, the position command for the next point table will be started after the position command for the selected point table is completed and the set dwell is passed. The dwell is disabled when the auxiliary function is set to 0 or 2. Continuous operation is enabled when the auxiliary function is set to 1, 3, 8, 9, 10, or 11 and the dwell is set to 0.
Auxiliary function	0 to 3, 8 to 11	Set auxiliary function. (1) When using the point table with the absolute position command method 0: Automatic operation for a selected point table is performed. 1: Automatic operation is performed to the next point table. 8: Automatic operation for a point table selected at startup is performed. 9: Automatic operation of the point table No. 1 is performed. (2) When using the point table with the relative position command method 2: Automatic operation for a selected point table is performed. 3: Automatic operation is performed to the next point table. 10: Automatic operation for a point table selected at startup is performed. 11: Automatic operation of the point table No. 1 is performed.
M code	0 to 255	Set a code to be outputted when the positioning is complete.

Notes: 1. Change the unit to mm/inch/degree/pulse with [Pr. PT01].  
2. The speed unit is r/min for the rotary servo motors and mm/s for the linear servo motors.

### Example of setting point table data

Point table example

Point table No.	Target position (position data)	Servo motor speed [r/min]	Acceleration time constant [ms]	Deceleration time constant [ms]	Dwell [ms]	Auxiliary function	M code
1	1000	2000	200	200	0	1	1
2	2000	1600	100	100	0	0	2
:	:	:	:	:	:	:	:
255	3000	3000	100	100	0	2	99

### Operation

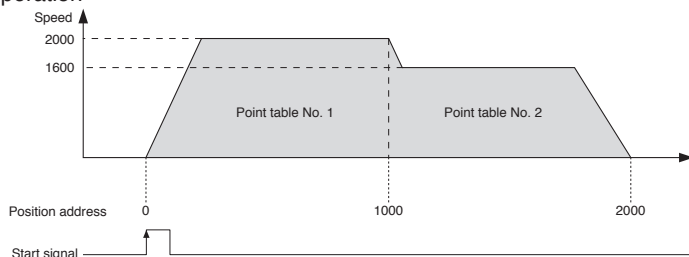

# Servo Amplifiers

## Restrictions

The restrictions on the communication cycle for the functions in the list are as follows.

### Communication cycle

Category	Function	Communication cycle (minimum)
Control mode	Profile position mode (pp)	250 $\mu$ s
	Profile velocity mode (pv)	250 $\mu$ s
	Profile torque mode (tq)	250 $\mu$ s
	Positioning mode (point table method)	250 $\mu$ s

# 4 Rotary Servo Motors

Model Designation.....	4-2
HG-KNS Series	
Specifications.....	4-3
Torque Characteristics.....	4-4
Dimensions.....	4-5
Special Shaft Dimensions.....	4-8
HG-SNS Series	
Specifications.....	4-9
Torque Characteristics.....	4-10
Dimensions.....	4-11
Special Shaft Dimensions.....	4-12
Power Supply Capacity.....	4-13

**HG** HG series

\* Refer to p. 6-32 in this catalog for conversion of units.

\* The characteristics and numerical values without tolerances mentioned in this catalog are representative values.

# Rotary Servo Motors

HG

## Model Designation (Note 1)

●HG-KNS series (low inertia, small capacity)

H G - K N S 1 3 B J

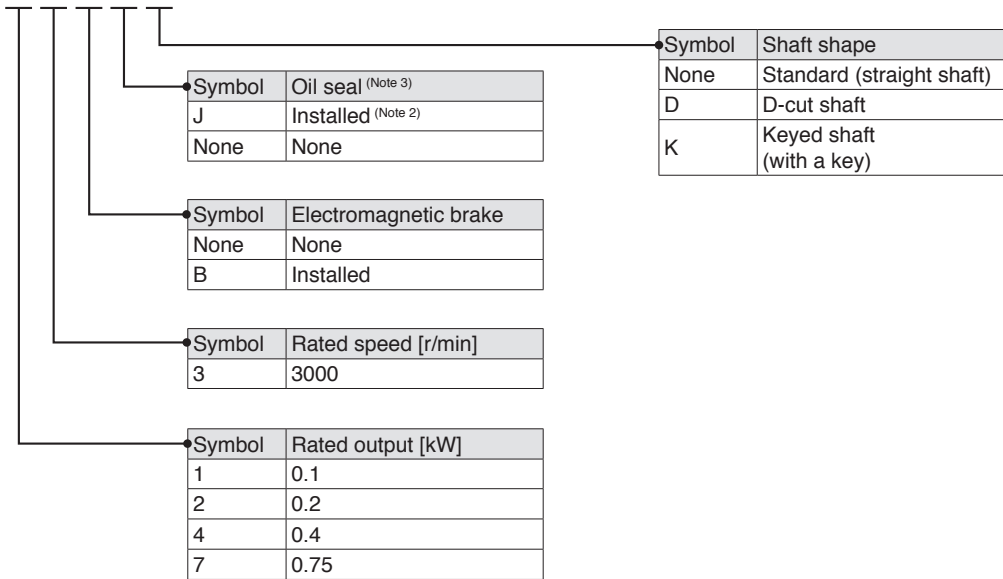

●HG-SNS series (medium inertia, medium capacity)

H G - S N S 5 2 B J

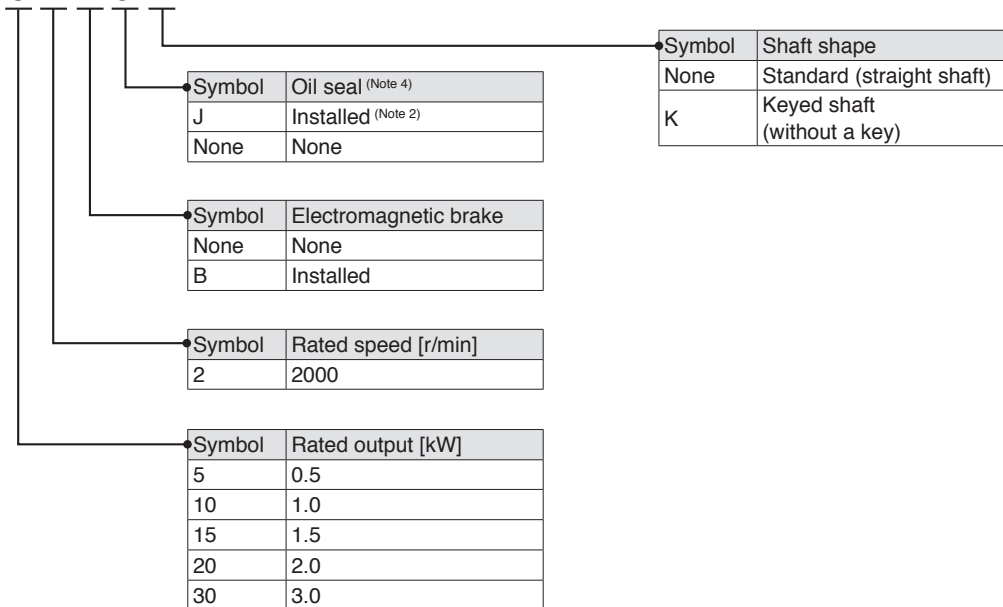

- Notes:
1. This section describes what each symbol in a model name indicates. Some combinations of symbols are not available.
  2. An oil seal is installed as a standard for all servo motors.
  3. The dimensions of this series vary depending on whether or not an oil seal is installed. Refer to the dimensions for details.
  4. The dimensions of this series are the same regardless of whether or not an oil seal is installed.

## HG-KNS Series (Low Inertia, Small capacity) Specifications

**HG**

Flange size		[mm]	40 × 40	60 × 60	80 × 80	
Rotary servo motor model		HG-KNS	13J	23J	43J	73J
Continuous running duty (Note 4)	Rated output	[kW]	0.1	0.2	0.4	0.75
	Rated torque (Note 3)	[N·m]	0.32	0.64	1.3	2.4
Maximum torque		[N·m]	0.95	1.9	3.8	7.2
Rated speed (Note 4)		[r/min]	3000			
Maximum speed (Note 4)		[r/min]	6000			
Power rate at continuous rated torque [kW/s]	Without electromagnetic brake		12.9	18.0	43.2	44.5
	With electromagnetic brake		12.0	16.4	40.8	41.0
Rated current		[A]	0.8	1.3	2.6	4.8
Maximum current		[A]	2.4	3.9	7.8	14
Moment of inertia J [× 10 <sup>-4</sup> kg·m <sup>2</sup> ]	Without electromagnetic brake		0.0783	0.225	0.375	1.28
	With electromagnetic brake		0.0843	0.247	0.397	1.39
Recommended load to motor inertia ratio (Note 1)			15 times or less (Note 6)		15 times or less	
Speed/position detector		Absolute/incremental 22-bit encoder (battery backup type) (Note 5) (resolution: 4,194,304 pulses/rev)				
Type		Permanent magnet synchronous motor				
Oil seal		Installed (Servo motors without an oil seal are available.)				
Electromagnetic brake		None (Servo motors with an electromagnetic brake are available.)				
Thermistor		None				
Insulation class		130 (B)				
Structure		Totally enclosed, natural cooling (IP rating: IP65) (Note 2)				
Vibration resistance *1		[m/s <sup>2</sup> ]	X: 49, Y: 49			
Vibration rank			V10 <sup>-3</sup>			
Permissible load for the shaft *2	L	[mm]	25	30	40	
	Radial	[N]	88	245	392	
	Thrust	[N]	59	98	147	
Mass [kg] (with oil seal)	Without electromagnetic brake		0.57	0.98	1.5	3.0
	With electromagnetic brake		0.77	1.4	1.9	4.0
Mass [kg] (without oil seal)	Without electromagnetic brake		0.54	0.91	1.4	2.8
	With electromagnetic brake		0.74	1.3	1.8	3.8

- Notes: 1. Contact your local sales office if the load to motor inertia ratio exceeds the value in the table.  
 2. The shaft-through portion is excluded. Refer to the asterisk 4 of "Annotations for Rotary Servo Motor Specifications" on p. 4-14 in this catalog for the shaft-through portion.  
 3. When unbalanced torque is generated, such as in a vertical lift machine, keep the unbalanced torque of the machine under 70 % of the servo motor rated torque.  
 4. The continuous running duty and the speed are not guaranteed when the power supply voltage is dropped.  
 5. When configuring an absolute position detection system with a rotary servo motor having a battery backup type absolute position encoder, whether a battery (MR-BAT6V1SET-B) is required depends on the system configuration. In addition, use the battery branch cable (MR-BT6V4CBL03M) when using the battery. Refer to "Battery" in this catalog for information on whether a battery is required, details, and connections of the battery.  
 6. The recommended load to motor inertia ratio is for operating the servo motor at the rated speed. If operating the servo motor at a speed exceeding the rated speed, check with the drive system sizing software Motorizer if a regeneration option is required for the operation.

Refer to "Annotations for Rotary Servo Motor Specifications" on p. 4-14 in this catalog for details about asterisks 1 to 3.

## Electromagnetic Brake Specifications (Note 1)

Model	HG-KNS	13BJ	23BJ	43BJ	73BJ
Type		Spring actuated type safety brake			
Rated voltage		24 V DC (-10 % to 0 %)			
Power consumption [W] at 20 °C		6.3	7.9	10	
Electromagnetic brake static friction torque [N·m]		0.32 or higher	1.3 or higher	2.4 or higher	
Permissible braking work	Per braking	[J]	5.6	22	64
	Per hour	[J]	56	220	640
Electromagnetic brake life (Note 2)	Number of braking times	20000			
	Work per braking	[J]	5.6	22	64

- Notes: 1. The electromagnetic brake is for holding. It cannot be used for deceleration applications.  
 2. Brake gap is not adjustable. Electromagnetic brake life is defined as the time period until readjustment is needed.

Common Specifications

Servo System Controllers

Servo Amplifiers

Rotary Servo Motors

Linear Servo Motors

Options/Peripheral Equipment

LVSM/Wires

Product List

Precautions

Support

# Rotary Servo Motors

HG

## HG-KNS Series Torque Characteristics (Note 1)

— : For 3-phase 200 V AC  
 - - - : For 1-phase 230 V AC

### HG-KNS13J

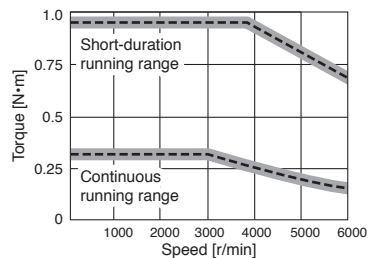

### HG-KNS23J

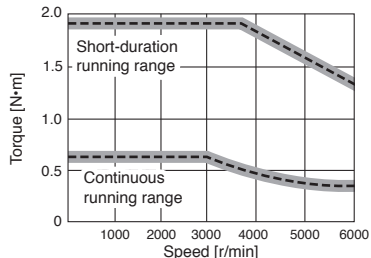

### HG-KNS43J

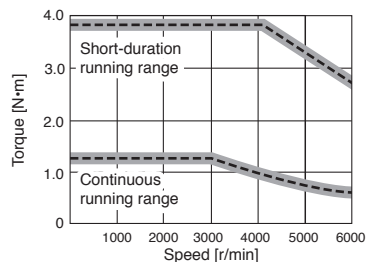

### HG-KNS73J

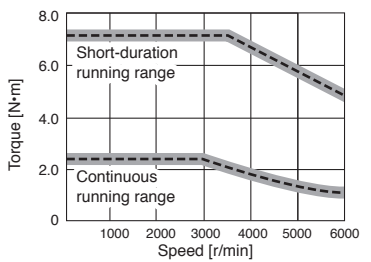

Notes: 1. Torque drops when the power supply voltage is below the specified value.

HG

## HG-KNS Series Dimensions (Note 4, 5)

### HG-KNS13(B)J

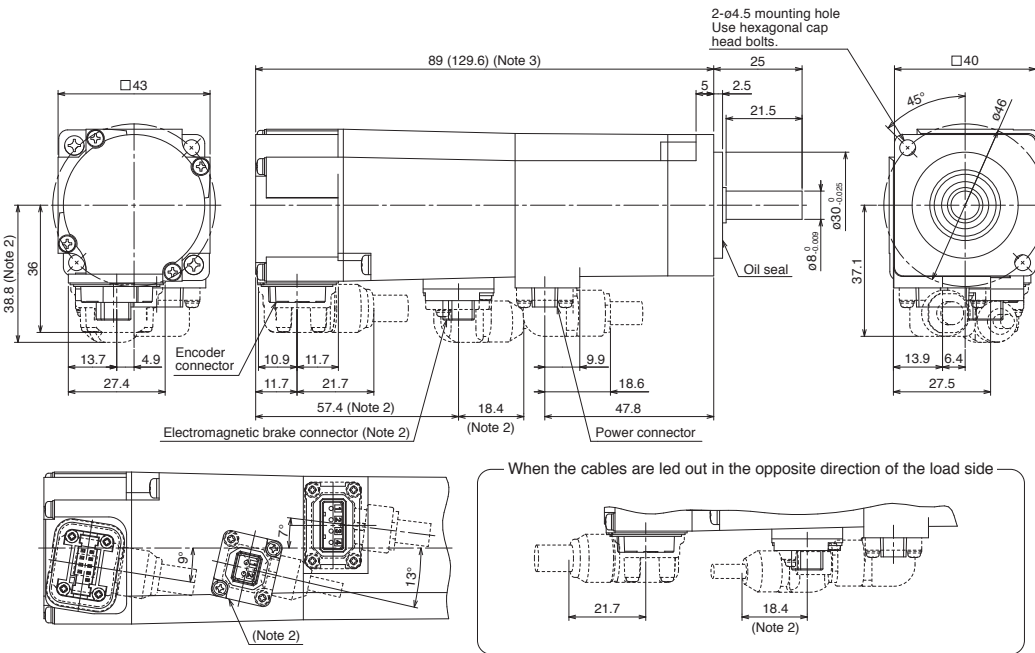

Power connector

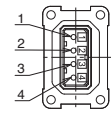

Pin No.	Signal name
1	E
2	U
3	V
4	W

Electromagnetic brake connector (Note 1)

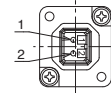

Pin No.	Signal name
1	B1
2	B2

[Unit: mm]

### HG-KNS13(B)

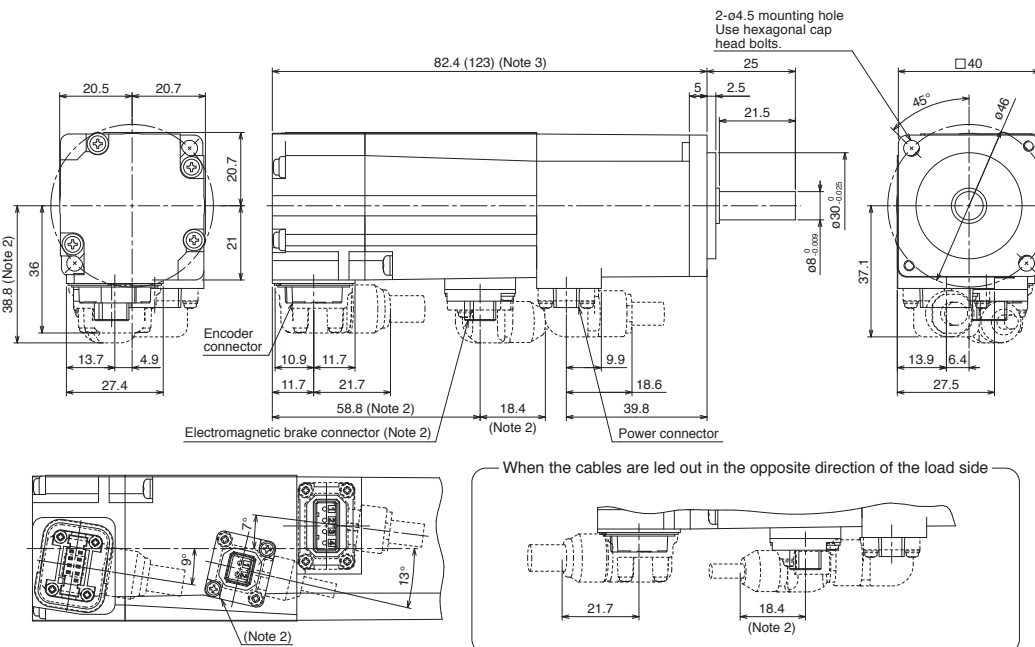

Power connector

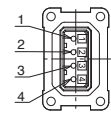

Pin No.	Signal name
1	E
2	U
3	V
4	W

Electromagnetic brake connector (Note 1)

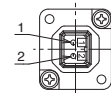

Pin No.	Signal name
1	B1
2	B2

[Unit: mm]

- Notes:
1. The electromagnetic brake terminals do not have polarity.
  2. Only for the models with an electromagnetic brake.
  3. The dimensions in brackets are for the models with an electromagnetic brake.
  4. Use a friction coupling to fasten a load.
  5. The actual dimensions may be up to 3 mm larger than those shown in the drawing because of shifting and variance of parts that occur during the assembly and manufacture of the rotary servo motors. The dimensions and tolerances shown are applicable at a temperature of 20 °C and may vary depending on the ambient temperature. Design the machine to allow for sufficient space.

# Rotary Servo Motors

## HG-KNS Series Dimensions (Note 4, 5)

HG

### HG-KNS23(B)J, HG-KNS43(B)J

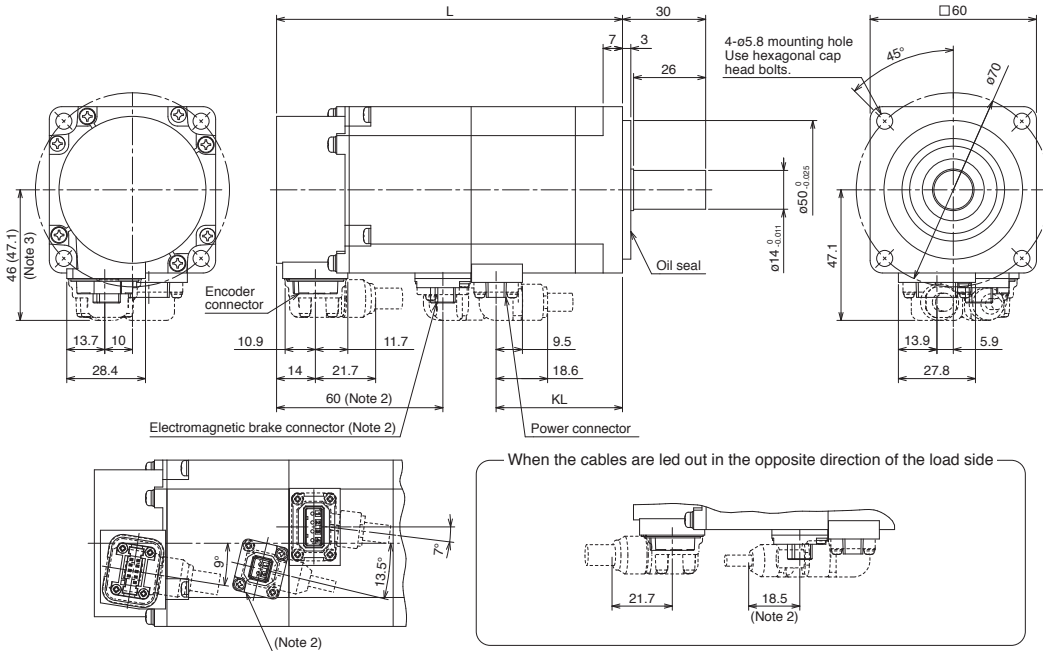

Power connector

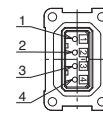

Pin No.	Signal name
1	E
2	U
3	V
4	W

Electromagnetic brake connector (Note 1)

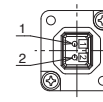

Pin No.	Signal name
1	B1
2	B2

Model	Variable dimensions (Note 3)	
	L	KL
HG-KNS23(B)J	88 (124.8)	45.6
HG-KNS43(B)J	109.7 (146.5)	67.3

[Unit: mm]

### HG-KNS23(B), HG-KNS43(B)

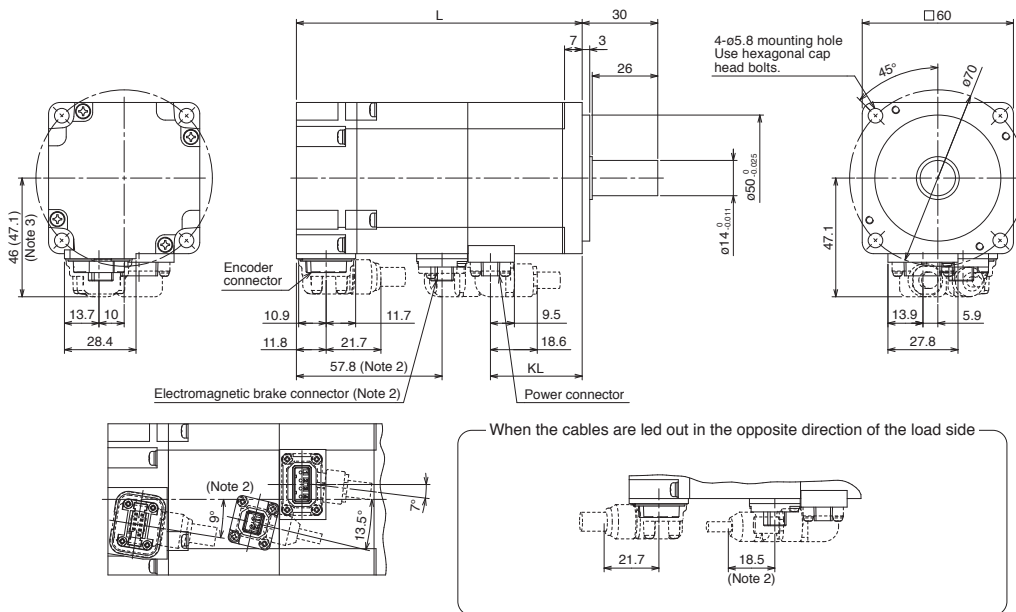

Power connector

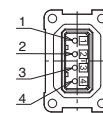

Pin No.	Signal name
1	E
2	U
3	V
4	W

Electromagnetic brake connector (Note 1)

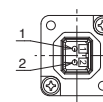

Pin No.	Signal name
1	B1
2	B2

Model	Variable dimensions (Note 3)	
	L	KL
HG-KNS23(B)	76.6 (113.4)	36.4
HG-KNS43(B)	98.3 (135.1)	58.1

[Unit: mm]

- Notes:
1. The electromagnetic brake terminals do not have polarity.
  2. Only for the models with an electromagnetic brake.
  3. The dimensions in brackets are for the models with an electromagnetic brake.
  4. Use a friction coupling to fasten a load.
  5. The actual dimensions may be up to 3 mm larger than those shown in the drawing because of shifting and variance of parts that occur during the assembly and manufacture of the rotary servo motors. The dimensions and tolerances shown are applicable at a temperature of 20 °C and may vary depending on the ambient temperature. Design the machine to allow for sufficient space.



HG

## HG-KNS Series Dimensions (Note 4, 5)

### HG-KNS73(B)J

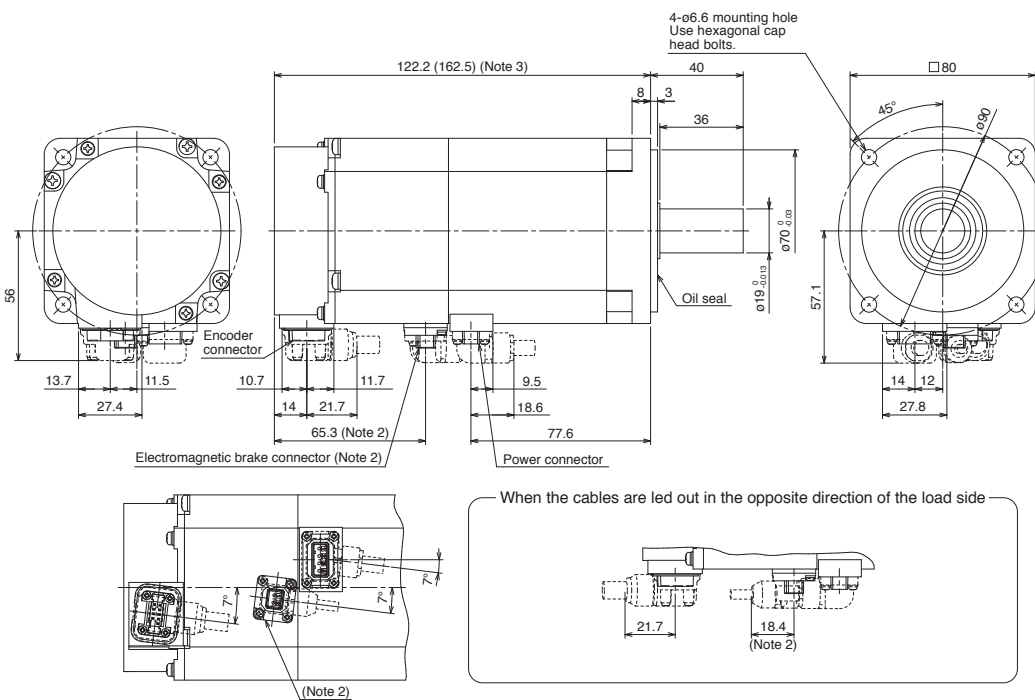

Power connector

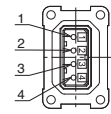

Pin No.	Signal name
1	E
2	U
3	V
4	W

Electromagnetic brake connector (Note 1)

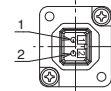

Pin No.	Signal name
1	B1
2	B2

[Unit: mm]

### HG-KNS73(B)

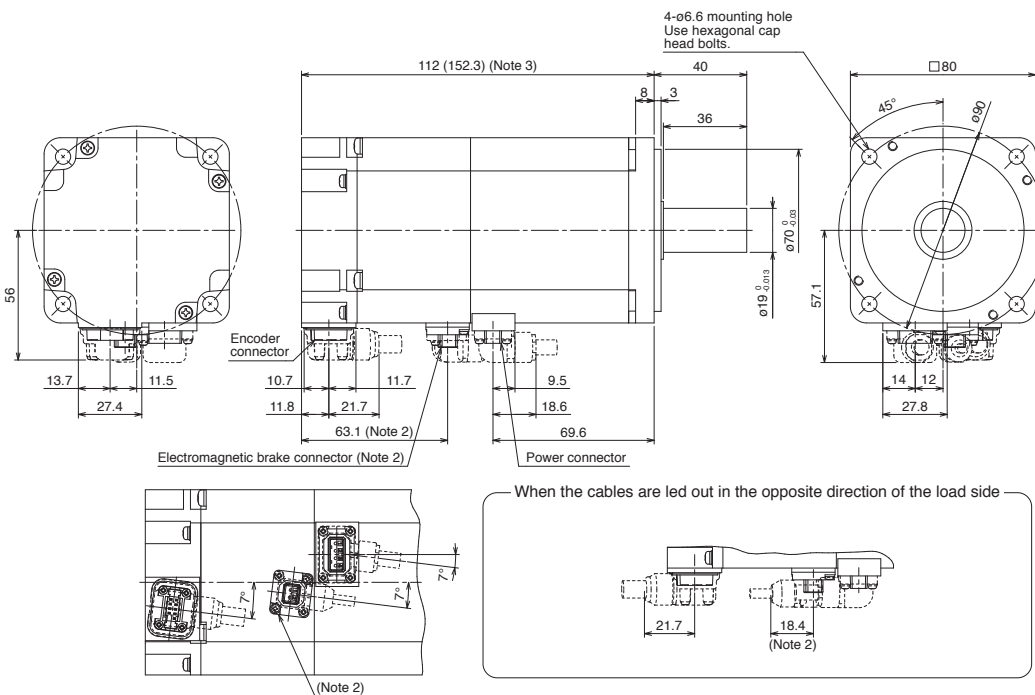

Power connector

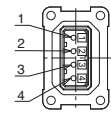

Pin No.	Signal name
1	E
2	U
3	V
4	W

Electromagnetic brake connector (Note 1)

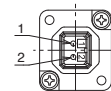

Pin No.	Signal name
1	B1
2	B2

[Unit: mm]

- Notes:
1. The electromagnetic brake terminals do not have polarity.
  2. Only for the models with an electromagnetic brake.
  3. The dimensions in brackets are for the models with an electromagnetic brake.
  4. Use a friction coupling to fasten a load.
  5. The actual dimensions may be up to 3 mm larger than those shown in the drawing because of shifting and variance of parts that occur during the assembly and manufacture of the rotary servo motors. The dimensions and tolerances shown are applicable at a temperature of 20 °C and may vary depending on the ambient temperature. Design the machine to allow for sufficient space.

# Rotary Servo Motors

HG

## HG-KNS Series with Special Shaft Dimensions

Servo motors with the following specifications are also available.

### D: D-cut shaft (Note 1)

Model	Variable dimensions	
	Q1	Q2
HG-KNS13JD	21.5	20.5

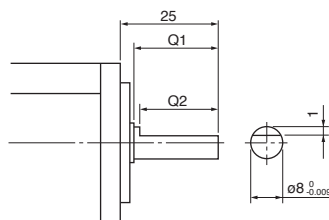

[Unit: mm]

### K: Keyed shaft (with a double round-ended key) (Note 1)

Model	Variable dimensions								
	T	S	R	Q	W	QK	QL	U	Y
HG-KNS23JK HG-KNS43JK	5	14 <sup>0</sup> <sub>-0.011</sub>	30	26	5	20	3	3	M4 Screw depth: 15
HG-KNS73JK	6	19 <sup>0</sup> <sub>-0.013</sub>	40	36	6	25	5	3.5	M5 Screw depth: 20

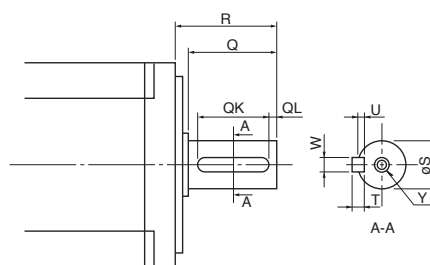

[Unit: mm]

Notes: 1. Do not use a servo motor with a D-cut shaft or a keyed shaft for frequent start/stop applications as this may cause the damage to the shaft.

**HG-SNS Series (Medium Inertia, Medium Capacity) Specifications**

**HG**

Flange size		[mm]	130 × 130			176 × 176	
Rotary servo motor model		HG-SNS	52J	102J	152J	202J	302J
Continuous running duty (Note 4)	Rated output	[kW]	0.5	1.0	1.5	2.0	3.0
	Rated torque (Note 3)	[N·m]	2.39	4.77	7.16	9.55	14.3
Maximum torque		[N·m]	7.16	14.3	21.5	28.6	42.9
Rated speed (Note 4)		[r/min]	2000				
Maximum speed (Note 4)		[r/min]	3000				2500
Power rate at continuous rated torque [kW/s]	Without electromagnetic brake		7.85	19.7	32.1	19.5	26.1
	With electromagnetic brake		6.01	16.5	28.2	16.1	23.3
Rated current		[A]	2.9	5.6	9.4	9.6	11
Maximum current		[A]	9.0	17	29	31	33
Moment of inertia J [× 10 <sup>-4</sup> kg·m <sup>2</sup> ]	Without electromagnetic brake		7.26	11.6	16.0	46.8	78.6
	With electromagnetic brake		9.48	13.8	18.2	56.5	88.2
Recommended load to motor inertia ratio (Note 1)			15 times or less				
Speed/position detector			Absolute/incremental 22-bit encoder (battery backup type) (Note 5) (resolution: 4,194,304 pulses/rev)				
Type			Permanent magnet synchronous motor				
Oil seal			Installed (Servo motors without an oil seal are available.)				
Electromagnetic brake			None (Servo motors with an electromagnetic brake are available.)				
Thermistor			None				
Insulation class			155 (F)				
Structure			Totally enclosed, natural cooling (IP rating: IP67) (Note 2)				
Vibration resistance <sup>1</sup>		[m/s <sup>2</sup> ]	X: 24.5, Y: 24.5			X: 24.5, Y: 49	
Vibration rank			V10 <sup>3</sup>				
Permissible load for the shaft <sup>2</sup>	L	[mm]	55			79	
	Radial	[N]	980			2058	
	Thrust	[N]	490			980	
Mass [kg] (with/without oil seal)	Without electromagnetic brake		4.8	6.2	7.3	11	16
	With electromagnetic brake		6.7	8.2	9.3	17	22

- Notes: 1. Contact your local sales office if the load to motor inertia ratio exceeds the value in the table.  
 2. The shaft-through portion is excluded. Refer to the asterisk 4 of "Annotations for Rotary Servo Motor Specifications" on p. 4-14 in this catalog for the shaft-through portion.  
 3. When unbalanced torque is generated, such as in a vertical lift machine, keep the unbalanced torque of the machine under 70 % of the servo motor rated torque.  
 4. The continuous running duty and the speed are not guaranteed when the power supply voltage is dropped.  
 5. When configuring an absolute position detection system with a rotary servo motor having a battery backup type absolute position encoder, whether a battery (MR-BAT6V1SET-B) is required depends on the system configuration. In addition, use the battery branch cable (MR-BT6V4CBL03M) when using the battery. Refer to "Battery" in this catalog for information on whether a battery is required, details, and connections of the battery.

Refer to "Annotations for Rotary Servo Motor Specifications" on p. 4-14 in this catalog for details about asterisks 1 to 3.

**Electromagnetic Brake Specifications (Note 1)**

Model		HG-SNS	52BJ	102BJ	152BJ	202BJ	302BJ
Type		Spring actuated type safety brake					
Rated voltage		24 V DC (-10 % to 0 %)					
Power consumption		[W] at 20 °C	20	20	20	34	34
Electromagnetic brake static friction torque		[N·m]	8.5 or higher	8.5 or higher	8.5 or higher	44.0 or higher	44.0 or higher
Permissible braking work	Per braking	[J]	400	400	400	4500	4500
	Per hour	[J]	4000	4000	4000	45000	45000
Electromagnetic brake life (Note 2)	Number of braking times		20000	20000	20000	20000	20000
	Work per braking	[J]	200	200	200	1000	1000

- Notes: 1. The electromagnetic brake is for holding. It cannot be used for deceleration applications.  
 2. Brake gap is not adjustable. Electromagnetic brake life is defined as the time period until readjustment is needed.

Common Specifications  
 Servo System Controllers  
 Servo Amplifiers  
 Rotary Servo Motors  
 Linear Servo Motors  
 Options/Peripheral Equipment  
 LV/SWires  
 Product List  
 Precautions  
 Support

# Rotary Servo Motors

## HG-SNS Series Torque Characteristics (Note 1)

HG

— : For 3-phase 200 V AC  
 - - - : For 1-phase 230 V AC

### HG-SNS52J

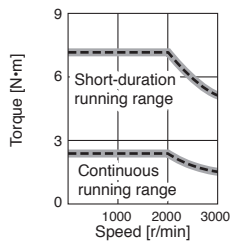

### HG-SNS102J (Note 2)

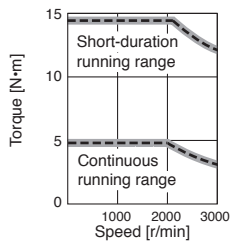

### HG-SNS152J (Note 2)

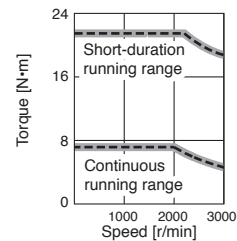

### HG-SNS202J (Note 2)

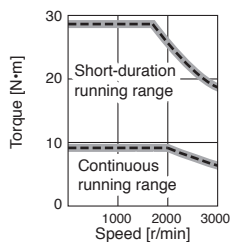

### HG-SNS302J

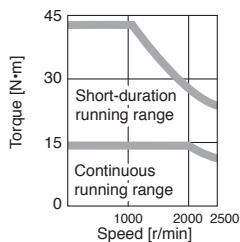

- Notes: 1. Torque drops when the power supply voltage is below the specified value.  
 2. When using a combination of the servo motors of over 750 W and MR-JET-100G\_ or MR-JET-200G\_ with a 1-phase power supply, use the servo amplifiers at 75 % or less of the effective load ratio.

## HG-SNS Series Dimensions (Note 1, 5, 7)

HG-SNS52(B)J, HG-SNS102(B)J, HG-SNS152(B)J

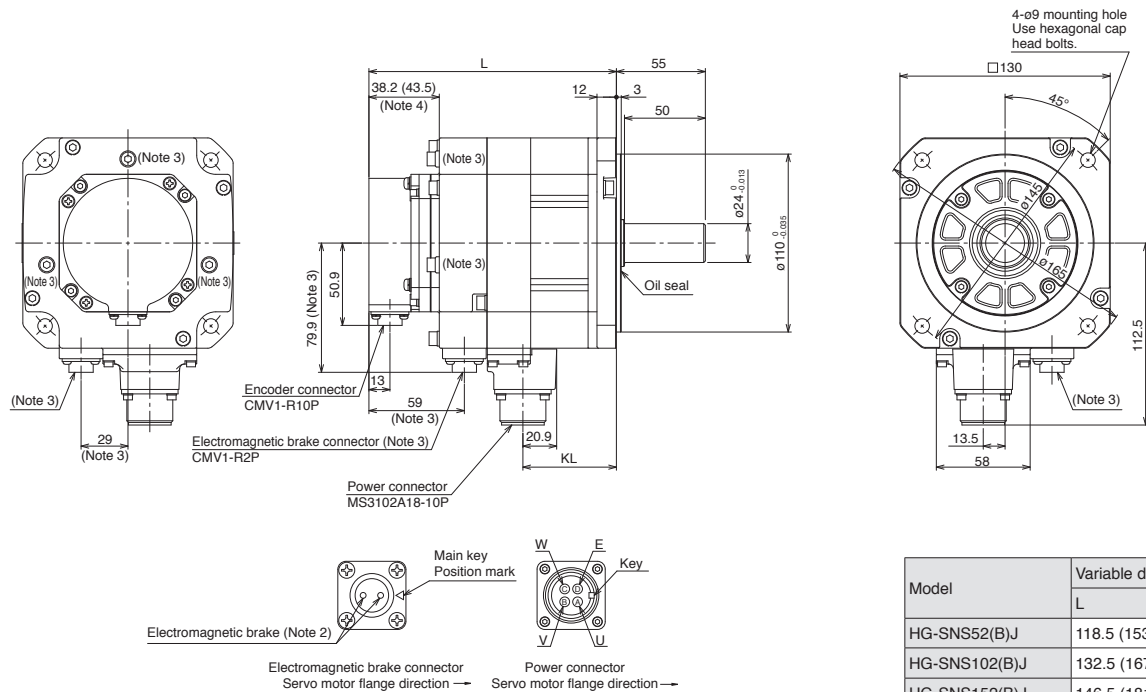

[Unit: mm]

## HG-SNS202(B)J, HG-SNS302(B)J

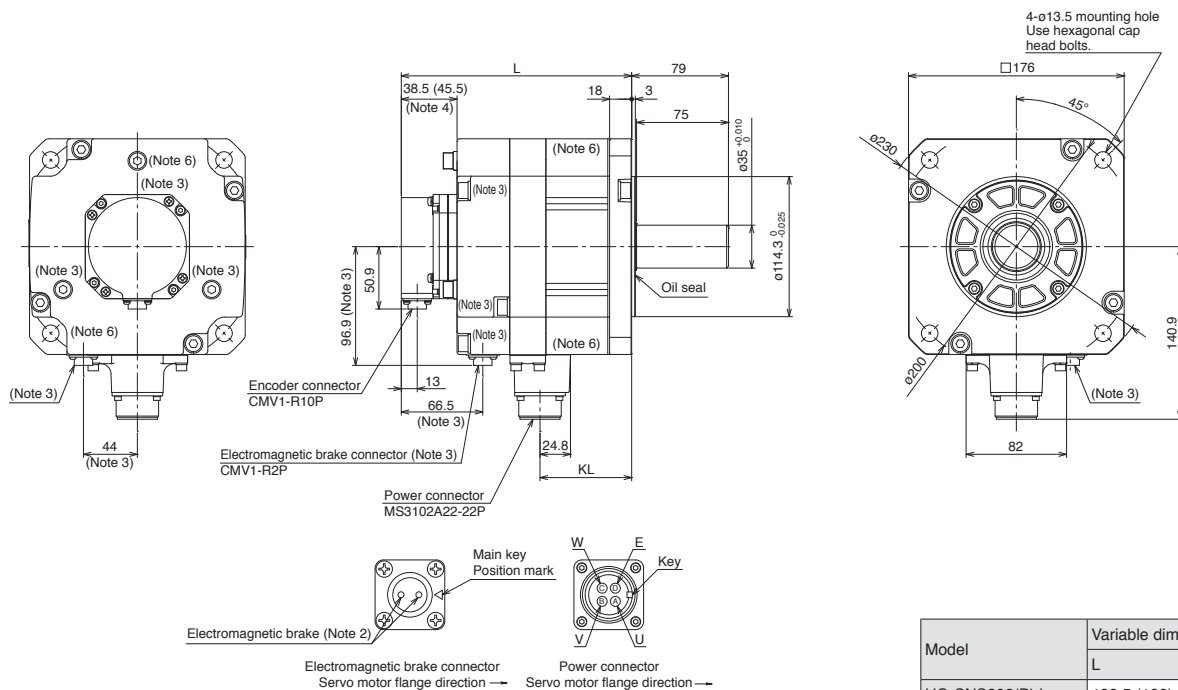

[Unit: mm]

- Notes:
- Dimensions of the HG-SNS series are the same regardless of whether or not an oil seal is installed.
  - The electromagnetic brake terminals do not have polarity.
  - Only for the models with an electromagnetic brake.
  - The dimensions in brackets are for the models with an electromagnetic brake.
  - Use a friction coupling to fasten a load.
  - HG-SNS302(B)J has screw holes (M8) for eyebolts.
  - The actual dimensions may be up to 3 mm larger than those shown in the drawing because of shifting and variance of parts that occur during the assembly and manufacture of the rotary servo motors. The dimensions and tolerances shown are applicable at a temperature of 20 °C and may vary depending on the ambient temperature. Design the machine to allow for sufficient space.

# Rotary Servo Motors

## HG-SNS Series with Special Shaft Dimensions

HG

Servo motors with the following specifications are also available.

K: Keyed shaft (without a key) (Note 1, 2)

Model	Variable dimensions								
	S	R	Q	W	QK	QL	U	r	Y
HG-SNS52JK									
HG-SNS102JK	24 <sup>0</sup> <sub>-0.013</sub>	55	50	8 <sup>0</sup> <sub>-0.036</sub>	36	5	4 <sup>+0.2</sup> <sub>0</sub>	4	M8 Screw depth: 20
HG-SNS152JK									
HG-SNS202JK	35 <sup>+0.010</sup> <sub>0</sub>	79	75	10 <sup>0</sup> <sub>-0.036</sub>	55	5	5 <sup>+0.2</sup> <sub>0</sub>	5	
HG-SNS302JK									

- Notes: 1. Do not use a servo motor with a keyed shaft for frequent start/stop applications as this may cause the damage to the shaft.  
2. The servo motor is supplied without a key. The user needs to prepare a key.

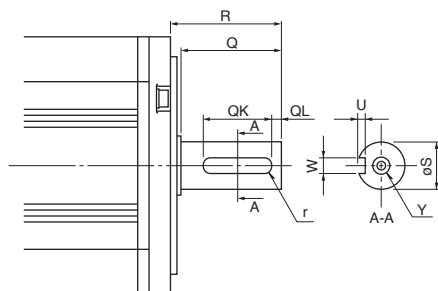

[Unit: mm]

## Power Supply Capacity

Rotary servo motor		Servo amplifier	Power supply capacity [kVA] <small>(Note 1)</small>
HG-KNS	HG-KNS13J	MR-JET-10G_	0.3
	HG-KNS23J	MR-JET-20G_	0.5
	HG-KNS43J	MR-JET-40G_	0.9
	HG-KNS73J	MR-JET-70G_	1.3
HG-SNS	HG-SNS52J	MR-JET-70G_	1.0
	HG-SNS102J	MR-JET-100G_	1.7
	HG-SNS152J	MR-JET-200G_	2.5
	HG-SNS202J	MR-JET-200G_	3.5
	HG-SNS302J	MR-JET-300G_	4.8

Notes: 1. The power supply capacity varies depending on the power supply impedance.

## Annotations for Rotary Servo Motor Specifications

- \*1. The vibration direction is shown in the diagram below. The numerical value indicates the maximum value of the component (commonly the bracket in the opposite direction of the load side).  
Fretting tends to occur on the bearing when the servo motor stops. Thus, maintain vibration level at approximately one-half of the allowable value.

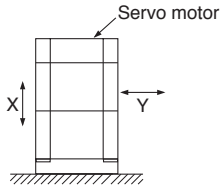

- \*2. Refer to the diagram below for the permissible load for the shaft. Ensure that loads applied on the shaft do not exceed the values specified in the table. The values in the table are applicable when each load is applied singly.

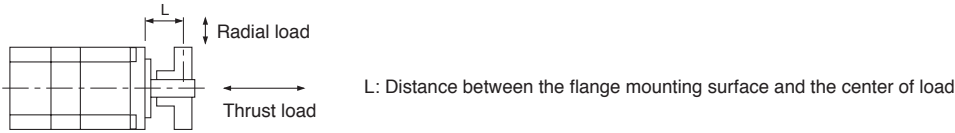

- \*3. V10 indicates that the amplitude of the servo motor itself is  $10\ \mu\text{m}$  or less. The following shows mounting orientation and measuring position of the servo motor during the measurement:

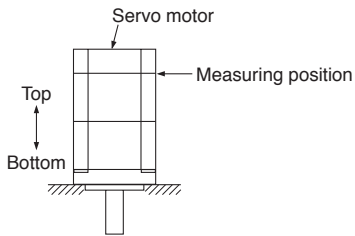

- \*4. Refer to the diagram below for the shaft-through portion.

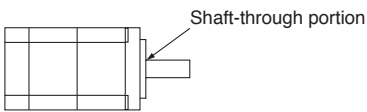



# 5

## Linear Servo Motors

Model Designation.....	5-2
Specifications	
LM-H3 series.....	5-6
LM-AJ series.....	5-8
LM-AU series.....	5-10
Power Supply Capacity.....	5-12
Dimensions	
LM-H3 series.....	5-14
LM-AJ series.....	5-16
LM-AU series.....	5-20
List of Linear Encoders.....	5-25
Determining the Number of the Secondary-Side (Magnet) Blocks.....	5-27

\* Refer to p. 6-32 in this catalog for conversion of units.

\* The characteristics and numerical values without tolerances mentioned in this catalog are representative values.

# Linear Servo Motors

## Model Designation (Note 1)

●LM-H3 series

LM - H 3 P 2 A - 0 7 P - (Primary side: coil)

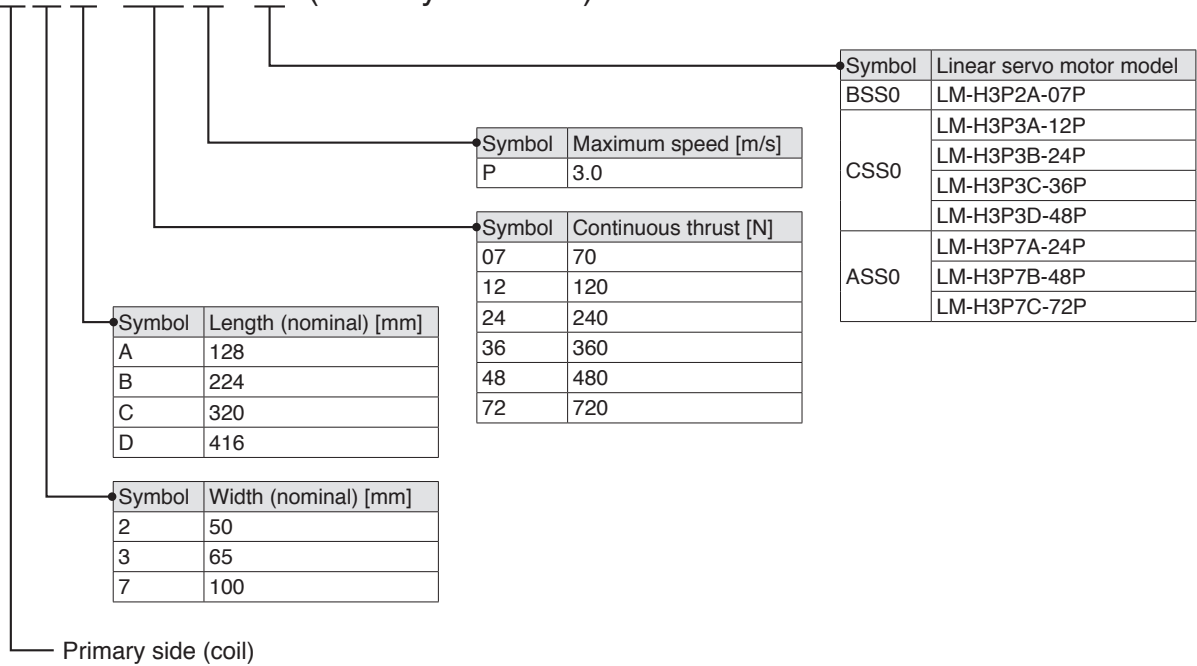

LM - H 3 S 2 0 - 2 8 8 - (Secondary side: magnet)

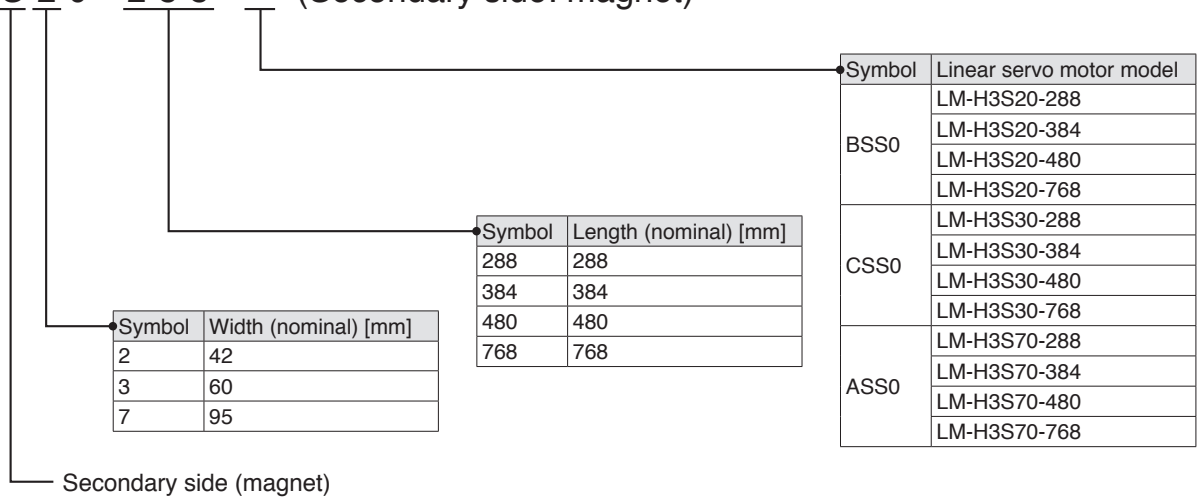

Notes: 1. This section describes what each symbol in a model name indicates. Some combinations of symbols are not available.

**Model Designation** (Note 1)

● LM-AJ series

LM - AJP1B - 07K - (Primary side: coil)

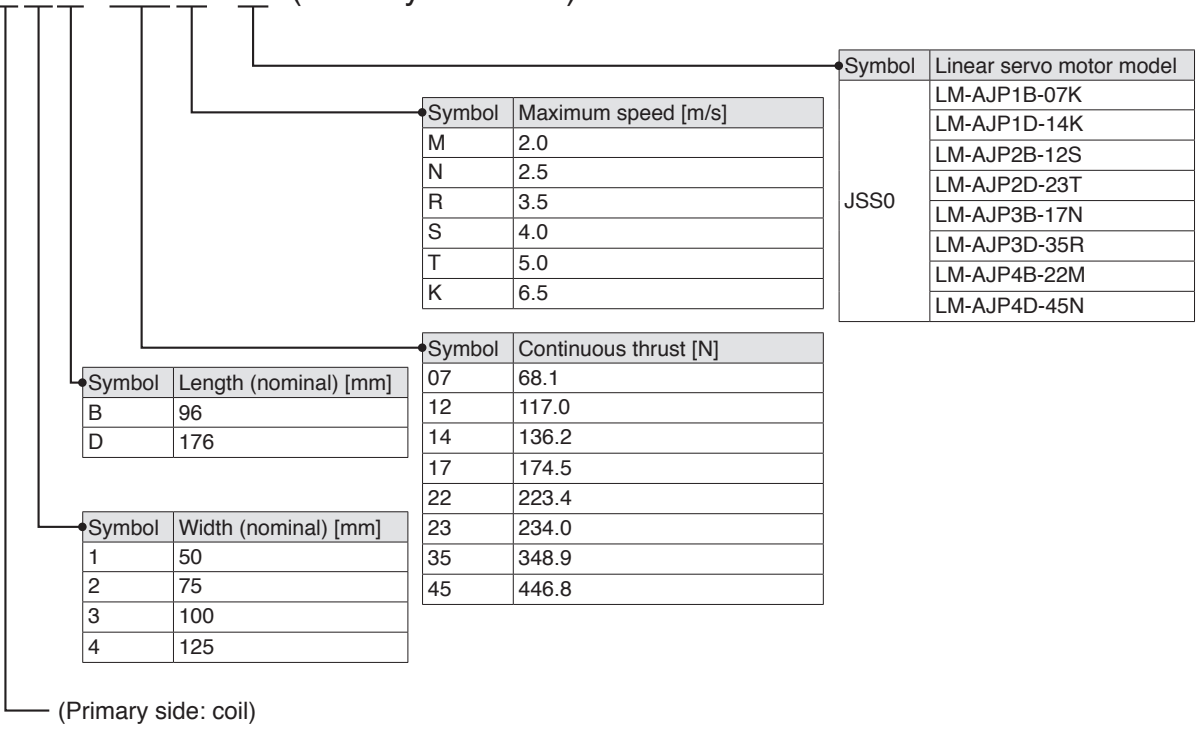

LM - AJS10 - 080 - (Secondary side: magnet)

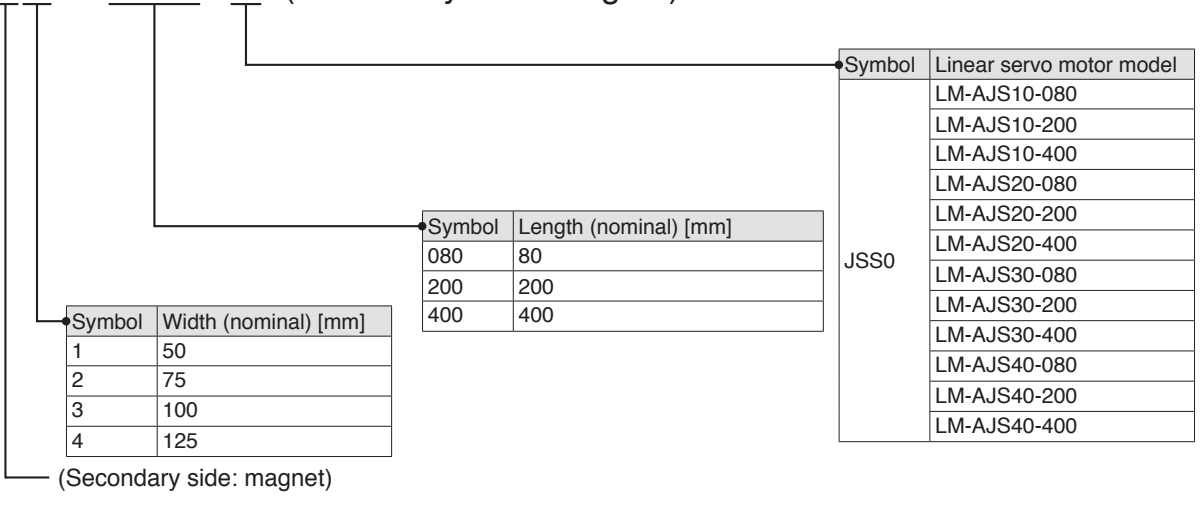

Notes: 1. This section describes what each symbol in a model name indicates. Some combinations of symbols are not available.

# Linear Servo Motors

## Model Designation (Note 1)

● LM-AU series

LM - A U P 3 A - 0 3 V - (Primary side: coil)

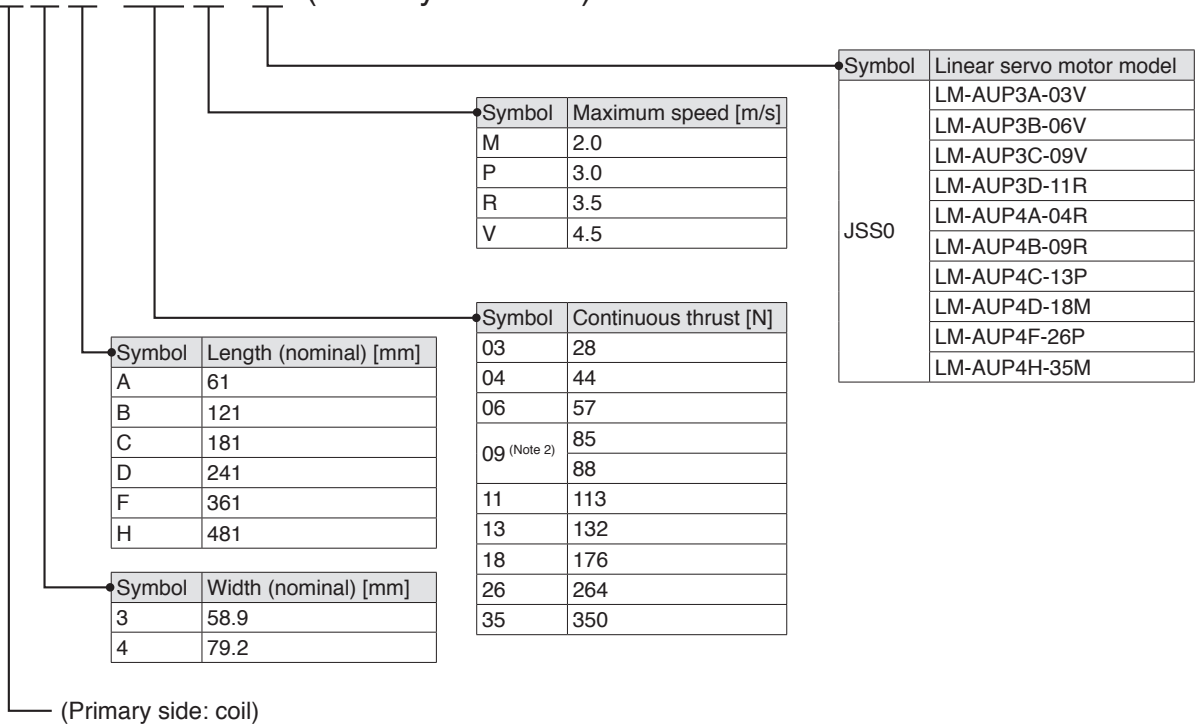

LM - A U S 3 0 - 1 2 0 - (Secondary side: magnet)

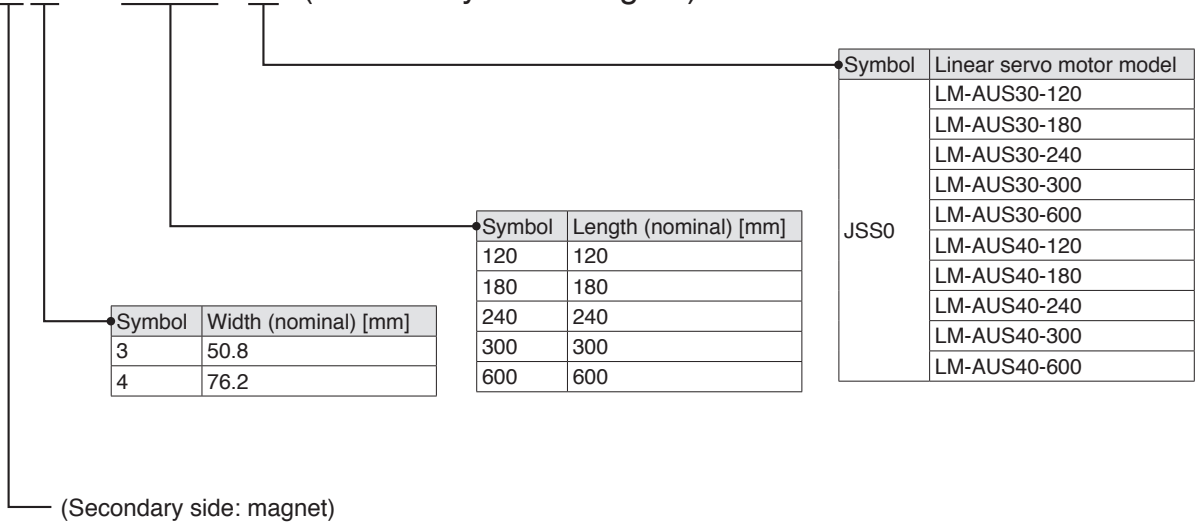

Notes: 1. This section describes what each symbol in a model name indicates. Some combinations of symbols are not available.  
 2. The continuous thrust for LM-AUP3C-09V-JSS0 is 85 N.  
 The continuous thrust for LM-AUP4B-09R-JSS0 is 88 N.

MEMO

Common Specifications

Servo System Controllers

Servo Amplifiers

Rotary Servo Motors

**Linear Servo Motors**

Options/Peripheral Equipment

LV/SWires

Product List

Precautions

Support

# Linear Servo Motors

## LM-H3 Series Specifications

Linear servo motor model Primary side (coil)	LM-H3	P2A-07P-BSS0	P3A-12P-CSS0	P3B-24P-CSS0	P3C-36P-CSS0	P3D-48P-CSS0	P7A-24P-ASS0	P7B-48P-ASS0	P7C-72P-ASS0	
Linear servo motor model Secondary side (magnet)	LM-H3	S20-288-BSS0 S20-384-BSS0 S20-480-BSS0 S20-768-BSS0	S30-288-CSS0 S30-384-CSS0 S30-480-CSS0 S30-768-CSS0				S70-288-ASS0 S70-384-ASS0 S70-480-ASS0 S70-768-ASS0			
Cooling method		Natural cooling								
Thrust	Continuous <sup>(Note 2)</sup>	[N]	70	120	240	360	480	240	480	720
	Maximum	[N]	175	300	600	900	1200	600	1200	1800
Maximum speed <sup>(Note 1)</sup>		[m/s]	3.0							
Magnetic attraction force		[N]	630	1100	2200	3300	4400	2200	4400	6600
Rated current		[A]	1.8	1.7	3.4	5.1	6.8	3.4	6.8	10.2
Maximum current		[A]	5.8	5.0	9.9	14.9	19.8	9.6	19.1	28.6
Recommended load to motor mass ratio <sup>(Note 3)</sup>			35 times or less							
Type			Permanent magnet synchronous motor							
Thermistor			Built-in							
Insulation class			155 (F)							
Structure			Open (IP rating: IP00)							
Vibration resistance		[m/s <sup>2</sup> ]	49							
Mass	Primary side (coil)	[kg]	0.9	1.3	2.3	3.3	4.3	2.2	3.9	5.6
	Secondary side (magnet)	[kg]	288 mm/pc: 0.7	288 mm/pc: 1.0			288 mm/pc: 2.8			
			384 mm/pc: 0.9	384 mm/pc: 1.4			384 mm/pc: 3.7			
			480 mm/pc: 1.1	480 mm/pc: 1.7			480 mm/pc: 4.7			
		768 mm/pc: 1.8	768 mm/pc: 2.7			768 mm/pc: 7.4				

- Notes: 1. The maximum speed of the linear servo motor or the rated speed of the linear encoder, whichever is smaller, is the upper limit of the linear servo motor speed.  
 2. Use the linear servo motor at 70 % or less of the effective load ratio when it is in the servo lock state or in a small reciprocating motion.  
 3. This is the ratio of the load to the linear servo motor primary side mass. Contact your local sales office if the load to motor mass ratio exceeds the value in the table.

LM-H3 Series Thrust Characteristics

LM-H3P2A-07P-BSS0 (Note 1, 2, 3)

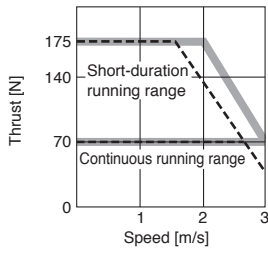

LM-H3P3A-12P-CSS0 (Note 1, 2, 3)

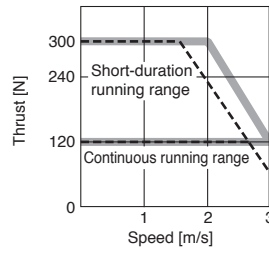

LM-H3P3B-24P-CSS0 (Note 1, 2, 3)

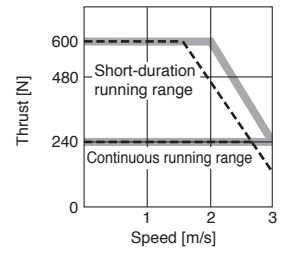

LM-H3P3C-36P-CSS0 (Note 1, 2, 3)

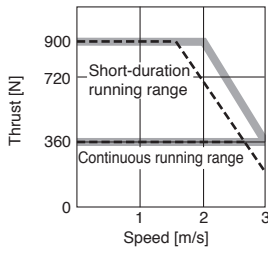

LM-H3P3D-48P-CSS0 (Note 1, 2, 3)

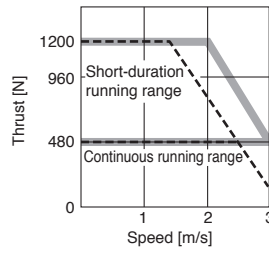

LM-H3P7A-24P-ASS0 (Note 1, 2, 3)

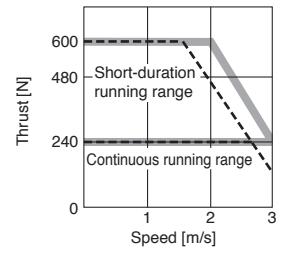

LM-H3P7B-48P-ASS0 (Note 1, 2, 3)

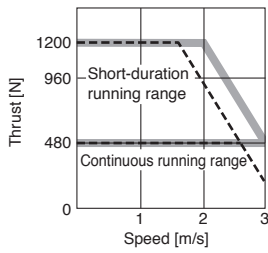

LM-H3P7C-72P-ASS0 (Note 1, 2, 3)

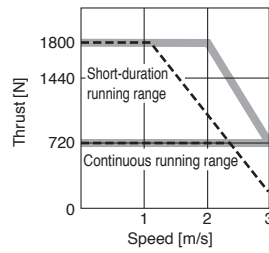

- Notes: 1. — : For 3-phase 200 V AC.  
 2. - - - : For 1-phase 200 V AC.  
 3. Thrust drops when the power supply voltage is below the specified value.

- Common Specifications
- Servo System Controllers
- Servo Amplifiers
- Rotary Servo Motors
- Linear Servo Motors
- Options/Peripheral Equipment
- LV/S/Wires
- Product List
- Precautions
- Support

# Linear Servo Motors

## LM-AJ Series Specifications

Linear servo motor model Primary side (coil)	LM-AJ	P1B- 07K-JSS0	P1D- 14K-JSS0	P2B- 12S-JSS0	P2D- 23T-JSS0	P3B- 17N-JSS0	P3D- 35R-JSS0	P4B- 22M-JSS0	P4D- 45N-JSS0	
Linear servo motor model Secondary side (magnet)	LM-AJ	S10-080-JSS0 S10-200-JSS0 S10-400-JSS0		S20-080-JSS0 S20-200-JSS0 S20-400-JSS0		S30-080-JSS0 S30-200-JSS0 S30-400-JSS0		S40-080-JSS0 S40-200-JSS0 S40-400-JSS0		
Cooling method	Natural cooling									
Thrust	Continuous <sup>(Note 2)</sup>	[N]	68.1	136.2	117.0	234.0	174.5	348.9	223.4	446.8
	Maximum	[N]	214.7	429.4	369.0	738.1	550.2	1100.4	704.5	1409.1
Maximum speed <sup>(Note 1)</sup>	[m/s]	6.5		4.0	5.0	2.5	3.5	2.0	2.5	
Magnetic attraction force	[N]	378.8	757.6	651.1	1302.1	970.7	1941.4	1242.9	2485.9	
Rated current	[A]	2.3	4.6	2.3	4.6	2.3	4.6	2.3	4.6	
Maximum current	[A]	9.0	18.0	9.0	18.0	9.0	18.0	9.0	18.0	
Recommended load to motor mass ratio <sup>(Note 3)</sup>	10 times or less   25 times or less   20 times or less   25 times or less   30 times or less									
Type	Permanent magnet synchronous motor									
Thermistor	None									
Thermal protector	Built-in									
Insulation class	105 (A)									
Structure	Open (IP rating: IP00)									
Vibration resistance	[m/s <sup>2</sup> ]	49								
Mass	Primary side (coil)	[kg]	0.6	1.1	0.9	1.7	1.2	2.3	1.5	2.9
	Secondary side (magnet)	[kg]	80 mm/pc: 0.26 200 mm/pc: 0.65 400 mm/pc: 1.30		80 mm/pc: 0.40 200 mm/pc: 1.00 400 mm/pc: 2.00		80 mm/pc: 0.56 200 mm/pc: 1.40 400 mm/pc: 2.80		80 mm/pc: 0.70 200 mm/pc: 1.70 400 mm/pc: 3.50	

- Notes: 1. The maximum speed of the linear servo motor or the rated speed of the linear encoder, whichever is smaller, is the upper limit of the linear servo motor speed.  
2. Use the linear servo motor at 70 % or less of the effective load ratio when it is in the servo lock state or in a small reciprocating motion.  
3. This is the ratio of the load to the linear servo motor primary side mass. Contact your local sales office if the load to motor mass ratio exceeds the value in the table.



LM-AJ Series Thrust Characteristics

LM-AJP1B-07K-JSS0 (Note 1, 2, 3)

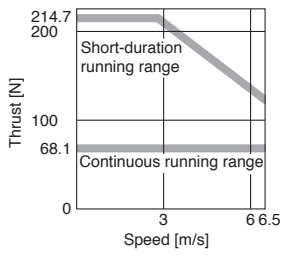

LM-AJP1D-14K-JSS0 (Note 1, 2, 3)

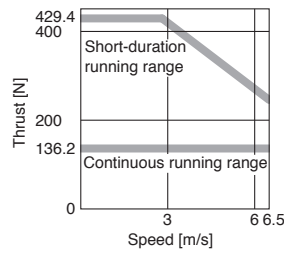

LM-AJP2B-12S-JSS0 (Note 1, 2, 3)

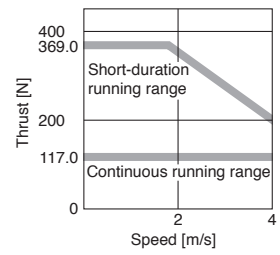

LM-AJP2D-23T-JSS0 (Note 1, 2, 3)

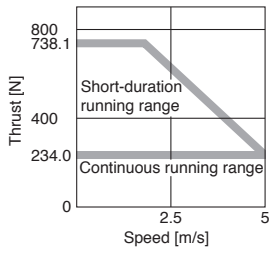

LM-AJP3B-17N-JSS0 (Note 1, 2, 3)

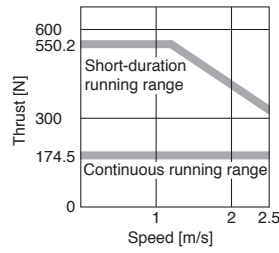

LM-AJP3D-35R-JSS0 (Note 1, 2, 3)

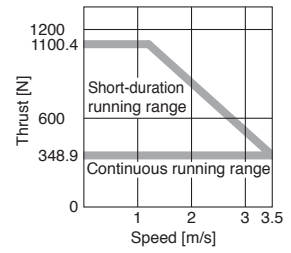

LM-AJP4B-22M-JSS0 (Note 1, 2, 3)

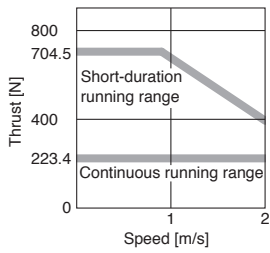

LM-AJP4D-45N-JSS0 (Note 1, 2, 3)

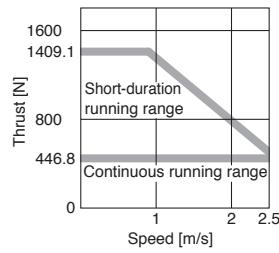

- Notes: 1. : For 3-phase 200 V AC.  
 2. Contact your local sales office for the thrust characteristics for 1-phase 200 V AC.  
 3. Thrust drops when the power supply voltage is below the specified value.

- Common Specifications
- Servo System Controllers
- Servo Amplifiers
- Rotary Servo Motors
- Linear Servo Motors
- Options/Peripheral Equipment
- LV/S/Wires
- Product List
- Precautions
- Support

# Linear Servo Motors

## LM-AU Series Specifications

Linear servo motor model Primary side (coil)	LM-AU	P3A-03V-JSS0	P3B-06V-JSS0	P3C-09V-JSS0	P3D-11R-JSS0	
Linear servo motor model Secondary side (magnet)	LM-AU	S30-120-JSS0 S30-180-JSS0 S30-240-JSS0 S30-300-JSS0 S30-600-JSS0				
Cooling method	Natural cooling					
Thrust	Continuous <sup>(Note 2)</sup>	[N]	28	57	85	113
	Maximum	[N]	122	274	411	549
Maximum speed <sup>(Note 1)</sup>	[m/s]	4.5			3.5	
Magnetic attraction force	[N]	0				
Rated current	[A]	1.8				
Maximum current	[A]	9.2				
Recommended load to motor mass ratio <sup>(Note 3)</sup>	35 times or less			25 times or less	20 times or less	
Type	Permanent magnet synchronous motor					
Thermistor	None					
Thermal protector	Built-in					
Insulation class	105 (A)					
Structure	Open (IP rating: IP00)					
Vibration resistance	[m/s <sup>2</sup> ]	49				
Mass	Primary side (coil)	[kg]	0.22	0.45	0.68	0.91
	Secondary side (magnet)	[kg]	(120 mm/pc) 1.0 (180 mm/pc) 1.5 (240 mm/pc) 2.0 (300 mm/pc) 2.5 (600 mm/pc) 5.0			

Linear servo motor model Primary side (coil)	LM-AU	P4A-04R-JSS0	P4B-09R-JSS0	P4C-13P-JSS0	P4D-18M-JSS0	P4F-26P-JSS0	P4H-35M-JSS0	
Linear servo motor model Secondary side (magnet)	LM-AU	S40-120-JSS0 S40-180-JSS0 S40-240-JSS0 S40-300-JSS0 S40-600-JSS0						
Cooling method	Natural cooling							
Thrust	Continuous <sup>(Note 2)</sup>	[N]	44	88	132	176	264	350
	Maximum	[N]	280	561	842	970	1684	1764
Maximum speed <sup>(Note 1)</sup>	[m/s]	3.5	3.0		2.0	3.0	2.0	
Magnetic attraction force	[N]	0						
Rated current	[A]	1.9				3.7		
Maximum current	[A]	13.0				26.0		
Recommended load to motor mass ratio <sup>(Note 3)</sup>	35 times or less							
Type	Permanent magnet synchronous motor							
Thermistor	None							
Thermal protector	Built-in							
Insulation class	105 (A)							
Structure	Open (IP rating: IP00)							
Vibration resistance	[m/s <sup>2</sup> ]	49						
Mass	Primary side (coil)	[kg]	0.28	0.56	0.89	1.2	1.8	2.4
	Secondary side (magnet)	[kg]	(120 mm/pc) 1.8 (180 mm/pc) 2.7 (240 mm/pc) 3.6 (300 mm/pc) 4.5 (600 mm/pc) 8.9					

- Notes: 1. The maximum speed of the linear servo motor or the rated speed of the linear encoder, whichever is smaller, is the upper limit of the linear servo motor speed.  
2. Use the linear servo motor at 70 % or less of the effective load ratio when it is in the servo lock state or in a small reciprocating motion.  
3. This is the ratio of the load to the linear servo motor primary side mass. Contact your local sales office if the load to motor mass ratio exceeds the value in the table.

LM-AU Series Thrust Characteristics

LM-AUP3A-03V-JSS0 (Note 1, 2, 3)

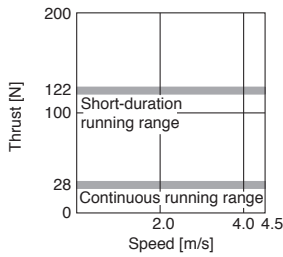

LM-AUP3B-06V-JSS0 (Note 1, 2, 3)

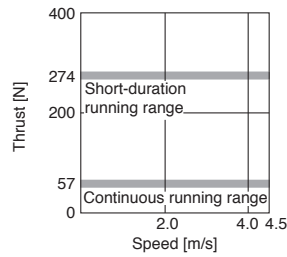

LM-AUP3C-09V-JSS0 (Note 1, 2, 3)

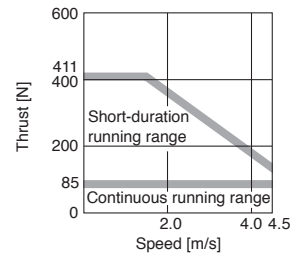

LM-AUP3D-11R-JSS0 (Note 1, 2, 3)

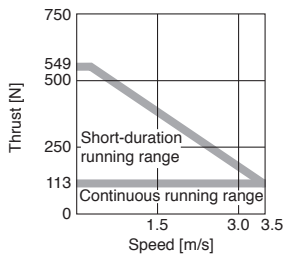

LM-AUP4A-04R-JSS0 (Note 1, 2, 3)

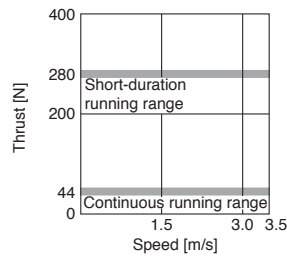

LM-AUP4B-09R-JSS0 (Note 1, 2, 3)

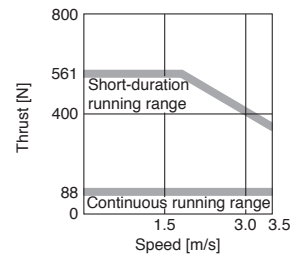

LM-AUP4C-13P-JSS0 (Note 1, 2, 3)

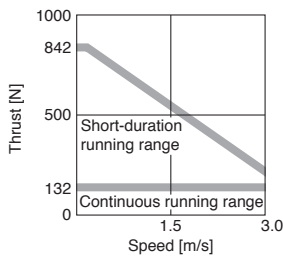

LM-AUP4D-18M-JSS0 (Note 1, 2, 3)

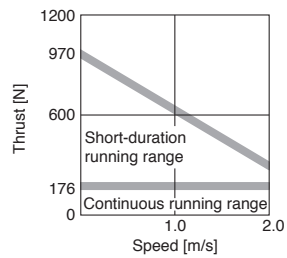

LM-AUP4F-26P-JSS0 (Note 1, 2, 3)

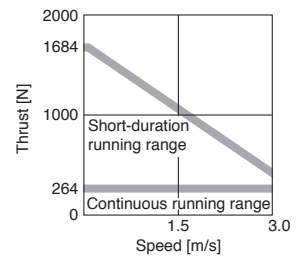

LM-AUP4H-35M-JSS0 (Note 1, 2, 3)

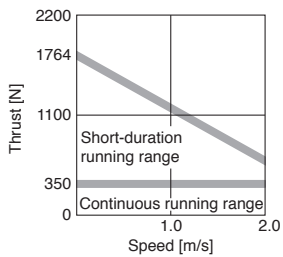

- Notes: 1. : For 3-phase 200 V AC.  
 2. Contact your local sales office for the thrust characteristics for 1-phase 200 V AC.  
 3. Thrust drops when the power supply voltage is below the specified value.

- Common Specifications
- Servo System Controllers
- Servo Amplifiers
- Rotary Servo Motors
- Linear Servo Motors
- Options/Peripheral Equipment
- LV/SWires
- Product List
- Precautions
- Support

# Linear Servo Motors

## Power Supply Capacity

Linear servo motor (primary side)		Servo amplifier	Power supply capacity [kVA] <sup>(Note 1)</sup>
LM-H3 series	LM-H3P2A-07P-BSS0	MR-JET-40G_	0.9
	LM-H3P3A-12P-CSS0		
	LM-H3P3B-24P-CSS0	MR-JET-70G_	1.3
	LM-H3P3C-36P-CSS0	MR-JET-70G_	1.9
	LM-H3P3D-48P-CSS0	MR-JET-200G_	3.5
	LM-H3P7A-24P-ASS0	MR-JET-70G_	1.3
	LM-H3P7B-48P-ASS0	MR-JET-200G_	3.5
LM-H3P7C-72P-ASS0	MR-JET-200G_	3.8	
LM-AJ series	LM-AJP1B-07K-JSS0	MR-JET-40G_	0.9
	LM-AJP1D-14K-JSS0	MR-JET-70G_	1.3
	LM-AJP2B-12S-JSS0	MR-JET-40G_	0.9
	LM-AJP2D-23T-JSS0	MR-JET-70G_	1.3
	LM-AJP3B-17N-JSS0	MR-JET-40G_	0.9
	LM-AJP3D-35R-JSS0	MR-JET-70G_	1.3
	LM-AJP4B-22M-JSS0	MR-JET-40G_	0.9
LM-AJP4D-45N-JSS0	MR-JET-70G_	1.3	
LM-AU series	LM-AUP3A-03V-JSS0	MR-JET-40G_	0.9
	LM-AUP3B-06V-JSS0	MR-JET-40G_	0.9
	LM-AUP3C-09V-JSS0	MR-JET-40G_	0.9
	LM-AUP3D-11R-JSS0	MR-JET-40G_	1.2
	LM-AUP4A-04R-JSS0	MR-JET-70G_	1.3
	LM-AUP4B-09R-JSS0	MR-JET-70G_	1.3
	LM-AUP4C-13P-JSS0	MR-JET-70G_	1.3
	LM-AUP4D-18M-JSS0	MR-JET-70G_	1.3
	LM-AUP4F-26P-JSS0	MR-JET-200G_	3.5
LM-AUP4H-35M-JSS0	MR-JET-200G_	3.5	

Notes: 1. The power supply capacity varies depending on the power supply impedance.

MEMO

Common Specifications

Servo System Controllers

Servo Amplifiers

Rotary Servo Motors

**Linear Servo Motors**

Options/Peripheral Equipment

LV/SWires

Product List

Precautions

Support



**LM-H3 Series Secondary Side (Magnet) Dimensions**

- LM-H3S20-288-BSS0
- LM-H3S20-384-BSS0
- LM-H3S20-480-BSS0
- LM-H3S20-768-BSS0

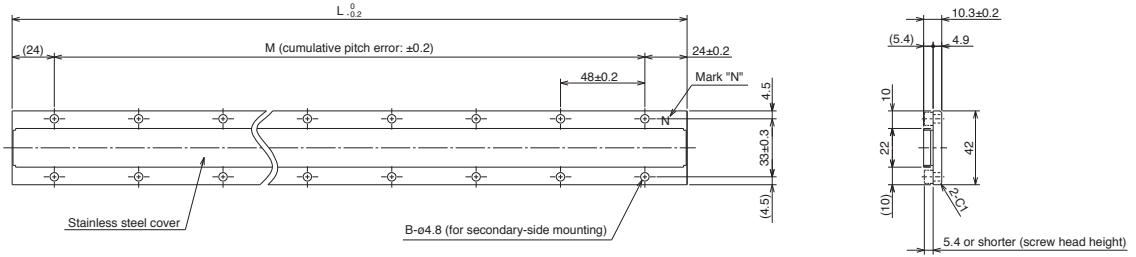

Model	Variable dimensions		
	L	M	B
LM-H3S20-288-BSS0	288	$5 \times 48 = 240$	$2 \times 6$
LM-H3S20-384-BSS0	384	$7 \times 48 = 336$	$2 \times 8$
LM-H3S20-480-BSS0	480	$9 \times 48 = 432$	$2 \times 10$
LM-H3S20-768-BSS0	768	$15 \times 48 = 720$	$2 \times 16$

[Unit: mm]

- LM-H3S30-288-CSS0
- LM-H3S30-384-CSS0
- LM-H3S30-480-CSS0
- LM-H3S30-768-CSS0

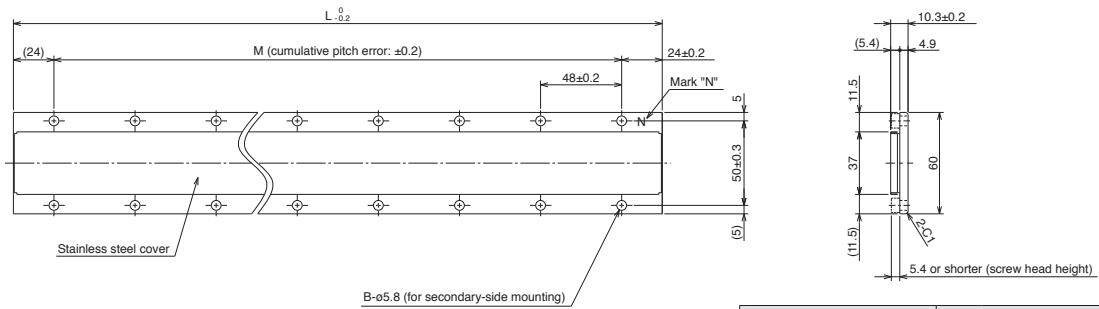

Model	Variable dimensions		
	L	M	B
LM-H3S30-288-CSS0	288	$5 \times 48 = 240$	$2 \times 6$
LM-H3S30-384-CSS0	384	$7 \times 48 = 336$	$2 \times 8$
LM-H3S30-480-CSS0	480	$9 \times 48 = 432$	$2 \times 10$
LM-H3S30-768-CSS0	768	$15 \times 48 = 720$	$2 \times 16$

[Unit: mm]

- LM-H3S70-288-ASS0
- LM-H3S70-384-ASS0
- LM-H3S70-480-ASS0
- LM-H3S70-768-ASS0

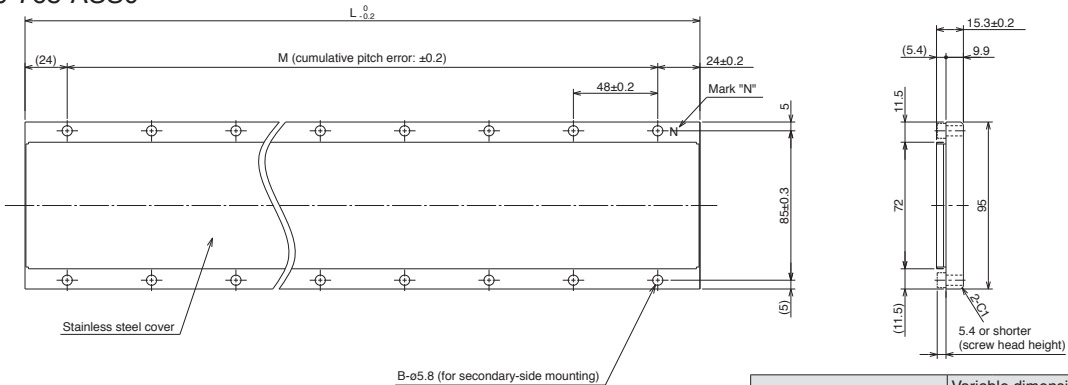

Model	Variable dimensions		
	L	M	B
LM-H3S70-288-ASS0	288	$5 \times 48 = 240$	$2 \times 6$
LM-H3S70-384-ASS0	384	$7 \times 48 = 336$	$2 \times 8$
LM-H3S70-480-ASS0	480	$9 \times 48 = 432$	$2 \times 10$
LM-H3S70-768-ASS0	768	$15 \times 48 = 720$	$2 \times 16$

[Unit: mm]

Common Specifications

Servo System Controllers

Servo Amplifiers

Rotary Servo Motors

Linear Servo Motors

Options/Peripheral Equipment

LV/SWires

Product List

Precautions

Support

# Linear Servo Motors

## LM-AJ Series Primary Side (Coil) Dimensions (Note 1, 2)

### ●LM-AJP1B-07K-JSS0

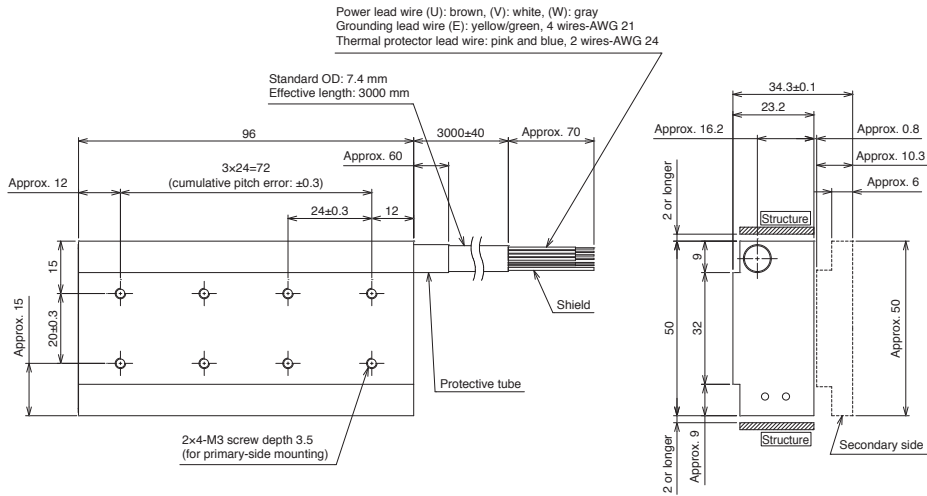

[Unit: mm]

### ●LM-AJP1D-14K-JSS0

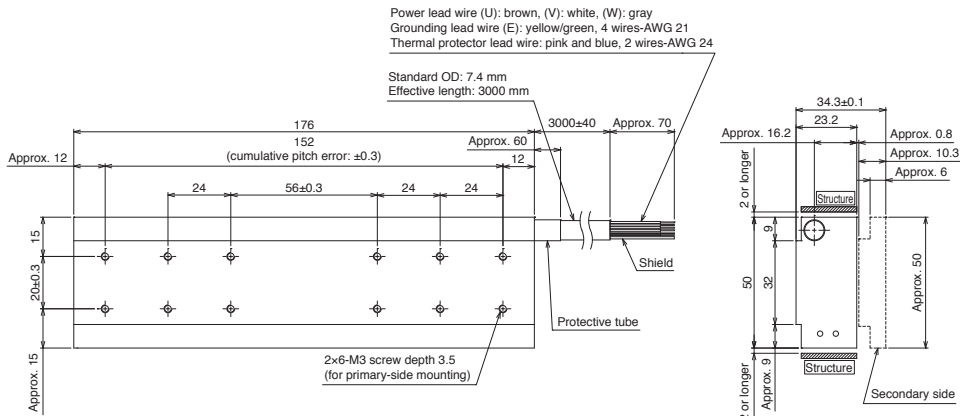

[Unit: mm]

## LM-AJ Series Secondary Side (Magnet) Dimensions

### ●LM-AJS10-080-JSS0

### ●LM-AJS10-200-JSS0

### ●LM-AJS10-400-JSS0

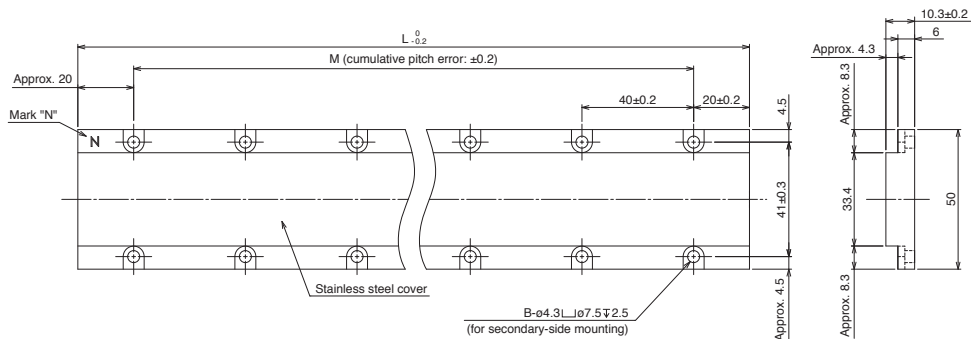

Model	Variable dimensions		
	L	M	B
LM-AJS10-080-JSS0	80	1 x 40 = 40	2 x 2
LM-AJS10-200-JSS0	200	4 x 40 = 160	2 x 5
LM-AJS10-400-JSS0	400	9 x 40 = 360	2 x 10

[Unit: mm]

- Notes: 1. Power, grounding, and thermal protector lead wires do not have a long bending life. Fix the lead wires led from the primary side (coil) to a moving part to prevent the lead wires from repetitive bending.  
 2. Minimum bending radius of the lead wire equals to 10 times the standard overall diameter of the lead wire.



LM-AJ Series Primary Side (Coil) Dimensions (Note 1, 2)

●LM-AJP2B-12S-JSS0

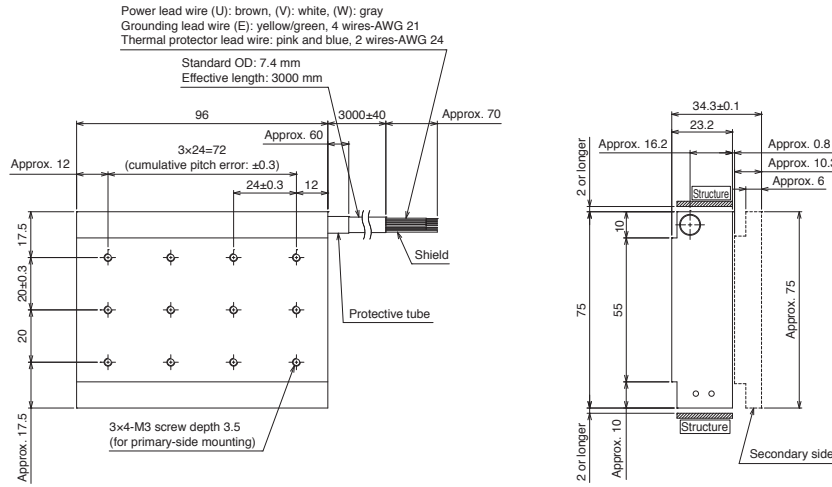

[Unit: mm]

●LM-AJP2D-23T-JSS0

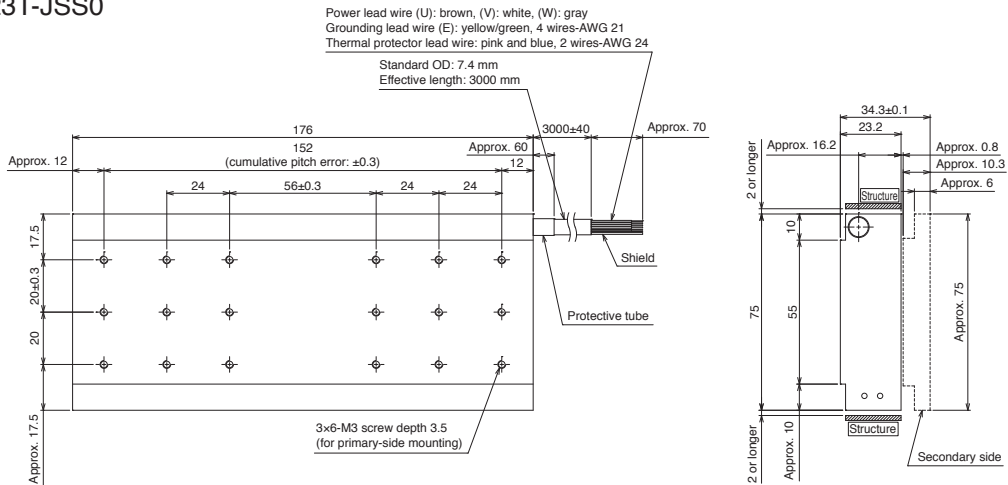

[Unit: mm]

LM-AJ Series Secondary Side (Magnet) Dimensions

●LM-AJS20-080-JSS0

●LM-AJS20-200-JSS0

●LM-AJS20-400-JSS0

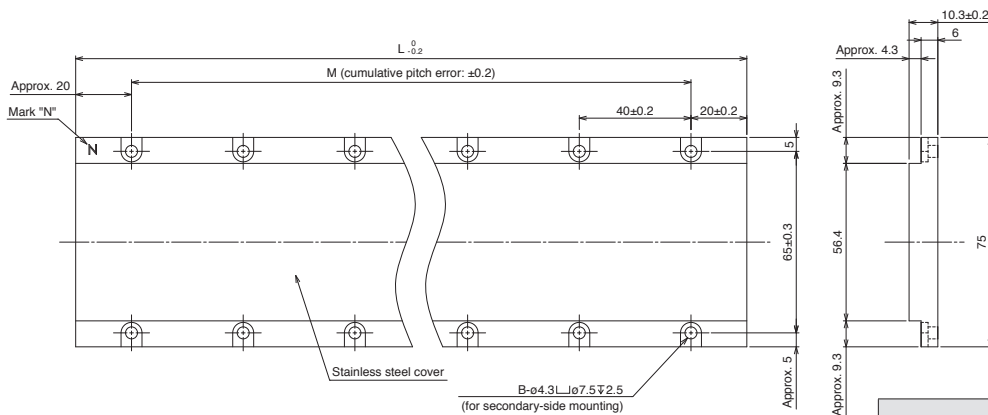

Model	Variable dimensions		
	L	M	B
LM-AJS20-080-JSS0	80	1 × 40 = 40	2 × 2
LM-AJS20-200-JSS0	200	4 × 40 = 160	2 × 5
LM-AJS20-400-JSS0	400	9 × 40 = 360	2 × 10

[Unit: mm]

Notes: 1. Power, grounding, and thermal protector lead wires do not have a long bending life. Fix the lead wires led from the primary side (coil) to a moving part to prevent the lead wires from repetitive bending.  
 2. Minimum bending radius of the lead wire equals to 10 times the standard overall diameter of the lead wire.

Common Specifications  
 Servo System Controllers  
 Servo Amplifiers  
 Rotary Servo Motors  
 Linear Servo Motors  
 Options/Peripheral Equipment  
 LVSWires  
 Product List  
 Precautions  
 Support

# Linear Servo Motors

## LM-AJ Series Primary Side (Coil) Dimensions (Note 1, 2)

### ●LM-AJP3B-17N-JSS0

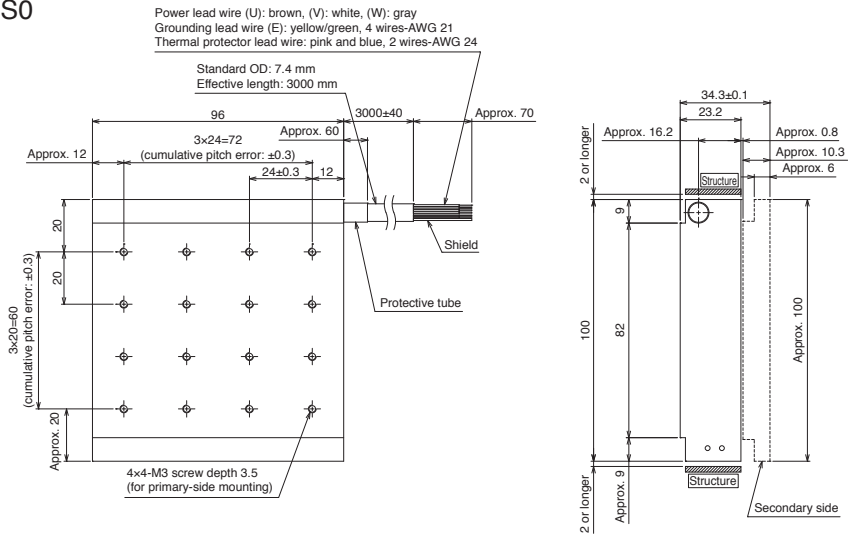

### ●LM-AJP3D-35R-JSS0

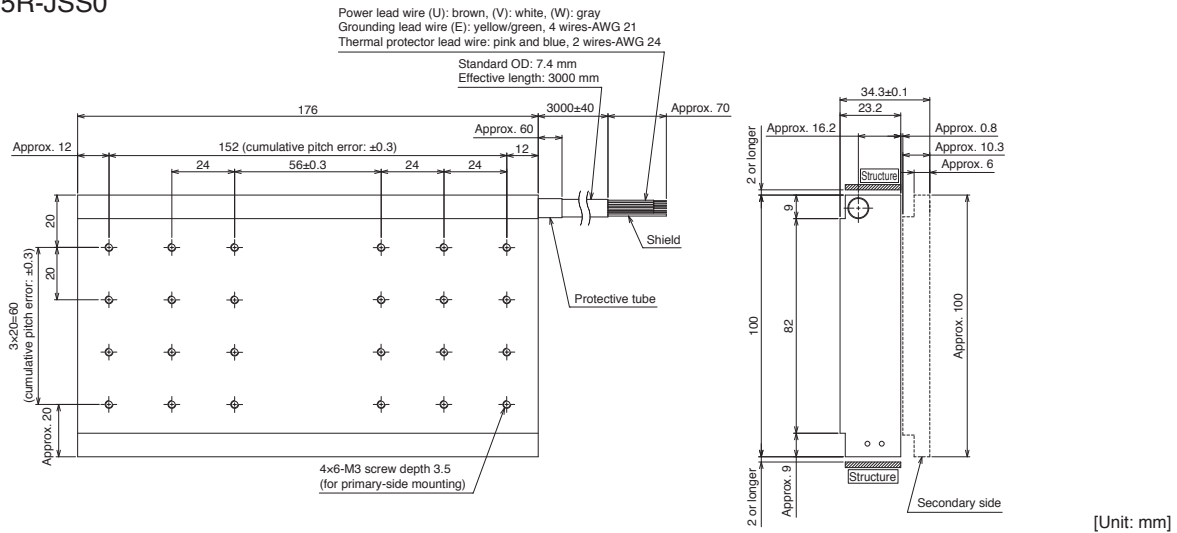

## LM-AJ Series Secondary Side (Magnet) Dimensions

### ●LM-AJS30-080-JSS0

### ●LM-AJS30-200-JSS0

### ●LM-AJS30-400-JSS0

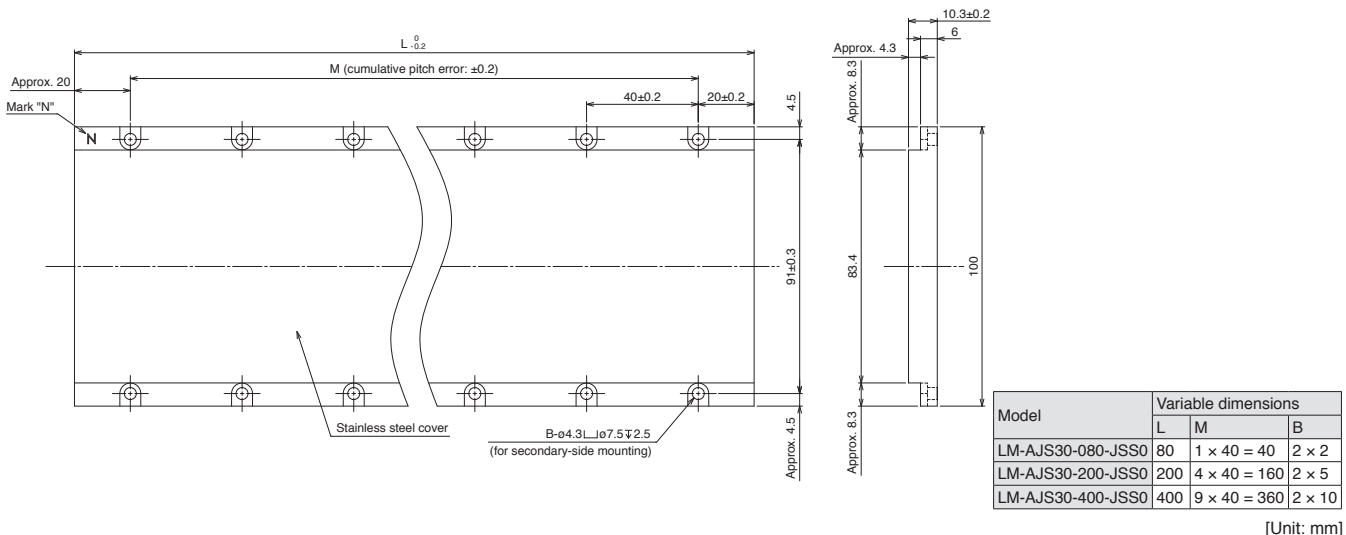

Notes: 1. Power, grounding, and thermal protector lead wires do not have a long bending life. Fix the lead wires led from the primary side (coil) to a moving part to prevent the lead wires from repetitive bending.  
 2. Minimum bending radius of the lead wire equals to 10 times the standard overall diameter of the lead wire.

**LM-AJ Series Primary Side (Coil) Dimensions (Note 1, 2)**

● **LM-AJP4B-22M-JSS0**

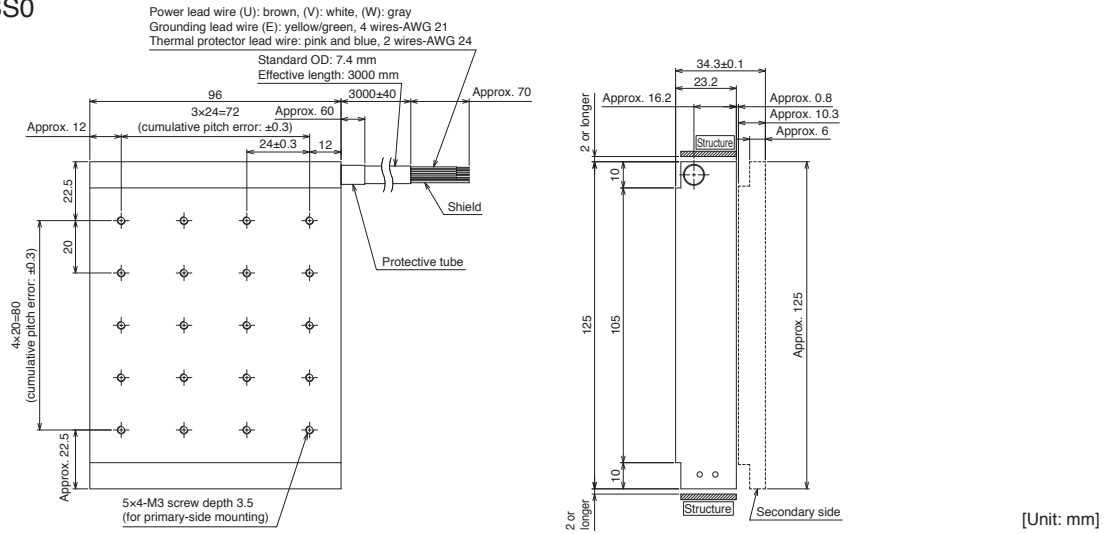

● **LM-AJP4D-45N-JSS0**

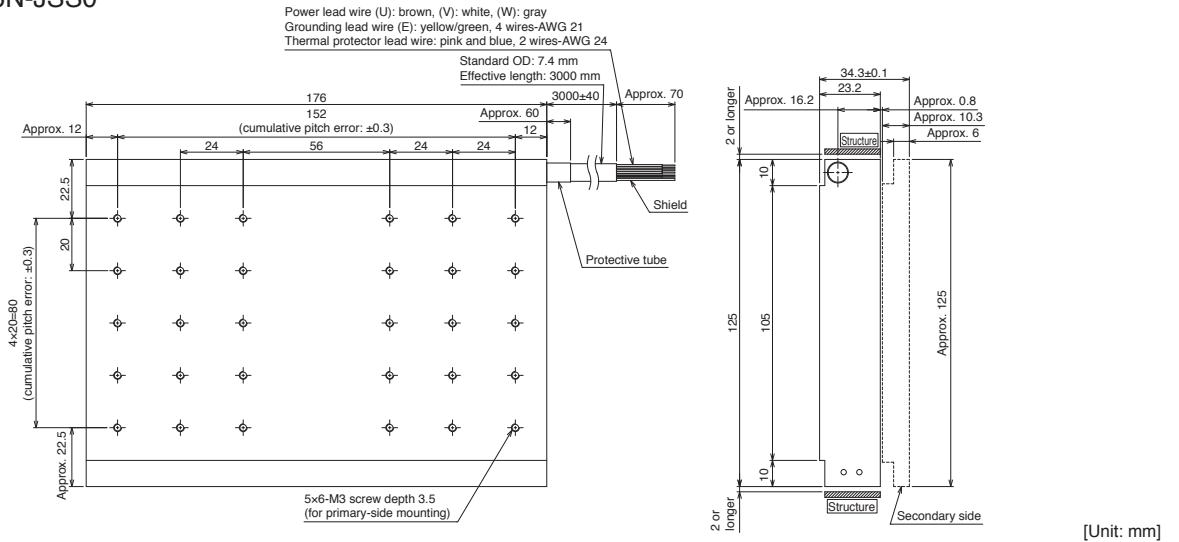

**LM-AJ Series Secondary Side (Magnet) Dimensions**

● **LM-AJS40-080-JSS0**

● **LM-AJS40-200-JSS0**

● **LM-AJS40-400-JSS0**

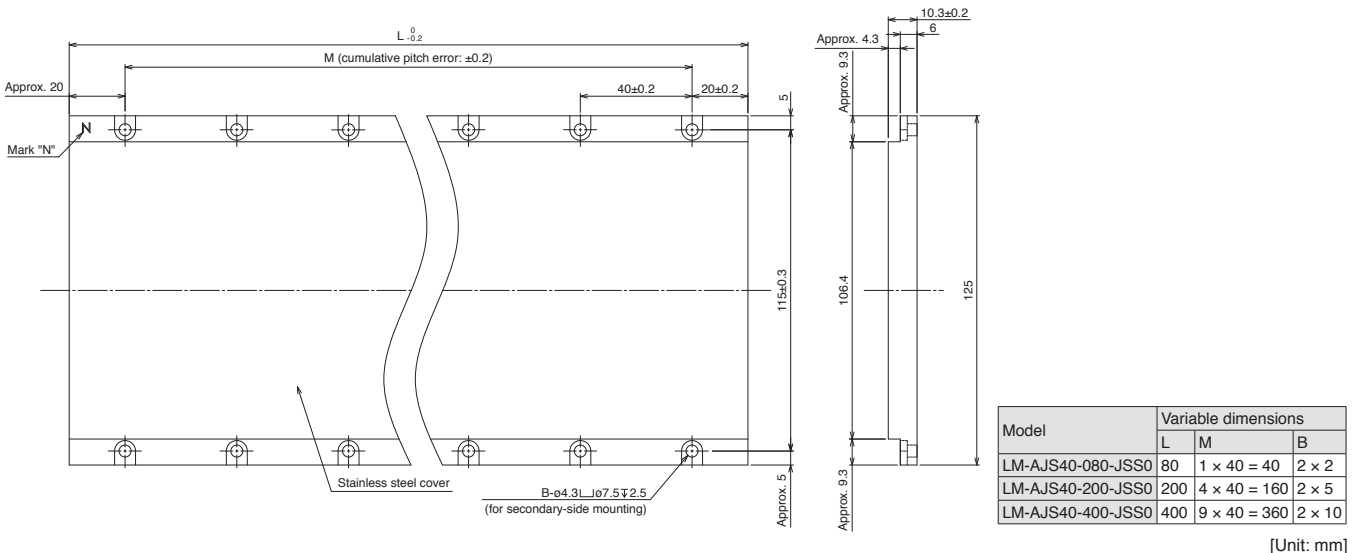

Notes: 1. Power, grounding, and thermal protector lead wires do not have a long bending life. Fix the lead wires led from the primary side (coil) to a moving part to prevent the lead wires from repetitive bending.  
 2. Minimum bending radius of the lead wire equals to 10 times the standard overall diameter of the lead wire.

Common Specifications  
 Servo System Controllers  
 Servo Amplifiers  
 Rotary Servo Motors  
 Linear Servo Motors  
 Options/Peripheral Equipment  
 LVSWires  
 Product List  
 Precautions  
 Support

# Linear Servo Motors

## LM-AU Series Primary Side (Coil) Dimensions (Note 1, 2)

### ●LM-AUP3A-03V-JSS0

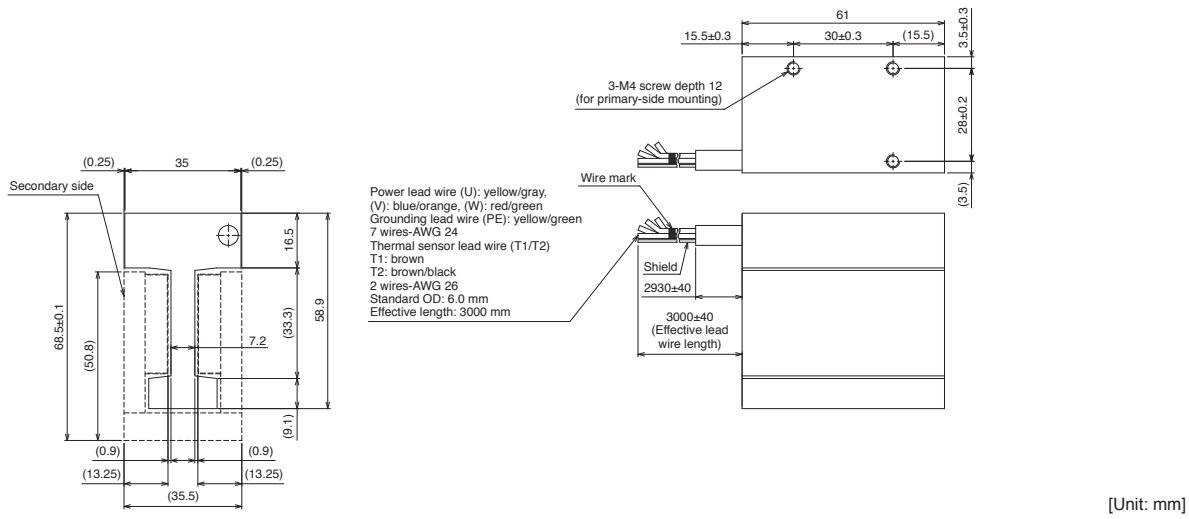

### ●LM-AUP3B-06V-JSS0

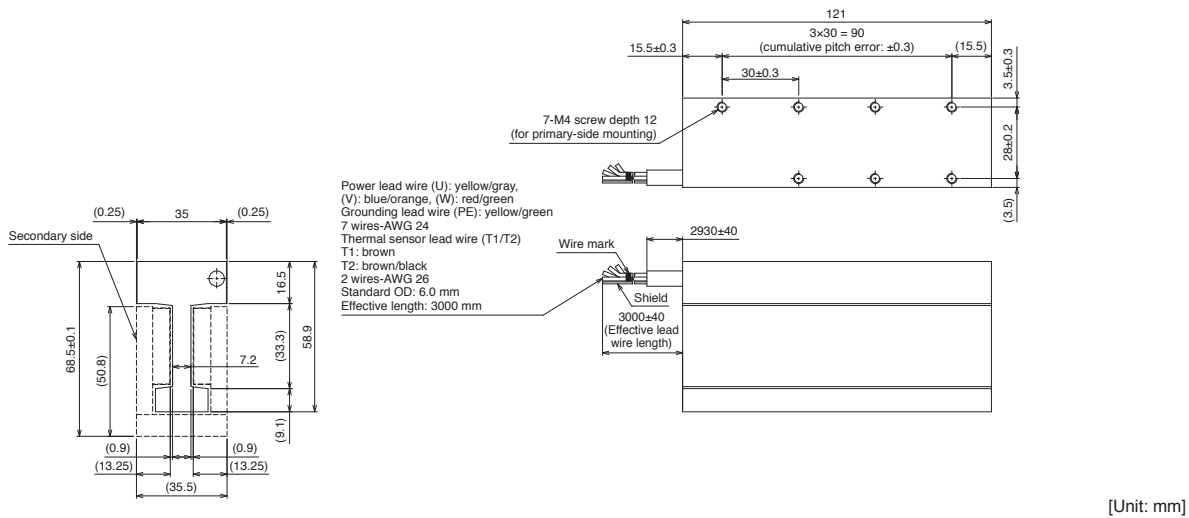

### ●LM-AUP3C-09V-JSS0

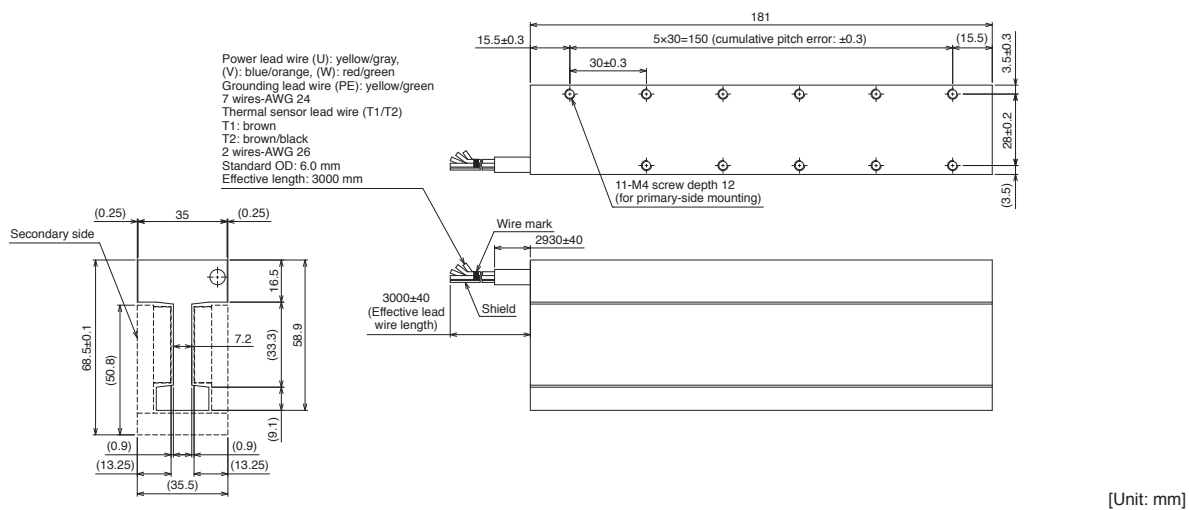

Notes: 1. Power, grounding, and thermal sensor lead wires do not have a long bending life. Fix the lead wires led from the primary side (coil) to a moving part to prevent the lead wires from repetitive bending.  
2. Minimum bending radius of the lead wire equals to 10 times the standard overall diameter of the lead wire.

**LM-AU Series Primary Side (Coil) Dimensions** (Note 1, 2)

●LM-AUP3D-11R-JSS0

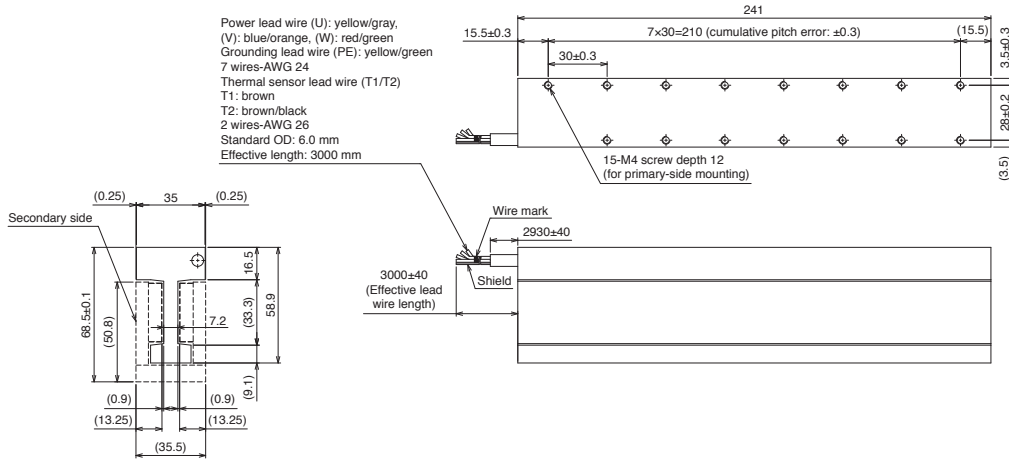

[Unit: mm]

**LM-AU Series Secondary Side (Magnet) Dimensions**

●LM-AUS30-120-JSS0

●LM-AUS30-180-JSS0

●LM-AUS30-240-JSS0

●LM-AUS30-300-JSS0

●LM-AUS30-600-JSS0

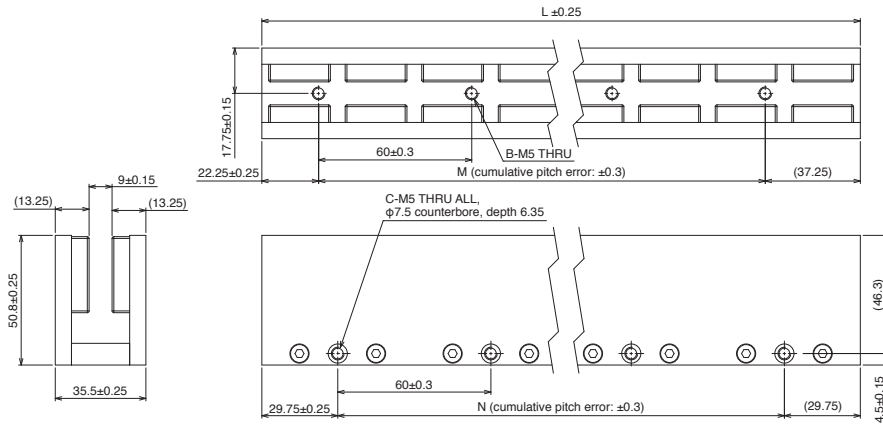

Model	Variable dimensions				
	L	M	N	B	C
LM-AUS30-120-JSS0	119.5	60	60	2	2
LM-AUS30-180-JSS0	179.5	2×60 = 120	2×60 = 120	3	3
LM-AUS30-240-JSS0	239.5	3×60 = 180	3×60 = 180	4	4
LM-AUS30-300-JSS0	299.5	4×60 = 240	4×60 = 240	5	5
LM-AUS30-600-JSS0	599.5	9×60 = 540	9×60 = 540	10	10

[Unit: mm]

- Notes: 1. Power, grounding, and thermal sensor lead wires do not have a long bending life. Fix the lead wires led from the primary side (coil) to a moving part to prevent the lead wires from repetitive bending.  
 2. Minimum bending radius of the lead wire equals to 10 times the standard overall diameter of the lead wire.

# Linear Servo Motors

## LM-AU Series Primary Side (Coil) Dimensions (Note 1, 2)

### ●LM-AUP4A-04R-JSS0

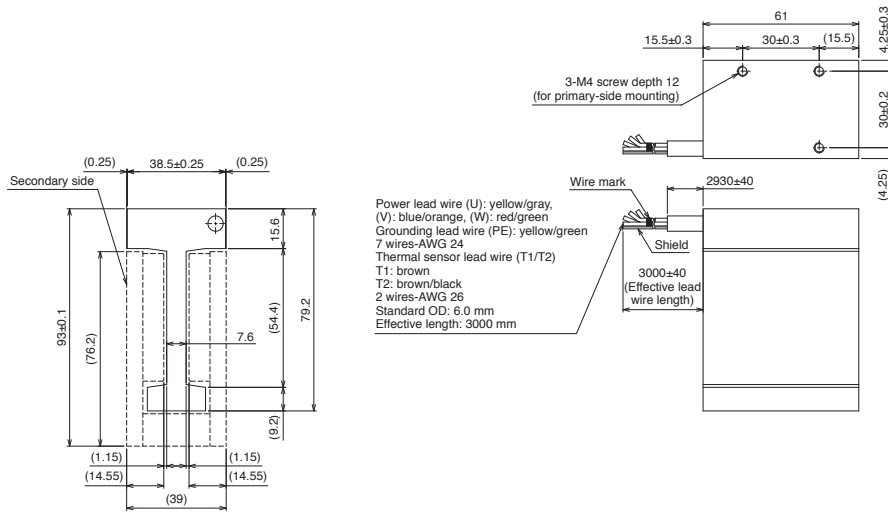

[Unit: mm]

### ●LM-AUP4B-09R-JSS0

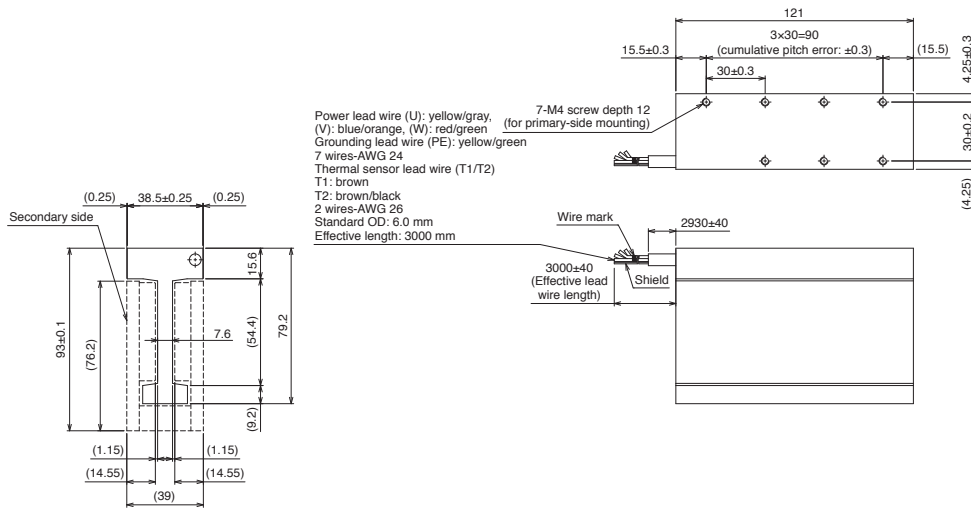

[Unit: mm]

### ●LM-AUP4C-13P-JSS0

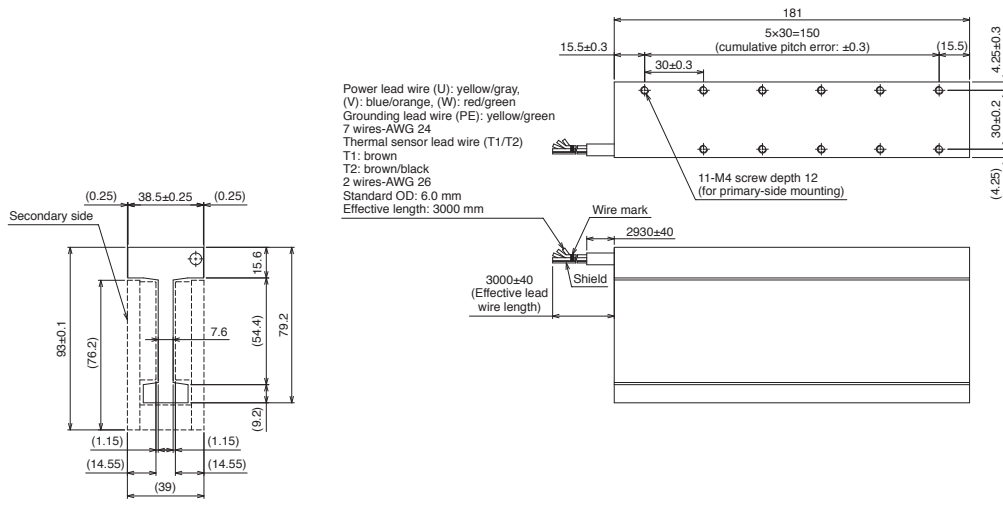

[Unit: mm]

- Notes: 1. Power, grounding, and thermal sensor lead wires do not have a long bending life. Fix the lead wires led from the primary side (coil) to a moving part to prevent the lead wires from repetitive bending.  
2. Minimum bending radius of the lead wire equals to 10 times the standard overall diameter of the lead wire.

LM-AU Series Primary Side (Coil) Dimensions (Note 1, 2)

●LM-AUP4D-18M-JSS0

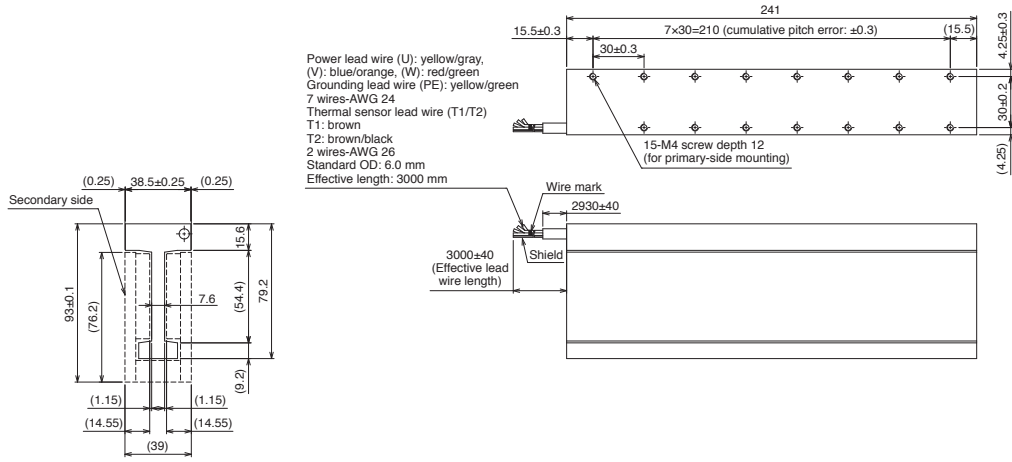

●LM-AUP4F-26P-JSS0

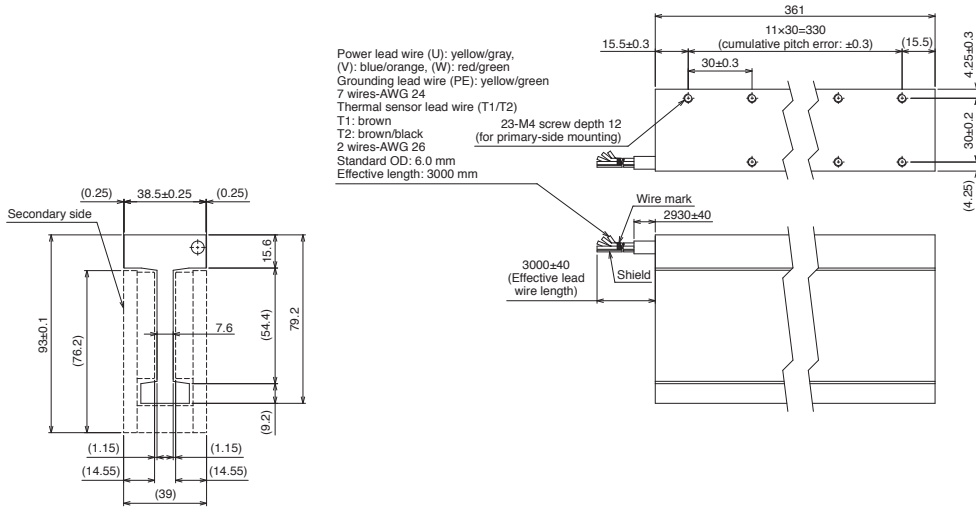

●LM-AUP4H-35M-JSS0

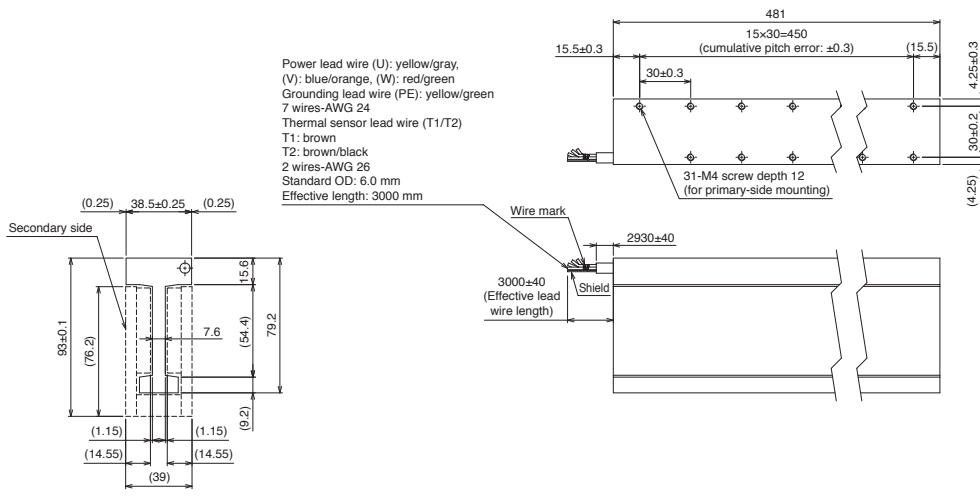

Notes: 1. Power, grounding, and thermal sensor lead wires do not have a long bending life. Fix the lead wires led from the primary side (coil) to a moving part to prevent the lead wires from repetitive bending.  
 2. Minimum bending radius of the lead wire equals to 10 times the standard overall diameter of the lead wire.

Common Specifications  
 Servo System Controllers  
 Servo Amplifiers  
 Rotary Servo Motors  
 Linear Servo Motors  
 Options/Peripheral Equipment  
 LVSMWires  
 Product List  
 Precautions  
 Support

# Linear Servo Motors

## LM-AU Series Secondary Side (Magnet) Dimensions

● LM-AUS40-120-JSS0

● LM-AUS40-180-JSS0

● LM-AUS40-240-JSS0

● LM-AUS40-300-JSS0

● LM-AUS40-600-JSS0

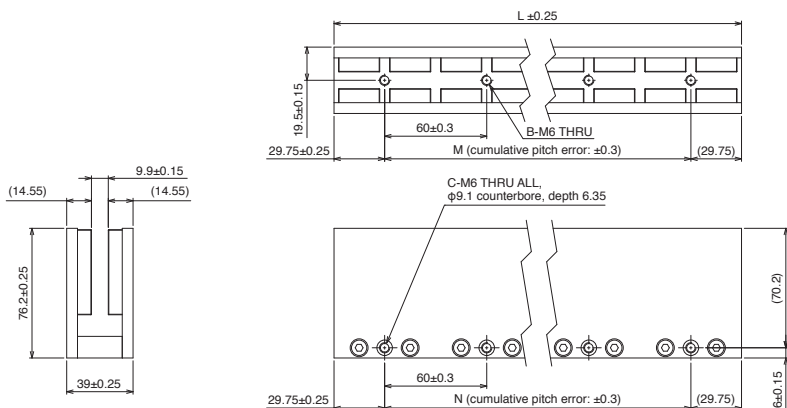

Model	Variable dimensions				
	L	M	N	B	C
LM-AUS40-120-JSS0	119.5	60	60	2	2
LM-AUS40-180-JSS0	179.5	2×60 = 120	2×60 = 120	3	3
LM-AUS40-240-JSS0	239.5	3×60 = 180	3×60 = 180	4	4
LM-AUS40-300-JSS0	299.5	4×60 = 240	4×60 = 240	5	5
LM-AUS40-600-JSS0	599.5	9×60 = 540	9×60 = 540	10	10

[Unit: mm]



**List of Linear Encoders** (Note 1)

Contact your local sales office for compatible linear encoders.

Mitsubishi Electric high-speed serial communication-compatible absolute type

Manufacturer	Model	Resolution	Rated speed (Note 2)	Maximum effective measurement length (Note 3)	Communication method
Magnescale Co., Ltd.	SR77	0.05 μm/	3.3 m/s	2040 mm	Two-wire type
	SR87	0.01 μm		3040 mm	
	SR27A	0.01 μm	3.3 m/s	2040 mm	Two-wire type/ Four-wire type (Note 4)
	SR67A			3640 mm	
	SmartSCALE SQ47	0.005 μm	3.3 m/s	3740 mm	
SmartSCALE SQ57	3770 mm				
Mitutoyo Corporation	AT343A	0.05 μm	2.0 m/s	3000 mm	Two-wire type
	AT543A-SC		2.5 m/s	2200 mm	
	AT545A-SC	20 μm/4096 (Approx. 0.005 μm)	2.5 m/s	2200 mm	
	ST743A	0.1 μm	5.0 m/s	6000 mm	
	ST744A				
	ST748A				
ST1341A	0.01 μm	8.0 m/s	12000 mm		
ST1342A	0.001 μm		4200 mm		
Renishaw	RESOLUTE RL40M	1 nm 50 nm	100 m/s	2100 mm 20990 mm	Two-wire type
	EVOLUTE EL40M	50 nm/100 nm/500 nm	100 m/s	10010 mm	
Heidenhain	LC 495M	0.001 μm/	3.0 m/s	2040 mm	Four-wire type (Note 4)
	LC 195M	0.01 μm		4240 mm	
	LIC 4193M	0.005 μm/ 0.01 μm	10.0 m/s	3040 mm	Two-wire type/ Four-wire type (Note 4)
	LIC 4195M			28440 mm	
	LIC 4197M			6040 mm	
	LIC 4199M	0.05 μm/ 0.1 μm	10.0 m/s	1020 mm	
LIC 2197M	6020 mm				
LIC 2199M		6020 mm			
RSF Elektronik	MC15M	0.05 μm/ 0.1 μm	10.0 m/s	3020 mm	
Nidec Machine Tool Corporation	MPFA-HZ-M01	0.1 μm	30.0 m/s	8000 mm	Two-wire type

- Notes: 1. Contact the relevant linear encoder manufacturer for details on operating environment and specifications of the linear encoder such as ambient temperature, vibration resistance and IP rating.  
 2. The listed values are the manufacturer's specifications. When combined with MR-JET- servo amplifiers, the specification value is either the listed value or the servo motor maximum speed, whichever is lower.  
 3. The listed values are the manufacturer's specifications. The maximum length of the encoder cable between a linear encoder and a servo amplifier is 30 m. For a linear encoder manufactured by Nidec Machine Tool Corporation, the maximum length of the encoder cable between the linear encoder and a servo amplifier is 20 m.  
 4. For fully closed loop control, the load-side encoder and the servo motor encoder are compatible only with two-wire type communication method. Four-wire type cannot be used.

Common Specifications  
 Servo System Controllers  
 Servo Amplifiers  
 Rotary Servo Motors  
 Linear Servo Motors  
 Options/Peripheral Equipment  
 LV/S/Wires  
 Product List  
 Precautions  
 Support

# Linear Servo Motors

## List of Linear Encoders (Note 1)

Contact your local sales office for compatible linear encoders.

### Mitsubishi Electric high-speed serial communication-compatible incremental type

Manufacturer	Model	Resolution	Rated speed (Note 2)	Maximum effective measurement length (Note 3)	Communication method
Magnescale Co., Ltd.	SR75	0.05 $\mu\text{m}/$	3.3 m/s	2040 mm	Two-wire type
	SR85	0.01 $\mu\text{m}$		3040 mm	
	SL710 + PL101-RM/RHM	0.1 $\mu\text{m}$	10.0 m/s	100000 mm	
	SQ10 + PQ10 + MQ10	0.1 $\mu\text{m}/$ 0.05 $\mu\text{m}$	10.0 m/s	3800 mm	Two-wire type/ Four-wire type (Note 6)
Heidenhain	LIDA 483 + EIB 3091M (16384-fold subdivision) (Note 7)	20 $\mu\text{m}/16384$ (Approx. 1.22 nm)	4.0 m/s	3040 mm	Four-wire type (Note 6)
	LIDA 485 + EIB 3091M (16384-fold subdivision) (Note 7)			30040 mm	
	LIDA 487 + EIB 3091M (16384-fold subdivision) (Note 7)			6040 mm	
	LIDA 489 + EIB 3091M (16384-fold subdivision) (Note 7)			1020 mm	
	LIDA 287 + EIB 3091M (16384-fold subdivision) (Note 7)	200 $\mu\text{m}/16384$ (Approx. 12.2 nm)	4.0 m/s	10000 mm	
	LIDA 289 + EIB 3091M (16384-fold subdivision) (Note 7)				
	LIF 481 + EIB 3091M (4096-fold subdivision)	4 $\mu\text{m}/4096$ (Approx. 0.977 nm)	1.6 m/s	1020 mm	
	LIP 6081 + EIB 3091M (4096-fold subdivision)			1440 mm	
Nidec Sankyo Corporation	PSLH041	0.1 $\mu\text{m}$	5.0 m/s	2400 mm	Two-wire type
Nidec Machine Tool Corporation	MPFA-HI-M01 (Note 9)	0.1 $\mu\text{m}$	30.0 m/s	10000 mm (Note 8)	Two-wire type

### A/B/Z-phase differential output type (Note 4, 10)

Manufacturer	Model	Resolution	Rated speed (Note 2)	Maximum effective measurement length (Note 3)	Communication method
Not designated	-	0.001 $\mu\text{m}$ to 5 $\mu\text{m}$ (Note 5)	Depends on the linear encoder	Depends on the linear encoder	A/B/Z-phase differential output method

- Notes:
- Contact the relevant linear encoder manufacturer for details on operating environment and specifications of the linear encoder such as ambient temperature, vibration resistance and IP rating.
  - The listed values are the manufacturer's specifications. When combined with MR-JET\_ servo amplifiers, the specification value is either the listed value or the servo motor maximum speed, whichever is lower.
  - The listed values are the manufacturer's specifications. The maximum length of the encoder cable between a linear encoder and a servo amplifier is 30 m. For a linear encoder manufactured by Nidec Machine Tool Corporation, the maximum length of the encoder cable between the linear encoder and a servo amplifier is 20 m.
  - A fully closed loop control system does not support the A/B/Z-phase differential output type encoder.
  - Select the linear encoder within this range.
  - For fully closed loop control, the load-side encoder and the servo motor encoder are compatible only with two-wire type communication method. Four-wire type cannot be used.
  - For this combination, it is recommended using EIB 3091M with a subdivision of 16384. EIB 3091M with a subdivision of 4096 is also available. For details, contact the manufacturer.
  - For the measurement length over 10000 mm, contact Nidec Machine Tool Corporation.
  - There are some restrictions on this linear encoder. When using it, contact your local sales office.
  - The phase difference of the A-phase pulse and the B-phase pulse, and the width of the Z-phase pulse must be 200 ns or wider. The output pulse of A-phase and B-phase of the A/B/Z-phase differential output linear encoder is in the multiply-by-four count method. For linear encoders without Z-phase, some of the homing modes cannot be used. Refer to "MR-JET User's Manual" for details.

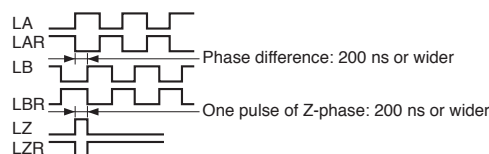

### Determining the Number of the Secondary-Side (Magnet) Blocks

The number of the secondary-side (magnet) blocks is determined according to the total distance calculated from the following equation:

$$(\text{Total length of aligned secondary side (magnet)}) \geq (\text{Maximum feed distance}) + (\text{Length of the primary side (coil)})$$

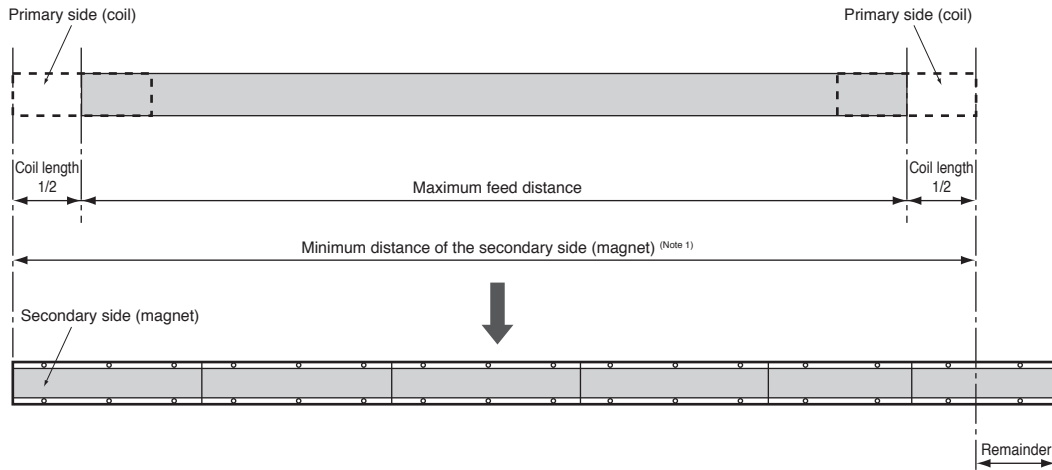

Notes: 1. Keep the cumulative pitch error of the mounting screw holes within  $\pm 0.2$  mm. When two or more secondary sides (magnets) are mounted lined up, there may be a gap between each block, depending on the mounting method and the number of the blocks.

- Common Specifications
- Servo System Controllers
- Servo Amplifiers
- Rotary Servo Motors
- Linear Servo Motors
- Options/Peripheral Equipment
- LV/SW/ires
- Product List
- Precautions
- Support

## Linear Servo Motors

MEMO



# 6

## Options/Peripheral Equipment

Cable and Connector Selection Table for HG Series Rotary Servo Motors.....	6-2
Configuration Example for HG Series Rotary Servo Motors.....	6-4
Configuration Example for Linear Servo Motors.....	6-11
Details of Option Connectors for Servo Motors.....	6-13
Products on the Market for Servo Motors.....	6-16
Configuration Example for Servo Amplifiers.....	6-19
Details of Option Connectors for Servo Amplifiers.....	6-21
Products on the Market for Servo Amplifiers.....	6-21
Regenerative Option.....	6-22
Replacement Fan Unit.....	6-25
Junction Terminal Block.....	6-25
Battery.....	6-26
Radio Noise Filter/Line Noise Filter/Data Line Filter.....	6-27
Surge Killer.....	6-27
EMC Filter.....	6-28
Surge Protector.....	6-28
Power Factor Improving AC Reactor.....	6-29
Servo Support Software.....	6-30
Unit Conversion Table.....	6-32

### **HG** HG series

\* Options and peripheral equipment for servo amplifiers are the same regardless of the network. Refer to the servo amplifiers with the same rated output.

\* Refer to p. 6-32 in this catalog for conversion of units.

## Cable and Connector Selection Table for HG Series Rotary Servo Motors

Necessary option cables and connectors vary depending on the servo motor series.  
Refer to the following tables for necessary options.

### Selecting options for servo motor

Use the cables in the following tables.

For the cable descriptions, refer to the relevant letters in each list.

Capacity	Servo motor	Reference list		
		Encoder cable	Servo motor power cable	Electromagnetic brake cable <sup>(Note 1)</sup>
Small capacity	HG-KNS series	Column A in encoder cable list	Column A in servo motor power cable list	Column A in electromagnetic brake cable list
Medium capacity	HG-SNS series	Column B in encoder cable list	Column B in servo motor power cable list	Column B in electromagnetic brake cable list

Notes: 1. An electromagnetic brake cable is required only for servo motor with an electromagnetic brake.

### Encoder cable list

	Cable length	IP rating <sup>(Note 1)</sup>	Cable direction	Bending life <sup>(Note 2)</sup>	Model	Reference
A	10 m or shorter (direct connection type)	IP65	In the direction of the load side	Long bending life	MR-J3ENCBL_M-A1-H	p. 6-7
				Standard	MR-J3ENCBL_M-A1-L	
			In the opposite direction of the load side	Long bending life	MR-J3ENCBL_M-A2-H	p. 6-7
				Standard	MR-J3ENCBL_M-A2-L	
	Over 10 m (junction type)	IP20	In the direction of the load side	Long bending life	Two types of cables are required: MR-J3JCBL03M-A1-L, MR-EKCBL_M-H	p. 6-7
				Standard	Two types of cables are required: MR-J3JCBL03M-A1-L, MR-EKCBL_M-L	
			In the opposite direction of the load side	Long bending life	Two types of cables are required: MR-J3JCBL03M-A2-L, MR-EKCBL_M-H	p. 6-7
				Standard	Two types of cables are required: MR-J3JCBL03M-A2-L, MR-EKCBL_M-L	
		IP65	In the direction of the load side	Long bending life	Two types of cables are required: MR-J3JSCBL03M-A1-L, MR-J3ENSCBL_M-H	p. 6-7 and 6-8
				Standard	Two types of cables are required: MR-J3JSCBL03M-A1-L, MR-J3ENSCBL_M-L	
			In the opposite direction of the load side	Long bending life	Two types of cables are required: MR-J3JSCBL03M-A2-L, MR-J3ENSCBL_M-H	p. 6-7 and 6-8
				Standard	Two types of cables are required: MR-J3JSCBL03M-A2-L, MR-J3ENSCBL_M-L	
B	2 m to 50 m	IP67	-	Long bending life	MR-J3ENSCBL_M-H	p. 6-8
	2 m to 30 m			Standard	MR-J3ENSCBL_M-L	

Notes: 1. The IP rating indicated is for the connector's protection against ingress of dust and water when coupled to a servo motor. If the IP rating of the servo motor differs from that of these connectors, overall IP rating depends on the lowest of all.  
2. Long bending life cables and standard cables are for moving parts and fixed parts respectively.

## Cable and Connector Selection Table for HG Series Rotary Servo Motors

HG

## Servo motor power cable list

	Cable length	IP rating (Note 1)	Cable direction	Bending life (Note 2)	Model	Reference
A	10 m or shorter (direct connection type)	IP65	In the direction of the load side	Long bending life	MR-PWS1CBL_M-A1-H	p. 6-9
				Standard	MR-PWS1CBL_M-A1-L	
	Over 10 m (junction type)	IP55	In the opposite direction of the load side	Long bending life	MR-PWS1CBL_M-A2-H	p. 6-9
				Standard	MR-PWS1CBL_M-A2-L	
				Standard	Connect a user-fabricated cable to MR-PWS2CBL03M-A1-L (option cable).	p. 6-9
					Connect a user-fabricated cable to MR-PWS2CBL03M-A2-L (option cable).	p. 6-9
	IP rating (Note 1)	Compatible servo motor		Model		Reference
B	IP67	HG-SNS52J, 102J, 152J		Fabricate a cable that fits to MR-PWCNS4 (option connector set).		p. 6-9
		HG-SNS202J, 302J		Fabricate a cable that fits to MR-PWCNS5 (option connector set).		p. 6-9

## Electromagnetic brake cable list

	Cable length	IP rating (Note 1)	Cable direction	Bending life (Note 2)	Model	Reference
A	10 m or shorter (direct connection type)	IP65	In the direction of the load side	Long bending life	MR-BKS1CBL_M-A1-H	p. 6-10
				Standard	MR-BKS1CBL_M-A1-L	
	Over 10 m (junction type)	IP55	In the opposite direction of the load side	Long bending life	MR-BKS1CBL_M-A2-H	p. 6-10
				Standard	MR-BKS1CBL_M-A2-L	
				Standard	Connect a user-fabricated cable to MR-BKS2CBL03M-A1-L (option cable).	p. 6-10
					Connect a user-fabricated cable to MR-BKS2CBL03M-A2-L (option cable).	p. 6-10
	IP rating (Note 1)	Compatible servo motor		Model		Reference
B	IP67	HG-SNS series		Fabricate a cable that fits to MR-BKCNS1 or MR-BKCNS2 (option connector set) (straight type).		p. 6-10
				Fabricate a cable that fits to MR-BKCNS1A or MR-BKCNS2A (option connector set) (angle type).		p. 6-10

Notes: 1. The IP rating indicated is for the connector's protection against ingress of dust and water when coupled to a servo motor. If the IP rating of the servo motor differs from that of these connectors, overall IP rating depends on the lowest of all.

2. Long bending life cables and standard cables are for moving parts and fixed parts respectively.

## Configuration Example for HG Series Rotary Servo Motors

HG-KNS series: encoder cable length 10 m or shorter

- For leading the cables out in the direction of the load side (Note 1)

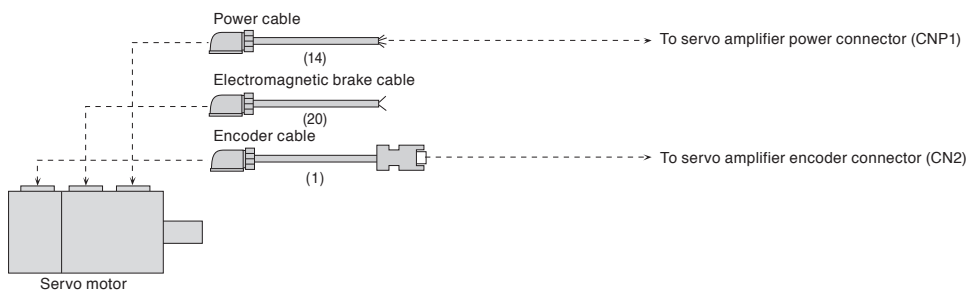

- For leading the cables out in the opposite direction of the load side (Note 1)

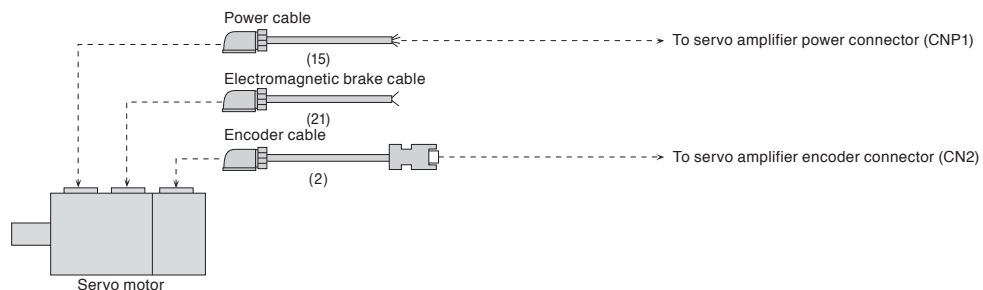

Notes: 1. Cables for leading two different directions may be used for one servo motor.



## Configuration Example for HG Series Rotary Servo Motors (Note 5)

HG-KNS series: encoder cable length over 10 m

- For leading the cables out in the direction of the load side (Note 4)

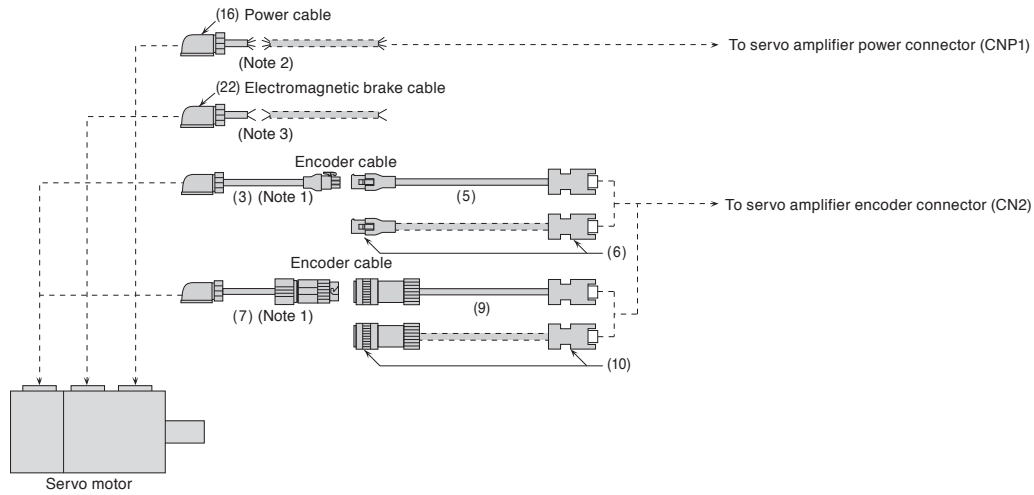

- For leading the cables out in the opposite direction of the load side (Note 4)

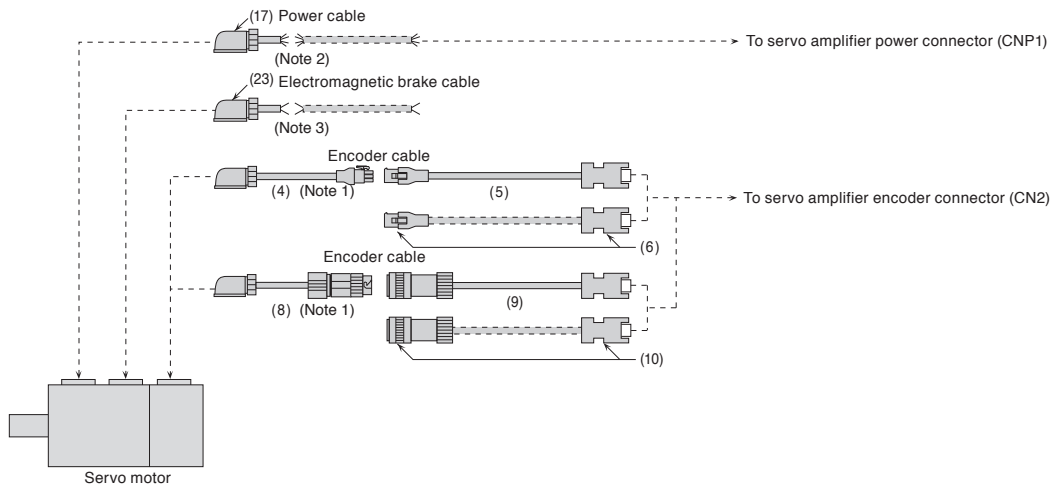

- Notes:
1. Secure this cable as it does not have a long bending life.
  2. Relay a cable using MR-PWS2CBL03M-A1-L or MR-PWS2CBL03M-A2-L. Secure this cable as it does not have a long bending life.
  3. Relay a cable using MR-BKS2CBL03M-A1-L or MR-BKS2CBL03M-A2-L. Secure this cable as it does not have a long bending life.
  4. Cables for leading two different directions may be used for one servo motor.
  5. Cables drawn with dashed lines need to be fabricated by users. Refer to "Rotary Servo Motor User's Manual (For MR-JET)" when fabricating the cables.

## Configuration Example for HG Series Rotary Servo Motors (Note 2)

HG

### HG-SNS series

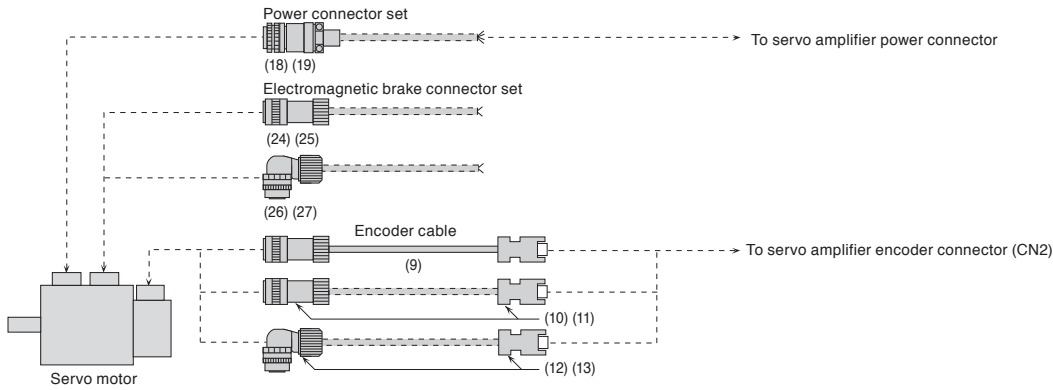

### Fully closed loop control (Note 3)

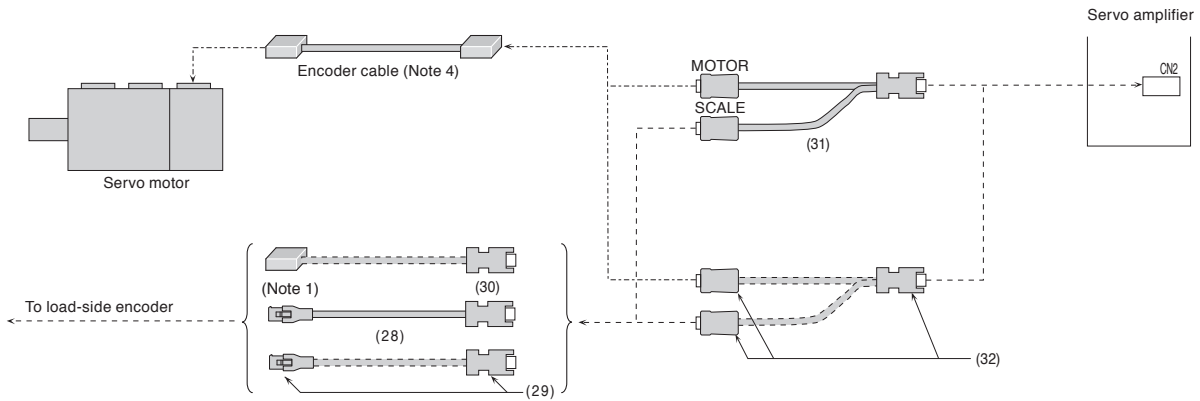









- Notes:
1. Contact the relevant linear encoder manufacturers for connectors to connect with the head cables.
  2. Cables drawn with dashed lines need to be fabricated by users. Refer to "Rotary Servo Motor User's Manual (For MR-JET)" when fabricating the cables.
  3. Connections other than mentioned are the same as those for each rotary servo motor. Refer to cables and connectors for relevant servo motors in this catalog.
  4. Necessary encoder cables vary depending on the servo motor series. Refer to cables and connectors for relevant servo motors in this catalog.

HG

## Cables and Connectors for HG Series Rotary Servo Motors

Refer to "Details of Option Connectors for Servo Motors" in this catalog for the detailed models.





No.	Item	Model	Cable length	IP rating (Note 1)	Application	Description
(1)	Encoder cable (Note 2, 6, 7) (load-side lead)	MR-J3ENCBL2M-A1-H	2 m	IP65	HG-KNS series (direct connection type)	Encoder connector    Servo amplifier connector 
		MR-J3ENCBL5M-A1-H	5 m			
		MR-J3ENCBL10M-A1-H	10 m			
		MR-J3ENCBL2M-A1-L	2 m			
		MR-J3ENCBL5M-A1-L	5 m			
		MR-J3ENCBL10M-A1-L	10 m			
(2)	Encoder cable (Note 2, 6, 7) (opposite to load-side lead)	MR-J3ENCBL2M-A2-H	2 m	IP65	HG-KNS series (direct connection type)	Encoder connector    Servo amplifier connector 
		MR-J3ENCBL5M-A2-H	5 m			
		MR-J3ENCBL10M-A2-H	10 m			
		MR-J3ENCBL2M-A2-L	2 m			
		MR-J3ENCBL5M-A2-L	5 m			
		MR-J3ENCBL10M-A2-L	10 m			
(3)	Encoder cable (Note 2, 6, 7) (load-side lead)	MR-J3JCBL03M-A1-L	0.3 m	IP20	HG-KNS series (junction type)	Encoder connector    Junction connector 
(4)	Encoder cable (Note 2, 6, 7) (opposite to load-side lead)	MR-J3JCBL03M-A2-L	0.3 m	IP20	HG-KNS series (junction type)	Use this in combination with (5) or (6). 
(5)	Encoder cable (Note 2, 6, 7)	MR-EKCBL20M-H	20 m	IP20	HG-KNS series (junction type)	Junction connector    Servo amplifier connector  Use this in combination with (3) or (4).
		MR-EKCBL30M-H (Note 3)	30 m			
		MR-EKCBL40M-H (Note 3)	40 m			
		MR-EKCBL50M-H (Note 3)	50 m			
		MR-EKCBL20M-L	20 m			
		MR-EKCBL30M-L (Note 3)	30 m			
(6)	Encoder connector set (Note 5)	MR-ECNM	-	IP20	HG-KNS series (junction type)	Junction connector    Servo amplifier connector  Use this in combination with (3) or (4).  Applicable cable Wire size: AWG 26 to 22 Cable OD: 7 mm to 9 mm
(7)	Encoder cable (Note 2, 6, 7) (load-side lead)	MR-J3JSCBL03M-A1-L	0.3 m	IP65 (Note 4)	HG-KNS series (junction type)	Encoder connector    Junction connector 
(8)	Encoder cable (Note 2, 6, 7) (opposite to load-side lead)	MR-J3JSCBL03M-A2-L	0.3 m	IP65 (Note 4)	HG-KNS series (junction type)	Use this in combination with (9) or (10). 

- Notes: 1. The IP rating indicated is for the connector's protection against ingress of dust and water when coupled to a servo motor. If the IP rating of the servo motor differs from that of these connectors, overall IP rating depends on the lowest of all.
2. -H and -L indicate a bending life. -H indicates a long bending life (for moving parts), and -L indicates a standard bending life (for fixed parts).
3. This encoder cable is available in four-wire type. Servo parameter setting is required to use the four-wire type encoder cable. Refer to "MR-JET User's Manual" for details.
4. The encoder cable is rated IP65 while the junction connector itself is rated IP67.
5. The crimping tool (91529-1) manufactured by TE Connectivity Ltd. Company is required. Contact the manufacturer directly.
6. For unlisted lengths of the cables, please contact Mitsubishi Electric System & Service Co., Ltd. OVERSEAS SERVICE SECTION. (Email: osb.webmaster@melsc.jp)
7. Encoder cables are not subject to Low Voltage Directive (50 V AC to 1000 V AC and 75 V DC to 1500 V DC).

## Cables and Connectors for HG Series Rotary Servo Motors

HG

Refer to "Details of Option Connectors for Servo Motors" in this catalog for the detailed models.





No.	Item	Model	Cable length	IP rating (Note 1)	Application	Description
(9)	Encoder cable (Note 2, 6, 8)	MR-J3ENSCBL2M-H	2 m	IP67	HG-KNS series (junction type) HG-SNS series (direct connection type)	 <p>Junction connector or encoder connector      Servo amplifier connector</p> <p>Use this in combination with (7) or (8) for HG-KNS series.</p>
		MR-J3ENSCBL5M-H	5 m			
		MR-J3ENSCBL10M-H	10 m			
		MR-J3ENSCBL20M-H	20 m			
		MR-J3ENSCBL30M-H	30 m			
		MR-J3ENSCBL40M-H	40 m			
		MR-J3ENSCBL50M-H	50 m			
		MR-J3ENSCBL2M-L	2 m			
		MR-J3ENSCBL5M-L	5 m			
		MR-J3ENSCBL10M-L	10 m			
		MR-J3ENSCBL20M-L	20 m			
MR-J3ENSCBL30M-L	30 m					
(10)	Encoder connector set (one-touch connection type) (Note 3, 5)	MR-J3SCNS	-	IP67	HG-KNS series (junction type) HG-SNS series (direct connection type) (straight type)	 <p>Junction connector or encoder connector      Servo amplifier connector</p> <p>Use this in combination with (7) or (8) for HG-KNS series.</p> <p>Applicable cable Wire size: 0.5 mm<sup>2</sup> (AWG 20) or smaller Cable OD: 5.5 mm to 9.0 mm</p>
(11)	Encoder connector set (screw type) (Note 3, 4, 5, 7)	MR-ENCNS2	-	IP67	HG-SNS series (straight type)	 <p>Encoder connector      Servo amplifier connector</p> <p>Applicable cable Wire size: 0.5 mm<sup>2</sup> (AWG 20) or smaller Cable OD: 5.5 mm to 9.0 mm</p>
(12)	Encoder connector set (one-touch connection type) (Note 3, 5, 7)	MR-J3SCNSA	-	IP67	HG-SNS series (angle type)	 <p>Encoder connector      Servo amplifier connector</p> <p>Applicable cable Wire size: 0.5 mm<sup>2</sup> (AWG 20) or smaller Cable OD: 5.5 mm to 9.0 mm</p>
(13)	Encoder connector set (screw type) (Note 3, 4, 5, 7)	MR-ENCNS2A	-	IP67		

- Notes:
- The IP rating indicated is for the connector's protection against ingress of dust and water when coupled to a servo motor. If the IP rating of the servo motor differs from that of these connectors, overall IP rating depends on the lowest of all.
  - H and -L indicate a bending life. -H indicates a long bending life (for moving parts), and -L indicates a standard bending life (for fixed parts).
  - Cable clamps and bushings for cable OD of 5.5 mm to 7.5 mm and of 7.0 mm to 9.0 mm are included in the set.
  - A screw thread is cut on the encoder connector of HG-SNS series, and the screw type connector can be used.
  - The connector set contains a plug and contacts. Using contacts for other plugs may damage the connector. Use the enclosed contacts.
  - For unlisted lengths of the cables, please contact Mitsubishi Electric System & Service Co., Ltd. OVERSEAS SERVICE SECTION. (Email: osb.webmaster@melsc.jp)
  - For fabricating cables, please contact Mitsubishi Electric System & Service Co., Ltd. OVERSEAS SERVICE SECTION. (Email: osb.webmaster@melsc.jp)
  - Encoder cables are not subject to Low Voltage Directive (50 V AC to 1000 V AC and 75 V DC to 1500 V DC).

HG

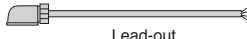
## Cables and Connectors for HG Series Rotary Servo Motors

Refer to "Details of Option Connectors for Servo Motors" in this catalog for the detailed models.

No.	Item	Model	Cable length	IP rating (Note 1)	Application	Description
(14)	Power cable (Note 2, 4) (load-side lead)	MR-PWS1CBL2M-A1-H	2 m	IP65	HG-KNS series (direct connection type)	Power connector  Lead-out
		MR-PWS1CBL5M-A1-H	5 m			
		MR-PWS1CBL10M-A1-H	10 m			
		MR-PWS1CBL2M-A1-L (Note 3)	2 m			
		MR-PWS1CBL5M-A1-L (Note 3)	5 m			
		MR-PWS1CBL10M-A1-L (Note 3)	10 m			
(15)	Power cable (Note 2, 4) (opposite to load-side lead)	MR-PWS1CBL2M-A2-H	2 m	IP65	HG-KNS series (direct connection type)	* The cable is not shielded.
		MR-PWS1CBL5M-A2-H	5 m			
		MR-PWS1CBL10M-A2-H	10 m			
		MR-PWS1CBL2M-A2-L (Note 3)	2 m			
		MR-PWS1CBL5M-A2-L (Note 3)	5 m			
		MR-PWS1CBL10M-A2-L (Note 3)	10 m			
(16)	Power cable (Note 2) (load-side lead)	MR-PWS2CBL03M-A1-L	0.3 m	IP55	HG-KNS series (junction type)	Power connector  Lead-out
(17)	Power cable (Note 2) (opposite to load-side lead)	MR-PWS2CBL03M-A2-L	0.3 m	IP55	HG-KNS series (junction type)	* The cable is not shielded.
(18)	Power connector set (Note 5)	MR-PWCNS4	-	IP67	HG-SNS52J, 102J, 152J	Power connector  Applicable cable Wire size: 2 mm <sup>2</sup> to 3.5 mm <sup>2</sup> (AWG 14 to 12) Cable OD: 10.5 mm to 14.1 mm
(19)	Power connector set (Note 5)	MR-PWCNS5	-	IP67	HG-SNS202J, 302J	Power connector  Applicable cable Wire size: 5.5 mm <sup>2</sup> to 8 mm <sup>2</sup> (AWG 10 to 8) Cable OD: 12.5 mm to 16 mm

Notes: 1. The IP rating indicated is for the connector's protection against ingress of dust and water when coupled to a servo motor. If the IP rating of the servo motor differs from that of these connectors, overall IP rating depends on the lowest of all.

2. -H and -L indicate a bending life. -H indicates a long bending life (for moving parts), and -L indicates a standard bending life (for fixed parts).

3. Shielded power cable MR-PWS3CBL\_M-A\_-L is also available. Contact your local sales office.

4. For unlisted lengths of the cables, please contact Mitsubishi Electric System & Service Co., Ltd. OVERSEAS SERVICE SECTION. (Email: osb.webmaster@melsc.jp)

5. For fabricating cables, please contact Mitsubishi Electric System & Service Co., Ltd. OVERSEAS SERVICE SECTION. (Email: osb.webmaster@melsc.jp)

Common Specifications

Servo System Controllers

Servo Amplifiers

Rotary Servo Motors

Linear Servo Motors

Options/Peripheral Equipment

LV/SWires













Product List

Precautions

Support

## Cables and Connectors for HG Series Rotary Servo Motors

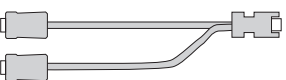
Refer to "Details of Option Connectors for Servo Motors" in this catalog for the detailed models.

No.	Item	Model	Cable length	IP rating (Note 1)	Application	Description
(20)	Electromagnetic brake cable (Note 2, 5) (load-side lead)	MR-BKS1CBL2M-A1-H	2 m	IP65	HG-KNS series (direct connection type)	 Electromagnetic brake connector Lead-out
		MR-BKS1CBL5M-A1-H	5 m			
		MR-BKS1CBL10M-A1-H	10 m			
		MR-BKS1CBL2M-A1-L	2 m			
		MR-BKS1CBL5M-A1-L	5 m			
		MR-BKS1CBL10M-A1-L	10 m			
(21)	Electromagnetic brake cable (Note 2, 5) (opposite to load-side lead)	MR-BKS1CBL2M-A2-H	2 m	IP65	HG-KNS series (direct connection type)	* The cable is not shielded.
		MR-BKS1CBL5M-A2-H	5 m			
		MR-BKS1CBL10M-A2-H	10 m			
		MR-BKS1CBL2M-A2-L	2 m			
		MR-BKS1CBL5M-A2-L	5 m			
		MR-BKS1CBL10M-A2-L	10 m			
(22)	Electromagnetic brake cable (Note 2) (load-side lead)	MR-BKS2CBL03M-A1-L	0.3 m	IP55	HG-KNS series (junction type)	 Electromagnetic brake connector Lead-out * The cable is not shielded.
(23)	Electromagnetic brake cable (Note 2) (opposite to load-side lead)	MR-BKS2CBL03M-A2-L	0.3 m	IP55	HG-KNS series (junction type)	 Electromagnetic brake connector Lead-out * The cable is not shielded.
(24)	Electromagnetic brake connector set (Note 4, 6) (one-touch connection type)	MR-BKCNS1	-	IP67	HG-SNS series (straight type)	 Electromagnetic brake connector Applicable cable Wire size: 1.25 mm <sup>2</sup> (AWG 16) or smaller Cable OD: 9.0 mm to 11.6 mm
(25)	Electromagnetic brake connector set (Note 3, 4, 6) (screw type)	MR-BKCNS2	-	IP67		 Electromagnetic brake connector Applicable cable Wire size: 1.25 mm <sup>2</sup> (AWG 16) or smaller Cable OD: 9.0 mm to 11.6 mm
(26)	Electromagnetic brake connector set (Note 4, 6) (one-touch connection type)	MR-BKCNS1A	-	IP67	HG-SNS series (angle type)	 Electromagnetic brake connector Applicable cable Wire size: 1.25 mm <sup>2</sup> (AWG 16) or smaller Cable OD: 9.0 mm to 11.6 mm
(27)	Electromagnetic brake connector set (Note 3, 4, 6) (screw type)	MR-BKCNS2A	-	IP67		 Electromagnetic brake connector Applicable cable Wire size: 1.25 mm <sup>2</sup> (AWG 16) or smaller Cable OD: 9.0 mm to 11.6 mm
(28)	Encoder cable (Note 2, 7)	MR-EKCBL2M-H (Note 5)	2 m	IP20	Connecting a load-side encoder	 Junction connector    Servo amplifier connector
		MR-EKCBL5M-H (Note 5)	5 m			
(29)	Encoder connector set (Note 7, 8)	MR-ECNM	-	IP20	Connecting a load-side encoder	 Junction connector    Servo amplifier connector Applicable cable Wire size: AWG 26 to 22 Cable OD: 7 mm to 9 mm
(30)	Encoder connector set	MR-J3CN2	-	-	Connecting a load-side encoder	 Servo amplifier connector
(31)	Junction cable for fully closed loop control	MR-J4FCCBL03M	0.3 m	-	Branching a load-side encoder	 Junction connector    Servo amplifier connector
(32)	Connector set	MR-J3THMCN2	-	-	Branching a load-side encoder	 Junction connector    Servo amplifier connector

Notes: 1. The IP rating indicated is for the connector's protection against ingress of dust and water when coupled to a servo motor. If the IP rating of the servo motor differs from that of these connectors, overall IP rating depends on the lowest of all.

2. -H and -L indicate a bending life. -H indicates a long bending life (for moving parts), and -L indicates a standard bending life (for fixed parts).

3. A screw thread is cut on the electromagnetic brake connector of HG-SNS series, and the screw type connector can be used.

4. The connector set contains a plug and contacts. Using contacts for other plugs may damage the connector. Use the enclosed contacts.

5. For unlisted lengths of the cables, please contact Mitsubishi Electric System & Service Co., Ltd. OVERSEAS SERVICE SECTION. (Email: osb.webmaster@melsc.jp)

6. For fabricating cables, please contact Mitsubishi Electric System & Service Co., Ltd. OVERSEAS SERVICE SECTION. (Email: osb.webmaster@melsc.jp)

7. Use MR-EKCBL\_M-H or MR-ECNM to connect to an output cable for AT343A, AT543A-SC or AT545A-SC scales manufactured by Mitutoyo Corporation.

8. The crimping tool (91529-1) manufactured by TE Connectivity Ltd. Company is required. Contact the manufacturer directly.

**Configuration Example for Linear Servo Motors (Note 2)**

**LM-H3 series**

● When using a serial linear encoder

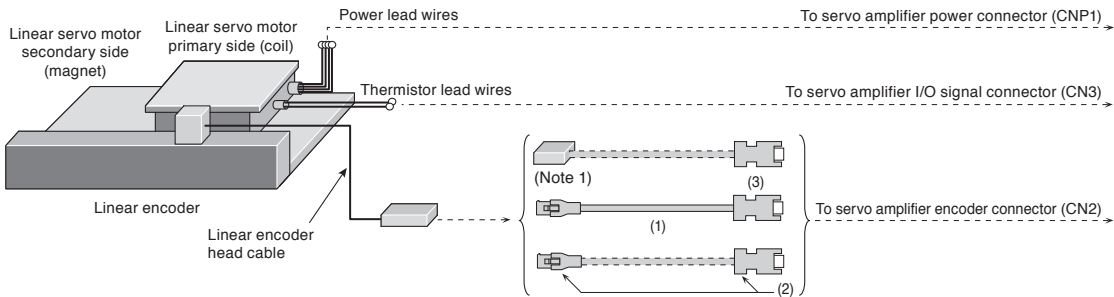

● When using an A/B/Z-phase differential output type linear encoder

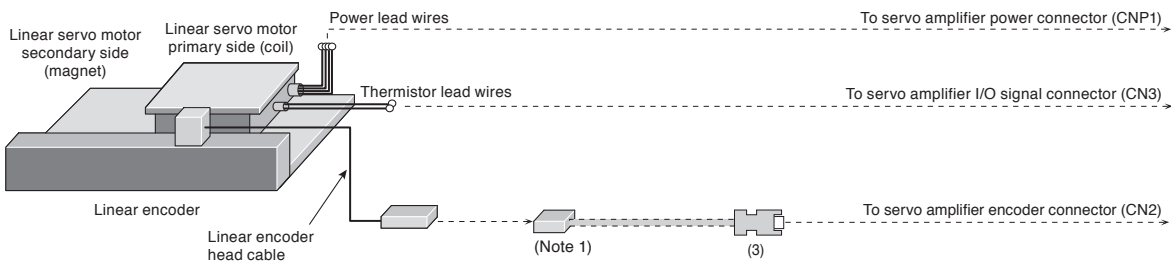

**LM-AJ series/LM-AU series**

● When using a serial linear encoder

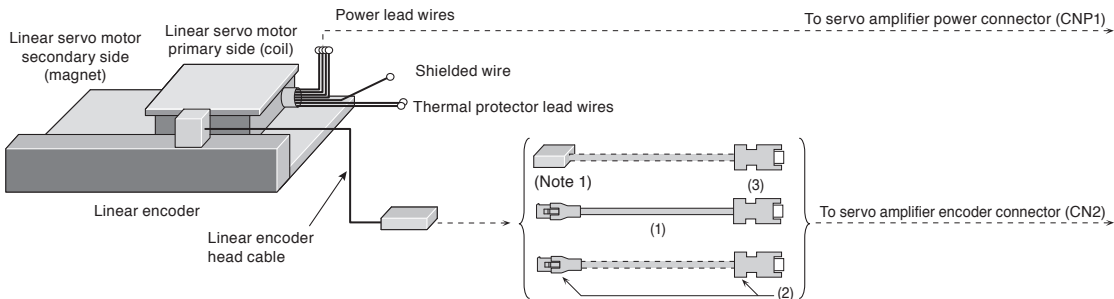

● When using an A/B/Z-phase differential output type linear encoder

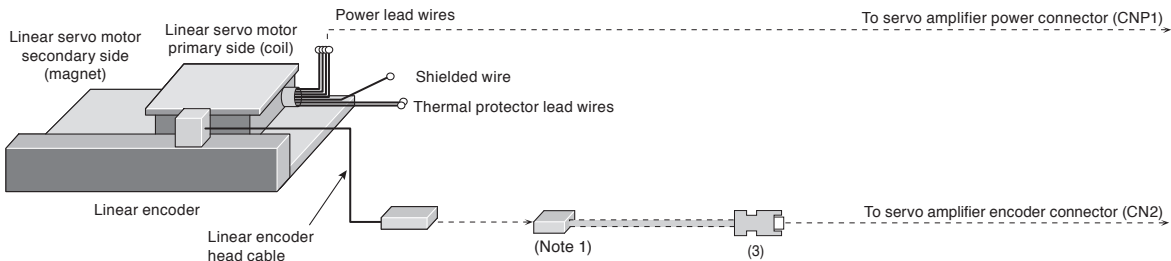



Notes: 1. Contact the relevant linear encoder manufacturers for connectors to connect with the head cables.  
2. Cables drawn with dashed lines need to be fabricated by users. Refer to "Linear Servo Motor User's Manual" when fabricating the cables.

Common Specifications  
Servo System Controllers  
Servo Amplifiers  
Rotary Servo Motors  
Linear Servo Motors  
Options/Peripheral Equipment  
LV/SW/Wires  
Product List  
Precautions  
Support

## Options/Peripheral Equipment

### Cables and Connectors for Linear Servo Motors

Refer to "Details of Option Connectors for Servo Motors" in this catalog for the detailed models.













No.	Item	Model	Cable length	IP rating (Note 1)	Application	Description
(1)	Encoder cable (Note 3, 4, 5)	MR-EKCBL2M-H	2 m	IP20	Connecting a linear encoder	Junction connector      Servo amplifier connector 
		MR-EKCBL5M-H	5 m			
(2)	Encoder connector set (Note 2, 3)	MR-ECNM	-	IP20	Connecting a linear encoder	Junction connector      Servo amplifier connector   Applicable cable Wire size: AWG 26 to 22 Cable OD: 7 mm to 9 mm
(3)	Encoder connector set	MR-J3CN2	-	-	Connecting a linear encoder	Servo amplifier connector 

- Notes:
1. The IP rating indicated is for the connector's protection against ingress of dust and water when coupled to a servo motor. If the IP rating of the servo motor differs from that of these connectors, overall IP rating depends on the lowest of all.
  2. The crimping tool (91529-1) manufactured by TE Connectivity Ltd. Company is required. Contact the manufacturer directly.
  3. Use MR-EKCBL\_M-H or MR-ECNM to connect to an output cable for AT343A, AT543A-SC or AT545A-SC scales manufactured by Mitutoyo Corporation.
  4. -H indicates a long bending life (for moving parts), and -L indicates a standard bending life (for fixed parts).
  5. Encoder cables are not subject to Low Voltage Directive (50 V AC to 1000 V AC and 75 V DC to 1500 V DC).

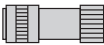

## Details of Option Connectors for HG Series Rotary Servo Motors

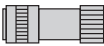
HG

Model	Encoder connector	Servo amplifier connector
MR-J3ENCBL_M-A1-H (Note 2) MR-J3ENCBL_M-A1-L (Note 2) MR-J3ENCBL_M-A2-H (Note 2) MR-J3ENCBL_M-A2-L (Note 2)	 2174053-1 (TE Connectivity Ltd. Company)	 Receptacle: 36210-0100PL Shell kit: 36310-3200-008 (3M) or Connector set: 54599-1019 (Molex, LLC)
Model	Encoder connector	Junction connector
MR-J3JCBL03M-A1-L (Note 2) MR-J3JCBL03M-A2-L (Note 2)	 2174053-1 (TE Connectivity Ltd. Company)	 Contact: 1473226-1 (with ring) Housing: 1-172169-9 Cable clamp: 316454-1 (TE Connectivity Ltd. Company)
Model	Junction connector	Servo amplifier connector
MR-EKCBL_M-H MR-EKCBL_M-L MR-ECNM	 Housing: 1-172161-9 Connector pin: 170359-1 (TE Connectivity Ltd. Company) or an equivalent product Cable clamp: MTI-0002 (Toa Electric Industrial Co., Ltd.)	 Receptacle: 36210-0100PL Shell kit: 36310-3200-008 (3M) or Connector set: 54599-1019 (Molex, LLC)
Model	Encoder connector	Junction connector
MR-J3JSCBL03M-A1-L (Note 2) MR-J3JSCBL03M-A2-L (Note 2)	 2174053-1 (TE Connectivity Ltd. Company)	 Cable receptacle: CM10-CR10P-M (DDK Ltd.)
Model	Encoder connector	Servo amplifier connector
MR-J3ENSCBL_M-H (Note 2) MR-J3ENSCBL_M-L (Note 2)	 For 10 m or shorter cable Straight plug: CMV1-SP10S-M1 Socket contact: CMV1-#22ASC-C1-100 For 20 m or longer cable Straight plug: CMV1-SP10S-M1 (long bending life) CMV1-SP10S-M2 (standard) Socket contact: CMV1-#22ASC-C2-100 (DDK Ltd.)	 Receptacle: 36210-0100PL Shell kit: 36310-3200-008 (3M) or Connector set: 54599-1019 (Molex, LLC)
Model	Junction connector/encoder connector	Servo amplifier connector
MR-J3SCNS (Note 1, 2, 3)	 Straight plug: CMV1-SP10S-M2 Socket contact: CMV1-#22ASC-S1-100 (DDK Ltd.)	 Receptacle: 36210-0100PL Shell kit: 36310-3200-008 (3M) or Connector set: 54599-1019 (Molex, LLC)

- Notes: 1. Cable clamps and bushings for cable OD of 5.5 mm to 7.5 mm and of 7.0 mm to 9.0 mm are included in the set.  
2. Some cables or connector sets may contain the connectors of different shapes. However, these connectors are all usable.  
3. The connector set contains a plug and contacts. Using contacts for other plugs may damage the connector. Use the enclosed contacts.

Common Specifications

Servo System Controllers

Servo Amplifiers

Rotary Servo Motors

Linear Servo Motors

Options/Peripheral Equipment











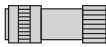

LV/SWires

Product List

Precautions

Support







## Details of Option Connectors for HG Series Rotary Servo Motors

Model	Encoder connector	Servo amplifier connector
MR-ENCNS2 (Note 1, 3)	 Straight plug: CMV1S-SP10S-M2 Socket contact: CMV1-#22ASC-S1-100 (DDK Ltd.)	 Receptacle: 36210-0100PL Shell kit: 36310-3200-008 (3M) or Connector set: 54599-1019 (Molex, LLC)
MR-J3SCNSA (Note 1, 2, 3)	 Angle plug: CMV1-AP10S-M2 Socket contact: CMV1-#22ASC-S1-100 (DDK Ltd.)	 Receptacle: 36210-0100PL Shell kit: 36310-3200-008 (3M) or Connector set: 54599-1019 (Molex, LLC)
MR-ENCNS2A (Note 1, 3)	 Angle plug: CMV1S-AP10S-M2 Socket contact: CMV1-#22ASC-S1-100 (DDK Ltd.)	 Receptacle: 36210-0100PL Shell kit: 36310-3200-008 (3M) or Connector set: 54599-1019 (Molex, LLC)
MR-PWS1CBL_M-A1-H (Note 2) MR-PWS1CBL_M-A1-L (Note 2) MR-PWS1CBL_M-A2-H (Note 2) MR-PWS1CBL_M-A2-L (Note 2)	 Plug: KN4FT04SJ1-R Socket contact: ST-TMH-S-C1B-100-(A534G) (Japan Aviation Electronics Industry, Limited)	
MR-PWS2CBL03M-A1-L (Note 2) MR-PWS2CBL03M-A2-L (Note 2)	 Plug: KN4FT04SJ2-R Socket contact: ST-TMH-S-C1B-100-(A534G) (Japan Aviation Electronics Industry, Limited)	
MR-PWCNS4	 Plug: CE05-6A18-10SD-D-BSS (straight) Cable clamp: CE3057-10A-1-D (DDK Ltd.)	
MR-PWCNS5	 Plug: CE05-6A22-22SD-D-BSS (straight) Cable clamp: CE3057-12A-1-D (DDK Ltd.)	
MR-BKS1CBL_M-A1-H MR-BKS1CBL_M-A1-L MR-BKS1CBL_M-A2-H MR-BKS1CBL_M-A2-L	 Plug: JN4FT02SJ1-R Socket contact: ST-TMH-S-C1B-100-(A534G) (Japan Aviation Electronics Industry, Limited)	
MR-BKS2CBL03M-A1-L MR-BKS2CBL03M-A2-L	 Plug: JN4FT02SJ2-R Socket contact: ST-TMH-S-C1B-100-(A534G) (Japan Aviation Electronics Industry, Limited)	

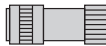
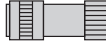

- Notes: 1. Cable clamps and bushings for cable OD of 5.5 mm to 7.5 mm and of 7.0 mm to 9.0 mm are included in the set.  
 2. Some cables or connector sets may contain the connectors of different shapes. However, these connectors are all usable.  
 3. The connector set contains a plug and contacts. Using contacts for other plugs may damage the connector. Use the enclosed contacts.

## Details of Option Connectors for HG Series Rotary Servo Motors

HG

Model	Electromagnetic brake connector	
MR-BKCNS1 (Note 1, 2)		Straight plug: CMV1-SP2S-L Socket contact: CMV1-#22BSC-S2-100 (DDK Ltd.)
MR-BKCNS2 (Note 2)		Straight plug: CMV1S-SP2S-L Socket contact: CMV1-#22BSC-S2-100 (DDK Ltd.)
MR-BKCNS1A (Note 1, 2)		Angle plug: CMV1-AP2S-L Socket contact: CMV1-#22BSC-S2-100 (DDK Ltd.)
MR-BKCNS2A (Note 2)		Angle plug: CMV1S-AP2S-L Socket contact: CMV1-#22BSC-S2-100 (DDK Ltd.)
MR-J3CN2	Servo amplifier connector	
		Receptacle: 36210-0100PL Shell kit: 36310-3200-008 (3M)
	or	Connector set: 54599-1019 (Molex, LLC)
MR-J4FCCBL03M MR-J3THMCN2	Junction connector	
		Plug: 36110-3000FD Shell kit: 36310-F200-008 (3M)
		Servo amplifier connector
		
		Receptacle: 36210-0100PL Shell kit: 36310-3200-008 (3M)

## Details of Option Connectors for Linear Servo Motors

Model	Junction connector	Servo amplifier connector
MR-EKCBL_M-H MR-ECNM		
	Housing: 1-172161-9 Connector pin: 170359-1 (TE Connectivity Ltd. Company) or an equivalent product Cable clamp: MTI-0002 (Toa Electric Industrial Co., Ltd.)	Receptacle: 36210-0100PL Shell kit: 36310-3200-008 (3M) or Connector set: 54599-1019 (Molex, LLC)
MR-J3CN2	Servo amplifier connector	
		Receptacle: 36210-0100PL Shell kit: 36310-3200-008 (3M)
	or	Connector set: 54599-1019 (Molex, LLC)

Notes: 1. Some cables or connector sets may contain the connectors of different shapes. However, these connectors are all usable.  
2. The connector set contains a plug and contacts. Using contacts for other plugs may damage the connector. Use the enclosed contacts.

Common Specifications

Servo System Controllers

Servo Amplifiers

Rotary Servo Motors

Linear Servo Motors

Options/Peripheral Equipment

LV/SWires

Product List

Precautions

Support

## Products on the Market for HG Series Rotary Servo Motors

HG

Contact the relevant manufacturers directly.

When fabricating a cable with the following connectors, refer to the relevant manufacturers' instruction manuals for wiring and assembling procedures.

### Encoder connector (servo amplifier side)



Application	Connector (3M)
Servo amplifier CN2 connector	Receptacle: 36210-0100PL Shell kit: 36310-3200-008
	Connector (Molex, LLC)
	54599-1019 (gray)
	54599-1016 (black)

### Encoder connector for HG-KNS series



Applicable servo motor	IP rating (Note 1)	Connector (TE Connectivity Ltd. Company)	Crimping tool (TE Connectivity Ltd. Company)	Applicable cable example
HG-KNS series	IP65	2174053-1	For ground clip: 1596970-1 For receptacle contact: 1596847-1	Wire size: 0.13 mm <sup>2</sup> to 0.33 mm <sup>2</sup> (AWG 26 to 22) Cable OD: 6.8 mm to 7.4 mm Wire example: Fluorine resin wire (Vinyl jacket cable TPE. SVP 70/0.08 (AWG#22)-3P KB-2237-2 Bando Densen Co., Ltd. (Note 2) or an equivalent product)

Straight type      Angle type



### Encoder connector for HG-SNS series

Applicable servo motor	IP rating (Note 1)	Connector (DDK Ltd.)				Applicable cable example
		Type	Type of connection	Plug	Socket contact	Cable OD [mm]
HG-SNS series	IP67	Straight	One-touch connection type	CMV1-SP10S-M1	Select a solder or press bonding type. (Refer to the table below.)	5.5 to 7.5
				CMV1-SP10S-M2		7.0 to 9.0
			Screw type	CMV1S-SP10S-M1		5.5 to 7.5
				CMV1S-SP10S-M2		7.0 to 9.0
		Angle	One-touch connection type	CMV1-AP10S-M1		5.5 to 7.5
				CMV1-AP10S-M2		7.0 to 9.0
			Screw type	CMV1S-AP10S-M1		5.5 to 7.5
				CMV1S-AP10S-M2		7.0 to 9.0

Contact	Socket contact (DDK Ltd.)	Wire size (Note 3)
Solder type	CMV1-#22ASC-S1-100	0.5 mm <sup>2</sup> (AWG 20) or smaller
Press bonding type	CMV1-#22ASC-C1-100	0.2 mm <sup>2</sup> to 0.5 mm <sup>2</sup> (AWG 24 to 20) Crimping tool (357J-53162T) is required.
	CMV1-#22ASC-C2-100	0.08 mm <sup>2</sup> to 0.2 mm <sup>2</sup> (AWG 28 to 24) Crimping tool (357J-53163T) is required.

- Notes: 1. The IP rating indicated is for the connector's protection against ingress of dust and water when coupled to a servo motor. If the IP rating of the servo motor differs from that of these connectors, overall IP rating depends on the lowest of all.  
2. Contact Toa Electric Industrial Co., Ltd.  
3. The wire size shows wiring specifications of the connector.

Products on the Market for HG Series Rotary Servo Motors

Contact the relevant manufacturers directly.

When fabricating a cable with the following connectors, refer to the relevant manufacturers' instruction manuals for wiring and assembling procedures.

Power connector for HG-KNS series



Applicable servo motor	IP rating (Note 1)	Connector (Japan Aviation Electronics Industry, Limited)	Crimping tool (Japan Aviation Electronics Industry, Limited)	Applicable cable example
HG-KNS series	IP65	Plug: KN4FT04SJ1-R Socket contact: ST-TMH-S-C1B-100-(A534G)	For contactor: CT170-14-TMH5B	Wire size: 0.3 mm <sup>2</sup> to 0.75 mm <sup>2</sup> (AWG 22 to 18) Cable OD: 5.3 mm to 6.5 mm Wire example: Fluorine resin wire (Vinyl jacket cable RMFES-A (CL3X) AWG 19, 4 cores Dyden Corporation (Note 3) or an equivalent product)

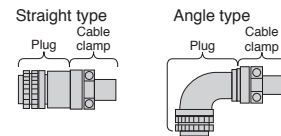

Power connector for HG-SNS series

Applicable servo motor	IP rating (Note 1)	Plug (with backshell) (DDK Ltd.)		Cable clamp (DDK Ltd.)	Applicable cable example	
		Type	Model	Model	Wire size (Note 2)	Cable OD [mm]
HG-SNS52J, 102J, 152J	IP67	Straight	CE05-6A18-10SD-D-BSS	CE3057-10A-2-D	2.2 mm <sup>2</sup> to 3.5 mm <sup>2</sup> (AWG 14 to 12)	8.5 to 11
	-			CE3057-10A-1-D		10.5 to 14.1
HG-SNS202J, 302J	IP67		CE05-6A22-22SD-D-BSS	CE3057-12A-2-D	5.5 mm <sup>2</sup> to 8 mm <sup>2</sup> (AWG 10 to 8)	9.5 to 13
	-			CE3057-12A-1-D		12.5 to 16
HG-SNS52J, 102J, 152J	IP67	Angle	CE05-8A18-10SD-D-BAS	CE3057-10A-2-D	2.2 mm <sup>2</sup> to 3.5 mm <sup>2</sup> (AWG 14 to 12)	8.5 to 11
	-			CE3057-10A-1-D		10.5 to 14.1
HG-SNS202J, 302J	IP67		CE05-8A22-22SD-D-BAS	CE3057-12A-2-D	5.5 mm <sup>2</sup> to 8 mm <sup>2</sup> (AWG 10 to 8)	9.5 to 13
	-			CE3057-12A-1-D		12.5 to 16
		D/MS3106B18-10S	D/MS3057-10A	2.2 mm <sup>2</sup> to 3.5 mm <sup>2</sup> (AWG 14 to 12)	14.3 or smaller (bushing ID)	
		D/MS3106B22-22S	D/MS3057-12A	5.5 mm <sup>2</sup> to 8 mm <sup>2</sup> (AWG 10 to 8)	15.9 or smaller (bushing ID)	
		D/MS3108B18-10S	D/MS3057-10A	2.2 mm <sup>2</sup> to 3.5 mm <sup>2</sup> (AWG 14 to 12)	14.3 or smaller (bushing ID)	
		D/MS3108B22-22S	D/MS3057-12A	5.5 mm <sup>2</sup> to 8 mm <sup>2</sup> (AWG 10 to 8)	15.9 or smaller (bushing ID)	

Notes: 1. The IP rating indicated is for the connector's protection against ingress of dust and water when coupled to a servo motor. If the IP rating of the servo motor differs from that of these connectors, overall IP rating depends on the lowest of all.  
 2. The wire size shows wiring specifications of the connector. Refer to "Selection Example in HIV Wires for Servo Motors" in this catalog for examples of wire size selection.  
 3. Contact Taisei Co., Ltd.

Common Specifications  
 Servo System Controllers  
 Servo Amplifiers  
 Rotary Servo Motors  
 Linear Servo Motors  
 Options/Peripheral Equipment  
 LV/S/Wires  
 Product List  
 Precautions  
 Support

## Products on the Market for HG Series Rotary Servo Motors

HG

Contact the relevant manufacturers directly.

When fabricating a cable with the following connectors, refer to the relevant manufacturers' instruction manuals for wiring and assembling procedures.

### Electromagnetic brake connector for HG-KNS series



Applicable servo motor	IP rating (Note 1)	Connector (Japan Aviation Electronics Industry, Limited)	Crimping tool (Japan Aviation Electronics Industry, Limited)	Applicable cable example
HG-KNS series	IP65	Plug: JN4FT02SJ1-R Socket contact: ST-TMH-S-C1B-100-(A534G)	For contactor: CT170-14-TMH5B	Wire size: 0.3 mm <sup>2</sup> to 0.5 mm <sup>2</sup> (AWG 22 to 20) Cable OD: 3.6 mm to 4.8 mm Wire example: Fluorine resin wire (Vinyl jacket cable RMFES-A (CL3X) AWG 20, 2 cores Dyden Corporation (Note 2) or an equivalent product)

Straight type

Angle type

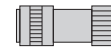

### Electromagnetic brake connector for HG-SNS series

Applicable servo motor	IP rating (Note 1)	Connector (DDK Ltd.)				Applicable cable example
		Type	Type of connection	Plug	Socket contact	Cable OD [mm]
HG-SNS series	IP67	Straight	One-touch connection type	CMV1-SP2S-S	Select a solder or press bonding type. (Refer to the table below.)	4.0 to 6.0
				CMV1-SP2S-M1		5.5 to 7.5
				CMV1-SP2S-M2		7.0 to 9.0
				CMV1-SP2S-L		9.0 to 11.6
			Screw type	CMV1S-SP2S-S		4.0 to 6.0
				CMV1S-SP2S-M1		5.5 to 7.5
				CMV1S-SP2S-M2		7.0 to 9.0
				CMV1S-SP2S-L		9.0 to 11.6
		Angle	One-touch connection type	CMV1-AP2S-S		4.0 to 6.0
				CMV1-AP2S-M1		5.5 to 7.5
				CMV1-AP2S-M2		7.0 to 9.0
				CMV1-AP2S-L		9.0 to 11.6
			Screw type	CMV1S-AP2S-S		4.0 to 6.0
				CMV1S-AP2S-M1		5.5 to 7.5
				CMV1S-AP2S-M2		7.0 to 9.0
				CMV1S-AP2S-L		9.0 to 11.6

Contact	Socket contact (DDK Ltd.)	Wire size (Note 3)
Solder type	CMV1-#22BSC-S2-100	1.25 mm <sup>2</sup> (AWG 16) or smaller
Press bonding type	CMV1-#22BSC-C3-100	0.5 mm <sup>2</sup> to 1.25 mm <sup>2</sup> (AWG 20 to 16) Crimping tool (357J-53164T) is required.

- Notes: 1. The IP rating indicated is for the connector's protection against ingress of dust and water when coupled to a servo motor. If the IP rating of the servo motor differs from that of these connectors, overall IP rating depends on the lowest of all.  
2. Contact Taisei Co., Ltd.  
3. The wire size shows wiring specifications of the connector. Refer to "Selection Example in HIV Wires for Servo Motors" in this catalog for examples of wire size selection.

## Configuration Example for Servo Amplifiers

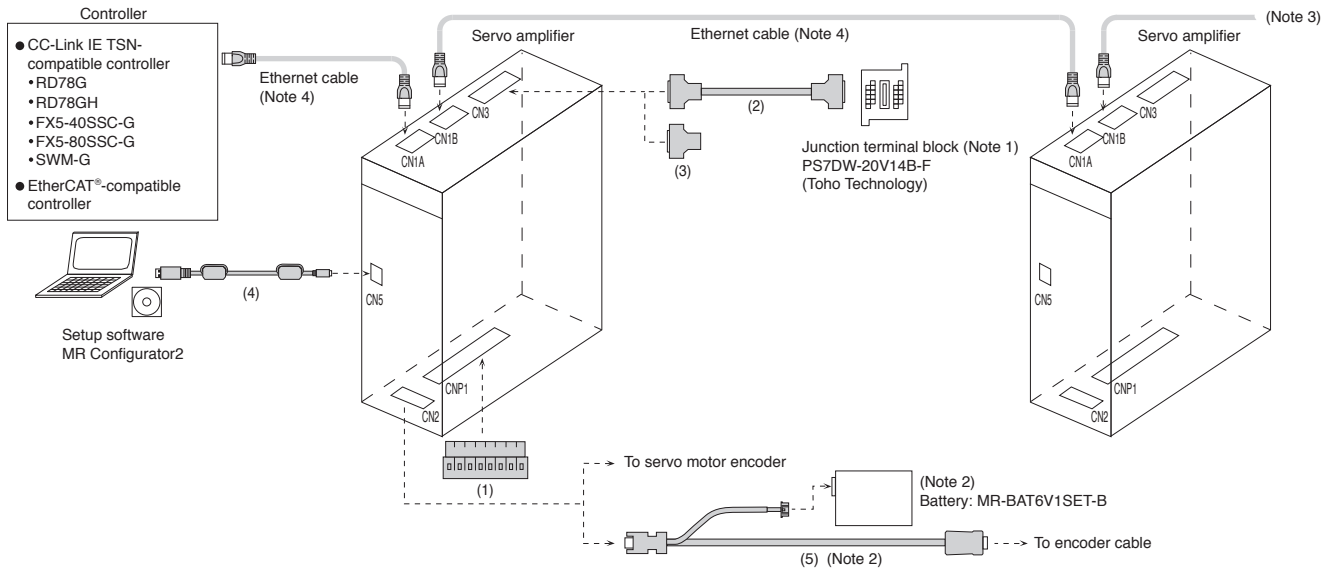

- Notes:
1. Refer to "Junction Terminal Block" in this catalog.
  2. When configuring an absolute position detection system with a rotary servo motor having a battery backup type absolute position encoder, whether a battery (MR-BAT6V1SET-B) is required depends on the system configuration. In addition, use the battery branch cable (MR-BT6V4CBL03M) when using the battery. Refer to "Battery" in this catalog for information on whether a battery is required, details, and connections of the battery.
  3. When branching off CC-Link IE TSN (synchronous communication function) with a switching hub, use a switching hub (Class B) recommended by CC-Link Partner Association. When a switching hub (Class A) is used, there are restrictions on the topologies to be used. Refer to the controller user's manual for details.
  4. For specifications of the Ethernet cable, refer to "Ethernet Cable Specifications" in this catalog.

## Ethernet Cable Specifications











Item	CC-Link IE TSN <sup>(Note 1, 2)</sup>	EtherCAT®/CC-Link IE Field Network Basic
Ethernet Cable	Category 5e or higher, (double shielded/STP) straight cable	
	Standard	The cable must meet the following: • IEEE802.3 (1000BASE-T) • ANSI/TIA/EIA-568-B (Category 5e)
	Connector	RJ-45 connector with shield

- Notes:
1. Use wiring parts recommended by CC-Link Partner Association for wiring the CC-Link IE TSN.
  2. Cables for CC-Link IE Controller Network cannot be used with CC-Link IE TSN.

## Options/Peripheral Equipment

### Cables and Connectors for Servo Amplifiers











Refer to "Details of Option Connectors for Servo Amplifiers" in this catalog for the detailed models.

No.	Item	Application	Cable length	Model	Description
For CNP1	(1) Servo amplifier power connector set	For MR-JET-100G or smaller	-	(Standard accessory)	CNP1 connector  Open tool  Applicable wire size <sup>(Note 1)</sup> : AWG 18 to 14 Insulator OD: 3.9 mm or smaller
		For MR-JET-200G/ MR-JET-300G	-		CNP1 connector  Open tool  Applicable wire size <sup>(Note 1)</sup> : AWG 16 to 10 Insulator OD: 4.7 mm or smaller
For CN3	(2) Junction terminal block cable	For connecting MR-JET-_G and PS7DW-20V14B-F	0.5 m	MR-J2HBUS05M	 Servo amplifier connector      Junction terminal block connector
			1 m	MR-J2HBUS1M	
			5 m	MR-J2HBUS5M	
(3)	Connector set	For MR-JET-_G	-	MR-CCN1	 Servo amplifier connector
For CN5	(4) Personal computer communication cable (USB cable)	For MR-JET-_G	3 m	MR-J3USBCBL3M	Personal computer connector  Servo amplifier connector  A connector      mini-B connector (5-pin)
For CN2	(5) Battery branch cable	For MR-JET-_G	0.3 m	MR-BT6V4CBL03M	Servo amplifier connector  Battery connector  Junction connector  Cable length Encoder side: 0.3 m Battery side: 0.1 m

Notes: 1. The wire size shows wiring specifications of the connector. Refer to "Selection Example in HIV Wires for Servo Motors" in this catalog for examples of wire size selection.



## Details of Option Connectors for Servo Amplifiers

Model	CNP1 connector		Open tool
Servo amplifier power connector set For MR-JET-100G or smaller (standard accessory)		1-2349815-2 (TE Connectivity Ltd. Company)	 1981045-1 (TE Connectivity Ltd. Company)
Model	CNP1 connector		Open tool
Servo amplifier power connector set For MR-JET-200G/ MR-JET-300G (standard accessory)		1-2349825-8 (TE Connectivity Ltd. Company)	 2349891-1 (TE Connectivity Ltd. Company)
Model	Servo amplifier connector	Junction terminal block connector	
MR-J2HBUS_M	 Press bonding type <sup>(Note 2)</sup> Connector: 10120-6000EL Shell kit: 10320-3210-000 (3M) or an equivalent product	 Press bonding type <sup>(Note 2)</sup> Connector: 10120-6000EL Shell kit: 10320-3210-000 (3M) or an equivalent product	
Model	Servo amplifier connector	Solder type <sup>(Note 1)</sup> Connector: 10120-3000PE Shell kit: 10320-52F0-008 (3M) or an equivalent product	
MR-CCN1			
Model	Servo amplifier connector	Battery connector	Junction connector
MR-BT6V4CBL03M	 Receptacle: 36210-0100PL Shell kit: 36310-3200-008 (3M)	 Contact: SPHD-002GW-P0.5 Housing: PAP-05V-S (J.S.T. Mfg. Co., Ltd.)	 Plug: 36110-3000FD Shell kit: 36310-F200-008 (3M)

Notes: 1. The press bonding type (Connector: 10120-6000EL and shell kit: 10320-3210-000) (3M) is also usable. Contact the manufacturer directly.  
2. The solder type (connector: 10120-3000PE and shell kit: 10320-52F0-008) (3M) is also usable. Contact the manufacturer directly.

## Products on the Market for Servo Amplifiers

## Ethernet Cable

Item	Model	Specifications
Ethernet Cable	For indoor	SC-E5EW-S_M _: cable length (0.5 m, 1 to 100 m (unit of 1 m))
	For indoor and moving part	SC-E5EW-S_M-MV _: cable length (0.1, 0.2, 0.3, 0.5 m, 1 to 45 m (unit of 1 m))
	For indoor/outdoor	SC-E5EW-S_M-L _: cable length (1 to 100 m (unit of 1 m))

Double shielded cable (Category 5e)

For details, please contact Mitsubishi Electric System & Service Co., Ltd. OVERSEAS SERVICE SECTION. (Email: osb.webmaster@melsc.jp)

\* When using CC-Link IE TSN, refer to the website of CC-Link Partner Association for cables on the market other than above.  
<https://www.cc-link.org/en/>

## Options/Peripheral Equipment

### Regenerative Option (MR-RB)

Servo amplifier model	Permissible regenerative power [W] <sup>(Note 2)</sup>						
	Built-in regenerative resistor	Regenerative option					
		MR-RB					
		032	12	14	30 <sup>(Note 3)</sup>	34 <sup>(Note 3)</sup>	50 <sup>(Note 1)</sup>
	40 Ω	40 Ω	26 Ω	13 Ω	26 Ω	13 Ω	
MR-JET-10G	-	30	-	-	-	-	-
MR-JET-20G	-	30	100	-	-	-	-
MR-JET-40G	10	30	100	-	-	-	-
MR-JET-70G	30	-	-	100	-	300	-
MR-JET-100G	30	-	-	100	-	300	-
MR-JET-200G	100	-	-	-	300	-	500
MR-JET-300G	100	-	-	-	300	-	500

- Notes: 1. Cool the unit forcibly with a cooling fan (92 mm × 92 mm, minimum air flow: 1.0 m<sup>3</sup>/min). The cooling fan must be prepared by users.  
 2. The power values in this table are resistor-generated powers, not rated powers.  
 3. It may be necessary to cool the unit forcibly with a cooling fan (92 mm × 92 mm, minimum air flow: 1.0 m<sup>3</sup>/min), depending on the operating environment. Refer to "MR-JET User's Manual" for details. The cooling fan must be prepared by users.

#### \* Precautions when installing and connecting the regenerative option

1. The regenerative option causes a temperature rise of 100 °C or higher relative to the ambient temperature. Fully examine heat dissipation, installation position, wires used before installing the unit. Use flame-retardant wires or apply flame retardant on wires, and keep the wires clear of the unit.
2. Use twisted wires for connecting the regenerative option to the servo amplifier, and keep the wire length to a maximum of 5 m.
3. Use twisted wires for connecting a thermal sensor so that the sensor does not fail to work properly because of inducted noise.
4. There are restrictions on the mounting direction of the regenerative option. Refer to "MR-JET User's Manual" for details.

Regenerative Option (MR-RB)

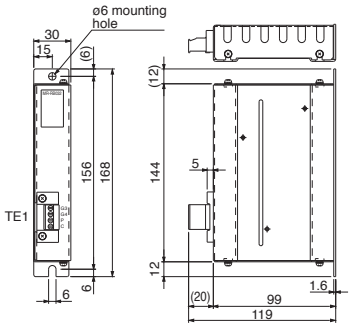
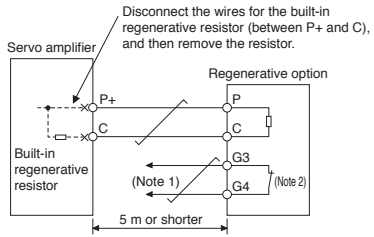
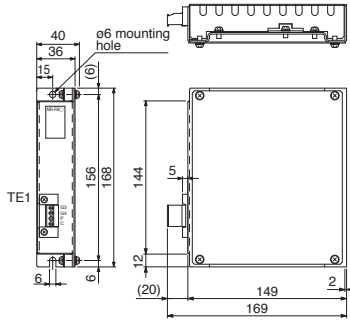
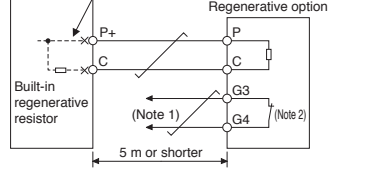
Dimensions	Connections										
<p>MR-RB032</p>  <p>Terminal arrangement</p> <table border="1" data-bbox="869 425 901 537"> <tr><td>TE1</td></tr> <tr><td>G3</td></tr> <tr><td>G4</td></tr> <tr><td>P</td></tr> <tr><td>C</td></tr> </table> <p>Applicable wire size (Note 3): 0.2 mm<sup>2</sup> to 2.5 mm<sup>2</sup> (AWG 24 to 12) Mounting screw size: M5</p> <table border="1" data-bbox="810 616 1008 667"> <thead> <tr> <th>Model</th> <th>Mass [kg]</th> </tr> </thead> <tbody> <tr> <td>MR-RB032</td> <td>0.5</td> </tr> </tbody> </table>	TE1	G3	G4	P	C	Model	Mass [kg]	MR-RB032	0.5	 <p>Disconnect the wires for the built-in regenerative resistor (between P+ and C), and then remove the resistor.</p>	
TE1											
G3											
G4											
P											
C											
Model	Mass [kg]										
MR-RB032	0.5										
<p>MR-RB12, MR-RB14</p>  <p>Terminal arrangement</p> <table border="1" data-bbox="869 772 901 884"> <tr><td>TE1</td></tr> <tr><td>G3</td></tr> <tr><td>G4</td></tr> <tr><td>P</td></tr> <tr><td>C</td></tr> </table> <p>Applicable wire size (Note 3): 0.2 mm<sup>2</sup> to 2.5 mm<sup>2</sup> (AWG 24 to 12) Mounting screw size: M5</p> <table border="1" data-bbox="810 963 1008 1034"> <thead> <tr> <th>Model</th> <th>Mass [kg]</th> </tr> </thead> <tbody> <tr> <td>MR-RB12</td> <td rowspan="2">1.1</td> </tr> <tr> <td>MR-RB14</td> </tr> </tbody> </table>	TE1	G3	G4	P	C	Model	Mass [kg]	MR-RB12	1.1	MR-RB14	 <p>5 m or shorter</p>
TE1											
G3											
G4											
P											
C											
Model	Mass [kg]										
MR-RB12	1.1										
MR-RB14											

- Notes:
1. Create a sequence circuit that turns off the magnetic contactor when abnormal overheating occurs.
  2. G3 and G4 terminals are thermal sensor. G3-G4 opens when the regenerative option overheats abnormally.
  3. The wire size shows wiring specifications of the connector. Refer to "Wires, Molded-Case Circuit Breakers, and Magnetic Contactors" in this catalog for examples of wire size selection.

Common Specifications

Servo System Controllers

Servo Amplifiers

Rotary Servo Motors

Linear Servo Motors

Options/Peripheral Equipment

LV/SWires

Product List

Precautions

Support



## Replacement Fan Unit (MR-JET-FAN1)

The cooling fan of the 2 kW and 3 kW servo amplifiers has a fan and a fan cover as a unit. Replace the fan unit when the fan needs to be replaced. Refer to "MR-JET User's Manual" for replacement of the cooling fan.

Servo amplifier model	Replacement fan unit model
MR-JET-200G MR-JET-300G	MR-JET-FAN1

[Products on the Market]

## Junction Terminal Block (PS7DW-20V14B-F)

This terminal block is used for wiring signals.

Dimensions	[Unit: mm]
	<p>Toho Technology Corp., Kyoto Factory</p> <p>Applicable wire: 1.25 mm<sup>2</sup> maximum</p>

Common Specifications

Servo System Controllers

Servo Amplifiers

Rotary Servo Motors

Linear Servo Motors

Options/Peripheral Equipment

LV/SWires

Product List

Precautions

Support

# Options/Peripheral Equipment

## Battery (MR-BAT6V1SET-B)

When configuring an absolute position detection system, refer to the table below to check whether a battery is required.

Motor side	Semi closed loop control system	Fully closed loop control system	
		Load-side	Linear encoder
Rotary servo motor with a battery backup type absolute position encoder	Required	Required	Not required
Linear servo motor	Not required	Not supported	Not supported

MR-BAT6V1 is built in MR-BAT6V1SET-B. When the battery life runs out, please replace MR-BAT6V1. Refer to "MR-JET User's Manual" for installation of the battery.

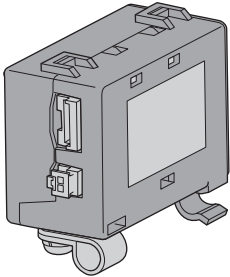
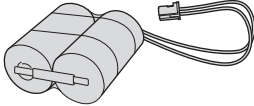
External appearance	MR-BAT6V1												
 <p>Mass: 62 g (including MR-BAT6V1 battery)</p>	 <table border="1" data-bbox="794 898 1332 1048"> <thead> <tr> <th>Model</th> <th>MR-BAT6V1</th> </tr> </thead> <tbody> <tr> <td>Nominal voltage [V]</td> <td>6</td> </tr> <tr> <td>Nominal capacity [mAh]</td> <td>1650</td> </tr> <tr> <td>Lithium content [g]</td> <td>1.2</td> </tr> <tr> <td>Primary battery</td> <td>2CR17335A (CR17335A × 2 pcs. in series)</td> </tr> <tr> <td>Mass [g]</td> <td>34</td> </tr> </tbody> </table>	Model	MR-BAT6V1	Nominal voltage [V]	6	Nominal capacity [mAh]	1650	Lithium content [g]	1.2	Primary battery	2CR17335A (CR17335A × 2 pcs. in series)	Mass [g]	34
Model	MR-BAT6V1												
Nominal voltage [V]	6												
Nominal capacity [mAh]	1650												
Lithium content [g]	1.2												
Primary battery	2CR17335A (CR17335A × 2 pcs. in series)												
Mass [g]	34												

\* MR-BAT6V1 is an assembled battery composed of lithium metal batteries of CR17335A. This battery is not subject to the dangerous goods (Class 9) of the UN Recommendations. To transport lithium metal batteries and lithium metal batteries contained in equipment, take actions to comply with the following regulations: the United Nations Recommendations on the Transport of Dangerous Goods, the Technical Instruction (ICAO-TI) by the International Civil Aviation Organization (ICAO), and the International Maritime Dangerous Goods Code (IMDG Code) by the International Maritime Organization (IMO). To transport the batteries, check the latest standards or the laws of the destination country and take actions. Contact your local sales office for more details.

\* Please dispose of the battery according to your local laws and regulations.

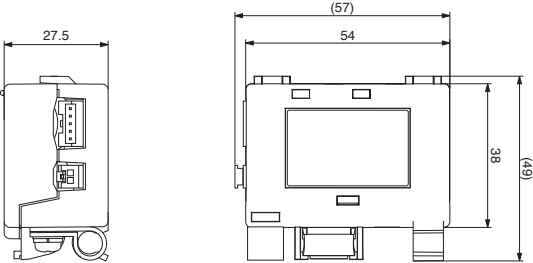
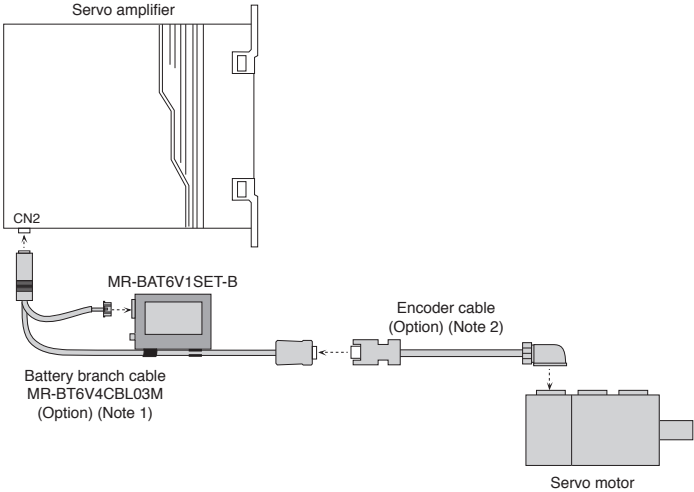
Dimensions	Mounting
	

Notes: 1. Refer to "Cables and Connectors for Servo Amplifiers" for details.  
 2. Refer to "Cables and Connectors for Rotary Servo Motors" for details.

## Radio Noise Filter (FR-BIF)

This filter suppresses noise from the power supply side of the servo amplifier, especially effective for the radio frequency bands of 10 MHz or lower. The radio noise filter is designed to be installed on the input side.

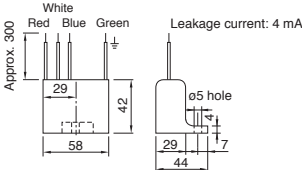
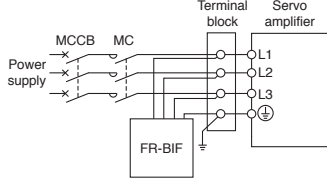
Dimensions	[Unit: mm]	Connections
 <p>Approx. 300 White Red Blue Green Leakage current: 4 mA ø5 hole</p>		<p>Do not use the radio noise filter on the output side of the servo amplifier. Wiring should be as short as possible. Grounding is required. Insulate the unused wire when using the radio noise filter with a 1-phase power supply.</p> 

## Line Noise Filter (FR-BSF01)

This filter is effective in suppressing noise emitted from the power supply side or the output side of the servo amplifier, and also in suppressing high-frequency leakage current (zero-phase current), especially within 0.5 MHz to 5 MHz band.

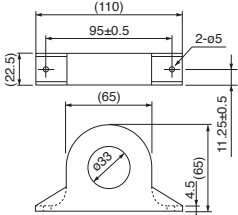
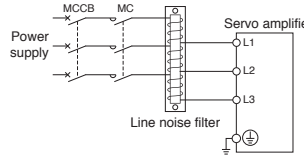
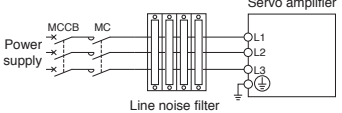
Dimensions	[Unit: mm]	Connections
<p>FR-BSF01 For wire size of 3.5 mm<sup>2</sup> (AWG 12) or smaller</p> 		<p>The line noise filters can be mounted on lines of the power supply (L1/L2/L3) and of the servo motor power (U/V/W). Pass each of the wires through the line noise filter an equal number of times in the same direction.</p> <p>For wires of the power supply, the effect of the filter rises as the number of passes increases, but generally four passes would be appropriate. For the servo motor power lines, passes must be four times or less. Do not pass the grounding wire through the filter. Otherwise, the effect of the filter will drop.</p> <p>Wind the wires by passing through the filter to satisfy the required number of passes as shown in Example 1. If the wires are too thick to wind, use two or more filters to have the required number of passes as shown in Example 2.</p> <p>Place the line noise filters as close to the servo amplifier as possible for their best performance.</p> <p><b>Example 1</b></p>  <p><b>Example 2</b></p> 

## Data Line Filter

This filter is effective in preventing noise when attached to the motor encoder cable, etc.

Example) ESD-SR-250 (manufactured by TOKIN Corporation)  
ZCAT3035-1330 (manufactured by TDK)  
GRFC-13 (manufactured by Kitagawa Industries Co., Ltd.)  
E04SRM563218 (manufactured by Seiwa Electric Mfg. Co., Ltd.)

## Surge Killer

Attach surge killers to AC relays and AC valves around the servo amplifier. Attach diodes to DC relays and DC valves.

Example) Surge killer: CR-50500 (manufactured by Okaya Electric Industries Co., Ltd.)

Diode: A diode with breakdown voltage four or more times greater than the relay drive voltage, and with current capacity two or more times greater than the relay drive current.

# Options/Peripheral Equipment

## EMC Filter

The following filters are recommended as a filter compliant with the EMC directive for the power supply of the servo amplifier. A surge protector is separately required to use the filters. Refer to "MR-JET User's Manual" for details.

Fulfill the following requirements when connecting one or more units of servo amplifiers to one EMC filter.

- Rated voltage [V] of EMC filter  $\geq$  Rated input voltage [V] of servo amplifier
- Rated current [A] of EMC filter  $\geq$  Total rated input current [A] of servo amplifiers connected to EMC filter

Operating environment	Total length of servo motor power cables	EMC Filter						
		Model	Rated current [A]	Rated voltage [V AC]	Operating temperature [°C]	Mass [kg]	Fig.	Manufacturer
IEC/EN 61800-3 Category C2/C3 (Note 1)	50 m or shorter	FSB-10-254-HU	10	250	-40 to 85	1.8	A	COSEL Co., Ltd.
		FSB-20-254-HU	20					
		FSB-30-254-HU	30					
IEC/EN 61800-3 Category C3 (Note 1)	50 m or shorter (Note 2)	HF3010C-SZB	10	500	-20 to 50	0.9	B	Soshin Electric Co., Ltd.
		HF3020C-SZB	20			1.3		
		HF3030C-SZB	30					

- Notes: 1. Category C2: Intended to be installed in either the first environment (residential environment) by a professional or in the second environment (commercial, light industrial, and industrial environments).  
 Category C3: Intended to be installed in the second environment (commercial, light industrial, and industrial environments).  
 2. If the length of the power cable exceeds 20 m, install the radio noise filter (FR-BIF) on the input side of the servo amplifier.

## Connections

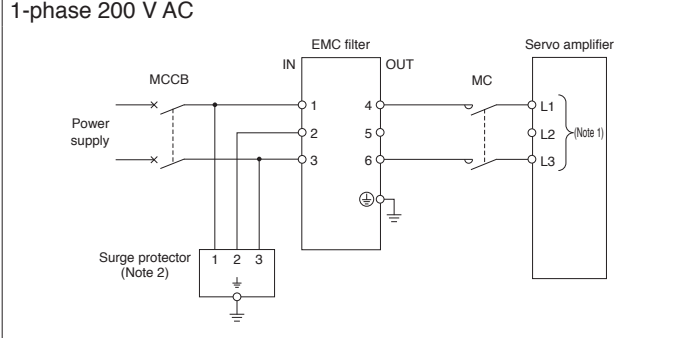
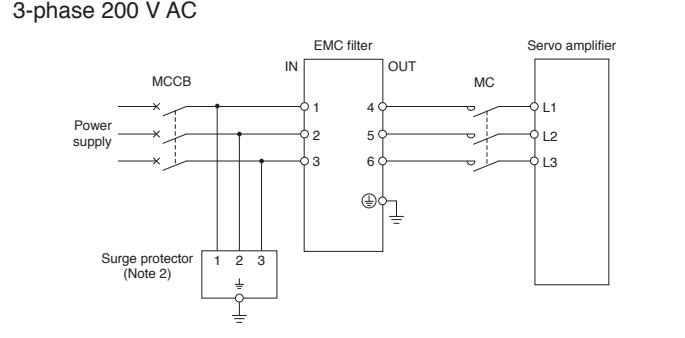

- Notes: 1. Connect the power supply to L1 and L3 terminals. Do not connect anything to L2.  
 2. This is for when a surge protector is connected.

## Dimensions [Unit: mm]

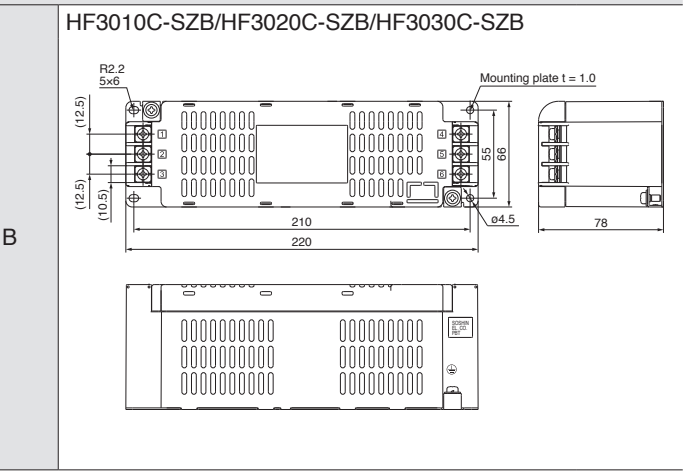
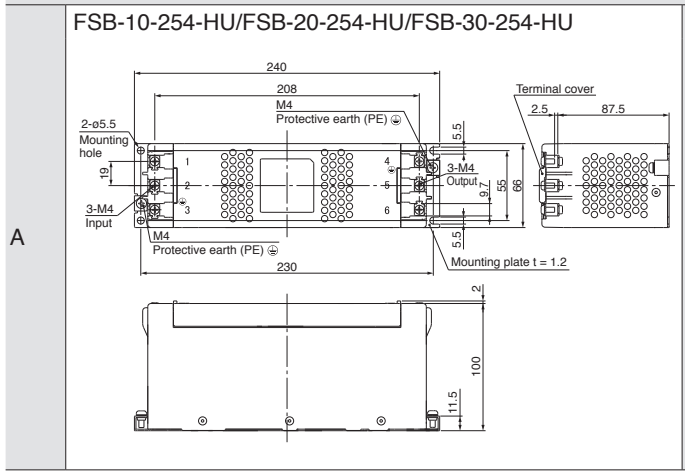

## Surge Protector

Attach surge protectors of RSPD series (manufactured by Okaya Electric Industries Co., Ltd.) or LT-CS-WS series (manufactured by Soshin Electric Co., Ltd.) to the servo amplifiers.



## Power Factor Improving AC Reactor (FR-HAL)

This boosts the power factor of servo amplifier and reduces the power supply capacity.

Servo amplifier model	Power factor improving AC reactor model <sup>(Note 1)</sup>
MR-JET-10G	FR-HAL-0.4K
MR-JET-20G	FR-HAL-0.75K
MR-JET-40G	FR-HAL-1.5K
MR-JET-70G	FR-HAL-1.5K
MR-JET-100G (3-phase power input)	FR-HAL-2.2K
MR-JET-100G (1-phase power input)	FR-HAL-3.7K
MR-JET-200G (3-phase power input)	FR-HAL-5.5K
MR-JET-200G (1-phase power input)	FR-HAL-5.5K
MR-JET-300G	FR-HAL-5.5K

Notes: 1. When using the power factor improving AC reactor, install one reactor for each servo amplifier.

### Connections

#### 3-phase 200 V AC

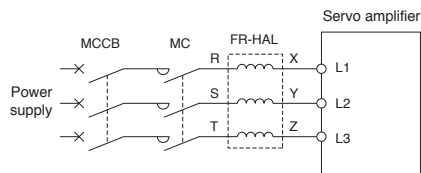

#### 1-phase 200 V AC

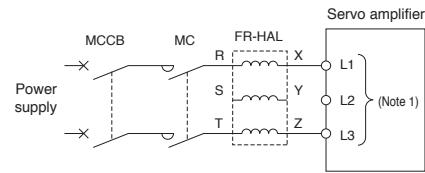

Notes: 1. Connect the power supply to L1 and L3 terminals. Do not connect anything to L2.

### Dimensions

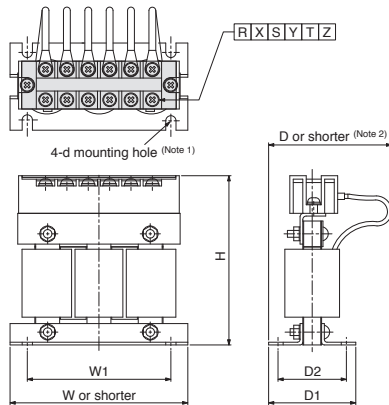

Model	Variable dimensions [mm]							Mass [kg]	Terminal screw size
	W	W1	H	D	D1	D2	d		
FR-HAL-0.4K	104±2	84	99	72	51	40	M5	0.6	M4
FR-HAL-0.75K	104±2	84	99	74	56	44	M5	0.8	M4
FR-HAL-1.5K	104±2	84	99	77	61	50	M5	1.1	M4
FR-HAL-2.2K	115 <sup>(Note 2)</sup>	40	115	77	71	57	M6	1.5	M4
FR-HAL-3.7K	115 <sup>(Note 2)</sup>	40	115	83	81	67	M6	2.2	M4
FR-HAL-5.5K	115 <sup>(Note 2)</sup>	40	115	83	81	67	M6	2.3	M4

Notes: 1. Use this mounting hole for grounding.

2. This indicates the maximum dimension. The dimension varies depending on the bending degree of the input/output lines.

## Options/Peripheral Equipment

### Servo Support Software

### Drive System Sizing Software Motorizer

#### Specifications

Item	Description
Types of motor/drive	Servo, inverter, sensorless servo
Types of load mechanism	Ball screws, rack and pinions, roll feeds, rotary tables, carts, elevators/hoists, conveyors, fans, pumps, crank, generic (rotary), generic (linear), linear servo
Types of transmission mechanism	Coupling, external gear reducer, V belt and pulley, toothed belt/roller chain
Operation pattern	Constant speed/pause, acceleration/deceleration, trapezoid, triangle, speed csv file, MELSOFT GX LogViewer file
Types of input support of moment of inertia calculation function	Solid cylinder, hollow cylinder, disk, rectangular solid, truncated cone, sphere, generic
Sizing results	Result, motor type, power supply voltage, motor, motor capacity, drive, drive capacity, effective torque, torque effective load rate, peak torque, peak load rate, effective torque at stop, effective load rate at stop, motor output, motor output rate, maximum speed, maximum speed rate, maximum load inertia moment, inertia moment ratio, regenerative power, regenerative load ratio, regenerative option, maximally increased torque, rated speed, brake, oil seal, structure specification, graph of motor side speed/motor side torque/motor output
Printing of output of results	Prints load mechanism, transmission mechanism, operation pattern, and sizing results.
Data saving	Load mechanism, transmission mechanism, operation pattern, motor selection, drive selection, and sizing results are saved with a file name.

#### Operating environment (Note 1, 2)

Item	Description
OS	Microsoft® Windows® 10 (64-bit/32-bit)
.NET Framework	.NET Framework 4.6 or later
CPU	Desktop PC: Intel® Celeron® processor 2.4 GHz or more recommended Laptop PC: Intel® Pentium® processor 1.9 GHz or more recommended
Memory	1 GB or more recommended (32-bit OS) 2 GB or more recommended (64-bit OS)
Free hard disk space	For installation: 1 GB or more free hard disk capacity For operation: 512 MB or more free virtual memory capacity
Monitor	Resolution 1024 × 768 or more (XGA) Compatible with above personal computers

Notes: 1. This software may not run correctly on some personal computers.

2. Surrogate pair characters and environment dependent characters are not available.

## Servo Support Software

MELSOFT

### MR Configurator2 (SW1DNC-MRC2-E) <sup>(Note 1)</sup>

MR Configurator2 can be obtained by either of the following:

- Purchase MR Configurator2 alone.
- Purchase GX Works3 or MT Works2: MR Configurator2 is included in GX Works3 and MT Works2 with software version 1.34L or later.

#### Specification <sup>(Note 2)</sup>

Item	Description
Project	New/Open/Save/Save As/Delete Project, Read Other Format, Write Other Format, System Setting, Print
Parameter	Parameter Setting, Network Parameter, Axis Name Setting, Parameter Converter
Safety	Safety parameter setting, Change password, Initialize password
Positioning-data	Point Table, Program, Indirect Addressing, Cam Data
Monitor	Display All, I/O Monitor, Graph, ABS Data Display, Object Monitor
Diagnosis	Alarm Display, Alarm Onset Data, Drive recorder, No Motor Rotation, System Configuration, Life Diagnosis, Machine Diagnosis, Linear Diagnosis, Fully Closed Loop Diagnosis, Gear Failure Diagnosis, Encoder Communication Diagnosis
Test Operation	JOG Operation, Positioning Operation, Motor-Less Operation, DO Forced Output, Program Operation, Single-Step Feed, Test Operation Information
Adjustment	One-Touch Tuning, Tuning, Machine Analyzer, Advanced Gain Search
Others	Servo Assistant, Update Parameter Setting Range, Machine Unit Conversion Setting, Switch Display Language, Help

Notes: 1. MELSERVO-JET series is supported by MR Configurator2 with software version 1.105K or later.  
2. Supported items vary depending on the servo amplifiers. Refer to "MR Configurator2 SW1DNC-MRC2-E Installation Guide" for details.

#### Operating environment <sup>(Note 1, 3)</sup>

Components	Description
OS	Microsoft® Windows® 11 Education Microsoft® Windows® 11 Enterprise Microsoft® Windows® 11 Pro Microsoft® Windows® 11 Home Microsoft® Windows® 10 Education Microsoft® Windows® 10 Enterprise Microsoft® Windows® 10 Pro Microsoft® Windows® 10 Home Microsoft® Windows® 10 IoT Enterprise 2016 LTSB <sup>(Note 2)</sup>
CPU (recommended)	Windows® 11: 2 or more cores on a compatible 64-bit processor or System on a Chip (SoC) Windows® 10: Desktop PC: Intel® Celeron® processor 2.8 GHz or more Laptop PC: Intel® Pentium® M processor 1.7 GHz or more
Memory (recommended)	Windows® 11: 4 GB or more (64-bit OS) Windows® 10: 1 GB or more (32-bit OS), 2 GB or more (64-bit OS)
Free hard disk space	1.5 GB or more
Monitor	Resolution 1024 × 768 or more, 16-bit high color, Compatible with above personal computers
USB cable	MR-J3USBCBL3M
Ethernet cable	Cable type: Category 5e or higher, (double shielded/STP) straight cable Standard: IEEE802.3 (1000BASE-T) or ANSI/TIA/EIA-568-B (Category 5e) Connector: RJ-45 connector with shield

Notes: 1. This software may not run correctly on some personal computers.  
2. This software is supported by 64-bit OS only.  
3. Surrogate pair characters and environment dependent characters are not available.

Common Specifications

Servo System Controllers

Servo Amplifiers

Rotary Servo Motors

Linear Servo Motors

Options/Peripheral Equipment

LV/SWires

Product List

Precautions

Support

## Options/Peripheral Equipment

### Unit Conversion Table

Quantity	SI (metric) unit	U.S. customary unit
Mass	1 [kg]	2.2046 [lb]
Length	1 [mm]	0.03937 [in]
Torque	1 [N·m]	141.6 [oz·in]
Moment of inertia	1 [( $\times 10^{-4}$ kg·m <sup>2</sup> )]	5.4675 [oz·in <sup>2</sup> ]
Load (thrust load/axial load)	1 [N]	0.2248 [lbf]
Temperature	n [°C]	$n \times 9/5 + 32$ [°F]

# 7

## Low-Voltage Switchgear/ Wires

Wires, Molded-Case Circuit Breakers, and Magnetic Contactors.....	7-2
Type E Combination Motor Controller.....	7-2
Selection Example Compliant with IEC/EN/UL 61800-5-1 and CSA C22.2 No. 274.....	7-3
Selection Example in HIV Wires for Servo Motors.....	7-4

\* Low-voltage switchgears/wires for servo amplifiers are the same regardless of the network. Refer to the servo amplifiers with the same rated output.  
\* Refer to p. 6-32 in this catalog for conversion of units.

## Low-Voltage Switchgear/Wires

### Wires, Molded-Case Circuit Breakers, and Magnetic Contactors

The following are examples of wire sizes when 600 V grade heat-resistant polyvinyl chloride insulated wires (HIV wires) are used. The wire size for U/V/W/E varies depending on the servo motor. Refer to "Selection Example in HIV Wires for Servo Motors" in this catalog for details on wires for each servo motor.

Servo amplifier model	Molded-case circuit breaker (Note 4, 5, 6)	Magnetic contactor (Note 2, 5)	Wire size [mm <sup>2</sup> ] (Note 4)		
			L1/L2/L3/⊕	P+/C	U/V/W/E
MR-JET-10G	30 A frame 5 A (30 A frame 5 A)	S-T10	2 (AWG 14)	2 (AWG 14) (Note 1)	0.75 to 2 (AWG 18 to 14) (Note 3)
MR-JET-20G	30 A frame 5 A (30 A frame 5 A)				
MR-JET-40G	30 A frame 10 A (30 A frame 5 A)				
MR-JET-70G	30 A frame 15 A (30 A frame 10 A)				
MR-JET-100G (3-phase power supply input)	30 A frame 15 A (30 A frame 10 A)				
MR-JET-100G (1-phase power supply input)	30 A frame 15 A (30 A frame 15 A)				
MR-JET-200G (3-phase power supply input)	30 A frame 20 A (30 A frame 20 A)	S-T21	3.5 (AWG 12)		1.25 to 5.5 (AWG 16 to 10) (Note 3)
MR-JET-200G (1-phase power supply input)	30 A frame 20 A (30 A frame 20 A)				
MR-JET-300G	30 A frame 30 A (30 A frame 30 A)				

- Notes:
1. Keep the wire length to the regenerative option within 5 m.
  2. Use a magnetic contactor with an operation delay time of 80 ms or less. The operation delay time is the time interval from current being applied to the coil until closure of contacts.
  3. The wire size shows applicable size for the servo amplifier connector.
  4. When complying with IEC/EN/UL/CSA standard, refer to "Selection Example Compliant with IEC/EN/UL 61800-5-1 and CSA C22.2 No. 274" in this catalog.
  5. Install one molded-case circuit breaker and one magnetic contactor for each servo amplifier.
  6. When using a power factor improving AC reactor, use a molded-case circuit breaker listed in the brackets.

### Type E Combination Motor Controller

The Type E Combination Motor Controller is comprised of the Manual Motor Starter, Short-circuit Display Unit "UT-TU", and Power Side Terminal Cover Kit "UT-CV3". (Note 3)

Servo amplifier model	Rated input voltage AC [V]	Input phase (Note 2)	Manual Motor Starter			SCCR [kA] (Note 1)
			Model (Mitsubishi Electric)	Rated voltage AC [V]	Rated current [A] (Heater design)	
MR-JET-10G	200 to 240	3-phase	MMP-T32	240	1.6	50
MR-JET-20G					2.5	
MR-JET-40G					4	
MR-JET-70G					6.3	
MR-JET-100G					8	
MR-JET-200G					18	
MR-JET-300G					25	25

- Notes:
1. The value is applicable when the Type E Combination Motor Controller is combined with the servo amplifier.
  2. 1-phase power input is not supported.
  3. Information on the UL standard is for MMP-T series products that bear the UL mark only.

**Selection Example Compliant with IEC/EN/UL 61800-5-1 and CSA C22.2 No. 274**

The molded-case circuit breakers, semiconductor fuses, and recommended wire sizes in the table are examples based on the rated inputs/outputs of the servo amplifiers.

**Molded-case circuit breakers/semiconductor fuses**

Servo amplifier model	Molded-case circuit breaker (240 V AC) SCCR 50 kA (Mitsubishi Electric)	Semiconductor fuse (700 V) SCCR 100 kA (Bussmann) <sup>(Note 1)</sup>
MR-JET-10G	NF125-SVU-15A (125 A frame 15 A)	170M1408 (10 A)
MR-JET-20G		
MR-JET-40G		
MR-JET-70G		
MR-JET-100G (3-phase power input)	NF125-SVU-15A (125 A frame 15 A)	170M1409 (16 A)
MR-JET-100G (1-phase power input)	NF125-SVU-15A (125 A frame 15 A)	170M1412 (32 A)
MR-JET-200G (3-phase power input)		
MR-JET-200G (1-phase power input)	NF125-SVU-20A (125 A frame 20 A)	170M1413 (40 A)
MR-JET-300G		

Notes: 1. When complying with UL/CSA standard, use semiconductor fuses.

**Recommended wires**

Servo amplifier model	75 °C stranded wire [AWG]		
	L1/L2/L3/⊕	P+/C	U/V/W/E
MR-JET-10G	14	14	14
MR-JET-20G			
MR-JET-40G			
MR-JET-70G			
MR-JET-100G			
MR-JET-200G (3-phase power input)	12		
MR-JET-200G (1-phase power input)			
MR-JET-300G			

Common Specifications

Servo System Controllers

Servo Amplifiers

Rotary Servo Motors

Linear Servo Motors

Options/Peripheral Equipment

LVSMWires

Product List

Precautions

Support

## Low-Voltage Switchgear/Wires

### Selection Example in HIV Wires for Servo Motors

The following are examples of wire sizes when 600 V grade heat-resistant polyvinyl chloride insulated wires (HIV wires) with a length of 30 m are used. Refer to "Rotary Servo Motor User's Manual (For MR-JET)" when using cab-tire cables for supplying power (U/V/W) to HG-SNS series.

Rotary servo motor model	Wire size [mm <sup>2</sup> ]	
	For power and grounding (U/V/W/E)	For electromagnetic brake (B1/B2)
HG-KNS13J, 23J, 43J, 73J	0.75 (AWG 18) <sup>(Note 1, 2, 3)</sup>	0.5 (AWG 20) <sup>(Note 4, 6)</sup>
HG-SNS52J, 102J	1.25 (AWG 16) <sup>(Note 5)</sup>	1.25 (AWG 16)
HG-SNS152J, 202J	2 (AWG 14)	
HG-SNS302J	3.5 (AWG 12)	

Linear servo motor model Primary side	Wire size [mm <sup>2</sup> ]	
	For power and grounding (U/V/W/E)	For thermistor (G1/G2)
LM-H3P2A-07P-BSS0	1.25 (AWG 16) <sup>(Note 5)</sup>	0.2 (AWG 24)
LM-H3P3A-12P-CSS0		
LM-H3P3B-24P-CSS0		
LM-H3P3C-36P-CSS0	2 (AWG 14)	
LM-H3P3D-48P-CSS0		
LM-H3P7A-24P-ASS0	1.25 (AWG 16) <sup>(Note 5)</sup>	
LM-H3P7B-48P-ASS0	2 (AWG 14)	
LM-H3P7C-72P-ASS0		

Linear servo motor model Primary side	Wire size [mm <sup>2</sup> ]	
	For power and grounding (U/V/W/E)	For thermal protector
LM-AJP1B-07K-JSS0	1.25 (AWG 16) <sup>(Note 5)</sup>	0.2 (AWG 24)
LM-AJP1D-14K-JSS0		
LM-AJP2B-12S-JSS0		
LM-AJP2D-23T-JSS0		
LM-AJP3B-17N-JSS0		
LM-AJP3D-35R-JSS0		
LM-AJP4B-22M-JSS0		
LM-AJP4D-45N-JSS0		
LM-AUP3A-03V-JSS0		
LM-AUP3B-06V-JSS0		
LM-AUP3C-09V-JSS0		
LM-AUP3D-11R-JSS0		
LM-AUP4A-04R-JSS0		
LM-AUP4B-09R-JSS0		
LM-AUP4C-13P-JSS0		
LM-AUP4D-18M-JSS0		
LM-AUP4F-26P-JSS0		
LM-AUP4H-35M-JSS0		

- Notes:
1. Use fluorine resin wires of 0.75 mm<sup>2</sup> (AWG 18) for wiring to the servo motor power supply.
  2. This size is applicable for wiring length of 10 m or shorter. For over 10 m, use MR-PWS2CBL03M-A\_-L and extend it with HIV wires of 1.25 mm<sup>2</sup> (AWG 16).
  3. Use a cable provided by Mitsubishi Electric or Mitsubishi Electric System & Service Co., Ltd. When fabricating a cable, select wires applicable for the usage. The National Electrical Code recommends that the wire size should be a minimum of AWG 14 (2 mm<sup>2</sup>).
  4. Use fluorine resin wires of 0.5 mm<sup>2</sup> (AWG 20) for wiring to the electromagnetic brake.
  5. The National Electrical Code recommends that the wire size should be a minimum of AWG 14 (2 mm<sup>2</sup>). Refer to the servo motor User's Manual for details.
  6. This size is applicable for wiring length of 10 m or shorter. For over 10 m, extend the wires with HIV wires of 1.25 mm<sup>2</sup> (AWG 16).



MEMO

Common Specifications

Servo System Controllers

Servo Amplifiers

Rotary Servo Motors

Linear Servo Motors

Options/Peripheral Equipment

**LVSM/Wires**

Product List

Precautions

Support

# Product List

## Servo system controllers

Item	Model	Application
Motion module	RD78G4	Maximum number of control axes: 4 axes CC-Link IE TSN master station
	RD78G8	Maximum number of control axes: 8 axes CC-Link IE TSN master station
	RD78G16	Maximum number of control axes: 16 axes CC-Link IE TSN master station
	RD78G32	Maximum number of control axes: 32 axes CC-Link IE TSN master station
	RD78G64	Maximum number of control axes: 64 axes CC-Link IE TSN master station
	RD78GHV	Maximum number of control axes: 128 axes <sup>(Note 1)</sup> CC-Link IE TSN master station
	RD78GHW	Maximum number of control axes: 256 axes <sup>(Note 1)</sup> CC-Link IE TSN master station
	FX5-40SSC-G	Maximum number of control axes: 4 axes CC-Link IE TSN master station
FX5-80SSC-G	Maximum number of control axes: 8 axes CC-Link IE TSN master station	
Motion Control Software <sup>(Note 2)</sup>	SW1DNN-SWMG-M	<ul style="list-style-type: none"> <li>• SWM-G Engine                      • SWM-G Operating Station                      • Network API</li> <li>• SWM-G API                              • Real Time OS (RTX64)</li> </ul>
USB key for Motion Control Software	MR-SWMG16-U	Maximum number of control axes: 16 axes, USB key (license)
	MR-SWMG32-U	Maximum number of control axes: 32 axes, USB key (license)
	MR-SWMG64-U	Maximum number of control axes: 64 axes, USB key (license)
	MR-SWMG128-U	Maximum number of control axes: 128 axes, USB key (license)

Notes:

1. When the controller is connected to MR-JET-G, the number of the maximum control axes is 120.
2. Download and install Motion Control Software from Mitsubishi Electric FA global website.

## Engineering software

Item	Model	Application
MELSOFT iQ Works	SW2DND-IQWK-E	FA Engineering Software
MELSOFT GX Works3	SW1DND-GXW3-E	Programmable Controller Engineering Software (including motion control setting)
MELSOFT MT Works2	SW1DND-MTW2-E	Motion Controller Engineering Software

Servo amplifiers

Item	Model	Rated output	Power supply input
MR-JET-G	MR-JET-10G	0.1 kW	3-phase or 1-phase 200 V AC to 240 V AC
	MR-JET-20G	0.2 kW	3-phase or 1-phase 200 V AC to 240 V AC
	MR-JET-40G	0.4 kW	3-phase or 1-phase 200 V AC to 240 V AC
	MR-JET-70G	0.75 kW	3-phase or 1-phase 200 V AC to 240 V AC
	MR-JET-100G	1 kW	3-phase or 1-phase 200 V AC to 240 V AC
	MR-JET-200G	2 kW	3-phase or 1-phase 200 V AC to 240 V AC
	MR-JET-300G	3 kW	3-phase 200 V AC to 240 V AC
MR-JET-G-N1	MR-JET-10G-N1	0.1 kW	3-phase or 1-phase 200 V AC to 240 V AC
	MR-JET-20G-N1	0.2 kW	3-phase or 1-phase 200 V AC to 240 V AC
	MR-JET-40G-N1	0.4 kW	3-phase or 1-phase 200 V AC to 240 V AC
	MR-JET-70G-N1	0.75 kW	3-phase or 1-phase 200 V AC to 240 V AC
	MR-JET-100G-N1	1 kW	3-phase or 1-phase 200 V AC to 240 V AC
	MR-JET-200G-N1	2 kW	3-phase or 1-phase 200 V AC to 240 V AC
	MR-JET-300G-N1	3 kW	3-phase 200 V AC to 240 V AC

Common Specifications

Servo System Controllers

Servo Amplifiers

Rotary Servo Motors

Linear Servo Motors

Options/Peripheral Equipment

LV/SWires

Product List

Precautions

Support

# Product List

## Rotary servo motors

Item	Model	Rated output	Rated speed
HG-KNS series With an oil seal B: With an electromagnetic brake	HG-KNS13(B)J	0.1 kW	3000 r/min
	HG-KNS23(B)J	0.2 kW	3000 r/min
	HG-KNS43(B)J	0.4 kW	3000 r/min
	HG-KNS73(B)J	0.75 kW	3000 r/min
HG-KNS series Without an oil seal B: With an electromagnetic brake	HG-KNS13(B)	0.1 kW	3000 r/min
	HG-KNS23(B)	0.2 kW	3000 r/min
	HG-KNS43(B)	0.4 kW	3000 r/min
	HG-KNS73(B)	0.75 kW	3000 r/min
HG-SNS series With an oil seal B: With an electromagnetic brake	HG-SNS52(B)J	0.5 kW	2000 r/min
	HG-SNS102(B)J	1.0 kW	2000 r/min
	HG-SNS152(B)J	1.5 kW	2000 r/min
	HG-SNS202(B)J	2.0 kW	2000 r/min
HG-SNS series Without an oil seal B: With an electromagnetic brake	HG-SNS302(B)J	3.0 kW	2000 r/min
	HG-SNS52(B)	0.5 kW	2000 r/min
	HG-SNS102(B)	1.0 kW	2000 r/min
	HG-SNS152(B)	1.5 kW	2000 r/min
HG-SNS series Without an oil seal B: With an electromagnetic brake	HG-SNS202(B)	2.0 kW	2000 r/min
	HG-SNS302(B)	3.0 kW	2000 r/min

Linear servo motors

Item	Model	Continuous thrust	Maximum thrust	Maximum speed	Length
LM-H3 series primary side (coil)	LM-H3P2A-07P-BSS0	70 N	175 N	3.0 m/s	—
	LM-H3P3A-12P-CSS0	120 N	300 N	3.0 m/s	—
	LM-H3P3B-24P-CSS0	240 N	600 N	3.0 m/s	—
	LM-H3P3C-36P-CSS0	360 N	900 N	3.0 m/s	—
	LM-H3P3D-48P-CSS0	480 N	1200 N	3.0 m/s	—
	LM-H3P7A-24P-ASS0	240 N	600 N	3.0 m/s	—
	LM-H3P7B-48P-ASS0	480 N	1200 N	3.0 m/s	—
	LM-H3P7C-72P-ASS0	720 N	1800 N	3.0 m/s	—
LM-H3 series secondary side (magnet)	LM-H3S20-288-BSS0	—	—	—	288 mm
	LM-H3S20-384-BSS0	—	—	—	384 mm
	LM-H3S20-480-BSS0	—	—	—	480 mm
	LM-H3S20-768-BSS0	—	—	—	768 mm
	LM-H3S30-288-CSS0	—	—	—	288 mm
	LM-H3S30-384-CSS0	—	—	—	384 mm
	LM-H3S30-480-CSS0	—	—	—	480 mm
	LM-H3S30-768-CSS0	—	—	—	768 mm
	LM-H3S70-288-ASS0	—	—	—	288 mm
	LM-H3S70-384-ASS0	—	—	—	384 mm
	LM-H3S70-480-ASS0	—	—	—	480 mm
	LM-H3S70-768-ASS0	—	—	—	768 mm
LM-AJ series primary side (coil)	LM-AJP1B-07K-JSS0	68.1 N	214.7 N	6.5 m/s	—
	LM-AJP1D-14K-JSS0	136.2 N	429.4 N	6.5 m/s	—
	LM-AJP2B-12S-JSS0	117.0 N	369.0 N	4.0 m/s	—
	LM-AJP2D-23T-JSS0	234.0 N	738.1 N	5.0 m/s	—
	LM-AJP3B-17N-JSS0	174.5 N	550.2 N	2.5 m/s	—
	LM-AJP3D-35R-JSS0	348.9 N	1100.4 N	3.5 m/s	—
	LM-AJP4B-22M-JSS0	223.4 N	704.5 N	2.0 m/s	—
	LM-AJP4D-45N-JSS0	446.8 N	1409.1 N	2.5 m/s	—
LM-AJ series secondary side (magnet)	LM-AJS10-080-JSS0	—	—	—	80 mm
	LM-AJS10-200-JSS0	—	—	—	200 mm
	LM-AJS10-400-JSS0	—	—	—	400 mm
	LM-AJS20-080-JSS0	—	—	—	80 mm
	LM-AJS20-200-JSS0	—	—	—	200 mm
	LM-AJS20-400-JSS0	—	—	—	400 mm
	LM-AJS30-080-JSS0	—	—	—	80 mm
	LM-AJS30-200-JSS0	—	—	—	200 mm
	LM-AJS30-400-JSS0	—	—	—	400 mm
	LM-AJS40-080-JSS0	—	—	—	80 mm
	LM-AJS40-200-JSS0	—	—	—	200 mm
	LM-AJS40-400-JSS0	—	—	—	400 mm
LM-AU series primary side (coil)	LM-AUP3A-03V-JSS0	28 N	122 N	4.5 m/s	—
	LM-AUP3B-06V-JSS0	57 N	274 N	4.5 m/s	—
	LM-AUP3C-09V-JSS0	85 N	411 N	4.5 m/s	—
	LM-AUP3D-11R-JSS0	113 N	549 N	3.5 m/s	—
	LM-AUP4A-04R-JSS0	44 N	280 N	3.5 m/s	—
	LM-AUP4B-09R-JSS0	88 N	561 N	3.5 m/s	—
	LM-AUP4C-13P-JSS0	132 N	842 N	3.0 m/s	—
	LM-AUP4D-18M-JSS0	176 N	970 N	2.0 m/s	—
	LM-AUP4F-26P-JSS0	264 N	1684 N	3.0 m/s	—
LM-AUP4H-35M-JSS0	350 N	1764 N	2.0 m/s	—	
LM-AU series secondary side (magnet)	LM-AUS30-120-JSS0	—	—	—	120 mm
	LM-AUS30-180-JSS0	—	—	—	180 mm
	LM-AUS30-240-JSS0	—	—	—	240 mm
	LM-AUS30-300-JSS0	—	—	—	300 mm
	LM-AUS30-600-JSS0	—	—	—	600 mm
	LM-AUS40-120-JSS0	—	—	—	120 mm
	LM-AUS40-180-JSS0	—	—	—	180 mm
	LM-AUS40-240-JSS0	—	—	—	240 mm
LM-AUS40-300-JSS0	—	—	—	300 mm	
LM-AUS40-600-JSS0	—	—	—	600 mm	

Common Specifications  
Servo System Controllers  
Servo Amplifiers  
Rotary Servo Motors  
Linear Servo Motors  
Options/Peripheral Equipment  
LV/SWires  
Product List  
Precautions  
Support

# Product List

## Encoder cables/Junction cables for HG series rotary servo motors

Item	Model	Length	Bending life	IP rating	Application
Encoder cable	MR-J3ENCBL2M-A1-H	2 m	Long bending life	IP65	HG-KNS series (direct connection type) (Load-side lead)
	MR-J3ENCBL5M-A1-H	5 m	Long bending life	IP65	
	MR-J3ENCBL10M-A1-H	10 m	Long bending life	IP65	
	MR-J3ENCBL2M-A1-L	2 m	Standard	IP65	
	MR-J3ENCBL5M-A1-L	5 m	Standard	IP65	
	MR-J3ENCBL10M-A1-L	10 m	Standard	IP65	
	MR-J3ENCBL2M-A2-H	2 m	Long bending life	IP65	HG-KNS series (direct connection type) (Opposite to load-side lead)
	MR-J3ENCBL5M-A2-H	5 m	Long bending life	IP65	
	MR-J3ENCBL10M-A2-H	10 m	Long bending life	IP65	
	MR-J3ENCBL2M-A2-L	2 m	Standard	IP65	
	MR-J3ENCBL5M-A2-L	5 m	Standard	IP65	
	MR-J3ENCBL10M-A2-L	10 m	Standard	IP65	
	MR-J3JCBL03M-A1-L <sup>(Note 1)</sup>	0.3 m	Standard	IP20	HG-KNS series (junction type) (Load-side lead)
	MR-J3JCBL03M-A2-L <sup>(Note 1)</sup>	0.3 m	Standard	IP20	HG-KNS series (junction type) (Opposite to load-side lead)
	MR-EKCBL20M-H <sup>(Note 2)</sup>	20 m	Long bending life	IP20	HG-KNS series (junction type)
	MR-EKCBL30M-H <sup>(Note 2)</sup>	30 m	Long bending life	IP20	
	MR-EKCBL40M-H <sup>(Note 2)</sup>	40 m	Long bending life	IP20	
	MR-EKCBL50M-H <sup>(Note 2)</sup>	50 m	Long bending life	IP20	
	MR-EKCBL20M-L <sup>(Note 2)</sup>	20 m	Standard	IP20	
	MR-EKCBL30M-L <sup>(Note 2)</sup>	30 m	Standard	IP20	
	MR-J3JSCBL03M-A1-L <sup>(Note 3)</sup>	0.3 m	Standard	IP65	HG-KNS series (junction type) (Load-side lead)
	MR-J3JSCBL03M-A2-L <sup>(Note 3)</sup>	0.3 m	Standard	IP65	HG-KNS series (junction type) (Opposite to load-side lead)
	MR-J3ENCSCBL2M-H <sup>(Note 4)</sup>	2 m	Long bending life	IP67	HG-KNS series (junction type) HG-SNS series (direct connection type)
	MR-J3ENCSCBL5M-H <sup>(Note 4)</sup>	5 m	Long bending life	IP67	
	MR-J3ENCSCBL10M-H <sup>(Note 4)</sup>	10 m	Long bending life	IP67	HG-KNS series (junction type) HG-SNS series (direct connection type)
	MR-J3ENCSCBL20M-H <sup>(Note 4)</sup>	20 m	Long bending life	IP67	
	MR-J3ENCSCBL30M-H <sup>(Note 4)</sup>	30 m	Long bending life	IP67	
	MR-J3ENCSCBL40M-H <sup>(Note 4)</sup>	40 m	Long bending life	IP67	
	MR-J3ENCSCBL50M-H <sup>(Note 4)</sup>	50 m	Long bending life	IP67	
	MR-J3ENCSCBL2M-L <sup>(Note 4)</sup>	2 m	Standard	IP67	
	MR-J3ENCSCBL5M-L <sup>(Note 4)</sup>	5 m	Standard	IP67	HG-KNS series (junction type) HG-SNS series (direct connection type)
	MR-J3ENCSCBL10M-L <sup>(Note 4)</sup>	10 m	Standard	IP67	
	MR-J3ENCSCBL20M-L <sup>(Note 4)</sup>	20 m	Standard	IP67	HG-KNS series (junction type) HG-SNS series (direct connection type)
MR-J3ENCSCBL30M-L <sup>(Note 4)</sup>	30 m	Standard	IP67		

Notes:

1. Use this cable in combination with MR-EKCBL\_M-H, MR-EKCBL\_M-L, or MR-ECNM.
2. Use this cable in combination with MR-J3JCBL03M-A1-L or MR-J3JCBL03M-A2-L.
3. Use this cable in combination with MR-J3ENCSCBL\_M-H, MR-J3ENCSCBL\_M-L, or MR-J3SCNS.
4. When using this cable for HG-KNS series, use it in combination with MR-J3JSCBL03M-A1-L or MR-J3JSCBL03M-A2-L.

Encoder connector sets for HG series rotary servo motors

Item	Model	Description	IP rating	Application
Encoder connector set	MR-ECNM <sup>(Note 1)</sup>	Junction connector × 1 Servo amplifier connector × 1	IP20	HG-KNS series (junction type)
	MR-J3SCNS <sup>(Note 2)</sup>	Straight type Junction connector or encoder connector × 1 Servo amplifier connector × 1	IP67	HG-KNS series (junction type) HG-SNS series (direct connection type) (one-touch connection type)
	MR-ENCNS2	Straight type Encoder connector × 1 Servo amplifier connector × 1	IP67	HG-SNS series (screw type)
	MR-J3SCNSA	Angle type Encoder connector × 1 Servo amplifier connector × 1	IP67	HG-SNS series (one-touch connection type)
	MR-ENCNS2A	Angle type Encoder connector × 1 Servo amplifier connector × 1	IP67	HG-SNS series (screw type)

Notes:

1. Use this connector set in combination with MR-J3JCBL03M-A1-L or MR-J3JCBL03M-A2-L.
2. When using this connector set for HG-KNS series, use it in combination with MR-J3JSCBL03M-A1-L or MR-J3JSCBL03M-A2-L.

Power cables for HG series rotary servo motors

Item	Model	Length	Bending life	IP rating	Application
Power cable	MR-PWS1CBL2M-A1-H	2 m	Long bending life	IP65	HG-KNS series (direct connection type) (load-side lead, lead-out)
	MR-PWS1CBL5M-A1-H	5 m	Long bending life	IP65	
	MR-PWS1CBL10M-A1-H	10 m	Long bending life	IP65	
	MR-PWS1CBL2M-A1-L	2 m	Standard	IP65	
	MR-PWS1CBL5M-A1-L	5 m	Standard	IP65	
	MR-PWS1CBL10M-A1-L	10 m	Standard	IP65	
	MR-PWS1CBL2M-A2-H	2 m	Long bending life	IP65	HG-KNS series (direct connection type) (opposite to load-side lead, lead-out)
	MR-PWS1CBL5M-A2-H	5 m	Long bending life	IP65	
	MR-PWS1CBL10M-A2-H	10 m	Long bending life	IP65	
	MR-PWS1CBL2M-A2-L	2 m	Standard	IP65	
	MR-PWS1CBL5M-A2-L	5 m	Standard	IP65	
	MR-PWS1CBL10M-A2-L	10 m	Standard	IP65	
	MR-PWS2CBL03M-A1-L	0.3 m	Standard	IP55	HG-KNS series (junction type) (load-side lead, lead-out)
	MR-PWS2CBL03M-A2-L	0.3 m	Standard	IP55	HG-KNS series (junction type) (opposite to load-side lead, lead-out)

Power connector sets for HG series rotary servo motors

Item	Model	Description	IP rating	Application
Power connector set	MR-PWCNS4	Straight type Power connector × 1	IP67	HG-SNS52J, 102J, 152J
	MR-PWCNS5	Straight type Power connector × 1	IP67	HG-SNS202J, 302J

## Product List

### Electromagnetic brake cables for HG series rotary servo motors

Item	Model	Length	Bending life	IP rating	Application
Electromagnetic brake cable	MR-BKS1CBL2M-A1-H	2 m	Long bending life	IP65	HG-KNS series (direct connection type) (load-side lead, lead-out)
	MR-BKS1CBL5M-A1-H	5 m	Long bending life	IP65	
	MR-BKS1CBL10M-A1-H	10 m	Long bending life	IP65	
	MR-BKS1CBL2M-A1-L	2 m	Standard	IP65	
	MR-BKS1CBL5M-A1-L	5 m	Standard	IP65	
	MR-BKS1CBL10M-A1-L	10 m	Standard	IP65	
	MR-BKS1CBL2M-A2-H	2 m	Long bending life	IP65	HG-KNS series (direct connection type) (opposite to load-side lead, lead-out)
	MR-BKS1CBL5M-A2-H	5 m	Long bending life	IP65	
	MR-BKS1CBL10M-A2-H	10 m	Long bending life	IP65	
	MR-BKS1CBL2M-A2-L	2 m	Standard	IP65	
	MR-BKS1CBL5M-A2-L	5 m	Standard	IP65	
	MR-BKS1CBL10M-A2-L	10 m	Standard	IP65	
	MR-BKS2CBL03M-A1-L	0.3 m	Standard	IP55	HG-KNS series (junction type) (load-side lead, lead-out)
	MR-BKS2CBL03M-A2-L	0.3 m	Standard	IP55	HG-KNS series (junction type) (opposite to load-side lead, lead-out)

### Electromagnetic brake connector sets for HG series rotary servo motors

Item	Model	Description	IP rating	Application
Electromagnetic brake connector set	MR-BKCNS1	Straight type Electromagnetic brake connector × 1	IP67	HG-SNS series (one-touch connection type)
	MR-BKCNS2	Straight type Electromagnetic brake connector × 1	IP67	HG-SNS series (screw type)
	MR-BKCNS1A	Angle type Electromagnetic brake connector × 1	IP67	HG-SNS series (one-touch connection type)
	MR-BKCNS2A	Angle type Electromagnetic brake connector × 1	IP67	HG-SNS series (screw type)

### Encoder cables/Encoder connector sets for connecting load-side encoders/linear encoders

Item	Model	Length	Bending life	IP rating	Application
Encoder cable	MR-EKCBL2M-H	2 m	Long bending life	IP20	Connecting a load-side encoder
	MR-EKCBL5M-H	5 m	Long bending life	IP20	Connecting a linear encoder
Junction cable for fully closed loop control	MR-J4FCCBL03M	0.3 m	Standard	-	Branching a load-side encoder
Encoder connector set	MR-J3THMCN2	-	-	-	Branching a load-side encoder
	MR-J3CN2	-	-	-	Connecting a load-side encoder Connecting a linear encoder
	MR-ECNM	-	-	IP20	Connecting a load-side encoder Connecting a linear encoder

### Junction terminal block cables/Connector sets

Item	Model	Length	Application
Junction terminal block cable (For PS7DW-20V14B-F)	MR-J2HBUS05M	0.5 m	Connecting MR-JET-G(-N1) and PS7DW-20V14B-F (Toho Technology Corp.)
	MR-J2HBUS1M	1 m	Connecting MR-JET-G(-N1) and PS7DW-20V14B-F (Toho Technology Corp.)
	MR-J2HBUS5M	5 m	Connecting MR-JET-G(-N1) and PS7DW-20V14B-F (Toho Technology Corp.)
Connector set	MR-CCN1	-	Connecting MR-JET-G(-N1) and PS7DW-20V14B-F (Toho Technology Corp.)



## Regenerative options

Item	Model	Specifications	Application
Regenerative option	MR-RB032	Permissible regenerative power: 30 W, resistance value: 40 Ω	MR-JET-10G(-N1) to MR-JET-40G(-N1)
	MR-RB12	Permissible regenerative power: 100 W, resistance value: 40 Ω	MR-JET-20G(-N1) and MR-JET-40G(-N1)
	MR-RB14	Permissible regenerative power: 100 W, resistance value: 26 Ω	MR-JET-70G(-N1) and MR-JET-100G(-N1)
	MR-RB30	Permissible regenerative power: 300 W, resistance value: 13 Ω	MR-JET-200G(-N1) and MR-JET-300G(-N1)
	MR-RB34	Permissible regenerative power: 300 W, resistance value: 26 Ω	MR-JET-70G(-N1) and MR-JET-100G(-N1)
	MR-RB50	Permissible regenerative power: 500 W, resistance value: 13 Ω	MR-JET-200G(-N1) and MR-JET-300G(-N1)

## Battery/Battery branch cable

Item	Model	Length	Application
Battery	MR-BAT6V1SET-B	-	MR-JET-_G(-N1)
	MR-BAT6V1	-	MR-BAT6V1SET-B
Battery branch cable	MR-BT6V4CBL03M	0.3 m	Connecting MR-JET-_G(-N1) and MR-BAT6V1SET-B

## Replacement fan unit

Item	Model	Application
Replacement fan unit	MR-JET-FAN1	MR-JET-200G(-N1) and MR-JET-300G(-N1)

## Peripheral cable

Item	Model	Length	Application
Personal computer communication cable (USB cable)	MR-J3USBCBL3M	3 m	MR-JET-G(-N1)

## Servo Support Software

Item	Model	Application
MELSOFT MR Configurator2 <sup>(Note 1)</sup>	SW1DNC-MRC2-E	Servo setup software for AC servo

Notes:

1. MR Configurator2 can be obtained by either of the following:

- Purchase MR Configurator2 alone.
- Purchase GX Works3 or MT Works2: MR Configurator2 is included in GX Works3 and MT Works2 with software version 1.34L or later.

Common Specifications

Servo System Controllers

Servo Amplifiers

Rotary Servo Motors

Linear Servo Motors

Options/Peripheral Equipment

LV/SWires

Product List

Precautions

Support

## Precautions

### For your safety

- To use the products given in this catalog safely, be sure to read the User's Manuals and the appended document prior to use.
- In this catalog, the safety instruction levels are classified into "WARNING" and "CAUTION".

#### **WARNING**

Indicates that incorrect handling may cause hazardous conditions, resulting in death or severe injury.

#### **CAUTION**

Indicates that incorrect handling may cause hazardous conditions, resulting in medium or slight injury.

Note that the CAUTION level may lead to a serious consequence depending on conditions.

Please follow the instructions of both levels because they are important to personnel safety.

### Safety instructions

#### **WARNING**

##### [Wiring]

- To prevent an electric shock, turn off the servo amplifier power and wait for 15 minutes or more before starting wiring and/or inspection.
- To prevent an electric shock, ground the servo amplifier.
- To prevent an electric shock, any person who is involved in wiring should be fully competent to do the work.
- To prevent an electric shock, mount the servo amplifier and the servo motor before wiring.
- To prevent an electric shock, connect the grounding wire to the cabinet protective earth (PE) terminal via the servo amplifier protective earth (PE) terminal.
- To prevent an electric shock, do not touch the conductive parts.
- To prevent an electric shock and burn injury, do not operate the servo amplifier and the servo motor with wet hands.

##### [Operation]

- To prevent an electric shock and burn injury, do not operate the servo amplifier and the servo motor with wet hands.

##### [Maintenance]

- To prevent an electric shock, any person who is involved in wiring should be fully competent to do the work.
- To prevent an electric shock and burn injury, do not operate the servo amplifier and the servo motor with wet hands.

#### **CAUTION**

##### [Transportation/installation]

- To prevent injury, transport the products correctly according to their mass.
- To prevent injury, do not touch the sharp edges of the servo motor, shaft keyway, or others with bare hands when handling the servo motor.
- For the linear servo motor, attraction force is generated between the permanent magnet on the secondary side and the magnetic materials. To prevent injury to fingers and other body parts due to the attraction force between the secondary side and the magnetic material side, take special care in handling the linear servo motor.

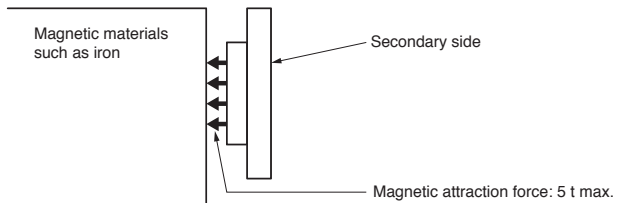

##### [Operation]

- To prevent injury, do not touch the rotor of the servo motor during operation.

##### [Disposal of linear servo motors]

- To prevent burn injury, do not touch the secondary side after the demagnetization of the secondary side by heating over 300 °C until it becomes cool enough.

**For proper use**

- To use the products given in this catalog properly, be sure to read the User's Manuals and the appended document prior to use.
- In this catalog, instructions for incorrect handling which may cause physical damage, instructions for other functions, and so on are classified into "NOTICES".

**⚠ NOTICES**

**[Model selection]**

- Select a rotary servo motor which has the rated torque equal to or higher than the continuous effective torque.
- Select a linear servo motor which has the continuous thrust equal to or higher than the continuous effective load thrust.
- When the linear servo motor is used for vertical axis, it is necessary to have an anti-drop mechanism using springs and counter balances in the machine side.
- For the system where the unbalanced torque occurs, such as a vertical axis, the unbalanced torque of the machine should be kept at 70 % or lower of the rated torque.

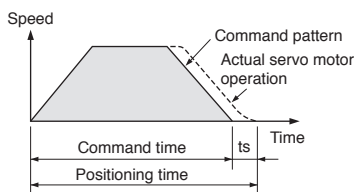

- Create operation patterns by considering the settling time (ts) to complete positioning.
- Load to motor inertia ratio or load to mass ratio must be below the recommended ratio. If the ratio is too large, the expected performance may not be achieved, and the dynamic brake may be damaged.
- Use the servo motor with the specified servo amplifier.

**[Transportation/installation]**

- To prevent a malfunction, do not drop or strike the servo amplifier and servo motor.
- When fumigants that contain halogen materials, such as fluorine, chlorine, bromine, and iodine, are used for disinfecting and protecting wooden packaging from insects, they cause a malfunction when entering our products. Please take necessary precautions to ensure that any residual materials from fumigant do not enter our products, or perform disinfection and pest control using methods other than fumigation, such as heat treatment. Perform disinfection and pest control at timbering stage before packing the products.
- Do not get on or place heavy objects on the servo amplifier or the servo motor.
- The system must withstand high speeds and high acceleration/ deceleration.
- To enable high-accuracy positioning, ensure the machine rigidity, and keep the machine resonance point at a high level.
- Install the servo amplifier and the servo motor on incombustible material. Installing them directly or close to combustibles will lead to smoke or a fire. In addition, the servo amplifier must be installed in a metal cabinet.
- The regenerative option becomes hot (the temperature rise of 100 °C or higher) with frequent use. Do not install within combustibles or objects subject to thermal deformation. Make sure that wires do not come into contact with the unit.
- Securely fix the servo motor onto the machine. If attached insecurely, the motor may come off during operation.
- Install electrical and mechanical stoppers at the stroke end.
- Mount the servo amplifier on a perpendicular wall in the correct vertical direction.
- To prevent a malfunction, do not block the intake and exhaust areas of the servo amplifier.

- When installing multiple servo amplifiers in a row in a sealed cabinet, leave space around the servo amplifiers as described in User's Manuals. To ensure the life and reliability of the servo amplifiers, prevent heat accumulation by keeping space as open as possible toward the top plate.
- Do not disassemble, repair, or modify the product.

**[Environment]**

- Use the servo amplifier and the servo motor in the designated environment.
- Avoid installing the servo amplifier and the servo motor in areas with oil mist or dust. When installing in such areas, be sure to enclose the servo amplifier in a sealed cabinet, and protect the servo motor by furnishing a cover or by taking similar measures.
- In the condition where cutting fluid or lubricating oil are constantly applied, and condensation occurs due to excessive humidity, continuous operation of the servo motor for a long period of time may result in the deterioration on the insulation of the servo motor. Provide measures such as oil proof, dust proof cover, and dew condensation prevention to protect the servo motor.
- To prevent a malfunction or a failure, do not use the servo system products under a strong electric field, magnetic field, or radiation environment.

**[Wiring]**

- The grounding must be connected to prevent faults such as a position mismatch.
- Do not supply power to the output terminals (U/V/W) of the servo amplifier or the input terminals (U/V/W) of the servo motor. Doing so damages the servo amplifier and the servo motor.
- To prevent abnormal operation and malfunction, connect the servo amplifier power outputs (U/V/W) to the servo motor power inputs (U/V/W) directly. Do not connect a magnetic contactor and others between them.
- The phases (U/V/W) of the servo amplifier power outputs and the phases (U/V/W) of the servo motor power inputs should match with each other.
- Check the wiring and sequence program thoroughly before switching the power on.
- Carefully select the cable clamping method, and make sure that bending stress and the stress of the cable's own weight are not applied on the cable connection section.
- In an application where the servo motor moves, determine the cable bending radius based on the cable bending life and wire type.
- To prevent malfunction, avoid bundling the servo amplifier's power lines (input/output) and signal cables together or running them in parallel to each other. Separate the power lines from the signal cables.

**[Initial settings]**

- Set the control mode by the controller.
- When using the regenerative option, change [Pr. PA02.0-1]. The regenerative option is disabled as default.

**[Operation]**

- Do not use a product which is damaged or has missing parts. In that case, replace the product.
- Turn on the stroke limit signals (FLS/RLS), or the stroke end signals (LSP/LSN) in position or speed control mode. The servo motor will not start if the signals are off.
- When a magnetic contactor is installed on the primary side of the servo amplifier, do not perform frequent starts and stops with the magnetic contactor. Doing so may damage the servo amplifier.
- Do not use the dynamic brake to stop in a normal operation as it is the function to stop in emergency.

Common Specifications

Servo System Controllers

Servo Amplifiers

Rotary Servo Motors

Linear Servo Motors

Options/Peripheral Equipment

LV/SM/Wires

Product List

Precautions

Support

## Precautions

- Note that the number of operation times of the dynamic brake is limited. For example, when a machine operates at the recommended load to motor inertia ratio or less and decelerates from the rated speed to a stop once in 10 minutes, the estimated number of operation times is 1000.
- If the protective functions of the servo amplifier activate, turn the power off immediately. Remove the cause before turning the power on again.
- The servo amplifier, the regenerative resistor, and the servo motor can be very hot during or after operation. Take safety measures such as covering them.

### [Maintenance]

- When an error occurs, ensure safety by turning the power off, etc., before dealing with the error. Otherwise, it may cause an accident.
- Before wiring or inspection, turn off the power, wait for 15 minutes or more until the charge light turns off.
- In a maintenance inspection, make sure that the emergency stop circuit operates properly such that an operation can be stopped immediately and a power can be shut off by the emergency stop switch.

### [Use of rotary servo motors]

- To prevent a malfunction on the encoder, do not apply shocks, e.g. hit with a hammer, when coupling the shaft end of the rotary drive motor.
- When mounting a pulley to the rotary servo motor with a keyed shaft, use the screw hole in the shaft end.
- When removing the pulley, use a pulley remover to protect the shaft from excessive load and impact.
- Do not apply a load exceeding the tolerable load onto the rotary servo motor shaft. The shaft or the rotor may break.
- When the rotary servo motor is mounted with the shaft vertical (shaft up), provide measures so that the servo motor is not exposed to oil and water entering from the machine side, gear box, etc.
- Mount the rotary servo motor in the specified direction.
- Do not use the 24 V DC interface power supply for the electromagnetic brake. To prevent malfunction, use the power supply designed exclusively for the electromagnetic brake.
- Do not apply the electromagnetic brake when the servo is on. Doing so may cause the servo amplifier overload or shorten the brake life. Apply the electromagnetic brake when the servo is off.
- Torque may drop due to temperature increase of the rotary servo motor. Be sure to use the motor within the specified ambient temperature.
- The temperature rise of the rotary servo motors varies depending on the installation environment and the operation conditions. Conduct a test run on the servo motors before an actual operation to make sure that no alarm occurs.

### [Use of linear encoders]

- When the linear encoder is incorrectly installed, an alarm or a position mismatch may occur. In this case, refer to the following checking points for the linear encoder to check the mounting condition.
- Checking points for the linear encoder
  - (a) Check that the gap between the head and scale is proper.
  - (b) Check the scale head for rolling and yawing (decrease in rigidity of scale head section).
  - (c) Check the scale surface for dust and scratches.
  - (d) Check that the vibration and temperature are within the specified range.
  - (e) Check that the speed is within the permissible range without overshooting.

### [Use of linear servo motors]

- The linear servo system uses powerful magnets on the secondary side. Magnetic force is inversely proportional to the square of the distance from the magnetic material. Therefore, the magnetic force will be significantly stronger as closer to the magnetic material. When mounting the secondary side of linear servo motor, ensure the sufficient distance from the magnetic bodies around it and securely fix those magnetic bodies.
- One who uses a medical device like a pacemaker must keep away from the product and equipment.
- Do not wear metals such as watches, pierced earrings, necklaces, etc.
- Do not put magnetic cards, watches, portable phones, etc. close to the motor.
- Place a caution sign such as "CAUTION! POWERFUL MAGNET" to give warning against the machine.
- Use non-magnetic tools, when installing or working near the linear servo motor.  
e.g., explosion-proof beryllium copper alloy safety tools (BEALON manufactured by NGK Insulators, Ltd.)
- If the linear servo motor is used in such an environment where there is magnetic powder, the powder may adhere to the permanent magnets of the secondary side and cause a damage. In that case, take measures to prevent the magnetic powder or pieces from being attracted to the permanent magnets of the secondary side or from going into the gap between primary side and secondary side.
- The linear servo motor is rated IP00. Provide protection measures to prevent dust and oil, etc., as necessary.
- Install the linear servo motor so that the thrust is applied to the center of gravity of the moving part. Failing to do so will cause a moment to occur.
- The cables such as the power cable deriving from the primary side cannot withstand the long-term bending action. Avoid the bending action by fixing the cables to the moving part or others. Also, use the cable that can withstand the long-term bending action for the wiring to the servo amplifier.
- Increase in the temperature of the linear servo motor causes a thrust drop. Be sure to use the motor within the specified ambient temperature.

### [Disposal of linear servo motors]

- Dispose the primary side as industrial waste.
- Demagnetize the secondary side with a heat of 300 °C or higher, and dispose as industrial waste.
- Do not leave the product unattended.

## Servo system controller

### Warranty

#### 1. Warranty period and coverage

We will repair any failure or defect (hereinafter referred to as "failure") in our FA equipment (hereinafter referred to as the "Product") arisen during warranty period at no charge due to causes for which we are responsible through the distributor from which you purchased the Product or our service provider. However, we will charge the actual cost of dispatching our engineer for an on-site repair work on request by customer in Japan or overseas countries. We are not responsible for any on-site readjustment and/or trial run that may be required after a defective unit is repaired or replaced.

#### [Term]

For terms of warranty, please contact your original place of purchase.

#### [Limitations]

- (1) You are requested to conduct an initial failure diagnosis by yourself, as a general rule.  
It can also be carried out by us or our service company upon your request and the actual cost will be charged.  
However, it will not be charged if we are responsible for the cause of the failure.
- (2) This limited warranty applies only when the condition, method, environment, etc. of use are in compliance with the terms and conditions and instructions that are set forth in the instruction manual and user manual for the Product and the caution label affixed to the Product.
- (3) Even during the term of warranty, the repair cost will be charged on you in the following cases;
  - (i) a failure caused by your improper storing or handling, carelessness or negligence, etc., and a failure caused by your hardware or software problem
  - (ii) a failure caused by any alteration, etc. to the Product made on your side without our approval
  - (iii) a failure which may be regarded as avoidable, if your equipment in which the Product is incorporated is equipped with a safety device required by applicable laws and has any function or structure considered to be indispensable according to a common sense in the industry
  - (iv) a failure which may be regarded as avoidable if consumable parts designated in the instruction manual, etc. are duly maintained and replaced
  - (v) any replacement of consumable parts (battery, fan, smoothing capacitor, etc.)
  - (vi) a failure caused by external factors such as inevitable accidents, including without limitation fire and abnormal fluctuation of voltage, and acts of God, including without limitation earthquake, lightning and natural disasters
  - (vii) a failure generated by an unforeseeable cause with a scientific technology that was not available at the time of the shipment of the Product from our company
  - (viii) any other failures which we are not responsible for or which you acknowledge we are not responsible for

#### 2. Term of warranty after the stop of production

- (1) We may accept the repair at charge for another seven (7) years after the production of the product is discontinued. The announcement of the stop of production for each model can be seen in our Sales and Service, etc.
- (2) Please note that the Product (including its spare parts) cannot be ordered after its stop of production.

#### 3. Service in overseas countries

Our regional FA Center in overseas countries will accept the repair work of the Product. However, the terms and conditions of the repair work may differ depending on each FA Center. Please ask your local FA Center for details.

#### 4. Exclusion of loss in opportunity and secondary loss from warranty liability

Regardless of the gratis warranty term, Mitsubishi shall not be liable for compensation to:

- (1) Damages caused by any cause found not to be the responsibility of Mitsubishi.
- (2) Loss in opportunity, lost profits incurred to the user by Failures of Mitsubishi products.
- (3) Special damages and secondary damages whether foreseeable or not, compensation for accidents, and compensation for damages to products other than Mitsubishi products.
- (4) Replacement by the user, maintenance of on-site equipment, start-up test run and other tasks.

#### 5. Change of Product specifications

Specifications listed in our catalogs, manuals or technical documents may be changed without notice.

#### 6. Application and use of the Product

- (1) For the use of our servo system controller, its applications should be those that may not result in a serious damage even if any failure or malfunction occurs in the servo system controller, and a backup or fail-safe function should operate on an external system to the servo system controller when any failure or malfunction occurs.
- (2) Our servo system controller is designed and manufactured as general purpose product for use at general industries. Therefore, applications substantially influential on the public interest for such as atomic power plants and other power plants of electric power companies, and also which require a special quality assurance system, including applications for railway companies and government or public offices are not recommended, and we assume no responsibility for any failure caused by these applications when used.  
In addition, applications which may be substantially influential to human lives or properties for such as airlines, medical treatments, railway service, incineration and fuel systems, man-operated material handling equipment, entertainment machines, safety machines, etc. are not recommended, and we assume no responsibility for any failure caused by these applications when used.  
We will review the acceptability of the abovementioned applications, if you agree not to require a specific quality for a specific application. Please contact us for consultation.
- (3) Mitsubishi Electric shall have no responsibility or liability for any problems involving programmable controller trouble and system trouble caused by DoS attacks, unauthorized access, computer viruses, and other cyberattacks.

# Precautions

## AC servo

### Warranty

#### 1. Warranty period and coverage

We will repair any failure or defect hereinafter referred to as "failure" in our FA equipment hereinafter referred to as the "Product" arisen during warranty period at no charge due to causes for which we are responsible through the distributor from which you purchased the Product or our service provider. However, we will charge the actual cost of dispatching our engineer for an on-site repair work on request by customer in Japan or overseas countries. We are not responsible for any on-site readjustment and/or trial run that may be required after a defective unit is repaired or replaced.

#### [Term]

For terms of warranty, please contact your original place of purchase.

#### [Limitations]

- (1) You are requested to conduct an initial failure diagnosis by yourself, as a general rule. It can also be carried out by us or our service company upon your request and the actual cost will be charged. However, it will not be charged if we are responsible for the cause of the failure.
- (2) This limited warranty applies only when the condition, method, environment, etc. of use are in compliance with the terms and conditions and instructions that are set forth in the instruction manual and user manual for the Product and the caution label affixed to the Product.
- (3) Even during the term of warranty, the repair cost will be charged on you in the following cases;
  - (i) a failure caused by your improper storing or handling, carelessness or negligence, etc., and a failure caused by your hardware or software problem
  - (ii) a failure caused by any alteration, etc. to the Product made on your side without our approval
  - (iii) a failure which may be regarded as avoidable, if your equipment in which the Product is incorporated is equipped with a safety device required by applicable laws and has any function or structure considered to be indispensable according to a common sense in the industry
  - (iv) a failure which may be regarded as avoidable if consumable parts designated in the instruction manual, etc. are duly maintained and replaced
  - (v) any replacement of consumable parts (battery, fan, smoothing capacitor, etc.)
  - (vi) a failure caused by external factors such as inevitable accidents, including without limitation fire and abnormal fluctuation of voltage, and acts of God, including without limitation earthquake, lightning and natural disasters
  - (vii) a failure generated by an unforeseeable cause with a scientific technology that was not available at the time of the shipment of the Product from our company
  - (viii) any other failures which we are not responsible for or which you acknowledge we are not responsible for

#### 2. Term of warranty after the stop of production

- (1) We may accept the repair at charge for another seven (7) years after the production of the product is discontinued. The announcement of the stop of production for each model can be seen in our Sales and Service, etc.
- (2) Please note that the Product (including its spare parts) cannot be ordered after its stop of production.

#### 3. Service in overseas countries

Our regional FA Center in overseas countries will accept the repair work of the Product. However, the terms and conditions of the repair work may differ depending on each FA Center. Please ask your local FA Center for details.

#### 4. Exclusion of loss in opportunity and secondary loss from warranty liability

Regardless of the gratis warranty term, Mitsubishi shall not be liable for compensation to:

- (1) Damages caused by any cause found not to be the responsibility of Mitsubishi.
- (2) Loss in opportunity, lost profits incurred to the user by Failures of Mitsubishi products.
- (3) Special damages and secondary damages whether foreseeable or not, compensation for accidents, and compensation for damages to products other than Mitsubishi products.
- (4) Replacement by the user, maintenance of on-site equipment, start-up test run and other tasks.

#### 5. Change of Product specifications

Specifications listed in our catalogs, manuals or technical documents may be changed without notice.

#### 6. Application and use of the Product

- (1) For the use of our AC Servo, its applications should be those that may not result in a serious damage even if any failure or malfunction occurs in AC Servo, and a backup or fail-safe function should operate on an external system to AC Servo when any failure or malfunction occurs.
- (2) Our AC Servo is designed and manufactured as a general purpose product for use at general industries. Therefore, applications substantially influential on the public interest for such as atomic power plants and other power plants of electric power companies, and also which require a special quality assurance system, including applications for railway companies and government or public offices are not recommended, and we assume no responsibility for any failure caused by these applications when used.

In addition, applications which may be substantially influential to human lives or properties for such as airlines, medical treatments, railway service, incineration and fuel systems, man-operated material handling equipment, entertainment machines, safety machines, etc. are not recommended, and we assume no responsibility for any failure caused by these applications when used.

We will review the acceptability of the abovementioned applications, if you agree not to require a specific quality for a specific application. Please contact us for consultation.

- (3) Mitsubishi Electric shall have no responsibility or liability for any problems involving programmable controller trouble and system trouble caused by DoS attacks, unauthorized access, computer viruses, and other cyberattacks.



# Extensive global support coverage providing expert help whenever needed

## Global FA centers

### EMEA

#### Europe FA Center

MITSUBISHI ELECTRIC EUROPE B.V. Polish Branch  
Tel: +48-12-347-65-00

#### Germany FA Center

MITSUBISHI ELECTRIC EUROPE B.V. German Branch  
Tel: +49-2102-486-0

#### UK FA Center

MITSUBISHI ELECTRIC EUROPE B.V. UK Branch  
Tel: +44-1707-27-8780

#### Czech Republic FA Center

MITSUBISHI ELECTRIC EUROPE B.V. Czech Branch  
Tel: +420-734-402-587

#### Italy FA Center

MITSUBISHI ELECTRIC EUROPE B.V. Italian Branch  
Tel: +39-039-60531

#### Turkey FA Center

MITSUBISHI ELECTRIC TURKEY Elektrik Urunleri A.S.  
Tel: +90-216-969-2500

### Asia-Pacific

#### China

##### Beijing FA Center

MITSUBISHI ELECTRIC AUTOMATION (CHINA) LTD.  
Beijing FA Center  
Tel: +86-10-6518-8830

##### Guangzhou FA Center

MITSUBISHI ELECTRIC AUTOMATION (CHINA) LTD.  
Guangzhou FA Center  
Tel: +86-20-8923-6730

##### Shanghai FA Center

MITSUBISHI ELECTRIC AUTOMATION (CHINA) LTD.  
Shanghai FA Center  
Tel: +86-21-2322-3030

##### Tianjin FA Center

MITSUBISHI ELECTRIC AUTOMATION (CHINA) LTD.  
Tianjin FA Center  
Tel: +86-22-2813-1015

#### Taiwan

##### Taipei FA Center

SETSUYO ENTERPRISE CO., LTD.  
Tel: +886-2-2299-9917

#### Korea

##### Korea FA Center

MITSUBISHI ELECTRIC AUTOMATION KOREA CO., LTD.  
Tel: +82-2-3660-9630

#### Thailand

##### Thailand FA Center

MITSUBISHI ELECTRIC FACTORY AUTOMATION (THAILAND) CO., LTD.  
Tel: +66-2682-6522 to 31

#### ASEAN

##### ASEAN FA Center

MITSUBISHI ELECTRIC ASIA PTE. LTD.  
Tel: +65-6470-2475

#### Malaysia

##### Malaysia FA Center

Malaysia FA Center  
Tel: +60-3-7626-5080

#### Indonesia

##### Indonesia FA Center

PT. MITSUBISHI ELECTRIC INDONESIA  
Cikarang Office  
Tel: +62-21-2961-7797

#### Vietnam

##### Hanoi FA Center

MITSUBISHI ELECTRIC VIETNAM COMPANY LIMITED  
Hanoi Branch Office  
Tel: +84-24-3937-8075

##### Ho Chi Minh FA Center

MITSUBISHI ELECTRIC VIETNAM COMPANY LIMITED  
Tel: +84-28-3910-5945

#### Philippines

##### Philippines FA Center

MELCO Factory Automation Philippines Inc.  
Tel: +63-(0)2-8256-8042

#### India

##### India Ahmedabad FA Center

MITSUBISHI ELECTRIC INDIA PVT. LTD.  
Ahmedabad Branch  
Tel: +91-7965120063

##### India Bangalore FA Center

MITSUBISHI ELECTRIC INDIA PVT. LTD.  
Bangalore Branch  
Tel: +91-80-4020-1600

##### India Chennai FA Center

MITSUBISHI ELECTRIC INDIA PVT. LTD.  
Chennai Branch  
Tel: +91-4445548772

##### India Coimbatore FA Center

MITSUBISHI ELECTRIC INDIA PVT. LTD.  
Coimbatore Branch  
Tel: +91-422-438-5606

##### India Gurgaon FA Center

MITSUBISHI ELECTRIC INDIA PVT. LTD.  
Gurgaon Head Office  
Tel: +91-124-463-0300

##### India Pune FA Center

MITSUBISHI ELECTRIC INDIA PVT. LTD.  
Pune Branch  
Tel: +91-20-2710-2000

### Americas

#### USA

##### North America FA Center

MITSUBISHI ELECTRIC AUTOMATION, INC.  
Tel: +1-847-478-2100

#### Mexico

##### Mexico City FA Center

MITSUBISHI ELECTRIC AUTOMATION, INC.  
Mexico Branch  
Tel: +52-55-3067-7500

##### Mexico FA Center

MITSUBISHI ELECTRIC AUTOMATION, INC.  
Queretaro Office  
Tel: +52-442-153-6014

##### Mexico Monterrey FA Center

MITSUBISHI ELECTRIC AUTOMATION, INC.  
Monterrey Office  
Tel: +52-55-3067-7599

#### Brazil

##### Brazil FA Center

MITSUBISHI ELECTRIC DO BRASIL COMERCIO E SERVICOS LTDA.  
Tel: +55-11-4689-3000

## List of Instruction Manuals

Relevant manuals are listed below:

### Servo System Controller

Manual name	Manual No.
MELSEC iQ-R Motion Module User's Manual (Application for Simple Motion Mode)	IB-0300572ENG
MELSEC iQ-R Motion Module (Simple Motion Mode) Function Block Reference	BCN-B62005-1040ENG
MELSEC iQ-R Motion Module User's Manual (Advanced Synchronous Control for Simple Motion Mode)	IB-0300575ENG
MELSEC iQ-R Motion Module User's Manual (Startup)	IB-0300406ENG
MELSEC iQ-R Motion Module User's Manual (Application)	IB-0300411ENG
MELSEC iQ-R Motion Module User's Manual (Network)	IB-0300426ENG
MELSEC iQ-R Programming Manual (Motion Module Instructions, Standard Functions/Function Blocks)	IB-0300431ENG
MELSEC iQ-R Programming Manual (Motion Control Function Blocks)	IB-0300533ENG
MELSEC iQ-F FX5 Motion Module/Simple Motion Module User's Manual (Startup)	IB-0300251ENG
MELSEC iQ-F FX5 Motion Module/Simple Motion Module User's Manual (Application)	IB-0300253ENG
MELSEC iQ-F FX5 Motion Module/Simple Motion Module User's Manual (Advanced Synchronous Control)	IB-0300255ENG
MELSEC iQ-F FX5 Motion Module User's Manual (CC-Link IE TSN)	IB-0300568ENG
MELSEC iQ-F FX5 Motion Module/Simple Motion Module Function Block Reference	BCN-B62005-719
Motion Control Software SWM-G User's Manual (Startup)	IB-0300562ENG
Motion Control Software SWM-G Operating Manual	IB-0300563ENG



**Servo Amplifier**

Manual name	Manual No.
MR-JET User's Manual (Hardware)	IB-0300453ENG
MR-JET User's Manual (Function)	IB-0300458ENG
MR-JET User's Manual (Adjustment)	IB-0300473ENG
MR-JET User's Manual (Troubleshooting)	IB-0300483ENG
MR-JET-G User's Manual (Introduction)	IB-0300448ENG
MR-JET-G User's Manual (Communication Function)	IB-0300463ENG
MR-JET-G User's Manual (Object Dictionary)	IB-0300468ENG
MR-JET-G User's Manual (Parameters)	IB-0300478ENG
MR-JET-G-N1 User's Manual (Introduction)	IB-0300495ENG
MR-JET-G-N1 User's Manual (Communication Function)	IB-0300500ENG
MR-JET-G-N1 User's Manual (Object Dictionary)	IB-0300505ENG

**Servo Motor**

Manual name	Manual No.
Rotary Servo Motor User's Manual (For MR-JET)	IB-0300488ENG
Linear Servo Motor User's Manual (LM-H3/LM-U2/LM-F/LM-K2)	SH-030316ENG
Linear Servo Motor User's Manual (LM-AJ/LM-AU)	IB-0300518ENG

**Others**

Manual name	Manual No.
EMC Installation Guidelines	IB-67310
MR-JET Partner's Encoder User's Manual	IB-0300523ENG

Android and Google Play are trademarks of Google LLC.  
Apple, iPad, iPad Air, iPad mini, and App Store are trademarks of Apple Inc., registered in the U.S. and other countries.  
Microsoft, Windows, Visual C++, Visual Studio, and IntelliSense are either registered trademarks or trademarks of Microsoft Corporation in the United States and/or other countries.  
Celeron and Pentium are either registered trademarks or trademarks of Intel Corporation in the United States and/or other countries.  
PLCopen and related logos are registered trademarks of PLCopen.  
EtherCAT is a registered trademark and patented technology, licensed by Beckhoff Automation GmbH, Germany.  
All other company names and product names used in this document are trademarks or registered trademarks of their respective companies.

## Precautions before use

This publication explains the typical features and functions of the products herein and does not provide restrictions or other information related to usage and module combinations. Before using the products, always read the product user manuals. Mitsubishi Electric will not be held liable for damage caused by factors found not to be the cause of Mitsubishi Electric; opportunity loss or lost profits caused by faults in Mitsubishi Electric products; damage, secondary damage, or accident compensation, whether foreseeable or not, caused by special factors; damage to products other than Mitsubishi Electric products; or any other duties.

## For safe use

- To use the products given in this publication properly, always read the relevant manuals before beginning operation.
- The products have been manufactured as general-purpose parts for general industries, and are not designed or manufactured to be incorporated in a device or system used in purposes related to human life.
- Before using the products for special purposes such as nuclear power, electric power, aerospace, medicine or passenger-carrying vehicles, consult with Mitsubishi Electric.
- The products have been manufactured under strict quality control. However, when installing the products where major accidents or losses could occur if the products fail, install appropriate backup or fail-safe functions in the system.

# YOUR SOLUTION PARTNER

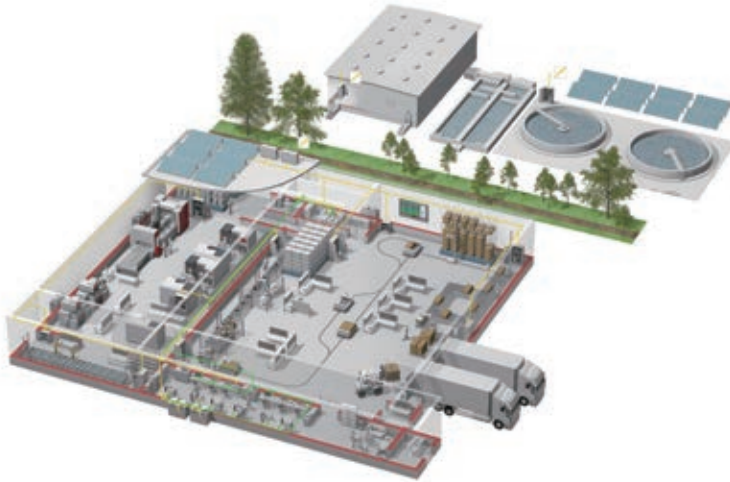

Mitsubishi Electric offers a wide range of automation equipment from PLCs and HMIs to CNC and EDM machines.

## A NAME TO TRUST

Since its beginnings in 1870, some 45 companies use the Mitsubishi name, covering a spectrum of finance, commerce and industry.

The Mitsubishi brand name is recognized around the world as a symbol of premium quality.

Mitsubishi Electric Corporation, established in 1921, is active in space development, transportation, semi-conductors, energy systems, communications and information processing, audio visual equipment and home electronics, building and energy management and automation systems, and has 183 factories, laboratories and offices worldwide in over 140 countries.

This is why you can rely on Mitsubishi Electric automation solution - because we know first hand about the need for reliable, efficient, easy-to-use automation and control in our own factories.

As one of the world's leading companies with a global turnover of over 4 trillion Yen (over \$40 billion), employing over 146,000 people, Mitsubishi Electric has the resource and the commitment to deliver the ultimate in service and support as well as the best products.



Low-voltage Power Distribution Products



Transformers, Med-voltage Distribution Products



Power Monitoring and Energy Saving Products



Power (UPS) and Environmental Products



Compact and Modular Controllers



Servos, Motors and Inverters



Visualization: HMIs



Edge Computing Products



Numerical Control (NC)



Collaborative and Industrial Robots



Processing machines: EDM, Lasers

\* Not all products are available in all countries.

# Mitsubishi Electric AC Servo System MELSERVO-JET

Country/Region	Sales office	
USA	Mitsubishi Electric Automation, Inc. 500 Corporate Woods Parkway, Vernon Hills, IL 60061, U.S.A.	Tel : +1-847-478-2100
Mexico	Mitsubishi Electric Automation, Inc. Mexico Branch Boulevard Miguel de Cervantes Saavedra 301, Torre Norte Piso 5, Int. 502, Ampliacion Granada, Miguel Hidalgo, Ciudad de Mexico, Mexico, C.P.11520	Tel : +52-55-3067-7500
Brazil	Mitsubishi Electric do Brasil Comercio e Servicos Ltda. Avenida Adelino Cardana, 293, 21 andar, Bethaville, Barueri SP, Brazil	Tel : +55-11-4689-3000
Germany	Mitsubishi Electric Europe B.V. German Branch Mitsubishi-Electric-Platz 1, 40882 Ratingen, Germany	Tel : +49-2102-486-0
UK	Mitsubishi Electric Europe B.V. UK Branch Travellers Lane, UK-Hatfield, Hertfordshire, AL10 8XB, U.K.	Tel : +44-1707-28-8780
Italy	Mitsubishi Electric Europe B.V. Italian Branch Campus, Energy Park Via Energy Park 14, Vimercate 20871 (MB) Italy	Tel : +39-039-60531
Spain	Mitsubishi Electric Europe B.V. Spanish Branch Carretera de Rubi, 76-80-Appdo. 420, E-08174 Sant Cugat del Valles (Barcelona), Spain	Tel : +34-935-65-3131
France	Mitsubishi Electric Europe B.V. French Branch 2, rue de l'Union-92565 Rueil-Malmaison Cedex-France	Tel : +33-1-55-68-55-68
Czech Republic	Mitsubishi Electric Europe B.V. Czech Branch, Prague Office Pekarska 621/7, 155 00 Praha 5, Czech Republic	Tel : +420-734-402-587
Poland	Mitsubishi Electric Europe B.V. Polish Branch ul. Krakowska 48, 32-083 Balice, Poland	Tel : +48-12-347-65-00
Russia	Mitsubishi Electric (Russia) LLC St. Petersburg Branch Startovaya street, 8, BC "Aeroplaza", office 607; 196210, St. Petersburg, Russia	Tel : +7-812-449-51-34
Sweden	Mitsubishi Electric Europe B.V. (Scandinavia) Hedvig Mollersgata 6, 223 55 Lund, Sweden	Tel : +46-8-625-10-00
Turkey	Mitsubishi Electric Turkey Elektrik Urunleri A.S. Serifali Mah. Kale Sok. No:41 Umraniye / Istanbul, Turkey	Tel : +90-216-969-2500
UAE	Mitsubishi Electric Europe B.V. Dubai Branch Dubai Silicon Oasis, P.O.BOX 341241, Dubai, U.A.E.	Tel : +971-4-3724716
South Africa	Adroit Technologies 20 Waterford Office Park, 189 Witkoppen Road, Fourways, South Africa	Tel : +27-11-658-8100
China	Mitsubishi Electric Automation (China) Ltd. Mitsubishi Electric Automation Center, No.1386 Hongqiao Road, Shanghai, China	Tel : +86-21-2322-3030
Taiwan	SETSUYO ENTERPRISE CO., LTD. 5F, No.105, Wugong 3rd Road, Wugu District, New Taipei City 24889, Taiwan	Tel : +886-2-2299-2499
Korea	Mitsubishi Electric Automation Korea Co., Ltd. 7F to 9F, Gangseo Hangang Xi-tower A, 401, Yangcheon-ro, Gangseo-Gu, Seoul, Korea	Tel : +82-2-6103-9474
Singapore	Mitsubishi Electric Asia Pte. Ltd. 307 Alexandra Road, Mitsubishi Electric Building, Singapore 159943	Tel : +65-6473-2486
Thailand	Mitsubishi Electric Factory Automation (Thailand) Co., Ltd. 101, True Digital Park Office, 5th Floor, Sukhumvit Road, Bang Chak, Prakanong, Bangkok, Thailand	Tel : +66-2092-8600
Indonesia	PT. Mitsubishi Electric Indonesia Gedung Jaya 8th Floor, JL. MH. Thamrin No.12, Jakarta Pusat 10340, Indonesia	Tel : +62-21-3192-6461
Vietnam	Mitsubishi Electric Vietnam Company Limited 11th & 12th Floor, Viettel Tower B, 285 Cach Mang Thang Tam Street, Ward 12, District 10, Ho Chi Minh City, Vietnam.	Tel : +84-28-3910-5945
India	Mitsubishi Electric India Pvt. Ltd. Pune Branch ICC-Devi Gaurav Technology Park, Unit no. 402, Fourth Floor, Survey no. 191-192 (P), Opp. Vallabh Nagar Bus Depot, Pune - 411018, Maharashtra, India	Tel : +91-20-4624-2100
Australia	Mitsubishi Electric Australia Pty. Ltd. 348 Victoria Road, P.O. Box 11, Rydalmere, N.S.W 2116, Australia	Tel : +61-2-9684-7777

## MITSUBISHI ELECTRIC CORPORATION

HEAD OFFICE: TOKYO BLDG., 2-7-3, MARUNOUCHI, CHIYODA-KU, TOKYO 100-8310, JAPAN  
NAGOYA WORKS: 1-14, YADA-MINAMI 5-CHOME, HIGASHI-KU, NAGOYA 461-8670, JAPAN